

the TAPE *price 2/-* RECORDER

AUGUST 1963
VOL. 5 NO. 7

INCORPORATING "SOUND AND CINE"



A RIBBON MIKE TO BUILD



SEE
ALL
MAKES

Hear all makes. At the Tape Recorder Centre showroom you can see, hear and compare them *all*, on the spot. The country's leading specialists in tape recording are there to give you unbiased help in choosing from the country's largest stocks of equipment. At The Tape Recorder Centre there is the model best suited to your needs (and your pocket). And everything else for tape recording, office dictation and hi-fi, plus excellent HP terms. See all makes, hear all makes, at

THE
T C R **TAPE**
RECORDER
CENTRE

Philips
Elizabethan
Grundig
Ferrograph
Stella
Vortexion
Brenell
Ampex
Tandberg
etc

82 High Holborn, London, W.C.1. Tel: CHAncery 7401



SEE **ALL** MAKES

Hear all makes. At the Tape Recorder Centre showroom you can see, hear and compare them *all*, on the spot. The country's leading specialists in tape recording are there to give you unbiased help in choosing from the country's largest stocks of equipment. At The Tape Recorder Centre there is the model best suited to your needs (and your pocket). And everything else for tape recording, office dictation and hi-fi, plus excellent HP terms. See all makes, hear all makes, at

THE
TAPE
RECORDER
CENTRE



Philips
Elizabethan
Grundig
Ferrograph
Stella
Vortexion
Brenell
Ampex
Tandberg
etc

82 High Holborn, London, W.C.1. Tel: CHAncery 7401

lovely water music from ancient Bath

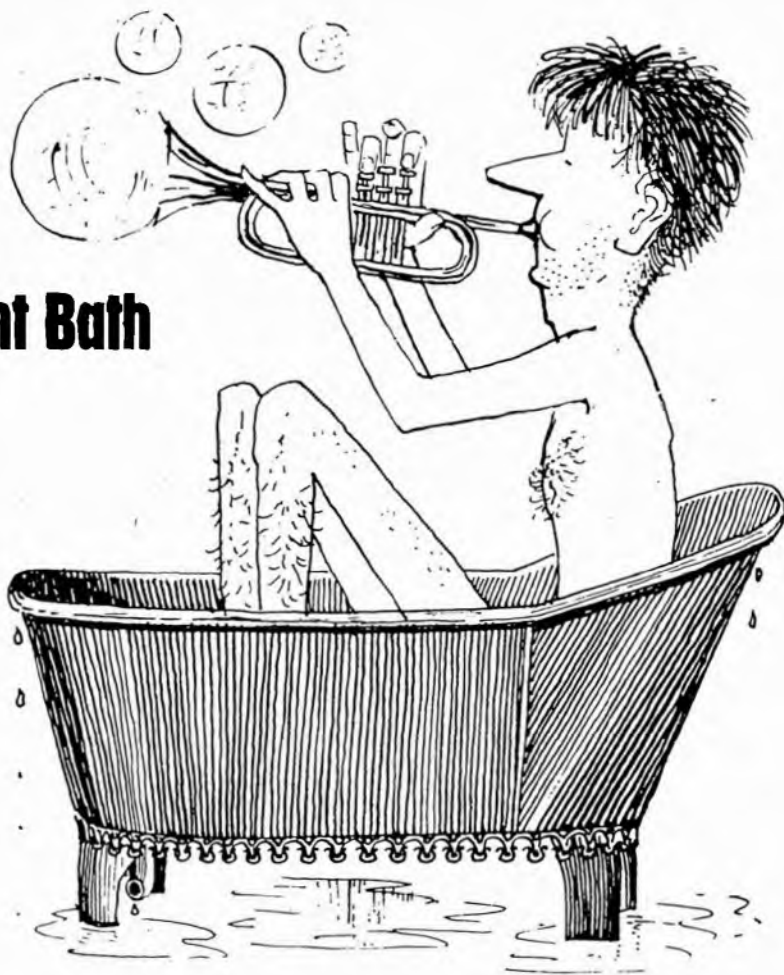

Abandoned lute in Spanish hideaway. Complicated passages in modern Works. The whole world of sound faithfully recorded on Mastertape magnetic recording tape. For both $\frac{1}{2}$ track and $\frac{1}{4}$ track recordings there is nothing better. Don't spoil them for a ha'porth of tape. For free literature and your nearest stockist write to M. S. S. Recording Company Limited, Colnbrook, Bucks. Telephone Colnbrook 2431.



Mastertape

MAGNETIC RECORDING TAPE

British Mastertape
Makes Sound Sense



Send for free full colour brochure of tape prices and tape recording accessories
MSS RECORDING COMPANY LTD, COLNBROOK, BUCKS. Tel: Colnbrook 2431

A MEMBER OF THE BICC GROUP OF COMPANIES

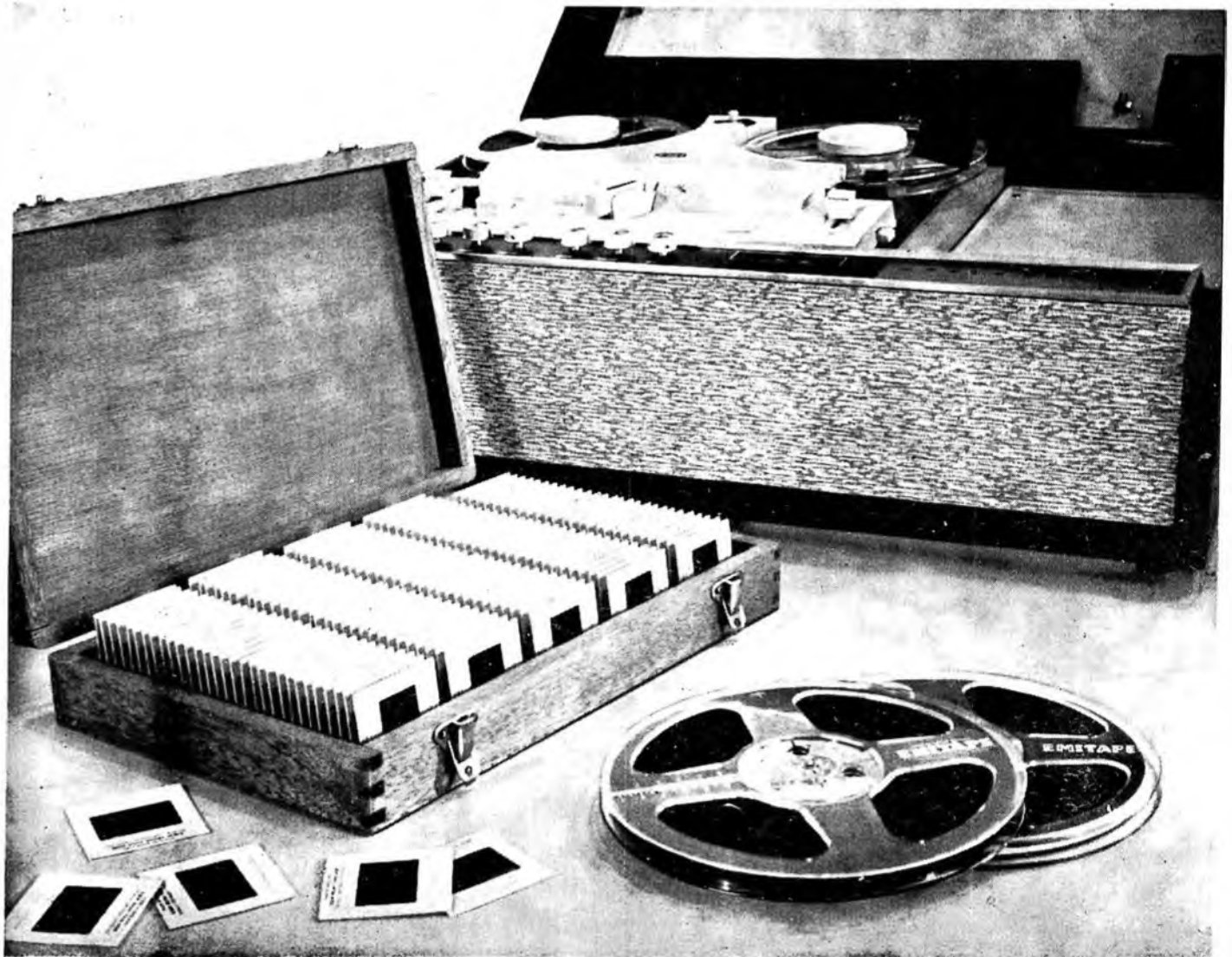

How to make slides speak for themselves with Emitape

A colour slide show is twice the fun when it's planned around a soundtrack on Emitape. Get a new reel now. Then team up your recorder and camera, and start collecting sounds as well as pictures.

You can snap the voice with the face, and capture the *sound* of a scene. Afterwards you have fun editing the tape, matching effects against slides, adding music, and recording a commentary. The show will be the

smoothest you have put on, because it has been planned and prepared beforehand, slide by slide. Emitape never hesitates or forgets a name!

NOT SURE HOW TO START? Then write in for No. 3 in the new series of Emitape leaftapes: *Adding Sound to Slides with Emitape*. It has been written specially for Emitape by John Borwick, and it's completely free. Also available: *Two and Four-track recording with Emitape*.

Get another reel of **Emitape**

Please send me your free leaflets *Adding Sound to Slides with Emitape* and *Two and Four-track recording with Emitape*.

NAME

ADDRESS



TR2

E.M.I. TAPE LIMITED, HAYES, MIDDLESEX

the TAPE RECORDER

Editor - - - - - MILES HENSLOW
 News Editor - - - - - Alan Lovell
 Advertisement Editor - - - - - Julian Berrisford
 Editorial Offices - - - - - 99 Mortimer Street, London, W.1
 Telephone - - - - - MUSEum 3967 to 3969



MEMBER OF THE
 AUDIT BUREAU
 OF CIRCULATIONS

EDITORIAL

BEFORE we deal with the main subject this month—one which we have raised in similar terms, though in different vein, in *Hi-Fi News*—we wish to apologise to many of our readers for the truly shocking quality of production of the July number of *Tape Recorder*. Explanations would be tedious and not helpful. Suffice it to say that, owing to a combination of almost unbelievable circumstances, we were at pistol point, with the clock behind us when we had to decide whether to go ahead with production; and, probably wrongly, we decided it better to produce something far below standard, in order to get copies of the magazine away, rather than to fall somewhere between one and two weeks behind our dateline. This meant, of course, that many hundreds of our readers received a travesty of what they have come to expect of the *Tape Recorder*. Since there is nothing effective that we can do to put things right—in terms of good copies—we have been thinking overtime for ways and means for making good our lapse—in terms of value for money—to those who feel that we have let them down; and there must be many. We have received shoals of letters, from the really angry to the humorously sarcastic. To every one who suffered we do offer our most abject apologies. To support this apology we invite any reader who feels that he has received bad value for money to write to us, enclosing the *Tape Recorder* "Binders" advertisement on page 257. In return, we will post him a 2s. voucher, valid for one year, which he can set against the cost of any of our publications (other than *Tape Recorder* or *Hi-Fi News*) that he may wish to purchase from us.

Over the years, as many of our readers will know, we have repeatedly expressed the opinion that the annual Audio Show could be a much bigger and far more comprehensive event. Time slides past at an alarming rate, and we are already approaching the planning time for the Audio Show for 1964. One of our past suggestions was that there should be an extension of the show—possibly into an adjoining building—so that tape could be properly represented, with studios, recording sessions and what-have-you. A major objection to this idea was that very many exhibitors featured both tape and high fidelity equipment, and that they naturally could not tear themselves into two parts, dissipating their energies, to say nothing of their expenses. Nevertheless, if "tape", "audio", "hi-fi" or a combination of them all—is to benefit, it is surely time to consider an exhibition on a far more ambitious scale than hitherto, and most certainly of a far less "closed shop" nature. We suggest that future exhibitions should be staged at, for example, London's Olympia. There, or in some other large hall, *everyone* interested could pay to enter. What is needed is new life and new ideas. The distributors should be able to exhibit, as they can at other shows. Attractions of interest to visitors should be staged. The "Trade" would welcome a few thousand new faces each year, in addition to the stalwarts who come, year after year, to the present annual club outing. The more that come, the better the

AUGUST - - - - - 1963

VOL. 5 - - - - - No. 7

CONTENTS

	Page
News from the World of Tape	267
Tape Recorder Service	
No. 20. Körting Recorders	
By H. W. Hellyer	268
Readers' Problems	271
Recording in Morocco	
By Bob Danvers-Walker	272
Tape Recorder Workbench. No. 49	
By A. Bartlett Still	275
The Language Laboratory	
By C. Malone	277
Build this Ribbon Microphone	
Part 2. Assembly and Testing	
By M. H. O. Hodkinson	278
Wow and Flutter	
By R. J. Crome	281
Sound and Cine	
By Richard Golding	283
Details of New Products	287
Equipment Reviewed	289
Classified Advertisements	292
Advertisers' Index	294

chance for the industry to expand—and it does not need us to outline the benefits that would follow for everyone, from manufacturers to customers.

We have never understood the present basis of "admission by ticket, obtainable from so-and-so", though there must presumably be a good reason for it. It can only restrict attendance, and it certainly limits this attendance to those people who already know what the show is all about. After all, surely the main object of an exhibition (if it is meant to be a commercial success) is to attract as many potential customers as possible, not to keep them out. Certainly there would be few visitors who would resent the two or three bob that would give them a really lively show to see; and this entry fee would mean a comparably lower burden for the exhibitors, or more exhibition days to offset the immense labour that they have to put in anyway. We want to see things grow, not stagnate. Other exhibitions which have started in a small way have become national events of real importance. The annual "Audio Show", under different titles, has now been with us for eight years. We think it about time for it to start to grow, too, cosy though it may be for the few as it is; and we think that our manufacturer and dealer friends who share our views should take action to do something about it. What do you think?

COVER PICTURE

THE interesting BBC photograph which we publish on our front cover this month is of the Blattner-Stille recorder reproducer which the Corporation used at its Maida Vale studio nearly thirty years ago—to be accurate, it was photographed there in May 1935. When we compare this machine with our small modern portables we certainly find something to think about. The giant drums held about one and three-quarters of a mile of steel tape, and provided some thirty minutes of playing time. The record/replay speed was sixty inches per second! Just about as tricky as a hand saw for careless fingers, we imagine. It is, as it almost looks, the grand-daddy of recorders.

SUBSCRIPTION RATES

The subscription rate to *The Tape Recorder* is 27/6 per annum (U.S.A. \$4.00) from The Tape Recorder, 99 Mortimer Street, London, W.1. Subscription + Index, 30/- (U.S.A. \$4.25). The same rates apply to *Hi-Fi News*.

Anyone who
can read
plain English



can build any
of our models
—and save money

TO ALL MUSIC LOVERS AND HI-FI ENTHUSIASTS

No electronic or soldering experience is necessary to build any Heathkit model: our simple, well illustrated manual guides you step by step. A FREE CATALOGUE of the full range, and detailed specifications of any item, will be gladly sent without obligation on your part, on request.



TA-IS

TAPE AMPLIFIER UNITS

Models TA-IM and TA-IS
The monophonic version (TA-IM) can be modified to the stereo version (TA-IS) by modification kit (TA-IC). Special features include the provision of a bias level control easy-to-read thermometer-type recording level indicators; large printed circuit boards. Both models have identical presentation. TA-IM £19.2.6 TA-IS £24.10.0 TA-IC £6.15.0



TRUVOX D83 2 AND D83 4

Tape Decks. High-quality stereo tape decks. D83 2, 2-track for highest fidelity £31.10.0 With TA-IM £47.2.6 With TA-IS £52.6.0 D83 4, 4-track, for most economical use of tape (same presentation). £29.8.0 With TA-IM £45.5.0 With TA-IS £50.9.6

NEW! MONO CONTROL UNIT. Model UMC-1. Designed to operate with our model MA-12 or any amplifier requiring 0.25V or less for full output. Suitable for cabinet mounting or free standing. Size 10" x 7" x 4". Available shortly. £8.12.6



UMC-1

"COTSWOLD" MFS SPEAKER SYSTEM

A minimum floor space model. Size 36in. high x 16½in. wide x 14½in. deep with performance similar to the standard model. Specially designed for small rooms.



MFS

"COTSWOLD" SPEAKER SYSTEM

This is an acoustically designed enclosure 26in. x 23in. x 14in. housing a 12in. bass speaker with 2in. speech coil, elliptical middle speaker, and a pressure unit to cover the full frequency range of 30-20,000 c.s. Capable of doing justice to the finest programme source. Delivered complete with speakers, cross-over unit, level control, Tygan grille cloth, etc. Either Model £23.4.0



NEW! "OXFORD" TRANSISTOR RADIO Model UXR-2. Luxury solid leather case, full long and medium wave coverage. Printed circuit facilitates assembly. 7" x 4" high-flux speaker. Send for full details. £14.18.0 incl. P.T.

POWER AMPLIFIER 12-WATT Model MA-12. 0.1" THD at 10W. Wide frequency range. Ideal for use with USC-1 and UMC-1. £11.9.6

COLLARO 'STUDIO' TAPE DECK. Operating speeds: 1½ in., 3½ in. and 7½ in. p.s. Wow and flutter not greater than 0.15% at 7½ in. p.s. £17.10.0



With TA-IM £30.10.0

OVER 50 MODELS TO CHOOSE FROM—EVEN A NOVICE CAN BUILD ANY KIT-SET

STEREO CONTROL UNIT Model USC-1

Push-button selection, accurately matched ganged controls to 1dB. Negative feedback, rumble and variable low-pass filters. Printed circuit boards. Accepts inputs from most tape heads and any stereo or mono pick-up. £19.10.0

GARRARD AUTO RECORD PLAYER Model AT-6. 4-speed stereo and mono unit, manual or automatic record selection. Ronette 105 cartridge £13.12.1 With Decca Deram cartridge £14.6.1

GOLDRING-LENCO TRANSCRIPTION RECORD PLAYER Model G.L.58. Fitted with the G.60 pick-up arm it has infinitely variable speed adjustment between 33½ and 80 r.p.m. and four fixed speeds. 3½ lb. turntable to reduce rumble "wow" and "flutter". With Ronette 105. £18.19.2

HI-FI FM TUNER, Model FM-4U
For your convenience, this model is available in two units sold separately: Tuning Unit (FMT-4U—£2.15.0 including P.T.) with 10.7 Mc s.i.f. output, and Amplifier Unit (FMA-4U—£12.6.0). Built-in power supply; 7 valves. Total £15.1.0



MALVERN

HI-FI EQUIPMENT CABINETS
A range of over a dozen equipment cabinets is now available to meet the differing needs of enthusiasts. Designed for maximum operating convenience or for where room space is an over-riding consideration, this range includes kits, ready assembled cabinets or assembled and fully finished cabinets, and has at least one model to meet your requirements. Why not send for full details? Prices from £6.19.6—£29.8.0

HI-FI MONO AMPLIFIER. Model MA-5. A general purpose 5 w. amplifier with inputs for Gram., Radio. Presentation similar to S-33. £10.19.6

AM FM TUNER. Model AFM-1.

This model is available in two units sold separately. Tuning heart (AFM-T1 £4.13.6 incl. P.T.) IF Amplifier (AFM-A1 £20.13.0) range 88-108 Mc s (FM) 16-50, 200-550, 900-2000 (AM). Printed circuit board. Total price £25.6.6



HI-FI STEREO 6-WATT AMPLIFIER Model S-33. Attractively styled. Printed circuit construction. 0.3% distortion at 2½ W chal. 20 dB N.F.B.; sensitivity 200 mV. U.L. output, ganged controls. £13.7.6

DE LUXE STEREO AMPLIFIER Model S-33 H. De luxe version of S-33 with many refinements. Ideal for use with Decca Deram pick-up. £15.17.6

WE GUARANTEE PERFORMANCE TO OUR PUBLISHED SPECIFICATIONS



AUDIO SIGNAL GENERATOR Model AG-9U. Delivers up to 10 volts pure sine-wave (less than 0.1% distortion, 20 c.s to 20 kc s). Decade switch-selected frequencies from 10 to 100,000 c.s. Internal 600 Ohm N.I. load, or external. £21.9.6

AUDIO SINE SQUARE WAVE GENERATOR AO-IU. Covers 20 c.s—150 kc.s in four ranges. Choice of sine or square waves, the latter up to 50 kc.s. £13.15.0

SUGDEN MOTOR UNIT "CONNOISSEUR CRAFTSMEN". Heavy duty motor operating at 33½ and 45 r.p.m. Very heavy 12 in. turn-table. Virtually no rumble. £16.6.6

HI-FI STEREO 18 WATT AMPLIFIER Model S-99. Within its power rating, this is the finest stereo amplifier available, regardless of price. Printed circuit board construction; ganged controls. U.L. push-pull output. 0.2% distn. at 9 W chal. £27.19.6



TRANSISTORISED TELEPHONE AMPLIFIER, Model TTA-1. Provides instant group listening and conversation. Freely portable for use with any telephone; hands-free operation; automatic switch; 9v battery operated; compact and elegant cabinet. £7.9.6

TRANSISTOR INTERCOM, Models XI-IU AND XIR-IU. Designed for use in the business office or the home, the Master unit (XI-IU) can operate up to five Remote units (XIR-IU) which give instant service without warming-up delay. "Private" switch. 9 volt battery operated. Supplied with assembled saple-mahogany cabinets XIR-IU £4.7.6. XI-IU £10.19.6

HI-FI SPEAKER SYSTEM Model SSU-1. This kit is easily assembled. It contains two speakers and a balance control in its ducted port reflex cabinet. It is equally suitable for stereo or mono in average room. (Legs 14 6. Less legs, £10.17.6



A WHOLE RANGE OF PACKAGED DEALS (INCLUDING "CONNOISSEUR CRAFTSMAN" TURNTABLE AND DECCA f155 PICK-UP) NOW AVAILABLE TO SAVE YOU FURTHER MONEY.

ALL MODELS ARE ALSO AVAILABLE ASSEMBLED—PRICES ON REQUEST

All prices include free delivery in U.K. Deferred terms available on orders over £10

JUST POST THIS COUPON FOR FURTHER INFORMATION

Without obligation please send me



FREE BRITISH HEATHKIT CATALOGUE . . .

FULL DETAILS OF MODEL(S)

Kindly write below in BLOCK CAPITALS

NAME

ADDRESS

TICK
HERE

HT.8

OVER 250 AMERICAN HEATHKIT MODELS AVAILABLE
Full details of Mail Order scheme and catalogue can be obtained from us for 1 - Post Paid.

DAYSTROM LTD. DEPT. H.8
GLOUCESTER, ENGLAND

A member of the Daystrom Group, manufacturers of
THE LARGEST-SELLING ELECTRONIC KITS IN THE WORLD

NEWS FROM THE WORLD OF TAPE

Waverley on Festival "Fringe"

CRAIGHALL STUDIOS—the home of Waverley Records—is to be open to the public during Edinburgh International Festival of Music and Drama (August 18—September 7).

£20,000 of equipment installed last year make this the most up-to-date studio for commercial and private recordings in Scotland. Visitors to the city will have an opportunity of seeing the latest in Mono/Stereo techniques and will hear some of the recordings made by this company.

Invitations to the studios—9.30 a.m. to 12.30 p.m. Monday, Wednesday and Friday of each week—are being distributed through music shops, the Scottish Tourist Board and the Festival Office. If any reader would like to visit this studio and cannot obtain an invitation, they should contact **Waverley Records, 21 Young Street, Edinburgh 2.**

Dropouts

SUPERMARKETS nowadays are relying more and more on the use of tape to boost sales in these establishments. In fact, they appear to be suffering not from "dropouts" but "dropins" or purchasers placing more goods in the trolleys. Customers who, before tape was used, often missed the attractive and well-placed items now have these brought to their notice by means of tape recorded announcements. The sound level is measured automatically every thirteen seconds and increased or decreased according to the amount of noise in the shop.

Tape Recorders used on Everest

A TAPE recorder was used by the United States expedition recently on the assault of Mount Everest. Dr. R. M. Emerson, a member of the climbing party, carried the recorder in his pack and operated the machine by remote control. A change of tape reels would have involved stopping the party and untying pack straps in the thin air and high winds. To overcome this problem, Dr. Emerson used five-inch reels of tape containing 1,800 ft. of tape which gave six hours of recording time. Other members of the group also used tape for recording data for research studies.

High Speed Tape Recording

A VERY intrepid water skier was seen recently in the Torquay area speeding over the surface of the water with a portable recorder, encased in a polythene bag, strapped round his waist. A microphone on a lavilier cord enabled a sound commentary to be produced with the appropriate sound effects. It could have been a very expensive outing!

History on Tape

THE Ministry of Public Buildings and Works are experimenting with tape recorders as guides to Ancient Monuments.

Two methods are being studied. One uses a portable machine giving a commentary in several languages and operated by a Guide, the other will be through a static recorder with extension speakers. The latter may be operated by a coin-in-the-slot device or by the Warden on payment of a small charge.

Scotland already has four sites served by non-portable tape recorders, the one at Edinburgh Castle giving its commentary in no less than four languages. The other three, at Jedburgh Abbey, Skelmorlie Isle and Cairnpapple Hill only talk English at present, and Jedburgh Abbey



A SCOTTISH pipe and drum band provided the sound effects microphone of the Walthamstow and District Tape Recording Society with background effects during the Walthamstow Carnival. The recording booth can be seen on top of the flat roofed building which must have given the commentators an excellent vantage point.

alone makes a charge—one penny! In August, a further two experimental systems will be installed; one at Dover Castle and the other at Scarborough Castle. Both will be static offering a commentary in at least three languages.

If the Ministry's studies of portable systems prove satisfactory, it is proposed to introduce this method of giving historical backgrounds in a number of other Ancient Monuments by 1964.

Tape at Sea

RECENTLY H.M.S. *Ursa* was fitted with a system for using tape recorded music throughout the ship. The equipment was supplied by Reditune and over 100 tapes containing 4,000 titles were put into the ship's library. Commander J. D. Baker, captain of the ship stated that the Reditune service has proved to be a very effective and pleasing means of increasing efficiency and stimulating interest in the job in commerce and industry.

Grundig Autumn Review

GRUNDIG (Great Britain) Limited have organised a special Autumn Preview for Grundig dealers in the ballroom of the London Hilton on August 27th, 28th and 29th. The ballroom is being completely transformed, and will be open with many attractions from 10.0 a.m. to 10.0 p.m.

Grundig dealers, who were told that admission would be by invitation only, were quick off the mark—within three days more than 1,700 applications were received!

New Saga Tape Catalogue

A NEW and up-to-date catalogue of Saga tape-records is now available, containing full details of all tape-records currently available and including future issues for July and August.

The catalogue is divided into sections covering Classical (listed in composer order), Recitals and Collections, Show and Film Music, Popular Music, Folk Music, Dance Music, Jazz, and Children's tape-records. The catalogue also contains a complete numerical list.

All Saga tape-records have been newly re-mastered and are available with leader-tape at both ends. Records are available in Mono and Stereo. Mono are 3½ i/s twin-track on 5 in. spools (32s. 6d.); Stereo are 7½ i/s ½-track on 7 in. spools (£3 3s.). The catalogue is available free of charge from all Record Dealers or direct from Saga Records Limited, 127 Kensal Road, London, W.10.

**PLEASE MENTION "THE TAPE RECORDER" WHEN
REPLYING TO ADVERTISEMENTS.**

TAPE RECORDER SERVICE

No. 20 KÖRTING RECORDERS

By H. W. HELLYER

THIS month's choice has been dictated partly by questions about sluggish recording; partly in order to demonstrate yet another method of tape transport. Some time ago a reader asked, with beguiling innocence that seemed to indicate a tongue in his cheek, what was the "best" kind of mechanical system for domestic tape recorders. Was the single motor or a three-motor system preferable, he asked, and should speed changing be electrical or mechanical? Was relay-operated equipment better, or more troublesome. . . and if so, why?

I have waited patiently for one of the back-room boffins to jump in quickly with his defence of a particular system. In my humble way, I hoped to learn something from the facts behind the choice of, for example, an outer-rotating cage of a hysteresis motor employed as flywheel, or belt drive as opposed to idler wheels, peripheral versus wrap-around brakes. But the silence has been deafening: perhaps our tongue-in-cheek reader should have re-phrased his question: "Why in heaven's name does the Superstar Special have no drive capstan?" Then Messrs. Superstar's chief engineer could have started the controversy rolling.

This article has no brief to be controversial—though any practising engineer will have his prejudices, and will favour certain types of machine. He will also be well aware of good and bad examples of the different designs touched upon in the previous paragraph. Not always, it must be added, depending on the purchase price.

★ ★ ★

If our mythical Superstar suffered from the lack of a drive capstan, the same cannot be said of the Körtling dual-speed deck, for it not only employs two, but has a separate roller for each. The rudiments of the drive system are shown in fig. 1, and the two rollers can be seen more clearly in the head plate diagram, fig. 2. The latter diagram also shows the solenoid which is used to effect engagement of the appropriate pinch roller and the pressure pad. Brakes are also solenoid-operated—but more about this later.

First, reverting to fig. 1, let us take a look at this drive system. The motor is a rim-drive type and its drive wheel *M* rotates constantly

effected by the rotation of the speed selector switch, whose spindle is coupled to the toothed wheel *T*, driving a cogged rack at the edge of the plate.

The mounting plate for the pinch wheels, as well as the pressure lever, is moved by a lever system from the action of the solenoid *S*, the Record/Play Solenoid. Pressure between the roller and spindle in each case should be between 1,100 and 1,200 grams. Adjustment can be made by the lever and stop pin position, but first check the return springs of the solenoid arm. These simple tension springs have a long straight piece and only a small coil, and care must be taken not to distort them if, for any reason, they may have to be uncoupled.

★ ★ ★

The take-up clutch is quite simple, and the drive from the motor pulley, apart from the possibility of a fouling belt, should give little trouble. If there is too great a pull, check the compression spring at the base of the spool carrier spindle assembly *R*.

Back torque is supplied by an unregulated friction plate, which is actually a metal plate on which the felt pad at the lower face of the left-hand spool rests. The back tension, when the machine is in *Record* or



Körtling MK 128

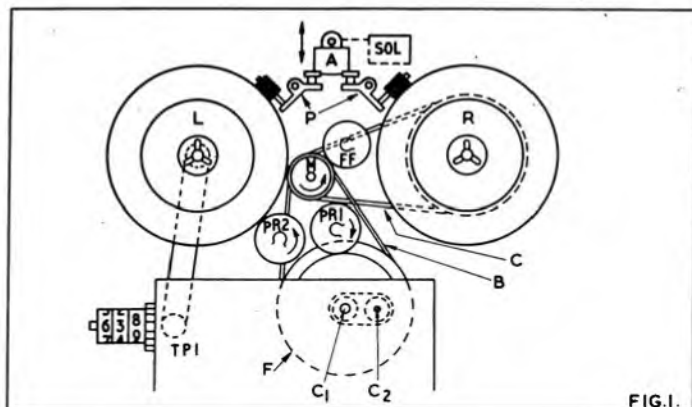

(anti-clockwise, viewed from above), with the various functions selected by engagement of idler wheels with this basic motor drive, and belts from the same source. Therefore, the first point to check is the correct mounting of the motor and the security of this drive wheel.

From the motor pulley, a flat section belt drives the flywheel *F*. This belt, *B* in fig. 1, must be correctly positioned and tensioned, and should not rub on any of the rewind levers. (A similar stricture applies to the take-up belt *C*, also driven from the motor pulley).

The $7\frac{1}{2}$ i/sec. capstan is directly mounted on the flywheel and is 8 mm. diameter. From the flywheel a further drive controls the 4 mm. spindle, *C2*, which gives the $3\frac{1}{2}$ i/sec. tape speed. This speed change system differs from those described previously, in that the basic drive is constant, and selection is by engagement of the appropriate pinch roller, *R1* or *R2* (fig. 2), when the plate *S/S* is moved laterally. This movement is

Play, should be approximately 30 grams. This measurement is normally made by winding several turns of fine cord around the plate flange and attaching a spring balance, pulling in the direction of normal tape movement until the friction is overcome. Clean the felt in the normal way for correct friction. Make sure that the metal plate is free from oil or any other foreign matter.

Fast winding in both directions is obtained by engagement of idler pulleys, with a simple lever system. For fast forward, idler *FF* engages the motor drive wheel (upper section of pulley) and the upper section of the right-hand spool carrier. Note that these carriers have wide outer flanges, perforated for lightness—this is not shown in my drawings (already quite complicated enough, and again, not to scale).

Rewind requires two idlers, to ensure the correct direction of rotation, and the lever system is separate for each idler, so that incorrect action needs a little closer attention. Check the springs and the lever pivots, and the throw of the relevant solenoids. Before becoming too involved in mechanical tests, always check that the solenoids are receiving the correct energising voltage, which should be 30 V D.C. when the machine is operating from a 240 volt mains.

★ ★ ★

Brake operation is also by means of a solenoid, shown at the top of fig. 1. Brake cams are applied to the edge of each carrier plate rim, normal spring pressure being such that the pivoted arms *P* are automatically in the "Brake On" position until any of the functions is selected. Then, as described below (Relay operation), the solenoid energises to hold the brakes off with a clearance of 0.7 to 1 mm. Note that there should be a gap of 0.2 mm. between the brake solenoid lever and the brake arm (*A* in fig. 1) when the brake is applied. A small amount of adjustment can be made by the angle lever setting, but the clearances noted above should be checked first.

Tape pressure to the heads during *Record* and *Play* is made by the action of a swivel lever carrying a tape guide pin. This swivels, as shown

by the dotted line and arrow in **fig. 2**, to give a 160 degree wrap around the R/P head face and about 150 degrees around the erase head facings. The R/P head is mounted on a floating plate and three-screw fixing allows azimuth adjustment, in the usual manner. In a head plate system of this kind, it is advisable to check first that the tape is running level and true between spool flanges and along the guide path, and not running up or down the guide pins on the sub-plate, then to check the erase setting, finally to set the R/P head for an inward distance of 0.1 mm. between the top of the head gap and the edge of the tape, play back a 6 Kc/s test note and adjust for maximum output.

Relay Operation

There are two relays and four solenoids used in this deck, fed by a 30 V D.C. line, derived from a full-wave bridge rectifier circuit and a separate winding on the mains transformer of the main machine. For the purposes of these notes, the machine referred to is the R.G.D. 102, 107, but the deck has been incorporated in various rigs and there may be individual differences, particularly as regards the Remote Control facility.

Relay 1 is energised when the Record button is pressed and the speed change selector at neutral. Under these conditions, the switch beneath the speed selector slide plate places the machine in a "straight-through amplifier" condition. When the speed change selector is turned to one speed or the other, the Relay 1 acts to change from Record to Play, and vice versa. But note that these changes are circuit connections—the mechanical function is obtained from the solenoid action.

Relay 2 provides a delayed action in engaging tape pressure and releasing brakes when the machine is switched from Fast Forward or Rewind to Record or Play. The relay is energised during fast winding.



switch connection energises the Rewind solenoid, and the delay relay Rel 2, is connected in parallel with the Rewind solenoid by the same switch action, breaking the R/P solenoid return path.

The auto-stop is provided by a split guide, G/S, and the action is by short-circuiting of these split halves with the metal leader tape foil, releasing the slide of the key assembly, via a solenoid, returning the keys to neutral. This is a similar action to pressing the stop button.

★ ★ ★

Auxiliary Erase. An unusual feature of this deck is the provision of a second erase head. The circuit is such that this head is energised when the erase button is pressed. By this means, portions of the tape can be erased during playback, immediately after the reproduced signal—an aid to the experimenter. But the deck lends itself to modifications, and this head position could also be used for the fitting of a monitoring head, with quite simple switch alterations. One possible fault that can be quite disconcerting is intermittent recording, if the contacts of the auxiliary erase switch are faulty.

★ ★ ★

Lubrication. The grease cups of the 3½ ips spindle and the spool carrier plates should not be more than half-filled with a medium grease, but the cup of the 7½ ips spindle (flywheel) can be filled right up. Care must be taken to avoid grease or oil on outer surfaces, where it can contact belts, idlers or even the tape. A light smear of medium grease can also be used on the idler bearings, and solenoid bearings require occasional light oiling. Pure vaseline can be used for switch contacts and sliding members, and paraffin oil is recommended for the tape position indicator pulleys.

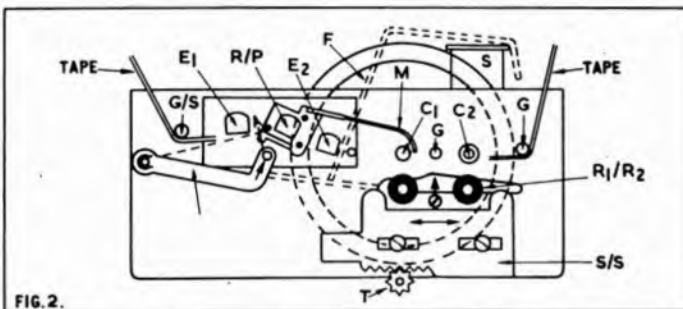

When Record/Play is selected, a spring toggle of the R/P solenoid closes a discharge circuit and the relay is allowed to discharge through a 100 mfd capacitor. A small metal rectifier prevents back surge in the Rewind Solenoid circuit and, in conjunction with another rectifier and blocking capacitor, reduces peak currents. The time constant of the circuit is such that between ½ and ⅓ second elapses between the time of the Record/Play selection and the actual closing of the solenoid. During this period, the brakes are momentarily applied and the tape comes to a controlled halt. This virtually eliminates the risk of spillage, even when the machine is used hastily. Any observed spillage should lead one to check the 100 mfd capacitor and back surge diode. Persistent spillage may be due to dirty switch contacts on the solenoid isolating circuit.

★ ★ ★

The brake solenoid is in series with the other solenoids and is thus energised when any function is selected, removing the brakes. Action is as described above.

The Forward Winding solenoid engages FF with the motor pulley and spool carrier R as described above.

Rewind solenoid has a similar action, via pulleys PR1 and PR2. Apart from the Remote control switch changes, these two circuits are straightforward.

★ ★ ★

Remote control (on the machine under discussion) is effected by pulling out the tone control knob, when connections to the 5-pin socket (St 4) change several circuits, as follows: R/P solenoid and Rewind solenoid open-circuited to chassis, so that pressing the relevant buttons has no effect. The remote control switch, plugged into the aforementioned socket, completes the circuit of the R/P solenoid. A further

CRAIGHALL RECORDING STUDIOS

(Geo. Jeffrey Ltd., Edinburgh)

These modern and fully equipped studios offer the following services:

Commercial and Private Recording Sessions.
Hire of Studio for Practice and Rehearsal Work.
Tape to Disc Transfer Service.

Mobile Recording Unit also available.

Send for our Fully Detailed Price List

GEORGE JEFFREY LTD.

23 Earl Grey Street, Edinburgh 3. Tel.: FOU 8389
(Studios: 68 Craighall Road, Edinburgh 6. Tel.: GRA 3485)

SOUND FOR SOUND...



IT'S THE BRILLIANT NEW

LUXOR

STEREO TAPE RECORDER

*... for better performance
and better value for money*

At only 74 gns. this new Swedish built 4-track machine offers the facilities and standard of performance associated with equipment costing nearly half as much again. The MP423 illustrated is fitted into teak or mahogany case, incorporates two built-in Luxor Speakers, forward and side facing, and has facilities, for example, for connection of centre speaker for stereo playback, and separate balance controls for both recording and playback. Write now for illustrated brochure on this magnificent new machine.

SEE IT . . . HEAR IT . . . NOW

R·E·W

(EARLSFIELD LTD.)

Dept. TR 266, Upper Tooting Road, London, S.W.17

Telephone: BALham 7710

An unrivalled selection of the latest machines available on our famous **LOW DEPOSIT—NO INTEREST TERMS** over 12 months. (18–24 months H.P. terms available).

FREE Servicing

FREE Delivery

Home demonstrations gladly arranged in London area.

ELECTRONIC WORLD

is by far the cheapest
HIGH QUALITY TAPE
on the market

★ **Acclaimed by experts**

Reprints of reviews available

★ **Backed by our Guarantee**

If you are not completely satisfied with any purchase, we undertake to refund the full price plus your return postage

POST COUPON NOW!

DE VILLIERS (Electronic World) LTD.

16d Strutton Ground, London, S.W.1

STANDARD PLAY (Acetate base)

3 in. spool 175 ft. 4 spools for 18/-
or 48/- dozen

4 in. spool 300 ft. 4 spools for 26/-

5 in. spool 600 ft. 2 spools for 26/-

5½ in. spool 850 ft. 16/- per spool

7 in. spool 1,200 ft. 19/- per spool

ARCHIVISTS' GRADE (S.P. Polyester)

7 in. spool 1,200 ft. 22/6 per spool

LONG PLAY (Acetate Base)

7 in. spool 1,800 ft. 28/-

LONG PLAY (Polyester Base)

3 in. spool 225 ft. 4 spools for 22/-
or 60/- dozen

4 in. spool 450 ft. 2 spools for 21/-

5 in. spool 900 ft. 2 spools for 35/-

5½ in. spool 1,200 ft. 24/- per spool

7 in. spool 1,800 ft. 31/- per spool

DOUBLE PLAY (Special Polyester Base)

3 in. spool 375 ft. 4 for 40/-
or 108/- per dozen

4 in. spool 600 ft. 2 for 30/-

5 in. spool 1,150 ft. 27/- per spool

5½ in. spool 1,750 ft. 35/- per spool

7 in. spool 2,400 ft. 45/- per spool

I enclose remittance for £ s. d.

Post Free

Name

Address

BLOCK LETTERS PLEASE

Cash with order

Readers' Problems

★ Readers who encounter snags, or who run into trouble with their tape recording equipment, are invited to write to this editorial office for advice, marking the envelopes "Readers' Problems—Tape". Replies will either be sent direct by post, or published in this column if the subject is of general interest. However, we must emphasise that this advisory service cannot include requests for information about manufacturers' products when such information is obviously obtainable from the makers themselves. It is also essential to keep the queries reasonably short and to the point, and to limit them to one specific subject if at all possible. And, please, in no circumstances confuse such letters with references to other matters which have to be dealt with by other departments in our office.

Playback Noise

Dear Sir:—I have a Philips battery portable (EL3585) which has done good work over the last eighteen months. Recently, however, I have been experiencing a loud "buzz" on playback which is ruining the machine's efficiency. This "buzz" occurs when the machine is running in the playback position even when there is no tape on the spools. It is subject to the volume control.

Could it be a fault in the motor?

Yours faithfully, O. J. S., Wakefield.

Noise on Playback with your Philips EL3585 could be caused by several faults. The fact that it is controllable by the volume control isolates it to either the input stage or the motor.

I mention the latter because there is a distinct possibility of motor noise pick-up when the switch contact that brings in the suppressor circuit becomes noisy or intermittent. If it fails altogether, there is a tendency for the machine to run too fast—which should give you a clue. Best method of checking whether it is indeed motor fault, or suppressor failure, is first to disconnect the motor and note results, next to switch to rewind but close the isolating switch connection that mutes the amplifier—this then proves whether the suppressor is the culprit if there is no buzz.

Supposing these things to be in order, transfer your attention to the base resistors in the first transistor stage, especially the 33 k in the base to negative line. Finally, check the 2.5 nfd capacitor that couples the head to the input, via the switch (although if this failed also there would be a definite effect upon recordings).

I think, however, your trouble may prove quite simple—and would apologise for reminding you to check the obvious, that is the earth return connection on the volume control itself.

Excessive Treble

Dear Sir:—I am the owner of a Grundig 700L Reporter, and I have been experiencing far too much treble on play back and on reproducing the gramophone. Can you possibly recommend a cure for it.

Yours faithfully, H. R., Petersfield.

I must apologise for a delay in replying. This was because I was unable to procure a copy of the circuit diagram of this machine. It is quite a while since I handled one, and my workshop notes on this machine and its fault symptoms have become buried in a mass of other data.

In desperation I appealed to Mr. Spring, the Chief Engineer of Grundig, who told me that this was a fault that had been noted before under the conditions you state—reproducing gram through the Reporter, and was usually caused by cartridge mismatch. He suggests you try inserting a resistor of 50,000 to 100,000 ohms in the line from the pick-up to the tape recorder, to restore the bass.

Faulty Rewind

Dear Sir:—I have a Cossor four-track tape recorder, model No. CR1602. I have had it about two years. Just recently it seems to have developed a fault in the fast rewind to the recording side.

The other fast rewind to the left is alright, so is the recording and playback. This is what happens, on starting fast rewind it starts off all right, and as the reel gets full it slows down and sometimes almost stops before the rewind has finished. I have used a few drops of oil in the likely places, that makes no difference and as the other fast rewind is O.K. I cannot figure out the reason for this.

Could you please offer me any guidance to cure the annoying trouble.

Yours faithfully, E. R., London.

The difficulty of sluggish fast forward spooling on your Cossor CR1602 is probably due to a hardened clutch felt, but may be caused also by wear of the Vulcanan plugs in the coupling wheel.

If you remove the RH spool carrier, you will note that a piece of felt is inserted in a groove on the lower surface. Degrease and soften this with methylated spirit. Also degrease and clean the white plastic clutch plate.

Take care when replacing this that the spigot seats in the cut-out in the hub-plate of the coupling wheel. Beneath the clutch plate there are two washers, and the plate sits on the flange of the spindle. Note that the spindle, if removed, must be replaced with the flattened end to the right (looking down) and sit in the groove of the slotted lever beneath the deck.

At this stage of dismantling you will note three yellowish plugs that are near the upper edges of the coupling wheel, made of translucent, rubbery material. These are plugs of Vulcanan, simply pushed into holes in the wheel. They should protrude sufficiently to get a good grip of the carrier during fast wind, but should be clear during take-up, allowing the clearance between the plugs and the turntable carrier to be 0.8 to 1.2 mm. Beneath the coupling wheel there are two washers, and it may be necessary to remove one of these (or add one if the machine has been serviced before!) to attain the correct level.

Finally, check that the tension wheel that equalises the pressure of the common belt, is tautly sprung during fast wind. For this adjustment, see my article in the May 1962 issue of the magazine.

* * *

Automatic Stops

Dear Sir:—I have just acquired a second-hand Grundig TK20. It works well except for the automatic stop. When the machine has been run for about 15 minutes this functions correctly but after about an hour this will not operate. The tape stop foils are in order.

Please could you offer any information as to rectify this trouble.

Yours faithfully, M. D., Wolverhampton.

The circuit of the auto-stop is quite simple: a relay is connected the upper half of the auto-stop so that contact with the foil effectively short-circuits this connection to chassis. The live side of the relay coil is taken to the junction of two resistors, 50,000 ohms and 7,000 ohms which are connected between the 260 volt H.T. line and chassis. So short-circuiting of the auto-stop effectively applies a voltage to the relay. There is a 50 microfarad electrolytic across the lower, 7K resistor. Possibilities of fault are:

- (1) low h.t., caused by a failing metal rectifier,
- (2) 50K resistor going "high" when hot,
- (3) electrolytic capacitor developing an excessive internal resistance.

The first is the most likely, but is usually a fault that has additional symptoms, and will be cumulative, as the metal rectifier deteriorates. The third possibility is one that is likely to develop to the point of a direct short-circuit and burning out of the upper resistor.

Note that there is another possibility—that is that the relay is working, but that the contacts themselves are not making and breaking cleanly. Operate the autostop by short-circuiting with a screw-driver, tape removed and listen for the click. Clean the contacts very gently with a camel-hair brush moistened with switch cleaner or meths and oil very lightly.

BRAND NEW TOP QUALITY 100% TESTED RECORDING TAPE

(As supplied to the Far East Broadcasting Corp.)

	Size	Length	Price
STANDARD	3"	160'	2/6
	5"	600'	9/-
	5½"	900'	11/6
	7"	1,200'	16/-
LONG PLAY	3"	220'	3/-
	5"	900'	11/6
	5½"	1,200'	16/-
	7"	1,800'	23/-
DOUBLE PLAY	5"	1,200'	23/6
	5½"	1,800'	28/6
	7"	2,400'	41/-

Postage 1/- per spool 4 or more P.F. Refund Guarantee (never ever requested)
Recorder repairs at reasonable prices. (Collected and delivered in London Area)

N. WALKER, 28 Linkcroft Avenue, Ashford, Middlesex
Telephone: ASHFORD 53020

By Bob Danvers-Walker

RECORDING IN MOROCCO

As a Travel Correspondent, Bob Danvers-Walker goes on many foreign assignments gathering material for broadcast travel programmes, the press and other publications. Tools of his profession are a tape recorder and a pen. Wherever he goes, he takes his Fi-Cord 202. His sound-seeking missions have ranged from Lap settlements far above the Arctic Circle to big game hunting below the Equator in Uganda. And always spiced with adventure. Recently he left London by B.E.A. Vanguard in the early hours of the morning and by the evening of the same day he was setting foot in the High Atlas region of Morocco's "Blue Men". Read now how he went about taping a "cavalry" charge by Berber horsemen and revisited the location where battle sequences of the film "Lawrence of Arabia" were shot.

ZIDANI BOUAZZA had driven me some 400 miles over the snow capped Atlas Mountains in Southern Morocco and now we sat on the ruined walls of a Kasbah on the fringe of the Sahara desert. The sun was pushing the temperature over the hundred in the shade mark, except that there was no shade. The microphone was almost as hot to hold as when I recorded impressions of a Sauna bath in Finland. In my experience it is extreme humid heat which gives trouble.

The hot, moisture-laden atmosphere affects the tape face and causes an adhesive effect resulting in tape drag. I had this occur once with my Fi-Cord 1a. No fault of the machine but a drain on the batteries and ruination to resultant sound due to speed fluctuation. The dry heat of the desert could also well cause trouble when metal and bearing faces heated up. So I kept my recorder shaded from direct sun as much as possible. And fine sand blown by gusts of turbulent wind causing "willy willies" (columns of sand swirling upwards into the sky) if it got into the works could wreck everything.

The Arab chauffeur spoke to me in a mixture of French and English. I was returning to a battlefield about which a famous man has put these words on record. "We were shooting in fearful heat round Ourzazate . . . where the French Foreign Legion send their men for punishment". As we spoke we walked across the scorching desert to where the Sirocco-blown sand was rapidly covering up the carcasses of horses and mules killed in the "blood bath" when the Turkish columns were annihilated by the Arabs under "El Auren". This had happened nearly a year ago, but the horse's head and the body of the mule that I hauled out of the sand were quite recognisable although the plaster was breaking away from the burlap base.

The men in London who had made the prop animals for the film "Lawrence of Arabia" could still be proud of them. The "shooting" referred to by Director David Lean whom I quote above, was the superb work of men re-creating history on film under conditions where ther-



The author seen standing by one of the plaster horses left behind by the film company.

mometers had to be kept refrigerated. Zidani had been Producer Sam Spiegel's personal chauffeur during the whole time the Unit was in Morocco. The big American saloon in which I travelled was the one used

exclusively by Anthony Quinn. My room in the State Inn in Ourzazate had been allocated to David Lean. There are camel drivers and men of the Royal Moroccan Army who still speak of the time Ourzazate was virtually taken over and they acted in crowd shots and battle sequences.

Our presence in the desert had not gone unobserved. Out of the water-like mirage we followed the approaching speck of someone riding a heavily laden animal—the only other living creatures between us and the horizon. The figures wobbled and distorted like a black currant jelly on a hot plate. Within twenty minutes Mohammed Ben Hadou, a bellows maker on his way to a Souk (market place) fifty miles away, came up to us. I switched on to record the greetings exchanged. His son sat amid the vast piles of merchandise heaped across the back of the mule. Mohammed wore the usual tattered djellabah (hooded robe) of heaviest camel wool. The way he trekked along on foot beside his burdened animal was amazing. Through Zidani I learnt that Mohammed had been employed as a labourer in the building of sets erected in the desert. Over there beside that escarpment in the direction he pointed was the location where the sequence dealing with the gathering of the Arab Legions before Damascus had been shot.

Hotel in the Kasbah

I bought a pair of rather crudely made bellows from him, gave them a bottle of water and, after a last look round, made off back to the Hotel in Ourzazate. About five miles away there is an Annexe to this Hotel in the Kasbah at Tifoutout where they heat the water for domestic use with sun-reflecting mirrors located on the roof of this very comfortable Gite d'Etape (literally a "sheltered halting place") which resembles a desert fortress. In point of fact at one time portion of it was. Many of the Berber staff now working in this seventeen-roomed holiday resort less than ten years ago were slaves in the employ of the representative of the Pasha of Marrakech. Yet today it's a peaceful, restful oasis with instant sun and full booking lists for holidays from people all over Europe.

I felt it good to escape momentarily from the flesh-burning midday heat into the cool of the Hotel, put down an ice cold beer and re-wind my tapes. The drain on my batteries is always considerable. After recording I am more or less compelled by "force majeure" to play the tape back. Usually there's so much excited chatter going on that no one really hears it properly and I have to roll back and start all over again. People love to hear their voices even though they never recognise themselves. With Mohammed's bellows I blew fine dust out of the 202. Then I cleaned the recorder head with a cotton bud dipped in metholated spirit. These are essentials I always carry in my maintenance kit. It was two days later that dust became an even greater hazard.

Annual Folklore Festival

Outside the massive 25 foot high 11th Century wall which, for seven miles rings the Red City of Marrakech, there is the Djemaa El Fna, the great gathering place for merchants, snake charmers, story tellers, acrobats, musicians, water carriers and country traders who gather on market days. Berber horsemen had pitched their tents (for this was the occasion of the Annual Folklore Festival) and these warrior men of the High Atlas were there to give one of the most spectacular sights one may ever hope to see in Morocco. This is the Fantasia when some twenty or more Barbers garbed in flowing white robes and mounted on Arab stallions give a series of wild charges brandishing their moukhala (flint rifles) above their heads and firing them all off together at a given signal.

Sound level problems as well as dust set me thinking as I moved among the assembling horsemen saddling up their mounts and priming their firearms. What I wanted was the approaching sound of horses hoofs, the cries of the warriors and spectators, the thunder of the charge as it flashed by followed by the crash of the exploding muzzle loaders. Admittedly there would be several charges so if I failed on one take I could improve on the others. Since I was an invited guest visiting the country to gather material of interest in the promotion of tourism, my freedom of movement was taken care of by the local Ministers in all

the regions visited. I have recorded some of my most valuable and indeed historical tapes in Morocco and each time I have been there I have found the country more and more enchanting. And I am not the only one who thinks this. The Mamounia Hotel in Marrakech is where Sir Winston Churchill goes when he travels abroad to paint. So, with my 202 slung across my chest I stationed myself slap in the middle of the track facing the horsemen a hundred yards away at the "starting gate". My friend Zidani got the message through to them that I would remain quite still in the path of the charge and they were to gallop past me as I knelt with the microphone pointing at them. I saw the line of horsemen move—slowly at first, then gather pace: the flintlocks were raised in the air. I switched on.

Overloading

The little motor signal light blinked; then on with tape drive and I faded up the volume control. There was a wild shout and down they came, robes flying out, a dust cloud billowing up behind a solid wall of Arab horseflesh. Torn between watching them come at me and keeping my eyes on the volume indicator I misjudged the setting and the needle peaked over the limit of the red segment. Then came the thunderclap of the volley. That needle really took a pounding. As the fine white sand settled like a fog about me I figured out what I must now do. Their approach is muffled by the soft sand. Therefore I had given too much boost resulting in overload when the lot came on me.

I was hot and sweating and I had had a bit of a scare when the horsemen parted on either side of me; they left it to the very last moment. The prancing Arab stallions were making their way back to the starting point, small Arab boys were tearing across the track to see what I was up



This still from the Columbia Pictures film "Lawrence of Arabia" shows "El Aurens" gathering the Arab legions together before Damascus. One of the important sequences shot in Morocco in the desert just outside Ouarzazate.

to and the crowd was shrieking with delighted expectancy of the next charge. Like flies round a bit of putrid meat the youngsters clamoured around me until driven off by officials with little canes. I felt sweat running down between my shoulder blades, the black carrying case of my recorder was grey with dust and I was trying hard to think just how to handle the next charge. This time I must watch the V.I. all the time and be ready to adjust. For the rifle fire I must cut right back. Trouble was they let fly rather close. So I advanced up the course about fifteen paces. I opened the opaque cover and tapped both spools to seat them firmly on their spindles: all this dashing about can cause them to work up a bit. I went down on one knee and levelled my Beyer at the waiting horsemen feeling just as though I were the last remaining fusilier in the thin red line. Down they came. This time I riveted my eyes on the V.I. needle. Head down and resisting the temptation to look up, I sensed rather than saw the approaching body of horsemen shouting wildly, some flinging their firearms into the air and catching them on the charge as they had done before.

A Flurry of Hooves

The sudden sound of a flurry of hooves and they were on me. There was a violent tug, the recorder swung over my shoulder and the thought flashed through my mind—I won't get trampled, horses jump over fallen



Berber warriors from the High Atlas mountains mounted on their Arab horses in the terrifying charge known as "The Fantasia". The thunderclap volleys from muzzle loaders is no easy thing to record, and Sahara sand imposed other problems.

bodies. With that there was an almighty crash from the muskets and I found myself standing with the microphone held out like a French policeman directing traffic with his truncheon. The lead was trailing uselessly in the dust and the Fi-Cord hung behind me like a schoolboy's satchel. The free-flowing microphone lead had caught in a stirrup and been pulled out. I gave vent to every bit of Billingsgate I knew, including French and Arab translations. The charges after that were just not the same and the display was winding up anyway. Why is it that the best is always the one you didn't get, be it picture, tape or fish.



Ancient walled Ksars (palaces), stud the region around Ouarzazate on the Sahara side of the snow capped Atlas mountains, Morocco. One may now holiday comfortably in such places which have been converted into hotels.

HI-FI FOR BEGINNERS

This is the first title in a long-awaited series of HI-FI books, and we recommend it thoroughly to every enthusiast.

PRICE 7/6d., plus 9d. postage.

Available from:

MILES HENSLow PUBLICATIONS LTD, 99 MORTIMER STREET

for Professional Performance...

Tandberg

SERIES 6

STEREO TAPE DECK



- 3 SPEEDS
- 3 HEADS
- 4 AMPLIFIERS
- *4 TRACK and 2 TRACK

- High and low level mixer inputs and cathode follower outputs.
- "On and off the Tape" monitoring.
- Sound-on-Sound simultaneous record and playback.

110 gns

Booklet of Technical Reviews on request.

SERIES 7

STEREO TAPE RECORDER



- 3 SPEEDS
- 2 HEADS
- and 2 Power Amplifiers

- Two Indicators.
- Two Monitor Speakers.
- Two outputs for additional speakers or Hi-Fi.

*4 TRACK and 2 TRACK
Send for leaflet.

BUILD-IT-IN OR CARRY-IT-AROUND!

4 track model 74
2 track model 72
(Luggage type carrying case. £7 1s 8d. extra).

93 gns

Tandberg GB

ELSTONE ELECTRONICS LIMITED,
Edward St., Templar St., Leeds 2.
Telephone: Leeds 3-5111 (7 lines)

FRANCIS OF STREATHAM

Akai M6 1/2 & 1/4 Tr. St.	130 gns.	* Telefunken 96 4 Tr.	69 gns.
* Brenell Stereo STB/1	£120	* Telefunken 97 1/2 Tr. Stereo	95 gns.
* Brenell Mk. V Model M	88 gns.	* Telefunken 98 1/2 Tr. St.	95 gns.
* Brenell Mk. V Series 2	69 gns.	Truvox Series 80/2 Tr.	55 gns.
Cossor 1603	28 gns.	Truvox Series 80/4 Tr.	59 gns.
Cossor 4 Tr. 1604 2 sp.	39 gns.	Truvox 60 Series 1/2 & 1/4 Tr.	39 gns.
Cossor 4 Tr. 1605 4 sp.	62 gns.	* Vortexion WVA	£93.13.0
Elizabethan 'Popular'	22 gns.	* Vortexion WVB	£110.3.0
Elizabethan LZ30	32 gns.	* Vortexion C Stereo	£148.10.0
Elizabethan LZ29	36 gns.	* Vortexion CBL Stereo	£160.0.0
Ferguson 3200	26 gns.	Wyndor Trident	33 gns.
Ferguson 3202 4 Tr. 2 sp.	33 gns.		
* Ferrograph 422 or 424	110 gns.		
* Ferrograph Series 5	85 gns.		
Fidelity Argyll Minor	22 gns.		
Grundig TK14	35 gns.		
Grundig TK18 "Magic Ear"	39 gns.		
Grundig TK23 4 Tr.	45 gns.		
Grundig TK40 4 Tr.	75 gns.		
Grundig TK41 2 Tr.	75 gns.		
* Grundig TK46 4 Tr. St.	99 gns.		
Loewe Opta 403	45 gns.		
Philips 4 Tr. 3541 H	42 gns.		
Philips 4 Tr. 3549	62 gns.		
Philips 4 Tr. stereo 3534	92 gns.		
Philips Starmaker 4 Tr.	27 gns.		
* Reflectograph 'A' 1/2 Tr.	105 gns.		
Robuk	36 gns.		
* Simon SP5	93 gns.		
Sony Stereo 462 4 Tr.	75 gns.		
Sony 521 Stereo	89 gns.		
Stella 458 4 Tr.	39 gns.		
Stella 459 4 Tr.	62 gns.		
Stella 456	28 gns.		
* Tandberg Series 6	110 gns.		
* Tandberg Series 7	93 gns.		
* Telefunken 85 de luxe	83 gns.		
* Telefunken 95	59 gns.		

BATTERY PORTABLES

Cossor 1620	25 gns.
Philips Portable	24 gns.
Loewe Opta 414	47 gns.
(Mains/Battery/Car)	
* Butoba	66 gns.
Clarion Phonotrix	19 gns.
* Fi-Cord 202	66 gns.
Stella	25 gns.
Stuzzi Memo-Cord	25 gns.
Uher 4000S	93 gns.

Mains Power Packs

Philips, Stella or Cossor	£5.00
Grundig	8 gns.
Butoba	11 gns.
Fi-cord	£7.10.0

TRUVOX DECKS with PRE-AMPS

PD 82—Standard Twin Tr.	£42.0.0
PD 83—Pro. 2 Tr.	£48.10.0
PD 84—Stand. 4 Tr.	£46.0.0
PD 85—Professional 4 Tr.	£52.10.0
PD 86—Pro. 4 Tr. St.	£63.0.0
PD 87—Pro. 2 Tr. St.	£63.0.0

Tape Decks by Brenell, Wright & Weaire.
Tape to disc and copy service

LEADING STOCKISTS OF EQUIPMENT FOR TAPE and HI-FI

... and NO EXTRA FOR CREDIT TERMS

- ★ Minimum Deposit
- ★ No Interest or Service Charges on H.P. up to 18 months
- ★ Free Service during Guarantee Period

● MICROPHONES, MIXERS, ETC.

Grampian Reflector	£6.0.0
Grampian Ribbon	£11.10.0
Grampian DP/4 Dynamic	£8.0.0
Lustraphone VR/64	£7.17.6
Lustraphone LFV/59	£8.18.6
Simon 'Cadenza' Ribbon	£10.10.0
Reslo Ribbon	£10.2.0
Reslo Cardioid Dynamic	£10.15.6
AKG Stereo D.88	£19.19.0
AKG D.19C	£17.10.0
TSL 3 Channel Mixer	£2.7.6
Grundig Mixer Stereo	18 gns.
AKG K 50 Headphones	£7.10.0

Also in stock microphones by ACOS, FILM INDUSTRIES, TELEFUNKEN, etc.

ALL WALGAIN PRODUCTS

- STANDS OF ALL TYPES
- TAPES & ACCESSORIES
- Standard, Long Double, Triple Play in all sizes by all leading makers.
- DEFLUXERS BY WEARITE, WALGAIN
- Pre-recorded Tapes by Columbia, H.M.V., and all E.M.I. Labels. Saga, Tutor-tape, etc.
- Bib, Bond and E.M.I. splicers. Matching transformers. Plugs, sockets, etc.
- Prices subject to alteration as announced by manufacturers.

HI-FI DEPT.

- STEREO AND MONO AMPLIFIERS—
- Quad, H.M.V., Pye, Rogers, Leak, Aveley, Armstrong, Tripletone, Scott, B & O Chapman, Eagle
- TUNERS
- Quad Rogers Pye H.M.V. Leak Aveley Armstrong Chapman B. & O. Tripletone
- LOUDSPEAKERS
- Quad Pye Rogers W.B. Kef Wharfedale Goodmans Tannoy Colrad Lowther Mordaunt Leak Lockwood
- MOTORS, PICKUPS
- Garrard Tannoy EMI Goldring Lenco Shure Connoisseur Decca Stereo Decca Deram Pickering Philips Ronette Ortofon B & O Acos SME Mk. II Thorens ADC BSR
- All types of Diamond and Sapphire styl. stereo and mono. Microlifts, Garrard, Goldring and Acos Pressure Gauges. Disc Preener. Acos Dust Bug. Cabinets by Record Housing and G.K.D.

169-173 STREATHAM HIGH ROAD, LONDON, S.W. 16

Between St. Leonard's Church and Streatham Station

STReatham 0466/0192

Please note this is our only address

... tape recorder workbench

No. 49 TRANSISTOR CIRCUITS

by A. Bartlett Still

TWO months ago, in the June issue of the "Tape Recorder", I gave several circuit sections suitable for putting together to make up a transistorised mixer unit. Several readers have well and truly caught me out, and I hasten to make amends! I suggested the use of fig. 3, an emitter follower input stage as being suitable for crystal microphones, trying to offer as high an input impedance as possible with a transistor device. It has been rightly pointed out to me that the input impedance of the circuit I gave can only be of the order of 8 K ohm, nowhere near high enough. I had been concerned to apply bias stabilisation to all the circuits I gave, including the emitter follower, forgetting that the 10 K ohm resistor would shunt the input of the transistor. If this resistor is omitted the input impedance can be allowed to rise to the normal figure of some 40 or 50 K ohm.

Now I am well aware that to achieve good bass response a crystal microphone should see an impedance of several megohms but, from the practical point of view, I doubt whether the cheaper crystal units ever see this sort of loading, or would be vastly improved by it. There is another way of tackling the problem, and that is to use the grounded emitter circuit of fig. 2 with an input transformer. A suitable auto-transformer that used to be available was made by Ardenite, Type T1075. The voltage gain of one stage would be some 10-12 dB.

There have been a couple of other queries that may be of general interest. One concerned the provision of a high impedance output. This, I would suggest, is not required, since a low impedance output allows a far wider range of load resistances. A fairly safe rule for most voltage signal connections is that the load impedance should be at least twice the source impedance.

The other question was about the provision of separate tone controls on each channel. Apart from the tremendous complications this would introduce, I firmly believe that the place for tone correction is on replay, not on the input to a tape recorder. If an occasion arises where some form of colouration is required on a particular channel, this should be performed before the signal is applied to the mixer, otherwise that channel is severely restricted in its use.

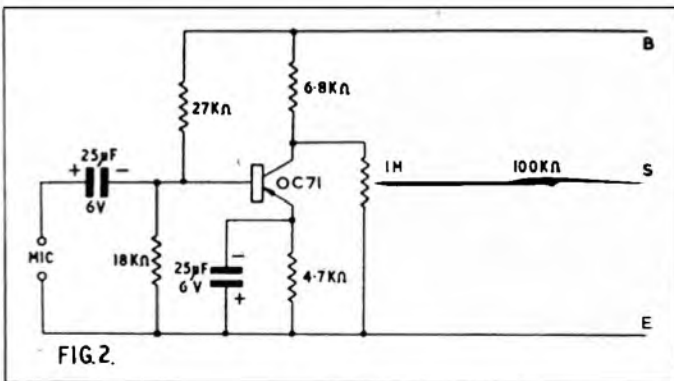

Another very interesting letter brings me back once again to the subject of impedances and matching and asks several very pertinent questions. I will try to answer these by discussing some examples, hoping thereby to clear up what I believe may be some popular misconceptions. The whole question is really governed by that old faithful—Ohm's Law—concerning Voltage, Current and Resistance. Suppose we talk of a signal of 1 Volt, developed with a source resistance of 1 K ohm. If the output is short-circuited, there will obviously be no longer 1 Volt, but there will be a current flow. This current is, in fact, determined by the total resistance in the circuit, here 1 K ohm, and would, therefore, be 1 mA. The important point is that the 1 Volt has not disappeared, it is used up, so to speak, in driving the short circuit current through the source impedance.

★ Apparent voltage ★

If the short circuit were replaced by a load, also of 1 K ohm, the total resistance will now be 2 K ohm the voltage still 1 V and the new current $\frac{1}{2}$ mA. The *apparent* voltage will be that developed by the current of $\frac{1}{2}$ mA through 1 K ohm, i.e. $\frac{1}{2}$ V. So the higher the load resistor, relative to the source resistance, the higher the signal usefully available—less will be lost in the source resistance as the current value drops. That is our first rule. The second is also easy to see—the lower the source resistance, the lower the load resistance at which now appreciable voltage drop will occur. These are the rules we apply when we are concerned with voltage

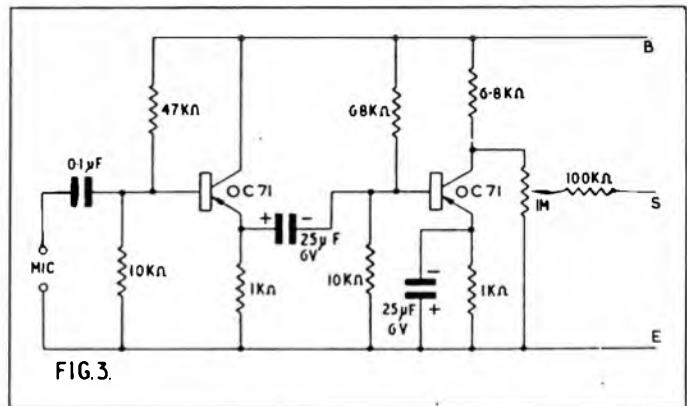

amplification, tape recorder into pre-amplifier, and thence to main amplifier, etc. We usually want as big a voltage as possible, and so the tendency is to keep the load resistor as high as possible, compatible with certain other considerations.

Now let us consider power as normally represented by Volts \times Amps, and go back to the examples above. If these, and one or two others, are worked out on this basis, it will be found that the most power is dissipated in the load resistor when it is equal to the source resistance. Here is our third rule—for maximum power transfer load and source must be matched. Less often required, but fairly obvious, is the maxim that if maximum current is required the load resistance should be as low as possible.

So far so good, but when are we concerned with voltage, when with power, and so on. Here I can only give examples, some obvious, some not. To drive a loudspeaker, power is required, and so it should match the amplifier. The amplifier, however, is arranged to be driven by voltage, and so it will have a high input impedance, and should be connected to as low a signal impedance as possible. A more difficult question is that of microphones and pickups. Crystal and condenser microphones and crystal pick-ups are, by their nature, voltage producing devices, but their high internal resistance renders them useless as power devices. Moving Coil or ribbon units, on the other hand, have a low signal voltage, but they also have low internal resistance, and it is often better to treat than a power device. They are therefore matched into a transformer, to get maximum power transfer, which then produces the voltage, at higher impedance, that an amplifier needs.

I have so far talked of both resistance and impedance. What is the difference? Impedance is, in simplest terms, A.C. resistance, which may be a combination of pure resistance and capacitance or inductance. I may have used the words a little loosely for the purists, but I hope I have been able to get the idea across.

One final point occurs to me, a power source, such as an amplifier output, does not *have* to be loaded fully. In a lot of cases it is quite in order to load with a high impedance and take off a voltage signal. However, the incorrect loading may cause distortion in the amplifier, so it is usually better to match with a dummy load and take off the signal voltage produced across it.

GRUNDIG TK 60



**S
T
E
R
E
O**

SPECIAL OFFER!!

We have a number of the fabulous TK60 STEREO TAPE RECORDERS available at the fantastic price of 89gns. This recorder is listed at £134 and at the price offered shows a saving of over £40!! Absolutely complete in the last detail with two superb detachable acoustically designed speakers, 9 watts output, frequency response 50-16,000 c/s, bass and treble controls, automatic tape stops, etc. Superb value and an absolutely unrepeatable offer, BRAND NEW in sealed cartons with full maker's guarantee. Hire Purchase terms available. We specialize in mail order. Write to our HEAD OFFICE at Stratford - address below.

- ★ HIGHEST PART EXCHANGE ALLOWANCES
- ★ OVER 250 NEW & S/H RECORDERS ON DISPLAY
- ★ H.P. TERMS OVER 9-24 MONTHS
- ★ FREE HOME DEMONSTRATIONS
- ★ TAPE RECORDER REPAIR SPECIALISTS
- ★ FREE DELIVERY. FREE TECHNICAL ADVICE

NOTE.—OUR CITY SHOP OPEN MON.-FRI. 9-6. CLOSED SAT. OPEN SUN. 9-2 p.m.

**CITY & ESSEX
T A P E
RECORDER CENTRES**

228 Bishopgate, E.C.2. Opp. Liverpool St. Station. Bis 2609
2 Maryland Station, Stratford, E.15. (Adj. Station) Mar 5879
205 High St. Nth. (Opp. East Ham Station), E.6. Gra 6543

Introducing THE WHARFEDALE BOOKSHELF 2

Where space is limited or where mobile external speakers are required for use with a mono or stereo Tape Recorder or Record Player, the "Bookshelf 2" gives a remarkable performance judged on a size/price/mobility basis. Its outstanding performance is due mainly to the efficiency of its modern 10-in. unit (with the very low resonance of 25/30 c/s) and is fitted with flexible roll surround and polystyrene diaphragm to improve the bass and act as an acoustic filter. The special 5-in. treble unit is fitted with a volume control so that H.F. response can be adjusted to suit listening room conditions and position of speaker. Two of these handy speakers give very good results on stereo.

SIZE: 19 in. x 11 in. x 6 1/2 in. deep. IMPEDANCE: 8-16 ohms.

UNITS: Specially designed 10 in. WEIGHT: 18 lb. and 5 in. Speakers are fitted with Wharfedale Silver Magnets 12,500 lines flux density.

Polished walnut, oak or mahogany veneers **£16.10.0**

Unpolished **£15.15.0**

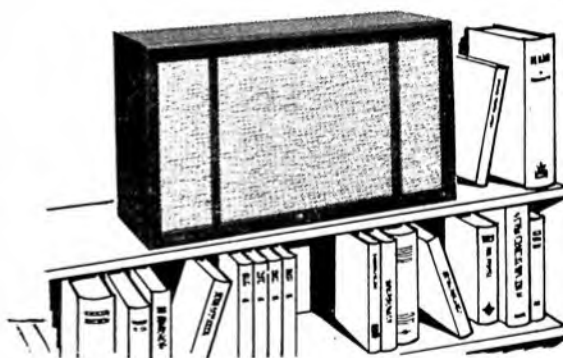

The clean low-frequency performance is clearly illustrated by the wave form oscillograms taken with an input power of 3 watts.

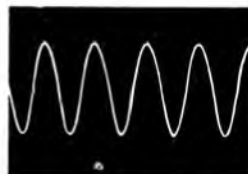

50 c/s

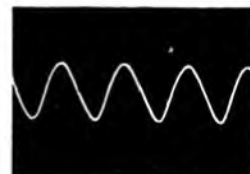

60 c/s

LOAD MATCHING:

When used with a set or tape recorder with small output at 2/3 ohms a WMT. 1 transformer is worth fitting for optimum results.

Free leaflet on request



WHARFEDALE WIRELESS WORKS LTD.

Idle, Bradford, Yorkshire Telephone: Idle 1235-6
Telegrams: 'Wharfdel' Idle, Bradford

LANGUAGE LABORATORY

WITH the growing need for trained people in every sphere, ways and means to speed the teaching process are always being sought. In recent years, there has been a major revolution in the U.S.A. in using the tape recorder for teaching. At present, while there are less than fifty language laboratories in England, there are more than 3,000 in North America. It is therefore interesting to investigate the needs and aims of such a laboratory and to outline some of the facilities required.

As the name "language laboratory" implies, this teaching method was initially devised to teach languages, but the use of such a laboratory is limited only by the imagination of the teacher. Although there are many different ways of putting together a language laboratory, this article will outline only one type, which will however cover many other less flexible designs.

Constant repetition of basic sounds

A baby, or young child, learns its mother tongue by constant repetition of basic sounds. An adult faces the problem that the basic inflections of his or her own language differ, often severely, from the inflections of the language he is learning. Also, the rules of grammar, the order of words, and most of all the idiom, are peculiar to each individual language. Unfortunately, the dialects within a country vary quite severely, and while it is a good thing to retain local dialects, it is unfortunate that, for example, a cockney and a person from Newcastle may find each other's English very strange.

However, this is all by the way. Let us assume we have a typical English person who is to be taught another typical language, and consider why and how the language laboratory can help. Taking a few things for granted, to be explained later, let us assume that the student enters a language laboratory which has been carefully designed. He would be assigned to a student position and would be presented with a combined head-set and boom microphone, a set of push-buttons, a volume control, three indicator lights and nothing else.

Out of sight, possibly under the desk top, would be a high quality tape-recorder, capable of complete remote control, and in front of the class would be the master, or masters, with rather more complex control panels.

On pressing the "Listen" button, the student would hear the master explaining vowel sounds, asking questions, or saying short sentences, etc. Between each section there might be a short pause. Having listened to the lesson, the student would press the "Rewind" button. The tape then rewinds automatically and stops at the beginning of the lesson. The student now presses the "Learn" button, and repeats or answers as necessary.

As the machine replays track 1, it now records the student's voice on track 2. At the end of the tape, the student again rewinds and now presses the "Revise" button. In this position, he hears the master recorded on track 1 and his own voice recorded on track 2. At this stage he is free to return and repeat in the "Learn" mode any inaccuracies he has found in his own voice. The only other buttons at his command which control the machine, are "Fast-Forward" and "Stop".

Coloured Light Indicators

Simple lights can be provided to show when the student is at either end of the tape. Green-beginning, and Red-end, for example. In these extremes, operational buttons would in turn become inoperative, so that the student could not run off the tape at either end. A third "On" light would also be provided—this light would simply indicate when a particular student position was operative. Finally, there would be a simple intercom to the master who could, on request, connect one student or another for interpreting or joint working.

In front of the student, and on either side, would be acoustic screens. Probably these would be removable so that the laboratory could be easily converted into a standard classroom. From the instant the student starts the lesson, he can work at his own speed. His effective concentration is much higher and with the ability to hear and correct his own lesson, the rate of learning is much faster. Obviously, this method can teach at any level.

Now let us consider the position of the teacher in such a laboratory. The teacher's console will also include at least one similar tape recorder,

★
This picture shows one of the most advanced language laboratories in Europe. Situated at the Teachers' training school Hørring, Denmark, this laboratory has been in use for the last eighteen months and has twelve student positions



★
but the facilities are necessarily more. Initially, the teacher would record his own lesson on track 1 of his master-tape. This recording could be made in the laboratory or on a similar recorder elsewhere. Facilities would be provided at the recording place to allow the teacher to record parts of his lesson from another tape, radio or gramophone.

Having made the master-tape, the teacher (having access to the student machines) would load suitable length tapes. The next stage is to start his own machine remotely on "play"; and to start the student machines on "Record", track 1. Thus the lesson is recorded. Possibly this would be done with the student listening, and so could effectively cover the "Listen" stage of the lesson.

Once the students are at work, the teacher must be able to hear what the student speaks or hears, and must also be able to stop the student's machine remotely, so as to help him by direct two-way conversation. Coupled to this circuit would be some indicating device, so that the teacher would know when the student wanted to speak to him. Possibly the teacher would require to record part of a student's tape for later discussion, and this could be done on a new tape put on the master machine for this purpose.

So, in outline, we begin to discover some of the basic requirements for the language laboratory. However, a given class may not fill the room; and our system, as so far explained, does not seem to allow more than one lesson to be taught. However, if the master records one lesson for half the students before they come in, this class can start straight away—listening, learning and revising—while the second class listens to the next lesson being recorded.

Even greater facilities may be obtained by using two or even three master control consoles. In such a laboratory each master would have the facility for selecting any of the student positions, and in this way up to six lessons (not necessarily in the same language) could be conducted at the same time. Since classroom space may be limited, this final installation offering every facility could be the cheapest on the overall costing.

What about the machine? As previously mentioned, full remote control is desirable so that the student, who may never have used a tape recorder, is not confused by operational requirements. For most European languages, a frequency response up to 10,000 c/s is adequate, with negligible wow and flutter and low distortion. For some languages, with very subtle phonetic sounds, an even better frequency response is necessary. To accommodate any language, the machines should operate at $3\frac{1}{2}$ i/s or $7\frac{1}{2}$ i/s, and where the response requirements were less exacting, the slower speed could be used. It would be up to the teacher to decide at what speed the students' machines would operate.

It will be realised that the laboratory described here is considerably more flexible than any so far installed in Great Britain. However, such a system could be manufactured at an economic price. Any reader who wishes to discuss this subject in more detail is invited to write to the Editorial office of the "Tape Recorder". The details for this short article were provided by Mr. Friedman of the A.V.L.A. (Audio Visual Language Association).

Index to Volume 4 of THE TAPE RECORDER
Available now - - - - Price 2s. 6d.

MAKE THIS RIBBON M

PART TWO

ASSEMBLY AND TESTING

MOVE the pole-pieces out of the way by taking out the top end 8 B.A. fixing screws and swinging them clear of the slot by pivoting on the bottom screws. When well clear, finger-tighten them temporarily. Remove one screw from each of the clamping plates at the top and bottom and slacken off the other. Swing the outer ($\frac{3}{16}$ in. thick) plate at either end clear of the inner one (which should remain in position) and lay the ribbon on to it. Carefully return the outer plate back over the ribbon and inner plate and replace the 10 B.A. screw, thus lightly holding the ribbon in place. It should be left quite slack, however, and the ribbon free to slide in the clamp.

Repeat the procedure with the clamping plates at the other end. The ribbon must now be lined up very accurately, so that it is central down the slot, and this can be done by referring to the $\frac{3}{16}$ in. wide guide marks made on the frame when it was under construction.

When it is straight and level tighten up the clamp screws at one end without disturbing the ribbon position. Before tightening up the other clamp the ribbon must be given a slight tension, and this can be done by

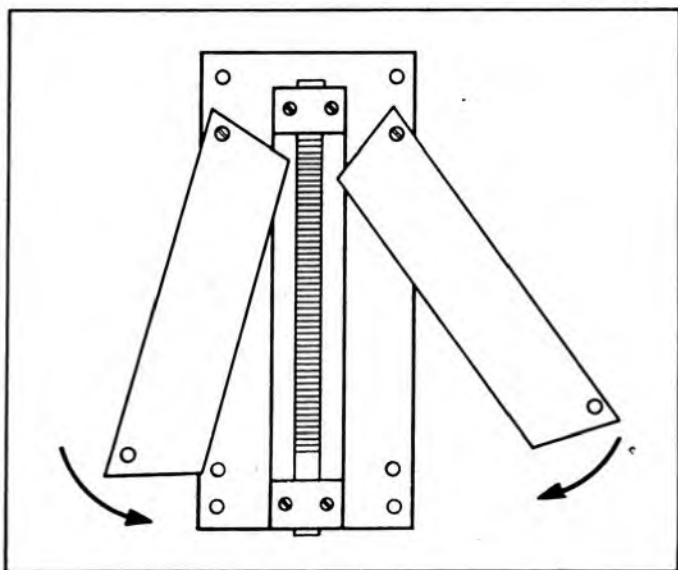

Fig. 8. *Swinging the poles back into position after fitting the ribbon.* placing the forefinger over the tail protruding from the slack clamp. Very gently slide it away from the clamp until the ribbon has no slack in it and tighten the clamp screws.

This tensioning technique is impossible to describe satisfactorily and it is necessary to use a certain amount of trial and error to find the correct tension. As a rough guide the ribbon should just bow slightly when *very lightly* blown on. Now elsewhere in this article I have emphasised the danger of wind on the ribbon so the care with which this puff must be made should be obvious.

When the tensioning has been done satisfactorily the polepieces can be returned to their working position. This must be done one at a time, taking care that they do not accidentally touch the ribbon. Whilst swinging them back keep an eye on the closing gap as they approach the ribbon, especially at the end nearest the pivoting screws. When back parallel to the frame the 8 B.A. holding screws should be replaced and finger tightened as soon as the holes line up.

There should be a gap roughly about $\frac{1}{16}$ in. between the poles and the ribbon at this stage. Now, whilst watching the gap through an eye glass, and holding it up to the light, very carefully tap the outer edge of each pole. The gap will slowly close up until it is about the thickness of a piece of paper. The holding screws should now all be tightened up. The setting

of this gap is not critical, but a close fine one will improve sensitivity; if there is any danger of fouling the ribbon the constructor is advised to leave it on the open side. Check now that there are no contact spots between the ribbon and poles with the eyeglass, and if all is clear the constructor may relax, knowing that he has completed the difficult part of the job. I found the fitting of the ribbon and aligning of the poles rather heavy on ribbons and did several dummy runs (using the spoil one first) until the technique was mastered.

The final job is the placing of the magnets, a simple matter, requiring only a few precautions. The two magnets used are very powerful for their size and attract iron particles in a disconcerting fashion. It is therefore advisable again to dust down the bench top, or to transfer the job to the dining room table before taking them out of their boxes. They should be applied slowly to the polepieces holding each item firmly to ensure that there is none of the usual flying together associated with magnets.

Each magnet should be placed as near to the end of the polepieces as possible, allowing a gap of about $\frac{1}{16}$ in. in the centre between them. Remember that these magnets are working in parallel and that the same poles of each must go on the same polepiece, *i.e.*, the two *Norths* together on one side and the two *Souths* on the other.

Although two magnets are shown on this microphone it will work with one, though with less sensitivity. In fact the design would be improved acoustically as there would be less shielding of the rear face of the ribbon. However, as the magnet layout was designed specifically for a high output, suitable for domestic recorders without pre-amplification, I felt that loss of rear sensitivity was less important. It still maintains a figure of eight response—if a little one-sided.

All that now needs to be done to the unit is the fitting of the leads to each end of the ribbon. The 10 B.A. screws on the clamping plates are long enough to protrude through the paxolin frame and still leave enough thread to accept a solder tag and nut.

If the unit is to be used upright, which is usual, then the indicated top and bottom shown in **fig. 6** should be noted. This will mean that one of the leads will pass down parallel to the ribbon and this should be duplicated and brought down each side of the frame. This is a minor precaution against induced interference and need not be done with the bottom lead which will leave the frame directly (see **fig. 1b** for details).

Testing

It will probably be realised by now that the ribbon microphone is essentially a low impedance instrument, and if the recorder only has a high impedance input then a transformer will be necessary to balance the circuit. Indeed, a transformer will be necessary anyway, as even low impedance inputs are around 20–30 ohms, whereas the ribbon is only a fraction of an ohm. There are several very compact microphone transformers on the market—at a price—but I decided that here again, to keep the cost down, something easily obtainable and cheap must be found. After some experiments, the common bell transformer revealed itself as apparently ideal in ratio and size. Using the 3 volt output terminals to link to the ribbon and the 230 volt input terminals to link to the tape recorder, a good, well balanced output was obtained with negligible hum. Details of the one I used are given at the end of this article though I don't doubt that any miniature type would do as well. As the output of the transformer is at high impedance, low loss co-axial cable should be used between it and the tape recorder.

Checking

To check the microphone it is helpful to be able to go up and down the musical scale, and a piano is very useful. Not only will it give a good idea of the frequency response and any excessive resonant spots, but it is a very critical test of tone quality. However, the constructor should not be too worried if the test recordings do not sound perfect, for a piano is a very difficult instrument to record domestically, even with a

MICROPHONE

commercially made microphone. I have been quite disappointed with the results of recordings made with one well known make until I discovered how damning room acoustics can be. Nevertheless this microphone has shown itself quite capable of passable piano recordings, far better than those made with the commonly used crystal types.

Some interesting tests can be made using typical domestic noises. Crockery rattling, newspaper crackles, hand-clapping, a sewing machine, or even the coke spitting in the stove all serve to demonstrate the microphone's ability to handle evenly a wide range of sound well and a remarkable realism is imparted to the recordings.

I cannot quote any test figures for its sensitivity, but I can give some results, if a trifle unscientific, on its actual performance. With my recorder (which is a Wyndsor "Victor") with its input control set almost at $\frac{3}{4}$ to full, I can obtain conversation recordings 2 ft. from the microphone at a perfectly adequate level on the tape. This setting will, of course, vary with individual recorders but it is at least equivalent to the test made with a commercial ribbon microphone and suggest that it would be satisfactory with most of the popular makes without pre-amplification.

If all the directions given have been followed correctly there should be little wrong, but variations in performance, due to incorrect ribbon tensioning are likely, and only trial and error can overcome this. A common fault is to overtension it. This tightens up, and nullifies the effect of the corrugations, lowers the output, and produces an unpleasant boxiness in the recorded sound. The ribbon must be slack enough to vibrate, almost like a concertina, without deforming or losing its exact position between the poles.

A persistent, complete failure of output, with everything apparently correct, may be due to the magnets being in opposition—*i.e.* a *North* on the same side as a *South*. A weak distorted output may be due to the ribbon fouling the polepieces.

If any of these symptoms appear *don't* on any account use a test meter to check the microphone's circuitry. Even the tiny currents used to operate the meter would cause immediate and irreparable damage to the ribbon by twisting it.

Excessive hum may be due to pickup by the transformer, which should be screened, or directly by the microphone. This is a point which must be borne in mind when using this type, as they are notoriously sensitive to electromagnetic hum. This one cannot be used within 4 or 5 feet of the radio or TV set, and it even detects the electric clock at a distance of a foot.

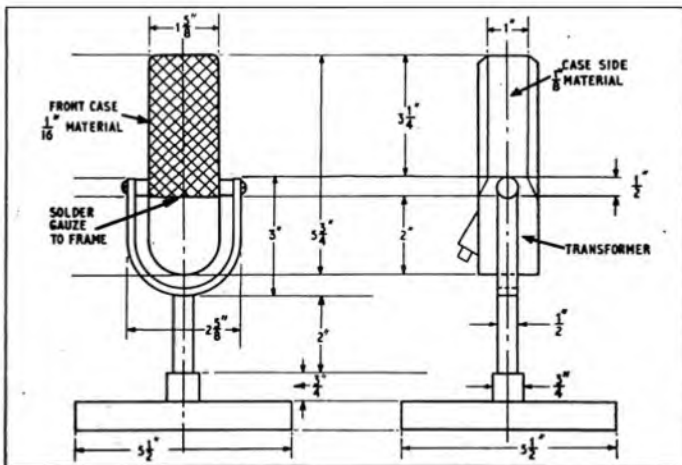
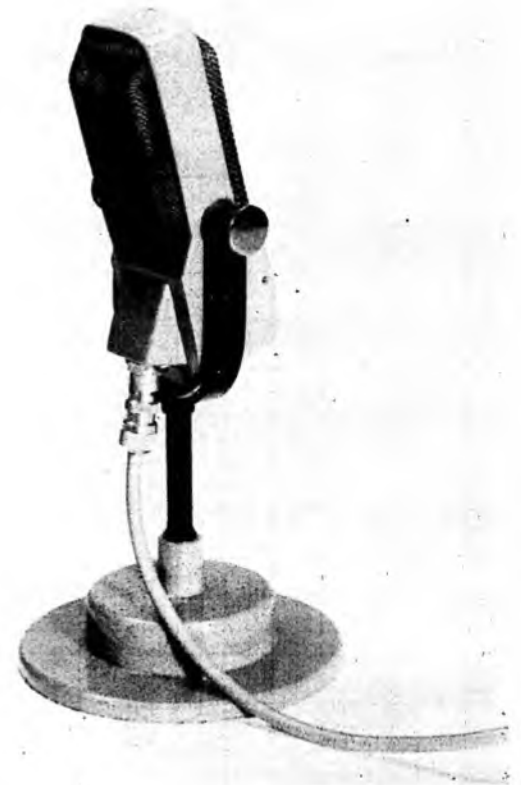

Fig. 9. A suggested design for the case. Note that the box may be round or square.



The case

Having decided that the microphone is working satisfactorily, some thought should be given to the case to house it in. Before this is done, however, it must be decided where to place the transformer. In the design shown in the photograph I have incorporated it in the microphone case, and the lead to the tape recorder is high impedance, using a coaxial cable. This makes for a neat compact setup for home use. An alternative setup is to have the transformer at the recorder end and to use a low impedance line to the microphone. This would consist of screened twin lead specially made for the job.

For indoor use in the average sized room there is little to choose between the two arrangements, but if one is going to be more ambitious and want long lengths (over 18 ft.), then it is usual to stick to low impedance lines.

A more professional solution to the problem would be to use a small transformer to bring the ribbon impedance up to about 30 ohms, thus avoiding the losses due to cable resistance in conjunction with the very low ribbon impedance, while retaining the advantages of relatively low impedance lines. If this is done it is possible to make direct connection to a recorder with a low impedance input (20-30 ohms), or to connect a further transformer *at the recorder* to take the impedance up to about 100 K. Having made that clear I will assume that the constructor will continue with the built-in version as shown in the photograph.

There are only two important points to be kept in mind when making the case. The first concerns the position of the openings. This type of ribbon microphone, to work well, requires both sides of the ribbon to have free access to the air. Although this point is partly nullified by the magnet design, it is, nevertheless, still worth keeping to in the case construction. The best method of mounting is, therefore, vertical, and having each side protected by a wire gauze or perforated grill.

The second point concerns the materials used for the case. They must be non-ferrous throughout, indeed the only permitted iron parts in its entire construction are the polepieces. Ideally, brass should be used, but as this material requires some metalworking skill, plastics, wood or even cardboard can be used as alternatives. Perspex springs to mind immediately as a very easily worked plastic, using it $\frac{1}{8}$ in. thick and with chloroform as the gluing agent. It can easily be bent when hot and it threads well if required. Wood and cardboard are rather less precise materials though will still make a workable case.

It is not proposed to give detailed drawings for the case as this will depend so much on the personal taste, handicraft ability, and the junk box of the constructor. I have, however, outlined the design shown in

(Continued on page 280)



for the professional

IRISH

—the recording tape that gives the finest fidelity possible. How? Through the unique Ferrosheen process. Exclusive to Irish tape, this process produces a mirror-smooth surface to a magnetic tape with distinct technical advantages to satisfy even the most meticulous professional. The Ferrosheen process makes for exceptional high frequency response (due to precise perfection of tape/head contact) . . . head wear is minimal . . . external lubrication unnecessary — less oxide abrasion, no lubricant build-up on recorder head . . . minimum drop out . . . maximum reduction of background noise. Your Irish Tape stockist, and other details including technical data, from A. C. Farnell Ltd. Hereford House, Vicar Lane, Leeds 2 Tel: 35111.

"IRISH", "FERROSHEEN" and "Signature Binding" are registered trade marks of Orradio Industries Inc., Opelika, Alabama.

Making a Ribbon Microphone—continued

the photograph in fig. 9 for anyone open to ideas. The dimensions given in the diagrams, by the way, are the minimum internal sizes necessary to house this microphone and its transformer.

The original case and stand were made of brass, the sides from a $\frac{1}{8}$ in. thick strip, 15 in. by $1\frac{3}{8}$ in. and the stand from a casting. In Perspex this thickness would still apply, though the base would have to be made of laminated pieces to build it up. The front and back are plates cut to fit the curve of the sides and the protective gauze is soldered to the tops of the plates. The edges of the gauze are strengthened by the addition of thin strips of brass soldered on to it, and this enables these edges to be a good, tight push-fit into the upper part of the case.

The aperture of the gauze is not critical, but a strong type capable of withstanding some pressure is advised. As additional dust protection a finer type can be fitted inside. Details of the gauzes are given in the notes at the end. It is worth noting that this gauze will virtually mould into corners and allow quite a measure of freedom in design. If perforated sheet is used (e.g. zinc sheet) then some allowance for cutting and soldering corners must be made.

The outlets for the cable should, if possible, be sockets fitted to the back plate (magnet side). This is a much better idea than having one of those irritating permanent leads so often seen fitted to microphones. In the diagram it will be seen that the socket is fitted at an angle. This is to enable the centre pin to clear the backplate, and to allow room for a lead to be taken into the case through a hole and on to the transformer. This will be more obvious when making the case, as the transformer occupies almost all the space in the bottom half of the case. If a non-metallic case is made it may help to reduce hum, etc., by lining it with aluminium foil and earthing this to the co-axial cable via the socket.

I should remind newcomers to this business that the co-axial shielding (which is of course a lead) should be connected right through the case, if of metal, and on to the output of the transformer. The laminations should also be linked to this common earth. In effect, therefore, only one lead of the output of the transformer needs to be insulated from the case.

It will be unnecessary to emphasise the delicacy of the assembled microphone to anyone who has just finished making it. Nevertheless, a few well chosen words may help to prevent that success disappearing in a welter of disaster through some unexpected pitfall. Let me list a few important *don't's*:

Don't use the microphone closer than 18 in. for two reasons, (1) Low frequencies become accentuated and boom and (2) condensation from breath may corrode the ribbon and poles and damage them.

Don't use it out-of-doors. The ribbon is very sensitive to wind and can be damaged by it. Heavy muffling can stop this if it *must* be used outside.

Don't expose the microphone in a dirty atmosphere where it is likely to be contaminated by iron particles. Ordinary fluff, etc., can be a menace, but magnetically attracted particles are absolutely disastrous. If this misfortune should occur the magnets must be removed, and cleaned if necessary, and the unit tapped gently to shake off the particles. If this fails then the whole thing must be stripped.

In view of this delicacy it should always be protected when not in use, and the least that can be done is to enclose it in a plastic bag. Professionally, the ribbon microphone is kept in a case and the constructor would be well advised to think on these lines.

In closing, I want to address a few words to those who have found the construction of the microphone straightforward. The design given here may be termed, in colloquial prototype language, a "Mark 2", and probably capable of many variations. I would urge them, therefore, whilst keeping to the few points essential in the design of a ribbon microphone, to try further experiments. Miniaturising of the ribbon and magnet assembly comes to mind as fertile ground for this and may possibly improve the overall performance. This will somewhat tax the fingers and eyesight but I can recommend it as an absorbing and rewarding exercise for those who prefer to obtain good quality recordings entirely by their own skill.

Stereo hi-fi is cheaper than you think ●

a postcard will bring you IDEAS IN HIGH FIDELITY

LISTEN — LOOK — COMPARE — good sound and good looks — NEW SCANDINAVIAN LINE FURNITURE

10 a.m. to 10 p.m. daily (Sundays from 6 p.m.) Closed Thursdays. MA1 0B55

STUDIO 99 57, FAIRFAX ROAD, SWISS COTTAGE
HAMPSTEAD · N.W.6 **LONDON**

WOW AND FLUTTER

WOW and Flutter are the names given to a slow and quick rise and fall in pitch, of any music or speech reproduced on a recorder. These pitch variations are caused by the alteration in tape speed past the recorder heads, and the alterations are produced entirely by the mechanical side of the recorder, that is, the capstan, pinch roller, take-up spool, feed spool, clutches, any idler wheels or belts, also brakes and pressure pads and, last but not least, dirt on any or all of these parts.

Wow is the slower of the two, and can be pinned down to any rotating parts used in actual tape transport mechanism. The Wow cycle will be found to correspond to one revolution of a revolving part incorporated in the tape drive.

Flutter, on the other hand, will be generated by only non-moving parts. Let us see how these deck parts effect play-back in these two ways, and what steps can be taken to produce a remedy.

Capstan and spindle

The capstan and spindle that actually drives the tape sometimes runs eccentric; that is, it runs out of true or wobbles, creating an artificial increase and decrease in its diameter. This of course increases and decreases the speed of the tape past the heads, in such a manner as to make a rhythmic variation in pitch of the music played. The cycle of this variation will correspond to one revolution of the capstan, creating a Wow. To rectify this fault the capstan can be re-ground true, *but only if the eccentricity is small*, because if too much is ground off the diameter the tape speed will be lowered. The easiest way for most people will be to replace it completely: trying to straighten it is out of the question.

The pinch roller

The pinch roller, or rubber wheel that holds the tape against the capstan, can also run eccentric or wobble, making the same artificial increase and decrease in diameter as the capstan; but the Wow is caused in a different manner—by the varying pressure between the roller and capstan. When the higher pressure takes place the capstan will be slowed down, and when the lower pressure comes into operation, the capstan and also the tape will speed up, creating this undesirable wow fault.

These two pressures (and therefore the two speeds) occur once every revolution of the roller. The remedy here is the same as before—grind the roller concentric or true with its bearing. The finished diameter is not so important here as with the capstan, as the loss in size can be taken up by the pressure spring that controls the movement of the roller. Of course a new replacement roller can be fitted if available.

Take-up and feed spools

Spools can cause trouble if warped or bent to such an extent that they rub on the deck face with each revolution. My advice here is to keep all empty spools in boxes, and do not pile other loaded spools or heavy objects on top of them. Also keep them away from heat. By the way, a little thing here—do not have long lengths of leader tape popping out the centre of your spools when they are being used, because these can affect the operation of the machine by flapping, rubbing, or in some cases, getting caught up with the bits and pieces on the tap deck top.

Idler wheels

Idler wheels run between the electric drive motor and the capstan, and are used to change to the different tape speeds at which the recorder is designed to work. Sometimes these wheels wear more on one side than the other (due to poor quality rubber) making them run eccentric, like the capstan and roller faults mentioned earlier. Flats or dents can be formed in these wheels by letting them remain in their working position when not revolving, that is when the machine is switched off. A small change in tape speed will take place every time one of these dents comes round. To avoid this trouble always press the mechanical stop button or knob *before* switching off the machine at the mains; then they will not be left in contact through an oversight. Remedy—regrind or replace affected wheel or wheels.

Belts

Belts can cause trouble if they are allowed to become perished or over stretched. Also grease and oil that gets on to any belt will give you

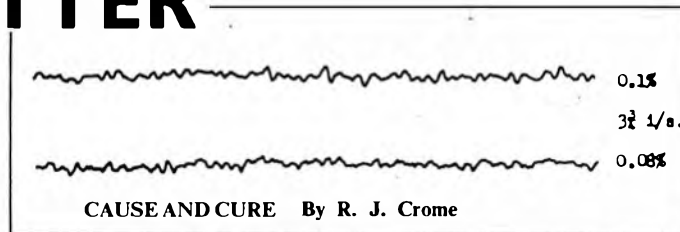

(An article based upon the author's personal experiences gained in modifying and repairing recorders.)

intermittent slipping, and Wow will result. If a belt does become oily, you can never really clean it properly, although a bit of french chalk will help. The only way is to replace it as soon as possible.

Brakes

Brakes stop the take-up and feed spools from revolving whenever the tape transport mechanism is not in use, and they should completely release the spool spindles when it is required to start up the tape either for recording, play-back, or fast re-winding. I have found that the brake drums on the spool spindles do not always run true, and if the brake pads, shoes or bands do not give sufficient clearance to allow for this wobble, a very distinct Wow will result. The remedy here is to adjust the brakes for more clearance, or to true-up the brake drums on a lathe, and, of course, buy a complete replacement.

Clutches

Some machines use clutches to provide a slipping drive to the spool spindles. These clutches can be affected by oil and dirt to such an extent that they either make the drive too fierce, or judder, or in bad cases not drive at all. If this happens, they must be taken apart and thoroughly cleaned. I have found that a little french chalk will make them run nice and smoothly again. This is the last of the Wow-creating parts of a tape deck. Now for *Flutter*.

Pressure pads

The Pressure pads come into the scene here. They are pads of felt that keep the tape in tight contact with the recording and play-back heads. I have known these to sing, or flutter, to such an extent that the frequency of the note they generate has been found to be superimposed on the tape when recording. This takes place because the tape has been allowed to come away and return to the erase-head by the vibrating pressure pad. Leading edge pads are the worst offenders. Trailing edge types do not seem to suffer as much from this annoying flutter. There are two ways of curing it. Either a very, very small smear of graphite on the pad faces, or in some cases I have fitted small damping weights in the form of pieces of bent solder over the pad-holding springs, clamps, or holders. It also helps if all pads are kept free from dirt.

Tape guides

Loose tape guides have been found to cause bad flutter, and here the remedy is obvious—replace. These also must be kept clean. By the way, I cannot emphasize too strongly the need to keep clean *all* parts that come in contact with the tape. Please do not (and I repeat, **do not**) use sticky tape to make tape splices, as the adhesive used will ooze out and spread all over the very parts that you wish to, and *must* keep clean, collecting dirt in a very alarming manner, in fact, literally "gumming up the works".

The Pimper

You may well ask "what is a Pimper?" As it is a very rare fault, I don't expect you have come across it, but believe me it exists. A *Pimper* is a capstan spindle that has developed a small hair crack down the outside, parallel to its axis. The metal on each side of the crack acts as the North and South poles of a very small magnet which has become magnetised by the constant passing of the tape. Every time the capstan revolves, a pip like the sound caused by a cracked gramophone record being played, will be recorded on the tape. De-fluxing the spindle will rectify the fault. . . . For a short time, but it will soon return. . . . The only remedy is complete replacement.

TAPE RECORDER COVERS



Smart waterproof cover to give complete protection to your tape recorder. Made from rubberised canvas in navy, wine, tan, grey and bottle green with white contrasting pipings, reinforced base, handy zip microphone pocket and name panel.

Grundig TK.1	49/6	Philips EL3536	70/-
" TK.5	55/-	" EL3515	57/6
" TK.8	63/-	" EL3541/15	57/6
" TK.14 & 23	59/6	" Starmaker... ..	66/-
" TK.20	52/-	Coscor 1602	57/6
" TK.24	55/-	" 1601	63/-
" TK.25	55/-	" 1605	84/-
" TK.30	60/-	Stella ST455	63/-
" TK.35	63/-	" ST454	57/6
" TK.40 & 41	66/-	" ST459	84/-
" TK.46	82/-	Saja MK.5	57/6
" TK.55	63/-	Stuzzi Tricorder	58/-
" TK.60	75/-	Saba	63/-
" TK.830/3D	63/-	Wyndso Victor	60/-
" Cub	35/-	Elizabethan Princess	60/-
Telefunken 85	65/-	" Escort	57/6
" 75/15 & 76K	55/-	" Major	63/-
" 95	69/6	" FT.1	66/-
Philips 8108	57/6	" FT.3	75/-
" 8109	63/-	" LZ29	75/-
" 3534	87/-	Fi-Cord	52/6
" 3459	79/6	Harting Stereo	66/-
" EL3538	63/-	Fidelity Argyle	55/-
" EL3542	63/-	Simon SP4	63/-
		Clarion (with strap)	52/6
		Brenell Mk.5	77/-
		" 3 star	69/-
		Minivox C	61/-
		Robuk RK.3	67/6
		Ferrograph	80/-
		Sony 521	90/-

*Without pocket. †Price to be announced

A. BROWN & SONS LTD.

24-28, GEORGE STREET, HULL TEL: 25413, 25412

REMOTE CONTROL TAPE DECKS

As a result of the great interest shown in these units at the London Audio Fair, the Planet UI and UI/15 are now available with semi or fully remote control operation.

Semi Remote Control Deck: the standard push button assembly is retained but in addition the start/stop function can be applied remotely.
Price (standard UI ½-track) £48.

The Fully Remote Deck has only one emergency stop button on the deck facia. The remote panel is attached by a cable giving stop and start, rewind left and rewind right facilities. The buttons on this panel are electrically inter-locked and also a space is left for amplifier switching.
Price (standard UI ½-track) £65.

The standard UI and UI/15 decks are being continually praised by experts throughout the world for outstanding quality, reliability and value for money. Send today for independent test reports.

Price UI £39. 10s. 0d., UI/15 £44 10s. 0d.

Available from local Hi-Fi dealers or direct from the manufacturers

TRADE ENQUIRIES INVITED

PLANET PROJECTS LTD.

GOODMAN WORKS, BELVUE ROAD, NORTHOLT, MIDDX.



The Grampian Ribbon Microphone

Exceptionally wide frequency response — virtually level from 40 c/s to 15 Kc/s—combined with excellent transient response, makes this the ideal instrument for the studio and wherever a high standard of fidelity is essential. Two models are available, each in three impedance sensitivities.

Model GR. 1, having a semi-cardioid response, gives approximately 10 db suppression to high frequencies at the rear face. It is ideal for overcoming problems of feed-back between microphone and speakers.

Model GR. 2, having a bi-directional "figure of eight" sensitivity pattern, discriminates against unwanted side noise both in the vertical and horizontal planes.

Supplied in attractive, padded instrument case, complete with 18 ft. screened lead, swivel holder and connector. **£11.10.0.**

Grampian

30 years' experience in the manufacture of high-quality microphones

A full range of accessories is available. Please send for illustrated leaflet. Enquire too for details of the famous Grampian DP4 range of Moving Coil Microphones
GRAMPIAN REPRODUCERS LTD
Hanworth Trading Estate, Feltham, Middlesex. FELtham 2657

Lee Electronics

TAPE RECORDER & HI-FI AUDIO SPECIALISTS

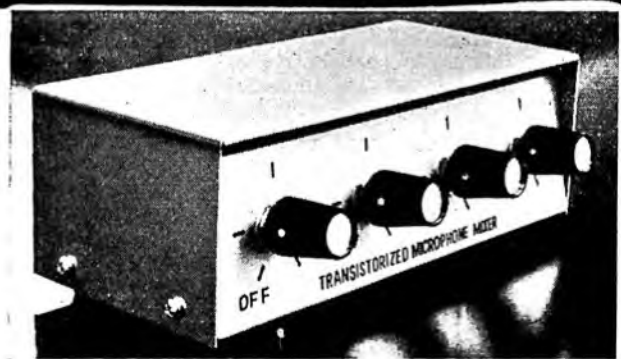

AT LAST A 4-CHANNEL TRANSISTORISED MICROPHONE MIXER AT A REASONABLE PRICE

Four high impedance inputs, e.g. four mics or two mics, one gram and one radio. Output gain approximately 6dB. Inputs, standard jack sockets. Battery PP3.

Price complete with PP3 circuit diagram, instructions etc

£3 - 19 - 6

TRADE SUPPLIED

Details of this, and other offers, available on request.

400 Edgware Road, Paddington

PAD 5521

by Richard Golding

SOUND AND CINE

A VISIT TO LARKINS ANIMATION FILM STUDIOS

THE animated film cartoon presents a generally exaggerated and comic view of the actions of humans, animals and objects. Its drawn characters have a fantastic ability to move in any possible way and it can be fused with any sound to get any desired effect. Technical animation is mainly concerned with the factual interpretation of methods or the working of things. It can show how a computer functions, how the eye-muscles move or even how a great organisation distributes its profits. By the means of animating a series of basic drawings of cross-sections, key factors or key situations it can make its point clearly and quickly and easier to understand.

The Larkins Studio has gained an outstanding reputation through developing both these forms of animation to a high degree in the service of both Industry and Education, sometimes blending the two so that they form an ideal vehicle for both entertaining and instructing at the same time.

Both types of animation contain an exact, many-staged process demanding extreme adaptability from a specialist team headed by a Director-designer. There are three Directors at Larkins—Denis Gilpin, Beryl Stevens and Dick Taylor—and these three have many prize-winning cartoons behind them. Among these, perhaps the brilliantly witty "Mr. Finley's Feelings", made in 1956 for the Metropolitan Life Insurance Company of New York, and the technical tour-de-force "Horlicks", 1962 Television Award winner at Venice, are best representative of the work produced at the studios, but the list does not stop there and every so often a new plaque is added to the boardroom wall.

To find out exactly what goes into one of these films I went along to the studios in London's Mayfair to watch the team working on the latest Dick Taylor film—"The Sure Thing"—a 14-minute informational cartoon with a strong humorous approach to British Insurance.

The film was in the shooting stage, that is, almost all scenes had been completed and whole sequences of artwork were in the hands of the Cameraman, but I was able to retrace through the previous stages to the cartoon's beginnings.

The Storyboard

The production followed the normal pattern for a Larkins film and the early ideas were developed by Dick Taylor into a series of captioned visuals. These later became the Storyboard or complete series of scene-by-scene sketches covering every action in the film. Once this Storyboard had been approved timing was taken from it and the sound-cue-sheets were charted together with the proposed music, dialogue and effects. These sheets then served as the complete guide for the soundtrack which, after being recorded, was transferred to 35 mm magnetic filmstock. (It is usual to record the track before any artwork is attempted, because, in animation it is generally easier to match the pictures to the sound rather than the reverse). In the meantime, several copies of the Storyboard had been made for use in the various departments.

Track reading

The sound track was then analysed on an *Acmiola* Editing machine equipped with variable speeds and a magnetic head, and broken down into beats with every word, syllable or effect marked on the film in wax-pencil. These details were then noted down on sound-timing-sheets and passed to the Director. From these sheets Dick Taylor worked out the action for each scene (the degree of pre-drawing for the animation guide varying, the Animator being allowed, in some cases, a fair amount of scope to develop his own ideas), drawing, scene-for-scene, character models and deciding on their tone and colour. He then finalised the overall design for the film, sketching out the backgrounds for the background artist. At the same time he fixed most of the limits or "fields" within which the drawn images were to move under the camera. Complete information for a scene, together with timing-sheets and a copy of the storyboard was then given to the Key Animator.

The Animator

The Animator is the artist who brings the character to life and he does this, initially, in pencil on thin, white animation paper. He draws only the extremes of action, that means for one second of film he may

Photographs by David Dunn-Yorker

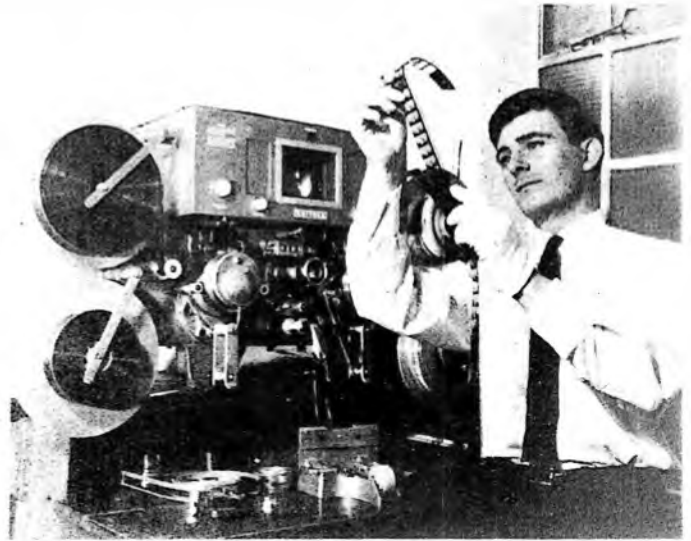

Bill Leach the Sound Editor examining a line test with the Editola in the background.

draw only frames 1, 6, 12, 18 and 24 and then he will hand these to his assistant (known as a "betweenner") who will draw the action for the frames in between.

Animation paper is punched with a set of registration holes and the Animator sits at a special desk fitted with registration pegs. The desk contains a turntable fitted with a ground-glass screen. The screen is back-lit and when switched on the light under the thin paper sheets makes it possible for him to see through several thicknesses so that the smoothness of the action may be observed through several frames of movement.

All drawings are given numbers and each scene has a number. For each scene there is a camera instruction chart or "dope sheet" on which the numbers of the drawings are written down in the sequence to be photographed for the line test. The dope sheets also contain information as to panning—tracking—mixing—and etc.

The whole scene is then given to the Cameraman for a line test to be shot. This is photographed over a light-box on B & W filmstock and the drawings are normally in four thicknesses for several levels of action may be going on at the same time. The line test is important for only when the Director sees his ideas on the screen can he be sure of success. The film is developed to negative and cut to the soundtrack. It is then screened in a negative picture to give white lines on a black background. When the Director and, in most cases, the Client, approve this version the tracing and painting can begin.

Tracing and Painting

Once the line test for "The Sure Thing" had been approved the subsequent copying of the line drawings could start. The numerous backgrounds had already taken form and presented an astonishing variety of materials used. For instance, the castle walls in the earlier scenes had almost entirely been drawn in different coloured magic marker inks on backing of white card. This method had been used both for speed in execution and effect. Gouache had been used on other backgrounds and even wax pencils had been employed to cut down on time.

The line drawings were handed to the tracing and painting department where the tracing and painting was done on paper and stuck on to sheets of cellulose acetate (cel). Each cel had been given a set of registration holes to correspond with those of the line drawings. The paints had been mixed in quantity and checked throughout the various sequences

(Continued on page 285)

REVOX STAND THE GREATEST TEST—TIME



For two years now the Revox Language Laboratory at Hjørring in Denmark has operated during day and evening classes virtually without a stop. The total servicing requirements of the entire system have amounted to no more than half a dozen calls by the local engineer.

Revox Language Laboratories are now in use in many centres in Europe. They are chosen in the face of less expensive alternatives, simply because they are easy to operate and outstandingly reliable. They provide every facility and are adaptable to any teaching system. If you are interested in further particulars, please do not hesitate to contact us.

REVOX—SOUND SUPREME

Write for further details to:

C. E. HAMMOND & CO. LTD., 296 Kensington High Street, London, W.14—WEStern 4343



Can't see clearly?

ARE YOU SO BLINDED BY VARIETY AND TECHNICAL SPECIFICATIONS THAT YOU CAN'T DECIDE WHICH TO BUY?

Don't worry! Tape Recorders are a specialised subject and you must get expert advice. You certainly won't get it from most shops, but you can from us—for nothing. **Who are we?** The biggest specialists in the country, who sell more machines than any other dealer, that's who!

Wherever you live (our Mail-Order service covers the whole of the British Isles), we offer you the best terms and service available, INCLUDING 18 MONTHS FREE H.P. ON MOST MODELS. Interested enough to know more? Full details of all our terms and free brochures on all the best makes are yours for the asking:

218 HIGH ST.,
BROMLEY,
KENT

RAVensbourne
4000 & 4477

HOWARD

TAPE RECORDERS · CAMERAS · HI-FI

SOUND AND CINE — continued

to see that there was no change in tone. This cutting out of the drawings from paper and sticking them on the cel is a departure from the normal procedure but it works exceedingly well and saves time in drying. The normal procedure, of course, is for each copy to be traced on the cel with special inks, using pen or brush. The reverse of the cel is then filled in with paint.

When all the cels in one scene were finished they were assembled with their backgrounds, checked carefully and then sent down with the dope sheets to the camera room.

The Camera Rostrum

In number three camera room, down in the basement, I watched Den Hall, head of camera department, handle a scene from the film. The rostrum, on which he was working, carried a special *Bell and Howell* animation camera designed to shoot one frame at a time. At the side of the giant rostrum finger-tip equipment allowed him fully-calibrated movement of the camera to track in or out as required, controlled movement of parts of the table in all directions—North, East, South, West and dimming facility for B & W filmstock. The table carried registration pegs and could be panned for about one foot in either direction at single moves down to .001 in. if required. The camera was fitted with a variable shutter for colour fading and it seemed that fades effected this way really did match. He told me that he can carry out 8 different exposures over the same section of the film and that he can guarantee a perfect result.

Following the instructions on the dope sheets, he first set the field or size of area to be photographed, he then placed down the background and then the cels in depth, finally bringing down a heavy glass pressure-plate to maintain perfect contact between cels and background.

The scene was very complicated for several levels of movement were required and every time a new frame was shot two or three cels had to be changed with it. When you consider that there are over 20,000 frames



Den Hall at the camera rostrum brushing the artwork carefully before bringing down the pressure plate and filming the shot.

in a 14 minute film you can appreciate the number of movements that this calls for on the part of the camera operator alone. You can appreciate, also, that full animation can be a costly process. "It can work out at over £1 per frame", said Den Hall, "but there are many short cuts that can be employed to cut down the cost. Nowadays, we tend to use double-framing more and more, shooting only 12 movements for every 24 frames (that is one second of film) for this is perfectly acceptable

with present-day design. In "*The Sure Thing*" there is quite a lot of double framing but when you see the film you will not be able to tell the difference."

The Insurance Image

I did see the film in its entirety, eventually, and I must agree with Den Hall that the animation certainly comes off. Some of the situations are exceedingly comic, especially where the story tells of the risks and



Dick Taylor working out the field with a graticule over the long panning background on his desk.

hazards throughout history. I liked, too, some modern scenes where hats of all shapes and sizes were used to demonstrate insurance cover for car users.

I understand that "*The Sure Thing*" will be available in the usual way for Society booking and will probably be ready for inclusion in this coming winter's programmes. If you book the film I think that you will be delighted with it for you will find the image of British Insurance presented in an always entertaining (sometimes hilarious) but sympathetic way.

In other words it looks very much like yet another outstanding success for Larkins and the Dick Taylor team.

PLEASE MENTION "THE TAPE RECORDER" WHEN REPLYING TO ADVERTISEMENTS.

AUTOMATED SLEEP-SUGGESTION

- WHAT IS SLEEP-SUGGESTION ?
- HOW DOES IT WORK ?
- HOW CAN IT BENEFIT YOU ?

SEND NOW for FREE BROCHURE for up-to-the-minute information on this vital subject.

EDUCATIONAL RECORDINGS LTD.
Dept. 13, 21 Bishops Close, Church Lane, London E.17

Two Years Guarantee

NOT MASS PRODUCED BUT VIRTUALLY HAND-MADE FOR RELIABILITY AND CONSISTENTLY HIGH STANDARD OF PERFORMANCE

R10 SPECIFICATION: 2 or 4 track version. 10 watts push/pull output.

Record Replay Responses—

7½ ips. 40–16,000 C.P.S. } ±3 dBs.
 3½ ips. 40–10,000 C.P.S. } At optimum
 1½ ips. 50– 6,000 C.P.S. } bias setting.

Signal/Noise ratio—

half track 50 dBs at 2½ ips.
 quarter track 45 dBs at 3½ ips.

Modified Collaro Studio Deck. Microphone and Radio/Gram inputs each with separate gain controls for mixing. Separate bass and treble controls. ± 12 dBs at 50 cycles and 12 k/cs. Adjustable monitor volume control independent of record level. Peak signal level meter 2¼ in. square. Bogen heads. Record safety device. 600 ohms Cathode follower output. Two per cent total harmonic distortion on peaks. 200/250 volts 50 cycles or 100/120 volts 60 cycles. Valve line up: 3 EF86, 2 ECC83, 1 ECC82, 2 ECL86. Metal rectifier, contact cooled.

Prices: 2 Track 7" spools 59 gns.
 4 Track 7" spools 69 gns.



Fully illustrated literature available on request—
REPS (TAPE RECORDERS) LTD.
 118 Park Road North, South Acton,
 London, W3 Phone: Acorn 4141

THE RECORDER CO. for best machines on advantageous terms

	Deposit		12 Monthly Payments		Cash Price Gns.
	£	s. d.	£	s. d.	
4-TRACK STEREO/MONAUROAL					
Akai M6	13	13 0	10	4 9	130
Ferrograph 424	11	12 0	8	13 2	110
Grundig TK46	10	12 0	7	15 7	99
Telefunken 97	10	0 0	7	9 7	95
Sony 464 CS	10	0 0	7	7 10	94
Siemens Mod. 12	9	16 0	7	9 5	93
Philips EL3534	9	16 0	7	4 8	92
2-TRACK STEREO/MONAUROAL					
Brenell STB 1	12	0 0	9	0 0	£120
Ferrograph 422	11	12 0	8	13 2	110
Telefunken 98	10	0 0	7	9 7	95
MAINS TWIN-TRACK					
Brenell 5 Type "M"	9	5 0	6	18 7	88
Ferrograph SA/N	8	19 0	6	13 10	85
Telefunken 85	8	15 0	6	10 8	83
Grundig TK41	8	0 0	5	17 11	75
Brenell 5/2 (Meter)	7	15 6	5	16 7	74
Brenell 5/2	7	5 0	5	8 8	69
Reps R10	6	4 0	4	12 11	59
Telefunken 95	6	4 0	4	12 11	59
Truvox R82	5	15 6	4	6 8	55
Grundig TK18	4	2 0	3	1 5	39
Truvox R62	4	2 0	3	1 5	39
Grundig TK14	3	13 6	2	15 2	35
Wyndor Trident	3	10 0	2	11 11	33
Elizabethan LZ30	3	7 3	2	10 5	32
Ferguson 3200	2	16 6	2	0 10	26

H.P. also over 18 and 24 months

Open Saturday until 6.0 p.m. Friday 6.30 p.m.

If unable to call, write for free brochure or send deposit now for quick delivery.

INTEREST FREE TERMS

Agents for FERROGRAPH, VORTEXION, REFLECTOGRAPH, SONY, GOODMAN'S, ETC.

Whatever the time - Wherever you are -
 you're completely independent
 with the NEW -

**UHER
 4000 S**

Price
93 gns.



Ever-ready
 leather carrying
 Case—9 gns. extra

4 speeds. 7½, 3½, 1½ and ¼ i.p.s. Reel size up to 5". Push button controls. Remote Control. Combined Record level/Battery Meter Indicator. Operated from rechargeable "Dryfit" storage Battery, or 5U2 batteries, or Mains operated Power Unit. Complete with Dynamic Remote Control Microphone and 5" Tape.

We will be pleased to demonstrate this fine model or send full details.

THE RECORDER CO.

(Dept. R) 188, WEST END LANE
 WEST HAMPSTEAD, LONDON, N.W.6.
 Telephone: SW1 4977

FREE DELIVERY · PART EXCHANGE

TAPE, RECORDERS & ACCESSORIES

FIRST DETAILS OF NEW PRODUCTS

● We remind our readers that notices of equipment listed and illustrated in this monthly feature are in no sense reviews. When figures, specifications and diagrams are published, these data are extractions from manufacturers' lists. When samples of this equipment are submitted for test, they are passed to our technical contributors, whose reports are published in a separate section.

LATEST arrival in the tape recorder line from Denmark is the Bang and Olufsen Beocord Stereomaster, which is the first machine available with a built-in three channel mixer. It is completely transistorised and has three tape speeds; $7\frac{1}{2}$; $3\frac{3}{4}$; and $1\frac{3}{4}$ i/s. Two track and four track versions are available.



Many interesting features are provided in this machine, they include: echo by means of delay from record and playback heads, synchronous monitoring for recording pilot tones for an automatic slide projector and monitoring the input and recorded signal.

The technical specification provided gives frequency response figures of 30–20,000 c/s at $7\frac{1}{2}$ i/s; 30–16,000 c/s at $3\frac{3}{4}$ i/s and 50–8,000 c/s at $1\frac{3}{4}$ i/s. The signal to noise ratio is claimed to be better than 50 dB. Harmonic distortion 1% at 5 watts, separation better than 45 dB and wow and flutter 0.2% peak to peak at $7\frac{1}{2}$ i/s. The power output is 8 watts per channel.

Separate bass and treble controls are fitted together with a balance control. The recording level is checked by two VU meters which have built-in pilot lights. A tape counter and automatic stop control is fitted. An interesting feature is the loop compensator which is fitted to prevent jerks when starting the tape on record or playback. The weight of the Beocord Stereomaster is 33 lb. and the price is approximately £126. Distributors Aveley Electronics Ltd., Ayrou Road, Aveley Industrial Estate, South Ockendon, Essex.

Beyer Microphones and Headphone

FI-CORD International are now marketing two new microphones and a headphone set manufactured by Beyer in West Germany.

The first of these is the high quality M66 cardioid dynamic moving coil microphone with a 180 degree suppression effective for the lowest

frequencies. It suppresses all unwanted sounds and there is claimed to be no distortion even with high sound pressure. The frequency range is stated to be 40–16,000 c/s. To suppress the pickup of noise through the body of the microphone, the internal unit is mounted in rubber. The price is £42 17s.

The other microphone is the M219, which has an omni-directional pattern and is also a moving coil type. The claimed response is 50–16,000 c/s. The price is £16 10s. 1d.

With a response of 30–17,000 c/s, the D96 headphones have been produced for high quality music reproduction and acoustical tests. The capsules are connected to a resilient headband without special leads to eliminate breaks. Sufficient volume is guaranteed even from low power voltage outputs. The price is £9 14s.

The distributors for these new products are: **Fi-Cord International, 40a Dover Street, London, W.1.**

Stuzzi have introduced four new recorders which will be available with or without built-in radios. The first of these is the 201, a two speed ($7\frac{1}{2}$ and $3\frac{3}{4}$ i/s) two track recorder. Seven inch spools can be fitted. The claimed frequency response is 40–20,000 c/s at $7\frac{1}{2}$ i/s. Facilities include monitoring, and superimposition. The dimensions are $13 \times 10\frac{1}{2} \times 6$ in., weight $16\frac{1}{2}$ lb. Price £47. 5s. The Model 202 is identical to the 201, but is fitted with a stereo pre-amplifier enabling the playback of stereo tapes. The price is £49. 7s.



A built-in radio is fitted to the Model 203 which is a single speed recorder operating at $3\frac{3}{4}$ i/s. Once again 7 in. spools may be fitted. Price £57. 15s. including Purchase Tax.

The last and most expensive recorder of the four is the Model 504 which has speeds of $7\frac{1}{2}$ and $3\frac{3}{4}$ i/s. This too, has a built-in radio with medium and long wavebands. The price of this four track recorder is £69 6s. including Purchase Tax. **The distributors are Recording Devices, 44, Southern Row, Kensington, London, W.10.**

Global Speed-Erase

BULK erasing tapes can be quite an arduous process when using the recorder to wipe out all the recordings made on any size tape. Four track recorder owners will know from experience before sending tapes to friends with two track machines. However an instrument called a bulk eraser will complete the task in a few seconds.

Latest of these to be announced is the Global Speed-Erase which can also be used for demagnetising recording and playback heads. It operates from A.C. mains and is used simply by depressing a button, placed against the tape reel and then withdrawn still with the button depressed. The instrument is full insulated and costs £2 2s. 6d. or £2 5s. post free. **Manufacturers: Global Products, 13 Stanley Street, Rothwell, Northamptonshire.**



AMERICAN HI-FI RECORDING TAPES
(made by C.B.S.)

New, Boxed & Guaranteed		
5 ins.	600 ft.	Std. 13/-
5 ins.	900 ft.	L.P. 17/6
5 ins.	1200 ft.	D.P. 30/-
5 1/2 ins.	900 ft.	Std. 16/-
5 1/2 ins.	1200 ft.	L.P. 19/6
5 1/2 ins.	1800 ft.	D.P. 35/-
7 ins.	1200 ft.	Std. 21/-
7 ins.	1800 ft.	L.P. 28/-
7 ins.	2400 ft.	D.P. 45/-

With leader and Stop Foil
Suitable for 1/2 & 1 Track Recorders



SPECIAL

**1 PRICE
2 OFFER**

**ONLY
3 GNS.**

**NEW GRUNDIG GCM 3
CONDENSER MICROPHONES**

Suitable for all makes of TAPE
RECORDERS and AMPLIFIERS

CASH WITH ALL ORDERS : BY RETURN : ALL POST FREE : ALL CALLERS WELCOMED

K. & K. ELECTRONICS LTD.
DEPT. T.R., 25/39 ROMAN ROAD, LONDON, E.2 Tel.: ADVance 1936

get even better

recording by using

THIS FANTASTIC MICROPHONE



MICROKIT
CONDENSER
MICROPHONE

For the first time, an authentic condenser microphone giving superb quality reproduction at a down-to-earth price is available. Top recording studios who use this microphone are continually amazed at its outstanding performance. The unusually high output (150mV) enables the microphone to be fed into any amplifier or tape recorder. Output impedance: 600 ohms cathode follower. The Microkit Condenser Microphone is available in kit form, with illustrated 'step-by-step' and easy to understand manual, or complete, ready tested and assembled. We offer a unique ONE YEAR FREE Replacement/Service guarantee with each microphone in either version. The Microkit Condenser Microphone is finished in 'matt-chrome' and has a swivel bracket and floor stand adaptor, together with power pack. Write, call or telephone for full technical specification, and remember, delivery is from stock!

IN KIT FORM FOR ASSEMBLY
20 gns
ASSEMBLED AND TESTED
25 gns

25 DENMARK ST., LONDON W.C.2
Telephone: COV 3026 Cables: Kassmusic London

world distribution
CHATEAU PRODUCTIONS LIMITED
Distributors of Professional Electronic Recording Equipment

<p>TAPE HEAD ASSEMBLIES Bradmatic, as fitted to COLLARO STUDIO deck (Erase & Record/Playback heads complete on mounting plate) 39/6 each, P & P 1/6</p>	<p>Ferrograph Series 5 85 gns. Vortexion 420 Series 110 gns. Wearite Decks from £42 Vortexion WV B £110.3.0 Vortexion CBL (Stereo) £160 Jason JTL Tape Pre-amp 29 gns.</p>	<p>TAPE OPPORTUNITY Brand new nationally famous brands offered at prices to save you £ £ £ £ £ £ £. Write for details . . .</p>
<p>TANNOY STUDIO MICROPHONES (Ribbon). List Price 18 gns. Now only £6/15/0 each. Limited number of these superb microphones available. P & P 4/-</p>	<p>The Tele Radio Master Mixer 4-channel High Quality Mixer 21 gns. The Master link M3 is produced specially to meet those instances where individual needs make it desirable to have a Pre-amp of exceptional quality and flexibility.</p>	<p>VERITONE Exclusive purchase of liquidated stock of the famous Veritone Company including Recorder Type 16. This superb machine has such an impressive specification that you must not miss this opportunity to write for full details or come in and hear it for yourself.</p>
<p>TRANSISTORED MIXERS Limited number of 3-channel mixers (Hi-impedance) 69/6 each, P & P 2/-</p>	<p>To Tele-Radio (1943) Ltd., 189 Edgware Road, W.2 Please send me the following equipment:..... Please answer the following Audio Questions:—..... To Audio Club, Tele-Radio (1943) Ltd., 189 Edgware Road, W.2 Please enrol me as a member of Audio Club. I enclose £1 membership fee for 12 months. Please send me free copy of Hi-Fi Year Book. Free Gift Voucher (worth 21/-) details of the Bonus Scheme and news about special deals. Name Address</p>	
<p>GRAM-TAPE DECK MOTORS Special offer of famous manufacturer's motors. 19/6 each, P & P 2/-</p>	<p>TELE-RADIO (1943) LTD. 189 EDGWARE ROAD, W.2 Telephone PADDington 4455</p>	

EQUIPMENT REVIEWED



★
**GRUNDIG
 TK18
 AUTOMATIC**

★

Manufacturer's Specification: Mains voltage: 210 mA, 230 V A.C. only. Power consumption: 60 watts approx. Fuses: 150 mA H.T., 400 mA surge resisting. Maximum spool size: 5½ in. Tape speed: 3½ i/s. Valves: EF86, EF83, ECC81, ECL86, plus two metal rectifiers. Recording sense: International twin track. Wow and flutter: ±0.2%. Frequency response: 40-12,000 c/s plus 3 dB minus 5 dB. Input sensitivities: Microphone, 2-45 mV. Radio, 100 mV-2 V, recording level automatically adjusted. Output power: 2.5 watt. Full recording level via tape: 700 mV (line output). Distortion factor: 6% maximum. Microphone input impedance: 1 Meg. Radio/Pickup, 1 Meg. High impedance output, 15 K. Extension L.S. 5 ohms. Loudspeaker: 5½ in. by 4½ in. elliptical. Hum and noise level from high impedance line output: 3 mV (-47 dB), from low impedance output 14 mV. Weight 20 lb. approx. Dimensions: 14½ in. × 11½ in. × 6½ in. Price: £40 19s. Grundig (G.B.) Ltd., Newlands Park, Sydenham, London, S.E.26.

HERE is a recorder with no record level indicator and no recording level control. The signal reaching the tape is maintained at optimum level by special A.V.C. circuits in the recording amplifier. So that, providing the input signals are above a certain minimum level, it is virtually impossible to make a really dud recording. I found it a bit disconcerting at first to have no magic eye or meter to watch, and no knob to twiddle whilst recording, but the results soon proved that the A.V.C. circuit could cope with almost any eventuality.

The styling, appearance and technical performance (apart from the automatic volume control facility) is almost identical with the TK14 recorder which I was rather surprised to find I reviewed as long ago as December 1961. The red recording knob can now be locked in the down position before pressing the start key, so that setting up for recording is no longer a two handed operation. The red button springs up whenever the stop key is used so that the circuit reverts to the playback position.

Speed Wow and Flutter

On the TK14 we had some slight trouble with tape speed, so this was first checked and found to be within 1% of the nominal speed of 3½ i/s.

Wow and flutter were measured by recording a constant 3 Kc/s tone and playing it through an audio F.M. discriminator circuit. The short

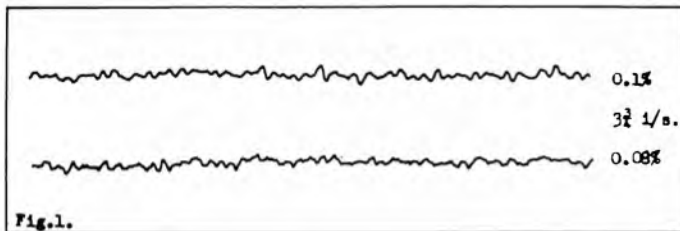

term deviations from a constant frequency (tape speed) were recorded on a high speed pen recorder to give the fluttergram shown in fig. 1. The integrated R.M.S. readings remained within limits of 0.08% and 0.1% showing that there was no predominant cyclical component which could add or cancel to give wide variations in the combined record and replay reading.

Play only Tests

A C.C.I.R. 200 microsecond test tape was played and the output measured at the high impedance line output to learn something about

the playback equalisation of this machine. Apart from a fall in bass response below 250 c/s, the response of fig. 2 is a classic example of a C.C.I.R. tape played on an N.A.R.T.B. equalisation (see my article in May 1962 issue). This proves that the playback equalisation is to N.A.R.T.B. 400 microsecond characteristic.

System noise and hum, with no tape running, was 36 dB below test tape level or 48 dB below theoretical peak recording level.

Record Play Tests

Before measuring the overall record replay response, it was necessary to find where the audio A.V.C. started to operate, otherwise the automatic control circuit could cancel all recording pre-emphasis and give some very peculiar results. A 500 c/s tone was recorded at radio input levels ranging from 0.1 V to 3 V, and it was found that the line output

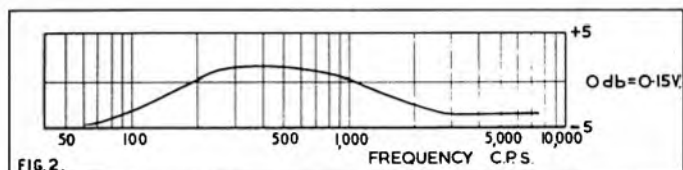

remained constant at 0.6 V for all inputs higher than 0.6 V. C.R.O. examination of the recorded waveform showed that it remained a true sine wave under all conditions.

Test tape level at the high impedance line output was 0.15 V, so that limiting level was precisely 12 dB above test tape level and corresponded to true peak recording level. Thus the full dynamic range of the tape is used, and signals, which would overload the tape normally, are turned down by the automatic control circuits so that no distortion can occur.

As N.A.R.T.B. high note pre-emphasis is very severe, amounting to over 20 dB at 10 Kc/s, the record play responses were recorded 10 dB below test tape level, or 22 dB below peak or limiting level. Fig. 3 shows the overall record-play response, and it will be seen that the bass fall of fig. 2 has been compensated by a corresponding rise in record current

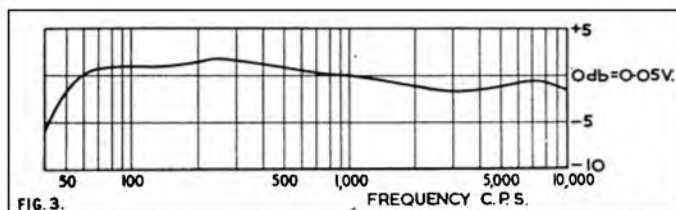

at low frequencies, and that the N.A.R.T.B. pre-emphasis has levelled the high note response to give a response level within 2 dB from 50 c/s to 10 Kc/s.

Tape recorded with the radio input short circuited showed an erase and bias noise only 1 dB above system noise so that signal to noise ratio, from tape noise to peak recording level, is 47 dB.

Acoustic Response

Twenty-five one third octave bands of filtered white noise were recorded on the tape at 10 dB below test tape level and replayed via the loudspeaker to give the acoustic response of fig. 4, which was measured on the speaker axis by a calibrated microphone. The tilted response confirms the subjective impression of slight bass heaviness on most radio recordings.

Circuit Notes

Our subject this month must obviously be the audio A.V.C. circuit. An ECC81 double triode is fed from the output of the record amplifier at a level of about 10 volts. The first triode is biased back so that only signals above a certain level, preset by a variable cathode resistor, are passed to the second triode. This is connected as a cathode follower to provide a low source impedance for a diode rectifier which rectifies the control signal to give negative D.C. bias for the first and second pentode audio amplifier stages.

(Continued on page 291)

**THE PROFESSIONAL FINISH
Starts With
LOW BACKGROUND NOISE**

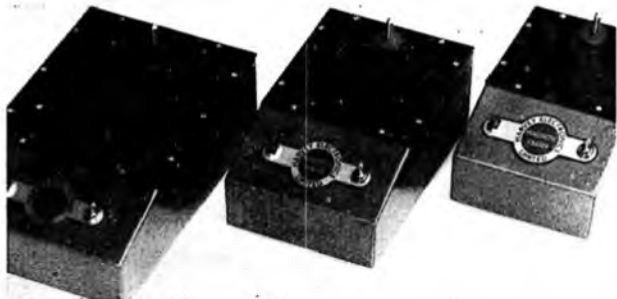

Harvey Electronics Bulk Erasers under test by an independent recording studio show an appreciable reduction in background noise. These units are available to amateur recorders as well as professionals and a complete range is available.

Model 102/103 200-250v/100-115v 3"-8½" reels £8-15-0

Model 104/105 200-250v/100-115v 3"-12" reels £14-5-0

(Special models available for ½" and 1" tape)

Write or phone for leaflet No. 109

HARVEY ELECTRONICS LTD.

Farnborough Road, Farnborough, Hants. Tel. 1120

Trade inquiries invited

**THE
Ferrograph
CENTRE**



NEW SERIES

MODELS

5A - 422 - 424

on

PERMANENT DEMONSTRATION

It pays to deal with a specialist

**USE YOUR TAPE RECORDER
FROM ANY D.C. SUPPLY**

You can operate your recorder from a car, caravan or boat battery, or from any D.C. mains supply with a VALRADIO D.C. CONVERTER. These D.C. converters enable you to operate T/RECORDERS, etc., for play-back music, telephone conversations and reports whilst on long journeys, in addition to making outside recordings.

Electronic types of converters are also available for 200/250 D.C. with outputs up to 200 watts 50 c/s. from ships' supply or D.C. mains.

Available for practically all makes of recorders, record players, radiograms, amplifiers, etc., with prices ranging from £7.3.0., VALRADIO D.C. CONVERTERS add versatility to your equipment.

For further details
just post coupon below to:



Valradio

LIMITED,
Browells Lane,
Feltham, Middlesex.
Tel. Feltham 4242 & 4837



Valradio and Stereosonoscope are the registered trade marks of Valradio Ltd.

Please send me fully descriptive leaflet, ref: TR on D.C. CONVERTERS for tape recorders and other equipment.

NAME
ADDRESS
Make and type of equipment:.....
D.C. volts in:..... A.C. watts out:.....

BINDERS

for
THE TAPE RECORDER

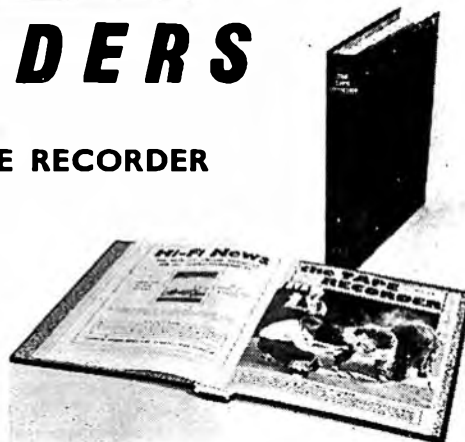

Semi-permanent Binders for
Volume 5 now available.

From the first number keep your copies clean and ready for easy reference. Semi-permanent binders are available for volume 4. Each case will take twelve copies plus index and will open flat at any page. They are covered in black buckram and gold blocked on spine with name and volume number. Also available, volume 3.

Price 15s. post free.

MILES HENSLOW PUBLICATIONS LTD
99 MORTIMER STREET, LONDON W.1

EQUIPMENT REVIEWED — continued

Thus all signals above a predetermined level are rectified to alter the grid voltage of the record amplifier so that the gain of this amplifier is inversely proportional to the control signal.

Comment

My only criticism concerns the rather low sensitivity of both microphone and radio/pickup input circuits. Few tuners, pickups, or normal Ext L.S. sockets provide a mean signal much above 0.3 V, and I feel that the excellent A.V.C. circuit will be called into operation only very occasionally on abnormally large radio inputs or when shouting an

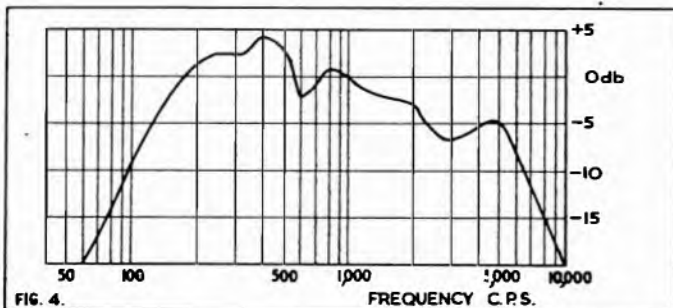

inch or two from the microphone, but perhaps that is as it should be, and that further experience with the circuit would convince me that Grundig have selected the correct operating conditions.

I must admit that I half expected a quiet whisper at several yards from the microphone to be recorded at about the same level as loud voice only a few inches away. Instead it sounds like a perfectly ordinary tape recorder set at about half gain, with the whisper down in noise and the loud voice recorded normally, a shout does not actually distort, but it does sound louder than the loud voice.

I suspect that if the sensitivity were to be increased to meet my criticism I would be very conscious of changes in the level of the ambient acoustic background noise as the sound input varied. What I am asking for in fact is a volume compressor, as used in film and TV recording, and not an automatic volume control.

A. Tutchings.

Manufacturer's Comment

Without knowing precisely the sequence of operations adopted by the Reviewer it is difficult to comment on a number of points raised.

It struck us as significant that the Reviewer did not mention the different time delays incorporated in a machine to ensure that the full dynamic range is embraced by the TK18 when pianissimo and fortissimo passages are recorded in alternating fashion.

The AVC control amplifier contains a delay network which is so designed that after the correct recording level has been found, this is kept constant for long periods even if the signal amplitude decreases.

When using the radio (extension loudspeaker/gramophone pick-up) input then a signal of high enough amplitude to cause a reduction of the recording level to almost minimum (to prevent distortion) will maintain this recording level for a long period. In fact, assuming that no other signal is fed into the machine after the initial burst, it will take fifteen minutes until the machine has again attained a maximum recording level setting. When the microphone is used (i.e. when microphone selector button is depressed) then, because of different circumstances which prevail when making microphone (mainly speech) recordings, a time delay, under the same conditions as above of three minutes only is provided.

Additionally it must be pointed out that the AVC network does not come into operation until a small input signal is fed into the machine. The purpose of this is to prevent the recording at maximum level of hum and noise signals when no recording signal is fed to the machine.

The tests conducted by the Reviewer depend very much on their sequence and whether sufficient time has been allowed for the machine to settle down to any given condition. For example, measurements for input sensitivity are only valid if one starts at the low end, not if one starts at the high end. Otherwise sufficient time must be allowed to lapse in each case (depending on which input is selected) to allow the machine to adjust to the newly found conditions.

Obviously, input levels, output amplitudes and distortion are intimately related and although a maximum distortion figure of 6% is quoted in our Specification, no such high level is in fact met in practice.

YOUR TAPE DEALER

Specialists in Hi-Fi Equipment and Tape Recorders

CHELSEA RECORD CENTRE

203 KINGS ROAD, S.W.3 FLA 2596

Open till 8 p.m. (except Thursdays)

Disc and Tape Reproducing Equipment and Tape Recorders
by Leading Manufacturers

Custom Built Installations

All High Fidelity Requirements and Services Available
Estimates Free Personal Service

Custom High Fidelity

371 Green Lanes Palmers Green N.13 PALMERS GREEN 5228

hifi

FOR ALL LEADING
AUDIO EQUIPMENT

call, write, or telephone

hampstead HIGH-FIDELITY

91a Heath Street, Hampstead, London N.W.3 Telephone HAMpstead 6377

ENGLAND'S BIGGEST T/R SPECIALISTS

HOWARD

218 HIGH ST. - BROMLEY - RAV. 4000

LASKY'S RADIO

ALL LEADING MAKES IN STOCK

Cash or Easy Terms

LONDON'S FINEST SERVICE

207 EDGWARE ROAD, W.2

PAD 3271/2

152-153 FLEET STREET, E.C.4. FLE 2833

33 TOTTENHAM COURT ROAD, W.1. MUS 2605

★ PART EXCHANGES WELCOMED ★

- ★ ALL MAKES Hi-Fi and Tape Recorders supplied
- ★ PART EXCHANGES. Terms 12, 18 or 24 months
- ★ SONY Specialists. Full Range Stocked
- ★ GUARANTEED Recorder Repair Service

MAC'S CAMERA SHOPS LIMITED

258-252 KING STREET, HAMMERSMITH, LONDON, W.6

RIV 8581-2 Hours 9-6 Thursday 9-1

SHEEN TAPE RECORDER CENTRE

SPECIALISTS IN TAPE RECORDERS, ACCESSORIES, HI-FI EQUIPMENT
YOUR CENTRE FOR FRIENDLY HELP—SALES AND SERVICE

8 STATION PARADE,
SHEEN LANE, SHEEN,
LONDON, S.W.14

Showrooms Open until 7 p.m.

PROSPECT 0985

(Opposite Mortlake Station S.R.)

CROYDON'S TAPE RECORDER CENTRE

All leading makes in stock, Hi-Fi equipment, cabinets, etc.
Service agents for AKAI Tape Recorders

SPALDING ELECTRICAL LTD.,

352/354, Lower Addiscombe Road,
CROYDON.

ADDIscombe

1231/2040

— YOUR TAPE DEALER —

MANCHESTER
LANCASHIRE HI-FI Limited
and now incorporating
The Tape Recorder Specialists
DIXONS ELECTRONIC (Sales and Service)
8 DEANS GATE next to Grosvenor Hotel

TAPE RECORDERS and HI-FI

The Largest Electrical Store in the North

Fenham Radio

158, NEW BRIDGE STREET,
NEWCASTLE UPON TYNE 1
Telephone: 29866

WESTWOOD'S of **OXFORD**

46 GEORGE STREET
PHONE: 47783

PETERBOROUGH, NORTHANTS Tel: 5643/5644

CAMPKINS RECORD SHOP
RECORD TAPE AND HI-FI EQUIPMENT SPECIALISTS

NEW ADDRESS **15 LONG CAUSEWAY** LARGE STOCKS
(IN CITY CENTRE)

HAMILTON ELECTRONICS
HIGH FIDELITY TAPE RECORDERS **35 LONDON ROAD**
SOUTHAMPTON
TEL. 28622

18 QUEEN STREET **SALISBURY**
J. F. SUTTON
RECORDS — RECORDERS — HI-FI
421 SHIRLEY ROAD **SOUTHAMPTON**
111 EAST STREET

Audio Electronics (Midlands) Ltd.
Specialists in Dictation Mcs., Tape Recorders, Inter-Com., Tapes and Accessories
Full After Sales Service on all Equipment
PHILIPS, GRUNDIG, TRUVOX, UHER, ETC.

203 STAFFORD STREET WALSALL Tel.: 21086

WORTHING, SUSSEX
We stock Hi-Fi Equipment by Leak, Quad, Goodsell, RCA, Acos, Garrard, Collaro, Tannoy, Wharfedale and Goodman and give fully comparative Demonstrations

BOWER & WILKINS LTD.
1 Becket Bldgs., Littlehampton Road Worthington 5142

CLASSIFIED ADVERTISEMENTS

Advertisements for this section must be pre-paid and accompanied by a postal order, money order, or cheque. The rate is 6d. per word with a minimum charge of 7/6. Box numbers may be used for an extra charge of 1/6. The trade rate is 9d. per word, plus 2s. for a box number, conditions on application. Send replies to box numbers, c/o "The Tape Recorder", 99 Mortimer Street, London, W.1.

No responsibility will be accepted by the editor, the publishers, or the printers of *The Tape Recorder* for the quality of any goods offered, bought or exchanged through the medium of these columns, or for any failure in payment, etc., though the greatest care will be taken to ensure that only bona fide advertisements are accepted.

Advertisements for the September issue must arrive not later than August 2nd.

FOR SALE

Find that review you want—get a copy of the index for "Tape Recorder", volumes 1, 2, 3 and 4. Price 2s. each volume, plus 6d. postage, from 99 Mortimer Street, London, W.1.

Easysplice Tape Splicer makes accurate splicing easy—guaranteed 5s. 6d. Scotch Boy splicing tape 3s., P. & P. 6d. Easysplice, 30 Lawrence, Ealing.

Simon Minstrelle, Table Portable. Garrard Magazine Loading Deck. Built in Mic. Bought 18 months, £43. Good condition. £15 o.n.o. Write Box (Middx) 318.

Akai stereo tape recorder, Model M7, never used, all accessories, must sell. £100.—A. Mark, 56 Gibson's Hill, London, S.W.16.

Fi-Cord 212. As new, leather carrying case, Beyer M119 Mike, mains power pack, leads, new batteries, extra tapes, £60.—Box No. (London) 319.

Underpillow Speakers. Listen without disturbing others. 3 in. x 5 in., 15 ohms, £2 11s. 6d. Timer Unit, designed especially for whisper teaching, famous make. 3 on/off periods in 24 hours. 13 amp., 200/240 V., comp. plugs, etc., £6 13s. 3d.—S.P. Ltd., York House, Huddersfield.

TRADE

A Service for the Connoisseur. Ferrotape available by post, all sizes in stock. Also Hublok empty spools. Send for price list.—J. Turner, 51 East Street, Horncastle, Lincs.

Ferrograph 5A/N, 422 and 424, Revox F36, etc., always in stock.—City and Essex Tape Recorder Centres (see page 276).

Tape and gram equipment repairs/mods.—Harding Electronics, 120A Mora Road, Cricklewood, N.W.2.

Deimos Ltd., announce an outstanding new type of amplifier. This is the most versatile unit ever offered to the tape enthusiast, mono or stereo, magic eye or meter up to 7 mono channels etc. Specifically suitable for the Planet Decks. Send for full details to 8 Corwell Lane, Hillingdon, Middx.

Recorder need Repairing? Then let City and Essex Tape Recorder Centres do it for you expertly and economically (see page 276).

Cinesmith Depolariser demagnetizes your record/playback heads in situ. Use occasionally for better recordings without hiss and with background silent as the grave no matter how often played. From your dealer or Cinesmith Products, Regent Street, Barnsley. £2 5s. Write for leaflet.

Pre-recorded tapes. Unique complete catalogue listing all makes, mono, stereo. 7½ and 3¼ i/s including World Record Club tapes. Call for free copy or send 1s. mailing fee. Dept. T.R.3 Teletape Ltd., 33 Edgware Road, W.2. PAD 1942.

Erase tape in seconds with the Global Speed-Erase. 45/—Global, 13 Stanley Street, Rothwell, Northamptonshire.

NEW PRODUCTS — continued

Sound and Vision Recorder

THE first tape recorder which will record vision as well as sound has been developed in this country by NEV (Nottingham Electronic Valve). Not only will this unit be incorporated into television sets, but also be available as a separate unit. Called Telcan, this unit will record one programme on television whilst the operator is watching the other channel.

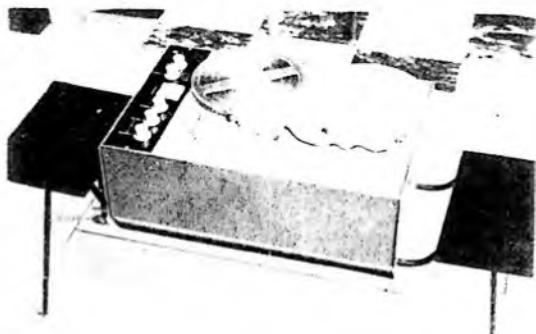

It operates in the same way as any sound recorder with instant play-back, using $\frac{1}{4}$ in. standard tape which can be used time and time again. For use as a separate unit, for use in conjunction with existing television sets and for sound only recording the price is £61 19s. Built-in to a television set, it is claimed that the cost of the set would be higher by about 25%.



The Telcan unit can be produced to operate on 405, 525 and 625 lines. Tape speed is approximately 120 i/s, but using 11 in. spools, two fifteen-minute programmes can be recorded using the two tracks. The signal is taken direct from the sets detector, amplified and assembled in a form that can be recorded on magnetic tape.

The commercial development of Telcan is the result of work carried out by a partnership of technical and commercial knowhow with the final breakthrough coming within the last three months.

Transistor Oscillator Test Set

TO overcome the limitations imposed by the relatively short duration of the various frequency bands on test discs and tapes, Lowther have produced a transistorised oscillator test set providing four fixed frequencies at constant level. The frequencies covered are 100 c/s, 1 Kc/s, 5 Kc/s, and 8 Kc/s, and for many setting-up purposes these should be adequate. The lowest frequency may be used for correct loudspeaker phasing and to check the efficiency of bass and rumble-filter controls; 1 Kc/s can be used for reference purposes; 5 Kc/s is useful for determining correct speaker positioning for stereo; and 8 Kc/s is suitable for tape-head alignment and checking the effects of treble and filter controls. Other frequencies may be obtained to order.

The unit operates from a PP7 battery and measures $5\frac{1}{2} \times 3 \times 2\frac{1}{2}$ in. Connections are via phone plugs and the price is £8. **Manufacturer: The Lowther Manufacturing Co., Lowther House, St. Mark's Road, Bromley, Kent.**

— YOUR TAPE DEALER — — Country and Provincial —

BOURNEMOUTH

NATIONAL RADIO SUPPLIES

66 Holdenhurst Road,
Bournemouth

Tape, Hi-Fi & components

Tel. 25232

H. D. KIRK

Stereolectrics

LIMITED

Specialists in High Fidelity — Phone: 23093
150 HIGHER BRIDGE STREET

BOLTON

R.E.S. (COVENTRY) LTD.

SPECIALISTS IN HIGH FIDELITY and all makes of Tape Recorders

All leading makes of High Fidelity Equipment stocked and demonstrated under ideal conditions. ★ *The Best Selection—Terms and After Sales Service in the MIDLANDS.*

R.E.S. (Coventry) Ltd. 128 Far Gosford St.

Coventry 28781/2

FARNHAM, SURREY

- ★ Stockists of all the leading makes of High-Fidelity Equipment
- ★ Comparative Demonstrations
- ★ Cabinet Manufacturers and Designers
- ★ Personal service and satisfaction guaranteed
- ★ Specialists in custom-built Hi-Fi Equipment

LLOYD & KEYWORTH LTD, The Record Shop

26/7 Downing Street, Farnham, Surrey. Telephone: Farnham 5534
SURREY AND HAMPSHIRE'S HI-FI DEALERS

TAPE RECORDER CENTRE (HALIFAX)

Stock all the best Tape Recorders; Hi-Fi Equipment;
Tape; L-P Records, etc.

DEMONSTRATIONS DAILY BY EXPERT STAFF
2 years FREE SERVICE ON NEW RECORDERS over £35

30 King Cross Street, Halifax. 'phone 66832

LEICESTER

ALL YOUR HI FI REQUIREMENTS

Speakers by: H.M.V. QUAD LEAK ROGERS
TANNOY MORDAUNT LOWTHER W.B.
WHARFEDALE GOODMANS.

Tape: FERROGRAPH REFLECTOGRAPH GRUNDIG
SIMON BRENNEL

Record Department: ALL LABELS-PARASTAT SERVICE.

LEICESTER CO-OPERATIVE SOCIETY LIMITED, High Street, Leicester. Tel: 20431

STOCKPORT

FAIRBOTHAM & CO. LTD.

47 LOWER HILLGATE STO 4872
FERROGRAPH, REVOX, TANDBERG, BRENNEL,
SIMON, TRUVOX, SONY, PHILIPS, MAGNAVOX
All models on comparison demonstration
Evening demonstrations by appointment

PLEASE MENTION "THE TAPE RECORDER" WHEN
REPLYING TO ADVERTISEMENTS.

CLASSIFIED ADVERTISEMENTS

"Bel Clear" Canadian Tape (Guaranteed). 5 in. 600 ft. 12/6 (16/-); 5 in. 900 ft. 15/- (18/6); 5½ in. 1200 ft. 18/6 (23/6); 7 in. 1200 ft. 18/6 (25/-); 7 in. 1800 ft. 25/- (35/-). Also American "Brand Five" (prices in brackets). Postage 1/3 per reel.—Blakey, 27 Cookridge Street, Leeds 2.

Summer Sale of quality Tape Recorders. Part-exchange Ferrograph 4/AN, in very nice order £52. Shop soiled Dem. model Brenell Mark 5.M. reduced from 89 gns. to 68 gns. in perfect condition.—Lancs. Hi-Fi Ltd., 8 Deansgate, Manchester.

Use up those odd lengths of tape, splice them together professionally after reading "How to Splice Tape", price 2s. 6d. posted, from The Tape Recorder, 99 Mortimer Street, London, W.1.

All makes of tape recorders repaired or modified. Miniflux heads supplied "Audiomaster" equipment serviced. Audio installations built to your specification by John C. Latham, Deimos Ltd., 8 Corwell Lane, Hillingdon, Middlesex.

Full building instructions for the remarkable "Tricolumn" loudspeaker are available in reprint form from Hi-Fi News, 99 Mortimer Street, London, W.1. Price 2s. 6d. post free.

Collaro Studio Tape Deck. Official Spares and Service. New Decks can be supplied mounted on plinths with ½ track or ¼ track heads. Monitor heads also available. Hampstead High Fidelity, 91a/b Heath Street, Hampstead, N.W. 3. HAMPSHAD 6377.

A Unique Buy! Recording tape top brand, 5½ in. 1200 ft. 19s. 6d.; 7 in. 2400 ft. D.P. 28s. 6d. P. and P. 1s. 6d. per spool. Bargains in all sizes. S.A.E. for list. E. C. Kingsley & Co., 132 Tottenham Court Road, London, W.1. EUSton 6500.

WANTED

Good Cash prices for tape recorders.—Tel.: Maryland 5879 (see page 276).

"An Hi-Fi enthusiast in North London seeks audible specialist for installations, modifications and service repairs for his own private equipment. Day, evening or week-ends.—Please write details of time availability, approximate charges, experience/capabilities, etc., to Box No. 320.

EDUCATIONAL

Frenchman teaches French by tape recorder. Captivatingly vivid 1963 style lessons. Takes half the time to learn at home by post. (Also Spanish). To enrol, write—R. de Breville, 22 University Street, Belfast, 7.

"Sleep Learning"—the book essential for all go-ahead people. Send 6/6d. to York House, Dept. A, Huddersfield.

TAPE TO DISC

Tape to Disc service, editing, and dubbing, all speeds. Studio available for musical groups. Outside recordings our speciality. Ilford Sound Recording Service, 63 Aintree Crescent, Barkingside, Ilford, Essex. Telephone: CRE 8947 and GRA 5107. S.A.E. for list.

Rapid Recording Service, 78s and L.Ps. from your own tapes. (48-hour service) Master Discs and pressings. Recording studio. Mobile recording van. Manufacturers of the Sleep-o-matic Unit. Foreign language courses available for sleep-learning. Brochures and price lists on request from Dept. T.R. 21 Bishops Close, London, E.17.

Tape to Disc Recordings. Finest professional quality, 10 in. L.P. 35s. (32 min.); 12 in. L.P. 40s. (45 min.); 7 in. E.P. 17s. 6d. 48-hour Postal Service. S.a.e. for leaflet to: Deroy Sound Service, 52 Hest Bank Lane, Hest Bank, Lancaster.

— TAPE TO DISC SERVICES —

The following are members of the Association of Professional Recording Studios who can be relied on to give satisfaction

MJB RECORDING & TRANSCRIPTION SERVICE

specialise in the production of microgroove records from Professional and Amateur recordings (Acetate copies; Mono and Stereo pressings). Extended playing times achieved by controlled cutting techniques. Studio, Mobile, "Off the Air" and all recording services. Detailed booklet available.

7 HIGH STREET, MAIDENHEAD (Tel: 25630)

TAPE RECORDERS - AUDIO EQUIPMENT - DISC CUTTING STD & LP FROM TAPE - STUDIO FACILITIES - HIRE SERVICE - SALES - EXCHANGES

MAGNEGRAPH

1 Hanway Place, London, W.1.

Tel: LAN 2156



A BETTER RECORDING

Starts with a better microphone

Most popular models available from stock post free.

Grampian, Reslo, Film Industries, A.K.G., Cadenza, Lustraphone, Foster, Grundig, etc.

Send particulars of your requirements or 6d. stamp for full list.

416 MOSELEY ROAD, BIRMINGHAM 12
Telephone Calthorpe 2554

ADVERTISERS' INDEX

A. Brown & Sons Ltd	282
A. C. Farnell Ltd.—Irish Tape	280
Chateau Productions Ltd.—Microkit	288
City & Essex Tape Recorder Centres	276
De Villiers (Electronic World) Ltd.	270
Educational Recordings Ltd	285
Elstone Electronics Ltd.	274
E.M.I. Tape Ltd.	264
Francis & Starbuck	274
Grampian Reproducers Ltd.	282
C. E. Hammond & Co. Ltd.—Revox	284
Harvey Electronics Ltd	290
Heathkit	266
Howard Tape Recorders	284
Geo. Jeffrey Ltd	269
K. & K. Electronics Ltd.	287
Lee Electronics	282
M.S.S. Recording Co. Ltd	263
Nusound Recording Co.	290
Planet Projects Ltd.	282
Recorder Co.	286
Reeves Sound Service Ltd	293
Reps Tape Recorders Ltd.	286
R. E. W. Earlsfield Ltd	270
Tape Recorder Centre	262
Teleradio (1943) Ltd.	288
Vatradio Ltd.	290
N. Walker	271
Wharfedale Wireless Works Ltd	276

PLEASE MENTION "THE TAPE RECORDER" WHEN REPLYING TO ADVERTISEMENTS.

hi-fi books

CINE YEAR BOOK . . .

For the first time ever, a comprehensive survey in one complete volume of the cine market for the cine user. The new reference book for the professional, the enthusiast and the photo dealer. This valuable book follows the unique pattern set and maintained by the "Hi-Fi Year Book"—separate and detailed directories for every product group—Cameras, Lenses, Exposure Meters, Lighting, Film Stock, Screens, Projectors, etc. Some 200 photographic illustrations, suppliers' addresses, product specifications, library lists, cine services are all included in this book. **Price 11s. 6d. post paid**

HI-FI FOR BEGINNERS . . .

The ideal book for everyone who has just started, or is about to start the hobby. The various chapters deal with Loudspeakers, Amplifiers, Pickups, Turntables, Radio Tuners, Stereo and Installing. Hi-Fi Readers whose particular interests lie with tape will find that Chapter 7 alone will make the book worthwhile. **Price 8s. 3d. post paid**

SOUND & CINE FOR BEGINNERS . . .

An up-to-date guide for the beginner by Richard Golding, with an introduction to some advanced methods including the latest means of producing experimental soundtracks. Contents include making up separate tape tracks; sound stripe; optical sound-on-film; special recording apparatus; recording sessions; how to write commentaries, etc., with photographs and line illustrations. "The most comprehensive small book ever to be written on the subject of adding sound to film." **Price 8s. 3d. post paid**

CABINET MAKING . . .

This book gives you all the necessary information for building your own Hi-Fi cabinet. Subjects covered include, designing; ordering timber, marking out, tools; materials; joints and finishes. The many photographs and diagrams help to make this book indispensable not only for Hi-Fi applications but also for general cabinet work encountered in the home. It is written by the well-known expert Wheeler Smith whose recent articles in "Hi-Fi News" have created considerable interest. ". . . highly recommended." **Price 8s. 3d. post paid**

EXPERIMENTAL RECORDING . . .

This book presents in convenient form the series of articles by A. Tutchings on "Twenty Practical Experiments in Magnetic Recording" and full introductions for "Building a Fully Portable Recorder", using a clockwork motor and transistor amplifier. **Price 5s 9d post paid**

STEREO FOR BEGINNERS . . .

For those who are confused or not wholly converted by Stereo reproduction this book gives all the answers. The author, B. J. Webb, explains in clear language what stereo is, and how best to obtain it, whether from disc, tape or radio. Advice and guidance on the purchase, installation and maintenance of suitable equipment; a six page glossary, many illustrations and special drawings are included. **Price 8s. 3d. post paid**

AVAILABLE SHORTLY

Available from Hi-Fi Dealers, W. H. Smith & Sons Ltd., or direct from the publishers:

MILES HENSLOW PUBLICATIONS LTD. 99 MORTIMER ST., LONDON, W.1



First published in 1956 the Hi-Fi Year Book has steadily grown in size. This year for the first time it tops the 300 page mark and yet still costs the same price — 10/6. All the entries have been revised and brought up to date and there are new articles by leading authorities, on Pickups, Tuners, Amplifiers, Speakers, Tape Recording, Microphones together with an Audio Diary. The 16 Directory Sections cover all High Fidelity products currently available in the U.K. giving a brief specification, price, also manufacturers' names and addresses.

TAPE RECORDERS

HI-FI YEAR BOOK

AMPLIFIERS

MOTORS

COMPLETELY REVISED

TUNERS

TAPE AMPLIFIERS & MIXERS

MICROPHONES

TAPES

SPEAKERS

CONSTRUCTIONAL KITS

TAPE ACCESSORIES

PICKUPS

(11/9 post paid)

HI-FI DEALERS

Price



MILES HENSLOW PUBLICATIONS LTD. 99 MORTIMER ST., LONDON, W.1