

MAKING PLASTIC LENSES

NEWNES

# PRACTICAL MECHANICS

1/6

EDITOR: F. J. CAMM

MARCH 1951

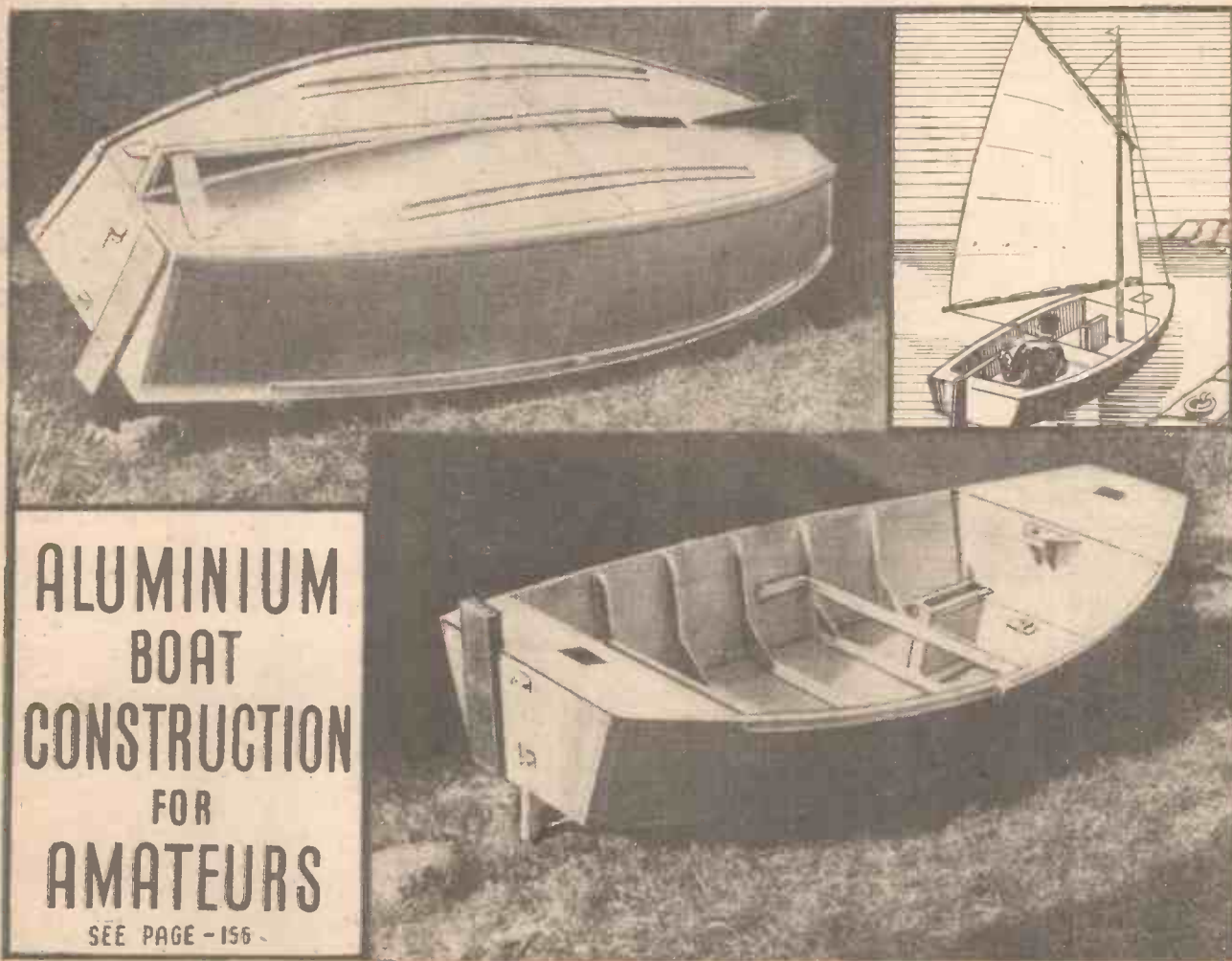

ALUMINIUM  
BOAT  
CONSTRUCTION  
FOR  
AMATEURS

SEE PAGE - 156 -

## PRINCIPAL CONTENTS

Sinking an Oil Well  
Principles of the Boomerang  
Model Engineering Practice

Radio-controlled Models  
Woodturning  
World of Models

Letters from Readers  
Queries and Enquiries  
Cyclist Section



**THAT CLIP YOU NEED**



**IS MADE BY**



**TERRY'S** *(the Spring people)*

*and 3 Special Clips*

Two very popular types, 80 and 81. In a range of sizes from  $\frac{1}{4}$ " to 2" from stock. No. 300 is a very popular drawing board clip with a host of additional uses. 5/- a doz. (incl. P.T.) from stock.

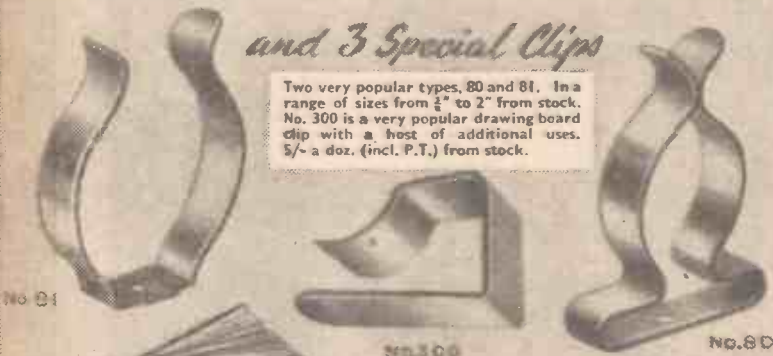

Clips in every shape, size and form . . . steel clips, bronze clips, stainless clips, little clips, big clips, clips made exactly as you want them. If you desire it we can design any kind of clip to your own exact specification. *(We've been designing clips for 95 years!)*

Sole Makers:  
**HERBERT TERRY & SONS LTD.**  
 London • REDDITCH • Manchester  
 Birmingham

WANT TO KNOW ALL ABOUT SPRINGS? HERE IS THE MANUAL — 10/6 POST FREE.



## TYZACK'S 'ZYTO' MACHINERY FOR WOOD AND METALWORK

THE "ZYTO" 3½in. SCREWCUTTING AND TURNING LATHE

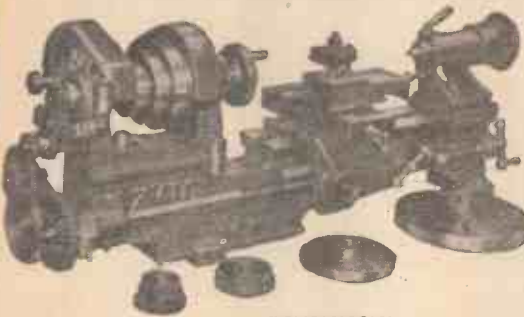

Back geared, with tumbler reverse, hollow mandrel and tailstock, fully compound slide rest, rack feed set over tailstock. 12½in. between centres **£25/10/0** Extended payments arranged with pleasure—please ask for details.

### DIMENSIONS

Height of centres .. .. .	3½ins.	Headstock mandrel admits ..	½ins.
Distance between centres ..	12½ins.	Tailstock barrel admits ..	½ins.
Height from gap .. .. .	4½ins.	Headstock pulley, 3 speeds ½in. flat belt	6ins.
Height from saddle .. .. .	2ins.	Faceplate—diameter ..	30ins.
Guide screw .. .. .	8 T.P.I.	Overall length of lathe ..	30ins.

FULLY ILLUSTRATED LEAFLET FREE AND POST FREE ON REQUEST

### MOTORISED LATHE COMPLETE ON STAND

£45/10/0

The "ZYTO" Ten Saw Table Ball-bearing Spindle. 18in. x 1½in. table takes roin. saws, right and left hand mitre slide canting table with rise and fall motion, long rip fence, guards in accordance with Home Office Regulations.

Price **£18/13/9**

FULLY ILLUSTRATED LEAFLET FREE AND POST FREE ON REQUEST.

PLEASE SEND US YOUR ENQUIRIES FOR ALL WOOD AND METALWORK MACHINERY

**S. TYZACK & SON LTD.** 341-345 OLD STREET, LONDON, E.C.1

Telephones: CLERKENWELL 8301 (ten lines)

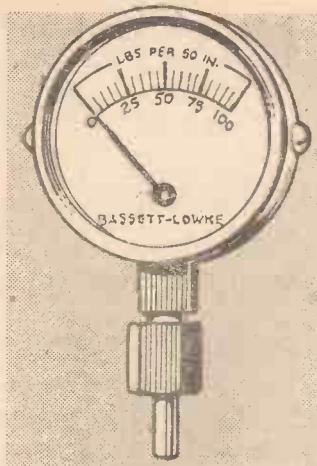

The neatest and most efficient miniature fittings in the world.

## Pressure Gauges

for Locomotives Stationary and Launch. Boilers and all model engineering purposes.

1½in. diameter reading to 80, 100, 120, 150 lb. Price **18/6** Tax 4/2.

1in. diameter reading to 80, 100, 120, 150 lb. Price **17/6** Tax 3/11.

1½in. diameter reading to 100, 120, 150 lb. Price **12/6** Tax 2/10.

2in. diameter reading to 100, 120, 150 lb. Price **14/6** Tax 3/8.

Syphon for 1½in. and 1in. sizes, price 2/3 plus Tax 6d. U-tube syphon for 1½in. gauge, price 2/6 plus 6d. Tax. For 1in. 3/6 plus 9d. Tax. For 1½in. 4/- plus 10d. Tax.

These fittings have been specially made and are the result of many years' practical experience in this specialised field. Every gauge is subjected to a careful test before delivery. Write for MODEL SUPPLIES (MS/12). Price 6d., Post Paid.

## BASSETT-LOWKE LTD NORTHAMPTON

London: 112, High Holborn, W.C.1. Manchester: 28, Corporation Street.

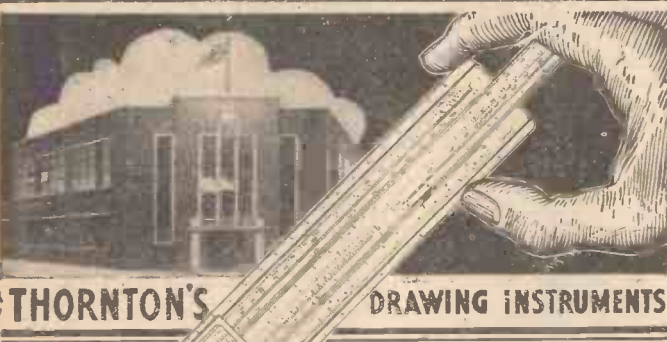

THORNTON'S DRAWING INSTRUMENTS

## PIC SLIDE RULES

We are the largest manufacturers of high-grade Drawing Instruments and Slide Rules in the British Empire, and our Kinwest Drawing Materials have gained a reputation throughout the world for superb quality and accuracy. Insist on using only Thornton's for complete satisfaction.

Our illustrated Catalogue, which includes particulars of Drawing Instruments, Drawing Boards, Tee and Set Squares, Scales, Curves, etc., is sent Post Free on request.

**A. G. THORNTON LTD**  
Drawing Instrument Specialists  
WYTHENS H A W E, M A N C H E S T E R.  
Tel: WYThenshawe 2277 (4 lines)

THREE INVALUABLE SOLUTIONS FOR AMATEUR PHOTOGRAPHERS

### FOR FILMS UNITOL



The new ready-to-use, concentrated liquid, fine grain developer. Use one ounce for one film and use it once only. No trouble, no waste, gives wonderful negatives. 8-oz. bottle, 3/6. 20-oz. bottle, 6/6. Unitol Calculator (price 4d.) shows developing times for any film at any dilution.

### FOR PRINTS UNIVERSAL

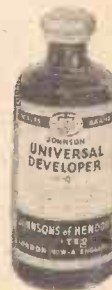

An excellent one-solution developer prepared from a concentrated M-Q formula. Suitable for all contact or bromide papers. Produces prints of rich quality with a wide range of tones. Contains 142 for fog prevention and 325, wetting agent. 8-oz. bottle, 2/6. 20-oz. bottle, 4/-.

### FOR FIXING FIX-SOL



Concentrated acid hardening fixing solution. For negatives use one part diluted with three parts of water, for papers five parts. Greatly minimises the risk of scratched negatives and, when used for prints, makes for easier glazing with heat. A 20-oz. bottle costs 3/6 at your dealers.

JOHNSONS OF HENDON LTD. LONDON. N.W.4

# I.C.S. TRAINED MEN are in Greater Demand than Ever—Maximum production depends on high technical skill, such as that acquired by I.C.S. Students

**TENS OF THOUSANDS MORE  
TRAINED MEN ARE URGENTLY  
NEEDED NOW—BUT THERE IS  
NO WORTH-WHILE PLACE FOR  
THE UNTRAINED**

**Ambitious men everywhere have succeeded through  
I.C.S. Home-Study Courses. So also can you.**

The man with an I.C.S. Training in any one of the subjects listed below knows it thoroughly, completely, practically. And he knows how to apply it in his everyday work.

Accountancy  
Advertising  
Air and Vacuum  
Brakes  
Air-Conditioning  
Arable Farming  
Architecture  
Architectural Drawing  
Auditing  
Boiler Engineering  
Book-keeping  
Building Construction  
Building Specifications  
Business Training  
Business Management  
Carpentry and Joinery  
Chemical Engineering  
Chemistry, I. & O.  
Civil Engineering  
Clerk of Works  
Coal Mining  
Commercial Art  
Concrete Engineering  
Diesel Engines

Draughtsmanship  
Drawing Office Practice  
Electrical Engineering  
Electric Power, Light-  
ing, Transmission  
Traction  
Eng. Shop Practice  
Fire Engineering  
Foremanship  
Free-Lance Journalism  
Fuel Technology  
Heating and Ventilation  
Horticulture  
Hydraulic Engineering  
Illumination Eng.  
Industrial Management  
Lettering  
Machine Designing  
Machine-Tool Work  
Marine Engineers  
Mechanical Drawing  
Mechanical Engineering  
Mine Surveying  
Mining Engineering

Motor Engineering  
Motor Mechanic  
Motor Vehicle Elec.  
Municipal Eng. Elec.  
Plastic  
Plumbing  
Quantity Surveying  
Radio Engineering  
Radio Service Eng.  
Refrigeration  
Sales Management  
Salesmanship  
Sanitary and Domestic  
Engineering  
Sheet-Metal Work  
Short-Story Writing  
Steam Engineering  
Structural Steelwork  
Surveying  
Telegraph Engineering  
Television Technology  
Welding, Gas and Elec.  
Woodworking Drawing  
Works Engineering

And most of the Technical, Professional, Commercial and Civil Service and Educational Examinations.

(I.C.S. students preparing for Examinations are coached till successful)

If you need technical training, our advice on any matter concerning your work and your career is yours for the asking—free and without obligation. Let us send you our special free booklet on the subject in which you are specially interested. **DON'T DELAY. Make ACTION your watchword.**

The successful man **DOES** to-day what the failure **INTENDS** doing to-morrow. Write to us **TO-DAY**

Use this Coupon

## INTERNATIONAL CORRESPONDENCE SCHOOLS LTD.

Dept. 95, International Buildings, Kingsway, London, W.C.2.

Please send me the free booklet describing your Courses in

Name..... Age.....  
(USE BLOCK LETTERS)

Address.....

Addresses for Overseas Readers

Australia: 140, Elizabeth Street, Sydney.  
Egypt: 40, Sharia Abdel Khalak Sarwat Pasha, Cairo.  
Eire: 13, Anglesa Street, Dublin, C.4.  
India: Lakshmi Bldgs., Sir Rheroosha Mehta Rd., Fort  
Bombay.  
New Zealand: 182, Wakefield Street, Wellington.  
N. Ireland: 26, Howard Street, Belfast.  
South Africa: 45, Shortmarket Street, Cape Town.



**CLICK COUNTERS** Brand new, individually wrapped. Sizes—1in. cube with base plate 1 1/2in. long. Reading by 1's to 9,999 with a left hand trigger. As sold by makers at over 40/-. Suitable for attendance counter or has 1,001 workshop and engineering uses, e.g., repetition work on drills, or presses. Fully guaranteed by us. In solid metal case heavily plated. **OUR PRICE post free 22/6**

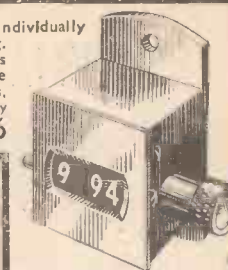

**9/- MOTOR CYCLISTS' VISORS**



This is the celebrated "JEFCO" face screen. Brand new, made in England, supplied in small cardboard cartons. Consists of a heavy grade plastic Visor with subsidiary sunshield. Fabric forehead protector with leather sweatband, fully adjustable strap. Send today whilst stocks last!

**SENSITIVE TACHOMETER**

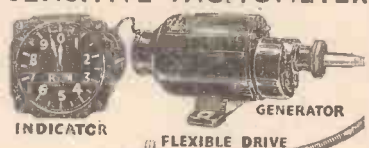

Fitted British Aircraft, reads 0-5,000 r.p.m., incorporates 4:1 gearbox. Also be used as 1:1. Consists flexible drive for connection to crankshaft, motor, etc., 3-phase A.C. generator, sensitive 2-pointer indicator. Suitable all H.P. Installations, with instructions. Tested by us.

**HAND-BEARING COMPASS**



A fine bearing compass with prism, spirit-filled bowl, card marked 0/360 deg. x 1 deg. x 1 deg. Divisions. The handle is a torch for card illumination, suitable for day or night observations of extreme accuracy, in wood transit case. **65/-** (Post and packing 1/6).

**45/-** By British manufacturers. Carriage paid.

**STUDENTS' DRAWING INSTRUMENT SETS**

Each set consists of fine blue leatherette case divided into compartments, and contains spring-bow dividers, spring-bow compass, spring-bow combination pen-pencil compass large dividers, large combination compass and drawing pen. These are draughtsmen's instruments of quality, and with high finish. Includes Registered **50/-** Postage.



**PSYCHROMETER**

A beautifully made, brand new, ex R.A.F. meteorological instrument consisting of Wet and Dry Bulb Thermometers. Calibrated from 10 to +110 degrees F. and tubes are over 1 1/2in. in length. Made by leading British instrument makers and in very solid frame with good water-tank and scientifically accurate screening to bulbs. **42/6** Carriage paid.

**AERD-SPARES CO. (Dept. 85)**

70-71, High Holborn, London, W.C.1. Telephone: AM3assada 287112 (All depts.).

**A. J. REEVES & CO.**

for

- MYFORD AND HALIFAX LATHES
- FOBCO "STAR" 0-3in. MOTORISED DRILLING MACHINES
- CHAMPION No. 2. 0-3in. DRILLING MACHINES
- SELECTA AND WOLF GRINDERS
- WOLF ELECTRIC DRILLS
- ADEPT BENCH HAND SHAPERS
- POOL MILLING MACHINES

The above are available on our well known "Out of Income" terms. Details of these and other carefully selected tools are to be found in our comprehensive illustrated catalogue. A 6d. stamp will bring you a copy by return post.

**416 MOSELEY RD., BIRMINGHAM 12.**  
**"THE CHOICE OF EXPERIENCE"**

**"DE LUXE" SLIDE RULES**  
**AMAZING VALUE**

12 inch log-log sin-tan rule, 9 scales, for all problems. Celluloid faced on polished hard wood. Multiplication, division, proportion, percentages, discounts, roots, weights, measures, currencies, etc.

**10/6**

Post and Packing 6d.

Complete In Case

Also 5in. scale model complete in case. (As illustrated.)

**ONLY 5/6 Post & Packing 4d.**

Including Comprehensive Slide Rule Book.

Approval or money refunded.

**MARINE & OVERSEAS SERVICES (1939) LTD.**

(DEPT. L.H.)

**16, BARTER STREET, HOLBORN, LONDON, W.C.1**



**RAPID ANGLE INDICATOR**

Solves at a glance all angles, sides of a right angled triangle **2/-** Post 3d.

**THREAD CHART**

Threads per inch. Whitworth, B.A., and Gas tapping—clearing sizes for threads. Standard sizes, decimals, wire gauge, millimetres, etc. **1/9** Post 3d. (Tel. Hol. 0380)

# A new solder

## FOR WORKSHOP AND HANDYMAN

- CONTAINS 2 CORES OF FLUX
- NO EXTRA FLUX REQUIRED
- REPLACES STICK SOLDER, FLUID AND PASTE FLUXES
- IF DESIRED FLUX RESIDUE READILY WASHES OFF WITH WATER
- SO FAST THAT IT WILL EVEN SOLDER BLUED SPRING STEEL WITHOUT PRE-CLEANING

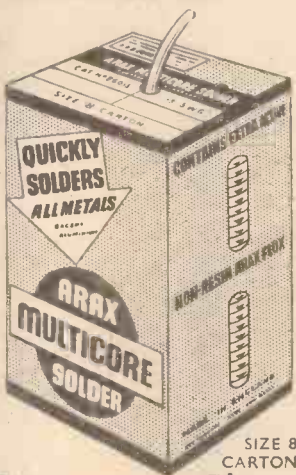

SIZE 8  
CARTON  
5/- each

No. 10 KIT 2/- each



Available in 5/- retail cartons (4 specifications) or 2/- Multicore Solder Kit contains 2 specifications Arax Multicore Solder and 2 specifications Ersin Multicore

Solder for electrical wire to tag joints. Now obtainable from many stores.

In case of difficulty 5/- cartons or 2/- Multicore Solder Kits sent post free on receipt of postal order or stamps.

MULTICORE SOLDERS LTD., MELLIER HOUSE, ALBEMARLE STREET, LONDON, W.1

## For Metalworking and Woodworking

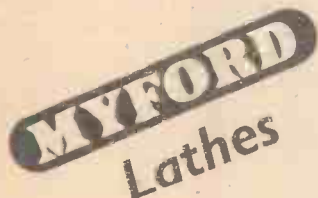

remain

THE  
CRAFTSMAN'S  
CHOICE

## MODEL RAILWAY CLUB EXHIBITION

EASTER WEEK, TUES. MARCH 27 to SAT. MARCH 31

The work of members of the Model Railway Club, over 3,000 models of locomotives, coaches, wagons, signals and working tracks. Free rides behind real steam engines.

### CENTRAL HALL, WESTMINSTER

Tuesday, 2 p.m. to 9 p.m. Thereafter, 11 a.m. to 9 p.m.  
ADMISSION - Adults 2/6, Children under 14, 1/-  
Special terms for organised parties on application to R. C. Panton, 162a, Strand, London, W.C.2.

## LAWRENCES

**NEW AMERICAN AIR BLOWERS.**—3 in 24 v. D.C. (run on A.C. with transformer). Precision motor with ball races. Dim., 2in. diam. x 4in. long. Superbly engineered. 12/6 each.

**DIMMER RHEOSTATS.** Porcelain Bar type, 1,000 ohms, 4 amp. Spindle control with knob, 14/- each. Also rotary type 2½in., 8 ohms. 50 watts. 3/6.

**NEW TEMA SPIRIT LEVELS,** 8in., Brass faced, rosewood body. Best quality. 3/3 each.

**NEW AMERICAN D.C. MOTORS TYPE C/2BB/1A.** Series connected. Laminated Field pieces. 27.5 v. D.C. 7,000 r.p.m., .01 h.p. BB. Dim.; 2in. diam. by 3in. long. Shaft ¼in., 11/6.

**NEW MOVING COIL METER RECTIFIERS.** Westinghouse for 1 m.a. movement. 3/6. Also for 500 microamp movement, 3/9.

**FINEST QUALITY SWITCHES.** Panel mounting toggles. S.P.S.T., 1/9. D.P.D.T., 2/6. Rotary toggle action, S.P.S.T., 2/6. Yaxley switches, 1p—3-way ceramic, 2p—2 way. 4p—2 way. 1 p—6 way ceramic. 4p—11 way. 6p—6 way. Any type, 3/- each. Heavy duty stud switches. Ceramic insulation. 1p—3 way. 1p—4 way. 1p—5 way. Suitable for chargers, etc., 7/6.

**NEW MINIATURE RELAYS, LEACH U.S.A.** S.P.C.O. 280 ohms. Dim. 1.25 x 1 x .6in., 3/- each. Advance U.S.A. 650 ohm D.P.C.O., 3/- each.

**NEW SKYROD TYPE WHIP AERIALS.** Flexible, withstand high wind, with low-loss mounting insulator. Improve your Radio Performance! 5/6 each.

**NEW PHOTOMULTIPLIER CELLS TYPE 931A.** High vacuum type, with high response in visible region. Gain over 1 million. Great sensitivity, low noise level, freedom from distortion, low dark current and small size. Ideal for film scanning, colorimetric measurement, spectography, astronomical measurements. Alpha particle counting and facsimile transmission, etc. Direct equivalent to type 27M1. Complete with holder, resistance network, lightproof chamber, and circuit, 27/6.

**NEW FIXED CRYSTAL DETECTOR VALVES.**—Highly efficient. Ideal for sensitive crystal sets, 3/6.

**STAGGERING OFFER !!!**—A wonderful assortment of valuable Aircraft Instruments, including Aneroids, gauges and other intricate types. Eight instruments, really worth over £10, to clear at 9/6 the parcel; plus postage, 1/6.

Experienced Export Shippers. All prices include U.K. carriage. Terms C.W.O. Satisfaction guaranteed or money immediately refunded.

**LAWRENCES 61, BYROM STREET, LIVERPOOL, 3**

Telephone: CENTRAL 4430

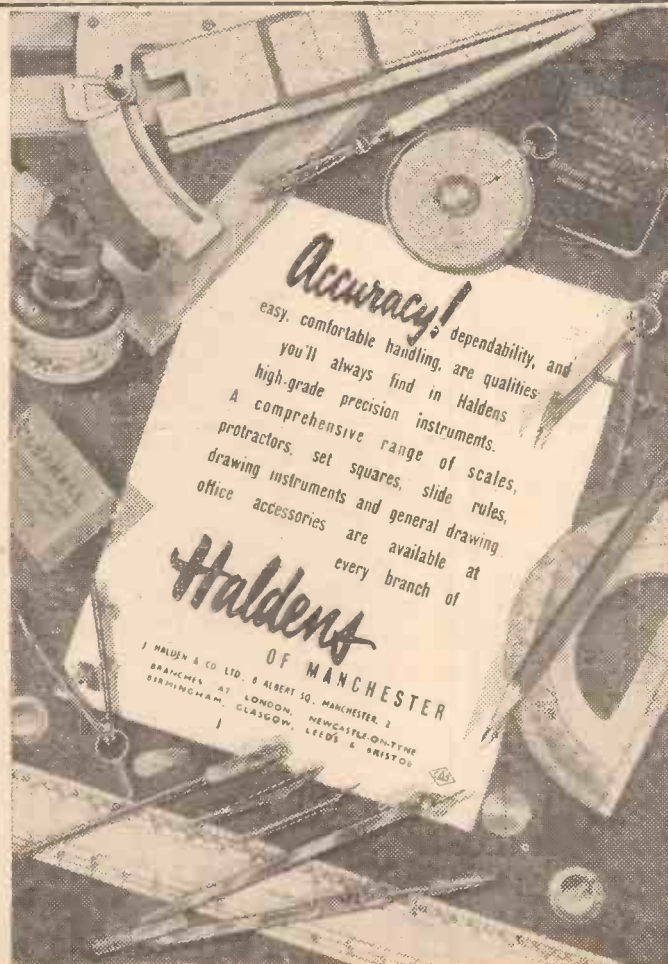

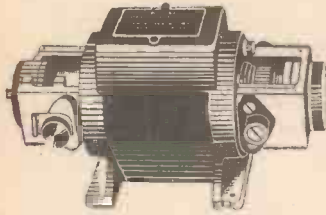

**REMINGTON**  
"Blue Streak"  
**ELECTRIC DRY SHAVER**

The World's finest Multiple Head Shaver. Shave anywhere without fuss. No brush, soap or hot water needed. Even the toughest beard and tenderest skin respond to the Remington.

The **FOURSOME** (4 shaving heads), £7/18/5  
The **FIVESOME** (5 shaving heads), £8/17/7  
Hire purchase terms available

**D.C. 'STEP-UP' GENERATOR**

A universal purpose motor generator, fully guaranteed, brand new, and in original maker's cartons.

This unit can be driven from D.C. voltages from 2 v. to 14 v. and will give varying outputs according to the input voltage. For example: at 6 v. D.C. input an output of 230 v. 30 m/a will be obtained; at 4 v. D.C. input—180 v. 25 m/a.; at 12 v. D.C. input—480 v. 40 m/a.

The motor will also provide sufficient power for use as a grinder, polisher, etc., as a spindle protrudes 1in. from the casting—sufficient length for mounting these. Approximate r.p.m. at 12 v. D.C. input is 2,000 (varying according to the applied voltage).

The cost of manufacturing these useful motor generators was approximately £8 to £9.

EACH ONE CARRIES FULL GUARANTEE.

OUR PRICE 8/11 Post and packing 1/1.

**GUARANTEED SPEAKERS**

- 2 1/2 in. P.M., less transformer..... 19/6
- 5 in. P.M., less transformer..... 10/6
- 5 in. M.E., with transformer..... 15/6
- 6 in. M.E., less transformer..... 12/6
- 8 in. M.E., less transformer..... 16/6
- 8 in. M.E., with transformer..... 21/6
- 10 in. P.M., less transformer..... 19/6
- 12 in. P.M., less transformer..... 39/6

Terms; Cash with Order



**BEAUTIFY your HOME with LIGHT**

These beautiful table lamps are finished in grained Tufinol which looks like walnut and wears like ebony. Ideal for any room in your home. Complete with plasticised fabric shade as illustrated, with 6ft. flex, packed in sturdy cardboard cartons.



12/11 (Postage and packing 1/1) or, less shade,

10/11 (Postage and packing 1/1)

**BURGOYNE SOLDER GUN**

No wasted current. No element to burn out. Press the button and count seven! Brand new and boxed. 2-year guarantee. 52/6 post free.

**MAIL ORDER SUPPLY CO.**

The Radio Centre, (Dept. PM)  
33, TOTTENHAM COURT ROAD,  
LONDON, W.1

Telephone: MUSEum 6667,8/9



THE "FLUXITE QUINS" AT WORK

"Tommy rot! Flying saucers," cried EE.  
"Hallucinations strikes me."  
"You mean," chuckled OH,  
"Flying saucers, I know.  
But FLUXITE'll mend 'em, you'll see."

For all **SOLDERING** work—you need **FLUXITE**—the paste flux—with which even dirty metals are soldered and "tinned." For the jointing of lead—without solder; and the "running" of white metal bearings—without "tinning" the bearing. It is suitable for ALL METALS—excepting ALUMINIUM—and can be used with safety on ELECTRICAL and other sensitive apparatus.

With Fluxite joints can be "wiped" successfully that are impossible by any other method

Used for over 40 years in Government works and by leading engineers and manufacturers. Of all Ironmongers—in tins, from 1/- upwards.

TO CYCLISTS! For stronger wheels that will remain round and true, here's a time-tested tip. Tie the spokes where they cross with fine wire AND SOLDER. It's simple—with FLUXITE—but IMPORTANT.

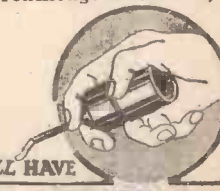

ALL MECHANICS WILL HAVE

**FLUXITE**

IT SIMPLIFIES ALL SOLDERING

Write for Book on the ART OF "SOFT" SOLDERING and for Leaflets on CASE-HARDENING STEEL and TEMPERING TOOLS with FLUXITE. Also on "WIPE JOINTS." Price 1d. Each.

FLUXITE LTD., Dept. P.M., Bermondsey Street, S.E.1

**TAKE UP PELMANISM**

For Progress and Prosperity



**PELMANISM** is a working course in Practical Psychology directed to the needs of the average man and woman.

The Pelman Course is based on over 50 years' intensive study concurrent with experience in dealing with the difficulties, failings, fears, aspirations and ambitions of more than 750,000 men and women of all ages and occupations in all parts of the world.

You would like your affairs to prosper and your income to increase. Pelmanism will help you to achieve this and will enable you to develop that zest for living which comes with an awakened mind; also with quickened mental powers, your awakened ability will enable you to enjoy those purchasable pleasures that come with extra money.

Reduced fees for all serving and ex-Service members of His Majesty's Forces (Apply for Services Form)

The Pelman Course is simple and interesting and takes up very little time; you can enrol on the most convenient terms. The Course is fully described in a book entitled "The Science of Success," which will be sent, gratis and post free, on application to:—

**Pelmanism**

- develops:—
- Courage
  - Initiative
  - Judgment
  - Will-Power
  - Concentration
  - Self-Confidence

**Pelmanism**

- eliminates:—
- Worry
  - Pessimism
  - Depression
  - Frustration
  - Forgetfulness
  - Weakness of Will

**HOW TO LEARN LANGUAGES**

The Pelman Languages Institute teaches French, German, Spanish and Italian without translation. The Pelman method is explained in four little books, one for each language. Write for the book that interests you and it will be sent to you by return, together with a specimen lesson, gratis and post free. Reduced fees for serving and ex-Service members of His Majesty's Forces. Pelman Languages Institute, 130, Norfolk Mansions, Wigmore Street, London, W.1.

**PELMAN INSTITUTE,**

130, Norfolk Mansions, Wigmore St., London, W.1

Established over 50 years. Callers welcomed.

**POST THIS FREE COUPON TO-DAY**

To the Pelman Institute,  
130, Norfolk Mansions, Wigmore Street,  
London, W.1

Please send me, gratis and post free, a copy of "The Science of Success."

Name .....  
(Block letters please)

Address .....

**YOU can become a first-class RADIO ENGINEER**

We are specialists in Home-Study Courses in Radio Engineering, Servicing, Transmission, Television, Mathematics and Radio Calculations

**T. & C. RADIO COLLEGE**

To: R. Heath Bradley, T.C.R.C.,  
50, Harland Road,  
Southbourne, Bournemouth.

Name .....  
Address .....  
M.68

Post coupon now for free booklet and learn how you can qualify for well-paid employment or profitable spare-time work.

(Post coupon in unsealed envelope—1d. Postage.)

The New

*Lumsden*

**WOOD  
WORKER**



This combined Sawbench, Wood-turning Lathe, Polisher and Grinder is a robust Machine capable of turning out first-class work for the professional or the amateur.

Few moderately priced machines offer so many attractive features in so sturdy a form. Models from £11 to £31.

Send for Illustrated Leaflet.

**LUMSDEN LAMP CO.**

3, MILLBURN, ALMONDBANK, PERTH

*Plastics* LTD  
(MANCHESTER)

11 Whitworth Street, Manchester, 1. Tel: Gen. 0272-1725.

BRITAIN'S LEADING STOCKISTS OF:  
"PERSPEX" (Acrylic) sheet, rod and tube.  
"CRINOTHENE."  
B.X. ACRYLIC ROD.  
P.V.C. SHEETING (Admiralty Specification).  
"CASEIN" Rod, Sheet and Tube.  
CELLULOSE ACETATE Film and Sheet.

Official Stockists for:  
IMPERIAL CHEMICAL INDUSTRIES LTD., ERINOID LTD.,  
B.X. PLASTICS LTD., UTILEX LTD.  
Catering especially for Industry, The Hobbyist and the Model Maker.  
Contractors to the Admiralty, most Government Departments, Schools,  
Institutions, etc.

Trade and Technical enquiries solicited.

Fabrication, Engraving, Moulding, Cutting to Size, Shape, Contour a speciality.



YOU CAN GET ANYTHING  
TO DO WITH MAGNETIC  
RECORDING

udge Industries, 783 Romford Road, Manor Park, London, E.12

**QUALITY REPRODUCTION**

Where High Sensitivity is desired it is definitely obtainable when you choose and use S. G. BROWN Type "F" (Featherweight) Headphones. D.C. Resistance 4,000 ohms.



Write for Brochure "P.M." it gives details of all types of S. G. Brown headphones.

Impedance 14,000 ohms at 1,000 c.p.s. Sensitivity 8 Dbs below 1 microwatt per bar at 1,000 c.p.s. Weight 9 ozs.

High quality Reproduction is one of the outstanding characteristics of S. G. BROWN Type "K" Moving Coil Headphones. Excellent for DX work, laboratory purposes, monitoring, etc.

D.C. Resistance 47 ohms. Impedance 52 ohms at 1,000 c.p.s. Sensitivity 1.2-10-12 watts at 1 KC-.0002 DYNE/CM<sup>2</sup>.

*S.G. Brown, Ltd.*

SHAKESPEARE STREET, WATFORD, HERTS

Largest stocks, best selections  
**CLYDESDALE**  
and Bargains in Ex-Services Radio and Electronic Equipment

Sperry Computer, Type BB. Ref. 10992 "M."



Repeater Motor. Anti-Vibration Mtg. Servo Syphon Unit. Fine worm gear with Ledden. Electric Motor. Pitch Gyro. Rheostat. Tubular Steel Frame. Reversible Friction Clutch.

This unit represents a wealth of mechanical and electrical components. Consists of: Over 100 various precision gear wheels, helicals, rollers, spirals, levels, ratchets, worm drives, skew gears and variable pitch worm gear. Precision pitch stabilizing gyro unit. Servo syphon unit with four concertina type reservoirs, small bore servo tubes, servo switch. Two 24-volt D.C. 1.5 A. motors with pulleys shaft each end and reversing clutch mechanism. Selsyn 24 volt repeater motor (9/2282). Slow motion dials, counters, aneroid, capsules, shafts, springs, metal and flexible tubing, plus over 800 spacers, washers, nuts and bolts, etc., etc., etc.

The complete unit is enclosed in a metal box with removable side covers: 19 x 14 1/2 x 3 1/2 in. finished in black crackle and suspended in a tubular metal cradle frame by four heavy duty anti-vibration mountings. Weight 96 lbs.

This unit was designed for use with the American T1 Bombsight.

CLYDESDALE'S 69/6 each CARRIAGE PAID

**Hand-Driven Generator**

H. 409. Hand-driven Generator 10K/13043 comprising of a 40 : 1 gearing unit driving a generator producing 6.3 v. .5 a. and 300 v. 50 ma complete with ratchet handle. Diam. 7in. long. Used, but in good condition.  
CLYDESDALE'S 13/6 POST PAID  
PRICE ONLY

H. 408. Hand-driven Generator by BENDIX, comprising of a 70 : 1 geared unit driving a generator producing 28 v. .175 a. and 300 v. at 40 ma. The generator is detachable, measuring 4 1/2 in. x 2 1/2 in. The unit is complete with ratchet handle. Used, but in good condition.  
CLYDESDALE'S 13/6 POST PAID  
PRICE ONLY

**Magnetic Compass**

H. 406. Magnetic marching Compass MK 1 for day or night use, enclosed in a black Bakelite case. 3in. x 2 1/2 in. x 1 1/2 in., complete with instructions for use.  
CLYDESDALE'S 21/- each POST PAID  
PRICE ONLY

**CLYDESDALE SUPPLY CO. LTD.** • 2 BRIDGE STREET GLASGOW - C.5

Send now for new illustrated lists.

Phone: SOUTH 270517. Please Print Name and Address.

# FREE!

to every ambitious engineer  
this valuable 176-page handbook!

# B

Better days lie ahead if you add "ENGINEERING OPPORTUNITIES" to your bookshelf. If you want to put yourself in line for quick promotion, higher pay and all that goes with it, as well as the sort of job you've always wanted, this enlightening guide to success—176 pages of vital, right up-to-date information—is your blue-print for a brighter future.

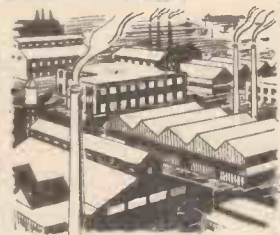

# I

In this book you will find out how to take advantage of to-day's opportunities; how you can rise to a position that ensures success, prosperity and security—the sort of job which, in Peace or War, Prosperity or Slump, makes you a "key" man on whom the craftsman or fighting-man is equally dependent.

# E

"ENGINEERING OPPORTUNITIES," besides showing how you can be helped to become a trained technician in your spare time, describes our unique Advisory and Employment Depts. Read about them and also about the superb range of Home Study Courses you can choose from... learn something of the methods that have already brought success to men in all branches of engineering throughout the world.



# T

Thousands of B.I.E.T. Students—ordinary people with no special advantages except a real desire to succeed—have, under our guidance passed A.M.I.Mech.E., A.M.I.C.E., CITY & GUILDS and other major examinations. Because of our outstanding successes, you, too, can be confident of your success, under the guidance of B.I.E.T.

WRITE IF YOU PREFER NOT TO CUT PAGE

**POST THIS COUPON TODAY!**

Please send me a FREE copy of the latest 176-page edition of "ENGINEERING OPPORTUNITIES"

IT IS UNDERSTOOD THAT NO REPRESENTATIVE WILL CALL ON ME  
NAME .....

ADDRESS .....

.....

.....

I am interested in.....

(State subject, exam, or type of appointment that appeals to you.)

**B.I.E.T. 410A SHAKESPEARE HOUSE,  
17-19, STRATFORD PLACE, LONDON, W.1.**

Which  
of  
these  
is  
your  
Pet  
Subject?



**Mechanical Engineering**

A.M.I.Mech.E.—CITY & GUILDS—General Mechanical Eng.—Maintenance Eng.—Diesel Eng.—Sheet Metal Work—Welding—Metallurgy—Machine Drawing & Design—Refrigeration, etc.

**Electrical Engineering**

CITY & GUILDS—General Electrical Eng.—Installations—Illuminating Eng.—Electrical Science—Electricity Supply—Meters & Measuring Instruments—Mains Eng., etc.

**Radio & Television**

A.M.Brit.I.R.E.—SERVICING CERTIFICATE—C. & G. Telecommunications—General Radio Eng.—Radio Servicing—Television Servicing—Sound Film Projection—Electronic Eng., etc.

**Production Engineering**

A.M.I.P.E.—Works Management—Foremanship—Staff Supervision—Planning Eng.—Costing, etc.

**Automobile Engineering**

A.M.I.M.I.—CITY & GUILDS—General Automobile Eng.—Automobile Repairs—High Speed Diesels—Garage Management, etc.

**Building & Civil Engineering**

A.M.I.C.E.—F.R.I.C.S.—L.I.O.B.—General Building—Architectural Drawing—Sanitary Eng.—General Civil Eng.—Surveying—Specifications & Quantities—Heating & Ventilating—Painting & Decorating—Plumbing—Carpentry & Joinery—Timber Technology, etc.

PLASTICS—DRAUGHTSMANSHIP—AERONAUTICAL ENG.—FORESTRY

**SOME LETTERS AFTER YOUR NAME?**

A.M.I.Mech.E. A.M.I.C.E. F.R.I.C.S. A.M.S.E.  
A.M.I.Struct.E. L.I.O.B. A.M.Brit.I.R.E.  
A.F.R.Ae.S. A.M.I.P.E. A.M.I.M.I.

HUNDREDS OF OTHER COURSES

(Tell us what interests you)

**WE DEFINITELY GUARANTEE  
"NO PASS-NO FEE"**

We have printed "ENGINEERING OPPORTUNITIES" more than a hundred times and distributed over a million copies to ambitious men. Whatever your age, education or experience, if you are earning less than £12 a week, you really cannot afford to miss reading it. Send for your own copy to-day—FREE and without obligation.

**BRITISH INSTITUTE OF  
ENGINEERING TECHNOLOGY**

**THE B.I.E.T. IS THE LEADING INSTITUTE OF ITS KIND IN THE WORLD**



# PRACTICAL MECHANICS

MARCH, 1951  
VOL. XVIII. No. 207

EDITOR  
F. J. CAMM

Owing to the paper shortage "The Cyclist," "Practical Motorist," and "Home Movies" are temporarily incorporated.

FAIR COMMENT

By The Editor

## The City and Guilds of London Institute

**S**IR FREDERICK HANDLEY PAGE, chairman of the City and Guilds of London Institute, at a dinner which he recently gave to the City Livery Companies, gave an account of the work which the Institute has carried out in the field of technological education, largely as a result of the generous financial support accorded to it by many of the Livery Companies.

It is particularly appropriate that in Festival of Britain year, when the centenary will be celebrated of the Great Exhibition of 1851, that the City and Guilds Institute should withdraw its light from the bushel which has obscured its brilliance for far too long and show to the world what we do in this country to encourage love of craftsmanship, love of knowledge and ambition for the higher posts.

The Institute was founded in 1878 by the Corporation and Livery Companies of the City of London for the advancement of technical education. This resulted in the setting up of the Department of Technology to hold examinations and award certificates in a wide variety of technical subjects—the Arts School in 1879, the Finsbury Technical College in 1881, and the Central Technical College in 1885.

Thus the Institute set up teaching colleges, the prototypes of later institutions, and by drawing up syllabuses and setting examinations it promoted a lively interest amongst craftsmen and technicians towards a better standard in their work. It has had the co-operation and support of the Ministry of Education—formerly the Board of Education. For a considerable time the Institute has practically discharged the functions of the Ministry in the technical fields.

Well over 1,000,000 students have sat for the Institute's examination, and it is most encouraging to see the way in which the numbers have increased from 47,824 in 1927, 58,639 in 1948, 69,253 in 1949 to 73,500 in 1950.

Of course, this increase is due in some measure to the higher standards insisted upon by employers for apprentices. Some insist upon a City and Guilds of London Institute certificate in the particular subject.

No less than 81,500 entered and paid for the examination in 1950, and I am informed that even greater numbers are expected this year.

The great strength of the Institute is derived from its practice of bringing together in its Advisory Committees all

expert interests—the industrialist, the trade unionist, the educationalist, the administrator, the technologist, the technical teacher and other professional men at all other levels.

That the value of this work is recognised is shown in the report of the Parliamentary and Scientific Committee on "Technical Education and Skilled Manpower." The Report says: "The body which deservedly holds the greatest prestige in the award of certificates for craft training is the City and Guilds of London Institute. Its syllabuses, in general, are very good. They are so framed as to demand definite craft training, which is carried forward in the courses for the final certificates to a most satisfactory educational standard. The vast numbers taking these examinations indicate that the syllabuses have a unique appeal to the student desiring a recognised qualification in craftsmanship. The scheme of the City and Guilds of London Institute for consultation with industry, with the Minister of Education and with the technical college is unrivalled.

"The Ministry of Education should vigorously encourage the development of courses leading to the award of City and Guilds of London Institute certificates in order that the general level of craftsmanship should be improved and that the future foremen should be able to follow advanced practical courses."

Fifty per cent. of our waking life is spent at work, and it is my view that the State should not cease to take an interest in youth once school-leaving age has been reached. Careers are just as important as education, and the whole question of analysing the ability and the adaptability of youth for various occupations should be the concern of the Ministry

of Labour and the Ministry of Education. By this means we should avoid fitting square pegs into round holes, and have the right men in the right places.

### MECHANICAL MOVEMENTS — NEW SERIES OF DATA SHEETS

**R**EADERS of our recently-concluded series on the "Elements of Mechanics and Mechanisms" will recall that the series dealt with all those laws and principles which govern the design of machines. I have received a large number of requests from the principals of technical colleges, science teachers, teachers at evening classes and from readers for further articles showing the practical application of those principles. Those wishing to amplify the series covered in this journal now have the opportunity of collecting week by week, from our companion weekly *Practical Engineering*, eight Data Sheets showing examples, with relevant formulæ and data, on almost every type of mechanism in use to-day.

The Data Sheets will cover not only the application of the known mechanical principles in their elemental forms but also in their combined forms, and the series will continue for at least 13 weeks. In order that readers may preserve them in permanent form a binder is available for a nominal sum. These Data Sheets commenced in our companion journal *Practical Engineering* with issue dated February 23rd, and readers wishing to start collecting may obtain back issues from a stock held specially for that purpose.

The early sheets give a concise summary of the principles and formulæ which govern the design of machines and mechanisms, including the elementary mechanisms such as the lever, the pulley, the inclined plane, the screw, and the gear. The later sheets deal with combinations of all these.

By collecting the Data Sheets each week readers will secure a unique and valuable manual worth at least one guinea.

Information on the design of mechanisms is very scant, and except for one or two German textbooks produced many years ago nothing has been published in this country on the subject for a long time.

The seriousness of the paper position makes it necessary for those who wish to collect this unique series of Data Sheets to place a regular order for *Practical Engineering*, published at 4d. every Friday.—F. J. C.

#### SUBSCRIPTION RATES

including postage for one year

Inland	- - - -	14s. per annum.
Abroad	- - - -	14s. per annum.
Canada	- - - -	13s. per annum.

Editorial and Advertisement Office: "Practical Mechanics," George Newnes, Ltd., Tower House, Southampton Street, Strand, W.C.2

Phone: Temple Bar 4363  
Telegrams: Newnes, Rand, London  
Registered at the G.P.O. for transmission by Canadian Magazine Post.

Copyright in all drawings, photographs and articles published in "Practical Mechanics" is specially reserved throughout the countries signatory to the Berne Convention and the U.S.A. Reproductions or imitations of any of these are therefore expressly forbidden.

# Sinking an Oil Well

The Method Used for Boring, and How the Oil is Brought to the Surface

**O**IL is a vital factor in our economy today, and it is interesting to note the great progress that has been made in recent years in the science of discovering oil-bearing strata, and in the methods used for extracting the oil.

Well over a million oil wells have been sunk during the last 90-odd years by various methods, of which the percussion system was the first.

(Right) Looking up a derrick at Houston, Texas. The man seen on the platform is getting ready with a new length of drilling shaft.



Unscrewing the drillpipe.

In the case of exploratory wells, as distinct from those drilled in a known oilfield area, on an average not more than one in four is successful. A deep well may cost £100,000 or more to drill.

## Rotary Drilling

Most of the modern wells used are sunk by rotary drilling, which reaches deeper objectives faster and more economically. The first step in rotary drilling, in which the hole is made by the rotating action of a cutting head, is to take out upon the site a cellar about 24 feet deep and 15 feet square. Over this excavation a steel derrick usually about 136 feet in height is erected for the purpose of raising and lowering the drilling kit. In a large unit the derrick may have to handle a load up to 350 tons. The diagram, Fig. 1, shows the whole surface

**The "Kelly"**  
The drilling "string" can be divided into four sections. The first is the "Kelly," which is generally of square or hexagonal cross-section. It fits into a suitably shaped hole in the turntable. Next comes the drillpipe, which is screwed into the "Kelly." Then come the drilling collars, which are hollow steel bars added to give weight and rigidity above the bit. Finally, there is

equipment that is installed. It is simple but very efficient. At the top of the derrick is mounted the "crown" block from which, by means of pulleys and travelling block, the swivel—a rotating joint to which the drilling tools, or "string," are attached—is suspended on wire ropes.

the bit itself, which does the cutting. There are several kinds of bit used, according to the nature of the formation through which the well is being driven. For drilling in soft strata use is made of a multi-bladed drag bit. In hard formations bits with several cutters running on roller bearings are used, whilst for drilling exceptionally hard formations the cutting edges of the bits are studded with industrial diamonds.

As the drilling proceeds and the hole becomes deeper the "Kelly" disappears through the turntable till only a short length

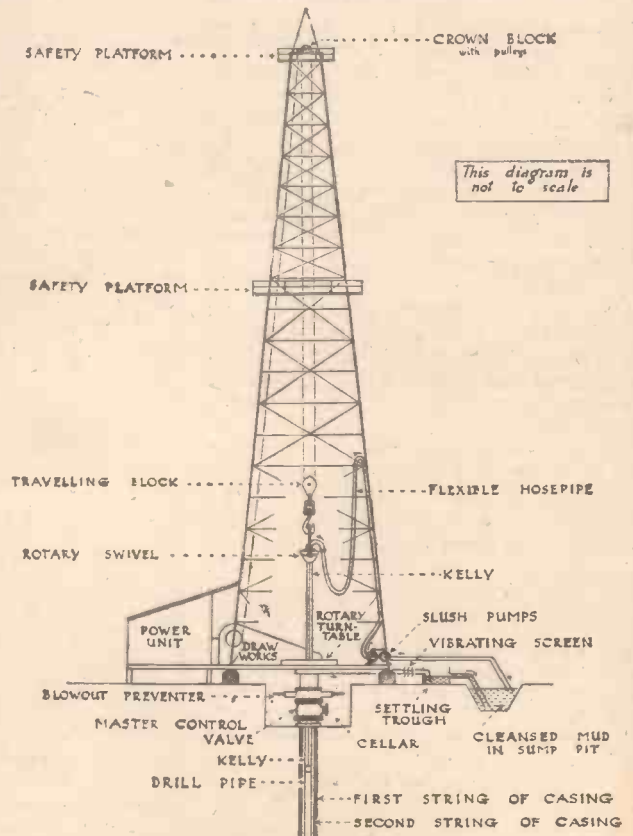

Fig. 1.—Diagram showing the surface equipment for oil well sinking.



The site of an oil well sinking at Elk Basin, Wyoming, U.S.A.

is visible above it. That is the signal for the addition of a fresh length of drilling pipe. The whole "string" is raised until the "Kelly" is clear. The top length of drillpipe is held in the turntable with chocks, the "Kelly" removed and a new section of the drillpipe is added and connected to the "Kelly." Down goes the "string" again to resume drilling until the downward progress of the bit causes the operation to be repeated. When the bit wears out, as it does on an average in good conditions every 200 feet, then the whole shooting match has to be raised, everything unscrewed in lengths and sections until the bit is reached and renewed. Then the drilling "string" is put together again and lowered to its work.

**Mud Circulation**

During drilling, mud is circulated around the well bore in order to remove the rock chippings formed by the action of the bit, to keep the bit cool and to help to prevent caving-in. The drill mud, generally prepared from local clays, is despatched by the slush pump (see Fig. 1) from the sump, via the hosepipe of the rotary swivel. It is forced down through the "Kelly" and the drillpipe to emerge from holes in the bit (Fig. 2). The mud is then forced up to the surface between the outside of the drillpipe and the walls of the well. It passes over a vibrating screen which separates the mineral fragments it contains so that they can be examined by a geologist. The mud returns to the sump to settle, after which it is forced down the well again.

**Inserting the Casing**

At a given point, usually about 500ft., the drilling "string" is removed and casing is inserted in 30ft. lengths. That keeps the hole clear. Liquid cement is then pumped down the casing to force the mud out of the well up between the outside of the casing and the walls of the well. The casing is always a little smaller in diameter than the drill hole. The cement fixes the casing in place and seals off water. The cement plug left in the bottom of the casing is drilled out when drilling is resumed with a new bit of slightly smaller diameter than the inside of the casing that has been inserted. New strings of casing,

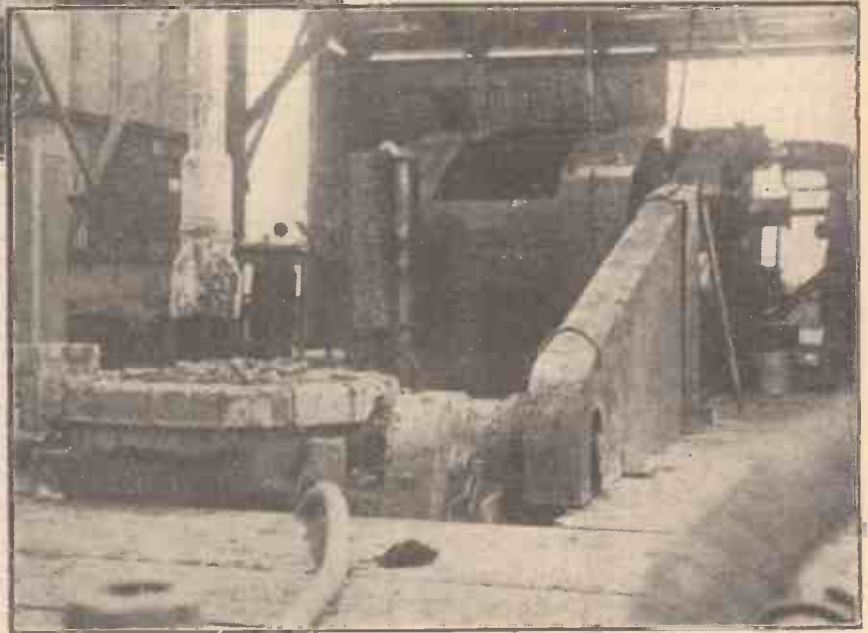

A diesel-driven drilling outfit, showing the draw-works and a drilling bit suspended over the bore hole.

each smaller in diameter than the last, are sent down from time to time so that the various lengths of casing in the well make up a sort of telescope with the eyepiece on the bottom. From the top it looks like a rifle target or a closed telescope.

Of course the size of the bits used are progressively smaller with each reduction in the diameter of the casing.

**How the Well is "Brought-in"**

When oil is reached the well has to be "brought-in" under proper control. It may be easy; it may be tricky, and at times it is very dangerous. Sometimes the well can be "brought-in" by just removing the drilling string and gradually reducing the weight of mud enough to let the oil flow. When oil is under high pressure, the weight of the mud may not be enough, and pressure drilling becomes necessary. A blow-out preventer is fitted, as you see in the diagram of the derrick, under the turntable and over the master control valve, the drillpipe is passed through it and rotated under pressure. Precautions are taken, too, to prevent the drillpipe being forced out of the well. Pressure can be made to hold down the oil by throttling the pressure of the returning mud, whilst pumping in fresh mud. This sounds rather rough and ready, but by these means it is possible to adjust

pressure at the well bottom within very fine limits. It is not often that a well gets out of control these days. Of course, the other extreme is found. There is no pressure at all—the oil will not come up and engineers have to pump it up mechanically or assist it to the surface by such devices as injecting gas.

**Some Snags**

All sorts of things crop up to hinder. Part of the drilling "string" may be lost by twisting off. They call the job of recovering it "fishing." It is a complicated, difficult and slow operation calling for the use of special tools. It may even lead to the abandonment of the well.

Caving, too, is another source of hindrance and difficulty. Special drilling mud may prevent it, but cement plugging and re-drilling may have to be resorted to.

It is easy for a well to get out of straight, and frequent tests have to be made to be

sure it is vertical, for drillpipes may well break in a crooked well as they may also do from excessive wear. Usually a crooked well can be straightened.

Oil is a very important subject, and the foregoing notes are intended to give readers an idea of the way in which a great deal of the oil we use is brought to the surface.

(Note. The photographs and diagrams illustrating this article are reproduced by the courtesy of the Petroleum Information Bureau.)

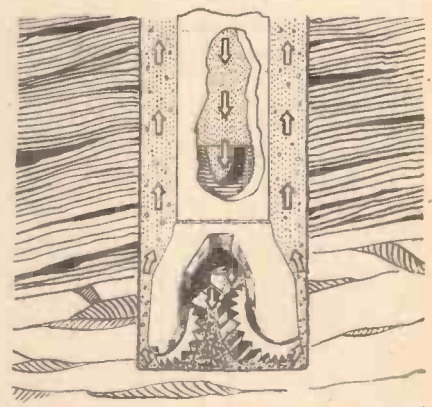

Fig. 2.—The bottom of the drill cut away to show the mud flow.

# Plastic Lenses

How They Can be Made in the Home Workshop

By C. G. GREEN, A.M.Inst.Mech.

**T**O those who have access to a lathe, the necessary skill in its use, together with a fair amount of patience, the manufacture of plastic lenses is a reasonably simple operation.

The finished article could not be termed perfect optically, but is precise enough for everyday use, and is as accurate as the cheaper uncorrected type of lens that can be purchased to-day.

## Radius of Curvature

The first thing to be decided upon is the focal length of the lens required, and this is governed by two factors. (1) The refractive index of the material used; (2) the radius of curvature of the lens surfaces. One point to remember is that the shorter the focal length, the higher the magnification of the lens. Most types of magnifying lens found in everyday use have either a flat face on one side and curved on the other (plano convex), or curved on both sides (double convex) and, in either case, the focal length can be worked out by the use of a simple formula.

(1) Plano convex :

$$\frac{1}{f} = (\mu - 1) \frac{1}{v}$$

$$\therefore f = \frac{v}{\mu - 1}$$

$\mu$  = refractive index of material used.

$v_1$  and  $v_2$  = radius of curvature of lens surfaces.

$f$  = focal length.

If  $v_1$  and  $v_2$  are equal, which is usually the case with a double convex lens, then

$$\frac{1}{f} = (\mu - 1) \frac{2}{v}$$

$$f = \frac{v}{2(\mu - 1)}$$

In other words, a double convex lens has half the focal length of a plano-convex lens of the same radius of curvature and made of the same material.

## Method of Manufacture

Let it be assumed that the material, the focal length, and the outside diameter have been decided upon. With regard to the "Perspex" to be the most satisfactory.



Fig. 4.—Wooden formers used for polishing.

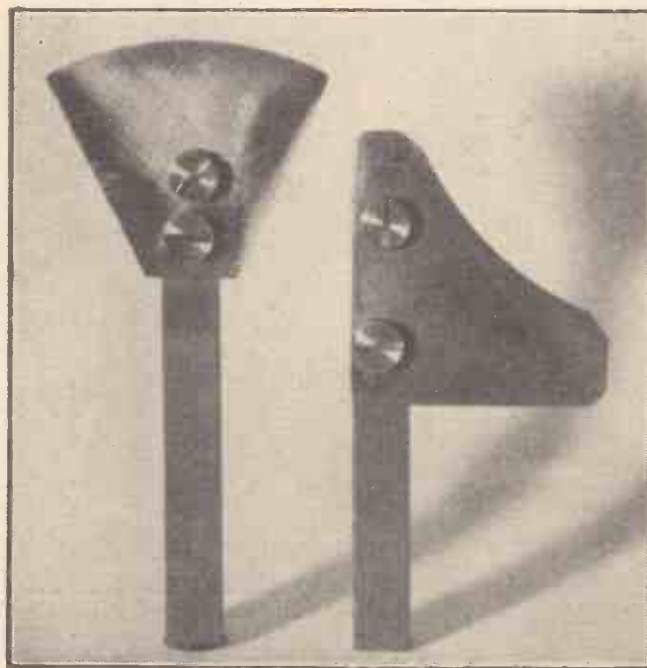

Fig. 1.—Convex and concave forming tools.

The next step is to make two forming tools, one convex and the other concave, but both of the same radius of curvature. The tools I used can be seen in Fig. 1, and were made as follows :

A piece of mild steel sheet about  $\frac{1}{8}$  in. thick and of sufficient size was mounted on the faceplate and a hole bored in it, the radius of which was exactly the same as the radius of the lens. As the cutting edge of the tool needs to be backed off, the top slide was set over a few degrees and used for boring; this has the effect of chamfering the edge of the hole. (See Fig. 2.)

The sheet was

then removed from the faceplate and a section cut out as seen in Fig. 3. This section, after being mounted on a suitable holder and case-hardened, made the concave tool. The convex tool was made from a similar piece of mild steel sheet, turned into a disc of the same radius as the concave tool, the edge backed off in a similar manner, a section cut out as before, mounted on a holder, and case-hardened. It is of the utmost importance for the radius of the two tools to be exactly the same.

## Cutting Out the "Perspex" Disc

The next step was to cut out a disc of "Perspex" of the correct diameter and thickness, it is well to note that the more the face is curved the thicker the lens will be. I made all my lenses from a  $\frac{1}{8}$  in. thick sheet, first marking out the required circle with the dividers, then cutting out the enclosing square, lopping off the corners and turning the disc

by the usual methods. It does not matter if the surfaces become slightly scratched as they have to be machined and/or polished afterwards.

The disc was then mounted in the three jaw chuck and the concave tool mounted in the toolpost with its top edge at dead centre. The spindle was started on high speed and the tool slowly fed in, using an ample supply of coolant. It is very important to keep the work cool or the plastic will flow and the lens will be ruined from the start. Cutting was

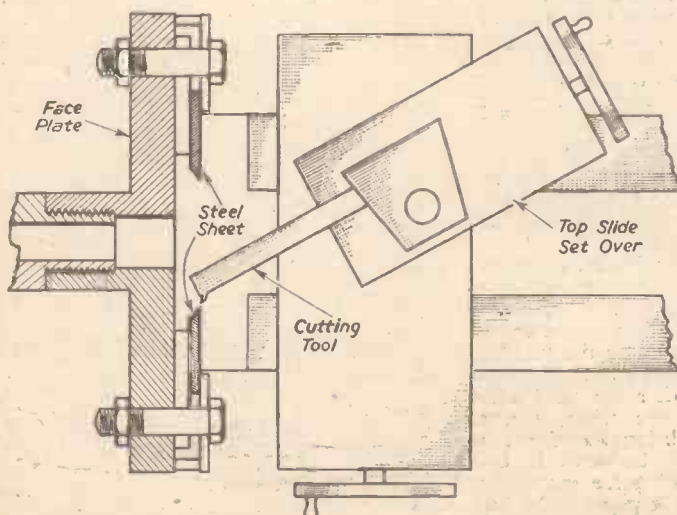

Fig. 2.—Method of turning the mild steel plates.

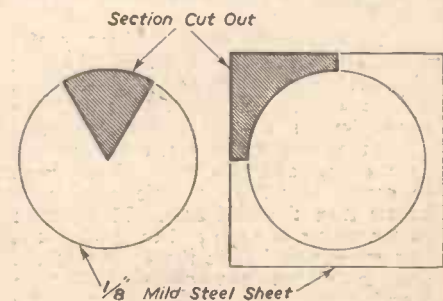

Fig. 3.—The sections required for making the forming tools.

continued until the face of the plastic was machined all over. Upon removing the disc from the chuck it will be seen that the worked face is curved to exactly the same radius as the tool only, of course, it will be convex. Now if the plano-convex lens is required, the other face is left as it is, but if, on the other hand, it has to be double convex, the disc is reversed in the chuck and the second face treated in a like manner.

### Polishing

The next and final stage was to polish the two faces of the lens, curved or otherwise, and to polish the flat face of the plano-convex lens was quite a simple matter. A piece of felt was placed on to a flat surface soaked with metal polish, and the plastic polished on this with a circular motion. When all the visible scratches were removed, a final polish was given using jewellers' rouge as a medium.

To polish the curved face, a wooden former was necessary. For this a piece of hard wood of suitable size was set up and machined until round, then, with the convex forming tool, a concave depression was cut into the front face, also a fairly deep groove was cut into the periphery about an inch back. Then, without removing the former from the chuck, a piece of soft cloth was placed over it and held in contact with the front face by means of the curved surface of the lens then fixed into position by tying a piece of string into the groove. (See Fig. 4.)

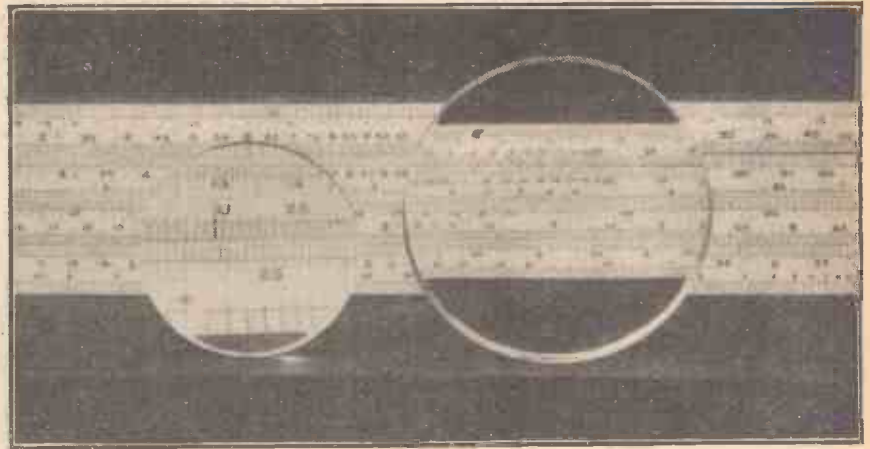

Fig. 5.—A finished plano-convex plastic lens, and a double-concave lens.

### Rotary Action

Metal polish was then applied to the cloth, the lens face placed into contact and the spindle started. It is very important at this stage that the lens be rotated slowly the whole time so as to avoid polishing one part of the surface more than others. As before, all scratches on the surface of the lens were polished out with metal polish and then,

using a fresh cloth, the lens was finally polished with rouge.

If a concave lens is required, the convex tool is used for roughing out and a polishing block is made with the concave tool. The only thing to remember is that the focal length is a negative quantity. Two of the lenses I made can be seen in Fig. 5, the small one being plano convex and the larger, double concave.

## New Sound Equipments

Details of Installations Carried Out by the G.E.C. at Singapore

**T**WO important sound equipment installations which have been carried out by The General Electric Co., Ltd., are at Singapore, where G.E.C. equipments are used by the Legislative and Municipal Councils.

The present installation for the Legislative Council, is situated in the Victoria Memorial Hall, and arose out of a U.N.O. conference in 1949 for which the G.E.C. supplied a temporary sound system. This system was very successful and the Malayan Government invited the company to supply a permanent installation.

### Ribbon-type Microphones

This is now in operation and consists of a 30-watt amplifier which feeds a total of 18 loudspeakers. Twenty-four ribbon-type

microphones are used in conjunction with automatic selection equipment. This equipment is based on automatic telephone switches and enables each member of the council to connect his microphone to the system within  $\frac{1}{2}$  second by simply pushing a button. This feature is of great importance at conferences and in council chambers because where a manual system of switching is used, as in the U.N.O. building at Lake Success, delegates wishing to speak have to raise their hands for several seconds before their microphone is made alive, and this inevitably leads to confusion when two delegates raise their hands at the same time.

Only one member's microphone can be in circuit at a time and when a button is pressed it automatically disconnects the microphone previously in circuit. Circuits are arranged,

however, so that the President's microphone and that of the clerk of the council are in circuit continuously, as procedure often necessitates a quick exchange between the clerk and the president. The latter may also wish to speak quickly to any member. The president, however, has a priority key whereby he can disconnect all microphones except his own. This facility is necessary in case cross-arguments arise at a meeting.

### Pre-amplifier for Each Microphone

Pre-amplifiers are used for the microphone circuits, one for each microphone. This may seem an elaborate procedure but it is considered to be well worth while as it enables each microphone to be balanced individually with regard to acoustic conditions, and its electrical response.

As it was considered necessary for the control engineer to know which microphone is in use, indicator lamps are arranged on the amplifier rack in a layout which is the same as the positions of the microphones in the hall.

The microphone equipment is arranged for easy removal as the council tables are removed between meetings. Special sunken boxes are provided in the floor which enables the table wiring to be connected easily by means of multi-way plugs. The control room which houses the amplifier, automatic selection and power equipments is housed in a small anteroom behind the Council Chamber.

The equipment used for the Municipal Council installation in the Municipal Building is similar to that of the Legislative Council and also consists of a 30-watt amplifier feeding 18 loudspeakers. Sixteen microphones are used, again in conjunction with automatic selection equipment. The control room is outside the Council Chamber and has means whereby the monitoring loudspeaker can be locked out of circuit by the Secretary to the Council, should it be desired to hold a secret session.

Both these installations have been tested at a number of meetings and have proved entirely satisfactory in spite of the very considerable fluctuation of mains voltage which is experienced in Singapore. Means are provided in the equipments to overcome this variation.

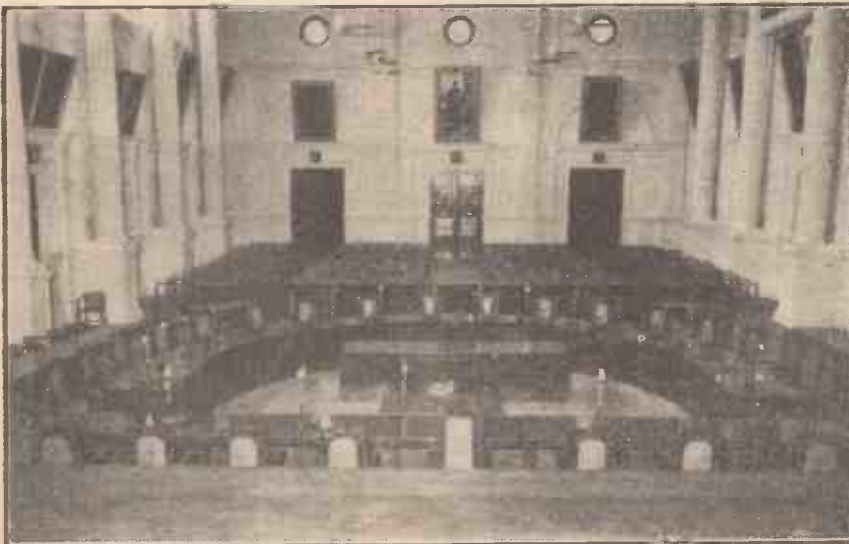

The Legislative Council Chamber in Singapore, showing conference tables with microphones.

# Building Aluminium Boats—1



A completed 12ft. aluminium dinghy.

THE use of aluminum alloys has increased considerably during recent years and a number of firms now have aluminum boats on the market. The object of this series of articles is to introduce aluminium as a material for amateur boat building. Within limits, an aluminium boat is as easy to build as a wooden one, and could be undertaken by any handyman able to use hacksaw, hand drill and hammer. It must be emphasised that the construction and design methods described are not necessarily the best, or would be advocated for the professional boat builders. They are, however, considered the most satisfactory for amateurs whose skill and time are limited, and whose equipment consists of a few hand tools. The most important result of this is that only the hard chine type of boat is dealt with. There are two types of hard chine boats, flat bottomed and vee bottomed. As the former are the simplest and quickest to build, most of the designs dealt with are the flat-bottomed type. There is a lot of prejudice against flat-bottomed boats in this country and they are commonly supposed to be slow, unseaworthy and easily capsized. In actual fact, a properly designed flat-bottomed sailing boat is as fast as a round bilge boat on all points of sailing except when beating to windward against a head sea. In these latter conditions they are definitely slower and for that reason are not popular for racing. As regards seaworthiness, a properly designed flat-bottomed boat can be as seaworthy as any other type of boat, as is proved by the Grand Bank's fishing dory. This is a small, flat-bottomed, open boat carried by the Grand Bank fishing vessels and habitually used in rough water. Contrary to general belief, the flat-bottomed boat is more stable than a round bilge boat of the same beam and can carry more sail without capsizing. However, while the round bilge boat will heel to a larger angle before capsizing, the flat-bottomed boat capsizes at a much smaller angle with less warning. This means that if a boat is hard pressed when racing, the flat-bottomed boat is more likely to be capsized accidentally than the round bilge boat. It will be noticed that these remarks apply to sailing boats, and are of less importance in rowing and motor boats. For general use in the comparatively sheltered waters in which small boats are normally used, the

flat-bottomed boat is at little disadvantage. The great advantage of building your own boat is the saving in cost. An amateur-built aluminium boat costing only one quarter to one third of the standard price.

## Aluminium and its Alloys

Aluminium is produced by an electrolytic process discovered about fifty years ago. Since then its use in industry has been steadily increasing. As a result of the enormous demand for aluminium in aircraft construction during the late war, production of aluminium in all its commonly used forms has increased to a point where it can be obtained as easily as other commonly used construction materials such as steel and wood.

The most important quality of aluminium is its lightness; volume for volume, it weighs only about one third as much as the other commonly used metals. Other important properties are its resistance to corrosion and ease of fabrication, in both of which it is superior to steel.

Pure aluminium is soft and not very strong, and to increase its strength it is alloyed with other metals such as copper, manganese, silicon, iron, magnesium zinc and nickel. These elements are used either singly or in combination, but the amount of alloying elements rarely exceeds six to seven per cent. The most important alloys for structural use are those in which copper or magnesium are the main alloying element, although the use of zinc alloys is increasing in the aircraft industry. In general, aluminium alloys can be divided into wrought alloys

With Notes on Design

By G. F. WALLACE, A.F.R.Ae.S.

and casting alloys, of which only the wrought alloys concern us in these articles. The wrought alloys are again divided into heat-treated and non-heat-treated alloys, and into copper and magnesium alloys. The copper alloys are usually heat-treated, whereas the magnesium alloys are usually non-heat-treated. The heat treatment of aluminium alloy is analogous to the hardening and tempering of steel and considerably increases the tensile strength of the material. Although most of the magnesium alloys cannot be heat-treated, they are very prone to work hardening, and when rolled into sheets or drawn into tubes, etc., are nearly as strong as the heat-treated copper alloys. The magnesium alloys have the great advantage of being far more resistant to corrosion by sea water than the copper alloys, and for this reason are the ones usually employed for the construction of boats and marine fittings generally.

The only alloys recommended for use in the construction of small boats in addition to pure aluminium sheet for components which have to be formed, are magnesium alloys for sheet and angle sections. The properties of the magnesium alloys will be considered in more detail.

The accompanying table gives the specification numbers and makers of the commonly used aluminium magnesium alloys.

## Corrosion

When exposed to the atmosphere a thin, hard layer of aluminium oxide forms on the surface of the metal, and this protects the metal underneath and normally prevents further corrosion. If under severe conditions corrosion does take place, it takes the form of a white powder appearing on the surface of the metal, and if this is scraped off the surface is found to be finely pitted. Even after several years' exposure to all weathers this corrosion is nothing like so severe as the rusting of unprotected steel under the same conditions. Paint of suitable quality gives complete protection against corrosion, and if a small area of paint is accidentally removed the resulting corrosion does not spread under the surrounding paint as on steel. This is because aluminium will not corrode under the paint film as steel does. This means that the maintenance on an aluminium boat is simpler and cheaper than on wood or steel boats. As long as the paint film is intact there is no need to worry about rusting, shrinking, worm, dry or wet rot. If a small area of paint is damaged it is only necessary to clean the area and repaint; there is no

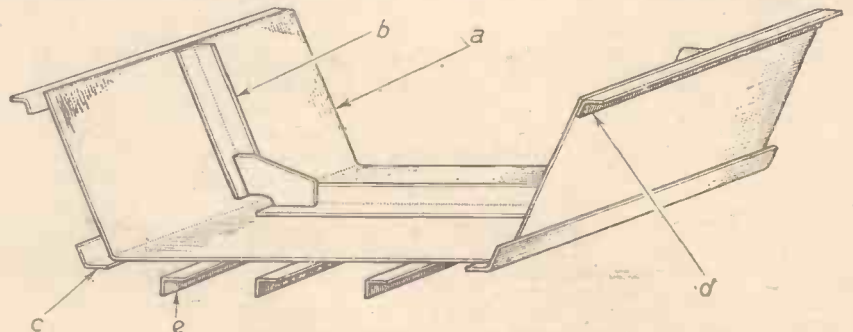

Fig. 1.—A section of a flat-bottomed skiff.

need to remove any of the surrounding paint. One important point, however, is that paint containing lead pigment or mercury compounds must on no account be used on aluminium as they accelerate corrosion.

**Comparison of Aluminium Alloy with Wood**

In comparing the strength-weight ratio of aluminium and wood, yellow pine is taken as a representative wood and A.W.6 as a suitable alloy. The comparison is based on safe working strength and not on ultimate strength.

Material	Safe-working stress per sq. in.	Weight lb. per cu. in.
Yellow pine	1,400lb. per sq. in.	.023
A.W.6	11,700lb. per sq. in.	.096

This gives a strength-weight ratio of alloy to wood of .52 or, for the same strength, the alloy has only half the weight of the wood. These figures apply to the main compression and tension stresses set up in the boat, and do not give the full story. Wood is not an isotropic material, and its strength for loads perpendicular to the grain is only 250lb. per sq. in., as compared with 11,700 lb. per sq. in. for the alloy. Again, the horizontal shear stress for yellow pine is only 125lb. per sq. in., compared with 6,700lb. per sq. in. for the alloy. This means that an aluminium boat designed to

has a plastic yield, whereas wood has not. This means that when the safe stress is exceeded the aluminium will buckle but will not necessarily fracture, whereas wood splits and breaks apart. It also means that damage is more likely to be localised in an aluminium boat. It follows that damage

the life of the boat. For ease of construction the advantage is with aluminium for hand chine designs and with wood for round bilge designs. Aluminium is an ideal material for hard chine boats, which can be constructed without any special plant or equipment. Round bilge boats, on the

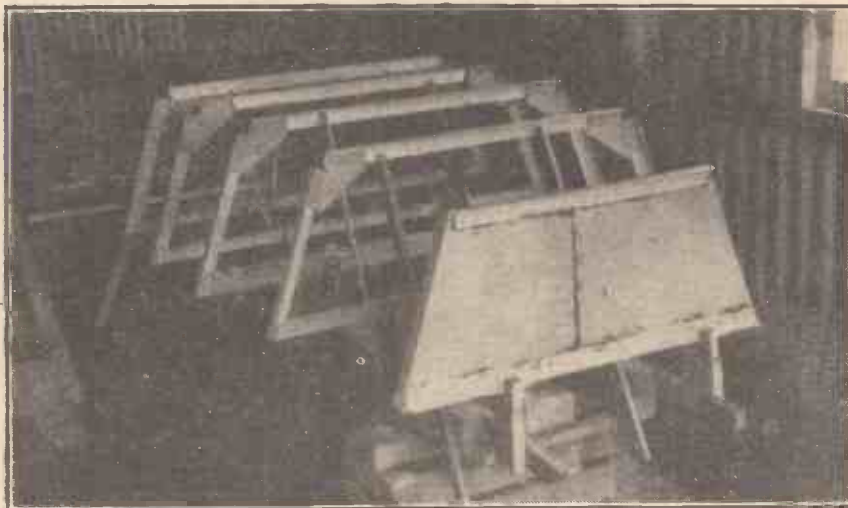

Frames set up on stocks.

**STANDARD MAGNESIUM ALLOYS**

% Magnesium	British Standard Specification	Northern Aluminium Co. Specification	James Booth Specification	Birmetals Ltd. Specification	High Duty Alloy Specification
1.5-2.5	A.W.4	M57S	M.G.2	B.B.2	Hiduminium 22
3.0-4.0	A.W.5	—	M.G.3	B.B.3	Hiduminium 33
4.5-5.5	A.W.6	—	M.G.5	B.B.5	Hiduminium 05
6.5-7.5	A.W.7	—	M.G.7	B.B.7	—

**MECHANICAL PROPERTIES**

B.S. Specification	Condition	SHEET			EXTRUSION		
		.1% proof stress	Ultimate tensile stress Tons/ in.	Elongation % on 2in.	.1% proof stress	Ultimate tensile stress	Elongation % on 2in.
A.W.4	Soft	—	11	18	—	11	18
	half-hard	12	15	5	—	—	—
A.W.5	Soft	7	14	18	6	14	18
	half-hard	15	18	5	—	—	—
A.W.6	Soft	8	17	18	8	16	18
	half-hard	17	20	5	—	—	—
A.W.7	Soft	9	20-23	18	9	20	18
	half-hard	19	26	5	—	—	—

have the same strength as a wooden boat for the main bending loads would be far stronger in other directions, such as the attachment of the plating to the frames and the attachment of fittings.

Another important point is that aluminium

is usually more easily repaired in the aluminium boat.

Properly designed and constructed, an aluminium boat is easier to make and keep watertight. Usually they are drum tight when launched and never leak a drop during

contrary, involve panel beating for the plating and bending operations for the frames and stringers. These are highly skilled operations and require special plant, such as wheeling machines and bending rolls.

There is one other point, a small, unballasted wooden boat will float if accidentally capsized and filled with water, whereas an aluminium boat will sink in similar circumstances. It is therefore necessary to provide buoyancy tanks on small aluminium boats, and these are best built into the boat by means of watertight bulkheads.

**Comparison of Aluminium with Steel**

The magnesium alloys of aluminium have two great advantages over steel. First, lighter weight, the aluminium alloy being only little over one-third the weight of mild steel for only a small reduction in strength. Comparing alloy to specification A.W.6 with typical shipbuilding steel, the strength-weight ratio is .495, or as for wood, an aluminium boat could be made for half the weight of a steel boat for the same strength. The second advantage of magnesium aluminium alloy is its resistance to corrosion. As already mentioned, the magnesium alloys are not only more resistant than steel but can be more effectively protected against corrosion by painting. It is in the smaller craft that aluminium shows the greatest advantage over steel. Whereas steel has completely replaced wood in the construction of large vessels, in small craft, to achieve a reasonable weight, the plating has to be made so thin that it is liable to be easily buckled and dented and has little reserve against corrosion and abrasion. Aluminium, on the other hand, can be made three times as thick for the same weight and is therefore far stiffer. For the same strength it also has a 30 per cent. reserve against corrosion and abrasion. It is highly probable, therefore, that aluminium will ultimately replace wood as the standard material for the construction of small craft as completely as steel has replaced wood in the construction of large vessels.

The following are the specifications recommended for the construction of the boats described in these articles.

Plating: B.S.S. A.W.6 half-hard or James Booth's M.G.5 half-hard.

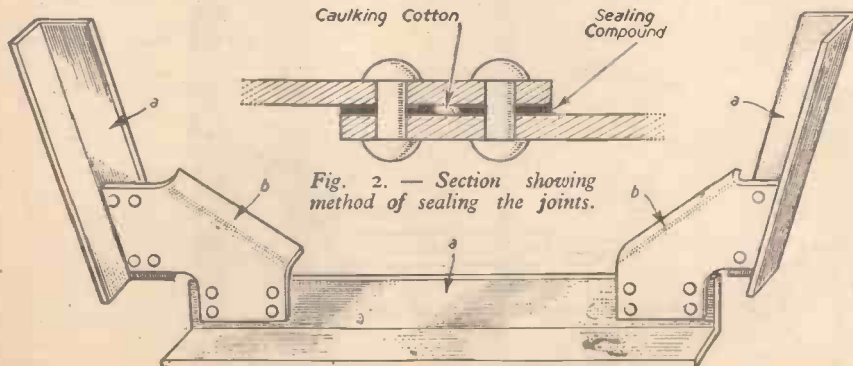

Fig. 2. — Section showing method of sealing the joints.

Fig. 3.—A typical frame, showing the gusset plates.

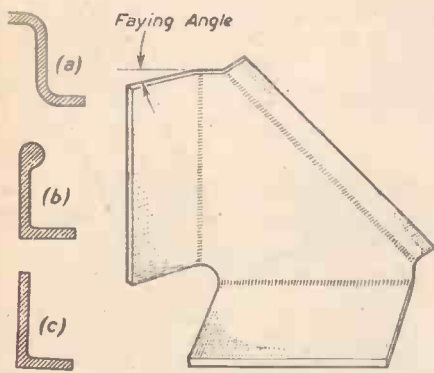

Fig. 4.—Three types of frame members.

Fig. 5.—Detail of a gusset plate, showing the faying angle.

Extruded Sections for frames etc.: B.S.S. A.W.7 or James Booth's M.G.7.

Chines and Gunwales or any other component that has to be formed: commercially pure aluminium sheet in soft condition.

Rivets: Commercially pure soft aluminium.

One of the troubles of amateur constructors is the fact that the various materials are required in such small quantities. Many firms will not supply the quantity required for the building of a single boat. This applies particularly to extruded sections, no stocks of these are usually carried and firms will not set up tools for quantities of less than 1 cwt. However, Messrs. James Booth, of Birmingham, will usually supply both extrusions and sheet in quantities small enough for a single boat. Rivets are easier to obtain; they are sold by weight, and quantities down to 1lb. can be supplied. The following firms will usually supply rivets:—

Messrs. Baxters (Bolts, Screws and Rivets) Ltd., Parade Works, Sheepcote Street, Birmingham, 15.

Messrs. J. Stone and Co., Ltd., Deptford, London, S.E.14.

Messrs. Guest, Keen and Nettlefolds, Ltd., Box No. 24, Heath Street, Birmingham, 18.

**The Method of Construction**

There are various ways of building a boat in aluminium, but the method described is considered to be the easiest for amateurs. Where alternative systems are described, as in the riveting of the chine angles, the builder can use the one which he prefers.

The method of construction used is based on the "stressed skin" system used in the construction of aeroplanes, in which the strength of the boat is in the bottom, side and deck plating or skin. This means that no heavy keel or gunwales are needed to take the bending loads in the hull, although the plating needs to be stiffened with frames and stringers to prevent local buckling and to preserve its shape. The general principles of this construction are shown in Fig. 1, which represents a section from a flat-bottomed skiff. The skin or plating *a* is held in place by the frames *b*. The bottom and side plates are joined together by the chine angle *c* which serves both to make the joint watertight and to stiffen the corner or "chine." The top edge of the sides is stiffened by the gunwale angle *d* and the bottom is stiffened by the stringers *e*. In a larger boat in which the depth is great compared to the thickness of the skin it may

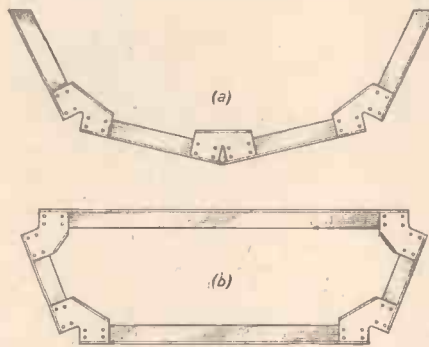

Fig. 6 (a).—Frame for a V-bottomed boat, and (b) a frame with top member for carrying the deck.

be necessary to have one or more stiffeners on the side between the gunwale and chine. This type of hull can be divided into four main sets of components:—

1. The plating.
2. The frames.
3. The chine and gunwale angles.
4. The fittings and details.

**The Plating**

The material recommended for plating is magnesium alloy to specification B.S.S. A.W.6 in the half-hard condition. The thickness is measured by standard wire gauge, and only the even number gauges

are usually employed. The six gauges 20 S.W.G. to 10 S.W.G. should cover all amateur requirements, although nothing thicker than 16 S.W.G. is specified for the designs dealt with in these articles. The largest size sheet normally made is 8ft. by 4ft.; sheet roft. by 3ft. can also be obtained in the thinner gauges. The most common size sheet, however, is 6ft. by 3ft. This size can usually be obtained from stock in most gauges, and is more convenient for transport and handling than the larger sheets. The following table shows the thickness and weight of the various gauges:—

S.W.G.	Inches	Weight per sq. ft.
20	.036	.534
18	.048	.721
16	.064	.949
14	.08	1.187
12	.104	1.542
10	.128	1.899

The main operations carried out on the plating are cutting to shape and riveting. The plate easily bends to the shape of the boat and can also be bent to sharp angles provided the bend is along a straight line. In the specification recommended the plating is too hard for forming operations to be successfully carried out by amateurs. The best way of cutting plate is with a hacksaw fitted with a sheet metal adaptor. Sheets of 20 S.W.G. and 18 S.W.G. can be cut with large tin snips, but these tend to curl and distort the edge of the sheet and their use is not recommended. A pair of old leather gloves should be worn when cutting up sheet and all burrs should be removed with a file and emery cloth before the sheet is handled with bare hands.

The plating is joined together and fastened to the frames and chines by means of rivets. The diameter of rivets used depends on the size of the plates to be joined, and on the rivet material. Normally the material used for rivets is the same or similar to that used for the plating. For amateur construction, however, it is considered preferable to use soft aluminium rivets of slightly larger diameter. These rivets, of course, are nothing like as strong as alloy rivets, but on the majority of joints in the boat the rivet pitch is decided by considerations of stiffness and watertightness rather than strength. The riveting of the soft rivets is much easier, and they are unlikely to be split by over riveting. The diameter of rivet for various thickness of plate together with the drilling diameter is shown in the following table:—

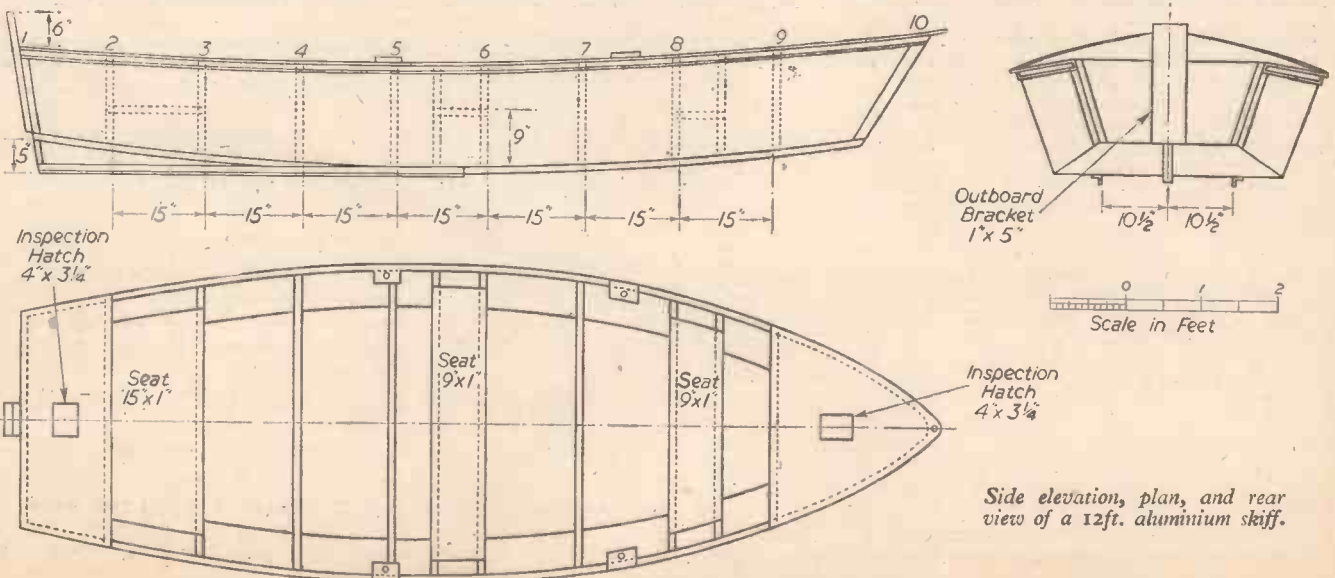

Side elevation, plan, and rear view of a 12ft. aluminium skiff.



Plate thickness S.W.G.	Rivet diam.	Drill size Morse	Drill size inches
20 } 18 }	5/32in.	2I	.159
16 } 14 }			
12 } 10 }	3/16in.	1I	.191
	1/4in.	F	.257

The length of rivet depends on the thickness to be joined, but a length of at least the diameter of the rivet must be allowed for forming the head.

Rivets are made in the following range of lengths: 1/4in., 5/16in., 3/8in., 7/16in., 1/2in., 5/8in., 3/4in., 1in. and 1 1/4in.

Joints in the plating are made by means of lap joints the width of the lap depending on the thickness of the plate and the diameter of the rivets, but must be wide enough to allow for a double row of rivets. The rivet pitch again depends upon the diameter of the rivet and whether it is a watertight joint or not. For attaching plating to frames or any other joint not

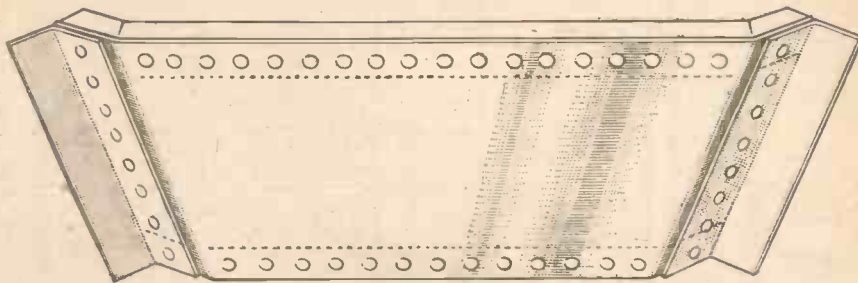
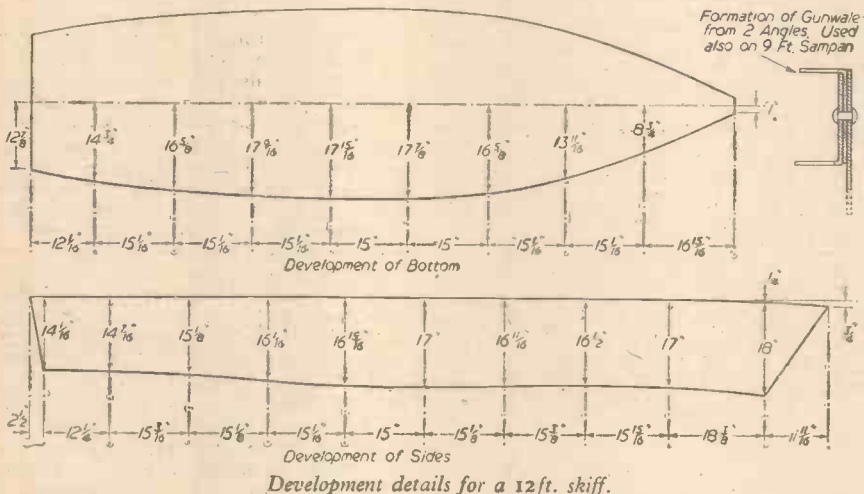

Fig. 7.—A watertight bulkhead.

the "Z" section illustrated in Fig. 4a; this is folded up from sheet the same thickness as the plating. The folding must be done in a folding machine, it cannot be done by hand or bending bars. The most efficient extruded section is the bulb angle, as shown in Fig. 4b. The section recommended, however, is the plain extruded angle, as shown in Fig. 4c. This is heavier than the bulb angle

to the point of the chine angle but are cut short by the width of the chine angle. This simplifies both the cutting of the angle and the construction of the frames, and as the chine is adequately stiffened by the chine angle, no material loss of strength or stiffness results. Fig. 6a shows a frame for a Vee-bottomed boat, in this the bottom member is in two parts, joined by an extra gusset plate. Where the boat is decked the frames must have a top member to carry the deck, as shown in Fig. 6b. In this case two extra gussets are required in addition to the top members. In some cases the frame is replaced by a watertight bulkhead, a typical example of which is shown in Fig. 7. The gusset plates are replaced by the plate extending over the whole area of the section, but the edges are stiffened by angle in the same way as the frames. It will be noticed that the side edges of the plate are bent to an angle to conform to the curvature of the boat. It is not possible to do this in addition to the bottom and top edges. It is therefore necessary to set the stiffening angle on the top and bottom edge to the faying angle. In addition, it will be seen that unlike the frames the stiffening angle is carried to the point of the chine, and that the top and bottom angles are on the opposite side of the plate to the side angles. This is to ensure a watertight joint at the corners. It is essential that the frames and bulkheads be made as accurately as possible, because once riveted up, the shape cannot be altered and it is upon the shape of the frames and bulkhead that the shape of the finished boat depends.



**The Chine and Gunwale Angle**

The satisfactory manufacture and fitting of the chine angle is probably the most difficult operation in the construction of an aluminium boat. The reason for this is that it is the only member that has to be curved in two planes at once. There are two types of chine, the single and the double chine. The single chine needs more rivets to ensure a watertight joint, whereas the double chine needs twice the amount of chine angle. On the other hand, the double chine is smaller and can be made of thinner material.

(To be continued)

watertight the following pitches are recommended:

5/32in. rivets	1 1/2in. pitch
3/16in. rivets	2in. pitch
1/4in. rivets	3in. pitch

Watertight joints may be single row or double row, although double row is more common and is invariably used for joints in the plating. The following pitches are recommended:

5/32in. rivets	single row	1in. pitch
5/32in. rivets	double row	1 1/2in. pitch
3/16in. rivets	single row	1 1/4in. pitch
3/16in. rivets	double row	2in. pitch
1/4in. rivets	single row	1 1/2in. pitch
1/4in. rivets	double row	2 1/2in. pitch

Preferably mushroom-head rivets should be used, wherever possible, with the mushroom head on the outside. If mushroom heads cannot be obtained, however, ordinary snap-heads can be used. On no account should countersunk rivets be used on thin plate as it is very difficult to obtain a watertight joint with them. Riveting alone, at the pitches recommended, will not give a watertight joint, and it is necessary to use a jointing compound in addition. Any of the rubber-based jointing compounds will do, "Bostik" being the best known and most easily obtainable. In addition to the jointing compound a thin thread of caulking cotton is placed between the rivet rows, as shown in Fig. 2.

**The Frames**

A typical frame is shown in Fig. 3; it consists of three members of extruded angle (a) joined by two gusset plates, (b) there are several types of section that can be used for the frame members. The most efficient is

for the same strength, but is easier to obtain, easier to make up into frame and easier for attaching fittings. The folded section is only recommended if for some reason it is impossible to obtain extruded angle. The material for extrusions should be to B.S.S. A.W.7. The gusset plates are made from the same material as the plating, and can usually be made from the scrap left after cutting the sides and bottom to shape. A gusset plate is shown in more detail in Fig. 5. It will be noticed that the free edge is stiffened by turning over about 1/2in. to form an "L" section. It will also be noticed that the lugs of the gusset plate that are riveted to the frame are set at an angle. This angle is to allow the side and bottom members to conform to the curvature of the boat. Referring to Fig. 3 it will be seen that the angles are not carried

**BOOKS FOR ENGINEERS**

By F. J. GAMM

- Screw Thread Tables, 5/-, by post 5/3.
- Refresher Course in Mathematics, 8/6; by post 9/-.
- Gears and Gear Cutting, 6/-, by post 6/6.
- Workshop Calculations, Tables and Formulæ, 6/-, by post 6/6.
- Dictionary of Metals and Alloys, 10/6, by post, 11/-.
- Wire and Wire Gauges (Vest Pocket Book), 3/6, by post 3/9.
- Newnes Metric and Decimal Tables, 3/6, by post 3/9.
- Screw Thread Manual, 6/-, by post 6/6.
- Newnes Electrical Tables and Data, 10/6, by post 11/-.
- Slide-rule Manual, 5/-, by post 5/3.
- Mathematical Tables and Formulæ, 5/-, by post 5/3.
- Every Cyclist's Pocket Book, 7/6, by post 7/10.

Published by

GEORGE NEWNES, LTD. TOWER HOUSE, SOUTHAMPTON STREET, STRAND, W.C.2

# MODEL ENGINEERING PRACTICE

Article No. 17

by F.J. Camm

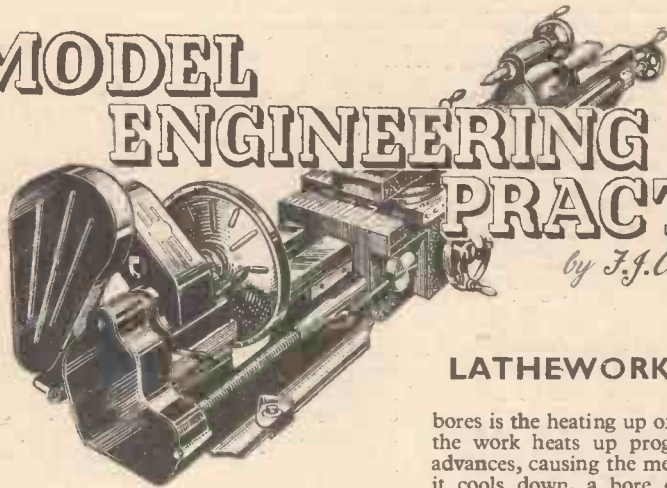

## LATHEWORK (Continued)

OF several methods of making holes in metal those associated with the lathe are drilling and boring. Drills are extremely useful for holes of standard size, and twist drills are obtainable in all sizes, from one sixty-fourth upwards, progressing by sixty-fourths, and also in letter sizes and number sizes for drilling holes which are to be tapped. A drilled hole, however, is seldom accurate. It is not of much use, for example, as a bearing, for however carefully a drill is ground, it is bound to cut oversize. If a hole exactly  $\frac{1}{16}$  in. in diameter is required a drill of  $\frac{1}{16}$  in. diameter will not cut it. It will be obvious to the reader that a steel shaft exactly  $\frac{1}{16}$  in. in diameter will not enter a hole exactly  $\frac{1}{16}$  in. in diameter. So for accurate work a hole must be drilled undersize and brought to the size required by reaming.

These methods are convenient for certain work, but when dealing with castings large holes may be required outside the capacity of drills, and such holes may appear in the castings as roughly cored openings. It is in such cases that we must resort to boring. A plain drilled hole is usually rough, but by boring, a smooth-finished hole exact to any size within the capacity of the lathe can be obtained, and when a glass-like finish is required subsequent lapping (allowing for this by boring the hole slightly undersize) by means of a brass lap and emery paste will provide a finish from which all turning marks have been removed.

### Boring-bars

There are many forms of boring-bars, and some of them are illustrated in Figs. 57 to 59. A primary requirement is a stiff bar which does not spring, for a tool which is unduly flexible will cause the hole to be bell-mouthed—that is to say, have a larger diameter at the front than at the back. Unfortunately, even though the boring-bar is of the most robust construction, a certain amount of spring is bound to be present. If the hole is large, a strong bar of ample dimensions can be used, provided it will easily pass into the hole, and then the amount of bell-mouthing which results will be slight, due only to the sudden application of the cutting load when the tool first meets the work.

By careful finishing cuts (a series of very light cuts) bell-mouthing can be entirely eliminated. Another cause of non-parallel

bores is the heating up of the work; naturally, the work heats up progressively as the tool advances, causing the metal to expand. When it cools down, a bore of irregular diameter may result. The initial roughing cuts can be fairly heavy or greedy, but it is always advisable before taking finishing cuts to allow the work to cool down. An adequate supply of cutting lubricant should be directed on to the point of the tool by means of a pump driven by the lathe.

With very small holes, however, it is necessary to use a boring-bar or boring-tool,

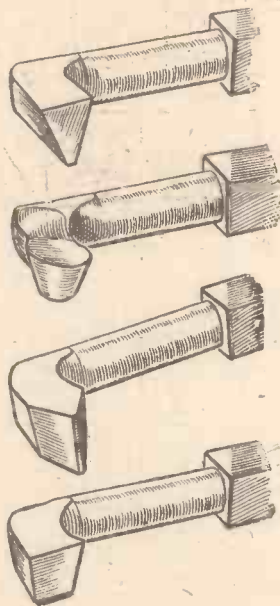

Fig. 56.—Solid boring tools for various operations.

reduced in diameter so that it can enter the hole; these tools usually give trouble owing to their flexibility. It is, therefore, necessary to proceed cautiously with the work. The initial cut should always be a tentative one to level down the high spots if the hole is cored. If the hole is not cored a hole should first be drilled and finished to size by boring.

It is particularly necessary to take light cuts where ports lead into the bore, as when the tool passes these openings, the load on the tool is released, and when it again starts to cut a high spot is left, causing ovality.

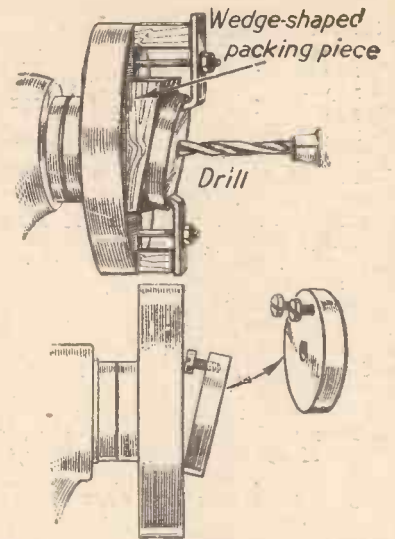

Fig. 55.—For drilling holes at an angle it may be necessary to pack the work as shown here.

### Screw Cutting

The principle of screw cutting consists of gearing the lead-screw to the headstock mandrel in such a manner that by revolving the lathe spindle one turn the lead-screw will rotate sufficiently to carry the saddle forward a distance exactly equal to the pitch of the thread to be cut. For screw-cutting purposes the saddle is generally connected to the lead-screw by means of a lever-operated split-nut. It will be apparent that to cut a thread of, say, 24 threads to the inch, the saddle, and consequently the tool, must travel a distance of  $\frac{1}{24}$  in. for each revolution of the lathe spindle.

Lead-screws are commonly cut either 10, 8, 6, 4 or 2 threads per inch. To cut a thread of 24 threads per inch on a lathe with a screw of  $\frac{1}{16}$  in. in pitch it follows that, while the spindle is making one turn, the lead-screw, in order to advance  $\frac{1}{24}$  in., must revolve only  $\frac{1}{6}$ th of a turn. Obviously, to do this, the gear train connecting the spindle to the lead-screw must give a speed reduction of 6 to 1.

Therefore, the first step is to find the ratio of the gearing to employ by dividing the number of threads per inch to be cut by the number of threads per inch of the lead-screw.

### Change-wheels

A set of change-wheels may consist of 22 wheels, ranging from 20 to 120 teeth, each wheel having five teeth more than the next smaller, one of the smaller gears, usually a 40, being in duplicate. With lathes having a lead-screw of six or eight threads per inch, the wheels may run from 24 to 100 teeth in increasing stages of four teeth.

Having found the ratio all that needs to be done is to select a train of wheels having numbers of teeth in the same ratio. As an example: what wheels are required to cut 20 threads per inch on a lathe having a lead-screw of four threads per inch? Twenty divided by four equals five. The wheel on the lead-screw therefore requires to have five times as many teeth as the spindle, or 100 and 20 teeth respectively. As these two gears run on

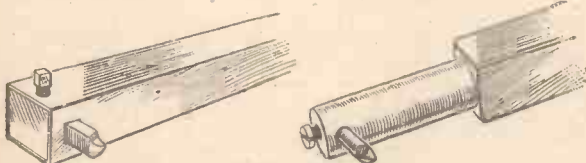

Fig. 57.—Square and round boring-bars, with inserted boring-bits.

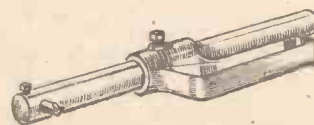

Fig. 58.—Tool-post boring tool-holder.

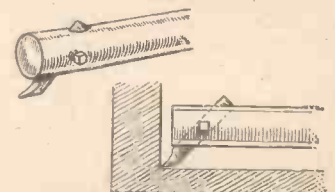
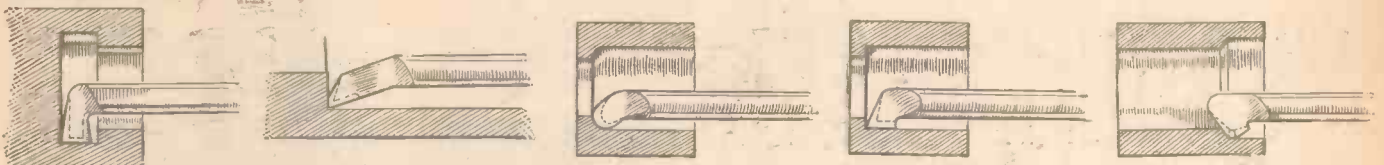

Fig. 59.—Boring-bar with the cutter inserted.



Figs. 60 to 64.—Various slide-rest boring-tools.

centres that are fixed, some means is necessary to transmit the drive from one gear to another. Provision is made for this in the slotted quadrant plate which is pivoted off the centre of the lead-screw. Into the slot is fitted an adjustable stud, working on which is a bush having a key to suit the change-wheels. Any convenient-sized wheel is selected as an intermediate gear, and the stud is raised in the slot sufficiently to allow the wheel to pass on to the bush clear of the lead-screw wheel. A smaller gear is put on in front as packing and locked by the nut provided. The intermediate wheel is then dropped into mesh with the lead-screw wheel and the stud locked in the slot, after which the quadrant plate is swung over, until the gear engages the one on the spindle, and locked. The top left-hand wheel represents the spindle, and the lowest one the screw, the smaller wheels on the screw and in front of the intermediate or idler gear being used as packing.

Obviously, with the standard wheels the limit of a simple train of gears is represented by a ratio of 6 to 1, 20 being the smallest gear available and 120 the largest: these, by the way, will cover all standard Whitworth pitches from 3/16in. in diameter, and B.S.F. from 5/16in. in diameter up to the largest size likely to be handled, without needing a compound train.

**Compound Trains**

For finer pitches than 24 threads per inch, use will have to be made of compounding the gear train when, for instance, a screw having a pitch of 30 threads per inch is required.  $30 \div 4 = 7\frac{1}{2}$  to 1 ratio. To cut this with a simple train would require wheels of 20 and 150 teeth; as the larger size is not available, recourse is made to a compound train of gears. This consists of splitting the gearing up into two units, as it were; one gear on the spindle drives a gear on the stud, a second gear having a different number of teeth is also mounted on the stud in front of the first and is driven at the same speed. This front or second gear meshes with the wheel on the screw.

Thus, by using a 20-wheel on the spindle to drive a 100-wheel on the stud, giving a reduction of 5 to 1, and the second wheel on the stud having 30 teeth driving a wheel with 120 teeth on the screw, a total reduction of 20 to 1 would be obtained. In the case under review, the gears could be split up into two trains to give a first reduction of  $3\frac{3}{4}$  to 1 and a second of 2 to 1, or a first of  $2\frac{1}{2}$  to 1 and a second of 3 to 1. To cut 30 threads, then, the following gears could be used: spindle 20, driving stud 75, stud 50, driving screw 100; or, in the same order: 30, 75, 40, 120. This may be expressed as follows:

$$\text{Lead screw (thds. per in.)} = \frac{4}{30} \times \frac{4 \times 1}{15 \times 2} =$$

$$\frac{4 \times 5}{15 \times 5} \times \frac{1 \times 50}{2 \times 50} = \frac{20}{75} \times \frac{50}{100} \text{ or } \frac{4}{30} =$$

$$\frac{2 \times 2}{6 \times 5} \times \frac{2 \times 20}{6 \times 20} \times \frac{2 \times 15}{5 \times 15} = \frac{40}{120} \times \frac{30}{75}$$

In this last example, 40 could drive 75, giving a reduction of  $1\frac{3}{4}$  or  $1\frac{1}{2}$  to 1, and the 30 driving the 120 giving a second reduction of 4 to 1, so that  $1\frac{1}{2}$  multiplied by 4 is equal to  $7\frac{1}{2}$  to 1 required.

**Cutting the Thread**

Having turned the work ready for threading and mounted the wheels, set the screw-cutting

tool for centre height and the flanks of the tool square with the work by means of a centre- or screw-cutting gauge. Then bring the saddle back so that the tool is well clear with the front of the work. The nut is engaged with the lead-screw, and the tailstock locked hard up against the saddle to form a stop. A cut is put on, noting the position or reading on the cross-slide index. When the tool has travelled a distance along the work equal to the length of thread required,

The nut is then disengaged at the end of the cut as before, and the saddle returned to the stop, and the lathe run until both sets of lines coincide when the nut is dropped in. It should be mentioned that to cut left-hand threads, where the lathe is not fitted with a tumbler gear, two intermediate wheels will be required in a simple train and one intermediate wheel in a compound train. Metric pitches require a 63-tooth wheel (for a  $\frac{1}{4}$  pitch lead-screw), and in some cases a 127-tooth wheel.

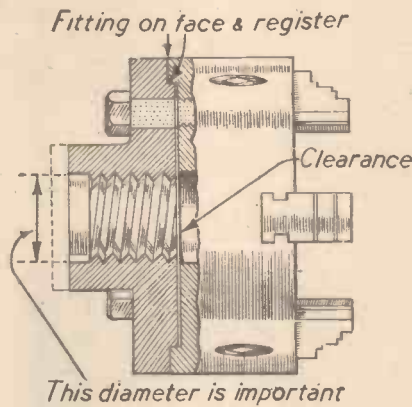
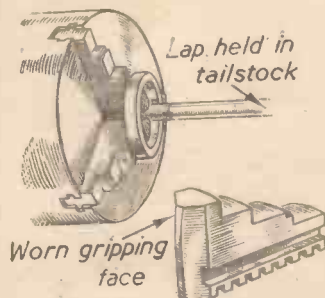

Fig. 65.—The back-face seating on the shoulder of the lathe-nose must be flat, and the register bored in the back must be a good fit.

disengage the nut, and at the same time recede the tool smartly.

Return the saddle up to the stop and put further cuts on as before until the thread fits the female part. During the cutting, particularly with deep threads, the tool is advanced slightly several times during the cutting operation, but allowing the tool to cut all over on the last one or two cuts to obtain a thread of correct form.

This procedure is adopted for any number of threads per inch that is a multiple of the threads per inch on the lead-screw. When threads such as 9 or 11 are to be cut, the nut is not disengaged, but the cut is withdrawn and the lathe reversed by pulling the belt backwards, or, when the saddle is first brought back against the stop and the nut engaged, a chalk mark is made on the face of the headstock cone or on the gearwheel, and a corresponding mark made on the front bearing housing or gear guard. Similar lines are made on the lead-screw and lead-screw bracket.



Figs. 66 and 67.—The lapping process is carried out with an expanding lap, rigidly held in the tail-stock, as shown. When the jaws are worn so that they grip only at the back they can be corrected by lapping.

**Scroll Chucks**

The handiest and most-used item in the equipment of a centre-lathe is definitely a geared scroll chuck. The class of chuck now being referred to is that which is provided with two sets of three jaws. One set is for holding bar work; the jaws being stepped away from the centre also allows them to be expanded into bored holes when necessary to operate on outside diameter or faces. The second set is stepped away towards the centre and will hold work that is outside the capacity of the other jaws.

Chucks are not included as standard equipment with a lathe, so that when a new lathe is purchased the question of a chuck or chucks is one that has to be considered. Where the lathe is a screw-cutter, the most satisfactory procedure is undoubtedly to do the work of adapting the chuck to the spindle on the lathe itself.

The adaptor or back-plate can be made from a standard iron-casting. Such castings are supplied in varying sizes suitable for chucks of any diameter.

Before proceeding with the machining, reference to Fig. 65 will make several points clear. The first is that the back-face, seating on to the shoulder of the lathe-nose, must be flat; secondly, the register bored in the back must be a good fit on the corresponding portion of the lathe-nose; and, lastly, the thread must be an easy fit. The true running of the chuck is largely governed by careful attention to these details. It is obvious that a bad-fitting register will allow the back-plate, after fitting, to "pull-up" out of true by an amount equal to the difference in diameters in any direction. A tight or good-fitting thread is likely to cause trouble should it ever become at all gritty, and may also prevent the back-face from seating.

To ensure that this register does fit properly it is not a bad plan to turn a short plug on the end of a piece of bar between the centres to exactly the same diameter as the register on the lathe-nose.

After measuring the total length of the thread and register, and finding the pitch of the thread, mount the adaptor casting on the faceplate. Turn outside and face sufficient material off the small boss to leave the total length of the casting  $\frac{1}{16}$  in. to  $\frac{3}{16}$  in. longer than the length of the nose. This may entail removing a lot of metal, but it should be remembered that by so doing the amount by which the chuck would otherwise overhang is reduced. Bore the hole for the thread slightly larger than is ordinarily necessary, to leave a flat on the crest of the threads when cut. After screwing, remove the faceplate from the lathe with the casting still upon it.

(To be continued)

# RADIO-CONTROLLED MODELS

Their Development, Construction and Operation

By C. E. BOWDEN, A.I.Mech.E.

(Continued from page 132, February issue).

**T**HE danger of crashing due to a stuck-on rudder control has recently become far less likely than with the original "dipping" sets which were very poor in this respect. Even with the latest small gas-filled valve sets the danger does exist to some extent as the reader will appreciate as he reads on. The "raised" current system is a little heavier, and, therefore, more suited to larger models, and is a little more expensive, but it can be made virtually "crash-proof" from sticking-on controls. These points are matters for very serious consideration when deciding upon a radio set, and the model that will carry it. Let us now examine the working principles of each system.

## The "Dipping" Principle

In either principle there is a transmitter on the ground, a receiver with its dry batteries in the model, in which is incorporated the vital "relay" which is really an electrical switch, and a servo motor (sometimes called an actuator) which operates the rudder or other controls. The receiver collects the signal from the transmitter and operates the relay, which switches the servo and its rudder or other controls on and off. *The working of the relay is the ticklish point!* (Fig. 5.)

In the "dipping" principle, with radio switched on but receiving no signal, a "standing current" is registered in the receiver's valve and the relay arm is attracted down or "in." This "in" position switches off the servo motor's battery. The servo is, therefore, not operating a control, i.e., the relay points are open, for these points are positioned at the other end of the centrally pivoted arm. On receipt of a signal from the transmitter the current in the receiver valve is lowered or "dipped." This current dip at best is very small, being measured in milliamps (one thousandth of an amp). As the current is dipped, the attraction to the relay arm dies and the arm is released, thus closing the points at the other end of the

arm by spring pressure. This "makes" or switches on the servo motor battery circuit, which pulls over the rudder. The servo motor finds power to operate the rudder against wind or water pressure through a wound-up clockspring or alternatively by a wound-up skein of elastic.

The relay is therefore released as long as the signal is on. As soon as the signal is stopped the full "standing current" again passes through the valve, and this is once more sufficiently powerful to pull down the relay arm and so switch off the



Fig. 15.—An E.D. clockwork assisted servo motor to operate the rudder by fishing line cords, which are adjustable for length, is mounted just aft the wing where its weight is near the centre of gravity of the model.

servo (Fig. 6a). It will be appreciated that in this model, if the battery voltage in the model drops or a signal is poorly received, or out of tune, the standing current may be insufficient, and the relay will obviously be on with rudder control hard over. As already emphasised, this may cause a crash through a spiral dive to earth, which cannot be taken off by the operator. The new baby gas-filled Hivac valve has made these lightweight "thyatron" receivers far more efficient, using very little current. For instance, the new Mark III E.D. receiver with its batteries, and the servo motor and its battery, only weigh approximately 7½ oz. The E.C.C. set is approximately the same in weight. Both receivers are protected

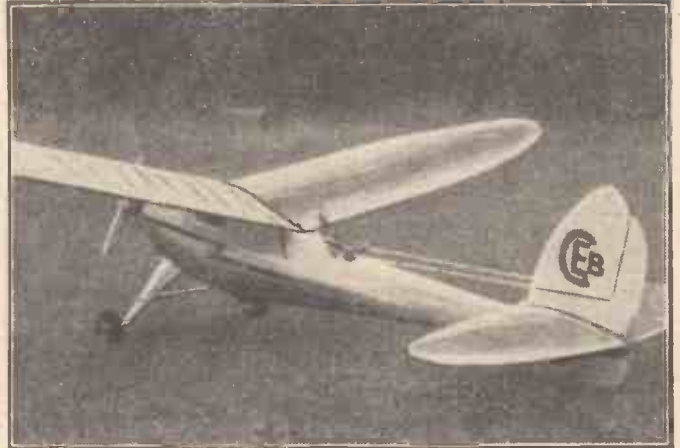

Fig. 17.—The author's monocoque model has the servo motor fitted just behind the wing where the weight is close to the centre of gravity.

by being in a plastic tube or box. The E.D. Mark III transmitter has an input of 4 watts to ensure good range. This Hivac gas-filled mini valve is also now used by most amateur constructors of radio sets to control models. It can have a very short life if too great a current is used. One well-known operator never uses more than 1.5 milliamps as the standing current, whilst many use no more than 1.8 milliamps. The dip may go down to ½ ma.

## The "Raised Current" System

In this system the relay is worked by exactly the reverse conditions, in that there is a low "standing current," and a rise in current on receipt of signal works the relay to switch on the servo motor. This system can be made completely foolproof as regards stuck-on controls. This is a comforting thought if the model is heavy and valuable, for the worst that can happen if a signal does not get through is that the model flies like a free-flight model until the fuel ends, when it glides to earth in the normal manner. I have experienced this on a large 10-ft. span model weighing 10lb., and shudder to think of what the results would have been if that model had spiralled viciously in with a stuck-on control!

In the "raised current" method the tuning can be very simple, a matter of merely listening to the best note whilst moving a tuning lever. It is therefore highly suitable for the novice. The E.D. firm was responsible for introducing this system, the set being designed by Mr. Honnest Redlich. It is the one that I personally use on all my large-scale models from a wingspan of about 6ft. up to 12ft. Naturally, I use the new lightweight "thyatron" sets we have discussed in my little models, for weight reasons. (See Figs. 7 and 8.)

In the raised current system there is a constant "carrier" emanating from the transmitter when switched on, and this carrier is "modulated" when a signal is sent. This "modulation" can be heard in earphones which are plugged into the model for tuning purposes only. All the modeller has to do is to plug in his phones when tuning at about 50 yds. distance from the transmitter and get a friend to press the transmitting button. This is called "keying" the transmitter. The operator then moves a little tuning lever slowly until he hears the loudest and strongest note in his phones. The receiver is then tuned. It is as simple as that!

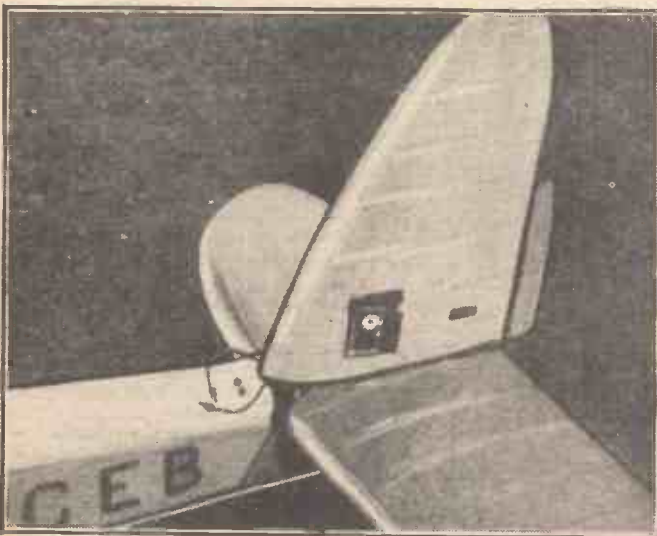

Fig. 16.—The servo motor can be housed in the fin of a large model, or in the rear end of the model, where short wire rods operate the rudder. A counter-balancing weight has to be located in the fuselage nose.

The modulation by signal allows a greater current to pass through the detector valve. (On the E.D. receiver there are two amplifying valves which give the set outstanding range, beyond a distance where one can watch the model, even through glasses, to control it.) The "standing current" is kept low at approx.  $\frac{1}{2}$  ma. by the use of a grid-bias battery. This must be 6 volts and is very important. The relay is set to click in at 2 ma. As the signal is received, the current rises to between 3 and 4 ma. On its rise it passes the 2 ma. spot and naturally works the relay which switches on the servo, and so operates the rudder control. It will be understood that there is a large safety

factor, and if the signal should, by any mischance of poor reception or bad tuning, not arrive correctly the relay refuses to come into operation and the rudder will not go over. There can be no sticking-on of a control. The only way the controls could stick-on would be if the grid-bias battery were to be low and fail to hold down the standing current when at rest, so that this rose to the position of 2 ma. or over, when the relay would click in. This cannot happen in practice if the grid-bias battery is occasionally changed, because it has no drain on it other than old age or what is known as "shelf life." Modern manufacturing methods prevent the only other possible way

of a stick-on, through residual magnetism at the servo. If the arm is properly tinned, as is done on the E.D. three-valve receiver, this cannot happen.

**Summary**

We may therefore summarise by saying that the modern "thyatron" lightweight "dipping" set is very good nowadays, and that the new valve has created a very different and far better set than the original "dipping" receiver, which used a great deal of current and proved very tricky to operate in many cases. Furthermore, the new transmitters with 4-watt input have given better range which was sadly lacking in the original

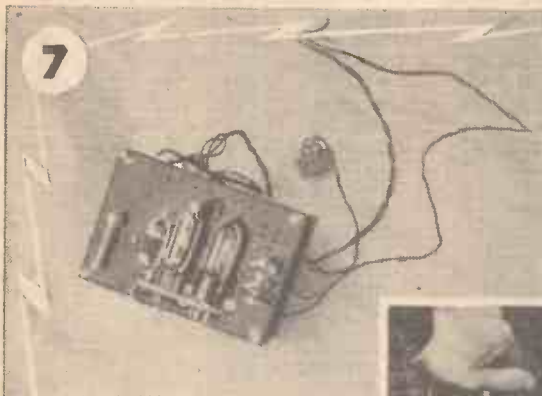

Fig. 7.—A three-valve E.D. "modulated" receiver. Note the little white tuning lever on the left. The operator moves this until he hears the strongest and loudest note from earphones plugged in to tune.

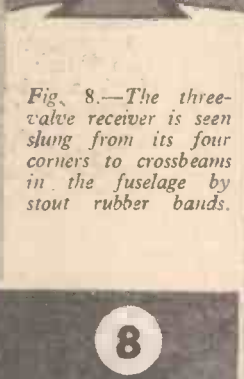

Fig. 8.—The three-valve receiver is seen slung from its four corners to crossbeams in the fuselage by stout rubber bands.



Fig. 9.—The 3-valve "modulated" receiver installed in the author's speedboat model "Swordfish." A watertight box has since been fitted to protect from spray.

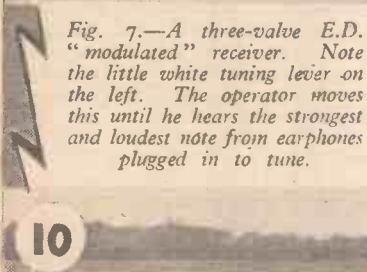

Fig. 10.—The author's "Swordfish" speedboat with Vee bottom is here seen travelling fast and doing a banked turn under radio control.

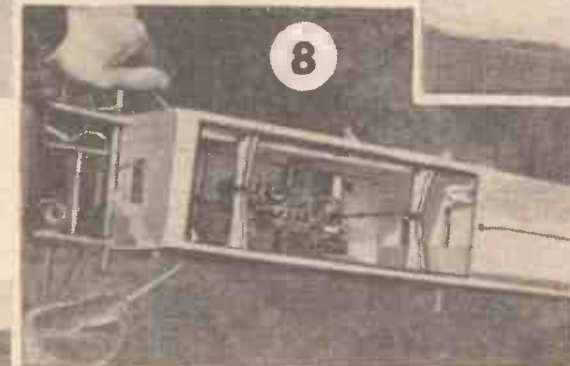

Fig. 11.—A small "dipping" receiver fitted in Mr. R. Curwen's model. The receiver and batteries are housed in a watertight box.



Fig. 12.—"Clovis," owned by Mr. Curwen, is seen on a radio-controlled run. This boat travels slowly and is very suitable for small ponds. It is highly manoeuvrable.



Fig. 13.—The author's 6ft. 6in. radio model aeroplane "White-wings" is fitted with a 3-valve E.D. receiver.

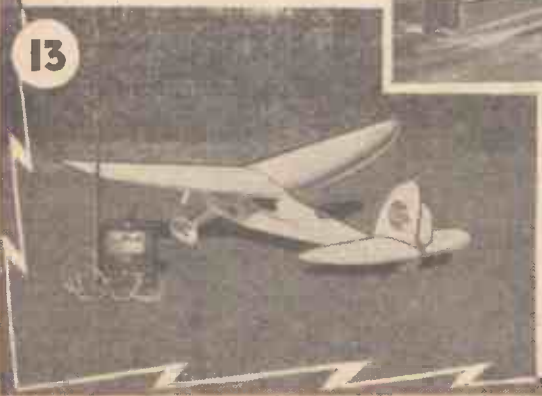

Fig. 14.—A "modulated" receiver is fitted to the author's monocoque fuselage.



Fig. 14.—A "modulated" receiver is fitted to the author's monocoque fuselage.

sets. It is also true that the lightweight "dipping" set cannot be made entirely fool-proof as regards stuck-on controls, but that this does not matter so much when flying a very light model which is less prone to damage than a heavyweight. Boats are not likely to suffer damage should the rudder stick-on, and therefore these little receivers are very useful for watercraft. Naturally, all small flying models around 45in. span cannot carry anything heavier than the lightweight sets. We can also safely say that the three-valve modulated "raised current" type of receiver is the safest proposition where the extra weight can be carried by models having a wingspan of over 6 feet, or where a fast stunt model of about 5 feet is employed, for this type of receiver can be made safe against a stuck-on control. It is, however, more expensive than the little lightweight simple-circuit "dipping" sets.

**The Normal Radio Set-up in a Model**

There are many variations of detail installation in varying shapes of model aeroplane or boat, but the main set-up will be seen in Fig. 5.

There is the transmitter on the ground; this should have a large case for the batteries, etc., because there should be a firm base to support the aerial of approximately 8 feet in height. In actual fact a smaller case is possible, but is not always desirable. The "dipping" type transmitter has a high tension and a low tension dry battery, which are normal radio batteries obtainable at any radio shop. The "modulated" raised-current type of set has a dry battery for H.T. and

an accumulator for the L.T. The latter can be trickle charged occasionally from the house mains, or can be charged by a radio shop as required. The best arrangement for either set is a thumbswitch and a long flexible cable, so that the operator can move around as he watches his model performing, whilst he sends out signals. (See Fig. 13.)

The receiver in the model should be slung by elastic bands from its four corners, or placed on a piece of serbo rubber. These mountings save damage in the event of a crash. (See Figs. 8 and 14.) Rubber bands must be stout, or the receiver will fly forward against the fuselage or hull if the model should charge some unforeseen object. Fig. 8 shows a receiver slung in a fuselage, whilst Fig. 9 shows a similar receiver slung in a model speed boat which I built when stationed at Gibraltar before the last war, and which I have now converted to radio control. The hull is 3 feet 10 inches long and is powered by a water-cooled engine. It is named the "Swordfish." There is considerable fun to be gained from a fast planing boat like this, which is very realistic when planing on either sea water or a lake. This type of hull automatically banks or turns by radio. I have used this boat hull to gain experience of radio work over water for a radio-controlled flying boat which has recently been built (Fig. 26).

**The Battery Box**

Referring back to Fig. 5, it will be noted that ahead of the receiver, which is slung about the centre of gravity of the model, there is a battery box located in the nose of

the model. This is made of balsa with the lid kept in position by rubber bands. Batteries should have all connections soldered or have multi-pin plugs and sockets so that they can be renewed frequently. Unsoldered twisted wire joints are not sound practice.

**The Servo Motor**

Some people call this the actuator, and the task it does is to move the rudder or other controls when the relay in the receiver switches it on and off. The servo motor should be mounted aft of the wing where it can operate the rudder by cords made from fishing line, and where its weight is near the centre of gravity of the model. It can also be mounted in the fuselage just in front of the tail, or it can go inside a large fin. In either of these latter positions, control of the rudder is by wire rods. If mounted in the tail like this, there is the very distinct disadvantage of having to add weight to the aircraft's nose to balance a weight situated so far aft. It is always desirable to group weights in the centre, and keep tail ends light, but many people cannot abide the appearance of external cords. I build for practical results, and furthermore like to be able to get at electrical gear for quick examination, and I find it a great advantage to be able to quickly adjust the rudder angle by tightening one cord and slackening the other, as required, from observation of the flight control. Fig. 5 shows the C.G. grouping, and Fig. 15 shows the E.D. clockwork assisted servo. Fig. 16 depicts a Mercury Cossor servo mounted in a large fin. (See also Fig. 17.)

*(To be continued)*

# Mathematics as a Pastime

The Use of Sketches for Solving Problems By W. J. WESTON

MANY of the problems posed to you necessitate a sketch. A clear mental image may suffice, but a sketch—even a rough sketch—usually guides you more speedily to the solution. It is amazing, for example, how so many, thinking only of numbers and declining to call into mind definite images, falter and fail at that old problem of the two-volume book. The volumes, each with binding 1/2 in. thick and pages 1 in. deep, stand on the bookshelf in the ordinary way; the industrious bookworm eats through from page 1 of the first volume to the last page of the second volume; how deep is its depredation? The usual, and erroneous, answer is 2 1/2 in. But on the shelf, of course, the two pages are separated only by the two backs, and the answer is 1/2 in.

**The Tumbler and Sphere**

Again, a sketch is well-nigh indispensable for the following problem. Tackle it without a sketch and you flounder hopelessly; make a sketch and you swim smoothly to the answer. A drinking-glass is in the shape of the frustum of a right circular cone and is full of water. The diameters of the top and bottom of the glass are 3 in. and 2 in., and its slant-height is 5 in. (inside measurements). Calculate (1) what volume of water the glass holds; (2) what volume would be expelled if a sphere, of such a size that it just fits into the glass when touching the bottom, is immersed.

Make your sketch and, as they say on the B.B.C., "have a go" yourself before you proceed further with this note. The first calculation is easy enough. The frustum is a piece frustrated in its efforts to become a cone, and you first complete the cone. The slant height must be 15 in., since there is a uniform tapering from 3 to a point, and since when you reach 2 you have 5 in. The perpendicular

height therefore must be  $\sqrt{15^2 - (\frac{3}{2})^2}$  that is  $\sqrt{\frac{891}{4}}$  that is  $\frac{9\sqrt{11}}{2}$  And, since the volume of a cone is 1/3 of the circular base multiplied by the height, the volume of the

whole cone is  $\frac{1}{3} \pi (\frac{3}{2})^2 \times \frac{9\sqrt{11}}{2}$  And the volume of the cone based on 2 is  $\frac{1}{3} \pi (1)^2 \times \frac{2}{3} \times \frac{9\sqrt{11}}{2}$  that is  $\frac{1}{3} \pi \sqrt{11} \times 3$ . The difference is  $\frac{1}{3} \pi \sqrt{11} (\frac{81-24}{8})$ , that is  $\frac{57}{3 \times 8} \pi \sqrt{11}$ , that is  $\frac{19}{8} \pi \sqrt{11} = 24.7$  cubic inches.

The difficulty about the sphere is to find the radius. But a little study of the sketch shows you the particular right-angled triangle of which the radius is one side. Call the apex of the cone A, the centre of the sphere B, the point where the sphere touches the slant side of the glass C, D the end of the 2 in. diameter, and E the centre of the 2 in. diameter. DE and DC are equal tangents to the sphere; DC is therefore 1 in. and BCD is a right-angle.

The length AB is made up of 3/4 of the height; that is  $3\sqrt{11}$  plus the radius. The length AC is made up of 10+1, that is 11. BC, the radius, is therefore  $\sqrt{(3\sqrt{11}+R)^2 - 11^2}$ . We make this into an equation:

$$R^2 = (3\sqrt{11}+R)^2 - 11^2. \text{ That is } R^2 = 9 \times 11 + 6\sqrt{11}R + R^2 - 11^2$$

That is  $6\sqrt{11}R = 11^2 - 9 \times 11 = 22$   
Therefore  $R = \frac{22}{6\sqrt{11}} = \frac{2 \times 11}{6\sqrt{11}} = \frac{\sqrt{11}}{3}$

The volume of the sphere is, therefore,

$$\frac{4}{3} \pi (\frac{\sqrt{11}}{3})^3 \text{ That is } \frac{4 \times 11 \times \sqrt{11} \times \pi}{81} = \frac{44}{81} \sqrt{11} \times \pi = 5.66 \text{ cubic inches.}$$

Diagrams illustrating the use of sketches for helping to solve problems. (Below) The problem of the two-volume book. (Right) The tumbler and sphere.

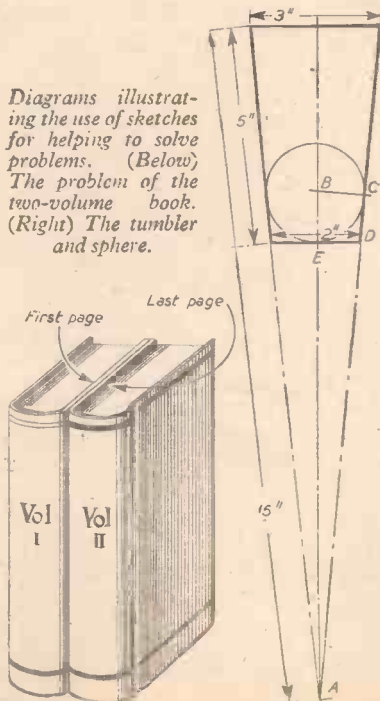

**REFRESHER COURSE**  
IN  
**MATHEMATICS**  
By F. J. CAMM  
8/6, by post 9/-

# Wood Turning—14

Circular Mouldings, etc.

By FREDERICK JACE

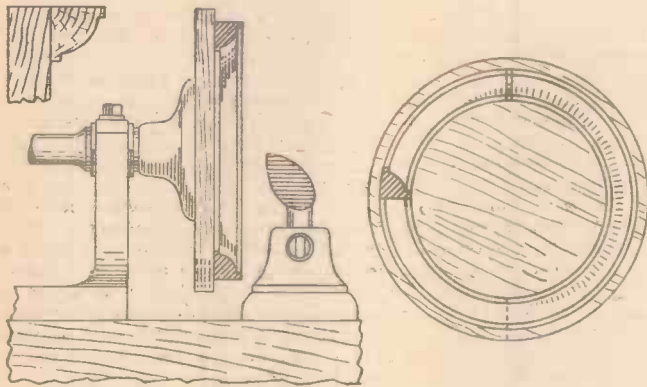

Figs. 156 to 158.—  
Lathe face-plate in side  
elevation, and example  
of turned moulding.

CERTAIN examples of decorative wood-work call for the use of circular mouldings, either as complete mouldings or as quadrants. Figs. 156 to 158 show the set-up. The Tee-rest is set at right-angles to the lathe shears, with the wood to be turned secured to the face-plate. It will be seen that a circular piece of wood about  $\frac{3}{4}$  in. thick and about  $\frac{3}{4}$  in. in diameter larger than the mouldings that it is required to turn is secured to the screw chuck to form the wooden face-plate. It is turned dead flat and a line scribed to the required diameter so that the pieces of wood to form the cornice moulding may be accurately centred.

The timber for the mouldings must, of course, be larger than the finished product. Paper is glued to the back of the wood, which is then secured to the face-plate, also by means of glue. The moulding is then turned to the desired cross-section, using a template for gauging purposes. Of course, if a large number are required, a special form tool can be filed up for finishing to correct form after the roughing out operation.

The object of gluing paper is to facilitate removal by means of a hack-knife. The remnants of paper can be soaked off or rubbed away with a moist cloth.

## Turning Wooden Spheres

The cup chuck is the best accessory to use when turning balls, and the sequence of operations is represented by Figs. 159 to 164. The top illustration shows the method when the chuck is employed. They should first be roughed out and then a steel template, backed off to provide a cutting edge, must be held against the wood and moved in a circular manner to provide a perfect sphere. This operation must be carried out very carefully because only a very thin piece attaches the ball to the remainder of the stock.

When finished, the ball may be tapped

off, and the slight pip sandpapered away. The lower sketch shows a method of finishing them off when extreme accuracy is required. It will be seen that two blocks of wood are hollowed out to receive the ball. The back centre is eased off so that the ball

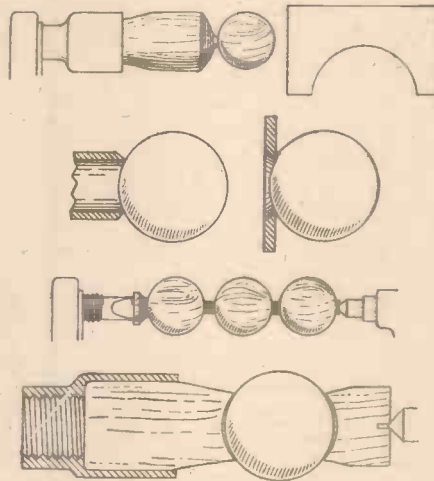

Figs. 159 to 164.—Method of turning wooden spheres.

can take up a fresh position for truing purposes.

A piece of steel tubing of suitable diameter with one end turned square and sharpened on the outside to form a cutting edge can also be used for truing purposes.

For turning woods for the game of bowls a special radial turning attachment is used, as these need to be extremely accurate. The illustrations show a method of turning the spheres in gangs, and this is satisfactory where a number are required and accuracy of form is not an important consideration. Lignum vitæ should be used for bowls.

## Fluting

Strictly speaking this is not a wood-turning operation. Where pillars are required to be fluted the cylindrical pillars are mounted between centres, after the circumference has been marked out for the required number of flutes, and an overhead attachment driving a revolving cutter is used for the flutes, which are cut, of course, one at a time. This operation necessitates locking the headstock centre, and the use of some method of dividing round for the required number of flutes.

This device can take the form of a plate with a series of holes corresponding to the number of flutes, fastened in some way to the headstock spindle (the point of attachment will vary according to the make of lathe), and a peg which can be inserted in one of the holes. Such fluting work, however, is best carried out by hand. With pillars having an entasis there is really no satisfactory method of fluting in a lathe.

## Turning Chessmen

Plain chessmen can to a certain extent be turned in the lathe, although the knight will require a certain amount of hand carving. The two standard forms, the plain and the Staunton, are shown in Figs. 165 and 166 respectively, and they may be scaled up for shape and size by making use of the parallel lines drawn through them. Of course, a certain amount of liberty has been taken with the designs. The crown of the queen as used on hand-cut chessman is here replaced by a simple turned knob, and, of course, is it not possible to turn the Bishop's mitre. However, if the turner is able to use hand carving tools a piece of stock could be left at these points for hand finishing.

## Wood for Chessmen

Chessmen must be turned from very hard wood, such as boxwood, teak, lignum vitæ, or from one of the hard thermo-setting plastics now available. For decorative finishes alternate layers of different coloured hardwoods may be used, using an odd number of laminations so that the outer laminæ are of the same colour. The various layers are glued together under pressure before turning. Different coloured woods may obviously be used for the various men. If bone or ivory are used the tools must have a more obtuse cutting angle than for wood.

If it is not possible to obtain woods in various colours the men must be stained. Do not forget to turn the bases slightly concave so that the men stand firmly on the board.

There are, of course, 32 chessmen in a set, 16 white and 16 black—8 pieces and 8 pawns. The pieces consist of 1 king, 1 queen, 2 bishops, 2 knights and 2 rooks.

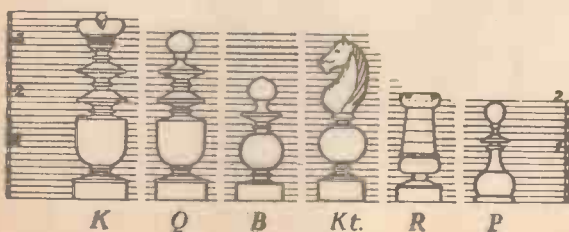
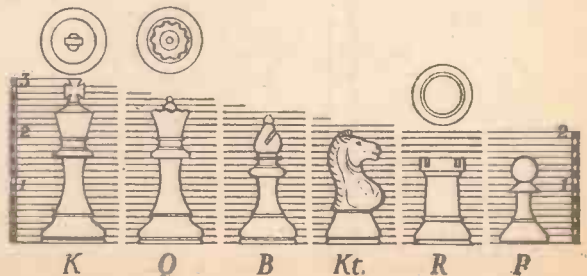

Fig. 165 (Left).—  
Plain Chessmen.  
Fig. 166 (Right).—  
Staunton Chessmen.



# Principles of the Boomerang

A Special Study in the Mechanics of Motion

By J. F. STIRLING



An Australian native in the act of throwing a boomerang. An expert thrower can determine accurately how far the weapon will travel, and where it will land—usually at his feet.

THE flying saucer may hold out an intense topical interest for the modern observer, but the interest in the flying boomerang is perennial.

The boomerang has often been supposed to possess a "secret," not only in regard to its mode of construction, but also in connection with the technique of its throwing. It has, from time to time, been suggested that no present-day individual other than a fully-initiated Australian aborigine can really command the flight of a boomerang and impart to it the paradoxical and sometimes almost seemingly miraculous character which is shown in its performances.

A boomerang will commonly describe circles, loops and even a figure of eight in the air. It will hit its quarry or object and then return faithfully to its thrower. It can be made to whirl itself round a house and then come back on the other side of the building and drop behind the thrower. A boomerang, too, can be made to travel closely parallel to the ground in an almost straight line and with a peculiar hopping or ricocheting movement. There is, it would seem, practically no limit to the strange modes of progression which, by an expert thrower, may be imparted to the flight of a boomerang.

In our time the boomerang has always been regarded as a missile or weapon of the Australian natives, and such, indeed, is the case. But so far as we can determine, Australia alone cannot claim the boomerang either geographically or historically. The people of ancient Egypt appear to have known all about the strange properties of a curious throwing-stick which they made use of. There are reports of a similar stick-like missile having been known to the Eskimos in much more recent times, and it is certain that this weapon (or something very much like it) survives to-day among some of the native tribes of North-East Africa as well as of Southern India. But tradition has now associated the boomerang with Australia, and because tradition is often more accurate than written history it is generally agreed that Australia is the one country of the world in which the peculiar properties of the

boomerang have been developed to an amazing and a veritably uncanny degree.

## Two Types

There are two distinct types of boomerang—the return and the non-return missile. It is averred that a non-return boomerang can be made to come back to its starting place by a skilled thrower. Be this as it may, the non-return weapon is merely a variation of the ordinary "throwing-stick" of many native races. It is only the return boomerang which does all the spectacular

about 8 ounces, and may be more or less, according to the actual size of the missile, but the  $\frac{1}{2}$  lb. missile seems to have been a favourite all along.

The strangeness of the boomerang's flight depends mainly on its skewed ends and, of course, on the precise technique of its throwing. It is held vertically in the right hand of the thrower. The concave side of the weapon (if there is one) is held downwards and the missile is normally thrown in a plane parallel to the ground's surface. The thrower, before he finally lets go of the weapon, gives it a strong, deft twist. This is absolutely essential to the good performance of the boomerang. A skilled thrower will impart to the missile as much rotation as possible.

After leaving the thrower, the boomerang normally flies for about 30 yards with a nearly vertical rotation. Then it moves to the left, inclining over to one side and rising in the air. After following a circle of 50 yards diameter, it returns to the thrower. Some specially skilled throwers are able to make the boomerang travel for 100 yards before rising in the air. After this, the weapon will ascend nearly 150 feet in the air and will circle four or five times before returning to its point of departure.

In the hands of a skilled thrower, the boomerang, even a small and a light one, can function as a deadly weapon for dealing with a running enemy, a flying bird or some other distant quarry. In the hands of a novice who throws energetically, a boomerang may well be as dangerous to the thrower as it is to the object at which it is aimed, since part of the skill in aiming is to pre-determine the exact spot to which the weapon will return.

## The Problem of Flight

Leaving aside the various tricks which the boomerang can be made to perform, we are confronted with the problem of what determines and conditions the characteristic flight of the missile. What makes the boomerang travel so accurately and, equally as accurately, return eventually to its sender? In other words, what is the secret of the weapon?

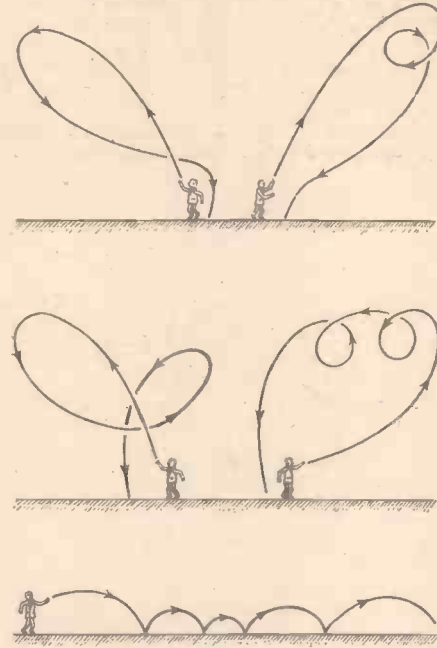
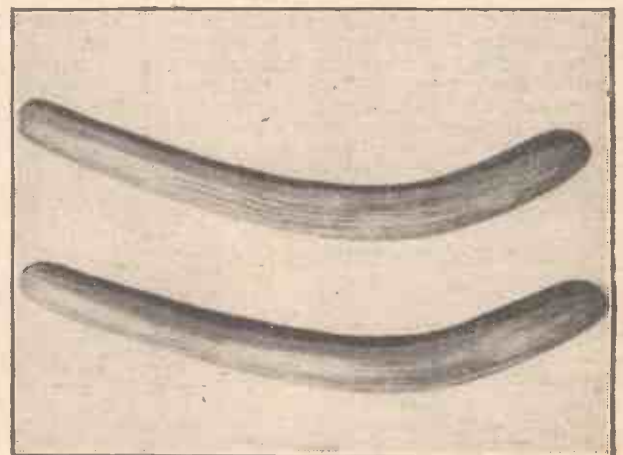

Fig. 1.—Some curious trails of boomerang flight. A number of pre-determined flight tracks which an expert boomerang-thrower can command at his will.

tricks and which at times appears to defy even nature's own laws.

Both forms of weapon follow similar constructional lines. They are essentially bent, sickle-shaped sticks of thin wood, or occasionally of ivory or steel. Sometimes the crescent-like shape is very pronounced. At other times it is hardly appreciable. The actual design of the weapon depends on the use which is to be made of it and the sort of performance which it is intended to put up. On the average, we may say that the actual thickness of a boomerang is about one-sixth of its breadth, which latter is one-twelfth of its length, the last-named dimension being anything from 6 in. to 3 or 4 ft. The two ends (or arms) of the boomerang are given a skew, being twisted about 2 or 3 deg. from the plane running through the centre of the weapon. The total weight of a wooden boomerang is



Native Australian "throwing sticks" or boomerangs fashioned out of the wood of a desert tree known as "Bangguma." These are non-return boomerangs, and are used for hunting, fighting, and other purposes.



Well, there is nothing secret or uncanny about the boomerang. It is a plain, straightforward case of applying certain natural laws of motion. Unquestionably, the unknown native tribes who first investigated the properties of boomerangs and other types of throwing-sticks were utterly unacquainted with these natural laws. Nevertheless, they must, by dint of long periods of trial and error, have arrived at certain conclusions regarding the actual shape of the stick and the manner of its throwing in order to obtain the results which are so characteristic of it.

Have you ever noticed the manner of a leaf's descent as it falls from a tree during a light gust of wind in the autumn of the year? There is no bomb-like accuracy and directness in such a descent. There is no smooth gliding downwards to the earth. Many autumn leaves keep rolling over and over in the air during their descent. Others fall with a sort of swinging movement, dipping first one edge or side and then the other. Other varieties of leaves fall with a twirling motion which tends to make them descend almost vertically to the ground.

Notice that the leaf is a flat object and that these varying movements are mainly due to its flatness. Now, the boomerang is also a flat object. In fact, if the weapon has one essential character it is its flatness. In this quality it resembles a leaf, and it might, perhaps, be expected to behave like a leaf when falling through the air.

**Gyro Action**

But the boomerang is given a very pronounced spin at the moment it leaves the hand of the thrower. This means that it has a gyrostatic influence imparted to it at the commencement of its flight. It is this gyrostatic influence, coupled with its characteristic flatness, which underlies the "secret" of the boomerang.

As anybody who has ever handled a gyrostic spinning top knows, the revolving wheel rotates freely and easily enough to get up a high speed of revolution. The top may be moved sideways, upwards and downwards, backwards and forwards, with the greatest of ease, yet it will offer the strongest resistance to any attempt to alter the plane or axis of its rotation. If you attempt to give the spinning gyro top a twist you will have to exert quite a surprising amount of force to turn the spinning wheel through

even a slight angle. Because of this gyro action, a spinning body is much less susceptible to deviations from its travel-path than a body which does not spin during its period of travel. Rifle bullets spin during their speedy journey to their targets. So do high-explosive shells and a host of other types of missiles.

It is a most difficult job to throw an ordinary stick—a walking-stick, for instance—through the air with any accuracy of aim. It usually turns end over end during its flight, and it can as a rule be guaranteed to land anywhere other than at its intended

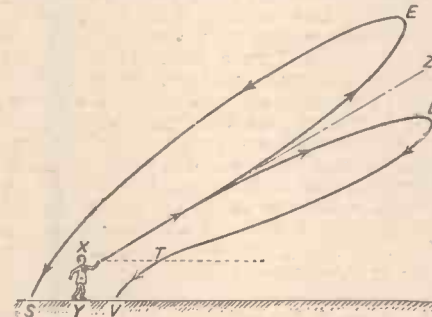

Fig. 2.—Diagrams illustrating the principles of the boomerang's return to its thrower.

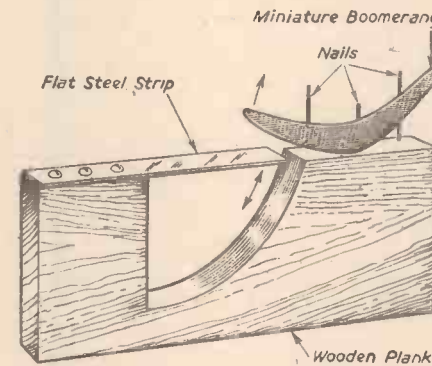

Fig. 3.—This simple appliance for the launching of miniature boomerangs is capable of producing many interesting results, as described in the article.

target. If the boomerang were perfectly straight like the average walking-stick it would behave in a similar manner. The boomerang, however, is given a crescent-like shape and its centre of gravity lies at approximately the centre, or "bulge," of the crescent. The weapon is grasped at one end by the thrower. It is not difficult to appreciate that a sudden movement given to one end of the boomerang by the thrower makes it rotate about its centre of gravity, both ends of the stick moving in opposite directions. In addition to its rotational spin the boomerang is, at the moment of its discharge from the hand of the thrower, given a forward impetus. Hence the missile is caused to travel through the air with its acquired rotational spin about its centre of gravity. Gyro action is set up by the spin, and this causes the steady flight of the weapon as it travels to its destination. All the peculiarities of flight which have made the boomerang so well known (by repute, at least, if not in



An Australian aborigine practising boomerang throwing in a North Australian bush clearing.

actual practice) are, in reality, products of its gyro action.

Let us consider the most prominent of all these flight characteristics and peculiarities, to wit, the return of the boomerang missile to the thrower.

Consider the diagram (Fig. 2) for a moment. The figure XY represents the thrower. The dotted line XZ indicates the direction in which the boomerang is thrown. Now just suppose that XZ were a solid surface of polished metal sloping upwards like the average house-roof. If the boomerang were made to travel up this slope it would simply go as far as its initial impetus would carry it, after which it would reverse its movement and slide down the slope to the place at which it had been started, being supported all the time by the metal slope on which it was sliding.

**Rotational Spin**

Much the same thing happens during the flight of the boomerang. Its rotational spin keeps its flight on an even course, and because it is started on its flight with its flat sides facing upwards and downwards the weapon is able to rest on the air in a similar manner to the wings of an aeroplane. The air, of course, is not rigid like the hypothetical metallic plane which we have just considered. The air yields all the time, so that the boomerang tends always to drop. It travels outwards along the direction of the continuous line XD. At the point D, its outwards impetus having been expended, it turns, and begins to slide backwards through the air almost exactly as if it were falling down the metallic plane mentioned previously. But all the time it is falling through the air as well as sliding down the air. Continuing downwards, it reaches the level T (the level at which it started), at a point which is usually considerably in advance of its starting point, and continuing its downward progress it meets the ground V almost at the feet of the thrower.

For the sake of simplicity we have spoken of the boomerang having two flat surfaces. As a matter of fact, few boomerang weapons are constructed in this manner. The surfaces have a slight camber, or, alternatively, one surface may be flat or slightly concave, the other having a camber. Again, one surface may have a slight, continuous slope from back to front. It is this sort of construction which gives the boomerang its

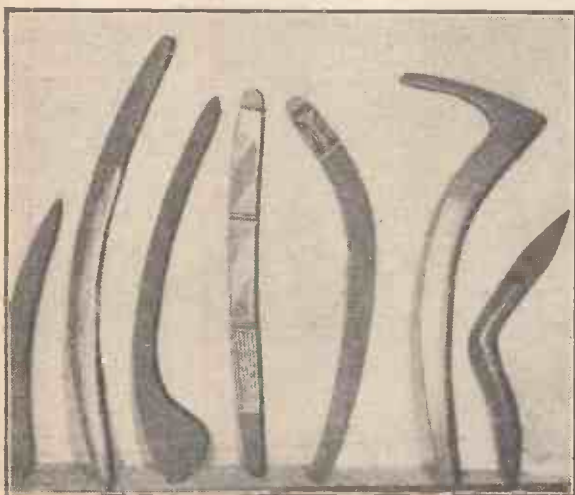

Various boomerangs—all from Central Australia. The third from the right is a typical return boomerang. The one at the extreme right is a battle boomerang, whilst the third from the left is a boomerang stick, which can also be used as a battle axe. These weapons are all quaintly carved and grooved, and are decorated with native ochre colourings in red and yellow.

property of ever tending to rise rather than fall in the air. A boomerang of this type will, it is true, travel for a distance horizontally, but always it will rise, the rising tendency of the weapon ever tending to counteract the falling tendency caused by gravity. Thus, referring again to Fig. 2, a boomerang of this type following its theoretical course along the dotted line XZ would, instead of tending to fall, actually commence to rise in the air above the plane XZ. Consequently, the boomerang would eventually arrive at point E. Turning backwards at this point, it would slide down the air, and, passing over the thrower's head, it would fall to the ground at a point S at his rear.

#### More Complex Motion

These are essentially simple cases of boomerang action. It must be remembered that boomerangs vary considerably in the details of their construction, and also that boomerang throwers are, by long experience and continual practice, able to throw the weapon in several different ways. A boomerang is like a good violin in the respect that no two of them are alike. It has its own peculiarities and its own idiosyncrasies. That is why, when impelled by an expert thrower, it is able to put up such astonishing performances in the air. If we seek the reasons for these variations from normal boomerang flight, variations such as the describing of circles, ellipses, and more-complicated figures, we must remember that the boomerang during its travel through the air is given not only a rotary motion but a very powerful forward motion as well. The boomerang is travelling through the air and spinning round at the same time. This results in the arm going forwards in the spin tending to rise and the arm revolving in the opposite direction tending to fall, and here the gyro action of a spinning body comes into effect. The spinning forces in the body resist change in the axis of rotation. They insist on a compromise being set up, and this compromise will always depend on the direction of the spin.

In the case which we have just outlined, one side of the flying boomerang tends to rise. The plane of the boomerang's rotational spin is thus twisted upwards on one side of the flying missile and also upwards at its front. This change brings about a change in the general direction of the missile's flight. The boomerang tends to turn upwards, a tendency which is strongly resisted by the earth's gravity but which, nevertheless, does prevail. These causes are ever present during the boomerang's flight. Their effects, therefore, are persistent and cumulative, and they cause the boomerang to make a partial or a complete circular path in the air, and at times even more than merely one complete circuit.

The upward lift of one side of the boomerang can become so powerful and excessive that the entire weapon turns over in the air. This completely alters the conditions under which the missile has been travelling. But if it still retains any forward motion (as it often does in such circumstances) it continues its flight under the new conditions which it has thus set up for itself, with curious results which are, more often than not, completely unpredictable. Here, therefore, lies the essence of the boomerang's curious propensity for playing strange and unexpected tricks of flight, which, on occasion, even the most experienced native throwers cannot control.

In built-up areas, in suburban districts and in many other regions, it is not safe to experiment with boomerang flights, and readers are not advised to enter into such activities. Such experiments may easily result in broken windows and other varieties

of damage, if not actually in injured limbs. Boomerang practice demands the open spaces of the countryside; which is, perhaps, one of the reasons why this difficult art and technique has only been excelled in by certain of the more-primitive races.

#### Safe Experiments

Nevertheless, the interested reader may readily and safely carry out his own experiments in boomerang flight with the aid of miniature boomerangs made of light wood (balsa, for example) or of cardboard. The equipment is simple enough, and is shown in Fig. 3. A piece of wood about a foot long and about half an inch thick is cut out in the manner shown. To one upper side is firmly screwed down a flat steel spring. In the opposite upper side are driven two or three thin nails, after filing off the heads. The wooden or card boomerang is positioned so that it rests against the nail supports. The spring is depressed with the finger. On being released it flies upwards and makes contact with one arm of the miniature boomerang. The latter is impelled into the air. The spring impact will give it a strong

forward motion and, at the same time, a strong axial spin, copying very closely the actual forces which impel the large-scale boomerang.

By this means, even in a fair-sized room, many of the phenomena of boomerang flight may be obtained. The actual weight, the size, and the degree of skew or twist of the boomerang should all be varied. So, too, should the degree of camber or curvature of its flat surfaces. The strength of the impelling spring also calls for variation; the positioning of the miniature boomerang prior to starting, its precise angle of tilt as it rests against the nail supports, the thickness or thinness of its edges (they may be blunted or made almost razor-sharp), the effect of purposely weighting the missile with tiny insets of metal—all these and other constructional variants may be tried out. The experimenter may not, as a result, become a practised thrower of the orthodox large-scale boomerang, but he will certainly come to know much about the basic conditions which determine and so greatly influence that supposedly mechanical paradox—the flight of the boomerang.

## Items of Interest

**T**HE Minister of Transport, the Rt. Hon. Alfred Barnes, M.P., accepted the invitation of the Railway Executive to christen the British Railways' first standard locomotive, the "Britannia," at Marylebone Station, London. The ceremony was duly carried out and the name "Britannia" has been chosen as being a link with the Festival of Britain, and as a traditional British engine-name.

The new "Britannia" (British Railways No. 70,000) is one of 25 similar locomotives, suitable for either express passenger or fast freight trains, now under construction at Crewe.

Prior to the naming ceremony the new locomotive, which has just been completed, will be undergoing running-in and preliminary tests in the Crewe area and on the main line between there and Carlisle.

#### Tunnel Through the Mourne Mountains

**I**T is reported that a tunnel nearly 2½ miles long has been driven through the granite of the Mourne Mountains in Northern Ireland, as part of a big water supply development scheme. It is estimated that six million gallons of water a day will flow through this tunnel from the Annalong Valley catchment area for supplying the Silent Valley reservoir.

#### High-capacity Electric Trucks

**A**T the new steel works nearing completion near Port Talbot, in South Wales, five American battery-electric ram and fork-lift trucks have been installed. Each truck, which is capable of handling 30,000 lb. of steel coil at a time, is powered by a four-wheel front drive assembly consisting of twin motor units driving the two pairs of wheels.



One of the new standard British Railways locomotives being prepared for wheeling in the erecting shop, at Crewe.



# The WORLD of MODELS

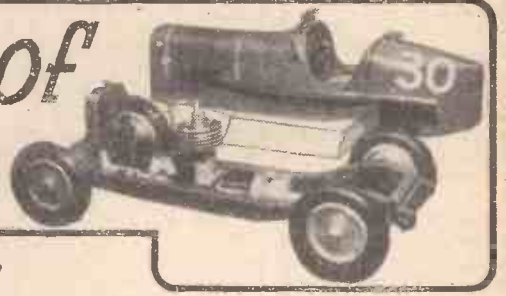

By "MOTILUS"

Steam-driven OO Gauge Locomotive : Model Railway at Leipzig Fair : Scale Model Factory

**WORKING** scale model steam locomotives are almost unknown in the small OO gauge size. But I recently came across a very fine example of such a locomotive. It was made all the more interesting by being a scale model of an American-type 2-10-10-2 Mallet locomotive. The prototype has been closely followed in all exterior detail, as far as is possible, without detriment to working performance. The only dummy details are the bell and sand-boxes.

This model (Fig. 1) was built throughout by Mr. A. A. Sherwood, of London, who gives the following particulars about it. The right-hand air reservoir serves as a standby displacement lubricator and that on the left hand contains the steam whistle. The

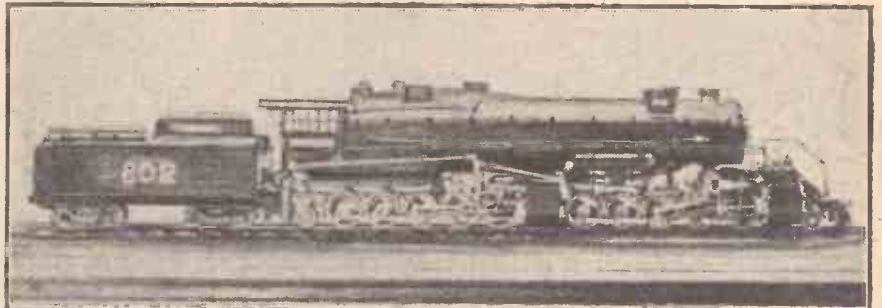

Fig. 1.—This unusual OO gauge working steam model locomotive is the work of Mr. A. Sherwood, of London. It represents an American-type 2-10-10-2 Mallet locomotive.

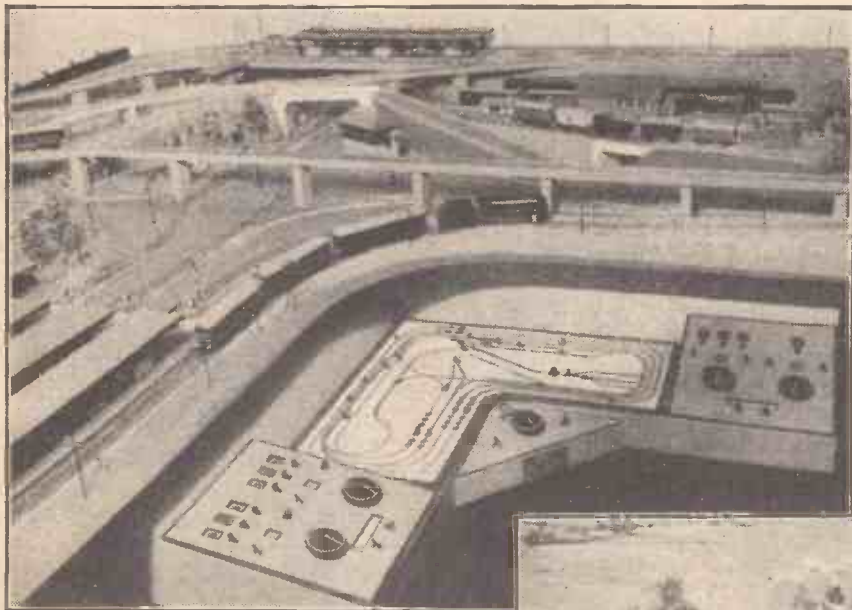

Fig. 2 (Above).—Portion of the OO (HO) gauge working model railway at the Leipzig Spring Fair, held in the Petershof, 1950.

Fig. 3 (Right).—A miniature working railway, electrically-operated, in the hobby shop of Mr. Walter Fahrbach in Leipzig.

“feed water heater” contains the lubricating pump. The boiler has five  $\frac{1}{4}$ in. flues and one  $\frac{5}{16}$ in. superheater flue and combustion chamber. Coal-firing has been used, with some success, but Meta fuel is probably better, as it does not foul the tubes and smoke-box and is, easier for stoking. The high-pressure cylinders are  $\frac{3}{8}$ in. bore and  $\frac{5}{16}$ in. stroke: the low-pressure cylinders are the same stroke, but  $\frac{9}{16}$ in. bore. The frames are of  $\frac{3}{32}$ in. tool steel, with equalised springing: driving wheels are forged from mild steel bar. All motion work is in stainless steel.

The cab fittings include pressure gauge

(up to 80lb. per sq. in.), water gauge ( $\frac{1}{2}$ in. diameter), blower and whistle valves, regulator and reverse lever. Boiler feed is by axle-driven pump and tender hand-pump. Compound operation is used, with variable steam bleed to receiver, to equalise loading. The model will traverse a 6ft. radius curve.

This OO gauge steam locomotive caused much interest at the 1950 Model Engineer Exhibition in London, where Mr. Sherwood was awarded a bronze medal for this enterprising exhibit.

### Model Railway at Leipzig Fair

I was most interested to receive from a correspondent in Germany a photograph and particulars of a model railway exhibit at the 1950 Leipzig Spring Fair. This OO (HO) electric working display was unique in that as well as being an attractive layout, the control board (Fig. 2) included a miniature



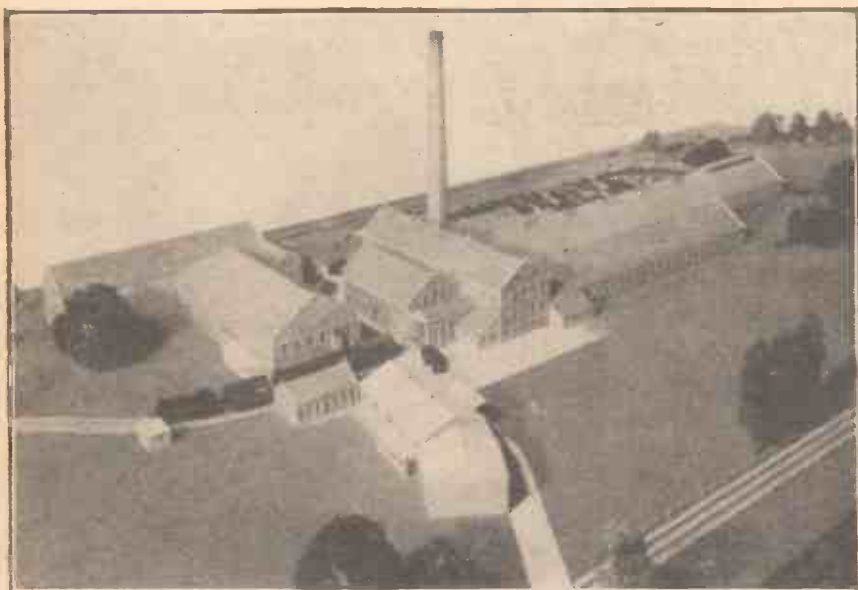

Fig. 4.—Exhibition Model of the Polysulphin Works, near Keynsham, to a scale of  $\frac{1}{4}$  in. to 1 ft., and including a OO gauge working railway. Made to the order of the Polysulphin Co.; Ltd., and shown at the Laundry Exhibition, Olympia, 1950.

diagrammatic layout of the whole railway. Progress of locomotives and rolling stock could be easily followed on this diagram by automatic lighting which indicated their positions.

This model railway was constructed by "Pico-Express," a firm now producing OO (HO) gauge model railways and equipment in eastern Germany. The popular Maerklin models are manufactured in the Western Zone of Germany, and it is extremely difficult to purchase them in the Eastern Zone. As a result, these new "Pico-Express" models are becoming much in demand.

Model railway enthusiasts in the eastern section are now receiving considerable encouragement towards expanding their hobby, or to start a model railway if they have not one already. One retail shop in Leipzig, "The Hobby Railway Shop," has an electrical working model railway display, which has been constructed mostly from pre-war Maerklin parts. A well-executed landscape background adds to the attraction. The illustration of this layout (Fig. 3) just shows the main station of the model railway, which is quite an extensive one, and of interest to "old hands" as well as beginners.

#### Scale Model Factory

The combination of a modern factory with a working railway, all in model form, proved a great draw at the 1950 Laundry Exhibition at Olympia. The model (Fig. 4) was to a scale of  $\frac{1}{4}$  in. to 1 ft. and was made in Northampton, under the supervision of Mr. E. H. Clifton, in collaboration with Messrs. Bassett-Lowke, Ltd., the model railway used being a OO gauge Trix production.

This model was made to the order of the Polysulphin Company, Ltd., of Keynsham, near Bristol, at the instigation of Mr. Ivo Peters, joint managing director.

The base of the model measures 12 ft. by 5 ft., the factory having a grass surround with trees, hedges, a hill and the River Avon running alongside. Model barges, loaded with steel drums, are seen on the river, and more drums stand in the factory yard. The factory buildings are grey, with red roofs, and nearby is shown the house of the resident engineer adjoining the factory.

The miniature train runs through a tunnel under the hill, reappears after going right through the factory, and then describes a

large circle before re-entering the tunnel. It runs on a neat, realistically ballasted track. During the Laundry Exhibition last year the train covered a distance of about 54 actual miles in nine days.

This fascinating and unusual model was instrumental in drawing many hundreds of people to the stand of the Polysulphin Company at the Exhibition, and innumerable

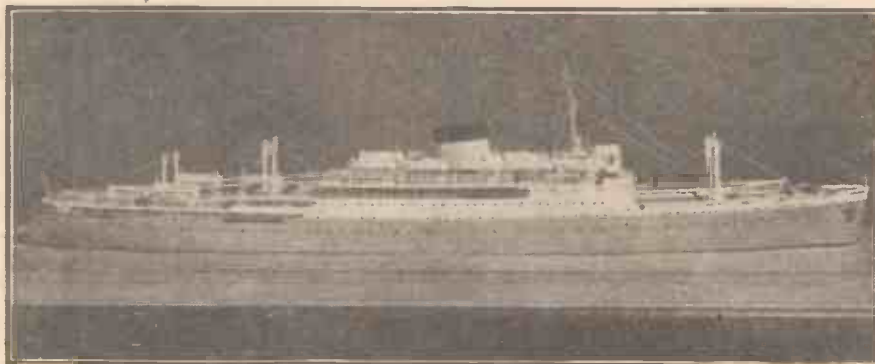

Fig. 5.—A lovely waterline model of a new and attractive motor ship, "Bloemfontein Castle," of the Union-Castle Line. The model is to a scale of  $\frac{1}{4}$  in. to 1 ft.

comments were made concerning the beautiful workmanship and detail of the model.

#### Model of the "Bloemfontein Castle"

The illustration of a ship model this month (Fig. 5) shows a waterline model of the Union-Castle liner, *Bloemfontein Castle*. This is a new motor-ship built by Messrs. Harland and Wolff, of Belfast, for the intermediate service to Cape Town, a voyage of 18 days. The model illustrates well the splendid lines of the ship and the interesting detail of modern equipment on her decks, bridge, etc.

On her maiden voyage the ship sailed on the usual Atlantic route to Cape Town, Port Elizabeth, East London and Durban and then returned homeward via the Suez Canal, calling at various ports, including Mombasa, Aden, Suez, Port Said, Genoa, Marseilles and Gibraltar. On her normal service, however, she sails both out and home by the Atlantic route.

This attractive-looking vessel, in the well-known colours of the Union-Castle Line, has an overall length of 595 ft. and has a gross tonnage of 18,400 tons.

The *Bloemfontein Castle* is a one-class ship, a type of liner becoming popular among long-distance travellers under present-day conditions. Many people prefer not to be confined to one part of a ship, as is usual on two- or three-class passenger liners, but to have the pleasure of free access to all parts of public rooms and decks, especially on a long voyage.

At moderate rates the *Bloemfontein Castle* offers excellent accommodation for 739 passengers. The interior furnishing and decoration is good and the main lounge extends the whole width of the ship, providing clear views forward and to port and starboard.

## Giant Telescope

A 74-inch reflecting telescope, one of the six largest in the world, will be one of the most outstanding exhibits in the Dome of Discovery at the South Bank Exhibition of the Festival of Britain.

Its assembly, in a massive prefabricated setting, at an unfamiliar site and without the usual test assembly at works, is, in itself, an example of British ingenuity. The telescope will be on view as an exhibit only; visitors will not be able to "look through it."

The instrument, based fundamentally on Newton's reflecting principle and built on British design by British craftsmen, is being made by Sir Howard Grubb Parsons & Co. for the Australian Commonwealth Observatory at Mount Stromlo, near Canberra; it is being lent to the Festival authorities by courtesy of the Commonwealth Government of Australia.

The latticework telescope tube is about

30 ft. long and 8 ft. in diameter; the moving parts weigh about 40 tons, yet so freely does it turn and so well is it balanced that the slightest push will move it. Its movement is, however, mechanically controlled about two axes. One axis, the polar axis, is set parallel to the axis of the earth, so that accurate mechanical rotation about this axis cancels out the effect of rotation of the earth. The second axis, the declination axis, pivoted at right-angles to the other, allows the tube to be moved in elevation.

#### Optical Arrangements

The reflecting mirror of glass, surfaced with a very thin polished film of aluminium, has the clear aperture of 74 in., which gives the instrument its name. (The mirror at the exhibition will be a dummy.) The optical system, as usual for large reflecting telescopes, provides for visual work as well as for work with photographic plates or a spectrograph; visual work is, in fact, seldom done with such large instruments.



# LETTERS

# FROM READERS

### Velocity of Escape

SIR,—I noticed in the December issue that "Planetas" is in some difficulty, and hope the following may put him on the right track.

Applying Newton's Laws of motion and gravitation to the case of a planet with a satellite, we can easily show that

$$g = 4\pi^2 D^3 / R^2 T^2 \dots\dots\dots (1)$$

where  $g$  = surface gravity of the planet  
 $D$  = planet—satellite distance  
 $R$  = planet radius  
 $T$  = period of satellite around the planet and, also, for the planet alone

$$v_e = \sqrt{2gR} \dots\dots\dots (2)$$

where  $v_e$  = escape velocity  
 $g$  = surface gravity  
 $R$  = planet radius.

"Planetas" remarks that  $v_e$  is proportional to  $g$ , whereas equation (2) shows  $v_e$  to be proportional to the square root of  $g$ , and also to the square root of  $R$ , the radius of the planet. Thus, even if two planets have the same  $g$  value, the escape velocity will not be the same in both cases unless the radii are the same.

By substituting equation (1) in equation (2) we obtain

$$v_e = \sqrt{2R4\pi^2 D^3 / R^2 T^2}$$

$$\text{i.e. } v_e = 2\pi\sqrt{2} \frac{D}{T} \sqrt{\frac{D}{R}} \dots\dots\dots (3)$$

and from this formula the escape velocity may be calculated for many planets without knowledge of their  $g$ -value.

Notice that the validity of the above formulæ does not depend on any author, but on Newton's Laws, and 200 years' vigorous application of same to practical astronomy.

Examples.—Adjusting equation (3) for convenience we have:

$$V.E. = \frac{2\pi\sqrt{2}}{86,400} \frac{D}{T} \sqrt{\frac{D}{R}}$$

$$= 1.028.10^{-4} \frac{D}{T} \sqrt{\frac{D}{R}} \text{ miles/sec.}$$

if  $\frac{D}{R}$  are measured in miles  
 $T$  is measured in days.

1. *Earth*  
 $D = 240,000$   
 $D/R = 60$   
 $T = 27.3$   
 $\therefore v = 7.0 \text{ m.p.s.}$
2. *Mars*  
 $D = 14,600$  for Deimos  
 $T = \frac{30}{24} = 1.25$  days for Deimos  
 $D/R = 7.0$   
 $\therefore v = 3.1 \text{ m.p.s.}$
3. *Jupiter*  
 $D = 417,000$   
 $T = 3.53$   
 $D/R = 9.4$   
 $\therefore v = 37.2 \text{ m.p.s.}$
4. *Moon*

In this case we cannot apply equation (1) directly, for the moon has no satellite; and so as equation (3) depends on (1) this is of no use here.

There is no need to examine the modifications involved, however, for if we take the lunar surface gravity as one-sixth that on the

earth, viz.  $5.3 \text{ ft./sec.}^2$ , we can apply equation (2) directly.

Take  $R = 1,100$  miles, then

$$v_e = \sqrt{2 \cdot 5.3 \cdot 1100 \cdot 5280} \text{ miles/sec.}$$

$$= \sqrt{61,824}$$

$$\text{i.e. } = 1.49 \text{ miles/sec.}$$

(Notice this is *not* the same as for Mars.)

The above are rough evaluations, and serve merely to show the order of the values involved.

I hope the above is of some value to "Planetas" and that he will be able to use the formulæ for his own calculations.—  
 W. J. YOUNG (Leyton).

### Testing Spirit Levels

SIR,—May I, as a surveyor, refer to the answer to the query on testing spirit levels published in the December issue of PRACTICAL MECHANICS? In testing a spirit level the point is to adjust the level until it is parallel to the wood case, and may be carried out in the following manner. The wood case, of course, must be perfectly parallel itself. To do this two large-headed wood screws should be screwed into the top of a perfectly firm and stationary wood bench or other wood surface, the distance apart just less than the length of the level. The screws are screwed down until they are approximately level with each other and the level is placed on top of these and the position of the bubble is noted, then reverse the level and if the bubble is not in the same position then it must be adjusted until the same reading is obtained each time it is reversed. Although the screws may not themselves be perfectly level, and it is not necessary that they should be, when adjusting the level do not try to get the bubble in the centre but to read the same in both directions. The same test can be carried out with the vertical levels by using two screws in a door jamb and testing in similar manner by changing the edges of the level case and adjusting the level until it reads the same.—  
 E. R. BURGESS (Macclesfield).

### Imitation Marble Effect

SIR,—With reference to the query by S. M. Scales (Aberdeen) in the December issue, an imitation marble effect which may suit his purpose could be obtained by spraying. The cement articles would have to be smoothly faced as a base, then a spraying of one or more enamel undercoats (rubbing down in between each coat to help fill up any pores) to make a satisfactory surface for the finishing coats. Assuming black and white are the "colours" chosen for the marble effect, with white veins showing on a black background, the article would be sprayed first with the white enamel and allowed to dry thoroughly. A small hank of tow or hemp (good quality preferable) is now required about 10in. long. This is carefully pulled apart until it thins out and forms a square. The criss-cross

pattern of fibres, if laid flat on a painted surface and sprayed through, would be reproduced on that surface. The pattern of fibres should be arranged as required; for example, the fibres bunched thickly together at certain parts of the "mat" to prevent the superimposed black from getting on to the white, therefore leaving white "veins" showing distinctly, while the more penetrable portions of the mat would allow the black to go through and obliterate most of the white undercoat. The "balance" is left to the individual, and here experiment is well worth the time spent. Other colour "tints" could be superimposed in addition if required. Of course, the colours of the whole scheme would have to be carefully chosen to give a realistic imitation. When the mat has been arranged as regards the design, it must be laid on a level surface and sprayed on both sides with clear lacquer, it is then carefully picked up and placed on a clean surface (sheet metal, for example), and while still tacky patted down with the palm of the hand. Do this both sides until all the fibres lay flat. When thoroughly dry, the pattern will not be affected by spray pressure. I might add it is best to hold the spray-gun well away from the mat when lacquering, as this minimises any tendency to blow the pattern about. The mat is moved all over the article until the effect is general, and a slight turn here and there will give the veins a different angle according to requirements. Too much use of one mat will soak it, and perhaps mar the work, so it is advisable to keep several in hand, and use them alternately. Drying out will give them a little longer lease of life. The better quality of tow or hemp is of a silky uniform nature, much different from the common type, and it is free from fluff and loose bits which would adhere to a wet surface and therefore prove irritating, apart from probably spoiling the whole surface.—  
 F. H. SWINGLER (Gedling).

### Preparing Hydrogen Gas

SIR,—I noticed in the Queries and Enquiries section of the January issue of PRACTICAL MECHANICS that a reader wished to find a cheap way of preparing hydrogen gas for use in balloons. The following simple method may be of use to him.

An iron tube is filled with copper turnings and brought to red heat; steam is then passed through one end of the tube over the red-hot copper, where the oxygen is removed and hydrogen issues from the other end of the tube. One filling of copper will do for a good deal of gas and when the copper has all been oxidised it can be reduced and used again. For economy's sake the same fire that heats the tube can be used to boil the water. This method was, I believe, used to fill airships in the old days.

Your method produces purer hydrogen, of course, but calcium hydride is difficult to obtain, and the old way is quite good enough for filling balloons.—  
 L. DOHERTY (London, S.W.).

### Optical Details of Enlarger

SIR,—Regarding the description of an enlarger in your January issue, I think there is one point worth commenting on and that is where reference is made to the condenser throwing a parallel beam of light on to the negative. This same error was made by a contributor in your columns a year or so back, in which he suggested putting the diffuser between the condenser and negative. The function of the condenser is to throw an image of the light source into the centre of the enlarging lens, and therefore the beam of light is convergent and not parallel. Ideally, the light source should be a point; opal lamps and diffusers being used only to increase the light source area so as to save

constant adjustment of the lamp-to-condenser distance. The proper adjustment of this distance is especially important in 35 mm. work, in order to project the maximum amount of light through the small negative area without losing it on its way to the projection lens.—D. A. CARTY (Hull).

#### Fire-alarm System

SIR,—In reply to criticisms made by J. W. Robson, Wallsend (January issue), concerning the fire-alarm system published in *Queries and Enquiries* (June issue) and consequently applied to the same circuit with relay modification submitted by me in Sept.-Oct. issue, may I point out that the intermediate connection is illustrated by an arrow purposely to indicate the tapping to be of a selective nature consistent with the voltage required. Therefore its actual position on the diagram is immaterial, providing it is located at an opposite polarity to that of the relay contact supplying the bells and Klaxons.

If the circuit is connected in this way there can be no series discharge, and consequently

no necessity for universal voltage or extra relay contacts.

If the intermediate tapping is moved to the left-hand extremity of the battery, as suggested by the reader, then the same effect can be achieved by connecting to an electrode of the same polarity on any other cell in the battery. This will permit lower voltage bells to be used in comparison to the voltage required by the Klaxons, as previously described.—F. SLATER (Spalding).

#### Series Lighting for a Cycle

SIR,—I have what is, in my opinion, a better method of controlling both cycle head and rear lamps from the handlebar than was described by W. A. Melhuish (Tiverton) in the January issue of *PRACTICAL MECHANICS*.

I have used the method for two years.

In my arrangement I use two batteries, one in each lamp, a twin-cell for the headlamp and a single cell for the tail-lamp. These lamps are connected in series, as in Mr. Melhuish's arrangement.

I have the headlamp situated on a bracket on the front fork; the switch is on the handle-

bars, at the right-hand side. It is wired up as follows:

A lead runs from the positive (top) terminal of the headlamp battery to one of the terminals of the switch, the lead from the other switch terminal runs to the negative terminal of the rear-lamp battery, which is insulated from the lamp case by a felt or cardboard disc.

The "return" is taken by the cycle frame, care being taken to ensure a good contact between the metal of the lamps and the metal frame, paint being removed where necessary to ensure a good earth.

The switch screw of the headlamp is raised and a layer of insulating material inserted between the switch and the positive battery terminal.

The rear-lamp switch must be "on" before lamps can light, putting this switch "off" prevents anyone from switching the lights on while the cycle is parked.

The switch is fastened to the handlebar by means of an old bell clip; a layer of insulation around the handlebar under the clip is a good protection against a short circuit.—R. A. JOHNSON (Prudhoe-on-Tyne).



*Club secretaries are asked to note that the latest date for receiving copy is the first of the month for the following month's issue.*

#### The Tees-side Society of Model and Experimental Engineers

THE third annual exhibition of the above society will be held in the Town Hall, Middlesbrough, from February 26th to March 3rd.

This year we will have on show members' models that were awarded prizes at last year's M.E. exhibition held in London.—J. W. CARTER, hon. sec., 28, East Avenue, Billingham, Co. Durham.

#### Institute of Handicraft Teachers

THE Institute of Handicraft Teachers are holding their annual National Conference for 1951 at Hendon Technical College from Saturday, 24th, to Wednesday, March 28th, inclusive.

The conference includes an exhibition of all kinds of craftwork done in the schools and colleges of Middlesex and Hertfordshire. Traders and publishers who supply tools, machinery, materials and books for the crafts will also be exhibiting. A number of machines will be demonstrated.

Times of opening to the general public are:

Saturday, March 24th.—1.30 to 4.30 p.m.  
Monday, March 26th.—9.30 to 1.30 p.m. (teachers and education staffs). 1.30 to 4.30 p.m.  
Tuesday, March 27th.—As Monday, but close at 7 p.m.  
Wednesday, March 28th.—9.30 to 4.30 p.m. Admission is free.

#### Aylesbury and District Society of Model Engineers

THIS year the annual general meeting was held as usual at Hampden Buildings, Temple Square. Only one new name appeared on the committee, the others being all old hands. Mr. Forest was re-elected to the chairman's seat, whilst last year's chairman becomes a vice-chairman. One of the noticeable features of this year is the holding of three offices by Mr. Smith, our secretary. Among the officers re-elected into their posts were Mr. Eborn as president, Mr. Cleaver as vice-president and Mr. C. Barker as librarian.

We hope the club will be at least as successful under the new committee as it was under the old.—Hon. secretary, E. H. SMITH, Mulberry Tree Cottage, Devonshire Avenue, Amersham, Bucks.

#### Northern Models Exhibition

THE third Northern Models Exhibition will be held in Manchester at the Corn and Produce Exchange on March 16th, 17th and 18th, 1951.

We expect to make this year's event the finest show of its kind in the North. This exhibition will enable the people who were unable to visit the London Model Engineers' Exhibition a chance of seeing some of the best examples of the model engineer's craft.

In addition to the competition and loan models we expect to have a selection of

models from overseas, thus giving an international aspect to the exhibition.

Amongst the radio-controlled models there will be some of the boats which will be demonstrated on the model pond at the Festival of Britain (South Bank).

The exhibition will be open daily on the dates mentioned, from 11 a.m. to 9 p.m.

Further details and competition entry forms can be obtained from the exhibition secretary, E. AXON, 5, Winstanley Road, Sale.

#### Acton Model Engineering Society

AT the annual general meeting held at the society's workshop on January 2nd the chairman, Mr. S. Holtorp, reviewed the activities of the past year and expressed the opinion that in spite of the small membership a good deal of progress had been made. Not only in regard to the workshop, but activities such as film shows and visits to places of interest had done a great deal to keep alive the interest of members and stimulate newcomers into joining the society.

Furthermore, as the financial report showed, the society was on a firm footing in that respect. Continuing, Mr. Holtorp said that he was aware that this encouraging state of affairs was due not to any one or two members, but to the combined efforts of all.

In closing, the chairman regretted that Mr. Hickmore found himself no longer able to continue in his capacity as honorary secretary, and on behalf of all the members Mr. Holtorp expressed sincere gratitude for his work during what must be considered as having been the most trying period of the society's history.

The officers for the coming year were elected as follows: Chairman, Mr. Holtorp; hon. secretary, Mr. A. R. Lyon; and treasurer, Mr. J. Archer.

The society's workshop is open every Tuesday and Thursday evening from 6.30 p.m. New members and visitors from neighbouring clubs may be sure of a welcome, and particulars can be obtained from the hon. sec., Mr. A. R. Lyon, 18, Midland Terrace, Willesden Junction, N.W.10.

#### OUR COMPANION JOURNALS

Practical Wireless, 1/- Every Month  
Practical Television, 1/- Every Month  
Practical Engineering, 4d. Every Friday

# MAKE MORE in your own workshop!

**14/-**

**HORIZONTAL STAND**  
for grinding and tool  
sharpening, buffing and  
polishing



A fully powered 1/4 inch Electric Drill for only **£5-10**

**45/-**

**1/4 INCH BENCH STAND**  
Here's the way to convert  
your 'HANDY UTILITY'  
Drill into a  
sturdy drill-  
press. You'll  
find plenty  
of jobs that  
demand a  
Bench Stand.

NOW ... put those ambitious ideas into practice! Invest in this powerful, low-priced 1/4" Portable Electric Drill! Make faster, neater, deeper holes in wood, steel, plastics ... grind and buff metals! 'HANDY UTILITY' and its accessories are like a workshop on their own. With the Wire Wheel Brush, will remove paint and rust around the home as well.

*The mate of all work*

# ELECTRIC HANDY-UTILITY TOOLS

**10-176**

**1/4 INCH DRILL KIT**  
Drill, 13 h/s Bits,  
Horiz. Stand, Grinding  
Wheel, Wire Wheel  
Brush, Buff, Arbor,  
Metal Carrying Case.

**17/6**

**ACCESSORY KIT**  
Grinding Wheel, Wire  
Wheel Brush, Buff,  
Arbor. etc.



A PRODUCT OF BLACK & DECKER LTD.

OBTAINABLE FROM YOUR LOCAL TOOL SHOP, IRONMONGER OR STORE

# Trade Notes

A Review of the Latest Appliances, Tools and Accessories

## G and T Thermostatic Oven

THIS cylindrical-type oven, which is marketed by Griffin and Tatlock, Ltd., has been designed specially for use in chemical, metallurgical, bacteriological and pathological laboratories. The cylindrical form simplifies manufacture and provides a surface which can readily be cleaned. The exterior is finished in a durable cream enamel, which does not readily chip, and which indefinitely withstands the action of heat. The heating chamber is of nickel-plated copper, and contains three removable shelves mounted on runners. The door and casing are heavily lagged, and the door is fitted with a roller catch operated by a lever handle. A thermally insulated combined thermometer support and rotatable ventilator is provided at the top of the oven. The controls are located in the base and consist of a sensitive slow-motion temperature control, with a circular graduated scale, and a rotary on/off switch.



The G and T thermostatic oven.

A pilot lamp is also provided which is alight during the time when the thermostat is operating. The oven is normally supplied for use on 200-250 volts, and an extra resistance is included in the base to enable the oven to operate on 100-110 volts. A sensitive thermostat provides close temperature control for the oven, and a constancy of control of  $\pm 1$  deg. C. is claimed over the range of 35-220 deg. C. Further particulars can be obtained from Griffin and Tatlock, Ltd., Kemble Street, London, W.C.2.

## The Johnson Photocopia

JOHNSONS OF HENDON, LTD., have just issued a handy pocket-book, bearing the above title, which is intended as a companion volume to the Johnson "Wellcome" Year Book. The Photocopia includes that other information to which reference can be made at home, or in the dark-room, and which, if it were added to the Year Book, would result in a volume of unwieldy size. The new volume, which should prove invaluable to both the beginner and the advanced amateur photographer, is packed with information on all phases of photography, including composition, exposure, development of negatives, printing, lantern slides and fixing baths. Several pages at the end of the book are devoted to a description of various chemicals and their uses. There is also a sectional index and a general index.

## "Mopal" Compressor Unit

A COMPACT compressor unit, including an A.C. motor, compressor, 13ft. air line, cycle pump or Schrader valve connector,

and an attachment for drilling, grinding and buffing, is now being marketed by the manufacturers, Overseas Engineering Co., Ltd., 200, Bishopsgate, London, E.C.2. This handy unit, which is easily transportable by means of its carrying handle, should prove indispensable in the garage for inflating car tyres, spraying, clearing blocked pipelines, and for other uses. It will inflate cycle tyres up to 70-75 lb. per sq. in. in a few seconds. Weighing only 30 lb., the unit is of robust construction and forms a very useful outfit for the handyman, as well as the small workshop. The motor is of  $\frac{1}{4}$  h.p., and can be supplied in all voltages in A.C. or D.C. if required.



The "Mopal" MO.11 compressor unit.

A smaller unit comprising motor, compressor, air line and connector only is also available. An illustrated leaflet giving further particulars and prices is obtainable from the above address.

## BOOKS RECEIVED

**Concrete, Stone and Brickwork.** By Noel D. Green, A.C.G.I., A.M.I.Mech.E. Published by C. Arthur Pearson, Ltd. 152 pages. Price 5s. net.

THIS book, which is one of the well-known Home Mechanic Series, provides the necessary information for enabling the home handyman to undertake successfully a variety of outdoor constructional work for adding to the amenities of the garden. After introductory chapters explaining the various types of concrete mixes and methods of mixing, full instructions are given for laying crazy paving, making paths with squared paving, bird baths and aquariums. Detailed information is also included on the more ambitious reinforced structures, such as fences, garages and greenhouses. The final chapters of this comprehensive book deal with brickwork and wall construction, pointing, rendering and damp-proofing. A notable feature of this volume is the excellent line drawings which illustrate the text.

**Motor Cycle Maintenance and Repair Series: Triumph Motor Cycles,** by A. St. J. Masters; **B.S.A. Motor Cycles,**

by D. W. Munro, M.I.Mech.E.; **Royal Enfield Motor Cycles,** by C. A. E. Booker, A.M.I.Mech.E. Published by C. Arthur Pearson, Ltd. Price 5s. net each volume.

EACH of these three handbooks form a practical guide for owners and repairers, and deal with the servicing and maintenance of the respective machines. Engine dismantling, assembly and overhaul; repair and adjustment of clutch and gearbox; adjustment of wheels, brakes and chains, and lighting and ignition equipment are among the numerous items dealt with. Each handbook is well illustrated and has a full index.

**The Villiers Engine.** By B. E. Browning. Published by C. Arthur Pearson, Ltd. 140 pages. Price 5s. net.

THIS handbook, which is one of the Motor Cycle Maintenance and Repair Series, is a practical guide covering all models of the Villiers engine from 1913 to the present day. The general care and maintenance of the engine is fully explained,

and for the benefit of the novice there is a section on how to obtain maximum efficiency and performance. The first chapter describes in detail the basic construction of the engine, and other chapters are devoted to the carburettor and magneto. The book, which also includes a handy fault-finding chart and an index, is illustrated with numerous half-tones and line drawings.

**Model Yacht Construction and Sailing.** By C. E. Bowden, A.I.Mech.E. Published by Percival Marshall and Co., Ltd. 122 pages. Price 3s. 6d. net.

THIS interesting and entertaining book deals with the principles of the design, construction and operation of model and small racing craft in the light of modern knowledge of aerodynamics and hydrodynamics. There are seven chapters covering respectively Classes of Model Racing Yachts, Airflow Around the Sails, Hull Design, Constructional Methods and Rigging a Model, Automatic Steering Gear, Sailing a Model, Wingsail Experiments. The author has had considerable experience of the subject and this little book, which is profusely illustrated, should arouse interest not only in beginners, but also in old and experienced hands.



# RAWLPLUG PRODUCTS

**INDISPENSABLE  
IN THE WORKSHOP  
HANDY IN THE HOME**



## DUROFIX

The indispensable adhesive for instant use on crockery, glass, wood, metal, celluloid and the thousand and one things handled by the hobbies enthusiast. Instant drying, insulating, waterproof and heatproof. Durofix is grand for repairs to electrical, sports and leather goods. Tubes 9d. and 1/3d. Tins 2/9d. and 7/6d.



## DUROGLUE

UNDILUTED ANIMAL GLUE OF INCOMPARABLE STRENGTH  
Ready for instant use for the many purposes for which an extra strong glue is needed. Wood, cloth, fabric, felt, leather and any greaseless surface can be stuck with Duroglue. Tubes 6d. and 1/-. Tins 2/3d. and 3/9d.



## PLASTIC WOOD

APPLIED LIKE PUTTY, DRIES LIKE WOOD  
Can be cut, planed, polished and painted like wood. Will take nails and screws like wood. It does not blister, crack or decay. Rawlplug Plastic Wood is actually the best quality product of its kind on the market. Tubes 10/3d. Tins 2/- and 5/-.



## DUROLASTIC

ELASTIC SEALING COMPOUND  
Forms permanently elastic waterproof joints with great adhesive qualities to any dry surface. Resists vibration or shock and will not break away with expansion or contraction. Non-crumbling, non-staining, does not exude oil. Can be painted in a few hours. Ideal for boat-builders. In easy-to-use tubes at 1/6d.



## SOLDERING IRONS

MAKES SOLDERING CERTAIN AND SIMPLE

This is a guaranteed electric tool which will pay for itself many times over by repairing and giving longer life to metal household goods. In the workshop it is indispensable. Supplied with Standard bit for 25/-. Hatchet or Pencil bit for 26/-. Voltages 100/110, 200/220, 230/250. Universal AC/DC.



## HEATLESS SOLDER

No iron is needed with Rawlplug Heatless Solder which is in paste form and dries in a few minutes. It is very useful for quick repairs to metalwork, but is not suitable for wireless or electrical connections. Tubes 9d.



## IRON CEMENT

Water and Gas pipes, Radiators, Cisterns, Buckets, Kettles, Saucepans, Stoves, Kitchen Utensils, etc., etc. 1/3 per tin.

### RAWLPLUG FIXING DEVICES & TOOLS

Whatever your fixing problems, there's a Rawlplug Device that will solve it for you—easily and quickly. Rawlplugs make neat and absolutely firm fixings in any material from plaster or brick to stone or slate, with a size for every screw from No. 3 up to 1/2" coach screws. Rawlplug Tools are easy to use and ensure a perfect hole without damage to surrounding surfaces. Other Rawlplug Devices include Rawlbolts for heavy duty fixings, Rawlanchors and Toggle Bolts for thin or hollow materials and Rawlclips for instant fixing of conduits and cables to girders—a device in fact for every need.

Rawlplug fixing devices and products can be obtained from Ironmongers, Hardware Dealers, Stores, or Model Makers Suppliers.

B389E

**THE RAWLPLUG COMPANY LTD. LONDON. S.W.7.**

### Gears

Rack and driving pinion complete, and mounted on die-cast frame fitted with 1/4 in. diameter drive shaft and bearings. Rack length 2 1/2 in., breadth 3/16 in., 1/4 in. thick. Pinion diam. 1 1/8 in. Solid brass rack and pinion precision cut. An extremely well-made unit at below original cost price. Useful to engineers, model makers, experimenters, etc. Price 5/6 each, complete. Postage and packing, 6d.  
Crown and bevel gears: matched set consisting of a 24-tooth, 1/4 in. approx. diameter crown wheel and 48-tooth 1/4 in. approx. diameter bevel, both of solid brass, precision cut, and fitted with mounted bracket and shaft. Price 2/6 per set. Postage and packing, 6d.

### Rectifier Units

Metal cased, 20 in. by 1 1/2 in.; input 110 or 230 volts A.C., output 100/120 volts D.C. 2.5 amps. By fitting a suitable ballast resistor and meters this could be used as a battery charger; worth many times our price of £3/10/0 each, carriage paid.

### Waterproof Covers

Originally engine covers, made of finest quality American cloth; double sheets with kapok packing between, approx. 1 1/2 in. by 6 in., fitted at one end with asbestos material manifold cover which can be easily removed. An exceptionally well-made heat and waterproof cover for tractors, small boats, engines, cars, etc. The material alone is worth many times our price, and we offer these as a definite bargain. All brand new and unused at 25/- each, carriage paid.

### Luminous Paint

First quality, made for use in aircraft; high glow, with a long life; suitable for a variety of uses such as dashboard instruments, well switches, posters, fuse boxes, and any other application where it is required to locate or make adjustments in the dark. Price 2/6 per jar. Post and packing, 3d.

Send S.A.E. for our Super Detailed List

**WILFLO PRODUCTS**  
216-222, GORBALS STREET  
GLASGOW, C.5

## POSTAL BARGAINS



TYPE 3

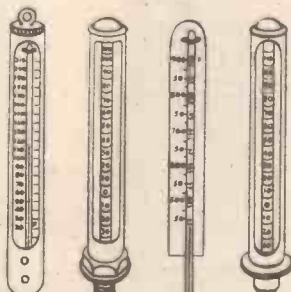

TYPE 1

TYPE 2

TYPE 4

TYPE 5

### INDUSTRIAL THERMOMETERS

Type 1 for ordinary temperatures, extra robust, heavy brass case Price 12/6 each with hook.  
Type 2 reading up to 900°F., can be used without back plate, graduations Price 7/6 engraved on glass, each.  
Type 3 for door or wall of baking or processing oven. Heavy brass case and protective cover. This reads up to 600°F. Price 32/6 Plus 2/6 for returnable transit case.  
Type 4 for low temperatures, minus 300°F. up to 110°F. As illus. for mounting through pipe line or tank, etc. Price 32/6  
Type 5 is as type 4 except that there is a much longer reach. Price 39/6

### 2 volt ACCUMULATOR

Suitable for radio or model driving, house lighting, etc. Heavy mass type plates—pre-charged—only need filling. New unused—size 7 in. x 2 in. x 2 in.

15/- value for only 4/9 Post and ins. 1/3d.

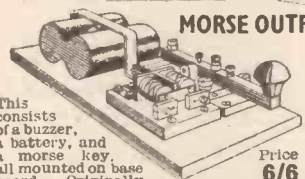

### MORSE OUTFIT

This consists of a buzzer, a battery, and a morse key, all mounted on base board. Originally intended for training R.A.F. recruits. Price 6/6 plus 1/- postage.

### PORTABLE HEATER

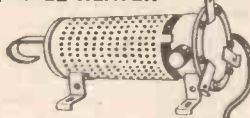

Sturdily constructed, made by the G.E.C. for the Navy. Will give a lifetime of service, absolutely safe in explosive atmospheres, useful for the motorist to warm the garage or put under the engine on very cold nights, to hang in the loft to prevent tanks and pipes from freezing, to help along young seeds and to keep frost out of the greenhouse or cold frames. The price is only 15/- plus 1/6 post

### BARGAIN 8/6



Post & ins. 1/8. Set of three brand new 2v. battery valves (listed 21/-), plus data circuit diagrams, etc., of battery receiver requiring no soldering. To-day sources this amazing bargain

Britool 0.9 B.A. Tool sets. Chrome Alloy Steel, in steel boxes, 26/-.

New Brown's Moving Reed Headphones. Best in the World, 7/9.

Moving Coil Microphones with Pressel Switch, 6/- Matched Transformer, 5/6.

Small 24 v. D.C. Multi-gear Motor with reversible clutch, 11/6.

Powerful small Motors. Reversible connection 110 v. A.C./D.C., 3 1/2 in. x 2 1/2 in. x 2 1/2 in., 11/6.

Westinghouse F.N. Bridge. 5 mA. Meter Rectifiers, 7/6.

Meters, M/c., 0-250 Milliamps, 2 1/2 in., 10/-, 2 in. 0-300 v. 10/-, 0-1 mA., 11/6.

Miniature Motors, 24 v. A.C./D.C., 2 1/2 in. x 1 1/2 in. x 1 1/2 in., 8/6. Post paid. 24 v. Trans., 13/6.

250-watt Double Wound Transformers, 230/115 v. Made by G.E.C. With Steel Shroud. New. £2/7/6 each.

New Osram, Crompton, Mazda, etc., 12 v. Car Bulbs. Double contact. 10 watt, 11/3.

Transformers 230/24 v. 1 a., 13/6.

New 12 in. Elliptical Energised Speakers, 400 ohm Field with Push-Pull Output Transformer, 21/6.

Powerful Small Blower Motors, 24 v. A.C./D.C., 14/- Transformer 230/24 v., 13/6.

Army Carbon Microphone with switch. New and Boxed, 4/6. Trans. to match, 3/-.

Admiralty 3 1/2 in. S.M. Dials, 100-1 with vernier. White Ivorine dial 0-100. Worm drive. New and Boxed, 8/6.

All Carriage Paid. Money Back Guarantee from:

**THERADIO & ELECTRICAL MART,**  
253B, Portobello Road, London, W.11.  
Park 6026.

**E. P. E. LTD.** (1) Electron House,  
WINDMILL HILL, RUISLIP MANOR, MIDDLESEX

**HIGHSTONE UTILITIES**



**Crystal Sets.** Our latest Model is a real radio receiver, which is fitted with a permanent crystal detector. Why not have a set in your own room? 10/6, post 6d. De Luxe Receiver in polished oak cabinet, 18/6, post 1/.

**Spare Permanent Detectors,** 2/- each. When ordered separately, 2/6. With clips and screws, 2/10, post 3d. **Headphones,** brand new, S. G. Brown, G.E.C., etc., 15/-, 23/-, and super-sensitive, 30/- a pair post 8d.

**New Headphones,** 10/- a pair. Balanced armature type (very sensitive), 12/6 a pair. Both post 8d. **New Single Earpieces,** 3/6. Bal. armature type, 4/6: ex-R.A.F. earpiece, 2/-, post 4d. **Headphones,** in good order, 4/6 and 5/6 (better quality 7/6), all post 8d. **Headphones** with moving coil mike, 15/-. **Similar phones** with throat mikes, 12/6, post 8d. **Headphone Cords,** 1/3 a pair, post 3d. **Replacement Bands,** 1/3, post 4d. **Wire Bands,** 6d. (All Headphones listed are suitable for use with our Crystal Sets.)



**Best Transformers** These guaranteed transformers work from any A.C. Mains, giving 3, 5, or 8 volts output at 1 amp., operate bulb, buzzer or bell. Will supply light in bedroom or ladder, etc. **PRICE 8/-,** post 8d. **BELLS** for use with either the above or batteries, 6/6, post 6d. **"Big Ben" Chimes,** Housed in Cream Plastic Case. Easily connected to give Two-Note Chime from Front Door, and Single Note from Rear. Operates from 6-9 volt Batteries or Transformer (shown above), 17/6, post 10d.

**EX-R.A.F. 42-valve (2-volt) Microphone Amplifiers** as used in 'plane inter-com., in self-contained metal case; can be used to make up a deaf aid outfit, intercommunication system, or with crystal set; complete with valves, 20/-, post 1/6. Useful wooden box with partitions to hold amplifier, 2/- extra. Ditto, less valves, 10/-. One valve amplifier, complete with valve, 10/6, post 1/-.

**Hand Microphones,** with switch in handle and lead, 4/-. **Similar instrument,** moving coil, 7/6, post 6d.

**Sparking Plug Neon Testers** with vest-pocket clip, 3/3, and with gauge, 3/6, post 3d.

**S.B.C. Neon Indicator Lamps,** for use on mains, showing "live" side of switches, etc., 3/6, post 4d.



**Soldering Irons.** Our new streamlined Iron is supplied with

two interchangeable bits, one each straight and curved; 200/250 v. 50 watts, 10/-, post 6d. **Standard Iron** with adjustable bit, 200/250 v., 60 watts, 11/-, post 6d. **Heavy Duty Iron,** 150 watts, 14/-, post 8d. All parts replaceable and fully guaranteed. **Small Soldering Irons,** for use on gas, 1/4, post 4d. Resin-cored solder for easy soldering, 6d. packets, or 1lb. reels, 6/-, postage extra.

**Microphones.**—Just the thing for impromptu concerts, room to room communication, etc. Bakelite table model, 6/9; Suspension type, 8/6. Post 6d. **Mike Buttons (carbon),** 2/-. **Moving Coil, 4/6; Transformers, 5/-.** All post 4d, each.

**Rotary Transformers,** 24v. input; Output 1,200 v. 2 amp. in case with suppressors, etc., easily converted to run as a high voltage motor, 25/-, carr. 3/6. Also 12v. input; Output 6v., 5 amp., 150 v., 10 mA. and 300v., 20/240 mA., 22/6, carriage 3/6.

**Morse Keys.**—Standard size keys wired to work Buzzer or Lamp, 3/-, post 6d. Slightly smaller keys, 2/6, post 4d. **BUZZERS,** 2/3, or heavy duty, 4/6, post 5d.

**Terminals,** brass, 2BA, mounted on strip 6d. pair. **.0005 Airspaced Variable Condensers,** 2/6, post 4d. **.00003 twin rans** with trimmers, 2/6, post 4d. **24-volt 15 m/m. M.E.S. Bulbs** for model railways, etc., 1/- each, 10/- doz., post 4d. **Wander Plugs,** Brass, 1/6 doz., post 4d. **Fuses.**—1 amp., 14in. packet of 10, 2/6, post 3d. Also 150 mA. and 250 mA. same price.

**Bargain Parcels** of really useful equipment, containing Switches, Meters, Condensers, Resistances, Phones, etc., 10/- or double assortment, 17/6; treble, 25/-, All carriage paid. This country only.

**Field Intercommunication Sets,** complete with ringing hand generator, bell, signal lamp, morse key, relay, in strong metal case with circuit diagram, 25/- each, carr. 2/6; 47/6 pair, carr. 3/6. **EX-G.P.O. Telephone Twin Bells,** with box, 6/-, post 9d. **Telephone hand generator,** with handle, 7/6, post 1/6; Bell, 3/6, post 6d.

**Meters,** 10v., 21in. Rectifier (A.C.), in wooden carrying case, 14/6; 15v., 21in. m/c, 9/6; 150v., 2in. m/c, 10/-; 3,500 v., 3 1/2in. m/c, 20/-; 6,000v., 3 1/2in. m/c, 57/6; 15,000v., 2in. m/c, double reading, 8/-; 100 mA., 2in. m/c, 7/6; 3.5 amp. 2in. T.C. 5/-; 4 amp., 2 1/2in. T.C., in case with switch, 7/6. **Meter Movements,** 2in. size with magnet and case (500 microamp), 2/6. All meters post extra.

Money refunded if not completely satisfied.

**HIGHSTONE UTILITIES**  
58, New Wanstead, London, E.11.  
Letters only.  
New Illustrated List sent on request with 1d. stamp and S.A.E.

STUDY  
AT  
HOME

IN YOUR  
SPARE  
TIME

**THE BENNETT COLLEGE**

*will set you on the right course for success*

You make sure of planned progress in the career of your choice when you let the most progressive, most successful Correspondence College in the world coach you through the post. By friendly, individual training we equip you with the specialised knowledge you must have for a well-paid, key position.

Make the first move TO-DAY—post the coupon below!

**ALL TEXT BOOKS ARE FREE!**

We send you as many volumes as the subject chosen demands, and they become your personal property.



**IS YOUR CAREER HERE?  
IF NOT, WRITE FOR FREE ADVICE**

- Accountancy Examinations
- Agriculture
- A.M.I. Fire E. Examination
- Applied Mechanics
- Auctioneers and Estate Agents
- Aviation (Engineering and Wireless)
- Blue Prints
- Boilers
- Book-keeping, Accountancy and Modern Business Methods
- Builders' Quantities
- Building, Architecture and Clerk of Works (A.R.I.B.A. Exams.)
- Carpentry and Joinery
- Chemistry
- Civil Engineering
- Civil Service
- All Commercial Subjects
- Commercial Art
- Common Prelim. E.J.E.B.
- Concrete and Structural Engineering
- Diesel Engines
- Draughtsmanship
- Electrical or Mechanical Engineering, all Branches, Subjects and Examinations
- General Certificate of Education Examinations
- General Education
- G.P.O. Eng. Dept.
- Heating and Ventilating
- Institute of Housing
- Institute of Municipal Engineers
- Journalism
- Languages
- Mathematics
- Metallurgy

- Mining, all Subjects
- Mining, Electrical Engineering
- Motor Engineering
- Naval Architecture
- Novel Writing
- Plastics
- Play Writing
- Plumbing
- Police, Special Course
- Preceptors, College of Press Tool Work
- Pumps and Pumping Machinery
- Quantity Surveying—Institute of Quantity Surveyors Exams.
- Radio Service Engineering
- Radio (Short Wave)
- Road Making and Maintenance
- Salesmanship
- Sanitation
- School Attendance Officer
- Secretarial Examinations
- Sheet Metal Work
- Shipbuilding
- Shorthand (Pitman's)
- Short Story Writing
- Social Welfare
- Structural Engineering
- Surveying (R.I.C.S. Exams.)
- Teachers of Handicrafts
- Telecommunications (City and Guilds)
- Television
- Transport Inst. Examinations
- Viewers, Gaugers, Inspectors
- Weights and Measures Inspectors
- Wireless Telegraphy and Telephony
- Works Managers

**COUPON. CUT THIS OUT**  
IF YOU ATTEND TO THIS NOW IT MAY MAKE A  
WONDERFUL DIFFERENCE TO YOUR FUTURE

**To DEPT. 76, THE BENNETT COLLEGE LTD.**  
**SHEFFIELD, ENGLAND.**

Please send me (free of charge) particulars of.....

Your private advice about.....

(Cross out line which does not apply)

PLEASE WRITE IN BLOCK LETTERS

NAME .....

ADDRESS .....



**GALPIN'S**

ELECTRICAL STORES

408, HIGH STREET, LEWISHAM, S.E.13  
Tel.: Lee Green 0309, N.r. Lewisham Hospital.  
Early Closing Day Thursday. Terms: Cash With Order. No C.O.D. All goods sent on 7 days approval against cash.

**MAINS TRANSFORMERS (New),** all 200/250 volt primaries in steps of 10 volts: Output 350/0/350 volts, 250 m.a., 6.3 v. 8 a., 6.3 v. 8 a., 4 v. 4 a., 5 v. 4 a., 6.2/6 each; 500/0/500 volts, 300 m.a., 6.3 v. 8 a., 6.3 v. 8 a., 4 v. 4 a., 5 v. 4 a., 6.2/6 each; 500/0/500 volts, 300 m.a., 6.3 v. 8 a., 6.3 v. 8 a., 4 v. 4 a., 5 v. 4 a., 3 v. 4 a., 6.7/6 each; 350/0/350 volts, 250 m.a., 6.3 v. 8 a., 4 v. 8 a., 4 v. 4 a., 6.3 tapped 2 v. 2 amps. (Electronic), 57/6 each. Carr. 3/6.

**DYNAMOS BY WELL-KNOWN MAKERS,** 110 volts, 1 kilowatt, D.C. output, 2,300 r.p.m., £51/0/0 each, carriage 10/-. A.C. Alternators, output 85 volts at 2 1/2 amps., 75 cycles, 2,300 r.p.m., £31/0/0 each.

**MAINS TRANSFORMERS (new),** all with 200/250 volt primaries in steps of 10 volts; output 350/0/350 volts, 180 m.a., 6.3 v. 8 a., 5 v. 3 a., 37/6 each; 500/0/350 volts, 180 m.a., 6.3 v. 4 a., 5 v. 3 a., 4 v. 4 a., 37/6 each; 500/0/500 volts, 150 m.a., 6.3 v. 4 a., 4 v. 4 a., 5 v. 3 a., 42/6 each; 425/0/425 volts, 160 m.a., 6.3 v. 3 a., 6.3 v. 3 a., 5 v. 3 a., 39/6 each. Carriage extra 1/6.

**METERS EX-W.D. SURPLUS (new),** 2in. scale, moving coil 0 to 20 volts, 6/- each, post 9d.; another 0 to 40 volts, 7/6 each, post 9d.; another 0 to 10 amp., 12/6 each, post 9d.

**MAINS TRANSFORMERS,** 230 volts, 50 cys., 1 ph. input, tapped output, 0, 6, 12, 18 volts at 4 amp., at 17/6 each, post 1/6; another 230 volt input, 700/0/700 volt, 70 m/amp., 12 v. 1 a., 4 v. 2 1/2 a., 27/6 each, post 1/6.

**EX-U.S.A. HAND GENERATORS,** with 3 outputs, all D.C., 415 volts at 110 m/amp., 6 v. 2 1/2 amp., 3 v. 1 a.; these machines are as new, but less the winding handle, contain many useful parts and are completely smoothed, price to clear, 17/6 each, carriage 2/6.

**ROTARY CONVERTERS,** 24 volts D.C. input, 50 volts, 50 cycles, 1 ph. at 450 watts output, complete with step up Transformer from 50 to 230 volts, £71/0/0 each, carriage 10/-. Condition as new.

**MAINS VARIABLE SLIDE RESISTANCES,** protected type, by well-known makers, 450 ohms., 9 amps, 22/6 each; ditto, 1,500 ohms to carry 4.5 amps., 22/6 each; not protected, 0.4 ohms, to carry 25 amps., 10/- each; 1.4 ohms to carry 11/4 amps., 12/6 each.

**POWER TRANSFORMER AUTO WOUND,** voltage changer tapped 0, 110, 150, 180 and 230 volts at 1,600 watts, £515/0 each, carriage 3/6; ditto, 2,000 watts, £615/0 each, carriage 3/6; another tapped 0, 110, 200, 230 volts at 350 watts, at 48/6 each, carriage 2/-.

**EXTENSION P.M. SPEAKERS,** Makers, Johnson & Phillips, 3 1/2in. 213 ohm.; speech coil will handle 1 1/2 watts (new, boxed), 8/6 each. Rotary Transformers, ex-R.A.F., D.C. to D.C., 28 volts to 1,200 volts at 70 m/amps., 7/6 each, carriage 1/6.

**MAINS TRANSFORMERS (New),** All 200/250 volts input in steps of 10 volts. Outputs, 0, 6, 12 and 24 volts at 10/12 amps., 47/- each; 0, 18, 30, 36 volts at 5/6 amps., 42/6 each; 0, 6, 12 and 24 volts at 25/30 amps., 68/6 each; 0, 6, 12 and 24 volts at 5/6 amps., 35/- each.

**EX-R.A.F. MICROPHONE TESTERS.** These contain a 2 1/2in. scale 0 to 450 micro-amp. meter, shunted to 1 m/amp., calibrated 0 to 10 volts, moving coil, complete with 1 m/a rectifier, "mike transformer," etc., all contained in polished wood box, as new, 17/6 each.

**PRE-PAYMENT 1/2 SLOT ELECTRIC LIGHT CHECK METERS,** all electrically guaranteed, 200/550 volts, 50 cycles, 1 ph., A.C. input, 2 1/2 amp. load, 27/6 each; 5 amp. load, 35/- each; 10 amp. load, 42/6 each; 20 amp. load, 50/- each, carriage 2/- extra; in quantities of one dozen or more a special discount of 10 per cent.

**ELECTRIC LIGHT CHECK METERS,** quarterly type, for sub-letting garages, apartments, etc., all fully guaranteed electrically for 200/250 volts A.C. mains, 50 cys., 1 ph., 5 amp. load, 17/6 each; 10 amp. load, 20/-; 20 amp. load, 25/- each; 50 amp. load, 37/6 each; 100 amp. load, 45/- each; carriage 2/- extra on each; special discount of 10 per cent. on quantities of one dozen or more.

**BRIDGE MEGGERS,** by well-known makers, 250 volt type, complete in leather carrying case as new, £12/10/0 each, carriage and packing 7/6.

**LARGE STUD TYPE VARIABLE Dimmer Resistances (unprotected),** 10 ohms to carry 9/18 amps., 35/- each, carriage 5/-, small type, 10 ohms to carry 3 amps., 15/- each, post 1/6.

# Sailing a radio-controlled yacht

This is one of the outstanding articles in the first quarterly issue of the Modelcraft Magazine for 1951. In addition to a full contents list of interesting articles, the magazine contains a supplementary list to the Modelcraft List, giving the latest additions to our plans, planbooks, kits and accessories.

# Modelcraft Magazine February 1951

1/- POST FREE or from your modelshop

## MODEL CRAFT LIMITED

77 (L) Grosvenor Rd., London, S.W. 1

## THERMOELECTRICS LTD.

**CHAPEL WORKS. HAMPTON-ON-THAMES.**

Here is an opportunity for the amateur engineer to acquire a precision Bi-metal Thermostat, capable of controlling A.C. currents of  $\frac{1}{2}$  AMP within the temperature range 50 degrees Fahrenheit to 200 degrees Fahrenheit.

<b>ROOM THERMOSTAT.</b>	40-80 deg. F., 60-100 deg. F. or 6-27 deg. C., 15 amps, 250 v. A.C. 1/10 amp. D.C.		<b>PRICE 3/9 EACH</b>
<b>35/-</b>			
<b>IMMERSION THERMOSTAT.</b>	90-190 deg. F., 13 amps, 250 v. A.C.		
<b>CONVECTOR THERMOSTAT.</b>	40-80 deg. F., 15 amps, 250 v. A.C. 1/10 amp. D.C.		

Controlled Heating for the Experimental Engineer.

**SPECIAL OFFER.** Asbestos Covered, Fully Flexible Heating Cord. 60 ohms per yard. Price: 1/- per yard.

## CHEMICAL APPARATUS CATALOGUE

POST 2/6 FREE

The Abridged Chemical List S.A.E.

### 1951 CHEMICAL PRICE LIST

NOW READY SEND STAMP

## VICSONS LTD

148 PINNER RD., HARROW, MIDDLESEX.  
FOR ALL LABORATORY APPARATUS

*Contractors to Education Authorities and many of the large industrial laboratories*

## GOOD INVESTMENTS

**METERS.**—D.C. moving coil panel meters, 2in. flush, 50 amps, 5/-, 50 amps, C.Z., 5/-, 20 amps, 5/-, 40 volts, 7/6, 30 ma., 6/-, post 6d. extra on all meters. **Thermal Ammeters**, 2 1/2in. flush panel, Ferranti, 0-6 amps, 10/-, post 9d. **A.C./D.C. Voltmeters**, 2 1/2in. flush, 0-15 volts, Met. Vic., 21/-. **Switchboard Meters**, ironclad G.E.C. 4 1/2in. 0-40 amps, 35/-, 0-60 volts, 35/-, Met. Vic. 5in. A.C./D.C. **Ammeters**, 0-50 amps, 35/-, 0-300 volts, 35/-, Frequency Meters, 6in., projecting panel, ironclad switchboard, 230 volts, 40/60 cycles, £10. **Prepameter House Meters**, Ferranti 5 amp, 220 volt, A.C. 50 cy., 1/- coin calibrated 7d. per unit, 21/-, carr. 3/6. **Check Meters**, A.C. 50 cy., 200/240 volt, 100 amps, 35/-, 50 amp., 30/-, 20 amp., 25/-, 10 amp., 20/-, 5 amp., 17/6. Surplus stocks.

**VARIABLE SLIDER RESISTANCES**, double tube, 250 ohms, 2-1.2 amps, 35/-, Single, 50 ohms, 1.3 amps, 15/-, 5 ohms, 10 amps, 21/-, 300 ohms, 1/2 amp., 12/6, 1.2 ohms, 15 amps, 10/-.

**DIMMER RESISTANCES**, panel, totally enclosed, 100 ohms, 1/2 amp., 2/6; open type wire wound, 10 ohms, 1 amp., 2/6.

**STAGE LIGHTING DIMMERS**, wire wound, enclosed, 100 watts to 5,000 watts, prices on application. Surplus sliding dimmers, 110 volts, 500 watt, 40/-, 1,000 watts, 70/-, 5 K.W., £71/10/0, 5 K.W. on mobile stand, £81/10/0.

**MORSE KEYS**, A.M. precision key on bakelite base with insulated knob, 2/6; practice buzzer in metal case, 2/6. G.P.O. twin-coil buzzer, 2/6.

**MICROPHONES**, G.P.O. hand mike in moulded bakelite case, 3/6. Siemens torpedo shape hand mike in bakelite case, 3/6. Transformer, 2/6, postage 9d. No. 3 ex-W.D. Hand Mike, bakelite case, switch in handle, cord and Plug. Carbon inset, 7/6, post 9d.

**LIQUID LEVEL INDICATORS** with geared float, watertight case for reading on distant dial, 3/6, post 9d.

**PRESSURE GAUGES**, Bourdon plus 8lb. per sq. in. to minus 7lb. for testing blowers, vacuums, etc., luminous dial; new surplus, 5/-, post 6d.

**MAGNETS**, D.C. electro magnets, twin coil, weight 10 ozs., lift 4lb. on 6 volts, 3/6, on 4 volts, 5/-, post 6d.

**WIRELESS CONTROL UNITS**, Ex-R.A.F. contain Xaxley switch and knob, connection strip, fuse and holder, coil socket and connections all in metal case, 2/-, post 1/-; larger model with two Xaxley switches and pilot lamp, 3/-, post 1/-.

**SWITCHES**, Dewar key switch, new surplus, 7 pole C.O. with top plate, 5/-, Lucas 8-way switchbox, 3/6, post 9d. 6-way, 3/-, post 7d. Xaxley switches, 8 pole 1 way or 3 pole 3 way, 2/6.

**TRANSFORMERS**, B.T.H., double wound, 230 volts, 50 cy. input 30 volts 6 amps and 2 volts 20 amps, 45/-, carr. 5/-.

**FOSTER DOUBLE-WOUND TRANSFORMERS**, 230 volts, 50 cy. input 50 volts 2 amps, output, 15/-, post 2/-.

**AUTO TRANSFORMERS**, 230 volts, 50 cy., input 110 volts 75 watts, 25/-, 100 watts, 30/-, 150 watts, 35/-, 200 watts, 40/-, 300 watts, 60/-, 1 K.W., £71/10/0.

**D.C. HAND GENERATORS**, 6 volts, 5 amps, with geared drive in handle to 100 r.p.m., 25/-, carr. 3/-.

**D.C. GENERATORS**, 12 volt, 101/5 amp., 1,400 r.p.m., 50/-, carr. 5/-, 12 volts, 50 amps, 3,000 r.p.m., £41/10/0, carr. 5/-, 24 volts, 18 amps, 1,200 r.p.m., £121/10/0, carr. 5/-, 50/70 volts, 25 amps, 2,500 r.p.m., £20, carr. 10/-.

**TELEPHONES**, House and office type, ex-G.P.O. Wall phone constructors parts, comprising cabinet, Bin. x 6in. x 3in., bracket mike, mag. bell transformer and condenser, switch-hook and contacts, long magnet bell receiver connection strip, etc., with wiring diagram and hand magneto generator, 35/- per pair, carr. 5/- extra.

**TELEPHONE EXCHANGE** manual, 5-line with drop indicators, speaking and ringing keys, operator's call bell and terminals for operator's headset, 75/-, carr. 5/-.

**WESTINGHOUSE METAL RECTIFIER UNITS**, Ex-G.P.O., 230 volts, 50 cy. input, 50 volts 5 amps D.C. output, £9, 50 volts, 1 1/2 amps, £6, 50 volts, 1/2 amp., £41/10/0, all in vent. metal case, carr. extra.

**WIRE**, 10 gauge covered wire, 21 lbs. reels, 5/- each. Glass-covered wire, 21 gauge, on reels, 14/2 1/2, each 4 1/2 lb., reels 1/3.

**PARCELS**, 10lbs. useful oddsments for the junk box all clean dismantled from G.P.O. and surplus Govt. apparatus, 7/6, post free. (For Home Buyers Only.)

**NIFE CELLS**, New surplus, type F.4, 12 volts, 45 amp. Hr. 9 cells in wood crate, £8/10/0, carr. extra.

## BUILD YOUR OWN RADIO!



Are you a Beginner, Serviceman, Dealer, Experimenter or Hobbyist? Whatever your interest in radio you will find something for you in the NEW EDITION

of our world-famous publication "THE HOME CONSTRUCTOR'S HANDBOOK." Here are some of the good things it contains:

- ELEVEN tested and guaranteed circuits, with full descriptions and COMPLETE parts lists.
- Feeder Units, Tuning Units and Superhets. (A.C. AC/DC and Battery).
- Quality Amplifiers.
- Test Gear.
- Coils. (Used in "P.W." 9 valver!)
- Servicing and Constructional Hints and Tips.
- Resistance Colour Code, Charts, etc.
- Useful Formulae.
- And many other interesting items. The price? 1/6 ONLY (worth many times this purely introductory price). So SEND NOW for your copy. Vast numbers of beginners have built modern factory-designed superhets, using our Tuning Units. Failure is impossible, when using our UNIQUE easy-as-abc Construction Sheets.

**MODEL 30 TUNING UNIT**, 3 wave-band—consisting of iron-cored 30 coil pack, iron-cored I.F.T.'s, J.B. 2-gang condenser, and 3-colour 8" x 6" dial. ALIGNED AND SEALED AS A UNIT in a standard 5 valve superhet receiver. No further adjustments necessary whatsoever! 69/9 (inc.).

**MODEL 40 TUNING UNIT**. Similar to above but with R.F. stage! 99/6 (inc.) or 120/3 (inc.) with spin-wheel J.B. S.B. Tuner. H.C. Handbook given FREE to all purchasers of either unit. Mail order ONLY DIRECT FROM

**RODING LABORATORIES**  
(MAIL ORDER DEPT. M.1.)  
70, LORD AVENUE, ILFORD, ESSEX.

### WRITE TO US FOR THE FOLLOWING MATERIALS

- 'PERSPEX' ACRYLIC SHEET—cut to any size.
- 'CATALIN' CAST RESIN in a multitude of shapes.
- 'CATACOL' RESIN ADHESIVE
- 'CATACAST' CASTING RESIN } and accelerator
- 'VINAMOULD' FLEXIBLE MOULDING COMPOUND

... and every other requisite for the serious Craftworker. 1/6 procures our Illustrated Catalogue and 3d. our price list.

## greenwoods

Dept. 3c, 13-17, Victoria Street, HUDDERSFIELD

### CRYSTAL SET AMPLIFIER.

Will work a loudspeaker at good strength from your crystal set without alteration. Price complete, 32/6. Suitable crystal set, if required, 14/6, post 9d.

**A.C. BATTERY CHARGER** parts for car accumulators, easily assembled parts with diagram for 6 or 12 volt. cells, charging at 14 amps, 30/-, 3 amps, 42/6, 4 amps, 50/-, Postage 1/-.

**PHOTO-ELECTRIC CELLS.** For all sound films, high fidelity production, speech and music. Small tube size, 2in. x 1in. dia., 26/6. Midget tube, 1 1/2 x 1in., 22/6.

**COMPLETE OPTICAL SYSTEM** for 35 or 16 mm. sound film, 42/-.

**ECONOMIC ELECTRIC CO.,**  
64, London Road, Twickenham

### DRILLS—HIGH SPEED

New and best quality. Sets complete with Stand. Fractions—1/16th to 1in.

x 64ths	...	...	67/6
Letter A-Z	...	...	52/6
Number 1-30	...	...	63/-

Special bargain selections of assorted high speed drills, boxed—no stands

Set HS/A 12 drills app. 3/64 to 1in. 6/-  
Set HS/B 12 drills app. 3/64 to 1in. 9/-  
Set HS/C 30 drills app. 3/64 to 7/16 20/-

All above post free.

Terms: c.w.o. or c.o.d.

**BULLERS**  
Printing Office St., Doncaster.  
Est. 1916 Phone: 2346



**PRACTICAL MECHANICS** (full Apprenticeship or Pupillage) may secure status of Professional Membership by using this COUPON.—To the Secretary, INSTITUTE OF EXECUTIVE ENGINEERS AND OFFICERS, EXECUTIVE CHAMBERS, 241, BRISTOL ROAD, BIRMINGHAM, 5. I AM INTERESTED IN MEMBERSHIP: PLEASE SEND ME AT ONCE PARTICULARS AND APPLICATION FORM:

NAME IN FULL (Block Letters).....  
ADDRESS (Home) (Block letters).....  
Present position..... Industry..... Age.....  
Date.....1951. Signature.....

**ELECTRADIX RADIOS**  
214, Queenstown Road, Battersea, London, S.W.8.  
Telephone: MACaulay 2159

## DUKE & CO. BARGAIN MONTH

**No. 25 (1196) SETS.**—New 6 valve S/het. 9/6. These convert easily to A.C. Universal or Battery All-wave receivers. 465 I.F. 4 tuning condensers, 24 condensers, 32 resistances (popular types), transformers, switches, V-controls and all usual parts, less valves. **NOTE.**—We supply **FREE** all drawings and circuits to convert this buy. to a very sensitive, high-quality receiver. **DO NOT MISS THESE** as the quantity is limited. Post, 1/6 extra.

**H.T. BATTERIES.**—Still our best seller. 150 volt guaranteed minimum, tapped 21-90-111, 11 L.T. All-dry. All are tested before despatch. 5/6. Allow 1/6 post.

**ELECTRIC MOTORS.** 1/3rd h.p. S-phase A.C. 110 volt, easily converted to 230 v. Complete with forge type blower 3 1/2 in. dia. outlet. Motor is 2,850-3,450 r.p.m., 1/2 in. spindle. To clear, 50-plus carr.

**GERMAN INVASION CRAFT.**—20 to 30 ft. by 6 to 8 ft., inflatable, room required. Sizes as they come. 50/- carr. extra.

**TINY TUBS.**—Four-stroke design, press button, has an output of 300 watts at 12 volts. New. £17/10/- plus carr.

**CAR HEADLAMPS.**—Ex-L.P.T.B. Std., single bolt fittings. 7/6.

**LAMPS.**—Ex-L.P.T.B. Std., B.C. fittings, 24 v. 12 watt and 12 v. 12 watt. Ideal for boats, caravans, etc., 9/- doz.

**MACHINE MOTORS.**—200-250v. A.C. repulsion wound. Approx. 1/20 h.p., made by Klaxon. Ball bearings. 35/- plus 1/6 post.

**SEATS.**—Ex-coach approx. 3ft. long, Moquette, leatherette, and hide covered, plywood base, 15/- . A few seat backs to match, 15/- both plus carr.

**DUMPY BUCKET SEATS.**—Single, ex-coach. Ideal for fireside, television viewing, small cars or vans, etc., 17/6 plus 4/- carr.

Money back guarantee if not satisfied. Cash With Order. Please, and allow sufficient for postage or carriage. Stamps ONLY for lists. **REMEMBER.** If interested in FISHING, ask for our separate ANGLING CATALOGUE.

219, ILFORD LANE, ILFORD, ESSEX. ILFord 0295

## PRECISION TOOLS FOR PRACTICAL MECHANICS SPECIAL OFFER!



### JAGROSE 3" LATHE

Surfacing, Screw-cutting, Set-over Tailstock, Hollow Mandrel, Complete with set of Screw-cutting Gears.

£24-10-0

E.P. Terms £5-12-6 deposit, 7 monthly payments of £3/7.

### 3 1/2" MODEL £49-10-0 or E.P.

Jagrose Bench Drill	60/-	Jagrose Bench Grinder	10/9
Columbus Type Gauges	15/9	Jagrose Hand Vices	2/11

Send for particulars P.M.I.

**JAMES GROSE LTD.,**  
379-381, EUSTON ROAD, LONDON N.W.1. EUS 5231

## CHEMISTRY APPARATUS Send Stamp for COMPLETE PRICE LIST



Booklets:  
"Experiments" 7d.  
"Formulas" 10d  
"Home Chemistry" 2/3  
Post Paid.

**BECK** (Scientific Dept. A)  
60 HIGH STREET,  
Stoke Newington, London, N.16

# Leytool RATCHET SPANNERS

**HUGE** demand enables us to offer "Leytool" Ratchet Spanners at prices little above those paid for ordinary good quality spanners. They save time and money because they work faster, operate more easily, and get into those inaccessible places where ordinary spanners will not go.

They are a sound British Engineering job, made of carbon chrome steel, hardened all over and regraded. Available in 8 standard sizes to fit 150 nut sizes in B.A., Whitworth, B.S.F., S.A.E., Metric and square. Special sizes made to order.

Also available, Mechanic's Set of 5 "Leytool" Ratchet Spanners in Canvas Wallet, 49/6.



## 'Look to Leytools' FOR THE MOST UP-TO-DATE



Precision Hand Drill

Ratchet Spanners (Mechanic's Set)

Universally Jointed Socket Spanners

4-bladed Pocket Screwdriver

## AND EFFICIENT DESIGN

All Leytools are entirely original and patented designs. Write for **FREE** Illustrated Booklet.

LEYTONSTONE JIG & TOOL CO., LTD., High Road, Leyton, London, E.10  
Telephone: LEYtonstone 5022-3-4.

## For ECONOMICAL CYCLE LIGHTING

# Get a DYNAMO SET



The latest range of Lucas Dynamo Sets are all powered by the CD33 dynamo, which weighs only 12 1/2 ozs. complete with bracket. Maximum output at 8-9 m.p.h. producing 3.3 watts at 6 volts, with ample light at walking pace. All headlamps have fluted reflectors which give a wide, powerful, long-range riding beam. Twin wiring throughout eliminates earthing troubles. Ask your local cycle dealer to show you a Lucas set.

## Be sure it's

# LUCAS "KING OF THE ROAD"

Complete Sets from 27/6.  
No. 853 as illustrated 40/-

JOSEPH LUCAS (CYCLE ACCESSORIES) LTD • CHESTER STREET • BIRMINGHAM 4

## WILCO ELECTRONICS

204, Lower Addiscombe Rd., Croydon

**AIRCRAFT CLOCKS** with splendid 8-dia. jewelled movement, range type, made by stringent Govt. specification. Brand new guaranteed. Ideal for car, study, bedroom etc., will withstand vibration and shocks. Special offer, 65/- each, post free.

**PORTABLE TEST METER.**—Just the job for the home constructor, in neat case 6 1/2 in. x 5 1/2 in. x 4 1/2 in., reading 1.5, 3, 150 volts, and 50 ma, 5 k, and 25 k, ohms. D.C. 50 post free.

**CLOCKWORK MECHANISM.**—Precision made movement with contacts making an breaking twice per second, can be used for switching on and off lamps, etc. Brand new in sound-proof cabinet with thermostat temperature control. Ideas for flashing signs. Price 15/- postage 1/6.

**SHOWCASES.**—Hardwood with plate glass opening front, 3ft. 3in. x 2ft. 3in. x 5ft. 10 in. Ideal for shops, factories, etc., 45/- carriage 10/-.

**GEARED CAPACITOR MOTOR.** 200/240 v. A.C. 30 watt, size 7in. x 4in., 1,500 r.p.m. with 300 r.p.m. on final shaft, standard foot mounting, brand new, reversible, with capacitor, 84/- post 1/6.

**KLAXON GEARBOX MOTORS.** No. IK58B-717. Torque 1lb. 10 in. 15, R.p.m. 175. Motor r.p.m. 1,400 at 230 v. A.C. Split phase induction type, £10 each.

**KLAXON CAPACITOR INDUCTION MOTORS** with 4in. fan, 1/40 h.p. 220/240 v. A.C., 2,700 r.p.m. No. EM5CB2 with condenser, 55/- each.

**24 VOLT D.C. MOTORS** with double ender shaft, 2in. x 3in., 10/6, postage 1/-.

**THERMOSTAT SWITCH.**—Bimetal type in sealed glass tube, 2 1/2 in. x 1 1/2 in. 30 deg. Cent. Ideal for Aquariums, Wax and Oil Baths, Glue Pots, Soil Heating, Fire Alarm etc. will control 1 amp at 240 volts, 5/- each

**VOLTMETERS.**—0-300 A.C. Moving Iron, 2 1/2 in. Flush, 17/6; 3 1/2 in. Flush or Surface 22/6.

**MANTS, TELESCOPIC.** extending to 12ft. in 7 sections, 15/6, post 1/-.

**THERMOSTAT.** Satchwell 12in. sent 0/250 volts A.C. D.C., 10 to 90 deg. Cent. 35/-

**SPEAKERS.**—P.M. 8in. Goodman, in wall case, with transformer, 21/- Post & pkg. 2/6

**CYCLE LAMP BATTERIES TYPE 800**—E. R. Make. Sealed Carton of 20 for 10/- Post Free.

**RECEIVER R.1155.**—One of the best communication receivers covering 7.7 Mc/s to 75 Mc/s in 5 wavebands, complete with 10 valves, Brand new in maker's transit case. £12/10/0, carriage 8/6.

## WALTON'S of WOLVERHAMPTON

The leading Midland Ex-Government Surplus Stores.

Send to-day for a copy of our latest surplus and clearance list. You will be amazed at the value we offer. Send stamp (1d.) only or large S.A.E.

The following popular lines are still available. **Ni-Fe Accumulators**, voltage 2.5 (2 cells), Cap. 15 Amp. P.H. Act. Size 2 1/2 in. x 2 1/2 in. deep. List price over 50/- . Our Special price 12/6 each, 3 for 30/- , 12 for £5. All are new and have never been filled with Electrolyte, but are soiled (slightly) externally, due to storage. Boxes of Nuts and Bolts, mainly B.A. approx. 1,000 items, 3/6, mainly 6d. postage. **931A Photo Electric Cells**, 20/-, or complete unit, 27/6, post 1/- . **455KC Crystal Unit** in case, 10/-, post 3d. **Burns Counter**, made by Veeder, 0-999 in steps of 1/10, 5/- each, post 6d. As above but reading 0-99, 3/6 each, post 6d.; and hundreds of other items.

## Walton's Wireless Stores

203, Staveley Rd., Wolverhampton

## "THEY LAUGHED AT FIRST"



but when I began to play —  
—*It all upon the room.*  
*I played the first few bars*  
*of Beethoven's immortal*  
*'Moonlight Sonata.'* My  
friends sat spellbound.  
*Who was your teacher?*

I receive similar letters daily from students of MY **POSTAL LESSONS** for the **PIANO**, who started without knowing a note. My class is seldom less than 2,000 pupils, and have taught over 85,250, and I CAN TEACH YOU, from ordinary musical notation, no freakish methods, enabling you to read and play at sight any standard musical composition. **FREE** book and advice. Say Moderate. Elementary or Beginner.

Mr. H. Becker (Dept. 458), 69, Fleet St., E.C.4



VOL. XIX

MARCH, 1951

No. 346

All letters should be addressed to the Editor, "THE CYCLIST," George Newnes, Ltd., Tower House, Southampton Street, Strand, London, W.C.2.

Phone: Temple Bar 4363

Telegrams: Newnes, Rand, London

## Comments of the Month

By F. J. C.

### Festival of Cycling

**T**HE Festival of Cycling is to be held at the Dunlop Sports Ground in Birmingham on June 23rd. This news was announced at a luncheon early in the year given to members of the technical press, members of the industry, and cycling institutions. The chairman was Mr. F. J. Urry, who, in his introductory remarks, stated that it was the first occasion on which rival bodies had sat down at one table in amity and in perfect agreement on the subject of cycling. We, too, were pleasantly surprised to find that a platform had been found on which all conflicting interests could find agreement.

For whatever the opposing points may be the part cannot be greater than the whole. It is the sport and pastime of cycling which counts. It is fitting that in Festival Year this great industry should stage a Festival of Cycling, not only to symbolise the magnitude of the pastime and the industry which supplies it but also to impress our foreign visitors. The idea is excellent and we invite everyone to support it. Indeed, the promoters ask for the support of every cyclist, every club, and anyone else who can help to make it the most gigantic spectacle in the whole history of British cycling. It is 100 years since the Great Exhibition of 1851. Cycling at that time, except on bone-shakers, was practically unknown.

MacMillan's first rear-driver was but 12 years old, and it was many years before cycling developed. Not indeed until the production of Harry J. Lawson's Safety bicycle, which sounded the death knell of the Ordinary. There were no bicycles at the 1851 Exhibition, but there will be plenty of evidence at the Festival of Britain of the virility of the cycle industry, which was born in England, gave birth to the motor-cycle, the motor-car, and the aeroplane, produced the pneumatic tyre, and has supplied the rest of the world ever since with its best bicycles.

This giant cycling rally will include a pageant of cycling history, dozens of demonstrations, an exhibition of cycling during the past 100 years, a large number of displays and side shows and gymkhana events.

The sponsors of the Festival of Cycling are two large film organisations, the C.T.C., the N.C.U. and the National Clarion Cycling Club, augmented by the practical support of the British Cycle and Motor Cycle Manufacturers and Traders Union who will act for the industry.

The whole event will be a gargantuan demonstration in honour of the bicycle and its enthusiasts.

The sponsors claim that it will be put on with all the glamour and glitter of the film world. No doubt the R.T.T.C. at the appropriate time will be asked to co-operate.

In addition to dozens of cycling events with big prizes there will be pageants showing Britain's country craft and costumes, dancing to British music, and much of the colour and festivity of the British countryside, which is such a large part of the attractiveness of cycling, will be introduced.

We hope that there will be a symposium of early cycling songs up to and including the famous "Daisy Bell."

The two film companies are planning special entertainments for the visitors to the event who arrive overnight in Birmingham. These plans include special late shows with cyclists' admission tickets. Manufacturers will provide breakfasts and give the Festival the backing of their great resources.

On the Saturday, festivities will be concluded with a firework display, whilst on the Sunday it is hoped to hold the biggest Church Service for cyclists ever organised.

We think there should be a representation of some of the older clubs who have celebrated their jubilee and whose roots were planted at the same time as the industry was born.

We think the Science Museum should be invited to put on an exhibit of early bicycles, including the replica of MacMillan's first rear-driven bicycle; a special demonstration of feminine cycling attire from the bloomer and zouave days to the present one of shorts would also be of interest.

We invite our readers to submit suggestions for making the Festival a complete representation of cycling, past and present. These we shall pass on to the sponsors.

The Festival Organiser is Mr. E. T. Bannister, who has already made considerable progress with preliminary plans.

It is pleasing to be able to record that all the cycling organisations are co-operating whole-heartedly to make it the success which it deserves to be.

### Traffic Census 1950

**T**HE results of the pilot census arranged by the Ministry of Transport, which took place from Monday, August 14th to Sunday, August 20th, to find out what

variations had occurred in the traffic flow in urban, industrial and rural areas since 1938 when the last census was taken, has provided some surprising results.

The census covered 266 points, 73 on trunk roads, 117 on class I roads and 75 on class II roads. Every vehicle passing a census point between 6 a.m. and 10 p.m. on each of the seven days was counted, and motor-cycles, motor-cars, omnibuses, goods vehicles, horse-drawn vehicles and pedal cycles were separately enumerated.

The overall increase in the average daily volume of traffic based on all the census points was 7 per cent. On the trunk and class I roads it was 6 per cent. and on class II roads 12 per cent.

The average daily numbers recorded on trunk and class I roads showed an increase in England and Wales of 6.3 per cent., in Scotland of 1.4 per cent. and in Wales and Monmouthshire of 11.2 per cent.

Comparing 1938 and 1950, on trunk and class I roads, horse-drawn traffic decreased by 71 per cent., pedal cycles by 35 per cent., all passenger vehicles (motor-cycles, motor-cars, taxis, omnibuses and coaches) by 6 per cent., motor-cars and taxis by 11 per cent. But motor-cycles increased by 16 per cent., omnibuses and coaches by 34 per cent., and goods vehicles by 59 per cent.; and there was an overall increase in all mechanically-propelled vehicles of 6 per cent.

The last pre-war census for class II roads was taken in 1936, and after making reasonable adjustments to bring the figures to estimated 1938 values, a comparison with the 1950 census indicates that horse-drawn traffic decreased by 80 per cent., and pedal cycles by 30 per cent., whereas all mechanically-propelled vehicles increased by 12 per cent., omnibuses and coaches by 42 per cent. and goods vehicles by 44 per cent.

Although traffic as a whole was slightly more than in 1938 the variation from point to point was very much greater. Of the 190 points on trunk and class I roads, of which 172 were in England and Wales and 18 in Scotland, 133 showed increases in the volume of traffic, while the remainder showed decreases. Increases were recorded at 122 points in England and Wales (involving a total increase in traffic of 15 per cent.) and at 11 points in Scotland.

In the predominantly agricultural eastern counties of England 20 of the 23 points and in the industrial north 23 of the 38 points showed increases.

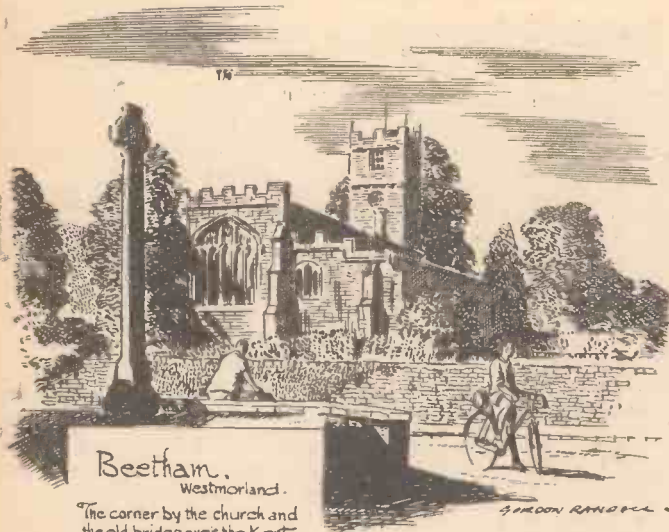

Beetham,  
Westmorland.

The corner by the church and the old-bridge over the Keist. The church dating from the 12<sup>th</sup> Century contains many lovely examples of the work of past crafts men. The little village stands by the side of the main Lancaster-Kendal road close to the Lancashire border.

### St. Neots Cyclists Entertain

OVER 100 members of the Club and of clubs from a wide area were present at the annual dinner of the St. Neots and District Cycling Club held at the Connaught Rooms, St. Neots, at which ace rider, Bob Haythorne, secretary of Luton Wheelers, was guest of honour. The Club's president, Mr. E. J. Bass, presided over the gathering. Mr. Haythorne proposed the toast of "The Club" and the St. Neots Wheelers' secretary, Mr. Ken Fleet, replied. Prizes and trophies won during the past season were awarded.

### South Yorks Speedway League

AT a meeting at Doncaster, twelve South Yorkshire cycle speedway clubs decided to form a South Yorkshire Cycle Speedway League, which will be affiliated to the National Amateur Cycle Speedway Association. Plans are being made for the season to open at Easter, when exhibition races will be run by riders from the London Lea Valley League. Mr. Paul Gow, who has done a good deal of work in connection with the formation of the League, feels that within a very short time there will be four leagues operating in South Yorkshire.

### Silver Jubilee Planned

DONCASTER WHEELERS will be celebrating the 25th anniversary of the formation of the Club in March, and plans are being made for a special celebration dinner to mark the occasion.

### More Speedways

WOLVERTON (Bucks) Urban District Council have been considering requests from cycle speedway enthusiasts in the district for permission to have a track. During the discussion, one councillor said some of the boys had told him that "a few holes and bumps make the ground interesting," but another bunch of riders wanted a cinder track. The suggestion of having a cinder track in Wolverton recreation ground was turned down because of the risk of cinders getting into the grass-cutting machine. The Council have agreed to permit a track in the far corner of the recreation ground, in addition to the existing track at New Bradwell, not far away.

### Prescription—One Bicycle

TO bring back to full use a knee damaged in racing, Freddie Williams, champion motor-cycle speedway racer, took the advice of his doctor and started riding a cycle round the Wembley Stadium track. The doctor advised that regular exercise on the cycle would play a great part in bringing the knee back to normal.

### Study Tour

TO study local customs and to come to know people" is the reason given by two young New Zealanders, Trevor Johanson and

heavy floods of March, 1947, the old bridge fell into the Trent and a Bailey bridge for single-line traffic was erected by the Royal Engineers as a temporary measure. There is a good deal of traffic on the road, much of it heavy vehicles, and it is considered that the replacement of the bridge would be of national importance. However, the Ministry say that capital expenditure must be restricted so—no bridge!

### Time for Alterations

DURING the course of an inquest at Lincoln on a man killed in a road accident near Scampton R.A.F. station, the Lincoln South District Coroner said: "If we will continue to use these roads constructed by the Romans, with very little done to them, these accidents will occur." At the spot where the accident happened there is a dip in the road, and although Roman chariots may have had time to avoid each other at this dip, it is far from safe for modern traffic. The Roman Minister of Transport may have known his job in those far-off days, but he could hardly be expected to anticipate motor traffic.

### Just a Local Custom?

THE sight, in the Fen country of East Anglia, of cyclists riding along with one hand on the handlebars and the other acting as towing-bar for a pram, complete with baby, leads one to wonder whether this is just a Fenland custom. Admittedly Fen roads, running for miles straight across country, seem endless for the pusher of a pram, particularly when the baby is fretful, and any speedier mode of transport is attractive, but with other traffic on the road it can hardly be called a safe method of travel.

### Paid With His Life

AT the Leicester inquest on a cyclist who received fatal injuries in a road accident, evidence was given to the effect that the brakes on the cycle were absolutely useless. It was stated that the rear brake cable was broken and tied with string to the handlebars while the front brake blocks were worn out and would not grip. The cyclist's widow told the coroner that the machine was her daughter's and had not been used for some time, but her husband took it as his own was being repaired.

### Long Ride for a Book

MR. PADDY IRWIN, a 37-year-old Irishman, claims to have covered over 11,000 miles on his cycle since he started off from Southern Rhodesia in March, 1949. He set off with the object in mind of gathering material to write a travel book about Africa and on the way he visited Tanganyika, the Belgian Congo, Kenya, Uganda and French Equatorial Africa, and many other parts of the continent. Back in England he called at the factory where his bicycle was made in Birmingham and then he went back to Ireland to begin the task of sorting out the mass of notes he has accumulated.

### Slowing Them Down

IT is suggested by a reader that the number of accidents caused by speeding motorists might be reduced if roads were made undulating at danger spots, such as cross-roads and blind turnings. The undulations would so jolt the motorist and his passengers that it would be impossible to drive above a slow and safe speed. It would certainly stop motorists from streaking into the main line of traffic from some unsuspected side road, but although many of our roads do have undulations in them now the Minister of Transport would probably take rather a poor view of deliberate undulations in the road surface.

# Peragrams.

Douglas Stewart, who are on a 31,000 miles cycle ride covering France, Belgium, Holland, Germany, Switzerland, Spain and Italy.

### Cycle Parking Places Suggested

WELLINGBOROUGH Chamber of Trade has asked the Urban District Council to consider providing slotted slabs in the pavements in various parts of the town in order to assist in the parking of cycles.

### Free Drink Goes!

THE ancient pump standing in front of the Coach and Horses Inn at Kibworth, Leics, which was used by coach travellers over a century ago and was said by them to give the best and most refreshing drinking water between London and Leicester, has been removed. It is to be installed in the old Leicester street scene in the Newark Houses Museum, Leicester. Here it will be able to rest in peace, for since road traffic became heavy it has several times been hit by passing cars and lorries, and it should have every chance of reaching its 200th birthday.

### Holbeach Wheelers' Loss

HOLBEACH Wheelers are the poorer by losing the services of their popular and hard-working secretary, Mr. Ken Pack, who has been forced to leave the club as he is taking up another post. Keenly interested in the sport, Mr. Pack did a great deal of racing until ill-health forced him to give up and he then took over the duties of general and racing secretary of the club, and gave other members the benefit of his expert advice. His was that enthusiasm that kept the club going in its early days until it found its feet.

### Ministry Says No

THE Ministry of Transport has "indefinitely delayed" a scheme, estimated to cost £100,000, for the rebuilding of the Cavendish bridge at Shardlow on the trunk road between Leicester and Derby, in spite of strong pressure from Leicestershire and Derbyshire County Councils. During the

# Around the Wheelworld

By ICARUS

## N.C.U. and C.T.C. Membership

A RECENT announcement from the N.C.U. and the C.T.C. shows that during 1950 each increased its membership. The N.C.U. give their membership as 66,528, which is the highest ever, and the C.T.C. 53,574, which is the highest figure it has reached since the year 1900. The previous year's figures were 62,219 N.C.U. and 51,146 C.T.C.

When the war ended the membership of the N.C.U. was only 24,415, whilst the C.T.C. was 23,703. The N.C.U. are planning an all-out drive to top the 70,000 mark before the end of the year.

The club affiliation figure for the N.C.U. is 43,000 members, and private members jumped from 8,240 to 9,642.

## The Festival

IT was pleasant to see the lions and the lambs seated in harmony with the critics at Kettner's Restaurant when colleague Frank Urry, acting as neutral chairman (who has the greater right! is he not the doyen of cyclists?), disclosed the plans for the Festival of Cycling to be held in June at Birmingham. It shows that when there is a common call personal differences can be sunk, and it seems a pity that in other matters of a more trifling character the same spirit cannot prevail.

## C. T. C. James

YOU will remember that I referred to this author who wrote a number of touring novels and one or two cycling novels in the late nineties. His initials do not mean that he was a member of the Cyclists' Touring Club, however. He was Lt.-Col. C. T. C. James, and he wrote a fair number of novels, including "Two on a Tandem," "Where Thames is Wide," "At the Sign of the Ostrich" (dealing with the Ostrich Inn at Coinbrook), and "On Turnham Green" (dealing with the Pack Horse next door to Chiswick Empire).

I have managed to acquire the two latter. If any reader has copies of the others for disposal I shall be glad to buy them.

Incidentally, when is someone going to write a modern cycling novel? Why must it always be motor cars and aeroplanes when the villain or the hero wishes to escape?

C. T. C. James was related to Walter Hancock, the man who pioneered vulcanised rubber and made the pneumatic tyre industry possible.

## C.T.C. Norris

THE initials in this case *do* mean that Mr. Norris is a member of the C.T.C., and he writes to tell me how much he and fellow section members enjoy "Comments of the Month." They were read aloud to the rest of the section by one of the senior members, and they want more. They shall have them! This shows how much notice is taken by club members of our forceful comments and criticisms.

## C. W. Schafer

C. W. SCHAFFER, who died in Liverpool on Christmas Day, was a great rider in the 'nineties. According to a periodical of the period he was the best medium distance amateur rider in Lancashire and the North. He was a member of the Man-

chester Wheelers, although his first club was the Jupiter C.C., of London. In 1886-87 he won the championships of that club. He helped to found the Bath Road Club, in 1888 became a member of the Polytechnic C.C., whilst in 1886 he rode in two 24-hour races on a Kangaroo, and covered 185 miles on one of them. Later he won the championship of the Kildare C.C. He was one of the four riders who beat Selby's London to Brighton and back coach record. This ride was done in stages, each rider taking a turn, and was the forerunner of the now "classic" record.

In 1889 he beat the world's one-mile competition record on a solid-tyred safety, doing 2 min. 37 secs. At that time he was known as a good man at 50 miles, for, besides making best time in the Polytechnic Club's road races at that distance for two successive years, he beat Holbein's 50 miles world's record in 1890, doing 2 hrs. 38 mins. 3 secs.



One way of foiling the cycle thief (see paragraph).

on the North Road, usual course. In 1893 he went to Manchester to reside, and, going for the 50 miles Northern Road record, did 2 hrs. 23 mins. 42 secs. He also beat the local path records for 1 hr. and 50 miles. In 1894 he beat the world's road record for 50 miles, out and home course, his time being 2 hrs. 25 mins. 13 secs., and a fortnight later, along with Arthur Gastall, beat the tandem record for the same distance. The same year he again beat the hour and 50 miles track records for the North of England. In 1895 he made two or three attempts at the 50 miles road record, but failed owing to accidents. He then devoted his sole attention to the path and was successful in winning the three principal Manchester path championships, viz., 50 miles N.C.U. Centre; 100 miles championship of the Manchester Wheelers; and the 25 miles championship of the Manchester A.C., besides beating the hour and 50 miles path records once more and establishing a 100

miles path record for the North of England. That season he finished by getting the 50 miles Scottish path record at Powderhall Grounds, Edinburgh.

In 1896 he won the one and 100 miles championships of the Manchester Wheelers on the same day, besides beating the 50 miles cinder track record by doing a 2 hrs. 2 mins. 12 secs. He was beaten in the 50 miles centre championship by what many considered a fluke, but this defeat he wiped out in 1897 by winning the event at Bolton, when he again lowered the Northern record to 1 hr. 56 mins. 25 secs.

In 1897 he beat the Northern record one hour three times, his top distance being 26 miles 640 yards, at Bolton. He marketed the Schafer range of pedal cycles, and most of his racing was done on machines of his own make.

## Stolen Bicycles

THERE was excitement in the office the other day when a detective-inspector from Scotland Yard was shown into my office. However, he had not come to arrest me (yet!) for non-payment of income tax, but to appeal once again for the co-operation of every cyclist in foiling cycle thieves. Thousands of bicycles are still stolen every year, and although the police recover a fair number of them the owners are unable to recognise their own machines when asked to identify them by the police. They cannot remember frame numbers nor any individual marks.

The photograph shows one method which resulted in 130 cycle thieves being caught in Ireland. When the machine is left unattended a small white disc is locked to the front spindle extension. This indicates to the police that the machine is in unauthorised use, and naturally they stop the rider. The weakness of such a scheme is that a thief would take great care to remove such a disc if the district were deserted. In a busy district, however, anyone seen cutting the disc off (it is made of metal) would be suspect, and in any case the very essence of cycle stealing is quickness.

A padlock and chain is a good deterrent. But in any case adopt some method of preventing the machine from being ridden away without your consent. Keep a record of the frame number and details of any distinguishing marks. Perhaps manufacturers of bicycles could give away a small metal disc giving the model number, frame number and date of purchase which the cyclist could keep by him.

I was informed that in spite of all the precautions which have been taken, cycle thefts are on the increase. Bicycles are going to be very short this year owing to the rearmament programme, and it therefore behoves everyone to take at least elementary precautions against loss by theft.

My own machine is fitted with a pair of Resilion thief-proof brake levers. A Yale lock is incorporated in the pivot of the brake levers and when the bicycle is left the brakes are locked in the hard-on position. Thus it cannot be ridden away.

## Mynott's Record

THE ride of R. F. Mynott, North Road C.C., in the North Road "24" on August 27th last year, has now been passed as a national competition record; the official distance being 459.50 miles.



Cockermouth  
Cumberland.

The great Gatehouse of the historic Castle standing on a hill above the swift flowing Derwent. The house where William Wordsworth was born in 1770 can be seen in the High St. with its garden running down to the river. . . .

GORDON RANDALL

## Wayside Thoughts

By F. J. URRY

### The Flick for Improvements

PERHAPS the sign of growing older is exemplified by the more frequent use of a low gear, particularly when the winds rave against me and the rainstorms spill into my lap. Several of my bicycles are fitted with four-change hub gears, and I find that when I want the low ratio quickly—and there is nearly always the urgency—it is difficult to engage because the bar trigger is stiff to push home for engagement in the bottom gear. Maybe my fingers are not so supple as they once were, but that is not remarkable. The point I want to make is that when you need a low gear you generally need it quickly, and there are times when I have had to struggle with the lever to make it click home in the bottom notch. Other users have mentioned this little handicap, and several have told me the wise way is to engage the bottom gear before you really need it, when the going is comparatively easy. But I should hate to do that, for I like to use my variables to match the wind, the weather and the hills. It seems to me these four-change hubs would be infinitely improved in their change mechanism if the order of their engagement were reversed, when the low ratio would merely need a flick of the finger to obtain the desired change. After all, the high gear is only needed when the going is easy and pedal pressure light, but the drop from it to lesser gears should need the simplest possible manipulation. Such used to be the case when the three-gear S.A. hub first came on the market and when the old two-gear Manchester hub was invented. There may, of course, be mechanical reasons why this suggested reversal of the change lever cannot be incorporated, but I don't know of them, and certainly one of the hub gears has this easy type of change, I am told.

### Your Tyres

WE shall have to take more care of our tyres, for the cost of them is beginning to remind me of the latter part of the last century. I don't know what the fellows running the little motor attachments think of this matter, but from what I know and hear, tyre troubles are fairly brisk with them and

tyre costs a handicap on the pocket. My tyres, on the average, carry me safely for six to seven thousand miles, and then they begin to be too much of a nuisance and it becomes merely wisdom to change them. All of them are of the light-weight variety, and rolling over town and country roads, and my puncture troubles average about three a year, a wonderful testimony to modern tyre building. But I keep them blown hard, and do not bump them up low pavements or over very rough ways. Now we shall have to take greater care in treatment of them, for when cover replacements of the best tyre are

habit, for then he will find, as I have, that cycling is much more valuable as an exercise, an observation of ever-changing delight, an introduction to country life with the leisure to make it friendly, and perhaps, above all, a silent independence of spirit, free from the racket and rush of modern things. It debars you from nothing else you want to do and can comfortably undertake, but it gives you a delightful escape from the noise and bustle, and all the fresh air you can imbibe. If you want to keep alive and lively, then never give up cycling just because the individual speed drops; the miles come to you in due time, and they are very lovely and comfortable, even in the roughest weather.

### A Real Danger

THE suddenly-opened offside doors of cars in the charge of thoughtless drivers are a danger. I was nearly "bagged" a few evenings ago on my way home and only just had time to kick the door and make its right angle an incline of about 30° past which I wobbled. I could not swerve because of the following and approaching traffic, and what would have happened had the door been flung open a fraction of a second later is not pleasant to contemplate. On my journeys I keep a wary eye on the car that passes me and then pulls up, and it is astonishing how many times the driver's door is opened without his apparently glancing to see if all is clear. Some day cars will be made to fit sliding doors, but I suppose there has not been enough people killed and injured by the carelessly-opened offside door yet, for the question of compulsory design to be embodied in the law of "safety-first." Such doors can be made fool-proof and rattle-proof—I've seen them—but a few more victims must be immolated on the altar of fashion and alleged economy before the simple change is made compulsory.

### Go Safely—But Go

SOME of my old friends have told me that I ought to know better than ride a bicycle through the winter. On the contrary, I know better than not to! Here I am ready for the spring, and readier than ever to welcome the sunshine and the warm, wet, western winds. A winter of idleness would have left me the need to get fit; now I am fit and ready to take all the roaming the leisure hours will provide. Why folk think I ought not to ride in winter surpasses my comprehension. In these days I go circumspectly; if the fellow behind is in a hurry and denotes the fact, well, let him have the road; he will learn better manners some day. I do not try to swing out and pass the bus picking up passengers unless I know the road is clear both ways; or use my bicycle when the ice is on the surface and adhesion precarious. I suppose you have to grow old to accept these very slight limitations to cycle travel with complacency, knowing as you do so that it detracts nothing from the journey, but makes for a safe passage, even though you may be occasionally irritated by the other fellow's conduct. A perfect example came to my notice just before the turn of the year, when icy roads put one of my friends into hospital, and three others limped round with varying strains. The icy road is the worst danger of all, but it seems to take a long while for some people to realise it. Beyond these cares there is little enough to worry about in the winter, and it is a certain fact that my mode of travel is quicker than bus or train and infinitely more convenient, to say nothing of the health aspect.

going to cost upwards of 15s. or more, a little time spent in the help of a patch on a weak spot and the removal of grit from the treads is worth while. Cyclists, like other people, are going to suffer from shortages of quite common things. I hear all sorts of rumours that steel for the making and equipment of bicycles is going to be a problem this year, and it seems only fair to pass on the knowledge to all the crowd who desire to be sure of the machine and its attachments. Mudguards will be scarce, it is said, and chains might be, to say nothing of hubs and spokes, and all those repair essentials most of us want occasionally. So get your equipment as early as you can and if you are a regular rider to work it might be just as well to have a spare chain in stock—in case.

### Older Wisdom

AS you will probably have gathered from the foregoing paragraph I have done quite a lot of breeze-battling during the last weeks, and, taking it all in all, have found the journeying easier than I expected. This is due entirely to the full use of gears plus that necessary mental attitude of patience, not to be in too much of a hurry to get along at the normal speed of summer-time travel. That condition has come to me slowly down the years; indeed, to be candid, it has been quietly forced on me by the years, and I have found it pleasant because had it not occurred like that, had I still been dominated by the old spirit of "making the grade" at something like the old pace, it is possible I may not have been cycling, and that is a most unkind thought. Yet I have known many men over the three-score mark who have given up the pastime because they thought the pastime had given them up; in other words, they have been disappointed with their performance a wheel and hurt themselves in the process of trying to approach the speeds of yesteryear. There is a certain attitude of pride in this matter that needs breaking down if a man is to enjoy his cycling, say, after the three score and ten; but I can promise this to the fellow who will cheerfully exchange this pride for sheer comfort, that he will enjoy his trips far more as a result of the exchange, particularly when the kindlier speed has developed into a



**IMPORTANT NOTICE to**  
 Owners of **MOTORISED BICYCLES!**  
 You've got the **EXTRA MOTIVE POWER**  
 NOW you need the **EXTRA BRAKING POWER**

of  
**"Cantilevers"** (REGD.)

**MOST POWERFUL and SMOOTH ACTING**  
**CYCLE BRAKES in the WORLD**

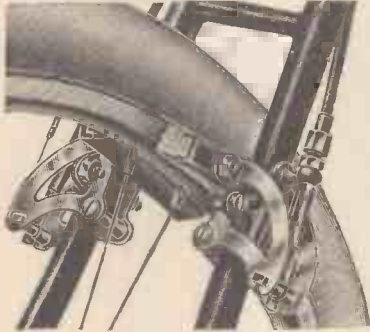

CANTILEVERS have been given special tests on bicycles fitted with many of the leading Motor Units, and as a result they are being strongly recommended for their complete **EFFICIENCY and RELIABILITY.** Your life depends upon your brakes, and the addition of a motor unit to your bicycle makes it vital that you are equipped with the best brakes obtainable. CANTILEVERS will give you complete **CONFIDENCE in ANY EMERGENCY.** Fixed rigidly on the forks or stays, they are always positive in action, smooth and powerful, grip well in the wet, and give long service. Special models available for use on Westwood rims. Fitted with our Locking Lever, they make the ideal **SAFEGUARD** against petty thieving. Twelve month guarantee with all new brakes.

**SAFETY FIRST! Second Thoughts are Too Late!**  
 THE RESILION CO. LTD., 200, LIVERPOOL ROAD, LONDON. N.I.

**YOU CAN**  
**ALWAYS**  
**RELY ON**



**LIGHTING EQUIPMENT FOR**  
**CYCLES & MOTOR CYCLES**

Cyclists and riders who are also practical mechanics have a doubly good reason for choosing **MILLER** —they know by practical experience that the way it's made makes it the *best of Lighting Equipment.*

MILLER & CO., LTD., ASTON BROOK STREET, BIRMINGHAM, 6.

**Keep**  
**your eye**  
**on**  
**Halfords**

See and handle the goods before you buy them. Our Managers will be pleased to discuss your requirements.



**HEAD OFFICE:**  
**239 CORPORATION ST.,**  
**BIRMINGHAM 4**



# DUNLOP Cycle Saddles

- Smooth Riding
- Floating Comfort
- Completely Waterproof

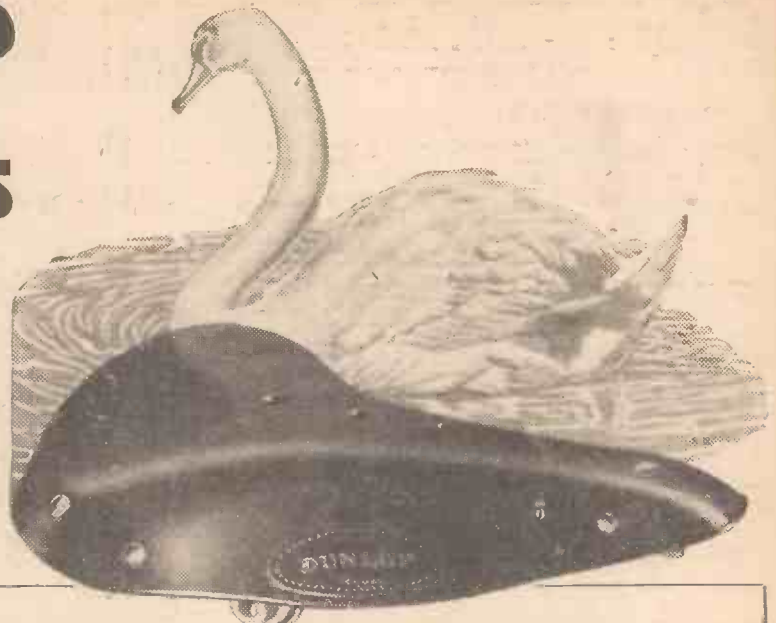

THERE IS A DUNLOP SADDLE FOR YOUR KIND OF CYCLING

**1** Flexible Moulded Seat

A Dunlop Saddle gives a feeling of cushioned ease right from the start. This instant comfort is the result of a unique flexibility which does away with the usual 'breaking-in' period. The seat is moulded to shape on a specially woven cotton foundation which always keeps its shape, yet has just the right amount of 'give' for easy riding.

**2** Sprung Suspension

The Dunlop Saddle, scientifically designed to absorb every bump and shock of riding, provides floating comfort. The seat is suspended on stout, perfectly tempered springs, so arranged that the rider's weight is completely 'spring-supported.'

**3** Waterproof, Frictionless Surface

The frictionless surface of the Dunlop Saddle will ensure cool riding on the longest run. It's waterproof, too, so that after even the heaviest rain it can be wiped dry in a moment. All that it needs to keep it in perfect condition is an occasional polish with a cloth lightly smeared with any household wax polish. This will remove any dust or dirt and keep the surface smooth and glossy.

50H/320

Give your cycling **BSA** GOLDEN WINGS

FEATURES INCLUDE frame of Reynolds 531 tubing (Ladies' model with 531 tubing has Maes dropped bar); Dunlop Sprite tyres; central-pull caliper brakes; attractive finish in blue or maroon with silver panels.

Available on easy terms. Go and see your dealer and insist on a B.S.A.

**PRICES:**  
**GENT'S MODELS**  
 from £14. 9. 10  
 (including tax)

**LADIES' MODELS**  
 from £13. 17. 6  
 (including tax)

**IT'S TIME YOU HAD  
 A BSA**

**COUPON:** To B.S.A. Cycles Ltd.,  
 12 Armoury Rd., Birmingham, 11

Please send me at once the B.S.A. Cycle Catalogue.

NAME .....

ADDRESS .....

.....

Let's STOP here!

SKIDDAW — mountain in Cumberland, 4 miles N. of Keswick. Summit can be reached in 3 1/2 hours from Keswick. Height 3054 Feet.

You can stop anywhere with **FIBRAX**

FIBRAX — does its job in practical fashion—gently yet so firmly! Made in two types for all brakes: soft red for alloy rims, black for steel rims. Both act well and last long.

FROM ALL GOOD DEALERS

# Fibrax

**BRAKE BLOCKS**

FIBRAX LIMITED, 2 TUDOR STREET, LONDON, E.C.4

F.1350

# CYCLORAMA By H. W. ELEY

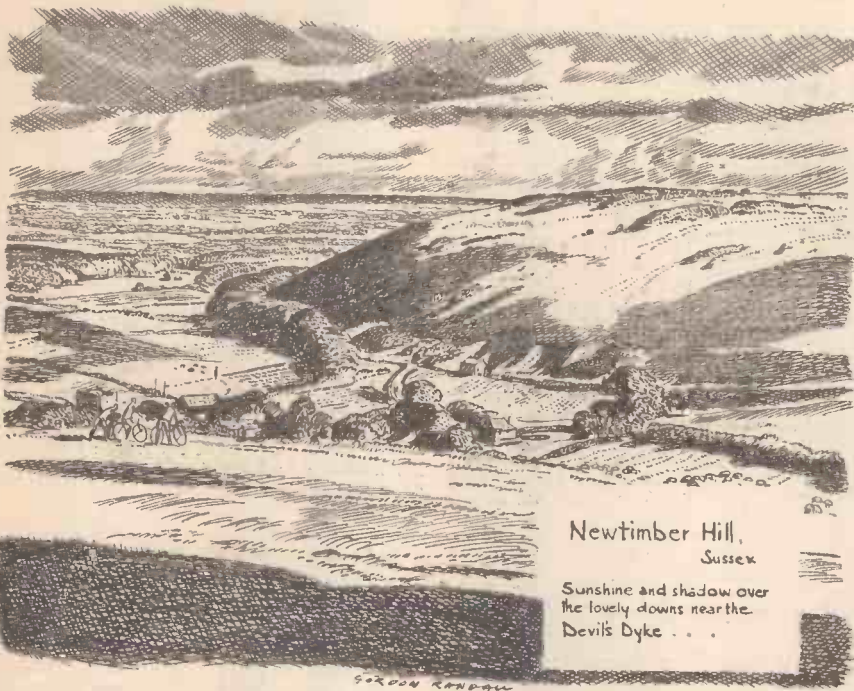

Newtimber Hill,  
Sussex

Sunshine and shadow over  
the lovely downs near the  
Devils Dyke . . .

S. GORDON RANDALL

## Points of Interest

RECENTLY I met a Sheffield party near ancient Yougcrave, where, by the way, there is a mysterious "stone circle" rivalling Stonehenge in antiquity, and suggesting all manner of grim pagan rites and awesome sacrifices. Some riders came to my own village, and whilst the cottage which, in the good days of old, would have provided ham and egg teas, and "lashings" of farm butter and home-made jam, could only produce scanty repasts, the happy Yorkshire riders enjoyed it all . . . and I was privileged to show them our church, and conduct them round a farm which was once a priory of the Knights Hospitallers of Jerusalem.

## A Great British Industry

SALUTE to the British Cycle and Motorcycle industry which last year set up an all-time record of £32,172,197 exports and beat the 1949 figures by nearly £3,000,000. The number of cycles sold overseas—2,109,864—is indeed a heartening achievement, and is proof of the amazing and continuing virility of the industry. Nearly a quarter of a million of these machines went to Malaya, and Pakistan took over 200,000. British West Africa imported 201,949, and India 126,215. These are splendid figures, and the industry deserves the highest praise for its efforts. Turning to accessories, we find that bells, saddles, and lighting equipment went up from £1,180,781 to £1,378,232.

## Leaning Over a Gate

IN "write-ups" about famous men, and "quizzes" as to their hobbies and interests, one sometimes finds strange confessions. Recently, I read of a famous author who "liked to lean over gates." It is no bad thing to do. There is something quite fascinating in propping up the bike against a post, lighting an old favourite pipe, and . . . leaning over a field gate. One sees the ancient lines of a hawthorn hedge; the differing tints of fields . . . red upturned earth, emerald green pasturage, the neglected weedy field which is yet beautiful with its thistles and charlock, and all manner of tares which cry aloud for scientific spraying; one can watch the slow

rhythmic movement of cattle and sheep; away to the left there is an immemorial oak, gnarled and twisted with its weight of years; and in the distance, there is the grey tower of an ancient church. In a whirling world where "escape to solitude" is at times a sheer necessity, there is a lot to be said for . . . leaning over a gate.

## The Bike from Kent

ONE is so used to associating cycle manufacture with Coventry and Birmingham, that I am always a little intrigued when I see a "Norman" machine, and note from its transfer that it is manufactured in Ashford in Kent. Last week, when I dismounted at "The French Horn" in a nearby village, for a tankard of ale, I fell to chatting with two cyclists on tour. One rode a "Sun"—the other a "Norman." And we talked together of cycles, and touring, and cycle factories, and road records, and . . . Kent. The "Norman" rider had chosen his machine because he was a "Man of Kent" . . . and although exiled long from his native heath, he still loved the orchards, and the oast-houses, and the primrose-decked lanes of his native county. We talked of Canterbury, and the ancient weavers' houses by the Stour; of Romney

## EVERY CYCLIST'S POCKET BOOK

Owing to an unprecedented demand, and in spite of a large print order, the first edition of this cyclist's "Bible" went out of print shortly after publication.

We are pleased to be able to announce, however, that special arrangements have been made to produce a Second Edition which is now on sale. Copies may be ordered from newsgagents, or direct from us. Copies cost 7s. 6d., or 7s. 9d. by post, from the Publisher, Book Dept., George Newnes, Ltd., Tower House, Southampton Street, Strand, W.C.2.

The book measures 5in. x 3in., is strongly bound in green cloth with gilt lettering, and contains 400 pages of valuable information and tables on every aspect of cycles and cycling, including 84 pages of indexed road routes of Great Britain.

Order Your Copy Now!

Marsh sheep, of the white cliffs of Dover . . . and of busy Ashford, where the "Norman" is made. That is the charm of living in the country, and pottering around villages . . . one never knows what interesting chat is in store, or what good riders one will meet. We parted firm friends . . . the man from Kent, myself from Staffordshire, and the "Sun" rider from Manchester. All proud of our counties, all enthusiasts for the rolling English road . . .

## The Neglected Saddle

I WONDER why it is that so many cyclists neglect that vital component . . . the saddle? Many a time I have seen machines, carefully kept in every other respect, but woefully neglected as regards the saddle. What comfort is lost! What discomfort endured! Personally, I am a "bit of a crank" where saddles—and tyres—are concerned. I like comfort, I play for safety. And the right choice of saddle, and a little attention paid to it from time to time—and correctly inflated tyres, can make a world of difference to one's cycling pleasure.

## Lure of Lancashire

TO many, Lancashire means . . . Oldham, and Rochdale, and Bolton, and "satanic mills" and grim industry. The truth is that Lancashire is a grand touring land. Why, part of the Lake District is in Lancashire! I commend any would-be tourist who is in doubt as to what part of England to explore, to go to Pendle Hill. It is in the land of the "Lancashire witches," and if you go, it is no bad plan to read Harrison Ainsworth's old book, "Lancashire Witches," so that you may absorb the romance and atmosphere of this fascinating area. See the Ribbles Valley; see the fine Norman castle at Clitheroe; learn how steeped in history is this part of the great county which, maybe, you have always associated with cotton mills, and music-hall comedians, and . . . tripe and onion suppers. Every village has associations with the Pendle witches, with the grim struggles of the Wars of the Roses, and you will find old manor-houses as lovely as any in the softer south. Yes!—read some books on the scenic beauty of Lancashire, and—this year—go north!



Rye, Sussex.

The old houses lead up on all sides to this fine old church standing right at the top of the hill, the whole forming a landmark for miles over the marsh-land and sea.

S. GORDON RANDALL

# My Point of View

By "WAYFARER"



The Chapel and great West Gate of Warwick. Built on rock in the fourteenth century. Behind the gate stands the beautiful Leicester Hospital (1571) one of the few great Elizabethan houses to escape the fire that swept the town in 1694.

## The Greater Praise

A FEW months ago, asked to write an article for a souvenir booklet which was being prepared to celebrate the coming-of-age of a certain cycling organisation, I chose as my theme the enthusiasm for our pastime which is so often displayed by cyclists who live in surroundings that may in very truth be described as forbidding. To them, indeed, must great praise be accorded. For some reason which is now beyond my recollection, my pen—or, rather, my typewriter—turned my thoughts in quite a different direction. This was just as well, because, when the booklet made its appearance in finished form, I noted that one of my friends and contemporaries had selected my discarded theme as part of the topic on which he was to discourse. There had been no collusion—no exchange of thought. My friend and I had not met for some years and nothing had passed between us on the point. It was just a case of "great minds thinking alike."

He wrote that "not always does cycling flourish in the localities best suited to it. Often the greatest cycling enthusiasm can be found in those industrial centres that involve the painful negotiation of miles of cobbled streets before the joys of the countryside can be tasted," and he added that this was not such a contradiction as it might seem, "for the bicycle is the ideal means of escape from bricks and mortar." How true it is! And here, of course, may be a case of cause and effect. We live in grim surroundings? Let's get out of them—and in the easiest and cheapest way. So the dweller in Bermondsey or Bethnal Green reaches out for the countryside, while the man who lives in Warwick or Lyndhurst merely philanders with our grand pastime. It is true that, in his case, there is not the same urge to go in search of things beautiful, which he can often see without moving a muscle. Nevertheless, how great is his loss, and what a pity that, man for man, he does not possess the cycling enthusiasm of his friend in Bermondsey or Bethnal Green!

The greater praise is due to those cyclists who live in forbidding surroundings which might indeed tend to destroy all desire for all things beautiful, producing an attitude of sullen indifference and lassitude. Nor is the process of reaching "the promised land" too easy or too comfortable, when the miles of setts that have to be negotiated are visualised—and the horrors of the return journey on a cold and wet night are contemplated.

## Do We Appreciate?

IT seems sometimes open to question whether we cyclists do count our blessings with meticulous accuracy, and whether, having so counted them, we attach the full and correct value to all that we have and are. Do we? It is for you to say. In the pastime of cycling we possess a magnificent and varied—and valuable—way of spending our leisure-time. It is a method which is hardly affected by the weather, though I am quite prepared to share with others a lack of enthusiasm for deep snow or for fog. It is a method which can be practised regardless of the time of day—or night. It is good for 10 minutes, or 10 days, or 10 weeks, or 10 months. It is good all the time, and for all time. It is grand whether you travel alone or in company. To say that cycling is an open-air pastime, and that it provides a most admirable form of exercise, is but to emphasise the obvious and to proclaim the commonplace. It takes you to "the living out-of-doors," and keeps you there. It teaches: it educates: it broadens the mind. It exhibits things which otherwise most of us would never have a chance of seeing. It reveals the eternal kindness of people, especially country people, and, stepping on to a lower plane, it provides us with many welcome changes of food. It shows us "the sacrament of sunset" and makes us conscious of the healing charm of the countryside, with its marvellous silence. This, perhaps, above all—it bestows upon us a sense of freedom—infinite freedom—obtainable in hardly any other way. Cycling, indeed, is the unfettered pastime.

So far, so good. But whither are we travelling? The question is a timely one and serves to put a period to my rhapsody. Nevertheless, I go back to my original point: do we count our blessings and do we evaluate those blessings with exactitude? Not always, I fear! We sometimes become a bit fed-up, don't we? There was that Saturday when it rained from morn till night. There was that Sunday when we had to "chew acid" all day because of an unnecessarily relentless and boisterous head-wind. (Reason in all things, we said to ourselves, as we bent over our task!) There was that week-

end when the leader of the expedition seemed to seek out every hill within a 50-mile radius, and, contrary to established custom, all those hills had an eternally upward tendency! There were those bitterly cold days and those blisteringly hot days, and those days when we were unlucky over our meals. Really, this cycling game is compacted of troubles, difficulties, and discomforts: it is, in very truth, Hard Work. Count your blessings! You have two good legs, haven't you—and two good arms and eyes and ears? You suffer from no serious disability, and you are considered as being pretty fit. Then add up your blessings again, and, rather like the man in the Bible (but with a different spirit) think "whatever gods may be" that you are not as other men, and especially like the one-legged cyclist I had the privilege of meeting the other day. He ran no moaning department. On the contrary, he was extraordinarily cheerful, realising the effect of his disability, and determined to make the best of things. He would be readily forgiven, and nobody would criticise him, were he to follow the line of least resistance and spend his holidays in East Anglia, where the flatness of the land would tend to make things easy for him and thus neutralise the loss of his leg. He is not going to East Anglia for his holidays. Where, then, is he going? His plan is to go to North Wales, where (as he knows) they jolly-well "grow" hills—as many to the square mile as you'll find anywhere in these islands. I was so impressed with his decision that I promised to "see him right" as regards the saddle he wanted for the job, if he failed elsewhere.

North Wales is not an easy country even for an able-bodied cyclist. To be sure, the hills, as a rule, are well-graded—and they have been known to go in two directions, down as well as up! All the same, a one-legged cyclist has a difficult "row to hoe" in such circumstances, and a minute's consideration will suggest that he might well find himself in Queer Street were an emergency, necessitating a quick dismount, to arise.

So I come back to my "text." Let's count our blessings, and see to it that, as able-bodied cyclists, we are not shamed by others less fortunate than we.

## Menace

THIS note was written on the day which produced the first (and, possibly, the last) snow of the current winter season. By noon the roads were in a menacing condition, especially in the suburbs, where the snow had not been smashed and scattered. Frankly, I did not like the look of them at all and, following my usual practice, I "played safe." There was a time, now long years ago, when I revelled in the conditions prevailing on this sort of day, and I had many a jolly snow ride. There were downfalls, of course, but at that period of the world's history a toss or two did not matter very much. For one thing, we were all a lot younger and more resilient; for another, we had the roads to ourselves, and there was never any danger of a ten-tonner crashing over us as we picked ourselves out of the gutter. So nowadays, when the roads are tricky, I "stand from under"—and I don't care who knows it! My responsibilities are still pretty great, and I refuse to accept needless risks.

## WIRE AND WIRE GAUGES

3/6, or 3/9 by post

From George Newnes Ltd., Tower House, Southampton Street, Strand, London, W.C.2

"Practical Mechanics" Advice Bureau  
This coupon is available until March 31st, 1951, and must be attached to all letters containing queries, together with 3 penny stamps. A stamped, addressed envelope must also be enclosed.  
Practical Mechanics  
March, 1951

Published about the 30th of each month by GEORGE NEWNES, LIMITED, Tower House, Southampton Street, Strand, London, W.C.2, and Printed in England by W. Spaight & Sons, Ltd., Exmoor Street, London, W.10. Sole Agents for Australia and New Zealand—Gordon & Gotch (A/asia) Ltd. Sole Agents for South Africa—Central News Agency, Ltd. Subscription Rate (including postage): For one year, Inland and Abroad 14s. (Canada 13s.). Registered at the G.P.O. for transmission by Canadian Magazine Post.

**NOW AVAILABLE  
GERMANIUM  
CRYSTAL DIODES**

LATEST, SMALLEST,  
SUPREME CRYSTAL DETECTOR.

Midget Size, 5/16in. x 3/16in.  
Wire Ends for Easy Fixing.  
4/6 each, postage 2d.

Wiring instructions for a cheap, simple  
but high quality Crystal Set included.  
Technical Details and Selected Types  
available.

**SILICON CRYSTAL VALVE**  
3/6 each, postage 2d.  
Fixing Brackets 3d. Extra

**COPPER INSTRUMENT WIRE**

ENAMELLED, TINNED, LITZ,  
COTTON AND SILK COVERED.  
Most gauges available.

B.A. SCREWS, NUTS, WASHERS,  
soldering tags, eyelets and rivets.  
EBONITE AND BAKELITE PANELS,  
LUFNOL ROD, PAXOLIN TYPE COIL  
FORMERS AND TUBES.  
ALL DIAMETERS.

Latest Radio Publications.  
SEND STAMP FOR LISTS.

**CRYSTAL SET  
INCORPORATING THE SILICON  
CRYSTAL VALVE**

Adjustable Iron Cored Coil.

**RECEPTION GUARANTEED**

Polished wood cabinet, 15/-, post 9d.  
A REAL CRYSTAL SET, NOT A TOY.

**POST RADIO SUPPLIES**

33 Bourne Gardens, London, E.4

**BOOKS:**

"Make Your Own G.O. Motor" ...	2/6
"Working Model Railways" ...	3/-
"Loco. Body Construction" ...	3/-

**ALLWAY PARTS:**

Scale Bicycles ...	2/3	2/6
Scale Bushes or Shrubs ...	4/4	4/4
Plastic Station Staff ...	3/0	4/8
Plastic Passengers ...	4/11	3/8
Sitting Passengers ...	4/21	7/4
Scale Petrol Pumps ...	1/-	1/-
Water Cranes ...	2/9	4/6
6x-R.A.F. 16 S.W. Boxes ...	5/6	5/6
20-volt Lamps for Hornby ...	12/1d.	
Brass Driv. Wheel Castings, 1 1/2 in., 1 3/4 in. ...		1/-

Stage extra. "00" or "0" Parts List 9d.  
**ELDESLEY & HOLBROOK (M.E.T.A.),**  
19, DEANSGATE, MANCHESTER, 3

**"THAMES VALLEY"  
BATTERY CHARGERS**

2-6-12 VOLTS 1 AMP. 47/6  
6-12 VOLTS 3 AMP. 79/6  
Both types are brand new and are in  
enamelled steel cases with ammeters.  
Suitable for 200-250 volt A.C. mains.

**Thames Valley Products (P),**  
28, Camden Ave., Feltham, Middx.

**Mains Transformers UPRIGHT DROP  
TYPE TO U.G.H. A'S  
ILLUSTRATED.**  
Two Types Only.  
Guaranteed.

No. 1: 250-0-250v., 80  
mA., 0-4-0.3v., 5 amp.  
0-4-5v., 2 amp. No. 2:  
Same, but 350v. Both  
14/6, post 1/- for 1 to 3.

**HILLFIELDS RADIO,**  
8, Burnham Road,  
Whitley, Coventry

Telephone Sets. Consists of two com-  
bined microphones and telephones.  
25ft. flex, gives perfect two-way  
communication; no batteries required,  
ready for use, cheapest form of  
intercom. Price 7/6 per set. Trade  
supplied. Send S.A.E. for list. Many  
other bargains.

**L. C. NORTHALL,**  
16 Holly Rd. Quinton, Birmingham 32.  
Retail Branch: 416, High St., Smethwick.

**RATCHET & REVOLUTION  
COUNTERS**

Ask for  
Leaflet No. 18/6  
Speed up to  
6,000 r.p.m.  
**B. & F. CARTER  
& Co., Ltd., Bolton 5**  
Members of B.E.S.T.E.C. Organisation.

**NO MAN CAN KNOW TOO  
MUCH OF HIS PRODUCT**

The Ultra Lens is a revealing eye of six actual  
diametrical magnifications, which brings  
out points of strength or weakness, and  
enables the most minute measure-  
ments to be gauged accurately.  
Whether you are engaged  
in manufacturing, buy-  
ing or selling, it  
is an ally of  
real value.  
No instru-  
ment you can  
buy will more  
quickly justify  
and pay for itself.  
Full particulars  
on request.

PRICE 4/15s. 0d., complete in case with spare bulb, battery and transparent mensur-  
ing scale. ADAPTOR, A.C. Mains, 27/-. Transformer, if required, 6/5

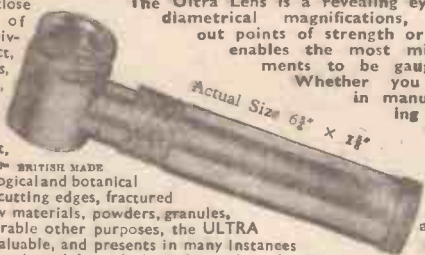

**THE ULTRA LENS COMPANY,**  
75, Finsbury Court, Finsbury Pavement, London, E.C.2.

**MASON  
MASTER**

**TUNGSTEN CARBIDE  
DRILLS**

For clean round holes in brick, con-  
crete, marble, glazed tiles and rock, etc.  
Sizes from 5/32in. to 2in. dia. Send  
for full details.

**YOU CAN GET MASON MASTER  
DRILLS FROM ALL GOOD TOOL  
STOCKISTS.**

**JOHN M. PERKINS & SMITH LTD.**  
Braunston, Near Rugby  
Phone: Braunston 238

**THE TIP DOES THE TRICK**

**MACHINE TOOLS AND ACCESSORIES**

**METAL LATHES, Etc.**

From 1 1/2 in. to 5 in., Bench Millers, Drilling Machines, Hand  
Bench Shapers.  
All Loose Tools and Equipment.

**WOOD LATHES, Etc.**

From 3 in. to 5 1/2 in., Ball Bearing Planers 4 1/2 in., 7 in., 10 1/2 in.  
Ball Bearing Saw Benches 6 in. and 12 in. Sanders, Band  
Saws, Grinders, Jigsaws.  
All Loose Tools and Equipment.  
Write at once for details.

**NUTTALL'S (LATHES) LIMITED,**  
MANSFIELD, NOTTS.

**TARGET BLOWPIPES**

The "Target" FINE  
FLAME Gas Blowpipe  
(self-blowing) is ideal for  
all those small and deli-  
cate soldering and brazing  
jobs essential to model mak-  
ing. Fine intense flame easily  
melts small copper rivets. Solder-  
ing and small brazing jobs done  
in no time. PRICE 2s. 9d. each.  
POST FREE.

The "Target" FIERCE FLAME Gas  
Blowpipe (self-blowing). For soldering  
and brazing LARGER jobs.  
Gives a fierce roaring 4-inch  
flame. Guaranteed to melt  
1/2 in. copper tube. PRICE  
(with full instructions),  
3s. 6d. each. POST FREE.  
Retailers Enquiries Welcomed  
**TARGET MFG. CO.,**  
Wollaston, Wellingborough  
(Dept. P.M.)

**WEBLEY AIR PISTOLS**

Marvellously  
accurate for  
target prac-  
tice.

No licence required to  
purchase for use on  
enclosed premises.

Senior Mark 1  
Junior Webley Air Rifle

Write for List. **WEBLEY & SCOTT, LTD.,**  
106, Weaman Street, Birmingham, Eng.

**ADANA PRINTING MACHINES**

Print in the odd hours with an  
Adana—still the most absorbing  
of crafts. No. 1 H/S  
Machine 24-10-0  
No. 2 H/S Machine  
20-15-0. Will  
quickly pay for itself.  
Send for illustrated  
folder to Dept. P.M. 41  
**ADANA (Printing Machines) Ltd., Twicken-  
ham, or call 8, Grays Inn Rd., London, W.C.1.**

Price  
28 5s. 6d.  
Carr. Extra.

The 'Adept' Bench  
Hand Shaper  
Length of stroke of  
ram, 3 1/2 in.  
No. 2B. Fishaper, 6 1/2 in.  
stroke.  
Price 21s 0s. 0d.  
Ask your dealer.  
Manufactured by:  
**ADEPT WORKS, SELLERS STREET, SHEFFIELD, 8**

The SUPER  
'ADEPT' LATHE  
1 1/2 in. centres, 6 in.  
between  
centres.

Price 100/-  
Postage and Packing, 2s. 3d.  
Chuck. Reversible Jaws, 35/-  
A Good Range  
of Accessories is available.

The "Adept"  
3 1/2 in. 4-Jaw  
Lead-dependent  
A Good Range  
of Accessories is available.

**F. W. PORTASS,  
SELLERS STREET, SHEFFIELD, 8**

**SPARKS'  
DATA SHEETS**

Now recognised as the Safest, the  
Simplest and the Finest Radio Con-  
structional Sheets obtainable. All  
my Designs being Fully Tested and  
Guaranteed, you are sure of

**COMPLETE SATISFACTION.**

**GOOD LISTENING WITH  
ECONOMY**

Four more of my  
**TESTED AND PROVED**  
A.C./D.C. Designs:

**THE "CHALLENGER"** Portable.  
Radio in any room without Aerial  
or Earth. Fine tone and power. M/L  
waves. Very popular ... 3/-

**THE "UNIVERSAL FOUR."** A 2-  
valve plus Rect. M/L wave T.R.F.  
Circuit giving 4 watts output. Widely  
used and praised ... 3/-

**THE "CUB."** A 2-valve plus Rect.  
Power and Quality on the "local"  
stations. An exceptional little set on  
M/L waves ... 3/-

**THE "OLD FOLK'S TWO."** plus Rect.  
Similar to the Cub but with 3 station  
selection by switch. Greatly appreci-  
ated ... 3/-

The above are only 4 of the 40 designs  
available.

SEND STAMP FOR COMPLETE LIST.

**COMPONENTS SUPPLIED.**

**L. ORMOND SPARKS (M)**

48A, HIGH STREET,  
SWANAGE, DORSET.

**Jubilee  
PATENTED  
WORM DRIVE  
CLIP**



Absolutely leakproof  
joints on Air, Water,  
and Oil lines are  
swiftly and easily made  
by using "Jubilee" Worm  
Drive Clips. They stand  
up to any pressure.

Write for details  
quoting reference **RP/12.**

THE FINEST  
CLIP IN THE  
WORLD.

**L. ROBINSON & CO. (GILLINGHAM), LTD.**  
Gillingham, Kent

**THE PRECISION  
HOLE CUTTER**  
A LUFBRA PRODUCT

**14/-**  
BOXED  
incl. postage

Square or  
round shank  
cap. 1 1/2" - 4 1/2" with  
vernier adjustment  
1/2" Toolbit.

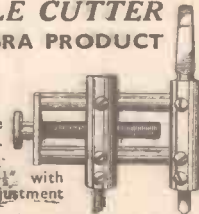

PROV. PAT. APPLIED

**RIGID TOOLS SUPPLY CO.**

4, KENSAL PLACE,  
LONDON, W.10.

**PRECISION MACHINED  
PARTS** made to your sample or  
drawing in small or large quan-  
tities. Perspex, Aluminium Sheet-  
ing, cut, drilled and made up to  
your requirements. Enquiries  
welcomed.—**THE H.B.H. COM-  
PANY, Civic Chambers, Port-  
land Crescent, Leeds, 1.**

# Free Guide - "Success in Engineering"

One of the following Courses taken at home in your spare time can definitely be the means of securing substantial promotion in your present calling, or entry into a more congenial career with better prospects.

## ENGINEERING; AERO, ETC.

Plastic—Radio—Aero Engines—Aircraft Design—Welding—Aerodynamics—Electrical Engineering—Television—Electric Wiring—Diesel Engineering—Generation and Supply—Works Management—Metallurgy—Refrigeration—Planning. Estimating. Rate-fixing—Time and Motion Study—Aero Inspection—Automobile Engineering—Sheet-metal Work—Engineering Draughtsmanship—Aero Draughtsmanship—Jig and Tool Draughtsmanship—Press Tool and Die Draughtsmanship—Structural or R/F Concrete Draughtsmanship—Sanitary Engineering.

## GENERAL

Gen. Cert. of Educ.—College of Preceptors—A.C.C.S.—A.C.I.S.—Aircraft Apprentice.

## MUNICIPAL SERVICE

School Attendance Officer—Handicraft Teacher—Registrar—Housing Manager—Sanitary Inspector—Weights and Measures Inspector—Inst. of Mun. Engineers—A.R.I.C.S.—L.A.B.S.S.

"PRACTICAL ENGINEERING" said—

We recommend all readers interested in improving their position to apply for a copy of this valuable book. "Success in Engineering" is not a pamphlet. It is a 132-page book, containing valuable and vital information on all branches of engineering. . . . There are many engaged in engineering who owe their success to The National Institute of Engineering.

The FREE GUIDE explains:

- Openings, prospects, salaries, etc., in Draughtsmanship, Inspection, and opportunities in all other branches of Engineering and Building.
- How to obtain money-making technical qualifications through special RAPID FULLY-GUARANTEED COURSES.

Write now for your copy of this remarkable publication.

A.M.J.Mech.E., A.M.I.M.I.,  
A.M.Brit.I.R.E., A.M.I.P.E.,  
A.M.I.C.E., A.M.I.Struct.E.,  
A.M.I.Mun.E., M.R.San.I.,  
A.M.I.E.D., A.F.R.Ae.S.,  
London B.Sc., Degrees.

Fully guaranteed postal courses for all the above and many other examinations. Fully described in the Free Guide.



## THE BUILDING BOOM— SECURE YOUR SHARE!

The Free Guide also gives particulars of our extensive range of modern Building and Structural Courses, Building Draughtsmanship, etc. The great post-war Building programme offers unlimited prospects to technically trained men.

## BECOME A DRAUGHTSMAN QUALIFY AT HOME AND EARN BIG MONEY

Men and Youths urgently wanted for well paid positions as Draughtsmen, Inspectors, etc., in Aero, Jig and Tool, Press Tool, Electrical, Mechanical and other Branches of Engineering. Practical experience is unnecessary for those who are willing to learn—our Guaranteed

"Home Study" courses will get you in. Those already engaged in the General Drawing Office should study some specialised Branch, such as Jig and Tool or Press Tool Work and so considerably increase their scope and earning capacity.



**NATIONAL INSTITUTE OF ENGINEERING**

(Dept. 29)

**148, HOLBORN, LONDON, E.C.1**

**OVER SIXTY YEARS OF  
CONTINUOUS SUCCESS**

SOUTH AFRICA: E.C.S.A. P.O. BOX 8417, JOHANNESBURG

FOUNDED 1885—FOREMOST TODAY—OVER 100,000 SUCCESSES

## THE ACID TEST OF TUTORIAL EFFICIENCY SUCCESS—OR NO FEE

We definitely guarantee that if you fail to pass the examination for which you are preparing under our guidance, or if you are not satisfied in every way with our tutorial service—then your Tuition Fee will be returned in full and without question. This is surely the acid test of tutorial efficiency.

If you have ambition you must investigate the Tutorial and Employment services we are able to offer. Founded in 1885, our success record is unapproachable.

Why not fill in and post the attached Coupon NOW for further details and Free Authoritative Guide to openings in Engineering and Building? This book contains a mine of valuable and exclusive information and may well prove to be the turning point in your career.

**PROMPT TUTORIAL SERVICE GUARANTEED**

## FREE COUPON

To NATIONAL INSTITUTE OF ENGINEERING  
(Dept. 29), 148, Holborn, London, E.C.1.

Please Forward your Free Guide to

NAME .....

ADDRESS .....

My general interest is in: (1) ENGINEERING (Place a cross against the branches in which you are interested.)  
(2) AERO (3) RADIO (4) BUILDING  
(5) MUNICIPAL WORK

The subject or examination in which I am especially interested is

To be filled in where you already have a special preference  
(i.e. Stamp only required if unsealed envelope used.)