

A MASTER BATTERY CLOCK

NEWNES

PRACTICAL MECHANICS

9^p

EDITOR: F. J. CAMM

JUNE 1950

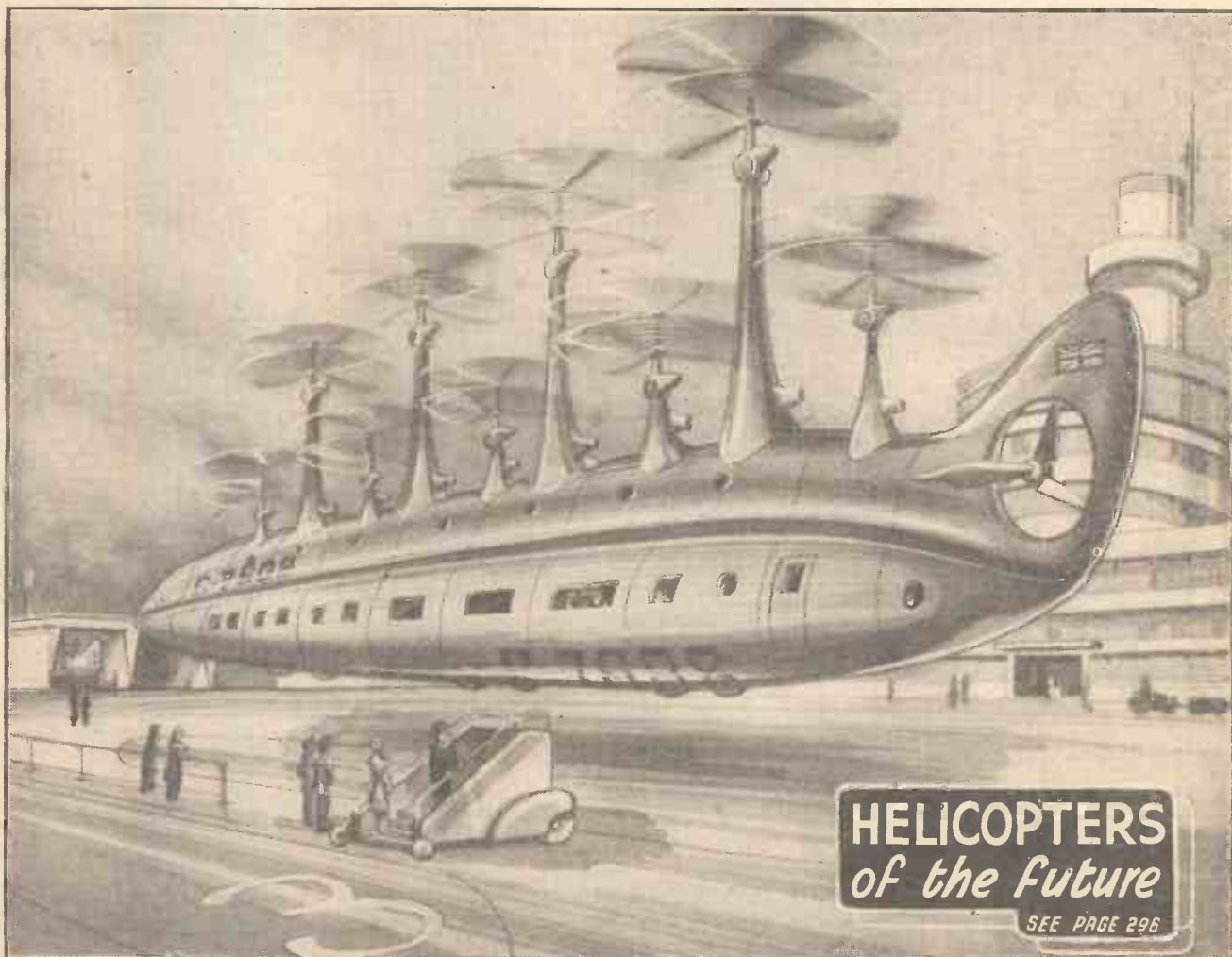

PRINCIPAL CONTENTS

Model Electric Launch
Elements of Mechanics
A 60-watt Rectifier Panel

Einstein's Theory of Gravitation
A Master Battery Clock
World of Models

Model Engineering Practice
Queries and Enquiries
Cyclist Section

YOU NEED CLIPS

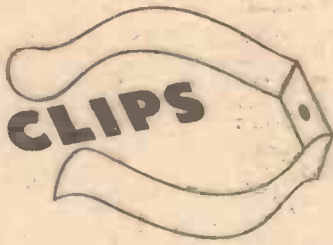

TERRY'S MAKE CLIPS

in every shape and size—steel clips, bronze clips, stainless clips, etc., etc.
Here we show a tiny selection from the enormous range we have produced.
Our Research Department can design any clip to your own specification.
(94 years of clip-making experience is at your disposal.)



No. 81

Two popular types. In a range of sizes to grip from 1/2" to 2". Delivery from Stock.



No. 80



No. 300

A drawing board clip. Plated finish, delivery from Stock. 4/- doz. plus P.T.

The most comprehensive and informative text book on springs yet published. 10/6 post free.



TERRY



Sole Makers:

HERBERT TERRY & SONS LTD. REDDITCH. London · Birmingham · Manchester



Good photographers use **Johnson goods**
CHEMICALS, EQUIPMENT & ACCESSORIES

Two Grand Developers

AZOL.

A concentrated one-solution developer. Only needs dilution with water. Always ready for use. Best for developing film or plate negatives. No developer can be more economical.

7-oz. bottle, 4/6
17½-oz. „ 9/9

UNIVERSAL.

This M.Q. developer is recommended for printmaking on any gaslight or bromide papers. Produces a rich, bright picture with clean margins. Can be used also to develop roll films.

8-oz. bottle, 2/6
20-oz. „ 4/-

All photographic dealers sell Johnson developers.

JOHNSONS OF HENDON LTD., LONDON, N.W.4



**COMPTON
MARK II H
SPRAY GUN**

£2-1-6

UNSURPASSED FOR
SMALL JOBS
WHERE A FINE
FINISH IS REQUIRED

THOUSANDS IN
USE ALL OVER
THE WORLD

- LOW AIR CONSUMPTION—THEREFORE ONLY A SMALL COMPRESSOR REQUIRED.
- INEXPENSIVE GLASS CONTAINERS MAKE QUICK COLOUR CHANGES SIMPLE.
- NOVEL HERMETIC SEALING DEVICE PREVENTS PAINT CONGEALING IN JETS AND ELIMINATES THE NEED TO CLEAN OUT GUN AFTER USE.
- SPRAYS: CELLULOSE; SYNTHETIC PAINTS; OIL PAINTS; STAINS; ETC.

PLEASE WRITE FOR OUR LEAFLETS

**DAWSON, McDONALD & DAWSON,
COMPTON WORKS, ASHBOURNE, DERBYSHIRE.**

TRADE AND EXPORT ENQUIRIES INVITED.



**SHIPS FITTINGS
for Model Perfection**

Bassett-Lowke Ships' Fittings will give the final touch of realism to your Model.

	PRICE		PRICE
1. BYERS STOCKLESS ANCHOR.		6. ENGINE ROOM TELEGRAPH.	
1½ in. long	3/9	½ in. high	3/5
1½ in. long	4/8	7. PORT & STARBOARD LIGHTS	
2. TORPEDO TUBE.		(Launch Pattern), ½ in. dia., ½ in. high—per pair	3/9
2½ in. long, ½ in. diam.	5/-	8. PORT & STARBOARD LIGHTS	
3. STEERING WHEEL.		(with screws)—per pair	6/10
2 in. dia., wheel 1½ in. high	3/5	9. MERCHANT PATTERN CAP-STAN,	
4. PRESSURE GAUGES.		7/16 in. high, 7/16 in. dia.	2/9
½ in. dia. 0 to 80/100/120/150 lbs.	18/6	10. VENTILATORS.	
1½ in. dia. 0 to 80/100/120/150 lbs.	17/6	5/16 in. pipe—1½ in. high	3/9
1½ in. dia. 0 to 100/120/150 lbs.	12/6	½ in. pipe—1½ in. high	3/5
2 in. dia. 0 to 100/120/150 lbs.	14/6	5/16 in. pipe—1½ in. high	3/9
5. TROTMAN'S PATTERN ANCHOR.		½ in. pipe—1½ in. high	3/9
1½ in. high	5/-		

All fittings are finished in nickel plate. Other fittings include: Anchor Chains, Bollards, Davits, Cleats, Fairleads, Syphons, etc.

For details of full range of Ships' Fittings, machinery & drawings, ask for Ships' List S/12, Price 1/-.

AVAILABLE FROM STOCK FROM

BASSETT-LOWKE LTD.

NORTHAMPTON

London, 112 High Holborn, W.C.1.
Manchester, 28 Corporation Street.



★ **NEW** ★

American Star

Identification Instruments

A-N Type 1

An accurate instrument with which it is possible to obtain positions of all the stars and planets which are included in British and American Almanacs or, alternatively, it can be used for identifying or spotting stars.

The Northern or Southern sky may be viewed on the Star Base, so that, with the seven graphs which are provided, the instrument can be used in all parts of the world.

Originally manufactured for the U.S. Hydrographic Office at considerable cost, they are now to be sold at a greatly reduced price.

As supplied to leading shipping companies and airline operators, at home and abroad.

An outstanding offer at 5s. each, complete in leather case with instructions.

Order early to avoid disappointment.

★ **LAWRENCES**

61, BYROM STREET, LIVERPOOL, 3

Tel.: CENTRAL 4433

I.C.S. TRAINED MEN are in Greater Demand than Ever—Maximum production depends on high technical skill, such as that acquired by I.C.S. Students

**TENS OF THOUSANDS MORE
TRAINED MEN ARE URGENTLY
NEEDED NOW—BUT THERE IS
NO WORTH-WHILE PLACE FOR
THE UNTRAINED**

**Ambitious men everywhere have succeeded through
I.C.S. Home-Study Courses. So also can you.**

The man with an I.C.S. Training in any one of the subjects listed below knows it thoroughly, completely, practically. And he knows how to apply it in his everyday work.

- | | | |
|-------------------------|-------------------------|------------------------|
| Accountancy | Diesel Engines | Mining Engineering |
| Advertising | Draughtsmaanship | Motor Engineering |
| Aero Engineering | Drawing Office Practice | Motor Mechanic |
| Air and Vacuum | Electrical Engineering | Motor Vehicle Elec. |
| Brakes | Electric Power, Light- | Municipal Eng. |
| Air-Conditioning | ing, Transmission | Plastics |
| Architecture | Traction | Plumbing |
| Architectural Drawing | Eng. Shop Practice | Quantity Surveying |
| Auditing | Fire Engineering | Radio Engineering |
| Bol. r Engineering | Foremanship | Radio Service Eng. |
| Book-keeping | Free-Lance Journalism | Refrigeration |
| Building Construction | Fuel Technology | Sales Management |
| Building Specifications | Heating and Ventilation | Salesmanship |
| Business Training | Horticulture | Sanitary and Domestic |
| Business Management | Hydraulic Engineering | Engineering |
| Carpentry | Illumination Eng. | Sheet-Metal Work |
| Chemical Engineering | Industrial Management | Short-Story Writing |
| Chemistry, I. & O. | Joinery | Steam Engineering |
| Civil Engineering | Lettering | Structural Steelwork |
| Clerk of Works | Machine Designing | Surveying |
| Coal Mining | Machine-Tool Work | Telegraph Engineering |
| Colliery Examiner's | Marine Engineers | Television Technology |
| Colliery Overman's | Mechanical Drawing | Welding, Gas and Elec. |
| Commercial Art | Mechanical Engineering | Woodworking Drawing |
| Concrete Engineering | Mine Surveying | Works Engineering |

And most of the Technical, Professional, Commercial and Civil Service Examinations; also U.C.T.A. Exam. in Salesmanship.

(I.C.S. students preparing for Examinations are coached till successful)

If you need technical training, our advice on any matter concerning your work and your career is yours for the asking—free and without obligation. Let us send you our special free booklet on the subject in which you are specially interested. **DON'T DELAY. Make ACTION your watchword**

The successful man DOES to-day what the failure INTENDS doing to-morrow. Write to us TO-DAY

Use this Coupon

INTERNATIONAL CORRESPONDENCE SCHOOLS LTD.

Dept. 95, International Buildings, Kingsway, London, W.C.2.

Please send me the free booklet describing your Courses in

Name Age

(USE BLOCK LETTERS)

Address

Addresses for Overseas Readers.

- Australia: 140, Elizabeth Street, Sydney.
- Egypt: 40, Sharia Abdel Khalek Sarwat Pasha, Cairo.
- Eire: 13, Anglesea Street, Dublin, C.4.
- India: Lakshmi Bldgs., Sir Pheroza Mehta Rd., Fort Bombay.
- New Zealand: 182, Wakefield Street, Wellington.
- N. Ireland: 26, Howard Street, Belfast.
- South Africa: 45, Shortmarket Street, Cape Town.



TELEVISION AERIAL

Ex-Government television aerials, good working order but require cleaning. Full size "H" type, 10ft. high, 5ft. wide with bracket for mounting on pole or against brickwork. Complete with 36ft. of coaxial cable: frame of heavy tubular metal construction. Carriage, paid. **27/6**

"POLAROID" FILTERS

Red tinted "Polaroid" filters for eyepieces, etc. By merely revolving slightly causes glare and dazzle to disappear. Beautifully made and brand new, with rubber eyepiece attached. Can be used singly.
1in. diameter, **11/-** single **6/6**
per pair,
2in. diameter, **15/-** single **9/6**
per pair
All post free



ALTIMETER

Reading to 20,000ft. An accurate British instrument by Smith, Kelvin, etc. Diameter 3 1/2 in. Depth 2 1/2 in. Convertible to barometer, pressure switch, etc. Made to top R.A.F. standard. **5/6**

Post and packing 6d.

BOX KITES



Ex-R.A.F. Brand new. Light alloy collapsible frame. High quality canvas. **10/6**
Post and packing 9d.
—or complete in handy metal container with special anti-twist cord. **12/6**
Post and packing 9d.

DRAWING INSTRUMENTS

British made by Harling. Ex-Army, used but complete. Includes three spring bows, small and large compass, small and large dividers, pens, etc. Complete in fitted polished wooden case. Worth over £10 new. Registered post and packing 1/6. **£5/15/0**

Send 3d. stamp for list 210.

AERO-SPARES LTD. (Dept. 95), 71 HIGH HOLBORN LONDON, W.C.1

S.G. BROWN

Precision

Sapphire Needle
For high Fidelity of Reproduction
with minimum of wear on the record



FIVE TYPES TO CHOOSE FROM

The above are designed and manufactured to suit all types of pick-ups.

- No. 1. "Miniature" jewel tipped needle for light-weight pick-up.
- No. 2. "Straight" jewel tipped needle for crystal pick-up.
- No. 3. "Trailer" jewel tipped needle for medium-weight pick-up.
- No. 4. "Knee Bend Trailer" jewel tipped needle for the older heavy-weight pick-up.
- No. 5. "Miniature Solid Sapphire" needle for light-weight pick-up.

PRICES:—Nos. 1-4, 10/1 each. No. 5, 13/4 each.

A "TIP" WORTH TAKING

An interesting and instructive Brochure giving technical details, valuable information and advice on the choice of a S.G. Brown precision Sapphire Needle to suit your pick-up, will be sent on request. Write Department "N"

S.G. Brown, Ltd.

SHAKESPEARE STREET, WATFORD, HERTS.

Telephone: Watford 7241

BARGAINS IN TOOLS

EVERY TOOL BRAND NEW AND FULLY GUARANTEED

Iron adjustable Smooth Planes, 9in. by 2in. Record, 28/6. Iron adjustable Jack Planes, 14in. by 2in., 34/9. Beech Smooth Planes, 2 1/2in. iron, 10/6. Beech Jack Planes, 2in. iron, 14/6. Set of Wood Chisels, 12/6 set of six. 36in. Tee Bar Carpenters' Cramps, 19/3. 10in. Bowsaw Frames, 12/3. 36in. Bricklayers' Levels Double Plumb, 18/6. Carpenters' Hammers, 16 oz., 3/6. 2 1/2in. Beech Spokeshaves, 3/9. 9in. Record Woodwork Vices, 49/6. Beech Marking Gauges, 1/8. Beech Mortice Gauges, 5/6. Iron Adjustable Rebate Planes, 25/- . Leytool Hand Drills, 18/6. 3/4in. Hand Drills, 9/3. 1/2in. Breast Drills, 18/9. Electricians' Pocket Knives, 5/6. 4in. Engineers' Squares, 4/9. 1 pint Brass Blowlamps, 22/6. 1/2 pint Brass Blowlamps, 17/6. Toolmakers' Clamps, 5in., 4/6. 4in. Adjustable Spanners, 3/6. 7in. Scissors, 7/3. 6in. Quick Grip Woodworkers' Vices, 25/- . 2in. Table Vices, 17/6. Hair Clippers, 000 size, 14/6. Nail Pullers, 19 1/2in., 10/6. Ratchet Screwdrivers, 3/6. 3/4in. New Pattern Electric Drill, £4/19/6. Revolving Punch Pliers, six-hole, 5/6. Rawhide Mallets, 4/- . Sets of Six Spanners, 1/4 to 1 1/2in., 8/6 set. 10in. Plain Braces, Carpenters, 10/6. 8in. or 10in. Ratchet Braces, Carpenters, 15/6 each. 12in. Beech Mitre Blocks, 2/3. 6in. Combination Pliers, 3/6. 3in. Mechanics' Vices, 21/- . 7in. Tinmen's Snips, 3/3. Sets of Conduit (Electric) Stocks and Dies, 1/2, 3/4, 1in., 38/6. 26in. Handsaws, 15/3. 1 lb. Plumbers' Hammers, 3/6. 1/2in. Electric Drills, £11/17/6. 4 1/2in. Electric Double End Grinders, £6/15/0.

All the above carriage paid.

Delivery from stock subject to being unsold.

ROSS & ALEXANDER (LONDON) LTD.,

165/167, BISHOPSGATE, LONDON, E.C.2.

Telephone : Bishopsgate 2220

One plastic material



MAKES MANY PERMANENT MODELS

and utility objects, from simple instructions in illustrated Booklet—please read below.



ONLY 4^D IN STAMPS BRINGS BOOK

... showing how such models as those above, and many others, can be made, without skill or special tools, from Sankey's PYRUMA Plastic Cement. Ready for immediate use in its plastic state, Pyruma sets or bakes to stone-hardness, and can be painted or enamelled in all colours according to instructions. Therefore realistic natural-colour models can be made from Pyruma, including

HOUSES, BUILDINGS FOR MODEL RAILWAYS, DOCKS AND AIRPORTS, SHIPS, MODEL FURNITURE, ANIMALS, FIGURES, RELIEF MAPS, Etc. as well as utility objects such as **ASH TRAYS, BOOKENDS, MENU HOLDERS, PAPER WEIGHTS, ORNAMENTS and DECORATIVE OBJECTS.**

Pyruma is inexpensive, and easily obtainable in tins from Ironmongers, Art Material Dealers and Hobbies Shops. Send 4d. in stamps to the address below for illustrated Instruction Book.



Dept. 4

J.H. SANKEY & SON, LTD.

ILFORD

EST. 1857

ESSEX



Accuracy!

dependability, and easy, comfortable handling, are qualities you'll always find in Haldens high-grade precision instruments. A comprehensive range of scales, protractors, set squares, slide rules, drawing instruments and general drawing office accessories are available at every branch of

Haldens
OF MANCHESTER

J. HALDEN & CO. LTD., 8 ALBERT ST., MANCHESTER, 3.
BRANCHES AT LONDON, NEWCASTLE ON TYNE, BIRMINGHAM, GLASGOW, LEEDS & BRISTOL.

CLYDESDALE

Bargains in Ex-Services Electronic Equipment

Brand New SHADED POLE MOTOR MODEL S.R.2.

A rugged and highly efficient Motor, giving an amazing performance at an economical price. It will stand heavy overloads, and for intermittent ratings is capable of giving up to twice the rated power.

200-220 230-250 volts. 50 cycles. Under 30 deg. C. Rise. Continuous rating.

Stack Thickness	... 0.675in.
Watts (light)	... 17
R.P.M. (light)	... 2750
Starting Torque (in ozs.)	... 1.7
Pull Load Torque (in ozs.)	... 2.0
Full Load R.P.M.	... 2000
Weight	... 1.7 lb.

Shaft Diameter: 0.1875 in. Steel Centreless Ground. Bearings: Graphite Bronze Oilless type, Self Aligning. Rigid Diecast Bearing Brackets. Vacuum Impregnated Layer Wound coil.

Carefully tested for balance, and individually put through a Silent Room test, this motor is ideal for Gramophone Motors, Wire and Tape Recorders, Fans, Motion Displays, Switch Movements, Timing Mechanisms and many other applications.

CLYDESDALE'S PRICE ONLY

25/-

POST PAID

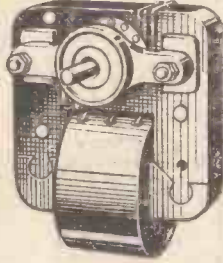

READY JUNE

Complete Illustrated List No. 7 of Ex-Services Bargains, PLUS

List of Radio and Television Components by foremost manufacturers, fully illustrated, also containing useful valve, coil and other data. Send 6d. to cover distribution cost. Please print name and address.

MIDGET SPIRIT LEVEL, 9/567

3in. long overall, 7/16in. broad, 2-hole fixing.

Price 1/9 each, post paid.

Ex-ROYAL NAVY SOUND POWERED TELEPHONE

No batteries required, gives long service without attention. Complete with warning indicator lamp and generator, giving a high-pitched note, which can be heard through any noise, where a number of units are used the lamp would indicate which one is being called. Dim.: 7 1/2in. x 9in. x 7 1/2in. overall, for wall mounting. Designed for Ships' use, but suitable for the Home, Office and Factory.

CLYDESDALE'S CARRIAGE PRICE ONLY 27/6 each PAID

Order direct from:

Phone: SOUTH 2706/9

CLYDESDALE SUPPLY CO. LTD. 2, Bridge Street, Glasgow, C.5.
Branches in Scotland, England and Northern Ireland



THORNTON'S DRAWING INSTRUMENTS

We are the largest manufacturers of high-grade Drawing Instruments and Slide Rules in the British Empire, and have gained a reputation throughout the world for superb quality and accuracy. Insist on using only Thornton's for complete satisfaction.

Our illustrated Catalogue, which includes particulars of all drawing instruments, sent on request.

PIC SLIDE RULES

A. G. THORNTON LTD
Drawing Instrument Specialists
WYTHENSHAWE, MANCHESTER.
Tel: WYThenshawe 2277 (4 lines)

FRANK'S of GLASGOW

SELECTED MISCELLANEOUS ITEMS

EX-W.D. PRISMATIC BINOCULARS, by Ross, Kershaw, etc. 6 x 30. Eyepiece focusing. These instruments have a wide field of view and brilliant definition. Every glass has been examined in our own workshops, and is guaranteed to be in sound optical and mechanical condition. Complete with web case and straps **£7 5 0**
(Leather cases available if desired 7/6 extra)

CHARTBOARDS (EX-A.M.)
Comprising wood drawing board 17in. x 17in. to which is attached brass parallel link motion arm with perspex rule protractor. New **12 6**

HEATER ELEMENTS
230 volt, 500 watt. Circular. 4 5/16in. dia. Fireclay heating surface. Brand new and perfect **3 6**

EX-GOVT. TERRY ANGLEPOISE LAMPS
32in. fully extended. Fitted with small bayonet cap lamp-holder and Pygmy reflector. Ideal for fitting to bench or wall. Supplied complete with flex. New and unused **35 0**

POCKET FOCUSING MICROSCOPES
A precision instrument constructed in our own workshops. The optical system consists of 8 lenses (4 achromatic doublets). Definition is crisp and free from colour and distortion. Magnification 20 X **27 6**

SPERRY GYRO UNITS
This unit contains the Gyro and five sets of extremely high precision ball bearings, etc. Brand new **5 6**

MASTER CONTACTORS TYPE II-24 volt
A precision mechanical device driven by a twelve-hour clock which makes and breaks contact 120 times per minute. Spark suppressors are built in. Contained in rubber-lined oak box. Brand new **9 6**

SATISFACTION ON ALL PURCHASES OR REFUND OF PAYMENT

Charles Frank

67-73 SALTMARKET, GLASGOW, C.1.
PHONE: BELL 7100
INSTRUMENT MAKERS AND DEALERS SINCE 1907

LOCOMOTIVES

Their Construction, Maintenance and Operation
By **A. MORTON BELL, O.B.E., M.I.Mech.E.**
New Edition—Revised—Now Ready

The whole of the Engine's mechanism is fully described and illustrated. It explains how the various parts work, their functions and how to keep in good order. The running repairs section shows how to dismantle, remove faulty parts and to effect temporary repairs.

FREE APPROVAL is the Best Test of Value

This is a Work to read and to study for pleasure and for profit. As a work of reference to be referred to in all cases of doubt, it is priceless. The index contains 1,500 references, which enable you to turn up what is required instantly.

ILLUSTRATED BY LARGE FOLDED PLATES IN COLOURS, KEYED DIAGRAMS, DRAWINGS AND PHOTOGRAPHS.

A FEW PRESS OPINIONS:

The Locomotive Journal: "The Set surpasses anything we have hitherto come across."

L.M.S. Magazine: "This work is thoroughly recommended."

G.W.R. Magazine: "This should be a Standard Work for some time."

FREE EXAMINATION FORM NO CHARGE AND NO OBLIGATION TO ORDER

To **VIRTUE & CO., LTD., P.M. Dept.,**
Crown Chambers, Upper Parliament Street, Nottingham.

Please send me "LOCOMOTIVES," in 2 Volumes, price 55/-. I will return it in one week, or send you 5/- deposit, and the balance by 5 monthly payments of 10/-. (Cash price 52/6.)

Signature.....
(Send this Form in an unsealed envelope, stamped 1d.)

Address.....

Occupation.....

PRICE
£4.19.6
COMPLETE

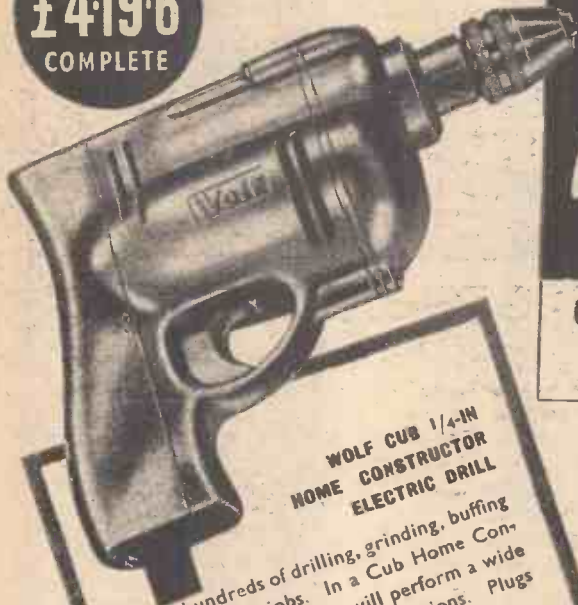

**WOLF CUB 1/4-IN
HOME CONSTRUCTOR
ELECTRIC DRILL**

Does hundreds of drilling, grinding, buffing and polishing jobs. In a Cub Home Constructor Drill Stand it will perform a wide range of bench drilling operations. Plugs into any electricity supply socket.

*Profitable Pleasure
for YOU!*

**COMPREHENSIVE HOME CONSTRUCTOR KITS
WITH **Wolf Cub** ELECTRIC DRILL**

*Specially designed for home use
—at attractive low cost!*

Here is your opportunity to find new joy and pleasure in repairing and constructing things at home! You will be amazed at the many jobs you will do with new power, confidence and real professional skill. From drilling holes to sawing—from grinding to intricate wood-turning! From removing old paint and rust to polishing a table top—from fixing a hat-rack to building "Junior" a model ship! Your Guarantee of Quality is the fact that all the equipment is designed and made by WOLF—Britain's largest manufacturers of Industrial Electric Tools. Realising the long-felt want for a multi-purpose electric tool, Wolf designed the "Cub" to be the power unit in a number of Home Constructor Kits, brief details of which are given below!

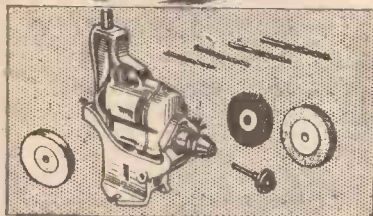

**WOLF CUB HOME CONSTRUCTOR DRILLING,
GRINDING AND POLISHING KIT**

Drills holes in steel, plastics, wood, etc.; grinds all kinds of surfaces; wirebrushes rust and old paint; prepares surfaces for painting; fixes all sorts of household gadgets and fittings.

PRICE
£6.17.9
COMPLETE

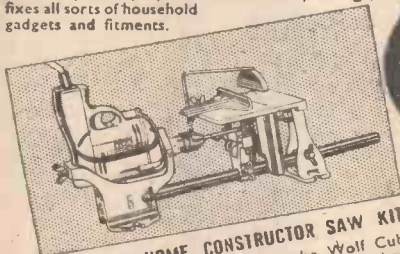

WOLF CUB HOME CONSTRUCTOR SAW KIT

Complete saw kit powered by the Wolf Cub. Table and guard adjustable to take 1" thick timber; 4" circular saw; adjustable straight edge. Also provides a powered work-head and portable electric drill.

PRICE
£8.8.0
COMPLETE

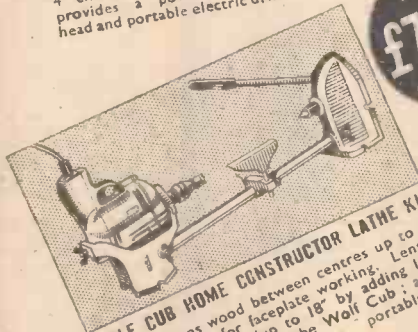

WOLF CUB HOME CONSTRUCTOR LATHE KIT

Turns wood between centres up to 2" dia. and 4" dia. for faceplate working. Length between centres 9" (up to 18" by adding longer pillar). Power unit is the Wolf Cub; also for use as portable electric drill.

See the Cub and the Kits at your local tool supplier. Write for fascinating attractive fully illustrated leaflet, "Profitable Pleasure for Home Constructors," to address below.

Wolf Cub

HOME CONSTRUCTOR ELECTRIC DRILL AND KITS

**SIMPLE
INEXPENSIVE
CONVERSION
SETS-**

**—brings Complete Workshop
Kit within reach of all**

By adding the necessary conversion sets to Cub or any Kit you will possess the complete Wolf Comprehensive Home Constructor Equipment. Conversion Set prices are extremely low and you can purchase sets as and when you wish. There is no need to save up—this is the ideal easy-stage way to indulge your fancy—the moment you feel the need to extend your range of operations.

**WOLF ELECTRIC TOOLS LIMITED
PIONEER WORKS · HANGER LANE
LONDON · W.5 Tele.: Perivale 5631-4**

FREE! TO AMBITIOUS ENGINEERS



This enlarged and entirely new edition of the valuable Handbook "ENGINEERING OPPORTUNITIES"

For 21 years this unique book has been a guiding light to Engineers all over the world. More than 1,000,000 copies have been distributed... there have been 104 editions. Still the demand continues! After months of research, we have been able to produce a better and even bigger "ENGINEERING OPPORTUNITIES" packed from cover to cover with vital, up-to-the-minute information that every engineer requires—information you must have if you want rapid promotion, higher pay, and one of the many worth-while appointments open to technically trained men.

176 PAGES OF PRACTICAL GUIDANCE

"ENGINEERING OPPORTUNITIES" explains the modern, quick way of preparing in your spare time for recognised engineering examinations, outlines hundreds of examination and non-examination courses in all branches of Engineering, describes the benefits of our Employment Dept., and enables you to visualise a secure, better paid and more important position for yourself.

We definitely Guarantee "NO PASS—NO FEE"

B.I.E.T. has helped thousands of ambitious men. We can and will help you. It will cost you no more than a stamp to inquire, and in any case "ENGINEERING OPPORTUNITIES" is well worth having. It will reveal many opportunities you are now missing and, if you are earning less than £10 a week, will be of special interest to you. Make sure of your FREE copy by posting the coupon now.

POST THIS COUPON TODAY!

(Write if you prefer not to cut page)

Please send me FREE and entirely without obligation a copy of the new and enlarged edition of "ENGINEERING OPPORTUNITIES."

NAME

ADDRESS

I am interested in.....

(State subject, exam., or type of appointment that appeals to you.)

BRITISH INSTITUTE OF ENGINEERING TECHNOLOGY
410A Shakespeare House, 17-19 Stratford Place, London, W.1

WHICH IS YOUR SUBJECT?

Mechanical Engineering
A.M.I.Mech.E.—CITY & GUILDS—General Mechanical Eng.—Maintenance Eng.—Diesel Eng.—Sheet Metal Work—Welding—Metallurgy—Machine Drawing & Design—Refrigeration, etc.

Electrical Engineering
CITY & GUILDS—General Electrical Eng.—Installations—lluminating Eng.—Electrical Science—Electricity Supply—Meters & Measuring Instruments—Mains Eng., etc.

Radio & Television
A.M.Brit.I.R.E. — SERVICING CERTIFICATE—C. & G. Telecommunications—General Radio Eng.—Radio Servicing—Television Servicing—Sound Film Projection—Electronic Eng., etc.

Production Engineering
A.M.I.P.E.—Works Management—Foremanship—Staff Supervision—Planning Eng.—Costing, etc.

Automobile Engineering
A.M.I.M.I. — CITY & GUILDS — General Automobile Eng. — Automobile Repairs — High Speed Diesels—Garage Management, etc.

Building & Civil Engineering
A.M.I.C.E. — F.R.I.C.S. — L.I.O.B. — General Building — Architectural Drawing—Sanitary Eng.—General Civil Eng.—Surveying—Specifications & Quantities—Heating & Ventilating—Painting & Decorating — Plumbing — Carpentry & Joinery—Timber Technology, etc.
PLASTICS — DRAUGHTSMANSHIP—AERONAUTICAL ENG.—FORESTRY

SOME LETTERS AFTER YOUR NAME
A.M.I.Mech.E. A.M.I.C.E. F.R.I.C.S.
A.M.I.Struct.E. L.I.O.B. A.M.Brit.I.R.E.
A.F.R.Ae.S. A.M.I.P.E.
HUNDREDS OF OTHER COURSES
(Tell us what interests you)

B I E T

THE B.I.E.T. IS THE LEADING INSTITUTE OF ITS KIND IN THE WORLD

PRACTICAL MECHANICS

EDITOR
F. J. CAMM

JUNE, 1950
VOL. XVII. No. 200

Owing to the paper shortage "The Cyclist," "Practical Motorist," and "Home Moviss" are temporarily incorporated.

FAIR COMMENT

By THE EDITOR

WATER DIVINING

I HAVE been investigating the claims of certain people to be able to locate water by means of a hazel twig or whalebone. The B.B.C. has been giving a great amount of attention to this and it might be concluded from broadcasts and published matter that there is no room for doubt as to the ability of certain gifted persons to find water by such unscientific means.

Accordingly, I thought I would obtain two pieces of whalebone, clamp them together at one end, by means of a piece of rubber tube in the approved way, and try my hand at the mystic art.

I also sought an interview with a water diviner or dowser who arrived complete with a whalebone divining rod and proceeded to demonstrate that it would be able to locate my watch or water. The *modus operandi* is that the two pieces of whalebone are splayed, one limb being held in each hand. A slight tension is placed on the whalebone by the hands and then the operator gradually approaches some spot where he thinks water may be found. If the joined front end of the divining rod makes a violent dip either up or down, water is supposed to be beneath that spot. It is important to remember here that water may be found practically anywhere if you go deep enough so that the dowser is on a fairly safe bet. I tried holding the whalebone myself and the nose end of it took a violent dip as I approached a cup of water. It did the same thing over my watch. Unfortunately for the demonstrator it would take a violent dip anywhere whether water was present or not. I took it to the seventh floor of Tower House, and it still made a violent dip.

The answer of course is, that the dip is caused by the force exerted by the hands on the whalebone, which being flexible soon yields under the pressure, and will dip either up or down to release the pressure. I tried it on every member of my office staff and found that they were all dowsers!

The whalebone people are evidently cashing in on what appears to me to be a scientific racket, because when I telephoned a well-known whalebone importer and told him I wanted two pieces of whalebone of a certain size, he immediately asked me if I required it for water divining, because, he said, "we have whalebone divining rods already in stock at 5/- each!" As the total value of the two pieces of whalebone plus the piece of rubber tubing which joins them together cannot be more than about a penny, one can well imagine that the whalebone manufacturers believe in the divining rod, if not for locating water, certainly for locating silver and gold!

It is my firm conviction that water cannot be divined by means of a hazel twig or a whalebone, and that those who claim successfully to have done so had a large slice of luck. The astonishing thing is that firms of well borers sometimes employ dowsers at quite expensive fees to locate water when it is desired to sink a well. Such firms may save their money in future by writing to me for the address of the whalebone manufac-

turer to whom I have referred and obtaining from him for 5/- a pennyworth of whalebone by means of which they will be able to "locate" water themselves—if they do not decide to go out of business as well borers, and enter the whalebone business.

MODEL COMPETITION RESULT

IN our issue dated January, 1950, I offered prizes of £20, £10, and £5 for the best design for a model or other piece of apparatus. The judging is now completed, and the result is shown in the accompanying list.

Mr. Cain's model was of a vertical steam engine, Mr. Johnson submitted a design for a model hydroplane, and Mr. Shelley a design for a model crane. I hope to publish the winning designs in later issues.

First Prize £20: Mr. S. G. Cain,
11, Park Road, Douglas, I.O.M.

Second Prize £10: Mr. P. S. Johnson,
147, Hamstead Road, Southchurch,
Southend-on-Sea, Essex.

Third Prize £5: Mr. R. Shelley, 45,
Avenue Road, Tottenham, N.15.

THE HYDROGEN BOMB

LITTLE information has been disclosed about the hydrogen bomb; it would seem, however, that it is not ordinary hydrogen which is used but heavy hydrogen, or a compound of it. In nuclear physics it is known that energy can be obtained by converting light atoms into heavier ones. In the atom bomb two pieces of plutonium are used, one at each end of the bomb, the mechanism of the bomb causing one piece to be fired rapidly at the other, and causing an explosion.

PROPELLING PENCILS

NEXT month I hope to publish the results of our propelling pencil competition for which we have received a very large

entry indeed. The judging is almost completed as we go to press with this issue, and this indicates that some really ingenious designs have been thought out by our readers. Some competitors have submitted prototype pencils as well as drawings, although I did not ask for these. I shall publish a selection of the designs submitted in the hope that they will interest mechanical pencil manufacturers.

"PRACTICAL TELEVISION"

OUR new companion journal, *Practical Television*, the third issue of which is now on sale, is a phenomenal success and the demand for it is greatly in excess of our expectations. The demand is evenly divided over the whole country, which indicates that its educational value appeals to those who wish to know about this new science in advance of it being brought to their particular district in programme form. I must apologise to all those readers who, in spite of a large reprint on No. 1, a 100 per cent. increase in the print of No. 2 and an augmented print for No. 3, have failed to obtain copies. Paper and production difficulties, however, must be blamed for this state of affairs. It is hoped that the position may change before the end of the year.

The fourth issue of *Practical Television* will contain instructions for building a television receiver designed and constructed in our own laboratory.

THE FIRST GAS TURBINE

IN our article on The First Gas Turbine Car, in the May issue, there was not space to refer to the original Whittle development work at the Rugby Works of the British Thomson Houston Company. This work began in 1936 and ended with the first flight of a jet in 1941. The Government were not particularly interested in this type of engine in 1936, and had it not been for the work jointly performed by Power Jets, under the direction of Sir Frank Whittle, and by the turbine department of the British Thomson Houston Company, it is unlikely that the jet engine would have been developed so successfully and as quickly as it has been.

The Rover Company came into the development at the stage where there was no doubt about the final outcome, and their part was expected to be the mass production of Whittle engines. This part of the development afterwards went over to the Rolls Company. The pioneer work of B.T.H. resulted in the production of the first flight jet engine. Engine W.1., built by B.T.H. and now in the Science Museum, South Kensington, is the jet engine which in a Gloster airframe made the first flight on May 15th, 1941.

A sister engine W1X, also built by B.T.H., and which also had flown, was sent in secrecy to the United States in September, 1941, for the American General Electric Company to study. This engine has been presented to the Smithsonian Institution, Washington, U.S.A.

SUBSCRIPTION RATES

Including postage for one year

Inland	- - -	10s. 6d. per annum.
Abroad	- - -	10s. 6d. per annum.
Canada	- - -	10s. per annum.

Editorial and Advertisement Office: "Practical Mechanics," George Newnes, Ltd.

Tower House, Southampton Street, Strand, W.C.2

Phone: Temple Bar 4363

Telegrams: Newnes, Rand, London.

Registered at the G.P.O. for transmission by Canadian Magazine Post.

Copyright in all drawings, photographs and articles published in "Practical Mechanics" is specially reserved throughout the countries signatory to the Berne Convention and the U.S.A. Reproductions or imitations of any of these are therefore expressly forbidden.

Helicopters and Their Development

Past, Present and Future

By E. W. TWINING

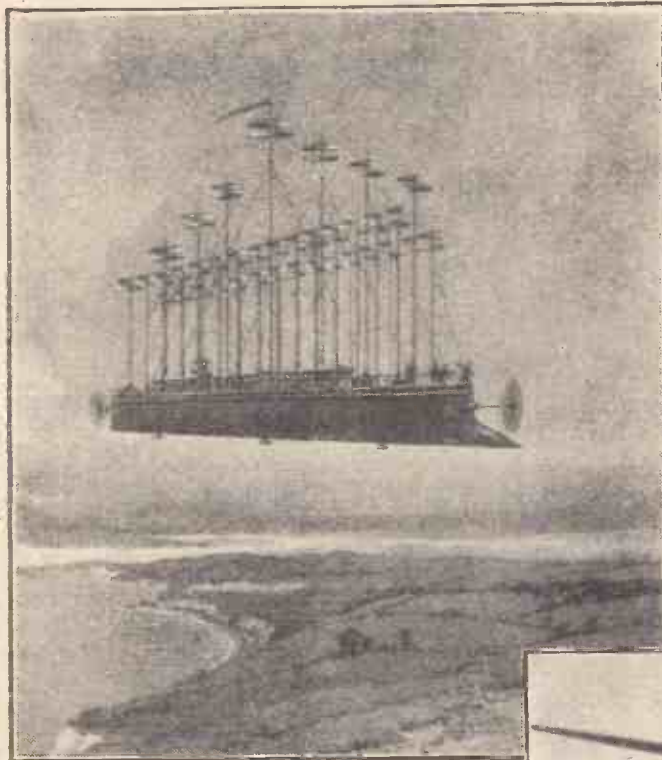

Fig. 1.—Jules Verne's "Clipper of the Clouds."

THE article "Early Days of Model Flying" which I contributed to PRACTICAL MECHANICS for March, 1949, contained a reference to an envelope enclosing sheets of drawings of models, which were the results of my experiments in model aeroplane work up to the date of publication by Messrs. Percival Marshall and Co. in the year 1909. With those drawings the envelope contained a booklet and where, in that booklet, I discussed design and the types of aircraft of those days, I expressed my firm belief that for certain kinds of air travel the—as I called it—"helicoptere," or suspensory screw type of machine, would, in time, be evolved. I ventured to prophesy that, some day, this type would come and urged the need for a larger army of designers and experimenters to carry on the work of bringing it to fruition.

That booklet was written towards the close of the year 1908, forty-one years ago, and now the "helicoptere" is an accomplished fact, though in English we spell and pronounce it "helicopter."

Jules Verne

I would like here to pay a tribute to the genius of that marvellously versatile, scientific story-writer, Jules Verne, a Frenchman, whose birth centenary was celebrated on February 7th, 1928. Most of my older readers, and I should hope many young ones, have been thrilled by the tale of the wonderful aerial voyage of "The Clipper of the Clouds," which clipper, named "The Albartross," was a vessel having a hull shaped much like a sea-going ship, built of a very light and hard material and was airborne by no less than seventy-four rotors or suspensory screws, carried on and revolved by thirty-seven vertical axes or shafts, there being two screws on each shaft. The vessel was, of course, a very far advanced helicopter.

The story made its appearance, fully illustrated, in the pages of *The Boys' Own Paper*, in the year 1887, when I was a schoolboy, and I well remember how one of the prefects and I were thrilled each month as the "paper" came out and how anxiously we awaited the next instalment. Young as I then was I never lost that thrill, nor the firm belief which it inspired in the possibility of mechanical flight until I had myself built machines which flew. My

powered by electricity, the rotors drawing current from ultra-lightweight piles and accumulators; but he concentrated all his machinery into one engine room, amidships, so just how the vertical shafts were rotated we do not know, and he does not explain. In the event of some of the rotors or their connections failing the power which they had been absorbing was automatically transferred to those still working, which resulted in increased revolution speed; thus the lift remained the same. Underneath the Clipper there were buffers, or shock absorbers, for landing, but no wheels, presumably these were deemed unnecessary.

Modern Helicopters

We will now take a look at some of the modern helicopters, and there are not many machines which are other than modern, although a few of an experimental nature were built in the years between the two world wars. One which I remember seeing illustrated had an open rectangular frame



Fig. 2.—The Westland-Sikorsky "S51."

younger readers must remember that the date of reading this story was some sixteen years before anyone actually flew in a heavier-than-air machine.

A few years ago my friend, Clifford W. Tinson, one of the projection engineers of the Bristol Aeroplane Company, lent to me the volume of the B.O.P. containing Jules Verne's story; I perused it again and found it most nostalgic reading. After forty-eight years I still managed to recapture the old thrill. Wonderful vision had Jules Verne. He, as I suppose most people know, wrote other stories, amongst them being: "Twenty Thousand Leagues Under the Sea," a tale of a wonderful submarine, long before any really practical submarine had been evolved. Then there were others: "A Voyage to the Moon," "A Journey to the Centre of the Earth," "The Mysterious Island," and many more.

I have made a drawing of "The Albartross," copied from one of the illustrations to "The Clipper of the Clouds," and this is reproduced in Fig. 1.

Jules Verne makes his dream ship to be

with four rotors, or suspensory screws, one at each corner. This I believe was American. Then there was the Weir machine which rose vertically and hovered above one of the London aerodromes. It is evident that in most cases the engines installed in these machines did not develop sufficiently high horse-powers, and it was not until the appearance on the scene of the Sikorsky that a really powerful and reliable helicopter was evolved. Then came the Bristol machine, which was conceived some five years ago and is now in production.

The Sikorsky S.51 is illustrated in Fig. 2, and is being manufactured in this country by the Westland Aircraft Company. Figs. 3 and 4 show the Bristol Type 171, built by the Bristol Aeroplane Company, to whom I am indebted for all three of the photographs. In Fig. 4 the Bristol is shown with rotor blades in the stowed positions.

A few months ago these two machines, working in conjunction with a Gloster Meteor, Mark VII, jet-propelled normal aeroplane, set up a remarkable record. Rising vertically from a small plot of ground, used

as a car park at the east end of St. Paul's Cathedral, in the heart of London, the Bristol 171 flew to a Kent aerodrome, where the Gloster Meteor was waiting, transferred the message which it was carrying to the Gloster pilot, who took off and landed at Orly, the civil airport, Paris; there the Westland-Sikorsky took over and descended beside the Air Terminal in the Place des Invalides. The trip from the centre of the capital city of one country to the heart of another capital was scheduled to be performed in something under an hour; actually the time occupied was forty minutes. The scheme was sponsored by *The Aeroplane*.

It is obvious that no type of aircraft other than the helicopter could, at the present day, have rendered such a feat possible.

Below is an abridged table of dimensions and other data of the two machines; from this it will be seen that although they differ considerably in the general outline of the nacelles and tail fuselages they are very similar in point of size, weight and performance and both are powered with the same engine.

There is a smaller type of Sikorsky helicopter known as the R.4 (Hoverfly II), this, a single seater, is fitted with a 235 h.p. engine. Then there is the Cierva-Skeeter, also a single seater, having much the same appearance as the Sikorsky, but is still smaller.

Torque Reaction

It will, of course, be obvious to anyone

engine mountings to the machine, which tends to rotate the whole in the opposite direction to that of the lifting blades. This force is known as torque reaction. Many attempts have been made in the past to overcome this, some by the provision of two

opposite direction the reverse action and effect would apply.

In the Bristol, Fig. 4, may be seen, on the port side of the tail, opposite and in line with the torque rotor, a small horizontal fin; this is an elevator, the effect of depressing which



Fig. 4.—The Bristol 171 with rotor blades stowed.



Fig. 3.—The Bristol, type 171.

possessing but a small amount of knowledge of mechanics that it is not possible to have a centralised motor, giving power in one direction without having a reactionary force acting oppositely; so, with the engine driving the blades of a suspensory rotor of a helicopter, there is a reaction transmitted through the connecting rods, cylinders, crankcase and

engines and rotors placed sufficiently far apart to give clearance between the rotor discs, each set of blades revolving in opposite directions, and in others by superimposing the contra-rotating blades, the upper set being driven by a shaft passing through a hollow one on which the lower blades are mounted. The two shafts, hollow and solid, have of course to be coupled by differential gearing.

In the helicopter, as we now know it, both torque reaction and directional steering is provided for by what has become known as a torque rotor; this is clearly seen in the photograph of the Bristol, Fig. 4. It closely resembles a normal propeller and has variable-pitch blades. For straight flying the side thrust of this rotor is made to exactly balance the torque, whilst for a starboard turn the variable pitch-angle of the blades is increased, causing the tail to move to port against the main torque. For a port turn the blades are partially feathered, so reducing the side thrust and allowing the main engine torque to react on the machine. This applies to the Bristol only; since the main rotor blades of the Sikorsky revolve in the

is to raise the tail-end of the aircraft and tilt the axis of the main lift rotors to a forward angle, thus producing a component from the lift to give progressive forward flight. Conversely, the raising of the elevator will, of course, arrest travel and allow the machine to hover.

A variant of the single torque rotor was shown at the Paris Aero Salon last year, fitted on the S.E.-3110, two-seater helicopter, powered by a 200 h.p. Salmson engine. Two arms, streamlined, projected upwards from the extreme end of the tail fuselage, each at an angle of 45 deg. with the horizontal. A two-bladed rotor was mounted on each arm, with the planes of rotation also at 45 deg. and at 90 deg. with each other; but whether they were rotated both at the same time and whether the blades could be independently feathered I do not know. It was evident that they were rotated in opposite directions. The claims put forward for them were: anti-torque, added lift and fore-and-aft directional control.

Jet-propelled Rotor Blades

From time to time aircraft designers and inventors have endeavoured to find means of revolving the lifting rotors by other than centralised engines: that is to say, they have attempted to drive the blades by motors carried by the blades themselves, in several cases, I believe, by small engines driving propellers near the tips of the blades. This, however, without much success, as might have been expected. It was, however, obvious that could the blades be driven independently then all torque effect on the body of the machine—excepting, perhaps, the minute amount due to bearing friction—would be eliminated. Immediately it became known, or recognised, that propulsion by jets was a practicable proposition, inventors, chiefly in Germany, turned their attention to their use for driving the helicopter rotor blades;

	BRISTOL TYPE 171	WESTLAND-SIKORSKY S-51
Rotor diameter (3 blades)	47ft. 5in.	48ft. 0in.
Tail rotor (diameter)	9ft. 7.3in.	8ft. 5in.
All-up weight	5,200lb.	5,100lb.
Tare weight	3,770lb.	3,850lb.
Payload	Pilot, 4 passengers + 150lb. luggage	Pilot and 3 passengers
Speed	100 m.p.h. and over	103 miles per hour, maximum
Range	300 miles at 100 m.p.h.	—
Hovering ceiling	—	7,000
Engine	Alvis "Leonides"	Alvis "Leonides"
Horse-power	550	500
Rotor rotation (in plan)	Clockwise	Anti-clockwise

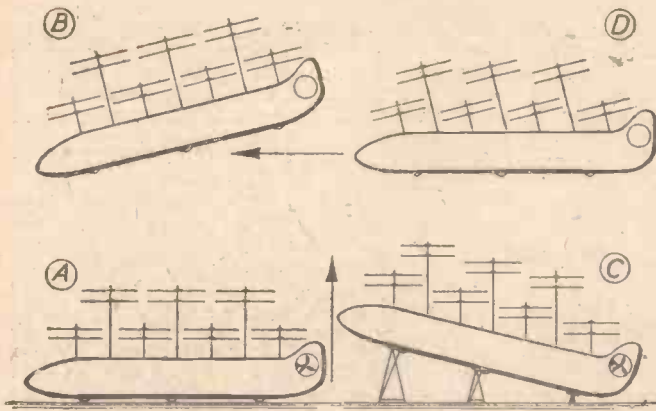

Fig. 5.—Undesirable rotor arrangements.

not by burning fuel in the jets, but by making the central engine drive compressors which supplied air at high pressure to jets on the trailing edges of the blades.

Since the last war proper jet propulsion, as we now understand it, has been experimented with in America. The most successful—and I think it may be said to be fully successful, as regards static lift—is an experimental machine built by the American Helicopter Company, of Manhattan, Kansas. In this, the pulse-jet is employed, the jets having a diameter of 8.75 in. and length of 3 ft. 8 in. Each weighs 23 lb., and its accessories, fuel-pump, valve, meter, etc., 10 lb. The static thrust, maximum, is 95 lb. and the firing frequency 150 pulsations per second. There are two rotor blades only, each sweeping out a radius of 16 ft. 6 in., measured to the centres of the jets, that is to say, a circle of 33 ft. in diameter. The blades have the great width of 20 in., in my opinion a very good point. The blade tip speed is from 300 to 325 ft. per second.

The foregoing particulars of these jet-propelled rotor blades have been taken from *Flight*, for May 12th, 1949.

It is a pity that no figures were given of the anticipated or actual performance of this machine. If we look at the published figures, take the mean blade-tip speed as, say, 312 ft. per second and the diameter 33 ft., the revolution speed is 3 per second, which seems fairly high and likely to set up great centrifugal stresses at the roots, to say nothing of the bending moment at the shaft, on the side of the forward moving blade, when the aircraft is travelling at maximum speed.

It would appear that this out-of-balance effect of the rotor blades is one of the great disadvantages of the present type of helicopter having single big-sweep rotors, for to the tip speed of each blade must be added the forward speed of the machine as a whole. If the aircraft is flying at 100 miles per hour, which is 147 ft. (nearly) per sec., then the forward travelling blade is moving at the rate of $147 + 312 = 459$ ft. per second. On the other side of the helicopter the other blade (assuming there are two only) is moving backwards at a rate of $312 - 147 = 165$ ft./sec. only, so that the out-of-balance lift must be equal to the difference between 165 and 459, that is to say, 294 ft./sec.

It would seem then that, apart from the question of stresses, the out-of-balance lift effect of the two blades will set up a high frequency oscillation in the machine which must, to say the least, be extremely uncomfortable to the pilot and passengers.

Oppositely Revolving Rotors

It should be understood that the foregoing criticism refers more particularly to the experimental two-bladed rotor of the American company, and it may be that the final production aircraft will have more than

two blades on the rotor or that more than one rotor will be employed. With jet propulsion there should be no difficulty in superimposing rotors and driving them in opposite rotational directions, providing they are placed sufficiently far apart, one above the other, to avoid any risk of dangerous interference. If their rotation is properly synchronised any vibration would then be in a vertical direction, since it would obviously be balanced on opposite sides and vibration effect in this case would probably be damped out by the flexibility of the blades. Obviously with the single, three-bladed rotors of the Bristol and the Sikorsky the out-of-balance lift is still present, but I

Future Possibilities

Now what of the helicopter of the future? It appears to me that the machines of this type, at the present day, are in the nature of aeroplanes in which the wings are made to travel in a circular path instead of being fixed to the body of the aircraft and driven straight-forwardly through the air and that this rotation involves the introduction of aerodynamic and mechanical faults which are unavoidable. Why not abandon the rotating wing and revert to the high-speed screw, either centrally driven or jet propelled. If we reduce the rotor diameter and greatly increase the rotative speed we almost eliminate the out-of-balance lift, and by contra-rotation do away with its effects entirely. Moreover, I would introduce multiple units of engine power and multiple rotors or lifting screws.

When Jules Verne designed his clipper helicopter the light internal combustion engine was unknown; there was no motor working on the explosive principle, but the factory gas engine and steam engines had

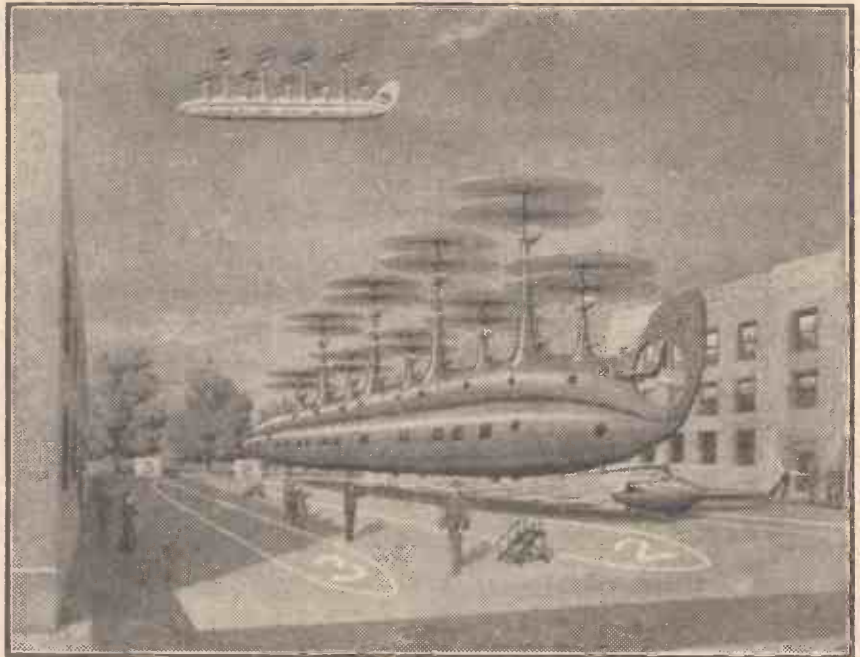

Fig. 6.—The author's conception of a helicopter of the future.

am told that with the speed rotation rate adopted it is not felt by pilot or passengers.

If, as I have suggested above, oppositely revolving rotors are employed there would be no torque on the machine, but either the usual tail airscrew or a large rudder would be required for directional control, preferably the former, because a rudder would be inoperative for rotating the machine whilst hovering. The blades of this screw would be feathered for forward flight or its axis rotated so that it revolves in a horizontal plane; it would then be of use as an elevator or depressor.

Just as I had written all the foregoing a brief description of a new helicopter appeared in the March, 1950, issue of this journal; this from the pen of Mr. M. F. Allward. The machine, of which a photograph was given, is the Fairey Gyrodyne, having a single lifting rotor and no tail rotor. Torque is counteracted by a tractor screw placed on the port side well away from the centre-line of the fuselage. On the fuselage sides there are short wings. For forward travel no lift component is utilised, traction being produced by the normal tractor screw or propeller. No particulars of horsepower or engine are given.

been made which were far lighter than this. Since then internal combustion engines have been developed to such a degree that we now have them weighing less than 1 lb. per horse-power. It would therefore seem that something on the lines of the aerial "Clipper" should now come within the bounds of possibility, though the vertical shafts driving the lifting screws would have to be far more substantial and much shorter than was indicated by the illustrations to the story.

Weight-to-Horsepower Ratios

I have been looking into some of the weight-to-horsepower ratios of the two British helicopters, to which I have referred at some length, and comparing these with two well-known aeroplanes, the Bristol Beaufighter and the Bristol Brabazon. The Beaufighter works out at 6.50 lb. per h.p. The Bristol helicopter "171" has a ratio of 9.45 lb./h.p., the Sikorsky 10.2 lb./h.p., and the Brabazon is loaded to 14.5 lb./h.p. From these figures it would seem that with a multiple power-unit scheme each engine being of high power, that is to say, in the region of 1,600 to 2,500 h.p., the weight

per horse-power could be brought reasonably low, considerably lower than that of any present-day helicopter. By installing a number of such engines, each driving contra-rotative lifting airscrews, we should have a machine which would carry a payload and come well within the bounds of practicality.

The weight of the *Beaufighter*, equipped for long-range flying, is 21,470lb., powered by two Bristol Hercules engines of 1,650 h.p. each. If we installed seven such engines and allowed 5lb/h.p., we should have a machine weighing 57,750lb., or, say, 25.7 tons. With nine Bristol Centaurus engines of 2,500 h.p. each, the weight per unit of power could be slightly reduced, say, to 4lb./h.p., giving a permissible all-up weight of approximately 40 tons. Such machines should be capable of vertical lift at the estimated rate of about 300ft. per minute.

The Bristol Brabazon I aeroplane has a maximum all-up weight of nearly 130 tons and is powered by eight of the Centaurus engines, so that whether our proposed helicopter would be economical to run, as compared with the normal aeroplane, seems doubtful, but against the higher cost of transport by its means must be set the fact that it could rise from and descend into constricted areas in the hearts of cities or on to the flat roofs of buildings forming both transport offices and central airports, and so costly runways on distant aerodromes would be rendered redundant. Added to this is the possibility of making emergency landings in any field or piece of vacant land.

Accessibility to the airport in towns and cities on the part of the intending passenger would constitute a considerable asset, and the payload rate of charges could be higher.

I have said nothing regarding how such an aircraft, having risen into the air, is to be propelled forward. There are three ways in which this can be done: by separate engines driving ordinary propellers, by the employment of jet propulsion or by tilting the vertical lifting screws so as to obtain a forward component from the lift thrust. With the exception of the case of the new *Fairey Gyrodyne*, the last is the method adopted in all existing helicopters, except for the fact that not the rotor axes but the whole machine is inclined in a forward direction.

As our suggested machine will have considerable length, as compared with width, a certain amount of inconvenience would result from tilting the body, hull or fuselage as a whole, because the machine would have to be inclined to the horizontal, either the whole of the time it is in flight or inclined during vertical lift and whilst it is on the ground. Fig. 5 shows four diagrams of a seven-engined machine. A and B would be the attitudes of a machine having axes at right-angles to the fuselage centre line. A on the ground and B in flight, whilst C and D show a machine with inclined axes. Both A and C are in positions to rise vertically, but C and D would involve either retractable supports or an inclined take-off surface, whilst the flying attitude of B is, of course, out of the question.

Angular Thrust

Obviously, as our helicopter would have

to compete to some extent with the aeroplane for rapidity of point-to-point travel, the angle of inclination for the forward thrust component would, for maximum speed, be fairly steep and would, moreover, have to be variable; therefore neither of the forms shown in Fig. 5 are practicable, and the only satisfactory way in which to obtain the angular thrust would be to provide radially pivoted joints in the shafts by means of simple gears, and these joints would best be placed immediately under the rotors. An alternative would be to pivot the masts with their fairings and, with them, the engines, but this would introduce other problems, not the least of which being that whilst the centre of lift would be moved forward the centre of gravity of the fuselage would remain where it was.

In Fig. 6 I give a pictorial view of two helicopters of the future, such as I have attempted to foreshadow, one near the ground having just taken off, and one, with its rotors inclined, in the air.

I have, just by way of suggestion, mentioned Bristol Hercules and Bristol Centaurus engines for the motive power for lifting-screws, but it may be that gas turbines, such as are to be used in the *Brabazon II*, would be more suitable. I have no doubt that they would be lighter.

Finally, I have just had the news that the Bristol Aeroplane Company are projecting a Bristol 173 helicopter, a 10- to 12-seater bus, which, it is hoped, will make its first flight in 1951. It will be powered by two Alvis Leonides engines. So it looks as though the baby is growing up.

A 60-watt Rectifier Panel

A Handy Unit for the Home Workshop

By G. A. MACGREGOR

THE urge to construct a rectifier panel such as the one about to be described was prompted by two motives: the first, to provide the means of giving 12-volt car batteries a boost during the winter months when the amount of current used for lighting is apt to exceed the amount supplied by the dynamo; and the second to afford a reliable low voltage D.C. supply for the purpose of operating 24-volt ex-Air Ministry motors which it was desired to use for driving small tools in the home workshop.

Experiences with "small mains motors" which turned out to be rotary transformers were somewhat unfortunate. None of them gave a power output commensurate with current consumption, and they all tended to overheat badly. One or two were more or less successfully rewound, but this operation involves the amateur in a good deal of trial and error.

Components Required

Tried out on a 12-volt soil-heating transformer a 24-volt camera motor behaved so promisingly that it was decided to introduce a proper low voltage D.C. supply. Two items, viz., a 230-volt transformer giving outputs of 20v.-3a and 32v.-1.5a respectively, and a small rectifier were obtained from advertisers dealing in surplus W.D. goods. These articles cost 19s. 6d. and 17s. 6d. each. Transformer and rectifier have been mounted on a baseboard together with an ammeter and three square-pattern bakelite plug sockets, as in the accompanying diagram. The ammeter reads to 5 amps. and was recovered from an old charging board. The plugs and sockets are of the three-pin

multiple store. The use of a three-pin plug obviates the risk of inserting a plug the wrong way round in the D.C. socket when battery charging. The third pin is, of course, not connected, as an earth was not deemed to be necessary on the low voltages employed.

Wiring

The baseboard is of 3/4 in. softwood, painted two coats of grey undercoat and varnished. The board is mounted on two inch-square battens which afford a means of affixing it to the wall of the workshop and also provide

clearance for the wiring which is at the back of the board. The wiring is carried out in rubber-covered and braided flex, but the new plastic-covered flex, if of sufficient current-carrying capacity, would be suitable. The input from the mains to the transformer is of three-core flex, with the frame of the transformer properly connected to earth.

The transformer is wholly encased in a strong plywood box and attached to the baseboard by six brass glass plates. The rectifier is fixed by passing the clamping and clamping up behind with nut and large washer.

The wander plug on the rectifier input permits of two alternate voltages to the D.C. output. The lower voltage is used for battery charging and the other for supplying current to the 24-volt motors.

Two Motors in Use

So far two of these motors have been brought into use. A small square machine approximately 2 1/4 x 2 1/4 x 3 in. is used as a tool post grinder, with a 2 in. Aloxite wheel belt driven by a small pulley on the motor. The other motor is somewhat larger and drives a flexible shaft and hand tool with circular brush, carborundum tips and polishing mops.

The machines run for 15 to 20 minutes without overheating, or, in fact, becoming really warm.

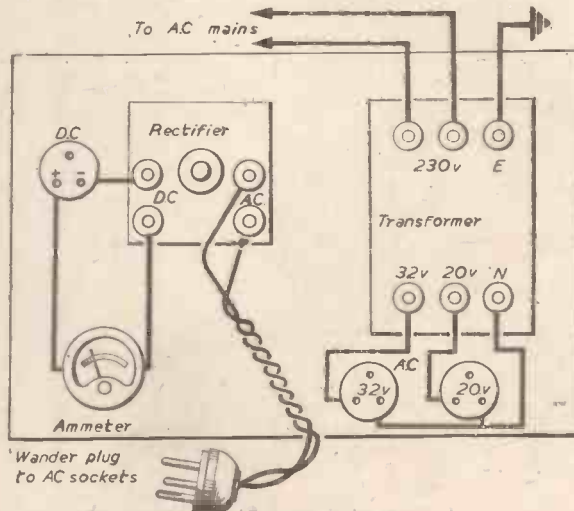

Layout of components and wiring for the 60-watt rectifier panel.

Midget Mains Transformers

Their Design and Construction

By ERIC LOWDON

ALTHOUGH "midget" is the operative word in the title of this article, it would probably have been more correct to say, "Precise Mains Transformer Design," for that is what midget design boils down to in the end, and all the points discussed in this article are applicable to transformer design in general. "Midget" in this case does not mean merely small transformers with correspondingly small ratings, it means small transformers with ratings, so far as output is concerned, which will compare favourably with considerably larger components.

Here, for example, is the specification used in the design example given later in the article:

Primary, 230v. 50 cycles.

Secondaries, 250-0-250v., .070 A., 5.0v.

2.0 A., 6.3v. 1.5 A.

Size, 3×2×2½ inches.

Despite the evident compactness of the design in relation to the rating, safety margins throughout are ample and no special materials are used in its construction.

What, then, is the secret? The answer is simply that the materials from which it is constructed are worked at the safe limit of their capacity. That is to say, the iron is worked at maximum flux density, and therefore the number of turns required on the windings are the minimum; the interleaving and interwinding insulation in the windings is of minimum thickness, thus more of the winding space is available for the copper; and lastly, but not the least important, the temperature rise of the transformer is calculated to be as high as possible compatible with

exceeds 75,000, and, therefore, it is this figure that is used throughout this article.

From the basic formula

$$T = \frac{10^8}{4.44 \times F \times A \times B_x}$$

where T = Turns per volt.

F = Frequency of mains supply.

A = Cross section area of core.

B_x = Flux density.

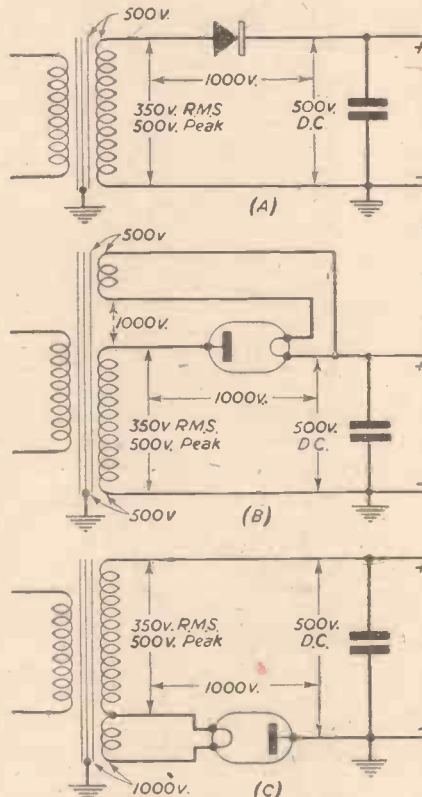

Fig. 1.—Diagrams showing voltages existing between windings, and core and windings, under various circuit conditions.

we can now derive an expression using as constants B_x=75,000 and F=50 that will enable us to find the turns per volt required on the windings, given a particular area of core, thus:

$$T = \frac{10^8}{4.44 \times 50 \times A \times 75,000} = \frac{6}{A}$$

The turns per volt are therefore directly proportional to the core area; if the area of the core is 1.0 square inch then the turns per volt necessary will be 6, or if the area is 2.0 square inches, the turns per volt will be 3, and so on.

There is always a core loss in transformers, that is to say, a portion of the input watts is dissipated as heat in the iron, and the extra current necessary to supply the loss also means increased copper loss in the primary. The loss is usually given by the manufacturers of the laminations in watts per lb. weight of core, and for accuracy in design it is just as well to know what this figure is likely to be. For .015 inch laminations at flux density = 75,000 and frequency = 50 cycles, the figure may be taken as 1.0 watt per lb.

Insulation

The insulation requirements of a transformer, i.e., the paper interleaving between

layers and windings, are governed firstly by the electrical stresses that it will be required to withstand, and, secondly, by the mechanical stresses. The first mentioned will depend to a great extent on the type of circuit with which the transformer is to be used. Consider Fig. 1(A), which illustrates a simple half-wave power supply circuit, using a metal rectifier.

The secondary volts are given as 350, but as this is the R.M.S. value the peak volts appearing across the winding will be: 1.414×350=494.9 volts, say 500 volts to avoid unwieldy figures. If we assume a very small load on the circuit then the peak D.C. volts on the condenser will also be 500 volts, thus the peak voltage appearing across the rectifier will be 1,000 volts made up of the steady 500 volts D.C. across the condenser, and the 500 volts across the winding on the non-conducting periods of the rectifier.

As the core is normally earthed the maximum volts appearing between any two points in the transformer will be that between the top end of the secondary winding and the core, i.e., 500 volts, and the insulation at this point must be sufficient to withstand this voltage.

In the circuit of Fig. 1(B) a somewhat different state of affairs obtains. Here we have a similar circuit, but using a valve rectifier instead of metal. As before, 500 volts are developed across the secondary H.T. winding, 500 volts across the condenser, and 1,000 volts across the rectifier. The position is, however, complicated by the presence of the heater winding, for the 1,000 volts developed across the rectifier must also occur

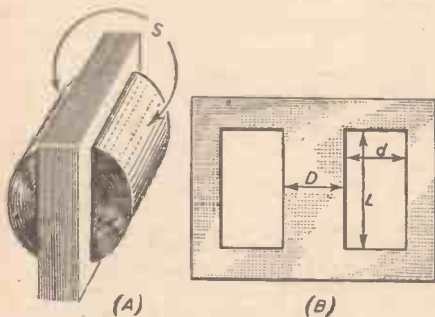

Fig. 2.—(A) Showing the surface areas taken into account in temperature calculations, and (B) the lamination dimensions used.

the safety of the insulation, thus allowing the thinnest wires to be used.

It is precisely on these points that the rule-of-thumb methods, commonly used by amateurs, fall down, for the safety margins used are usually too generous. There is little merit in building a bridge to carry 20 tons if it is to be called upon to carry a maximum of only 5 tons.

All this may lead the reader to believe that he is about to be dazzled by a display of mathematical pyrotechnics. Far from it! The mathematics involved are of the simplest, and can be successfully dealt with by any amateur.

The Core

Suppose we make a start with the core. The material used is silicon iron such as Stalloy or Silcor. The maximum flux density for this material is often quoted at round about 82,000 lines per square inch, but for a number of reasons the writer never

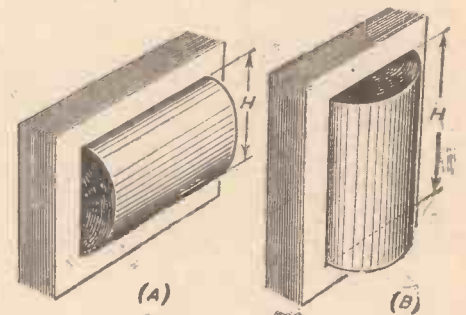

Fig. 3.—(A and B) Explaining dimension H used in temperature calculations.

between the heater winding and the H.T. winding, and the insulation between them must be sufficient to withstand this pressure. In addition we still have 500 volts between H.T. winding and core plus 500 volts between the heater winding and core, this is the D.C. potential developed across the condenser.

If we try to ease the insulation requirements by using the circuit of Fig. 1(C) the high potential between H.T. winding and heater winding is certainly eliminated but it now appears between windings and core.

It will be seen, then, that by taking account of the circuit with which the transformer is to be used no more insulation than is necessary need be included. It cuts both ways, of course, for we will also ensure that we put sufficient insulation in the right places.

As a guide to the choice of inter-winding insulation a barrier of paper .020in. thick, built up of several turns of thinner paper, say, 4 turns of .005in., will be safe for 800 volts and will withstand a flash test voltage of more than 2,000 volts. It should also be remembered that the thinner the paper with

which the barrier is built up the better will be the insulation properties, that is to say, 10 turns of .002in. paper is better than 4 turns of .005in., also varnished fabrics are superior to paper but are, of course, more expensive.

The barrier thickness will be proportionate to the volts, thus 1,600 volts will require a thickness of .040in. and 400 volts a thickness of .010in., but, for mechanical reasons, and irrespective of the volts, the thickness should never be less than this figure of .010in.

Temperature Rise

The principal limiting factor to the reduction in size of a transformer is the temperature to which it will rise, for the temperature of a small component will be greater than that of a larger component of similar rating, and if reduced too far a point will be reached where the heat generated internally will be sufficient to destroy the insulation over a period of time.

A generally-accepted safe, maximum figure is in the region of 95 deg. C. Now it follows that part of the final temperature will be contributed by the heat generated in the transformer itself, and part by the temperature of the atmosphere surrounding the transformer. For instance, the temperature inside a receiver cabinet and particularly in the vicinity of the valves will be quite high. It is, in fact, normal practice to design the transformer for a maximum temperature rise not exceeding 50 deg. C. and to assume that it will be used in locations where the ambient will not be greater than 45 deg. C., making a total temperature of 95 deg. C. It will be obvious, then, that if the transformer is to be used in an open location where the ambient is expected to be considerably lower than 45 deg. C. it can, with safety, be designed for a higher temperature rise and, therefore, smaller bulk, providing the total is not more than 95 deg. C.

The temperature rise of a transformer is that of the hottest part of the winding and will usually be located in the primary. It is related to the watts loss in the windings; the thickness of insulation through which the heat must pass to the outer air; and the surface area of the coil on which the heat will be dissipated. The core temperature due to iron loss can be neglected, for it is found that the interchange of heat between core and coil is so slight that it will contribute little to the ultimate winding temperature.

For design purposes the following formula will give the temperature rise with a good degree of accuracy:

$$T = \frac{20W}{S} (9.4t + H)$$

where W = Watts dissipated in the windings.

S = Effective cooling surface area of the coil.

t = Total thickness of paper insulation in windings.

H = Vertical height of the coil.

The factors taken into consideration in assessing a value for S will be understood by referring to Fig. 2(A). The surface area is taken to be the exposed surfaces of the winding on each side of the transformer, shown shaded in the diagram. The parts of the surface covered by the core can be neglected, also the sides of the coil contribute little to the cooling as air trapped between the interleaving papers forms a very effective blanket.

Thus, provided the window space of the lamination is completely filled, as it should be for maximum efficiency, S can be written in terms of the lamination dimensions shown in Fig. 2(B) thus:

$$S = 2L (D + \pi d)$$

The meaning of the symbol H will be clear by reference to Fig. 3 (A and B). It is assumed that the transformer will be

mounted in one of the two positions shown. Shrouded components, or those mounted with one side of the winding below chassis, are not catered for in this formula. In such cases the temperature rise will be somewhat higher.

General Design Points

During the course of the design it will be necessary to work out a number of small arithmetical sums, and, though simple enough taken singly, they may become confusing taken altogether unless steps are taken to put them down in an orderly fashion. A design

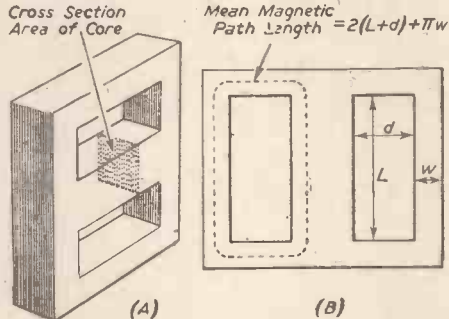

Fig. 4.—(A) Shows cross-section area of core and (B) the mean magnetic path length.

sheet on the lines of that shown in the accompanying design sheet should be drawn out, and the result of each calculation entered thereon as it is done.

Now, with regard to the calculations themselves. There are a number of small points which must be observed if accuracy is to be obtained. First, core calculations.

It is usual in articles of this description to give a formula for assessing the core area to be used for a given power rating. It should be understood, however, that such formulae are intended only as a rough guide. Bearing this in mind, the following formula may be used to obtain the approximate area required, the figure obtained being subject to modification as the design proceeds.

$$A = .15\sqrt{W}$$

Where A = Cross section area of core as indicated by the shaded portion Fig. 4(A).

W = Total watts input to the transformer.

To find the total watts lost in the core it is necessary first to calculate the weight of the core. This is done by first of all calculating the volume (V) of the material as given by the cross section area of core multiplied by the mean magnetic path length, that is the mean path length round one window of the lamination as shown in Fig. 4(B). The weight for silicon iron is now:

$$Wt. = Volume \times .28lb.$$

and the watts lost in the core

$$W = Weight \times \text{watts per lb.}$$

a suitable figure for watts per lb. was given earlier in the article.

Winding Calculations

The following points with regard to winding calculations are very important and should be noted carefully.

In working out the number of turns per layer of the winding the turns per inch figure given in wire tables should be multiplied by a "winding factor" of .95, i.e., if the wire tables give the turns per inch of a particular gauge of wire as being 100 the actual figure used in the calculations should be $100 \times .95 = 95$, and this makes allowance for the fact that it is seldom possible to lay the wires exactly side by side.

Because of bulge in the windings the depth is always greater than the total thickness of materials used, and to allow for this it is necessary to add approximately 15 per cent. of the calculated depth to the figure obtained in order to arrive at the actual depth occupied in practice. This point will be quite clear in the worked out example.

The current ratings given in wire tables are usually on the basis of 1,000 amps per square inch; this figure may be doubled if necessary provided that the temperature rise of the transformer is within the limits of safety.

(To be continued)

First Gas-turbine Locomotive



The new gas-turbine locomotive, the first to travel on British Railways, is here seen passing through Wootton Bassett during its first main-line trial. Rated at 2,500 h.p., it reached a speed of 90 miles an hour during tests in Switzerland, where it was built.

The Elements of Mechanics and Mechanisms—32

Methods of Power Transmission (ALL RIGHTS RESERVED)

WHATEVER the source of energy utilised for the performance of mechanical work, whether it be steam, electricity, internal combustion or anything else, some mechanism is usually needed to convert that power into the form necessary for the particular type of work. For instance, in the case of the ordinary steam-engine the power is supplied in a reciprocating form, that is, by a piston which moves backwards and forwards, whereas it is usually required in a rotary form. The necessary conversion is therefore carried out by means of a connecting rod and crank.

Connecting Rod and Crank Systems

An illustration of the steam-engine system of connecting rod and crank is given in Fig. 70. The fact that steam is fed to both the top and bottom of the piston alternately necessitates the use of a rod known as the piston rod, which operates through a steam-tight gland in the end of the cylinder and transmits the power from the piston to the connecting rod. The piston rod is really a necessary evil, for it does nothing in itself to convert the direction of the piston's motion. It is employed merely to convey the motion of the piston to the little end of the connecting rod, without allowing the escape of useful steam from the cylinder. Its external end slides between two guides. Of course, without these guides it would tend to warp or bend with each thrust of the piston, the greatest strain being when the crank is roughly at right-angles to the axis of the cylinder. Fig. 72 shows how the force of the piston and resistance of the connecting rod resolve themselves into this side thrust on the end of the piston rod, thus necessitating the use of guides.

In the internal-combustion engine, as employed in motor-cars, motor-cycles and model planes and speed-boats, the driving force is confined to the top of the piston, therefore the use of piston rod and guide rods, etc., is entirely dispensed with. Fig. 73 shows how the little end of the connecting rod is pivoted directly inside the hollow piston.

This form of transmission can be made extremely difficult, especially if the main bearings of the crankshaft and the big end of the connecting rod are carried on ball or roller bearings. It suffers, however, from that one disadvantage associated with all reciprocating systems, due to the weight of the reciprocating parts. This weight not only reduces the speed of acceleration and

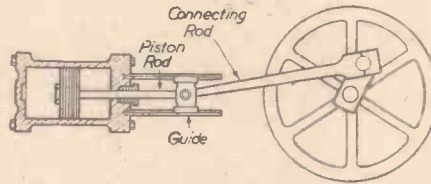

Figs. 70 and 71.—Connecting rod and the crank mechanism of a steam-engine.

deceleration, but tends to produce vibration. Even with the weight of the piston and connecting rod most carefully balanced by means of counterweights incorporated in

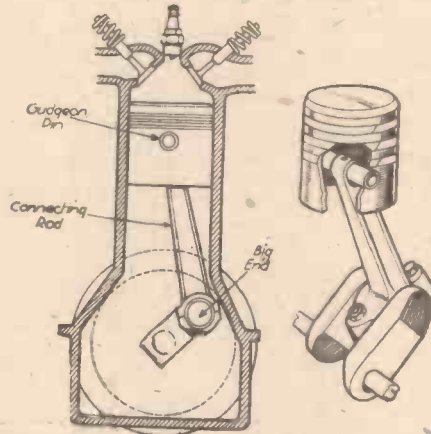

Fig. 73.—Connecting rod and crank assembly of an automobile engine.

the cranks or flywheels, vibration is likely to manifest itself at high speeds. Sometimes vibration "periods" occur. For example, an engine will run quite smoothly up to a certain number of revolutions per minute, say, 3,000—and will then vibrate badly up to, say, 3,500 r.p.m.

Above this speed, however, it will again run smoothly. This phenomenon is often due to the "natural" frequency of the whole unit coinciding with the frequency of the reciprocations of the engine at that certain speed. It is analogous with the classic example of the troop of soldiers

marching in step across a suspension bridge and, by reason of the rhythmic beat of their feet coinciding with the natural period of frequency of the bridge, causing it to oscillate violently in harmony with each step.

Weight of Reciprocating Parts

The need for making the piston and connecting rod as light as possible becomes very apparent if you consider that quite a usual speed for an internal-combustion engine is 5,000 r.p.m., and that this speed means about 167 upward and downward movements of the piston per second. In other words, the piston is started and stopped 334 times per second. If you look at Fig. 73 you will see the reason for this. At the instant depicted the piston is moving downward. When half-way down it will be moving at its greatest speed, but this speed will decrease rapidly until it reaches the bottom of its stroke, when for an infinite short time it will remain stationary. It will then start on its upward journey until it reaches half-way, when it will once more decelerate until it stops at the top of its stroke. It then starts on the next downward stroke, and so on. Thus, you see, the piston actually accelerates twice and decelerates twice in the course of one revolution of the crank. Obviously, if the piston and the connecting rod are very heavy, the inertia to be overcome in alternately accelerating and decelerating something like 300 times per second will be enormous. It speaks well for the skill of modern metallurgists that alloys are available for piston and con. rod construction which are light enough and strong enough to permit of speeds up to 10,000 r.p.m.

The design of cranks is by no means uniform, and various types are employed in different mechanisms. In some cases the crank is built up as in Fig. 71, in others it may be a solid forging such as the crankshaft of an automobile engine as shown in Fig. 74, or again crank and flywheel may be combined as in Fig. 75. This last arrangement is commonly used for small model steam-engines of the oscillating cylinder type, while Fig. 76 shows a motor-cycle engine in which the big end of the connecting rod bears on a crank-pin joining the two flywheels.

In aero-engine design, where multi-cylinder power units are the rule, some very elaborate con. rod and crank assemblies are to be found. Fig. 77 shows the principle of

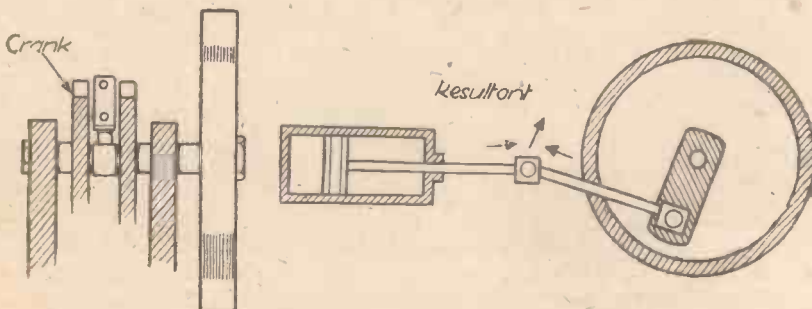

Fig. 72.—Diagram showing the forces producing side thrust on a piston rod.

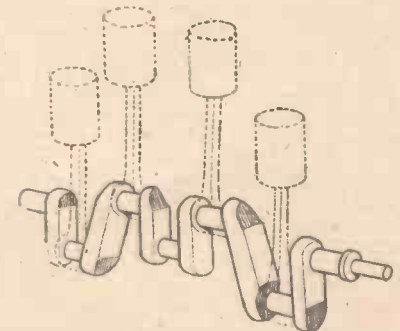

Fig. 74.—The arrangement of the cranks in a 4-cylinder engine (three-bearing crankshaft).

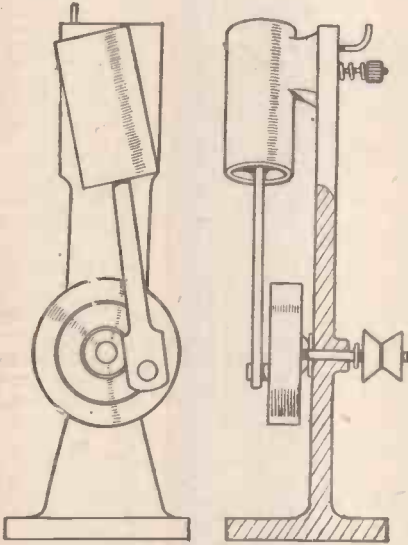

Fig. 75.—Simple oscillating steam-engine showing overhung crank.

the radial and rotary types of engine. Here several connecting rods operate on the one crank, and some ingenious methods are employed to accommodate the big ends of the various connecting rods. A simple example of how more than one big end can be accommodated on one crank, when the cylinders are in line, is shown in Fig. 78. This is the usual arrangement adopted with a "V" type twin-cylinder engine. A stirrup-shaped big end is used for one of the con. rods. An alternative method is shown in Fig. 79. Of course, where it is not necessary to have the cylinders in line, the big ends may be placed side by side as in Fig. 80. However, in the design of radial and rotary engines, with perhaps 14 or 18 cylinders, the problem is not quite so simple. Usually an elaboration of the method shown in Fig. 79 is employed.

The Eccentric Belt Cam

A piece of apparatus which is closely allied to these crank devices is the eccentric cam. Builders of model steam-engines and locomotives will be quite familiar with this. It is illustrated in Fig. 81, and is usually used to carry out a reversal of the action performed by the con. rod and crank, that is, it converts rotary motion into reciprocating motion. In the steam-engine it is used to impart a backward-and-forward motion to the valve gear by utilising the rotation of the crankshaft. Keyed or otherwise fixed to the crankshaft C is a circular disc or Cam E. This, as its name implies, is mounted eccen-

trically on the shaft so that as the shaft revolves the centre of the disc traces out a circular path round the shaft. A metal strap S encircles the eccentric, which is able to rotate freely inside the strap. As this strap is an integral part of the eccentric rod R, the rotation of the eccentric causes the rod to adopt a crank-like action and so push the rod V backwards and forwards. This latter rod operates the valve. The dotted lines in Fig. 81 show various positions of the eccentric and rod in the course of a revolution of the crank.

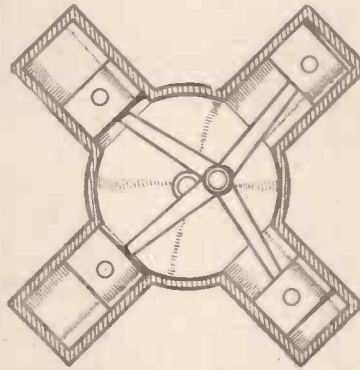

Fig. 77.—Principle of radial and rotary type engines.

The circular belt cam of the steam-engine is but one of circular cam devices usual for converting circular motion into reciprocating motion, and vice versa.

The cams used to operate valve gear of automobiles are either pear-shaped or else squarish, as in Fig. 82. The object of a cam is to open and close its associated valve at the appropriate times during the explosion cycle. The ideal to be aimed at is the sudden opening of the valve to its full open position at just the right instant; the retention of

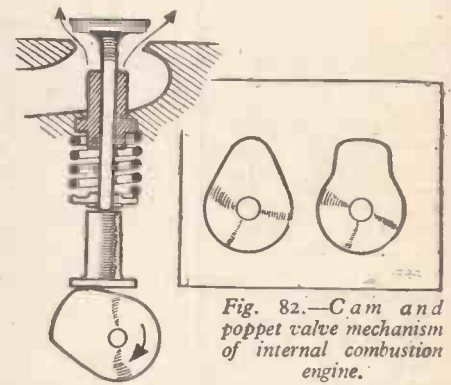
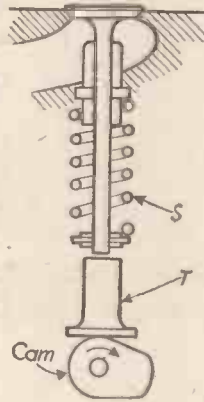

Fig. 82.—Cam and poppet valve mechanism of internal combustion engine.

cam, after which the valve is instantly closed again by the force of the spring.

(To be continued.)

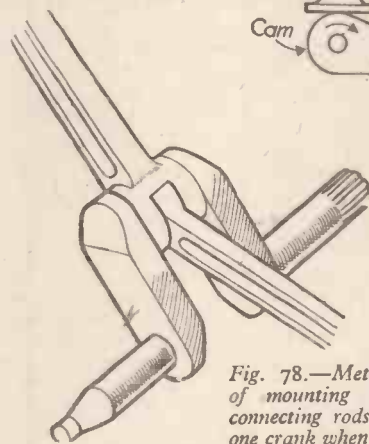

Fig. 78.—Method of mounting two connecting rods on one crank when the cylinders are in line.

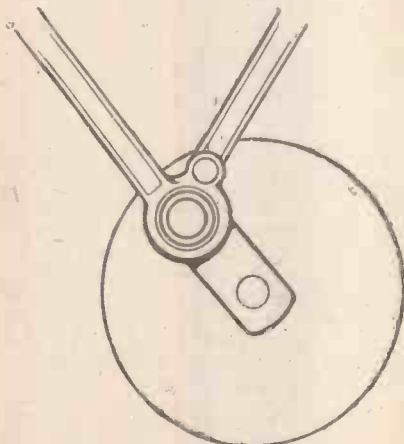

Fig. 79.—An alternative method.

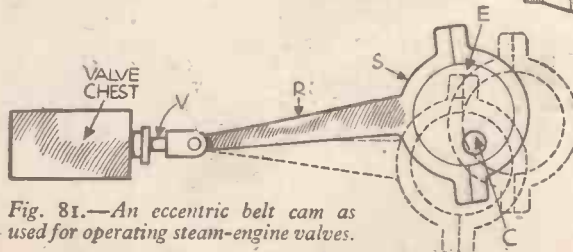

Fig. 81.—An eccentric belt cam as used for operating steam-engine valves.

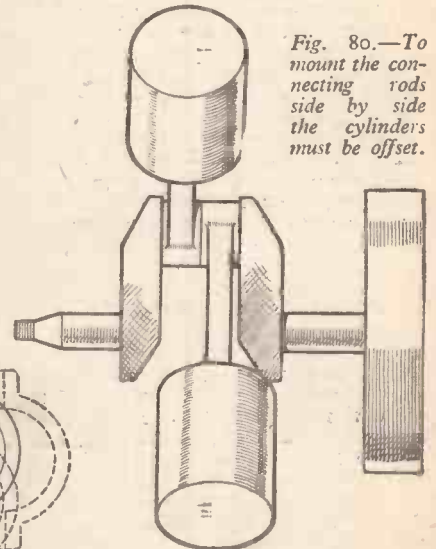

Fig. 80.—To mount the connecting rods side by side the cylinders must be offset.

New Industries Will Bring New Jobs

A Million Boys To-day Will Work in the New Industries of To-morrow

By Professor A. M. LOW

TEN or twenty years hence a million or more men and women in Britain will be working at jobs which do not exist to-day because the industries are still in their infancy. It has happened before. There is an interesting case of plastics recently quoted by Mr. Brendan Bracken. A few years ago the number of men and women making a few simple articles in plastics was only two or three hundred. Now it is about 100,000, and it would be a bold man who suggested that this number will not be at least doubled within a generation.

The number of workers in the electrical industry in Britain a century ago was negligible. In fifty years it became some hundreds of thousands as the result of jobs "created" by inventions such as the dynamo, the electric motor and electric lighting. In more recent times we have seen completely new industries grow from feeble beginnings to full stature. Artificial silk was in the embryo stage not so many years ago and the industry seemed as precarious as the thread produced, but men had faith in it, and it is interesting to note that it is one of the instances where exports have steadily increased, even during the war.

Always the difficulty has been a shortage of technically trained young men and women to enter the new industries because there has been so little foresight. The motor industry, when it began to grow rapidly, had to recruit men from other trades. Viscount Nuffield himself, it will be remembered, "graduated" from bicycles.

To-day there are probably more "new" industries in process of growing up than we have ever known. Our success with them will depend very much upon having the right young men and women to take an interest, and to train in readiness for the day when recruits are needed.

Radio and Television

What are the industries that will offer to-morrow's new jobs? Radio, built up almost entirely since the last war, should expand greatly, especially if we can learn to make the kind of sets wanted by other countries which have no radio industry of their own. Television will bring millions of new customers, at home and abroad, and if we are enterprising there is not likely to be a mere "boom" followed by a slump when all the customers have their sets. If sets can be made so cheaply that it "pays" to replace them every few years (as with cars) there will be a continuous demand, and it will soon be possible to introduce improvements such as "stereoscopic" and colour reception.

A great number of the workers in the radio industry will be comparatively unskilled, but with an expanding industry there should be a steady demand for the technically qualified men. They will be required for erecting installations at home and abroad, for repairs, for the servicing of sets that will become more complex, and for design or testing. We began the post-war period with the asset of many thousands of men and women trained to varying degrees in the Services, but we should also ensure that there are plenty of boys to-day with the opportunity of becoming the highly skilled radio engineers of to-morrow. It is fashionable to minimise the value of a degree or other institutional qualification, but from long experience of engineering I would encourage the young man to qualify before anything else. It means more than a string of letters after his name if he

is a little better than the memory-examination crank.

Electronics

Radio is only one branch of a great new industry with a name which is not even generally familiar—"electronics." This really covers the whole field of devices in which the electron is harnessed. Astonishing things are being done with "electrons" to-day. Radiolocation is only one example of the control it permits. Cooking without outside heat, smoke and dust collection, new forms of lighting, magnification on an unprecedented scale, completely automatic sorting and testing of almost every kind of product—these are a few electronic devices well past the experimental stage, although not yet in mass production. There seems almost no

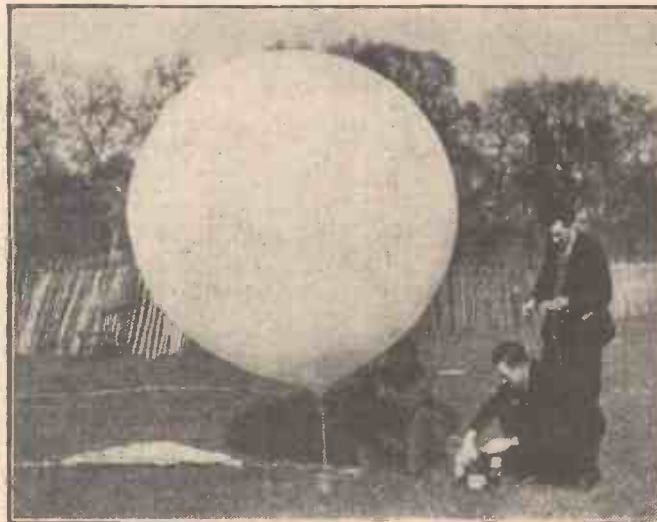

At a recent demonstration in Hyde Park, a radiophone, designed by Salford Electrical Instruments, Ltd., for the Meteorological Office, was released. Signals automatically transmitted from the radiophone were received, and details of the proceedings were relayed by G.E.C. "walkie-talkie" radio. (Photo by General Electric Co., Ltd.)

limit to the complexity of the manufacturing process which electronic devices can control automatically. The device that guides a remote-controlled gun in a bomber on to a fighter weaving in at 400 m.p.h. will be adapted to the control of manufacturing processes requiring equally intricate calculations.

The future for electronics is as bright as was the future of electrical engineering 70 years ago—perhaps brighter, for progress is likely to be much more rapid. It will give thousands of skilled jobs to young men who to-day hardly know its name. They will handle with ease devices which to their fathers will seem little less than "magical."

New Metal Alloys

Another industry likely to offer great opportunities, although, perhaps, less dramatically, is that of new metal alloys. The war has seen a tremendous development in the use of magnesium and aluminium alloys with all their advantages of lightness with strength. A development such as the perfection of a magnesium alloy suitable for cooking utensils would see to-day's demand as great as that in war. The number of possible alloys of the metals is virtually infinite and new industries will be based on

harder metals, springier metals, stronger metals—on alloys specially designed for making every kind of machine from a watch to a locomotive more efficient and hard wearing.

Plastics

That plastics will offer thousands of new jobs hardly needs emphasis. During the last thirty years Britain's textile exports have melted away. If we can find the technicians there seems a great opportunity in the next ten or twenty years to regain our position as the premier textile country with completely new fabrics; in many cases they can be a combination of natural with the synthetic fibre. The plastic house may be far away, but it is obvious that new industries are going to be based upon the plastic impregnated plywood that has shown itself as strong as steel in aircraft. A new industry may also be founded

on the discovery of methods by which common woods can be impregnated with chemicals to make them as strong and effective as oak or other more valuable hardwoods.

Aviation

What about aviation? After the tremendous "boom" of the war it seemed likely that the number of qualified men would far exceed the demands for civil aviation for many years to come. On the present lines of development it does not look as if civil aviation in Britain will offer a career to more than a comparative handful of men for some years. When the new era of private

aviation comes it may be a different matter. Obviously, if the aeroplane became as common as the car, new industry would be built up for the construction, repairing and servicing of planes.

"New" Industries

These are only a few of the "new" industries that will offer the jobs of to-morrow. There will be a vast expansion of the industries making refrigerators and other household articles. Dehydration, quick-freezing and other methods of preserving food will mean a demand for more men with technical knowledge. The twenty years ahead, indeed, should see a tremendous demand for technicians of every kind, and upon our ability to meet it depends not a little our prosperity, health and happiness. The spreading of spending power brought about by taxation or social legislation can result in many additional jobs in the older trades and professions. Now that everyone has full and free medical and dental treatment, there will be more need for doctors and dentists. Education, in the same way, will demand many more teachers in the higher grades.

Model Electric Launch

Constructional Details of a Small Boat with a Tinsplate Hull

By G. DEWYNTER

THIS small model electric launch will provide many hours of fun and pleasure for any youngster between 7 and 14 years. The whole job should not take more than a few hours to build, and the total cost not more than 12/6, of which 8/6 is for the small but efficient "Electro-tor" motor.

Start by marking out and cutting the flat

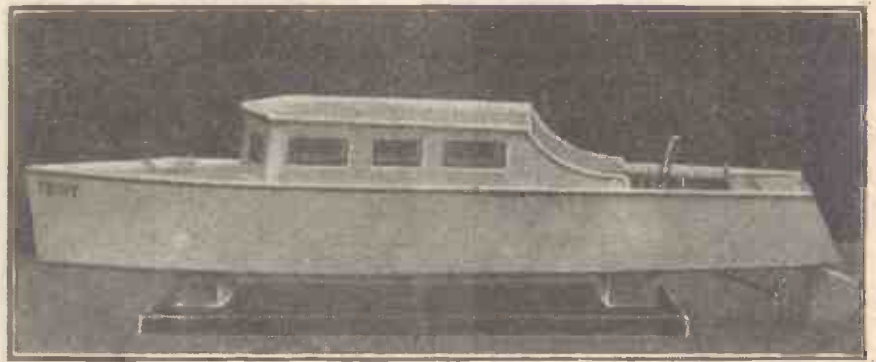

This view of the completed model launch gives a good idea of its neat appearance, and also shows the position of the switch lever.

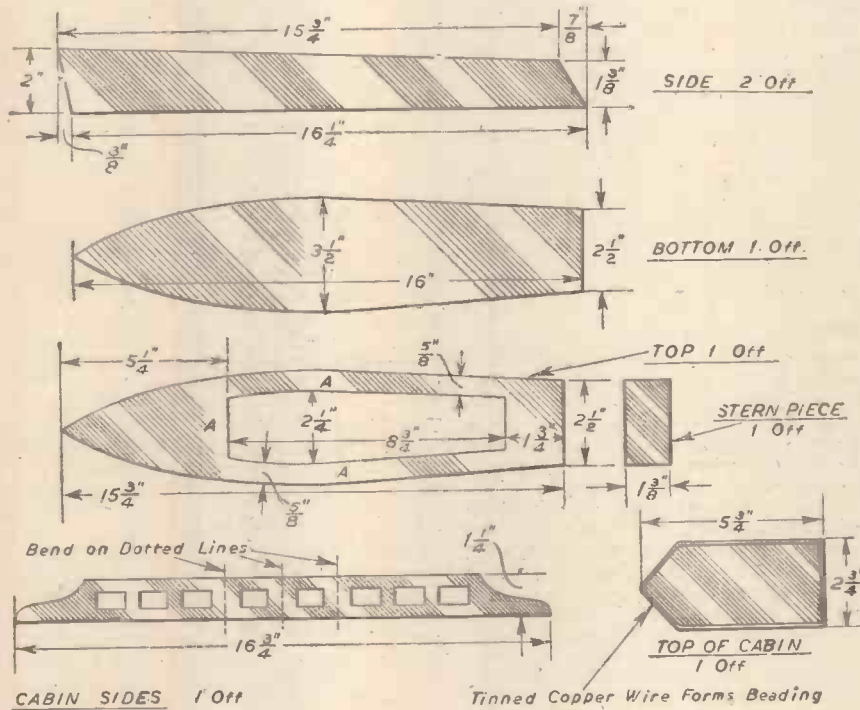

Fig. 1.—Showing how to mark out the blanks for forming the hull and superstructure.

bottom (Fig. 1) from 24-gauge sheet tin, obtainable from any good ironmonger for 2/6 (size approx. 30in. x 20in.). Next the two sides are cut out, then the stern piece followed by the decking. The original boat was 16in. long, but it can be made larger, keeping all parts in the same proportion as the sketches.

Forming the Hull

Commence assembly by soldering the sides in position along each edge of the bottom and follow on by fitting stern piece. Next, make up battery-holding angles, the bulkhead and the motor-fixing clip, and solder all in position. Fit decking and cabin sides, the latter being in one piece.

The rudder is made from 1/16in. sheet brass soldered to a length of cycle spoke, which is pushed through a piece of brass tubing and bent over to form a tiller (see Fig. 2).

The propeller is made from thin sheet brass, in the flat, and the blades twisted a little to give the pitch. Solder to a piece of

cycle spoke and, after fitting the propeller tube in place, push the shaft through the tube ready for fitting to motor spindle, with a short piece of rubber tube for a flexible coupling. A short piece of rubber insulation from a flexible cable was found to be quite suitable.

The motor is run off two 1 1/2-volt cells (Ever-Ready U2) and these in series were found to give a better performance than the standard 4 1/2-volt flat torch battery in spite of the voltage being only 3.

The Switch

A small switch may be made from odds and ends. The base is a small piece of fibre, or ebonite, the handle the top of an old wireless plug, and the switch blade is a thin piece of springy flat brass. Contacts are brass pins driven into the fibre block, and soldered connections are made to them at the back of the block. One side of the battery and one side of the motor is "earthed" through the hull so that two wires only are needed in wiring up.

Now cut out the top for cabin and fit pieces of angle, bent up out of tin, round

(Continued on page 306)

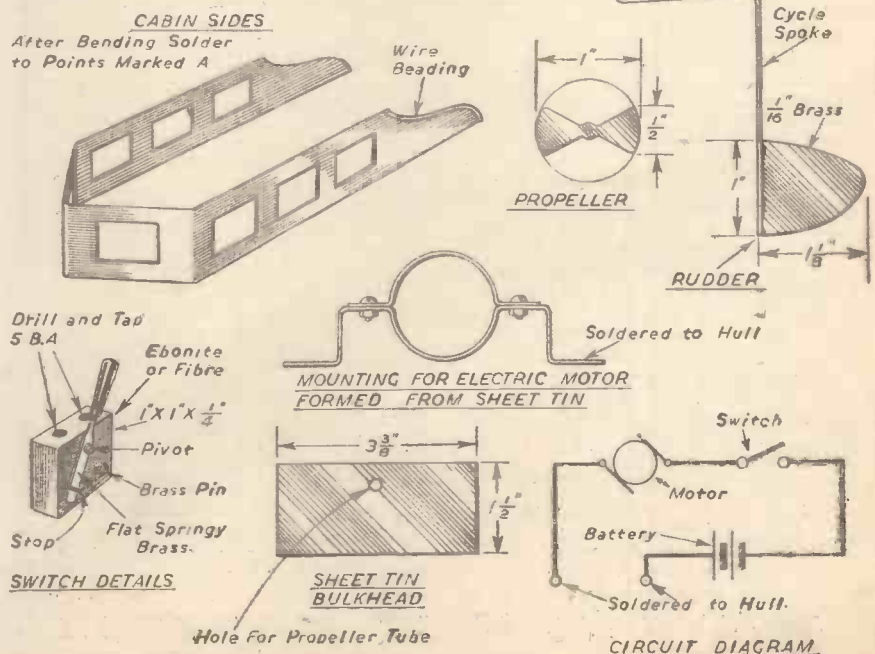

Fig. 2.—Details of the cabin sides, propeller, rudder, switch, and the circuit diagram.

Einstein's Theory of Gravitation

What it Means to Present-day Scientific Thought

By "TECHNICUS"

SINCE 1905 Albert Einstein has exerted an influence on science unequalled by any man since Newton. What the latter did for eighteenth-century thought Einstein has accomplished for present-day thought. In that year he enunciated his special theory of Relativity, in which space and time were united and regarded as co-existent. Not only was it an important scientific step but it opened up a new philosophical outlook on space and the universe. As a result of his mathematical work for this theory he found that mass and energy were equivalent, and thereby laid the practical foundation for the development of atomic energy which we are to-day witnessing.

Mass and Energy

In his classic relation showing the equivalence of mass and energy he established, as it were, the first bridgehead for his present work. This relation states that

$$E = mc^2$$

where E = energy, m = mass and c is the velocity of light. The last value is large, 186,000 miles per second, to be exact, and if one stops for a moment to consider the squaring of this it will be immediately evident that E , or energy, is something of immense magnitude. In fact, the energy equivalent of one kilogram of a substance would equal about the total output from all the electricity generating stations in Britain for over a year.

Electro-magnetism

If Einstein's contribution to science had only been this fundamental relation his name would have passed down through history. As it is he has placed chemical and physical theory on a sure mathematical basis, and, in doing so, has enabled certain practical advances to be made. Following his Special Theory, he enunciated his General Theory of

Relativity in 1916, which gave new life to physics and astronomy. In this he showed that inertia and gravity were equivalent, thus bringing into one concept energy, mass, gravity and inertia. There still remained, however, one stubborn phenomenon, which could not be fitted into his mathematical theory: electro-magnetism.

Universal Phenomenon

Electro-magnetism is a universal phenomenon and, while it can be defined, in itself, quantitatively, there has been no clue to its real origin or how it fits into the general scheme of things. Every attempt of the scientists to fit it into the theory of the space-time-mass-inertia concept has failed. That there was a theoretical connection was evident to Einstein, but for many years the solution eluded him, especially as the English physicist, Clerk Maxwell, had revealed the electro-magnetic nature of light in the latter part of the nineteenth century. One might say that the work of Clerk Maxwell provided Einstein with a springboard for his own classic work in the twentieth century.

Unified Field Theory

His recently announced Unified Field Theory, to give it a name by which it may be known, has at last brought electro-magnetism into line with gravitation. In so many words this may not sound much, but in its achievement lies an intellectual victory of the highest order. It means, in effect, that atomic phenomena can be related to terrestrial phenomena; in other words, we are given a continuous theoretical concept extending from the smallest division of matter to the universe of matter.

The full implication of Einstein's latest work is not yet fully understood. But it is recalled that his Relativity Theories took a while for their full implication to fall upon the world of science, and to-day they are

regarded as the backbone of a branch of physics. As to the validity of his new Unified Field Theory one can quote Einstein himself, who says that it is "highly convincing." He says that it still requires to be confronted by experiment to prove itself fully, but there is little doubt that this will be forthcoming with the years. One can measure the possible truth of the Theory against the background of Einstein's other work. He offered his Special and General Theories of Relativity with equally disarming modesty, the intervening years demonstrating their exact truth in the physical sense. Similarly with his classical equivalence of mass and energy, his fundamental equation for viscosity and many other theoretical treatments. Indeed, the world of science has come to regard the pronouncements of Albert Einstein as something unique in human intellectual achievement. It may be some years before his latest work is fully applied, or even fully understood, but it is quite apparent to those who are in a position to judge that electro-magnetism has been geared to the many complex phenomena that we know as the world of nature. A tremendous step forward has been taken which may open the door yet farther to an understanding of the forces that govern the universe around us.

The Final Chapter

According to Einstein himself, his latest work is the last-but-one of the great chapters to which he has devoted his life. He is now working on the final one, under the care and patronage of Princeton University, America, to whom the world owes a debt for enabling Dr. Albert Einstein to work in sympathetic peace during the past fifteen years. Many a charming tale is told of the ways of this man of genius, and it is perhaps symbolic that he should be so happy among children, being himself the child of a great age of knowledge to come.

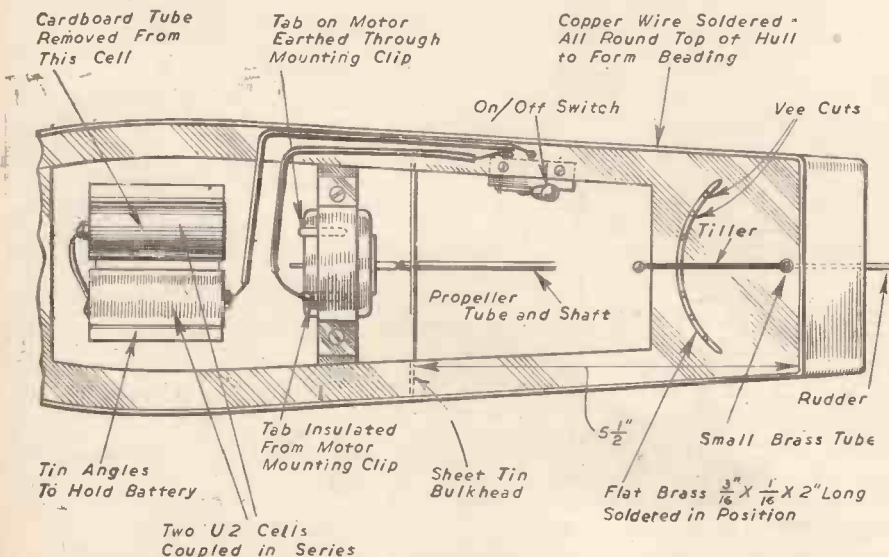

Fig. 3.—Plan of the rear half of the launch showing the layout of the motor and battery.

MODEL ELECTRIC LAUNCH

(Continued from page 305)

the underside to position the roof on the cabin sides. To finish off, solder a beading of tinned copper wire round the top of sides (Fig. 3) and also round the cabin roof. With regard to painting, the colour scheme can be carried out to the builder's own particular taste.

A NEW VEST POCKET BOOK

NEWNES METRIC & DECIMAL TABLES

By F. J. CAMM

3/6 or 3/9 by post from

Geo. Newnes, Ltd., Tower House,
Southampton St., Strand, W.C.2.

12th Article of a New Series

MODEL ENGINEERING PRACTICE

by J. J. Camm

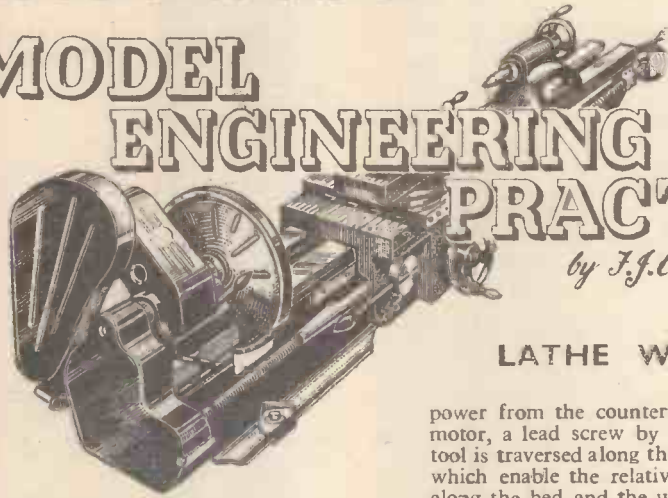

LATHE WORK.

IN most hand-processes, such as filing, chiselling, planing, etc., the action is that of a tool moving against a stationary piece of work. With the lathe, however, both the tool and the work move, and it is by the combination of these two movements that it is possible to turn work truly cylindrical and also to cut (as in facing operations) a flat surface.

The lathe combines the purposes of several tools; for example, by simple setting up it is possible to cut gears, slots, to turn ovals, to plane and shape, as well as to do drilling and to turn special forms by means of specially shaped tools. As an instance, if it is required to turn a knob, a tool is filed up to the profile required, when a straight-in cut will form the knob. There is scarcely a mechanical operation which cannot be done in the lathe.

The appearance of work done in the lathe surpasses that done by improvised methods, and turning also eliminates a considerable amount of building up, such as is necessary when a lathe is not available. Pieces can be cut from the solid which in the ordinary way would be built-up from several pieces.

Whether the reader is interested in model-making, pure metal-turning, overhauling a car or motor-cycle, or in general engineering, a lathe saves a vast amount of time, and always gives a superior result.

The Various Parts

It is the object of this series of articles to explain the principles of the lathe and its tools, and how to perform the various operations. There are certain standard methods of doing work, but some jobs call for special set-ups, and it is intended to explain in full every operation and every type of job which comes within the scope of metal- and wood-turning.

Although each make of lathe differs in form, they all work on the same principle, and all contain the same elements or parts. A simple lathe merely consists of a headstock, a tailstock, a bed, a handrest and a treadle. Cutting tools with handles, similar in appearance to ordinary wood-working tools, are used and naturally the scope of such a lathe is limited. Some lathes are known as "dead-centre" lathes. In these there is no rotating centre; both of them are stationary, and the work is revolved by means of a bow, as in the old watchmaker's "turns." Such lathes are nowadays almost obsolete. A typical example of a simple bench lathe is shown in Fig. 1. It will be seen that it has a headstock, a tailstock, a bed formed of two members known as shears (some lathe-beds are, however, of one piece), a cone pulley for transmitting the

power from the countershaft or the driving motor, a lead screw by means of which the tool is traversed along the bed, change-wheels which enable the relative speeds of the tool along the bed and the work to be varied (as in screw-cutting), a swing frame which accommodates the change-wheels, and a back gear which gives a very slow rotational movement to the work (which is chiefly used for hard materials or work of large diameter, or for tapping, reaming, etc.). There is also the slide-rest, the face-plate and chuck.

can be turned in the gap is called the "gap centre."

There are special lathes for special work, but these are chiefly of use for factory operation, and the student is not concerned with them. There are special lathes for boring, tool-makers lathes, chasing lathes, and turret or capstan lathes. Naturally, the small works has to select an all-round lathe on which can be performed almost all lathe operations as well as a certain amount of grinding, milling, etc. One should choose a screw-cutting lathe with slide-rest of $3\frac{1}{2}$ in. centre height, and preferably with a back gear.

Calculation of change wheels for cutting various pitches of screws on lathes fitted with standard lead screws will be given later.

A lathe employed by an instrument-maker or tool-maker may be capable of accomplishing a variety of diverse operations with the help of attachments. Grinding, external and internal, accurate drilling, milling, gear-cutting, shaping, slotting, broaching, relieving or backing off the cutting edges of mills and other cutters are all possible. Many of these processes are on a small scale, where it would be out of the question to effect them on appropriate machines, as would be done in a larger shop; but much of the fine tool-, die- and cutter-making may be performed by one skilled lathe man carrying out several of the above-mentioned operations on his precision lathe. In a large tool-making department, or one devoted to the manufacture of fine parts, youths run the small lathes set up for one process only.

The Self-act and Hand-feed

Some lathe-beds have a gap near the nose of the lathe spindle so that discs of greater diameter than can normally be turned between centres can be operated on (see Fig. 1.) A special nut is fitted to the slide-rest so that the latter can be disconnected from the lead screw.

The tailstock is adjustable along the bed to suit work of varying lengths. In certain operations, such as in drilling, tapping and reaming, suitable tools in holders may be attached to the tailstock, and fed into the work by means of the tailstock spindle-feed.

Lathe Terms

There are certain terms concerning the lathe which the apprentice should memorise. These terms always appear in the specification of a lathe. The maximum length of work which can be turned between centres is always stated as "between centre capacity," the maximum radius of work which can be turned between centres is termed the "centre height" (a 3 in. centre lathe will, therefore, turn work up to 6 in. in diameter), the tailstock centre is called the "back centre," and the radius of work which

Special-purpose Lathes

Special-purpose lathes are numerous in motor, textile, agricultural, engine, carriage and wagon, locomotive and marine engineering shops. They take only one size or type of object, and have facilities for rapid handling, chucking, bringing the tools to position, measuring the results, if necessary; and removing the finished pieces. Shafting lathes use tools at front and back, roughing and finishing at a rapid rate to gauge. Pulleys and flywheels go on face lathes, with tools cutting at front and back, and often a boring-bar for the hole working simultaneously. Railway wagon, carriage and locomotive axles are rapidly handled on axle lathes possessing a central headstock revolving the axle, and slide-rests at each end turning the journals simultaneously. Hard steel rollers may effect a burnishing action subsequently to impart a close, hard finish to these bearing surfaces.

Tyres are bored on face lathes equipped with sets of tools controlled to bore and

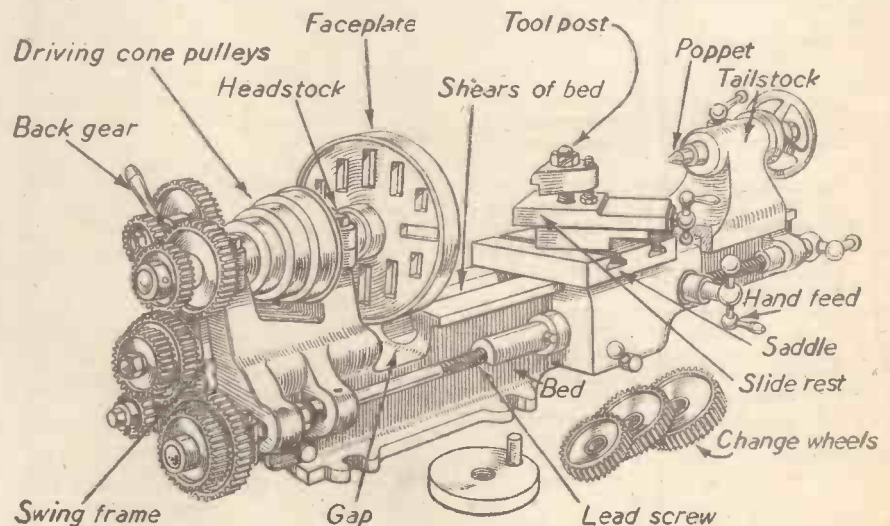

Fig. 1.—An explanatory diagram showing the various parts of a lathe.

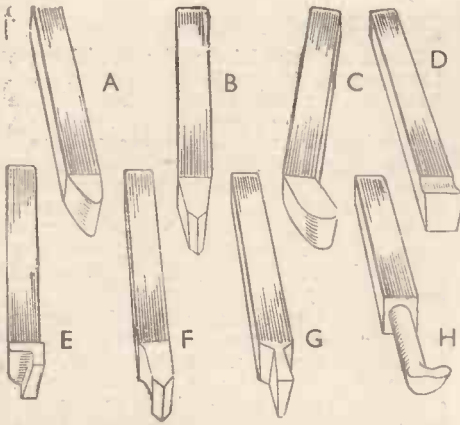

Fig. 3.—Some essential lathe tools. A, round-nose roughing. B, for roughing or cutting into corners. C, bent rougher. D, square-nose finisher. E, knife or side-tool for cutting down faces. F, screwcutting. G, parting off or grooving. H, boring; also made square-edged.

recess to gauge, and arrangements are made for one attendant to look after two or more lathes. Mounted sets of tram, wagon or locomotive wheels go in double-ended lathes carrying a driving chuck on each headstock. Special devices raise the sets to position, either a pneumatic hoist below, or an overhead hoist on a girder, and one headstock is moved along by power to complete the chucking. Two duplex slide-rests manipulate sets of tools at front and rear to rough and finish and complete the profiles, and overhead gauge rods may be applied to ascertain whether both rims are exactly the same diameter.

Multi-cutting Lathes

These have developed extensively of late. The idea is to do away with the piecemeal treatment of shafts, spindles, pins, hubs, wheels, gear blanks, etc.—that is, by taking cuts in an ordinary lathe over the different sections in turn instead of having a lathe with elaborate tool outfits cutting on all or most of the surfaces at one pass. Production time is thus limited to the period consumed in taking the longest cut. Frequently, roughing and finishing sets of tools come into action successively. Cams or hydraulic cylinders operate the feeds, and by sliding, rocking, angular and compound movements the tools can be fed to cut complicated forms. Quick chucking facilities are essential, and coolant is flooded on from numerous pipes. Specialised designs deal with cam-shafts and crank-shafts, the first having a rocking motion according to the cam-contours to be turned, the latter chucking arrangements and steadies in which to drive the shafts.

The capstan or turret principle appears in a vast number of hand, semi-automatic and full-automatic machines. A complete set of drills, counter-bores, facing tools, reamers, turning, boring, threading and other tools goes in the capstan, while a cross-slide is usually included with ordinary or turret holders. The tools operate in quick succession, being brought up by hand manipulation, or automatically under control of cams and other details. Time is saved by giving rapid motion to and from the cutting positions. The processes are subdivided according to the relative suitability of the turret and the cross-slide for the respective cuts. Very complicated articles may need so many tools to be used that the turret "stations" are insufficient, and one or more must be arranged to receive two or more tools, substituted by hand, and locked with a clamp handle. The dimensions cut is governed by the construction of some of the tools, made

or set to size; or diameters, lengths, depths depend on "stops," solid blocks or strips to positively check the movement of the tool-carrying elements. In some automatics cams exercise control.

Capstan Lathes

Small capstan lathes are run by three handles: for feeding and chucking the rod or holding single components, and actuating the capstan and the cross-slide. Stopping and starting and possibly reversing is effected by an overhead lever or pedals. The larger capstan and some turret lathes embody power

TABLE OF TURNING SPEEDS

Diam. Ins.	Feet per Minute		
	30	60	100
	Revolutions per Minute		
1/2	458	917	1528
5-16	367	733	1222
3/8	306	611	1019
1/2	228	458	764
3/4	153	306	509
1	115	229	382
1 1/8	91	183	306
1 1/4	76	153	255
1 1/2	57	114	191
1 3/4	46	91	153
2	38	76	127
2 1/4	33	65	109
2 1/2	28	57	95
3	25	50	85
3 1/2	22	46	76
4	20	42	69
4 1/2	19	38	64

feeds to the slides; consequently, the attendant has only to exert a slight degree of control and the feeds are automatically tripped. Several types of full automatic machines only require the component to be chucked, and the sequence of operation goes through without further attention; but if the bar is fed automatically, or a magazine discharges intermittently to the chuck, production becomes continuous.

Tools

With regard to tools, the difference between those for wood and metal is one of cutting angle. The former type can be thin-edged, to penetrate the easily worked material, or brazed or welded on to shanks, and this practice has spread so much recently that tool-holders do not find much favour in some shops for the engine lathes. The tip is fitted on a ledge or in a slot of the shank, and united with the greatest firmness by the brazing or welding action.

Turning

This may be accomplished by a straight-forward movement or by a traverse, the first-named method being restricted to some finishing cuts, grooving, forming and parting. Traverse is effected with a v-edged or round-nosed tool, and top slope or slide rake must be ground to slope away from the direction of feed. Hence the reason for right-hand and left-hand tools. A roughing cut is generally taken of good depth in order to remove most of the metal and leave only a slight amount for smooth and accurate finishing. Formerly it was imperative to get well under the skin of a casting or forging at the first cut to avoid the risk of the edge being damaged by occasional scraping over the skin, but this does not matter now that new compounds, including the latest, tungsten-carbide, will operate, without injury, on scale.

Using carbon-steel tools, brass can be cut at a surface speed of 80 to 100ft. per minute, cast-iron 40 to 60ft., mild steel 30 to 40ft. The newer high-speed and super high-speed steels permit rates to be increased enormously. Rotational speeds for three surface rates are given in the accompanying table.

Evolution

The lathe is still the principal machine-tool. In a primitive form it existed for many hundreds of years, and was composed of two tree trunks or stumps, each holding a nail to make the pointed centres on which the work spun to and fro under the compulsion of a cord and bow. The tools were held by the hands, or sometimes partly guided by the toes, and beautiful specimens of wood-turning resulted from this simple device. The elements are still apparent in most lathes, the stumps being represented by the poppets or heads, but the work is rotated by a running spindle and driver.

The important changes which occurred at the beginning of the industrial era were the substitution of power for hand-drive, and the introduction of the slide-rest, carrying the tool positively and unyieldingly to cut any shape. The screw-cutting mechanism marked another very important advance. The other vital improvements were substitution of automatic feeds for hand operation and the multiplication of tools, both in ordinary (called engine lathes) and the turret lathes. Some of the automatic lathes and screw machines are very highly complicated, and run continuously when supplied with magazines of single pieces, or bars from which to turn and cut components.

The differences in types of lathes are concerned with the size and shape of the workpieces, the particular operations which have to be performed, and the relative quantities of like shapes required.

Centre and Chuck Work

Primarily, lathe subjects are divisible into centre work and chuck work, and although both can be dealt with on many kinds of lathes, there are specialised designs solely for one or the other. The centre or engine lathe is often set up for long periods to turn shafts, spindles, rods, tubes and all sorts of cylindrical forms mounted on centres. Parallel or tapered contours can be produced, the latter by a suitable motion of the slide-rest, or by setting over the loose head or tailstock. The tools are controlled by hand, and are for amateurs and certain trades, such as brass-finishing and scientific instrument making. In the majority of cases the slide-rest imparts longitudinal and transverse feeds, by handle or self-acting gear, and ensures (with proper care) accuracy in the desired shape.

For chuck work the loose head does not come into action, and the piece is held either on the face-plate by clamps or dogs, or in a chuck having sliding jaws. Several types of lathes, called face or chucking lathes, operate solely in this manner, and vertical turning and boring mills are also run on the same system, but with a horizontal chuck, a more convenient way of handling some work and observing the cutting processes.

(To be continued)

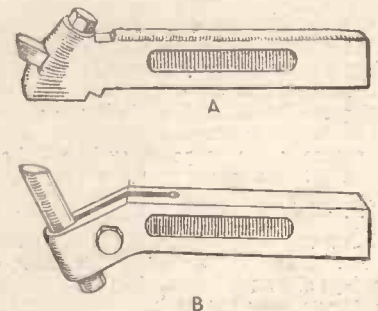
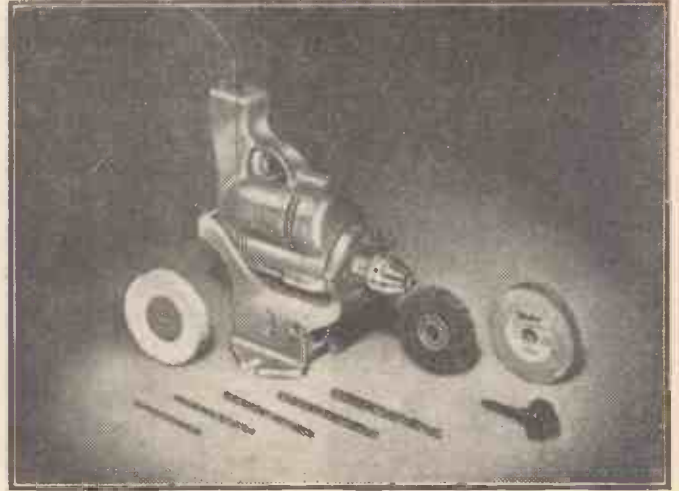
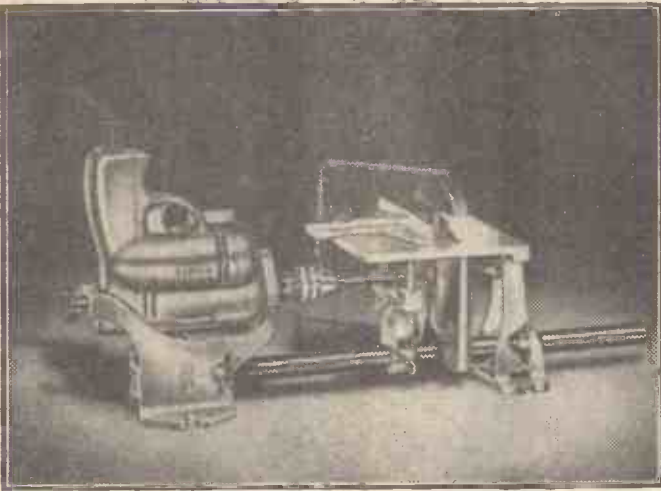

Fig. 4.—Holders which take a bit or cutter of tool steel. A needs grinding only on the front; B only on the top.



Figs. 2 and 3.—(Left) showing the electric saw, and (right) the polishing kit.

Electric Drill Kit for the Small Workshop

Conversion Sets for Drilling, Grinding, Polishing, Sawing and Lathe Turning

REALISING the want felt by every handyman for a multi-purpose tool, Wolf Electric Tools, Ltd., have incorporated the ½in. Wolf Cub Electric Drill (Fig. 1) as the power unit in a number of kits. The free speed is exceptionally efficient for the various kinds of work for which the tool is recommended and full load speed ideal for ½in. drilling in steel with the high-speed quality twist drills provided. Current consumption is small and the drill costs less than 2d. per hour to run. Having purchased the Cub drill or any one set of attachments it is a very simple matter to acquire additional pieces until the complete equipment is obtained.

Next to the drill the two major components are the bench clamp and the drill stand which, by ingenious adaptation, comprise the main parts of the saw kit and the lathe kit.

Grinding and Polishing

In Fig. 3 is shown the grinding and polishing kit, which consists of the drill fitted in the bench clamp and an assortment of twist drills, wire brush, grinding wheel, calico mop and necessary arbors which are provided. A flexible rubber backing disc carries the appropriate sanding disc which may be had either for wood, metal or stone. Replacement of worn discs is simple. A lambswool bonnet

is supplied for polishing and is fitted over the rubber backing disc for car polishing, etc. A supplementary handle fitted behind the chuck provides admirable additional control for such work.

Sawing

By means of the bench clamp and drill stand, which serve as work head and horizontal bed respectively, a 4in. diameter circular saw is held rigidly in position and driven by the Cub drill. A saw table with

adequate clearance and adjustments for depth permits wood to be cut to thickness of 1in. A guard and straight-edge complete the very workmanlike equipment (see Fig. 2). Of interest is the fact that the drill may be removed within a few seconds for use as a portable tool.

Lathe Kit

This kit, Fig. 4, provides very clear proof of much careful expert planning. By a novel interchange of parts the drill stand base becomes a most effective adjustable tailstock, whilst the drill, held in the bench clamp and fitted with a driving centre, is the power-driven headstock. For faceplate turning the chuck is removed and replaced by the drill table, which screws direct on to the chuck spindle and acts as the faceplate.

Wood can be turned between centres up to 2in. diameter and up to a maximum of 4in. for faceplate work. The maximum standard length between centres is 9in.—but a longer pillar can be supplied as an accessory to provide a distance of 18in. between centres. Examples of wood turning are shown in Fig. 5.

The power unit must be properly earthed by means of a three-pin plug to connect to the power circuit. The universal motor is suitable for D.C. or single-phase A.C., 25/60 cycles.



Fig. 7.—The Wolf Cub Electric Drill which is used as the power unit in the various kits.

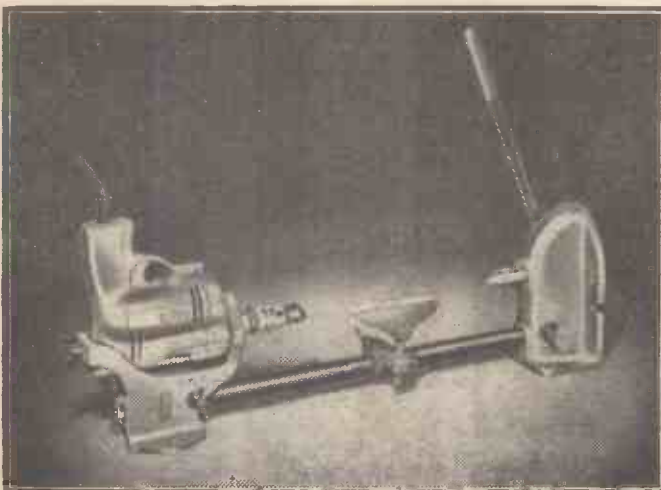

Figs. 4 and 5.—(Left) showing the lathe assembly, and (right) examples of wood turning carried out on the lathe.

A Master Battery Clock

Details of the Construction of a Battery Pendulum Clock with Seconds Train

By F. J. CAMM

former pendulum would be 22in. long and the seconds pendulum 39.12in. long.

The clock shown in these photographs is one which I constructed for our stand at the Model Engineer Exhibition; it does not, of course, exactly follow the blueprint, since I constructed the movement entirely from raw material, and did not make use of alarm clock parts. The principle of it, however, is precisely the same.

Main Frames

It will be seen from the photographs that the two plates or frames carry two extension pieces for the pivoted carriage to which is fitted the gathering pawl, whilst the ratchet itself is pivoted on a shouldered pin riveted to the front plate. I have also added a seconds train, a seconds hand being really necessary for close rating. Instead of making use of odds and ends from the scrap box, as many amateurs would have to do, I turned all the parts for my clock, so that the finished job would have an exhibition finish. The dial is of transparent

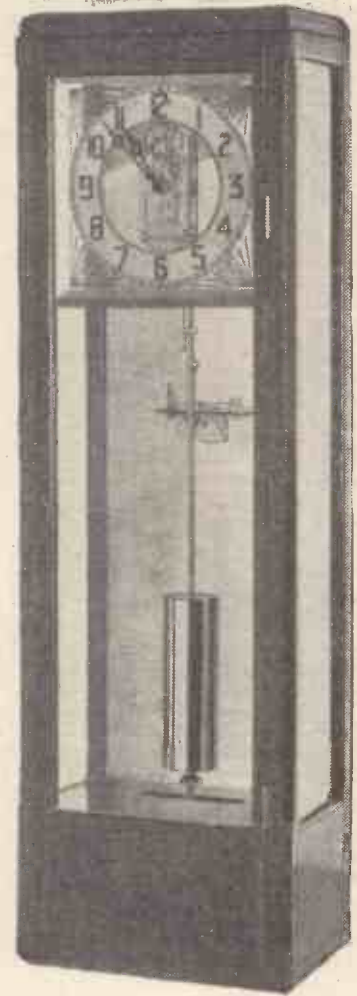

Three-quarter view of the clock showing bevelled glass panels.

Perspex with the chapter zone gilded with gold leaf, merely so that visitors to the exhibition could see the works. Over a period of three years the clock has kept a consistent rate of less than a second a day. Of course, the trigger mechanism will not cause contacts to be made at regular intervals of time, but if correctly adjusted, with the trigger mechanism free from back-lash, the variation should not exceed plus or minus one swing of the pendulum. That is to say, if the clock makes a contact every forty-four swings the variation should be within the limit of 43-45 times. The clock is reasonably silent, making no other noise except that caused by the slight rap of the trailer against the hard steel block mounted on the flat piece of clock spring carrying the moving contact. Even this noise could be removed by making the block of hard fibre. The trailer is sharpened off at its trailing end to the form of a watchmaker's screw-driver, so that it can easily dip in to the small notch in the contact block which should not be more than .02 inch wide and about .05 inch deep.

I made the two frames from hard rolled sheet brass soldering two pieces of it together, drilling and filing to shape and drilling such holes before parting the two pieces as were common to both plates. I previously prepared the wheels and pivots and so was able to broach the holes to a nice fit before separating the two plates and cleaning them up. The pillars, five of them, connecting the two plates are riveted to the back-plate, but they are drilled and tapped at the other end, so that the movement may quickly be taken to pieces.

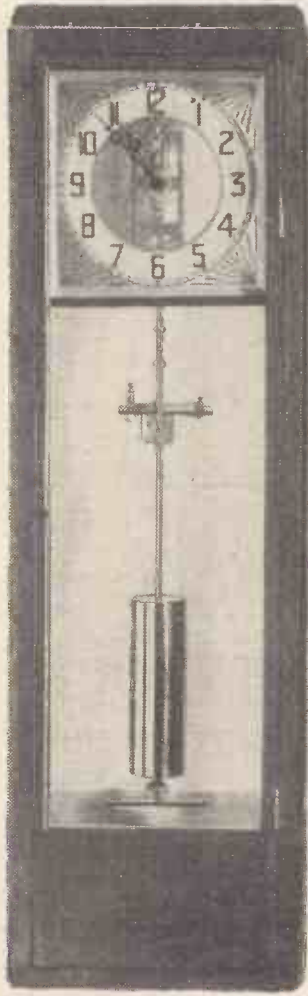

Front view of the clock built by Mr. F. J. Camm, showing slotted false bottom, to obscure batteries, and the lift-off case. The whole mechanism is fastened to the back-board.

THE P.M. Master Battery Clock is designed so that it may be constructed by amateurs without workshop or clock-making experience. It works on the well-known Hipp principle, namely, a trailing trigger attached to the pendulum sweeps across a tiny notched block mounted on a spring and carrying a contact at one end. This contact mechanism is mounted on a platform attached to the back-board to which the clock is secured. When the arc of swing of the pendulum drops by a few degrees, the trailer will drop into the slot in the contact block, close the contacts, and energise the electro-magnet fastened to the bottom of the clock case. Thus the armature secured to the bottom of the pendulum enters the magnetic field created by the closing of the contact, and imparts a pull to the pendulum.

The frequency of these contacts will depend, of course, upon the accuracy with which the clock is made, but if friction is kept to a reasonable minimum contacts should not be more frequent than one a minute. The longer the time between the contacts the longer the life of the two one-and-a-half-volt dry bell batteries, which are connected in series to energise the coils.

Our blueprint deals with a clock which makes use of the frames and a few of the wheels, including the cannon pinion, minute and hour wheels, of a cheap alarm clock. The only additional wheel required is a ratchet wheel having 40 teeth for a $\frac{3}{2}$ seconds pendulum or a 60-tooth ratchet wheel for a one seconds pendulum. The

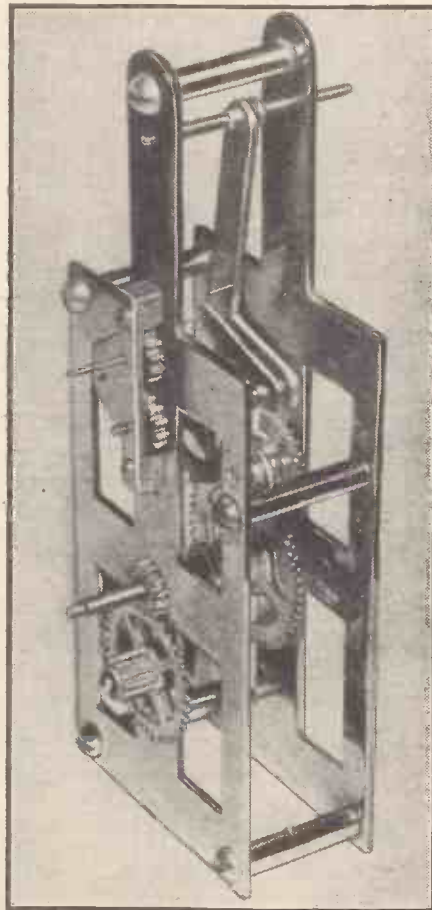

View of the movement showing the seconds train, gathering pawl and detent, gear train, plate pillars, etc.

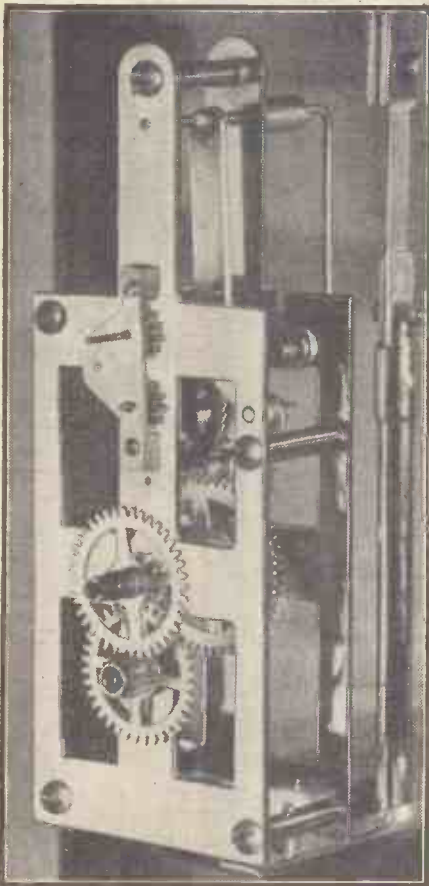

Another view of the mechanism of the clock, showing it mounted to brackets attached to the back-board.

Seconds Mechanism

It will be seen from the photographs that the pivots of the spindle which carries the ratchet wheel are extended for about half an inch through the back and front plates, the back pivot being intended to carry the contact mechanism for the slave clocks, and the front one to carry a pinion to provide the seconds drive.

With such a small train of wheels the seconds circle would be too close to the centre of the dial, and it is therefore necessary to carry it up so that the circle just breaks into 12 o'clock. To do this, two further pinions are necessary, the centre one acting as an idler reversing pinion whilst the top pinion carries the spindle to which the seconds hand is attached. This is the simplest way of fitting a seconds hand. Below, however, is shown the method of operating a seconds hand from a pendulum devised by Mr. V. A. Phipps, of East Barnet. Here it

will be seen that the device operates direct from the pendulum, the only addition being a brass collar slipped over the rod, the locking screw serving the purpose also of engaging the forked lever which operates the ratchet wheel and thereby registering every two seconds. Mr. Phipps used a 60-tooth ratchet taking two teeth each swing, but, of course, it could be a 30-tooth wheel. He found that the collar gave the correct stroke about 5 ins. from the top of the rod, and this brought the seconds dial conveniently below the slave dial, but a slight variation from this may be necessary in individual cases and position can easily be found by holding the unit in position while the pendulum is in motion; movement can also be varied by the position of the collar in relation to the forked lever. Although he is only using a 7lb. bob weight he tells me it was not necessary to alter the setting of the clock; the seconds hand is set to coincide with the drop of the gravity arm, at 30 and 60.

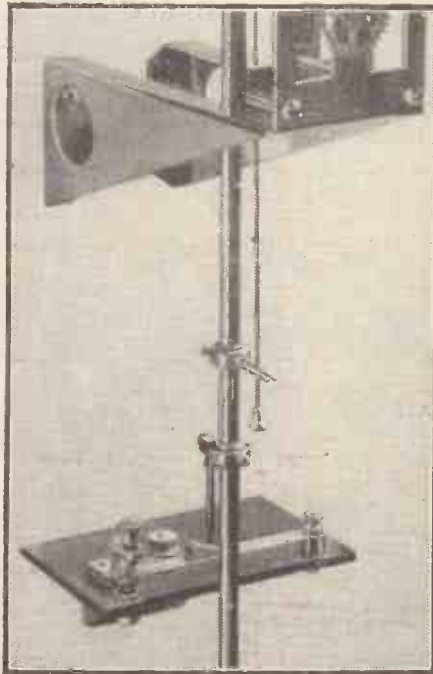

The brackets to which the movement is attached, the contact platform, the trailing trigger and the crutch rod are shown in this picture.

The sample Mr. Phipps submitted was extremely well made.

Contact Block Adjustment

I found that best results were obtained when the notch in the contact block was set a 1/4 in. to the left of the pendulum rod centre line, looking at it from the front, of course. To avoid the possibility of dead centre braking effect I mounted the two coils, with their iron cores secured to a common yoke, a quarter of an inch to the right of the pendulum rod centre line. This gives a contact, about every 45 swings of the pendulum. I do not recommend longer duration than this because of the risk that the angle of the pendulum towards the end of the free swing of the pendulum may be insufficient to carry the gathering pawl over the top of the ratchet teeth, and the clock will therefore lose time. The ratchet wheel on my clock is one inch in diameter with, of course, 40 teeth. The whole of the mechanism including the pendulum suspension bracket, the solenoids, the batteries, and the contact platform are

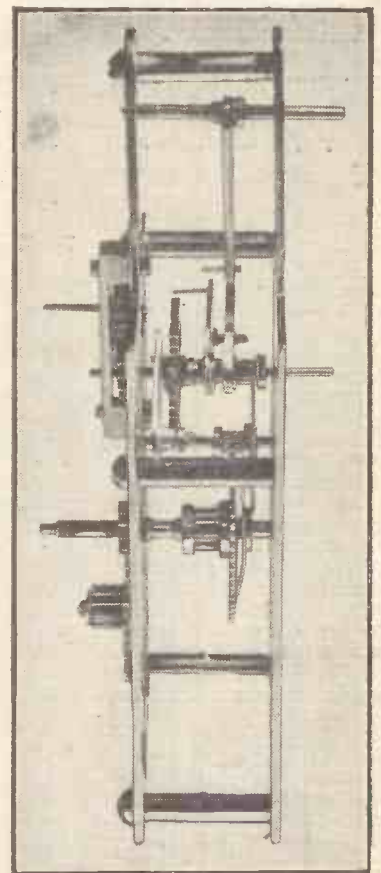

Side view of the movement, showing gathering pawl, detent, ratchet wheel, and seconds train.

mounted on the back-board, and the backless glass sided case, having four brass keyhole plates fitted to the back faces of the two rear-most pillars, drops over the movement, roundheaded screws dropping into the holes in the keyhole plates, and so fastening the case to the back-board. The batteries are concealed by a false floor with a slot to allow for the swing of the pendulum.

The height of the trailing trigger in relation to the block needs careful adjustment, being very sensitive to small variations. I found that adjustment was correct when, with the pendulum inert, the trailer point extended 1/4 in. below the top of the contact block. This trailer must swing freely, and in the bearing to which it is attached I drilled a small oil hole, well countersinking it at the top to provide a small oil reservoir. The top of the contact block should also be oiled occasionally.

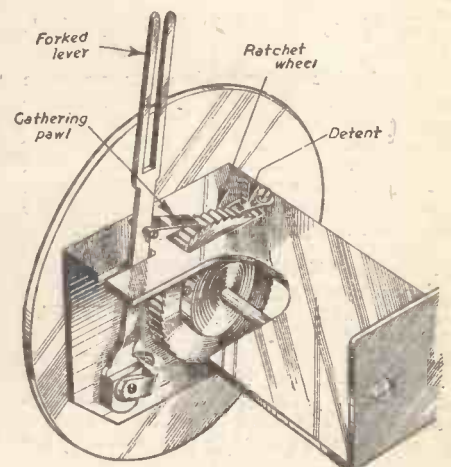
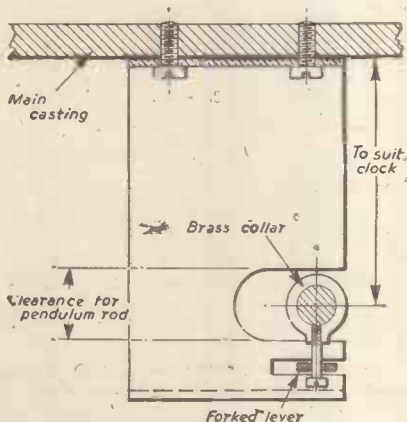

These two diagrams show the seconds mechanism evolved by Mr. V. A. Phipps, of East Barnet.

NEW SERIES

Wood Turning—9

Fancy Turning

By FREDERICK JACE

Turning Knobs

THE previous article gave designs for various forms of finials and knobs for decorative purposes. This article deals with the turning of knobs for purposes of utility, such as drawer knobs. For this purpose the wood chosen should be a hardwood, such as ash, oak, teak, mahogany, box-wood, lance-wood, etc. The reason is that the softer woods, because of the small sections on the undercut portions, would soon split. For turning drawer knobs it is necessary, first of all, to turn a chuck as shown in Fig. 88. A piece of wood is firmly drawn into the cup chuck and turned down to a spigot on which is cut a screwthread.

The screw thread is cut by means of a screw box obtainable from most of the tool material dealers. It is necessary to rock the screw box backwards and forwards until the

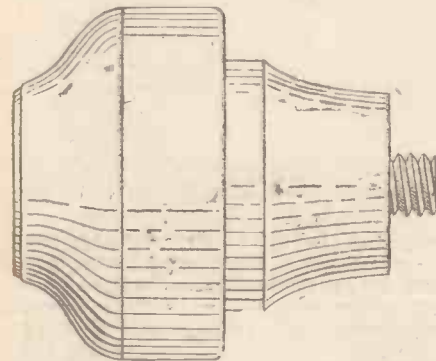

Fig. 88.—A cup chuck with screwed spigot.

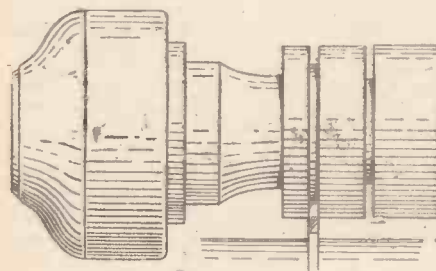

Fig. 89.—The first operation in turning a knob.

full length of thread is cut in order to remove the chippings. The first operation in finishing the knob is clearly indicated in Fig. 89. It will be seen that a parting tool is used for cutting the groove to the correct depth, whilst Fig. 90 shows a later operation in forming the knob to a pleasing curve. The position of the gouges is clearly shown.

Ornamental Knobs

A more ornamental knob is shown in Fig. 91. These knobs are usually fixed by a wooden screw of the form shown in Fig. 92 turned from hard wood. These may be turned as shown in Fig. 93, although they can be turned with equal facility in the cup chuck as in Fig. 94. This latter method has the advantage that the thread can be cut before removing the piece from the lathe.

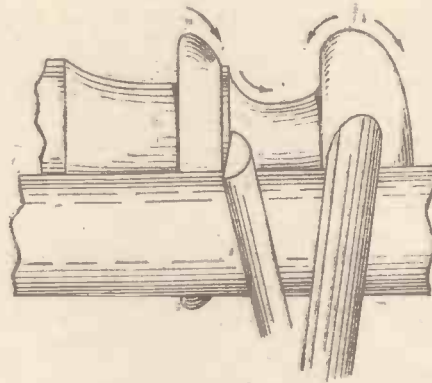

Fig. 90.—Using gouges for turning the curved parts of a knob.

The plain part of the pins should be slightly less in length than the thickness of the drawer through which they are to pass. In order to obtain a good thread, enabling the pins to butt up close, it is wise to slightly undercut them at the shoulder. Fig. 95 is

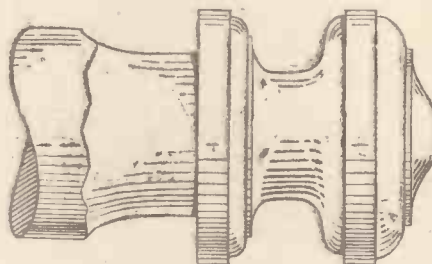

Fig. 91.—A more ornamental knob.

a design for yet another form of knob, in which the screw is turned integral with it. This means, of course, that a hole would need to be bored in the draw and tapped out to suit. Such knobs are roughed out as shown in Fig. 96 and the threads are cut after they are parted off. By turning them up two or more on one length one is enabled the more easily to match up the shapes. A cardboard template cut to the profile is of great help.

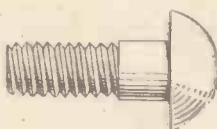

Fig. 92.—A wooden screw for fixing a drawer knob.

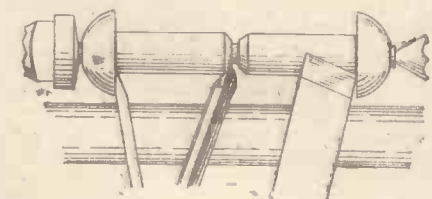

Fig. 93.—Method of turning two wooden screws together.

Of course, the knobs should be of a material to match the furniture for which they are intended, and this latter will also decide to some extent the style of the knob.

Finishing

They may be glass papered, using fine glass paper for the finishing operation, and then french polished in the lathe.

Certain of the new plastic materials such as bakelite, erinoid, and Perspex may be used for knobs of trinket boxes and similar small work.

A pleasing effect can also be obtained from laminated wood made by gluing together alternate layers of light- and dark-coloured

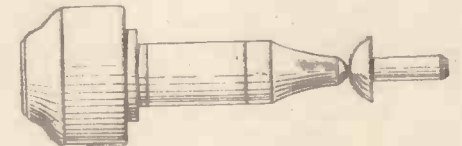

Fig. 94.—Turning a knob held in a cup chuck.

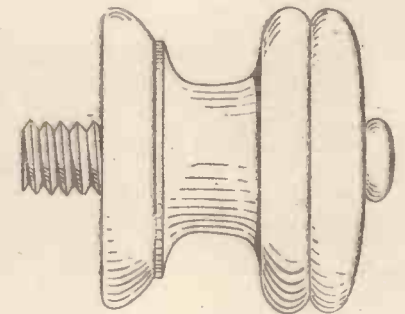

Fig. 95.—Another form of knob with an integral screw.



Fig. 96.—How knobs are roughed out previous to turning.

woods. If this latter method is adopted turning time can be saved by making each lamination smaller or larger in size so that the glued assembly leaves the undercuts where they are required. If square pieces of wood are used the corner should, of course, be sawn off before mounting in the lathe.

(To be continued.)

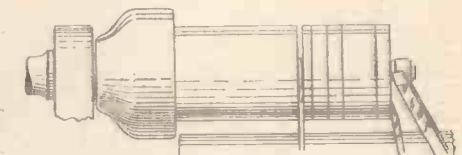

Fig. 97.—Another method of chucking a knob.



Fig. 98.—Section of Fig. 99.—First operation in turning a drawer knob.

The WORLD of MODELS

Northern Models Exhibition : The Kodak Model Engineering Exhibition

AMONG the many excellent model exhibitions held this spring, I was most interested in two: one in Manchester and one at Kodak Hall, Wealdstone, Middlesex.

The second Northern Models Exhibition, held at Manchester in March, indicates that this outstanding amateur display is well on

By "MOTILUS"

a working models arena, stands for competition models as well as many loan models and a number of trade stands.

On entering the hall, visitors found an Exhibition Layout Model, which assisted

Competition Models

The competition models in an exhibition usually attract first attention, as they are generally the latest model work of the competitors. First prizewinner in Class 1, Steam Locomotives over Gauge O, was Mr. L. R. Raper, of Horbury, who had entered a 4-6-0 free-lance design locomotive (Fig. 1): this model was also awarded the *Evening Chronicle* Trophy. A most creditable piece of model locomotive building, with good detail and paintwork, and which had been highly commended at the 1949 *Model Engineer* Exhibition. Second prize in this class went to Mr. H. Park, of Claydon-le-Moors, for his 4-6-2 "Hielan Lassie" locomotive, a well-known standard design by L.B.S.C., which is used in many exhibitions for competition. First prize among gauge o

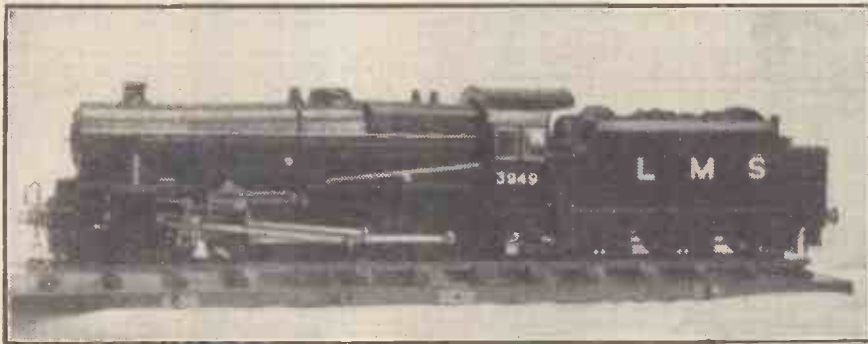

Fig. 1.—A free-lance design model at the Northern Models Exhibition. Based on a 4-6-0 L.M.S.-type locomotive, Class 5, mixed traffic, the model burns solid fuel. The builder, Mr. L. R. Raper, was awarded first prize in the Steam Locomotive Class.

the way to becoming an important annual event in the programme of the Northern Association of Model Engineers. This association, founded in 1945, comprises some twenty-six societies, bringing together nearly a thousand model enthusiasts from the North of England: it is organised and staffed entirely by amateurs, with headquarters in Manchester. Among the towns and cities represented in the membership are Manchester, Liverpool, Southport, Preston, Bradford and Stoke, as well as many others.

The first Northern Models Exhibition, in 1949, was held in the Corn Exchange, Hanging Ditch, Manchester, and the 1950 exhibition was again displayed there, with

them considerably as a guide to the twenty-seven amateur stands as well as to the commercial exhibits. This model, to a scale of $\frac{1}{4}$ in. to 1 ft., showed the stands in block form, each bearing a card giving details of the stand number, items on display, etc. It had been built up

by the assistant exhibition manager, Mr. R. E. Priestley, and is an idea that might

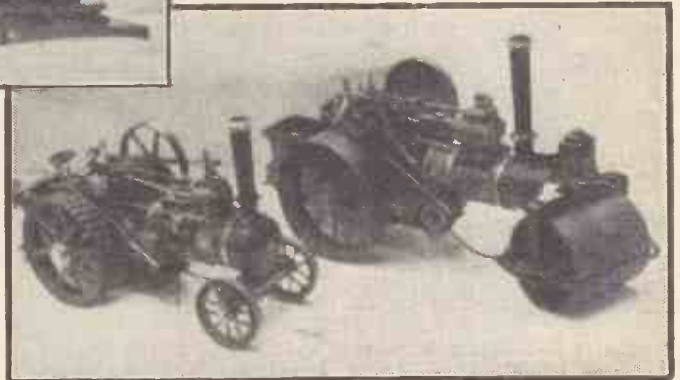

Fig. 2.—Two prize-winning models at the Northern Models Exhibition. On the left, a 1 in. scale model of a Ransomes, Sims and Jefferies' traction engine. On the right, a $1\frac{1}{2}$ in. scale 10 ton standard-type road roller model



Fig. 3.—An interesting model in the Loan Section at the Northern Models Exhibition. A well-built model church by Mr. G. Graham, of Stockport.

well be adopted for other exhibitions of this kind.

A number of trophies, diplomas and other prizes were awarded to competitors in thirty different classes, and the general standard of work in all competition sections was high. The "Myford" Trophy, for the best model in the exhibition, was awarded to Mr. J. Boydell, of Failsworth, for his $3\frac{1}{2}$ in. centre all-gear 1 at the, entered in Class 17—Tools and Workshop Appliances. Mr. Boydell also won the second prize in this class for his 24 in. planer.

models went to Mr. H. Jessop, of Oldham, for a Class 8F freight locomotive.

Competition entries in the marine section were more numerous than among the locomotives, although those of outstanding merit could easily be singled out. First prize in Class 6 for Working Steam or Power Boats was won by Mr. D. W. Gale, of Lincoln, for his s.s. *Caledonian Monarch*, to a scale of $1/16$ in. to 1 ft. The building of this model took some 1,500 hours, but the work was spread over a period from December, 1939, to August, 1949. The model is a combination of wood and metal and it received 16 coats of paint, resulting in quite an attractive well-finished ship, which was also awarded the Trophy of the Northern Association of Model Engineers. Second and third prizes in this class went to Mr. H. Bonsor for his electrically-driven tug boat, and Mr. A. H. Baddeley for his diesel-driven 24 in. motor launch. The $\frac{1}{2}$ in. scale 4 ft. steam-driven cabin cruiser by Mr. J. W. Greenhalgh is another model in this class worthy of mention. This has all deck fittings made by hand, with the exception of the ventilators and was carved from a solid

piece of timber. Although based on a steam-driven prototype, the model is driven by a two-speed electric drive from batteries.

In the Sailing Ship Section, a beautiful model of a British coasting type schooner, to a scale of $\frac{1}{2}$ in. to 1 ft., brought first prize to Mr. C. J. Clarke, of West Bromwich. This drew many admirers among lovers of sailing ships and is, incidentally, winner of a silver medal at the 1949 Model Engineer Exhibition in London.

Model Ship Section

No model ship display is complete without the miniatures and, of course, the inevitable ships in bottles. Some good examples of miniature ships came from two competitors, Mr. M. Maltby, of Sheffield, and Mr. J. Lauder, of Disley. First prize went to Mr. Maltby for his ketch, *Martinet*, to a scale of 1/20 in. to 1 ft. This admirable glass case model was mounted on an imitation sea with a most realistic swell of an "angry" green. Mr. Lauder gained second prize with his model of the *Archibald Russell* in a bottle. An excellent miniaturist, Mr. Lauder entered several exhibits of this type, all of them to a high standard.

Good standards, too, were set in the General Models Section. The $\frac{1}{2}$ in. scale, compound surface condensing marine paddle engine, by Mr. E. B. Wilcox, of Weaverham, is a beautiful engineering model: it won its maker first prize in its class. Messrs. F. Tapper, A. Kent and F. Molson, of Birmingham, entered a good model in this class: a 1 in. scale undertype steam engine, built entirely without castings. This team of modelmakers won second prize in the class for mechanically-propelled road vehicles, with their 1 in. scale Ransomes, Sims & Jefferies traction engine, a beautiful model correct in all details (Fig. 2). First prize in this class went to Mr. R. C. Stone, of Eastham, who entered a well-made 1 $\frac{1}{2}$ in. scale 10-ton road roller. Another prizewinner who entered a most interesting model was Mr. T. Jolly, of Whitefield, who had made a quarter full-size Lancashire weaving loom, which was working during the exhibition weaving cloth. The loom was made between 1928 and 1934 and Mr. Jolly cut all the gears by hand with hack-saws and then filed them!

Among the scenic models, and first prize-winner in its class, was a group of miniature furniture by Mr. F. Slater, of Holcombe Brook. This had been made with saw, pen-knife and files, and had been well arranged against a cottage living-room background. Also a prizewinning model in the same class was Mr. W. Stables' steam roundabout,

which has been seen at previous exhibitions and is deservedly a source of great admiration among modelmakers.

Entries in the competition sections for model aircraft were unusually large for an exhibition of this kind and contained some fine specimens. The *Aeromodeller* trophy was won by Mr. R. F. L. Gosling, of Liverpool, for a lovely 7 ft. span F.A.I. sailplane, "Tern II." It is interesting to note that a first prize for solid scale models went to a lady modeller, Miss J. K. Knowles, of Sale, for her tiny Heinkel H.E. 60, a neat, well-finished model.

Loan Models

A great many models at this exhibition were displayed on loan and some of these were very fine models indeed. Notable among them were a 1 in. scale G.W.R. 0-4-0 tank locomotive by Mr. B. Negus, of Shavington, Crewe, a model church by Mr. G. Graham of Stockport (Fig. 3), and Dr. H. Fletcher's working model of a river and coastal tug-boat, championship cup winner in the 1949 Model Engineer Exhibition, London. Dr. Fletcher also loaned an outstanding model of a 7-cylinder radial aero engine (2-cycle) which is certainly a very fine piece of work.

One of the most fascinating loan models, however, for both model fans and "lay" visitors was a 2 mm. scale highland railway layout by Mr. R. W. G. Bryant, of Preston, the "Inversnecky Branch." The tiny working locomotive is fitted with a permanent magnet motor with 5-pole armature and spur gear, and this runs on a two-rail system, complete with goods wagons and also passenger coaches if required. There are two stations, one boasting a station hotel, a tiny harbour with ships alongside the quay, crofters' cottages with washing on the line, and farther on lineside buildings include a distillery. The whole layout is a gem of modelling in miniature. Notwithstanding

all it includes, the model is in four sections and can be packed entirely into a banjo-case, which Mr. Bryant uses for its easy transport.

The organisers of this exhibition are to be congratulated on a varied and interesting display of models, many of which reached high standards in workmanship and enterprise. I am pleased to learn that attendances this year have encouraged the Association to plan a third exhibition for 1951.

Kodak Model Engineering Exhibition

"It is a fine thing that people can, and do, still turn to craft work in their leisure hours, especially in this age of 'ready-made' entertainment." So said Mr. K. N. Harris, of Kodak, Ltd., when I visited the Kodak Model Engineering and Craft Exhibition last April. I wholeheartedly agree with this view, and the bi-annual Kodak Exhibition had, as usual, some good examples of the results of many hours spent in craft work of all kinds. This year the sections covered general mechanical models, marine, aero and locomotive models, puppets, electronics, and arts and handicrafts.

The popular outdoor locomotive running track was once more a big attraction, with two 5 in. gauge locomotives putting in good service: a 4-6-2 tank locomotive built by Mr. A. D. Pole, of the Harrow and Wembley Society of Model Engineers and a 4-4-0 locomotive by Mr. Fairburn, of Ickenham.

An excellent model in the Locomotive Section, true to scale in every detail, even to the number of rivets, was Mr. C. R. Jeffries' 5 in. gauge, G.W.R. 8750 class pannier tank locomotive (Fig. 4). To a scale of 1 1/16 in. to 1 ft., this model is coal-fired and fitted with superheaters, mechanical lubricator, steam handbrakes, injector and Stephenson's link motion. Mr. Jeffries' tools are a lathe and the usual hand tools, with which he has produced a really worthwhile model.

Also in this section was a Model Engineer Bronze Medal winner (1948): a 3 $\frac{1}{2}$ in.



Fig. 4.—A fully-detailed and well-finished 5 in. gauge model of a G.W.R. 8750 Class pannier tank locomotive, to a scale of 1 $\frac{1}{16}$ in. to 1 ft.

(Photo. by C. R. L. Coles, of Kodak Society of Experimental Engineers and Craftsmen.)

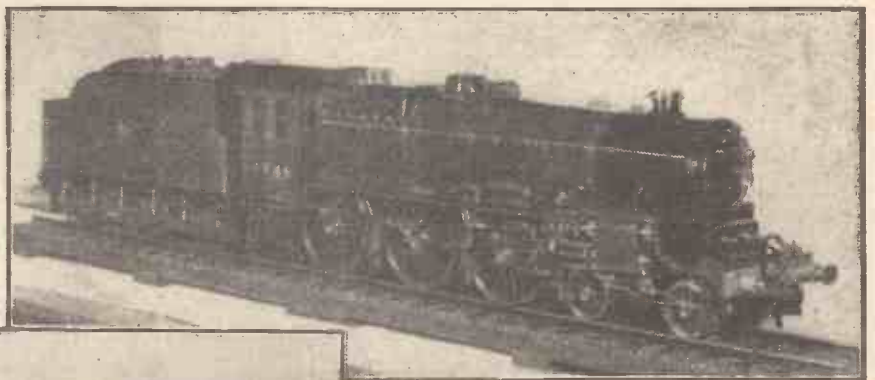

Fig. 5.—The largest model locomotive in the Kodak Exhibition. To a scale of 1 in. to 1 ft., this model is about 5 ft. long and represents a 4-6-0 locomotive of the London Midland Region. Built by Mr. S. T. Harris, of Cricklewood. (Photo by C. R. L. Coles, of K.S.E.E.C.)

gauge version of a Hunslet tank quarry locomotive, built to the modelmaker's own design from Hunslet drawings.

A 1 in. Scale Model Loco.

Probably the largest locomotive exhibit was a 5 ft. long "Amalgamation," to a scale of 1 in. to 1 ft. (Fig. 5). Similar to the 5XP Class of the London Midland Region, this 4-6-0 model is coal-fired and has four cylinders. Its builder is Mr. S. T. Harris, of Cricklewood, a member of Malden and District Society of Model Engineers, whose workshop facilities include a lathe, drilling machine and hand tools.

Sewing Machine Maintenance

How to Keep Domestic Machines in Proper Working Order

By "HANDYMAN"

THE sewing machine, like a watch, is a complicated mechanism, and, like a watch, when major faults develop, it can only be put right by the makers. Such faults are in almost every case due to wear, and replacement is the only solution. This replacement nearly always means the dismantling of the intricate mechanism and those without a mechanical bent are advised to leave it alone. Most of the faults, however, are of a minor character, fortunately, and are easily rectified. Indeed, they can be to some extent avoided by regular attention to oiling as instructed in the manual which accompanies the machine. If the machine is a new one it will, of course, be put right under the guarantee, but not if the owner has endeavoured to rectify the fault himself. Tampering with a machine under guarantee renders the guarantee invalid.

One of the commonest faults is frequent breaking of the cotton. Do not always blame the machine for this. There are some cottons of very poor quality, having low tensile strength, which snap quite easily even when the tensioning device is set to the slackest adjustment (Fig. 1). Presuming that the cotton is of good grade, breakage can be due to the use of the wrong size of needle causing a lump at the eye, which, as it passes through the needle, places an undue tension on the cotton. The makers recommend a cotton of either number 50 or 60 grade for the general run of light fabrics. A good test is to ascertain whether the cotton pulls easily through the eye. If it does not, the needle is too small or the cotton is of too stout a gauge. Sometimes there are sharp edges around the eye of the needle which cause a cut, and the remedy here is obvious. This, of course, applies to the top cotton. If frequent breakage of the under cotton occurs it is nearly always due to bunching of the cotton ends or to fluff and dust collecting and clogging under the shuttle spring. This is a frequent cause of trouble, because the dust and oil mixture is only visible when the spring is removed—a comparatively simple matter. If the shuttle is of the tubular variety, as it certainly will be in a machine of the vibrating shuttle type, reference should be made to the diagram, Fig. 2, to dismantle it. By removing the screw shown, the flat

spring is automatically released, exposing any fluff or dust which may have collected at this point.

Observe from the diagram that there is a second spring, of flat type, underneath the first, and it is important to take careful note of its correct way round when removing the top one. Of course, the breakage of this second spring renders the shuttle ineffective, and replacement is the only solution. In replacing the screw, fasten it home tightly so that the cotton does not catch in it.

The foregoing applies to more modern machines, but in some the older types the shuttles are not tubular but boat-shaped, as shown in Fig. 3. The spring is screwed on in exactly the same way and the method of cleaning and clearing it of dust accumulations is similar. In shuttles of this type, where the outer spring is not fastened by a screw, little trouble can be experienced, although occasionally cotton fluff may cause the action to jam.

When the machine has been in use for some time, the fair-leads and other parts through which the cotton passes, may become rough or slightly rusty; this is a frequent cause of cotton breakage. Such roughness should be removed by a piece of soft wood moistened in sewing machine oil and rouge (face powder will do) mixed together, and gently rubbed on the affected parts. Roughness is most likely to occur in the hole in the needle plate. Fine emery cloth may be used to remove it.

When a spare needle plate is supplied, as is the case with modern makes, remove the old plate by releasing the screw indicated in the diagram and refix the new one, taking care to see that the needle passes easily through the hole before finally refixing the screw. If it does not, the cotton will continue to break. It will be found that the plate may be moved slightly from side to side in order to secure easy passage of the needle.

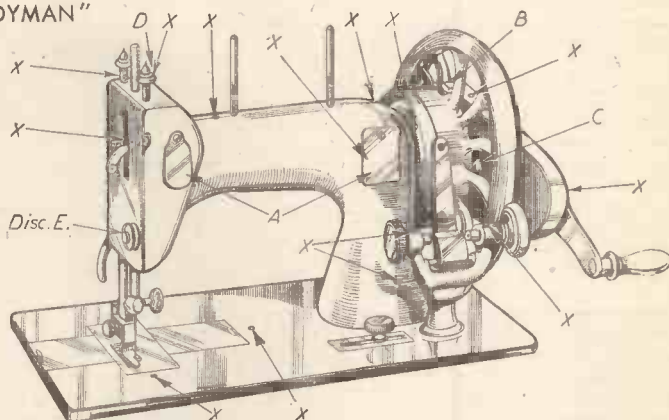

Fig. 1.—General view of a domestic sewing machine: A, the metal plate behind the winder; B, end of connection uniting hand appliance to machine; C, small lever to shut off machine when winding bobbins; D, tension screw. The points marked X are those which require lubrication.

Needle Breakage

Needle breakage is caused by using too fine a needle on stout material, or because it has become bent in use. Bent needles are nearly always caused by the operator trying to force the work through faster than the automatic feed underneath the foot.

Occasionally it will be found that the machine tends to work stiffly, causing erratic action of the needle and shuttle, gathered threads, and so on. In every case this is due to lack of oil, and the solution is obvious.

It is important when oiling a sewing machine to use the correct grade of oil—one that remains fluid for a long time, and not one which gums up and becomes a brake on the mechanism instead of a lubricant. Do not, as so often is done, use salad oil, olive oil, or hair oil!

Before re-oiling the machine it is essential to remove the old oil. This can be done by washing through the oil holes with paraffin, and swabbing off with a piece of clean linen before using the clean oil. Any superfluity of oil should, of course, be wiped off, otherwise fabrics will be stained.

It is wise to turn the machine whilst oiling, to observe when the correct amount has been inserted through the oilways. In addition, the machine should be turned when flushing through with paraffin.

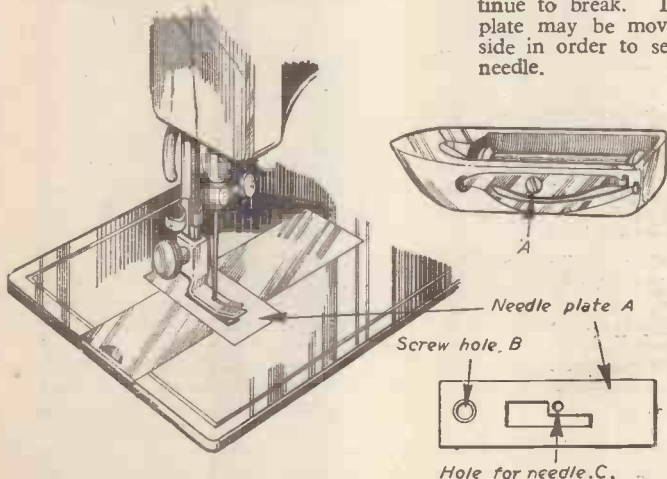

Fig. 3.—Details of straight-race machine.

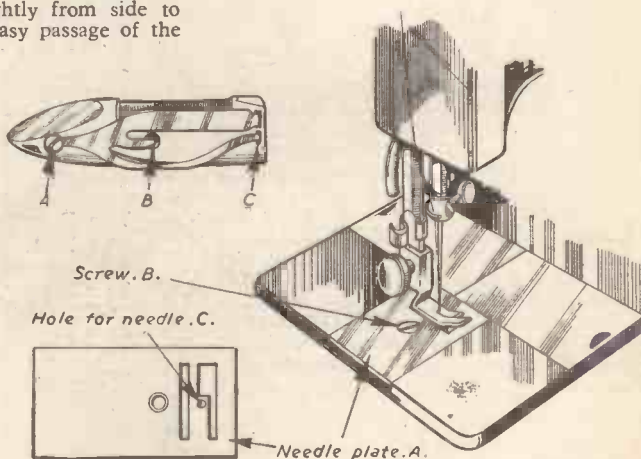

Fig. 2.—Details of vibrating shuttle machine.

Trade Notes

Multicraft Cutting Tool

OF particular interest to craftsmen in many trades is the Multicraft precision cutter which has been designed by Multicraft Tools, 29, Bolsover Street, London, W.1. It is many tools in one, wherever scoring, cutting and carving are required. The blades, which are ground like a scalpel, are stowed away inside the handle and are thus protected from rust and corrosion and damage to their fine edges. Made of aluminium alloy, the tool is very



This new British knife has four specially-shaped Sheffield steel blades which pack away inside the handle.

light, and is precision built and balanced like a fountain-pen for ease and comfortable handling when in use. The Sheffield steel blades are held rigidly, yet are instantly replaceable. The tool is priced at 5s., including four blades, a clip for the pocket costing 4d. extra. Spare blades are obtainable for 5d. each, or a set of four can be purchased for 1s. 6d.

Battery Booster-charger

BALLANGER BROS. (London), Ltd., 306, Holloway Road, London, N.7, are now supplying a hand-operated portable battery booster-charger rated at 6 volts, 5 amps. output when the handle is turned at 100 r.p.m. This handy generator charger, which is easy running on ball bearings, will charge 12-volt. car or storage batteries, and by varying the speed of turning 2-volt. wireless accumulators can also be charged. The machine should prove indispensable to motorists—for emergency starting when battery is low—and bungalow, caravan, cottage, and houseboat dwellers. It will operate

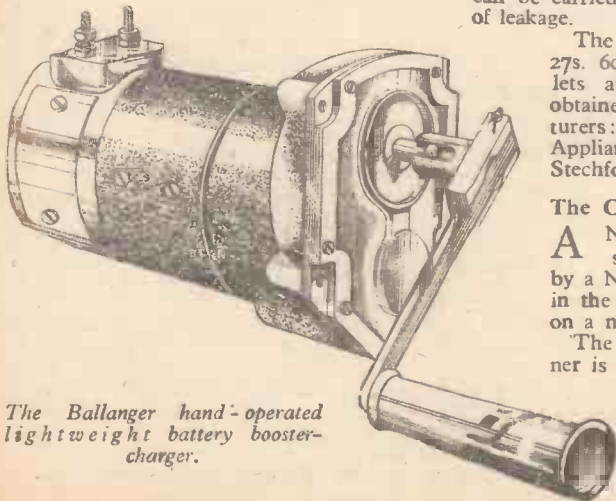

The Ballanger hand-operated lightweight battery booster-charger.

6- or 12-volt. car-type bulbs either direct or through storage batteries and also low-voltage electrical devices (ex-R.A.F. equipment) and model train sets, blowers, boat sirens, fire and burglar alarms in factories, schools, etc. The operating handle is easily removable, and alternative drives may be affixed, such as a wind propeller.

Measuring 7in. by 3in. (diam.), the weight of the charger is 7lbs. in its carton. The price is 30s. post paid, from the address given.

Lightweight Touring Stove

THE new Monitor No. 17B Touring Stove has been specially designed for campers, caravanners, cyclists, motorists and rambles—all who appreciate the advantages of preparing a hot drink or a simply cooked meal where and when they wish, yet must have lightweight equipment for travelling. It is claimed to be the lightest and most compact



The "Monitor" No. 17B touring stove.

of all paraffin stoves, easily assembled in a matter of minutes to form a highly efficient stove, and equally suitable for indoor or outdoor use.

The outfit comprises a collapsible stove ($\frac{1}{2}$ pint capacity) soundly constructed of best quality heavy gauge brass, wind-shield, spanner, methylated spirit can, and pricker—all fitted compactly into a smart metal container measuring only 2 $\frac{1}{2}$ in. x 4 $\frac{1}{2}$ in. x 6in. when closed. When not in use, the stove can be carried in any position without risk of leakage.

The new touring stove costs only 27s. 6d. complete. Illustrated leaflets and full particulars may be obtained from the sole manufacturers: Monitor Engineering and Oil Appliances, Ltd., Flaxley Road, Stechford, Birmingham, 9.

The Cromna Spanner

A NEW type of self-adjusting spanner has been introduced by a Norwegian firm, and, as shown in the illustration, the tool is based on a new principle.

The top jaw of the Cromna spanner is movable in the shank, and is connected by a ratchet to a movable segment in the bottom jaw. This segment is semi-circular in form and is embedded in the shank in such a way that it can

freely move and adjust itself to the nut to which it is applied. Between the upper jaw and the shank is located a spring which presses the jaw back to its initial position, i.e., its smallest aperture. When working with the spanner, there is no need for any screwing, twisting or other time-wasting movements. It suffices

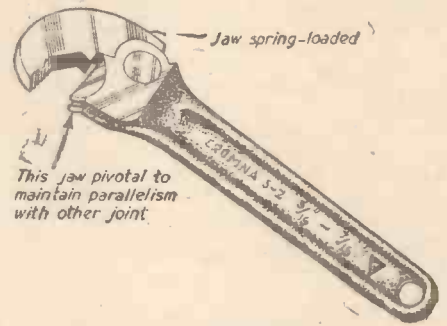

A new type of self-adjusting spanner.

to apply the tool to the nut, when a pull at the shank will cause the lower jaw to grip the nut, while at the same time the upper jaw turns on its pivot and assumes the required position. Once the spanner has gripped the nut, any further pressure applied to the shank will strengthen the hold and thus eliminate the possibility of slipping. It can also be used as a pipe wrench. The spanner is made in four sizes: 3/16in. to 5/16in., 5/16in. to 7/16in., 7/16in. to 5/8in., 5/8in. to 1in. Further information may be had on application to Norsk Cromna, Tollbugaten, 3, Oslo, Norway.

"Spot-on" Universal Test Indicator

THE universal test indicator, manufactured by Engineering Products, Ltd., Glenbrook Works, Littler's Close, Colliers Wood, S.W.19, is intended for the use of inspectors, toolmakers, setters and operators in all branches of engineering. Light in weight, weighing only 1 $\frac{1}{2}$ oz., it is constructed chiefly of stainless steel. The contact point, as shown in the illustration, has an 180 degrees adjustment, and it is securely held in any position.

The direction of movement of the hand relative to the contact point can be reversed by means of a small lever on the side of the body. The bezel is rotatable for setting to zero, and all parts are interchangeable.

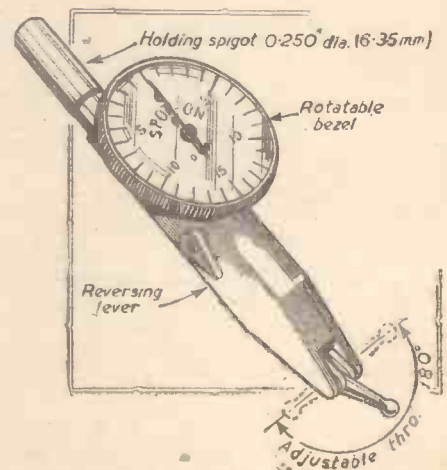

The "Spot-on" universal test indicator.



LETTERS

FROM READERS

New Theory of Gravitation

SIR,—With reference to your comment on gravitation in the February issue and your reference to the "Oersted Experiment" in particular, I have studied this experiment from a practical angle, having no knowledge of mathematics, and my conclusions are as follows:

The ether is not a medium, but an electrical field or pressure.

Matter is a resistance to that pressure.

Heat is not a condition, but a force (not a resultant force) capable of acting on matter but not on ether. It can be transferred but not disposed of.

Therefore, when ethereal pressure equals the resistance of matter, a static condition prevails, but when heat is added the result is motion—hence gravitation.—H. A. D. JOSEPH (Epsom).

Staining Perspex

SIR,—With reference to an enquiry on this subject in the April issue, suitable stable dyes dissolved in a mixture of 60 per cent. acetone and 40 per cent. water can be used for dip-dyeing many plastics, with highly satisfactory results. Smart opticians have taken advantage of this fact for several years. They stock a full range of sizes in plastic frames in clear or "crystal" only, and dip-dye them as required to suit the tastes of clients.

The querist is advised to consult *Plastic Craft*, by Ernest de Wick and John H. Cooper, published by the MacMillan Co., in U.S.A. (pages 86 and 87). English price, 25s. The book is splendidly produced.—W. A. SHEPARDSON (Durham).

National Inventions Organisation Act

SIR,—As one who has in the past read various articles in PRACTICAL MECHANICS with much interest, particularly where matters of national importance are concerned, I have waited to see if any practical developments would eventuate from the National Inventions Organisation Act, or whether it would have been better to have left it to those who made a start with the Industrial Development Corporation.

A number of people, of whom the writer is one, have long tried to persuade successive Federal Governments to either set up a similar organisation here or call attention of private enterprise to the need for it. The success or otherwise of the British Government's endeavour should indicate which is the better proposition.

Another entirely different matter in which I am interested is the question of moving ions causing a magnetic field.

I have certain lines of investigation in mind, but would be glad to learn of anything already done. I am also interested in knowing whether any work has been done on the electric magnetic and chemical co-relations of crystals or minerals, and would appreciate any information that may be available.

I continue to read PRACTICAL MECHANICS with much interest.—E. W. CHAMBERS (Heidelberg, Victoria, Australia).

Relative Motion and Propagation of Light

SIR,—The following problem in relative motion and propagation of light may be of some interest to other readers. Possibly someone can shed some light on the question?

Referring to Fig. 1, A is an observer at a beacon, a mirror B is fixed such that any ray from the beacon is reflected back to A. $AB = 300,000$ Km.

Another observer, C, is moving towards A on a path at right-angles to AB at a speed of, say, $50,000$ Km/sec. C also has a mirror fixed relative to himself at D, such that $CD = 300,000$ Km, and CD is

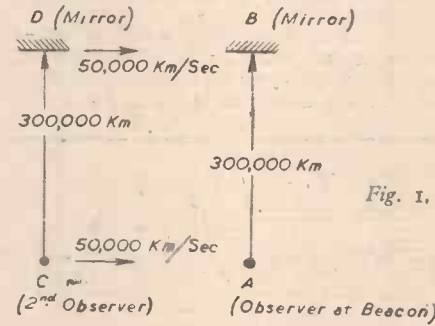
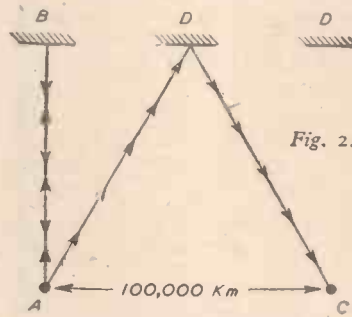

Diagram representing an observer, beacon and mirror.



At the instant of reception.

parallel to AB. If the beacon is flashed when A and C are at the same position (instantaneously), and it had been focused by A to give a parallel beam along AB only, then observers A and C will report as follows:—

A: "A beam was sent out to B and was reflected back in 2 sec., in which time C moved $100,000$ Km away."

C: "A beam was sent out towards D and was reflected back (or was it?) in 2 sec., in which time A moved $100,000$ Km away."

As far as I can see, both would be quite justified in their reports, for, at the instant of flashing, A, C and the beacon are at the same spot and the beam was sent to their respective mirrors.

The result is as follows: If C does get a reflected beam, then the light travelled as in Fig. 2, which A, who directed the beam, would say was impossible.

If C does not get the beam, then it might be said that, although A, C and the beacon were in the same spot, they still had relative motion.

By the following conditions both observers can be at rest relative to each other at the instant of flashing.

Let C be moving relative to A with simple harmonic motion such that A is the extreme end of the amplitude, i.e., when A and C are at the same point their relative motion is zero.

It does not matter in this case who brought the beacon or if both had a beacon, as all these cases give one fundamental condition—the instantaneous pause of A and C at a point coincided with the flash at their respective mirrors.

I have never heard this argument put forward before, and I am wondering if any experiments have been made to copy these conditions; I have in mind the Michelson-Morley experiment to which this one appears as a distant relation.

If C does get a reflected beam (and in the second case I cannot see how he could possibly fail to do so), then it would seem to indicate that there is a separate ether common only to each observer.

Finally, if I were at C, and I failed to get an answering beam, I should at once set out to buy a new mirror to replace the one which I should be quite justified in considering stolen or broken before the light reached it!—D. K. D. REES (Swansea).

Contact Lenses

SIR,—In his recent letter on contact lenses, Mr. P. Watkins, of Wolverhampton, states that he wonders why it is not possible to fix the lens centre to the lens of the eye without the cap to fit under the eyelid.

As I see it, the only method of achieving this would be to use some form of adhesive. This would have to be non-irritant and perfectly transparent, and it would not have to be affected by the natural lubricant in the eye. A non-irritating solvent would also be necessary to remove the adhesive when detaching the lenses. If Mr. Watkins could evolve a suitable adhesive and solvent, then his idea might be practicable.—J. B. CAINE (Douglas, I.ofM.).

Cycle-dynamo Lighting

SIR,—Having read Mr. Wiggins' letter (PRACTICAL MECHANICS, April, 1950) I regret that he has not been a little more explicit in stating what part of my argument he is questioning.

A possible clue lies in his apparent contradiction of himself when he states at the beginning of his letter that: "The only time a load can actually increase the terminal voltage of an alternator or transformer is when that load is capacitive and of high enough reactance to nullify the inductive reactance of the alternator stator," and at the end where he states that: "It is better that a dynamo should be slightly overloaded rather than underloaded. If the dynamo is underloaded its voltage will rise, and if it is seriously underloaded the voltage will rise sufficiently to burn out the bulbs;"—the latter being the very point which I set out to illustrate in my calculations.

Is it that he sees in my letter a possible inference that the off load terminal voltage of a cycle dynamo can be increased by the addition of a purely resistive load? If so, I can assure him that it was not intended.

As he (Mr. Wiggins) is fully aware, the

off load T.V. of the usual 6-volt cycle dynamo considerably exceeds this figure, but drops to the 6-volt level when the correct load in the form of the bulbs recommended by the makers is applied. If, however, this load is substituted for one of a lesser degree the voltage will rise—to a level somewhere between the "correct load" and "off load" terminal voltages.

Does this clear your point, Mr. Wiggins?
—V. BUTLER (Bethesda).

Enamelling a Bath

SIR,—With regard to G. R. Alexander's query on enamelling a bath in the February issue, I would not advise him to use any flat or priming paint as these contain oil and will peel off once hot water is applied. I enamelled a galvanised bath in the latter end of January, this year, and so far no blistering has taken place. The method used is as follows:—

Wash out the bath with solution of caustic soda and warm water to remove any grease or dirt. Dry out thoroughly, then apply two thin coats of aluminium paint, allowing each to dry out hard, then with a soft brush apply two or three coats of enamel, not too thickly. Kingston Brand Bath White, which I used, is the right enamel for this job. When the last coat has been applied let it set for two or three days before using the bath.—R. R. TREGASKIS. (St. Helier).

Terrazzo Flooring

SIR,—I note that, in the April issue of PRACTICAL MECHANICS, there is an answer to a query relating to Terrazzo flooring.

May I suggest that the method advised will not give the best results. I assisted with

several jobs in this material some years ago, and the method used was as follows:—

Using two grades of white marble chip-pings as aggregate, cement and powdered dye all very thoroughly mixed in the dry state, a mixture was made like concrete, which was trowelled on a well-wetted surface, tamped, and allowed to set until hard.

A flat sandstone block and plenty of water were then used to reduce the surface until flat and even.

A wash of cement with a little dye was then applied to fill in any slight imperfections, and when set the whole surface was re-dressed with the stone.

When the surface was satisfactory it was polished as follows: Candle grease was applied liberally and worked in with a swab of very hot felt (an electric iron inside a piece of felt). This gives a polished surface which is then treated with ordinary wax floor polish, as is lino floor covering.

It will be found that the dye has sunk, in varying degrees, into the marble, and the effect is very pleasing. About $\frac{1}{4}$ in. was rubbed from the surface as laid and allowance must be made for this.—J. R. D. (Leeds).

The New Cosmology

SIR,—The broadcast talks on the Universe and Creation given by Fred Hoyle were interesting listening and add another brilliant theory to the many others presented on Cosmology. As these are only views, the criticism and views of an ordinary listener on one or two of Mr. Hoyle's points will, I hope, not be out of place.

(A) The only evidence we have of an expansion of the Universe is obtained through spectroscopy and there have been, and still are, doubts as to whether the shift

towards the red is indicative of a true recession or is partly spurious. The writer has yet to hear of proof of recession apart from that claimed through the spectroscope.

(B) The resolving of matter from background material, as suggested by Mr. Hoyle as continuous creation, demands "the average density of the background must stay constant." From this one would reason that the rate of Creation throughout the Universe must also remain constant. "It is this Creation that drives the Universe," states Hoyle, "the new material produces an outward pressure that leads to the steady expansion." The trouble is we don't find a steady expansion rate, if we believe the spectroscope, but one which varies from a few million miles an hour in the nearer galaxies to that of a hundred million miles an hour in the more distant ones.

(C) In the writer's view there is no limit of size to the Observable Universe through the recession of the farther galaxies at a speed greater than that of light. The visible radiations being pulled down the wave length scale so that ultra violet becomes red, or sinks to heat, then to short wave radio waves, and finally on to radio waves of ever increasing proportions. The radiations would still be carried earthwards no matter how fast the radiating body receded. Have not radio waves been located coming in constantly from various points of the heavens? And, I think I have read, that not in all these points are either stars or galaxies to be found.

I refrain from comment on Mr. Hoyle's views on the future and the continuance of mind after death as I think the subject to be one outside the scope of the ordinary sciences, or even religion as many people know it.—C. J. WILLIAMSON (Scalloway).

Club Reports

Ilford and West Essex Model Railway Club

DURING the winter months a series of successful meetings have been held, including talks on model making and a film evening, when a number of sound films kindly loaned by British Railways were shown, and the annual competition, when Mr. G. R. Dow (P.R.O., London Midland Region) awarded the club cups as follows:

Locomotives—Mr. W. H. Betenson, EM Gauge L.B.S.C.R.—0-6-0 tank.

Rolling stock—Mr. D. M. Honeyman, Gauge 1 L.M.S. open wagon and welded coach bogie.

Lineside accessories—Mr. J. W. Pells, 4 mm. scale cottage and warehouse.

The club suffered a great loss by the untimely death in January of Mr. W. C. Hardy, a vice-president and one of the earliest members, but, through the generosity of Mrs. Hardy, has come into possession of his oo layout, which is now installed at the club for the use of members.

The junior section, for enthusiasts aged 14-18 years, continues to make satisfactory progress. Meetings are devoted to the construction of their own locomotives and practical talks on other aspects of the hobby.

The club council, ever anxious to improve the facilities that can be made available to members, has recently authorised the purchase of a lathe and high-speed drill, together with a number of hand tools. These will be installed within the next week or two

and should prove a boon to members who do not possess such equipment at home. New members are welcome.

Hon. Secretary, R. L. Riddle, 36, Vernon Road, Seven Kings, Ilford.

Aylesbury and District Society of Model Engineers

THE April meeting was held on the third Wednesday of the month, as usual, at Hampden Buildings. The committee had decided that the meeting should be used for general discussion among the members, of which full use was made. Much useful information was imparted to querists.

Hon. Secretary, N. F. Southerton, "Astracot," Bucklands Wharf, Aston Clinton, Bucks.

BOOKS RECEIVED

Enlarging for the Amateur. By S. B. C. Williams, M.A., B.Sc. Published by George Newnes, Ltd., 124 pages. Price 6/- net.

ENLARGING is now recognised as of increasing importance for the complete enjoyment of amateur photography, and is an essential part of the technique of the miniature camera. This book, which deals with the various kinds of apparatus required, and clearly describes all the steps of the process, should not only be invaluable for

beginners but also contains practical and proved advice which will assist the advanced worker to produce high-class exhibition prints. The complete processes of enlarging, including developing, printing, toning and retouching are fully dealt with. The book is well illustrated in line and half tone.

Pass Your Driving Test. By A. F. Kilgour. Published by C. Arthur Pearson, Ltd. 80 pages. Price 3s. 6d. net.

THE aim of this book, which has been written by a driver and instructor of long experience, is to assist applicants to pass the driving test on their first attempt. All that the learner needs to know is presented in this book in a form which is easily understood. The book explains the test itself, prepares the learner for the examiner, gives hints on likely questions about the car and the highway code, and provides a complete illustrated summary of traffic signs and signals. The book, which is of pocket size, is illustrated with over 50 instructional photographs and diagrams.

Ariel Motor Cycles. By C. W. Waller. 150 pages. Price 5/- net.

B.S.A. Motor Cycles. By D. W. Munro, M.I.Mech.E. 154 pages. Price 5/- net.

Royal Enfield Motor Cycles. By C. A. E. Booker, A.M.I.Mech.E. 186 pages. Price 5/- net.

THESE books, published by C. Arthur Pearson, Ltd., are three of a series of handbooks on the maintenance of the more popular motor cycles in use to-day. Each book deals exhaustively with the servicing and maintenance of the particular machines dealt with. The information given is intended to serve as a guide for the average owner, as well as the experienced mechanic or motor cycle repairer. Each book is profusely illustrated.

GALPINS

ELECTRICAL STORES

408, HIGH STREET, LEWISHAM, LONDON, S.E.13.

TEL: Lee Green 0309. Nr. Lewisham Hospital. TERMS: CASH WITH ORDER. NO C.O.D.

EARLY CLOSING THURSDAY FROM 9 a.m. UNTIL 4 p.m. SATURDAY

EXTENSION P.M. SPEAKERS, 3½ inch, by JOHNSON & PHILLIPS. Will handle 1½ watts. New boxed, 7/6 each. Post 9d. EX-R.A.F. D.C. TO D.C. MOTOR GENERATORS, 24/28 Volts input 1,200 volts 72 Mfamps. output, as new 7/6 each, post 1/6.

EX-R.A.F. MICROPHONE TESTERS. These contain a 2½ in. scale 0 to 450 Micro-amp meter shunted to 1 Mfamp. calibrated 0 to 10 volts moving coil, complete with 1 Ma. rectifier, "Mike transformer," etc., all contained in polished wood box, as new, 17/6 each.

MAINS TRANSFORMERS, 230 volts A.C., 50 cys. input 17½ volts 50 amps. output, 52/6 each, carriage 5/-; another auto wound, output 14 and 17 volts output at 30 amps., 35/- each, carriage 3/6; another with 2x4 volt 20 amp. windings, 25/- each, P/f.

PRE-PAYMENT 1½-SLOT ELECTRIC LIGHT CHECK METERS, all electrically guaranteed, 200/250 volts 50 cys. 1 ph., A.C. input, 2½ amp. load, 27/6 each; 5 amp. load, 35/- each; 10 amp. load 42/6 each; 20 amp. load, 50/- each, carriage 2/- extra; in quantities of one dozen or more a special discount of 10%.

MAINS TRANSFORMERS, 200/250 volts 50/11 ph., in steps of 10 volts. Output 500/1500 volts 300 Mfamps., 6/3v. 8 a., 6/3v. 8 a., 6/3v. 4 a., 5v. 4 a., 4v. 4 a., at 67/6 each; another same input/output, 450/1450 volts 300 Mfamps., 6/3v. 8 a., 6/3v. 8 a., 4v. 4 a., 5v. 4 a., at 62/6 each.

ELECTRIC LIGHT CHECK METERS, quarterly type, for sub-letting garages, apartments, etc., all fully guaranteed electrically, for 200/250 volts A.C. mains 50 cys. 1 phase 5 amp. load, 17/6 each; 10 amp. load, 20/-; 20 amp. load, 25/- each; 50 amp load, 37/6 each; 100 amp load, 45/- each; carriage 2/- extra on each; special discount of 10% on quantities of one dozen or more.

ISENTHAL MAIN VARIABLE. Resistances (Dimmers) 700/750 watts from fullbright to blout worm wheel control, as new 27/6 each, carriage 2/- total resistance 60 ohms.

MAINS TRANSFORMERS INPUT 200/250 VOLTS, 50/11 in steps of 10 volts, output tapped 0, 6, 12 at 24 volts at 10/12 amps., 47/- each; ditto as above, but at 25/30 amps. output, 68/6 each.

MAINS VARIABLE SLIDER RESISTANCES, protected type by well-known makers, 450 ohms, .9 amps., 22/6 each; ditto 1,500 ohms to carry .45 amps., 22/6 each, not protected, 0.4 ohms to carry 25 amps., 10/- each; 14 ohms to carry 1/4 amps., 12/6 each; 5.7 ohms to carry 8½ amps., 15/- each; 60 ohms to carry 1½ amps., 15/- each.

MAINS TRANSFORMERS, input 200/250 volts in steps of 10 volts, output 250/1350 volts 300 Mfamps. 4 volt 8 amp., 4 volt 4 amp., 6.3 volts 6 amp., 6.3 volts 2 amp., tapped at 2 volts (electronic) at 57/6 each; another same input as above output 500/350/1350/1500 volts 250 Mfamps. 5 volts tapped at 4 volts 4 amps. twice, 6.3 volts tapped at 2 volts 2 amps., 67/6 each.

SWITCHBOARD, A.C./D.C. AMP-METERS, Oto 14 amps. 4½ in. scale by well-known makers, as new, 25/- each.

MAINS TRANSFORMERS, 200/250 volts input in steps of 10 volts, output 350/1350 volts 180 Mfamps., 4 volts 4 amp., 5 volts 3 amp., 6.3 volts 4 amp., 37/6 each, ditto 500/1500 volts 150 Mfamps. 4 volts 4 amp., 5 volts 3 amp., 6.3 volts 4 amp., 42/6 each; ditto 425/10425 volts 180 Mfamps. 6.3 volts 3 amps. twice, 5 volts 3 amps. (Williamson Amplifier), 39/6 each; Ditto, 350/1350 volt 180 Mfamps. 6.3 volts 8 amps. 5 volts tapped 4 volts 3 amps., 39/6 each.

CELL TESTING VOLT-METERS, moving coil, reading 3/10/3 volts by well-known makers, complete with test leads, 7/6 each.

EX-GOVERNMENT AUTO WOUND TRANSFORMERS (as new) 1,000 watts output 115/230 volts or vice versa, £4/10/- each, carriage 5/-; another 1,000 watts from 5 to 230 volts with 32 various tapings inclusive of 110, 150, 60, 90 etc., etc., all tapping at 1,000 watts, £5/10/- each, carriage paid.

MAINS TRANSFORMERS 230 VOLTS 50 cys. input/output, 4 volts 5 amps. three times, 16/- each; another 6.65 volts 5 amps. twice, 16/6 each; another input as above, output 150/10/150 volts 150 Mfamps. 6.3 volts, 8 amps. 5 volts 2 amps., 16/6 each; all carriage paid.

MORE GREAT M.O.S. BARGAINS!

IMPEDANCE MATCHING UNITS

These little units, measuring only 2½ in. x 1½ in. x 1½ in., are the answer to the problem "How to match low resistance phones to a high impedance output." They will work with ANY low resistance phones, giving far more sensitive operation. Each unit contains a matching transformer and, if desired, the connections can be changed so that the unit will match low impedance line to high resistance phones (2,000,4,000 ohms). A standard jack plug is fitted to the body of the unit, and also a standard jack plug socket.

AS NEW, only 2/- (Post. Packing 6d.)

AVO INSTRUMENTS

Brand New Surplus in Manufacturers' Cases.

UNIVERSAL AVO MINOR. List price, £8 10s. 8d. Our Price, £6 15s. 0d.

DC AVO MINOR. List price, £5 5s. 0d. Our Price, £3 10s. 0d.

LIMITED QUANTITIES ONLY.

(Both plus 2/- Carr. & Pkg.)

AN ALADDIN'S LAMP

FOR YOUR GARAGE, HOME OR WORKSHOP.

A beautifully made canister, capacity just over 1 gallon, for which you can find a thousand uses—spare petrol, oil, paraffin for cleaning, a drip can, container for your redex and other upper cylinder lubricants, a cooling solvent feed for your lathe or capstan.

Yes—we could go on describing the uses of this little wonder unit, complete with filter (which is removable), top vent (which can be sealed), 1½ in. gas outlet at the bottom (which can be closed). You can fit a tap or whatever other ingenious use your mind can think of. You can use it for carrying spare petrol (if you can get it), not forgetting the motorcyclist!

This UNIVERSAL BEAUTIFULLY CONSTRUCTED CANISTER for 1/20th of its original cost, 5/6 (Post. Pkg. 1/-). Limited quantity only.



PRECISION LIFTING GEAR

Worm driven unit originally designed for lifting bombs into aircraft. Can either be operated by hand or motorised. Non-slip clutch incorporated in gear unit. Steel lifting hawsers capable of carrying a load of over 12 cwt. with a lift of over 7ft. The whole unit is brand new and is supplied complete with cables and shackle bolt.

Motor, aircraft and engineering organisations have a host of uses for this lifting gear which was built for the Air Ministry regardless of cost. Also suitable for adaptation to a 187:1 £5 each (Carriage paid). reduction gear.

METERS All Brand New.

0-5 amp. RF. 2 inch round projecting mtg. 6 for 12/-

0-4 amp. RF. 2½ inch scale, with Shorting Switch. 6 for 15/-

0-40/120 MA. 2 inch round. Pjtn. mtg. M.C.D.C. 5/- each

0-1 MA. 2 inch round. Proj. mtg. M.C.D.C. 7/6 each

0-500 microamps. 2½ in. round M.C.D.C. 7/6 each

0-1,500v. Electrostatic. 2½ inch round. Proj. mtg. 12/6 each

0-100 MA. 2½ inch scale. Portable type, with Shorting Switch, M.C.D.C. 8/6 each

0-35 & 0-70 amp. (dual) 2 inch square flush. M.C.D.C. 5/- each

0-25 amp. Moving Iron. D.C. only. 2½ inch round flush. 3/11 each

0-20 amp. 2 inch round. 3/11 each

Proj. mtg. M.C.D.C. (All plus 8d. Post & Pkg.)

M.O.S. MAIL ORDER SUPPLY CO.,

The Radio Centre, 33, Tottenham Court Rd., London, W.1. MUS 6667-8-9

ADVANCE NOTICE

TO ALL MYFORD "ML7" LATHE USERS

We are proud to announce the impending release of a simple

SCREWCUTTING GEARBOX

giving all the usual threads from 7 to 52, in addition to a series of self-act feeds. May be fixed to the lathe without any structural alteration of the existing machine. Can be made entirely on the lathe itself.

Designed by Lawrence H. Sparey (Editor, "The Model Mechanic" and author of "The Amateur's Lathe") and marketed exclusively by ourselves. Full constructional details are given in the special "Tool News," which can be obtained from us at 2/6 post paid.

Detailed quotations will be ready shortly for complete attachments and constructional kits and all interested users are invited to submit a stamped, addressed envelope for details.

Home and export trade enquiries particularly welcomed

ALL RIGHTS RESERVED

OBTAINABLE ONLY FROM—

T. GARNER & SON Ltd. HAND & MACHINE TOOL DIVISION Redbrook Works, Gawber, BARNESLEY

Phone: 2908 P.B.E. Grams: Garner 2908 BARNESLEY



CHEMICAL APPARATUS CATALOGUE
POST 2/6 FREE

The Abridged Chemical List S.A.E.

VICSONS LTD
148 PINNER RD., HARROW, MIDDLESEX.
FOR ALL LABORATORY APPARATUS

Contractors to Education Authorities and many of the large industrial laboratories



BALANCES FROM STOCK

THINGS TO MAKE AND DO

Make an accurate TIMING METER, 1 to 110 seconds, for repetition printing of enlargements without spoiling the picture. Kit of parts and circuit to enable job to work from 230v. A.C. mains. £2/1/4d. post. Estimated time needed to make, 8 hours (two evenings). Circuit and price list can be obtained separately for 6d.

Fix TWIN STOP LIGHTS to your MOTORBIKE—kit consisting of two red lights with 8v. bulbs, breaking switch and flex, 10/6d. Time needed to fix, 2 hours.

Make yourself an ELECTRIC FAN—230v. A.C./D.C. Kit of parts with instructions, 15/-+1/- post. Can be made in two evenings.

Don't let your vacuum cleaner or small motor DISTURB THE RADIO: fit a suppressor in radio mains lead, no need to interfere with chassis, fitted in ten minutes. Price 5/-+9d. post.

Make your RADIOGRAM EARN ITS KEEP—it can be easily adapted for magnetic recording on tape and for replaying your recordings. Most useful for cine enthusiasts, who can synchronise recording to film and make "talkies." All parts in stock, send for complete instructions and price list, 1/-.

Make a BATTERYLESS RECEIVER—Kit of parts and circuit, 18/8d.+9d. post. This radio when made will need no replacements, but will work for years non-stop. Time needed, 2 evenings.

Make a RECORD PLAYING AMPLIFIER—Kit of parts and circuit for 230v. A.C./D.C. mains, £3.10s.+1/4d. post. Circuit and price list can be obtained separately for 6d.

ARMATURE REWINDING of all types: prompt and efficient service: quotes by return. Please state type, phase, voltage, etc.

PARK RADIO OF MANOR PARK
676/8, ROMFORD ROAD, LONDON, E.12

BEST BRITISH BARGAINS

METERS, for all purposes. Voltmeters, D.C., Moving Coil, flush panel, 2in. dia., 0-30 volts, 4/6, 2 1/2in. dia., 100-0-100 volts, 7/6, 500 volts, 7/3, 3 1/2in. projecting panel, 0-3,500 volts, with series res. in case, 12/6. Milli-ammeters, D.C.M.C., 2in. dia., 0-1 m.a., 12/6, 3 1/2in. dia., 0-1 m.a., 30/-, 2 1/2in. dia., 0-50 m.a., 200 m.a., 500 m.a., 10/6 each.

AMMETERS, D.C.M.C., 2 1/2in. flush, 2 amps and 5 amps, 15/6 each, 2 1/2in. square, flush, 5 amps, 20 amps, 9/6 each, 50 amps, 7/6.

Switchboard Meters, A.C./D.C., 6in. projecting panel, 0-300 volts, 35/-, 0-50 amps, 3/16, 4 1/2in. dia., 0-14 amps, 25/-, 7in. dia., 10-50 amps, 34/-. **Frequency Meters**, Ironclad flush panel type, 5in. Crompton, 40/60 cycles, 230 volts, £5/10/0. Met. Vick, 6in. dial, projecting panel, 200/250 volts, 48/52 cc., £9.

CURRENT TRANSFORMERS, 400/5 amps, Sangamo Weston Model S.2, 50 cycles, 15 Va. System Voltage, 700 B.S.I., 30/-, 1,200/600 to 5 amps, dual range, Crompton Park, 15 Va., 35/-.

RESISTANCES, Enclosed field Reg. 1,000 ohms, 0.6 to 0.16 amps, 27/-, Zenith geared B.O.B. mounting, 4.6 ohms 16 amps, 35/-, Isenthal geared 60 ohms 2.8 amps, 25/-, Isenthal single slider Resistances, laminated brush gear 20 ohms 2.5 amps, 15/-, 300 ohms 1 amp, 12/6.

TRANSFORMERS, B.T.H. 200/230/250 volts input, 2 volts 20 amps, and 75 volts 6 amps, with 15 taps output, 45/-, carr. 5/-, Power Transformer, 230 volts 50 cy. input, 53 volts 15 amps, 6 volts 5 amps, 300/60 volts 1 amp. output, £4/5/0. Foster Transformer, 100 watts 50 volts 2 amps. output 230 volts 50 cy. input, 15/-, carr. 2/-.

VARIACS, consisting of two units in series, input 230 volts, output 115 volts or 115/230 volts 1.5 Kva., £9, other sizes in stock, state your requirements.

MAGNETS, Swift Levick, S.L.5. 36 circular horseshoe type, 1 1/2in. dia., 3/4in. thick, 3in. polar gap, drilled poles, weight 2 ozs., lift 3 lbs., 2/6. Special price for quantity orders. Electro Magnets, D.C., 6 volt to lift 4 lbs., weight 10 ozs., 5/-, Horseshoe Magnets, various sizes, send for leaflet. Alni Disc Magnets, 3in. dia., 3/4in. thick, 3 1/16in. centre hole, 3/6.

HAND MAGNETO GENERATORS, P.M. Steel Magnet, wound armature, driven by gearing in handle, output approx. 75 volts 25 m.a. A.C., 8/6, postage 1/6.

DYNAMOS, for Windmill work, 12 volt, 10/15 amp, C.A.V. 1,400 r.p.m., totally enclosed shunt, 40/-, carr., 5/-, D.C. Charging Dynamos, 24 volts 20 amps, 1,200 r.p.m., £10, 24 volts 30 amps, 1,000 r.p.m., £15, 30 volts 5 amp, with control box, 50/-, 24 volts 40 amps, 3,000 r.p.m., 70/-, 27/32 volts 9 amps., with Switchboard mounted on top, £4,10/0, carriage on any Dynamo, 5/- extra.

A.C. MOTORS, 1/6th h.p., 230 volts, G.E.C. and Newman make, £3, carr. 5/-.

D.C. MOTORS, 1/4th h.p., 110 volts, A.E.G., 30/-, 12 volt D.C. Motor, new, 3,000 r.p.m., 40/-.

TELEPHONE CONSTRUCTORS PARTS, comprising ex. G.P.O. wall type polished wood box fitted Microphone, switch-hook, and receiver, induction coil Mag. bell, transformer, condenser and connection strip. Hand Magneto Generator and wiring diagram, 30/-, per pair, carr. 5/- extra. These telephone parts are not toys, but can be used for workshop to office, house to garage, etc.

SOLDERING IRONS, 110 volt workshop irons, with flex and Cord, new and boxed, 10/-, postage 1/6.

TERMINAL BOXES, Bakelite, power type, 3 1/2in. x 2 1/2in., highly polished black, with 3in. centre fillet and screwed cover. 2-pole 5 1/16in. connection studs and nuts, 10/50 amps., wall or ceiling fixing, 1/6 each, post 6d., 13/6 dozen.

CONDENSERS, Ceramic condensers, 2, 3, 15, 30, 50 Pf., 6d. each, Eric Ceramics, 25, 75 Pf., 6d. each, Silver Mica, 100 Pf. and sizes up to 1,780 Pf., 6d., each. Special prices for quantity orders.

POT-METERS, 1 watt wire wound, 2,000 ohms, 1/6, 6 ohm, 1/3, 2 watt carbon, 500 ohms, 9d., 100,000 ohms, 9d., 500,000 ohms, 1/3, 1 meg., 1/6, 10,000, 20,000 or 30,000 ohms, 1/6. Special prices for quantity orders.

RELAYS, G.P.O. strip of 20 relays, 100 ohms, 2 1/2 volts 15 m.a., 10/-, postage 2/-.

MICROPHONES, G.P.O. carbon, Mike in bakelite case, 3/6, postage 6d. Transformer, 2/6, Carbon Insets, 2/-, post 3d. G.P.O. Mike Buttons, 3/6, Tannoy Hand Mike for announcers for Sports Meetings and Dance Hall, multi carbon type, metal clad.

Please include postage for mail orders.

ELECTRADIX RADIOS, 214, Queenstown Road, Battersea, London, S.W.8
Telephone: MACaulay 2159

MORE SALE BARGAINS

Metal (Mine) Detector
FOR the detection of ferrous or non-ferrous metals, underground, under water or in animals, timber, chemicals, etc., etc., originally intended for detecting mines by one of our allied armies. This equipment has never been used. We have to clear the warehouse in which these are stored, and therefore, we are offering these complete Mine Detectors for less than the cost of the transit-case alone. The equipment comprises a 3-valve battery amplifier in a steel case, a shoulder haversack, and long counter balanced search coil, short search coil, head-phones, junction box, sensitivity measuring stick and operating instructions and circuit diagram. The original cost of this equipment was enormous, but as we have to clear our store, we will supply while they last at the very low figure of 22 6/12 plus 12/6 carriage. We understand that these Mine Detectors were tested and in working order before being stored, but in view of the very low price, we can give no guarantee other than of completeness.

Power Pack Type 392
THIS is an extremely useful unit which works off A.C. without modification, giving an output of 700 v. D.C. adequately smoothed. Here is a list of the components contained in the power unit: Mains Transformer for 200-250 v. 50 cycle, with secondaries of 700-0-700 v. at 70 m.A., 4 v. at 2.5 amps, 12.5 v. at 1 amp. (Note, these are Admiralty ratings; the transformers will stand at least twice these figures.) Also included are: 100 ohm 10-watt resistors, three 4 mfd. 100 v. condensers, L.F. choke, 10 henry 100 m.A., 2 siydlok fuses. The power pack is unboxed and is contained in a louvered case size 12in. x 5 1/2in. x 8 1/2in. Sale price 47/6.

Receiver Type 25/73
THIS is the receiver portion of the TR.1198 and it is undoubtedly one of the most useful little receivers that has ever been offered as Government Surplus because once you have removed the tuning unit, and replaced it with a standard coil pack, you have a domestic receiver. You can use almost any valves, for instance, in the first stage it needs an B.F. pentode, 5P61, EF39,

6K7, etc. V2 is the frequency changer; here you can use V857, EK32, 6K8, etc. V3 is the I.F. Amplifier; this can be the same type as V1. V4 is the detector and first A.F. Amplifier; this can be EBC.33, 6Q7, VR55, etc. V6 is the output valve, say 6V6, EL32, 6F6, VT52, etc. You can see then that you will be able to make a very efficient superhet for a very small figure. Sale price 7/6 or 19/6 with valves.

A Free Gift
THE famous American indicator unit TAPNA uses a 5in. C.R. tube type 5CP1 and has a front panel which is most impressive, equal in fact to the most expensive 'scope. It is a double-decker unit and it is literally crammed with parts for it is a 26-valver. The parts include focus and brilliance and time base controls and hundreds of condensers, pot meters, resistors, etc., which if bought separately must cost £30 to £40. We give the unit away free if you buy the tube 5CP1 and the sale price we ask for this is only 27/6, plus 10/- partly returnable carriage and deposit on packing case.

Milnes H.T. Units
RECHARGEABLE H.T. batteries, 120 volts, 600 m.A. hours, rechargeable from 6 v. D.C. charge or car battery; will last for ever and show a great saving over dry batteries. Ideal for school, laboratories, boats, etc. Complete with full operating and maintenance instruction. Brand new and unused in carrying case with handle and armoured glass lid 14in. x 11in. x 8 1/2in. Sale Price 47/6 each, carr. and insurance, 7/6.

MCRI Power Packs
UNIVERSAL power supply to operate on any mains voltage. Designed for miniature receiver MCRI, but suitable for any small superhet. Output 120 volt H.T., 7.5 v. L.T. Size 2 1/2 in. x 3 1/2 in. x 8 1/2 in. Sale price only 24/6, carriage and packing 1/6.

Pay Us A Visit
WE have mentioned only a few of the many bargains which will be available during our sale. We suggest that you "Pay us a Visit" because there will be many items for callers only. Failing this you must send for our Bumper Sale List. Do not forget to enclose 6d. in stamps, because we shall probably have to send it out in two editions.

ELECTRONIC PRECISION EQUIPMENT

1, ELECTRON HOUSE, WINDMILL HILL, RUISLIP MANOR, MIDDX.

WALKY TALKY TRANSCEIVERS
65/-
A special purchase enables us to offer a complete Transmitter and Receiver, portable, weighing 9 lbs., covering short waves 30-50 metres, for only 65/- complete. Range 15 miles or more. Mazda valves. Foolproof and air tested before despatch, full instructions. Spare valves, phones, handsets and batteries are available from stock. Receiver will receive all normal Broadcast SW stations as well. Slow-motion dial.

COLLARO RECORD CHANGERS
9 gns.
Two brand new RC500 changers in makers' carton, 9 gns. each, carriage 7/6 extra. Crystal or Fidelity pick-up. 7 watt PUSH-PULL AMPLIFIERS
65/-
American type brand new push-pull miniature, measure 6in. square, in attractive satin finish cabinet. A.C./D.C. high gain, mike and pick-up input. Spare sets of valves, 12/6 only. De Luxe Model with quality output transformer. 95/-

VALVES, 3/- each: KTW61, KTW62, 6K7, VF20, P61, CV66, EB34, 954, 955, 4/- each: EBC33, MHL6D, 6F6, 6J5, 5/- each: 6F6, 6V6, PEN383, 12A6, 6A6, 5T4, 6K8, 12J7, 14HT, 7Y4, 7HT, 9/- each: U52, 5U4G, PENDD4020, 9/6.

Illustrated leaflets of amplifiers, TV equipment.

COLLINS RADIO, 24, Llysiville Road, London, S.W.6. ReNewn 4178.

REFILL YOUR OWN BALL PEN VISCOID REFILL KIT
Post Free 3/8 inc. tax.
COMPLETE WITH TOOL AND ILLUSTRATED FILLING INSTRUCTIONS
CONTAINS SUFFICIENT INK FOR 15 AVERAGE REFILLS
AVAILABLE IN BLUE, RED & GREEN
TRADE ENQUIRIES INVITED
VISCOID INKS (P.M.), 6, SHERLOCK MEWS, BAKER ST., LONDON, W.1

QUICKER CLEANER - CHEAPER
A Perfect Finish with all PAINTS, DISTEMPERS, CELLULOSE, etc. Any Liquid that flows.
FITS ANY VACUUM CLEANER
Approved by Electricity Board
With 2 jets and instructions
Extra jar, 1/8.
Connection for Bag Type Hose, 2/-.

19/6

● Press Button Control.
● Saves Brushing. ● Can't go wrong.
● Simple to use. ● Makes better job.

UNICO WHOLESALE
(Dept. P.M.), 51, THE MALL, W.5.
Trade enquiries invited.

CHEMISTRY APPARATUS
Send Stamp for COMPLETE PRICE LIST

Booklets:
"Experiments" 7d.
"Formulas" 20d.
"Home Chemistry" 2/3
Post Paid.

(Scientific Dept. A)
BECK 60 HIGH STREET, Stoke Newington, London, N.16

Modelcraft POWER BOAT PLANS & KITS

THE 'WALTON' CRUISER
A fine example of the modern British motor cruiser with streamlined yet seaworthy hull, which makessuch a happy holiday 8/- home for so many adventurers. Length 23in. 4 sheets of plans only. Post Free

THE 'DAYTONA' CRUISER
This is the American counterpart of the Walton, a 33in. craft, sleek yet not vulgarly over modern. Like the Walton the 11/- plans are for bread-and-butter construction. 4 sheets plans only. Post Free

THE DIESEL ELECTRIC TUG
Originally planned as a scenic adjunct for 4mm railway modelling, many modellers have found it sufficiently detailed to 3/- serve as a plan for a seaworthy "power-driven model." Hull Post Free length 15 1/2 ins.

THE 'OLGA' RIVER CRUISER
This was designed to be powered by the "Foam Wraith" miniature outboard motor, but many modellers have fitted all sorts of other power-units. The design is smart yet easy to construct and is typical of the small craft which ply on rivers and sheltered waters. Hull length 18 ins.

PLAN ONLY 3/- POST FREE KIT 13/6 post free

THE COASTAL CRUISER
In contrast to the bread-and-butter principle of construction of most model boats, this is built on the same scheme as the original craft itself. Yet it isn't very difficult. When completely you have a model that you can be really proud of. Hull length 17 ins.

PLAN ONLY 3/- POST FREE KIT 18/6 post free
Full details of these and other powercraft, of sailing yachts and over 550 other items, plans, kits and accessories are given in the Modelcraft List, 14/-, post free or from your modelshop. Includes refund voucher value 1/-

MODEL-CRAFT LTD.
77 (L) Grosvenor Rd., London, S.W.1

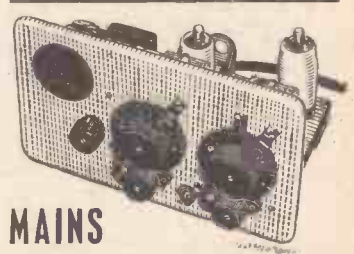

MAINS RADIO with LOUDSPEAKER!
29/6 plus 2/6 carr. and insurance.

AC3 midjet radio—covers medium waveband, home and light moving coil speaker, slow motion tuning, 2 valves—H.F. and output. Diode detector. Metal rectifier, mains transformer. Suitable for A.C. mains 200/250 v. The Army unit T18 contains everything necessary to rebuild this fine receiver from easy-to-follow blueprint. There is nothing else to buy.

LOUDSPEAKER BARGAIN
This is a beautifully made 10in. P.M. Speaker, a real precision product made by a very famous firm you will recognise immediately. It is undoubtedly a 10in. speaker with a 12in. quality reproduction, and has these special features: (A) a solid diecast frame (B) a dustproof speech coil arrangement, and (C) a patented speech coil suspension which gives wider frequency response. Speech coil is normal 2.3 ohm impedance. The correct retail price of this speaker is 35/-, but we are able to offer this fine receiver from easy-to-follow blueprint. There is nothing else to buy. plus 2/6 carriage and insurance.

CONSTRUCTORS PARCEL (A)
Heavy gauge metal chassis, cut out for 5 valve superhet. Size 14in. x 6in. x 2in. Mains transformer (250-0-250v. at 60ma. 6.3v. at 3 amps, 5v. at 2 amps.) L.M. and S. scale size 7in. x 5in., back plate, supporting brackets, pulleys, drive drum, pointer, two-speed spindle, complete with instructions. £1 plus 1/9 postage. Constructors Parcel (B) as for A but with 4v. type transformer, same price. Constructors parcel (C) as for B but with 6v. mains transformer 6/6, plus 1/6 post and pack.

MAIL ORDER ONLY.
THE INSTRUMENT CO.
11, Gunnersbury Lane, Acton, W.3.

QUERIES and ENQUIRIES

A stamped, addressed envelope, three penny stamps, and the query coupon from the current issue, which appears on page 72 (THE CYCLIST), must be enclosed with every letter containing a query. Every query and drawing which is sent must bear the name and address of the reader. Send your queries to the Editor, PRACTICAL MECHANICS, Geo. Newnes, Ltd., Tower House, Southampton Street, Strand, London, W.C.2.

Coloured Varnish Lacquer

I HAVE a number of fancy shaped clear glass bottles which I wish to convert into reading lamps, if I can find some method of colouring them, and at the same time producing a translucent effect. I would prefer the colour to be inside the bottle, and have tried the effect of ordinary paint which gave a solid appearance not to my liking.

I would be grateful for any advice you may be able to give me.—L. Hesketh (Liverpool).

OBTAIN from a retail ironmonger's or general stores a large tube of a cellulose adhesive. Or, alternatively, from a paint shop procure a tin of clear cellulose lacquer. Starting with either material, dilute it with sufficient amyl acetate (the so-called "banana oil") until you have a medium of thin varnish consistency. Now, obtain a small amount of a spirit-soluble dye. Dissolve this in methylated or surgical spirit so as to make up a strong solution of the dye.

Add one part of the dye solution to every 10 parts of cellulose varnish. Do not exceed this proportion, otherwise the varnish may be affected in transparency.

You will now have a transparent, coloured varnish lacquer. This can be sprayed or brushed on to glass and it will quickly harden to a transparent and coloured film, the depth of colour depending on the strength of the spirit solution of dye.

The coloured film will be reasonably stable to heat, but it will not withstand excessive heat, such as might be given off by a high-wattage lamp. If you confine the lamps to the use of the ordinary 60-watt bulbs, and give sufficient ventilation space all round the bulb, the coloured lacquer film will not be affected.

Thermostatic Control of Photographic Solutions

AS an amateur photographer I process my own films, etc., but I have experienced trouble in maintaining the solutions at a steady temperature.

I now propose to construct a thermostatically-controlled heating plate on which to place the dishes, for keeping solutions at a temperature of about 60 to 70 deg. F.

Could you advise me as to what type of heating I would need?

The size of the plate will be about 16in. by 12in. by 3in., with a top of sheet aluminium.—R. Collett (Abingdon).

FOR the thermostatic control of solution temperatures in a photographic darkroom you would have to employ electrical heating in conjunction with a special thermostat, the current being taken from the mains. Two or three 40-watt carbon lamps placed in a metal box might be used to heat an aluminium plate placed over the box, but the thermostat would have to be of the bi-metal switch type and you would have to purchase it specially from a firm of laboratory suppliers, such as Messrs. Baird & Tatlock, Ltd., 14-17, St. Cross Street, Hatton Garden, London, E.C.1. The thermostat would be expensive because it would have to be capable of very close working.

As a rule, we are decidedly against the electrical heating of solutions in amateur darkrooms. This on account of the danger of current leakages from inadequately insulated leads, particularly in the presence of conducting solutions, and the normally dimly lighted conditions.

If you could construct a small metal-lined box in which a small paraffin lamp could be burned you would, we think, be able to maintain your dish solutions at temperatures between 60 and 70 deg. F. You would have to rest the photographic dishes on a metal tray fitting tightly over the heating box, and the latter would have to be ventilated by means of light-trapped louvres or slots placed in the side of the box. Even in this case, there would be plenty of fumes. The cleanest and simplest method is, of course, to have the carbon lamps in a box and to dispense with any attempt at thermostatic control, merely relying on switching on and off the lamps from time to time. But, in this case, you must take every care to see that the electrical circuit is exceptionally well insulated and kept entirely away from surroundings in which the wires are liable to be splashed with photographic solutions.

Alloying Sodium and Potassium

COULD you please inform me whether it is possible to produce an alloy of sodium and potassium, which will be liquid at normal temperature? If so, what are the proportions?—H. G. Elfner (Liverpool).

THERE is a fairly long range of potassium-sodium alloys which are liquid at ordinary temperatures. An alloy of 16 parts of potassium and 10 parts of sodium is liquid at ordinary temperatures and looks like mercury. It becomes pasty at 8 deg. C. and solidifies at lower temperatures. By incorporating more potassium in the alloy (say, 20-25 parts) the alloy remains liquid at 0 deg. C.

In making up these alloys, the two metals should be melted gently together under solvent naphtha. The alloy, like its constituent metals, must not be allowed to come into contact with water, otherwise vigorous chemical reaction will take place, and alloys containing large amounts of potassium will inflame.

It is said that these alloys can also be made by adding metallic sodium to fused potassium acetate. The better way of preparing them, however, is the direct one of melting the constituent metals together under naphtha or some other oil to keep out air and moisture.

These alloys were, at one time, used for high-temperature thermometer making, but they are not

Readers are asked to note that we have discontinued our electrical query service. Replies that appear in these pages from time to time are old ones, and are published as being of general interest. Will readers requiring information on other subjects please be as brief as possible with their enquiries.

much employed for this purpose nowadays, since, unlike mercury, they "wet" glass and thus do not permit an accurate reading to be taken. Their high rates of oxidation also militates against their more general employment in thermometry.

Making a Zinc Sulphide Screen

HOW can I make a zinc sulphide screen so that it may see emanations from radioactive salts?—B. L. Greensmith (East Lothian).

OBTAIN a piece of zinc-blende, which is a natural mineral comprising, for the most part, zinc sulphide. This material can be obtained from most laboratory dealers, as, for example, Messrs. Griffin &

THE P.M. BLUEPRINT SERVICE

12 FT. ALL-WOOD CANOE.* New Series. No. 1. 3s. 6d.

10-WATT MOTOR. New Series.* No. 2. 3s. 6d. COMPRESSED-AIR MODEL AERO ENGINE.* New Series. No. 3. 5s.

AIR RESERVOIR FOR COMPRESSED-AIR AERO ENGINE. New Series. No. 3a. 1s.

"SPORTS" PEDAL CAR.* New Series. No. 4. 5s. F. J. CAMM'S FLASH STEAM PLANT.* New Series. No. 5. 5s.

SYNCHRONOUS ELECTRIC CLOCK. New Series. No. 6. 5s.*

ELECTRIC DOOR-CHIME. No. 7. 3s. 6d.*

ASTRONOMICAL TELESCOPE. New Series. No. 8 (2 sheets). 7s.*

CANVAS CANOE. New Series. No. 9. 3s. 6d.*

DIASCOPE. New Series. No. 10. 3s. 6d.*

EPISCOPE. New Series. No. 11. 3s. 6d.*

PANTOGRAPH. New Series. No. 12. 1s. 6d.*

COMPRESSED-AIR PAINT SPRAYING PLANT. New Series. No. 13. 7s. 6d.*

£20 CAR.* (Designed by F. J. CAMM.) 10s. 6d. per set of four sheets.

MASTER BATTERY CLOCK* Blueprints (2 sheets). 3s. 6d.*

Art board dial for above clock, 1s.

OUTBOARD SPEEDBOAT 10s. 6d. per set of three sheets.

SUPER-DURATION BIPLANE* Full-size blueprint, 2s.

The 1-c.c. TWO-STROKE PETROL ENGINE* Complete set, 7s. 6d.

STREAMLINED WAKEFIELD MONOPLANE—3s. 6d.

LIGHTWEIGHT MODEL MONOPLANE Full-size blueprint. 3s. 6d.

P.M. TRAILER CARAVAN* Complete set, 10s. 6d.

P.M. BATTERY SLAVE CLOCK—2s.

The above blueprints are obtainable, post free, from Messrs. George Newnes, Ltd., Tower House, Southampton Street, Strand, W.C.2.

An * denotes constructional details are available, free, with the blueprint.

Tatlock, Ltd., Kemble Street, Kingsway, London, W.C.2. Do not purchase the ordinary synthetic zinc sulphide, as it is of little use for the purpose.

Crush the zinc-blende very finely. Sieve it through a fine mesh and make the powder into a sort of paint by working it into a little tube cellulose cement, such as "Durofix," thinned down a little with acetone or benzene (preferably the former). Then smear a very thin coating of the resulting zinc blende paint on to a sheet of glass as thinly and as evenly as possible. Put the glass away for a few minutes to dry, and the screen will then be ready for use.

This is the principle of the Crookes' "Spintharoscope." A zinc-blende screen is mounted with a magnifying lens in front of it and when a piece of radioactive material is held at the back of the screen, the alpha-particles, which are shot out from the radioactive substance, impinge on the screen. The impact of each alpha-particle with the zinc-blende in the screen gives rise to a flash of light, so that when the front of the screen is examined through the lens, continual light flashes are seen on the screen.

It is quite safe to carry the zinc sulphide screen about with one, but it is dangerous to carry the radioactive material on one's person.

Refrigeration by Forced Evaporation

IS it possible to purchase, or make up, a container that will maintain a temperature of 40 deg. Fahrenheit or below, without going to the expense of buying a refrigerator? It is not desirable to freeze the materials. I have enquired about the possibilities of an ice-box, but I am told that the dry-ice necessary for it is difficult to obtain in this area, is messy and expensive.—W. J. Barber (Chepstow).

SINCE the use of an ice cabinet is precluded in your case and you are unable to use the ordinary methods of mechanical refrigeration, your only available cooling method will be the one of "forced evaporation."

In this method, a "cooling chamber" of thin, light metal is covered with one or two folds of cloth. Water is allowed to drip from above on to the cloth or, alternatively, the lower ends of the cloth may dip below water, thus causing the water to be drawn up by the fibres of the material.

The whole assembly is placed in a draught or, better still, a forced draught is artificially created by standing one or two electric fans in the near vicinity. The air current forcibly impinges on the moisture-saturated material and induces a rapid evaporation of the moisture.

The theoretics of the arrangement are quite easy to grasp. When water (or any other liquid for that matter) evaporates, it changes its state, turning from liquid to vapour. In order to make such a change it has to acquire the necessary energy. It takes the heat energy from its surroundings. Hence, the surroundings fall in temperature as a direct result of the "change of state" or evaporation of the water. The speedier the evaporation, the more the energy required and the greater the amount of heat energy which is abstracted from the surroundings of the evaporating liquid. Thus, by creating a forced draught, you decrease the temperature.

In effect, therefore, you will be surrounding your "cooling cabinet" with a thin water film which you will be causing to evaporate continuously. This will produce a substantial temperature-drop, although whether, in your case, it will be possible to lower the temperature down to 40 deg. F. we cannot say. We think that 45 deg. F. would be nearer the practical mark.

Sealing Porosity in Iron Castings with Black Cutch

INFORMATION is required regarding the use of Black Cutch (Catechu Nig) for the sealing of porosity in iron castings.

What methods are used in its application, and would such sealing be impervious to the action of water (hot or cold), aqueous ammonia or anhydrous ammonia (liquid or gaseous)? Is such sealing likely to be permanent, and does cutch in any way promote rusting of the iron? Where can the materials be obtained; also, should cutch not be a suitable medium for sealing against water and ammonia, can any other means be suggested?—J. Ashworth (N.W.9).

CUTCH or catechu is a wood extract obtained mostly from India. It contains a dye stuff plus tannin, and dissolves in boiling water, forming a deep brown solution. When clean iron is immersed in this, the iron forms a surface layer of iron tannate. This substance, to some extent, fills the pores of the metal surface and, therefore, acts as a "sealer." Moreover, it covers the metal surface with a non-metallic compound which adheres tenaciously and so protects the underlying metal from rust in much the same way as the more modern "cosletised" layers of iron phosphate do.

You will see, therefore, that cutch treatment does not in any way promote the rusting of iron and that, on the contrary, the treatment acts as a rust-preventor. The degree of "sealing" of the iron is not very high and ordinarily it is not to be considered permanent against really adverse influences. Such sealing would be effective against hot or cold water but not against liquid or gaseous ammonia (unless the gaseous ammonia were perfectly dry), or against any ammoniacal liquid. The normal phosphatised coatings would be more resistant against ammonia than would be the cutch-produced tannate coatings produced on iron. These phosphate coatings are produced by one of the variants of cosletising, one of which consists of the immersion of the iron or steel article in a solution of acid phosphate

of zinc. This develops on the metal surface a layer of zinc phosphate which is insoluble and non-hygroscopic, which resists moisture attack and, to some extent, ammonia attack.

In the cutch process, about 1 part of cutch is dissolved in, say, 5 or 6 parts of boiling water. The iron is immersed in this solution for 8 or 10 hours—the solution preferably being warm. After this time it is withdrawn and rinsed, when it should be uniformly black or dark-grey in colour.

Ordinary iron is not much good for resisting the attack of aqueous ammonia (supposing the ammonia content to be substantial). You require stainless steel or some type of nickel alloy, such as monel metal, to which end you should consult the Mond Nickel Co., Ltd., Grosvenor House, Park Lane, W.1. Cutch, in small amounts, can usually be obtained from one of the laboratory supply firms, i.e., Messrs. Griffin and Tatlock, Ltd., Kemble Street, Kingsway, W.C.2, or Messrs. W. and J. George and Becker, Ltd., 17-29, Hatton Wall, E.C.1, or, in larger quantities, from one of the firms specialising in dyewood extracts, such as Messrs. William Burton and Sons, Ltd., 2 and 3, Green Street, Bethnal Green, E.2.

Producing a Vacuum

PLEASE supply me with information on how to produce a vacuum in a vessel 1in. bore, 6in. in length, and the approximate time taken to do this.—S. Burton (Kingsland, N.I.).

THE precise method of producing a vacuum in any given vessel or container depends mainly on the extent or degree of vacuum which is desired. For low degrees of vacuum, an ordinary hand suction pump or a simple laboratory "water-pump" operated by a water-jet is all that is required, and it would be a matter of seconds to produce the vacuum within the container.

For a higher degree of vacuum you would have to use a rotary vacuum pump. Again, this is a piece of laboratory apparatus which will give really high degrees of vacuum within a few seconds.

The highest degrees of vacuum are produced by electrically-driven mercury pumps, and by various other devices. These take a longer period to set up the really high states of vacuum which they are capable of producing. They are expensive devices, and are only used for special purposes.

From your letter, we would suggest that an ordinary laboratory water-pump which is secured to the end of an ordinary water-tap might suffice to give you the degree of vacuum which you require. These simple pumps can be obtained from any laboratory apparatus dealer, such as Messrs. Vicsons, Ltd., 148, Pinner Road, Harrow, Middlesex.

Heat-resisting Paint

CAN you inform me of a suitable heat-resisting paint for painting the exhaust manifold of a motor-car? This is sometimes painted white when new. I have a pre-war car and the original paint has disappeared and now is rusty.—C. S. Barker (Stoke-on-Trent).

THE best heat-resisting paint for your purpose would be one which was based on a melamine resin. These resins set hard on heating even as low as 180 deg. F. They resist petrol, grease and oil. They are well adhesive and will stand up easily to 400 deg. F. For this reason, they are used for radiator finishers, heaters, irons, etc.

"Beetle Resin 5" is a typical one of the melamine type. It is soluble in butyl alcohol and the solution may be extensively diluted (for cheapening purposes) with methylated spirit, turps, benzene, acetone or amyl acetate. To make a paint, the solution of the resin (40 parts) is ground into dry pigment (60 parts), these quantities being approximate.

Butyl alcohol can be obtained from General Metallurgical and Chemical, Ltd., 120, Moorgate, London, E.C.2, price about 5s. lb. The melamine resin may be obtained from The Beetle Products, Ltd., Oldbury, Worcs., or Vicsons, Ltd., 148, Pinner Road, Harrow, Middx.

An alternative treatment is to mix your pigment with waterglass (slightly diluted with water). This is a cheap and ready method, and the resulting "paint" will stand up to a fair amount of heat provided that the pigment itself is heat-stable.

Black and Armour-bright Finish

I AM making for my own use some wrought iron lamp fittings and hanging lanterns out of mild steel strip, some of which is bright and some black.

Please tell me how I can obtain a really good finish in black and armour-bright, the finish to be either in all black or all armour-bright, as in factory-made goods.—R. G. Frith (Essex).

SINCE, presumably, you have only a small amount of metalwork to treat you will find the following method simple and inexpensive.

Make a thin paste of flowers of sulphur and turpentine or any light lubricating oil. Brush this as evenly as possible on the metal surface, the metal having previously been degreased and derusted. Then hold the metal strip in a non-luminous gasflame until all the oil and sulphur has burned away. If the metal surface is not an even black, repeat the process. Finally, give the metal surface a good rubbing over with an oily cloth. If the black surface is too dull and "dead" for your liking, give it a thin coat of shellac or any other varnish. If you wish to have the metal bright this will necessitate some form of abrasive polishing so as to bring up

the black surface to a dull sheen. Successive grades of emery cloth will accomplish this, but the process is a slow one, and it would be more easily done on a polishing wheel. The bright metal will, of course, then have to be given a coat of a clear lacquer.

On the whole, we think you would be better advised to adhere to your idea of an all-black finish for your lamp fittings, for, usually, they have a better and a more artistic appearance, and, generally, they harmonize better with their surroundings.

Fire-alarm System

I HAVE to instal a small fire-alarm system in an institution. Can you supply me with a suitable wiring diagram?

What is required is a bell and indicator in the office, nine push points throughout the institution, four Klaxon horns in the building, and alarm bells in two houses about 100-150yds. from the institution.

The idea being that if fire breaks out at any point a push there is pressed, the Klaxons go off, and the appropriate disc on the indicator operates to show the site of the fire, at the same time the alarm bells ring in the houses.

It is proposed to operate the system by a set of 24 Leclanché cells; is this sufficient? The greatest distance from end to end of the installation would be approximately 150-200yds.

Could earth be used as return for bells in the two houses (to save two overheads) or would two lines have to be run to each?

It is proposed to do the job in 3.029 single T.R.S. cable, mostly concealed.—P. C. Campbell (Stonehaven).

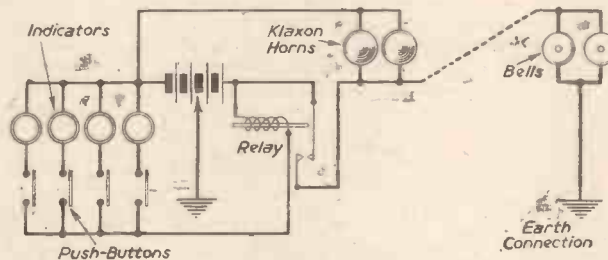

Circuit diagram for a small fire-alarm system (P. C. Campbell).

WE consider the best system would be to use the push-buttons to energise a relay fitted in a central position, each push-button also controlling a separate coil of the indicator. The four Klaxons and the alarm bells could be paralleled across the contacts and battery. If required a low voltage tapping could be employed for the bells. The proposed battery of Leclanché cells should be suitable for the purpose, provided low current Klaxons are used, but it may be necessary to connect them in series-parallel. Earth return could be used for the house bells, provided you have good low resistance earth connections; 3.029 cable should be suitable for wiring.

Ferrotypic Photographic Plates

I WISH to make a quantity of standard Ferrotypic photographic plates, using collodion as a vehicle; it is necessary that the solution can be sprayed on to the plates. What would the solution contain, and what are suitable quantities? What would be suitable as a black coating before spraying the solution and what would the developer contain? How are these plates made in the trade? Any suggestions regarding their manufacture would be appreciated.—E. C. Wheeler (Bexleyheath).

IN the manufacture of Ferrotypic plates, thin sheet iron or sheet steel is selected for freedom from surface imperfections, and it is given a coating of a brown or black varnish. The modern productions are coated with a gelatine emulsion which is very rich in silver, but collodion forms a better emulsion.

The making of gelatine and collodion emulsions is a very highly-skilled process, for the data of which we must refer you to a good textbook, such as E. J. Wall's "Dictionary of Photography," which you will find available in any library.

In general, the varnished metal sheet is coated with a layer of iodised collodion (obtainable from a large photographic dealer, such as Messrs. Wallace Henton, Ltd., New Bond Street, London, W.1). When this has set the plate is sensitised by immersion in the following bath for two or three minutes:

Silver nitrate	240 grains
Potassium iodide	1 grain
Water	8 ozs.

The plate is exposed whilst still wet, and it is developed immediately after exposure in the following developer:

Ferrous sulphate	1/2 oz.
Glacial acetic acid	1/2 oz.
Methylated spirit	1/2 oz.
Water	10 oz.

For close details of the wet collodion methods, refer to Chas. W. Gamble's "Wet Collodion Photography".

The ordinary street cameras of the "ready-in-a-minute" variety do not operate on wet collodion. They make use of ordinary metal plates, having an ordinary slow gelatine emulsion. These plates are exposed dry, like any other modern plates, and are made by the

ordinary trade methods of coating a silver-rich slow gelatine emulsion on varnished metal sheets instead of on glass or film. Emulsions are not brushed or sprayed on to the support. They are flowed or coated thereon, the emulsion (at a very definite temperature) being allowed to trickle on to the plate through a long slit, the plate being made to move under the slit at a definite rate of travel.

You should note that all photographic coating methods are very difficult to imitate on a small scale, and that there is much of a secret nature about them. That is why amateurs so seldom meet with success when they attempt to make their own sensitive material.

Antique Effect on Brass

I WISH to produce an oxidised or antique bronze effect on brass. I am interested in producing the effect shown on standard electrical fittings, i.e., a blue-black ground with the high spots, etc., in bronze.—N. F. Johnson (S.W.18).

IN order to produce the type of finish on brass which you desire, purchase from a photographic chemist 1oz. of sodium sulphide and dissolve this in about 1 pint of water. Clean and degrease the brass article and either immerse it in or brush it over with the solution. The brass surface will rapidly turn brown and ultimately, almost black—this action depending on the actual strength of the sodium sulphide solution. The brass article is then rinsed well and allowed to dry. After drying, a clean cloth charged with a fine abrasive paste is rubbed lightly over the areas in which "high spots" are required. In these areas the black deposit will be either wholly or partially removed, leaving anything from the naked brass to a light brown coating. Finally, the entire article is surface lacquered with a clear cellulose lacquer or varnish.

The above is a very simple method, but it gives a brown-black rather than a blue-black coloration. For the latter, the following formula is better:

Copper carbonate	1 lb.
Ammonia	1 quart
Water	3 quarts

Mix the copper carbonate and the ammonia and then add the water until as much as possible of the copper carbonate dissolves. There must be some excess of the carbonate left over undissolved. Heat the liquid to about 170 deg. C. Immerse the brass article in this liquid until the desired colour is obtained (usually half to one minute). Then rinse and rub up with fine abrasive for the high spots, as above. Finally lacquer.

Producing Coloured Smoke

COULD you give me some information on how to make coloured smokes, such as red, yellow, blue, green, brown and black?—R. Smith (Pinner).

THERE are no satisfactory blue and green smokes, but you will find below formulae for the other coloured smokes which you require:

Brown Smoke:	
Copper oxide	50 parts
Lead peroxide	35 "
Magnesium powder	15 "
Yellow Smoke:	
Potassium dichromate	66 parts
Bismuth subnitrate	20 "
Magnesium powder	14 "
Red Smoke:	
Potassium chlorate	1 part
Sugar	1 "
Paranitraniline Red	3 "

Black Smoke:
This may be produced by adding finely-ground hard pitch to any smoke-producing mixture, as formulated above.

Please note that all the "parts" in the above formulae are by weight and not by volume or measure. All materials should be very finely ground separately, and they should be quite dry. Be very careful not to grind any composition containing potassium chlorate.

Liquid Air

COULD you please tell me what pressure is required to maintain air in a liquid state at the following temperatures: 200 deg. F., 150 deg. F., 212 deg. F., and 250 deg. F.—A. M. Wilson (Hemsby).

NO degree of pressure will maintain air in a liquid state at the temperatures which you mention.

For every individual gas there is a certain temperature above which the liquefaction of the gas is impossible. This temperature is known as the "critical temperature" of the gas.

Now, assuming common air to be mainly a mixture of oxygen and nitrogen with a little carbon dioxide added, we give below the critical temperatures of these gases:

Nitrogen:	-146 deg. C.
Oxygen:	-119 deg.
Carbon dioxide:	+31 deg. C. (87.8 deg. F.).

You will observe that the highest critical temperature, which is that of carbon dioxide, is lower than the lowest temperature which you mention. For the above reasons, it would be quite impossible to maintain air liquid at your quoted temperatures, no matter what pressures were applied. Most gases need both pressure and cold to maintain them in a liquid state at ordinary temperatures.

MIDLAND INSTRUMENT CO.

New Unused Govt. Surplus Stock
ASTRO COMPASSES, contains True Course, True Bearing, Latitude and Declination variable scales, 2 spirit levels, and other incidentals, a very fine instrument, brand new in wood carrying cases, 10/- post 1/3. **OIL TEMPERATURE GAUGES**, 0-100 deg. "Cent." with 40ft. tubing and mercury capsule, new unused, 7/6, post 9d. **ELECTRO PNEUMATIC RAMS**, 12in. long, compresses to 19in., fitted 24v. solenoid, purpose unknown, fraction of original cost, brand new boxed, 2/6, post 1/-. **REFLECTOR GUN SIGHTS**, consists of lamphouse to take s.b.c. lamp, var. rheostat, high-grade lens projection system by "Ross", reflector glass and lead, brand new boxed, 7/6, post 1/-. **SELECTOR MECHANISMS**, in diecast cases, 12.24v., a high-grade impulse unit, will select 4 circuits from a remote position, with press button and selector position indicator, brand new boxed, 3/6, post 9d. **SOLENOIDS**, 12v. 3 amp. or 6v. 1 amp. very powerful tin. movement, 2/6, post 6d. **HEYWOOD AIR COMPRESSORS**, piston type, develops 450lb. sq. in. at 1,200 r.p.m., internal splined shaft fitting, superior job, brand new boxed, 25/-, post 1/3. **HOOVER BLOWER MOTORS**, 80v. D.C. or 115v. A.C., unused, 12/6, post 1/-. ditto smaller type 24v. A.C./D.C., 10/-, post 9d. **SMITHS SPEEDO**, METERS, 0-50 m.p.h., contains 0-9999 total cancelling trip and 0-9999 total counters, with right angle bevel drive, brand new, 7/6, post 1/-. **GENERATORS** for electrical speed indicators MK-11, brand new boxed, 10/-, post 1/-. **FIRE EXTINGUISHERS**, American superior all brass type, new and dry, hand pump with shut off valve, also suitable for garden water spraying, 1 1/2 quart continuous stream capacity, 15in. long, 3in. diameter, sent on approval against cash, indispensable to every home, 5/6, post 1/-. **SPIRIT LAMPS**, unsuitable, can be carried after filling with meths., small and compact, 3-leg. utensil holder, ideal for camps and picnics, etc., brand new boxed, 2/6, post 6d. **P.V.C. FLEXIBLE**, twin flat 7/36, 25 yds., 3/9, post 4d., 50 yds., 7/-, post 6d., 75 yds., 10/6, post 7d., 100 yd. drums 12/6, post 9d.
 Send s.a.c. for our 1950 Lists with supplement; if our C.O.D. service is cancelled for the time being.
MOORPOOL CIRCLE,
BIRMINGHAM, 17
 Tel.: HARborne 1398 or 2664.

MYFORD

METALWORKING LATHE, Type ML7

£39 : 17 : 6

QUALITY METALWORKING AND WOODWORKING LATHES SUPPLIED THROUGH LEADING TOOL MERCHANTS.



MYFORD ENGINEERING CO., LTD., BEESTON, NOTTINGHAM. 'Phone 54222.

"PRINCESS MARINA."

2-6 0 L.M.S. "Mogul" for 3 1/2in. gauge, designed by "L.B.S.C."
 "How to Build Princess Marina," by "L.B.S.C.," price 5/-, postage 3d.
 Blueprints, 6 sheets 15/- set, post free.
 A 6d. stamp to Dept. G.N. will bring you a copy of our comprehensive illustrated catalogue, with details of castings, materials, fittings and blueprints for this fine engine, and 36 other "L.B.S.C." designed small steam locomotives.

STEAM PRESSURE GAUGES by a leading manufacturer, 3in. dial. 0 to 100/120/150 lbs., lin. dial. 0 to 80/120/150 lbs. Price 12/6 each plus 3d. postage. Early application recommended.

MYFORD 3 1/2in. lathes, type M.L.7 are available on our "Out of Income" terms. Examples: Bench model, £39/17/6, deposit £9/19/6 and 12 monthly payments of £2/16/6. Lathe mounted on cabinet stand, motorised, 4in. 3-jaw Burner G.S. chuck, vertical slide swivelling, £70/9/9. Deposit £17/12/9 and 12 monthly payments £4/14/9 or 18 monthly payments £3/5/6. FREE DELIVERY. We shall be happy to quote for your individual requirements. Illustrated literature gladly sent.

A. J. REEVES & Co.,

416, MOSELEY ROAD, BIRMINGHAM, 12.

Grams.: Reevesco, Birmingham. 'Phone: CALthorpe 2554.

"THE CHOICE OF EXPERIENCE."

THINKING OF BUILDING A TELEVISION SET?



55/-

Carriage Paid

10 VALVE 1 1/2 METRE SUPERHET

Ideal for Conversion into Television Receivers. I.F.

12 Megs. Band width 4 meg. Co-axial input and output sockets. 10 Mazda Mains type VR65 (SP61) valves, 6.3 volt filaments. This chassis can be quickly modified for reception of sound and vision. The Pre-H.F. oscillator and mixer inductances may be shunted with 30 p.f. trimmers to cover T.V. frequency. Three of the I.F. circuits can be used for video and two isolated for audio.

(Dept. P.M.)

WIRELESS INSTRUMENTS (LEEDS) LTD.

54-56, The Headrow, Leeds
 Tel.: 22262

BUILD YOURSELF A RADIO SET, a RADIOGRAM and AUDIO AMPLIFIER or RADIO FEEDER UNIT and save £££!
 Full Constructional details comprising set of Blueprints and Point to Point Wiring Instructions how to build first class, professional instruments as follows:
 "Vanguard 4" 3-valve plus rectifier L. and M-wave Radio Set in attractive plastic cabinet (brown or ivory shade), 2/6. A.C. or A.C./D.C. model.
 "Overseas 5" 5-valve All-wave Superhet, a powerful receiver with wonderful tone in beautifully figured walnut cabinet, 5/- A.C. or A.C./D.C. model.
 "No. 1 4-watt Amplifier," volume, tone and negative feedback controls. A.C. only, 2/6.
 "No. 2 12-watt Amplifier," two inputs, 3-impedance output, ideal large house or hall, 4/6.
 "No. 1 Tuner"—L. and M-wave T.R.F. with infinite impedance detector, highest quality output, 3/6.
 "No. 2 Tuner"—All-wave Superhet, beautiful, elaborate, full-vision scale, special quality output, 4/6.
 Absolutely complete Kits of Parts available to build all above instruments at knock-out prices. Also available ready-built and tested. All fully guaranteed. Any constructor in difficulties fully advised and helped. Our Technical Dept. at your disposal—let us have your enquiries. All Record Players and Autochangers previously advertised still available. Full Bargain Catalogue 2/6.

Northern Radio Services,
 16, Kings College Rd., London, N.W.3.
 (PRIMROSE 8314)

HIGHER WAGES

- Sets of CLEAR DIAGRAMS and INSTRUCTIONS for making easily from readily obtainable materials only.
1. Toy and Model Makers' Lathe 3/6
 2. Toy and Table Model Fret 3/6
 3. Jig-Saw Machine Model Fret 3/6
 4. Ball-bearing Circular Saw 3/6
 5. Wind Charger—any Car Dynamo 3/6
 6. Table model Torch Battery-operated Cigarette Lighter and 6 lengths of Element Wire 3/6
 7. Tubular Furniture (all kinds) 2/6
 8. High Tension Batteries 3/6

Complete Set of 7. 10/6, post free.

P. M. BARHAM,
 Bridge Avenue, St. Sampsons, Guernsey, C.I.

MODEL ENGINEER EXHIBITION 1950 COMPETITIONS FOR MODELS OF ALL KINDS

Entries are now being accepted for the competitions to be held at "The Model Engineer" Exhibition, New Horticultural Hall, Westminster, London, August 9th to 19th. Many cups, medals, diplomas and money prizes are to be won.

This Exhibition is the foremost of its kind in the world and the awards are recognised as the highest distinctions in Model Engineering. Write to-day for full particulars and entry forms to:

"THE MODEL ENGINEER" EXHIBITION,
 Dept. PM, Exhibition Offices,
 23, Gt. Queen St., London, W.C.2.

THE WORLD'S GREATEST BOOKSHOP



New and secondhand Books on every subject. Stock of 3 million volumes
 Large Dept. for Technical Books
 119-125 CHARING CROSS RD. LONDON, W.C.2
 Gerrard 5660 (16 lines)
 Open 9-6 (inc. Sats.)

Meters. 10v., 21in. Rectifier (a.c.) in wooden carrying case, 14/6; 15v., 21in., m.c. 9/6; 150v., 21in., m.c. 10/-; 3,500v., 31in., m.c. 20/-; 6,000v., 31in., m.c. 57/6; 15,000v., 21in., m.c. double rectifier, 8/-; 100 m.a., 21in., m.c. 7/6; 3.5 amp. 21in., T.C. 5/-; 4 amp., 21in., T.C. in case with switch. 7/6. Meter Movements, 2in. size with magnet and case (500 microamp), 2/6. All meters post extra.

Bell Transformers. These guaranteed transformers work from any A.C. Mains, giving 3.5 or 8 volts output at 1 amp. operate bulb, buzzer or bell. Will supply light in bedroom or larder, etc. PRICE 8/-, post 6d. **BELLS** for use with either the above or batteries, 6/-, post 6d. **BUFFERS** 4/-, or Heavy Duty 4/6, post 5d. **EX-R.A.F. 2-valve (2-volt) Microphone Amplifiers** as used in 'plane inter-com., in self-contained metal case; can be used to make up a deaf aid outfit, intercommunication system, or with crystal set, complete with valves, 20/-, post 1/3. Useful wooden box with partitions to hold amplifier, 2/- extra. Ditto, less valves, 10/-. One valve amplifier, complete with valve, 9/6, post 1/-.
Hand Microphones, with switch in handle, and lead, 4/-; similar instrument, moving coil, 7/6, post 6d.

Mike Buttons (carbon), 2/-. **Moving Coil, 4/6;** **Transformers, 5/-.** All post 4d. each. **Sparkling Plug Neon Testers**, with vest-pocket clip, 3/3, and with gauge, 3/6, post 6d. **S.B.C. New Indicator Lamps**, for use on mains to show "live" side of switches, etc., 3/6, post 4d. **Soldering Irons.**—Our new streamlined Iron is supplied with two interchangeable bits, one each straight and curved; 200/250 v. 50 watts, 9/-; **Standard Iron** with adjustable bit, 200/250v., 60 watts, 9/6. **Heavy Duty Iron**, 150 watts, 12/6, all post 6d. **Crystal Sets.** Our latest Model is a real radio receiver, fitted with a permanent crystal detector. Have a set in your own room, 8/6, post 6d. **De Luxe Receiver** in polished cabinet, 18/6, post 1/-. **Spare Permanent Detectors, 2/- each.** When ordered separately, 2/6, with clips and screws, 2/10, post 3d. **Headphones**, brand new, S. G. Brown G.E.C., etc., 15/-, 23/-, and super-sensitive, 30/- a pair, post 8d. **New Headphones**, 10/- a pair. **Balanced armature type** (very sensitive), 12/6 a pair. Both post 6d. **New Single Earpieces**, 3/6. **Bal. armature type, 4/6; ex R.A.F. earpiece, 2/-, post 4d.** **Headphones**, in good order, 4/6 and 5/6 (better quality, 7/6), all post 6d. (All Headphones listed are suitable for use with our Crystal Sets.)
 Money refunded if not completely satisfied.

HIGHSTONE UTILITIES

58, NEW WANSTEAD, LONDON, E.11.
 New illustrated List sent on request with 1d. stamp and S.A.E. Letters only.

UNUSED Ex-W.D. BARGAIN

FRACTIONAL H.P. EX-R.A.F.

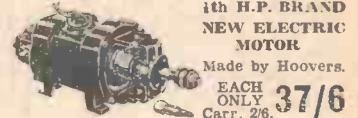

1th H.P. BRAND

NEW ELECTRIC

MOTOR

Made by Hoovers.

EACH ONLY 37/6

Carr. 2/6

Not to be confused with smaller, cheaper types. Size 11in. x 5 1/2in. x 5 1/2in. Weight 18 lbs. Volts 200-250: state A.C. or D.C. 2,000 r.p.m. Ideal for polishing, grinders, etc. Existing spindle lin. diam., 1in. long. All-purpose extn. spindles to screw on, 7/6 pair extra.

EX-ARMY HEADPHONES.

BRAND NEW AND BOXED.

Ideal for Crystal or Valve sets, hospitals, etc.

POST FREE 5/6 TWO 10/- PER PAIR

Precis. Insts., Bal. Arm. Units, Reed drive corrug. alum. Diaphragms, dble. H bands, 8ft. cords and plug. Worth about 42/- pair. Also makes telephone set by connecting earpieces to any length twin flex.

GENERATOR TOOL KITS. Complete in lock-up chest fitted race extractor. Assembly block, 3 drills, 2 box and 1 rime spanners for 500 and 1,000 watt generators, etc. 22/6 incl.

ELECTRIC BELLS. Made by Western Electric, double gong with moulded case, loud tone direct from 200/250 volts A.C., 50 cycles. 15/- each, post 1/-.
RESISTANCE SLIDER. Isenthall wire wind type 139. 3.4 ohms, 12 amps. vitreous former 12in. long x 2in. diam., 10/- each, post 1/-.
SCREENED LEADS. 18ft. long, 1in. diam. spade terminals each end. Technically perfect, 3/6 each, post 9d.

LAMP BULBS.

Million lamps, 450 types, for Projectors, Searchlights, Floods, etc. Signal, Mines, Car, Aircraft, Yacht, Ship, Workshop, House, Miscellaneous, etc. All unused in original wrappers at low cost. 1d. S.A.E. for LISTS.—1d. S.A.E. for RADIO/ELEC. LISTS.

AUTO COLLECTIONS LTD.,
 15, LAWRENCE STREET,
 NORTHAMPTON.

ATOM BOMBS

may have you worried, but you can forget them if you possess a copy of the new, revised "HOME CONSTRUCTOR'S HANDBOOK" (now in its eighth edition). This justly famous book is crammed full of many good things for A.L. radio beginners, servicemen, dealers, experimenters, hobbyists, etc.

- Eleven tested and guaranteed circuits, with full descriptions and parts lists.
- Feeder Units, Tuning Units and Superhets.
- Quality Amplifiers.
- Test Gear.
- Servicing and Constructional Hints and Tips.
- Resistance Colour Code, Charts, etc.
- Simple Formulae, etc.
- And many other interesting items.

We are proud to offer this most useful book to "P.M." readers for 1/6 ONLY. Send NOW for your copy of the NEW issue and catalogue.

DO YOU FIND RADIO HARD WORK?

To do anything really well involves hard work, but that is where we come in. Our technicians have developed really special radio coils and assembled them into units, together with all switching, trimmers, padders, iron-dust cores, etc. They are then ALIGNED and SEALED. All YOU do is to wire the remainder of your circuit. These coil-packs are 3-wave superhet., with or without RF stage. See how really easy and cheap radio construction can be. Space here doesn't allow details, but you'll also be amazed at our parts prices—much less than you normally pay! Earn easy money in your spare time!—All the 'gen' in the new issue of the Handbook.

RODING LABORATORIES
(MAIL ORDER DEPT. MJ),
70, LORD AVENUE, ILFORD,
ESSEX.

RESILION

have pleasure in announcing that

"Cantilette"

(Regd.)

Brakes

are now available in

ALL CHROME FINISH

CHOICE OF

Black or Silver Cables } at a price of
Straight or "C" Levers }

17/6

The Chrome model of CANTILETTES has been reserved for Export since the war, but in view of persistent requests that they should be made available in this country, we are now releasing a limited supply to the Home Trade. Although quantities will be restricted at first, we hope to make a gradual increase in the supplies becoming available.

CANTILETTES are designed with the sole object of providing an alternative brake which can be sold at a lower price, and yet incorporate the basic principles of the more famous CANTILEVERS. CANTILETTES carry our usual 12 month Guarantee and are of course backed by our reputation for quality and efficiency. They can be thoroughly recommended for use under all conditions, and are second only to CANTILEVERS, the brakes recommended by experts for those who insist on the best.

NOTE.—Can also be supplied with our Lock Levers at an extra charge of 9/6 only. Brake Blocks in three thicknesses. Special length Cables for Frames over 21in. All spares and spanners readily available. If in any difficulty write to us. Leaflets and Price Lists on request.

THE RESILION CO. LTD., 200 Liverpool Road, London, N.1

WILCO ELECTRONICS

204, Lower Addiscombe Rd., Croydon

A.C. INDUCTION MOTORS. Single Phase 1.425 r.p.m. all voltages, ideal for workshop and industrial uses. Heavy duty, silent running. No radio interference.



1 h.p. £8 5 6
1 h.p. £8 17 3
1 h.p. £8 8 7

Carr. and packing, 10/-.

GEARED CAPACITOR MOTOR.—30 watt, 220-240 volt A.C. 300 R.P.M. on slow speed shaft, 84/- each.

THERMOSTAT SWITCH.—Bimetal type in sealed glass tube, 2 1/2 in x 1/2 in., 30 deg. Cent. Ideal for Aquariums, 5/- each.

TELEPHONE HAND SETS.—Brand new with 4-way cord, 15/-.

VOLTMETERS.—0-300 A.C. Moving Iron 2 1/2 in. Flush, 17/6; 0-300 D.C. Moving coil 2 1/2 in. Flush, 10/6. Electrostatic 0-750v., 2 1/2 in. 25/-; 0-2000v., 2 1/2 in. 35/-; 3 1/2 in. 90/-; 0-330 A.C. Moving Iron, 3 1/2 in. Surface, 22/6; 0-250 A.C. Moving Coil Rectifier Type, 3 1/2 in. Flush, 30/-.

MAINS MOTORS. 200-250v. A.C. with gear box. Blower, very powerful, converted from rotary transformer, ideal for model work, grinders, polishing mops. Price 35/-.

CLOCKWORK MECHANISM.—Precision-made movement adaptable for photographic timing, etc., with contacts making and breaking twice per second, so can be used for switching on and off lamps, etc. Brand new in soundproof cabinet with thermostat temperature control. Price only 15/6.

WEE MEGGERS in leather carrying case, 30 megohms, 250 v. Brand new, £7-10-0 each.

P.M. SPEAKERS, 5in., in cabinet 9in. x 7 1/2 in. x 4 1/2 in., 17/6 each.

MASTS, TELESCOPIC, extending to 12ft. in 7 sections, 15/6, post 1/-.

THERMOSTAT, Satchwell 12in. stem, 0-250 volts A.C./D.C., 10 to 90 deg. Cent., 35/-.

24-VOLT MOTOR with reduction gear and cam-operated switches, suitable for model work, 15/6.

CO-AXIAL CABLE for Television down leads, impedance 75 ohms, 101d. per yard.

Get extra M.P.G. by fitting a new set of Plugs.
Standard Sparking Plugs—14 and 18. MM. Made by Siemens-Bosch for the German Army. New and Boxed, 4 for 7/-, 6 for 10/-. Short Reach.

200/250v. A.C. or D.C. Motors, about 1/2 h.p., fitted with 2 1/2 in. x 1/2 in. High-grade Grindstones, Medium or Fine, made by Nortons. 20/- each.

New Brown's Moving Reed Headphones. Best in the world. 6/6.

Moving Coil Microphones. 3in. diameter, with Pressel Switch, 5/6. Matched Transformer, 5/-.

New Carbon Microphones. U.S. made for the Type 58 Walkie-Talkie, 3/- Transformer, 3/-.

Powerful Small Motors, 24v. or 110v. A.C./D.C. with geared spindle, 3 1/2 in. x 2 1/2 in. 6/6.

Headphones with Breast Plate Microphones. Packed in wooden boxes Operate with 4 1/2 v. Battery. 10/- a set.

Meters. 2in. 0-500 Microammeters, 8/-; 2in. 0-300v. Mf.c., 10/-; 0-40v. Mf.c., 7/6.

Miniature Slow Motion Dials. 100-1 worm geared, 2 1/2 in. x 2in. Beautifully made. 4/- each.

24v. A.C./D.C. Motors, 5in. x 3in. Fitted with powerful blower fan. 14/- each. Ideal for Paint Sprayer, etc.

250 watt Double Wound Transformers, 240-110v. Made by G.E.C. With Steel Shroud. New. £2 7s. 6d. each.

New Osram, Crompton, Mazda, etc. 12v. Car Bulbs. Double contact. 80 watt, 2/9; 10 watt, 1/3.

All Carriage Paid. Money Back Guarantee from:

THE RADIO & ELECTRICAL MART.

253B Portobello Rd., London, W.11.
Park 6026.

MODEL ENGINEERS

FOR THE TURNER:

Lathes from 1 1/2 in. to 5in. Bench Millers. Drilling Machines. Hand Bench Shaping Machines.

FOR THE WOODWORKER:

Wood Turning Lathes 3 1/2 in.—5 1/2 in. centre height. 4 1/2 in., 7in. and 10 1/2 in. Ball Bearing Planers at competitive prices. 6in. and 12in. Saw Benches, Sanders, Grinders, Jigsaws.

Perspex, Catalin and Acetate Sheets always in stock.

NUTTALL'S (LATHES) LIMITED, MANSFIELD, NOTTS.

Jubilee
PATENTED
WORM DRIVE
CLIP



Absolutely leakproof joints on Air, Water, and Oil lines, are swiftly and easily made by using "Jubilee" Worm Drive Clips. They stand up to any pressure.

THE FINEST
CLIP IN THE
WORLD.

* Write for names
and references
R.P.12.

L. ROBINSON & CO. (GILLINGHAM) LTD., Gillingham Kent

1 H.P. A.C. MOTORS, CAPACITOR INDUCTION
Type, totally enclosed and dustproof, self-starting; 200-240 volts, 1-phase, 50-cycles, 1,400-1,450 r.p.m.; reversible rotation, no radio interference, compact size. These are new motors of high quality and good appearance, delivered under written guarantee and on purchasers' approval first 7 days. With single- or double-end shaft, 70/- carriage paid. Double-end type fitted as bench-grinder with adaptors for stone and mop, 11/3 extra. Bortex Engineering Co., 24, Watson Yard, Nth. Circular Road, London, N.W.2.

CARAVAN CHASSIS

and chassis undergear 8 to 35 cwt. Lightweight Camping and Commercial Trailers. Towing Hitches, Jockey Wheels, Brake Operated Legs, Aluminium Sheets 6ft. x 3ft., 24, 22, 20, 18 and 16 g.; 8ft. x 4ft., 22, 20 and 18 g. Comprehensive stocks of Beading, Angle, J Drain, T Door Plate and Strip, Veneered Oak panels, Insulation Board, Glass Wool, Sinks, Windows and Roof Ventilators, Stockists for Color Gas, Bottogas and Latofam Cushioning, Pithers Stoves and Eisan Chemical Closets. Send for our detailed illustrated list and visit our Showrooms. Open all day Saturday.

WATFORD WHEEL & TRUCK WORKS
173-175, Queens Road, Watford, Herts.
Phone: Gadebrook 2983

The "THAMES VALLEY" BATTERY CHARGER

2 - 6 - 12 VOLTS 1 AMP.
with AMMETER
for 200-250 volts 50 cycle mains
only 47/6 post free
Thames Valley Products (P),
28, Camden Ave., Feltham, Middx.

THE LATEST TYPE FIXED CRYSTAL DETECTOR THE CRYSTAL VALVE

as used in radar receivers,
Overall size 3/4 in. x 3/4 in.
AMAZING RESULTS

3/6 each, postage 2 1/2 d.
Protective Tube and Fixing Brackets, 3d. extra.

Wiring instructions for a cheap, simple but high quality Crystal Set included with each Detector.

These Crystal Valves or Diodes are not Government Surplus but brand new goods manufactured by one of the largest and most famous Radar Equipment Manufacturers in the country. They can be used in any Crystal Set circuit and are fully guaranteed.

CRYSTAL SET INCORPORATING THE LATEST CRYSTAL VALVE

Adjustable Iron Cored Coil
RECEPTION GUARANTEED
Polished wood cabinet, 15/- post 9d. A satisfied customer writes—"I should like to thank you for the headphones received 24-12-49, which combined with your crystal set really do give amazing results."

Send S.A.E. for lists of copper wires, screws, nuts, paraffin tubes, ebonite, tufnol rod and panels, etc. Copper wires, 14 s.w.g.-43 s.w.g., in stock.

POST RADIO SUPPLIES 33 Bourne Gardens, London, E.4

ADANA PRINTING MACHINES

Print in the odd hours with an Adana—still the most absorbing of crafts. No. 1 H/S Machine £4.10.0 No. 2 H/S Machine £9.15.0. Will quickly pay for itself. Send for illustrated folder to Dept. P.M. 35 ADANA (Printing Machines) LTD., 15-18, Church St., Twickenham, Middx.



Editor: F. J. CANN

VOL. XVIII

JUNE, 1950

No. 339

All letters should be addressed to the Editor, "THE CYCLIST," George Newnes, Ltd., Tower House, Southampton Street, Strand, London, W.C.2.

Phone: Temple Bar 4363

Telegrams: Newnes, Rand, London

Comments of the Month

By F. J. C.

The Lighting Regulations

THE new lighting regulations relating to Road Vehicles became effective as from May 1st. These regulations include those affecting cyclists, and these are a repetition of the 1936 regulations calling for a red reflector, white patch and red rear light. Up to the present, however, the regulation relating to the red rear light is suspended because of manufacturing difficulties. The Minister of Transport will at some time in the future appoint a day when everyone will have to carry a live red rear light. At the present time it is not an offence to ride without one. Many cyclists have, however, anticipated the appointed, though evil, day, and have fitted red rear lights.

The new regulations set at naught the fierce controversy which has been raging round red rear lights for the last thirty years. The question of rear lighting of vehicles first arose in connection with horse-drawn vehicles, and, strangely enough, the loudest critic of un-rear-lighted horse-drawn vehicles at the beginning of the present century was the Cyclists' Touring Club, which later was to severely oppose the outcry by motorists against cyclists without rear lights. The opposition of the C.T.C. to horse-drawn vehicles without the warning light at the rear was successful and, later, horse-drawn vehicles had to carry the warning. Looking back I have no doubt that the C.T.C. regrets its move, particularly in view of the attempt made some years later at one of its annual general meetings to get its articles of association altered so that motorists could be included as members. We wonder if they then would have opposed rear lights?

Too Many Clubs?

IT is our considered opinion that the R.T.T.C. has a moral responsibility to properly established clubs not to recognise clubs of the Tom-Tug and kerb-stone wheelers type. At present any club, even those having a membership of less than half a dozen, is recognised and can take advantage of affiliation just as a large club can do. Most districts to-day have clubs of standing, and applications for affiliations from newly founded clubs in those areas should be turned down with a letter advising them to join up with the established clubs. This would strengthen the club movement and stop local competition for membership. There are reputedly 17,000 clubs existing in this country. Dividing this into the total membership of the R.T.T.C. gives an average of not more than six members per club—probably less if we rule out plurality of membership, by which is meant being a member of more than one club. It is equally our view that a man should not be permitted to belong to more than one club. There are some cyclists who claim to be lifelong members of a particular club, but who are second-claim members of another which has claimed their entire attention, due

to removal from one district to another, for the best part of their cycling career.

As those two uneasy bed partners the R.T.T.C. and the obsolescent N.C.U. may endeavour during the year to arrange a marriage of convenience, and evolve a jointly acceptable unified set of rules for the conduct of road sport, we suggest that club secretaries should now be considering those rules, not from the point of view of increasing their number, but to reducing them to the lowest common multiple. What is wanted is a compact set of rules, and all the irksome regulations and restrictions framed in the belief that every racing cyclist is a potential fraud should be removed.

We hope that the R.T.T.C. will not submerge its identity to the N.C.U., with its shocking history of mishandling cycling affairs. "Clubs should be taught to detest the N.C.U.," wrote the late John Urry in a leading article in *Bicycling News*, when the N.C.U. endeavoured to stab road sport in the back by abandoning road sport and banning its officials from having anything to do with it. It lost its authority from that time, and is now trying to insinuate its unwanted attentions on time trials and road records. Let the N.C.U. die with track sport, for it cannot be denied that this is dying.

The Thousand Miles

THE motor industry of this country was founded by pioneering cyclists such as S. F. Edge, Lord Nuffield, Humber, Lancaster, and many others. The motor industry was comparatively small in the year 1900, when the thousand miles motor trial

was first run, which this year celebrates its jubilee.

Some of the cycling journals of the period changed their titles to include the new pastime of "Moting," and, as referred to in an earlier paragraph, the Cyclists' Touring Club membership, which was beginning to decline, feared the opposition of the motor-car and the motor-cycle to such an extent that an influential section of the membership endeavoured to get the rules changed so that motorists could become members. Although the motion was defeated, we wonder whether a greater spirit of amity would have pervaded the cycling world had such an incongruity taken place? Cyclists have tilted at motorists and vice-versa as the motor industry grew. The fears, however, were ill-founded, because motorists have never approached in numbers the total number of cyclists. There are about 4,000,000 motorists as compared with over 10,000,000 cyclists. At the same time, we must compare the membership of the motoring organisations, totalling well over 1,000,000, with the comparatively meagre membership of the cycling organisations—less than 100,000. There may not have been an A.A. or an R.A.C. if the alteration to which we have referred had taken place. The fact is, of course, that the vast majority of cyclists are either touring or utility cyclists and they are not interested in cycling sport, which is only a tiny part of the pastime, albeit one which is given undue prominence in the Cycling Press.

At one time there was a Cyclists' Club with large premises in the West End.



GORDON RANDALL

A quiet corner by the bridge at Church Cobham—looking across the River Mole to the old church.



MOBBURY
S. DEVON.

Old houses hugging the steep main street of this pretty South Devon market town.

Paragrams

Land/Water Cycle

RIDING an amphibian two-seater cycle, and pedalling some 1,120,000 times, two Finnish lads have just crossed the 28-mile stretch of the Gulf of Bosnia from Finland to Sweden. This novel cycle has a watertight body with retractable wheels, which are lowered on reaching land, and the heads of the two occupants are covered by plastic transparent hoods.

Cycle Trader for 62 Years

THE death has taken place, at the age of 76, of Mr. Henry Bacon, of 43, Nottingham Road, Chesterfield, who had spent altogether 62 years in the cycle and motor trade. He was for many years manager of the cycle business in Cavendish Street, Chesterfield, carried on by Mr. Robert Eyre. The business was later taken over by Cavendish Motors, Ltd., and subsequently the car side of the business was transferred to new premises in Holywell Street. Mr. Bacon continued to be associated with the business until he retired a few years before the last war.

Coat-of-arms for "Tulip-land"

SPALDING, the centre of the tulip fields of Lincolnshire, known to thousands of travellers in the springtime when the tulips are in full bloom, is considering a new coat-of-arms. Prominent among the various devices making up the coat-of-arms will be two tulips.

Rapid Growth

REFERENCE was made at the annual supper and prize presentation of the Grimsby Clarion Cycling Club to the healthy growth of the club since its formation in 1928. Five enthusiastic riders founded the club, with little but their keenness to keep it alive, and now there are 156 members. During the last 10 months of 1949, 110 new members joined the club.

North Midlands New President

MAURICE CLARK, well-known Bircotes (Yorks) rider and a prominent figure in South Yorkshire cycling circles for the past 20 years, was at the annual meeting of the North Midlands Cycling Federation elected president for the coming year. Riders from South Yorkshire clubs also

figured as vice-presidents, and among those elected were: T. R. Snowden (Doncaster Wheelers) and R. A. Huckle, of the same club; F. Oldfield (Conisborough Ivanhoe C.C.) and the federation's past-president, Frank Spencer.

No Parking

THE Bedford police have started to take a very poor view of cyclists who leave their machines propped against the kerb in High Street, and they swoop on them in the same way as they swoop on parked cars. One cyclist was told:

"Bicycles take up just as much room as cars"! Another cyclist meant to take no chances, and when he stopped to call at his tobacconist's he wheeled his machine into the shop with him.

Scared of the Ladies!

WHEN Mr. C. R. Barratt, of the Kesteven Aces Cycling Club, proposed the toast of the club at the first annual dinner, held at Grantham, he remarked: "I thought that by bringing in the ladies the club was doomed to failure," but went on to say that matters were entirely different and he was glad to say that the membership had grown to 67, including 14 ladies. At the time of the dinner the club had only been in existence for nine months. It is intended to make the club particularly attractive to young riders, and during the coming year membership will be free to members under 15 and National Service lads.

Cyclists Try Walking

IN bitterly cold weather, and with flakes of snow in the air, cyclists from a wide area went to Kettering to take part in a six-mile walking race organised by Kettering Friendly Cycling Club. There were 46 men and seven women entered, and among the clubs represented were: Wellingborough C.C., Marsh R.C. (London), Luton Wheelers, Nene Valley Wheelers, Northants R.C., V.T.T.A. (London) and Rugby R.C. Winner of the men's event was R. Odell (Luton Wheelers), who covered the course in 49 mins. 44 secs., while 17-year-old Doreen Mason, of Burton Latimer, won the women's event with a time of 59 mins. 36 secs.

Land or Water Suited Him

EQUALLY at home on land or in the water, Mr. Harry Lote, of Boston, a former track cyclist and winner of many awards and a fine all-round sportsman, has died at the age of 68. He excelled at every sport he took up and was a fine swimmer. Altogether he saved 48 people from drowning, and before he was 19 years old he had rescued 15 people.

To Beat the Railways!

JOHANN KAISER, of Munich, appears to have brought out the answer which we in this country could use to the cycle-smashing activities of British Railways. Kaiser's idea is to build all cycles to the normal ladies' pattern, but above the bottom

bracket he has devised a hinge so that the whole machine can be folded into two by the removal of one bolt. The folded cycle is then placed in a zipper-bag for transport, and even a railway employee would find his wrecking activities rather curtailed with this type of machine.

Former Cycle Trader Dies

FORMERLY a cycle dealer in business at Wellingborough, Northants, Mr. John Rowlatt, senior director of Messrs. J. Rowlatt and Sons, Ltd., ironmongers, Silver Street, Wellingborough, has died at the age of 65 after a week's illness. His father was one of the pioneers of the cycle trade in Wellingborough and district and Mr. Rowlatt took over the business from him in 1913, later turning to cars as motoring became popular. Mr. Rowlatt always used to say that he got his love of the open road from the days when he and his father were keen cyclists.

Good for the Muscles!

EVIDENTLY feeling in need of some fresh air and a change of scene, Otto Plantz, of Strasbourg, unearthed an 1871 model hobby-horse—that forerunner of the bicycle—and in the middle of December he started off on a tour of France. By the end of the month he had reached Bordeaux and the New Year saw him still pressing on. Reports do not say how many pairs of shoes the brave Otto has taken with him, or what arrangements he has made with cobblers in the towns through which he passes, but as he is propelling his unwieldy vehicle with his feet all the way his bill for shoe leather will be rather high.

Lines Centre Championship

GRANTHAM'S Kesteven Aces Cycling Club have arranged for the five-miles Lincolnshire Centre championship event to be held at the annual sports meeting of Messrs. Ruston & Hornsby, Ltd., Grantham, on June 24th.

Getting Tough

LEICESTER City magistrates have decided to take a stronger line with cyclists who break the law. During 1949, 243 out of the 272 summonses issued in respect of failure to observe halt signs were in respect of offences by cyclists. A further 277 cyclists were summoned for riding without proper lights. The chairman of the Bench told two riders who ignored a policeman's signal that fines would be heavier and said that more drastic steps would have to be taken in cases of lighting and other offences. Fines for failing to halt have gone up to £1.

Slow Workers

A REPORT of the Roads and Bridges Committee of the Huntingdonshire County Council states that the county's roads will be resurfaced once in fifty years if the rate of progress during the past ten years is maintained. The report does admit that the war years practically stopped road upkeep, although roads and bridges were subjected to exceptionally heavy wear and tear, but it looks as if the roads will be in a slightly bumpy state unless they are dealt with more often than twice each century.

Variety

GRANTHAM Borough magistrates the other day had almost every type of cycling offence come up for hearing. There were riders with no rear lights, riders with no front lights and riders with no lights at all, criminals who rode on the pavement and double-dyed villains caught riding two on a one-man machine. Such a wave of crime in this law-abiding town had never before been known!

Around the Wheelworld

By ICARUS

A Jazz Cycling Club?

THERE dropped on to my desk the other morning a comic circular letter in the following terms: "Got a bike ??? ... we wonder how often you use it? ... Not often ??? Perhaps you lack companion cyclists. If you are keen on cycling, if you are interested in jazz music, if you seek companions with like interests then perhaps you will be interested in our plans for Britain's only Jazz Cycling Club.

"Sunday ... cycling into the countryside during the day ... plenty of haits for rest, food and drink ... returning in the evening to one of the London jazz haunts! ! Does that sound like your 'cup of tea'? No great hurry to 'get there'—no great hurry to get back. Travel at the speed of the slowest rider. Stop ... and just laze in the sun (we hope) or go swimming or even just throw a ball (jazz-band variety) or talk and listen about jazz.

"If you are interested contact us. Fill in the form below and send to the address as below, and we will forward details of our first activity. Keep April the 2nd clear.

"If you are really keen to help us organise this club perhaps you will attend a meeting on Monday the 27th of March at 8 p.m. at the address below. This will be a short meeting leaving you time to attend the London Jazz Club if you wish. Hoping to hear from you."

When this journal sent its representative round to the address given on the circular no one seemed to know very much about it. Apparently the appeal is to hooligan school-boy cyclists who will ride their bicycles hands off playing Jews' harps, combs and paper, tin whistles and other guttersnipe instruments, and chuk-chuk every demoiselle who passes by. We have all met loads of these uncouth youths each week-end. They are doing immeasurable harm to cyclists. When they arrive at the appointed teashop, they conduct themselves in the manner of the pigsty in which they were born, and shy food at one another. No real cyclist would, of course, have anything to do with such a scheme.

"Crocodile Tourists"

I SEE that one of the chief constables has been criticising crocodile touring clubs by which I mean, clubs a hundred or so strong who weave their way along in double formation and occupy a couple of hundred yards of the road, thus making it difficult for vehicles to pass. I agree with the criticism. Clubs with a largish membership should break up its file into groups of not more than a dozen with a gap of 50 yards in between. It is all very well to cycle along asserting your rights, but you must remember that other road users have rights too. Remember, also, that it *can* be the subject of a prosecution. The practice is to be particularly deplored on narrow roads, where it causes obstruction to other traffic, and is likely to produce the usual notebook and pencil with policeman attached.

International Rally

THE Imperial Wheelers tell me that they are organising an International Rally, which will be held at Sophia Gardens, Cardiff, on July 8th. The object of the rally is to interest the youth of Wales in the benefits that can be obtained from organised cycling, and other open-air sports. There are to be parades through the main

streets of Cardiff. It is a fact that Wales is much behind England and Scotland in cycling matters. It is a hilly country and one, therefore, for a lightweight geared machine.

Cycle Upkeep Booklet

THE Fibrax Company have just produced an interesting booklet on the upkeep of cycles and their brakes. It deals with the frame and bearings, the free wheel, chains, tyres, punctures, rims and spokes, saddle comfort, riding comfort, gear sizes, pedalling, steering and brake maintenance. Copies are available free to readers.

1818 Hobby Horse

A HOBBY horse built in 1818 for the sixth Duke of Argyll, and handed down in the Argyll family for three generations, was ridden in a Cavalcade of Cycling at the Whitsun race meetings which were sponsored by Dunlop. The cavalcade was staged at the start of the evening meeting at The Butts, Coventry, on the Thursday, and during the interval at Herne Hill on the Saturday, and Fallowfield, Manchester, on Whit Monday.

The Old Ostrich at Colnbrook

I REVISITED, after a lapse of some years, that famous old inn on the Bath Road, exactly opposite the 17th milestone, which was built as a hospice by one Milo Crispin in 1106 and was left in alms to the Abbot of Abingdon, "For the benefit of travellers in this world, and the peace of their soul in the next." It is not generally known that the very first novel in the English language was written round the murder at the Ostrich of a very rich clothier of Reading, Thomas Cole, whose body was thrown in the brook. This incident was said to have given Colnbrook its name—Cole-in-the-brook, but I fear this cannot be supported. The novel was entitled "Thomas of Reading," and it was written by Thomas Deloney, in 1632, and published by him as a chap-book. There were few, if any, publishers in those days, and authors having had the book printed

would knock at doors in an effort to sell them. Deloney was not a rich man, and so could not print large editions. I started a witch hunt for one of these books, and was successful in finding one in a secondhand bookshop in Charing Cross Road. It cost me 30s., but it is an original edition and in good condition.

Over 60 murders were committed at the Ostrich before they caught the rascally landlord and his wife, one Jarman, who between them were responsible for the murders. It was the murder of Thomas Cole which led to their undoing. The old inn still to-day attracts cyclists, as it did 50 years ago when it was the headquarters of the Bath Road and other cycling clubs. The room in which the murders were committed now known as the music room, and the famous staircase may be viewed by visitors. Oddly enough, on my visit I was given a pamphlet written by your editor, F. J. Camm, on the old inn.

What a pity it is that the *bonhomie* of the Ostrich does not pervade many of the other old inns which can claim longevity. The Ostrich is the fourth oldest inn in the country which is more or less in its original condition, the oldest being the Fighting Cocks at St. Albans.

Rubberised Asphalt Roads

BRIEFLY, the advantages of using rubberised asphalt are expected to include a considerable reduction in skidding in wet weather and a reduction in ice formation on the surface of the road. In addition, and of equal importance, to public engineers, is the fact that rubberised asphalt does not crack in cold weather as does normal asphalt; nor, on the other hand, does rubberised asphalt soften at high temperatures.

The experimental work at Lambeth has been made possible by the co-operation of the Lambeth Borough Engineer, Mr. F. Batterbury, B.Sc., A.M.I.C.E., M.I.Mun.E., and the work was carried out by the Lambeth road engineer's staff in collaboration with Messrs. Sparkes Brothers, Ltd., of Feltham, who are preparing the rubberised asphalt surfacing material.



Burford,
Oxfordshire.

The long street climbing up from the Windrush. The town is rich in treasures of the past from its lovely church to old gabled cottages.



Billingshurst,
Sussex.

Old Sussex cottages with their picturesque tile-hung walls, and the spire of the old church rising behind.

Wayside Thoughts

By F. J. URRY

Photography and Cycling

SPRING is a precious time of year, and its delight grows as the years go over you, for it is savoured by the memory of so many past adventures. That is one reason why I like to go to places where first impressions confirmed me as a cyclist and gave me that wanderlust which has never since departed, nor I think will depart while activity lasts. There are, of course, districts in these islands over which my wheels have not passed, but not many, and not in places where contours make for loveliness of setting and great valleys swing to the sea. Sometimes I feel a desire to wipe out all the knowledge gathered through 60 years of cycling, to start all over again and marvel at the discoveries then unfolded; but as that cannot be for any of us, the next best thing is to remember when we turned a corner and looked into paradise. Maybe the rover of to-day starting this merry, vagabond life of cycling will have been introduced to the glory of it by the high art of photography, which in my young days was scarcely developed, and what there was of it depicted little more than scenes within reach of the railway. Now the picture penetration goes everywhere, and it is not remarkable that touring cyclists have become so attached to the art of reproduction that prints more than a picture, for it records a precious memory. I like going around with a keen maker of pictures; he gives me time to smoke, to sit and imbibe the loveliness and make an unconscious worship at a great shrine. That is why so many cyclists are famous photographers and why my debt to these patient fellows will never be paid, for they have given me a joy that returns for ever when I open the volumes of their work.

The Days Ahead

I DO not intend to spend my wheeling miles entirely among the old haunts; that would be neglecting opportunity when it travels my way. No, I will go on investigating to the end of the road, but on the way thither I must, as a surety, traverse many of the old routes, and how delightful they will be. In a way it is a pity the times have made holidays more expensive when one has grown old enough to welcome the amenities and is prepared to pay for them, for it follows that the dreams of a

joyful thought it is to anticipate these things, to feel the impulse of that joy sending you jauntily over the well-known ways with a song in your heart for the times ahead. That is the health of it, building up a simple happiness in life that has no peer in the pleasure of existence.

Activity is Life

THERE are a few people who believe I am writing the truth about cycling, and they tell me so and encourage me to go on with the process; but the huge majority think I am merely a fanatic, and it is obvious from notes and remarks that a few believe my expressed love for the pastime is a pose. If that is so, then I've been posing for 60 years, so it doesn't really matter, for in that period the pose must have become a habit, and the habit a conviction. It is the indifferent I should like to aid—for their own sake. I see so many of them using their leisure wrongly—resting, they call it—and rusting! The old adage that "change of occupation is rest" is probably the truest of all our easy maxims, as every cyclist knows, for it is only at odd times, and nearly always after cycling, that I find time to fill an hour in the company of the lads who have bound their thoughts in books. I know I am fortunate in being so placed that I can use a bicycle daily, but there are thousands of others similarly situated who do not, and they do not know what they miss. That is the pity of it, for life is surely best when it is used for the joy of its living, and whether you be man or woman, that is what cycling will do for you if it is given a chance. I speak to the hale and hearty who would hold that condition all the days of their lives, and I cannot understand why they do not. I know the doctors as a body will not be helpful; they are no longer cyclists either by inclination or necessity, and it is possibly due to their attitude to the pastime that it is not more prominent in their curriculum of cures. I am only a layman, very ignorant of matters medical, but I can tell you from so many angles how cycling has made my life intense and happy with a singular simplicity, and as for health I may be lucky, but I'm certain I have helped that good fortune through travelling by muscular power.

No Show

THE main reason why there will be no cycle show at Earls Court this year is the general upset in production at a time when export goods are in urgent demand. Candidly, I do not think anyone can grumble at the decision, always provided the lapse does not occur too often, for if that happened the many manufacturers may grow slack in seeking those minor improvements for the benefit of the rider which have transformed the bicycle in the important "little things" so enormously during the past five-and-twenty years. Certainly the present-day cyclist has no complaint to present to the trade, for, excluding purchase tax, the modern bicycle is about the cheapest piece of machinery I know, even in its highest price ranges. When you think of a bicycle in the terms of cash, consider the price is mainly labour costs, and deduct the purchase tax, you arrive at a figure no more than double the 1939 article, and a better job to boot. That, I think, is remarkable when you compare the figures with other types of machinery, or in fact anything not carrying a subsidy; and personally, I think the industry is to be congratulated on the performance, and we, who buy the goods, on our bargains. That may sound like an apologia on behalf of the trade; but then it has always been a mystery to me that a bicycle can be sold so cheaply, and now it is still more of a mystery, knowing as I do the wages increases during the last decade.

Memories

A FEW months ago I lost a favourite nephew whose life I had much to do with, and who for the last five-and-twenty years was with me in business, steadily eclipsing with his ardour my declining powers; and I was content it should be so. These last weeks I have been prowling round some of our old haunts when he first started riding a bicycle and I was made to help carry the fishing tackle and the food. They were great days before the first world war, those days when we went to remote pools in the hills, and with the permission of the landowner or farmer (and sometimes without) we had a day out under the summer skies at the cost of something less than a couple of shillings. He grew up, and while he was traversing the twenties I was well on in the forties; but we were still good riding companions until speed attracted him and his journeying became too rapid for my comfort. For two or three seasons he got well among the prizes, what time I was the handy man with the drink, the sponge, and the cheer. Then the job of work brought more money, marriage, and the urge, I suppose, to display success—the motor-car. I can hear him saying it now: "Don't look at me like that, I shall never desert the bicycle." Actually he never did—quite; but the occasions of his saddle journeys were few and far between. That, I'm afraid, is the way of the world, and in his moment of reminiscence he would regret the lapse from his wheeling days without actually admitting the fact. I may be wrong, yet I think my cycling is the reason for my enjoyment of robust health.

Chemico Graphite Grease

"CHEMICO" Graphite Grease, containing Acheson's Colloidal Graphite, reduces friction to a minimum and has long been recognised by cyclists and motor cyclists as the perfect lubricant for chains, coaster brakes, etc. For the first time since 1939, it is now available in the well-known red and blue tubes with special long nozzles for easy application, from cycle dealers and garages at 9d. per tube.

Whatever you do . . .



With the whole family awheel through the spring months, reliable tyres are more vital than ever. Dunlop Tandem have an ample reserve of strength and a low rolling resistance, they're durable and easy-riding, and they give you added safety.

. . . rely on
DUNLOP

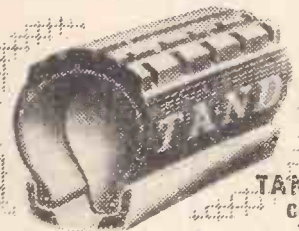

TANDEM
Cover 11 1/3
Tube 4 1/2

REG HARRIS RIDES ON DUNLOP

50H/304

The Soft Block with
the **FIRM GRIP**



Yes—it's the new soft FIBRAX red brake block—specially designed to be kind to alloy rims! Just as tough and hard-wearing as the FIBRAX black block, it gives safe stopping and smooth action at any speed. Coloured red for easy identification—an ideal partner for alloy rims.
NOTE.—The new FIBRAX red block is made for a special job—for steel rims the black block is still the best.

FIT

Fibrax
BRAKE BLOCKS

and get there safely!

FIBRAX LTD., 2 TUDOR ST., LONDON, E.C. 4.



Easy Come—
Easy Going

B.S.A. Light Tourist 619D, fitted with B.S.A. 3-speed hub.

With the B.S.A. Light Tourist you really can "get somewhere"—uphill and down dale, easily and in comfort. The B.S.A. Light Tourist has frame of Reynold's 531 Tubing; Dunlop Tourist Sprite Tyres; new "all-rounder" bar on 2in. forward extension; new smart green and gold finish with new B.S.A. headbadge.

Model 619A £12 plus 23 10s. tax.

Model 619D. With B.S.A. 3-speed Hub with Snap or top tube control. £13 11s. 6d., plus 23 3s. 5d. tax. Twist-Grip control extra.

Model 619T. With B.S.A. 4 Star Gear. £14 3s. 6d., plus 23 6s. 2d. tax. B.S.A. Hublite as illustrated. £1 18s. 6d. extra, plus 9s. 3d. tax.

IT'S TIME
YOU HAD A **BSA**

Write today for fully illustrated catalogue 23
B.S.A. CYCLES LTD., 1, SHAMPOUR ROAD, FIRMINGHAM 11



A smooth, sure GRIP, wet or dry

Ferodo All Weather Brake Blocks are made of a special friction material that is practically unaffected by weather and can be relied on to give you safe, positive control for long hills or emergency stops.

The price of standard sizes is now

6^{d.}
A PAIR

HUB BRAKES. Ferodo Linings are supplied in boxed sets, complete with rivets, for all makes of hub brake. The size is exact, and the friction characteristics correct, for each type. Also available in roll form.

FERODO

ALL WEATHER BRAKE BLOCKS AND LININGS FOR HUB BRAKES

FERODO LIMITED, CHAPEL-EN-LE-FRITH
A member of the Turner & Newall Organization

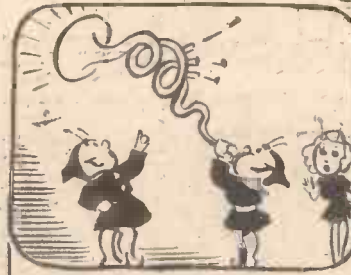

THE "FLUXITE QUINS" AT WORK

"William Tell" should sound smashing to-night.
With my horn repaired with FLUXITE.
Great Scott! What's that?
Why, the darn things unwrapped!
Cried Ol. "But it still sounds all right."

For all **SOLDERING** work—you need **FLUXITE**—the paste flux—with which even dirty metals are soldered and "tinned." For the jointing of lead—without solder; and the "running" of white metal bearings—without "tinning" the bearing. It is suitable for **ALL METALS**—excepting **ALUMINIUM**—and can be used with safety on **ELECTRICAL** and other sensitive apparatus.

With Fluxite joints can be "wiped" successfully that are impossible by any other method

Used for over 40 years in Government works and by leading engineers and manufacturers. Of all Ironmongers—in tins, 10d., 1/6 and 3/-.

● **TO CYCLISTS!** For stronger wheels that will remain round and true, here's a time-tested tip. Tie the spokes where they cross with fine wire **AND SOLDER**. It's simple—with **FLUXITE**—but **IMPORTANT**.



THE "FLUXITE" GUN puts "FLUXITE" where you want it by a simple pressure.
Price 2/6 or filled 3/6

ALL MECHANICS WILL HAVE

FLUXITE

IT SIMPLIFIES ALL SOLDERING

Write for Book on the **ART OF "SOFT" SOLDERING** and for Leaflets on **CASE-HARDENING STEEL** and **TEMPERING TOOLS** with **FLUXITE**. Also on **"WIPE JOINTS"** Price 1d. Each.

FLUXITE LTD., Dept. P.M., Bermondsey Street, S.E.1

—TAKE UP PELMANISM—

For Courage and Clear-Thinking

The Grasshopper Mind.

YOU know the man with the 'Grasshopper Mind' as well as you know yourself. His mind nibbles at everything and masters nothing.

At home in the evening he tunes in the wireless—tires of it—then glances through a 'magazine—can't get interested. Finally, unable to concentrate on anything, he either goes to the pictures or falls asleep in his chair. At his work he always takes up the easiest job first, puts it down when it gets hard and starts something else. Jumps from one thing to another all the time.

Half-fees for serving and ex-Service members of His Majesty's Forces.

There are thousands of these people with 'Grasshopper Minds' in the world. In fact, they are the very people who do the world's most tiresome tasks—and get but a pittance for their work. They do the world's clerical work, and the routine drudgery. Day after day, year after year—endlessly—they hang on to the jobs that are smallest salaried, longest houred, least interesting, and poorest funded!

What is Holding You Back?

If you have a 'Grasshopper Mind' you know that this is true. And you know why it is true. Even the blazing sun can't burn a hole in a piece of tissue paper unless its rays are focused and concentrated on one spot. A mind that balks at sticking to one thing for more than a few minutes surely cannot be depended upon to get you anywhere in your years of life!

What Can You Do About It?

Take up Pelmanism now! A course of Pelmanism brings out the mind's latent powers and develops them to the highest point of efficiency. It banishes such weaknesses and defects as Mind Wandering, Inferiority and Indecision, which interfere with the effective working powers of the mind, and in their place develops strong, positive, vital qualities, such as Optimism, Concentration and Reliability, all qualities of the utmost value in any walk of life.

Remember—Everything you do is preceded by your attitude of mind.

The Pelman Course is simple and interesting, and takes up very little time; you can enrol on the most convenient terms. The Course is fully described in "*The Science of Success*," which will be sent you, gratis and post free, on application to:

PELMAN INSTITUTE
130, Norfolk Mansions
Wigmore Street, London, W.1
Established over 50 years. Callers welcomed

POST THIS FREE COUPON TO-DAY
To the Pelman Institute,
130, Norfolk Mansions, Wigmore Street, London, W.1.

"The Science of Success," please.

Name

Address

PELMAN (OVERSEAS) INSTITUTES: PARIS: 175 Boulevard Haussmann. **AMSTERDAM:** Prinsengracht 1021. **MELBOURNE:** 896, Flinders Lane. **JOHANNESBURG:** P.O. Box 4923. **DURBAN:** Natal Bank Chambers (P.O. Box 1189). **DELHI:** 10, Allipore Road.

CYCLORAMA

By
H. W. ELEY



In the Weald of Kent—a springtime scene at Bethersden.

Magic of the Night

THERE is magic in night-riding, and if you would see a new and mysterious world I commend you to take out your cycle some moonlight night and ride away . . . away to lands of romance, where the common and ordinary things and objects of the garish day become tinged with mystery and magic, as if touched by some genie's wand. That haystack, so familiar in the light of day, becomes a strange apparition when seen in the silvery moonlight, and that cottage, which you know so well in Wraxley Green, takes on a queer shape and character as you approach it when the moon is up and all the world is touched with its radiance. And the trees in the old spinney are weird and fantastic, with the moonlight glinting through the branches. It is night . . . magical night . . . when the trees whisper their secrets, and lovers meet by the trysting stile, while the moon smiles and sighs. . . .

The Bike and the Bell

I RECENTLY overheard a hot argument, with many laughs and, I am afraid, precious few facts, about the law relating to the bicycle and the warning bell. It was in a friendly little inn on the Buckinghamshire borders, and I don't remember how the subject arose, but those cyclists, as they sipped their ale, had a real good argument about the legal position regarding the fixture of a bell to a cycle. What is the law? Is there an alternative permitted? How does a rider stand if, in case of accident, it is found that his machine has not a bell fitted? These were the points raised during the friendly but hectic chatter in that ancient tavern, on a fair May night. It is a pretty awful admission to have to confess total ignorance on such a subject, but I should appreciate enlightenment . . . and I await my "mail."

A Country Joy

SINCE I lived in my somewhat remote but altogether pleasant hamlet in Derbyshire I have sampled a new joy . . . for on more than one occasion this past winter I cycled to the meet of the hounds . . . the famous Meynell Pack. And it was a thrill! Something of an older and happier England seemed to unfold itself as I watched the gay scene outside some good inn, or near to

some ancestral hall. The opponents of fox-hunting may wax as virulent as they like . . . I contend that there is something fine and splendid about the chase. Whether Reynard likes being hunted, I know not; but as to the glamour and thrill of watching hounds move off, there is no shadow of doubt. I may be a "blood-thirsty throw-back" as one old lady called one of my village friends . . . but I shall, whenever possible, cycle to the meet . . . and get a free thrill!

Youth Hostels

IN London Town, I heard but little of the Youth Hostel Movement . . . quite naturally; but here, each week-end, one sees happy young folk riding up into "The Peak" . . . to spend a healthy and useful week-end, with a Youth Hostel as the base. I have talked with some of these keen cyclists and campers, from Sheffield, and Leeds, and Leicester, and Nottingham, and their enthusiasm is something to remember. The costs involved are negligible; each visitor has to do a job of work . . . cooking, "chores," etc.—and I believe that in this movement, which seems to have a special hold on the young folk of the North, there is the basis of real citizenship and understanding . . . with the barriers of class distinction well and truly broken down. . . .

The Lure of the Inn Sign

WHAT romance and history there is in the English inn sign! Whether a man be a lover of a tankard of ale in a village inn, or not, he cannot but be impressed by the names and designs of inn signs. And this is no new subject for THE CYCLIST, for I recall that some few years ago (just prior to the war I think) the journal ran a fascinating series called "Dictionary of Inn Signs." It was an illustrated series, and contained a wealth of information about the derivation of many of our popular signs. Almost every phase of our national life is featured in the inn sign; our wars and battles; our national games and pursuits; our kings and queens; the panorama of our agriculture and industry . . . the inn sign covers them all, and in this new area where I now live I am finding quite a thrill in noting the fresh inn names and the colourful signs. Plenty of the usual names . . . White Harts, and Black Swans, and Brown Bears . . . but an occasional unusual sign, like

"The Green Man and Black's Head" in ancient Ashbourne, with its great sign straddling across the street. An ancient hostelry this . . . where Doctor Johnson was wont to sip his ale, and, doubtless, regale the assembly with his wit and wisdom. There have been many books about the English inn and its sign . . . and some day I may be bold enough to write another. . . .

Cycle Slogans

WHENEVER I meet a fellow-cyclist of my own age and generation, I love to talk of old makes of machines, of early models, of the introduction of new devices . . . and the other day, chatting with a cycling parson, we fell to discussing the respective merits of the advertising slogans used by cycle manufacturers. My friend expressed a preference for the Enfield phrase "Made Like a Gun." I countered with "Rudge it . . . don't trudge it" . . . which I always think is a very noteworthy effort, and has the essential advantage that the slogan contains the brand-name, so that it can never be confused or credited to another make of machine. We did not forget "The Better Bike"—the slogan of Armstrong Cycles . . . and my friend was the rider of a bike which all the world knows as "The All-Steel Bicycle." There's power in a good slogan, but I think that there is still room for a "world-beater" as applied to cycles.

Drake's Devon

ONE of my old advertising friends, retired from the fray for some few years, has written to me from Devon . . . where he finds it good to let the great big world go by, and dream of Drake and the gay sea-dogs of Elizabethan times. He suggests a visit, lures me with the prospect of chats about old times, tells me of his garden and the sun-kissed lanes and abundant wild flowers; a truly lovely prospect, and I find myself, as I puff at a last pipe before turning in, toying with the idea of a long ride into Devon. Why not? It is an age since I rode westward . . . and there is magic in the Devon coast, and in Devon towns. I reach for my old and tattered map . . . and begin to dream dreams. . . .



The old Bell Inn
Tewkesbury.
The famous Elizabethan
Inn, standing in the shadow
of the great Abbey.

My Point of View

By "WAYFARER"

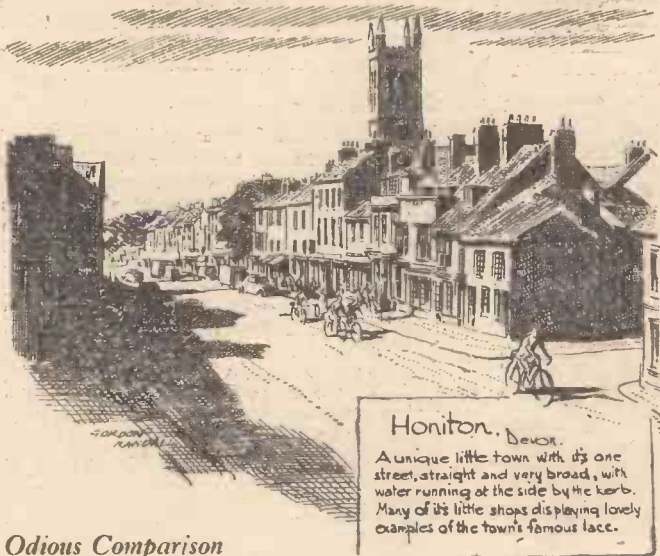

Honiton, Devon.
A unique little town with its one street, straight and very broad, with water running at the side by the kerb. Many of its little shops displaying lovely examples of the town's famous lace.

Odious Comparison

ONE of the nabobs of the great scheme for spoiling Snowdonia is reported to have said that the reservoir at Trawsfynydd can safely be compared for scenic grandeur with Lake Bala, an assertion which makes one wonder whether the nabob in question has ever seen Lake Bala. If not, he ought to repair the omission without delay and then let us have his revised opinion.

Dangerous Look

I STROLLED abroad the other Sunday evening just to look at the traffic along the main road near where I live. Despite petrol restrictions there was a good number of motor-cars, but, not unnaturally, I was much more interested in the cycling brigade, and the point that struck me forcibly—this is where my readers are going to be shocked, writing me down as a heretic—was the danger of riding along a motor-thronged highway! Let me hasten to say that there was no real danger, but there was definitely a dangerous look about the whole proceeding. This is the case not only with cycling, but with many other activities. The man who sails his small boat in a half gale of wind; the steersman of a speed-boat; the window-cleaner or house-painter perched up aloft—these people, and many another, seem to have one foot in the next world, though they themselves are blissfully unconscious of any danger. So it is with the cyclist dashing along in a medley of traffic, and no doubt it is because of this dangerous look that we are so frequently criticised in the press; no doubt it is partly because of the dangerous look that we hear so much about the desirability of abolishing us to cycle-paths. Also, mark you, it is the non-cyclist who is terrified at the dangers apparently threatening cyclists—it is the non-cyclist who gives one the impression that he wouldn't be a cyclist at any price. I shall not go so far as to say that there is no danger in the use of the public highways—that would be absurd, particularly

having regard to the bad behaviour of unreasonable beings who create hazards—but I do assert that cycling looks far more dangerous than it really is.

Outmoded

MANY cyclists of the younger generation will learn with interest and astonishment that there was once a bamboo bicycle. A current advertisement of the Iron and Steel Federation reminds us of this, stating that a few "safety" bicycles with bamboo frames were made in the late '70's, when it was found that using solid-steel bars made the new machine too heavy. The thought of those solid-steel bars seems as grotesque to-day as the bamboo-framed bicycle. Long years ago I did see one or two specimens of the latter freak, which I imagine had then been outmoded and were really museum pieces. Possibly the non-cyclist who in the '90s asked me whether "these"—the tubes of my new bicycle—were solid knew more about cycling than I did—then! The question surprised me at the time, but perhaps it was not quite so stupid as I thought.

Any Stick

IT is true of cyclists, as of dogs, that any stick is good enough for scourging us, and the frivolity of some of the complaints levelled against cyclists strikes me as being remarkable. Take the case of the anonymous critic who recently presented the world with a "triple complaint" through the correspondence columns of a prominent Midland newspaper. (1) He was astounded at the number of cyclists who were flouting the lighting regulations. On that point the critic should have given "chapter and verse" concerning the time of these alleged offences, because at certain periods of the year it often looks like lighting-up time when it isn't. While in such circumstances a cyclist is wise if he lights up ahead of the statutory hour, he cannot be "charged" for failing to do so.

(2) The anonymous critic complains that he has not heard a cycle bell for years, the implication being that we cyclists are compelled by law to carry and use bells. Is that a fact? It is not! The wise cyclist fits a bell and uses it on those comparatively rare occasions when it is desirable for him to make a noise. One would have thought that the cacophony of the roads was already satisfying in amount without the little extra din we cyclists should provide—if we set our minds to it! But what a grand whip for scourging us with!

(3) We cyclists—desperate fellows!—actu-

ally pass cars on the near side! This, despite the serious nature of the "crime," is not altogether an unnatural thing to do, especially when motorists so position themselves that they leave us no room to pass on the off side. It seems a pity to co-operate with them by leaving all that space on the left, and I wonder whether the anonymous critic has never seen motorists (including buses) creep in on the near side of other cars. However, is not the basis of this particular complaint against us a feeling of annoyance—and perhaps jealousy—that we, with our slinness and our mobility, are readily able to pass through traffic while our motoring friends are left standing? I rather think so.

"Unsung"

A NON-CYCLING friend rang me up on a recent Monday morning to make inquiries about a time-trial, the finish of which he had accidentally witnessed on the previous day. He was mildly excited about it. He had photographed the winner and was amazed at his achievement in riding at something like 20 miles an hour for 12 hours. My friend, who said that the total distance travelled would be more than enough for him to do in his car, thought that the lad's physical condition after this feat of strenuous endurance was truly remarkable. I provided such information as I possessed—it was very scanty, of course—and went on to tell my friend that a great many astonishing feats were achieved by speedy cyclists without the man-in-the-street being aware of what was going on, only those specially interested being able to find the peepholes in the iron curtain which conceals from the public gaze the time-trialling aspect of cycling. In giving this information I thought what a pity it is, in a way, that there is so much secrecy about the sport. The public judges the cyclist by the errand-boy who brings us our newspapers and our cabbages, or by the twice-round-the-block type of rider who fritters away his cycling opportunities in suburban streets, or by the mouth-organ group sprawling over a busy main road.

The public knows little or nothing about the cyclist who regularly does his 10,000 miles per year, which distance probably includes a 200-300-mile jaunt at each Bank Holiday week-end and a 1,000-mile tour in the summer. The public knows nothing about our speed merchants, whose victories are "unsung" in the daily newspapers. I am not suggesting that, as regards time-trialling, the position should be altered. I believe that a policy of hush-hush should be maintained, and I am certain that if would be highly undesirable to have a mob of non-cyclists congregating anywhere on the course. All the same, it is a pity that the man-in-the-street does not know something about the prowess of our fast roadmen, which is a tribute to their physical fitness and, in an age of flabbiness, is indeed good to behold.

OUR COMPANION JOURNALS

Practical Wireless, 9d. Every Month
Practical Television, 9d. Every Month
Practical Engineering, 4d. Every Friday

"Practical Mechanics" Advice Bureau COUPON

This coupon is available until June 30th, 1950, and must be attached to all letters containing queries, together with 3 penny stamps. A stamped, addressed envelope must also be enclosed.

Practical Mechanics

June, 1950

Published about the 30th of each month by GEORGE NEWNES, LIMITED, Tower House, Southampton Street, Strand, London, W.C.2, and Printed in England by W. Spearhead & Sons, Ltd., Exmoor Street, London, W.10. Sole Agents for Australia and New Zealand—Gordon & Gotch (Asia), Ltd. Sole Agents for South Africa—Central News Agency, Ltd. Subscription Rate (including postage): For one year, Inland and Abroad, 10s. 6d. (Canada 10s.). Registered at the G.P.O. for transmission by Canadian Magazine Post.

CONDITIONS OF SALE AND SUPPLY: This periodical is sold subject to the following conditions, namely, that it shall not, without the written consent of the publishers first given, be lent, re-sold, hired out or otherwise disposed of by way of Trade except at the full retail price of 9d.; and that it shall not be lent, re-sold, hired out or otherwise disposed of in a mutilated condition or in any unauthorised cover by way of Trade; or affixed to or as part of any publication or advertisements, literary or pictorial matter whatsoever.

SPARKS' DATA SHEETS

Now recognised as the Safest, the Simplest and the Finest Constructional Sheets obtainable. The Full-size Plans and Detailed Descriptive matter, plus Component List with all Values and Prices, and the fact that all the Designs are Fully Tested and Guaranteed, make these Sheets Second to None.

ALL-DRY BATTERY DESIGNS FOR THE SUMMER

The "POCKET PAK" One-valve Portable. Med. waves. Frame aerial and batteries self-contained. Fine "phone signals. Pocket size ... 2/9

The "ONE-VALVE PORTABLE." Slightly larger than the above but covers medium and long waves ... 2/6

The "TINY TWO" Portable. Med. waves. Self-contained frame aerial, batteries and 2 1/2 in. Speaker. For "local" station "Individual Listening" ... 2/6

The "THREE-VALVE PORTABLE." This model is 6 x 6 x 4 ins. and has a 3 1/2 in. Speaker. Covers medium and long waves. Good speaker results on the "locals" ... 2/6

The "FOUR-VALVE PORTABLE." Slightly larger than the above. Med. waves. 5 in. Speaker. T.R.F. Circuit. Has greater range than the 3-Valve model ... 2/6

The "CORVETTE." A 4-Valve Super-het covering S., M. and Long waves. Midget valves. Chassis approx. 5 1/2 x 2 ins. Ideal for Portable or House model. Fine range in any area ... 3/-

The "CRUISER." A 3-Valve T.R.F. circuit designed for use with a short aerial. Very efficient in any area. 2/6

The above are only a few of the 40 designs available.

SEND STAMP FOR COMPLETE LIST.

COMPONENTS SUPPLIED.

L. ORMOND SPARKS (M)
48A, HIGH STREET,
SWANAGE, DORSET.

Experimenters! Build the MATCHBOX RADIO SET.

With the aid of our full instructions you can build a complete radio set in a matchbox, using parts easily obtainable from your radio dealer. This is made possible by the use of the Crystal-Valve Radar Detector — a wartime discovery. Tunes the B.B.C. wavelengths, and works off a short indoor aerial in many districts. Powered entirely by the incoming signal, no batteries are required. Full step-by-step instructions, working drawings, and theoretical wiring diagram.

Price 2/9 Post Free.
JOHN O'BEIRNE (P.),
137, Cotham Burn, Bristol, 6.
Post Orders Only.

You can't do better than send to

THE FORREST PRESS LIMITED

for your

PRINTING

240 HOLLOWAY ROAD,
LONDON - N.7.

Phone: NORTH 2004.

NO MAN CAN KNOW TOO MUCH OF HIS PRODUCT

For the close scrutiny of every conceivable object, metals, tools, fabrics,

The Ultra Lens is a revealing eye of six actual diametrical magnifications, which brings out points of strength or weakness, and enables the most minute measurements to be gauged accurately.

fibres, minerals, precious stones, paint, print, manu-

BRITISH MADE scripts, biological and botanical specimens, cutting edges, fractured surfaces, raw materials, powders, granules, and innumerable other purposes, the ULTRA LENS is invaluable, and presents in many instances hitherto unsuspected data which can be used to advantage.

PRICE 24 15s. 0d., complete in case with spare bulb, battery and transparent measuring scale.

THE ULTRA LENS COMPANY,
75, Finsbury Court, Finsbury Pavement, London, E.C.2.

PLASTICS (MANCHESTER) LTD.

11 Whitworth Street, Manchester, 1. Tel: Gen. 0272-1725

BUY YOUR SUPPLIES FROM BRITAIN'S LEADING PLASTIC STOCKISTS FOR INDUSTRY, THE MODEL MAKER AND THE HOBBYIST

As Official Stockists for IMPERIAL CHEMICAL INDUSTRIES, LTD., B.X. PLASTICS LTD., ERINOID, LTD., AND UTILEX, LTD.

WE STOCK!!!

"PERSPEX" (Acrylic sheet). Clear and all colours sheet and rod.

From 1/16 in. thick upwards (Standard L.C.I. prices).

"CRINOTHENE" (Brand of Polythene). This is a ductile embossed sheet about .075 thick in all colours. Sold by the yard, 34 in. wide.

Used for lampshades, bags, etc., etc.

B.X. ACRYLIC ROD.

"CASEIN" Sheet, Rod and Tubes, etc.

CAST RESIN in a variety of shades and forms.

P.V.C. SHEETING (Admiralty Specification) for Curtains, Aprons, Rainwear, Shower Curtains, etc.

ACETATE FILM and SHEET. All colours, plain and embossed, for Lampshades, Fabricating, etc.

Lacquers and Dyes for "Perspex" (Acrylic Resin). Cements, Polishes, Luminescent Powders, Transfers, Instructional Manuals, etc.

Specialists in fabrication, injection moulding and engraving.

FREE PRICE LISTS AND INFORMATION ON REQUEST.

PLYWOOD OF LONG CUTS, New approx. details: 20 pieces, max. size 30 in. x 5 in., 14 lbs. for 3/4 carr. pd. Ideal for toy and modelmakers.

DUNLOPILLO UPHOLSTERY, slightly used, 34 in. x 15 in. seat type, 12/-.

Easily cut and joined, carr. pd. cash with order.

Write for Bargain List.

B. & M. SALES, 16, Hamm Moor Lane, Weybridge, Surrey.
Phone: Weybridge 3311.

PHOTO-ELECTRIC METER COMPONENTS

Selenium Light Cell ... 6s. 6d.
Microamp Meter Movement ... 10s. 6d.
Moulded Perspex Case ... 9s. 0d.
Assembly Instructions ... 2s. 6d.

All standard Photo-Cells in Stock.

G. R. PRODUCTS,
78, REPTON ROAD, BRISTOL 4.

SAILOR SAM'S SECRET

How to Make SHIPS IN BOTTLES
Kits, 5/6 and 6/-

OLD TIME GALLEONS
Kits 6in. to 22in. From 3/- to 27/6

Stocked by Model, Sports and Toy Stores

Please write for details

COOPER - CRAFT, LTD.
The BRIDEWELL, NORWICH

ALL PURPOSE LATHE HEADS

with grinding and sawing attachment, 4 speed with 1 in. capacity chuck, 36/-.

See Pulleys, all sizes from 2/2. Counter-shafts from 15/-.

Belong 44 lb. Plummer Blocks, 3/6. Steel Shafting, 1/11 ft. Grinding Wheels, 4/6. Fractional H.P. Motors and Modelmakers' Lathes, Tools, materials and equipment.

Send 6d. for fully illustrated Catalogue.

BEVERLEY PRODUCTS
28, Oakwood Avenue, Leeds, 8A

HORNET GAS BLOW LAMP

ONLY 3/6

INTENSE HEAT - SELF BLOWING

The handiest Tool for the Handyman, gives powerful, sharp, super-heated flame. Works off any Gas point. Ideal for Silver soldering, Hard soldering, Tinning, Brazing, Hardening, Glass Bending, etc., 3/6, plus 3d. post.

Heavy rubber tubing 8d. per foot. Cash back if not satisfied.

MACDONALD'S OF EPSOM, EPSOM, Surrey

BOOKS:
"Two Rail 00 Handbook" ... 1/3
"Railway Modellers Handbook" ... 2/6
"British Passenger Locos" ... 3/-
"Freight & Mixed Traffic Locos" ... 3/-
"Model Railway Signals" ... 3/-
Assorted Coloured B. Rly. Postcards. Set of 12, 3/-

USEFUL PARTS
Level Crossing S./Line for 00 0
Dublo ... 8/6 -
Island Platform, 24in. ... 7/6 -
Ex-P.A.F. 16 S.W. Blocks ... 5/6 5/6
20 v. Lamps for Hornby ... 1/2
Bakelite Wagons ... 2/11 10/6
Bakelite Vans ... 3/6 12/6

Postage extra, "00" or "0" Parts List 3d. per post.

TYLDESLEY & HOLBROOK (M.E.T.A.),
109, DEANSGATE, MANCHESTER, 3.

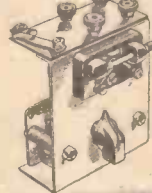

RADIO is interesting. With a D3 Coil you can build this crystal set, or 1, 2, and 3 valve sets. The most comprehensive radio coil for simple circuits. With full blueprint and circuits, 5/-.

HILLFIELDS RADIO,
Dept. M, 8, Burnham Rd., Whitley, Coventry.

Price 27 10s. 0d. Carr. Extra.

The 'Adept' Bench Hand Shaper
Length of stroke 0.1 in., 3 1/2 in.
No. 2B.H. Shaper, 6 1/2 in. stroke.
Price, 27 10s. 0d.
"Ask your dealer."
Manufactured by:
ADEPT WORKS,

The SUPER 'ADEPT' LATHE
1 1/2 in. centres, 6 in. between centres.
Price 44 10s. 2 1/2 in. 4-Jaw Chuck. Reversible Jaws, 32/-. A Good Range of Accessories is Available.
F. V. PORTASS, SELLERS STREET, SHEFFIELD, 8

THOMPSONS TRANSFORMERS and RECTIFIERS for D.C. WORK.
15 volts, 1 amp. ... £11.0
15 volts 2 amp. ... £16.0
15 volts 3 amp. ... £18.0
RECTIFIERS for above: For 1 amp. 13/6; 2 amp. 24/-; 3 amp. 32/-.
Quick Delivery; we wind to any odd voltage and amps. Many sizes in our List (Stamp), including Ground Heaters 26/-.

T. W. THOMPSON & CO.,
176 Greenwich High Road, Greenwich, S.E.10.

High Grade Spring Balances, made by Salters of Birmingham. Two types available, 0-100 grams and 0-200 grams, each absolutely Brand New complete with pan. Invaluable to all Amateur Photographers, Chemists and Students.

PRICE 12/6 each. Post Paid.

Special Rapid Backed Plates, packed in packets of 1 dozen, 1/2 Plate Size, 60 plates, 20/-.

Whole Plate Size, 36 plates, 10/-.

Post Paid.

G.45 Camera Magazines, 6 for 5/-. Post Paid.

Send to-day for our latest lists.

WALTON'S WIRELESS STORES,
203, STAVELEY ROAD,
WOLVERHAMPTON.

HEXAGON KEY SPANNERS



SIZES 1/8" TO 3/8" Complete + 6d. Post, Pkg.

* 9 HIGH GRADE STEEL KEYS *
* SPECIAL ALLOY RACK *

(Lists now available)

MORTONS, 13, Camden Road, Walthamstow, London, E.17.

Multicraft CATALIN Material *

Rods, Cylinders, Sheets, Sections. The most versatile of all materials. Beautiful colours easily worked. Special Offer to Turners, assorted rods from 1 in. up. 41s. 25/-; 81s. 49/-.

Sample Box 10/-. Assorted parcels 25/- & 50/-.

Stock List and Samples 6d.

Dept. PM, **COULDEN & SMITH,**
17, The Mead, West Wickham, Kent.

WEBLEY AIR PISTOLS

carefully curate for target practice.

no licence required to purchase.

Senior Mark I Junior Webley Air Rifle

Write for List. **WEBLEY & SCOTT LTD.,**
16, Weaman Street, Birmingham, Eng.

Astrogaphs, U.S. Type, in strong cases. Telephone Sets, balanced armature, cheapest intercom, no batteries, 25ft. flex. Instrument wire. Insulation materials. Many other Radio and Electrical bargains. Send S.A.E. for list.

L. C. NORTHALL, 16, Holly Road, Quinton, Birmingham 32.
Retail at 416, High Street, Smethwick.
Tel.: WOO 3166.

EWINDS AND REPAIRS to

vacuum-cleaners, portable electric tools and all types of electric motors. Trade invited.—Omega Electrical Rewinding Co., 318, High Road, Willesden, London, N.W.10. WILlesden 0769.

RATCHET & REVOLUTION COUNTERS

Ask for coupon No. 18/6. Speed up to 6,000 r.p.m. **J. & F. CARTER & Co., Ltd., Bolton 5** Members of B.E.S.T.E.C. Organisation.

Free Guide - "Success in Engineering"

One of the following Courses taken at home in your spare time can definitely be the means of securing substantial promotion in your present calling, or entry into a more congenial career with better prospects.

ENGINEERING, AERO, ETC.

Plastic—Radio—Aero Engines—Aircraft Design—Welding—Aerodynamics—Electrical Engineering—Television—Electric Wiring—Diesel Engineering—Generation and Supply—Works Management—Metallurgy—Refrigeration—Planning. Estimating. Rate-fixing—Time and Motion Study—Aero Inspection—Automobile Engineering—Sheet-metal Work—Engineering Draughtsmanship—Aero Draughtsmanship—Jig and Tool Draughtsmanship—Press Tool and Die Draughtsmanship—Structural or R/F Concrete Draughtsmanship—Sanitary Engineering.

GENERAL

Matriculation—College of Preceptors—A.C.C.S.—A.C.I.S.—Aircraft Apprentice.

MUNICIPAL SERVICE

School Attendance Officer—Handicraft Teacher—Registrar—Housing Manager—Sanitary Inspector—Weights and Measures Inspector—Inst. of Mun. Engineers—A.R.I.C.S.—L.A.B.S.S.

"PRACTICAL ENGINEERING" said—

We recommend all readers interested in improving their position to apply for a copy of this valuable book. "Success in Engineering" is not a pamphlet. It is a 132-page book, containing valuable and vital information on all branches of engineering. . . . There are many engaged in engineering who owe their success to The National Institute of Engineering.

The FREE GUIDE explains:

- Openings, prospects, salaries, etc., in Draughtsmanship, Inspection, and opportunities in all other branches of Engineering and Building.
- How to obtain money-making technical qualifications through special RAPID FULLY-GUARANTEED COURSES.

Write now for your copy of this remarkable publication.

A.M.I.E.E., A.M.I.Mech.E.,
A.M.Brit.I.R.E., A.M.I.P.E.,
A.M.I.C.E., A.M.I.Struct.E.,
A.M.I.Mun.E. M.R.San.I.,
A.M.I.E.D., A.F.R.Ae.S.,
London B.Sc., Degrees.

Fully guaranteed postal courses for all the above and many other examinations. Fully described in the Free Guide.



THE BUILDING BOOM— SECURE YOUR SHARE!

The Free Guide also gives particulars of our extensive range of modern Building and Structural Courses, Building Draughtsmanship, etc. The great post-war Building programme offers unlimited prospects to technically trained men.

BECOME A DRAUGHTSMAN QUALIFY AT HOME AND EARN BIG MONEY

Men and Youths urgently wanted for well paid positions as Draughtsmen, Inspectors, etc., in Aero, Jig and Tool, Press Tool, Electrical, Mechanical and other Branches of Engineering. Practical experience is unnecessary for those who are willing to learn—our Guaranteed "Home Study" courses will get you in. Those already engaged in the General Drawing Office should study some specialised Branch such as Jig and Tool or Press Tool Work and so considerably increase their scope and earning capacity.



THE ACID TEST OF TUTORIAL EFFICIENCY SUCCESS—OR NO FEE

We definitely guarantee that if you fail to pass the examination for which you are preparing under our guidance, or if you are not satisfied in every way with our tutorial service—then your Tuition Fee will be returned in full and without question. This is surely the acid test of tutorial efficiency.

If you have ambition you must investigate the Tutorial and Employment services we are able to offer. Founded in 1885, our success record is unapproachable.

Why not fill in and post the attached Coupon NOW for further details and Free Authoritative Guide to openings in Engineering and Building? This book contains a mine of valuable and exclusive information and may well prove to be the turning point in your career.

PROMPT TUTORIAL SERVICE GUARANTEED

FREE COUPON

To NATIONAL INSTITUTE OF ENGINEERING
(Dept. 29), 148, Holborn, London, E.C.1.

Please Forward your Free Guide to

NAME.....

ADDRESS.....

My general interest is in: (1) ENGINEERING (2) AERO (3) RADIO (4) BUILDING (5) MUNICIPAL WORK (Place a cross against the branches in which you are interested.)

The subject or examination in which I am especially interested is

To be filled in where you already have a special preference.
(Id. stamp only required if unsealed envelope used.)

NATIONAL INSTITUTE OF ENGINEERING

(Dept. 29)

148, HOLBORN, LONDON, E.C.1

OVER SIXTY YEARS OF
CONTINUOUS SUCCESS

SOUTH AFRICAN BRANCH: E.C.S.A. P.O. BOX 8417 JOHANNESBURG.

FOUNDED 1885—FOREMOST TODAY—OVER 100,000 SUCCESSES