

Palmer

TIMBER HOUSES

NEWNES

9^d.

PRACTICAL MECHANICS

MARCH 1945

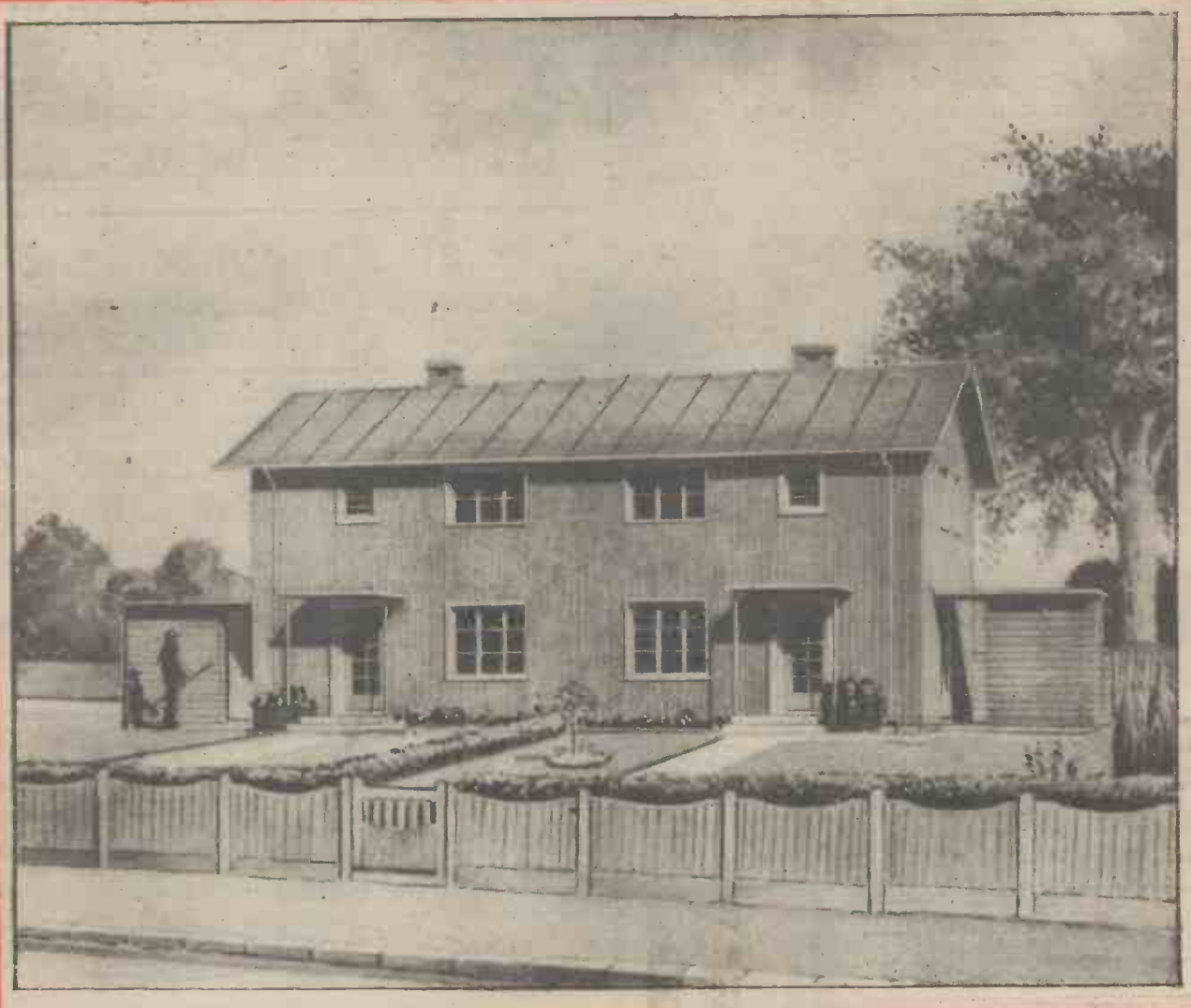

Have YOU Joined the Well-paid Ranks of the TRAINED MEN?

THERE IS ALWAYS A GOOD POSITION FOR THE MAN
WITH A SPECIALIZED TRAINING, BUT THERE'S
NO WORTH-WHILE PLACE FOR THE UNTRAINED

Ambitious men everywhere have succeeded through I.C.S. Home Study Courses. So also can you. We offer you the benefit of our 53 years' matchless experience as the creative pioneers of postal instruction. Since our establishment in 1891, more than 1,000,000 British men and women have enrolled for I.C.S. Courses.



The man with an I.C.S. Training in any one of the subjects listed below knows it thoroughly, completely, practically. And he knows how to apply it in his everyday work.

- | | | |
|--------------------------|---|-----------------------|
| Accountancy | Draughtsmanship
(State which branch) | Motor Engineering |
| Advertising | Drawing Office Practice | Motor Mechanic |
| Aeronautical Engineering | Electrical Engineering | Moulding |
| Aero Engine Fitting | Engine in Charge | Patternmaking |
| Aero Fitting and Rigging | Eng. Shop Practice | Plastics |
| Aeroplane Designing | Fire Engineering | Quantity Surveying |
| Air-Conditioning | Fitting and Turning | Radio Engineering |
| Architecture | Foundry Work | Radio Servicing |
| Architectural Drawing | Garage Management | Refrigeration |
| Boiler making | Gas-Power Engineering | Salesmanship |
| Book-keeping | Ground Engineer | Sanitary Engineering |
| Building Construction | Heating and Ventilation | Secretarial Work |
| Building Contracting | Hydraulic Engineering | Sheet-Metal Work |
| Business Training | Joinery | Steam Engineering |
| Business Management | Journalism | Structural Steelwork |
| Carpentry | Machine Designing | Surveying |
| Chemical Engineering | Machine-Tool Work | (State which branch) |
| Civil Engineering | Marine Engineering | Telegraph Engineering |
| Clerk of Works | Mechanical Drawing | Telephone Engineering |
| Colliery Overman | Mechanical Engineering | Templating |
| Colliery Management | Mine Electrician | Textile Designing |
| Commercial Art | Mine Fireman | Toolmaking |
| Concrete Engineering | Mine Surveying | Welding |
| Cotton Manufacturing | Mining Engineering | Woodworking |
| Diesel Engineering | | Works Engineering |

And most of the Technical, Professional, and Matric Exams.

Special terms for members of H.M. Forces and discharged disabled members of H.M. Armed Forces.

If you need technical training, our advice on any matter concerning your work and your career is yours for the asking—free and without obligation. Let us send you full information regarding the subject in which you are specially interested. DON'T DELAY. Make "ACTION" your watchword.

The successful man DOES to-day what the failure INTENDS doing to-morrow. Write to us TO-DAY

Use this Coupon

INTERNATIONAL CORRESPONDENCE SCHOOLS LTD.

Dept. 95, International Buildings, Kingsway, London, W.C.2.

(Use penny stamp on unsealed envelope)

Please send me particulars of your courses in.....

Name..... (USE BLOCK LETTERS) Age.....

Address.....



3 CORES
OF
ERSIN
FLUX

Radio Experimenters are now able to use "The Finest Cored Solder in the World," Ersin Multicore. The three cores of extra active non-corrosive flux ensure speedy soldering and eliminate high resistance or dry joints.

Available from electric and radio shops, ironmongers, etc.

Size 2 cartons:	16 S.W.G.	-	6d. ea.
Nominal 1-lb. reels:	13 S.W.G.	-	4/10 ea.
	16 S.W.G.	-	5/3 ea.

MULTICORE SOLDERS LTD. COMMONWEALTH HOUSE,
NEW OXFORD ST. LONDON, W.C.1. Tel: CHAncery 5171/2

Special Announcement to

ENGINEERS · ELECTRICIANS · FITTERS
MECHANICS · BUILDERS & PLUMBERS

Popular demand for RAWLBOLTS has resulted in our assembling this new RAWLBOLT *General Purpose* OUTFIT which contains the necessary fixing devices and tools for fixing electric fans, fire extinguishers, handrails, refrigerators, water heaters, etc. RAWLBOLTS are fixed quickly and easily—it is only necessary to make a small hole, insert the bolt, tighten the nut and the job's done. No grouting is needed. No waiting for cement to dry. Once in position RAWLBOLTS are absolutely secure.

Every man who has a fixing job to do needs this RAWLBOLT OUTFIT.

RAWLBOLT 'C' OUTFIT

Contains all
necessary
Fixing Devices
required for
the average
Bolt-fixing Jobs

22/6

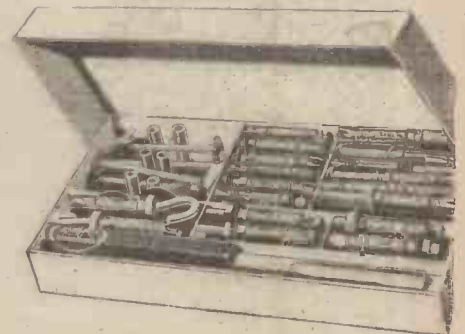

THE RAWLPLUG COMPANY LTD., LONDON, S.W.7

The World's Largest Manufacturers of Fixing Devices.

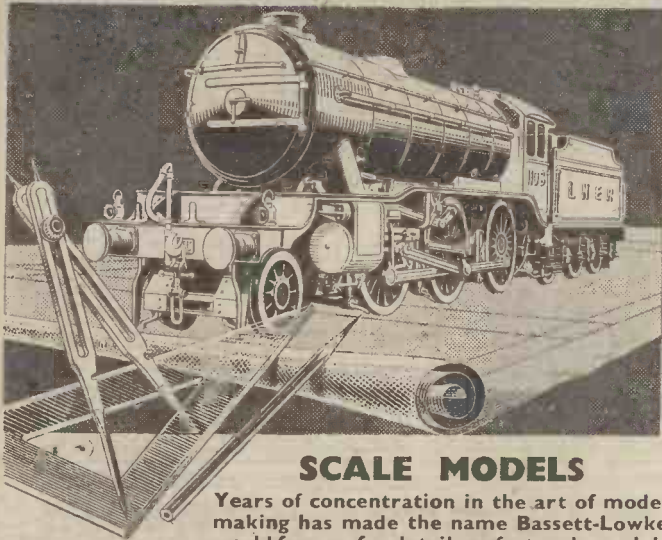

SCALE MODELS

Years of concentration in the art of model making has made the name Bassett-Lowke world famous for detail-perfect scale models of all types. To-day we are engaged on model work for H.M. Government, but we are also planning for the day when we can devote all the experience of our highly skilled craftsmen and the most modern and efficient methods to the production of even better models for all our customers. Our London and Manchester branches are still open and our wartime staff will be pleased to give assistance on any model matters. Wartime Stock List (L/12), price 4d.

"Building a 2 1/2 in. gauge Flying Scotsman," fully illustrated. Price 1s.

"How to Build a Traction Engine," illustrated. Price 6d.

"Laying Model Permanent Way," illustrated. Price 3d.

All the above post paid.

BASSETT-LOWKE, Ltd.

NORTHAMPTON

LONDON : 112, High Holborn, W.C.1.
MANCHESTER : 28, Corporation Street.

S. TYZACK & SON LTD.

*Specialists in Engineers and Woodworkers
Tools and Equipment*



GEARED SCROLL, 3 JAW SELF CENTRING LATHE CHUCKS WITH 2 SETS JAWS, NICKEL CHROME STEEL SCROLLS, ALLOY STEEL PINIONS,
4in. diam., £3/9/- 6 1/2 in., £4/7/6 7 1/2 in., £4/19/-
INDEPENDENT 4 JAW CHUCKS WITH REVERSIBLE JAWS
4 in., £1/12/- 6 in., £2/19/-
DELIVERY FROM STOCK



THE "ZYT0" FOURWAY Turret Toolpost
Spring locking action, hardened screws, malleable body. Base 4in. dia., height front base to toolrest 2in., size of turret 3in. square. Price complete, 50/-.
DELIVERY EX STOCK



ELECTRIC GRINDERS AND POLISHERS
(Double-ended)
1-1/2 h.p. motors
Complete with Wheels and Polishing Spindle
Full details on request.
DELIVERY FROM STOCK

PLEASE SEND US YOUR ENQUIRIES

S. TYZACK & SON LTD.,

341-345, OLD STREET, LONDON, E.C.1

Telephone : CLE 4004-5-5



*Pyruma
for Perfect Modelling*

You just mould this plastic cement to any shape. It sets to stone hardness by air-drying or baking. Paints or colours are then added.

The realistic village setting as photographed was modelled throughout in Pyruma. Sections were jointed with Tiluma, the finely adhesive jointing cement. Contour maps, figures, miniatures, plaques, etc.—all can be modelled just as easily with these plastic cements.

Sankey's Pyruma and Tiluma are obtainable in tips from Ironmongers, Hardwaremen, Artists' and Handicraft Shops. Send 1d. stamp for Illustrated Instructions for Modelling leaflet to J. H. Sankey & Son, Ltd., Modelling Dept. 5, Ilford, Essex.

PYRUMA
PLASTIC CEMENT

INSTRUCTION IN PLASTICS TECHNOLOGY

A NEW organisation has been formed to supply ambitious people interested in the Plastics Industry with modern instruction in Plastics Theory and Practice.

The new organisation, known as The British Institute of Plastics Technology, is the specialist Plastics Division of The British Institute of Engineering Technology, Ltd., one of the largest home-study technical training organisations in the world.

Specialist Plastics Courses are being prepared and will be available within a reasonable period. Those interested are advised to submit their names and addresses, when a copy of our Prospectus "OPPORTUNITIES IN PLASTICS" will be forwarded as our tutorial plans mature. Enrolment for the special courses will first be offered to those whose names have been thus recorded, but no obligation whatsoever will be incurred in lodging an application.

BRITISH INSTITUTE OF PLASTICS TECHNOLOGY

4, Shakespeare House,
17-18-19, Stratford Place, London, W.1

CHEMICALS

REAGENTS, FINE CHEMICALS
SCIENTIFIC APPARATUS

STUDENTS' MATERIALS A SPECIALITY

Write for quotations

CONSOLIDATED INDUSTRIAL RESEARCH
LABORATORIES, LIMITED,
295, Regents Park Road, Finchley, London, N.3

TRIGONOMETRICAL RATIO INDICATOR

Patent No. 16598.

An instant pocket size calculator of degree ratios multiplied by length of base giving at a glance to four places of decimals length of perpendicular and hypotenuse.
Rapid, accurate and efficient.
Invaluable time saver for the use of engineers, architects, designers, draughtsmen and mathematicians.
Applicable equally to British and metric systems.

Stacked by all leading retailers.

An I.D. Product
Made in England.

Finest washable indestructible
Thermo-plastic material.

INSTRUMENTAL DEVICES, LTD.,
7, Charlotte Mews, Tottenham Street, London, W.1



LOG-LOG SLIDE RULE

—priced at 7/6

HARDTMUTH'S meet the needs of the practical mechanic with the range of moderately-priced 'Classic' slide rules. Most popular of all is the 5" log-log rule, illustrated here. Like all 'Classic' slide rules, it is completely accurate, strongly made of seasoned Honduras mahogany, tongued and grooved, and reinforced with flexible stock unaffected by climatic change. The strong, view-free, unbreakable cursor has metal ends. Inch and centimetre scales on edges.



'Classic' Slide Rule, in strong, pull-off shoulder box with full instructions:

Series 1—5" Pocket Model	Price 5/6
" 1—10" Model	" 7/6
" 2—5" Log-log Slide Rule	" 7/6
" 2—10" Log-log Slide Rule	" 10/6

POST-WAR "KOH-I-NOOR" and "MEPHISTO"—perhaps the two best-known pencils in the world—will be in plenty again.

L. & C. HARDTMUTH (GREAT BRITAIN) LTD.



Temporary Address: 44, Alexandra Road, Epsom, Surrey.

ROTARY QUICK MAKE & BREAK

BRITISH MADE THROUGHOUT

For all purposes — fully tested Switches to customers' requirements.

Let us use our long experience to solve your Switching problems.

TOK SWITCHES LTD.,
CAMBRIDGE ROW, BURRAGE ROAD,
WOOLWICH, S.E.18

TOK SWITCHES

YOU CAN TIN ANY METAL QUICKLY AND EASILY
with

HOYT'S TINNING COMPOUND

consisting of powdered metal combined with an active flux
NO SEPARATE APPLICATION OF FLUX, SOLDER OR TIN REQUIRED
JUST CLEAN THE JOB AND FOLLOW DIRECTIONS

Heat the work and just sprinkle the powder evenly upon surface to be tinned. The flux should "boil" and its cleansing action will be assisted if the surface is scrubbed with a wire brush at this stage. When flux has all melted and the surface is tinned evenly all over, remove from heat and wipe with a clean rag.

Price 6/3 per lb. nett carr. paid.

HOYT METAL CO. of GT. BRITAIN, Dept. PM, DEODAR RD., PUTNEY, LONDON, S.W.15

Do your own Developing and Printing

Azol is a one-solution liquid developer. It is very easy to use. All you have to do is to add water. A quarter of an ounce of Azol and six ounces of water will develop two eight-exposure $2\frac{1}{2} \times 3\frac{1}{4}$ films. You can buy Azol from any good Photographic Dealer in 3-oz. bottles or you can send for the trial offer mentioned below. It is much more interesting to do your own developing and printing. You miss half the fun of photography if you let someone else do it.

AZOL

*is the developer
to use. It brings
out the detail.*

Special Trial Offer :

For 2/3 P.O. Johnsons will send you post free (G.B. only) a trial set of Chemicals, including 1-oz. bottle of AZOL, to develop eight spoils $2\frac{1}{2}$ in. by $3\frac{1}{4}$ in., 4-oz. tin ACID-FIXING, making 30-60 oz. solution, one packet AMIDOL DEVELOPER, enough for 2 to 3 doz. contact bromide or gaslight prints.

Address : Dept. 41,

JOHNSON & SONS Manufacturing Chemists Ltd. HENDON, N.W.4

40 YEARS' reliable service to the industry.

OLIVER PELL CONTROL LTD.

CAMBRIDGE ROW, BURRAGE ROAD,
WOOLWICH, LONDON, S.E.18.

**Electrical and Mechanical
Engineers**

Makers of **VARLEY** Products

BOLT DOWN THAT MACHINE IN HALF THE TIME with CINCH Bolt Anchors

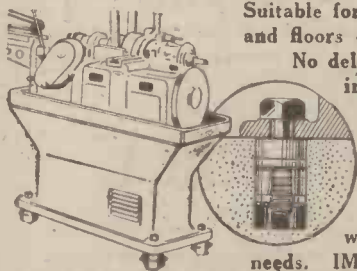

Suitable for all fixings to walls, ceilings and floors of cement, brick, stone, etc. No delay: full load can be applied immediately. Depth of hole 40% to 60% less than ordinary fixing methods. Cinch anchors give a quick and positive bite that holds permanently. Will not slacken or work loose. Sizes to suit all needs. IMMEDIATE DELIVERY.

Free! SAMPLE AND DETAILS ON RECEIPT OF TRADE CARD.
HOYT METAL CO. OF CT. BRITAIN, Dept. P.M., Deodar Rd., Putney, London, S.W.15

English: Nos. 206S 6"; *206 6";
209 9"; 212 12".
Metric: Nos. 215S 15cm.;
*215 15cm.; 225 25cm.;
230 30cm.
Duplex: Nos. 206SEM 6" & 15cm.
*206EM 6" & 15cm.
209EM 9" & 25cm.
212EM 12" & 30cm.

*Knife-edge jaws.

N.R.L. Certificate where required.

Precision VERNIER CALIPERS

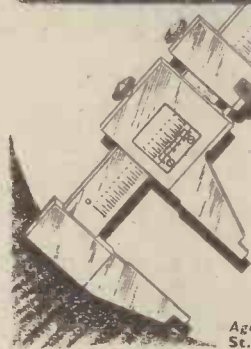

Made to highest possible standards of accuracy and fully guaranteed. Hardened and ground jaws; can be used for inside and outside measurements. Graduated in 40ths of an inch, with vernier readings in 1,000ths, or in $\frac{1}{2}$ mm., with vernier readings in 50ths of mm. Packed in push-lined mahogany case.

BRITISH N.S.F. CO., LTD
KEIGHLEY, YORKS.

London Office: 25 Manchester Sq., W.1

Agents: Stedall Machine Tool Co., 147-155 St. John St., London, E.C.1. Phone: Clerkenwell 1010 (10 lines).

MYFORD

Stands for Lathes

Really up-to-date cast iron Stands are available for Myford Lathes. They are sturdy and rigid, and incorporate heavy trays with integral facings designed for each type of Myford bed. Facings, tray undersides and legs are machined to level surfaces.

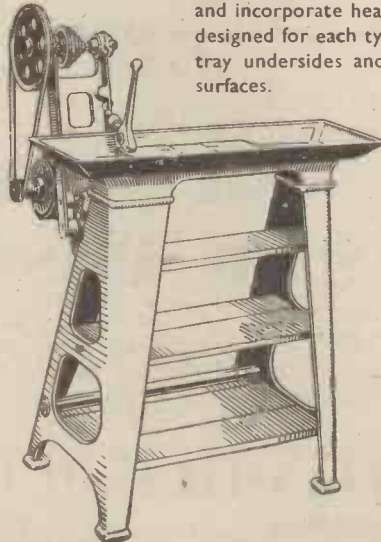

These Stands can be supplied with or without built-in Motorising Countershaft equipment of special design. This equipment utilizes Vee-rope drive and incorporates a hand lever for tension release, also fine adjustment of tension without resort to spanners.

Vee Headstock Pulleys can be supplied to convert Lathes with flat belt drive.

MYFORD ENGINEERING COMPANY LTD.,
BEESTON, NOTTS.

Phone: 54222/3/4

"ENGINEERING



OPPORTUNITIES"

PREPARE FOR PEACE-TIME COMPETITION

In the more competitive days of peace, technical training will be a vital necessity to the Engineer who wishes to safeguard his position and make advancement. "ENGINEERING OPPORTUNITIES" will show you how to secure this all-important technical training quickly and easily in your spare time. This 100-page book is full of valuable information and explains the simplest way of preparing for recognised Examinations. Among the courses described are :

MECHANICAL ENGINEERING GROUP

A.M.I.Mech.E.
City & Guilds
General Mechanical Eng.
Diesel-Engines
Draughtsmanship & Tracing
Works Management
Press Tool Work
Pattern Making
Foundry Practice

Estimating
Foremanship
Jig & Tool Design
Viewing & Inspection
Welding
Sheet Metal Work
Maintenance Eng.
Metallurgy
Refrigeration

COMMERCIAL ENGINEERING GROUP

A.M.I.P.E.
Commercial Eng.

Cost Accounts
Languages

CIVIL ENGINEERING GROUP

A.M.I.C.E.
Inst. Mun. & Cy. Engineer
A.M.I.Struct.E.
M.R.San.J.
Sanitary Inspector
Specifications
Structural Design

Road Eng.
Hydraulics
Municipal Eng.
General Civil Eng.
Structural Eng.
Reinforced Concrete
Railway Eng.

SURVEYING AND BUILDING GROUP

A.R.I.B.A.
F.S.I.
A.M.I.H. & V.E.
L.I.O.B.
F.A.I.

Costing & Valuations
Heating & Ventilating
Clerk of Works
Surveying & Levelling
Building (all branches)

ELECTRICAL ENGINEERING GROUP

A.M.I.E.E.
City & Guilds
General Electrical Eng.
Alternating Currents
Power House Design
Traction
Mains Eng.

Electricity Supply
Electrical Meters
Electrical Design
Illumination
Installations
Telegraphy
Telephony

WIRELESS GROUP

A.M.Brit.I.R.E.
City & Guilds
General Wireless
Short-Wave Wireless

Advanced Wireless
Radio Servicing
Television
Talking-Picture Eng.

AUTOMOBILE ENGINEERING GROUP

A.M.I.A.E.
M.I.M.T.
City & Guilds
I.A.E. Repair Certificate

General Automobile Eng.
Garage Management
Electrical Equipment
High Speed Diesels

AERONAUTICAL ENGINEERING GROUP

A.F.R.Ae.S.
R.A.F. (Maths.)
Pilots' Licences
Ground Licence

Aero Engines
Navigators' Licence
Aeroplane Design
Meteorology

UNIVERSITY DEGREES

London Matriculation
School Certificate

University Entrance
Intermediate B.Sc.

WE DEFINITELY GUARANTEE

"NO PASS—NO FEE"

If you are earning less than £10 a week you cannot afford to miss reading "ENGINEERING OPPORTUNITIES"; it tells you everything you want to know to make your peace-time future secure, and describes many chances you are now missing. In your own interest we advise you to write for your copy of this enlightening guide to well-paid posts NOW—FREE and without obligation

BRITISH INSTITUTE OF ENGINEERING TECHNOLOGY

410A, SHAKESPEARE HOUSE, 17, STRATFORD PLACE, LONDON, W.1

THE B.I.E.T. IS THE LEADING INSTITUTE OF ITS KIND IN THE WORLD

SUBSCRIPTION RATES

(including postage)

Inland	- - -	10s. 6d. per annum.
Abroad	- - -	10s. per annum.
Canada	- - -	10s. per annum.

Editorial and Advertisement Office: "Practical Mechanics," George Newnes, Ltd.
Tower House, Southampton Street, Strand, W.C.2
Phone: Temple Bar 4363
Telegrams: Newnes, Rand, London.

Registered at the G.P.O. for transmission by Canadian Magazine Post.

Copyright in all drawings, photographs and articles published in "Practical Mechanics" is specially reserved throughout the countries signatory to the Berne Convention and the U.S.A. Reproductions or imitations of any of these are therefore expressly forbidden.

PRACTICAL MECHANICS

Owing to the paper shortage "The Cyclist," "Practical Motorist," and "Home Movies" are temporarily incorporated.

Editor: F. J. CAMM

VOL. XII MARCH, 1945 No. 138

FAIR COMMENT

BY THE EDITOR

New Ways for Old

WE have a strong national tendency tenaciously to hold on to old methods, and a suspicion of new. The industrial history and development of this country is punctuated by aversion to change. When the spinning loom was introduced to replace hand methods, the workers revolted and smashed up the machinery in the factories. That experience has been repeated in many other branches of industrial and scientific progress. As a nation we have a nostalgic love of the past and the "good old days." They only become good old days in retrospect. None of us would like to live in the days of candles, unlighted streets, the crudest sanitation, water from the well, mud-track roads, coach travel, no railways, radio, newspapers, theatres or pictures. We enjoy the greater freedom, the increased leisure and the mental delight provided by the advance of science and education.

Yet we have those who would oppose any change; we have a society for the preservation of rural England, which vigorously opposes road development if it interferes with some beauty spot or some historic building. It is, of course, necessary to preserve some aspects of our past, but we must not cramp development, and if beauty spots must go we must sacrifice them at the altar of progress. The roadside forge is interesting for tourists, but it belongs to an era which can never return—the horse-drawn era. It is possible to cut new roads occasionally which by-pass the old villages, but it is doubtful whether it is wise to do so. Certainly it is often more costly, and in the future national expenditure will need to be watched more closely than was necessary before the war. It is also questionable whether the public really wants out-of-date villages and collections of ramshackle cottages to be preserved. There is always a melancholy aspect about a deserted village.

J.I.E. Presidential Address

IN his presidential address to the Junior Institution of Engineers, Major-General K. C. Appleyard dealt with this matter. He thought, after visiting many countries, that we suffer from a tendency to mix up a proper respect and admiration for the technical achievements of our forbears with unnecessary admiration and loyalty to their manufacturing methods and techniques. This is both wrong and dangerous. When we come to the matter of doing the things which must be done for ourselves, or of making the products which the world needs, and which we must exchange in order to maintain a reasonable standard of life, we must be prepared to throw the methods of the past

into the discard without regret or respect, just so soon as we have better ones.

All methods and processes have their day and are not intended to be continued in perpetuity. In these times that day is very short, for the competitive world moves ever faster, and unless we are moved by that divine discontent which brings progress, unless we ruthlessly put aside the ways of the past and are restlessly dissatisfied with those of the present, then others will pass us by.

Authoritative investigations into some of our basic industries such as cotton, coal-mining, and agriculture, show beyond doubt these industries have remained old in their outlook and their methods and have been left behind. The newer industries which depend upon them are handicapped from the start.

Certainly the past has left us an evil heritage, even if it has provided us with pleasant retrospect—pleasant to those of us who did not live in it. It is beyond all doubt that those who did, did not find them pleasant. Many of those living in modern times who have emigrated to other countries, find themselves transported to those primordial times which they so much admired when in this country. They are soon anxious to return, and renew their acquaintance with the benefits of civilisation.

Post-war Problems

THE present time may not seem opportune to consider some of these problems, for we have not much opportunity during the war. But on the credit side of the war it must not be forgotten that vast developments have taken place in every branch of industry which will be of immense benefit to this country and to the public, if we are wise enough to take advantage of them. This is a war of engineers, and they have provided us with a wealth of new knowledge which can be devoted to the purposes of peace. Most of our problems are economic, for we have lost our foreign investments, we have created a staggering national debt, and we depend for much of our food and many raw materials upon our ability to buy them from other countries. To do this we must export our products in face of fierce competition—a competition which will be even keener after the present conflict. As well, some of those markets even among our colonies may vanish.

Most countries and all of our colonies are engaged in this war. They have all equipped themselves with factories and machine tools and trained personnel, with which they hope after the war to manufacture for themselves the goods they formerly imported from us. The bicycle trade, for example, exported large numbers of cycles, motor-cycles and accessories

to Australia. The bicycle trade is now free of practically every wartime control and in investigating its pre-war markets has been informed by the Australian cycle trade that they are proposing to make their own bicycles.

Before this present war the Japs were selling bicycles in South Africa for 19s. Manchester has lost the Indian cotton trade.

On the other hand this country imported most of its machine tools from America, Switzerland and Germany. We have been compelled during the war to make machine tools ourselves, and hence we shall not be importing many of those lines after the war. Each country is tending to become more and more independent of imports. Paradoxically enough each country is becoming more and more dependent upon exports. We must, indeed, therefore, given proper leadership, put into our next job, as Major-General Appleyard says, all the guts and imagination and drive we have proved we possess. We are going to look forward and not backwards. Together, workers, managers, designers, scientists, inventors and leaders, we can do the job as a team. We shall have to use natural resources of every kind before importing and many of our basic industries must be radically overhauled and brought up to date. Our goods must be sufficiently cheap for a poorer world to buy. You cannot expect overseas buyers to pay higher prices for British goods in order to support social security schemes which are not in existence in their own countries. They are going to buy in the cheapest market. We have to find new markets and new lines which cannot be made elsewhere and our economists have the task of devising exchange methods which will allow this great potential trade to flow. In the last 50 years science has created many benefits—the telephone, the aeroplane, the motor-car, radio, the X-ray, the camera and cinematograph, the typewriter, the electric train, artificial silk, plastics, alloy steels, synthetic oils and dyes, jet propulsion, the power rocket, and television.

Scientific Surprises!

THE next 50 years will bring corresponding scientific surprises. Aerial travel will make our journeys to America and the Continent a matter of hours instead of days so that our shipping companies may largely be used only for the transport of goods. A similar situation confronts the railways. These large undertakings must not, as they have in the past, oppose progress. No one can deny that the ship and the train as means of travel are hopelessly out of date, and so are canals. Our railways have hardly improved in speed for 50 years.

Attractive Timber Houses



The prize-winning design. Perspective view from the road.

IN May, last year, the Timber Development Association organised a competition with the object of assisting the nation in finding practicable solutions to the problem of providing homes for the people in the immediate post-war years.

The object of this competition was to assist the promoters in putting forward, as an example, a design or designs for a pair of semi-detached houses which would show the positive advantages of timber construction in the speedy and economical provision, in quantity, of attractive permanent houses.

Three prizes were offered—1st, £250; 2nd, £100; and 3rd, £50. There were 167 entries, and the names of the prizewinners were recently announced. The competition demonstrated to the Association that “a great many architects are alive to the possibilities inherent in timber and plywood.”

Particulars of the Prizewinning Design, Submitted in the Competition Promoted by the Timber Development Association

The first prizewinner is Mr. John P. Tingay, A.R.I.B.A., “Hurstead,” Cheney Street, Eastcote, Middlesex, and his design for a pair of semi-detached timber houses is shown in the accompanying illustrations.

The following particulars are taken from the winner's report:

A pre-built system of construction has been adopted, there being four types of unit, as follows:

The wall unit, size 10ft. 7½in. wide ×



Back view from the garden.

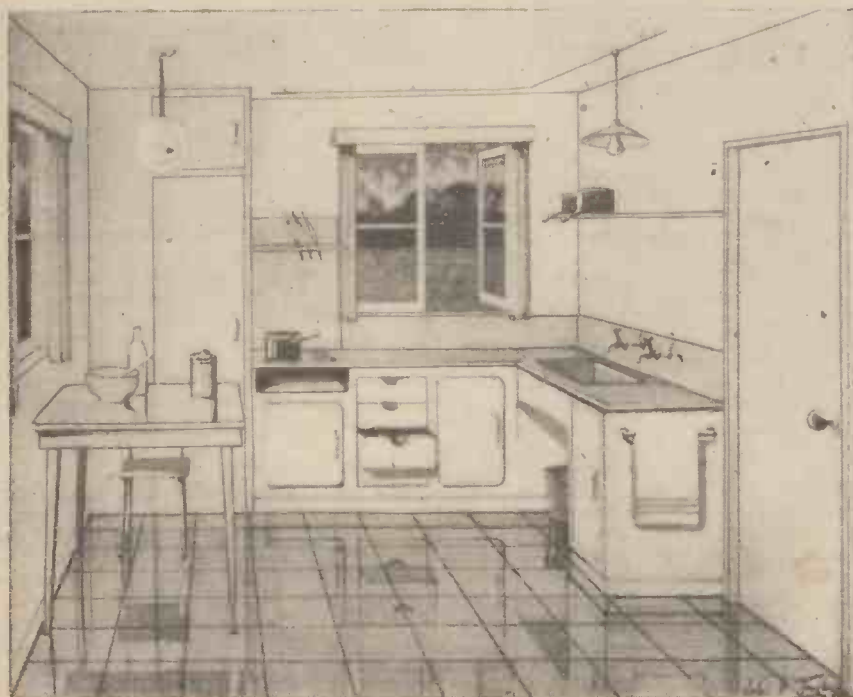

The kitchen lay-out.

17ft. 11in. high, has an external covering of 1in. thick diagonal boarding, a layer of bituminous paper, and a finish of 1in. thick red cedar siding, fixed vertically. These finishings are ready fixed in position before delivery to the site.

The units are bolted together, and also to the foundations, which are of the normal type. The internal wall linings (plywood, plaster or fibre board) are fixed after erection, as it is considered that there would be a certain risk of damage in transit, when dealing with large units.

The floor units, size 5ft. 3½in. × 10ft. 5½in., are constructed of 1in. thick T. and G. floor boarding, and a 1in. thick sub-floor (laid diagonally), spiked to 8in. × 2in. joists, which are staggered, so that the joists of adjacent units do not coincide, and in order that the unit may be reversible.

The truss units (span 21ft. 3in.) are placed at 2ft. 8½in. centres, and are spiked to the head of the wall units. They consist of a plywood web, suitably braced, and are held rigid by means of plywood stiffeners.

The roof covering units are constructed of two layers of 1in. thick boarding spiked together (one layer diagonal), and are supported by and spiked to the roof truss units.

The roof finish may be ruberoid, zinc or copper. It is thought that anything in the nature of red cedar shingles would increase the time factor unnecessarily.

It will be understood that, with this type



Front view of the model timber houses.

of construction, it would be possible to erect the main walls, floors and roof in the shortest possible time, thereby permitting all internal work to proceed under cover, and without delay.

Plumbing and Drainage

The whole of the plumbing and drainage system, including the hot- and cold-water tanks and the water waste-preventer, is contained in the plumbing unit, size 16ft. 9in. x 5ft. 11in. x 12in. The unit consists of a light steel angle skeleton framework, covered with plywood panels, which are made removable where possible, i.e., in w.c. and kitchen.

The two 6in. diameter flue pipes from the fire in the living-room, and the gas water heater in the utility room, are carried up to the full height of the house in a sheet steel hot-air duct. The air, which is heated in the duct, is discharged into the two main bedrooms and the landing. Regulators are fitted at these three points, in order that the flow of



Rear view.

air may be governed to suit varying conditions.

All stoking of fires is dispensed with during the summer months, and the occupants will have the comfort of a cheerful open fire in the winter.

External Finishes

Red cedar siding has been chosen for the external wall covering for the obvious reason that it needs no treatment, and that it is known to have a long life.

It is proposed to paint the windows, doors and frames, in order to give colour to the elevation, but, of course, red cedar may be used if desired.

Asbestos cement gutters and rain-water pipes are utilised, and need little or no upkeep.

Internal Finishes

- Hall and landing } .. Distempered.
- All bedrooms } .. Distempered.
- Living room } .. Red cedar boarding and brick fireplace.

- Kitchen } .. Hard gloss paint.
 - Utility room } .. Hard gloss paint.
 - Bathroom } .. Hard gloss paint.
 - W.C. } .. Hard gloss paint.
- The floors are boarded (T. and G.) throughout.

Aviation Notes

Photographing the Enemy by Night

PHOTOGRAPHING enemy troop movements and concentrations at night, while flying at high speed a mile and more up in the sky, is the unusual job of two Australians serving with a Mosquito squadron of R.A.F. 2nd T.A.F.

They are Flight-Lieutenant I. J. Ewing, of Bellevue Hill, New South Wales, and Warrant Officer W. Bone, of Brisbane, Queensland.

Operating from an advanced base on the Continent, they fly out at night behind the German lines and drop flares of 50 million candlepower, and then take their photographs. These are passed on to Army experts, who find from them valuable information about what the enemy is doing at night when he thinks he can move unseen.

Flight-Lieutenant Ewing said the squadron was recently congratulated by a Canadian general for supplying vital information to the Army with its photographs of one area.

Flight-Lieutenant G. Andrews, of Korumburra, Victoria, and Flying Officer J. M. Brown, of Rose Bay, New South Wales, fly Wellingtons in another R.A.F. squadron doing photographic reconnaissance at night.

The Wellingtons fly a few hundred feet above the ground (unlike the Mosquitoes, which operate from several thousand feet up). They drop flares and then, if they see anything, try to get photographs as well. They are always hunting for enemy transport, barges and ferries as well as lorries and horse-drawn vehicles

It can be dangerous work for the Mosquito and Wellington crews, because their flashes indicate their whereabouts. Andrews had his bomb-aimer injured in the head, and one of his engines damaged by flak in a recent sortie.

Brown, one night, made three runs over the Moerdyk Bridge, Holland, in spite of fierce flak. On the first run one motor was hit and put out of action. Then his cameras would not work. Undaunted, he made a second run at low level on one engine, and still the cameras failed. He turned round and ran over the same bridge the third time with every gun the Germans could muster pouring flak at his aircraft.

His cameras started working towards the end of the run, and he brought back his pictures.

The "Snifter" Saves Bombers' Tyres

THE "Snifter" at an airfield used by R.A.F. Wellingtons, in southern Italy, is not a drink. In official language it might be termed a magnetic sweep—an invention by the Wellingtons' engineering staff to search for pieces of metal that have been tearing the bombers' tyres.

Tyre damage was becoming a problem for the Wellingtons using the airfield. It had been heavily raided before being captured, and bits of fragmentation bombs were strewn over the runways and dispersal areas.

Many pieces had sunk into the ground, but had gradually worked up to the surface.

Rusty nails, bits of tin, and even spent bullets badly ripped the bombers' tyres.

New tyres had to be flown long distances, and the engineering staff hit on the plan of combing the runways and dispersals with a big magnet. They welded two lengths of metal together, leaving about six inches between them, attached three magnetic coils, and set the contraption on low rubber wheels.

It is hooked to the back of a truck and powered by two generator sets—one picked up among derelict German equipment in the Western Desert, and the other found in a dump on the airfield.

Pulled slowly along the ground, the "Snifter" combs about four feet in width. It has already picked up thousands of pieces of metal on its daily offensive sweeps—some of them six-inch lengths of jagged bomb splinters that would ruin a bomber tyre in a few seconds.

Aircraft—Saved by Tea

AN aircraft, operated by a Middle East group of R.A.F. Transport Command, in danger of crash landing, was saved by a flask of tea.

The pilot, Flying Officer E. F. Riddell, of Mount Road, Hinckley, Leicestershire, was bringing his Wellington in to land when he found that he was unable to lower the undercarriage owing to a shortage of hydraulic fluid in the reservoir. Riddell did some quick thinking, and he saw a flask of tea. The crew poured some of this into the reservoir.

The increased pressure provided was just sufficient to lower the undercarriage, and the aircraft made a normal landing.

An Ultra-violet Ray Lamp

Constructional Details of an Efficient Appliance for Home Use

By K. K. THOMSON

THE English winters are so lamentably devoid of the health-giving rays of the sun that we have little resistance against disease; our vitality flags, and when the germs of cold or flu, to say nothing of the numerous others, come our way, they find in us a receptive home in which to dwell and multiply. He is indeed fortunate who can face the winter months without the fear that he, or some member of his family, will "go down" with one of the seasonal maladies which are all too common. The chemist's specifics are of little use in curing

of "blackheads." More important, however, is the formation of vitamin "D" in the pores which makes the fat acceptable to our bodies, promotes healthy growth of the under tissues, and renders the breeding of germs less liable to occur.

Of course, since these rays will not penetrate our clothing, we must present our bodies to them as completely exposed as the temperature of the room will permit, but we must protect our eyes from the intense glare of the lamp by wearing dark glasses with side pieces: the kind used by welders

lamp standards before the war. It was a 230 volt, 400 watt, mercury vapour lamp of Crompton manufacture, but any other make of mercury vapour lamp is equally suitable, provided that the manufacturer's working conditions are adhered to.

The price of such a lamp is about £2 5s., which, with the choke, to be described later, and the goggles, flex, and plugs, makes the total cost of our sun-ray lamp about £6. When it is realised that the cost of a factory made sun-ray lamp was, in peacetime, about £20, the advantages of constructing a lamp of equal efficacy in the home will be obvious.

The type of lamp used is shown in Fig. 1. An outer glass bulb of 12ins. in length is surmounted at the top by a brass screw cap. Inside the glass bulb is another transparent bulb, about 8ins. long, made of fused quartz, and at each end of this are two electrodes, f and g. Inside the quartz tube is a tiny drop of mercury which, when vaporised, permits the current to pass between f and g, giving an intense white discharge along the full length of the tube. The two electrodes are brought to the outside of the lamp at the points h and j, and when the current is switched on it passes from h through d, which is a resistance, to e, then it jumps a gap between e and f and returns via f to j. This "spark" causes the mercury to light, and then the resistance between f and g becomes lower than that of d, and d is by-passed, causing the current to flow via h, c, g, f, j.

Only a small amount of the mercury will be vaporised at this stage, and the lamp will emit little more than a bluish glow, but as it burns and the vapour increases, the glow will become progressively more intense. A time of nearly five minutes must elapse before the lamp works at full efficiency.

When used in a street lamp standard no

After Removing Glass Bulb
Break Round This Rim With
Sharp Pointed Instrument

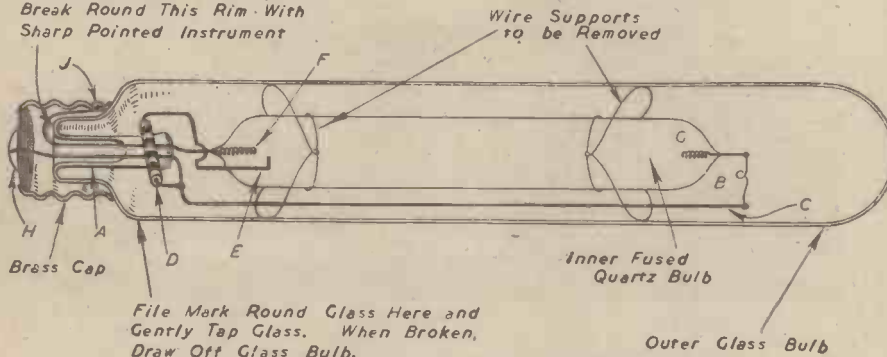

File Mark Round Glass Here and Gently Tap Glass. When Broken, Draw Off Glass Bulb.

Fig. 1.—Sectional diagram of the type of lamp used.

these ailments, and the old adage: "Prevention is better than cure," is only too true, but, one asks, how can these things be prevented, and it is the purpose of this article to show how artificial sunlight, with a generous supply of ultra-violet rays, may be easily and cheaply produced in almost any home where a supply of electricity is available.

Before describing the construction of the lamp a brief word about the properties of ultra-violet rays may not be out of place. These rays, which are of long wave-length, have very little penetrating power; they will not pass through clear glass nor a thin sheet of paper, and on the human body they enter our skins only to a very shallow depth. This may seem very trivial and of little use in toning-up our systems, but it is precisely in our skins that this effect may most satisfactorily be brought about. Our skins are pierced with myriads of tiny pores through which our bodies free themselves of certain impurities. When we perspire we find that water has exuded through them and carried with it certain soluble fats which are surplus to our bodies' requirements.

On a hot summer day, when we can perspire freely, this excess is quickly carried away, but during the cold days of winter the pores close up and Nature's remedy is hard pressed to function effectively. The fats remain in the pores and solidify. A little solid tube of hard fat occupies each one, and further accumulations of the surplus have no means of escape, and must build up beneath our skins, thus causing unhealthy and blemished tissue. Where such pores are on some exposed part of our bodies, such as our faces, the dust in the air may find its way into the pores, providing the tube of fat with a black head.

Now, when we subject our skins to a bombardment of ultra-violet rays, the hard fat in each pore is softened, and is permitted to escape, and one of the most noticeable effects of its application is the clearing away

with dark blue glasses, and costing about 3s., are recommended. It is vitally important to protect the eyes, and ordinary sun glasses, which do not give screening at the sides should on no account be used; they are a false economy, and may seriously damage the eyesight.

The Lamp

The lamp used by the writer was an electric discharge lamp designed for "moonlight" street lighting as used in certain street

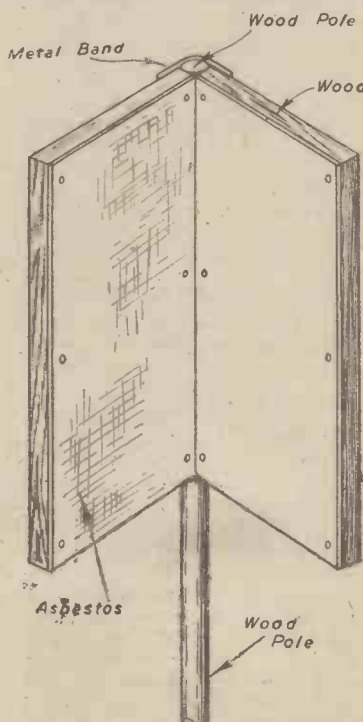

Fig. 2.—Details of the lamp frame.

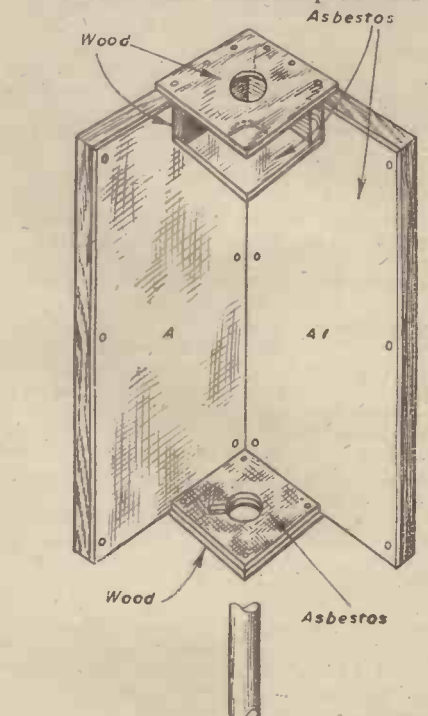

Fig. 3.—The completed frame ready for the lamp.

ultra-violet rays are emitted, since they will not pass through the outer glass bulb, and for the purpose of the sun-ray lamp which we are considering it is necessary to perform a slight, yet delicate, operation to the lamp. The glass bulb and screw cap must be removed, leaving the "innards" intact, apart from two spring-wire supports, which are also discarded.

Commence the operation by taking a three-cornered file and make a mark round the glass just below the shoulders, then tap gently with a sharp instrument until the glass is completely broken around the file mark, after which the lower part of the bulb may be gently removed.

Next remove the wire clips, which are easily cut with pliers, and finally remove the screw cap by delivering sharp knocks with a pointed instrument in the neck of the lamp, but see that the neck, a, remains undamaged. A word of caution is necessary here. After the glass bulb is removed there will be no support to the inner bulb excepting the two wires from c and f leading into the neck a, and great care must be exercised to ensure that these wires are neither bent nor broken. They are, however, fairly strong, and if care is taken the operation will prove to be quite simple.

Finally the two terminal wires must be separated from their soldered connections at h and j. The easiest way to do this is to hold the inner tube in the hand and present the screw cap to a gas flame. When the solder has melted it will drop off. Do not try to pull it off, as this might break one of the wires inside the neck at a point so far deep down as to make further connection to it impossible. About half-inch of each wire should protrude beyond the neck, to which the mains from the choke will be soldered after the lamp is assembled in its new holder.

The Frame

The frame is built up as shown in Figs. 2 and 3 from wood with a facing material. The writer used asbestos sheeting for the facing, since he had a few scrap pieces left over after building a garden shed of this material, but it is not essential; but as there is considerable heat from the lamp, the frame should be surfaced with some heat-reflecting material. It is useless to provide a highly-polished metal reflector in the hope of reflecting and concentrating the ultra-violet rays, since these cannot be reflected, except magnetically; but metal surfacing can be used to dissipate the heat, so long as it is well insulated from any of the external parts of the lamp which are "alive." Since the only wood available to most of us these days is rough stuff from soap boxes or the like, some facing material will also serve to improve the appearance of the finished lamp.

Two pieces were cut, as in Fig. 2, and secured to a pole at right angles to each other by three metal strips at top, bottom, and centre. Dimensions are not given in the sketches, since these will depend upon the size of lamp which is used by the constructor, but in the writer's case the side pieces measured 10ins. in length and 4ins. wide. The total thickness of wood and asbestos was half-inch, and the pole measured half-inch in diameter.

Of course, each constructor may modify the design of screen to suit his own requirements, in some cases perhaps even omitting a screen altogether, but it should be remembered that, besides their benefits to bodily health, ultra-violet rays are not always kindly; they have the unwelcome attribute of causing the colours to fade from curtains and other soft furnishings in the room, and as much screening as possible should be

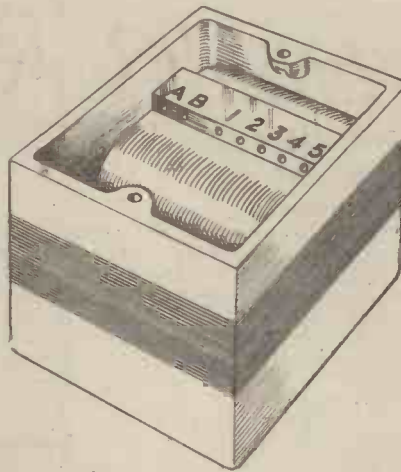

Fig. 4.—The choke with lid removed, showing the terminal strip.

adopted to keep the rays away from that part of the room where they are not wanted.

The type of lamp which we are considering was designed by the manufacturers to operate in a vertical position with the terminals uppermost, and the frame was made to accommodate it in this position. It might be added, however, that certain 80-watt lamps will operate horizontally, but the writer has no experience of them in ray emission, and cannot say if such a lamp will give sufficient emission to be of service to the "patient," but presumably, if it were applied for a longer period, the results might prove equally beneficial.

Having completed the frame in accordance with Fig. 2, top and bottom pieces were made to hold the lamp, as in Fig. 3.

Starting with the bottom piece, the asbestos was cut 2½ins. square, with the wooden piece overlapping on two sides by ½in. The wooden overlaps were nailed to the sides of the frame by brads driven from below. A hole 1in. in diameter was previously

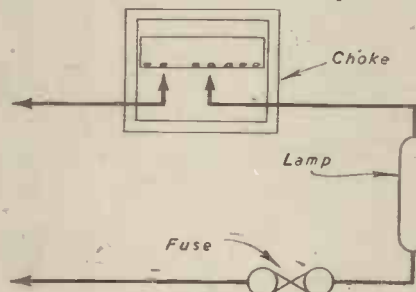

Fig. 5.—Wiring diagram.

cut to act as a seat for the tapered end b of the quartz tube, Fig. 1, and a slot was cut to accommodate the terminal bar c; and flexible connection between c and g. A top piece was made of similar surface area, but greater depth to accommodate the upper and lower parts of the neck, a, Fig. 1. For this purpose the sheet of asbestos was suspended ½in. below the top square of wood, which was nailed downwards on to the side pieces after the lamp was inserted on to its bottom seating. Fig. 3 shows the arrangement without the lamp.

Finally, before the lamp is put into position and the top piece secured, two small holes at A and A1 were drilled through each side piece, then a wire was passed through A, around the quartz tube and through A1, being secured at each outer end by a small wood screw entering each side piece from behind. This wire gives additional support to the tube and, of course, it must be so arranged that it does not touch the terminal bar c, Fig. 1.

Having thus secured the lamp in the frame, two pieces of flex were soldered to the terminal wires h and j, and, after being bound with insulation tape, were brought down the back of the frame to a 5 amp. plug, which was screwed to one of the sides.

It then remained to put a protective arched shield of fibroid over the exposed ends of the lamp at both top and bottom to protect each end from touch or damage, and the lamp was ready for its trials.

The writer did not provide feet to the lamp, pole, since he has a conveniently-shaped chair to which the pole was clipped at any desired height. The absence of feet also makes the lamp more portable, since, when it is not required, it can be stowed away in a drawer or cupboard.

The Choke

A choke is necessary to limit and control the current input into the lamp, but little need be said about it excepting that it must be of a wattage appropriate to the lamp which is used, and, if it is filled with wax, it must always be stood with its lid horizontal; but the method of connecting-up the choke is not so obvious, as the makers seldom supply a circuit diagram. On removing the lid, however, it will be seen that across the top of the coil is an insulation strip with seven terminals, these are marked "A, B, 1, 2, 3, 4, 5" (see Fig. 4), which shows the choke with the lid removed, and their purpose is to give a tapping which suits the supply voltage.

There is a difference of 5 volts between terminals A and B, and a difference of 10 volts between each of the five numbered terminals. As the choke and lamp are built to stand a supply pressure of 260 volts, the leads of such a pressure would be connected in A and 5, having the full choke in operation.

Similarly A and 4 would suit 250 volts; A and 3 240 volts; and A and 2, 230 volts, which is the normal supply pressure.

It is important that the choke and mains supply should be in potential balance, and before using the lamp for long periods, the actual pressure across the lamp should be measured with a voltmeter. Should this be found to be 225 volts, the connections would be to B and 2, or if 235 volts they would be to B and 3.

If the choke tappings are lower than the supply voltage, the life of the lamp will be shortened; whilst, if they are higher and there is a sudden drop in mains pressure, the lamp might be extinguished when it would not light again until it had cooled down and the vapour had solidified into liquid mercury, which would be deposited as a mist of tiny globules on the walls of the tube.

The choke is wired in series with the lamp and fuse, as shown in Fig. 5.

Using the Lamp

As has been stated, a period of about five minutes must elapse before the lamp attains full efficiency after switching-on. The "patient" can then stand or sit at any distance from it, but the nearer the lamp the stronger are its emanations. Three feet is a convenient distance.

The first "dose" of rays should be of short duration, not more than three minutes in the case of a young child, but each successive sitting may be of longer duration, extending by three to five minutes each time. No immediate effects will be apparent, but after a few applications the skin will be noticeably cleared of blemishes. Later, a healthy sunburnt tan will develop, and a gradual toning-up of the system will result.

the liquid rises and opens the float, the liquid returns to the evaporator, the level falls and the valve closes. This process is repeated continuously.

Expansion Valve System

This is known as a dry system, the liquid refrigerant being passed through a pressure reducing valve into the evaporator, thence to the compressor, through the condenser, into the liquid receiver, and back into the pressure reducing or expansion valve.

The Fundamentals of Servicing

The first operation in servicing a plant is to fit the gauges as shown in Fig. 4. Install the SAE to Briggs adaptors in the outlets, first making sure that the SSV and the CHSDV are fully turned to the left. Fit on the gauges and cylinder of refrigerant; open slightly the valve on the cylinder so that the compound gauge reads a pressure; shut; and open the line at the SSV adaptor so that any air is expelled (it is most important that air and moisture be kept out of the system, otherwise the working of the plant will be upset). Always purge the compound gauge line from the cylinder as the plant may be working on a vacuum. Open slightly the CHSDV and purge the line from the gauge. The SSV and the CHSDV should then be opened (turned to the right) so that the gauges read without excessive vibration, otherwise they are liable to be damaged.

Charging the Plant

Connections are made as shown in Fig. 4, the SSV being opened one or two complete turns so as to allow the easy entrance of the refrigerant. (Don't forget to purge the lines.) Open the cylinder valve, care being taken that liquid refrigerant does not enter the crankcase when charging; the best way is to keep the cylinder upright. The correct

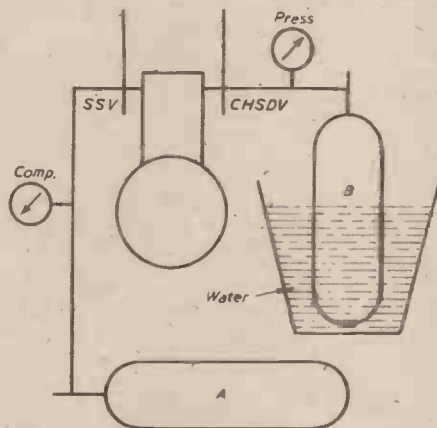

Fig. 5.—Method of removing gas from the expansion valve.

methods of ascertaining when the system is short and is fully charged will be described later.

Removing Gas from Expansion Valve

Connect up as shown in Fig. 5 and purge both lines; close in the CHSDV fully to the right; and open fully the valve on the cylinder. Start up the plant carefully, noting that the head pressure does not become excessive; if it does, splash the water around the cylinder until it cools off. Make sure that the cylinder used is of sufficient capacity to hold the entire charge of the plant; the gas charge is usually given on the condensing unit model plate. When a 20in. vacuum has been obtained, switch off, and close the valve on cylinder B. Balance the system (the compound gauge reading 0) by means of the refrigerant in the cylinder attached to the SSV. In actual practice it is usual to balance

to 1lb. pressure, to allow for inaccuracies in the gauge, and to make certain that the system is not opened under a vacuum.

Removing Gas from High Side Float Systems

Connect up the lines as shown in Fig. 6. On systems that have a HSFIV connect in the by-pass C. Purge all lines; close in the CHSDV; open to the right the HSFIV (this enables the gas to flow past the float), open fully the valve on the cylinder B, and then follow the procedure given previously. Where no service valve is fitted to the top of the float, it is necessary to remove the float from its mounting and carefully turn it on its side, taking care not to fracture the tubes.

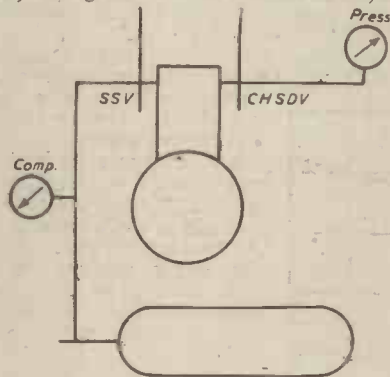

Fig. 4.—Fitting the gauges.

This allows the valve to open and pass the refrigerant through freely. Then follow as directed in the instructions for Expansion Valve Systems.

Pumping the Plant Down

It is often necessary to carry out repairs on the evaporator or compressor. It is then necessary to remove the refrigerant from these parts (known as the low side). Connect gauges as shown in Fig. 4, close the LRDV or HSFIV (whichever system you are working on). Start the compressor, pump a 20in. vacuum, then balance up as described previously.

Removing Air from Systems

After repairs have been carried out it is essential that any air be removed. Connect up the compound gauge as shown in Fig. 4, purge the line. Close in the CHSDV fully to the right; remove the plug. Hold a dry rag over the outlet, start the plant and pump at least a 20in. vacuum. If oil pumping occurs, stop the machine and turn the flywheel over by hand till the oil clears; fit the plug and tighten. Note if the vacuum holds, if not a leak is present and must be repaired. Open the CHSDV; admit gas from the liquid receiver and shut off when 10lb. pressure has been reached on the compound gauge; test for leaks, and repeat at 20lb. and 30lb. pressure. Air is often found in a system: already running, this is usually denoted by poor refrigeration, combined with high head pressure and a hot liquid line. Make certain by fitting a head gauge; run the plant for 15 minutes, note the pressure, switch off, note if the pressure falls or remains constant. If it falls it is certain that no air is present, but be very careful that the discharge valves in the compressor are not leaking, as this will give a false impression that the system is free, although air may be present. High head pressure can also be caused by sloppy pistons, dirty condenser, or overcharge of refrigerant. If the pressure holds it can be safely assumed that air is present; pump the plant down as described previously, remove the belt, and allow the motor to run for 10 minutes, till the condenser is cool. Switch off and purge from the outlet of the CHSDV

till pure gas can be smelt escaping; escaping gas usually feels cold and can also be detected by holding the fingers over the joint. Repeat the operation if required, and add refrigerant if required.

Testing for leaks

SO₂. Make up a swab from a stiff piece of wire, a clean piece of rag 3in. by 1in. folded over. Soak this in the .880 ammonia and hold near the joints, etc., being tested. Leaks are indicated by a white smoke.

CH₃CL and F12. Light the "Justrite" leak detector as directed in the instructions given, and when working hold the end of the flexible tube over the joints, etc., being tested. When testing the compressor gland or seal, always give the flywheel a quarter of a turn and retest. Leaks are indicated by the flame turning a greeny-blue colour.

Checking Quantity of Refrigerant in System

Firstly, the temperature of the gas in the evaporator and condenser, in relation to the surrounding air or brine temperature, must be found. As there is a temperature difference between the inside of the condenser or evaporator and the surrounding medium, and as this varies with the speed of the compressor, a correction has to be made. From the chart, Fig. 7, find the correct temperature difference, subtract this figure from the temperature of the medium being cooled or heated; this will then give the correct temperature that should be found inside the evaporator or condenser. The corresponding pressure can be then found on the gauge from the correct temperature scale. If the pressure shown by the gauge needle is higher the system is probably overcharged, if lower, an undercharge is indicated. (Note this does not apply to automatic type expansion valves.) Shortage is also indicated by incomplete frosting of the evaporator on high side systems, by the valve hissing on automatic expansion valves, and by the valve hissing, together with a high suction pressure, and incomplete frosting on the thermostatic expansion valve type. If on the expansion valve systems the valve is not hissing, but the evaporator is not fully frosting, and the head pressure is correct, the valve requires opening or flooding. It is advisable for the beginner to set the automatic type to the

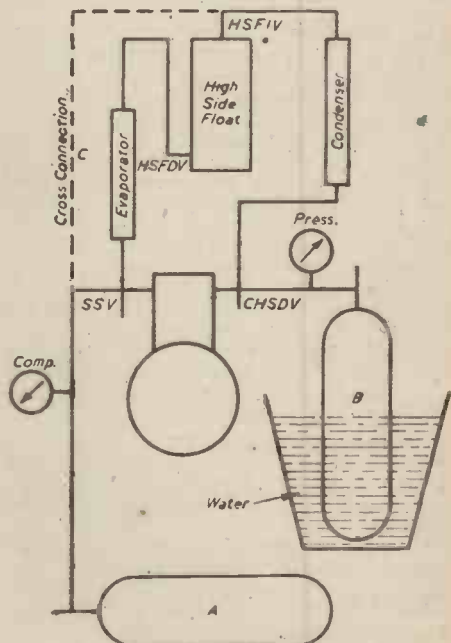

Fig. 6.—Connections for removing gas from high side float systems.

following pressures and adjust as required to the frost line when the cabinet is cold. SO₂. 5in. Vac. CH₃CL. 5lb. Pres. F12. 12lb. Pres. A worked example is as follows. The compressor speed is 450 r.p.m. from Fig. 7, the correction is 30 deg. for air, 16 deg. for brine or water. The suction pressure is 10lb., the head pressure 80lb. The oncoming air to the condenser is 60 deg. F, therefore the condenser temperature should be 60 deg. + 30 deg. = 90 deg. or a pressure of 87lb. The cabinet temperature was 45 deg. F., therefore the evaporator temperature should be 45 deg.—30 deg. = 15 deg. or a pressure of 11.25lb. From these figures it will be seen that both the condensing and evaporating pressures are lower than they should be. (Note these figures are for CH₃CL.) In the case of a high side system this would indicate a slight shortage; an automatic expansion valve system, that

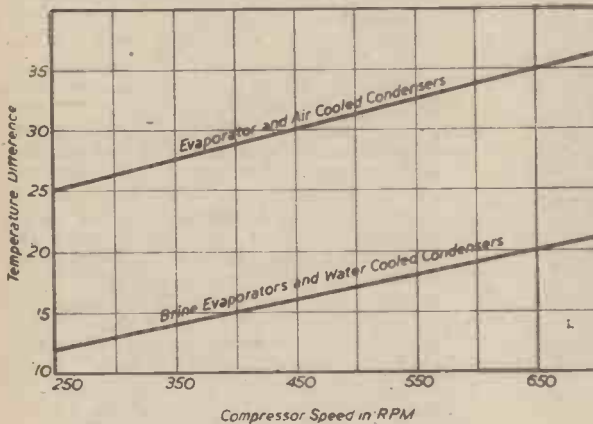

Fig. 7.—Temperature-compressor speed chart.

the valve required opening, and also a slight shortage. The thermostatic type, a slight shortage. A similar procedure is followed for brine tank evaporators, and water cooled condensers; but care must be taken that the correct differential is used. Also, when taking the temperature of water or air cooled condensers, the thermometer must be inserted in the oncoming air or the incoming water. In the case of brine tanks the thermometer must be lowered to a point midway in the brine.

Low Side Float Systems

Shortage is usually indicated by a high suction pressure, together with a hissing noise at the valve and very little frost. A slight shortage will be indicated by the valve hissing slightly, although other conditions may be normal. It is important that the valve should close completely, otherwise the plant is likely to short cycle due to the warm refrigerant entering and raising the temperature in the evaporator. It may be found that when the plant is short a considerable amount, the head pressure is higher than normal. An overcharge is usually denoted by a higher than indicated head pressure; care should be taken that this is not caused by air in the system.

Testing Compressors

Connect as shown in Fig. 5. Close the SSV fully to the right; start the plant and pump a 20in. vacuum, switch off, note if the compound gauge rises. (Be careful that cylinder A is tightly closed off.) If it does the discharge valves are leaking back and require renewing. Close the CHSDV fully to the right, open the valve on cylinder B, which must be empty; open the SSV, start plant, and pump up to 250lb. to 300lb. pressure. If the plant fails to do this, or takes a long time, all the compressor valves require renewing, or the pistons have be-

come sloppy and require rings fitting. Sources of noise are usually the bottom ends and occasionally the wrist pin in the piston. Main bearings very rarely require renewing, except in cases where the compressor has been run with little or no oil in the crankcase.

Overhauling Compressors

When assembling or dismantling compressors always work with the seal housing on the right-hand side; connecting rods and half pieces of the bottom ends should be marked with a centre punch on the back side, and numbered left to right. When fitting pistons never hold the cylinder block in a vice, otherwise it will be found that they cannot be entered without forcing, with the possible scoring of the bores. This is due to the very fine limits employed during manufacture. Remove the component parts carefully, noting how they are fitted. Remove all the old gaskets, carbon, etc., and wash all parts in carbon tetrachloride or similar degreaser. If necessary, tighten and lap in the bottom ends. As most bottom ends (except the larger models) are of cast iron running on cast steel crankshafts, the use of lapping compound is permissible. If new main bearings are required, it is advisable to have these fitted at a local engineering works, the shaft must be trued up, and the new bushes carefully reamed to fit snugly. The valve assemblies should be dismantled and cleaned, the seats be carefully lapped in on a cast iron or glass

lapping plate, using a figure eight motion. Use 480 mesh compound, finishing off with a mixture of flowers of sulphur and oil. If the seats are not scored they can be polished with fine silicon carbide lapping paper. When finished the seats should be free from all scratches and marks. Wash and assemble.

Valve reeds and discs have a smooth and a rough edge; care must be taken to fit the smooth edge to the seat. Smear with clean compressor oil before assembling. New gaskets should be used, and it is not necessary to use jointing cement; a thin smear of oil is all that is required. If the compressor is not to be assembled for some

time, it is most important that all parts be dipped in heavy grease and wrapped in paper, so that no rust can attack the metal. As most of the smaller compressors are fitted with ringless pistons, worn or sloppy pistons can be fitted with a ring on the top. The ring must be fitted to the bore before assembling on the piston. The shaft seal is the most important part of the compressor, as this enables the shaft to be kept gas tight with a minimum of trouble. It is not considered an economical proposition to reface the shaft and seal, so some form of replacement is necessary. The Rotary Seal Replacement Unit is the most economical method of ensuring a tight gland. Many of the leading service organisations have made the rotary seal a standard part of their equipment in their service work. Units can be obtained for practically every machine manufactured, and the writer has used them with great success over a number of years. The basic design used provides the necessary flexibility in an extremely durable diaphragm-acting neoprene ring, eliminating the common practice of flexing a thin delicate metal bellows. (See Figs. 8 and 9.) A highly polished steel ring is cemented into the outer flange, making contact with a compressed graphite ring which is carried in a sleeve on the shaft. This sleeve carries the neoprene ring, which forms a gas tight joint between the ring and the shaft. A suitably tensioned spring keeps the faces together at a predetermined pressure. Care must be taken in handling the graphite ring, as it is liable to be fractured if dropped. Carefully follow the instructions given, particular attention being paid to the distance A. Certain compressors have a spring loaded thrust end; when measuring A make certain that the shaft is pressed home against this spring. Clean the faces with carbon tetrachloride. Remove all burrs and dirt from the shaft with fine emery cloth; smear with compressor oil, place a few drops on the faces, smear the inside and face of the rubber with Vaseline, fit the spring, housing, rubber, and graphite face on the shaft, using the seal flange, carefully press the unit into position. In cases where the rubber is tight on the shaft, two long bolts can be used in conjunction with the end plate (three for five hole end plates) to draw the unit into position. Great care must be taken to bolt up evenly. Place the end plate in position and bolt up tightly, using the spring washers provided. Before finally tightening, centre the seal plate on the shaft. Where an eccentric type compressor is being fitted, the shaft must be turned during tightening up, otherwise the eccentrics are liable to jam. A few minutes' running may be required to form a gas tight joint. After assembling, the compressor must be run in; fill with oil to within 1/2in. of the centre of the crankshaft. Run

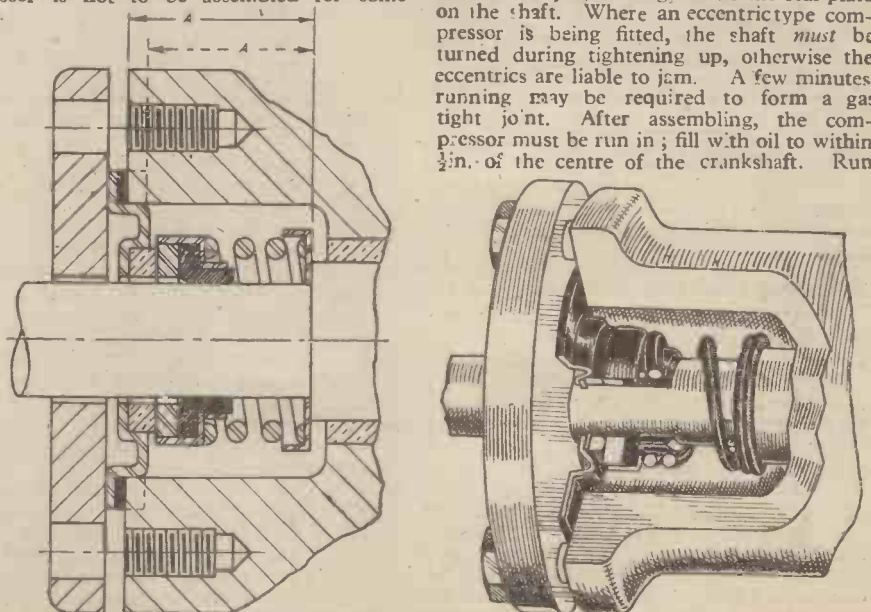

Figs. 8 and 9.—Section and part cut-away view of a compressor shaft seal. (By courtesy of Refrigerator Components, Ltd.)

for three or four hours; empty the oil out. Place the body in an oven heated to 240 deg. F.; close the SSV, and connect the CHSDV to a vacuum pump outside the oven. The body must be baked out for at least four hours under a 24 in. vacuum. After baking, refill with fresh oil, connect up a cylinder of refrigerant and test for leaks; seal up till ready for use. Care must be taken not to admit any air after baking.

Changing Type of Refrigerant in System

It is often desirable to refill a system with a different refrigerant; to do this an alteration in compressor capacity is required. When changing from SO₂ to CH₃CL the compressor speed must be reduced by one-third. It is usual to carry out this alteration by reducing the size of the motor pulley. If this is not done, the motor will be overloaded and will probably burn out. The oil must be changed, and all the old refrigerant removed. As F12 is at present only obtainable under licence, CH₃CL has to be used as a replacement. The speed has to be increased by 10 per cent. to allow for the increased capacity required. Under no circumstances whatever use CH₃CL in a system which has aluminium or magnesium alloys incorporated in the parts. A very dangerous gas is formed, and in the past explosions have occurred which have resulted in serious injury to the operator. Low side floats cannot be changed over without returning the float to the manufacturer for recalibration. High sides require no alteration, but

Model	Seat Dia-meter	Approx. Refrigeration Capacity in B.T.U.s per hour		
		SO ₂	CH ₃ Cl	F12
STAF	.040	7,500	6,000	3,000
STAF	.060	15,000	12,000	6,000
STAF	.080	30,000	24,000	12,000
LTAF	.110	60,000	48,000	24,000
LTAF	.170	120,000	96,000	48,000

Seat Size Dia.	Type	H.P. Limits	
		SO ₂ or CH ₃ Cl	F12
.040in.	FX	Up to 1/2	Up to 1/4
.060in.	FX	3/4 to 1 1/4	1/2 to 3/4
.080in.	FX	2 to 3	1 to 1 1/4
.110in.	HE	4 to 5	2 to 3
.170in.	HE	—	4 to 5

where dead weight pressure maintaining valves are fitted, replacement with a new one suitable for the new refrigerant is necessary. Thermostatically operated expansion valves must be completely replaced, care being taken that the orifice size is correct (see



Fig. 10.—Showing the corrosion of expansion valve needle, seat, and push-rods, due to acid formed by moisture in the system.

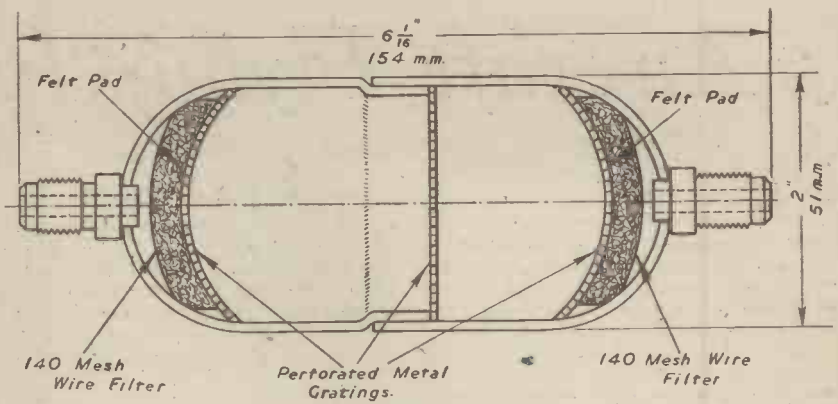

Fig. 11.—Sectional view of a drier. (By courtesy of British Thermostat, Ltd.)

table), i.e. F12 to CH₃CL requires a cases where the system is flooded with moisture, such as burst brine tanks, it is preferable that complete dehydration be carried out by the manufacturers of the plant. The

TEMPERATURE—PRESSURE EQUIVALENTS

This table, having been compiled mainly for the use of installation and service engineers, is approximate only, the values given being to the nearest 1/2 in. Hg. or nearest 1/2 lb. per sq. in. Centigrade readings to nearest 1/2°.

Temperature °F	Temperature °C	Vacuum ins. Hg.		Pressure lb. sq. in. gauge.	
		SO ₂	CH ₃ CL	F12	
-40	-40	23.5 ins. vac.	16 ins. vac.	11 ins. vac.	
-35	-37	22.5 "	13.5 "	8.5 "	
-30	-34.5	21 "	11.5 "	5.5 "	
-25	-31.5	19.5 "	9 "	2.25 "	
-20	-29	18 "	6 "	0.5 lb. sq.in.	
-15	-26	16 "	3 "	2.5 "	
-10	-23.5	14 "	0.25 lb. sq. in.	4.5 "	
-5	-20.5	11.5 "	2 "	6.75 "	
0	-18	9 "	3.75 "	9.25 "	
5	-15	6 "	6.25 "	12 "	
10	-12.5	2.5 "	8.75 "	14.75 "	
15	-9.5	0.5 lb. sq. ins.	11.25 "	17.75 "	
20	-6.5	2.5 "	13.5 "	21 "	
25	-4	4.5 "	17.25 "	24.5 "	
30	-1	7 "	20.5 "	28.5 "	
35	1.5	9.5 "	24.25 "	32.5 "	
40	4.5	12.5 "	28 "	37 "	
45	7	15.5 "	32.5 "	41.75 "	
50	10	18.75 "	36.25 "	46.75 "	
55	13	22.5 "	41.75 "	52 "	
60	15.5	26.25 "	47 "	57.75 "	
65	18.5	30.5 "	52.75 "	63.75 "	
70	21	35 "	57.75 "	70 "	
75	24	39.75 "	65.25 "	77 "	
80	26.5	45 "	72.25 "	84 "	
85	29.5	50.5 "	79.5 "	91.75 "	
90	32	56.5 "	87.25 "	99.5 "	
95	35	63 "	95.5 "	108 "	
100	38	69.75 "	102.25 "	117 "	
105	40.5	77.25 "	110.5 "	126.25 "	
110	43.5	85 "	118.25 "	136 "	
115	46	93.25 "	127.75 "	146.5 "	
120	49	106.25 "	139.25 "	157 "	

USEFUL CONVERSION FACTORS

One Ton Refrigeration (American)	12,000 B.T.U.s per hr.
One Ton Refrigeration (British)	13,440 B.T.U.s per hr.
One lb. Ice-melting	144 B.T.U.s.
One Watt-hour	3.41 B.T.U.s.
One Horse-power hour	2,545 B.T.U.s.
One Horse-power	746 Watts.

(By courtesy of British Thermostat, Ltd.)

Moisture in Systems

Moisture is detrimental to refrigeration plant; it not only prevents proper operation, but with SO₂ forms sulphurous acid, and with CH₃CL forms hydrochloric acid. This eventually causes corrosion, and usually results in the compressor seizing up. In

presence of moisture at the point of expansion not only corrodes the needle, but often stops all flow of refrigerant. (Fig. 10.) Where small amounts are present, removal is easily carried out by fitting one of the efficient driers, shown in Fig. 11.

(To be continued.)

Aircraft Flying Instruments

Their Functions Simply Explained

By T. E. G. BOWDEN

THE instruments that are required to enable a pilot to fly and navigate his aircraft from one point to another are now fairly well standardised, although the number used varies according to the size and the duties performed by the aircraft. Aircraft instruments have to function under extremely arduous conditions and require careful designing and construction. They must be robust and at the same time not be excessively heavy. A high degree of accuracy is required owing to the fact that modern aircraft fly at such high speeds and in all climatic conditions. Vibration is one of the main problems, and also the variation in temperature which occurs when climbing from ground level to the stratosphere. Acceleration of the aircraft must not affect the readings and thus all moving parts must be carefully balanced. Should the instrument be installed outside the aircraft, i.e., in the airflow, it must be compact and streamlined as possible so that

left open and receives the full impact pressure due to the forward velocity, and the other is open to the atmosphere by means of a series of small holes, so that the pressure in this tube

which alters in position as the air speed varies. This movement enables a rough estimation to be made and the instrument is usually mounted on one of the interplane struts, where it may be observed from the pilot's cockpit.

Air speed indicators only give correct readings at the altitude at which the instrument was calibrated, due to the varying density of the air. Corrections have to be made when the aircraft is being flown at other altitudes.

Altimeter

The next and equally important instrument is the altimeter, which records the height of the aircraft above the ground. The principle on which this instrument operates is that as the altitude increases so the air pressure and density also decrease. This alteration is recorded by means of a sensitive aneroid barometer, which measures changes in the

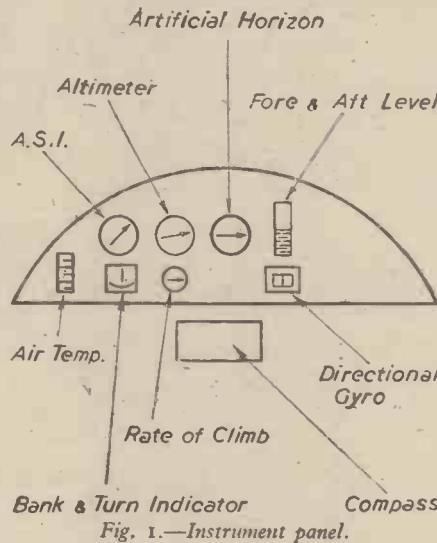

Fig. 1.—Instrument panel.

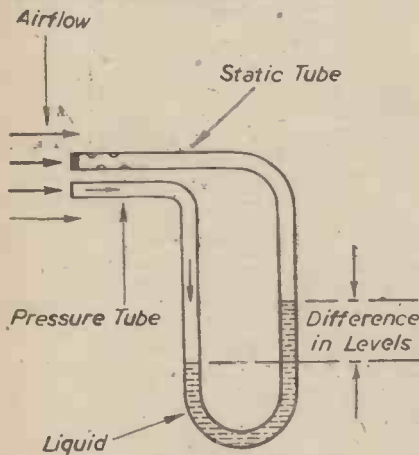

Fig. 2.—Diagram illustrating the A.S.I. principle.

drag and turbulence may be reduced to a minimum. The markings on the instrument dials have to be extremely clear to facilitate reading and maintenance should be as simple as possible.

The arrangement of the instruments in the pilot's cockpit is extremely important as they must be positioned so as to allow easy reading. A typical layout is illustrated in Fig. 1, in which the main flying instruments only are indicated.

Air Speed Indicator

One of the most important instruments is the air speed indicator which, as its name implies, gives the velocity of the aircraft through the air. It should be noted that the speed is not the ground speed, and to calculate this velocity the wind speed is required. For example, if the I.A.S. is 300 m.p.h. and the aircraft is flying against a wind of 60 m.p.h., then the rate of travel over the ground is $300 - 60 = 240$ m.p.h. This instrument is extremely important for navigation and also for indication of the approach of the stalling speed, i.e., the lowest speed of flight at which the aircraft can sustain itself in the air.

The principle of the most commonly used type of A.S.I. is as follows. Two tubes are arranged as shown in Fig. 2 and positioned in the airflow, usually under the wing or protruding from the fuselage. One tube is

is the static pressure. The difference between the two readings is proportional to the velocity of the airflow and by measuring the difference and transferring it to a dial the I.A.S. may be obtained. In Fig. 2, which is only a diagrammatic illustration, the difference in the two levels of the liquid indicates the pressure difference. In actual practice the two pipes are led from the pressure head, as it is termed, to the instrument on the pilot's dashboard, which operates as follows. A hollow metal diaphragm expands, due to the air pressure (see Fig. 3), and this movement is transmitted mechanically by means of levers and gear wheels. The whole mechanism is enclosed in an airtight box, the pressure in which is maintained at the static figure by being connected by the static pipe.

To avoid icing troubles, many pressure and static heads are heated electrically, and by this means blockage of the tubes is prevented. Stops are fitted on the recording instrument to prevent oscillation of the pointer due to abnormal pressure changes.

A simple A.S.I. used on light trainer aircraft consists of a spring-loaded plate,

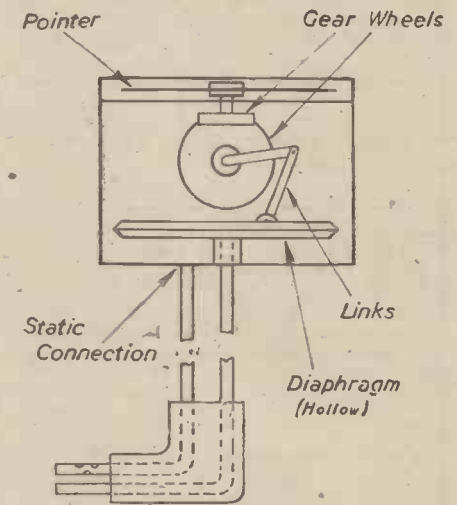

Fig. 3.—Diagram of an A.S.I. instrument.

air pressure. A flexible metal diaphragm is exhausted of air and placed in a box. As the pressure varies in the box due to alteration in height, the diaphragm fluctuates, and this movement is recorded by a pointer driven via gear wheels.

There are several important disadvantages that this instrument possesses. First, there is a considerable time lag between change of pressure and change of readings due to the diaphragm's elasticity, which is not perfect. Secondly, change in temperature affects the diaphragm's elasticity, causing incorrect readings. This latter disadvantage is being overcome by the use of a bi-metal strip.

As the atmospheric pressure varies at different airfields due to climatic changes and differences in level, it is important that there should be some form of adjustment incorporated in the altimeter so that the readings can be corrected to the pressure prevailing at the right airfield. An adjusting screw is fitted so that the position of the pointer may be altered in flight by the pilot.

A modern altimeter is accurate to within plus or minus 100ft. and as small a variation as 10ft. may be detected. To obtain this accuracy it is important that the airtight container be connected to the static side of the

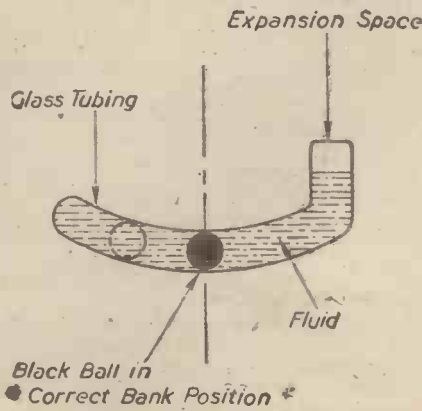

Fig. 4.—Bank indicator.

A.S.I. If the instrument is open to the pressure, say in the cockpit, errors are likely as the air pressure inside the aircraft varies from the correct static pressure.

Bank Indicator

To indicate whether the aircraft is flying with the correct amount of bank when turning a bank indicator is usually fitted. As shown in Fig. 4 it is very simply constructed, consisting of a glass tube slightly curved, in which a black ball is placed. The fluid is merely to give a damping effect and to prevent the ball oscillating too rapidly. To allow for expansion of the fluid an air space is incorporated at one end. In a correctly banked turn the ball remains in the neutral position, due to centrifugal force. If the banking angle is not correct the ball will be forced away from the centre, indicating to the pilot that more or less aileron movement is required.

The bank indicator is usually incorporated with a turn indicator to form one compact instrument. The turn indicator informs the pilot of the direction and rate of turn. A small gyro-rotor is fitted in this instrument and is driven by air pressure, acting on a series of small vanes or buckets. Air is drawn from the instrument case by means of a venturi tube or a suction pump and the air entering is guided through a jet on to the rotor. Gyroscopes possess the property of precession, i.e., if a force is applied tending to turn the gyro about an axis at right angles to the spindle the gyro will precess or rotate

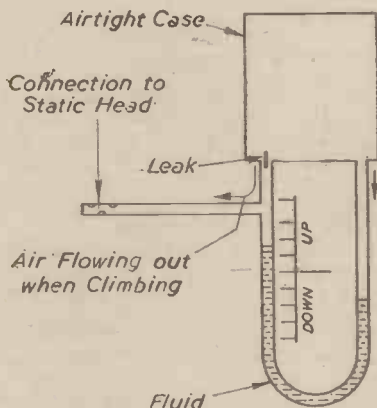

Fig. 5.—Rate of climb indicator.

about an axis at right angles to the axis of rotation. This property is utilised in the turn indicator by installing the rotor so that when the aircraft makes a turn, the rotor precesses and causes a pointer to move either to the left or right, according to the direction of turn. A dash-pot is usually fitted to ensure smooth operation and to re-erect the gyro when straight flying is resumed springs are incorporated.

The turn and bank indicator described in the previous paragraph is extremely important when flying blind, as the human senses cannot detect changes in course or position and only by fitting this instrument can normal flight be maintained.

Rate of Climb Indicator

The rate of climb indicator allows the pilot to be informed at the rate of vertical movement, either upwards or downwards. The variation in pressure at different altitudes is used to indicate the rate of climb, i.e., the more rapid the drop in pressure the higher the rate of climb. Fig. 5 indicates the principle by which this instrument functions. If a U-tube is connected to the static tube and an air leak is positioned as shown, the rate of climb may be measured as follows. When the aircraft climbs, the air tends to be drawn out of the container due to the decreased

pressure in the static tube. Owing to the small leak the rate of leakage is not sufficient to equalise the pressure, i.e., the liquid is forced down the tube, thus indicating the rate of climb.

Instead of fitting tubes filled with liquid, metal diaphragms similar to the type used in A.S.I.s are used and a pointer indicates the rate of climb or descent as shown in Fig. 6.

To indicate to the pilot whether or not the aircraft is flying level with regards to the longitudinal axis a fore and aft level is fitted. A typical design is illustrated in Fig. 7. As shown, it is only a glass tube filled with a coloured liquid which tilts with the aircraft. As the nose goes down then the level of the liquid in the indicating portion falls, thus giving a clear indication to the pilot.

To prevent too rapid movement of the fluid a restriction is incorporated as illustrated.

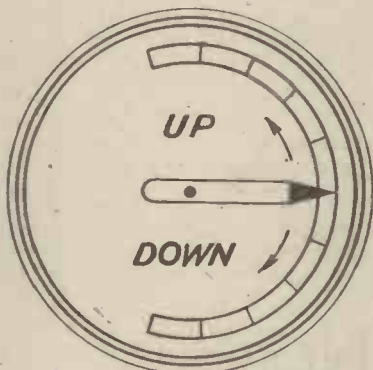

Fig. 6.—Rate of climb dial.

This instrument is affected when the aircraft turns and will then give incorrect readings, therefore it may only be relied upon for normal straight flying.

Directional Gyro

A directional gyro is often installed when the aircraft is liable to be flown blind, i.e., at night or in bad weather. Any deviation from the correct compass course is indicated by this instrument. A gyroscope driven by air pressure is fitted in a case and tends to remain in one position, i.e., if the aircraft turns either to port or starboard, the gyro remains in the original position. By fitting an indicator ring marked out in degrees, the amount of deviation may be noted. To the pilot it appears as though the indicator ring revolves, although actually it is the aircraft which revolves round the gyro.

To ensure that the gyroscope maintains an even position the air jets are so arranged that the flow of air tends to give a correcting force should the rotor move from the original

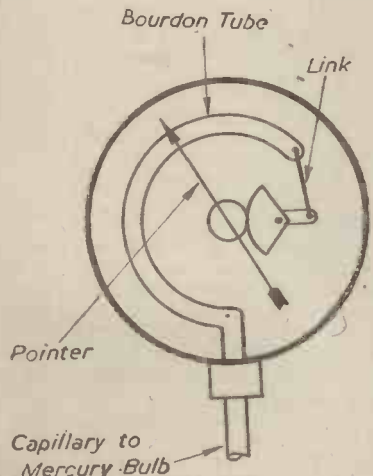

Fig. 8.—Air thermometer.

position. The indicating ring may be adjusted to allow for any discrepancies which occur due to mechanical inefficiencies and during the adjustment the gyro is locked horizontally to prevent any sideways movement.

An instrument which measures the temperature of the air through which the aircraft is flying is known as the air temperature thermometer. The reason why this thermometer is required is so that the altimeter and A.S.I. may be corrected as their readings vary with the air temperature.

This instrument is constructed as follows: A steel bulb is filled with mercury and connected to the recording instrument in the pilot's cockpit by means of a capillary tube. As the temperature rises or falls the mercury expands or contracts and the alteration in volume is transmitted via the capillary tube to a bourdon tube which forms part of the recording instrument. Fig. 8 illustrates the method of recording, i.e., if the air temperature increases so the mercury forces the bourdon tube to deflect and this movement is transmitted via gear wheels to the pointer. The bourdon tube is manufactured from a coiled flat steel tube open at one end only. An important advantage possessed by this instrument is the fact that it is not affected by any change in the external air pressure.

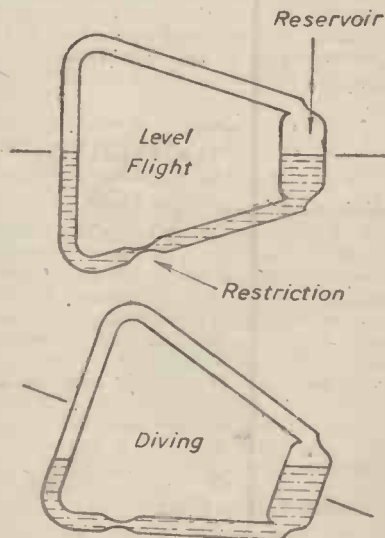

Fig. 7.—Fore and aft level.

Due to the varying coefficients of expansion of steel and mercury a compensating device is fitted in the capillary tube so that the readings are not affected. The length of the capillary is comparatively great and unless some such precaution is taken the instrument will be unreliable. A typical compensating link which may be inserted into the capillary length is constructed with an outer steel housing which encloses a core made from a steel which has practically no change in volume with changes in temperature. As the outer housing alters in size and as the core piece does not alter, the volume of the mercury in the casing is varied accordingly, thus correcting the readings.

Nitrogen filled thermometers are used when extremely low temperatures are liable to be attained and readings of -60 deg. C. are capable of being recorded.

Artificial Horizon

An artificial horizon is fitted to many modern aircraft and enables the pilot to tell at a glance the position of the aircraft relative to the horizon. Indication of climbing, diving and banking is given. The instrument consists of an air-driven gyroscope with a cross-level attached which acts as the horizon on the indicating dial. This horizon remains parallel to the earth's horizon due to the

gyroscope, while the case moves with the aircraft. If the aircraft adopts a diving attitude, the horizon appears to move above the centre line of the dial, and vice versa in the case of a climb.

An essential instrument that is required both for the pilot and the navigator is the compass. The type which is used on the majority of aircraft is the magnetic compass which indicates the magnetic north. Instead of the pointer being attracted to the magnetic north as is the case in the smaller type of compass, the aircraft compass incorporates a system of four or six bar magnets mounted on an iridium tipped pivot which bears on a sapphire cup. A wire running parallel to the N-S axis of the magnet indicates the magnetic north and a graduated dial allows the compass bearings to be noted.

There is a tendency for the magnets to dip and not remain horizontal, due to the fact that the north end is attracted downwards in the northern hemisphere and the south end is attracted downwards in the southern hemisphere. This is caused by the path followed by the magnetic lines of force, which are not parallel to the earth's surface, except at the equator. By mounting the magnetic system away from its centre of gravity this tendency may be avoided and true readings obtained. Alternatively, the magnets may be suspended from a point relatively high above their C.G.

A disadvantage of the magnetic type is the fact that the readings tend to lag behind

when the aircraft turns or accelerates. To prevent overshooting, damping wires are incorporated which in conjunction with the fluid in the bowl in which the magnets are mounted prevent undue oscillations. The fluid used is generally alcohol as it has a low coefficient of expansion. To allow for expansion of the alcohol a diaphragm is fitted below the bowl which absorbs the extra volume, thus preventing any change in the fluid level.

It is necessary to fit "correcting boxes" so that the true magnetic north may be indicated as, due to various electrical interferences from the aircraft, the compass may be deflected by a considerable amount. This is overcome by fitting a wooden box adjacent to the compass in which varying numbers of small magnets may be mounted in order to correct the readings. Alternatively, a more modern method of adjustment is to fit two pairs of magnets which may be altered in position mechanically by means of an adjusting key. The variation in the magnetic field of this system allows the compass to be corrected.

Gyro Compass

The gyro compass is now in common use and is the most efficient type. A gyro is incorporated and tends to maintain its position regardless of any movement of the aircraft. By rotating the gyro at approximately 10,000 r.p.m. an extremely sensitive direction-

indicating instrument is obtained. To counteract "wander," a weight is fitted to one end of the gyro and this cancels out any tendency for the indicator to deviate from the correct position. Repeater compasses may be fitted at various parts of the aircraft, thus ensuring that both the navigator and the pilot are working to the same reading.

Earth-inductor compasses have been developed and depend upon the fact that if the earth's magnetic lines of force are cut, voltage is generated and this current may be recorded by means of a galvanometer. No current is generated when the coil incorporated in the compass is parallel to the earth's lines of force, i.e., N-S, but when the coil is turned at right angles the current generated is a maximum. Extremely accurate navigating may be accomplished by using this type of compass.

From the above description of the main instruments fitted to aircraft to enable the pilot and his crew to fly on the correct course and in the correct attitude it will be seen that extreme care is necessary in the construction of the various types. Maintenance in most cases may only be carried out by skilled mechanics. The main difficulty in modern aircraft, due to the high speeds of flight being attained at the present time, is the effect of acceleration, and in the future when the bulk of the world's goods are being transported by aircraft, flying instruments will have to be as perfect as is humanly possible.

Science Notes

Britain's 1,000-mile Pipe Line

ONE of the well-kept secrets of the war is the existence of an oil pipe line in this country extending for over 1,000 miles. It is an elaborate interconnecting system linking the western supply ports with the consuming centres, such as airfields, and delivering aviation spirit, petrol, and oil for tractors. Underground tanks for holding large stocks are embodied in the scheme. Modern excavating equipment was used for laying the pipe line, which required 80,000 tons of steel and cost about £7,000,000.

New "X-ray" Bombsight

DETAILS have recently been released of the new "X-ray" bombsight, which has been developed with the aid of radar. All Allied bombers and fighters are now fitted with this invention, which enables airmen flying in dense cloud or fog to "see" their targets. The pilot simply switches on his set, and a continuous wave is transmitted from the plane to the ground. The wave hits the ground and rebounds, while in the cockpit of the plane there appears on a small screen an image of the target. The picture is not as clear as a television picture, but the outlines are presented in sufficient detail to permit of accurate bombing.

Radar is a development of radiolocation, and Sir Robert Watson-Watt—who was knighted for his work on the anti-aircraft device—is one of the team of British scientists who developed radiolocation to produce radar.

Mustangs' 450 M.P.H.

PERFORMANCE figures of the famous Mustang fighter plane, which is built in the United States, and is powered by a Rolls-Royce engine, were recently disclosed by the North American Aircraft Corporation. The aircraft is capable of 450 miles an hour in level flight, can climb more than 40,000ft., and has a range (out and home) of 2,000 miles.

When it was first brought to Britain it had a U.S. engine, later replaced by the Rolls-Royce Merlin.

Greenwich's Quartz Clock

THE new quartz clock at Greenwich Observatory was shown to the public for the first time recently by the Astronomer Royal, Sir Harold Spencer Jones. There are now two separate self-contained quartz time stations in different parts of Britain, to ensure quartz time against enemy action. Here time signals of an accuracy never before achieved are sent out regularly to British ships and aircraft. The quartz clock is replacing Greenwich's pendulum clock, and it loses or gains only one thousandth of a second a day.

In the new quartz clock a small rectangular plate, cut from natural quartz crystal, is set vibrating by an electric current, and special electrical devices are used to count its vibrations, which are 100,000 times a second. Its signal goes out every hour by special line to the B.B.C. and the Post Office. Clocks and watches in the Navy and Fleet Air Arm are tested and adjusted against this quartz clock in a special department of the Royal Observatory by a large staff of skilled workers.

Britain's Lead in Television

BRITISH scientists, working in secret to develop every branch of radio for the war effort, have enabled Britain to maintain its pre-war lead in television. In a recent statement to the Press, Mr. John L. Baird, one of the earliest experimenters in television, said that "in two aspects of television we are definitely ahead of America—stereoscopic transmission and definition."

Jet Airplanes

IT is reported that the U.S. Army's new jet-propelled airplanes are undergoing tests in Alaska. The airplanes are designed for use under any climatic conditions, having undergone secret tests in hot, sandy desert conditions satisfactorily. Russian Air Force engineers are stated to have spent six months in America studying jet-propelled aircraft.

18,000-ton Press

THE U.S. War Production Board recently announced that the Mesta Machine Co., of Pittsburgh, was constructing an 18,000-ton

die-forging press, the largest ever installed in the United States. The new press will be used for turning out larger and more efficient aircraft components and parts of military equipment necessitating larger forgings. No die-forging press of over 10,000 tons capacity has previously been available for the production of light metal forgings in the United States.

Aircraft's 3,000 Miles Range

THE "Privateer," the new American 65,000lb. searchplane, intended to replace the famous twin-tailed Liberator, can range unescorted more than 1,500 miles from base. Now that it has been introduced into the Far Eastern theatre of war, for which it was designed, no part of Japan's empire or surrounding waters can remain hidden from the eyes of the U.S. Navy. Heavily armed, the "Privateer" can fly well over 3,000 miles, and can stay in the air for 24 hours without refuelling.

Liquid Heat

THE research laboratories of the Government's National Housing Agency, which have been experimenting with raw materials and equipment for post-war houses, have produced what is called liquid heat—or what is chemically known as tetra cresyl silicate.

This is a fluid that can be heated to a temperature of 800 deg. F., or chilled to 50 deg. below zero.

Machinery installed in the basement of a house would heat the liquid in winter, and convey it by means of pipes to the kitchen for cooking, and for heating domestic irons, and water for radiators, and other purposes. In the summer the liquid would be chilled and used for refrigerators.

Windowless Boiler House

THE Chevrolet aluminium forge plant at Saginaw, Michigan, produces about 8,000,000 lb. of aluminium forgings a month. Designed to operate in complete black-out for wartime security, the boiler house of this war plant is windowless. Light trapping inlet louvres and roof ventilators provide the necessary ventilation. The louvres also supply the air for combustion purposes.

Miniature Plugs and Coils

Constructional Details of a Small Ignition Coil and Plug Suitable for Model Aircraft and Model Boat Engines

By D. R. BIRCHALL, Grad.I.E.E.

Coil Core

THIS is made from soft iron wires 2in. long. It is important, for good results, that the right type of wire is used. It can be obtained from an old car ignition coil to ensure that it is of the right quality. Sufficient wires to make a core of 3/16in. diameter are required, and the finished core should be wrapped with empire cloth insulation (one layer).

Primary Winding

The primary winding consists of approximately four layers of .024in. (23 S.W.G.) enamelled copper wire, hand wound on to the insulated core, reversing the winding 1/2in. from each end. (D.C. resistance, 4 ohms.)

Secondary Winding

This consists of 8,000 turns of .0024in. (46 S.W.G.) enamelled copper wire (D.C. resistance 5,000 ohms). A winding fixture or bobbin is required to produce the secondary winding successfully, and a suitable fixture for this purpose is shown in Fig. 1.

A former made from adhesive paper tape 1 1/2in. wide should first be wound on to the spindle of the winding fixture. Four layers are required, and care must be taken to see that the former is not too tight on the spindle, or there may be difficulty in withdrawing the finished secondary winding from the winding fixture. Start winding the secondary, interleaving each layer with paper, .001 in. thick and reversing each layer 1/2in. from each end of fixture. Make off the start and finish off the winding with a flex pigtail for connection purposes.

Withdraw the secondary winding from the winding fixture when complete.

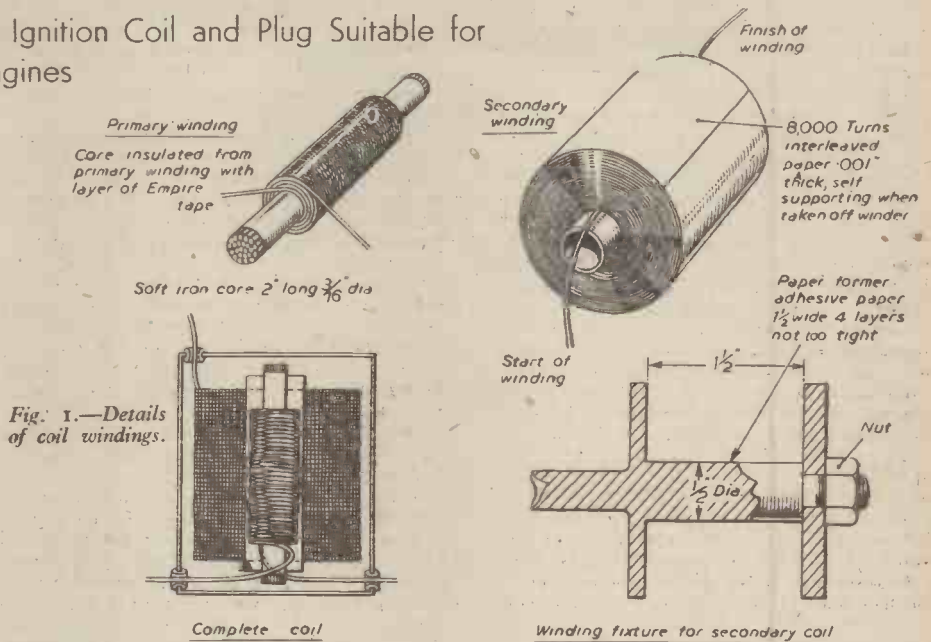

Fig. 1.—Details of coil windings.

Assembly

Insert the core and primary winding inside the secondary winding former, and place the assembled coil in a suitable container, joining the finish of the primary winding to the start of the secondary winding, and leading this through a suitable aperture, winding through the casing at suitable points in a similar manner.

Now immerse the complete coil and casing in hot paraffin wax, leaving it for a few moments until all air inside the container has been expelled. Withdraw from wax and drain off.

A Miniature Sparking Plug

Materials required:

1. Hexagon mild steel bar, 3/8in. across flats.

2. Old radio resistor body, with hole through the centre, made of steatite (a material similar to porcelain).

3. A piece of nickel chrome wire, obtained from an old electric fire element, of a diameter to suit the hole in the resistor.

4. A small quantity of gasket cement as used on motor-car joints, and a little French chalk, added to gasket cement to give body.

Making the Body

The hexagon bar should be checked in a centre or capstan lathe, faced and drilled 5/32in. diameter to a depth of 9/16in.

This hole should next be counterbored 1/4in. diameter to a depth of 1/4in. Turn the outside of the bar to 3/8in. diameter for a distance of 3/32in. and chamfer down to the 1/4in. hole to form a feather edge. Part off to give body a length of 1/2in.

Reverse the body in the chuck and turn down to 1/4in. diameter for a distance of 3/16in., and then screw cut or die the 1/4in. diameter 32 threads per inch.

Making the Insulator

Grind one end down to 1/4in. diameter for a length of 3/16in., and chamfer out to 3/8in. diameter at the same angle as drill used to counterbore the body.

Next, grind to 1/4in. diameter for a distance of 3/16in. from shoulder of chamfer, and then grind down to 3/16in. diameter with radiused shoulder. Grind off and face end approximately 1/4in. from start of shoulder.

The Electrode

Grind one end of the wire to a fine point, and bend it over at right angles. Make a small ferrule to fit the top of the electrode.

Assembly

Smear the inside of the plug body with jointing compound and insert the insulator. Spin over the feather edge of the plug body on to the radiused shoulder of the insulator, using the special tool shown in Fig. 2.

Paint the electrode with jointing compound, insert the insulator, and then fit the ferrule on the end of the electrode and carefully spin over, using tool in drilling machine. Finally, adjust the end of the electrode to give the correct gap.

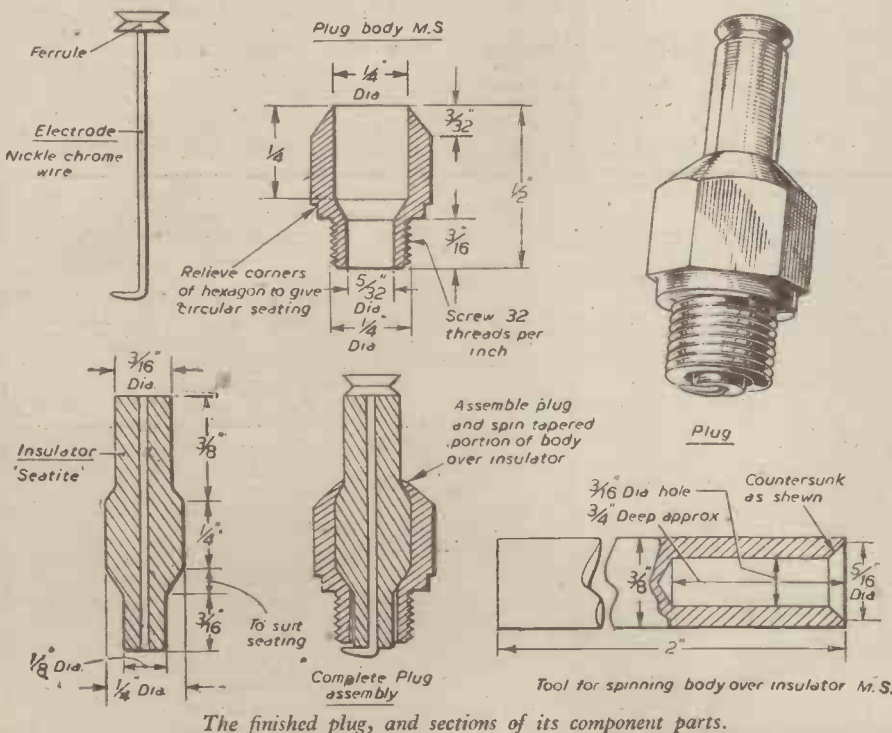

The finished plug, and sections of its component parts.

Diascopes and Episcopes—2

Constructional Details of an Efficient Episcopes

General Considerations

THE principle of any episcopes is that the object to be projected is floodlit by means of lamps and reflectors; a lens is placed so that some of the light reflected from the surface of the object is focused on the screen. As the screen illumination is comparatively feeble, this type of projector is more dependent on the use of a darkened room than other types. It is assumed that the object to be projected will usually be a postcard, photo, or book illustration; the design allows the use of a whole magazine or book, if not unduly thick, and the size limit for the actual picture to be projected is 5-5½ in. square.

The main problem in the design of an episcopes is to ensure a sufficiently bright screen-image without overheating the object which is being projected.

Lay-out

The projector to be described has been designed with a view to: (a) Simplicity of construction; (b) portability; (c) suitability for classroom use. The design provides the simplest possible lay-out for an episcopes, with the picture at the back and the lens at the front. The "throw," that is, the distance from the projector to the screen, is short, and a translucent screen, about 2ft. square, should be used. This type of screen is advantageous where use in controlled daylight is contemplated, and is required with an episcopes of this type in order to avoid the left-to-right reversal of the image.

Components

(a) Lamp-holder, batten-type, for E.S. Cap. Flexible cable, plug connector, and switch. Cost, about 6s.

(b) Lamp. Mains voltage, 250 watt, class A1 projection lamp, E.S. Cap., 32 mm. diameter. Cost, £1 1s.

Lamps of this type must not be expected to burn for more than 100 hours in all, if they are run on their maximum voltage. It is, however, feasible to use a lamp designed for a voltage which is ten higher than the mains voltage. This reduces the light output by about 12 per cent., but will probably double the life of the lamp. In the case of the episcopes, the above loss of light is by no means negligible.

(c) Glass chimney with reflecting surface (Fig. 8 on page 199), 11 in. high, 2½ in. external diameter, silvered round half its circumference from 2 in. above the base to a height of 6 in. above the base.

This component is made by cutting off a length of tubing and melting up the cut edges to smooth them. A patch is then silvered as indicated. The chimney surrounds the lamp and acts as a ventilating shaft to prevent over-heating of the picture. The silvered patch provides a reflecting surface immediately behind the lamp.

There are also three other reflectors cut from flat mirror glass.

Glass tubing of appropriate size for the chimney can be obtained from science apparatus firms and glass merchants, some of whom would also undertake the silvering.

For the experimental model, Messrs. W. and J. George, Great Charles Street, Birmingham, supplied the cylinders ready silvered. Cost, about 6s.

(d) Other reflectors (Figs. 6 and 7 on page 199), cut from a sheet of ordinary mirror glass about 1ft. square. Cost, about 1s.

(e) Projection lens, Petzval type; diameter, 2½ in.; focal length, 8 in.; area of field covered, 5½ in. diameter circle; mounted in focusing mount.

(By Courtesy of the British Film Institute)

Among firms generally able to supply suitable lenses are: The British Optical Lens Co., 315, Summer Lane, Birmingham; Messrs. Kalee, Ltd., 60, Wardour Street, London, W.1; Messrs. R. J. Beck, Ltd., 69, Mortimer Street, London, W.1; Messrs. Broadhurst, Clarkson and Co., Ltd., 63, Farringdon Road, London, E.C.1. Cost, £2 to £4.

Note.—If it is desired to project material which is so small that it might slip through the back aperture of the episcopes it will be necessary to mount a thin sheet of glass on the exterior face of the back panel. It will be found simplest to have the glass cut about 1 in. smaller than the panel in each direction and to fix it with small bent metal brackets. The drawback of using the glass is that it lessens the brightness of the image.

Construction

The body of the episcopes is a rectangular box, constructed of 6 mm. plywood, except the base, which is 12 mm. plywood; the main dimensions are given in Figs. 1, 2, and 3. Cut the five pieces, beginning with the base, then the ends, finally the back and front. Square up the edges with a plane, and cut the following holes, all of which should be smoothed with glass-paper:

- (1) A large hole in the base (see Fig. 1) just big enough for the glass cylinder to slip in easily. (Note that the two ends of the cylinder may be of slightly different diameters, and make a trial boring in a piece of waste wood first, if a washer-cutter is used.)
- (2) Two rows of ventilation holes (½ in. and ¾ in.) in the base (Fig. 1).
- (3) A round hole in the centre of the front for the lens mount.
- (4) An aperture in the centre of the back, 5 in. square, for the picture. (A circle of 5-5½ in. diameter may be preferred.)

Now begin assembly by fitting the ends to the base, using 1 in. oval nails and Seccotine or similar adhesive. Then fit the front

and back, using adhesive and ½ in. oval nails where the back and front fit the ends. The small nails must be driven with particular care, so that they enter the centre of the thickness of the wood. Additional strength at the four vertical corners may be obtained by gluing in quarter-round wooden beading, if desired. Trim up the top edges if necessary with the plane, turn the box upside-down on a piece of 6 mm. plywood, mark out and cut the lid (Fig. 2).

If the lid of the episcopes is a loose fit it may be found desirable to add some kind of clip at the sides to hold it in position.

Find two cylindrical tins which are a little more than 2½ in. in diameter, and at least 5 in. long. Cut out the bottoms of the tins with a tin-opener of the type employing a toothed wheel. Mark centres for two holes in the lid, one directly over the large hole in the base for the lamp chimney and the other in a corresponding position at the other side for a ventilation hole (Fig. 2).

Cut the two holes so that the tins can just be pushed through, top end first, from the underside of the wooden lid; the small flanges at the bottoms of the tins will prevent them from passing right through. Cut four pieces of thin sheet brass or tinsplate, each slightly more than a semicircle, which will just fit into the tops of the tins. Solder these in the positions indicated, where they act as light traps. Each tin is held firmly in place by three tabs of sheet brass, ¾ in. long (Figs. 2 and 3). These are bolted to the wood, and the three on one side are adjusted so that the top end of the glass cylinder will just slide easily between them. If fitted as shown, they will tolerate any slight expansion of the glass due to heat.

Bore five small holes for ventilation as in Fig. 2. Leakage of light through these holes must be prevented by a light trap which can be made from a strip of bent tin. The lid is positioned by wooden slips (Fig. 2).

The lamp-holder is mounted centrally on a strip of brass or hardwood which spans the large hole in the base of the box, and which is fixed on the underside of the base

PRINCIPAL LIBRARIES FOR FILM STRIPS

Visual Information Service, 168A, Bridge Road, London, S.W.11.

Newton & Co., Ltd., 43, Museum Street, London, E.C.1.

Catholic Truth Society, 38-40, Eccleston Square, London, S.W.1.

Types of Film: Geography, history, industry, science, art, literature, religion.

PRINCIPAL SOURCES OF SUPPLY FOR LANTERN-SLIDES AND MATERIAL SUITABLE FOR EPISCOPES PROJECTION

British Museum, Bloomsbury, W.C.1	Slides Cards Photographs	History, Fine and Applied Art.
Courtauld Institute of Art, 20, Portman Square, W.1	Slides	Fine and Applied Art.
Geffrye Museum, Kingsland Road, E.2	Slides Cards Photographs	Social History.
Imperial Institute, Exhibition Road, S.W.7	Slides Cards Photographs	Natural Resources, Industries, Scenery, and Life in the British Empire.
Imperial War Museum, Lambeth Road, S.E.1	Slides Cards Photographs	The 1914-1918 war.
National Gallery, Trafalgar Square, W.C.2	Slides Cards Photographs	Fine Art.
National Portrait Gallery, St. Martin's Place, W.C.2	Slides Cards	History.
National History Museum, Cromwell Road, S.W.7	Slides Cards	Natural History.
Science Museum, Exhibition Road, S.W.7	Slides Cards Photographs	Pure and Applied Science; Industry, Engineering, Transport.
Tate Gallery, Millbank, S.W.1	Cards	British and Foreign Painting and Sculpture.
Victoria and Albert Museum, South Kensington, S.W.7	Slides (to certain bodies only) Cards	Fine and Applied Art.
Wallace Collection, Hertford House, W.1	Slides Cards Photographs	Fine and Applied Art.

with wood screws. The strip should be reasonably rigid, and a $\frac{1}{16}$ in. hole should be bored in the centre to take the wires.

The clips for the mirrors (Figs. 4a and 5) are cut from hard-drawn brass strip, $\frac{1}{16}$ in. wide and $\frac{1}{16}$ in. thick, and their natural

spring enables each mirror to be held firmly in position. The three mirrors correspond roughly to three sides of a pyramid, with the picture at the base and the lens at the apex. The side mirror (Fig. 7) is an oblong, 6 in. high by 5 in. long; its lower edge is

positioned by two wooden slips (Figs. 1 and 4b). The other two mirrors are mounted in corresponding positions, on the base and on the lid respectively; in each case the longer of the two parallel edges rests against
(Continued on page 209)

Fig 1 PLAN (Lid Removed)

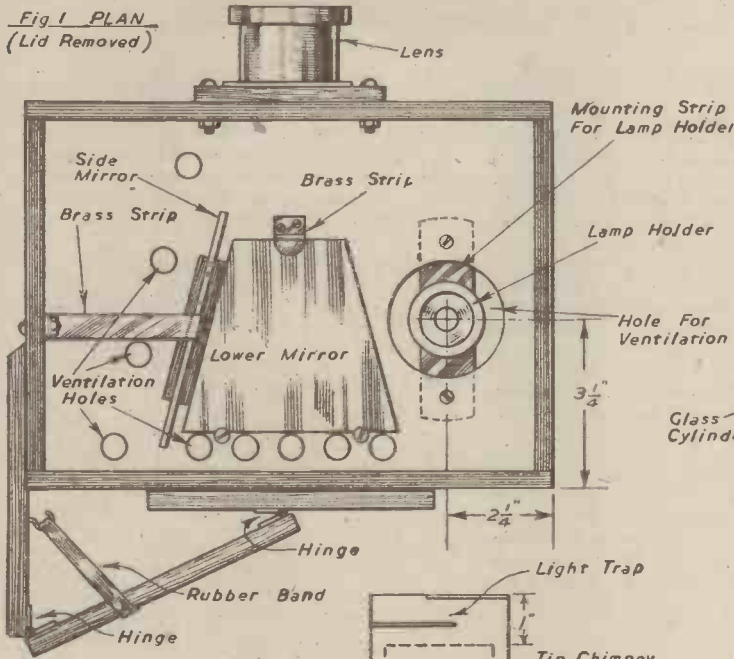
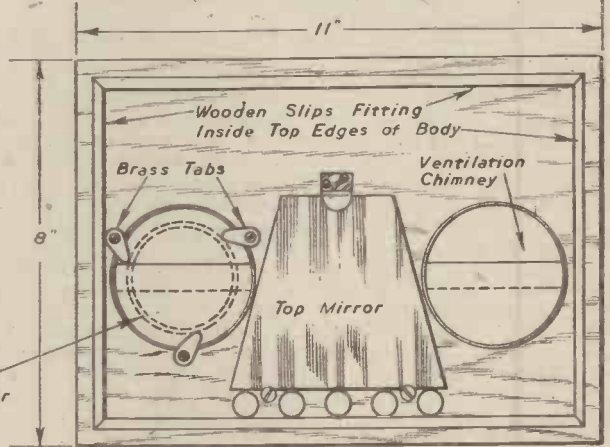

Fig 2 LID (Underside)



Brass Strip Fixing Top of Side Mirror



Fig 4a Hard Brass Strip $\frac{1}{2} \times \frac{1}{16}$



Fig 4b Wooden Slats Fixing Bottom of Side Mirror

Fig 7 Side Mirror



Fig 3 SIDE ELEVATION

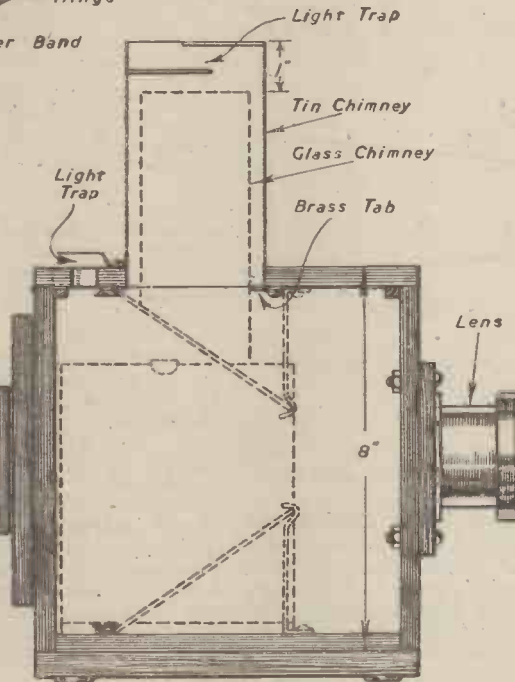

Fig 6 Top and Lower Mirror

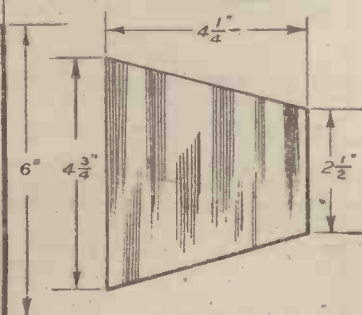

Fig 5 Brass Strips Fixing Top and Lower Mirror

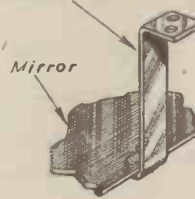

Fig 8 Glass Chimney



Fig 9 LID

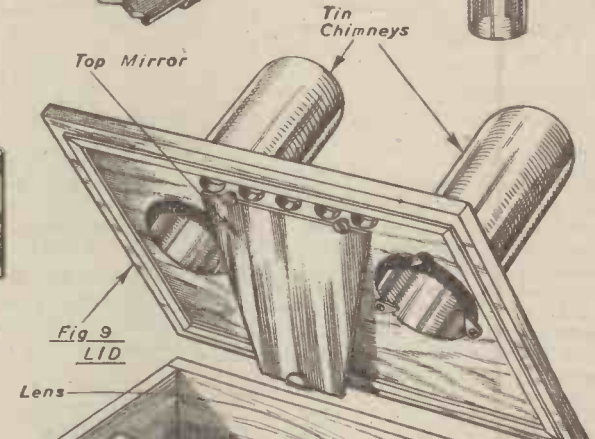
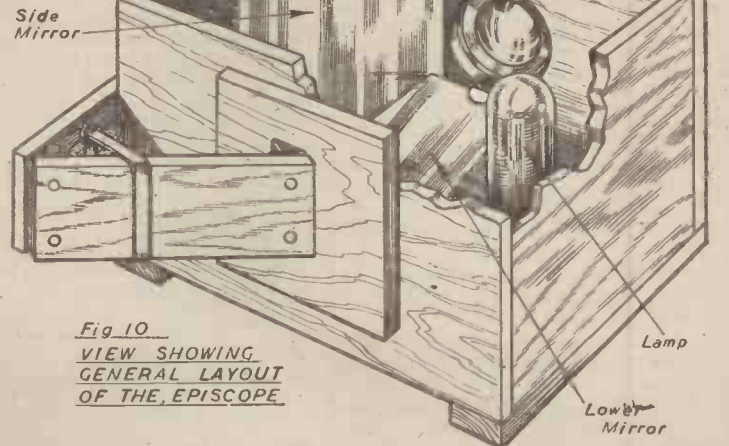

Fig 10 VIEW SHOWING GENERAL LAYOUT OF THE EPISCOPE



Figs. 1 to 10.—General layout and constructional details for the episcope.

Rocket Propulsion

Further Details of German Development : Rocket Research in Scotland : War Rockets in Spain

By K. W. GATLAND

(Continued from page 158, February issue)

A PART from his work concerning high speed aircraft forms, Sänger also carried out an extensive series of rocket motor tests. These he commenced in 1931 under the auspices of the University of Vienna. As the result of this work, a reaction unit of distinctive performance was developed; one capable of continuous function for periods of anything up to 30 minutes. A diagram of the Sänger constant-volume motor unit is shown in Fig. 17 and leading dimensions are as follows: Combustion chamber, approximately 2ins. spherical diameter; exhaust nozzle, length 10ins.; throat diameter, .25ins.; mouth diameter, 2ins. The motor and the nozzle throat were surrounded by a coolant jacket, the oxygen and fuel both entering the combustion chamber at the motor head. A light diesel fuel oil was employed as fuel. Prior to entering the combustion chamber, the fuel was passed through the jacket as coolant fluid, and forced from the tanks by means of a Bosch type

The thrust augmenter is merely a device employed in atmosphere to "augment" the mass flow of the rocket efflux, by the injection of atmospheric air into the combustion exhaust stream. It should be noted that if the rocket motor were able to function with anything approaching 100 per cent. efficiency, the thrust augmenter would be of no value because the exhaust gases would be at a minimum temperature upon emerging from the nozzle mouth, and, therefore, incapable of heating the inducted air. The injection of air into the gas stream should preferably be made before expansion is complete, allowing for further expansion after the air and efflux gases are mixed.

For the efficient function of the thrust augmenter a proportion of the heat energy of the fuel is utilised in raising the mass of inducted air to jet velocity, thereby reducing the amount of energy available for conversion to kinetic energy in the efflux itself. The net result is that there is produced a low

A mainplane of lifting section—4ft. span—with no dihedral, was fitted at the rear, while the horizontal stabiliser was similarly attached at the nose. Both aerofoils were "parasol" mounted, their mounts functioning as vertical stabilisers.

Intensified Research in Scotland

As the result of further experiment, more advanced types of rocket-powered model aircraft were produced. One particular model, fitted with a float attachment, was tested out across Loch Lomond and flew for more than five miles.

The persons mainly responsible for this further research were G. Aldred Roberts, J. J. Smith, J. Dennis, and, later, P. Blair—a specialist of military rockets. Their prime aim was to produce small-scale, ultra-high-speed rocket aircraft by the development of thrust augmenters.

In order to overcome the many difficulties imposed by working close to habitation two separate experimental sites were set up in open country—one in Cumberland, the other in Sutherlandshire. At these two places the group erected workshop buildings, and there, making use of most limited building resources, a great number of small-scale rocket aircraft and projectiles were constructed.

One of the first undertakings of the group after the completion of the experimental sites was the building of a large, rotary type, proving stand. With the aid of this very necessary apparatus a great number of individual ground tests were performed. Details of performance were derived by means of a stroboscopic device for direct optical observation; and also a small recording cine-camera.

However, before relating details of the subsequent experimentation, a word about the propellant used. For technical reasons it was decided to employ "gunpowder" charges, and these were obtained commercially. Their manufacture followed the usual practice of pyrotechnics in that water in the charge served to minimise the risk of explosion, and the incorporation of linseed oil and lead oleate mixture limited the rate of evaporation. By this method it was made possible for complete rocket units to be kept in store for quite lengthy periods with a reasonable degree of safety.

As a further precautionary measure the rocket unit—consisting of a thin steel case and metal nozzle—was so designed that excessive pressure—about 400 to 500lb./sq. in.—would split the casing at the nozzle attachment (see Fig. 18), and thus merely

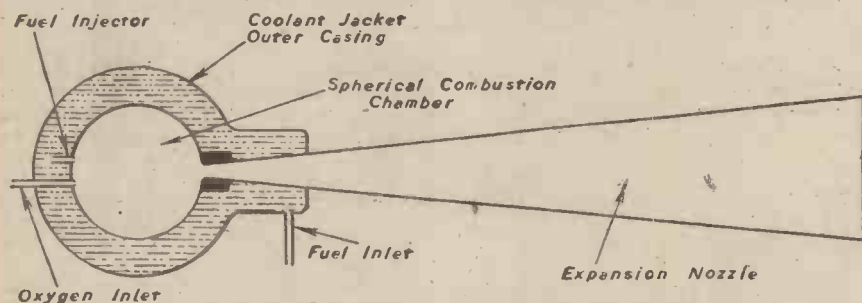

Fig. 17.—Diagram of experimental constant volume rocket motor developed by Dr. Eugen Sänger.

diesel injector pump. The fuel-feed operated at exceptionally high pressures, ranging between 450 and 2,200 lb./sq. in. Because of the high injection pressure, the combustion chamber received additional strength through the transmission of combustion stresses to the outer casing of the coolant jacket, via the high pressure fluid. With this point in mind, Sänger was able to design the combustion chamber with a minimum safety factor; and as a result, the chamber walls were quite thin.

The motor was tested on a simple proving stand, the thrust being indicated on a spring recording device. On several occasions, the motor developed a thrust reaction in excess of 55lb—the exhaust velocity varied between 6,600 to 11,500 ft./sec. During certain tests, compressed oxygen was employed in lieu of the liquid form.

British Research

The early development of rocket propulsion in Gt. Britain, owes much to a group of enthusiastic engineers who carried out extensive experimentation in Scotland during the 1930's.

However, their initial investigations and rocket trials date back to the 1914-18 war period, when preliminary work was conducted on the raising of the rocket's efficiency by the use of thrust augmenters. During these primary trials it was found that the developed thrust of a rocket projectile, fitted with a venturi augmenting device, could be almost double that of a "free-jet" rocket of identical mass.

velocity, high mass, efflux of burnt fuel and inducted air, instead of the high velocity, low mass, efflux of the un-augmented rocket power element.

Small-scale Rocket 'Plane Experiment

At Glasgow, in 1920, a demonstration was given of a simple tail-first model aeroplane propelled by a single powder-rocket charge. The 'plane flew for a distance of nearly three miles in the phenomenal time of one minute.

The fuselage of the model was merely a cardboard tube, 3ft. in length, and of constant section, 4ins. diameter. The propellant charge was contained within a steel-cased cylinder supported inside the fuselage tube at the aft end, and so placed that relative air entering at the nose flowed around the power charge, and passed out through the rear. The special nozzle had a jet discharge of 40 grains per second.

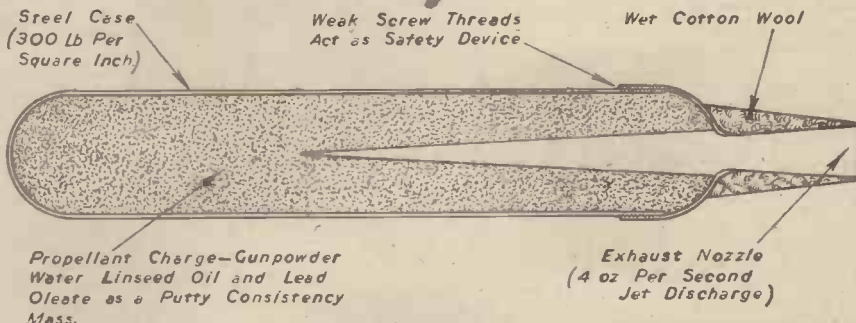

Fig. 18.—Section of a powder-charge rocket unit—4oz./sec. jet flow—developed in Scotland.

result in a mild explosion that did no serious damage.

In practice, the charges had to be made at least a week before use, and they would remain safely effective for three or four months. Many of the charges kept beyond this period either exploded, or, when put to test, failed to develop sufficient pressure to function the augments system with any degree of efficiency.

These brief observations serve to add further emphasis to the points already stressed regarding the severe instability of pre-mixed fuels.

Test Results

The rocket trials themselves were mostly made in conjunction with the proving stand. In these experiments the rocket unit under test was fired from a "starter tube." This was merely a tube of constant section—closed at one end—with an internal bore something in excess of the external diameter of the rocket unit. The principle of the "starter" is simply that the rocket, during its passage through the tube, serves to induct air through the tube "mouth," due to an initial vacuum effect created by the rocket exhaust within the tube. The air drawn into the tube

coolant for the vulnerable nozzle "throat." Used in conjunction with augmenters, this cooling system was only called upon to function during the first few moments of a firing run, after which the forced draught—due to the augments—served to remove the burnt wool, and, subsequently, cool the nozzle by air flow. The 40 grain/sec. nozzle, however, had no initial water cooling. Instead, a thin spun monel-metal jet was fitted. Otherwise, the nozzles were machined wholly from pure copper, although cast aluminium was also tried and found quite satisfactory.

Rocket-assisted Bi-plane.

As a demonstration of the capabilities of a small rocket unit fitted with augmenters, a suitable unit was fitted to a D.H. Tiger Moth, and by its aid was successfully assisted into flight. The device had an overall length of 1 ft., and was 1 ft. 6 ins. in diameter, weighing just over 33 lb. Merely 1 lb. of propellant powder supplied the propulsive jet, and the unit, in complete operation, developed a reactive thrust of 150 lb. up to 50 m.p.h. The power rating fell to only 100 h.p. at 100 m.p.h.

The Scottish group attribute these remarkable results, not entirely to the use of augmenters, but also to the metal, "de Laval" type, nozzles developed by G. Aldred, which

With thrust augmenters, this gave a thrust of six tons at forward speeds up to 80 m.p.h. The complete propulsion unit, which weighed two tons, had an overall length of 40 ft., with a maximum diameter of 20 ft.

Rockets in the Spanish Civil War

Mr. P. Blair—previously mentioned in connection with the Scottish research—working in Spain during the Civil War, took part in the development of several types of military rockets. The great majority of these were high explosive carriers, employing a liquid fuelled, constant volume, motor. As in the Scottish experiments, the rockets were fitted with thrust augmenters, and fired from a "starter tube." The launching apparatus, shown diagrammatically in Fig. 19, was a portable arrangement, and in order to absorb the thrust recoil in the starter tube the back end was not closed; instead a wood and cardboard cylinder, filled with water—which closely fitted the bore of the tube—was pushed into the rear. The backward pressure built up behind the rocket was taken by the block, which was ultimately blown out from the tube; the crew having previously taken cover at the sides.

The rocket projectile, shown in Fig. 20, employed paraffin as fuel, with liquid oxygen. It incorporated a one-stage augments, with a tail stabilising spinner. The initial weight of the projectile, fully charged with propellant, was approximately 48 lb. At the time of impact, on target, this weight was reduced to 30 lb., due principally to consumption of the fuel and oxygen, and also, because the augments and spinner were always torn away in flight by the pressure of the forced draught air flow. The projectile was ejected from the starter tube with a muzzle velocity of about 500 or 550 ft./sec., and accelerated at between 2 and 3g. on a high trajectory.

"Hot-spot" Ignition

The motors were fired by a development of "hot-spot" ignition, and, to facilitate starting, also pre-heated with oxy-acetylene flame jets.

A smaller version of the same type projectile, which weighed only 10 lb., was fired from a 50 mm. starter tube. These rockets had an extremely accurate trajectory and were effective in a high percentage of hits at 3,000 yards. At this range, their impact velocity was over 2,000 ft./sec.

These experiments with liquid fuelled war rockets proved clearly that by the proper use of the starter tube and thrust augmenters fully 80 per cent. of the fuel required in raising the speed from 0 to 2,000 ft./sec. could be saved.

Apart from the high explosive rocket, the Spanish Civil War saw the employment of powder charge rockets, containing propaganda leaflets, which were fired over the opposing lines. Similarly, "leaflet rockets" were used during the Russo-Finnish conflict, and also by the Germans in the invasion of Denmark in 1940.

is expanded by the rocket efflux, resulting in high pressures acting on the rear of the projectile to "push" it from the muzzle, much in the same way as a shell fired from a gun.

Most of the tests of units with augments attachments were made on the rotary apparatus, and during the course of numerous firings several highly conclusive figures were obtained of relative efficiencies in the employment of single and multi-stage augmenters. In the great majority of cases the entire augments attachment was torn off by the high velocity air flow. During one particular experiment, in which a three-stage augments was tested, the third stage was broken away at about 350 ft./sec. The second and first stage augmenters were likewise torn off at velocities approximating to 800 and 1,000 ft./sec., respectively.

Nozzles

Three type sizes of nozzle featured in the early work. The smallest used—40 grain/sec., jet flow—was designed for use with a charge case, 10 ins. in length, and 1.5 ins. internal diameter, which housed a propellant charge slightly in excess of 8 ozs. Another size nozzle—1/4 oz./sec., jet discharge—was fitted with a case, 5 ins. long and 3 ins. diameter, and contained a powder charge of just over 1 lb.

The 40 grain/sec. rocket unit, without augmenters, developed a thrust of approximately 1 lb. With augmenters fitted, the same unit proved itself capable of a consistent thrust of 6 lb., and in one particular test a 40 grain/sec. augmented unit achieved a thrust of 10 lb.

The larger type nozzles were ribbed externally, and, on test, wet cotton wool was pressed around the outside, which served as

gave a thrust three times greater than that of a similar commercially obtained rocket charge. By the use of augmenters, this reactive force was further multiplied more than ten times, while the same type augments device, fitted to a commercial rocket of identical charge, merely gave a thrust increase of three.

It is of particular interest to note that firing runs of over 30 minutes were obtained by the group, using nine individual rocket units fired in sequence and operated on the same principle of feed as the automatic revolver. With this device, it was found quite possible to maintain a constant thrust of 450 lb. at velocities up to 900 ft./sec. The complete unit, fully charged with propellant, weighed less than 750 lb., more than half this figure constituting fuel. The power ratio was thus a little under 1 lb./h.p.

Another experimental device employing a nozzle with a jet discharge of 2 lb./sec., is attributed to have developed fully 6,500 h.p. The jet velocity was given as 7,000 ft./sec.

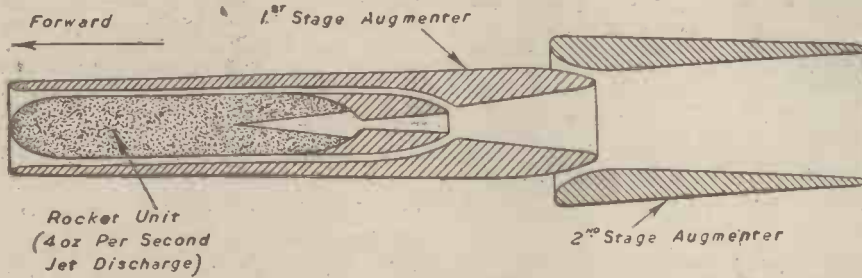

Fig. 19.—Sectional view of powder charge rocket unit with 2-stage augmenters—developed in Scotland (1936).

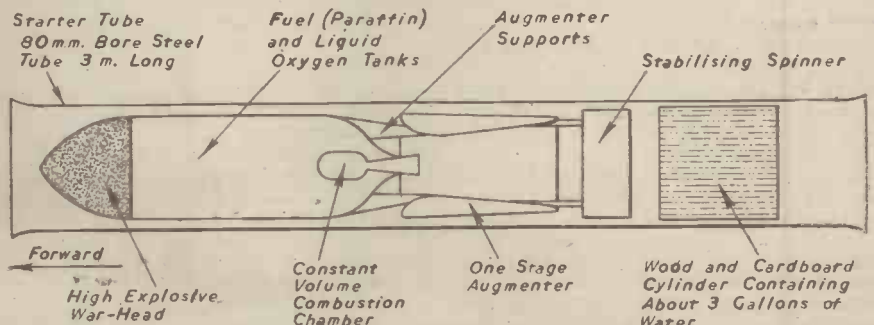

Fig. 20.—Diagram of one of the liquid fuelled rocket projectiles developed by P. Blair, and used with effect by Government forces in the Spanish Civil War.

Modern Power Transformers

Notes on Their Design and Function

By J. H. M. SYKES

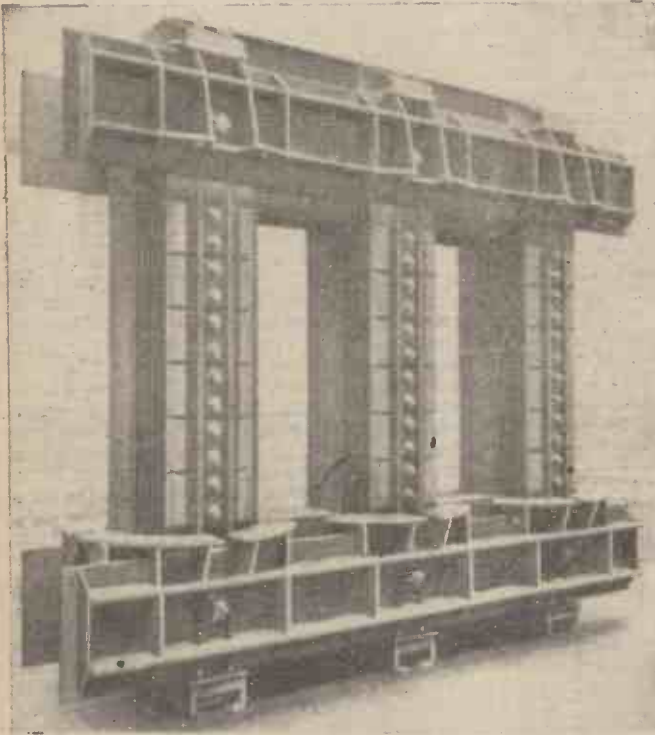

Fig. 1.—Large three-phase core with fabricated frame, showing tie-bolts and cooling ducts.

THE heart of the vast network of appliances which constitutes the electricity supply system of this or any other country is the transformer. Although it was originally conceived by Faraday in his momentous discoveries of the principles of electro-magnetic induction—and, indeed, its fundamental principles have not changed from that day to this—the transformer has gradually undergone successive stages of development until the modern large unit contains very many devices and design features of which Faraday would never have dreamed.

Essentials of Design

The essentials of transformer design can be simply stated. A magnetic circuit of a special type of iron has two separate coils wound on its circumference. Calling these the primary and secondary, we find that if an alternating voltage is impressed on the primary, then a voltage is induced in the secondary. The ratio of the number of turns in the primary to the number of turns in the secondary determines exactly the ratio of the two voltages.

This easy transformation of voltage has rendered possible the transmission of power over long distances by enabling supply engineers who wish to supply a given load at a remote point to do it by increasing the voltage and thus decreasing the current. Without the transformer the National Grid would be an impossibility, and all electric power would of necessity be generated in small local power stations.

The original experiments which led to the transformer being made a practicable proposition, used a core of solid iron, but the flux generated by the passage of current through the primary caused "eddy" currents to be formed within the structure of the iron, and internal heating, with consequent energy loss, was the result. The method of obviating this difficulty was to construct the core of laminated sheets with some thin form of insulation

cylinder insulates the low-tension windings. winding is usually typical core design, for a large three-phase transformer, is shown in Fig. 1, and by using laminations of this shape, the whole of the flux generated by the primary is caused to flow through the magnetic path provided and therefore cuts the secondary with the minimum loss due to leakage of flux. Fig. 2 shows the windings in position, on another transformer assembly.

Only the very smallest sizes of transformer are used in air, for in power transformers of, say, 10 kW or above, the designer will call for the whole unit to be immersed in a tank containing insulating oil. This oil serves a double purpose.

There are two types of losses which occur when a transformer is on load. First there are the copper losses due to the heating caused by eddy currents within the copper conductors themselves, and to the resistance drop due to the load current. Secondly there are the iron losses, which

between them, and modern transformer design still employs this method. The primary and secondary coils are usually wound one above the other, and very careful consideration is given to the rigid clamping of the coils so that the very severe mechanical stresses set up under short-circuit conditions will not cause displacement of the windings.

Coil Windings

The material of which the coils are made is copper wire or copper strip, and the insulation usually takes the form of a double covering of cotton. The windings are wound on formers which take the form of bakelised cylinders which are a tight fit on the limbs of the core. A similar high-tension from the core. The lower voltage on the outside. A

take two forms. There is the hysteresis loss in the core plates, and there are eddy current losses, which also occur in the laminations.

Hysteresis

Hysteresis is a phenomenon which occurs whenever iron [is magnetised. It is found that if an iron bar is placed in the path of a magnetic flux, which is built up to a maximum and then gradually reduced to a minimum, the iron will retain a considerable proportion of its magnetism. If, originally, soft iron is used, a mechanical tap will destroy this residual magnetism, which is thought to be due to intermolecular friction; but if the iron is undisturbed it will be necessary, if a magnetic flux in the reverse direction is now required to use a stronger magnetising force to build up a given flux density in the iron than would have been needed if the process had been started with an entirely unmagnetised bar. It is therefore obvious that the hysteresis effect causes a loss, and this loss varies with the "quality" or, more accurately, the chemical analysis of the specimen used. The best material from this point of view is silicon steel, but each manufacturer has his own special preference for the exact specification.

The second iron loss is due to eddy current formation in the laminations. This obviously depends on the density of the flux (fixed by other considerations), but the method of minimising the eddy current loss is to make



Fig. 2.—View from the high-tension side of the core and windings of a 15,000 KVA 66,000 to 22,000 volt transformer.

the plates as thin as possible, and to be sure of efficient insulation, not only between laminations, but between them and the bolts and clamps used to hold the laminations together. Modern designers have reduced the losses to a very small percentage, and it may be mentioned that an over-all efficiency (expressed as the output in watts, divided by the output in watts plus the total losses) of from 97 per cent. to 99 per cent. is always achieved in modern designs. Unfortunately, the 2 per cent. loss on a 30 MVA transformer is of the order of 600 kW., and all this energy is dissipated in the form of heat.

Cooling System

Returning to the oil, its primary purpose is to serve as the cooling medium, and by means of carefully designed ducts between the core and the windings, and between the different sections of the windings, permitting convection-driven circulation, the heat is carried away to the tank, and is consequently radiated from the external surfaces exposed to the atmosphere. To assist the cooling action the oil is—in any but the smallest sizes—also taken through additional cooling tubes welded to the tank and providing additional radiating surfaces. As the sizes get larger it becomes necessary to employ forced cooling of various forms. One form employs an external bank of radiator elements similar to those used in automobiles, over which a motor-driven fan forces a blast of air. To assist the circulation a pump is sometimes provided to force the oil through the radiators at a higher rate. In other types of transformer cooling lay-outs water pipes are inset in the tank in such a way that a forced flow of water through these pipes assists the natural convection flow.

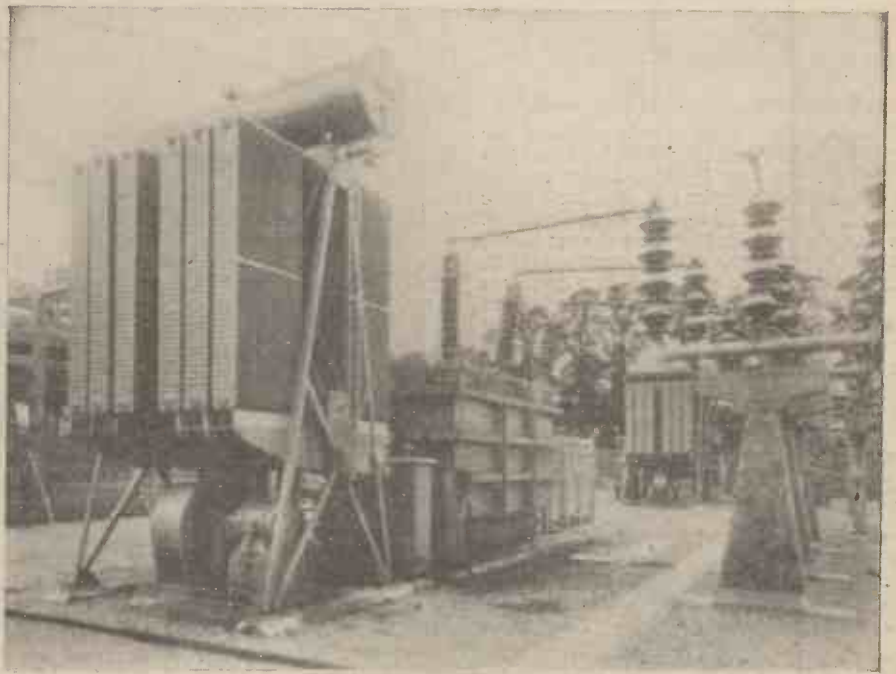

Fig. 5.—A 20,000 kW. 132,000-volt to 33,000-volt transformer assembly with cooling radiators and forced cooling by pump and fan.

The remaining purpose of the oil is to provide an insulating fluid inside the transformer tank. It is a mineral oil of a high flash point, and great care is taken to ensure that no moisture is permitted to gain access to the oil. The normal "breathing" which

occurs when the oil expands and contracts is arranged to take place through a mass of calcium chloride or silica gel, both of which are efficient dehydrating agents.

Fig. 3 shows a 50 kW. 11,000 to 400-volt transformer before assembly in its tank, and Fig. 4 shows the complete unit with the conservator, or oil reservoir, and the cooling tubes. In Fig. 5 is shown a 20,000 kW. unit.

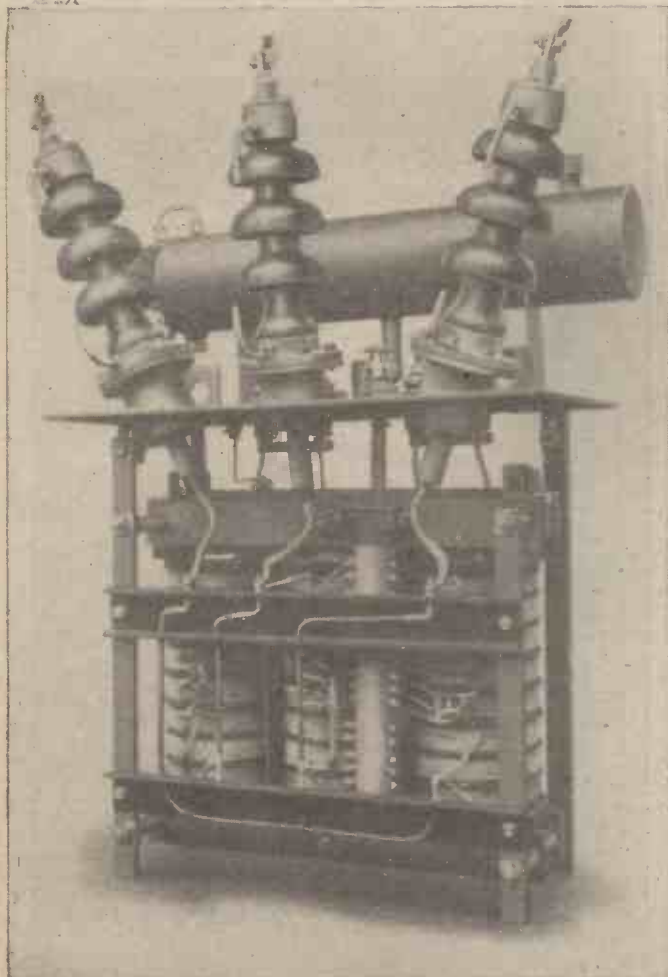

Fig. 3.—50 kW. 11,000-volt to 400-volt distribution transformer, showing core and windings.

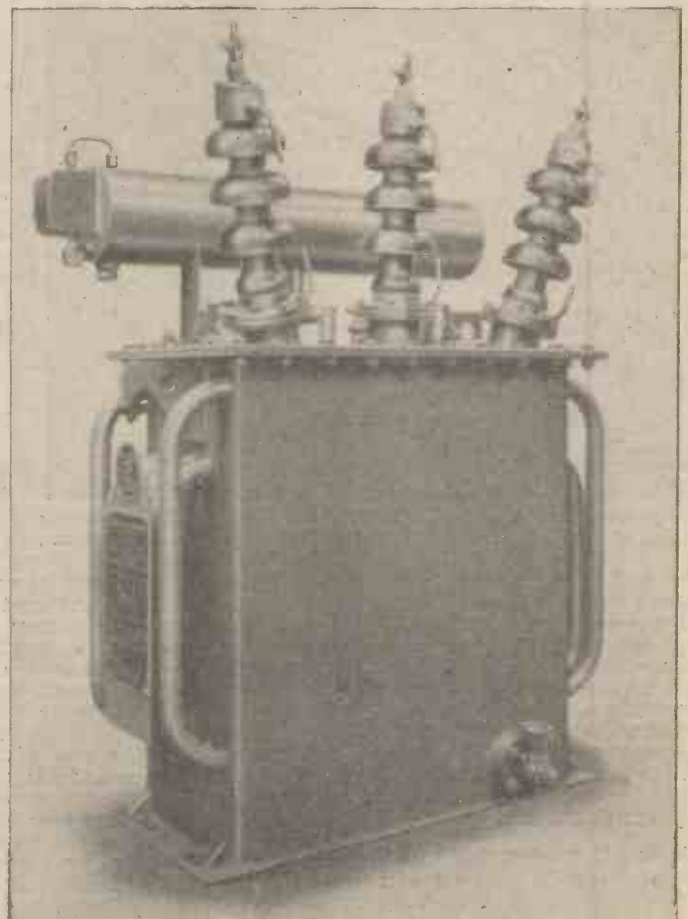

Fig. 4.—The transformer shown in Fig. 3, complete in tank.

complete with its additional radiators for forced cooling, with the fan for the air blast shown underneath the cooler.

Transformers for Special Purposes

Transformers are frequently required for special purposes, and Figs. 6 and 7 show two types built for low voltage, heavy current outputs, such as may be required for electric furnaces, or—rectified—for electro-plating. Fig. 6 is of a neat design where the secondary voltage is 15 volts, with a rectified D.C. current of 5,500 amps., and Fig. 7 shows the enormous amount of copper needed for a 60,000 KVA three-phase arc furnace transformer, with a low voltage output. For high voltages, transformers, though basically the same, assume a different aspect, and Fig. 8 shows a pair of 333,000-volt units

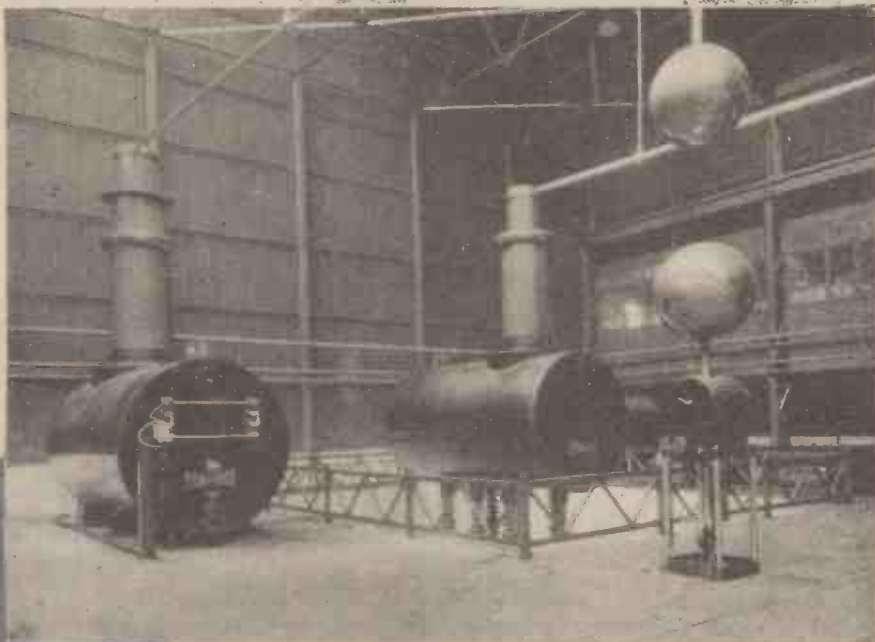

Fig. 8 (above).—The two 333,000-volt transformers shown here are connected in series to give 666,000 volts for use in a cable-testing laboratory.

rural areas often specify a transformer with, say, seven or eight tapped connections brought to a central link box which is easily accessible.

On-load Tap Changing

But this scheme involves the unit being taken off load, and this becomes impracticable when the larger sizes of transformer are used to give bulk supplies to whole communities. A method of on-load tap changing was therefore evolved.

(To be continued)

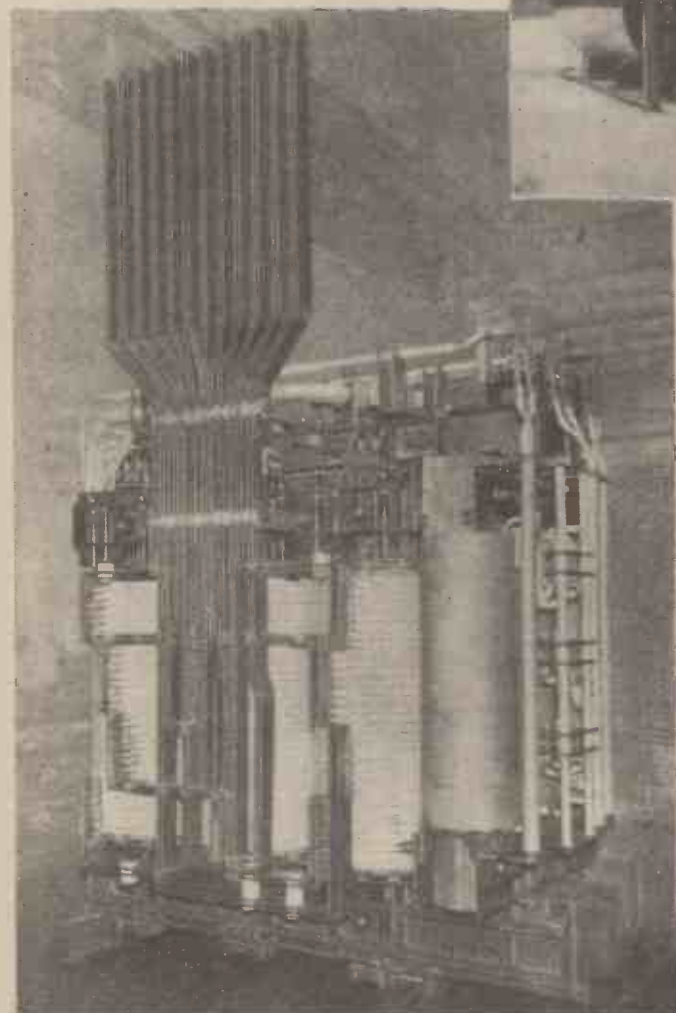

Fig. 7.—A transformer for use with arc-furnaces. The enormous amount of copper needed for the low voltage output is clearly shown.

of 500 KVA connected in series to give 666,000 volts for cable testing:

Modern research has resulted in detail improvements in every possible detail, from the iron core of the humble bell transformer used in domestic installations to the exact shape of porcelain bushing on a grid transformer weighing 100 tons; yet fundamentally the transformer remains unaltered, and has provided a lasting proof of the value of Faraday's pioneer research into electromagnetic phenomena.

Altering Transformation Ratios

Even the earliest designs of transformers were frequently equipped with a form of tapping switch, or perhaps a series of links, whereby the exact ratio of transformation

could be altered to suit local conditions; for instance, a transformer at the end of a heavily loaded spur line might have a voltage as much as 10 per cent. lower than normal applied to its primary terminals. If the ratio was unalterable the consumer would receive a lower voltage than that to which he is entitled by statute. But, by altering the ratio, it is possible to provide him with his standard voltage. Electricity undertakings in

Fig. 6 (below).—A transformer designed for heavy current output at low voltage. It delivers 3,000 amperes per phase, at 15 volts.

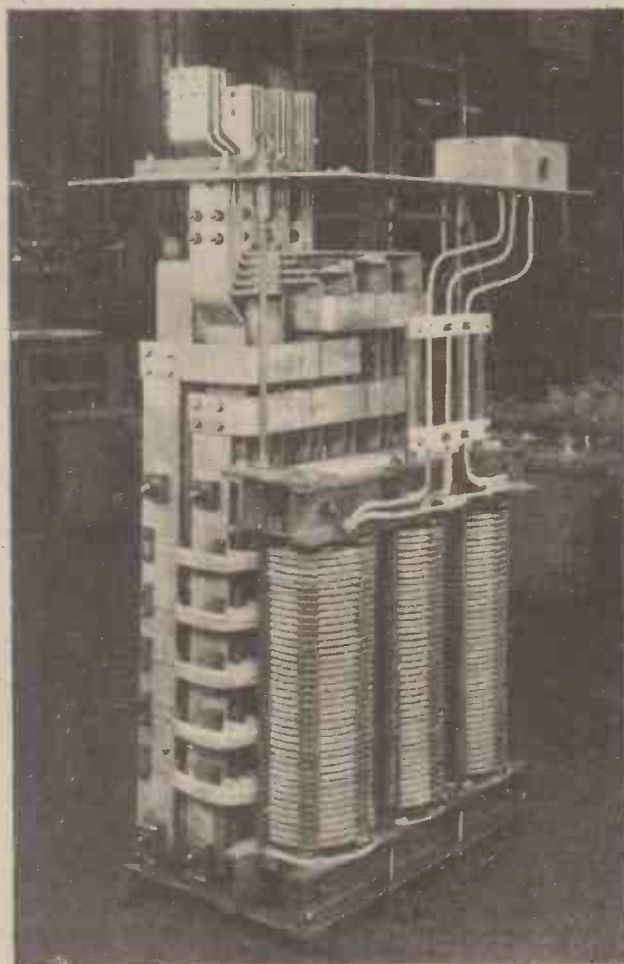

Modifying Car Dynamos and Starters—5

Conversion for Operation as Synchronous Motors

By D. E. BARBER

(Concluded from page 175, February issue)

IT has already been shown in the previous article that most of the methods of modification of automobile machines for use on A.C. are very unsatisfactory in the extreme, and cannot be used to serve any really useful purpose. The conversion outlined in these notes is, however, an exception to the rule, and quite good results have been obtained using these machines. There are certain limitations which are shared by all synchronous motors, and before proceeding further it is well that these should be enumerated. In the first place, the speed of a synchronous motor is fixed inflexibly by the supply frequency and no variation in speed is possible under operating conditions. If such a machine is overloaded, it pulls out of step and comes to rest. The second feature is that a synchronous motor requires a D.C. supply to excite its field system (except in very small machines), so that a battery or rectifier is needed as an auxiliary. The final drawback, and most important from the amateur viewpoint, is that the machine is not inherently self-starting, thus requiring some method of running up.

The best type of machine to use for modification is one having wide slots, since a rewind is necessary; as a rule this will eliminate starters and dynamotors as their slots are deep and narrow. Thus, a fairly large dynamo is indicated, preferably a four-pole machine as it has been found that two-pole machines sometimes give unstable running when operating as synchronous motors.

Mechanical Modifications Required

The field system will not require any alteration other than whatever cooling modifications are being carried out. There are, however, certain radical changes to the armature; this should be stripped of all its windings and the commutator can then be drawn off. This can usually be accomplished with the tackle shown in Fig. 16 which is self-explanatory. Two slip-rings are assembled in place of the commutator, and to conserve space it is suggested that surface disc-type slip-rings are used with the appropriate brush gear as shown in Fig. 17; a more elaborate type of brush gear can be incorporated if desired, but the writer has used the type illustrated and has experienced no trouble. To facilitate the winding of the armature, the slip-ring assembly should be carried out last.

Armature Winding

To find the correct number of conductors to put on the armature, it is necessary to know the working value of the flux in which the armature is running. One way to estimate this is to use the open circuit saturation curve taken on the original machine before modifying, and a point near the "knee" of the curve should be selected from which the field current required to generate a certain voltage can be ascertained. This value of field current is important as it represents the nominal excitation of the final synchronous motor. The speed at which the test curve was taken will be approximately known so that these various items can be substituted in the following formula which will give the effective flux for the chosen point.

$$\text{Flux} = \frac{\text{Volts} \times 100,000,000 \times 120}{\text{Total armature conductors} \times \text{r.p.m.} \times \text{number of poles on machine.}}$$

The number of armature conductors can be counted when stripping the winding; the above formula assumes that the original armature winding has two parallel circuits, the vast majority of car dynamos being of this type.

To estimate the number of conductors for the new A.C. winding a second formula must be used and the flux value derived from the first must be substituted in the second as follows:

$$\text{Total conductors required} = \frac{\text{A.C. supply voltage} \times 100,000,000}{1.5 \times \text{supply frequency} \times \text{flux value}}$$

The size of wire to use for the armature winding can be found by measuring up the winding space area of each armature slot. Reference to standard wire tables will then establish the largest gauge which can be used so as to get the correct number of conductors

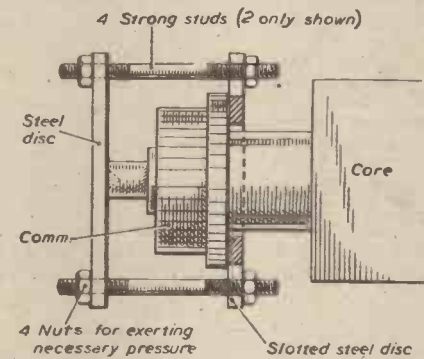

Fig. 16.—Drawing-off tackle for removing commutators.

per slot. When figuring this out an allowance should be made for the space taken up by the slot insulation, which will be influenced to some extent by the voltage at which the machine will eventually work. A rough guide as to the current rating of the armature can be obtained by multiplying the copper sectional area of the particular conductor by 3,000, the result giving the current in amps. which the winding could be expected to carry continuously without overheating. With exceptionally good ventilation, or in the case of short time rated machines, this constant can be increased to 3,500 or even 4,000.

"Concentric" Winding

The type of winding most suited to amateur machine construction is known as the "con-

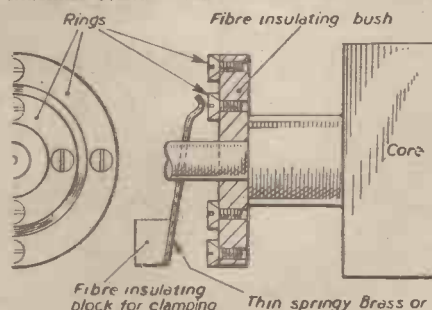

Fig. 17.—Mechanical assembly of slip-rings and brushes.

centric" winding and reference to Fig. 18 will show that this winding is very different from the usual D.C. armature winding. All the coils are formed into as many groups as there are poles on the machine, and Fig. 18a illustrates a 25-slot armature wound for a two-pole field, while Fig. 18b shows the same armature wound for a four-pole field, the total number of conductors being the same in either case. An odd number of slots has been deliberately chosen in the example as most medium and large car dynamos are provided with odd slot armatures, and the illustrations are intended to show how the winding layout is adjusted to meet this eventuality. As will be realised, the resulting winding is by no means ideal, being both electrically and mechanically out of balance, but in practice no trouble is likely to be experienced from this cause.

Examination of Fig. 18 shows that one or two slots in the centre of each group are left empty when winding and the reader may wonder for what reason this is done. The fact is that the coils near the centre of each group, being of only small span, are not so effective in producing voltage as the larger span outside coils, and as they represent so much extra resistance in the circuit, it is usual to exclude the centre coils from the winding. Allowance should be made for this when working out the number of conductors per slot since, in effect, the number of active slots is thereby reduced.

The actual winding process is commenced by putting into position the insulating slot linings for the whole of one pole group. Starting with the large span coil, the required number of turns should be wound on and then, without cutting the wire, the next coil in the group can be wound, in the same direction as the first; the procedure is continued until all the coils in the group are in position. The winding of the second group can follow; as before, the slot linings should be inserted first and the actual winding operation will be identical with that of the first group except that the direction of winding should be reversed so as to produce the opposite magnetic polarity, which should be checked with a compass needle when the whole armature winding is complete. From the point of view of securing the coils in the slots and regarding the dipping of the finished armature, the normal practice as outlined for D.C. machines will be quite satisfactory.

The assembly of the slip-rings on to the armature shaft can now be carried out, and all that then remains is to connect up the two leads from the winding to the rings. Soldering is one way to accomplish this or, alternatively, a small screw threaded into the back of the ring will hold the wire in position. If desired, the faces of the slip-rings

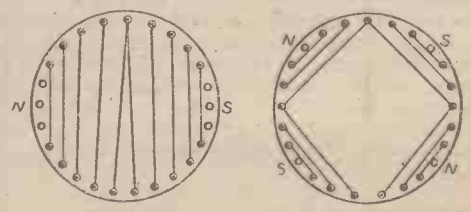

Fig. 18.—Winding diagrams for two- and four-pole fields.

can be skimmed up in a lathe, this being a good idea as it trues them up relative to the shaft.

The Field Coils

If a suitable D.C. supply is available the original field coils can be used without modification, but more often than not the only available supply for field excitation is at some different voltage so that a new set

constitutes the chief argument against the use of this type of motor for amateur use, although some satisfactory arrangement can invariably be found. Thus, if the motor is used to drive a generator for battery charging, the generator can be run as a motor for the starting period, current being derived from the batteries. There is plenty of scope for ingenuity in this matter, and to go to the extreme, the writer developed one scheme

tendency for this current to alter with excitation. The region of the curves above the dotted line denotes unstable running, test figures here being obtainable only with difficulty.

From the foregoing paragraph it can be seen that there exists a certain excitation value corresponding to the minimum current in the armature. Since high values of armature current will be accompanied by excessive copper loss, it is obviously economical to excite to the value mentioned above; the machine is then said to be operating at its maximum power factor and this is the ideal which should be aimed at when setting the final value for the field excitation.

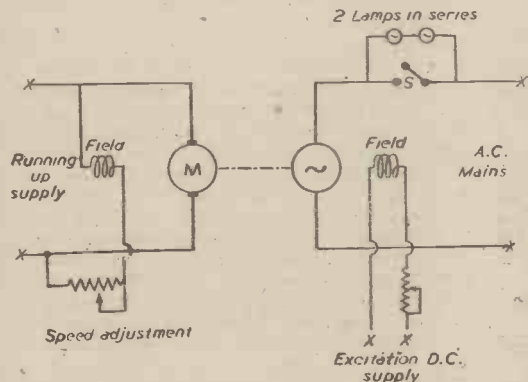

Fig. 19.—Circuit for starting up.

of coils will have to be wound. The design of a suitable field winding is exactly the same as that of a D.C. machine shunt coil and the formulae set out earlier in this series will provide the necessary information. As pointed out earlier, the nominal value of excitation should be assumed for this calculation.

Running Up the Machine

In order to test out the machine, it should be coupled up to some other motor which should be capable of taking it a little higher than its rated speed when nominally excited. In addition, it is advantageous to be able to make a fine adjustment of the speed of this running-up motor. The speed at which the synchronous motor will run is given by the formula:

$$\text{R.P.M.} = 30 \times \text{supply frequency} \times \text{number of poles}$$

so that a four-pole machine running from a 50-cycle supply would have a constant speed of 1,500 r.p.m. and a suitable running-up motor would be required to have a top speed of, say, 1,600 r.p.m. The circuit used for starting is shown in Fig. 19 and the correct procedure is as follows:

Excite the synchronous motor field to the nominal value and switch on the mains, first making sure that the switch S is open. The two lamps, each of which should be of mains voltage, will then light up dimly and the set may be started up by means of the running-up motor M. As the machines accelerate, the lamps will begin to flicker, quickly at first, but with decreasing frequency, until finally, at exactly "synchronous" speed, no light will be emitted at all. If the speed is allowed to rise beyond this point the lamps will begin to flicker again, this time with increasing frequency, and the running-up motor should be adjusted to bring the revs. down to the point where the lamps are again black. When this occurs the switch S may be closed, when the synchronous motor will be connected on to the mains and should pull into step at once; it is usually easy to tell when this happens, as a difference in the noise note of the machine will be noticed. The running-up motor can then be disconnected from its supply and the set will then continue to run at "synchronous" speed. This operation is called "synchronising" and should not give much trouble in such small machines; if it is found that after synchronising the machine "hunts," that is, fluctuates in speed in a periodic manner, experiments can be made with different values of excitation to determine the most suitable condition for stable running.

This rather complicated method of starting

whereby all the switching was done by means of relays which operated automatically from a centrifugal switch when synchronism was reached; another feature of this arrangement was the decoupling of the running-up motor after the starting sequence had been completed, this being made possible by the use of an electrically operated magnetic clutch.

The Operating Characteristics of Synchronous Motors

Finally, a word or two on the operating characteristics of these machines may not be out of place. As stated earlier, they run at only one speed, irrespective of the mechanical load on their shaft, and if overloaded they stop immediately and will burn out if not disconnected from the supply.

If a synchronous motor is running "light," that is, supplying no mechanical output, the armature current which it draws from the supply can be made to vary over quite wide limits by adjustment of the field excitation current. Curve (a) of Fig. 20 shows this no-load "V-curve" (so called because of its shape) and was actually taken on a modified two-pole car dynamo running from a 75 volt 50-cycle supply, the synchronous speed being 3,000 r.p.m. Similar curves were taken with the same machine operating with shaft loads of 150 and 300 watts, as shown by curves (b) and (c), and it will be observed that these are much flatter since the line current now contains a power component which swamps the

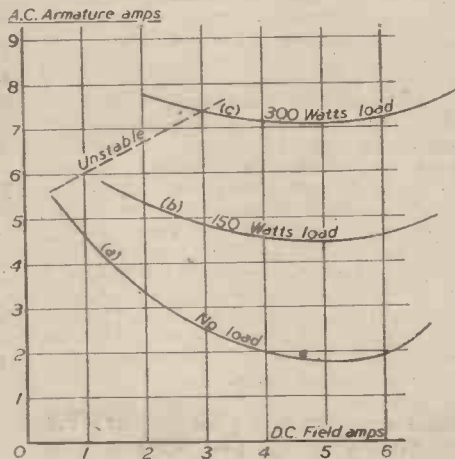

Fig. 20.—Synchronous motor "V-curves."

Such is the synchronous motor, and quite apart from the use to which it can be put, many interesting experiments can be carried out on it. In efficiency, it is far ahead of the other modified solid yoke machines operating on A.C. supplies; this is because the yoke carries only a steady unidirectional flux.

Mobile Ammunition Repair Shop



Part of a mobile ammunition repair centre, the first of its kind in this country. In the illustration British soldiers are seen buffing up the bodies of reconditioned shells.

NEW SERIES

The Annals of Electricity—2

Dr. Gilbert and the Beginnings of Electrical Theory

IF any one individual formed a distinct link between the nebulous theories of the ancients concerning magnetism and frictional electricity, and our present-day theories and practical utilisations of those forces, that person was surely the renowned Dr. William Gilbert, President of the Royal College of Physicians, Physician-in-Ordinary to Queen Elizabeth, and to her successor James I of England.

Gilbert's name is still famous the world over. Smith minor, budding scientist of his school's lower form, may perhaps be excused for informing us that Dr. Gilbert of Colchester invented the magnet, and made the first electrical frictional machine. Frictional electricity, "in the mass," as one might say, did not come until nearly a hundred years after Gilbert's time, whereas the magnetic properties of iron and of iron ore ("lodestone") were, as we saw in our previous article, known and recognised centuries before the advent of this particular Royal Physician.

Gilbert's greatness in electrical history derives from the fact that not only did he

was, perhaps, to him merely an interesting sideline. Nevertheless, it constituted a sideline which effectively sealed his fame and resulted in his being, in after years, given the title of the "Father of Frictional Electricity."

Colchester Born

Gilbert was born at Colchester in 1540.



Dr. William Gilbert, of Colchester, Physician in ordinary to Queen Elizabeth and King James I.

His family name seems to have been Gilberd, but, either intentionally or otherwise, it became changed to Gilbert by the time this individual reached maturity and fame. Of his earliest days we know nothing. He was educated at Cambridge, and later qualified as a medical man, taking his M.D. at some Continental medical school, and from 1573 he settled in London and established a lucrative and a successful practice in that city. He was elected a Fellow of the Royal College of Physicians in 1573, and eventually he became the President of that august body.

Gilbert's medical abilities must have been considerable, for his fame extended quickly to the Court circles. Queen Elizabeth,

the then reigning monarch, made him her personal physician, granting him a considerable annual pension.

Gilbert, previous to his removal to the English Court, seems to have established a sort of private hospital on or near Tower Hill, London. Perhaps it was an Elizabethan equivalent of our modern English "nursing home." At any rate, it was probably in this Institution that some of Gilbert's experimental work was done, although we have by no means any direct evidence of that fact.

There is no doubting that William Gilbert, quite apart from his medical fame, constituted the scientific star of Elizabeth's reign. Indeed, setting aside the claims of Friar Bacon, he was the first real scientific experimentalist which Britain has produced. Yet, strangely enough, the whole of Gilbert's epoch-making experiments were conducted by him entirely in his spare time and, to some extent, for his own personal amusement.

For seventeen long years he patiently plodded away at his magnet trials, at his simple playings with the attractive force of rubbed amber, at his extensive and comprehensive investigations into the past history of these subjects, and at his theorisings concerning them.

"De Magnete"

Eventually, the whole of Gilbert's work was summed up in his famous book about the Magnet. *De Magnete*, a ponderous folio tome, written in equally ponderous Latin, as was the style of the day, was published in 1600. Its complete title was *De Magnete Magneticisque Corporibus, et Magno Magnete Tellure, Physiologia nova*, which may best be translated into English as "Of the Magnet and Magnetic Bodies and that Great Magnet, the Earth."

Curiously, although Gilbert's *De Magnete* made such a stir in history it was never reprinted or translated into English until the beginning of our present century when, in 1900, it was issued in an English version by Professor Silvanus P. Thompson, the famous mathematician and physicist.

De Magnete is one of the world's most famous books. Yet few present-day science students have ever read or even examined it in its modern translation. The book, not so much by its mere contents, but rather as a result of the new spirit of practical scientific inquiry which it represented, heralded the coming of practical science and of direct experimental inquiry. *De Magnete* is, of course, the world's first text-book on Magnetism and Electricity, and we can recall with pride the fact that this truly momentous



Dr. Gilbert engaged in the composition of his famous treatise, *De Magnete*.

investigate for the first time the properties of magnetic substances. but that he also experimented with frictional electricity and showed that this phenomenon was different from that of pure magnetic attraction.

But Gilbert never got so far advanced in his studies as to construct a continuously working machine for the generation of frictional or static electricity. Possibly, he never generated a single electric spark. Most of his studies were given over to magnetism; the attractive force of rubbed amber and other materials



A modern pocket compass. It should be noted that the indicating scale came years after the death of Gilbert.



The pivoted magnetic needle, the properties of which Dr. Gilbert used for his investigations. Note the dip of the needle.

volume, and the researches which it describes are entirely of British origin. Thus Electrical Science first reared itself on English soil, gradually extending itself thereon and fructifying so enormously some two and a half centuries later in the hands of the immortal genius, Michael Faraday.

It is in *De Magnete* that we find a full account of all Gilbert's scientific work. Most of the volume is given over to researches in magnetism. Only a single chapter is concerned with investigations into electricity. Yet it is to Gilbert that we owe our present word, "electricity," although, in his book, he only uses it in the form of an adjective—*electricam*.

Electricity of Friction

The ancients knew that when amber is excited by friction it acquires the property of being able to attract to itself light bodies, such as pieces of fluff, dried leaves, and so on. Gilbert started off on his researches by asking himself why this property should be confined *only* to amber and to tourmaline, a semi-precious stone. He tried to discover an attractive property in water, in oils and metals, but totally failed to do so. Nevertheless, he discovered that glass, sulphur and many precious stones shared this attractive property with amber. He also noted the important fact that the attractive property was much more in evidence and persisted longer in dry atmospheres than in moist ones, and that an excited body loses its attractive property completely when moistened.

Gilbert realised quickly that the attractive property of rubbed substances was not the same as the magnetic attraction of a lodestone or a piece of magnetised iron. Yet he emphasised that there existed a relationship between the two phenomena, a relationship which we moderns utilise nowadays in the guise of electro-magnetic induction.

Gilbert's idea of frictional electrical attraction was conceived on traditional lines. He said that amber and other rubbed bodies exhaled a subtle, imponderable *effluvia* which united any light body in the neighbourhood of the excited substance, thus making one body out of two.

"Electrics"

Gilbert divided up all materials into two classes. Those which became attractive after rubbing he termed "electrics," from *elektron*, the Greek word for amber. All others were

"non-electrics." Here, of course, we have Dr. Gilbert sponsoring for the first time the introduction of the word "electric" into the English language.

We now know that every material substance develops an electrical charge after rubbing, but that when the substance is of a conductable nature (as, for example, in the case of metals) the charge at once leaks away. It is only with insulating materials that the existence of the charge is manifested in the ordinary way. Had Gilbert been able to perceive the fact that a metal mounted on an insulating material would function as one of his "electrics" he might have made more electrical discoveries than was actually the case.

We now know that the development of an electric charge on a substance which has been rubbed is simply due to the tearing away of surface electrons by friction, thereby leaving a preponderating positive charge of electricity on the material. This explanation, naturally, was far beyond Gilbert's conception.

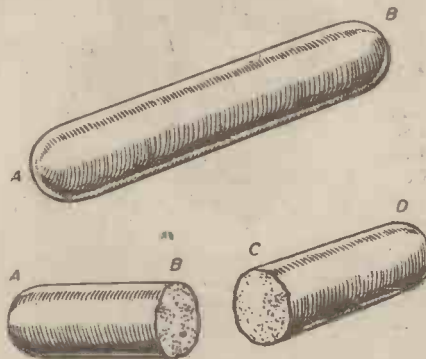

Illustrating Gilbert's experiment on the division of the lodestone. A single magnetised body, on being divided, becomes two bodies, each endowed with magnetic polarities.

It is curious that Gilbert never went forward to the next step in the investigation of his "electrics." He never seems to have conceived the notion of mechanically revolving an insulating or "electric" substance in contact with a frictional substance such as silk or hair, and of thereby generating more intense "static" charges which would show themselves in the form of electrical sparks. That honour went some forty or fifty years later, to the celebrated Otto von Guericke, the experimentally and mechanically inclined Burgomaster of Magdeburg, the inventor of the vacuum pump and of the first electrical friction machine.

All, therefore, that Gilbert did in connection with electrical knowledge was to differentiate between electrical and magnetic attraction, to extend the known range of electrifiable materials, and to give some sort of a reasoned explanation of these two phenomena. In other words, Gilbert set the ball rolling in connection with the development of electrical knowledge.

In the realm of magnetism, Dr. Gilbert was more prolific, this constituting the main theme of his spare-time studies.

Mariner's Compass

In considering the import of

Gilbert's magnetic researches we should realise that the mariner's compass was in existence long before his time, being introduced into Europe from the East (probably from China), about the twelfth century. The first of these compasses was merely a piece of wood-framed lodestone which was floated in a vessel of water. The pivoted needle was of later origin, but even this came before Gilbert's time.

Gilbert began his work on magnetism by firmly rejecting the many previous ludicrous theories concerning it which had formerly been held, such as, for instance, that magnetic attraction had miraculous curative powers, that lodestones lose their attractive force when smeared with garlic but regain it when coated with goat's blood, and so on.

The "Versorium"

He showed that a lodestone has poles of opposite attraction, and he constructed a *versorium* consisting of a small compass needle on a pivot. A spherical lodestone was obtained and the *versorium* was laid on the stone. The direction in which the *versorium* needle aligned itself was marked on the stone by a chalk line, which was then extended so as to form a circle. By repeating this experiment with the *versorium* at different positions on the spherical lodestone a series of chalk lines were produced each of which passed approximately through two opposite points or "poles" on the stone.

Gilbert also showed that if a magnetic body is divided up into two parts, each part becomes a complete magnet. A lodestone cut into two pieces does not lose its magnetism. Instead, it becomes two complete lodestones.

Again, Gilbert found that it was possible to construct chains of lodestones by enclosing a separate lodestone within each link of an iron chain. By this means he was able to increase the magnetic power of the individual stones.



The peculiar arrangement of iron filings round a horseshoe magnet, revealing the "lines of force" around the magnet. Dr. Gilbert made a correct conception of a field of influence surrounding a magnetic body.

"Terrella" or Earth Model

Arising out of these experiments, Gilbert was led to conceive the earth itself as consisting of one gigantic lodestone having poles at opposite points. He made a miniature earth out of a piece of lodestone. This he termed a *terrella*. And by experimenting with different positions of a magnetic needle in proximity to the *terrella* he conjectured that the "dip" of the needle (a phenomenon which had been previously discovered by Robert Norman, a London compass-maker, in 1581) would be greater near the poles of the earth than it is in London.

Gilbert himself had no means of proving this contention, but it was afterwards shown to be true by the explorer Hudson during his voyage to the Arctic regions in 1608. Gilbert, however, had been dead for five years at the time of Hudson's discovery.

The similarity between the earth itself and the *terrella* or model thereof led Gilbert to suppose that just as the magnetic influence

extends outwards from the *terrella*, so, also, must the earth's magnetic influence proceed outwards into space from it. He was then led on to the idea that all the heavenly bodies are endowed with magnetism, and, in this way, he attributed the earth's motion in space to magnetic attraction. Here, of course, he was at fault.

Deviation of Compass Needle

The variation of the earth's magnetic north pole from the true North was the discovery of the famed Christopher Columbus during one of his voyages to America. Gilbert was aware of this fact, but his explanation of it was that the magnetic north pole and the true north pole are in reality coincident and that the compass-variation is caused by its needle being slightly deflected out of its true-north alignment by the presence of large masses of magnetic material in mountains or other irregularities of the earth's surface.

An ingenious explanation, to be sure; but, again, one which later science found to be incorrect.

Royal Experiments

Queen Elizabeth of England seems, in her later days, to have interested herself in Gilbert's experiments. The worthy physician is supposed to have amused that royal lady by performing many of his experiments before her, and in the presence of other members of the Court.

However, on the death of the Queen in 1603, Gilbert transferred his allegiance to James I, by which monarch also he was granted a pension and continued in his post of "Physician-in-Ordinary." But his life's work had, at this time, arrived at completion, and on November 30th of the same year he also died, being buried at Colchester. He left his experimental apparatus to the Royal College of Physicians, but they afterwards suffered complete destruction in the Great Fire of London.

Items of Interest

Flying Postman's 8,000-mile Round

MAIL for R.A.A.F. personnel in the Philippines is supplied by one of the longest "courier" runs in the history of Australian aviation.

Excluding the Australians on Leyte and Mindoro islands in the Philippines, the furthest R.A.A.F. mail distribution base is 4,000 miles from Melbourne. Yet mail from Melbourne reaches this base in Western Dutch New Guinea only two and a half days after leaving Melbourne.

The round trip from Essendon, a Melbourne airport, to this outpost and return, involving about 8,000 miles of air travel, is made twice a week and takes little more than four days. It is, therefore, possible for a reply to a letter from Melbourne to be in the writer's hands in five days, though this would involve the serviceman recipient meeting the aircraft, and writing a reply on the airstrip to be picked up by the aircraft, which stays at the advanced base only three-quarters of an hour. The actual flying time for this service is 47 hours for the round trip of 8,000 miles. The courier stays overnight at four points.

The regularity and reliability of this service are appreciated by troops whose only link with home is by letter.

Bomber Command's Meteorological Flight

EVERY hour of the twenty-four, two Mosquitoes and their crews are waiting at a R.A.F. Bomber Command Station, ready to take off to anywhere from the Arctic Circle to the Mediterranean, even in weather when no other aircraft will be flying. These aircraft belong to the Meteorological Flight, manned by a small body of some of the most experienced airmen in the R.A.F.

For three years they have flown over Germany before every major attack by Bomber Command and, until recently, before every U.S.A.A.F. attack as well.

If they see an icing cloud which any other pilot would avoid, they go out of their way to fly through it. They are prepared to break cloud at a height of a few feet above Germany, and to fly the rest of the way home at tree-top height, or to make blind landings in fog, or with the cloud almost down to the surface of the airfield.

Moreover, it is their tradition that they never refuse a flight. And it was recently found that the average number of operational flights by each member of the Flight was 87, and that the Flight had won as many awards as there were men in it. They probably do more actual flying over enemy

territory than any other formation of the R.A.F.

When H.M. the King flew to Italy, a Mosquito of this Flight went ahead to keep a watch on the weather. Mosquitoes of this Flight have also been detailed to go ahead of Mr. Churchill.

In September, 1941, a question about the weather over the Continent arose, and could not be answered by any of the ordinary methods of forecasting. Accordingly, arrangements were made for a weather reconnaissance over enemy territory.

That was the beginning of this Met. Flight Unit, which for some time operated with R.A.F. Coastal Command, but in the spring of 1943 was transferred to R.A.F. Bomber Command—since more and more of its flights were being made to obtain information for use in forecasting the weather for bomber operations—and placed under the Pathfinder Force.

The Flight used to fly Mosquito IVs, but later was re-equipped with the pressure-cabin Mosquito XVI, which it now flies.

Over Germany

A MET. flight over Germany is normally planned so that the Mosquito lands some time before the heavy bombers are due to take off. But this is not always possible, and there have been instances where an operation was cancelled five minutes before take-off time, or even after the bombers were air-borne, on the report of a Met. Flight pilot.

Security is the constant pre-occupation of everyone associated with the Met. Flight because it is so much concerned with future operations.

Its busiest week, for example, was just before D-Day, when its aircraft were constantly over the Atlantic. Reports of men of the Flight helped to decide the fate of the *Tirpitz*. They fly over Germany by night as well as by day.

In the darkness, they often use flares to light up the clouds and observe their height, one of the main questions which the crews have to answer. The aircraft carry several cameras, and their crews photograph not only the weather, but anything in enemy country that may be of value to the Intelligence Sections of the R.A.F.

A photograph taken from an aircraft of this Flight, for example, led to an attack by the U.S.A.A.F. a short time after, on the V-Weapon Research Station at Peenemunde.

Routes must be well planned, yet in the shortest possible time, so that the Met. Flight navigators have a great responsibility, and crews are carefully briefed on the type of meteorological information required. The crews seldom fly to the actual target for a pending operation, but to the point from which the weather, as it will be over the target, is coming.

A comprehensive picture of the weather over the whole route, rather than a series of disconnected observations, is what is needed.

Johnson's Photographic Competition Prizewinners

MESSRS. JOHNSON & SONS, manufacturing chemists, of Hendon, London, N.W.4, have forwarded us the list of prizewinners in their November, 1944 photographic competition, which proved extremely popular.

The winners of the two first prizes of £5 are: Mr. P. Acomb, 52, Bishopthorpe Road, York, and Mr. R. Ernest Scott, 2, Mourne Villas, Strabane, N. Ireland. Three second prizes of £2 each are awarded to Mr. Llew. E. Morgan, of Swansea, Mr. F. Callon, of Wigan, and Mr. Wm. Ross, of Lisburn, Co. Antrim.

There were also ten third prizes of £1, twenty prizes of 10s., and twenty-five consolation prizes awarded to other successful competitors.

Diascopes and Episcopes

(Continued from page 199)

two small screws (Figs. 1, 2, and 3). Fig. 6 gives the dimensions of the upper and lower mirrors. The front edges of the mirrors should be as near as possible to an imaginary line passing through the centre of the lens, but must not encroach on the screen picture. The latter condition will be satisfied if the mirrors can only just be seen on looking into the lens.

The fitting of the device for holding the picture at the back of the projector is fairly clear from Figs. 1 and 10, a section cut from an old motor-car inner tube making an effective rubber band. Three wooden rails, about 1in. by 1/2in. section are fitted to the underside of the projector, to provide clearance for wiring, etc. One of them is shown in Fig. 3. Small rubber buffers should be fitted at the four corners.

New Edition
NEWNES ENGINEER'S
VEST-POCKET BOOK!
 By F. J. CAMM 7/6 or by post 8/-
 Obtainable from all booksellers, or by post from,
 George Newnes, Ltd. (Book Dept.), Tower House,
 Southampton Street, London, W.C.2.

THE WORLD OF MODELS

Models from the Continent, and Continental Model News

By "MOTILUS"

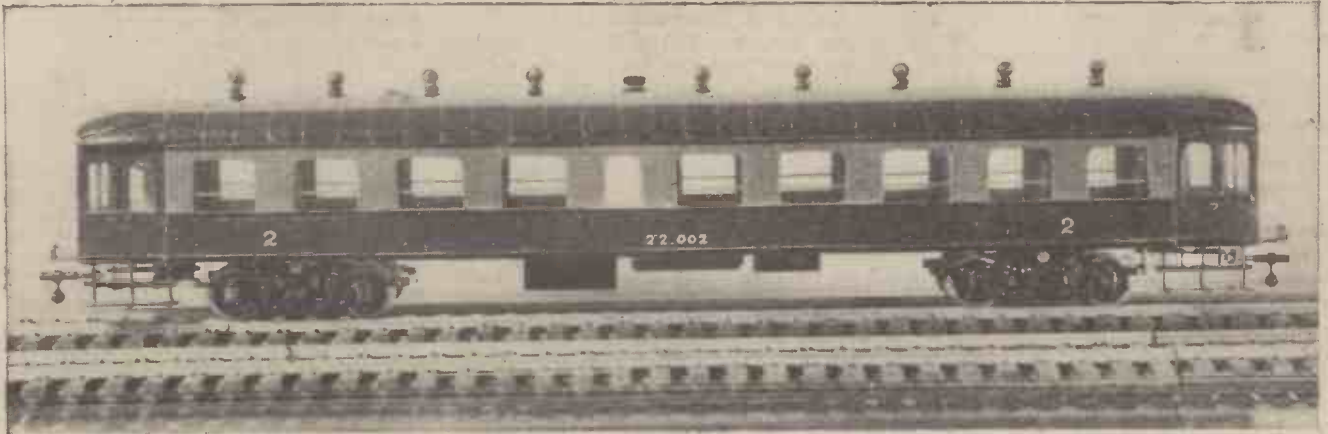

Fig. 5.—A model by the Belgian firm of *Chemins de Fer, Aviation, Marine*, of an up-to-date coach on the "bloc" or built trains running between Antwerp and Brussels. This is a model of a second-class coach and the finish and detail are excellent.

Model Pre-built Pierhead

THERE is no doubt that one date during this war will be remembered by we British, and passed on by us to posterity, and that is June 6th, 1944—D-Day

Models again played a big part in the planning for D-Day, and here is one made by Bassett-Lowke, Ltd., of a spud pierhead, one of many models made, the prototypes of which were towed across the Channel to

Arromanches, to make up a pre-built port as big as Gibraltar off the coast of Normandy.

The illustration, Fig. 1, shows a model which demonstrates the working of a pierhead pontoon. The spuds or large columns at each corner of the pontoon rest, in the real thing, on the sea bed, anchoring the pontoon, which can slide up and down with the rise and fall of the tide, and thus function as a floating pier.

Each L.S.T. pier consists of two pierhead pontoons and two artificial beaches upon which the landing ships can unload their tanks from the lower deck, while the lighter vehicles pass over the Y-ramps and discharge on to the shore.

The stores pontoon, which has no special Y-ramp, is used for unloading cargo from lighters by means of derricks, and the pierheads are connected by articulated bridge sections, which were also pre-built as were the caissons, and brought across the Channel by ocean-going tugs.

The model pontoon illustrated was one of many different types at the exhibition, which, it is suggested, should tour the country.

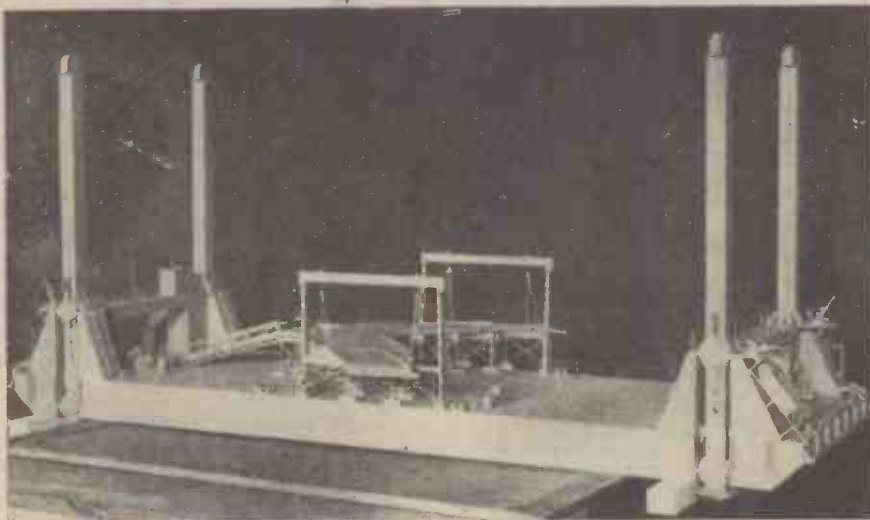

Fig. 1.—Model of a pierhead pontoon, one of the features of the Mulberry harbour pre-built in Britain, and towed across to the shores of Normandy to supply our liberating troops. The model pontoon slides up and down on the four spuds or columns, as in the prototype which moves with the water level.

—when the combined forces of America and this country—Navy, Army and Air Force—landed on the Continent as the first stage in the Liberation of Europe from the German Nazis.

The methods used for making a successful landing on the shores of Normandy are no longer secret. Photographs and sketches have appeared in the daily press, and an article on the subject was published in the December, 1944, issue of PRACTICAL MECHANICS. Also, an excellent exhibition sponsored by the Army Council, at the Institution of Civil Engineers in London, has made the public conversant with many wonderful plans which carried the enterprise successfully to the mainland of Europe despite the vaunted German might.

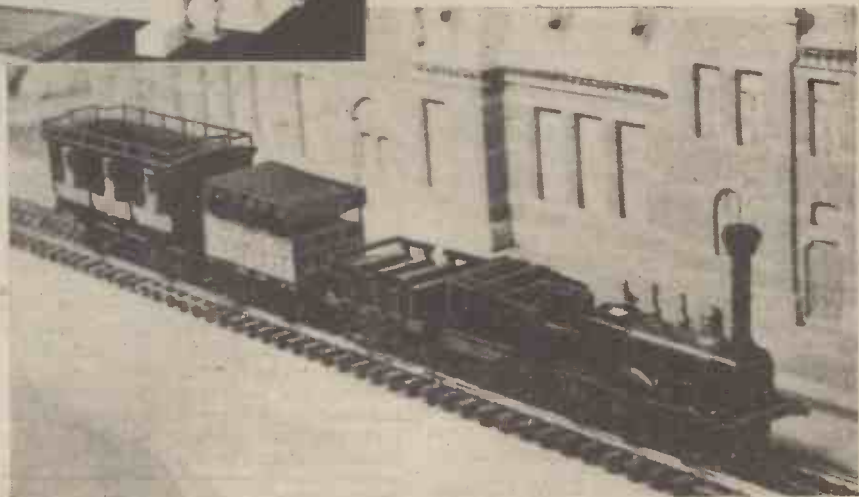

Fig. 2.—Portion of the Belgian layout at the International Water Exhibition at Liège in 1939—the work of *Chemins de Fer, Aviation, Marine* (Mr. F. Lebbe). The illustration shows the station at Vilvorde with a model of the first Belgian train "Le Belge," which was built in 1835. Models of the 1st, 2nd and 3rd class accommodation can be seen, and readers will note that third-class passengers had no cover, and would get the full benefit of the smoke from the engine!

Model-making in Belgium

The liberation of France and Belgium has brought to the model-making fraternity news of many of their old friends. One of the best known of model firms in Belgium was Chemins de Fer, Aviation, Marine, which, before the war, had constructed many fine model pieces. In March, 1940, I received a whole batch of photographs from Mr. F. Lebbe, head of the firm, and in view of the fact that I have just heard again from Mr. Lebbe that they have carried on with private model work throughout the war, which is more than many model makers in this country can say, I have selected a few pre-war pictures of this Belgian model work.

Illustrations Figs. 2, 3 and 4 are of a layout shown at the International Water Exhibition at Liège in 1939. The theme depicted in this model was the history of railways on the Continent, and their progress. In front was shown the first train of 1835, moving at an appropriate speed! The carriages are first second and third class.

Also modelled in this display were the first Belgian electric trains, which ran between Brussels and Antwerp, and also a series of Belgian passenger cars, and from the illustration Fig. 5 it will be seen that the finish of the models was of an excellent standard.

I have just received Mr. Lebbe's model catalogue for 1942, and have heard from a soldier in the B.L.A. of the publication of his new book, "Au Fil du Rail." Belgian model craft has done well to survive the occupation, and I look forward to hearing more from this source.

"Le Modele Reduit de Bateau"

Last month I made a reference to France and Monsieur Fournereau. Now a magazine devoted to modelling, "Le Modele Reduit de Bateau," has reached me by an ingenious device. As it was not allowed to send above a certain weight in one envelope, the magazine had been divided into four parts, which were each packed in a numbered letter, and when I had safely received all four missives I was able to construct the periodical very quickly. "Le Modele Reduit de Bateau" had been published throughout the war—monthly at first, but as time went on the issues became limited to three a year, and the one I have received is the second for 1944. It comes from Paris, and is well illustrated, giving pictures of the big model boating events of France—the "Coupe de Paris" and the "Coupe de France"—and also designs for model yachts, and a detailed drawing of a turbine steamer, "Ile de Beaute," besides a good sprinkling of advertisements, which seem to indicate



Fig. 3.—The station of Schaerbeek showing more up-to-date trains on the Belgian State Railways.

that there is plenty of model life in France despite the tribulations of war.

An Enthusiastic Model Maker

Across the North Atlantic—from Canada I



Fig. 6.—Enthusiastic model maker Mr. E. Phipps Walker at work when in hospital in Ottawa last year on a model of an Armed Trawler to the scale of 1/32in. to the foot.

have received a very enthusiastic message from model maker Mr. E. Phipps Walker, who while he was recovering from a severe

illness occupied much of his time in bed in model making. The illustration Fig. 6 shows him at work in Ottawa Civic Hospital, Canada, on a model of an Armed Trawler, scale 1/32in. to the foot, which will fit into a case made from a jam jar. Mr. E. Phipps Walker is the traveller of the family and has been away from England, except when on active service, for many years past. His uncle, Mr. Hubert Walker of Dorchester, is also keenly interested in model making, and when in Northampton two or three times yearly always take the opportunity of visiting Bassett-Lowke, Ltd.

Mr. E. Phipps Walker sent along several model-making magazines from America, and I also receive regularly from the U.S.A. that enterprising monthly magazine, the "Model Railroader," which has recently made a useful wartime survey of the age, education, occupation, income and many other details of model railway hobbyists.

Model-makers' Questionnaire

A questionnaire was sent to all the readers of the magazine and over 5,000 replies were received, which would probably represent a cross section in the same way as a Gallup poll does on national questions of America, and is now "operating" in England.

I am sure a few of the results would intrigue readers here. The average age of a model railway fan is 34 years. He comes from four categories—a high school graduate, a professional man, an executive or a skilled tradesman. His annual income is 3,400 dollars (£870 per annum) and the average income of every citizen of the United States is 1,050 dollars (about £283 per annum), so therefore the income of the model railway enthusiast is well above the average.

And now an interesting note to those who make model railways. He spends in one year 90 dollars (£22 10s.) on his hobby. In fact it comes out in the course of this investigation that over 40 per cent. of owners of model railways have devoted five years or over to the hobby. The preference as regards gauge is that H.O. (16mm.) still heads the list with 51 per cent. of hobbyists, and gauge "0," 38 per cent., the remaining 11 per cent. being divided among "00" gauge (19 mm.) and larger gauges than "0."

A CORRECTION

In the "World of Models" article in the January issue it was incorrectly stated in the caption under the first illustration that the model shown was "part of the new Roman Catholic cathedral." This should read "Anglican cathedral."

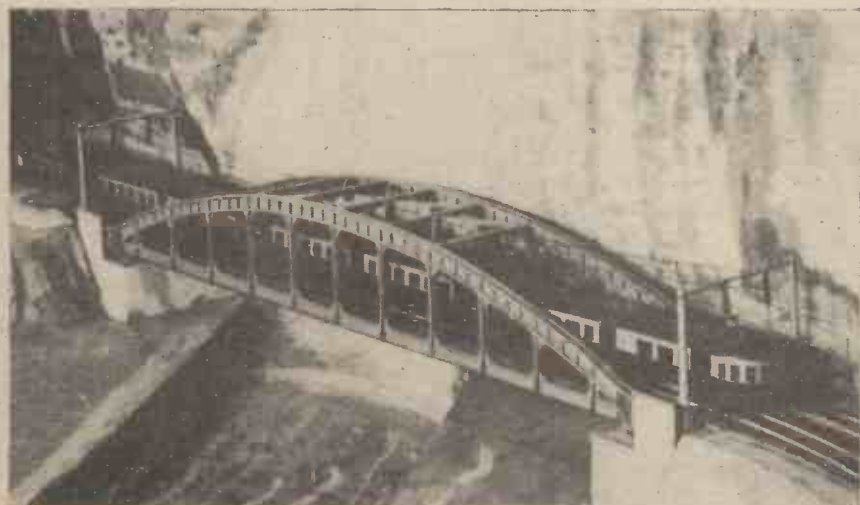

Fig. 4.—Model of the bridge over the canal between Louvain and Malines, with a modern electric train crossing.

QUERIES and ENQUIRIES

A stamped addressed envelope, three penny stamps, and the query coupon from the current issue, which appears on back of cover, must be enclosed with every letter containing a query. Every query and drawing which is sent must bear the name and address of the reader. Send your queries to the Editor, PRACTICAL MECHANICS, Geo. Newnes, Ltd., Tower House, Southampton Street, Strand, London, W.C.2.

Making Sugar from Beetroot

CAN you inform me if it is possible to make sugar sufficient, say, for a small household, at home? I have made maple sugar and maple syrup, and if sugar from beetroot is as simple to make it should be possible to supply a family of, say, four persons, even if of a poor grade and colour.—W. O. Bates (Ashbourne).

ALTHOUGH beetroot contains up to 16 per cent. of sucrose or cane sugar, it is not easy to extract it on a small scale, and we can give you no explicit directions for that purpose. The following, however, is an outline indication of the method which you would have to adopt for this purpose:

The beetroots are cut into slices and extracted with hot water. The hot water solution is concentrated by boiling, and then about 1 per cent. of its weight of milk of lime (lime slaked into a thin paste with water) is added in order to neutralise any acids present. The solution is then filtered, and it is treated with carbon dioxide gas in order to remove any excess of lime. It is again filtered, and then evaporated under partial vacuum in a steam-heated apparatus. A brown syrup is thereby obtained, which is decolorised and crystallised by special and highly technical methods.

In your case, so far as we can visualise, the only thing which you can do is to extract the cleaned and sliced beets with boiling water and then to concentrate the extract by further boiling and evaporation to a syrup. This will be brownish and it may actually taste acid, but it will contain an appreciable quantity of sugar. It can be decolorised to some extent by boiling with charcoal (preferably bone or nutshell charcoal) and by filtering the liquid, this operation being followed by further boiling and evaporation. You may add a little limewater to neutralise the acid, but if you add too much you will get lime in the syrup, which will be equally undesirable.

There are no really practical books published on this process, which, as run on a commercial scale, is semi-secret in practice.

Decomposing Water

I PROPOSE making an apparatus for decomposing water diluted with NaOH and collecting hydrogen and oxygen on the principle of the filter press-type cell, each cell being separated and insulated from the next by asbestos sheet.

(1) Would ordinary asbestos sheet, say 1/16 in. or 1/8 in. thick, be suitable for this purpose?

(2) What current density per square inch should I use (i.e., per square inch anode and cathode surface)?—S. C. Storry (Bath).

(1) 1/16 in. pure asbestos sheet should function satisfactorily for the purpose you mention. If, however, the asbestos sheet is heavily "filled" with extraneous matter, the diaphragm so formed will probably not be sufficiently porous for the cell to work.

(2) A very low current density will be required for decomposing a dilute caustic soda solution. We would suggest a current density of not more than .1 amp. per sq. in. The potential across the cell need not be more than 6 volt.

Test Board Details

I AM desirous of erecting a test board in my small workshop for the purposes of testing single, two and three phase motors and lamps, and if possible incorporating a drop test for all purposes.

The board measures 30 in. by 20 in., and I have already run in three phase wires and a neutral. Can you give me some information concerning the layout of the board?

I may add an ammeter and two voltmeters covering 230 v. and 440 v., and an alternative in the design embodying the above would be greatly appreciated.—T. P. Brodrick (Coventry).

PRESUMABLY it is your intention to test A.C. motors up to about 1 h.p. capacity. This rather elaborate programme will necessitate rather a lot of apparatus. For example, if you wish to test 2-phase motors, you will require a 2-phase supply in order to make a running-test; this could be obtained through the medium of a 3-phase to 2-phase transformer. Tappings could be provided on the primary and secondary windings to give you various voltages in 3-phase or 2-phase as may be required.

In order to carry out drop tests you require a fairly high current at low voltage and this could be obtained from tappings on the transformer and/or a variable resistance. A voltmeter, preferably having various

ranges, or two or more voltmeters covering a range of from a few millivolts to 500 volts. A useful test for two and three phase motors can be made by comparing the current input to each phase of the motor, and for this purpose an ammeter or ammeters covering a range of say 1 to 20 amps. would be useful.

The transformer could be mounted on the floor. The variable resistance behind the panel with control handle on the front of the panel along with the instruments and terminals. For such diverse tests it would probably be the simplest to mark all terminals with the voltage, etc., and to use odd lengths of cable to connect up the various apparatus for each test as required.

Banana Oil : Balsa Cement

(1) Could you please give me the composition of clear dope, banana oil and balsa cement as used in model aircraft?

(2) Can old film negatives be used in making the above, if so, what is the chemical used to remove the gelatine?—J. Baxter (Manchester).

(1) What is usually known in the shops as "Clear Dope" consists of a solution of scrap celluloid in some suitable solvent. You can make a quantity of this material for yourself by dissolving scrap celluloid in a mixture of equal parts of amyl acetate and acetone.

Balsa cement is often nothing more than a thick solution of celluloid in the above or similar solvents. Sometimes, also, it consists of a solution of celluloid in acetic acid, or a solution of gelatine in acetic or formic acids. Banana oil is supposed to originate in the banana tree, but much of the stuff which has been sold under this name consists of a thin oil of composite character.

(2) Old film negatives are certainly suitable for converting into celluloid varnish and/or cement. To remove the gelatine from the negatives, merely boil them in water. The gelatine on both sides of the film will dissolve away, or will permit of being readily scraped off, leaving the underlying celluloid film. This latter should be washed in warm water and then dried. When cut into shreds, it will easily dissolve in a mixture of amyl acetate and acetone. Caustic soda and even ordinary washing soda are solutions which will remove the gelatine from photographic negatives, but provided that hot or boiling water is used for this purpose, it is seldom that any chemical solutions will be required.

Ultra-violet Rays : Vitamins

(1) Can you please tell me the different means by which ultra-violet and infra-red rays are produced? I presume all the methods will be some form of lamp, electricity being the power used. If so, will they all operate on A.C. mains? What are the beneficial effects of infra-red rays?

(2) Are vitamins the same for man and animals? Could you give me a list of all the known vitamins and state the sources and beneficial effects of as many as possible of them? Does any danger exist in giving meat, meat foods or meat biscuits to animals which are, by nature, vegetarians, and if so, what is this danger? What is the substance viosterol, which is rich in vitamin D?

(3) I have noticed in photographs that persons using ultra-violet ray lamps wear goggles. Why is this and of what substance are the lenses made? I mean to use the rays on rabbits and other small animals, and could you suggest some means of protecting their eyes?—W. E. Bennett (Belfast).

(1) Ultra-violet rays are mainly produced by the electric arc, by quartz lamps, by burning magnesium ribbon, and by various electric discharge lamps. Infra-red rays are produced by any type of lamp or burning material. Even a burning candle produces infra-red rays.

All the electrical devices for the production of ultra-violet rays will operate on A.C. mains, as, for example, the various "Sunray" lamps, which are nowadays commercially marketed for this purpose.

Such devices, however, do not produce ultra-violet rays exclusively. The ultra-violet rays are mixed with visible light rays, so that if we require pure ultra-violet light rays, we have to screen out the other rays by means of a suitable light filter. The same, also, applies to infra-red rays. These are always mixed with ordinary light rays, and if we require the pure infra-red rays, we have to screen out the other accompanying visible rays by means of a special light filter. For a powerful source of infra-red rays, a sheet of ebonite, 1/62 in. in thickness, makes a good filter, since it is opaque to ordinary light, yet transparent to infra-red rays. A thin film of metallic silver "sputtered" on glass, or

better still, on quartz, is opaque to ordinary light, yet it passes ultra-violet light.

If you desire to experiment with the use of such screens (and with others of a similar nature), you can obtain such from Kodak, Ltd., Kingsway, London, W.C.2, or from Ilford, Ltd., Ilford, Essex.

Infra-red rays are considered to be beneficial in some cases because they are more or less pure heat rays, and they have the property of warming up a body upon which they impinge. They represent a powerful source of heat which can be focused.

(2) Vitamins have the same effect on man as they do on animals. Thus, cod-liver oil, which is a source of vitamin D, is administered to cattle, fowls and other animals, since it has as beneficial an effect upon them as it has on children and adults.

The chief vitamins known nowadays are:—
Vitamin A. This is present in fresh milk and in animal fat, but not in vegetable fats. Absence of vitamin A causes diseases of the eye, lungs and throat.

Vitamin B. Occurs in rice and other cereals. Its absence causes beri-beri, pellagra, nervous exhaustions and other complaints.

Vitamin C. Occurs in milk, green vegetables, fruit juices, etc. Its absence produces scurvy, fatigue, depression, loss of appetite, etc.

Vitamin D. Occurs in cod-liver oil and other fish oils. Its absence brings about rickets in children, malnutrition and wasting diseases.

Vitamin E. This is the "reproductive vitamin," without which an animal organism cannot reproduce itself. Is present in green leaves, etc.

There is little danger in feeding meat foods to animals which are really vegetarians, for the reason that such animals will, for the most part, refuse to eat such foods. If, however, such animals are habituated to such foods, their systems will suffer, since they are not equipped for dealing with flesh foods.

"Viosterol" is merely a trade-named preparation containing synthetic vitamin D. Vitamin D itself has now been shown to consist of a chemical named calciferol.

(3) Exposure of the eyes to ultra-violet rays would quickly result in loss of sight, since the ultra-violet rays have so very powerful an effect upon the retina. Hence workers with ultra-violet rays must of necessity employ a light filter to filter out the ultra-violet rays from their eyes. Such light filters comprise dyed gelatine films, which are cemented between glass and mounted in suitable goggle or spectacle frames. The dyes used for the dyeing of the gelatine "filters" are varied in nature, but, in general, almost any yellow-green dye will have the filtering effect required.

If you used ultra-violet rays on rabbits, you would have to fit some type of light filter over their eyes, which, of course, would be a rather difficult proposition. It would also be necessary for you to see that no actual burning of their skins took place. Hence, the animals should not be exposed for more than ten minutes at a time to the ultra-violet rays, and the lamp producing such rays should not be situated less than 2ft. away from the animals.

Rather than attempt to fit spectacles to the animals in order to protect their eyes from the ultra-violet rays, it would be better if you were to confine them in a box in which they could not turn round. You could then place the ultra-violet lamp behind the animals, thus avoiding the direct rays from coming in contact with their eyes.

Usually, however, it is far from necessary to give any type of ultra-violet ray treatment to animals.

Polish for Rubber Boots

WOULD you kindly inform me if it is possible to make up a preparation that will put a permanent polished surface on dull rubber without being deleterious to that substance?

I desire to obtain a good black polish on normally dull surfaced gum boots. I have used ordinary boot polish, but this entails a lot of hard rubbing, lasts no time at all, and is, so I understand, harmful to the rubber.—M. Joseph (Wimbleton).

A THIN solution of shellac in methylated spirits may be applied to your boots (the latter having been previously freed from all dirt) and then allowed to dry. This will give a shiny surface, but often the effect is inclined to be streaky. Furthermore, the shellac film thus deposited on your boots will be inclined to crack and to flake off. The same, also, may be said of any kind of synthetic lacquer which you might use.

Yours is a very difficult problem to solve satisfactorily, as well as being an entirely novel one. In the circumstances, we would suggest that you employed

THE P.M. LIST OF BLUEPRINTS

The "PRACTICAL MECHANICS" £20 CAR
(Designed by F. J. CAMM).
10s. 6d. per set of four sheets.

"PRACTICAL MECHANICS" MASTER
BATTERY CLOCK*
Blueprints (2 sheets), 2s.

The "PRACTICAL MECHANICS" OUT-
BOARD SPEEDBOAT
7s. 6d. per set of three sheets.

A MODEL AUTOGIRO*
Full-size blueprint, 1s.

The above blueprints are obtainable, post free, from Messrs. G. Newnes, Ltd., Tower House, Strand, W.C.2.

An * denotes that constructional details are available, free, with the blueprint.

SUPER-DURATION BIPLANE*

Full-size blueprint, 1s.

The I.-c. TWO-STROKE PETROL ENGINE*

Complete set, 5s.

STREAMLINED WAKEFIELD

MONOPLANE—2s.

LIGHTWEIGHT DURATION MODEL

Full-size blueprint, 2s.

P.M. TRAILER CARAVAN*

Complete set, 10s. 6d.

P.M. BATTERY SLAVE CLOCK* 1s.

an emulsified wax polish, as, for example, Johnson's "Glocoat" polish. This is a liquid polish containing wax in emulsified form.

In order to apply an emulsified wax polish, clean your boots thoroughly, and swab them over with a rag saturated with petrol or methylated spirits. When the boots are quite dry and slightly warm, swab the emulsified wax polish over them fairly liberally, allowing the polish to dry without rubbing it. When the polish is dry, give it a light rubbing with a clean duster, and we think you will then obtain the effect you desire.

Coil for Electric Clock

I AM building an electric clock and the first coil made for the motor had 8 ozs. of 36 s.w.g. enamelled wire on the coil. This coil got too warm, and another was made with the same size wire with 7 ozs. instead of 8 ozs. of wire. This coil also ran hot in a short while. Could you clear this matter up for me? Also, does size of coil core have any bearing? Could you also tell me where I may be able to purchase suitable wire. (House supply, 230 volts.—T. McRoberts (Erith).)

EVIDENTLY there is too much current passing through the coil of your clock. The current is limited by the resistance of the coil and by its inductance, and it would appear that the latter is too low. The inductance is proportional to the product of number of turns and total magnetic flux in the core. You should, therefore, try to increase the magnetic flux. This may be done by reducing the air gap between the stator and rotor, increasing the length of the stator polar arc, or increasing the cross sectional area of the magnetic circuit, i.e., stator, rotor, and/or coil core. Assuming the parts of the magnetic circuit are not so small that they are saturated with magnetism, the total magnetic flux created by a given number of amp. turns in the coil will be practically proportional to the cross sectional area of the iron. If you increase the cross sectional area of the core you will increase the mean length of one turn and thus reduce the number of turns and amp. turns obtained with the given length of wire. The increased periphery, however, will be less than the increased area. You may be able to obtain wire from Ormiston and Sons, Ltd., of 79, Clerkenwell Road, E.C.1.

Leather Substitute: Welding Mixture

(1) Will you please inform me what type of cloth, and/or canvas would be most suitable to use as a substitute for leather in making air bellows?

(2) I have tried using a mixture of 3 parts ferric oxide mixed with 1 part of aluminium powder, to weld two metal tubes together, placing the above mixture on the joints of the tubes, and a little potassium chlorate sprinkled on top with a piece of magnesium tape to ignite the mixture. But the magnesium did not seem to ignite the mixture properly, which flared up a bit and then went out. The ferric oxide I made by heating iron sulphate on a red-hot metal plate till it turned very dark brown.—A. Orwell (Manchester).

(1) No type of cloth will function as satisfactorily as thin leather for an air bellows, for the reason that most cloths are naturally porous. However, as a substitute, you may use any good rexine, which may be obtained from any upholsterers, or, alternatively, any good bookbinding fabric having a "close" surface. As another alternative, you could use "Linson fabric," an extremely tough and enduring cellulose-paper fabric, obtainable fairly cheaply from Russell Handicrafts, Ltd., Hitchin, Herts. This fabric costs about 20d. per yard, and is obtainable in a range of colours. It is light, washable, easily glued, and it is crease-resisting. Parchment or vellum, of course, would make a good "substitute" for leather, but, of course, these materials would be more expensive than leather.

(2) Your trouble in connection with your welding mixture is that you have not been using the correct ingredients. You should employ for the firing or "thermite" mixture equal parts of iron oxide and moderately coarse aluminium powder (not the very fine aluminium powder used for paint-making purposes). This mixture must be ignited, not by ordinary magnesium powder or ribbon, but by a "fuse" or "ignition" mixture made by mixing 60 parts of very fine aluminium powder and 600 parts barium peroxide. This "ignition" mixture can be fired either by laying a trail of red phosphorus or by means of magnesium ribbon. All the materials must be perfectly dry.

There seems to be nothing wrong with your ferric oxide. You can purchase thermite mixture and ignition mixture ready made, price 2s. and 4s. 6d. per lb., respectively, from Messrs. Harrington Bros., Ltd., Oliver's Yard, City Road, Finsbury, London, N.1.

"Vanishing" Ink

I HAVE been reading a document which was written in vanishing ink, i.e., although it was legible in its original state, it was eventually found to be quite blank.

I would like to know if there is such a thing as a vanishing ink, and if so, how does it differ from ordinary ink? Moreover, is it possible to control the degree of "vanishing," i.e., can such ink be made to disappear at the expiration of any pre-conceived time limit?—A. E. Nicholson (Ilford).

THERE are very few inks which can be guaranteed to fade completely, and particularly within a given time. The following inks, however, are available for your purpose:

1. Solution of iodine in water or alcohol. Characters written in this ink will fade away completely within a week. The characters can be caused

to disappear within a few minutes if the sheet of paper is warmed.

2. Iodide-starch Solution.

If a few crystals of iodine are added to a thin solution of starch in water, the solution will turn blue. If characters are written in this "ink" they will fade within a day or two, the fading again being capable of being speeded up by warming the paper.

By varying the dilution of the starch solution and the quantity of iodine added to it, it is possible, by experiment, to produce an "ink" which will disappear within a given time.

Thermo-Couples

CAN you give me some information regarding the construction of a thermo-couple giving 8-volts and working off an ordinary gas supply?

The details such as what different metals to use, the length of them, and how they are coupled together would be greatly appreciated. Also, could you inform me where to purchase a book on the subject?—J. Huggett (Brightlingsea).

AS an ordinary current-generator, the thermopile is impracticable, and we are of the opinion that if you attempt to construct one of these devices for practical work as a generator of current you will be disappointed. It is true that thermopiles containing

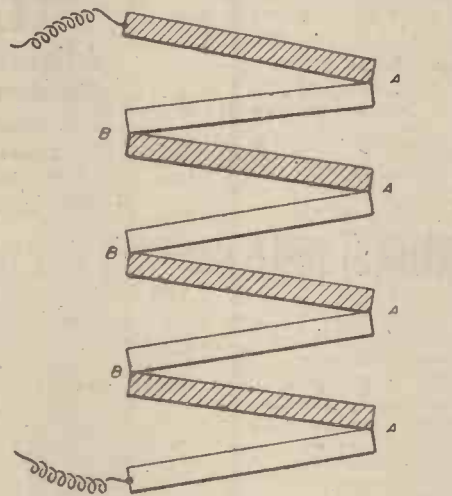

Arrangement of thermo-couple elements.

several thousands of elements have been constructed, and have been claimed to give something like 100 volts E.M.F. by being built into coke-fired furnaces, but all such articles have been merely curiosities and freaks.

The current generated by one thermo-couple element, say of nickel and steel, is very small, being the merest fraction of a volt. The current generated does not depend upon the size of the junctions, but upon their temperature relative to their opposite ends. Hence, if you wish to make a working thermopile, you must have a large number of thermocouple junctions so arranged that they can be heated conveniently from one source. Usually, the junctions are arranged around a central gas flame, the inner junctions being heated strongly by the flame and the outer ones being cooled by the surrounding air, each strip of metal being about 5 or 6 in. long.

The subject of thermo-electricity and thermopile construction is far too long to be condensed into the space of a brief reply. You will find the theory and construction of these articles dealt with in any competent textbook of electricity, as, for example, in "Electricity in the Service of Man," by R. Mullineux Walmsley (Cassell and Co.), which book might possibly be obtained secondhand from Messrs. W. & G. Foyle, Ltd., Charing Cross Road, London, W.C.2.

Essentially, the thermo-couple elements are arranged in series as shown by the accompanying diagram. The junctions marked "A" are heated, whilst the opposite junctions (marked "B") are kept as cool as practicable. A current is generated which flows from the thermopile via the lead wires.

A bismuth-antimony junction gives the greatest E.M.F. per degree temperature rise, but this junction has too low a melting-point to be of any practical service for your requirements. Hence we suggest a nickel-steel or a nickel-iron type of junction, the two metals being welded together.

Liquids for Compasses

WHAT is the liquid used in a ship's compass bowl spoken of as a spirit compass, and the quantities of each part? The liquids I have tried turn milky when diluted with either water, or distilled water. The liquid, of course, must not attack the paint of bowl or card.—F. Clarke (Prestwich).

THE liquid used for compasses and similar instruments usually consists of absolute alcohol diluted with about 5 per cent. of distilled water. Sometimes 1 to 2 per cent. of pure glycerine is also added. Other instrument liquids of this type comprise either the mono-methyl or the mono-ethyl ether of ethylene glycol.

All these liquids have very low freezing points, and they do not attack spirit-proof paints and varnishes.

Storing Carbon Tetrachloride

CAN C.T.C. (Carbon tetrachloride) be stored in a flexible container such as that used for small refills of petrol for petrol lighters? They appear to be made of gelatine. If gelatine is unaffected by C.T.C., could rubber containers be internally coated with gelatine for C.T.C. storage?—J. F. Reid (Orpington).

ALTHOUGH carbon tetrachloride is not a good solvent for rubber, it undoubtedly affects most grades of this material. Hence, carbon tetrachloride cannot be stored with safety in rubber containers. It is, however, without solvent action upon gelatine, and can therefore be stored in gelatine capsules, or, as you mention, in rubber containers which are lined with gelatine.

It is not difficult to line a hard rubber bottle with gelatine. Merely make up a 30 per cent. solution of fairly soft gelatine in water, pour some of it into the rubber bottle, and rotate the latter so that the gelatine solution comes in contact with every portion of the bottle's inner surface. Finally, pour away the surplus solution and stand the bottle aside for a few hours for the interior film of gelatine to set.

In order to make sure that the inner sides of the bottle are perfectly well-coated with the protecting gelatine film, it is advisable to give the bottle two successive gelatine treatments in the above manner.

Windcharger—Cutting-in Speed

I AM using a C.A.V. dynamo (type AT82) for a windcharger—output 12 volt 12 amps. cutting in at 350 r.p.m., maximum output at 1,000 r.p.m., and shall be glad if you will answer the following queries:

(1) How is the third brush wired into the field circuit? Does this decrease the output, lower the cutting-in speed, and by how much?

(2) What would be suitable dimensions for a propeller? I assume a medium speed propeller is suitable, using direct drive.

(3) I understand that the cutting-in speed can be reduced by connecting a 1 to 3 ohm resistance in the third brush circuit. Can you confirm, please?—D. A. Munro (Bristol).

THE shunt field coils are connected between one main brush and the third brush. The function of the third brush is to regulate the current output in conjunction with a battery load in order to avoid an excessive current being passed, at high dynamo speeds. The third brush will raise the cutting-in speed by perhaps 15 per cent. or so.

If the dynamo is designed to cut in at 350 r.p.m. it could be directly driven by a propeller. The propeller could be about 6ft. long of well-seasoned straight grained pine or cedar tapering from about 6in. wide at the hub to 4in. at the tips and with the blades at about 35 deg. to the plane of rotation. The boss should be strengthened by means of a steel piece clamped on and keyed to the shaft.

The cutting-in speed will be increased by connecting a resistance in circuit with the field windings. The only advantage of fitting a choke coil and condenser is in reducing interference with reception by nearby radio sets, which may result from sparking at the commutator. The two condensers may be connected across the brushes in series with each other, the common or mid-point of the condensers being connected to the earthed dynamo frame. The choke coil may be connected in series between the dynamo and its load circuit. When so connected the cutting-in speed is practically unchanged. We do not advise you to bother fitting such smoothing apparatus unless this is found necessary under operating conditions. In this case two condensers of 1 mfd. capacity may be found sufficient without a choke. If not, a choke could be made with about 80 turns of 14 s.w.g. wire wound round a 6-in. diameter former.

Mains Transformer Windings

I SHOULD be glad if you could supply me with details for the construction of a transformer suitable for use with a 20 amp. arc on 230 volt A.C. mains. It is at present working through a resistance, but the load is too much for the wiring here.

Also could one winding of a 230 to 25 volt transformer (secondary capable of carrying 8 amps.) be used as a choke for a small high pressure mercury vapour tube (about 70 watts)?—E. H. Bonner (London, S.W.).

THE transformer core could be constructed of laminations built up to a cross-sectional area of 5 sq. in. The primary may have 300 turns of 15 s.w.g. D.S.C. wire, and the secondary 80 turns of 10 s.w.g. D.S.C. wire. A portion of the existing resistance can be connected in series between the secondary winding and electrode.

It is not possible to say definitely whether the primary winding of the 230/25 volt transformer could be used as a choke coil for the mercury vapour tube without having full details of the operating voltage of the tube and of the transformer design. It is, however, extremely unlikely that such use would be satisfactory.

LET ME BE YOUR FATHER

You need help and Fatherly advice in difficult times like these. I am in the position to give that to you FREE.



We teach nearly all the Trades and Professions by Post in all parts of the world. The most progressive and most successful Correspondence College in the world.

If you know what you want to study, write for prospectus. If you are undecided, write for my fatherly advice, it is free. Distance makes no difference.

DO ANY OF THESE SUBJECTS INTEREST YOU?

- Accountancy Examinations
- Advertising & Sales Management
- Agriculture
- A.M.I. Fire E. Examinations
- Applied Mechanics
- Army Certificates
- Auctioneers and Estate Agents
- Aviation Engineering
- Aviation Wireless
- Banking
- Blue Prints
- Boilers
- Book-keeping, Accountancy and Modern Business Methods
- B.Sc. (Eng.)
- Builders' Quantities
- Building, Architecture and Clerks of Works
- Cambridge Senior School Certificate
- Civil Engineering
- Civil Service
- All Commercial Subjects
- Commercial Art
- Common Prelim. E.J.E.B.
- Concrete and Structural Engineering
- Draughtsmanship, all Branches
- Engineering, all Branches, Subjects and Examinations
- General Education
- G.P.O. Eng. Dept.
- Heating and Ventilating
- Industrial Chemistry
- Institute of Housing
- Insurance
- Journalism
- Languages
- Mathematics

- Matriculation
- Metallurgy
- Mining, All Subjects
- Mining, Electrical Engineering
- Motor Engineering
- Motor Trade
- Municipal and County Engineers
- Naval Architecture
- Novel Writing
- Pattern Making
- Play Writing
- Police, Special Course
- Preceptors, College of
- Press-Tool Work
- Production Engineering
- Pumps and Pumping Machinery
- Radio Communication
- Radio Service Engineering
- R.A.F. Special Courses
- Road Making and Maintenance
- Salesmanship I.S.M.A.
- Sanitation
- School Attendance Officer
- Secretarial Examinations
- Sheet Metal Work
- Shipbuilding
- Shorthand (Pitman's)
- Short Story Writing
- Speaking in Public
- Structural Engineering
- Surveying
- Teachers of Handicrafts
- Telephony and Telegraphy
- Television
- Transport Inst. Examinations
- Viewers, Gaugers, Inspectors
- Weights and Measures Inspectors
- Welding
- Wireless Telegraphy and Telephony
- Works Managers

If you do not see your own requirements above, write to us on any subject. Full particulars free.

COUPON. CUT THIS OUT

IF YOU AT-TEND TO THIS NOW IT MAY MAKE A WONDERFUL DIFFERENCE TO YOUR FUTURE.

To Dept. 76, THE BENNETT COLLEGE, LTD., SHEFFIELD

Please send me (free of charge) } (Cross out line which does not apply)
 Particulars of.....
 Your private advice about.....

PLEASE WRITE IN BLOCK LETTERS

Name

Address

Great FREE Offer to Armament and Aircraft Metalworkers

We offer to send you for seven days' free approval a three-volume work that teaches thoroughly every branch of metalworking—a New, Complete, Up-to-the-Minute Workshop Guide.

THE NEW PRACTICAL METALWORKER

A New and Up-to-date Textbook on Modern Machine-Shop Practice

Editor: BERNARD E. JONES

Assistant Editor: JOHN ST. DENYS REED

Written by Engineering Experts

Three Volumes. Over 2,300 illustrations

MODERN industrial conditions demand that the worker, if he is to progress, must be well informed, and the information contained in "THE NEW PRACTICAL METALWORKER" will assist the metalworker to make that progress. Every new and modern process in metalworking is described fully by modern specialists. All the great advances made recently in workshop engineering are included.

Progressive workers, craftsmen and practical mechanics of all grades will realise that this up-to-the-minute work, written by expert engineers, working specialists and leading mechanics, is the newest and best handbook of machine-shop practice ever issued.

To all metalworkers engaged in the armament or aircraft industries "The New Practical Metalworker" is indispensable. It will show you how to increase your efficiency, earn more money, and give your country the skilled help that is needed so urgently. To-day, as never before, it is vital that every engineer should provide himself with the most up-to-date knowledge available. That is why we recommend to every man in the industry—skilled, semi-skilled, or unskilled—this valuable work "The New Practical Metalworker."

ALL YOU WANT TO KNOW ABOUT:

- Metalworking Tools
- Metalworking Equipment
- Metals. Alloys
- Casting. Forging
- Fitting and Erecting
- Boiler Work
- Modern Lathes
- Milling. Planing
- Precision Grinding
- Screw Cutting
- Jigs and Fixtures
- Gauge and Template Making
- Presswork in Sheet Metal
- Polishing and Finishing
- Electro-plating
- Soldering. Brazing
- Welding. Pipework
- Hardening. Tempering
- Electrical Equipment
- Workshop Calculations
- Mechanical Drawing, etc.



Send TO-DAY for this Splendid New Work

Just sign and post the form below and on acceptance we will send you these three volumes, carriage paid, to examine for one week, free. You may either return them to us within 8 days to end the matter, or you may keep them on the very easy terms outlined.

"PRACTICAL MECHANICS" FREE EXAMINATION FORM

To the WAVERLEY BOOK CO., LIMITED, 96 and 97, Farringdon Street, LONDON, E.C.4.

Please send me, carriage paid, for seven days' FREE examination, "THE NEW PRACTICAL METALWORKER," complete in three volumes. It is understood that I may return the work on the eighth day after I receive it, and that there the matter ends. If I keep the books I will send you on the eighth day a First Payment of 10s., and, beginning 30 days after, four further consecutive monthly payments of 10s. each, thus completing the purchase price. (Price for cash on the eighth day, 22 7s. 6d.)

Name

Address

Occupation State if Householder

Parent's Signature required if under 21..... Date.....

P. Mech. 5 PLEASE FILL IN ALL PARTICULARS ASKED

ELECTRADIX

MOVING COIL SOUND UNITS. P.M. 45 ohm 3in. coil, 1 1/2in. overall, complete for little speakers, mikes, headphones, etc. Coil energised by famous ALNI Magnet. In bakelite case with 3in. front flange, as new, 12/6.

SMALL MOTOR GENERATORS by E. D. C. and others. Pocket size for use with receivers to take the place of H.T. Battery. will drive off small 6 or 12 volt accumulator, output 230v. 30mA. Beautifully made for Government radios. Brand new, 75/-.

HAND MIKES, for announcers, broadcasters and recorders, hand type, by Tannoy; multi-cell carbon type, weather-proof, for outdoor use or for Hall; has neat switch in handle, 21/-.

BUTTON MICRO-PHONES, provide interesting experiments. For making outside listeners, sound transmission, etc. These ex-G.P.O. Voice Units are under 1in. diameter, with mica diaphragm, etc. Only 2/6. Diagram and postage, 6d. High ratio mike transformer, 4/6.



TRANSFORMERS, 3 kW. Crypto 230 v. to 115 v., shrouded, £12. 3 kW. Metvick, 50 cy. 400 v. to 600 v., £9 10s. 1 kW. Powquip 50 cy. 250 v. to 50 v. 20 amps., £9. 500 watt Foster 50 cy. 440 v. to 110 v. 5 amps., £4 15s. 150 watt Foster 400 cy. 230 v. to 15 v. 10 amps., £2 15s. 5 watts H.T. test Transformers 110/220 v. to 1,000 v. 5 mA., 10/-. Current transformers for meters. Various sizes in stock.

TRANSFORMER PARTS. We have a limited number of shrouded transformer carcasses for rewinding, 3 kW. size, with laminations, first class make, 75/-.

METERS. Moving coil milliammeters, flush panel type, 3in. diam., 0-1 mA., 100 ohms resistance, bakelite case, new, 60/-.

MOTORS A.C. 230 volt. motors, new, 1,425 r.p.m. enclosed type with starting switch incorporated, 1/2 and 1/4 h.p., for prompt delivery.

MOTORS, D.C. Fine modern motors, 1/5th h.p., 200/250 volts, enclosed, drip proof, silent bearings, double end shaft, weight 35lbs. Compound, 1,440 r.p.m., 70/-.

PETROL FILTERS. Enots brass petrol filter, with union, 7/6.

MOTOR PUMPS. We can give immediate delivery of the famous Stuart Turner 12-volt D.C. motor pumps; 120 galls. per hour, 84/-.

USEFUL PRECISION-MADE SPARE PARTS. NEW. Chart drum and clips, 5/6. Magnetic Clutch, 6 volt., complete, 25/-.

RHEOSTATS "AETNA" panel switch rheos. to 4 ohm and 0.6, 6 volts 3 amps., with bulb in knob, 2/6 each, postage 6d. Slider rheos. for all currents; heavy grid 40 amp. 10-stud control, 240 volts to 45 volts, 33in. x 16in. x 14in., £5 10s.; smaller for 110 volts to 45 volts, £3 10s. Pitkin Lab. rheos., circular 8in. glass front, 50 ohms 2 amps., 35/-. Dimmers for all purposes. Send us your enquiries.

INVISIBLE RAY CONTROL. Photo cell Raycraft Set with bakelite selenium bridge, 10,000 ohm sensitive Relay, megostat, etc., with booklet, 42/-.

G.P.O. ELECTRIC CONTROLS to 10,000, 5/6 each.

Please include postage for mail orders.

ELECTRADIX RADIOS

214, Queenstown Road, Battersea, London, S.W 8

Telephone MACaulay 2159

SMALL TOOLS

Drills, Reamers, Lathe Tools, Chucks, Micrometers, etc.

EVERYTHING FOR THE MECHANIC

Circular Saw Benches, Planers, Sanders. All kinds of small Wood-working Machinery.

Send 4 1/2d. for List

NUTTALL'S (LATHES) LIMITED, MANSFIELD, NOTTS.

35 FIRST PLACES AND HUNDREDS OF PASSES

in the A.M.I.C.E., A.M.I.M.E., A.M.I.E.E., A.F.R.Ae.S., A.M.I.Chem.E., C. & G., etc., Exams. have been gained by students studying at home with the T.I.G.B. Engineering First Places are your best guide to the most successful Engineering Courses. Write to-day for "The Engineer's Guide to Success" containing the world's widest choice of Engineering Courses - over 200 - covering all branches - Mechanical, Electrical, Aeronautical, Wireless, Civil, Chemical, etc., and which alone gives the Regulations governing admission to the Recognised Institutions. The T.I.G.B. guarantees training until successful



World's best choice of Courses in Engineering

The TECHNOLOGICAL INSTITUTE OF GREAT BRITAIN, 218, Temple Bar House, E.C.4.

"Easily the best soldering fluid obtainable." This statement by a regular user of "BAKER'S" expresses the general opinion of motor and engineering trades. Sold in 6d., 1/- and 1/6 tins. Also in Bulk.



SIR WM. BURNETT & CO. (CHEMICALS) LTD. Gt. West Rd., Isleworth, Middx. Hounslow 0476

KIRK DESIGNS LTD. WOODFORD GREEN, ESSEX
Tel: Buckhurst 3835

BLUE PRINTS OF YACHTS
Full Size Details available of Model Sailing Yachts, from 2/6 to 7/-.
Please send 6d. P.O. and S.A.E. for List and Sample Print of Sail Plan of One Yacht. Many of the Yachts are equipped with automatic steering (full details).

ELECTRIC ETCHING EQUIPMENT



AS SIMPLE TO USE AS A PEN Will etch on any metal. Quicker than machine engraving. From Dealers or direct. Send for leaflet "Z.13."

RUNBAGEN MANCHESTER

WE WILL PURCHASE

Models and Machines of every description. Railways and parts from gauge 00 to 15. Boilers, Engines, Boats, Mecano, etc., etc. State fullest particulars and price required in first letter to save unnecessary correspondence. We also have FOR SALE fair stocks of the above. Stamp with requirements.

BOTTERILLS, HIGH STREET, CANVEY, ESSEX

JUBILEE WORM DRIVE HOSE CLIPS



The long-life clip with the ever-tight grip

The Best Known For Radiator Joints, Air, Oil and Water Hose Joints

We guarantee a Tight Joint
L. ROBINSON & Co. 25, London Chambers, GILLINGHAM, KENT

CHEMICAL APPARATUS



POST FREE APPARATUS OFFER
10/6 INCLUDING CHEMICALS 2/1-
(England, Scotland and Wales only.)
Send 1d. stamped envelope for Price List.

BECK
(SCIENTIFIC DEPT A), 60, HIGH STREET, STOKE NEWINGTON, LONDON, N.16.
Booklet "Experiments in Chemistry" 2d. P.O.

You'll be glad you kept on saving when you can again buy an

ADANA

Adana Printing Machines
—TWICKENHAM, MIDDLESEX

RATCHET & REVOLUTION COUNTERS

Ask for Leaflet No. 18/3
Speed up to 6,000 r.p.m.
B. & F. CARTER & Co. Ltd., Bolton 5

THE USEFULNESS OF PELMANISM

PELMANISM is useful in all the affairs of life. That is its outstanding recommendation to those who wish to make the best of themselves in their occupations, in all their recreations, and in their social and cultural relations.

Every line written in the Pelman Course is directly applicable to some aspect of human life and conduct. The intention of every word in the Course is to make clear to men and women the means by which they can develop their powers to the fullest extent so that they can live more happily and be more successful—so that, on the one hand, they will make and use occasions for profit and advantage and, on the other hand, be at ease in any company. Both conditions are necessary to complete self-respect and a full life.

Remember—Everything you do is preceded by your attitude of mind

Pelmanists are not left to make the applications themselves. An experienced and sympathetic instructional staff shows them, in exact detail, how to apply the principles of Pelmanism to their own circumstances and aspirations. Thus every Pelman Course is an individual Course. Over and over again our correspondents say in effect, "I feel that this Course was prepared for me, and me only." Substantially, this is so, for the instructional notes and letters of advice are entirely personal to the individual; they are for him or her only.

Half fees for serving members of His Majesty's Forces (Apply for Services Enrolment Form)

The present dominant aim for every man and woman must be to show a courageous, confident, well-equipped mental front. This assured, then all else will be achieved, and the world has no more proven method than Pelmanism to obtain this end.

Your Obligation

To-day there is an obligation upon every man and every woman to make the maximum contribution to the task which the Empire has undertaken. There is a demand for clearness of vision and concentration; there is, above all, a need, such as has never before been felt, for level-headedness and resourcefulness. The Pelman discipline establishes self-confidence, quickens the perception and promotes personal initiative.

Take Up Pelmanism Now

The Pelman Course is fully explained in "The Science of Success." The Course is simple and interesting and takes up very little time. You can enrol on the most convenient terms. The book will be sent you, gratis and post free, on application to-day to:

PELMAN INSTITUTE

(Established over 40 years).
130, Albion House, New Oxford Street, London, W.C.1.

PELMAN (OVERSEAS) INSTITUTES: NEW YORK, 271, North Avenue, New Rochelle, MELBOURNE, 395, Flinders Lane. DURBAN, Natal Bank Chambers. (P.O. Box 14899). JOHANNESBURG, P.O. Box 4928. CALCUTTA, 102, Clive Street. DELHI, 19, Allpore Road.

IF YOU HAVE A PHILIDYNE SET

The reliability of these sets, under the worst conditions, has been proved by thousands of cyclists throughout the war. But on those rare occasions when a set fails to function perfectly, our Service Department is there to put it right. The address is: Waddon Factory Estate, Waddon, Croydon, Surrey.

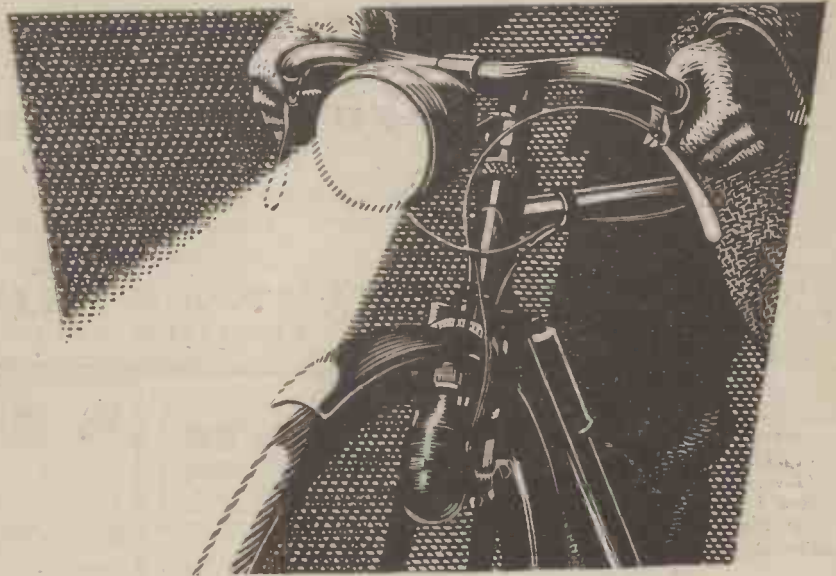

PHILIPS PHILIDYNE

CYCLE DYNAMO LIGHTING SETS

For light at walking speed

PHILIPS LAMPS LTD., CENTURY HOUSE, SHAFESBURY AVENUE, LONDON, W.C.2 (38 rev.)



U-boat expeditions, convoy movements and E-boat excursions all come under the watchful eye of the Fleet Air Arm, whose cameras are loaded with Ilford Film. Photography is indispensable to the Navy and plays a vital part in sea warfare. When this work is done Ilford Photographic materials, better than ever before, will come back into general use again.

ILFORD makers of **SELO** films
LIMITED

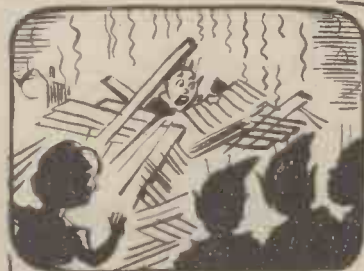

THE "FLUXITE QUINS" AT WORK

"What happened? Be brief! You young ass, just tell us how this came to pass."
Moaned OI: "I did right; I used the FLUXITE... But the pipe wasn't water—'twas GAS!"

For all SOLDERING work—you need FLUXITE—the paste flux—with which even dirty metals are soldered and "tinned." For the jointing of lead—without solder; and the "running" of white metal bearings—without "tinning" the bearing. It is suitable for ALL METALS—excepting ALUMINIUM—and can be used with safety on ELECTRICAL and other sensitive apparatus.

With Fluxite joints can be "wiped" successfully that are impossible by any other method.

Used for over 30 years in Government works and by leading engineers and manufacturers. Of all Ironmongers—in tins, 8d., 1/4d. and 2/8. Ask to see the FLUXITE SMALL-SPACE SOLDERING SET—compact but substantial—complete with full instructions, 7/6.

● TO CYCLISTS! Your wheels will NOT keep round and true unless the spokes are tied with fine wire at the crossings AND SOLDERED. This makes a much stronger wheel. It's simple—with FLUXITE—but IMPORTANT.

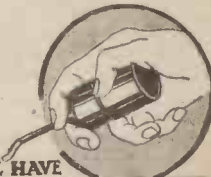

THE "FLUXITE" GUN puts "FLUXITE" where you want it by a simple pressure. Price 1/6 or filled 2/6.

ALL MECHANICS WILL HAVE

FLUXITE

IT SIMPLIFIES ALL SOLDERING

Write for Book on the ART OF "SOFT" SOLDERING and for Leaflets on CASE-HARDENING STEEL and TEMPERING TOOLS with FLUXITE. Also on "WIPED JOINTS." Price 1d. Each.

FLUXITE LTD., Dept. P.M., Bermondsey Street, S.E.1

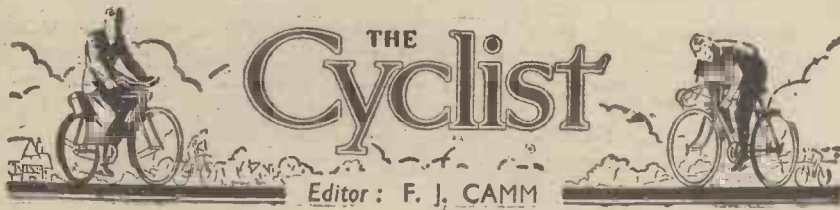

VOL. XIII

MARCH, 1945

No. 277

All letters should be addressed to the Editor, "THE CYCLIST," George Newnes, Ltd., Tower House, Southampton Street, Strand, London, W.C.2.

Phone: Temple Bar 4363

Telegrams: Newnes, Rand, London

Comments of the Month

By F. J. C.

Rear Lights, Reflectors and White Patches

MR. NOEL BAKER made it quite plain to the deputation representing cycling organisations and the manufacturers, that the Government were going to proceed with their Rear Lights Bill. The Bill has been postponed, pending the Law Reform Bill, which may change the situation. The deputation pointed out the well-known arguments against rear lights, and Mr. Noel Baker stated that he did not accept the view that rear lights would cause accidents to cyclists to increase. Thus ends over 30 years' fierce opposition to rear lights. This is a tremendous blow at the prestige of the cycling organisations, and in our view it will have repercussions on other matters. For example, if it is found as a fact that accidents to cyclists are reduced after rear lights become compulsory (the real testing time will, of course, be after the war), the Government is likely to assume that the cycling organisations are equally wrong on questions of taxation and cycle paths. Worse than that, they will also say that but for the opposition to rear lights put up by these bodies many thousands of cyclists now dead would be alive. It is a logical conclusion to be drawn; the Government will, in other words, accuse the cycling organisations of having caused the deaths of cyclists because of their opposition, which later experience has proved false. We think the argument that rear lights would increase the number of accidents to be a tactical error. If such proves to be the case the organisations will be in a strong position, and will have the best possible argument for pressing for a removal of the Act from the statute book.

The fact that it may be difficult to keep rear lamps alight is not a sound argument against the principle.

There are solid arguments against the use of rear lights and they are here set forth:

The Highway Code and common law require every road user to look where he is going and not to knock others down, whether they are lighted or not.

No person should be required to carry lights in order to break the law and disregard the Highway Code.

A red light is by universal convention a danger signal and should be restricted to dangerous obstructions and "traps," such as holes in the road.

A cyclist riding alone at night would hardly ever be able to recover compensation after being run down from behind. The impact would put his light out, and unless an independent witness could say that it was on before the accident he would be accounted guilty of contributory negligence as a law-breaker.

Rear lamps have been compulsory during the present war, and they were also imposed during the war of 1914-18 and the railway strike of 1919. Many cyclists carrying lighted rear lamps were run down, and the number killed at night during the present war (with rear lamps in compulsory use) is 1,770.

In the detailed analysis of fatal road

accidents in 1935, issued by the Ministry of Transport (when rear lamps were optional), it was shown that the number of cyclists killed at night while carrying lighted rear lamps was twice as great as the number killed in similar circumstances while carrying no rear warning of any kind.

The cyclist under existing (peace-time) laws carries several aids to visibility—his reflector and white surface, his front lamp casting a pool of light on the road, his glinting cranks and other bright fittings, his light-coloured clothing. Pedestrians, who are usually compelled to walk in the carriageway owing to the absence or inadequacy of footpaths, have none of these things except an infrequent item of conspicuous attire, and yet they are overtaken much more rapidly than a cyclist. As motorists *must* look out for unlighted pedestrians they can at the same time see the much more conspicuous cyclist.

Even if it be granted that a rear warning is necessary, a lighted lamp is not the best form for it to take. Tests conducted by a special committee set up by the Transport Advisory Council showed that red reflectors were generally superior to lighted lamps. As a motor vehicle overtakes a cyclist the reflector becomes steadily brighter in the headlights, whereas a lamp grows dimmer. Reflectors are now used with satisfaction on various road signs, in road studs, on telegraph poles, and even on motor vehicles.

The rear triangle of a bicycle frame is built as rigid as possible. It transmits a maximum of road vibration and causes electric filaments to break, oil lamps to jerk out, and other mechanical troubles to develop.

The rider cannot see whether his lamp is alight or not.

Batteries are liable to fail during a journey and cannot always be replaced at once.

In short, a cyclist with the best will in the world cannot depend upon keeping a rear lamp alight.

If cyclists carry lighted rear lamps, in addition to reflectors and white patches, the result will be that motorists will be gradually educated to look for red lights and to assume that the road is clear when they cannot see these warnings. This will mean death to the unlighted pedestrian and to all other slow-moving road users who for any reason fail to show warning lights.

If there are ten million cyclists in this country and the total membership of the national bodies ignoring overlapping membership is fifty thousand, the Government is quite right in assuming that the organisations do not speak on behalf of the great majority of cyclists. They have therefore been remiss in not collecting information from the millions outside their membership, and they have no right to express views on behalf of cyclists generally without consulting them.

Contributory Negligence

THE law regarding contributory negligence is to be amended. At present if a motorist can prove that the other party to an

accident is guilty of contributory negligence that is a complete defence and the plaintive has to pay the motorist's costs. When the new bill becomes law, damages will be assessed according to the degree of negligence. The Law Reform (Contributory Negligence) Bill which will remove the present injustice says in its preamble:

"Where any person suffers damage as the result partly of his own fault and partly of the fault of any other person or persons a claim in respect of that damage shall not be defeated by reason of the fault of the person suffering the damage, but the damages recoverable in respect thereof shall be reduced to such extent as the court thinks just and equitable having regard to the claimant's share in the responsibility for the damage."

N.C.U. Post-war Plans

THE committee elected by the N.C.U. General Council in 1943 has issued its report after many meetings. This report contains a number of recommendations for post-war plans which the committee thinks will enable the Union to reach "unprecedented heights as a national organisation catering for cyclists and cycling." One will search the report in vain, however, to find material upon which such hopes can be based, for a large portion of it deals with track racing and other forms of racing as distinct from time trials and massed-start racing on the public roads. The committee emphasise their previously expressed opinion that the sport and pastime of cycling suffers by the multiplicity of control now organised by the various organisations. If some or all of these could be amalgamated it would be to the advantage of cyclists and the pastime, and they urge the Union to neglect no opportunity of working to this end with the recommendation that they take the initiative and submit the suggestion to other organisations.

The Union is urged to take some positive action to improve facilities for track racing, and no doubt Herne Hill will be the venue. There are also recommendations for changes to rules, the formation of track-racing leagues, national championships, massed-start racing, rules for roller contests, improvement in the running of sports meetings and administration and a vast number of other matters. The document has been carefully thought out and we find ourselves in accord with much of it. At the same time the N.C.U. should remember that its plea for unity would not have been necessary had it maintained the position it held towards the end of the last century. Its attitude, then, when it tried to kill time trials as it is now endeavouring to kill massed-start racing on the roads, led to the formation of at least two other bodies—The Road Racing Council (now the R.T.T.C.) and the Road Records Association. If there are too many bodies as this report suggests (and we agree) the N.C.U. should not forget that it caused some of them to be created.

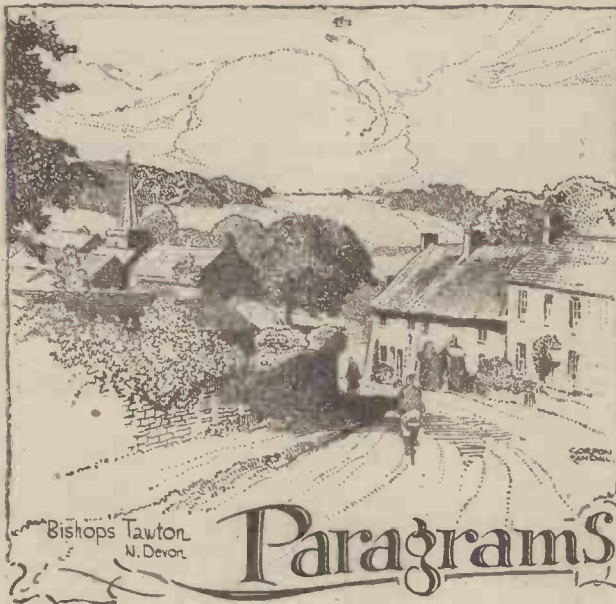

Buried at Antwerp

SERGEANT R. JORDAN, Regent C.C., of the Royal Air Force, who had been posted as missing, is now known to have been killed on an operational flight. He is buried at Antwerp.

Leicester's Loss

D. A. ELD, Leicester Forest C.C., previously reported missing while on an operational sortie, is now known to have been killed in action.

Manchester's Choice

A. J. BRADBURY, Chairman of the National Association of Cycle Traders, has been elected president of the Manchester Wheelers.

Useful!

IT is authoritatively stated that there are 75,000 British-made cycles used by the United States Air Force in this country, and that the use they are put to saves 25,000,000 gallons of petrol a year. The theory is that seven machines do the work of one jeep!

Olley's Honour

CAPT. G. OLLEY, famous old-time record holder, has been elected a vice-president of the Crabwood C.C.—a works club—as a token of appreciation of his son, **Ft. Lt. M. Olley** (who was on the staff of the Crabwood concern), who was killed in action.

Missing

SERGEANT J. H. STAFFORD, Rodney C.C., is missing, presumed killed, following an aircraft accident. His brother, **Arthur**, is a prisoner of war in Japanese hands.

Wolverhampton's Celebration

WOLVERHAMPTON WHEELERS come of age this year and anticipate appropriate celebration.

F. H. Habberfield Dead

F. H. HABBERFIELD, well-known track rider of two decades ago, has died. He was formerly a member of the Highgate C.C. before joining the Polytechnic C.C. and, in 1923, won several National Championships.

Union's New President

GEORGE B. WILSON, managing director of the Raleigh undertakings, is president of the British Cycle and Motor Cycle Manufacturers' and Traders' Union, Ltd. He succeeds **Gilbert Smith** (Norton Motors).

Generous Gesture

IN order that the club will be on a sound financial basis after the war, and that those at present away will be royally entertained when they return, the Southgate C.C. president (**H. W. Newby**) has donated £50 to a special reserve fund.

Portsmouth Champion

ROY RALPH, champion of the Portsmouth C.C. in 1940, is in India.

West Cornwall Presentation

H. HURLEY, hon. sec. of the West Cornwall Wheelers, was the recipient of a presentation, in appreciation of his services to the club, at the annual social gathering of members and friends.

Cornwall's Loss

THE Tamar Road Club is mourning the loss of "Ginger" Morgans, a flight-sergeant navigator, who was killed in action in Italy.

Walton Activities

B. W. BENTLEY, Walton C. and A.C., presided at the annual dinner of his club. He was a prominent roadman a few years ago. It was reported that one of the club's members, **Sergeant Leonard Mahon**, had been awarded the Military Medal for bravery while in action in Burma.

Hulse Interned

SERGEANT-PILOT J. HULSE, Wolverhampton Wheelers, is a prisoner of war in Germany. He was reported missing following an operational flight over enemy territory.

Call-ups

LATEST call-ups in the cycling world include those of **John Bishop**, Southern Coureurs, who is now with the Royal Navy; **G. Binns**, Halifax Road Club, for mining; and **L. Thorpe**, Barnet C.C., for the Navy.

Western Records

OF the 40 record distances and times of the West Counties Road Records Association, no fewer than 21 of the time standards still remain to be lowered.

Eastern Counties News

OVER 20 members of the Spalding C.C. are with the Forces, including **H. J. Honner** and **F. Barnes**, who are in India, and **C. Fulcher**, who is in Burma. Despite the drag on membership—but a handful of enthusiasts remain—an ambitious programme is scheduled for the coming season.

Dougherty's New Role

RALPH DOUGHERTY, well-known speedman, has been appointed an official time-keeper in the Midland areas. He was competing in road events only a short while ago.

Fred Worsnip Killed

SOUTH ELMSHALL C.C. mourns the death on active service in France of **Fred Worsnip**. Active in pre-war sport, he often represented his club as delegate to the local associations.

Dukinfield Loss

STAN JONES and his wife, of the Dukinfield C.C., have been killed as the result of enemy action. Although the club has over 30 members in the Forces this is the first casualty they have sustained. **Jones** had served during the early part of the war in the Navy.

Old Partners

P. BEARDSMORE and **M. A. McDonald**, well-known tandem pair of the Medway Wheelers, continue the combination in the Royal Navy. They reported together for duty, and have been detailed to the same mess in the service.

Cooke Reports for Duty

THE Norwood Paragon C.C. have lost another active and successful member, on road and track, in **John Cooke**, who has been called up.

Burton's Revival

TWO clubs have been resuscitated in the Burton-on-Trent area: the Swadlincote Wheelers and the Burton C.C. The last named has already a membership of 40 and anticipates renewing interest in road sport.

Lucky Man!

ROBERT READ, Wisbech Wheelers, who is serving with the Mercantile Marine, has been given permission to take his cycle aboard and intends to do as much riding as possible in foreign climes.

Wessex Man Missing

GERRY TILLY, appreciated member of the Wessex Road Club, has been reported missing in the Italian battle zone. He was in the Libyan and Sicilian campaigns and in the initial fighting in Italy.

General Eisenhower's Bike

IN those now far-away days just before "D"-day, General Eisenhower was to be seen of evenings learning to ride a bicycle in the garden of the house in which he was living. After a false start or two, he took kindly to it. We wonder if his desire to master a bicycle was simply prophetic intuition—or whether his Intelligence Staff had not provided in advance an accurate picture of the way in which Paris goes to work and play.

Road Accidents—December, 1944

CASUALTIES on the road during December totalled 12,234, of which 600 were fatal, 2,878 persons being seriously injured. In December, 1943, the total was 12,227, but the numbers fatally or seriously injured were higher, 600 and 3,150 respectively. The following table is an analysis of the number of deaths according to the type of vehicle primarily involved:

Type of Vehicle	No. of deaths
Service (British, Dominion and Allied, of the three Services)	116
Civil Defence	1
Public Service and Hackney	253
Goods	134
Private cars	97
Motor-cycles	26
Pedal-cycles	63
Others	19
Total	600

(The term "Vehicle primarily involved" means (i) where only one vehicle was concerned, that vehicle; and (ii) where more than one vehicle was concerned, the vehicle to which the accident appears to be primarily attributable. In neither case does it imply that the driver of the vehicle was culpable.)

Fatalities during the year totalled 6,416, compared with 5,796 in 1943. The increase of 620 may be explained partly by the increased road traffic during the preparations for the invasion of enemy-occupied Europe.



West Looe, Cornwall. Looking down the steep street to the river and East Looe.

Around the Wheelworld

By ICARUS



Winkle Street, Calbourne, Isle of Wight. A little island gem beloved by artists.

The F. T. Bidlake Memorial Plaque

AS there was not an outstanding invention during 1944 the Bidlake Memorial Trust has awarded the Bidlake Memorial Plaque to Frank Patterson "for his joyous delineation of the pastime of cycling for 51 years, and the pleasure his work has given in particular to cyclists serving their country the world over during 1944."

Blow to Prestige of National Bodies

IN my view, the decision of the Minister of Transport to proceed with his Bill making rear lights, reflectors and white patches compulsory on bicycles is a tremendous blow to the prestige of all of the national bodies concerned. For over 50 years opposition to rear lights has been fiercely maintained. Should the Minister be correct in his statement that the number of accidents to cyclists will be reduced as a result of rear lights, the national bodies will suffer a further loss of prestige, for it will damn their judgment and opinions on the other matters mentioned. Worse than that, it will mean that a large share of the responsibility for the appalling death roll will be laid at the doors of the C.T.C., the N.C.U. and the R.T.T.C. But will accidents drop as a result of rear lights? If they do not, there will be the strongest case for the rescinding of the Act.

Kentish Wheelers' Policy

THE Kentish Wheelers at their A.G.M. tabled the following resolution, which was carried unanimously:

"That in view of the statements made recently by members of the B.L.R.C. that the majority of London clubfolk are with them, and against the R.T.T.C. and N.C.U., in regard to the controversy on massed start racing on public roads, the Kentish Wheelers, on the occasion of its annual general meeting of December, 1944, thinks it fitting to reaffirm its past policy, and to continue wholeheartedly in support of the R.T.T.C. and N.C.U.

"Secondly, that this club believes the efforts to 'heal the (so-called) split' are misguided; the split having been caused

by people who broke away, and now, naturally, are desirous of seeing the split healed if it means that all their claims concerning massed start events on public roads are conceded by the R.T.T.C. and N.C.U. [Nonsense!—Ed.]

"Thirdly, that this club believes that the recent letters in the cycling press, setting forth the continued policy of the R.T.T.C. and N.C.U. toward the B.L.R.C., are perfectly reasonable, particularly so in view of the warnings from the Home Office concerning massed start racing on public roads." [Rubbish!—Ed.]

New Union President

MR. GEORGE WILSON, the new president of the British Cycle and Motor Cycle Manufacturers' and Traders' Union, Ltd., succeeded Sir Harold Bowden, Bart., as managing director of the Raleigh Cycle Co., Ltd., in 1938. He is also managing director of Sturmey-Archer Gears, Ltd., Rudge Whitworth, Ltd., the Gazelle Cycle Co., Ltd., and the Robin Hood Cycle Co., Ltd. He has been chairman of the Irish Raleigh Cycle Co., Ltd., since it was formed in 1936.

Mr. Wilson, who was born in County Dublin 50 years ago, was educated at Marlborough and Pembroke College, Cambridge. He served throughout the last war, first with the Army and later with the Royal Flying Corps and Royal Air Force, winning both the Military Cross and the Air Force Cross. After the war he went to Dunlop, and then the Champion Cycle Co., Nottingham, joining Sturmey-Archer in 1927. Mr. Wilson was made a Justice of the Peace in 1939, and in 1942 received the O.B.E. for his voluntary work for the National Savings Campaign in Nottingham, where he became chairman of the Nottingham Savings Committee and the Nottingham War Finance Executive Committee in the first December of the war.

Roadfarers' Luncheon

LORD BRABAZON, President, was the principal speaker at the Roadfarers' Club luncheon held on January 26th at the Waldorf, when there were many important guests, including the Marquess of Queensbury, Sir Frederick Handley-Page, Sir Arrol Moir, Sir Arthur Du Cros (son of the founder of the Dunlop Rubber Co., and author of a book on the history of the pneumatic tyre), and Woolf Barnato. Lord Brabazon in his speech dealt with post-war developments on the roads, while Sir Frederick Handley-Page dealt with civil aviation after the war. There were 120 members and guests present.

Road Time Trials Council Notes

AT a committee meeting held on January 21st, the following items were released for publication:

1945 Handbook.—The 1945 Dates List and Handbook will be on sale early in March, price 1s., post free. Orders, accompanied by cash, should be sent to S. Amcy, "Wynfrith," Inwood Avenue, Old Coulsdon, Surrey.

All-Rounder Competition.—The S.A.C.A./R.T.T.C. joint management committee is to meet shortly, when the final details will be settled. The council's representatives are Messrs. A. E. Armstrong, T. M. Barlow, and S. R. Forrest.

Competition Record.—A claim by Mrs. E. Broughton to have established a women's tricycle record at 50 miles was passed. The time of 2 hrs. 52 mins. 55 secs. was recorded in the Spelthorne C.C. event in July, 1944.

Levy.—The amount of the levy has been fixed at 3d. It should be noted that each entrant in open and association events must now include the levy with the entrance fee.

Awards.—Owing to the relaxing of certain regulations regarding the manufacture of medals, the National Committee decided that steps should now be taken to provide medals for the prizewinners in the 1944 National Championships and Best All-rounder Competition.

Charlotteville Officials

AT the annual general meeting of the Charlotteville C.C., the following officials were elected to office for 1945:

Hon. Racing Secretary (Open Events): D. J. Grey, "Rockstone," Eashing Lane, Godalming, Surrey.

Hon. Racing Secretary (Club Events): W. Stickle, "Pimperne," Tynley Grove, Jacobs Wells, Guildford.

Hon. General Secretary: D. E. Eldridge, 50, Weston Road, Guildford.

Misprint

I AM asked to point out that in the report on the R.T.T.C. dinner to the champions, we wrongly gave a speaker's name as H. Chamberlin. This should, of course, have been A. P. Chamberlin, and I mention the matter here as Mr. Chamberlin has taken the trouble to point out an obvious error. We are most anxious, of course, that the remarks should be taken as applying to the right person, and this paragraph should make the matter clear to those to whom the fame of Mr. Chamberlin is unknown.

International Sea Rule

THE Rule of the Road should be the same as the basic rule of the sea, said Admiral E. O. Hefford, O.B.E., Chairman of the Council of the Cyclists' Touring Club, speaking at a Press conference in London recently.

By agreement among all the civilised nations of the world, he explained, the onus of avoiding collision at sea when one vessel is being overtaken by another rests entirely on the overtaker. So it should be on land, and so it would be if the spirit of the Highway Code were the basis of our road laws. But the Road Transport (Cycles) Lighting Bill now before Parliament aims at making cyclists responsible for their own safety when overtaken by faster vehicles, and providing motorists who run them down with a ready-made excuse that will prevent the cyclist victim from obtaining compensation.

The driver of a car that runs a cyclist down from behind need only say that the rear lamp was out—as it will be after the collision—and he will escape all liability.

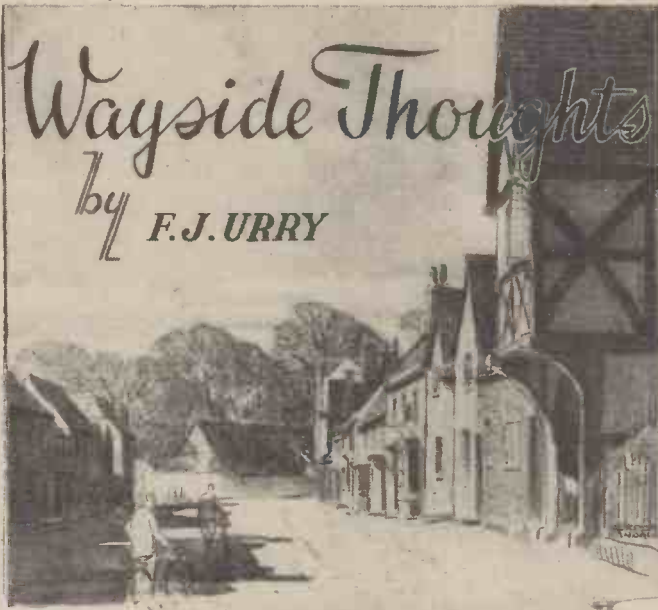

In the picturesque village of Lacock, Wiltshire.

Frightened Off

IT was not a good Sunday in the middle of December when I wanted to go on a thirty miles round to discover if my country friends would be kind to me on the question of Christmas fare. A young friend in the R.A.F. had arrived on the Saturday evening to spend a brief twenty-four hours with me, and had been looking forward to a jaunt over our Midland Shire for the purpose of comparing our flatter land of tiny streams and shallow valleys with the up-reeled caith of his native Scotland. We found a spare Mac and started—very gingerly, for there was ice on the road, ice with a damp surface, the slippiest kind of carpet I know. In parts the bus tracks had smashed a path for us, and so long as we could hold to them the course was fairly safe. But once off the verge for the purpose of allowing full room for overtaking traffic, and the tyres started to suddenly shiver sideways towards the gutters. It was nervy progress, and as I do not tumble quite so gracefully as of yore, and should hate to break a limb and debar myself from riding, I confess I was not enjoying the journey. In due course we wriggled beyond the regular traffic route, and then it started snowing, whacking great flakes that drove into our eyes and made visibility a trifle painful. And the icy carpet was no longer broken by heavy wheels, so the surface was like riding on jelly fish, and you never knew when one would move suddenly and take the bicycle with it, leaving you to hit the earth in the most graceful fashion you could contrive in a flashing fraction of time. I rebelled, to the disappointment of my young comrade, for I was scared. As we were within a mile of one of my calling places, where I knew we should be welcomed with a pot of tea and its appurtenances, we turned into a rough lane to make the traverse, and for once found its roughness a comfort. Having arrived we discovered to our regret that the owner of that hospitable house, while walking up his drive, had slipped on the deceptive surface and sprained an ankle. I never said a word to my young friend in justification of my refusal to carry on; which I think was rather clever on my part, since the wisdom of my action came from his lips when the tea cups were brimming and the biscuits bravely crackling. Yes, there are moments when cycling is difficult and slightly dangerous, and this was one of them, and growing older I eschew the adventure that might cripple me for a time.

The Creeping Fog

LATER in that same week we were blanketed out with a dirty thick fog. It came in with the dawn and persisted until sunset, when, thank goodness, it began to slink away in coils of grey vapour, leaving a rime on the raiment of the unprotected rider. I started on the work journey that morning with some trepidation, but fortunately there was no ice on the road, so the fog, although unpleasant and clingingly cold, slowed but did not stop me. There was a certain amount of quiet satisfaction in my chosen form of travel that morning and evening, for I was as fast as the cars and a good deal more comfortable. Except where I had to cross the traffic stream I could do on easy eight miles an hour, which was as good or better than the buses. Yet it is astonishing how you can miss a crossing in a real black-out fog, for twice I was dismayed only to discover I had anticipated my turning. It was chilling going, but you can sid circulation by the good old method of the London cabbie—thirty-six arm flaps at full vigour—and then are fit for another three or four miles of gutter crawling. I was only fifteen minutes late, less than a third of the journey time lost by my office confreres; and O! how sorry I felt for the cold people in the long queues at the bus stops, who looked as dismal as the weather. On the home journey the fog was swirling and patchy, but the

glimpses of light along the way marked the course, which in the nights of the late black-out would have been difficult to negotiate, and I felt again the comfort of the traveller that the lifting of that Egyptian darkness has given.

Not Far Behind

WITH the Christmas season over we can look forward with hope and joy to the advent of spring and all that season means to us who ride, and love the beauty of that blowing time. True, we may hit some bad days when snow will stop us and the icy roads deter, but let us hope they will be few or none; for as I grow older that type of weather for me—though it may have the excuse of being seasonal as its apologists say—only adds another pang to winter. A frost, yes, when the roads are iron bound and the top surface has no deceptive dampness to whip the wheels from under you; when the crackle of the tyres matches the sparkle in the air, and you know of a good place some miles on where the log fire will be roaring and a smoking meal is nearly ready. That's the kind of winter for me,

for with a lot of riding and a little walking to keep my feet warm, the daylight hours run away in joy, and the star-powdered sky at nights leads you home to chatter of the days ahead. There are good days in winter, and if they would only fall at the week-ends, we who roam would be happier mortals. Yet I still imagine we think as Shelley thought when he wrote: "If winter comes, can spring be far behind?" I hope it will not linger on the way but, blowing freely, will lay kind hands on the hedgerows and along the woodlands, and find this fair land on the verge of peace after stormy days, and down the road I shall see many of the younger tribe who have grown old in experience, but still retain that burning enthusiasm that shines so brightly in all their letters to me for this old game of wandering independence that is for ever so young.

The Perfect Leisure

THERE happened an evening just after Christmas when the air was calm and chill and out of a clear sky the moon dimmed the bright points of the stars. I had spent several stuffy nights and early mornings in mild conviviality and badly wanted a ride, so the journey home just put the touch to my desire, and having swallowed a meagre tea I paddled into the lanes near home and saw a well-known route of some 20 miles silvered o'er with the pale beauty of the night. It was a quietly glorious ride over ways that knew me when I was little more than a child, and once again I sensed the loveliness that can never be spoken (not even in the phrases of Shakespeare), of the Forest of Arden—or what is left of it—under the magic of moonlight. I heard the owls hooting down the silvered glades, and saw the dimpling waters of our little rivers of Blythe and Cole wink brightly at me as I sat on their bridges to enjoy a cigarette. Twice I walked a space to warm my feet under the silver flecked tunnels of the woodlands near Maxstoke, and once I stayed awhile at a transport hut to join a couple of lorry wayfarers en route to Liverpool, cheery fellows gay at

the prospect of a lit passage. Only for three miles did I see any traffic, three miles of the London-Liverpool road down which I have a foretime seen so many record breakers speed, and hope to live to see many another pass by. For I'm a spectator to-day, whereas before following cars were allowed I was a chaser of time's challenger along that classic route. There were many other things I recollected, too, as I went wandering home; all those great days when the air tyre was developing into the pneumatic we know now; all those sporting makers of bicycles and equipment who rode and used the wares they made and bragged about them; and the hostels along the road kept by cyclists for cyclists when the internal combustion engine was still a silent dream. And so I came home full of refreshment, and in possession of a real appetite for the festival crumbs still left in the larder.

Catering

WE are not to-day well served by our hotels and caterers, and in my opinion we never have been. There is excuse enough now to forgive the cursory manner with which our simple needs are met—the take it or leave it attitude—yet even when all the troubles connected with the business of catering are taken into account, I am quite sure that some of our calling places like our money and dislike our presence, or most certainly dislike it at times. I know all the excuses, and have often been a sympathiser with them in the selfish hope of better treatment, but such expediency does not blind me to the fact that the whole system needs overhauling if Britain is to have the opportunity of becoming—as it so richly deserves to become—a playground for the world. Many promises have been made by the Government that this very important matter will have immediate post-war attention, and if those promises are implemented one hopes that the cyclists' position, as among the biggest class of tourists, will not be overlooked. We want reasonable accommodation, with cleanliness and plain but substantial fare, and there should be no insuperable difficulty in formulating a standard that can easily be followed by the full or part-time caterer. Pre-war there were many good places; we knew them in our own districts; it was when we went further afield that we were so often disappointed.

One Day

I HAVE often said that winter weather is not always bad, but the unfortunate thing about it is that the good days so seldom fall at the week-ends. Yet even those free days are not wholly grim and grey, but now and then a rare jewel drops on us, and that "inverted bowl we call the sky" is a glory of colour under which the sleeping earth seems to awaken and take on the sunny reflections of loveliness. I was out on just such a Sunday some weeks ago, a lively day of wind that overnight had torn branches from the treacherous elms, and twice along my route the way was blocked by fallen trees. It was warm, and the air seemed scented as if its northern drift was bearing the spices of spring, while all the woodlands were in chorus and even the thin hedges were full of a rustling undertone. It was fine to be out, and finer still when I had arduously climbed to a high ridge overlooking a small forest and watched the great trees waving their arms with the sunshine striking jewelled flashes from their hoary trunks. That wind kept me busy for nearly 20 miles even though I had chosen the narrow lanes for shelter, for it came booming through the rattling gates and swooping among the open places to discover a lone wanderer was challenging its might, and to smite him for his temerity. Then I had a light lunch and a big pot of tea rounded off with a couple of hours' talk. Nor did I return unladen, which was part of the reason for the journey; but by then the wind was my kind friend, and taking a longer route I lingered on the road to see the last of the daylight go to sleep in a bed of purple and lemon, presaging more broken weather, which came on the morrow sure enough. But that day was delightful, nearly five hours of mixed tough and tender riding, and most of the daylight my very own.



A glimpse of a corner in Eardisland, near Leominster.



Cycle tyres in the forward areas have to stand up to conditions unheard of at home. Over there, as over here, Firestone Tyres are taking the strain.

they use

Firestone

★ Your help to meet this great demand is vital. Not one ounce of rubber, synthetic or natural, must be wasted. Keep all tyres properly inflated.

tyres

SCRAPBOOK OF



A PAGE FROM THE PAST

Dunlop tyres made cycling history; indeed, Dunlop tyres made modern cycling possible; for without the pneumatic tyre, such speed, safety and comfort as millions now enjoy would have been impossible of attainment.

DUNLOP



FIRST IN 1888 . . . FOREMOST EVER SINCE

4H/313

All Ready—

The expert craftsmen who built those "C.B." thoroughbreds you remember, are working very hard proving their supreme skill in efforts to get the lads home as quickly as possible. Their workmanship will once again go into the making of "C.B." machines—Yes! they're ready to give you the best ever.

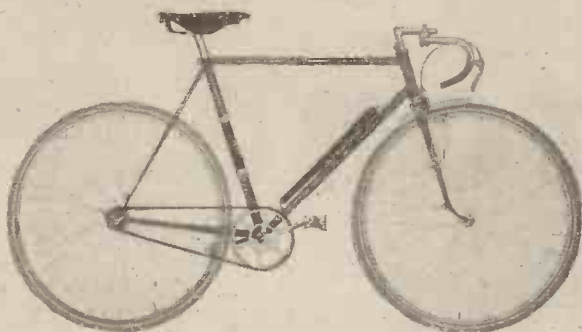

"Champions' Choice"

CLAUD BUTLER

CLAPHAM MANOR STREET, S.W.4.

APEX 'SUPERLITE' CELLULOID PUMP 15" 4/-

Thick Celluloid Beautifully Polished

Light of Weight but of robust construction

LASTWEL (Celluloid) 15" 4/-
LASTWEL (") 12" 3/9

The World Famous BAILEY'S 'SUPER' PUMP 15" 4/- Steel Lined Celluloid Covered

Lining is solid drawn cartridge fashion, the end being solid with the barrel.

Cannot warp nor leak

APEX PRODUCTS

Are in use in every Country in the world.

They are known and appreciated for their reliability; long service and efficiency in their job of inflating tyres.

War conditions have restricted supplies, and whilst control lasts we are only permitted to make 12" pumps and only small quantities.

MADE BY

APEX INFLATOR Co. Ltd.
ALDRIDGE ROAD, PERRY BAR,
BIRMINGHAM, 22B.



CYCLORAMA

By
H. W. ELEY



Norwich, Elm Hill. In the shadow of the old "Briton's Arms."

Frustrated by Fog

I AM afraid that the good rides I had planned for the early part of this year were defeated by the demon fog. In the south, I gather that the visitation of fog was not so severe, but in the Midlands the weather for the out-of-door man was spoiled by a thick pall of fog which hung about for two or three days, and destroyed any idea of a pleasant ambling ride through the villages. I was greatly disappointed, for on the northern side of Birmingham, where Warwickshire meets Staffordshire, there are some quite delectable villages... some still possessing old forges, old churches, and old inns. Tied to my fireside, I browsed over some of my old maps and touring note-books, and lived again some of the good journeys I had made in the years gone by. Not a bad plan this... to take out a map, and when the weather is unkind, plan a tour for the days when the sun shines again!

The Quality of Cycle Tyres

RECENTLY, I have read one or two complaints about the alleged poor quality of cycle tyres... and one correspondent waxed quite eloquent about what he termed the irony of telling cyclists to take good care of their tyres in view of the rubber shortage, when the tyres wore out so quickly, and were obviously of poor quality. Well, the question is rather a complex one, and the unfortunate tyre manufacturers should not be blamed. Practically all cycle tyres are now made from "synthetic" rubber, in the interests of the nation and the war effort, and I do not think that any manufacturer would claim that "synthetic" is equal in wearing qualities to natural, or "crude" rubber;

but needs must when the enemy drives... and it is quite logical to ask cyclists to take extra care of their tyres in these days. One day, Malaya will be in our hands again, and the good crude rubber we knew in the old days will be available for the manufacturers. Until then... we must put "first things first" and nurse our "synthetics" in the way which the manufacturers and the Ministry of Supply suggest.

The Cyclist and Dieting

BEFORE the war, controversies used to rage with almost boring regularity, about the best diet for the serious cyclist... and by "serious" I mean the rider who used to ride long distances, and tax his physical strength. How well I recall, having read an article about vegetarianism, making a vow that never again would I touch meat. The plate of roast beef, the succulent pork chop, the tender cut of lamb, made more delicious by mint sauce... these were to be avoided at all costs, and I remember making out a list of foods containing proteins, and reading a number of tomes about the evils of meat-eating. Alas! I speedily fell a victim to the lure of "meat and two veg."; I discontinued my grated carrots, my lentils, and my lettuce. And I do not think that my health suffered. It is all, I fancy, a matter of individual needs, and mental outlook. To-day, in the difficult times of war, I am glad to eat what I can get...

and I suppose that most riders are in the same position. The point is, has our health improved? Are we able to cycle longer distances, with a less degree of fatigue? I shall not mind if all this "starts a war"... diet is important after all!

Eastward Ho!

EARLY this Year, I am booked to ride into East Anglia... and I look forward to the prospect, for I am not one of those who regard Norfolk, and Suffolk, and the Fen country, as in any way uninteresting. On the contrary, I love the flat lands... I love the quiet towns of Suffolk, and the landscape of Cambridgeshire. I do not always pine for hills, and the rugged grandeur of the North. On a spring day, give me the homely country of Constable... the old mills, the little streams, the thatched cottages, the inns of the East country. Possibly I shall ride into East Bergholt, where the immortal landscape painter was born... and I shall gaze again at Flatford Mill, and see the scenes which inspired Constable to paint "The Hay Wain."

Ancient Coventry

IF one needed to be reminded that Coventry is an ancient city, with great traditions, the reminder came when I received, the other day, a letter about the forthcoming celebrations in connection with the granting of the Charter to the city in the year 1345. Six hundred years ago! And what changes Coventry has seen during the long centuries! From the legendary ride of Lady Godiva through the narrow streets, to the dread shower of bombs on the nights of the Great Blitz... Coventry has tasted life in many forms; it has nurtured many trades—silk, watches and clocks, cycles, cars, aeroplanes; to-day, though bearing honourable scars, it faces its future with hope and fortitude, believing that the best has yet to be. I gather that the Charter celebrations are to be on the grand scale, with possibly an exhibition portraying past and present greatness. Salute to Coventry!

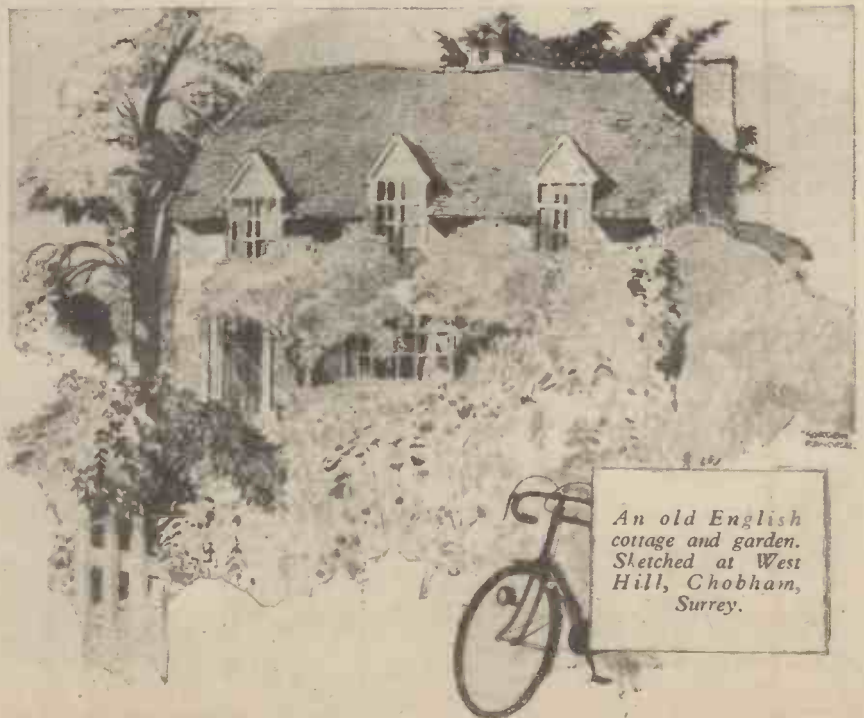

An old English cottage and garden. Sketched at West Hill, Chobham, Surrey.

Notes of a Highwayman

by LEONARD ELLIS

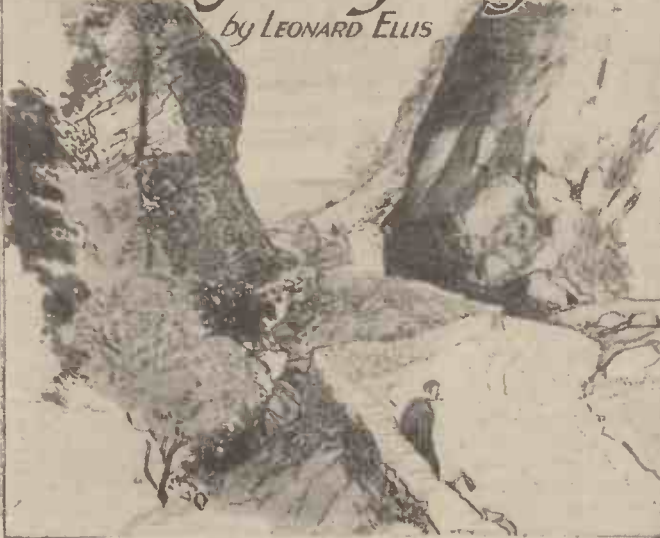

The Pass of Melfort, Oban, Argyllshire, Scotland.

Britain's Touring Grounds—(4)

AFTER North Wales it seems that Ireland was the next most popular touring ground, at any rate just prior to the war. In trying to put these touring grounds into an order of popularity it should be borne

in mind that only certain figures are available—there is no record of the thousands of cyclists who preferred to paddle their own canoe without any help in the way of planning.

The Emerald Isle is at the moment not a feasible proposition, and as I am not at any rate qualified to speak of it as a cycle tourist, I propose devoting this short sketch to the Lake District, which would appear to be the cyclist's next choice. Here we have one of England's grandest spectacles, marred only by one thing—notoriously bad weather. It is stated that Seathwaite is the wettest spot in England, although no doubt there will be many disputants. In a comparatively small area we find England's highest mountain, nearly all the lakes that this country possesses, and a wealth of good roads and fine scenery. It is generally supposed that the Lake District lies wholly in Cumberland and Westmorland, but in making this statement beware of the Lancastrian, who is rightly jealous of the fact that quite a bit is in Lancashire. He will probably remind you that the west side of Windermere, some of the east side, and the whole of Conistone is in his county, and he will be right.

England's Highest Peaks

ENGLAND'S three highest mountains, Skiddaw, Scafell and Helvellyn, are all to be found

within a few miles, and other peaks, such as Great Gable, Langdale Pikes and Saddleback, are merely the outstanding giants of this tumbled country. In the valleys formed by the slopes of these hills are a dozen or so lakes, all beautiful, and some admittedly finer than others. Wordsworth, the poet, spent his life among the hills and lakes of this district, and many of his poems sing the praises of his favourite spots. He was particularly fond of the two pretty little lakes Rydal Water and Grasmere, lying north of Windermere. Windermere is the largest lake, being some ten miles in length, and is noted for its beautiful shore line. Thirlmere, Derwentwater and Ullswater are grander, in that they are more enclosed in the mountain slopes. Wastwater is very wild and edged with great scree slopes, while Ennerdale and Bassenthwaite are quieter in their setting. Crummock Water and Buttermere are two more of the smaller lakes, both alluring and well worth a visit.

Pass Stormers' Paradise

FOR those who like rough cycling there are some magnificent passes—some by way of good roads and others that are mere tracks over the mountains. There is a tremendous thrill and fascination in most of them. Some of the most famous are Kirkstone Pass, from Windermere to Ullswater, passing tiny Brothers Water on the way. The road is generally good and not too steep. Honister Pass goes from Borrowdale, south of Derwentwater to Crummock Water, and is one of the wildest. Wrynose and Hard Knott Passes are rough tracks connecting Langdale and Eskdale, and are favourites with the adventurous cyclist. The Sty Head is another in this category, being but a track along the slopes of Great Gable and offering fine views of that mountain on the north, and Scafell Pike on the south. It continues finally to the shores of Wastwater. Waterfalls are many, Lodore being mentioned by more than poet almost in derision because of its habit of disappearing in a dry spell. Aira Force, on the shores of Ullswater, is very fine indeed. Others are Dungeon Gill, Stock Gill Force, and Skelwith Force. There are many interesting towns and villages in the district, but it must be conceded that the lakes and mountains have first claim. There are some antiquities, perhaps the most famous being the Druid's Circle, near Keswick.

My Point of View

By "Wayfarer"

Those Caterers!

ON a recent Sunday afternoon I called for tea at a certain hotel which I patronise from time to time. To my concern, the usual door was locked, and I prowled round until I found access, only to be confronted by the statement that "we don't usually provide tea on a Sunday!" I was slightly staggered, partly because of the impossibility of obtaining a meal elsewhere in the neighbourhood; but I said, with all the sweetness at my command, that I had had tea there on the previous Sunday. Rather awkward, that! Then the woman-of-the-house quickly changed her ground. It was the maid's day out—"but if you are alone, I can let you have some tea." So I had a very good tea, which fitted me for the remaining 25 miles of my journey. But oh! the subterfuges—the ingenuousness—of some of these caterers!

Signpost Method

A SMALL country town through which I often pass on my cycling expeditions held, a few months ago, what was called a "Safety Week," during which the populace had pumped into them a certain amount of propaganda concerning the need for taking care. I hope that the effort achieved some success. It was to be noted, however, that the members of the local Suicide Club were out in force during that week, following their usual practice (particularly in the dark) of deserting the perfectly good side-walks provided for their use and cluttering-up the roads. Physician, heal thyself! I attach little value to this signpost method of applying safety principles. The signpost, of course, tells you which way to go, without itself going that way. It was so with the populace of the small country town mentioned. As so often happens, all the good advice which was being ladled out was for that entity known as "the other fellow." It did not apply to the ladler!

For Adoption

ON a recent occasion the rain which had threatened all morning actually arrived when I had done the first four miles of a 50-mile journey. There was, of course, no question of turning back. If, for a moment, I thought dismally of the prospect of riding another 46 miles in "this"—on a November day—the idea was a fleeting one, and I soon reverted to my usual attitude of looking ahead optimistically, with the decision that every mile was to be viewed as a separate piece of pleasure, despite the damping-down which the climate was achieving. And, when you come to think of it, that is the right attitude to adopt in connection with all journeys, especially the longer ones which are done in difficult conditions. If you look upon the miles as a burden, then you are sunk. On the other hand, if you are convinced that every mile, every yard, is a chunk of pleasure, producing its quota

of mental and physical benefit, then you put yourself in the way of securing enjoyment. If you haven't tried this recipe, do so! It is worthy of adoption.

The Higher Intelligence

I HAVE previously commented on this page on the quite extraordinary (and woeful) ignorance concerning the possibilities of cycling which prevails amongst quite intelligent people. One Sunday last autumn, while having my lunch in a country cottage, I was asked by a lady, who shared the feast, how far I had to go in order to reach home. My reply was: "Only 50 miles." (The "only" is invariably included in such an answer, if merely to show the lack of importance attaching to distances!) Then came the astounding query: "Will you get there to-day?" Confronted by such a question, I followed my usual plan and elaborated the reply by saying (what is a fact) that I had done the journey involved, often enough, in an evening; it had also been accounted for in a morning. Then came the curious *non sequitur* inquiry as to

whether I carried a macintosh. As though anybody in this country would ever venture across the road without taking a proper supply of protection from the weather!

Everybody's Doing It

I CONTINUE to be amazed at the fact that practically everybody is able to ride a bicycle, and yet I hardly ever see people being initiated into the mysteries of balance. It is to be supposed that somebody must undertake this task—unless young people now ride bicycles by instinct. In my early cycling days I recall that there were actually people who paid money for being taught how to ride a bicycle, although most of us, of course, received our lessons free, and gladly passed on to others, on the same basis, what we learnt.

But, alas! What does not seem to be taught in these days is ankle action—and the proper position of the feet on the pedals. The result is that one sees some perfectly horrible exhibitions of how not to ride a bicycle. Usually, in these cases, the instep is used, and sometimes (incredible though it may appear!) the heel, while the feet posed at an angle of 45 degrees to the direction of the bicycle are a common (and paralysing) sight. I suppose that the answer to all this is that the majority of the people who now ride bicycles are not, and do not want to be, cyclists "within the meaning of the Act." They acquire their steeds for purely utilitarian purposes, and indulge in quick walking rather than in cycling. 'Tis a pity, having regard to the immense—nay, illimitable—possibilities of the bicycle.

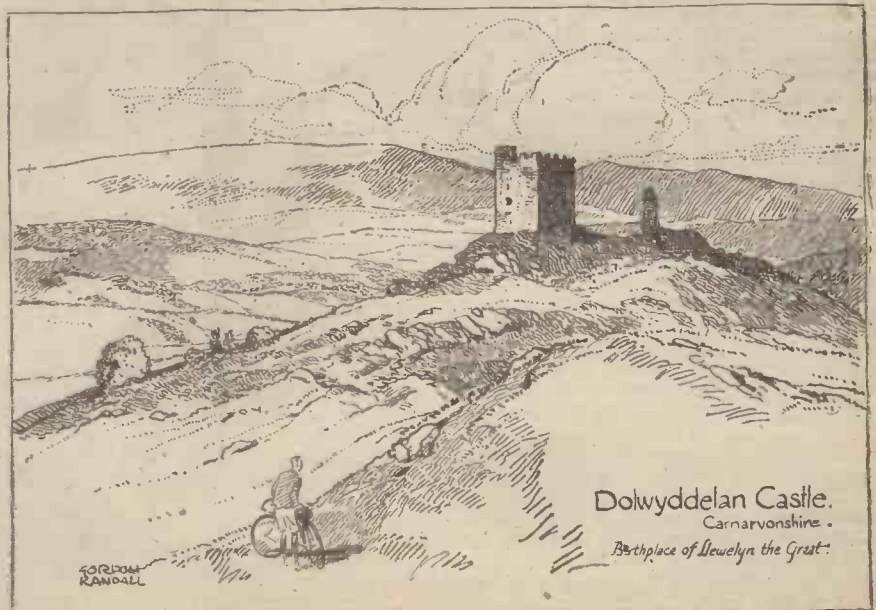

Dolwyddelan Castle.

Carnarvonshire.

Birthplace of Stewelyn the Great.

3-VALVE BATTERY RECEIVER

Following the amazing success of the "WIZARD" 4-valve Universal Mains Receiver (Circuit and Instructions, etc. 5/-, still available), we have been inundated with enquiries for a battery version of this popular set, and we now offer for 3/6d. the "DORSET" BATTERY THREE Manuscript, comprising complete constructional wiring diagrams, every step and wire described, schematic circuit with pick-up and tone control connections; full size drawings and parts list and average prices. Easily obtainable valves and no electrolytics. We sell any components separately. You do not have to buy the complete kit from us. "Coming shortly, 6-watt A.C./D.C. Amplifier. Send postcard for particulars." "Dorset" enquiries answered free S.A.E. No callers, mail order only. Weldona, Radio Accessories, Ltd., "Avon," Burlington Road, Swanage, Dorset.

S.O.S

This message means the same all the world over. How splendid if one could so easily communicate with people of all nationalities by means of one common language! It can be done if you know Esperanto, the international language which is now being spoken and written by people in every part of the world. Very easy to learn.

You can learn Esperanto by correspondence, and a course costs only 5s. including textbook and correction of exercises.

Write for full particulars to:

THE BRITISH ESPERANTO ASSOCIATION INC. Dept. P.M.44, Heronsgate, Rickmansworth, Herts.

MASTER THE PIANO

Easily, Quickly, Enjoyably

To learn to play beautifully is easy—with proper teaching. I Even if you start at middle age not knowing a note, I CAN TEACH YOU to play really well. By POST. Municipal. Fascinating lessons using ordinary musical notation, no freakish methods, enabling you to read and play at sight any standard musical composition. I have enrolled more than 16,500 adult pupils during the War. During 40 years I have taught over 65,750 and I CAN TEACH YOU. Send for FREE BOOK and advice. See Moderate, Elementary or Beginner.

Mr. H. BECKER

(Dept. 758.) 69, Fleet Street, E.C.4.

SHORTHAND

DUTTON'S ONE-WEEK SHORTHAND is used by over 60,000 men and women. Accepted by Services and examining bodies. Test Lesson 3d. Write Dept., P.M., 92, Great Russell St., W.C.1.

IN ONE WEEK

Easily made From Our Castings. J. HALLAM & SON, Upton, Poole, Dorset.

MINIATURE PETROL ENGINES for Aeroplanes and Speed Boats. Sent 3/- for particulars

Build your own POWER DRIVEN FRET-JIG SAW from easily obtainable parts ONLY (costing approximately 60/-). Using Coping Saw (2d.) will cut out TOYS, ANIMALS, PUZZLES and 101 other Saleable Articles. Well tested. Set of Diagrams and Instructions. Price 2/6. P. M. BARHAM, "HINTOP," Bradmore Green, Coulsdon, Surrey. (Parts Stocked.)

4 USEFUL PUBLICATIONS.

37. Aldvych, W.C.2.
1. TOYS FROM SCRAP FOR PLEASURE OR PROFIT. 3/6.
2. "THE ART OF SCALE MODEL AIRCRAFT BUILDING" by V. J. G. Woodason. 4.11 (8/6 cloth).
3. "AROUND THE WORLD WITH PEN AND CAMERA" by W. Buchler. 1/6 (3/9 cloth).
4. "MONEY IN EXPORTS" (Trading in 41 different countries). 10/6.

NO MAN CAN KNOW TOO MUCH OF HIS PRODUCT

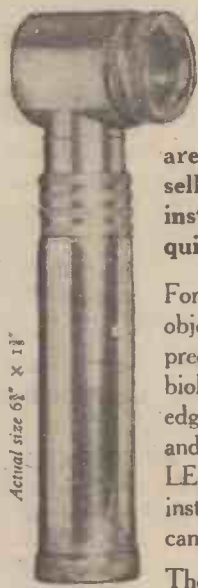

Actual size 6 1/2" x 1 1/2"

BRITISH MADE

Full particulars on request.

The Ultra Lens is a revealing eye of six actual diametrical—36 area magnifications, which brings out points of strength or weakness. Whether you are engaged in manufacturing, buying or selling, it is an ally of real value. No instrument you can buy will more quickly justify and pay for itself.

For the close scrutiny of every conceivable object, metals, tools, fabrics, fibres, minerals, precious stones, paint, print, manuscripts, biological and botanical specimens, cutting edges, fractured surfaces, raw materials, and innumerable other purposes, the ULTRA LENS is invaluable, and presents in many instances hitherto unsuspected data which can be used to advantage.

The price is £4-5-0 complete in case with spare bulb, battery, and transparent measuring scale.

The Ultra Lens Company,
RICHARD BOCK,
75, Finsbury Court, Finsbury Pavement,
London, E.C.2.

MATRICULATION

brings Success & Security

Whatever your age, you can now study for the all-important Matriculation Examination at home on "NO PASS—NO FEE" terms. "MATRIC" is the accepted passport to all careers, and opens up opportunities which would otherwise be completely closed to you. Ensure the success and security of you and yours through post-war difficulties by writing for our valuable "Guide to Matriculation" immediately—FREE and without obligation. B.T.I. (Dept. 160), 356, Oxford Street, London, W.1.

Ideas Wanted!

They may mean money for you!

We are open to consider any ideas or patents of practical worth with a view to making and marketing them. Write in confidence to:

Edron Industrial Group,
7 Park Lane, London, W.1.

LINESIDE FEATURES:

"00" "0"	
NEW STATION SEATS	1/3 1/3
OIL TANK STORAGE	15/6
COTTAGES	6/- 9/6
COAL OFFICES	4/- 8/6

BOOKS:

THE MCINTOSH LOCOS. OF THE CALEDONIAN 3/6, by post 3/9.
"TITANS OF THE TRACK" (S.R.) 2/-, by post 2/6.
OUR RAILWAY HISTORY Parts II & III 3/6, Postage 3d. extra.
MODERN LOCOS & ELEC. TRACTION OF S.R. 1/6, Postage 3d. extra.
CARDBOARD ROLLING STOCK AND HOW TO BUILD IT 2/6, by post 2/9.
TYLDESLEY & HOLBROOK, 109, Deansgate, Manchester 3
'Phone: Bls' 7312

HIGHSTONE UTILITIES

CRYSTAL SETS



Our latest Model is a REAL RADIO RECEIVER, and is fitted with a PERMANENT CRYSTAL DETECTOR. WHY NOT HAVE A SET IN YOUR OWN ROOM OR AS A STABLE-BOY?—9/6, post 6d. PERMANENT DETECTORS, 2/6, post 3d.

0003 Pre-set Condensers 2/-, post 3d. HEADPHONES

Reconditioned 9/6, 10/6 & 12/6. New 17/-, Post 6d.

MICROPHONES

Just the thing for impromptu concerts, room to room communication, etc. Bakelite table model, 6/9; Suspension type, 6/6. Post 6d. Super Model on stand, 12/6. FITTING INSTRUCTIONS INCLUDED. Mike buttons, 2/6. Transformers, 9/6. Public Address Transmitters, current 3/6, 37/6, post 1/-.

BUZZERS

No. 2. Square single coil model, 2/6. No. 3. HEAVY DUTY double coil, 4/9, post 3d.

MORSE KEYS

Practice on a regulation size Tapping Key. Our heavy brass model is mounted on a wooden base, has an adjustable gap and nickel contacts. Key is wired to work buzzer or flash lamp by using a 4-jolt battery or the transformer described above. BRASS KEY, 6/9. Chromium plated, 7/6. W.C. Model with heavy brass base and an additional front bracket, 9/6. Chromium plated, 10/6. Junior Key, mounted on a Bakelite base, together with a buzzer, 5/-. Should you require a complete outfit, our D.X.2 set consists of a heavy key mounted on a large polished board, 10in. x 7 1/2in., together with a buzzer, flash lamp, bulb and holder, with two switches to bring either into circuit. Terminals etc. also provided for distant sending and receiving. 19/6, post 6d.

BELL TRANSFORMERS

These guaranteed transformers work from any A.C. Mains, giving 3, 5 or 8 volt output at 1 amp. operate bulb, buzzer or bell. Will supply light in bedroom or larder, etc. PRICE 2/6. POST 6d.

SOLDERING IRONS. Adjustable Bit, all parts replaceable and fully guaranteed. 2/6, 2/50 v.v. 60 watts, 9/6; 150 watts, 12/6, post 6d. SEND 1d. S. A. E. FOR LIST B.P. OF USEFUL ELECTRICAL ACCESSORIES. Money refunded if not completely satisfied. Letters only. Please include postage, any excess will be refunded.

HIGHSTONE UTILITIES

58, New Wandstead, London. E.11

SPARKS' DATA SHEETS

Provide full constructional details and blueprints of Tested and Guaranteed Designs. JUST RELEASED
The L.O.Q.A. PORTABLE A.C./D.C. AMPLIFIER. 8 Watts. P/P Output. Ideal for E/Guitars, Mike and Band work. Full details, 3/6.

Other Data Sheets:

Electric Guitar (3rd Ed.)	5/-
Electronic One-String Fiddle	3/6
Microphone Trans Current	2/6
Shocking Coil	2/6
A.C. Charger, 2 and 6 Volt	2/6
D.C. L.T. Charger	2/-
31 Watt A.C. Amplifier	2/6
Two-Valve Amplifier (Battery)	2/6
High Gain Crystal Set (Coil Data)	1/6
A.C. Quality Two-Valver (Coil Data)	2/6
Compact Straight 3 (Batt. Coil Data)	2/-
S.W. Super Two-Valver (Batt.)	2/6
Automatic Bias Circuits: Ohm's Law: Colour Code (R. & C.) ea.	1/3

L. ORMOND SPARKS (M), 9, Phoebe Road, Brockley, S.E.4

HAVE YOU HAD YOUR COPY? If not order it now to avoid disappointment.

"AMERICAN MIDGETS" Radios and Valves.

This useful booklet describes clearly with many circuit diagrams the peculiarities of the small American (Midget) sets from the repairer's point of view. Valves used in these radios are also described with base diagrams and characteristics. PRICE 2/8, post free

From V.E.S. (P), Radio House, Melthorne Drive, Ruislip.

LARGE DEPT. FOR TECHNICAL BOOKS

FOYLES

★ BOOKSELLERS TO THE WORLD ★
New and secondhand Books on Engineering and all other subjects.
119-125, Charing X Rd., London, W.C.2
Open 9 a.m.-6 p.m. including Saturday.
Telephone: Gerrard 5660 (16 lines)
W & G. Foyle, Ltd.

B.A. thread screws and nuts, 1 gross assorted, useful sizes, 2/6; ditto brass washers, 1/6 gross; fibre washers, 1/6 gross; assorted solder tags, 2/- gross; assorted small eyelets and rivets, 1/3 gross; rubber-covered stranded copper wire, 1d. yard; heavier quality, 1 1/2d. yard; very heavy quality, 2 1/2d. yard; ideal for aerials, earths, etc. Tinned copper connecting wire, 20ft. coil, 6d.; ditto, rubber-covered, 10ft. coil, 6d.; twin rubber-covered flat bell wire, finest quality, 3d. yard; twin flat braided electric cable, 6d. yard; Wood's metal stick, 2 1/2in. by fin. 1/-; cotton-covered copper instrument wire, 1lb. reels, 18, 20, 22, 24 gauges, 1/6; 26, 28 gauges, 1/9; 30 gauge, 2/-; 34 g., 2/3; 24, 26, 28 g., silk-covered, 2 oz., 1/6; 30, 32, 34, 36 g., ditto, 1/9; 42 g., 2/-; 16 g., double silk-covered, 1 lb., 5/-; sensitive permanent crystal detectors, Tellurium-Zincite combination, complete on base, guaranteed efficient, 2/6; reliable crystal, with silver cats-whisker, 6d.; reconditioned headphones, complete, 4/00 ohms, 12/6. All postage extra. Post Radio Supplies, 33, Bourne Gardens, London, E.4.

SILVER PLATING SETS

as supplied to Electroplaters, but in miniature for small parts, etc., instructive small sets, 19/- inc. post. Send 2fd. stamps for printed folder.

MERCURY & PLATINUM SCRAP

required, high prices paid, please write for offer, or send (not under 2 pounds Mercury purchased).

ARGENTA PRODUCTS (D. C.),

40, Harrogate Road, LONDON, E.9.

TO PATENTEES AND OTHERS:

Patents and Ideas wanted for Bicycle Fittings and Accessories and similar articles, suitable for development and marketing.—Particulars to Smith, 5, Accl Road, London, N.W.6.

NEW MACHINERY.

For essential work only. Electric Motors, Band Saws, Drilling Machines, Pumps, Grinders, Welders, etc.—John P. Steel, Bingley.

MODELS made by engineer who specialises in all Patent Work, Design, Drawings, and marketing of patents.—BBIJ, London, W.C.1.

TOYS, MODELS and NOVELTIES.

Send for range of popular designs with instructions and hints on toy making. 2/6 only, post free.—Harrod (P), 10, Beaconsfield Road, Maidstone.

12in. POWER BENCH BANDSAWS.

Make your own, send 10/6 for working prints and photograph. Sound, simple design.—Rawlinson (PM), 34, Caegwyn Road, Whitchurch, Cardiff.

Free Guide — "Success in Engineering"

One of the following Courses taken at home in your spare time can definitely be the means of securing substantial promotion in your present calling, or entry into a more congenial career with better prospects.

ENGINEERING, AERO, ETC.

Radio—Aero Engines—Aero Navigation—Aircraft Design—Welding—Aerodynamics—Electrical Engineering—Television—Electric Wiring—Talking-Picture Work—Generation and Supply—Works Management—Metallurgy—Refrigeration—Planning, Estimating, Rate-fixing—Time and Motion Study—Aero Inspection—Automobile Engineering—Sheet-metal Work—Engineering Draughtsmanship—Aero Draughtsmanship—Jig and Tool-Draughtsmanship—Press Tool and Die Draughtsmanship—Structural or R/F Concrete Draughtsmanship—Sanitary Engineering—R.A.F. AND R.N. PILOTS AND OBSERVERS.

GENERAL

Matriculation—College of Preceptors—Chartered Institute of Secretaries—Aircraft Apprentice—Emergency Commissions (Army).

MUNICIPAL SERVICE

School Attendance Officer—Handicraft Teacher—Registrar—Relieving Officer—Sanitary Inspector—Weights and Measures Inspector—Inst. of Mun. and Cy. Engineers—P.A.S.I.

"PRACTICAL ENGINEERING" said—

We recommend all readers interested in improving their position to apply for a copy of this valuable Book. "Success in Engineering" is not a pamphlet. It is a 124-page book, containing valuable and vital information on all branches of engineering . . . There are many engaged in engineering who owe their success to The National Institute of Engineering.

The FREE GUIDE explains:

- Openings, prospects, salaries, etc., in Draughtsmanship, Inspection, and opportunities in all other branches of Engineering and Building.
- How to obtain money-making technical qualifications through special RAPID FULLY-GUARANTEED COURSES.

Write now for your copy of this remarkable publication.

A.M.I.E.E., A.M.I.Mech.E.,
A.M.Brit.I.R.E., A.M.I.P.E.,
A.M.I.C.E., A.M.I.Struct.E.,
A.M.I.A.E., A.F.R.Ae.S.,
A.M.I.S.E., M.R.San.I.,
London B.Sc., Degrees.

Fully guaranteed postal courses for all the above and many other examinations. Fully described in the Free Guide.



THE BUILDING BOOM— SECURE YOUR SHARE!

The Free Guide also gives particulars of our extensive range of modern Building and Structural Courses, Building Draughtsmanship, etc. The great post-war Building programme offers unlimited prospects to technically trained men.

BECOME A DRAUGHTSMAN or AERO INSPECTOR AND EARN BIG MONEY

Men and Youths urgently wanted for reserved occupations as, Draughtsmen, Inspectors, etc., in Aero, Jig and Tool, Press Tool, Electrical, Mechanical and other Branches of Engineering. Practical experience is unnecessary for those who are willing to learn—our Guaranteed



"Home Study" courses will get you in. Those already engaged in the General Drawing Office should study some specialised Branch such as Jig and Tool or Press Tool Work and so considerably increase their scope and earning capacity.

NATIONAL INSTITUTE OF ENGINEERING
(Dept. 29)
148, HOLBORN, LONDON, E.C.1

**NEARLY SIXTY YEARS OF
CONTINUOUS SUCCESS**

SOUTH AFRICAN BRANCH: E.C.S.A. P.O. BOX 8417 JOHANNESBURG.

FOUNDED 1885 — FOREMOST TODAY — OVER 100,000 SUCCESSES

THE ACID TEST OF TUTORIAL EFFICIENCY SUCCESS—OR NO FEE

We definitely guarantee that if you fail to pass the examination for which you are preparing under our guidance, or if you are not satisfied in every way with our tutorial service—then your Tuition Fee will be returned in full and without question. This is surely the acid test of tutorial efficiency.

If you have ambition you must investigate the Tutorial and Employment services we are able to offer. Founded in 1885, our success record is unapproachable.

Why not fill in and post the attached coupon NOW* for further details and Free Authoritative Guide to openings in Engineering and Building? This book contains a mine of valuable and exclusive information and may well prove to be the turning point in your career.

PROMPT TUTORIAL SERVICE GUARANTEED.

FREE COUPON

To NATIONAL INSTITUTE OF ENGINEERING
(Dept. 29), 148, Holborn, London, E.C.1.

Please forward your FREE Guide to

NAME

ADDRESS

My general interest is in: (1) ENGINEERING (Place a cross against the branches in which you are interested.)
(2) AERO (3) RADIO (4) BUILDING
(5) MUNICIPAL WORK

The subject or examination in which I am especially interested is

.....
To be filled in where you already have a special preference.
(Id. stamp only required if unsealed envelope used.)

"Practical Mechanics" Advice Bureau COUPON
This coupon is available until March 30th, 1945, and must be attached to all letters containing queries, together with 3 penny stamps. A stamped, addressed envelope must also be enclosed.
Practical Mechanics. March, 1945.

Published about the 30th of each month by GEORGE NEWNES, LIMITED, Tower House, Southampton Street, Strand, London, W.C.2, and Printed in England by the Newnes and Pearson Printing Co., Ltd., Exmoor Street, London, W.10. Sole Agents for Australia and New Zealand—Gordon & Gotch, Ltd. Sole agents for South Africa—Central News Agency, Ltd. Subscription Rates (including postage): Inland 10s. 6d. per annum. Abroad, 10s. per annum. Canada, 10s. per annum. Registered at the G.P.O. for transmission by Canadian Magazine Post.