

# BRITAIN'S LEADING RADIO JOURNAL

# Popular Wireless

No. 657,  
Vol. XXVI.  
January 5th,  
1935.

**AND TELEVISION TIMES**

P.W.'s LISTENERS' SERVICE  
 ★ ★  
 SPECIAL TELEVISION ARTICLE  
 ★ ★  
 LATEST B.B.C. NEWS  
 Etc., Etc.

EVERY WEDNESDAY PRICE **3D**



*Fixing*  
**EXTENSION  
 LOUDSPEAKERS**



# COSSOR

MODEL 535

## ALL-ELECTRIC SUPERHET

*with*  
**NEON  
VISUAL  
TUNING**



A special compensated circuit is used to eliminate fading from all worth while stations, and is combined with a Coszor Visual Neon Tuning Tube to facilitate accurate tuning and avoid distortion.

### ANTI-FADING

The many other advanced features of this remarkable Superhet are fully described in Folder L.120 — send the coupon for your copy.

#### ABRIDGED SPECIFICATION

All-Electric Superhet Model 535 is equipped with Five Coszor Valves (inc. Rect.). Illuminated Full Vision Scale—Single Knob Tuning—Volume Control with special scale. Tone Control, 8" Energised Moving Coil Loudspeaker. Magnificently finished cabinet, 20" high, 16" wide, 10 1/4" deep. For A.C. Mains only. 200/250 volts (adjustable), 40/100 cycles.

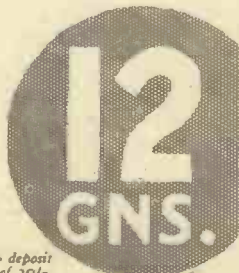

Prices do not apply in I.P.S.

Hire Purchase Terms: 40/- deposit and 12 monthly payments of 20/-.

To A. C. COSSOR LTD., Melody Dept.,  
Highbury Grove, London, N.5.

Please send me free of charge, literature giving full particulars of Coszor All-Electric Superhet Model 535.

Name .....

Address .....

Pop. 5/1/35

**THIS COUPON BRINGS FULL DETAILS**

L.120.

# POPULAR WIRELESS AND TELEVISION TIMES

MANAGING EDITOR: N.F. EDWARDS.

TECHNICAL EDITOR: G.V. DOWDING ASSOC. I.E.E.

AIRCRAFT AERIALS  
LONDON'S LICENCES  
TELEVISION  
POLICE RADIO

## RADIO NOTES & NEWS

SOME BROADCAST  
P.O. RESEARCH  
THE GHOST TRAIN  
RECORD RECEPTION

### Those Breakdowns.

ARE we not having an overdose of broadcast breakdowns of late? The question is one that I raise with some reluctance because I know what skill and care go into B.B.C. engineering.

Still, the fact remains that recently announcers have been continually apologising to listeners because this or that service succumbed to a technical hitch of so many minutes. And poor old North Regional was knocked right off his perch for over an hour on one occasion!

Miss Otis herself could not express regret more fervently than the announcers. But apologies are a thin substitute for entertainment.

### Too Attractive.

THERE was such a rush to attend the "Piezo-Electric" demonstration held by the Golders Green and Hendon Radio Scientific Society—of which I recently reminded you—that the hon. sec. has written me again.

He says: "The subject appears to be of general interest, as we had to refuse admission, due to lack of accommodation, to over thirty who had not obtained tickets and arrived late.

"I hope none of your readers were amongst them."

My goodness, so do I! There will be some vitriolic letters in my postbag if my well-meant tip resulted in a fruitless trek to those northern latitudes.

### Hengist's Aerial.

THE departure from Croydon of the first all-the-way air mail to Australia recently has brought me a letter from "Imperial," of Caterham. He says the machine (the Hengist) was a beautiful sight as it passed over his house, heading through the clouds for Paris.

"Where do they have their wireless aerials on these Heracles-class machines?" is the query he raises. For the benefit of other air-minded fans I will explain it, non-technically, as follows:

From the operator's cabin in the nose of the liner the fixed aerial runs right aft up to the tail plane, and thence up again at an angle to a point near the port navigation light.

There is also a trailing aerial which can be lowered when desired.

### London's Lapse.

WHEN the B.B.C. and P.O. experts added up the licence figures last time they found the usual increase continuing, with an astonishing exception. This was the little old-world Thames-side village of London—it showed a decrease!

Knowing how the official mind works in these matters, I here and now prophesy that Londoners will soon be hearing of B.B.C. detector vans and a war on pirates.

And knowing, too, how a guilty conscience works, I further prophesy that when that

Hugh McLean is his name. Preliminary work has been carried out at Coatbridge, and the vague details that have reached me concern instantaneous transmission, as contrasted with the present idea of building up a picture at comparatively slow speeds.

The only practical detail available at the time of writing is that the apparatus can be worked from any ordinary lighting fixture. Let's hope to hear more and see something of this.

### The Television Committee.

"NOW the New Year, reviving old desires, The thoughtful soul to Solitude retires."

So sang Omar Khayyam long, long ago. To-day we are feeling the old desires and wondering when those thoughtful souls who retired to think about television are going to tell the world. For months the Government's Committee has been cogitating upon the matter, but at the time of writing—not a word.

They have looked-in to their hearts' content, and now we look to them to content us. All we want to know is the answer to this simple question: What about television?

### Slick Work.

THE Brighton "Evening Argus" recently gave an interesting account of the city's pocket-wireless system in action. A message received from the East

Sussex Constabulary stated that between half-past ten and eleven o'clock in the morning a bicycle had been stolen at Lewes.

The message was radiated to the pocket receivers by wireless, and at twenty minutes past eleven a constable on the main Brighton-Lewes road questioned a youth who was riding a machine which answered the description.

Only twenty minutes! The youth was detained and later taken to Lewes—an old-fashioned town, maybe, but with some mighty slick methods.

### Hypnotic Aeronautics.

THE idea of hypnotising people to give them air confidence—to which I referred recently—has now been tried out with marked success.

The subject was Mrs. Ian Coward, who has feared heights  
(Continued on next page.)

ON OTHER PAGES

	Page
"P.W.'s" Listeners' Service - - - - -	587
Television - - - - -	590
On the Short Waves - - - - -	593
Radio During the Great War - - - - -	595

happens there will be a hurrying and scurrying to the P.O. licence counters. The radio programmes are cheap enough for ten shillings, and when peace of mind is thrown in, too, the bargain is irresistible.

### A Glasgow Hope.

THERE is an interesting rumour going round Glasgow that a young student of the university there has got hold of a revolutionary television idea.



It is a well-known fact that those who are deaf can often hear amplified music or speech with the help of headphones. The photograph shows this principle being used, at the Manchester Royal School for the Deaf, for teaching singing. The children are wearing special moving-coil headphones, which are connected to a powerful amplifier (seen on top of the piano). Next to the amplifier is a microphone. The results appear to be highly successful, judging by the expressions on the children's faces.

# A GRAND SALUTE OF FOUR HUNDRED HOOTERS

all her life. Her husband, who is an ardent airman, could never persuade her to try a flight, but after hypnotic suggestion from Mr. J. Louis Orton she went for a 40-mile flip in a stiff breeze.

You may have heard G 2 Y H transmitting to the plane when it was over Grays. But nothing heard then was so surprising to her friends as the fact that when Mrs. Coward alighted she was still unperturbed and calmly inquired: "What about lunch?"

## Birthday Salute.

ONE of the most curious broadcasts of which I have heard occurred in the U.S.A. It was in connection with an automobile club beano.

As a compliment to their president, who was celebrating a birthday, four hundred of the members had the hooters of their cars specially tuned, and at a given moment pressed the buttons in a prearranged order, producing an

altogether charming melody!

It must have been grand, though what the American Belisha thought of it is not disclosed!

## Vocal Artistry.

THAT sound can be represented by complicated wavy patterns is well known to radio men and to the patrons of the talkies. Experts can tell, by looking at the patterns, what words they make and can judge the quality of the voice.

Now one of the experts has gone farther and inverted the process. He draws original word patterns with great cunning, and then he has them converted into sounds, and thus hears words which have never been uttered before!

Nobody can understand them, of course, but the inventor says his idea is a pronounced success.

## Radio Conscious.

PALESTINE is rapidly becoming radio conscious, and the process will be expedited when the new broadcasting service is in full swing.

During 1933 Palestine bought 3,701 wireless sets from British firms, but this figure was almost equalled in the first four months of 1934.

All-wavers are in the greatest demand.

## Points from the News.

AN early start is to be made on the B.B.C.'s Scottish station at Burghead.

\* \* \*

America now has five major broadcasting networks, the latest being the American Broadcasting System (A.B.S.) with 25 stations.

\* \* \*

Over a thousand applicants write to Broadcasting House every year for the job of announcer. And the B.B.C. employs only about twenty in all.

## P.O. Research.

IN my capacity as a recording scribe I must make mention of some of the facts named by Sir Kingsley Wood, Postmaster-General, when opening the new P.O. building at Mount Pleasant.

He referred to the P.O.'s 11,300,000-odd miles of telegraph and telephone wires, and to Rugby Radio, the world's most powerful wireless station.

Other P.O. marvels are the picture and facsimile services with places abroad; the Dollis Hill laboratories, where experts are studying how to overcome the interference of electrical plant with wireless, and the hush-hush room there. It is "probably the most silent room in the world," he said, it being designed to eliminate all acoustic reflection.

## "Vellee Good."

IN the spicy island of Ceylon there is a Chinese cook who, thanks to radio, can still "Show a leg."

He was on a cargo boat, carrying no doctor, when a bad accident to his leg laid him out. Then gangrene set in, and the captain, anxious to avoid the perils of an amateur amputation, wirelessed to know if there was a doctor in the vicinity. The P. and O. liner Ballarat responded, the ships met in mid-ocean and the cook was transferred to the doctor's care.

When they landed Cookie at Colombo he was feeling positively Celestial!

## Stop and Buy Some.

A LANCASHIRE reader, G. B., heard this yarn from a chum of his:

"He told me he went to look at a friend's set, and on playing about with the controls he remarked: 'There's not much reaction, is there?'"



"That's just what I thought," said the owner of the set. 'I'm going down town to-night—I'll get some!'"

"I would have given a lot to have seen the shopkeeper's face when the set owner declared his wants!"

## The Spectral Express.

YOU will remember that considerable interest was aroused by a mysterious Ghost Train, distinctly heard by many "P.W." readers on their sets. It clanked over the points and chuff-chuffed so unaccountably that I asked for reports on it, thinking the explanation might be the Moscow Train signal (used sometimes in the interval at that station) or other natural cause.

But no—it cropped up at curious times and on many wavelengths in all parts of the country. And now, just to prove it is a ghost, it has done what they all do—clean disappeared!

Perhaps it is offended by all this "ead-tooked-underneath-'er-arm" business from the dance bands. Anyhow, it has gone!

## Loudspeaker Medicine.

THE Leader of the Opposition in the House of Commons, Mr. George Lansbury, now happily out of hospital, has been paying tribute to the curative powers of radio.

"When wireless was placed in my room," he said, "its coming changed every afternoon and evening for me. It was a perfect god-send."

Speaking from practical experience, he went on: "If people can be made cheerful and distracted from brooding on themselves, that helps more to get them well than all the medicine in the world."

There's a moral for programme compilers and uplifters in that selection of the word cheerful.

## Radio Paradise.

THE old question as to which is the best spot in the world for listening to radio is again to the fore. As always, New Zealand is greatly favoured, for even the simpler sets there reckon to rake in half the world.

The winner of a D X contest, Mr. Adams, of Timaru, recently bagged 546 overseas stations between 200 and 550 metres.

546!—and there were 15 Europeans, among them!

He got 377 from the U.S.A., 90 from Australia, 22 from Japan, 15 from Canada and 11 from Mexico. And odd ones were garnered in from such places as Venezuela, Cuba and Bolivia.

No wonder they call New Zealand a radio paradise!

## Trade Revival.

THE welcome signs of brightness in the trade outlook are clearly reflected by orders for wireless from British firms.

Recently Marconi's have landed two large contracts in South America and others for the wireless equipment of the Roumanian Army, the ground stations on the Capé-to-Cairo airway, as well as three new transmitters for Norway.

The South African Government has ordered commercial and aircraft equipment from the Standard Telephones and Cable Co., while both Denmark and Portugal have asked them for a broadcasting station.

Since every transmitter means many receivers, these are key orders opening the door to more radio trade.

## Catching 'Em Young.

WE have had car radio and all that for a long time, but what do you think of pram radio?

They have it in the States. The idea is not that the baby shall be lulled to sleep by music or anything like that, but merely that the attendant nurse-maid or "momma" shall be entertained in between her busy moments of watching the bottle and retrieving the woolly dog.



Nobody seems to have considered one important question: Is it fair on Junior?

ARIEL.

# Fixing Extension Loudspeakers



"THERE'S more in it than meets the eye." That expression might have been coined especially for the connecting up of an extension loudspeaker to a wireless set.

On the surface it is simply a matter of slinging any old bits of wire through the door, joining them up to the set and sticking another loudspeaker of any sort on the end. Of course, you get results. But what results?

Jolly good, did you say? Well, you must have been lucky, and I hope you will always be as lucky. But there

are many who have been disappointed, either by poor quality or weak results from the extension speaker, or by a great cutting down of power from the set's speaker.

But please don't get the idea that it's a difficult matter to get good results. That is far from being the case. It's a simple matter of knowing a few important things that make all the difference.

The set makers and the speaker manufacturers have done much to help in the matter, and it is the intention of this special article to give that little guide and help that will ensure success. As far as possible the article is completely comprehensive, covering all aspects of the subject,

and to increase its value for reference purposes I have divided it into broad sections.

## AT THE RECEIVER END.

Tackling the problem more or less as it will be experienced in practice, we will deal with the set end first. Here we have to consider the question of where to attach the extension leads.

So far as home-constructed sets are concerned, you are your own master and can attach the wires just how you like. This

is a great help at times when it is desired to make use of a speaker that is already on hand, because the connections can be arranged to suit the speaker, whereas with a commercial set it is often a matter of getting a speaker that suits the con-

nection arrangement supplied in the set itself.

indeed it should be in all cases in this article except where it is specifically mentioned as being of low impedance. The scheme is easily applied to home-constructed sets, and also to many commercial receivers where the necessary connections can easily be traced out. But with a commercial set, unless you feel quite sure of the connections, it is as well not to try to use this scheme.

Incidentally, it may be found that your set incorporates a switch for the extension speaker, in which case all you have to do is to attach the two extension leads to the appropriate sockets. But, in this event,

In this long, comprehensive article you are told everything about the use of extension loudspeakers—how to connect up to your receiver, how to run the leads, what speakers to use. Nothing is omitted that points the way to complete success.

By A. S. CLARK

## EXTENSION SPEAKER

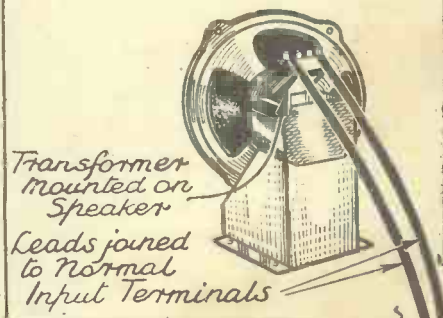

nection arrangement supplied in the set itself.

First of all we will suppose that it will not be desired to have the extension speaker on when the incorporated speaker is working, and vice versa. This is a simpler case than when both speakers are wanted together, because in the latter case they must be approximately balanced so that each gives somewhere about the same volume.

On the first page of this article you will find the connections for a change-over scheme that enables one or the other speaker to be used. The extension speaker must be of the high input-impedance type, as

read the maker's details to see whether the extra speaker should be of low impedance.

By the way, when the change-over scheme shown in the diagram is used the filter circuit is not entirely necessary, but is certainly well worth while. I shall have some more to say about this matter under the heading of "Running the Leads."

## Follow Maker's Recommendations.

In most commercial sets you will find two terminals or sockets for the extension wires. It is generally intended that both speakers shall work together.

But you must follow the maker's recommendations concerning whether the extension speaker should be of high or low impedance. In cases where high impedance is recommended

(Continued on next page.)

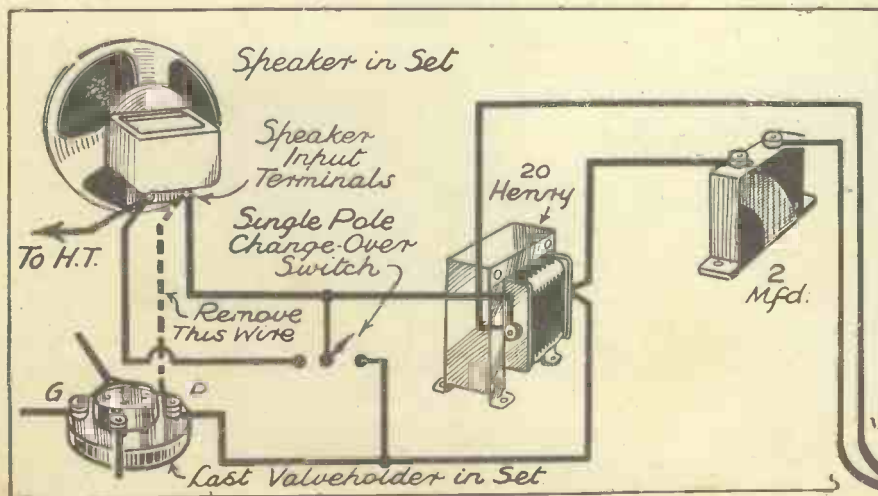

This composite diagram shows how a change-over switch is wired to permit the use of either the speaker incorporated in the set or an extension loudspeaker.

## FIXING EXTENSION LOUDSPEAKERS

(Continued from previous page.)

it is most likely that the extension leads will have to carry H.T.

This can be avoided, however, by the insertion of two 4-mfd. fixed condensers of about 400 volts working type, one of them in each lead. One 2-mfd. condenser could be used with an A.C. or battery set, if one of the extension wires is joined to the chassis. The 2-mfd. condenser would be joined in the other wire and tried first in one extension socket and then in the other. It would only work in one of them.

### RUNNING THE LEADS

There are several reasons why it is best not to have high tension running in the extension leads or to have either of them directly connected to high tension. First of all, so far as having H.T. actually flowing in the leads:

If the extension speaker is the only one

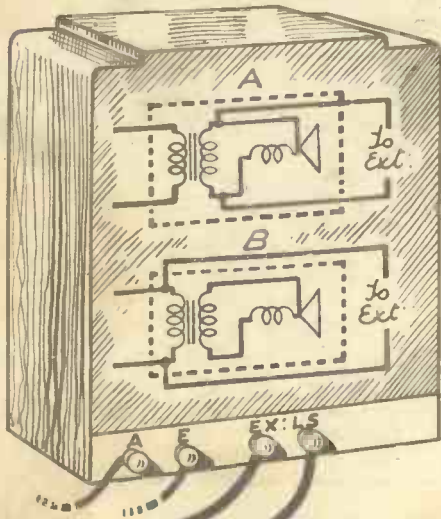

in the anode circuit of the output valve there is a possibility that any join in them may develop a sufficiently high resistance to produce a definite voltage drop. Also anyone catching hold of the ends of the extension leads might receive a shock. And finally, very good insulation is needed on the wire to avoid the possibility of H.T. shorts or leakage.

Even when there is another speaker in the anode circuit, namely the loudspeaker incorporated in the set, there is the chance of shocks being received and of high-tension leakage.

The use of a filter circuit, as shown in the diagram on the first page of this article, but with a condenser in each extension lead, avoids the above possibilities and makes the use of thin wire of quite modest insulation

properties entirely satisfactory and safe. In the case of a commercial set the use of condensers in the manner already described takes the place of the choke-condenser filter, the primary of the speaker transformer acting as the filter choke.

### The Wire to Use.

Now for the types of wire to use. If you do not use a filter and there is H.T.

attached to or running through the extension lead, you want good rubber-covered wire.

Either single wire or flex will do. Incidentally, good twin flex will be satisfactory, but don't be too ready to buy the very cheapest. I have found that in some cases the rubber on very cheap flex is perished and absolutely useless for insulating the wire.

It is sometimes advised that twin flex should not be used, because its capacity is high enough to spoil quality by by-passing top notes. But this is a point where even experts must differ. No matter how small the capacity of the wiring, there must be some by-pass effect, but I have yet to meet a case in which it has had noticeable effect on quality.

I have personally used a 20-yard extension of lead-covered twin bell wire with the lead casing earthed, and could not notice any effect on quality. And you know the old proverb about practice and theory.

Where no H.T. troubles arise, ordinary bell wire or even 22 D.C.C. wire can be used for extension leads. There is no real need to pull floorboards up to lay the wires. Just fix them round picture rails, wainscoting boards, over doors, etc.

If you use insulated staples to hold the wire it will not prove unsightly. In many cases you can make it invisible.

Do not drive home the staples hard or the wire may be cut or damaged. A light, thin-headed hammer such as that illustrated in one of the sketches accompanying this article is ideal for the job. Apart from not being too heavy it makes the starting of the staples a fairly easy task.

One last word: if your leads pick up hum, try running them differently. The trouble is probably due to the leads being in close proximity to mains wiring at some point. As a last resort lead-covered wire, such as I used, with the covering earthed, will shield the leads completely from electrical fields.

### CONNECTING THE EXTENSION SPEAKER.

And now, having dealt with the receiver and the extension wires, we come to the extension speaker itself. On this page you will find a diagram which shows the relation between set and extension-speaker connections for the two usual arrangements for moving-coil speakers.

Nowadays all moving-coil speakers are provided with low-impedance moving coils—namely, the actual coil of wire that is

attached to the cone. It is usual to feed these coils with an input transformer that has a high-impedance primary winding.

In the diagram referred to you will find two small circuits on the back of the set, "A" and "B." "A" shows the internal speaker wired up to its input transformer, and indicates that the extension plugs are across the secondary winding. This means that the external speaker is fed from the same trans-

former and should be of the low-impedance type.

The "A" circuit on the back of the extension speaker shows the correct connections that go with this arrangement. It will be seen that the extension leads go straight to the moving coil on the cone.

An input transformer on the extension speaker is not a necessary adjunct in this case. If you have a speaker in which the input transformer is permanently connected, all you have to do is to trace out the connections to the coil, remove them and

### SOON FIXED

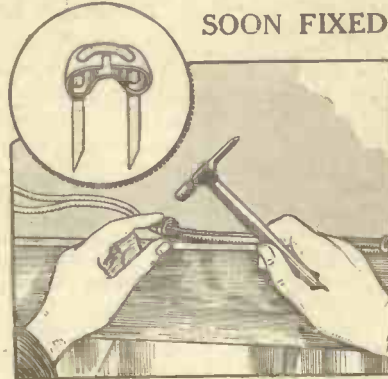

With the aid of insulated staples and a light hammer loudspeaker extension leads are soon fixed, and do not present an untidy appearance.

join up the extension leads to the coil itself. In doing this be careful to break the leads in such a way that they can be re-connected, if necessary, for future use.

The two circuits "B" also correspond. In this case the extension plugs are connected across the primary of the input transformer on the set, and therefore at the extension speaker they have to be joined to the primary terminals of the input transformer at that end.

### Joining in Series.

If you try to use the "A" circuit at one end with the "B" circuit at the other you will most certainly not get satisfactory results. The makers, or their data, will supply you with the information about which type of output scheme is used.

There is one other way in which speakers can be connected with advantage in some cases. As far as I know, it is never employed on commercial sets, and is most

(Continued on next page.)

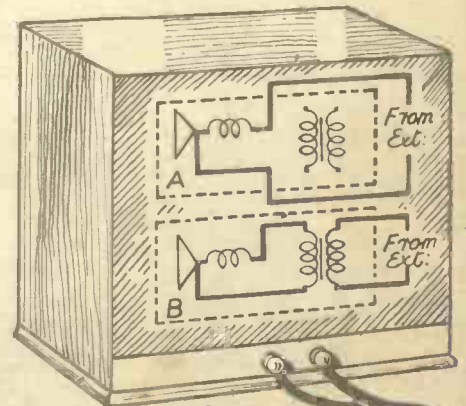

The two "A" circuits or the two "B" circuits illustrated in this diagram are used together: "A" when the extension speaker is of low impedance and "B" when it has a high-impedance input.

## FIXING EXTENSION LOUDSPEAKERS

(Continued from previous page.)

likely to prove useful on home-constructed sets when two of the older-type moving-iron speakers are to be employed.

The idea is to use both speakers at once by connecting them in series. Sometimes better results are obtained with them this way instead of in parallel. It is highly desirable to have an output filter with the arrangement.

One side of the set's speaker goes to one loudspeaker terminal, the other speaker terminal going to one of the extension leads. The other extension lead goes to the remaining L.S. terminal. For best results with this scheme both speakers should have about the same impedance and be of about the same sensitivity. It is ideal where two similar make and type instruments are employed.

### MATCHING THE INSTRUMENTS.

This question of similar impedances brings me to one of the most important aspects of extension-speaker working. Obviously, if one speaker has a much higher impedance than the other it is not going to get its half-share of the energy available, no matter what scheme of connecting is employed. And if it does not get its proper share of the energy it will be weaker than the other speaker.

This means that to get this speaker to work at a desirable volume the other would

On the Blue Spot speaker matching is carried out by means of plugs and sockets, and the sockets are so arranged that the instrument may be used as either a high- or low-impedance type. Incidentally, this speaker can be provided with a plug-in "armchair" volume control.

The Amplion loudspeaker has a veritable switchboard for matching purposes, and special arrangements are made for its use in connection with extension-speaker work.

Where it is not desired to have a speaker with variable matching it is as well to specify the set with which the speaker

with the speaker. When it is open the circuit is broken and the extension speaker rendered inoperative. Opening the switch will increase the volume from the set's speaker, but that is quickly readjusted. In the case of two speakers in series the switch would be wired across the extension one.

The second little diagram shows how more than one extension speaker can be used simply by wiring them all in parallel. In such cases it must be remembered that questions of matching apply to them all.

If one extension speaker is used, but it is desired to move it from one room to another,

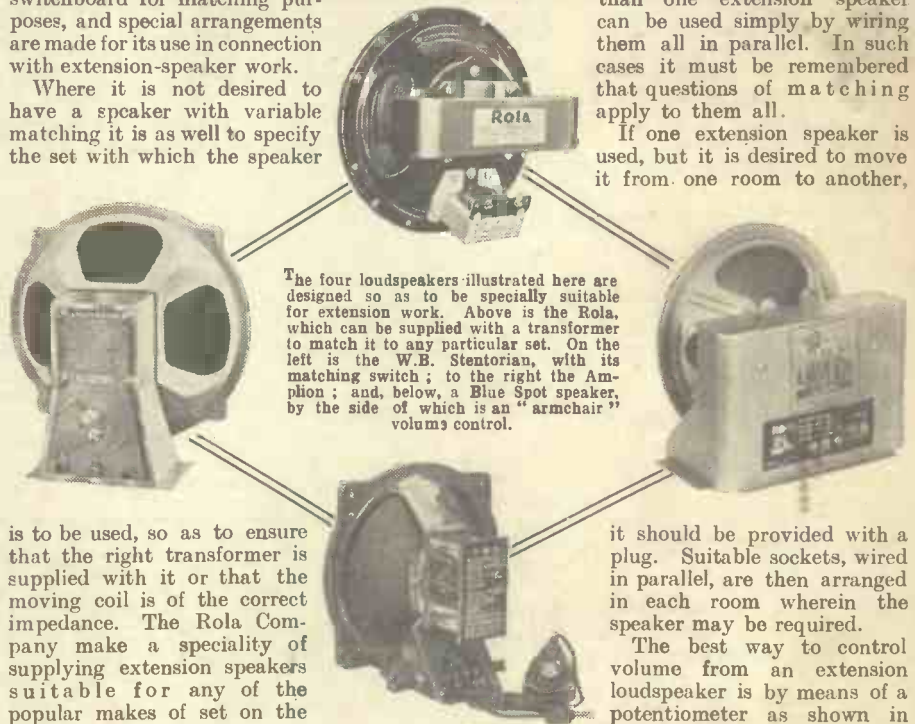

The four loudspeakers illustrated here are designed so as to be specially suitable for extension work. Above is the Rola, which can be supplied with a transformer to match it to any particular set. On the left is the W.B. Stentorian, with its matching switch; to the right the Amplion; and, below, a Blue Spot speaker, by the side of which is an "armchair" volume control.

is to be used, so as to ensure that the right transformer is supplied with it or that the moving coil is of the correct impedance. The Rola Company make a speciality of supplying extension speakers suitable for any of the popular makes of set on the market.

Actually there is a very wide range of types of loudspeakers from which to choose, but I recommend you to select a good make such as R. and A., Wharfedale, Ferranti, Celestion or any of those already mentioned.

If you have a speaker already on hand that you wish to use for extension work the only thing to do is to try it connected in the ways described in this article and hope for the best. If the extension speaker proves louder than the one incorporated in the set you can balance them up by means of a volume-control potentiometer.

it should be provided with a plug. Suitable sockets, wired in parallel, are then arranged in each room wherein the speaker may be required.

The best way to control volume from an extension loudspeaker is by means of a potentiometer as shown in the fourth small diagram.

The resistance of the potentiometer will vary with the resistance of the loudspeaker, but should be 10 to 20 times that of the speaker's resistance itself. With a good potentiometer it would be possible to cut the speaker out entirely.

There are all manners of remote controls for sets, and they can be very useful in conjunction with an extension speaker; but they hardly come within the scope of the present article—in fact, they would require a special feature to do them justice.

### The Switch on the Set.

On the first page of this article mention was made of the fact that a switch may be provided on your set in connection with the extension-loudspeaker sockets. This switch is not normally of the change-over type such as the scheme illustrated on the first page.

Its object is to cut out the speaker in the set while leaving the extension speaker working. Both speakers can, of course, be used at the same time when desired.

It is always advisable to see that the extension speaker is connected before operating the switch, as otherwise there is danger of all load being removed from the output valve.

In Class B circuits and other arrangements which employ an output transformer with a centre-tapped primary a low-impedance extension loudspeaker in parallel with the incorporated speaker across the transformer secondary is advisable. Otherwise three leads for the extension speaker would be necessary.

And that, I think, covers the last arrangement of connections with which any reader is likely to come in contact.

### SOME REFINEMENTS

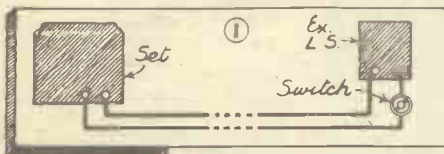

have to be too loud. Of course, varying sensitivity will also have a somewhat similar effect, but it will not be anything like so marked.

So if you have not already on hand the speaker you intend to use for extension work it is up to you to see that you get one that is matched up with the speaker in your set or one that can be matched up. There are numbers of speakers on the market in which the input impedances can be varied to enable the necessary matching to be done.

No matter how the two speakers are joined together, this question of matching still applies. The four loudspeakers illustrated on this page of the article are ideal for extension work, and three of them have means of varying the input impedance.

In the case of the W.B. Stentorian Senior model illustrated the impedance is quickly adjusted to the best value, both from the points of view of tone and volume, by means of the little switch arm on the back, which has nine different settings to choose from.

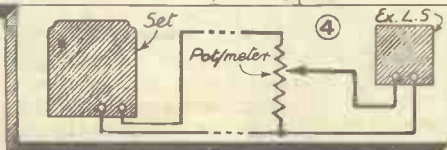
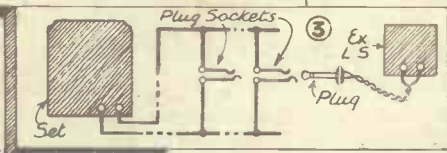
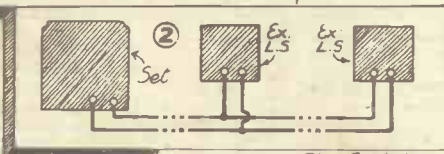

These four little sketches show variations on the normal straightforward extension-speaker connections and are fully dealt with in the text.

meter connected as described below.

### CONTROLLING EXTENSION SPEAKERS.

The extension loudspeaker being remote from the set, some means of controlling it without going out of the room is desirable. The simplest method is illustrated in the first of the four little sketches above.

It simply consists of a switch in series

## "HERE IS AN SOS . . ."

Almost every evening before the news, or breaking into the main programme, we hear those urgent appeals for witnesses of accidents or long-lost friends and relations. Every year hundreds of these vital messages are broadcast, and with an astonishing measure of success.

"BEFORE I read the news, here are a police message and an SOS." How often we have heard those words during our evening radio programme! They are, indeed, almost commonplace, and, except for their drama and poignancy, would have become so familiar as to be heard unheeded.

As it is, they claim more attention among listeners than any other broadcast material, because who knows for whom among us the message may be bearing its unwelcome tidings?

### The Case Must be Urgent.

It is evidence of the success of the SOS that we hear so many, and that they do not have to be repeated in indication that listeners are sharply aware of the importance of the few words the announcer utters.

Just a name or two, an address and a few facts. That is all, and yet this is sufficient to set the whole of the country agog and to stimulate into action all sorts and conditions of people ready to help the person for whom the message is intended in his journey to hospital or home.

Naturally, the case must be of the utmost urgency before either police message or SOS can be broadcast. The appeal of a certain lady for a dance partner to replace one that had let her down at the last moment obviously could not be entertained, nor could those many requests from various people to trace friends with whom they want to get in touch.

Before a police message is broadcast other efforts to obtain the information required must have failed, while in the case of the SOS all other means of obtaining a person's whereabouts or of getting a message to him must be unavailable. And in this case the tidings must also be those of life-and death urgency.

### How the Messages Started.

Probably the earliest SOS message was one that was the result of a brainwave by a porter at a London hospital. He, in his desire to help a patient who was dangerously ill and calling for her sister, got in touch with the newly formed B.B.C. and asked if it could do anything in the way of broadcasting an appeal for the lady in question.

The decision was one that had to be made quickly by the broadcasting authorities, and the fact that it was a precedent had to be taken into account. But the appeal was broadcast successfully, and the sister rushed post-haste to the hospital.

In present-day cases of SOS messages certificates have to be produced from a medical adviser to ensure that the case is really urgent, and no message can be sent

after the death of the person for whose benefit the message is being broadcast.

The percentage of success is a high one, especially in the case of police messages for witnesses of accidents, where about 70 per cent of the broadcasts are successful. Where the SOS for illness is concerned, about two-thirds of the appeals reach the required persons and are answered.

The support of the listening public is sometimes very striking in the case of the latter. Cars, motor-cycles, telephones and personal assistance are all offered to the recipient of the SOS, who often does not hear it direct, but is told by a friend or neighbour.

On one occasion a woman in a remote village was asked by radio to come to the side of her dying son in London. She was

## STUDYING THE HEART



A scene in a large American hospital where heart beats are electrically amplified and the resultant waveform thrown on to a screen so that the doctor can visually study the action.

told by several friends of the broadcast, and within a few minutes no less than six cars were at her door with offers to take her to him.

Another case that has been recently reported was that of a retired captain who heard an appeal for a cyclist touring in the west to go to his father in the south of France. The captain patrolled the chief roads leading from the town near which the son was supposed to be, and eventually located him coming along on his motor-cycle, recognising the machine by its number.

### Family Breaches Healed.

Scores and scores of similar cases are contained in the records of the B.B.C. among the hundreds of instances of successful appeals. Ships at sea have turned about so that members of their crews should visit sick relations (and this autumn brought a small crop of trawler SOS messages); dying parents have been reunited with their long-lost sons and daughters; and not infrequently family breaches have been

healed owing to the broadcast appeal from a dying or seriously ill member of the family.

Even animals have occasionally been sent for by radio where their presence is required for some urgent medical reason; in one instance it is said that an escaped pelican from St. James's Park was found and restored by virtue of the radio appeal.

### A Vital Part of the B.B.C.'s Activities.

The SOS is a vital and necessary part of the activities of the B.B.C.; and though there seem to be so many occasions on which such messages are broadcast, this is not because they are not urgent, but merely because they are so often successful. Incidentally, they are a sadly sure indication of how great is the need of an astonishingly large number of people.

K. D. R.

## THOSE SHORT PLAYS

Our broadcasting critic discusses recent B.B.C. programmes.

THERE'S much to be said for the very short play. It is usually a simple affair with no side tracks. And when the author contrives to introduce a surprise somewhere near the end of the play, then it's success is assured. There are many warm supporters of the short play. I am not one of these. Even if the play has all the virtues of its type I can never be more than mildly interested in it. It's a matter of personal taste, of course.

But I listened to the Midland Regional's trio, "K.O. Cameras," "How Very Bemusing" and "The Wager." They were all done in an hour, though candidly I thought them all unimpressive. In the case of two of them I am bound to say they were difficult to follow. "How Very Bemusing" was made up chiefly of wireless noises, and was, I take it, meant as a satire on those highbrow symphonies where you get the story from the music—chiefly of the noisy kind. I did not like it!

"The Wager" had a plot as old as the hills, and it was apparent from the start that the highwayman had got Jebb out of the way and was taking his place at the dinner. "O.K. Cameras," in which a man was electrocuted in a film studio, was a bit too far fetched, but the best of the three.

By far the best new thing in the way of comedy for months was the "Mr. Murgatroyd"—"Mr. Winterbotham" turn. These gents are not new to me, for their voices were those of Ronald Frankau and Tommy Handley. I want to hear a lot more of them. Their patter is clever, devoid of chestnuts, and they are sick.

Another turn that pleased me was by a new broadcaster, Mr. S. C. Roberts, playing Mr. Boswell and Dr. Johnson. Johnson, as we know, passed his weighty judgment on most of his contemporaries, much to our amusement and interest. Mr. Roberts has in the real Johnsonian style done the same with a few modern institutions. The result is no less amusing and interesting. I thought Mr. Roberts' script was as clever as his acting, and that is saying a good deal. Mightn't we have a second instalment of these Boswell-Johnson conversations—and a third? The institutions should last out.

The Saturday second News Bulletin is now quite a lengthy affair. The new stunt of interpolating experts, not of the art of broadcasting, but because they are closely connected with the subject mentioned in the news, has much to

(Continued on page 602.)



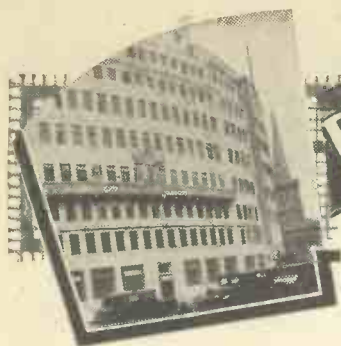

# P.W.'s LISTENERS' SERVICE

The most comprehensive weekly guide to modern receivers



## THE PRINCE'S INTEREST IN RADIO

**H**IS ROYAL HIGHNESS THE PRINCE OF WALES recently made a five-hour tour of the 80-acre factory of H.M.V. at Hayes, Middlesex, and during his inspection he amazed the officials who were conducting him round by his technical knowledge of engineering and radio.

The Prince was almost mobbed by the enthusiastic factory employees when he arrived to make an informal tour as the guest of Mr. Alfred Clark, the Chairman of H.M.V., and during the course of his visit His Royal Highness walked over four miles.

On arrival the Prince was conducted first to the machine factory, where he instantly recognised an escutcheon plate which is fitted to H.M.V.'s automatic record-changing mechanism. Picking one up he said: "This is the same as the one I have on my set."

### Ten Thousand Turns!

After paying a visit to numerous other departments in H.M.V.'s vast organisation the Prince was taken to the coil-winding section, where he spent a considerable time. On being told by Mr. Clark that the pick-up coils had 10,000 turns of wire on them the Prince remarked: "It seems almost incredible that these girls can handle practically invisible threads with such dexterity."

The Prince of Wales was very interested when the Chairman explained how extremely difficult it was to find girls capable of doing that work, and how it was discovered that those skilful at needlework made the best operatives.

The Prince was to have concluded his tour with a visit to the H.M.V. recording studios at Abbey Wood, but His Royal Highness displayed such great interest in the various manufacturing processes that he finished his inspection of the factories over an hour late, and the remainder of the programme had in consequence to be cancelled.

Before leaving Hayes the Prince heard a demonstration of high-fidelity reproduction in the research laboratories, and was most successful in identifying the sounds of some every-day noises which had been specially recorded at unusual volume. He also listened to the private records of the Royal Wedding ceremony which had been made by H.M.V. for the B.B.C.

So great was the crowd when the Prince attempted to leave that special police reinforcements had to be obtained to clear a way for his car.

Mr. Alfred Clark said afterwards that what impressed him most was the Prince's great technical interest in the various processes that had been demonstrated to him during his tour.

## R.I. PRODUCE A D.C. RECEIVER

**F**OR readers who are on D.C. mains, Messrs. Radio Instruments Ltd. have now produced a four-valve superhet receiver which is to retail at 15 guineas.

The circuit of this new R.I. D.C. mains design employs a heptode frequency changer, an intermediate frequency amplifier, a double-diode triode and a pentode output



Day-and-night work is being carried out on the extension to the Ekco factory at Southend—an extension that has been rendered necessary by the phenomenal demand for Ekco car-radio installations.

valve. It is fitted with all the worthwhile modern refinements, including automatic volume control and inter-station noise suppression.

The dial, which is illuminated, is calibrated both in station names and wavelengths, and all the set controls are conveniently placed on the side of the instrument.

Descriptive literature is available free on request to R.I. Ltd., Croydon.

## NEW FERRANTI RADIOGRAMS

**A**LL those readers who are familiar with the very high standards of Ferranti table-model receivers will welcome the news that this famous firm has now introduced an attractive range of radiograms.

It will have been obvious from the Triple-Test report which appeared in a recent issue of "P.W." on the Ferranti "Arcadia" receiver that we rate the firm's products as among the most outstanding "quality" instruments at present available, and we are confident that the fact that they are now producing radiograms will be enthusiastically received by listeners generally.

The new radiograms comprise the "Lancastria" at 24 guineas, which is available with automatic record-changing mechanism for an extra 9 guineas, and the "Arcadiagram" at 30 guineas, which can also be obtained with an automatic changer for the same extra charge.

### Visual Tuning Incorporated.

All of these models are available on hire purchase, and the terms range from a little more than 10s. a week for the "Lancastria" radiogram to 17s. a week approximately for the "Arcadia" autogram.

As is only to be expected of any Ferranti product, these latest models incorporate all the worth-while modern refinements, including a combined tone control and scratch filter for use when playing records. All, too, are fitted with the famous Ferranti "All-in" dial, which gives a visual indication not only of the correct tuning position for any station, but also of the settings of the tone and volume controls and the wavechange switch.

The radio chassis in each of the new radiograms is of the superhet type, and the design follows the best modern practice. In keeping with Ferranti's reputation as the manufacturers of first-class superhets, these latest instruments are both sensitive and selective, and the provision of automatic volume control ensures a wide choice of distant stations at real programme value.

Not the least attractive features of these new models are the superb cabinets into which they are fitted. The design in each case is pleasingly modern without being "hard," and the cabinet work is of a high standard of craftsmanship.

Those of our readers who would care for further details of these magnificent instruments can obtain them by sending a postcard to Ferranti, Ltd., Hollinwood, La. Co., mentioning POPULAR WIRELESS Listeners' Service.

While on the subject of Ferranti designs did you notice the "Gloria" Consolette which was shown on our cover last week? No wonder, when you study its appearance, that this set has proved a best seller.



His Royal Highness the Prince of Wales arriving at the Hayes factory of H.M.V. on the occasion of his recent five-hour tour of the works (see column one).

## “ . . . . A JOLLY GOOD SET . . . . ”

—The verdict of our chance-chosen critic following his tests of the Cossor Model “536” radiogram.

AS several regular readers of “P.W.” have raised the question of how the week-by-week choice of an unprofessional critic of wireless sets is made for the purpose of this series of articles, it may be of general interest to outline the method before introducing this week’s critic.

The set to be tested was the Cossor “Super-Ferrodyn” Radiogram, Model “536.” And to get an unbiased criticism it was essential to persuade someone not familiar with the receiver in question to hear it in action, and then to say what he thought about it.

Arrangements cannot be made in advance, since it would then be extremely difficult for anyone to conduct the test with a perfectly open mind. So it is our custom to arrange that some member of the staff

### A “QUALITY” CRITIC



Joe Loss, the popular dance-band leader, uses a Cossor Model “536” radiogram for comparing the score of his records with the reproduced version.

should approach an unsuspecting citizen—not necessarily a reader of “P.W.”—and guide a conversation round to wireless topics.

Once the ice is broken the “P.W.” scheme of choosing a critic by chance is explained and the invitation to hear the set is given. And it is surprising how readily and sportily the public responds.

It was really a lighter that would not light that drew Mr. W. J. Everest into the limelight this week. He is an artist, of 281, High Holborn, London, W.C.1, and when I saw him vainly trying to light his cigarette in windy Tallis Street I proffered a box of matches and thought to myself: “He’ll do.” Sure enough, Mr. Everest made no objection to my proposal, though he was obviously amused at being asked at a moment’s notice.

“It’s a radiogram, is it?” he asked. “Well, I’ve got a good one of my own at home, so, although I don’t know much about wireless in a general way, I certainly do know what sort of results I get myself.”

He told me the name of his set, and though it would be invidious to repeat it I may say it was a very well-known one. It cost him, he said, eighteen guineas about six months ago.

#### Convenient Controls.

On being told that the price of the Cossor All-Electric Radiogram was only sixteen guineas he looked surprised and examined the cabinet and controls with great interest.

“Looks good,” was his first observation. He scrutinised the cabinet work, and then stood back and remarked: “Very nice job, I should say.”

Indicating the controls on the front of the instrument, he continued: “I like these placed outside the lid in preference to shutting them in. Provided they’re like this one, of course, and satisfactory from the point of view of artistic appearance.”

He next asked about the loudspeaker, and when I assured him that it was one of the energised moving-coil type he nodded approval. “We’ll hear it in a moment,” he said, “and that’s the real test. But I must say I should have been disappointed with anything less than a mains-driven moving coil.”

#### The Wavelength Scale.

Our first test was made on gramophone, and we heard half a dozen or so different classes of record before we considered the set’s possibilities from the wireless standpoint.

What is “P.W.’s” tangible expression to every broadcast listener of a really Mappy New Year—a year free from Europe’s heterodynes and filled with prospects of unlimited world-wide loudspeaker reception?

IT’S COMING!—WATCH FOR IT!

Violin, piano, orchestra, speaking voice and singing voice—Mr. Everest heard them all and then gave his opinion.

“It’s every bit as good as mine,” he said. “Every bit. And there is one thing I like better. Though they are equal in tone and clearness of speech, I notice this one is very easily controlled from the volume knob. Mine isn’t too good in that respect, and I have often wished I could cut it down and bring it up, according to what strength you happen to want at the moment, as easily as this knob will do it.”

On switching over to radio Mr. Everest was interested first in the illuminated scale, which is switch-operated, so that when on long waves only those wavelengths were visible and when on medium waves the 200–560 metre scale came into view.

“That’s slick,” he commented.

#### Plenty of Stations.

Finally we tried the set’s capabilities on radio, starting at the bottom of the medium waves and working up first that waveband and then through the programmes above 800 metres.

There were far too many to count, so we listened only to the more easily received and powerful programmes, just to get a general idea of what the set could do in this direction. And it soon proved it could do a great deal. It certainly satisfied Mr. Everest.

“I don’t seem to have said much,” he concluded, “because, as I warned you, I don’t know a lot about wireless. But I do know enough to say that’s a jolly good set.”

P. R. E.

## “ . . . . I MUST CONGRATULATE COSSOR ”

—Our Music Critic.

I HAVE had a real treat the last weekend, for I have been using one of the latest Cossor radiogramophones. It has been a welcome change after a long run of radio sets, and I have made full use of the opportunity.

The radio side I am afraid I have not listened to very much, for I have mainly employed the instrument to run through some of my favourite records. And excellently it played them, too.

Radio on the Cossor was good, of course, but I was more than smitten with the brightness and fidelity of the record production, especially on heavily recorded full orchestral records.

Ravel’s famous “Bolero” was one that I played time after time, for the full range of the record was remarkably well brought out

### “PEAK” PERFORMANCE!



The highest radio in Great Britain is this Marconiphone Model “273” which is installed at the hotel on the top of Mount Snowdon.

on the instrument. The steady beat of the drum and the blare of the brass instruments were particularly satisfying.

Some of Gigli’s latest records, including the practically full recording of “Pagliacci” that has just been made by H.M.V., were also tried on the radiogram with extremely lifelike effect. A case of fine recording done real justice to by a fine instrument.

There is a crispness about the reproduction of the machine I tried that greatly appeals to me. So often one finds that designers of radiogramophones have “smoothed” the rasp of the fiddle strings, and the brass of the trumpet is softened into the croon of the saxophone. Why they are so afraid of the full harshness of some instruments of the orchestra I cannot understand, unless it is that the public still have that taste for “mellowness” of which they were accused some years ago.

It is a pity, and I must congratulate Cossor for turning a deaf ear to the cry for “roundness” of tone and for striking out for realism. It is high time the “mellow” set disappeared.

# TECHNICAL TESTS

NUMBER THIRTEEN:  
 THE COSSOR "SUPER-FERRODYNE" ALL-ELECTRIC RADIOGRAM, MODEL "536"

**T**HERE may be other all-electric radiograms which retail for the astonishingly low price of 16 guineas, but we are certain, as a result of tests which we have just concluded, that there are few, if any, to compare with the one produced by Messrs. Cossor.

Perhaps the reason for that is that Messrs. Cossor, no less to-day than in the years gone by, are pioneers of reasonably priced radio, and although they have never been content with anything but the very highest standards of performance, their present enviable position is no doubt due in a measure to the fact that they have attempted on a large scale to cater for the pocket of the man in the street.

### Remarkable Value for Money.

Small profits and quick returns is a slogan that has been the secret of success behind many enterprises, and although we are not in a position either to know or to divulge the inner secrets of Cossor policy, we do know that, consistent with the high standards of workmanship which are evident in the design of this 16-guinea radiogram, the margin of profit must be exceedingly fine.

Frankly, if it isn't one of the price sensations of the year, then it should be, for from our knowledge of a wide number of designs we know of no better value-for-money proposition than this one.

Consider it for yourself, for, even on paper and assuming a very ordinary performance, it must be obvious that the Cossor Model "536"—as it is called—is something right out of the rut.

It is what is termed by Messrs. Cossor a "Super-Ferrodyne" receiver. In other words, it incorporates certain Cossor developments whereby, and consistent with the circuit employed, the highest standards of selectivity are obtained.

### Not a Superhet.

It is not a superhet—a fact which perhaps, in some respects, tends to make one give vent to a sigh of relief. For whereas we have no particular objection to superhets, it is a fact that almost everybody seems to have gone "superhet mad" this season, with the inevitable result that there are on the market models which do more harm than good to radio as a source of home entertainment.

A good superhet is an asset; but one that is only mediocre—well, suffice it to say that a straight set is infinitely to be preferred by comparison. Let us put it another way.

A high-efficiency straight set which has been well designed and then well built is a far better proposition than a shoddy superhet which is deficient in performance only because it has been built down to a price.

Cossor, therefore, are to be congratulated for having taken the broad and sensible view. That they have not attempted for the sixteen guineas to "throw in" a superhet circuit is a

policy upon which they are deserving of every credit, especially when, as in the present case, the circuit upon which the design is based is so very efficient.

The actual circuit employed consists of a variable- $\mu$  screened-grid H.F. stage, a pentode detector and a pentode output valve, but the arrangement has been "hotted up" to such an

Then, too, there is the gramophone side of it. An electric turntable and a well-balanced pick-up are brought into operation in an instant by the movement of a switch, and with this alternative to supplement the radio programmes there need never be a dull moment with this set.

The Cossor "Super-Ferrodyne" Model "536" is for operation on A.C. mains, and, whether on radio or gramophone, the extent of the mains hum is absolutely negligible. It incorporates a mains-energised moving-coil speaker, and to facilitate easy-station selection the dial, which is illuminated, is calibrated in wavelengths.

### Sensitivity Very Good.

In our practical tests of this set the value of the pentode detector was rather strikingly exemplified, for the improvement in results over the ordinary type of S.G.-det.-L.F. three cannot be attributed to circuit improvements alone.

The overall sensitivity was good—very good, in fact, for the particular valve combination employed—and, used with a reasonable but not too large outdoor aerial, the degree of selectivity obtainable was sufficiently high to permit of the reception of a wide range of alternative programmes.

Selectivity was perhaps not up to superhet standard. Obviously it could not be without many more tuned circuits and added circuit complications. But it is something more than adequate for all normal listeners' requirements, and it is definitely higher than one is accustomed to expect for this type of set.

In any case, the degree of selectivity is to an extent controllable by the judicious use of the reaction control. With reaction set at zero, we found the degree of selectivity to be adequate for most ordinary purposes, but for the satisfactory separation of some of the adjacent-channel high-power stations, the application of reaction was necessary.

### Easy to Handle.

But it is an easy control to handle, and when used in conjunction with the radio volume control, there are few programmes under normal reception conditions which cannot be separated.

Such selectivity characteristics for a set of this type are exceptionally good, and when it is remembered that the distant programmes are appreciably free from superhet "background-

ness," the advantages of this type of set will be readily apparent.

With regard to quality of reproduction the results from the "536" are extremely pleasing, and our constant-frequency records test made it apparent that the response is appreciably linear at all frequencies that matter. This applies to radio and gramophone record reproduction.

As we have previously indicated, there may be other all-electric radiograms at 16 guineas, but we are confident that there are few, if any, to compare with the Cossor Model "536." For the money it is a remarkable design.



## TECHNICAL SPECIFICATION

**GENERAL DESCRIPTION.**—Four-valve (including rectifier) radiogramophone for operation on A.C. mains 200-250 volts, 50/60 cycles.

**CIRCUIT ARRANGEMENT.**—Variable- $\mu$  screened-grid H.F. stage (Cossor M.V.S.G.); screened H.F. pentode detector (Cossor M.S./Pen); and pentode output (Cossor P.T.41). Rectifier is Cossor 442BU. Reaction is applied to the circuit, and is controlled by a knob on the front of cabinet. Pentode output valve feeds into a moving-coil speaker of the mains-energised type.

**CONTROLS.**—Five in all, consisting of (1) main tuning (with concentrically mounted trimmer adjustment); (2) reaction; (3) radio volume control; (4) gramophone volume control; and (5) master switch.

The turntable brake is operated by the movement of the pick-up, and motor is automatically switched off at the end of each record. Special note: Turntable speed is adjusted for 78 r.p.m., assuming that mains voltage is to be 230 volts. If voltage on which instrument is to be used is above or below this figure, certain adjustments will be necessary (instructions are provided).

**SPECIAL FEATURES.**—(1) Low cost; (2) High quality reproduction; (3) full-vision illuminated scale calibrated in wavelengths; and (4) quietness of background on radio.

**MAKERS.**—A. C. Cossor, Ltd., Cossor House, Highbury Grove, London, N.5.

**CASH PRICE AND HIRE-PURCHASE TERMS.**—16 guineas, or 40s. deposit and seventeen monthly payments of 20s.

extent that it would require the trained ear of an expert to detect any difference between the performance of this set and that of the average superhet.

It will receive all the worth-while programmes in Europe at full loudspeaker strength under average reception conditions, and there is far less background than is usual with a set of the superhet type. To all intents and purposes it is an ideal set for the ordinary listener, for, apart from the fact that it is easy to operate, it does offer a widely differing choice of entertainment at any time of the day.

# TELEVISION

## A SPECIAL PRACTICAL SERIES FOR ALL READERS

By L. H. THOMAS

This week a most attractive kit of parts for constructing a televiewer is reviewed, and some details of an interesting neon tube are included.

I HAVE recently had an opportunity of testing the television kit marketed by the Mervyn Sound and Vision Co., Ltd., an illustration of which, fully assembled, appears on this page.

The makers claim that this kit represents "Television reduced to the simplest terms," and I certainly agree that nothing could be much more easy for the home constructor to assemble and operate.

For an outlay of precisely 60s., followed by less than an hour's work with a pair of pliers and a screwdriver, any owner of a good radio receiver can also make use of the bi-weekly television transmissions. If he has A.C. mains available the running expenses can be described as practically negligible, and no "maintenance" or replacements should be required for a very long time.

The kit, as received from the makers, consists of the following parts: A universal motor, with mounting brackets; a 16-in. disc; an "adjustable-fixed" resistance; a variable resistance with insulated spindle; a Mervyn "Nu-Glo" lamp and holder; two terminal blocks; and a set of wooden parts ready cut for assembling the chassis.

### Soon Made.

The conversion of this set of loose parts into a serviceable televiewer calls for no particular ability in handling tools. It is simply necessary to mount the motor between its two brackets, the front one of which carries the control resistance; to fix the disc on the motor shaft; to wire up the mains leads to the motor, in series with the variable and fixed resistances; and to mount the lamp in the appropriate position behind the disc.

This should take less than an hour, after which the gear is complete and ready for the reception of pictures.

The illustration shows the kit with synchronising gear added. This costs 35s. extra, but is by no means essential. As a matter of fact, I was extremely surprised at the ease with which reasonably steady pictures could be obtained without any synchronising gear whatever.

Should the reader wish, however, to add

this refinement after a while, the alterations necessary are very small, and again no skill or elaborate tools are required.

### Really Good Results.

On test the Mervyn kit gave excellent pictures. Within an hour of rigging it up on the bench the B.B.C. transmission (a Wednesday night programme) had commenced. We had not heard the initial announcements, but the two of us who were "looking-in" instantly recognised the features of a comedian who appeared before the spotlight.

The motor had been allowed to warm up for about a quarter of an hour, and once the correct setting of the control resistance was

that was transmitted with a "hazy" kind of background effect.

Incidentally, this lamp has three electrodes. At the rear is the usual type of flat plate. Immediately in front of this is the centre electrode, consisting of a pair of vertical rods parallel with the edges of the plate. In the front is a "grid" of fine mesh.

Several different arrangements of the connections are possible, as all three are brought out separately to the base. A receiver with a large output may be so arranged that the grid and plate are connected in parallel, giving two separate glowing areas, neither of which obscures the other. A smaller receiver may be used with two electrodes only—possibly the grid and the centre electrode.

The striking voltage is about 180, and a current as low as 6 mA. will give a glow completely covering either electrode. One can increase the total current up to the exceptional figure of 55 mA., however, without damaging the tube. Many different methods of connection can be experimented with, one of the most intriguing being concerned with the use of two output stages, one arranged for the reception of the higher frequencies and the other for the lower. One can then be connected to each glowing electrode, and some very interesting results may be obtained.

### A Well-Cut Disc.

Regarding the other parts, the disc is very accurately cut and gives a beautiful picture; the motor, as already mentioned, runs at a steady speed, and also possesses the merit of being extremely quiet. The variable resistance is of a fairly low value, and gives a speed control that is not too critical.

The chassis, when assembled, is very rigid and compact, and may easily be fitted into a suitable cabinet. Viewing lenses may be obtained if desired. Altogether this little kit may be taken as excellent value for money.

Results leave little to be desired, and its chief merit is its complete simplicity and the absence of unessential parts.

found it settled down to a remarkably steady speed. Although, naturally, the absence of "sync" caused a slight drifting of the images, it was not found necessary to sit with one's hand on the control. One simply allowed them to drift, first in one direction and then in the other, and most of the time they were steady.

### High Degree of Illumination.

Bearing in mind the fact that I have measured a considerable variation from time to time in my A.C. mains voltage, this is very creditable indeed.

The "Nu-Glo" lamp gives a high degree of illumination, and the glow is of a rich yellow-orange colour. Its modulation characteristics are also extremely good, showing up particularly well in an item

## AN INEXPENSIVE TELEVIEWER

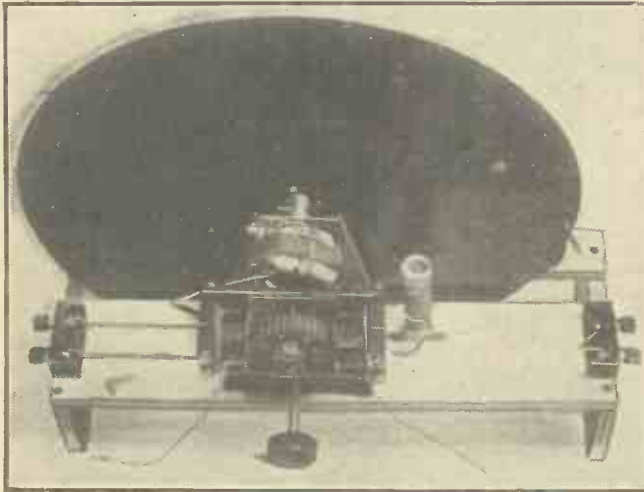

A photograph of the televiewer which can be constructed with the Mervyn kit of parts. This picture shows the synchroniser in position, but the instrument works extremely well even without this.



This is the special "Nu-Glo" flat-plate neon tube used in the Mervyn kit and described on this page.



Auntie forgets her operation



Uncle would sooner miss his club than his game



Mabel never will be left out



Father always wants to join in



Grandma feels quite young again



Jack says it's a spree

# Are You playing GRANDFATHERS WHISKERS Everyone Else Is!



Grandpa forgets his gout.

THE more you search for Grandfather's Whiskers, the more you will enjoy yourself. It's the most amusing and intriguing game ever devised, and one that will afford every member of the family a merry evening's entertainment. Any number of players can take part—no difficult rules to remember—just one big spell of excitement and laughter.

The pack comprises 48 cards, with brightly coloured pictures on the front which can be made into more than 1,000 uproariously funny figures. The backs of the cards form a series of six Jig Type Puzzles—simple ones for the children and more perplexing ones for grown-ups.

Don't be without your pack. As a round game to make dull evenings bright, this new card game would be hard to beat.

The Great 3 in 1 Card Game

Made by John Waddington Ltd., makers of the world's finest Playing Cards.

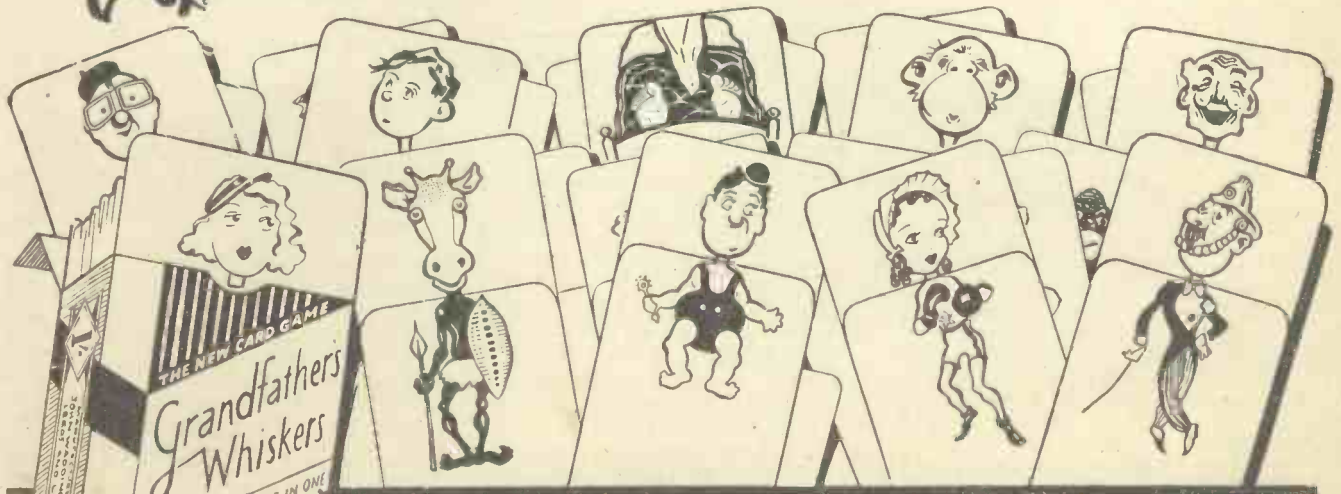

THE NEW CARD GAME  
Grandfathers Whiskers  
— IN ONE

1/- On Sale at all Newsagents, Stationers, Booksellers, etc. 1/-

IT is being taken as almost axiomatic that there will be a public inquiry into the B.B.C. The fact, however, is that the Government has wisely reserved its decision. Much will depend on the state of legislation and the decision of the date of the General Election. As there is no serious demand for any radical change of the B.B.C. constitution the Government might be able, with the concurrence of the Opposition parties, to renew the Charter by Order-in-Council.

The distribution of money is the only subject legitimately open to discussion. If, as is expected, the B.B.C. has to take up television seriously next year, then there is an irresistible case for a substantially bigger proportion of licence revenue than at present.

#### Sir Charles Carpendale in Switzerland.

Sir Charles Carpendale, the Administration Chief of the B.B.C., is now in Switzerland on his annual holiday. The gallant admiral saves up his leave from the summer in order to throw himself into the winter sports so dear to him. Last year he won several trophies, and he will be in competitions again this season. He is accompanied by his six-foot-four son Dick, who is also an accomplished athlete and a member of the staff of the B.B.C.

#### Dr. Boulton to Stay.

I can give an authoritative denial to the rumour that Dr. Adrian Boulton intends to leave the B.B.C. It is true that there have been difficulties about the place of music generally in the scheme of things at Broadcasting House; but a temporary adjustment of the difficulty was effected by Colonel Dawnay towards the end of last year. This adjustment has certainly given music a position of far greater importance.

#### Atmosphere of Change.

There is an atmosphere of change round Broadcasting House. Rumours of reorganisation and new appointments are insistent. There is also the suggestion of certain impending programme changes, notably a lightening of talks and a general speeding up of the presentation of programmes. Both these reforms would be very popular with the general body of listeners. Talks are undoubtedly too academic, and the transition between programmes is not as "slick" as it should be.

#### B.B.C. and Overseas Co-operation.

The B.B.C. is particularly grateful for the co-operation of Dominion broadcasters in the Christmas Day programme. Relations with the Canadian radio authorities, which had not been satisfactory, appear now to be more cordial. Anyway, Canada stood in well on the Christmas arrangements. Australia, New Zealand, South Africa and India also played up magnificently.

#### A Light Entertainment Novelty.

Something different in light entertainment is promised for Thursday, January 10th, when six versatile radio artists, the

Radio Three (girls) and Jack Lorrimer, Ronald Hill and Clive Errard, are giving a show that will be "strung together" by a compère.

The Radio Three appeared in "Wonder-Bar" and in "The Show Goes Over,"



Reginald New, the well-known organist, whose broadcasts from the Midland Regional are so popular.

and the men artists have appeared in various variety productions.

Apart from giving monologues and singing, three of the artists are solo pianists. Others play various instruments and sing

## THE GOVERNMENT AND THE B.B.C.

### News and Views from the "Big House"

in various ways that present-day broadcasting demands. Their programme will consist of sextet arrangements, solo comedy songs and various rhythm pianoforte arrangements for one, two and three pianos.

#### LISTEN TO THESE NEXT WEEK

**Midland Regional:** A musical and dramatic programme given by young Midland artists. The soloists are Hurst Burton (baritone), Eric Hope (pianoforte), who won the Federation of British Music Industries Challenge Cup two years ago, and Audrey Thompson (violinist). Also the Harold Brighouse comedy, "The Oak Settle," is to be acted by the Shakespeare and Dramatic Society of the Midland Institute, Birmingham. This dramatic society is one of the oldest in the Midlands. (Monday, January 7th.)

**West Regional:** A concert by the Torquay Municipal Orchestra relayed from the Pavilion, Torquay. The vocalist will be Margaret Tann Williams (contralto). (Tuesday, January 8th.)

**North Regional:** "The Cab," a one-act dialect play by John Taylor. (Monday, January 7th.)

A concert by the band of the Queen's Own Yorkshire Dragoons (Territorial Army). (Friday, January 11th.)

#### Mr. Dinwiddie on the Air.

Mr. Melville Dinwiddie, the Scottish Regional Director, is making one of his rare appearances before the microphone on Monday, January 7th, to tell listeners some of the more important programme plans during the next few months.

#### "The Babes in the Wood."

Forty minutes of the pantomime, "The Babes in the Wood," will form an attractive relay from the Theatre Royal, Nottingham, for Midland Regional listeners on Saturday, January 12th. Two of the scenes are in Sherwood Forest, as perhaps they should be, seeing that the performance comes from Nottingham.

Fred Clements, who is presenting it, has been producing pantomime since 1906. In the summer he runs the Arcadia Follies at Skegness. Do you remember their excellent broadcast show when the drought was on?

The cast is a good one, and the broadcast will be equally outstanding.

#### Last "Patent" Theatre.

Another pantomime relay (for West Regional listeners) will be available on Friday, January 11th, when a good chunk of "Little Miss Muffett" will be heard from the stage of the Theatre Royal, Bath.

It may be interesting to some people to know that this theatre was the first to become a patent theatre and the last in the provinces to lose the licence when the Lord Chamberlain decided to place all theatres on the same footing.

#### Midland Sunday Play.

Midland Region has decided to broadcast a Sunday play; and why not, since Sunday Shakespearean productions have been given for some time in the National programmes?

F. Sladen Smith's "St. Simeon Stylites" is the play chosen for Midland listeners on Sunday, January 6th. The scene is the legendary tower, and there the saint, interviewed by a young pilgrim, a lady and her attendant, and the devil and friend, gives his views on the state of the world.

The play will be acted by the Malvern Repertory Company and relayed from the Festival Theatre there.

#### A Tyneside Tour.

The present series of North Regional "microphone tours" is certainly working out very well.

For the next, on Friday, January 11th, a visit to one of the biggest ship-repairing yards in the world, on Tyneside, is now being arranged.

Most of us are quite unaware of the wonderful work done in ship repairing as distinct from ship building. Ships require much more attention to keep them in "A1" condition than is generally realised.

Listeners can hear all about the jobs, big and small, that have to be tackled from some of the men who do the actual work, and they can hear, too, some wonderful "effect" noises that have never yet been broadcast.

O. H. M.

# ON THE SHORT WAVES

*Conducted by W.L.S.*

**T**HIS week we have returned to a lay-out on the (nearly) standard base-board. I have had to make one or two alterations, but they are easy enough to follow, and I will explain them as we come to them.

A few weeks ago I mentioned, quite casually, that unusually good results could be obtained with a "separate-reactor" circuit, particularly by readers living in noisy localities. Much to my surprise, I have been deluged with letters asking for particulars of this circuit.

In a way it is very similar to the circuit of the screened-grid detector that I gave some time back—the one in which reaction was applied from the screen and the phones (or coupling to the next stage) connected in the anode circuit.

### It Is Worth While.

This arrangement, however, uses two separate triodes. Their grids are connected together, so that they both receive the input from the tuned circuit, but their plate circuits are entirely separate. One looks after the reaction and the other feeds the phones (or, again, whatever coupling you may use, if you want to use another valve after it).

The economically minded reader will at once ask: "Well, why bother? You can produce your reaction and your detection perfectly well in the same valve, so why use two?" And at first sight, I admit, it must appear that the only people to benefit will be the valve manufacturers.

But it is worth it. By separating your reaction circuit from your phone circuit you definitely do get rid of one or two undesirable effects that are present when the two are mixed up.

### Very Smooth Control.

For one thing, you are assured of a *much* quieter background, for reasons that are not easily explained in non-technical language. But if you reason out the state of affairs when an ordinary detector, on the verge of oscillation, is "struck" by a strong atmospheric you will begin to see why a separate reactor helps matters.

The reaction control is very much smoother and more stable, for one thing; and if you are working it "just on the edge" the sudden arrival of an atmospheric or a very strong signal will not cause the complete "spill-over" that one becomes hardened to with the ordinary reacting detector. Funny things may happen in the plate circuit of the reactor valve

momentarily, but they won't affect the plate circuit of the detector nearly so severely.

Anyhow, we are not concerned with theory so much as with practice, and in

## CUTTING OUT THE BACKGROUND

For best reception of really weak stations you need a silent background, and the easiest way to achieve this is in the manner described here by W. L. S.

practice the scheme is definitely worth while if you are a lover of quiet background and easily handled receivers.

Looking over the diagram on this page, you will note that I have left the "note-mag." valve holder in position for the benefit of those who would like to use some L.F. Needless to say, the L.F. follows the detector valve; the leads that go at present to the phone terminals are taken to

the coils. As the standard 2-pin coils, which I have shown all along, are not too easy to obtain nowadays I have shown an imaginary type of four-pin base. The two pins nearest the back of the base-board carry the reaction winding; the other two the grid winding.

Whatever type of coils you use you can easily arrange them to fit in with the wiring of this set, and even two of the old favourite "two-pinner," if you have them by you, can be mounted in place of the four-pin base shown.

### Setting the H.T.

Now with regard to the operation of this little set. Give the reactor valve the very lowest value of H.T. (H.T.+1 terminal) necessary to make it oscillate. Probably you will find it behaves perfectly with 25 or 30 volts. Don't worry if you have to have the reaction condenser nearly "all in" so long as it *will* oscillate all round the dial. The detector should have about 60 volts.

When you first switch on you will most probably think something has gone wrong, so quiet is the general effect. I had to listen hard at first to tell whether the set was oscillating or not, because I had happened to land on one of the very few parts of the short-wave spectrum in which there was no signal!

Even if you live in a fairly quiet location you will find the reduction of background noise a great boon. I can receive quite a few stations with a separate reactor that I can't normally get with a single-valver; with the former they *just* creep through the mush, and with the latter they *just* don't! If the difference in noise level is only 5 per cent it may mean that a few more stations are available for you, and in my case it is certainly greater than that.

### What Is Your Opinion?

I don't think I had better spoil your enjoyment by talking any more about this circuit. Try it out for yourself, and then write and tell me whether you really think the extra valve is justified.

The only disadvantage of the scheme (if you can call it one) is that the man who doesn't bother to listen to weak signals won't derive any advantage from it. It does *not* increase signal strength; it simply diminishes background noise. If you are one of the people who simply tune to W 8 X K late at night, and stick to him because he is the strongest station in the 49-metre band, this receiver won't help you.

## A SEPARATE-REACTOR CIRCUIT

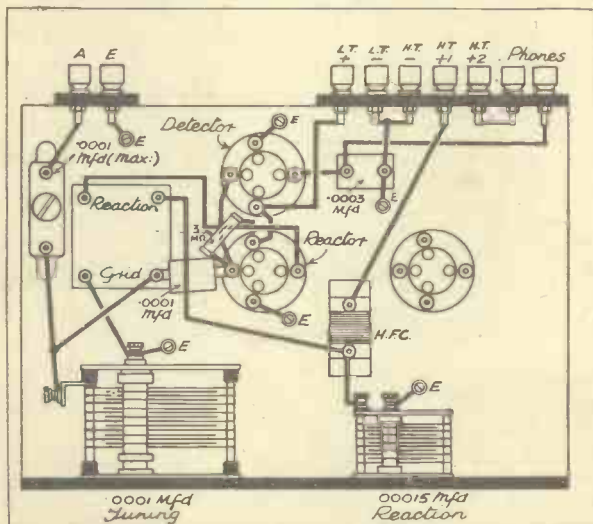

One of the valves in this circuit is used as detector, and another simply to provide reaction, the advantage over a single-valve reaction circuit being the silent background obtained.

the transformer primary or the anode resistance, or whatever you want.

I have left the phone jack on the front panel out of this particular set because the leads to it would be rather long. If you use a note-mag. you can bring it back into commission again.

Everything else connected with the layout should be clear, with the exception of

On the Short Waves—Page 2.

C. K. (Lee, S.E.12) comes forward with rather an unusual account of a short-wave set. He has made up one of my two-valvers, using a commercial set of four-pin "valve-base" coils. Everything appears to be working to schedule—reaction control good, no hand capacity, plenty of Morse, also speech and music, but reproduction is "woolly."

He has tried several different power valves, changed the grid leak, and done all sorts of things, but still the trouble is there. From more detailed descriptions that he gives it sounds to me as if the reaction control is not really as nice as he imagines, and I think instability—H.F. in the L.F. stage—is probably at the root of the trouble.

## IN TWO SECTIONS

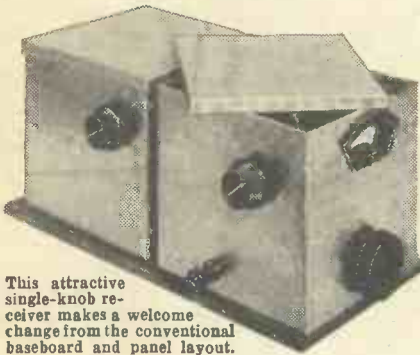

This attractive single-knob receiver makes a welcome change from the conventional baseboard and panel layout.

With a short-waver one sometimes does get the effect of a beautifully smooth reaction control up to a point, after which there is a nasty "plop." The trouble generally lies with either the grid leak, the detector valve or the value of H.T. I hope C. K. has found a clue from the above. If he hasn't I will try to have another go on receipt of further details.

THE International DX-ers' Alliance has now formed a London Chapter.

Meetings will be held regularly, and a full programme has been arranged for the winter season. Membership is open to anyone interested in long-distance reception, either on medium or short waves.

Prospective London members should get into touch with Mr. J. Knight, 6, Fleetwood Street, London, N.16. A Manchester Chapter is also being formed and should open shortly.

I was also given particulars of some special I.D.A. transmissions, but unfortunately, owing to Christmas, we had already gone to print with the last number in which the announcement would have been any good.

The same applied to the special transmission from EAQ for members of the International Short-Wave Club. If anyone did hear it, however, at midnight on December 21st, will he please report to Mr. A. E. Bear, 10, St. Mary's Place, Rotherhithe, S.E.16?

### Present Reception Conditions.

Conditions throughout December seemed to be pretty poor below 30 metres, but not too bad on the 31- and 49-metre bands. They are due for an improvement between now and the spring, but are usually good

## WHAT READERS ARE SAYING

Points of Interest from the Post-bag.

G. G. (S.W.11) wants to build the "H.A.C. Three-Valver," but finds that the number in which it was described is "O.P." He would like a good substitute. My advice is to hold on for another fortnight or so, as something suitable might be coming along. (That's just a hint.)

A Manchester reader (can't decipher his initials!) has just had his first smack at short waves, and wants to know (a) who is "P No D C" and (b) who is "C Q," whom he was calling. The first station referred to must have been the Dutch amateur P A-o D C; the second he will never hear. (See any list of abbreviations. "C Q"—general call for all stations.)

### Amateurs on Sundays.

J. M. W. (Aberdeen) is another newcomer who received his first short-wave station and promptly sat down to write and tell me all about it.

In this case it was the British amateur, G 5 M L, of Kenilworth, near Coventry. Probably he was in the 40-metre band, on which dozens of British amateurs on telephony should be heard every Sunday.

I. H. (Kirkby Lonsdale) wants the address of an amateur transmitter in Lancashire to whom he may go for some fatherly advice. I recommend him to get into touch with the R.S.G.B. District Representative for the North-Western district, who will probably find a "ham" near at hand for him. His address is Mr. J. Noden (G 6 T W), Fern Villa, Coppice Road, Willaston, near Nantwich.

W. G. M. (Southampton), who used to be a regular correspondent of mine, breaks out again with details of D X reception during

the past month or so. He, like most of them, has become really bitten with the "amateur" fever, and finds that there is always something of interest on the amateur bands, particularly if one can read Morse.

He has logged J 5 C E (Japan), P K 1 B O (Java) and, of course, dozens of Australians and New Zealanders. He suggests that now the days of the "H.A.C. Club" are over, we ought to find something to replace it.

He suggests a fellowship of all readers who have logged over 100 different countries—to be known as the "Centurions' Club"! But I'm afraid that would cut out all the non-Morse people. Can anyone possibly

## GANGED TUNING

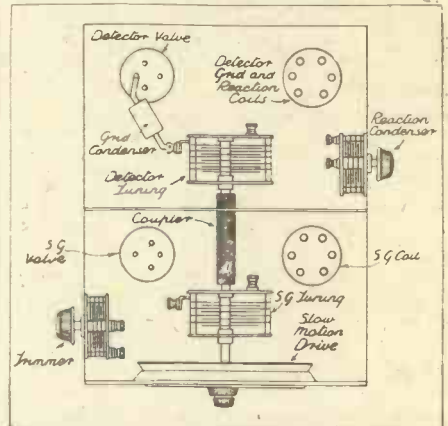

A suggested layout for an S.G. and detector set built on the general lines of the receiver illustrated in the first column.

claim to have received over 100 countries on telephony? I'm quite sure I can't, although my number on ccde is about 135.

The photograph and diagram on this page are published in answer to a request from K. F. (Birmingham) for "a layout that is a little different from the usual panel-and-baseboard variety."



during February, whatever the general "level" of conditions may be.

Bad conditions do not mean an absence of stations nowadays. The effect is merely that the better stations come through more or less according to schedule, while the weaker ones are more difficult to find or are sometimes not there at all.

### Keep a Long-period Log.

I am always asking for readers who will volunteer to keep a long-period log on one or two stations. May I renew this appeal and ask those who can do this to write to me here and now? I may have something of interest for them.

News of the progress of ultra-short-wave work seems to become more startling every day. Among the latest crop of items are the following: Stations in North and South

America working on wavelengths below 7 metres have been heard in this country.

... An amateur working on 2½ metres has been received at a distance of 75 miles.

... Another one working on 1½ metres has been heard at 35 miles.

And, finally, someone in the States is now designing a transmitter to operate on the wavelength of 35 millimetres!

### A New Classification.

And still we go on trying to talk about "long" and "short" waves! What about a new classification? We ought to have something like this: 10,000 to 1,000 metres, Group "A"; 1,000 to 100 metres, Group "B"; 100 to 10 metres, Group "C"; 10 metres to 1 metre, Group "D"; 1 metre to 10 centimetres, Group "E"; and the rest can sort themselves out for a while.

A scheme like that would fit in quite well with our present jargon. "Long" waves would fall in Group "A," "medium" in Group "B," "short" in Group "C." Everything below 10 metres, at present called "ultra-short," would need classifying as we begin to find out something about their possibilities.

When you come to think of it the general transmitting and receiving technique for 10,000 metres doesn't have much in common with that necessary for 10 metres and below.



# RADIO During the GREAT WAR



You will be specially interested in this description by G. C. Meikle of the part played by wireless in the Great War: particularly in the highly important work carried out by the direction-finding section of the Intelligence Department in tracing the movements of enemy warships and aircraft.

**N**CESSITY is the mother of invention, and also one of the main reasons for the abnormal rate of development of any particular science.

The years of the Great War saw the phenomenal development in this country of certain of the sciences directly connected with it, because of the terrific urge of a national emergency and in an endeavour to bring matters to a successful conclusion.

Chief amongst the sciences to be so rapidly developed was that of radio, or at least the receiving side of it, and this embraced the art of direction and position finding, and also the reception of weak long-distance signals by means of multi-valve receivers.

### A Chain of Stations.

Transmitters at this time were, generally speaking, far enough advanced in design to carry out efficiently what was required of them; and although improvements were made, the amount of time spent in transmitting research was not nearly so vast.

The importance of direction and position finding was realised immediately hostilities opened; but it was then in a semi-experimental state, and every possible endeavour was made to improve it so that it could be applied in the shortest possible time to give accurate indications of movements and locations of all enemy craft—sea and air—which used a wireless transmitter.

Enormous credit is due to the small band of engineers who, in the space of a few months, had erected along the East Coast of England and Scotland a chain of stations which could, in periods other than sunset and sunrise, locate exactly the positions of any wireless station up to a range of several hundred miles.

### Extremely Sensitive Sets.

They also developed concurrently types of multi-valve receivers for interception purposes, and it is interesting to know that some of these receivers finally employed over twenty high-frequency stages or valves in cascade, each stage being simultaneously tuned by a single control, or "joy stick," as it was popularly termed. The joy stick caused cores of finely divided iron and wax to slide in and out of the coils of each stage, thereby varying the tuning. It is also interesting to note that these freak receivers were perfectly stable in use

and that the ordinary methods of reaction could be employed to augment signal strength if required.

The effect of so many simultaneously tuned circuits in cascade was tremendous amplification—so much so that the weak buzzer signals used by the German High Seas Fleet when communicating from ship to ship whilst lying at anchor at its base at

and followed in detail. It is now a well-known fact that the movement of the High Seas Fleet from its base, which preceded the Battle of Jutland, and which immediately indicated that something unusual was happening, was observed first of all by one of these stations; and "forewarned is forearmed."

This same station also provided the information that German submarines were transferred for action in the Baltic Sea—information which was only supplied due to the fact that special apparatus for simultaneous direction and wavelength searching had recently been installed.

### Submarines and Zeppelins.

Not the least important of the work carried out by the S.W.S. was the continual watch kept on the movements of submarines which regularly communicated their reports to their bases by radio and received instructions by the same means. The knowledge of the exact positions of the submarines enabled the necessary actions to be taken in order to avoid or destroy them.

Aircraft, too, came in for their share of observance, and it was known as soon as any aircraft moved in the direction of this country to participate in a raid. Their progress could be observed and plotted on a chart from the time of leaving until the time of return, if a return was eventually made.

The actions of Zeppelins proved particularly absorbing during the period of a raid, more especially towards the end, when they could be expected to be somewhat erratic.

(Continued on page 601.)



One of the wartime Marconi direction-finding equipments with which the Type 55 amplifier was used.

Wilhelmshaven were received at good strength and easily readable.

It is a very happy circumstance that most of the experience gained during the War, with receiving apparatus was able to be applied immediately after the Armistice to peace uses and for the safety of life and improvement in commercial communication, whereas the first considerations were those of destruction.

The direction-finding and interception stations mentioned, and known as "S.W.S.," or "Shore Wireless Stations," were situated at strategic points, and to be attached to any one of them was to belong to an Intelligence Branch of the Service in which the continual changes in action on the part of the enemy were almost anticipated

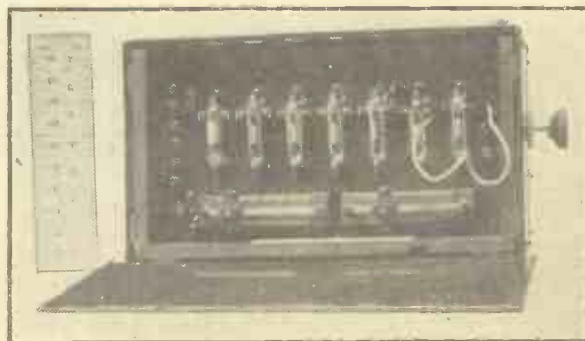

The Marconi Type 55 amplifier as used during the war. The compact dimensions of the amplifier can be seen by comparison with the scale. Note, also, the special low-capacity valves of the V24 type.

## CONDUCTING ELECTRICITY

Some interesting facts about electrons, and the way they behave in various substances, are here told in a fascinating manner

By J. F. STIRLING.

THE question of what goes on inside a conductor when an electrical current passes through it has occupied the minds of scientific men from the earliest days of electricity. It is still occupying scientific minds, for, although we have got a pretty good picture of the state of affairs within a piece of wire when a current flows through it, the picture is by no means as clear and as complete as one would like it to be.

It is a strange fact that the only really decent conductors of electricity are the metals, and of these only a handful provide the working materials of the vast, world-wide electrical and radio industry of to-day. So, therefore, compared with the enormous number of varying substances and materials which man has discovered or devised, only a few—a very few—are suitable for the tremendously important rôle of carrying electricity.

### Attracting a Pith Ball.

The basis of all electrical-conduction reasoning is the pith-ball experiment. You know the experiment well enough, of course. A glass rod is rubbed with a silk handkerchief, whereupon (if everything be perfectly dry) it takes upon itself the property of attracting a suspended pith ball or any other light object to itself.

Now what happens when the glass rod is rubbed with the silk handkerchief? Electrons are actually rubbed off the surface of the glass rod, so that the rod is left with a shortage of electrons. It becomes

positively charged, and, in such a condition, it will tend to attract electrons to itself from other bodies so that it may regain its normal neutral state.

If you allow the charged glass rod to touch any surrounding object it will immediately pick up electrons and so neutralise itself.

Note, therefore, that the atoms comprising the glass rod do not like to be shorn of any of their electrons, even of their most loosely-held ones, and that they will regain them when and whenever they possibly can do so.

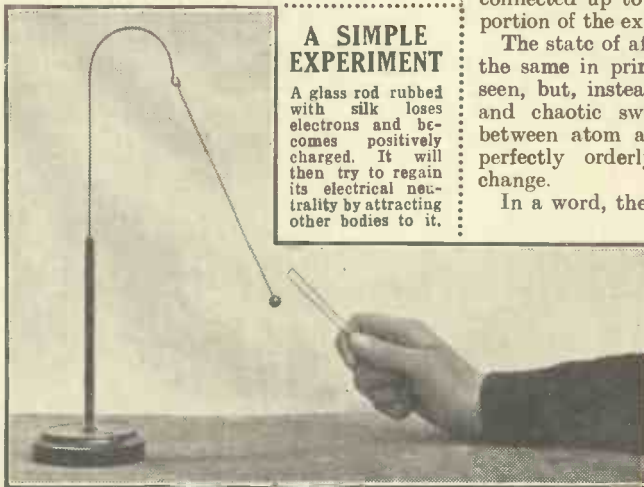

### A SIMPLE EXPERIMENT

A glass rod rubbed with silk loses electrons and becomes positively charged. It will then try to regain its electrical neutrality by attracting other bodies to it.

Bearing this great principle in mind, let us now take an ultra-ultra-microscopic view of the state of affairs prevailing in, say, a length of ordinary copper wire—the wire, for instance, which connects up a battery with some external circuit.

The wire is made up of countless trillions of atoms, each atom having fixed and semi-fixed electrons. The semi-fixed electrons are continuously escaping from the atoms—one atom, for example, will lose one or two of its electrons. Instead, therefore, of being a perfectly neutral body, as a well-behaved atom should be, its loss of negatively charged electrons will result in the atom becoming positively electrified. The atom, however, has no particular ambition to remain in this condition. Therefore it attracts one or more of the semi-fixed electrons from its neighbouring atom.

### A Methodical Interchange.

There is, you see, a continual swapping of semi-fixed electrons between the atoms in the wire.

What happens now when the wire is connected up to a battery and so forms a portion of the external circuit of the latter?

The state of affairs in this case is exactly the same in principle as the one we have seen, but, instead of a random, disorderly and chaotic swapping over of electrons between atom and atom, there is now a perfectly orderly and methodical interchange.

In a word, there will be a steady stream of electrons in the direction of the applied electro-motive force, and it is nothing more than this stream of electrons which constitutes the electric current.

You must not imagine, however, that any given electron

(Continued on page 601.)

## MORE NEW BULGIN COMPONENTS

IT frequently happens that it is possible to group resistances and condensers in a set. Sometimes both tend to fall into a defined grouping. This is generally because condensers particularly are so often employed for by-passing. And where there is by-passing there are almost invariably common earthing points.

Appreciating this, and, in their usual versatile manner, being always enterprising in meeting the needs of the constructor, Messrs. A. F. Bulgin, Abbey Road, Barking, Essex, have produced a com-

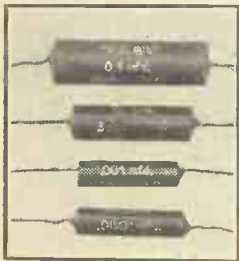

Wire-ended tubular condensers are among the latest components introduced into the Bulgin range.

ponent which they term the "Group Board."

It consists of a neat bakelite panel fitted with double-ended soldering tags. Anyone who is fairly deft with a soldering iron will at once appreciate how this little device can facilitate the grouping of components.

It is the sort of thing the active constructor and experimenter will wish to possess as a matter of course. It is available in two types. There is the five-way at 1s. and the ten-way at 1s. 9d. Messrs. Bulgin inform us that, although it is still quite a new

component, it has already proved popular, and we are not surprised.

The Bulgin wire-end tubular condensers were originally produced for manufacturers, we believe, but they are now available to constructors, who can therefore obtain the advantages of the precision mass production by which they are made.

The capacities of these low-priced, reliable condensers are accurate within a margin of negligible error, and their wire ends make them easy to connect into circuit with or without the aid of soldering.

They are suitable for practically any purpose, for they are designed for 500-volt-working pressures and have negligible inductance.

There is a very full range of values from .00005 mfd. to 5 mfd. at prices running from 4d. to 1s. 3d. We can recommend these con-



This Bulgin resistance "Group Board" comes in extremely handy for constructors of large receivers. The ten-way board costs 1s. 9d.

densers to all our readers. They provide still further proof of the versatility of Messrs. Bulgin and the services they are rendering to the home constructor.

In conclusion, we must again draw attention to the Bulgin catalogue. It is one of the most interesting that is published, and packed full of fascinating gadgets and novelties, as well as useful components of all kinds.

### A USEFUL FITTING.

MAINS connections most usually run in pairs, so that there is far from being a shortage of twin plugs, sockets, adaptors and such like.

But every experimenter must at one time or another encounter the need of a single plug-and-socket connection. For example, a common earth line joining two or more pieces of apparatus might make two-way "live" links between them quite unnecessary.

Exactly the right plug and socket for such a job is to be found in the comprehensive catalogue of Messrs. A. F. Bulgin and Co., Ltd.

It is the "Heavy-Duty Single 5-A Plug and Socket," of which the plug is List No. P44 and the Socket P45. The retail price is 6d. in each case.

The dimensions of these useful items correspond with the standard 5-A sizes, so that either can be used independently to take single connections away from a twin fitting.

They are heavily constructed, and there are bakelite coverings and ebonite shrouds to ensure good insulation and safety in handling.

The plug makes an excellent fit into the socket and an efficient contact is created.

A Heavy-Duty plug and socket that has just been placed on the market by the go-ahead Barking firm. Good insulation and safe handling are among its most important features.

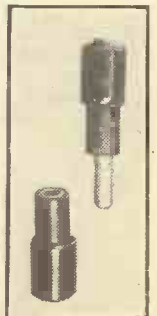

Messrs. Bulgin say that these attractive single plugs and sockets of theirs are "often used for the interconnection of accumulators and charging boards."

We can believe that, and can add that though we have not been in possession of our samples for more than a few weeks we have already found them most useful.

## ELECTRADIX MICROPHONE BARGAINS

**A New Practical Home Microphone** for broadcasting at home. It is a general purpose, robust mike, with solid bakelite body, back terminals, front metal grill. No. 11. New design, finely finished . . . 5/6  
 No. 11A. Special in solid brass body, unequalled at the price on speech and music, 7/6  
 "P.W." No. 11 Table Mike. This is a splendid Microphone for speech and music. The bakelite case, containing a 2-in. mike and transformer, is on a bronze pedestal. Switch and plug sockets are fitted on the case. It stands unrivalled for quality and price . . . 15/-  
**Crooners Lapel Mikes for Dance Bands.** American type model 12/6  
**Microphone Buttons for all purposes.** Usually sold at 3/6. Our price has always been 1/-.  
 We have supplied thousands to home users. A wonderfully interesting and useful Transmitter Unit, for fun with your home radio, detectaphones, baby alarm, rat hunts, speech amplifiers, etc. Usual price 5/-. As supplied to G.P.O. Our price 1/- only. Post 1/4d.  
**Parts for Home Constructors.** Microphone Carbon Granules, in glass capsule, for four buttons. Grade No. 1, 8d.; No. 2, Medium, 1/-; "P.W." No. 11, 15/-  
 No. 3, Fine, 1/6; Carbon, solid back, blocks, 4d.  
 Mouthpieces, curved or straight, 10d.  
 Carbon diaphragms, 55 M/m., 6d.  
 Panel Brackets, pivoted, 5/-.  
 Reed Receiver for Button Amplifier making, 3/-.  
 Headphones, L.R., 2/9.  
**Microphones.** Low prices, all purposes. We are makers and carry the biggest and most varied stock in London.



No. 11, 5/6



"Microphone Marvels," Illustrated Booklet by Lafone, 9d. post free.  
**ELECTRADIX RADIOS,**  
 218 Upper Thames Street, London, E.C.4  
 Telephone: CENTRAL 4611.

## THIS YEAR, NEXT YEAR . . .

THE prosperous car owner has long made a habit of changing his model annually. Judging by the sales of new models something in this nature must be taking place in wireless circles. And why not? Everyone knows the joy of welcoming a new radio to the home: the thrills of unpacking; the first sight of its shiny cranium; the desperate struggle to ease it from its moorings, only to find that you have attacked the wrong end and that it is held firmly down by some ingenious and tenacious shock absorber.  
 At last it slides out. The family cluster round. "A stunner!" "What a dinky little speaker!" "Coo, seven valves!"—this last from little Willie, who is instantly reproved for vulgarity. To relieve his feelings he kicks last year's model, now languishing in a dark corner, and is again reproved: this time for wearing out his boots.

### What Happens To Them?

Which raises the interesting point: What does happen to last year's models? Should the owner be an ultra-enthusiast, the set is placed under a suitable anaesthetic and subjected to a variety of interesting and exciting operations. From these it either automatically emerges in the exhibition grade or is banished to the tender mercies of the rising generation. A few are trundled up to the topmost attic, where they moulder away till the knobs drop off.

But the great majority eventually find their way into the second-hand mart, and here the little matter of depreciation raises much heartburning. Unlike the car, there appears to be no fixed depreciation rate on a wireless set. It resolves into a tussle between the optimism of the seller and the hard-won market knowledge of the dealer. Unfortunately, market value itself is a very elastic term, often meaning no more than the maximum price that particular dealer feels justified in paying. After all, it is a nasty jolt, having confided to your bosom pal that So-and-so allowed you £8 on the old outfit, to find that he wangled £7 for the same model farther down the street. Fixed values would surely lead to increased business.

E. O'M.

## START RIGHT for 1935

Get this latest and largest component catalogue ever published. Over 300 illustrations—descriptive details—technical manual—Fill in Coupon NOW.



Please send me, post free, the New Bulgin 80 Page Catalogue No. 154 "P."  
**I ENCLOSE THREEPENCE IN STAMPS.**  
 NAME.....  
 ADDRESS.....  
 (Block letters please).

A. F. BULGIN & CO. LTD., Abbey Rd., Barking, Essex.

## ENGINEERS! LISTEN...

256 PAGES FREE! There are thousands of opportunities around you, but unless you know where they are, and just how to prepare for them, the chances are that your opportunities will pass by unheeded. Our unique Guide, "ENGINEERING OPPORTUNITIES," clearly explains the steps you must take if you are to secure one of the things, the book explains how we can quickly prepare you, in your own home, for all salary-increasing qualifications, such as A.M.I.Mech.E., A.M.I.E.E., A.M.I.A.E., A.M.I.W.T., etc. The guide also gives details of over 100 courses in all branches of Civil, Mech., Elec., Motor, Radio and Aero Engineering and outlines the activities of our Employment Dept. Send for your copy of this unique Hand-book today FREE and without obligation. The book must benefit you. BRITISH INSTITUTE OF ENGINEERING TECHNOLOGY, 101, Shakespeare House, 29/31 Oxford Street, London, W.1

## RADIO GRAM CABINETS

As supplied to B.B.C.  
**65/- Polished Cabinet for 35/-**  
**No Middle Profits!**  
 Famous maker offers finest Radio Furniture. As Supplied to B.B.C. A Quality and Value impossible to better. Beautifully hand polished! **GUARANTEED** Piano Tone Acoustically.  
**Trial Will Delight You!** (Cash or 10/- Monthly.)  
**LIST FREE!** From Makers—  
**PICKETT'S**  
 Cabinet (P.W.) Works, Albion Rd., Bexleyheath, Nr. London

## The Paper for the Boy of To-day!

Such is MODERN BOY. Its every issue is brimful with thrilling stories and articles on the very latest Inventions, Adventures, Hobbies, etc. It is the paper for the youth of to-day. Buy it regularly.

## MODERN BOY

At all Newsagents and Bookstalls. Every Saturday 2d.

## HIGHEST in QUALITY LOWEST in PRICE



Absolutely non-microphonic detector types. S.G. types of exceptionally low inter-electrode capacity. Output valve giving larger undistorted output than "luxury" price valves.  
**362 BATTERY VALVES.** H., HL & L., 3/6. Power, 4/- Super Power, 4/6. S.G. & V.S., 7/6. V.P.2, 9/-. Pentode Type, 10/- B.A. & B.X., 9/-  
**362 A.C. MAINS.** ACHL4, 7/6. ACPX4, 9/- P.625, 8/- ACSG4 & ACVS4, 12/6. ACME4 & ACHM4, 13/- ACVP4, 13/- Full Wave Rectifiers RB41, 7/6. RB42, 10/-  
 If unobtainable from your dealer send P.O. to:—(DEPT. X), The 362 Radio Valve Co., Ltd., Stoneham Rd., London, E.5



**362 THE VALVE WITH THE 6 MONTHS' GUARANTEE**

# START THE NEW YEAR WELL AND ELECTRIFY YOUR SET!!

BY INSTALLING A—

## HEAYBERD

### LOW-TENSION TRANSFORMER

MODEL	OUTPUT	PRICE
723	2 + 2v. 3 amps.	12/6
727	2 + 2v. 5 amps.	17/6
731	2 + 2v. 10 amps.	22/6

WITH A SLIGHT ALTERATION TO YOUR BATTERY RECEIVER, AND FITTING A.C. VALVES, CONSTANT POWER AT MINIMUM COST WILL BE ASSURED.

SEND COUPON, TOGETHER WITH 3d. IN STAMPS, FOR OUR LATEST 1935 HANDBOOK, "MAINS POWER FOR YOUR RADIO."

Mr. ....  
Address ..... P.W.

**F. C. HEYBERD & CO.,** 10, FINSBURY ST., LONDON, E.C.2.

**LOUD SPEAKERS REPAIRED 4/-**  
(Blue Spot a Speciality, 5/-)  
Transformers and Headphones, 4/-, Eliminators, Mains Transformers and Moving Coils quoted for. 24-Hour Service. Trade Discount. Clerkenwell 9069.  
**E. MASON, 44, EAST ROAD (nr. Old Street Tube Station), LONDON, N.1.**

**FULL of  
INTEREST**



Fully illustrated with constructional details for building Battery and Mains S.W. Receivers—6v. S.W. Super set with A.V.C.—All Wave Wavemeter—5-metre Receiver—Simple 5-metre Transmitter—Crossfeeder Aerial System—Battery and Mains S.W. Converters—Amateur Bands Receiver—100 watt Transmitter—Eliminators, etc. COMPILED BY THE LEADING SHORT WAVE SPECIALISTS. Obtainable from your radio dealer, W. H. Smith, or in case of difficulty, STRATTON & Co., LTD. (Dept. 25), Bromsgrove Street, Birmingham. London Service Depot—Webb's, 14 Soho St., W.1 Glasgow Service—J. R. Hunter, 138 West Nile Street.

**PRICE  
1/6**

**1935 EDDYSTONE  
SHORT WAVE MANUAL**

# RADIOTORIAL

The Editor will be pleased to consider articles and photographs dealing with all radio subjects, but cannot accept responsibility for manuscripts or photos. Every care will be taken to return MSS. not accepted for publication. A stamped, addressed envelope must be sent with every article.

All Editorial communications should be addressed to the Editor, POPULAR WIRELESS, Tallis House, Tallis Street, London, E.C.4.

All inquiries concerning advertising rates, etc., to be addressed to the Advertisement Offices, John Carpenter House, John Carpenter Street, London, E.C.4.  
The constructional articles which appear from time to time in this journal are the outcome of research and experimental work carried out with a view to improving the technique of wireless reception. As much of the information given in the columns of this paper concerns the most recent developments in the radio world, some of the arrangements and specialties described may be the subjects of Letters Patent, and the amateur and the trader would be well advised to obtain permission of the patentees to use the patents before doing so.

## QUESTIONS AND ANSWERS

### NEW VALVES ARE NOT NECESSARILY PERFECT.

J. B. (Glasgow).—"Regarding the failure on my new set, your notes re fault finding have been most helpful. It was your remark that 'although valves may be new they are not above suspicion' that caught my eye, and I had all valves tested. To my great surprise I was informed that my detector was faulty. This was replaced by my dealer.

"On my first try-out, after having the valves reported faulty replaced (which was all that was wrong with the set), I logged 43 stations and each one different.

"I started at 5 degrees with Fécamp, and went right up the dial to 98, where I got Budapest at quite comfortable L.S. strength.

"My dial readings are + two from those published from the early information regarding the 'National Eckersley Three.' The selectivity is exceptionally fine, but I get a little spread between 52 to 58 on the local. Can you advise me how I may cut this down?

"I am handicapped for a real aerial owing to town and building restrictions, being right on the tram route and close to Corporation clinics which give electrical remedial treatment.

"I am compelled to work on an indoor aerial which is practically level with the overhead power lines for the trams. My earth is by way of plug into lighting system.

"My first test was made at night-time, when, as I state, I got 43 stations and all very good strength. I have also given a test in day-time (midday), when the Scottish stations were in full power, and was delighted to get London National, North Regional, Scottish National and above all Belfast, Dublin and Athlone, each and all clear of one another and very good volume.

"As regards ease of handling, this is a sheer delight, as members of my family can get just what they want and when they like. I have kept strictly to specification, and also fitted the H.T. Economiser, and on test the set is only taking 4.5 m/a, normally. (I have two M.C. Blue Spot speakers in parallel, and get all the volume and more at times than is really comfortable, which is easily controllable by the Regulator.)"

The spread you mention on the Regional is not really very great in all the circumstances. The best suggestion we can make regarding this point is the following:

Make absolutely certain that the trimmer condensers are adjusted to the best possible setting. This can best be effected on a station working on about 250 metres, and the station should not be too strong or interfered with.

For example, if you receive the London National

at fairly consistent strength in daylight, as you mention, the trimmers could be very well set on this transmission.

Sometimes a quite small change of trimming will improve both signal strength and selectivity, and even a slight improvement of both will have a very noticeable effect in circumstances like yours.

### TOO MANY MILLIAMPS?

W. E. D. (Hunslet).—"I don't get the volume that I ought to get from a three (S.G., Detector and Power).

"I have now tested with a milliammeter, and the set takes twenty milliamps with this in the negative H.T. lead.

"When I take out the power valve the needle drops right back to ten. And when I take out the Detector it only drops back one degree more, to nine.

## LONG WAVES AND THE S.T.600

On account of slight and inevitable differences in manufacturing methods, the long-wave station-naming on the "Spot-On" dial does not hold good for both makes of coils approved for the S.T.600 receiver.

It will be appreciated that with a dial such as the "Spot-On" it was not possible to make the readings applicable to more than one set of conditions. The chart was originally calibrated in conjunction with Wearite coils, and for the benefit of constructors who are using Colvern coils a re-calibrated long-wave section of the "Spot-On" dial is to be published in an early issue of "P.W." and it will be possible to cut this out and paste it in position on the existing dial.

May we remind readers that this does not affect the efficiency of the set in any way whatsoever, nor does it make any difference to the number of stations receivable on the long waves. It is simply and solely a matter of calibration, and, with the optional re-calibrated long-wave section, the "Spot-On" dial can be used successfully with either make of coil.

"Is this correct: the S.G. to take nine milliamps?—I am using a Cossor S.G.220, same as you said in the 'P.W.' describing this set.

"First I tried a battery, but now it is on eliminator, and no real 'P.W.' punch on either. Do you think one of the valves might be faulty?"

Yes. There is something wrong with that S.G. valve, or else with the wiring or components joined to it, since nine milliamps is far too much H.T. current for this valve alone. (The S.G.220 is a valve that is very "light" on H.T.)

Get the valve tested after you have made sure that its wiring, etc., appears O.K.

(The quickest method is to borrow another S.G.220 and try it in place of the present one, just for a moment. If H.T. drops right down from nine to one or two milliamps, you can be sure that the trouble lies in your valve.)

(Continued on next page.)

## RADIOTORIAL QUESTIONS & ANSWERS

(Continued from previous page.)

### THE WRONG TAPPING ON THE MAINS TRANSFORMER.

L. S. C. (Croydon).—"We had the set in a fortnight ago, and it has been on every day since for not less than five hours. One day it was going practically all day.

"Results were more than satisfactory, and it was only by chance, therefore, that I found that the mains plug at back of set was in the wrong socket. It has been working all that time on 220 instead of 240!

"I need hardly say that I changed it over at once and switched on again to see if any damage had been done. Apparently it makes not the slightest difference, because none of us can tell the slightest difference in the set now and when it was on 220.

"Is it likely to have hurt something inside which will 'play up' later on? And if so can I do anything about it?"

You were fortunate in soon discovering the wrong connection, since its effect on the valves would have been more pronounced if they had been subjected to the wrong voltage for a very long time.

And it was also lucky for you that there was not a very big difference in the voltage of the mains and the voltage to which the set was adjusted.

Probably you will never notice any trouble arising from the incident, though it might have had a serious effect in time. There is nothing that can be done now, anyhow, except to thank your lucky stars that it was not a serious discrepancy nor a long period.

### ANOTHER WIRING ALTERATION WHICH CALLS FOR RETRIMMING.

S. M. M. (Dundee).—"It was a surprise to me to read how little alterations in the wiring can upset trimming. And I found that there was an unsuspected instance in my own set.

"At my pal's suggestion I had used a short length of metallised screening lead between the S.G. and detector, and I did not think that the change to this from ordinary sleeved wire would make any difference. But when I tried retrimming, there was no doubt that a new adjustment was necessary.

"As valves were the same and everything else unaltered, I suppose this was the cause, although the wire in question was less than three inches long."

There would certainly be enough capacity to upset trimming in a wire of this length if it were in a critical part of the circuit.

And much shorter wires have been known to cause a similar effect, though in these instances part of the trouble may have been due to the accidental shifting of other leads, etc., when the alterations in wiring were carried out.

It is a good plan to check trimming after any alteration to the associated circuits.

### THE CAUSE OF DISTORTION.

E. L. (Bognor Regis).—"The circuit is S.G., detector of anode-bend type, followed by resistance and transformer-coupled L.F. stages. And the trouble is a terrible rattle.

"The loudspeaker seems to vibrate on certain passages of music, until you cannot bear to be in the room.

"The reaction causes awful distortion on turning it up a bit, so I have to keep it always off.

"I thought perhaps decoupling would help, but a rough hook-up which a friend tried out for me with resistances and condensers that he brought round seemed to make no difference.

"I see you advised trying batteries instead of mains unit, if possible, to see if the mains supply is causing the trouble, but £ s. d. makes that out of the question at the moment.

"I do not think it is the valves, as I have had the S.G.220 and the 1 H.L. tested, and I have tried two detectors with no difference in results. (At present there is a 2 D.X. in the detector socket.)

"What do you think might cause the

trouble? It cannot be the loudspeaker, as I have tried another. Just the same."

One likely cause of such trouble is the use of an unsuitable mains unit. If yours was not intended to give enough H.T. for a 4-valve set the effect might be very much as you describe.

To check this, add up the total H.T. consumptions of your valves, as stated by the manufacturers on their leaflets, and see how that total compares with the rated output of your mains unit.

If the latter is, say, 15 milliamperes, and the current consumption of the valves is well in excess of that figure, you will need a "bigger" mains unit, i.e. one capable of supplying the needs of the set without overloading.

Another possible cause of such symptoms is a faulty valve or component—the output valve, for example, could cause the trouble you describe. To get distortionless reception it must be of suitable type and in good condition, so you had better check up on that as well.

But first of all make sure that your mains unit is not hopelessly overloaded. For if you are trying to take twice as much smoothed current from it as it was intended to supply, nothing you can do to the set will be of any use.

### FAILURE ON LONG WAVES AND TOP OF MEDIUM WAVEBAND.

W. B. (Chatham).—"With reference to the letter of D. C. C., Lincoln (in 'P.W.' No. 651), and his trouble with the 'Double X 3,' I am in just the opposite position.

"I get fairly good results on two valves on medium waves up to and including London Regional. Above there I can get nothing but on long waves. I can only hear National very softly with reaction full on, and all other stations I cannot hear at all on long waves.

"When I put my third valve in action the set will bring in some stations louder than two valves, and yet with others—for instance, London Regional—it gives no more volume than on two valves.

"On long-wave National I have to put reaction up to oscillation pitch before I get any strength through loudspeaker. When

(Continued on next page.)



# The Reason's Why!

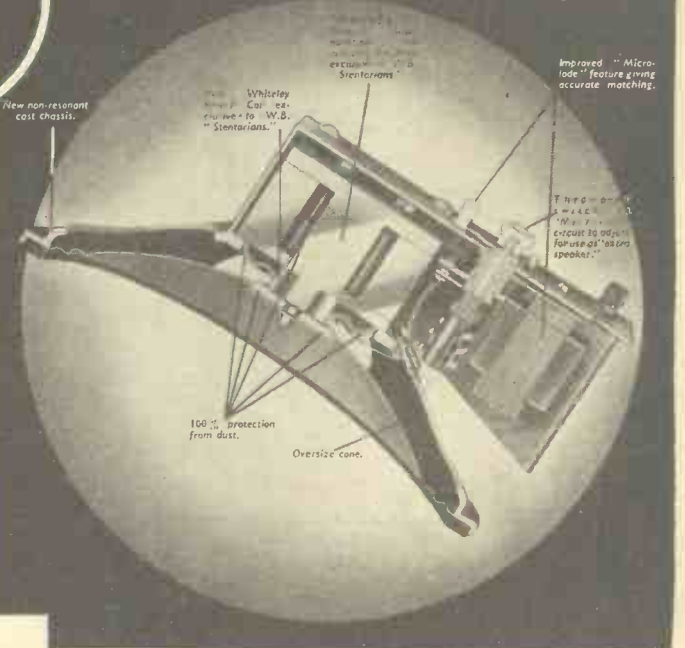

The extraordinary performance of these new moving-coil speakers is now universally acknowledged. Nearly every leading technician has paid his enthusiastic tribute to the remarkable results obtained. Every leading wireless journal has expressed its wholehearted approval of the new design, and specified a W.B. "Stentorian" as **exclusive or first choice for every important "constructor" receiver published.**

The illustration shows some of the unique features which bring this revolutionary performance.

**Test a W.B. "Stentorian" on your set. Listen to the greatly increased volume, clearer definition, and new vivid "realism." You will be amazed at the improvement it's unique features bring for such a modest outlay.**

# STENTORIAN

PERMANENT MAGNET MOVING-COIL SPEAKERS

- Stentorian Senior (PMS1) as illustrated - 42/- (100 per cent. dust protection. Oversize cone.)
- Stentorian Standard (PMS2) - 32/6
- Stentorian Baby (PMS6) - 22/6

Whiteley Electrical Mansfield, Notts.

Radio Co., Ltd. (Dept. P), Radio Works, Sole Agents in Scotland: Radiovision Ltd., 233, St. Vincent Street, Glasgow, C.2  
Sole Agents in I.F.S.: Kelly and Shiel, Ltd., 47, Fleet Street, Dublin

# Let Us Send You This 28-Page Booklet—Free



It gives all particulars of various Courses that cover every phase of Radio work.

The Radio Industry is progressing with amazing rapidity. Only by knowing thoroughly the basic principles can pace be kept with it. I.C.S. Instruction includes American broadcasting as well as British wireless practice. It is a modern education, covering every department of the industry.

### OUR COURSES

Included in the I.C.S. range are Courses dealing with the installing of radio sets and, in particular, with their Servicing, which to-day intimately concerns every wireless dealer and his employees. The Operating Course is vital to mastery of operating and transmitting.

There is also a Course for the Wireless Salesman. This, in addition to inculcating the art of salesmanship, provides that knowledge which enables the salesman to hold his own with the most technical of his customers.

Then there are Preparatory Courses for the City and Guilds and I.W.T. Exams.

We will be pleased to send you details and free advice on any or all of these Courses. Just fill in and post the coupon, or write in any other way.

International Correspondence Schools, Ltd.,  
Dept. 161, International Buildings,  
Kingsway, London, W.C.2

Without cost, or obligation, please send me your Radio booklet of information about the Courses I have marked X

- COMPLETE RADIO
- RADIO SERVICING
- RADIO EQUIPMENT
- RADIO SERVICING AND SALESMANSHIP
- WIRELESS ENGINEERING
- WIRELESS OPERATORS
- EXAMINATION (State which)

Name ..... Age .....

Address .....

## RADIOTORIAL QUESTIONS & ANSWERS

(Continued from previous page.)

putting my last new high-tension battery on I got motor-boating every now and again.

"That has stopped, and the set now wants to fade away at times and comes back after two or three minutes at full strength.

"I had a two-valve receiver before I built 'Double X 3,' but got more stations on both wavelengths with it. I am using all new parts in new set, and have had valves, coils, L.F. transformer, H.F. choke and reaction condenser tested, and was present while the same was done, and still I cannot get set up to perfection.

"Would I have to carry out the test as D. C. C., Lincoln, or can you give me any idea of where the fault lies?"

"Two or three of my pals have remarked on the fine layout of set, and I should like to get up to the top-half position with it.

"P.S.—Valves in use: Mullard P.M.1H.L., P.M.2A., Cossor S.G.220."

Although you have had the coils, etc., tested, we think you are still using a faulty part.

Your best plan is to concentrate on it as a two-valver first, until you discover why it fails to receive over the whole medium waveband. If you follow the advice given to D. C. C. in this connection you should get perfect medium-waveband results, and then you can extend your investigations to the long waves and other valve.

But get it right on two valves first, until it is at least as good thus as your previous two-valver. Providing your H.T. is up to normal, we still suspect the coil, screened H.F. choke, grid leak or grid condenser as the likeliest causes.

When O.K. on medium, make sure that the wave-change switch is in good order, and that will give you good 2-valve reception of long waves also.

When you are quite satisfied with it as a "2," on both wavebands, revert to the proper connections and try it as the 3-valver again.

While you are about it, check over once more the wiring, correct earthing to metal baseboard, etc., since, if anything is touching the metal which is not supposed to do so, the results will be thrown right out.

If you have any doubts, slip pieces of cardboard under the coil units, valve holders, etc., to keep them from accidental contacts with the baseboard.

Finally, don't give up or be satisfied with less than perfection. Your valve team is O.K., and if you have the right components, fault-free and connected properly, the set is certain to give you really first-class results on both wavebands.

### A USEFUL REACTION DODGE.

The following letter is self-explanatory, and since it contains a hint that may be useful to other readers who use plug-in short-wave coils, we give this extract just as received from a Middlesex correspondent.

"You will be glad to know that the short-waver is now going fine, using the original six-turn coil, which was formerly too big.

"Acting on your suggestion of reducing the number of turns, and remembering a hint I had seen in an old 'P.W.,' I soldered a couple of my old crocodile clips on to the ends of a piece of good, heavy flex, as short as I could get it conveniently. (Not more than an inch.)

"With this clipped on one of the reaction coil's outer turns at one end, I bridged the flex across to an adjoining turn, varying the position until I seemed to be getting the correct strength of reaction feed-back.

"It made just the necessary improvement I I had been looking for, and it is so quiet in action, just clipped on, that I am leaving it like that and not attempting to make a permanent joint of it.

"It is a pity that more short-wave fans do not know that just by this simple alteration you can turn a six-turn coil into a five or a four, or even get fractions of a turn, like I am at the moment, when the clip is arranged to cut out a about one turn and two-thirds."

## B.T.S. COMPONENTS

Details of an inexpensive dual-range coil and a neat H.F. choke.

THOSE constructors who are desirous of building inexpensive sets capable of coping adequately with modern reception conditions should be very interested in a new dual-range coil produced by British Television Supplies.

It is called the B.T.S. Droitwich Band Control and it retails at the low price of 3s. 6d. It is complete with feet for baseboard mounting and with terminals, so that it can be wired up without soldering.

The coil embodies a small condenser which figures in a novel and effective scheme. The purpose of the coil unit is to ensure the reception of Droitwich and other long-wave stations at good efficiency and without such troubles as are frequently encountered when the two broadcasting wavebands are being handled.



This B.T.S. H.F. choke is built into a nicely moulded bakelite casing and gives very satisfactory results.

The fixed condenser, which you will remember we indicated was integral with the construction of the unit, acts as an aerial coupling condenser for the medium waves, but, owing to its relatively small capacity, it becomes something of an opposition to the long waves.

But there is a separate aerial winding for the long waves, and this automatically comes into use, without switching, when such stations as Droitwich are being tuned in.

In this way a constant and efficient reception of the long waves is ensured. It is a neat and ingenious scheme which will commend itself to all constructors who can appreciate a break-away



An inexpensive dual-range coil made by B.T.S. which incorporates a novel aerial coupling system.

from the conventional with the end of better reception in view.

Another attractive B.T.S. component is their H.F. choke. This is a particularly neat little article. It is built into a nicely moulded bakelite casing.

Small dimensions in H.F. chokes are not always obtained without a sacrifice of effectiveness, but in the case of the B.T.S. one of a most acceptable order of efficiency has been obtained.

## CONDUCTING ELECTRICITY

(Continued from page 596.)

traverses the whole of the circuit. It may, in fact, only travel a very short distance. What happens is that atom number one, under the driving influence of the potential, is shorn of an electron. It immediately robs atom number two of an electron. Atom number two appropriates an electron from atom number three, and so the merry process of atom exchange goes on through the circuit.

### Fixed Electrons.

Now, when you think about the matter it becomes perfectly obvious that this sort of thing can only take place within an assembly of atoms a proportion of whose electrons are merely loosely held. If all the atoms possess completely fixed electrons, then this electron interchange cannot take place at all. Such a body is, therefore, an insulator.

As a matter of fact, however, no perfect insulator exists. You can always get a sufficiently high electrical potential to cause at least a very slight activity of this sort even in the most perfect of insulators.

A perfect conductor is a body in which the swapping over of electrons which I have just described takes place completely and with perfect freedom. And, like the perfect insulator, a perfect conductor is purely an imaginary entity. It does not exist in practical realms.

The electron stream consequent upon the electron interchange between atom and atom along the length of the conductor never flows without friction. Some atoms part with their loosely held electrons less readily than do others. Then, again, the physical constitution of the wire may hinder the electron stream. If the conductor is crystalline it will not be a very good conductor, because the trillions of crystal faces within it combine to inhibit the electron flow. The less crystalline, therefore, the make-up of the conductor the more easily the current flows.

Again, for a given potential the electron stream proceeds much more easily in a thick wire than it does in a thin wire.

### The Effect of Resistance.

Thus the individual electrons have always to fight their way in their short journeys between atom and atom. The path available for them is never a perfectly free one. The electrons invariably lose some of their initial energy of motion in forcing their way between atom and atom.

As we all know, however, energy is never lost. It is merely changed. And the dissipated energy of motion of the electrons appears in the form of heat.

The greater the resistance of the conductor the greater the amount of heat which is produced in it by the current. Indeed, the amount of heat generated in a circuit by the passage of a current through it is the exact counterpart of the energy which is lost by the electrons as they are interchanged between atom and atom along the circuit.

Such is the sort of thing which happens in a conductor when a current flows along it. There are all sorts of further details which we should like to know about this most

remarkable process, but, as yet, physical science has not been able to give any better picture of electrical conduction than the one which I have endeavoured to crowd into these few columns.

It is a most wonderful affair, electrical conduction. Personally, I find it at least equally as wonderful, if not, perhaps, even more wonderful, to contemplate than I do the passage of wireless waves through Space; and in this assertion I know that I am by no means alone.

## RADIO DURING THE GREAT WAR

(Continued from page 595.)

When attacked or when in adversity their distress signals of K.R. were in many instances transmitted in a condition of agitation which was easily discernible.

The last wails of several of these airships on being destroyed, and as their wireless transmitters gradually failed, were, even in the circumstances, pathetic to hear, and emphatically brought home to all hearing them the deplorability of war.

Another most important period for the staffs of these stations was when all enemy craft changed their call signs. In a very short time, however, each ship, air vessel or submarine was recognised by a peculiarity in the note of its transmitter or by a characteristic dash in the sending of its operator. An extra long dash or a clipped dot accounted for the detection of many craft which might have gone unrecognised for a long time, and caused considerable anxiety to the authorities.

It will be appreciated that the quick detection of craft after a complete change of call sign was largely due to the skill of the British wireless operators.

### A Far-Reaching Development.

One of the most far-reaching developments in the design of receiving apparatus was the introduction of the multi-valve shielded receivers known as the "55" series.

In these receivers six high-frequency stages were usually employed, but the "joy-stick" method of simultaneous tuning was dispensed with. The receivers were so designed that each of the series was effective over a wavelength band of several hundred metres, with high magnification, and no other tuning other than the aerial tuning condenser was necessary.

These receivers practically revolutionised the ease of manipulation and degree of certainty of direction-finding apparatus, and enabled quick searching to be carried out simultaneously with direction finding. It also added a large measure of simplicity and efficiency to interception work.

The "55" series was well known after the war and enjoyed great popularity in all branches of receiving work.

The good work carried out by the shore wireless stations has been mentioned in several books, but it is rather doubtful if it is generally known to what extent they assisted in the conduct of certain phases of the war.

Now that the science of radio is so popularly understood, it needs no great stretch of the imagination to realise what its importance will be in any future conflict on a large scale.

# PETO-SCOTT AFTER XMAS BARGAINS

FOR 5/- GIVE YOUR BATTERY SET SEVEN TIMES THE VOLUME 1935 CLASS "B" SPEAKER AMPLIFIER

WITHOUT CLASS "B" AMPLIFICATION YOUR PRESENT BATTERY SET IS OBSOLETE. This marvellous self-contained Unit comprises guaranteed 1935 Peto-Scott Class B Moving-Coil Speaker, Class B Transformer and B.V.A. Class B Valve. Gives 7 times the Volume... with mains quality and power. Low H.T. consumption. Connected to your set in a moment. JUST PLUG IN the amazing 5-WAY Automatic Connector. COMPLETE KIT of parts for instant assembly. Cash or C.O.D. Carriage Paid, 39/6. or yours for 5/- and 8 monthly payments of 5/-. COMPLETELY ASSEMBLED, ready to plug into your set. Cash or C.O.D. Carriage Paid, 45/-. or 5/- deposit and 9 monthly payments of 5/-.



## PETO-SCOTT 75/- DISC TELEVISION KIT

Designed to work from any 3-valve battery or mains set. Complete Kit comprises Peto-Scott Universal Television Motor and stand; controlling resistances; laminated and ready assembled chassis; Stroboscopic 16-in. scanning disc; lens and lens-holder; Neon Lamp and holder; together with sundry small parts. It is absolutely complete down to the last screw and piece of wire. Full-size Blueprint with assembly, wiring and operating instructions included with every Kit. Cash or C.O.D. Carriage Paid, 75/-.

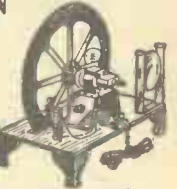

10/- DOWN

and 11 monthly payments of 6/6.

## PETO-SCOTT 1935 WALNUT ADAPTACRAM

CONVERTS YOUR SET TO A MAGNIFICENT RADIOGRAM. Hand French polished. Chromium fret surround. All joints mortised and tenoned. Ready to take your set, speaker, power equipment and your own gram fittings. With ready-fitted motor board. Plain front or vignettted to take any panel up to 18 in. by 8 in. or specially drilled to your own dimensioned sketch at slight extra cost. Oak or Mahogany, 10/- extra. Cash or C.O.D. 47/6 Carr. and Part Packing 2/6 extra. and 11 monthly payments of 5/6.



Overall Dimensions: 38 in. high by 22 in. by 17 in. deep.

7/6 DOWN

Plain Front, as illustrated, 47/6. Vignettted or drilled to customer's specification, 2/6 extra.

## MAKE YOUR SET an ALL-WAVE SET!

B.T.S. 1935 SHORT-WAVE ADAPTOR Simply plugs into your present battery or A.C. Mains set and gives world-wide reception. The only adaptor at the price incorporating 100-1 ratio aerial tuning and slow-motion reaction; for use either as Plug-in or Super-net Short-wave Adaptor; Air Dielectric Reaction and Tuning Condensers; Walnut Grained Bakelite Panel; Polished Cabinet. Send for fully descriptive leaflet.



52/6 With 2 plug-in coils, 13-26 and 24-52 metres. Extra coils, 46-96 and 90-260 metres, 4/6 each.

YOURS FOR 7/6 and 10 monthly payments of 5/-.

## PETO-SCOTT CO. LTD.

77, F.W.3, CITY ROAD, LONDON, E.C.1. Telephone: Clerkenwell 9406/7. West End Showrooms: 62, High Holborn, London, W.C.1. EST 1919.



G.E.C. 4-Valve A.C. Receiver in Pedestal Cabinet, ready to work. A Great Bargain. List price 18 Gns. Our price £8 19s. 6d.

ATLAS P.M. Speakers. One of the finest Moving Coils made. Complete with transformer. Suitable for Pentode or Power Valve. List price 42/6. Our price 14/11.

MARCONI 2-Valve Battery Receiver, complete with Valves and all Batteries. Self-contained Cabinet. List price 4 Guineas. Our price £2 2s. 6d.

TELSEN Matched Screened Coils, suitable for use as Aerial or Anode Coils. Can be embodied in any Circuit. List price 7/-. Our price 4/11.

SET of Telsen Band-pass Screened Oscillator Coil Units, comprising Band-pass Coils and Oscillator Coil. Complete with Wave-change Switch for Single-knob Control. List price 21/6. Our price 8/11 per Set.

TELSEN Radio-Grand Transformers, 3-1 ratio only. List price 7/6. Our price 4/3.

TELSEN Arc Transformers, 3-1 and 5-1. List price 5/6 each. Our price 3/9 each.

TELSEN—MORE COMPONENTS:

L.F. Coupling Units (4/6). L.F. Smoothing Chokes (3/11). Tapped Pentode Output Chokes (3/6). Class "B" Output Transformers (4/3). 313 Disc Drive (2/3). Air Dielectric .0005 Condensers (1/11). Bakelite Dielectric Tuning Condensers, .0003 ONLY (1/-). Short-wave H.F. Chokes (1/9). Binocular H.F. Chokes (3/6), etc., etc.

MOONBEAM 4-Valve A.C./D.C. 7-Stage Superhet. A beautiful 1935 model. List price 10 Gns. Our price £7 12s. 6d.

EKCO A.C. 74, a seven-stage Superhet, Delayed A.V.C., full-vision shadow tuning, Band-pass, and Moving Coil. List price 13 Guineas.

WE ALLOW £4 on your old set, no matter what it is.

THIS leaves a cash price of only  
£9 - 13 - 0

GUARANTEED BRAND NEW IN ORIGINAL SEALED MAKER'S CARTON.

TELSEN Band-pass Coil Unit, comprising pair of accurately matched Screened Band-pass Coils, complete with Wave-change Switch, Escutcheon and Knobs. List price 14/6. Our price 8/11 per Set.

TELSEN Set of Triple Matched Screened Coils, suitable for Aerial and 2 H.F. Stages; or can be embodied in practically every modern circuit. List price 21/6. Our price 12/11 per Set.

TERMS—Cash with Order or C.O.D.

All Goods Carriage Paid. Everything guaranteed O.K. Money refunded if not satisfactory. Please mention this paper when replying. Write for illustrated lists, post free.



MAIL ORDER DEPT.,

49a, SHUDEHILL, MANCHESTER.

MIDLAND DEPOT:

29, MARTINEAU ST., BIRMINGHAM.

BRANCHES: ALL PRINCIPAL TOWNS.

Add 50/- WEEKLY  
to your earnings

by charging accumulators  
in your spare time.

Complete plant for A.C. mains incorporating Westinghouse Rectifiers to charge 105 L.P. cells weekly. Trade price £4 4s., or 8s. monthly. Send for descriptive Booklet

M.P.R. Ltd ROMFORD, Essex.



PLEASE be sure to mention  
"POPULAR WIRELESS"  
when communicating with  
Advertisers. THANKS!

## INEXPENSIVE BRITISH VALVES

Some "362" Types that we recommend to Home Constructors.

NO matter whether you are a 2-, 4- or 6-volt battery-set user, or if you favour the A.C. or D.C. mains, you will find a range of "362" valves ready for you. The "362" catalogue is the only one we know that gives a complete list of 6- and 4-volters—including S.G. and pentode output valves.

The prices of "362" valves are astoundingly low, the 2-volt detector costing only 3s. 6d. and the L.P.2, L.P.4 and L.P.6 4s. And so we go on, a few pence at a time, to "larger" valves. One thousand milliwatt pentodes cost only 10s. in the battery range, while in the A.C. list we find 3-watt pentodes for 13s.

Particularly high mutual conductances are obtained in the battery valves as well as in the mains ranges. The L.P.2—a "small" output valve, giving 500 milliwatts—has a slope of 3 milliamps per volt, with an impedance of 5,000 ohms. Its mains triode output valve is the A.C.PX4, which has a slope of 4 milliamps per volt, giving an output wattage of 2.5 and having an impedance of 2,000 ohms. A very nice valve, that!

Rectifiers, too, are among the mains valves in the latest "362" catalogue, at prices of 7s. 6d. and 10s. for the 300-0-300 and 500-0-500 valves. The outputs are 50 and 100 milliamps respectively, and the valves are known as the RB41 and RB42.

We have been able to try many of these valves during recent tests and we have obtained very good results from the samples sent to us by the manufacturers.

All the valves are made in London, and particular care is taken that they shall all pass strict tests as to characteristics before they are allowed on the market. The "362" Radio Valve Co. and its associated Companies were established in 1923, and ever since have been manufacturing valves under contract to set manufacturers. As the company remarks in its most helpful book, "You have probably used and may still be using, "362" under another name."

## THOSE SHORT PLAYS

(Continued from page 586.)

commend it. But there is a danger when the expert is a poor broadcaster. The two ladies who gave their impressions of the Christmas shopping couldn't conceal their nervousness over the new experience. Tom, Dick and Harry are the last word in those matters which concern Tom, Dick and Harry, but if they can't broadcast their knowledge with ordinary ease, then the mike is no place for them.

The Saturday evening résumé of Soccer results strikes me as being as ludicrous as it is unnecessary. To make a long story out of Sunderland going to Portsmouth and bagging a couple of points, thus depriving the Arsenal (despite an 8-nil victory over Leicester) of the leadership of the League, was really comic. If this story was meant for the edification of Soccer fans I might point out that the said Soccer fans summed up the situation immediately the results of the two matches were announced at 6.15 p.m.

C. B.

## RANDOM TECHNICALITIES

Jottings of Interest to All

By Dr. J. H. T. ROBERTS, F.Inst.P.

### Distortion Due to Coupling.

I said something the other day about the distortion which you get in a set when the high-tension battery is getting a bit ancient and is developing the complaint "internal resistance," this forming a coupling between the different valve circuits. But you sometimes get distortion even if the H.T. battery is quite all right, and in such a case the best thing to do is to increase any decoupling arrangements which are already present in the set. This can be done by increasing the capacity of the decoupling condensers—for example, if you are using a 2-microfarad condenser you might add another 2-microfarad condenser in parallel with it or use a 4-microfarad condenser instead.

### Grid Bias in an All-Mains Set.

With an all-mains set a common method of obtaining grid bias is to make use of the voltage drop across a resistance and in these cases it is sometimes necessary to decouple the associated grid circuits. The usual method is by means of a resistance and condenser, the condenser being connected between the cathode of the valve and the end of the transformer secondary remote from the grid, whilst the resistance is connected between the transformer end of the above-mentioned condenser and earth. In some sets only a condenser is used, and if this is the case it is often an advantage to include the resistance which I have just mentioned, in place of a direct connection between the end of the transformer secondary remote from the grid and earth.

### Faulty Valve Grid Circuit.

We are all familiar with mains hum in our all-electric receivers, although this is not nearly so bad these days as it was when mains sets were a novelty. But you may not perhaps know that you sometimes get a very similar type of noise interference, due to a faulty valve grid circuit. Trouble will almost certainly be caused when there are unnecessarily long leads running into places where they can pick up hum from the mains leads or from any part that is carrying the A.C. voltage. Pick-up leads are a very likely source of trouble, especially when these have to be of some considerable length, as occasionally happens. They should be thoroughly shielded, and the best way is to use metal-braided wire for the leads. The braiding should be connected to earth, though sometimes it is quite sufficient as it is.

### Shielded Leads.

But if this does not cure the interference, then the shielding will certainly have to be earthed. You may find although the earthing gives you reliable shielding, it reduces high notes if the leads are really very long, but it is a bad design if the connections are so long that earthing causes loss through capacity.

You may get crackling and "frying" noises also in a mains set, sometimes very

(Continued on next page.)



## RANDOM TECHNICALITIES

(Continued from previous page.)

difficult to eradicate. The first thing to do is to ascertain whether they are being brought in on the aerial or earth or whether they are being generated within the set itself. You can tell a good deal by the very simple process of disconnecting first the aerial—and see what difference that makes—and then the earth—and see what difference that makes. If disconnecting the aerial reduces or stops the noises it shows that the aerial is picking them up from somewhere and bringing them into the set.

### Atmospherics or Man-made Static.

They may be atmospherics, which are very difficult to get rid of. Or the aerial may be picking something up from adjacent electric mains or electric machinery and so on. A very curious point is that you sometimes (though not often) find interference coming in on the earth lead. This I have already regarded as very remarkable, and, in fact, I feel sure that where it does occur it is due to—or rather is made possible by—some fault or inefficiency in the earth or earth lead. After all, we rely upon the "earth" as the ultimate stabilising element in the whole business, and if it starts to play us tricks, where are we? These are cases where interference can come in on the earth, but they are very exceptional, and generally, when this appears to be the cause, the real cause is that the "earth" is not properly earthed.

### Clarifying the Reproduction.

Have you ever noticed that if the loudness of reproduction from a speaker is greatly increased there appears to be a preponderance of bass? I don't know whether it is so actually, but it certainly seems that when the volume is greatly increased the bass is increased more than the other part and so seems to become unduly prominent. Conversely, if the volume is reduced, it often seems to have the effect of clarifying the reproduction. As I say, it is very difficult to determine whether this effect is physical or psychological—probably a bit of both.

At any rate, various devices have been brought forward from time to time for the purpose of enabling the volume to be put up without this corresponding "woolliness"—like the bark of a sea lion, or like a person talking with food in his mouth.

### Short-wave Receivers.

Interest in short-wave reception increases year by year, and with it we have more and more devices, such as special coils, to enable receivers to be tuned over a wider range. Broadcasting, in fact, quite apart from special and amateur transmissions, may be said to have extended much beyond what was once known as the "broadcast waveband."

The range from 500 to 1,000 metres includes a great many interesting European stations, not to mention airport and aircraft transmissions, and yet this is a range which quite a large percentage of receiving sets cannot get. Again, below 200 metres there are scores of transmissions worth having,

but which most receiving sets cannot tune in.

### Multi-range Coils.

These limitations are now to a large extent being got over since the introduction of multi-range coils, of which there are several types on the market, and there is no reason why most, if not all, receiving sets should not be considerably extended in tuning range by the aid of these coils.

The Lissen four-range coil is one that may be mentioned; in addition to the usual medium and long waves, it gives you a short-wave range from 100 metres down to nearly 10 metres. Another well-known tuner goes from 1½ metres to 550, and then from 1,000 to 2,000, which gives you pretty well everything that's going.

There are also now a number of combined coil-and-condenser units, which are extremely handy for the constructor, whilst one unit includes not only coils and condenser (triple-gang), but also switching for mains, radiogram and wavechange, and grid condenser and leak, all ready connected up. In fact, with so much done for him, it becomes a question of what there is left for the constructor to construct!

### Some Pick-up Points.

When using a gramophone pick-up with a radio circuit, the pick-up is often connected to the detector, which then becomes the first low-frequency amplifier.

Lots of people use this arrangement, but many do not bear in mind that the high-tension voltage applied to this valve should be increased when it is used as a low-frequency amplifier, as compared with that used when it was working as a detector. As a detector it probably has a fairly low H.T. voltage, in order to obtain smooth reaction, but as a first L.F. amplifier for the pick-up it should have a much increased H.T. voltage applied to its anode, and it is important also that it should have 1½ or 3-volts grid bias. Don't forget that when the pick-up is introduced the valve has ceased to be a detector and is a straight-forward low-frequency valve.

Another point which you should remember is that, in a battery set, switching should be provided so that the high-frequency valves of the radio set are not "on" when the pick-up is in use.

### Carrier-waves.

In the early days of broadcasting we used to talk quite a lot about the "carrier-wave" and the "modulation." For some reason, in these days we very seldom mention the carrier-wave, so that when people hear about it they are not always sure what it refers to.

### Constant Frequency.

I have many times been asked by readers what the carrier-wave is supposed to be. Well, it is simply the train of waves sent out by the transmitting station which is received by the high-frequency part of the set; the frequency of these waves is the so-called H.F. and is (or should be) extremely constant. Great precautions are taken by broadcasting stations nowadays to keep the frequency of their carrier-waves as constant as possible because, as you will see, since they are now working so close together in wavelength, any appreciable "wandering" of the frequency will cause

(Continued on next page.)



No need to close the prongs with pliers, no need to open them with a penknife. Clix are the only "Master" plugs which are non-collapsible and make perfect and permanent contact with any battery socket. No amount of vibration will move Clix plugs.

Change over to Clix now and forget faulty contacts.

Clix "Master" Plugs for H.T. and G.B. are supplied in Red and Black 1d. engraved, or 8 assorted colours. each.

There is a "Master Plug" available for every radio and electrical purpose.  
**LECTRO LINX LTD.,**  
 79a, Rochester Row,  
 London, S.W.1.

## What Station is that? Where are my Radio Papers?

These questions are solved with the

### RAYDOLOG

A unique folder for your radio papers. The relative strength of stations is given graphically and is readily noted and helpful for spotting stations.

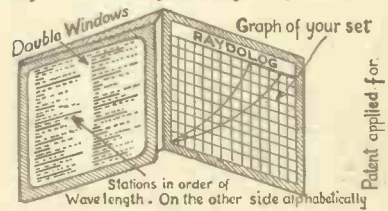

In maroon and gold. Price 2/9 post free or payment to postman 3/- from

**ALBUM SUPPLY CO.,**  
 20, Cranworth St., Hillhead, Glasgow.

PLEASE be sure to mention "POPULAR WIRELESS" when communicating with Advertisers. THANKS!

All applications for Advertising Space in POPULAR WIRELESS should be addressed to the Advertising Department, John Carpenter House, John Carpenter Street, London, E.C.4.

## RANDOM TECHNICALITIES

(Continued from previous page.)

heterodyning with one another and all sorts of troubles.

The high-frequency waves, as already mentioned, are handled by the H.F. part of the set and are there uplifted, prior to being passed through the detector. Having passed through the detector and been rectified, the waves are then dealt with by the rest of the circuit which may be said to concern itself with the modulation or special wave shapes impressed upon the carrier-wave by the microphone circuit at the transmitting end.

### Loud Loudspeakers.

I don't know whether you've noticed, but manufacturers seem to be competing with one another these days in the matter of the watts output of their sets. A few sets have been advertised to give an output of as much as 10 watts or so.

Now, to my mind this is far too much. When you remember that only half a watt of undistorted output is quite amply sufficient for all ordinary needs, you realise what 10 watts mean.

### Quality and Quantity.

Personally, I am all against these high-powered noisy loudspeakers, and I think they are apt to do far more harm than good. What is wanted is not quantity, but quality. And even if this super-powered reproduction were of good quality (which it sometimes is not) I should still be of opinion that it was very undesirable. The craze for louder and louder reproduction is apt to grow on people and become a vice. I think it is very important not to let this vice get a hold of you, and this can best be done by concentrating on maximum peak volumes of about 3 watts and high quality. And there would be less enmity between neighbours!

## NEXT WEEK

### EXPLORING THE WORLD ON SHORT WAVES.

SPECIAL ARTICLES

BY

G. T. KELSEY  
AND W. L. S.

DON'T MISS THIS PARTICULARLY INTERESTING NUMBER OF

"POPULAR WIRELESS."

On Sale Jan. 9th.

Price 3d.

### Terminals that "Keep on Turning."

One of the worst features of some terminals provided on components is that in five cases out of ten they are not properly secured into the bakelite, or whatever it is, with the result that when you come to tighten them up they rotate completely. This is very aggravating, because it makes it quite impossible to secure the wire to the terminal, but it is even more serious than that, because the wire lead which runs to the back of the terminal is almost certain to get broken if the terminal is loose.

## PREPAID MISCELLANEOUS ADVERTISEMENTS

3d. per Word

6d. per word for first words in heavy type

Minimum Charge 3/-

Remittance must accompany order.

Advertisements for these columns are accepted up to first post WEDNESDAY MORNING for following week's issue.

Radio components and accessories advertised in these columns at below list price do not carry manufacturers' guarantee.

The Proprietors have the right to refuse or withdraw advertisements at their discretion.

Postal orders, in payment for advertisements, should be made payable to the Amalgamated Press, Ltd., and crossed.

All communications should be addressed to:—Advertisement Department, "Popular Wireless," John Carpenter House, John Carpenter Street, London, E.C.4.

**PEARL & PEARL**, 190, Bishopsgate, London, E.C.2. All the following bargains guaranteed new goods. Cash or C.O.D. Carriage Paid.

**ELIMINATORS.** Special purchase of large quantity of Lincoln-Stewart Eliminators enables us to offer them at sacrifice prices. All models O.K. for 200-250 v. D.C. 25 milliamp output, 9/11; A.C. 30 milliamp output with Westinghouse Rectifier, etc., 24/11, or with half amp. Trickle Charger incorporated, price only 37/6. All fully guaranteed.

**MICROPHONES.** Super-sensitive mikes, complete on base with built-in transformer. Full instructions included. Our price 6/11.

**LISSEN L.N.5181** 3-ganged superhet coil units for A.C. or battery sets; with circuits and diagrams. Over 1,250 already sold to "P.W." readers. List price 30/-, now offered at special price, 6/6 only.

**LUCERNE COILS.** New Lucerne Dual-range Coils, 1/8 each. Screened iron-cored dual coils with circuits, 1/11 each.

**SPEAKERS.** Lumophon Permanent-Magnet Moving-Coil Speakers (8-inch cone), with universal transformer. Suit all receivers. List 32/6; our price 14/11.

**Lissen Cone Speakers**, complete, 5/11. Triotron 4-pole balanced armature speaker Units, type "B"; sensitive, beautiful tone. List 22/6. Our price 6/11.

**ALL GUARANTEED NEW AND IN MAKERS' ORIGINAL CARTONS.**

**CABINETS.** 2,000 Cromwell Cabinets (for set and speaker combined) just secured on terms which enable us to offer them at the astoundingly low price of only 4/11 each. Horizontal type, 23 in. wide, 8 in. deep, 11½ in. high. Polished Walnut veneer, additional baffle behind speaker grille. Our price 4/11. Supplied for cash with order, Carriage forward.

**FREE.** Our latest, fully revised Bargain List P, now ready. Send P.C. for your copy.

All Mail Orders Direct to

**PEARL & PEARL,**

190, Bishopsgate, London, E.C.2.

Telephone: Bishopsgate, 1212.

**SPECIAL OFFER.** Super Performance. **PIANO ACCORDEONS**, 120 bass, 4 reeds. Unrivaled finish, finest materials only. 40/- deposit.—Write for Illus. lists, **HESSYS Ltd.**, Manchester Street, Liverpool.

**WANTED FOR CASH.** Second-hand Wireless Parts, Sets, etc. Bring or send.—University Radio, 142, Drummond St., London, N.W.1. Nr. Euston Station (L.M.S.). Phone: MUSEum 3810.

**PLEASE BE SURE** to mention **POPULAR WIRELESS** when replying to advertisers.

**VAUXHALL.**—Radiophone Radiopack R.F. Superhet 535c. 110 or 117 kc., complete with volume control escutcheon plate, etc., and Station-named scale, 34/- I.F. Transformers to suit the above Pack, complete with terminals on bases, 4/6 each. Radiophone Midget Superhet or Straight Condensers, 10/- each.

**VAUXHALL.**—Magnavox permanent magnets, universal, suitable for Class B, power or pentode, 7-in. cone, 16/6; 10-in. cone, 23/-; mains energised, 2,500 or 6,500, 10-in. cone, 22/-; 7-in. cone, 15/3. Brand new, with humbucking coils; state power or pentode transformer.

**VAUXHALL.**—Benjamin Class B transformers, 1-1½ to 1, 6/6; Radiophone, Class B, 10/-; volume controls; Radiophone, with switch, 5,000 to 500,000, 3/6.

**VAUXHALL.**—Set Manufacturer's Surplus, Skeleton type Westinghouse rectifiers; H.T.8, 9/6; H.T.9, H.T.10, 10/-; Westectors, W.4, W.X.6, 5/9; mains transformers fitted with screened primary 300 + 300v., 60 m.a., 4v. 2.5 a., 4v. 4a., impregnated windings.

**VAUXHALL.**—Rothermel Piezo electric pickups, 30/-; B.T.H. Minor, 16/6; senior needle armature, 29/-; B.T.H. Truspeed gramophone motors, 30/-; Collaro 32 model, 32/6; complete unit A.C.200-250v. with first quality pickup and volume control in sealed cartons, 48/-.

**VAUXHALL.**—Dubilier condensers, 4 or 8 mfd., dry electrolytic, 500v. working, 3/-; 50 mfd., 50v. working, 1/9; tubular non-inductive, 0.1, 9d., 0.05 6d., 0.002, 0.0002, 0.001, 0.0001, 4d. each; T.C.C., mica, 0.002, 2,000-volt test, 10d.; Ormond, 0.0001, 4d.; 0.001, 0.01, 1/-; 1-mfd. Mansbridge, 1/3.

**VAUXHALL.**—3-gang condensers and set iron-cored cells, specially matched for S.G., det., pentode, complete with dial, drive, escutcheon, etc., 35/-; as above, suitable for band-pass or R.F. superhet, 37/6; gramophone switches, 3/6; Utility dials and drives, complete with escutcheon, black or brown, 5/-.

**VAUXHALL.**—Dubilier resistance, 1-watt type, 7d. each, all values; Clix valve holders, terminals, 7-pin, 9d.; 5-pin, 7d.; W.B. 5-pin; 4½d.; post paid, 2/6 or over, or C.O.D.

**VAUXHALL UTILITIES**, 163a, Strand, W.C.2; over Denby's the Booksellers. Temple Bar 9338. Send postcard for lists free.

### HULBERT, 6, CONDUIT STREET, W.1.

Read below:

If you are requiring realistic reproduction at remarkable low cost, send for one of the following high-grade speakers. Repeat orders are coming in daily.

**10/6 only.** Brand-new manufacturer's surplus moving-coil speakers, made by one of the best-known British makers. Energised, 2,000, 2,500, or 6,500 ohms field windings, power or pentode transformer, 8-in. cone, 10/6 each.

**12/6 only.** As above, but with 10-in. cone. A very powerful speaker capable of handling large outputs.

**15/6 only.** Brand-new manufacturer's surplus moving-coil speakers, made by one of the best-known British makers. Permanent-magnet model of high efficiency with power or pentode transformer, 8-in. cone, 15/6 each. **17/6 only.** As above, but with 10-in. cone. Ideal for use with quality receivers such as the **S.T.600.**

**2/9 only.** Brand-new cabinets suitable for above speakers, 2/9 each only. Secure one of these amazing speaker bargains now. Repeat orders are coming in daily. Cash with order or C.O.D.

### HULBERT, 6, CONDUIT STREET, W.1.

**500 GLADIOLI**, 3½-4 inch circ., in 10 named vars. 100 Anemones, 100 Ranunculus and 10 beautiful Lilies for only 10/- (C.O.D.), 10/6 carriage and duty free.

**P. WALRAVEN, STATIONSWEG, HILLEGOM, HOLLAND.**

**SOUTHERN RADIO'S WIRELESS BARGAINS.**

**RECEIVERS:** G.E.C. Osram 4-valve (Actual) Sets, complete with Four Osram Valves, Permanent Magnet Moving Coil Speaker, Magnificent Pedestal Cabinet. Ready to use on all Voltages A.C. All Osram proprietary Components in original sealed cartons, £6/15/0. (List £15/15/0.) An exceptional Bargain.

**BURGOYNE** Class "B" Receivers, 1935 Series. Brand New in original sealed cartons. Complete with 3 Mullard Valves. Exide Batteries and Accumulator. P.M. Moving Coil Speaker. Contained in attractive Cabinet, magnificently finished with chromium fittings £3/19/6 (List £6/10/0).

**COILS**—Igranic Superhet Set of Four (1 Osc., 2 I.F. with Pigtails, 1 L.F. Plain), 12/6. (List 50/-.)

Varley Constant Square Peak Coils B.P.5, complete with all accessories in sealed cartons, 2/3. Lewcoo B.P.F./R, T.B.F./C: O.S.C./126 (extensor), T.O.S./R, all at 3/6 each.

**PICK-UPS**—Marconi Model K25 (1935 issue), 21/-. (List 32/6.)

**BIFLO** Static Cut-outs. Definitely Cuts Out All Electrical Interference and Unwanted Noises, without decreasing volume. Brand New and boxed with simple fixing instructions, 2/3 each. (List 12/6.) State whether A.C., D.C., or Battery Set.

**CONDENSERS.** Lotus, 3-gang, 12/6; 2-gang, 8/6. Fully Screened with Trimmers. Complete with Dials, Knobs, and Escutcheons. Plessey 4-gang Condensers, Superhet type. Fully Screened with Trimmers (less Dials), any standard dial will fit, 10/6 (List 45/-). Dubilier Block Condensers, 4 mfd. (2+1+1), 1,000-Volt, 2/9; 45 mfd. (2.25+2.25), 3/-; T.C.C., 0.1+0.01, 1/3 each.

**SPEAKERS.** Blue Spot 66R Units, brand new and boxed, 10/6 (List 35/-). Complete mounted on Blue Spot Chassis, 16/6 (List 45/-).

**BLUE SPOT** Permanent Magnet Moving Coil Speakers, with Universal Transformers for Class "B" Super-power, Power or Pentode. All Brand New 1935 series in original sealed cartons. Type 45 P.M., 20/- (List 45/-). 99P.M., 30/- (List 59/6). 62P.M., in Magnificent Cabinet, 38/- (List 67/6). 32P.M., in Exquisitely Finished Cabinet, 45/- (List 87/6).

**MISCELLANEOUS.** Westinghouse Metal Rectifiers. H.T. 6, 7, 8, 9/3. Morse Tapping Keys with Flash Signal and Buzzer, complete with battery and bulb, 2/-.

All goods guaranteed and sent post paid.

**BRANCHES** at 46, Lisle Street, W.C.2; 16, Leicester Street, W.: 271/275, High Road, Willesden Green, N.W.10.

All Mail orders to 323, Euston Road, N.W.1.

**SOUTHERN RADIO**, 323, Euston Road, London, N.W.1 (near Warren St. Tube).  
Phone: Museum 6324.

**G.P.O. ENGINEERING DEPT.** (No experience required.) Commencing £4 per week. Age 17-23. Excellent prospects. Free details of Entrance Exam. from **B.I.E.T.** (Dept. 568), 31, Oxford Street, W.1.

**LISSEN A.C./PT.**, Pentodes, 9/6, list 18/6. Battery, 3/6. **SERVICE RADIO**, 51, St. Loy's Road, Tottenham.

**500 GLADIOLI**, 3½-4-inch circ., in 10 named vars., 100 Montbretias, 100 Anemones, 100 Ranunculus, 100 Clover of Happiness for only 10/-, carriage and duty free to destination (C.O.D. 6d. extra).

**THE FIRST HILLEGOM BULB NURSERIES, HILLEGOM, HOLLAND.**

**1,000 GLADIOLI**, first size, 4-5-inch circ., in 10 named vars., for only 20/-, half lot 10/-, carriage and duty free to destination (C.O.D. 6d. extra).

**THE FIRST HILLEGOM BULB NURSERIES, HILLEGOM, HOLLAND.**

**THE following unused Set Manufacturers' Surplus:** all goods guaranteed perfect: immediate delivery.

**DUBILIER** or Erie resistors, 1-watt type, 7d.; 2-watt type, 1/2, Marconi K19 pick-ups, 22/6.

**WESTINGHOUSE** rectifiers, HT8, 9/6; HT9; HT10, LT4, LT5, 11/-. Regentone transformers for HT8 or HT9 with 4v.-4a. I.T. winding, 7/6.

**MAINS** transformers, 350-0-350 v., 60 ma., 4v.-4a., 4v.-2a., 12/6. Eliminators, outputs, 150 v., 25 ma., S.G. and detector. A.C. type with Westinghouse rectifiers, 25/-. D.C. type, 12/6. Collaro gramophone motors, 100-250 v. A.C., 34/-.  
**DUBILIER** dry electrolytic condensers, 8 mf. or 4 mf., 500 v. working, 50 v., 50 mf., 3/6.

**ROTOROHM** volume controls with switch, 2/6. B.T.H. pick-up tone arms, 3/-.  
**MAGNAVOX** speakers, complete with hum-bucking coils, output transformers, etc., 152 (9-in. cone), 22/6; 154 (7-in. cone), 15/9. All with 2,500 or 6,500 ohm fields. Magnavox PM254, 18/-. Carriage paid, cash with order or C.O.D.

WE can supply complete Kits of specified components for the A.C. S.T.600 at a competitive price.

**WARD**, 46, Farringdon Street, London, E.C.4. Telephone: Holborn 9703.

**PREMIER SUPPLY STORES** offers the following Bargains in Brand-new. Guaranteed Valves, the surplus stock of a large Continental manufacturer.

THE following A.C. mains types, 4/6 each: H.F. Pen., Screen-grid, variable-mu screen-grid, H.L., L., directly-heated 1, 2, 4-watt pentodes, 250 v., 60 milliamper, full-wave rectifiers, 20 v., 18A. D.C. types, S.G., V.M., H.L., power, H.F. Pen.

THE following types, 5/6 each: 350 v., 120 ma. rectifier, 500 v., 120 ma. rectifier, indirectly-heated pentode.

THE following American types, 4/6 each: 80, 81, 210, 45, 250, 47, 46, 24, 35, 58, 37, 6A.7, 2A.7, 27.

THE following American types, 6/6 each: 51, 36, 78, 77, 38, 6A.4, 53, 2A.5, 2A.6, 6B.7, 2B.7, 6F.7, 6C.6, 6D.6, 39/44, 83, 523, 2525.

**SEND** for Catalogue of hundreds of Bargains in components. All post orders to Dept. P.A., **PREMIER SUPPLY STORES**, 20, High Street, Clapham, S.W.4. Callers to above address and 165, Fleet Street, E.C.4.

**"SWIFT SERVICE."**

**SEND** to us for your S.T.600 kits and all radio requirements.

**YOU WILL** get prompt attention and **COMPLETE SATISFACTION.**

**S.T.600** (Battery model) standard kit "A," £4 5s. 0d., or our S.T.600 alternative kit "A," £3 15s. 0d.

The alternative kit contains all the **ESSENTIAL COMPONENTS** specified by the designer.

Detailed lists were published in the XMAS number, December 8th, 1934.

"362" S.T.600 valves, £1 6s. 0d. per set, or **Hivac S.T.600** valves, £1 11s. 3d. per set. These valves are tested in the S.T.600 and have a six months' guarantee.

**A.C. S.T.600** kit "A," £8 15s. 0d.

**"SWIFT"** kits are **GUARANTEED** and **DO NOT CONTAIN** any surplus or second-hand components.

**WE CAN SUPPLY** W.B., Rola, Colvern, Graham Farish, Varley, Wearite, Polar, Formo, T.C.C., Bulgin, Erie, Dubilier and all standard makes of components and accessories.

**THE SWIFT SERVICE & SUPPLY CO.** (Dept. P.W.18), 3, FEATHERSTONE BUILDINGS, HIGH HOLBORN, LONDON, W.C.1. Phone: Holborn 1336.

**UTILITY SALES.** Always something NEW, interesting. Write for full Lists.

**TELEVISION** with guaranteed results. Join us as experimenter. Complete Kit of Parts, Universal Mains. One hour to assemble: motor, lamp, disc, lens, everything is there. Write for list P.W.T. £3/12/6.

**VALVE EMISSION TESTER** kit parts with diagram and charts. Milliammeter, cabinet, panel, switch, etc., 12/6.

**MICROPHONES.** Amusing and interesting; learn to broadcast. Hanging 2/6. Table model (transformer in base) 8/6.

**SELECTIVITY!!** Replace your Coils by Screened Iron-core. 2/6 with circuits. Specially matched for S.G.

**STATIC** and Interference cut out, 12/6 list, simple to fix, efficient, 2/6. Limited quantity.

**IGRANIC** Band-Pass Screened Iron-Core Unit on Base with Switch Diagram, 3-valve set, 14/6.

Cash with order, guaranteed 24 hours' Service. Your visit welcome for demonstrations.

**UTILITY SALES**, Færitone Corner, 57 Praed Street, London, Paddington 0251.

**PLEASE**

be sure to mention **POPULAR WIRELESS** when communicating with Advertisers.

**THANKS!**

**ORDER FORM**

The Advertisement Manager, "Popular Wireless,"  
John Carpenter House, Whitefriars, London, E.C.4.

Please insert our/my advertisement in "Popular Wireless" for.....  
insertions at a charge of £ s. d. per insertion. Remittance  
herewith.

Signed.....

Address.....

Date.....

# Give Your Set a Tonic!



PT2  
(4 or 5-Pin Base)

MPT4  
(5 or 7-Pin Base)

**Thin, harsh reproduction is a sign that the OUTPUT PENTODE needs renewing**

Pentode Output Valves are very commonly used in modern receiving sets owing to their high sensitivity. It is very important, however, that a large reserve of thermionic emission is available or the quality of reproduction will suffer severely due to excessive harmonic distortion, and at the same time the sensitivity will fall off.

Thin, harsh reproduction — particularly on reception of loud signals — is a sign that the Output Pentode requires renewing.

Do not wait until this is noticeably apparent — replace your Loudspeaker Pentode now and give the Receiver a new lease of life for the increased call upon it during the long winter evenings.

# Osram Valves

MADE IN ENGLAND

Sold By All Radio Dealers.

## A TONIC TO ANY SET

### OSRAM OUTPUT PENTODES

**PT2** ..... **13/6**  
For 2-volt Battery Sets.

**MPT4** ..... **18/6**  
or **MPT4 Catkin** **18/6**

For A.C. Mains Sets.

**DPT** ..... **18/6**  
For 0.25 amp. D.C. Sets.

WRITE for the OSRAM VALVE GUIDE (1934 Edition). Sent post free.

Advt. of The General Electric Co., Ltd., Magnet House, Kingsway, London, W.C.2.

# BRITAIN'S LEADING RADIO JOURNAL

# Popular Wireless

No. 658.  
Vol. XXVI.  
January 12th,  
1935.

AND TELEVISION TIMES

WHAT IS  
DISTORTION ?

★ ★

SOME FACTS  
ABOUT L.F.  
TRANSFORMERS

★ ★

BROADCASTING  
NEWS

EVERY  
WEDNESDAY  
PRICE **3<sup>d</sup>**

## EXPLORING *the* WORLD *on* SHORT WAVES



*Special  
Articles* by **G. T. KELSEY**  
and **"W. L. S."**

# G.E.C.H.T.

- Stabilised Electrolyte for purity and power
- Super insulation for longer life

**YOUR EAR** will notice  
the greater purity of tone  
**YOUR POCKET** will  
notice the longer life

120 volt, 144,000 milliwatt  
hours guaranteed  
MADE IN ENGLAND

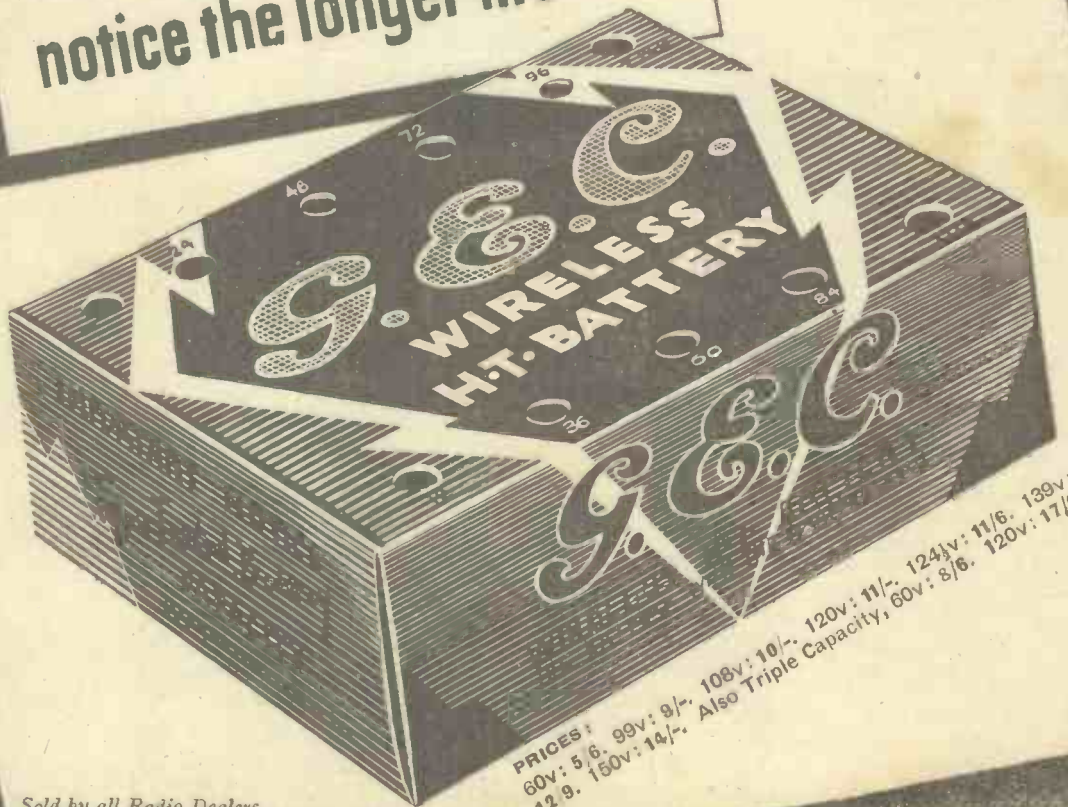

PRICES:  
60v: 5/6. 99v: 9/- 108v: 10/- 120v: 11/- 124v: 11/6. 139v:  
12/9. 150v: 14/- Also Triple Capacity, 60v: 8/6. 120v: 17/6.

*Sold by all Radio Dealers.*

**A TRIAL MEANS YOU'LL ALWAYS USE G.E.C.H.T.**

Advt. of The General Electric Co. Ltd., Magnet House, Kingsway, London, W.C.2.

# POPULAR WIRELESS

## AND TELEVISION TIMES

MANAGING EDITOR: N. EDWARDS.

TECHNICAL EDITOR: G.V. DOWDING ASSOC. I.E.E.

**A NEW STATION  
ROCK STEADY  
POWER INCREASES  
LOCAL KNOWLEDGE**

## RADIO NOTES & NEWS

**GOOD CONDITIONS  
A NICE GESTURE  
INTERVAL-SIGNALS  
FOG FIGHTING**

### Dutch Courage.

**T**HE Dutch have taken their courage in both hands at last and have decided to straighten up the Huizen-Hilversum tangle. The main proposal is to form a State-controlled radio business in which the radio companies will co-operate.

There will be a Board of Control to direct the company, and it is proposed that the Huizen station shall be closed down and that the power of Kootwijk shall be increased to give a better long-wave service.

Full details have not been worked out, but it seems certain that the three-monthly Dutch wavelength exchanges to which we have grown accustomed are to cease at last.

### Scotland's New Station.

**A** VALUED correspondent who writes from Aberdeen tells me that last month he went to the Burghead district in which the B.B.C. is to build the new Scottish station.

At that time, he says, the site was just a site—no building marked out—but he was told on very good authority that there would be an early start on the actual work of erection.

No opening date has yet been given by the B.B.C.

### "Steady, Boys—Steady!"

**T**HAT cheery soul, M. Braillard—who, as chief of the Brussels checking station, is Europe's head of Ether Police—recently paid a pretty compliment to the Vienna station.

He was talking about wavelength wobbling and saying that so good is present-day synchronisation that some stations are never more than five cycles off-tune in a whole year!

And then he disclosed that Vienna, for four whole weeks, had not wobbled by as much as *one* cycle! A Rock-of-Gibraltar steadiness on which "P.W." congratulates the Viennese engineers.

### Some Selection!

**T**HEY tell me that the music library at Broadcasting House now contains about 500,000 sheets of orchestral music, as well as items like 2,500 military-band works, 3,000 operatic full scores, thousands of songs and about 28,000 dance-band parts.

It seems a lot, but just reflect a moment. They must have at

least 10,000 copies of "Danny Boy," allowing for fair wear and tear, and an average use of each copy of about a hundred times before it drops to pieces. And "Danny Boy" is not the only evergreen in the B.B.C.'s garden!

### Popularity of Empire Programmes.

**T**HERE are likely to be some pertinent questions asked about the popularity of the B.B.C.'s Empire broadcasting now that France has disclosed the result of her recent census.

It was a great surprise to Paris to learn that only about 1,500 French-Colonial listeners could be traced, though it is common knowledge that the Radio-Colonial station at Pontoise has done good service on the various short wavelengths allotted to it.

Considering France's wide foreign interests, 1,500 is an amazingly low figure. What is the equivalent British number?

### The Upper Class.

**U**NDER the Ferrié Plan—which aims at reorganising French broadcasting on a worthy national basis—our cross-Channel neighbours are setting up a system like our own and Germany's. There will be a group of powerful medium-wave regionals, backed by a higher-powered long-waver known as the national station.

In our own case, Droitwich is up to 150 kilowatts, and Germany has announced that the Deutschlandsender is not to be content for long with its present 60 kilowatts. Now Radio Paris—or Paris National, as we must call him under the new regime—is also booked for 150 kilowatts. Who will be next?

### The Thirst for Knowledge.

**B**ELFAST has a good idea in the form of a questions-and-answers feature in the Children's Hour. All sorts of odds and ends of local knowledge are brought to light in this way, and I have no doubt that many of the grown-ups learn a lot, as well as the children.

Should the B.B.C. decide to answer questions about London in this way, I would like to ask one about those iron posts between London Bridge Station and the Hop Exchange. Are they really old cannon, as they appear to be?

### Radio-Ouest.

**L**ISTENERS to the Scottish National have probably noticed the talkative neighbour to that station—Rennes, on 288.5 metres. He has been working with a new 40-kilowatt outfit, but this is only a makeshift, as I think I warned you not long ago.

When Rennes really gets going it will be with a power of 120 kilowatts under the title "Radio-Ouest." The date for the change was given as "early in 1935," so he may blossom any day now.

### Truth About 1935.

**W**HAT is Young 1935 going to do for radio?

If we "look that guy right in the eye" (as Radio Luxembourg so often says) we must admit that there is no sign of radio settling down in the next twelve months; in fact, we may look for developments and progression quite as marked as in previous years.

There's this whole question of television to be settled, for one thing; the use of micro-waves, too, is bound to extend; and there are so many transmitter changes planned on the Continent that next winter's listening will surely be quite different from to-day's (which is very convenient for wireless scribes—gives 'em something to write about!).

### Printer's Pie.

**K**NOWING how a printer's error can knock the stuffing out of the best of us, I seldom gloat over the queer results that arise from one. But I had to smile over the report on the B.B.C.'s production of



This is George Garay and his Hungaria Gipsy Band which made its first broadcast recently in a relay from the Hungaria Restaurant, London.

(Continued on next page.)

# CELEBRATIONS COVER RADIO TRANSMISSIONS

"Hamlet"—unhappily rendered in print as "Helmet"!

Imagine the producer's surprise if he read that "it demanded close attention, but Gielgud's 'Helmét' was not a bit too long. . . ."

"Miss Fay Compton appeared in it to perfection."

## Cornered in China.

WHEN the Haardt Expedition across Asia was in Mongolia trouble broke out with the Chinese troops, and it became necessary to wireless news to a French cruiser in Hong Kong. How could it be done without exciting suspicion? First, the wily expeditionaries said they would celebrate the third centenary of the French Republic, so they proceeded to hang up all their flags on a



wire—that was the aerial!

Then they invited the natives to a concert, and in order to make "plentee big music" they started a gramophone and also a motor—that was the transmitter!

Finally, they made everybody sing and yowl, and when the appalling row was at its height nobody noticed that the dots and dashes were going out to Hong Kong! Good work—what?

## The Best Year?

A GOSPORT reader—who signs himself "Atta Boy"—wants me to support him in the statement that 1934 was far and away the best year for conditions for long-distance radio reception.

My inborn cautiousness revolts. How do we know? Can anybody say?

I will gladly commit myself to the statement that it was a very good year, and I expect that during 1934 more people heard the U.S.A. direct on medium waves than in any year before.

That, however, partly depended on improvements in receivers, greater number of listeners, etc. Some day we shall have a universally accepted scientific standard for comparing one year's reception with another's, but in the meantime comparisons are guesswork.

## The Good Samara.

A DARLINGTON reader who has been harking back to that question of interference by heterodyne with the North Regional programmes asks me if it was ever proved who was the guilty party.

Actually, there was no guilt attaching to anybody, since the offending station was rightly using the wavelength allotted to it. Samara was the station in question—a Russian, who lies so far to the east that he was not expected to interfere, though working on the same wavelength as North Regional.

When told of the unexpected trouble that had arisen Samara politely consented

to alter his wavelength—a very nice gesture on his part, I thought.

Thank you, Sam. I raise my glass of vodka to your good health.

## Those New Signals.

SIR JOHN REITH'S request to the Regional Directors that they should severally recommend distinctive sounds, typical of their various Regions and suitable for use as interval signals, reminds me that I suggested the same scheme years and years ago in "P.W."

It has obvious attractions, and now that there are only a few Regions it should be easy to arrange. When I first put the idea forward we had all the small stations instead of Regionals—I remember suggesting, for example, that the hoot of a steamer's siren could be used for Liverpool. That signal has now been adopted elsewhere, and Liverpool no longer has its own station—but the scheme remains a good one.

## Dumb Sets.

THIS propaganda-by-radio business is getting to a pretty pass. I see that the Budapest "Official Gazette" recently published a decree forbidding listeners to tune in speeches or lectures of a propagandist nature from foreign stations.



And now dealers in that part of the world are said to be offering to the public sets which are guaranteed not to be capable of

tuning in offending wavelengths!

Just fancy—half-dumb sets! It must have been blind folly that brought such a fate on radio usage.

## Quintuplets Broadcast

WITH characteristic consideration for those who look longingly towards some new thing the Columbia Broadcasting System recently broadcast the five-fold squawking of the world's one and only set of quintuplets.

Five equally aged babies, one and all demanding their common Momma—it must have been a thrill supreme! They tell me that W 2 X E relayed these Canadian wonders at 1.15 a.m.

Did any poor Poppa in this country hear them? If so I hope his heart didn't yearn over that Canadian father who possesses these five alarm clocks, for I understand that such is their prestige that infant-welfare institutions vied with one another for the honour of looking after this unique family.

## The Fog Menace.

THOSE in peril on the sea are keenly interested in some tests to be carried out by the Radio Research Board in the early part of this year. New direction-finding apparatus, easily fitted to any radio-equipped vessel, has been designed to cope with the menace of collision in fog.

It consists of a fluorescent screen on which flashing green lines represent neighbouring ships. If a line lengthens, that ship is getting nearer. If it also points continually in the same direction it indicates that the two ships are heading for a collision.

High hopes are entertained of this new safeguard, for the old trouble of night error has been removed and the receiving apparatus is only about the size of a suitcase.

## Representative Radio.

IN this progressive age the importance of a nation is reflected by its wireless strength. We do not now reckon national prestige by the number of ships, but by the power of the programmes."

So says a valiant advocate of Welsh broadcasting, with a gallant disregard of the mere facts. What about Luxembourg—a teeny-tiny State which most of us had hardly heard of until we were deafened by its radio power?

## A Timely Confession.

BEAR with me while I confess a fault—indeed, a grievous sin.

Temper! That's my trouble. The B.B.C. now keeps putting out one item which I cannot, and will not, listen to.

Laying my hand upon my bosom, I assure you that until recently I have never, never switched off my set just because I hated something too much to listen to it. But now, every time they start to play this particular piece, I leap up and silence the loudspeaker in a thoroughly bad temper.

Can you guess what it is? I can't bring myself to name the tune. But poor old Big Ben has been dragged into it, though he appears to chime reluctantly!

## The Ideal—and the Real.

FUNNY how often Realisation fails to come up to Expectation, isn't it?

The poet said: "The night shall be filled with music. . . ." But this is what a writer to a northern newspaper says:



"Scottish Regional is hopeless, with a continual whistle; Midland Regional is blotted out of existence by stations on each side. . . . The latest disappointment is

Droitwich. I find that music goes all cracked and jangled like tin cans banging about, which I infer is caused by fading.

"I have not mentioned Newcastle, as it is lost in a tornado of whistles, howls and Morse whenever I turn to it."

We all feel that way sometimes, don't we? But then we've been given a rise, won a sweep, or Somebody smiles—and lo! Roses all the way and melody on every wavelength! Is it not so, fellow fairies?

ARIEL.



# What is DISTORTION?

It is often said and written that any difference between the acoustic output of the loudspeaker and the input to the microphone indicates the presence of a measure of distortion.

I have never accepted this rather academic definition of distortion, for it is altogether too wide: it suggests that perfection in radio transmission and reception is attainable and that we must judge our reception against such perfection.

That is nonsense actually, with the technique at present available, the best we can strive for is the most *pleasing* reproduction and an output that helps our imagination to delude us into believing that we are listening to the real thing.

### Three Main Forms.

I have made a great variety of tests on listeners who have no technical knowledge whatever, and the results are consistent. I find that nine out of ten people actually prefer a receiver which deliberately distorts and which has an output that is a mile away from being "straight line."

A much more acceptable definition of distortion is, I believe, an *unnatural*

exactly what you would hear in the studio. You don't know and you probably never will!

There are dozens of ways in which reproduction can be "faked up" to suit individual tastes, and I do not intend to deal

There are two forms of so-called distortion: one is such that anyone would notice it and object to it, while the other is simply a matter of opinion. They are properly "put in their right places" in this explanation

By

**BERNARD BARNARD**

with them here. If you prefer a preponderance of bass you know what to do—or you ought to if you read "P.W." regularly—and when you have got just the right balance that pleases you, you will be very annoyed if your best friend tells you your reproduction is "distorted" just because it is not *exactly* the same as the original.

Having thus simplified the issue to a great extent, I am going to deal briefly with the causes and cures of *real* distortion—that is, the troubles that cause "cracked" piano notes, lisping announcers and shrieking sopranos.

There are three, and only three, faults that need be considered, and they are responsible for ninety-nine per cent of the distortion experienced in home-constructed sets. And, in order of merit (or perhaps I should say demerit), they are: valve overloading, detector distortion and parasitic oscillation.

### The Bias Question.

As regards the first named, it has been dealt with extensively in these columns from time to time, and a "memory refresher" will perhaps suffice.

The two valve curves on this page—Figures 1 and 2—indicate amplifier valves which are over-biased and under-biased respectively.

The numerical figures are for a small-power valve, but the same phenomena apply to output, L.F. and even H.F. valves which are overloaded by the signal-input voltages.

Note, in Figure 2, when the valve is insufficiently biased the distortion is produced by grid current flowing in the input circuit: this causes partial rectification by damping out the positive swings of the input voltage—much the same effect as is deliberately obtained with a leaky-grid detector.

Rectification also takes place when there is too much bias—Figure 1—but in this case it is the negative swings that suffer, due to their working on the bottom bend of the curve.

The cures for these troubles are obvious: be sure, however, that the valve in question is capable of handling the input when correctly biased and also that its emission is fully up to standard.

A millimeter in the plate lead will tell you all you need know: the needle will "kick" wildly when distortion takes place—upwards for over-biasing and downwards when grid bias is insufficient.

Now for trouble number two—distortion in the detector circuit.

### Detector Overloading.

Anode-bend detectors will handle most normal inputs and are comparatively free from distortion, but their popularity is restricted by their limited sensitivity.

Leaky grid is, of course, very sensitive, but bristles with possibilities for introducing "lisping."

A leaky grid detector usually has a slight positive bias on the grid, since it depends for its working on the flow of grid current. The state of affairs is, on paper, very much the same as for the under-biased amplifier (Figure 2).

The valve that is best suited for the job,

### PARTIAL RECTIFICATION

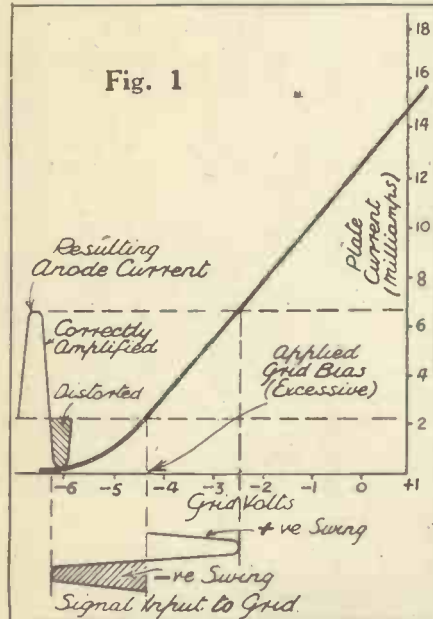

When an amplifier valve has too much grid bias it commences to work on the bottom of the curve like an anode-bend detector.

reproduction: it is a state of affairs that destroys the illusion of hearing the actual performance.

I think you will readily agree, after a little thought, that you have never looked upon distortion as just a vague difference between what you hear at home and what you *might* hear if you were in the studio.

And if you still don't agree with me, ask yourself how on earth you are to know

### GRID-CURRENT EFFECTS

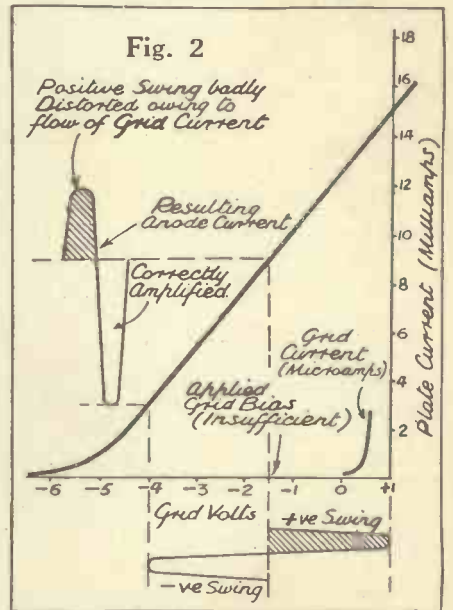

Distortion due to grid-current damping can occur on positive swings if the valve is not working on the proper part of its curve.

however, has a very limited "grid swing"—that is, the voltage range on the "grid-volts" axis of the curve is limited to not more than 2 volts.

If a signal of more than this voltage is applied to a leaky-grid detector the positive portion will be "wiped out" (as is desired), but the negative portion will swing on to the bottom bend of the curve and will also

(Continued on page 625.)

**T**HIS is the critical year for the B.B.C. True, the Charter does not expire until next year; but it is within these twelve months that the future constitution will be decided. The Government has not yet made up its mind what to do about broadcasting. Four courses are open. A Select Committee of both Houses may be appointed to investigate and report; a Departmental non-Party Committee may be set up by the P.M.G., as was done in 1925; a Royal Commission may be appointed; and, lastly, there may be no inquiry at all, the Charter being renewed by Order-in-Council. The second possibility finds favour in most interested quarters.

**The Broadcasting House Organ.**

The £8,000 organ in Broadcasting House has turned out to be a veritable "white elephant." When played it interferes with studios above and below. This seriously restricts its usefulness. Organists have to do their practising in the early morning hours before transmissions have begun.

But the situation is not hopeless. The money invested in the organ will not be locked up for good. Sooner or later the B.B.C. will have its own concert hall, and then the organ will come into its own.

**B.B.C. Concert in Bristol.**

The second concert of the B.B.C. Provincial tour will be given in Bristol, beginning at 7.45 p.m. on Wednesday, February 13th, and relayed in the National programme. Indications are that the B.B.C. Symphony Orchestra will be warmly received in Bristol. Dr. Boulton will be fresh back from his triumphal visit to the United States.

**"Sound Engineers" Get Together.**

At the inspiration of Captain Jack Frost, of early B.B.C. fame and now of Western Electric, sound engineers are forming a society. Most of the more prominent have been or are employed by the B.B.C. The objective is double: first, research in the common interest; and, secondly, social. About fifty engineers are concerned.

**Mr. Norman Acting-Chairman.**

Mr. Norman, the Vice-Chairman of the B.B.C. and brother of Mr. Montagu Norman, Governor of the Bank of England, is Acting-Chairman of the B.B.C. in the continued illness of Mr. Whitley. There is a strong rumour that Mr. Norman will be given a second tenure of office when his present appointment expires at the end of 1936.

**B.B.C. to Become Printer?**

Estate agents have heard of inquiries, understood to be on behalf of the B.B.C., to acquire either a printing works or a site

for a works as near as possible to Portland Place. If this accurately reflects an intention of Broadcasting House, then it represents an important change of policy, and one not likely to be undertaken during the run of the present Charter and Licence.

**George Burl.**

For the last fourteen years people in every town in Lancashire have heard George Burl playing his Chinese fiddle, a one-stringed instrument with a horn attachment which he taught himself to play, so



The Henderson Twins, two clever thirteen-year-old girls who recently made their broadcasting debut. They are the daughters of Dick Henderson, the music-hall comedian.

that thousands of people will be interested in his next broadcast on Saturday, January 19th.

Burl was born in Liverpool in 1898, but as he grew up his love for the country

staff at the Munich Opera House as a conductor under Felix Mottl, but it was not until 1929 that he first visited London, where he conducted the B.B.C. Symphony Orchestra in a broadcast concert.

Last February he conducted the Hallé Orchestra at short notice, when, incidentally, he renewed an old acquaintance with Alfred Barber, the leader of the Hallé, who spent several years in Russia, both before and during the Revolution.

The Hallé Concert programme on January 17th will include Rimsky-Korsakov's "Capriccio Espagnole" and Glazounov's Concerto in A minor, in which latter work the solo violinist will be Henry Holst.

**"For Northern Farmers."**

Mr. William Birkett, a well-known Northumbrian farmer of Bishop Auckland, is looking forward to attending his fortieth Royal Show, which is to take place next summer at Newcastle, where plans for the biggest event in the agricultural world are already being pushed forward.

For the greater part of his life Mr. Birkett has been a member of the Royal Agricultural Society, and few people are better qualified than he is to review the evolution of the Royal Show since 1887 to the present time.

The review will take the form of a discussion with Professor J. A. Hanley, of Armstrong College, Newcastle, and will be given in the series "For Northern Farmers in Particular," on Thursday, January 17th.

**Psalm-Tune Features.**

Beginning on Sunday, January 13th, and continuing at fortnightly intervals until about the middle of July, Scottish listeners are to hear a series of broadcasts illustrating the various stages of development of the Psalm tunes of Scotland. These recitals will be given by the Scottish Wireless Singers, conducted by Ian Whyte; and Dr. Millar Patrick, compiler and editor of the "Scottish Students' Song Book" and the "University Song Book," will provide historical notes that will assist in placing the tunes in their true historical perspective.

Experience has shown that programmes of this type are in considerable demand among Scottish listeners; and although many of the tunes were not written by Scotsmen, they have become naturalised and now represent the finer spirituality of the Scottish people.

**Midland "Radio Follies."**

Midland Regional's new concert party, "The Radio Follies," some of whose members made their names with "The Regional Revellers" and the "Midland Mischief Makers," which combinations, by the way, are still going on and flourishing, is to give the second of its monthly broadcasts on Thursday, January 17th. Few listeners will want to miss this programme.

O. H. M.

# 1935: THE B.B.C.'s CRITICAL YEAR

## Latest News and Views About Broadcasting

rather than the city grew more intense, and after the war, to which, by the way, he took his fiddle, he decided to "take to the road."

He found he liked it more than he did his pre-war life in various theatre orchestras, and though he has often been down and out, wet to the skin, and so penniless that he has had to play to people in the lowest doss-houses to raise the meagre sum required to pay for his bed, he still goes on. His items on January 19th will include Handel's "Largo" and Foulds' "Keltic Lament."

**A Special Hallé Concert.**

The Hallé concert on Thursday, January 17th, will be noteworthy, since, for the second time within a year, the orchestra will be conducted by Nikolai Malko, conductor of the Leningrad Philharmonic Orchestra and a professor of the Leningrad Conservatorium.

Malko was born in Poldolieu in 1883, and, having graduated at the St. Petersburg University, later studied at the Conservatorium there under Rimsky-Korsakov. He also served on the musical

# ON THE SHORT WAVES

Conducted by W.L.S.

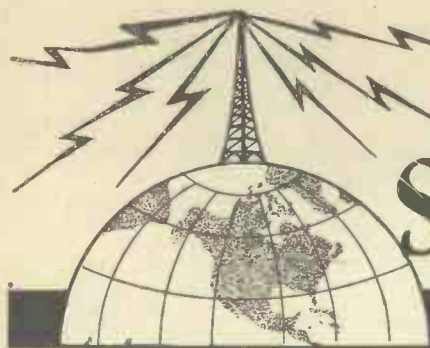

FOR rather more than seven years I have been writing a regular weekly short-wave article for "P.W." When the series started in the autumn of 1927 it called forth a dozen letters. Some of them abused the Editor for allowing me to waste his valuable space; others declared that the half-page then allotted was ridiculously inadequate for the purpose.

Most of us said, "We shall see!" and sat tight; and we have all seen. Short waves to-day are one of the most fascinating branches of radio to which the home constructor can turn his hand. Everyone who has been enterprising enough to give them a trial for himself will confirm that.

In fact, one of the characteristics of the average short-wave "fanatic" is a kind of intensely concentrated enthusiasm, the like of which one does not often meet in other branches of radio.

## Afraid to Take the Plunge.

The one snag is that so many people seem to be afraid of taking the plunge. One group says: "I can't be bothered to go back to the days of painful searching with headphones. Give me loudspeaker listening and I might take some notice of it." Another says: "These short waves are a lot of bunk put up by unscrupulous journalists. You don't expect me to swallow that stuff!"

Reader, if you belong to either of these groups please have patience and read on. I have a lot to say to you. I want to encourage you to believe that short-wave listening is going to be worth your while, and I promise you that if you will summon up the necessary energy to "break in on it" you will not be disappointed. Rather will you kick yourself for all the fun that you've been missing the last few years.

It's time you swallowed your pride, forgot those old-fashioned ideas and made up your mind that it's about time you *did* go in for short-wave reception.

## Not Expensive.

First of all, I've got to try to trace out your possible objections. Do you think it's an expensive business? Well, it certainly isn't. Do you think it's difficult? That's a matter of opinion, but I say it isn't, and so do some hundreds of readers who regularly write and tell me so.

Do you imagine that a short-wave set will bring in very little except thousands of Morse stations? Well, you'll get those all right, but there are over a hundred regular broadcast

programmes being put out between 80 and 12 metres. Surely that's enough to tempt you down there.

## Plenty of Room.

I wonder whether you are one of those who argue that there can't be much room from 200 metres downwards, seeing the fairly small number of stations that can work between 200 and 600 metres. I'm sure this point of view does exist in some people's minds. If it does in yours you had better rearrange your ideas forthwith.

Try to think in kilocycles for a moment,



## Details of what you can expect to hear.

for they are the only true basis of comparison. 600 metres is equal to a frequency of 500 kc.; 200 metres is 1,500 kc. So the medium broadcast band to which you are so well accustomed is really a frequency band 1,000 kc. in-width.

Now go down from 200 metres to 100 metres—1,500 kc. to 3,000 kc. There, in a band which you may have been mentally picturing as a narrow one, you have a greater amount of space than you have between 200 and 600 metres.

Instead of thinking of your "unknown region" as a waveband extending from

200 metres down to 2 metres, try to regard it as a frequency band going up from 1,500 kc. to 150,000 kc. That will give you some idea of the enormous amount of space that it occupies. And remember the fact, which never fails to impress people, that there is more than 100 times as much "room" between 200 and 2 metres as there is between 200 and 20,000 metres.

Forget your "metres" and think about "kilocycles." We shall all have to do that one day. And, by way of encouragement, remember that those hundred short-wave broadcast stations are much more widely spread out than are the medium-wave Europeans.

## The Broadcast Bands.

They are arranged in certain wavebands, roughly centring round 49, 31, 25, 19, 16 and 14 metres. In between these bands you will hear all the Morse that you have been worrying about, but within the broadcast bands all should be quiet with the exception of the stations you want.

The 31-metre band, for instance, extends roughly from 30.6 to 31.6 metres, and has a width of about 300 kc., which gives accommodation (under our 9-kc. separation) for 33 stations. Actually, within that band you will find four North Americans, two South Americans, three Australians, one Indian and a crop of Europeans.

Thanks to the characteristic behaviour of short waves, the European stations are generally no stronger than the others and do not interfere with them in any way. Take it from me that it is no more difficult to receive Sydney, Australia, on a short-wave set than it is to get, say, Katowice or Gleiwitz on the medium-wave broadcast band.

## Extra Transmissions.

In between these short-wave broadcast bands, although there are numbers of high-powered commercial stations working on C.W., there is still plenty to interest you. There are the amateur wavebands on 80, 40 and 20 metres, and there are various commercial experimental stations working on telephony and sometimes putting out complete musical programmes.

You may tune to a strong station, and until he announces you won't know whether he is in Germany or South America! Surely that will be an entirely new feeling for you.

I do earnestly appeal to every reader to give short waves a trial for himself.

## AMATEURS ARE AN ADDED ATTRACTION

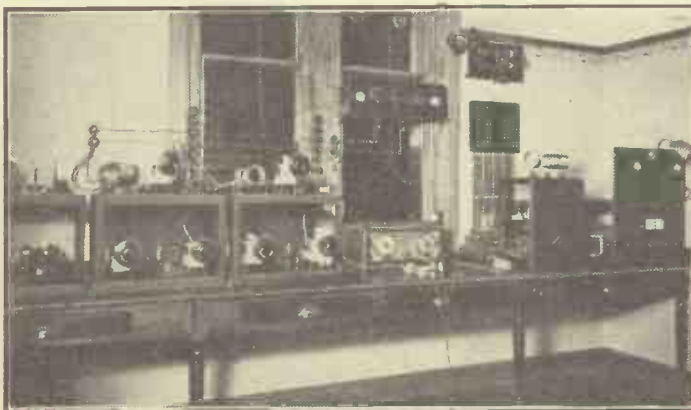

Apart from the large number of broadcasting stations to be heard on the short waves there are also many amateur transmitters to listen to on 80, 40 and 20 metres. Here is the British station G 8 F N, every bit as workmanlike and efficient as a regular broadcaster.

## ON THE SHORT WAVES—Page 2.

ONE of the most attractive points about short-wave work is the fact that a perfectly efficient receiver is extremely cheap and simple to construct. A little more than two years ago I described in "P.W." a short-wave single-valve set, and that attracted more interest than any other set I have ever made.

I still receive every week reports from readers who made it and find that they can receive with it stations that friends with ambitious receivers have never heard at all!

This may seem a little like "drawing the long bow," but, nevertheless, it is perfectly true. The chief reason is that some elaborate short-wave sets defeat their own object by introducing too high a "noise level." We don't have to receive signals so weak that they can't be heard on a single valve; our problem is to receive clear signals that come through the general background of "mush."

This mush is just the faint hissing that one hears when a receiver is reaching the oscillation point, and is made up of all sorts of different things. Distant atmospheric harmonics of commercial stations, some peculiar condition of the Heaviside Layer—whatever it is, it's always with us. If we don't go the wrong way about things and add a little more "mush" to it it need not worry us; but if we make a big set which generates a lot of noise on its own, then we shall lose signals which the man with a small, quiet set will hear.

At the Mercy of "Conditions."

H.F. amplification is not, as a rule, enormously useful on short waves, and too much L.F. is a distinct disadvantage. Whenever I get a complaint about poor results from a man who says that he uses two stages of L.F. I tell him to remove one or both of them, and he very often finds his reception improved.

Two L.F.'s are all very well for loud-

## A ONE-VALVE SET WORKS WONDERS

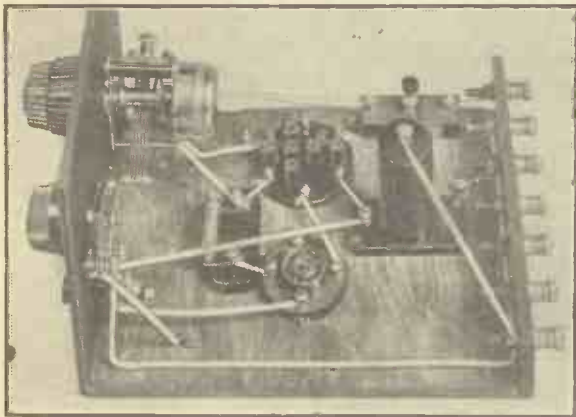

On short waves a single-valver will cover as big distances as a multi-valver. This efficient little set is the one referred to on this page by W. L. S.

speaker work, but for headphones—well, I can't stand them!

The problems that we have to face when we build a short-wave receiver, briefly, are these: we are dealing with very high frequencies, which require a little more care in treatment and will creep away down unwanted channels unless we look after them. We are dealing with fairly weak signals. We are at the mercy of "conditions" which nobody quite understands.

## SHORT WAVE SIMPLICITY

### Some notes on the apparatus needed for S.-W. reception

The best short-wave set in the world is occasionally powerless to bring in anything interesting, because "conditions" (bless them!) are such that no distant stuff is coming through at all. That state of things is right out of the control of the listener and the transmitter, and is being investigated. It has been, in fact, for the last nine years, and we are just beginning to find things out.

#### The "Weak Spots."

Our set, then, doesn't have to use a complicated circuit or freakish parts. A short-wave detector circuit is just the same sort of thing that one would use for the long and medium broadcast bands, with the exceptions that the coils are naturally much smaller and (more important) the tuning condensers, likewise, are but a fraction of the size.

Take a good broadcast-wave detector. Substitute for its coils a seven-turn aerial coil and a four-turn reaction coil. Remove the .0005 tuning condenser and substitute a .0001. Then, if the layout and wiring are good, you will have a little short-wave receiver that will tune, roughly, from 30 to 60 metres. Could anything be simpler?

Here is the one small snag. Short waves show up any little inefficiencies in a far more conspicuous way than do the longer waves. You may have a single-valve receiver working perfectly on the broadcast bands—at least, you may think it is perfect.

There may, however, be quite a few weak spots in it, each giving rise to a slight loss.

The results, however, will probably not show it. Put it on short waves and the weak spots will show up at once.

You can't treat a frequency of a million in quite the same off-handed fashion that you'd treat a thousand—and when you get down to 30 metres you are dealing with a frequency of ten millions.

#### Short Waves are Simple.

As I have said before, it's rather like the analogy of the touring car and the racing car. You can use materials in a car designed to travel at 30 miles an hour which would crack up in a few moments at 200 miles an hour. But—please note this—if you took the materials and general design of your 200-m.p.h. car and employed them in your 30-m.p.h. tourer it would be a vastly better car for it.

The touring car of to-day has evolved from the racer of yesterday. Such everyday components as four-wheel brakes and shock absorbers have all come from racing practice; and, applying the argument to radio, you will find that it still holds. If you "ginger up" your broadcast receiver

until it is capable of working well on short waves, then it will be a better broadcast receiver when you take it back to its old job.

Short waves are simple. The circuits are simple, the components are quite ordinary. It is the general design, layout and workmanship that make for success; and success brings its own reward.

A straightforward two-valver of the detector-and-L.F. type will bring in practically all the short-wave stations that one can hope to hear, provided one chooses the right time of day and the right season of the year. For instance, you haven't the faintest chance of hearing American broadcast at 11 a.m. in the summer on 49 metres; but if you look for it at 11 p.m. you will get it. At 11 a.m. you should be listening on 19 metres.

That is one of the particular charms of short-wave work. The various bands all

### FROM ALL PARTS

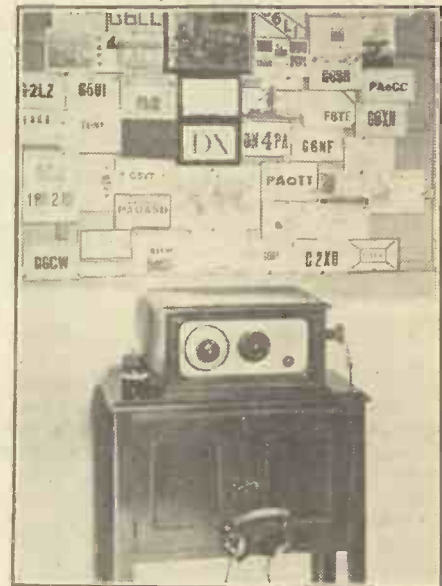

The simplicity of this complete short-wave receiving station, and the number of reception cards above it (usually termed Q.S.L. cards) from all parts of the world are proof that elaborate gear is unnecessary for successful short-wave reception.

have different properties, and there is something doing all the year round, any time of day or night, if you pick the correct wavelength. "P.W.'s" special short-wave section is written largely with the idea of helping you to make the most intelligent use of your receiver.

If you are a newcomer to the game you will find that the difficult business of "lay-out" is done for you. If you know a little more about it you can evolve your own and get a lot of fun from that. If you are a real old stager you still won't be bored. I'm not bored after ten years of it.

One can always improve on a simple circuit without necessarily making it complicated. Logical additions to a given circuit fit in with the existing scheme; my idea of a complicated circuit is one with all sorts of little "trimmings" and "gadgets" that are not strictly necessary.

Resolve that you will always use the simplest circuit compatible with efficiency, and you won't go wrong with short waves.

ON THE SHORT WAVES—Page 3.

PROBABLY, by now, my regular readers will be wondering what on earth has come over me. I haven't said a word to them since I began two pages back! Apologies, R. R.'s! This little homily is written with the particular idea of popularising our beloved short waves among some of the less enlightened brethren, and is all leading up to what I want to say right now.

Special Sets.

Next week "P.W." is giving the short-wave fraternity one of the biggest pushes it has ever had. We are really making a determined effort to boost short waves, and you are going to have an issue full of good things for your especial benefit. Its main purpose is to introduce the short waves to the broadcast listener, but there will still be plenty to interest the hardened "fan."

By way of inducing the broadcast listener to believe all that he has read in the previous two pages I am describing a short-wave set on which I have been quietly working for a long time, and in his honour it has been christened the "B.C.L. Two."

My friend and colleague, Mr. G. T. Kelsey, has designed another of his famous short-wave adaptors, and that, too, is going to be described in full. Thus you will be able to choose whichever method appeals to you more. You can either build a simple, inexpensive set which will be kept aside for the sole purpose of receiving short waves, or you can make an adaptor which will convert your own broadcast receiver into a loudspeaker short-waver.

A Snag-free Receiver.

Mr. Kelsey is telling you something about his adaptor on another page in this issue, so I must confine my remarks chiefly to my own set. Although it has, admittedly, been designed and built chiefly with this idea of attracting new talent to our branch of the game, there is much in it that will probably appeal to the man who is already keen.

It is capable of loudspeaker reproduction of the stronger short-wave stations, and yet it is sufficiently quiet to be used for headphone work on the weaker ones. It

A VERY SUCCESSFUL LISTENER



Although his receiver is built on quite ordinary lines, Mr. G. C. Allen, of south-east London, who is seen seated in the picture, won the last B.E.R.U. Receiving Contest with it.

uses a screened-grid detector and a pentode, with a special circuit that I have already described in the short-wave section. Anyone can assemble it in a couple of hours or so, and it is just about as "snag-free" as I know how to make a set.

As I write these notes (at 2.30 p.m.) it is receiving W 8 X K (Pittsburg) on 19.72

Why Not Start Next Week?

All about some good things for the new S.-W. listener

metres at quite reasonable loudspeaker strength. Judging by results on my own everyday receiver, conditions are somewhat below normal, as W 8 X K doesn't appear to be particularly strong. Two degrees lower down is W 2 X A D on 19.56, in the form of a very fine carrier-wave, but he hasn't started his programme yet.

A few degrees higher up, in the amateur band, is W 2 Z C, of Little Silver, N.J., working with a station in Central America on telephony, and every word is clearly audible on the speaker.

By way of a test for "hand capacity" I picked the set up in one hand just now, and there was apparently no effect upon W 8 X K. That's

to whet your appetite. Next week I shall be able to tell you what it will really do when it's roused!

(Last week, by the way, I spent an evening with Mr. Kelsey and his adaptor, which he was feeding into a well-known broadcast superhet. By 10.30 p.m. we had to cut down W 8 X K's 48-metre transmission on the volume control for fear of cracking a window.)

Of course, this "B.C.L. Two" is my set, and, naturally, I like it and think it's good. But what I like most about it is the fact that there's nothing freakish or frightfully clever in it. I can design a "clever" set when I want to, but I don't feel happy about the prospect of its being reliable. I don't feel that anyone—even a man who has never touched short waves—could make it up from my description and get away with it.

Quickly Constructed.

With the "B.C.L. Two" I have that feeling very definitely. All anyone has to do is to examine the wiring diagrams and photographs, get the components together and spend an hour or so wiring them up. Then one ought to be

able to connect up batteries, aerial and earth, and get the same results as I get myself.

If one has the patience to wade through my article and to choose the right times and wavelengths for listening one will probably get more. If I spent all the time "on the air" that I should sometimes like you

wouldn't see these notes any more, for I shouldn't have time to write them.

(How are we getting on, regular readers? Are you terribly fed up? Never mind, it's all in a good cause, and the more people we can entice on short waves the better will it be for all of us. We mustn't go on being a little select community for too long.)

Now for those of you who are not regular readers of "On the Short Waves." The heading to this page says "Why Not Start Next Week?" and I should like to know if you can think of any reason why you shouldn't.

You need not upset your existing set at all. You can either make an adaptor to feed into it, or you can build a completely separate two-valver, which won't break the bank. And for that small amount of trouble you will get plenty in return. Not trouble! Results.

You will have available well over a hundred stations that you have never heard before and could not hope to hear

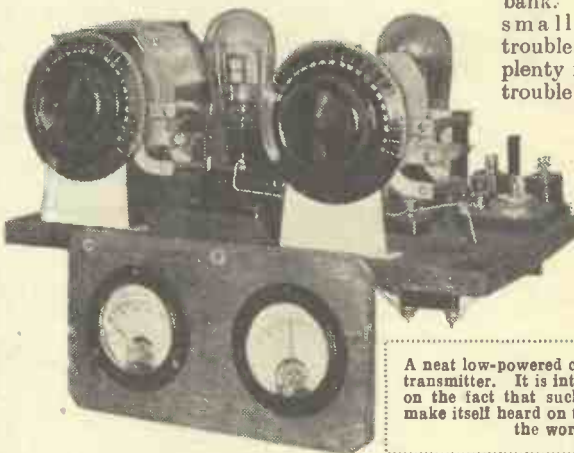

A neat low-powered crystal-controlled transmitter. It is interesting to muse on the fact that such apparatus can make itself heard on the other side of the world.

without a short-waver. You will have the thrill of your life when you first hear the call of the Kooka-Burra bird from Australia. You will be "one up" on the man next door whose idea of D X reception is Cairo—a mere local to you.

Big Developments to Come.

You will be a member of the great brotherhood of short-wave listeners whose friendly spirit, for some reason or other, is a thing quite unique. You will be able to join one of the short-wave clubs and get into touch with fellow members in your own district. In short, you're in for the time of your life if only you can summon up the energy to "take the plunge."

If you don't do it I will never forgive you!

Remember, too, that short waves are one of the newer branches of radio, and that it still pays one to get in as early as possible. You won't exactly be a pioneer, but in ten years' time you will certainly have a distinct advantage over anyone who is just starting.

Short-wave developments have been slowed down during the past few years, chiefly, I suppose, because we found out such a lot of things in that hectic rush round about 1925 and '26.

The amateurs are still making discoveries, though, and the general technique is going ahead wonderfully. Who can possibly predict what use will be made, for example, of the ultra-short waves in five years' time? I shouldn't be surprised to find the greater part of ordinary "local" broadcasting being carried out down there.

Sooner or later—as sure as my real name isn't W. L. S.—you will have to take to these short waves, so you may as well begin now.

W. L. S.

**THEY HAVE THEIR BREAKFASTS  
WHILE WE HAVE OUR SUPPERS !**

*And over in New York  
they are clearing away  
the tea things .....*

**IT'S ALL A MATTER OF TIME...**

*But never mind what they  
are doing in Australia and  
America—there is no time like  
the present for reserving your  
copy of the January 19th issue of*

# **POPULAR WIRELESS**

**AND TELEVISION TIMES**

FOR IN ADDITION TO CONTAINING

## **TWO MAGNIFICENT SHILLING GIFTS**

FULL CONSTRUCTIONAL DETAILS ARE TO BE PUBLISHED OF

### **THE 1935 KELSEY ADAPTOR**

—an ingenious unit that will instantly transform any ordinary receiver into a loudspeaker set for world-wide short-wave reception, and

THE "W.L.S." SHORT-WAVE MASTERPIECE

### **THE "B.C.L." TWO**

—a remarkable two-valve design that will receive every station on earth!

THIS SPECIALLY ENLARGED ISSUE OF  
BRITAIN'S LEADING RADIO WEEKLY WILL BE

## **THE SHORT-WAVE EVENT OF THE NEW YEAR!**

Buy this number and learn how simply you can

**MAKE THE WORLD YOUR BROADCAST PLAYGROUND**

ON SALE JANUARY 16th.

PRICE 3d. AS USUAL.

# TELEVISION

A SPECIAL PRACTICAL SERIES FOR ALL READERS

By L. H. Thomas

The use of mains synchronising, viewing tunnels and the adjustment of band-pass receivers are among the items dealt with by Mr. Thomas this week.

I HAVE received a long letter from a reader which is so full of common sense that I should like to quote it in its entirety. Since it occupies seven closely written pages of foolscap, however, I have a feeling that it would occupy the whole of this page, if not more, and I must be content with pieces here and there.

He starts off as follows: "I see that you have referred several times to the question of mechanical versus electrical means of receiving television. If the views of an enthusiastic amateur are of any interest to you I should like to say that, in my humble opinion, both systems are very imperfect.

"Worry the B.B.C."

"My particular grouse is that the whole business of synchronisation has been left too much to look after itself. The average television enthusiast, nowadays, has no trouble in designing a receiver that will give him excellent pictures; but he has to worry far more about the means of keeping them steady than he does about improving the pictures.

"I know of heaps of imperfections in my own gear, but I can't get down to them and put them right, simply because I can't get a picture steady for long enough to have a real look at it and decide what forms of distortion are present.

"Please carry on and worry the B.B.C. until they go on the 'grid'—then we shall be able to synchronise from the mains, and at least half our troubles will be over."

What About It?

So far, so good. I agree with everything that he has said. It is fundamentally wrong that the synchronising problem should take up so much of the television enthusiast's time and energy. It ought to be possible for someone to produce a device that would hold an electric motor dead steady at 750 r.p.m., without the need for using a lot of elaborate gear. It's not an easy problem, but I am quite certain that some of the big brains could have solved it by now if they had really got down to it.

Fig. 1, on this page, shows a simple eight-pole phonic wheel, such as we could all use for mains synchronising if we were on the same supply as the B.B.C. I have it on good authority that people living in the Marylebone district have not the

slightest trouble in obtaining dead-steady pictures, using a similar arrangement to this and not making use of the 375-cycle synchronising signal incorporated in the 30-line transmissions.

Projecting the Picture.

The principle, of course, is exactly the same as that of the 30-pole wheel, except that one feeds 50-cycle A.C. from the mains through the synchronising coils. With 220-volt mains it is usual to employ a series resistance of about 1,200 or 1,400 ohms.

Now my reader comes out with another point.

"You have been talking about projecting pictures through a scanning disc on to a screen. Is there really much point in producing larger pictures? We all know that if you look at the scanning aperture

The detail, of course, is *not* improved, and one must not be too critical or look at it from too close a viewpoint. After all, one doesn't grumble at the crudity of the photographs in the daily newspapers and say that they won't stand looking at through a microscope!

A "viewing tunnel" is a great help when one is using the ordinary neon tube behind a disc. One single lens, out in the open, is all very well in a crude way, but you really want something to cut out the leakage of light round the sides of the disc. Fig. 2 shows how perfectly easy it is to improvise something of the sort.

Inherent Limitations.

The lens may be mounted in a kind of cardboard tunnel, the inner surfaces of which should be given a dull black finish. Proper viewing tunnels with two lenses are also obtainable at quite reasonable figures, and certainly do add to the comfort of "looking-in."

But the point that my reader wished to bring up still stands—that 30-line television is 30-line television, with all its limitations, however one views it or whatever one tries to do to it.

Since last week I have rebuilt my receiver, as I was dissatisfied with the H.F. side of it. It's all very well for the pundits to tell us that a flatly tuned receiver is the only one that will give satisfactory pictures.

Receiver Tuning.

When we had transmissions on Friday mornings flat tuning could be tolerated. Now, however, a receiver of that type brings in the television signal on London National, complete with two very fine beat notes and often two musical programmes from Turin and Moravska-Ostrava!

If one gets over this by using a commercial band-pass (three-gang) device one has to be very careful about the trimming operation, otherwise bad quality will result. Most readers will be familiar with the adjustment of such a device that gives "sereechy" quality up the sides of a carrier-wave, with very little top when it is correctly tuned in. Such an adjustment, of course, is absolutely useless for television, and one must be *very* particular about the way in which one carries out the trimming.

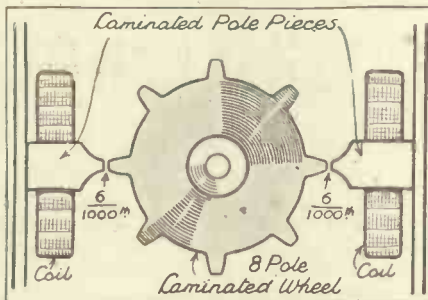
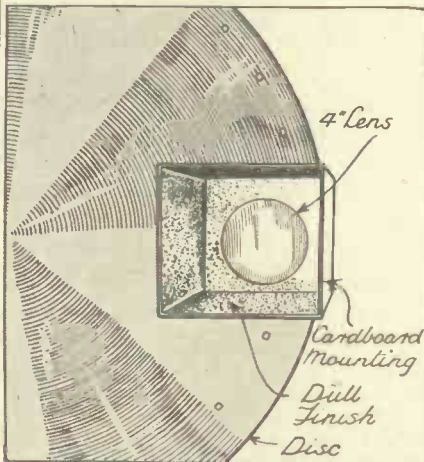

Fig. 1.—The 8-pole synchronising gear illustrated above would work satisfactorily on 50-cycle mains, and similar gear has been used successfully in the Marylebone district.

On the right (Fig. 2) is a single lens viewing tunnel which cuts out the leakage of light round the sides of the disc. It is made from cardboard.

## IMPROVING THE TELEVIEWER



of the ordinary 16-in. disc too closely you cannot make head or tail of the picture owing to the 'step effect.' Will such crude pictures really stand magnification?"

This question, incidentally, is being raised in several quarters. The fact of the matter is that it is simply more comfortable to look at a large picture from a distance of, say, six feet than it is to peer into a single lens over someone else's shoulder.

The Viewing Tunnel.

The large picture that one can obtain by projecting through a disc has the advantages of size and illumination, and can be viewed by a room half full of people, if so desired.

TELEVISION—Page 2.

## FURTHER HINTS ON SYNCHRONISING

More valuable data on the practical aspect of disc television reception.

IN previous issues I have been dealing with the effects on motor speed that one obtains when synchronising is used on a television viewer. Naturally, the subject of synchronising comes into television considerably, and the practical problems which one meets, when one studies the whole question of obtaining adequate synchronism, are extremely important.

Leaving the actual question of pictures out of it, the whole business, in a nutshell, is this: Can we make a motor revolve at exactly 750 revs. per minute for an indefinite period? And if we can't (and we certainly can't!) how are we going to help it to do so?

As we all know, a synchronising signal is incorporated in the actual television trans-

### CHECKING SPEED

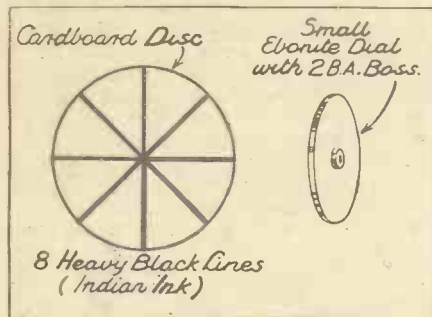

A simple method of making a stroboscope for checking the speed of the motor.

mission. A small portion of the picture is "blanked off" by means of a mask at the transmitting end, and this is responsible for introducing a very strong impulse into

ONE slight indication that the public is becoming "television conscious" is the fact that it is constantly alluded to in after-dinner speeches, debates and newspaper articles. Comedians constantly refer to it, and even cartoonists draw on it for "new" material.

And with all this one still hears the remark that "television is just round the corner." How long does a thing have to stay "just round the corner" before it may be said to be "with us"?

It's a funny thing, but we never hear anyone say "television is with us already," although it has been for years. I suppose "just round the corner" is more journalistic!

#### The Various Possibilities.

A keenly interested reader has asked me to make clear to him the advantages of high-definition television, with special reference to the point "When does it cease to be 'low-def.' and become 'high def.'?" That sounds like "Why does a chicken cross the road?" to me! The fact is that we have adopted these two arbitrary terms, and we don't really know what they mean.

They can only be comparative, but as there seem to be two complete groups of

the transmissions at the end of each strip of the picture. In other words, 375 times per second we have a strong impulse combined with the actual vision transmission.

We make use of this by means of our 30-toothed wheel, which I have already dealt with in some detail. Two pole pieces are mounted on either side of this wheel, and our signals are passed through two bobbins mounted on them in such a way as to exert a strong pull on the particular tooth of the wheel that is opposite each pole piece at the appropriate "split second."

The mechanical side of the matter is most important. For one thing, the pole pieces must be of opposite polarity, which means that the coils must be correctly connected. For another, their alignment with the teeth of the wheel must be very accurately carried out.

#### Checking the Revolutions.

Quite apart from this, our motor and disc must, obviously, be running at a speed which is as nearly correct as we can make it before we attempt any sort of control.

Most discs are equipped with some sort of stroboscopic device, which, when viewed in the light of a bulb or neon tube running from the 50-cycle mains, will tell us when the speed is nearly correct. Incidentally, if your disc is not so equipped, you can easily make such a device for yourself. I had to do so recently, and I used the little improvisation shown (left), with a cardboard disc mounted on an old ebonite dial.

Now look at the other sketch, showing one side of the toothed wheel and one pole piece. Most kits of synchronising gear are so arranged that a very easy adjustment of the pole-piece position is possible. With the smallest possible clearance each pole piece should be mounted so that it is exactly opposite one tooth of the wheel. This is important.

Having arranged this, rotate your disc till the wheel is in the position shown, i.e. with each pole piece between two teeth. When you switch on your receiver the D.C. flowing through the bobbins should

exert a sufficiently strong pull to move the wheel round a few degrees so that the nearest tooth takes up a position opposite the pole piece.

#### The Coil Connections.

If you have this amount of "pull" you may be fairly certain that your synchronising gear will be a big help to the success of your viewer. You may, by this same simple experiment, find out whether your two coils are correctly connected in series.

Or you may use a pocket compass to make sure that one pole piece registers "south" and the other "north." If they are of the same polarity, simply reverse the connections to one of the coils.

### TEST YOUR SYNCHRONISER

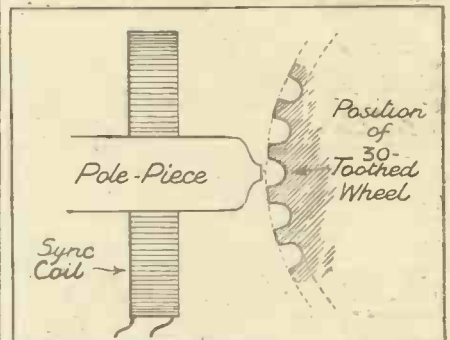

Test your setting by passing anode current through the pole windings, with the wheel and pole piece set like this. The pull of the pole piece on the wheel should move the latter so that a tooth comes opposite each pole face.

It is decidedly useful to install a switch to cut the synchronising gear out of circuit, the simplest way being to "short" it out. As outlined in a previous issue, you can devote your energies to obtaining a powerful "pull" on your toothed wheel, by careful adjustment of the alignment and by reducing the clearance between the pole pieces and the teeth until you are working at the bare minimum.

## TELEVISION JOTTINGS

Points of interest to all readers.

transmissions, with the B.B.C.'s 30-line system on one side and the newly developed 180- and 240-line on the other, without much in between, the question answers itself.

#### American Opinions.

Investigations have recently been carried out in America concerning the number of scanning lines necessary for the transmission of various scenes, and nothing below 120 lines is considered really adequate for anything.

"120" gives excellent close-ups and small groups of figures with very fair detail. Large-stage spectacles or outdoor scenes are considered to require 240 to 480 lines. Really large efforts, such as crowd scenes, to be really adequately dealt with, are said to require something up to 800 lines!

"30" is considered as just a kind of childish hobby, adequate for fairish close-ups and rather crude small groups, but of no use for anything else.

With the present technique it is inconceivable that even 180-line television could be carried out in any part of the spectrum but the very short wave bands. Even down there 800-line transmissions would constitute quite a serious problem.

Is it possible that everyone is barking up the wrong tree and that some revolutionary invention will upset the entire apple-cart by making high-definition transmission possible with simple apparatus and a narrow frequency band? More startling things than this have been happening ever since radio was first discovered.

#### What We Want.

What we are all looking out for is a system which renders scanning, as we now know it, obsolete. It must surely be ordained that someone, in the future, will hit upon a method for "sectionalising" a picture with less complication than is involved by 240-line scanning.

But how long is it to be, I wonder, before someone comes with that other brain-wave that we are all waiting for—a method of improving the quality of a picture without increasing the number of scanning lines?

L. H. T.



**IMPORTANT** Miscellaneous Components, Parts, Kits, Finished Receivers or Accessories for Cash or C.O.D. or H.P. on our own system of Easy Payments. Send us a list of your wants. We will quote you by return. C.O.D. orders value over 10/- sent carriage and post charges paid (GREAT BRITAIN ONLY). Hire purchase terms are NOT available to Irish and Overseas customers.

**S.T. ROLA P.R. 5**

AS SPECIFIED FOR THE S.T. 600

With universal tapped transformer. Send only 2/6, balance in 10 monthly payments of 3/-. Cash or C.O.D. Carriage Paid, £19/6.

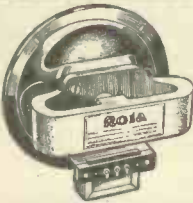

**NEW GARRARD A.C. 6. INDUCTION ELECTRIC MOTOR**

Complete with 12" turntable, 12" Unit Plate and fully automatic Switch. For A.C. mains only. Send only 2/6; balance in 11 monthly payments of 4/-. Cash or C.O.D. Carriage Paid, £22/6.



New Garrard A.C. 4 A.C. Mains Electric Motor. 12-in. turntable, motor plate, automatic stop. Cash or C.O.D. Carriage Paid, £22/6, or 2/6 down and 11 monthly payments of 4/-.  
New Garrard Model 202a. 12-in. turntable. Electric motor for A.C. Mains. Cash or C.O.D. Carriage Paid, £210/0, or 5/- down and 10 monthly payments of 5/.

**PIFCO ROTAMETER**

5/- DOWN

8 ranges, making possible over 100 tests. For Mains or Battery. In case, complete with leads. Send only 5/-; balance in 9 monthly payments of 3/-. Cash or C.O.D. Carriage Paid, £19/6.



De Luxe Moving-Coil Model. Cash or C.O.D. Carriage Paid £22/0, or 2/6 deposit and 11 monthly payments of 4/.

**Peto-Scott Guaranteed H.T. ELIMINATORS**

For A.C. Mains, 200/250 volts, 3 Tappings: S.G. 60-v. Detector 80-v. Power 120/150-v. Output 250 v. Incorporates Westinghouse rectifier. Send only 2/6, balance in 9 monthly payments of 4/-. Cash or C.O.D. Carriage Paid, £115/0.



D.C. Model for D.C. Mains only. Similar specification, but without rectifier. Cash or C.O.D. Carriage Paid, 17/6, or 2/6 deposit and 7 monthly payments of 2/6.

**GRAHAM FARISH RAIDER 3 KIT**

Complete Kit of parts for building, less valves and cabinet. Send only 5/-. Balance in 11 monthly payments of 6/3. Cash or C.O.D. Carriage Paid, £37/6. If valves and cabinet required, add £218/6 to Cash Price, or complete for 11/3 deposit and 11 monthly payments of 11/3.



**PILOT CLASS 'B' 4 KIT**

Complete Kit of parts for building, less valves and cabinet. Send only 5/-. Balance in 12 monthly payments of 6/-. Cash or C.O.D. Carriage Paid, £310/0. If valves and cabinet required, add £223/6 to Cash Price, or complete for 12 monthly payments of 10/6.

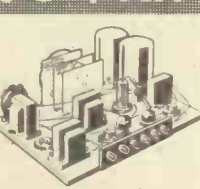

**PILOT AUTHOR KIT EXACT TO SPECIFICATION**

**WARNING** Don't be misled—ONLY PILOT AUTHOR KITS contain the identical parts as used by Mr. John Scott-Taggart in BRAND NAMES as well as values. BUILD WITH A PILOT AUTHOR KIT and duplicate Mr. John Scott-Taggart's results.

**S.T. 600 BATTERY VERSION**

**KIT "A" £4:19:6 OR YOURS**  
CASH or C.O.D. Carriage Paid FOR

**7/6**

Deposit and 12 monthly payments of 8/6

For full and detailed lists of parts, see our previous advertisements, Oct. 27, Nov. 3, 10 and 17.

**KIT "A"** Comprising complete kit of components, as first specified by Mr. John Scott-Taggart, including Peto-Scott ready-drilled Walnut-faced Panel, Metaplex baseboard, Ready-drilled plywood platform and Terminal Strip, and copy of "Popular Wireless" with free full-size blue print and S.T.'s 100 STATION "SPOT-ON" DIAL and other "P.W." FREE GIFT, less valves, cabinet and speaker.

**KIT "B"** As for Kit "A" but including set of 4 first specified valves, less cabinet and speaker. Cash or C.O.D. Carriage Paid, £74/0, or 12 monthly payments of 13/5.

**KIT "CT"** As for Kit "A," but including valves and Peto-Scott S.T. 600 Table Cabinet, less speaker. Cash or C.O.D. Carriage Paid, £81/6, or 12 monthly payments of 14/9.

**KIT "CC"** As for Kit "A" but including valves and Peto-Scott S.T. 600 Console Cabinet, with speaker baffle and battery shelf, but less speaker. Cash or C.O.D. Carriage Paid, £819/0, or 12 monthly payments of 16/8.

**PETO-SCOTT S.I. 1935 Permanent-Magnet Moving-Coil Speaker** recommended; If required, add 1/9 to deposit and each monthly payment.  
If W.B. Stereorian Standard Speaker required, add £112/6 to Cash Prices, or 3/- to each monthly payment.

**S.T. 600 FINISHED INSTRUMENTS and CABINETS**

**FINISHED INSTRUMENT Console Model** (as illustrated). Exact to Mr. John Scott-Taggart's First Specification. Aerial tested on actual broadcast.

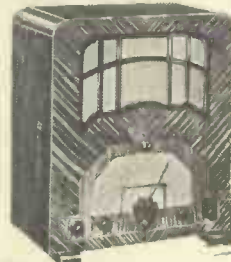

With B.V.A. valves and Peto-Scott S.I. P.M. moving-coil speaker. In Peto-Scott Cabinet, as specified and used. Cash or C.O.D. Carr. Paid, £111/0, or 12 monthly payments of 21/3.

**CABINET**

Console Model (as illustrated). With baseboard and battery shelf. Cash or C.O.D., 35/- (Carriage and part packing 2/6 extra). Or yours for 5/- and 6 monthly payments of 6/- including carr. and packing).

**FINISHED INSTRUMENT Table Model** (as illustrated). Exact to Mr. John Scott-Taggart's First Specification. Aerial tested on actual broadcast. With B.V.A. valves. In Peto-Scott Cabinet, as specified and used. Cash or C.O.D. Carriage Paid, £912/6, or 12 monthly payments of 17/9.

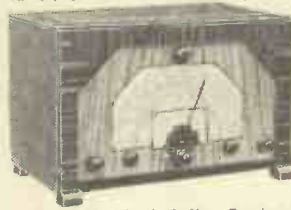

**CABINET** Table Model (as illustrated), with lift-up lid. Cash or C.O.D., 17/6 (Carr. and part packing 2/6 extra). Or yours for 2/6 and 4 monthly payments of 5/- (including Carriage and Packing).

**S.T. 600 A.C. Walnut CABINET** Another brilliant example of Peto-Scott's cabinet craftsmanship and supremacy, specified for the A.O. 30/- version of the S.T. 600. Cash or C.O.D. 30/-

**S.T. 600 STRUCTAKIT**

Comprising Peto-Scott Ready-Drilled Walnut-faced Panel, 16 in. x 9 1/2 in.; Metaplex Baseboard, 16 in. x 10 in.; Ready-Drilled Terminal Strip, 16 in. x 3 in. and Platform, 4 in. x 4 in. Exactly as FIRST specified by Mr. John Scott-Taggart. Cash or C.O.D. 6/6. With FREE copy S.T. 600 issue "P.W.," including S.T.'s 100-STATION "SPOT-ON" DIAL and other "P.W." FREE GIFT. Postage 6d. Extra.

**6/6**

**S.T. 400 to S.T. 600**

Comprising all FIRST Specified S.T. 600 Components necessary to convert your existing S.T. 400 to the S.T. 600, including copy of "Popular Wireless," Oct. 27th, 1934, with full-size Blue Print and S.T.'s 100-STATION "SPOT-ON" DIAL and other "P.W." FREE GIFT. SEND FOR DE-YOURS FOR TAILED LIST OF PARTS SENT BY RETURN OF POST. Cash or C.O.D. Carriage Paid, £38/6 or 12 monthly payments of 6/3.

**6/3**

**S.T. 500 to S.T. 600**

Comprising all FIRST Specified S.T. 600 Components necessary to convert your existing S.T. 500 to the S.T. 600, including copy of "Popular Wireless," Oct. 27th, 1934, with full-size Blue Print and S.T.'s 100-STATION "SPOT-ON" DIAL and other "P.W." FREE GIFT. SEND FOR DE-YOURS FOR TAILED LIST OF PARTS. SENT BY RETURN OF POST. Cash or C.O.D. Carriage Paid, £38/0 or 12 monthly payments of 6/3.

**6/3**

**S.T. 600 A.C. VERSION KIT "A"**

CASH or C.O.D. £9:15:0 Carriage Paid OR YOURS FOR Balance in 11 monthly payments of 17/9

Comprises complete Kit of Components as FIRST specified by Mr. John Scott-Taggart, including ready-drilled terminal strip and Metaplex baseboard, less valves, cabinet and speaker.

**KIT "B."** As for Kit "A," but including set of 3 Specified Valves. Cash or C.O.D. Carriage Paid, £12/8/6. Or yours for 22/9. Balance in 11 monthly payments of 23/-.

**KIT "C."** As for Kit "A," but including Valves and Specified Peto-Scott A.C. S.T. 600 Cabinet with Speaker Baffle and Mains Unit Shelf, less Speaker. Cash or C.O.D. Carr. Paid, £13/18/6. Or yours for 25/6. Balance in 11 monthly payments of 25/9.

**VALVES:** Set of 3 Specified Valves, £214/6, or 5/- deposit and 9 monthly payments of 6/-.  
Rola Speaker if required with the above, add £115/0 to Cash or C.O.D. price, or 3/3 to deposit and each monthly payment.

**PETO-SCOTT Co. LTD.** 77, P.W.4., CITY ROAD, LONDON, E.C.1. Phone: Clerkenwell 9406/7  
West End Showrooms—62, HIGH HOLBORN, LONDON, W.C.1. Phone: Holborn 3248

*Buy by Post—its Quicker—CASH—C.O.D.—EASIWAY*

# THE B.B.C. by LOOKER-ON A SURVEY

We are publishing from time to time articles forming a series on British Broadcasting. This is the third article, and it emphasises that programmes should hold the seat of major importance and also that broadcast aspects of the material transmitted should receive greater consideration.

FROM administrative organisation let us turn our inquisitive eyes towards the problem which most nearly concerns the average listener—that of the composition and handling of the programmes themselves.

It is perfectly true that the B.B.C. programmes, taken as a whole, are so superior to those produced by any of their foreign rivals that the Corporation may be justifiably proud. But pride must not be allowed to degenerate into complacency, and it is precisely this danger which is becoming ominously apparent. Some enormous and astonishing strides have been made. But a broadcasting organisation, like a bicyclist, can only keep going by movement. It must neither slumber nor sleep. The good can never be enough. For the possibility of the better is always there for investigation and experiment.

## The Engineering Department

To begin with, and as a general point, it seems unsatisfactory that the influence of programmes upon the B.B.C. as a whole is so definitely that of the junior partner. Administration must clearly issue the orders. But should administration also decide what the orders should be? More vital still, should the influence of the Engineering Branch be so unquestioned? The B.B.C. engineers are first-class men at their jobs. The technical service has a superb record. But engineers exist to enable programmes to reach the listener as clearly and efficiently as possible. They are the means to that end. Just as administrators are there to see that the machine which enables programme builders and producers to function runs well and easily.

As things stand, engineering and administrative branches both usurp influence and functions which are not properly theirs. Such things as studios and microphones are technical equipment. But they are used by programme builders and producers, who not only may have, but must have, ideas about them of the most vital importance.

## Closer Co-operation Required

The liaison between the Engineering and the Programme Branches needs tightening, and the former should be compelled to consult the latter, not as a matter of courtesy but of common sense, before new studios are built in a certain way or new types of microphone are installed. It is true that a Microphone Development Committee exists for this purpose, but its inception has admitted the reality of the problem without solving it. The Controller of Pro-

grammes might do worse than demand a higher professional recognition of the importance of his division as a whole. Most people since the Great War have joined Mr. Bernard Shaw in his profound conviction of the limitations of all experts—unless their special subject is unqualified by outside circumstance of any kind.

The most serious criticism that can reasonably be levelled against the programme branches at Broadcasting House is that more than a few of them forget that their principal business is broadcasting.

The worst offenders in this matter are undoubtedly the Music and the Variety

## CHIEF OF ADMINISTRATION



This is Vice-Admiral Sir Charles Cpendale, C.B., who is in charge of the administrative staff of the B.B.C. This section of the Corporation is looked upon as the "senior partner," but our contributor questions whether this arrangement is satisfactory from the point of view of the programmes.

Departments. The engagement of the celebrated dancing troupe and the staging of the Variety Show at the Radio Exhibition are but two examples of this attempt to imitate the theatre, which of course can never be successful. Radio officials no doubt weary of lack of audience and limelight. They are human. They like performances in public and addition of sex appeal to St. George's Hall Shows. But in the eyes of the average listener, who has accepted the studio

audience as a necessary evil due to the idiosyncrasies of the artists who refuse to learn how to broadcast, these things are waste of time, money and effort that could well go to improving material which is directed to the Corporation's proper audience.

Similarly, musical shows show a disquieting tendency to be accepted for broadcast production almost as "trailers" to enable film magnates to judge of their screen possibilities. Such a situation is Gilbertian and requires immediate liquidation. The Variety Director is one of the ablest of the B.B.C. staff. His energy and hard work compel admiration and respect. But he must turn his eyes away more steadfastly from the lures of stage and screen.

## The Musical Programmes

The Music Department has probably never been broadcast-minded. Professional musicians must staff it, and professional musicians are a clammy and singular lot of people. They will no doubt affirm that their department has done music in this country no end of good. And, *pace* Sir Thomas Beecham, they are right.

They point proudly to magnificent series of concerts, with fine artists and great conductors; to the creation of the best Symphony Orchestra in England; to the compliments paid to them by foreign musical organisations.

All these things are true enough, but the musical department of the B.B.C. have never—with the possible exception of studio opera—conceived of the broadcasting of music except in terms of enabling people outside concert halls to listen to what goes on inside them. They have never thought that the form of the average concert may be dull, or ineffective, or the wrong length from the broadcasting point of view.

## Operatic Broadcasts

They think of music first and of broadcasting music second. Which is natural enough in musicians, but is deplorable in the case of these musicians. In particular, the opera problem must be reconsidered in studio terms. Opera is particularly susceptible to broadcast treatment. Its stage form is conventional, its visuality quite inessential. It has been proved that classic drama can be transferred satisfactorily to the studio, if sufficiently adapted and cut by experts who have studied the particular requirements of the microphone at one end and the blind audience at the other. Opera must follow this example. Then there would be less complaint of the service supplied so ungrudgingly to a small minority of listeners interested in modern music.



# Short Waves And Long Distance for All

DO you like Amos 'n' Andy? Funny; so do I. When the day is nearing its end and I want a really satisfying epilogue there is nothing I like better than to make myself thoroughly snug in front of the fire and to listen to the misfortunes—or should I say fortunes?—of those most popular of all American microphone turns.

And then, you suppose, I wake up. Not a bit of it! Then it must be a relay? Don't you believe it! Just honest-to-goodness long-distance loudspeaker reception whenever I want it. Nothing complicated—nothing fiddling to tune. Just simple and inexpensive apparatus and the whole wide world from which to select my broadcast entertainment.

It's got to such a stage in my household these days that my wife almost turns up her nose if I descend to tuning in the locals for a change, and there is simply no kick left in Luxembourg on Sunday mid-days. She shows the most utter contempt for anything that isn't extra-European! My own fault, of course, for it must be months since I have listened to "one of the continentals." And I suppose the great attraction is that she can do it herself.

I smile to think of the exhilaration she must get out of being able to remark casually to her friends: "That's America, my dears."

Yes, short waves for me every time for real fun. There's nothing like them for fascination and really endless entertainment. And what freedom by comparison with broadcast waves! Freedom from Europe—freedom from its heterodynes and other congestion. If only our ordinary broadcast stations used short waves! Who knows? They may do, in fact, they may have to one of these days.

### Endless Possibilities.

After all, short waves do hold out endless possibilities, don't they? Perhaps you don't see why. Well, let us just cogitate on the whys and the wherefores for a few minutes.

As W. L. S. explains elsewhere this week, for interference-free reception it is essential for every station to have a 9-kilocycle band all to itself. So that if, to simplify our calculations, we assume that the medium waveband extends from 200 to 600 metres, then between 200 metres, which represents a frequency of 1,500 kilocycles, and 600 metres, which corresponds to a frequency of 500 kilocycles, there is a band

of frequencies 1,000 kilocycles wide available for broadcasting.

In other words, since every station must have a 9-kilocycle channel all to itself there is room between 200 and 600 metres for 1,000 divided by 9 stations, which equals 111. But there are already many more than 111 stations in Europe, with the sad result that a certain amount of overlapping is inevitable—overlapping which makes itself manifest in the form of heterodyne whistles and "monkey chatter."

But with short waves it is a very different

reception short waves are eminently suitable. They are used by our own Post Office for the transatlantic telephone service; they are used by governments for commercial traffic; they are used by our own Broadcasting Corporation for the transmission of programmes to the remote parts of the British Empire; and yet they are practically useless at the present stage of development for an essentially local service.

And the reason for that is what is known as the "skip" effect.

When a station is transmitting, the aerial radiates what is known as a direct ray and an indirect ray. The direct ray, which is the one by which we receive our local broadcasting, travels over the earth's surface, and, due to the fact that it is absorbed by buildings, mountains, etc., it never gets very far, the actual distance depending mainly upon the power of the transmitting station and the nature of the

surrounding countryside.

But it has the advantage of reliability, and in general it is not subject to fading, so that it is eminently suitable for purely local broadcasting.

The indirect ray, on the other hand, is radiated at an angle from the earth's surface, and were it not for the existence of what is known as the Kennelly-Heaviside Layer it might never come down to earth again.

But the fact that this layer exists causes the indirect ray to be reflected down to earth again, with the result that listeners hundreds of miles away are able to hear it.

### The Reflected Ray.

But the angle at which the indirect ray is propagated and the relative strengths of the direct and indirect rays vary very considerably with the wavelength. On ordinary broadcast waves it is the direct ray which provides the programme service and the indirect ray is of quite secondary importance. But on short waves it is the indirect ray which carries the transmission, for the direct ray, in this case, is to all intents and purposes non-existent.

Bearing in mind the fact that the indirect ray is propagated at an angle from the transmitting aerial, and that it may be hundreds of miles before the reflection comes down to earth again, it will be seen that, in the absence of a direct ray, listeners fairly near to the station may hear nothing at all, whereas those perhaps thousands of miles away will hear all that there is to be heard! That's how I hear Amos 'n' Andy.

(Continued on next page.)

The rapid strides that have recently been made in the technique of short-wave reception, coupled with the tremendous increase in the number of stations available, have brought really long-distance loudspeaker reception within the reach of all. The unlimited possibilities of this fascinating field are discussed in this special article

By G. T. KELSEY.

proposition, for between 30 metres, which corresponds to a frequency of 10,000 kilocycles, and 50 metres, which is the equivalent of 6,000 kilocycles, there is room for nearly 450 stations all spaced by the requisite 9 kilocycles, and by extending the band to from 20 to 60 metres it would be possible to accommodate nearly 1,200 stations!

Why, then, is it not done?



The author of this article, who was the originator of the short-wave-adaptor idea, is here seen at work on the experimental model of his latest adaptor, which is to be described in detail in the next issue of "P. W."

The main reason is that there are still many problems connected with short-wave reception which have yet to be overcome before a satisfactory "local" service could be instituted.

That brings us to the main point of this present article. For real long-distance

## SHORT WAVES AND LONG DISTANCE — Page 2.

It seems almost absurd—doesn't it?—and yet if you have a glance at the diagram on this page you will see just exactly what happens.

The listener with receiving aerial number one will hear the direct or ground ray only—that is, providing the station is using a wavelength on which there is a reasonably strong direct ray. But if the station transmits on short waves, then the listener with receiving aerial number two will hear the programme, and receiving aerial number one will receive little or nothing. In other words, aerial number one is within the "skip" distance so far as the short-wave transmission is concerned.

## Short-Wave "Locals."

The impossibility of establishing a local broadcasting service on short waves will be apparent from these considerations; but perhaps, and as a solution to the present European ether-congestion trouble, the time may come when the local station is situated sufficiently far away from those to whom it is to provide a service to avoid the skip effect. In that case the greatest argument against the use of short waves for ordinary broadcasting would be overcome.

The other great difficulty—that of fading—can be overcome by the design of suitable receiving apparatus. Fading is caused mainly through differences in the reflecting properties of the Kennelly-Heaviside Layer, and those differences can be compensated for by the use of efficient automatic volume control.

It would seem that sooner or later the use of short waves for broadcasting is inevitable, but until that time the reception of European broadcasting is going to become less and less worth while.

As the number of stations increases the heterodynes will become steadily worse and worse, and the fascination of having a set that will receive every station in Europe will diminish because so few of the stations will be worth listening to.

Now, this is not intended as a "scare" article. But, in view of present conditions, and facing what seems to be almost an inevitable possibility of even fewer European alternatives in the future, why not try to reach out a bit like I do? Why not leave Europe with its heterodynes and ether congestion behind and sample programmes from America, from Africa, from Australia; in fact, from all parts of the world?

## "Anyone Can Do It."

Can you do it? Of course you can do it! Anyone can do it these days with the right apparatus, and for the very same reason that short waves are unsuitable for a local programme service! The programmes are there waiting for you to tap them, and as soon as you rid yourself of the idea that short waves are intended simply for the experimenter the sooner will you be able to make the world your broadcast playground.

Short-wave reception to-day is very different from what it was even twelve

months ago. Not only are there many more stations available, but reception technique has improved to such an extent that short waves are now within the reach of every ordinary broadcast listener.

And all this is not just airy imagination. My assurances are based upon my own experiences over a period of some months now, and they are confirmed by that wizard of short-wave technique, W. L. S., with whom I have been collaborating.

Let me give you an example of what I mean. I use Pittsburg, Pennsylvania, and

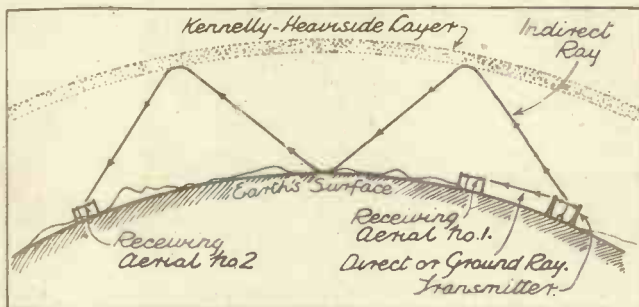

The reflected or indirect ray is the one that carries the programme to listeners on short waves, and to nearby listeners the station is often inaudible, due to what is known as the "skip" effect.

★ THE NEXT ISSUE OF "P.W." WILL BE  
THE SHORT-WAVE EVENT  
OF THE NEW YEAR

FOR IN ADDITION TO CONTAINING  
TWO MAGNIFICENT GIFTS

There will be full working details of  
The 1935 Kelsey Adaptor,

A simple unit that will transform any  
existing set into a short-wave superhet.

And the W.L.S. Masterpiece  
The "B.C.L." Two.

A magnificent 2-valve short-waver.

ORDER YOUR COPY NOW AND  
AVOID DISAPPOINTMENT.



The new station building of the short-wave station at Bangkok, Siam, is very eastern in effect. So, too, are the programmes, which can often be heard in this country.

Bound Brook, New Jersey, as my alternatives to the local stations, and I get them at loudspeaker strength every time I switch on! Yes, I hear Amos 'n' Andy any night I want to at sufficient strength and constancy to be thoroughly amused by their cross-talk and almost oblivious of the 3,000-mile radio link between us.

I listen to the United States Army Band direct from Chicago; I hear news items which I am not able to read about in our papers until the next day; in fact, whenever I want a really bright radio half-hour I tune in to the short waves. And it's child's play with a vengeance!

How do I do it? Simply by means of my 1935 short-wave adaptor attached to an ordinary broadcast receiver. From letters which I have received I know that many readers of "P.W." are at present using my previous adaptors. Well, all I want to say at this juncture concerning the new one is that it has got all the old ones beaten to a frazzle!

## Delightful Results.

It is an easy-to-control superhet—from the point of view of operation—and yet it uses a single valve. It is not an autodyne, and it gives... but there! This time next week you will know all that there is to be known about it, for a full description is to be published. Suffice it, therefore, to say at the moment that I have been working on this latest model for months, and I am simply delighted with it.

I claim that it can be used successfully with any existing broadcast receiver, whether battery or A.C. mains operated. While that is perfectly true, perhaps I should add that it is most desirable that the set to which the unit is to be connected should have one or more H.F. stages unless it is of the superhet type.

But surely that applies to all existing types of sets, for I can hardly believe that there are any "straight" sets in existence these days without H.F. If there are, then, unless there is something very remarkable about them, it is high time they were scrapped in favour of something more suitable for modern conditions.

As a matter of interest, technically my new adaptor can be used even with a straightforward "det.-L.F." type of receiver, but I am purposely insinuating that it cannot because I am so anxious that you should all experience just how good short-wave reception can be when carried out under proper conditions.

When used with a straightforward "det.-L.F." combination, my 1935 adaptor is better—although not vastly better—than previous ones I have described. But when used in the manner I advocate, its capabilities are astonishing, and the ease with which short-wave stations in all parts of the world can be tuned in on the loudspeaker is most gratifying.

## Full Details Next Week.

W. L. S., too, has been burning the midnight oil for some months past in the great cause of short waves and long distance for all, and he has succeeded in producing a design—a really hot-stuff design—for all those who prefer the idea of a separate set for short-wave work.

Just to what extent we have both been active you will know from the next issue. For many reasons the January 19th issue of "P.W." is the short-wave event of the year. Be sure you do not miss it.

# Some Facts About L.F. Transformers

A few details regarding one of the most important components used in modern radio-receiver construction.

By SYDNEY J. AUSTIN.

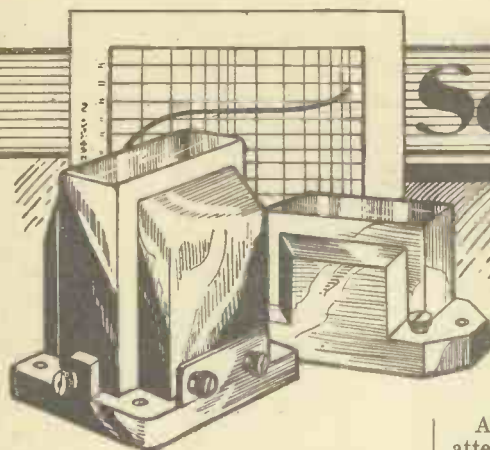

**T**HE modern L.F. transformer is not a very inspiring component to look at, and there is very little about it to make the amateur pause and ponder.

It is, however, quite obvious that the transformer has a most important job to do in the receiving circuit.

In order to be as accurate as brevity will allow we may say that a transformer alters the "character" of the electric power that is fed into it.

This power is, as you know, measured as so many watts.

One of the axioms about electricity that we have to bear in mind is that power cannot be created or destroyed—we can waste it or we can change its nature to suit some existing need, but we cannot produce it in a "Hey presto!" fashion or conveniently lose an excess of it.

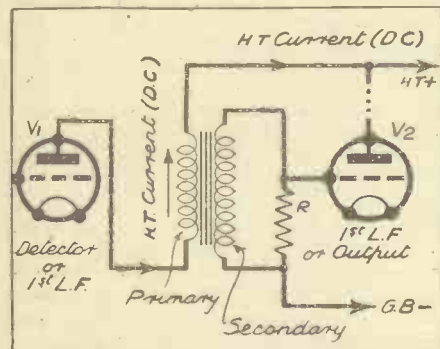

Frequency distortion may be introduced by allowing the anode current to flow through the primary of the transformer, and also if the resistance (R)—which is sometimes used to stabilise the circuit—is too low in value.

In the average L.F. amplifying circuit the "existing need" is to feed an alternating signal voltage to the grid of an amplifying valve.

This voltage has to be derived in some way from the alternating current output of the previous valve; to do this we can employ an L.F. transformer.

### Large Voltage Needed.

If we applied the signal current directly across the grid and filament of the amplifying valve we should, since the grid filament resistance is high, get a voltage difference across them, but this would be very small and would not nearly load a modern L.F. valve.

We want to make this voltage as large as the valve will handle so that we shall get the greatest possible amplification of the signal.

At first sight it looks as if we have to attempt the impossible and create some extra power; but, since watts = volts × amps., we can increase the volts by cutting down the amps. in proportion and still use only the same number of watts.

Here is a simple numerical example that will explain the procedure:

$$2 \text{ watts} = 1 \text{ volt} \times 2 \text{ amps.} \dots (1)$$

$$\text{and } 2 \text{ watts} = 2 \text{ volts} \times 1 \text{ amp.} \dots (2)$$

In both cases the power employed is only 2 watts, but in (2) we have twice as many volts as in (1).

The transformer does the above job for us to the exact degree that may be required.

That this degree varies very widely accounts for the fact that so many different ratios and types of L.F. transformers are available.

For instance, for a straightforward first-stage L.F. amplifier a step-up ratio of 1:3.5 may be used—i.e. the voltage derived from the transformer will be three and a half times the voltage that is fed into it.

### The Case of Class B.

But for Class B we need to draw an appreciable current from the transformer secondary, so it is necessary to use a step-down ratio in order to reduce the volts and have more amps. (that is, current) available.

So far we have assumed that a transformer is 100 per cent efficient and that we can take out just as many watts as we put in.

As with all machinery and electrical apparatus, transformers are not quite so economical and obliging, and another factor—known as the "Power Factor"—has to be taken into consideration.

In practice, watts—in A.C. circuits—are not exactly equal to the product of volts and amps., but have to be expressed as:

$$\text{Watts} = \text{volts} \times \text{amps.} \times k,$$

where "k" is the Power Factor of the circuit.

Obviously, if  $k = 1$ , then the circuit, and in our particular case the transformer, must be 100 per cent efficient, and it is the aim of designers to get as near to this figure as possible.

Actually they have succeeded to a large extent, and "k" does not bother us very much; it depends for its approach to unity on attention to detail, in building the transformer, on the way in which the wire is wound—either "side by side" or in layers, etc.—and also on the amount and

quality of the metal used in making the transformer core.

Incidentally, it is interesting to compare the size of the present-day transformer with that of a similar article designed about five or six years ago.

More suitable metals than the soft iron that used to be employed as a core have been discovered, and the result is that bulk and weight have been cut down enormously without adversely affecting efficiency.

The idea that distortion was inevitably linked with the use of transformers was widely held up to a few years ago.

However true that may have been, it cannot be said to hold good to-day.

### How Distortion Can Occur.

It is as well, though, to realise how distortion can occur, because carelessness in design or choice of transformer ratio may produce very unpleasant results.

The most common form of distortion traceable to transformer trouble is so-called "frequency distortion."

When this occurs certain notes are being treated disproportionately by the transformer. If the step-up is nominally 1:3, high and middle notes may receive this gain, while bass notes are only increased by 1:2 or even less.

Obviously, the reproduction will be unbalanced.

Common causes—apart from bad transformer design—of this form of distortion are the passing of too much D.C. current through the primary winding (indicated in one diagram) or a low resistance across the secondary, causing attenuation of bass and high notes respectively.

Another kind of distortion is "amplitude distortion"; it is more or less rare nowadays, and is seldom met with unless

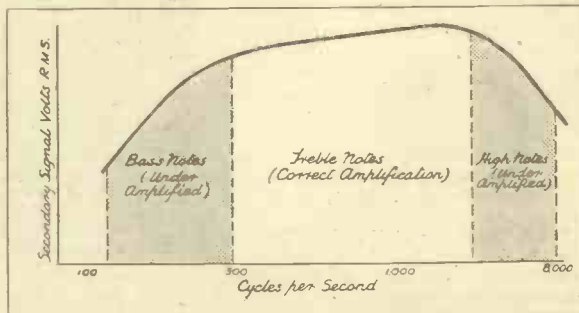

The sort of frequency-output curve that would result from the faults shown in the other diagram.

entirely unsuitable transformers have been chosen for intervalve coupling.

In this case loud notes are receiving  
(Continued on page 623)

# RADIOTORIAL

The Editor will be pleased to consider articles and photographs dealing with all radio subjects, but cannot accept responsibility for manuscripts or photos. Every care will be taken to return MSS. not accepted for publication. A stamped, addressed envelope must be sent with every article.

All Editorial communications should be addressed to the Editor, POPULAR WIRELESS, Tallis House, Tallis Street, London, E.C.4.

All inquiries concerning advertising rates, etc., to be addressed to the Advertisement Offices, John Carpenter House, John Carpenter Street, London, E.C.4.

The constructional articles which appear from time to time in this journal are the outcome of research and experimental work carried out with a view to improving the technique of wireless reception. As much of the information given in the columns of this paper concerns the most recent developments in the radio world, some of the arrangements and specialities described may be the subjects of Letters Patent, and the amateur and the trader would be well advised to obtain permission of the patentees to use the patents before doing so.

## QUESTIONS AND ANSWERS

### SCREENING TO PREVENT H.F. INSTABILITY.

C. E. F. (Wolverhampton).—"A friend has asked me to look over a set which has been giving him a lot of trouble, and as it has rather got me beat I wish you to tell me if you think it is H.F. instability that is causing the fault."

"There is a lot of unwanted oscillation, independent of the reaction, the set being S.G., detector (with leaky-grid rectification) and transformer-coupled pentode."

"Also the set goes weak and quiet sometimes, apparently being held in check by something or other which I put down as instability."

"I find that it is perfect if the lead to the anode terminal of the S.G. valve is disconnected and the set worked as pentode and detector only. But, of course, this is not capable of giving the power of the three valves, and I want to bring in the S.G. as well, working properly."

"Would I be right in assuming that this is a case of H.F. instability, and applying the remedies you have recommended for that?"

"More screening would be of benefit, I feel, as the leads are a little too close by 'P.W.' set standards. If you agree, what leads ought I to pay special attention to?"

We agree with your diagnosis, and think that if you treat for H.F. instability you will get over the trouble completely.

The most important leads to watch are the following: From fixed vanes of ganged condenser to the coil terminals and the grid leads of the S.G. valve; from the anode of the S.G. valve to the condenser; and in general detector-grid and all H.F. input wiring (aerial terminal connections, H.F. coil connections, etc.).

The lead to the anode of the S.G. and those from the fixed vanes of the condenser should be encased in screened sleeving, the outer covering of which should be earthed to the metallised baseboard.

If this is at present unscreened we should dismount the whole H.F. stage and remount on foil, securely connected to a screen isolating the H.F. stage.

### WAS IT THE L.T. BATTERY?

T. S. (Hertford).—"I bought the L.F. valve the first week in December, and at first it was like a new set. But just before the holiday it got weak again, as with the old valve."

"Now they say at the shop that the valve has been maltreated—excessive voltage. Would the cause of this be the old L.T. battery?"

"It has been going four and a half years, and there is a sort of thick deposit at the bottom, but otherwise it looks O.K. I had it tested when the valve was new, and it was then well up as regards voltage."

"It is getting expensive to keep buying, so I should like to know."

The sediment at the bottom of an accumulator is generally of little practical consequence, unless it is so copious that it connects the bottoms of adjacent plates together. And, in any case, it would not give excessive voltage.

The likeliest source of the trouble is insufficient grid bias. Make sure the voltage of the G.B. battery is O.K.

### LOW RESISTANCE IN THE OUTPUT CIRCUIT.

T. P. S. (Stockton-on-Tees).—"In addition to the condenser and resistance which are joined together and placed as a pair across the output transformer's primary, there is another resistance in the pentode's output circuit."

"In the sketch this is placed with one side of it connected to the anode of the pentode, which is not joined to anything else. The other side of resistance goes to transformer primary and to one end of the other resistance (that is, across it via the condenser); in addition, there is another condenser fixed from this (anode) side of transformer primary to filament line."

"This arrangement puts the pentode anode resistance (which is marked 50 ohms) in the plate circuit, where it must pass all the pentode's current. Is that right? Surely it will cause voltage drop?"

### OUR POSTAL QUERY SERVICE

We greatly regret that owing to the unusually large number of queries received during the last few weeks there has been a certain amount of delay in answering readers questions by post. Steps have been taken to cope with the tremendous demand on the services of our Query Department, and although letters are still flooding in we can assure readers that every effort is being made to reduce the delay.

"I don't know anybody else who has used a big pentode, so thought I had better make sure, as it is against all that has been said about low-resistance components in the output circuit."

It is quite in order to have a resistance of about 50 ohms placed in the pentode's anode circuit, as you describe it. The purpose is the prevention of parasitic oscillations which otherwise might spoil the result obtained.

The voltage drop certainly occurs, but is not a serious matter, being a very few volts.

### ABOUT THE S.T.500.

W. M. (Leytonstone).—"Just two points about the S.T.500. First, how about using an A.C. eliminator? Second, what is the undistorted output?"

An A.C. mains unit may be used perfectly well for the S.T.500 provided that it is of suitable design. It should be capable of a fifty milliamp output (maximum) and, like all units for Class B working, it must have good voltage regulation.

The undistorted output of the S.T.500 is about 1.5 watts.

### RESERVOIR CONDENSER CAPACITIES FOR DIFFERENT NUMBERS OF CYCLES.

"SERVICE" (Ealing, London, W.).—"I have proved by experience that the value of the reservoir condensers across the dry rectifiers in eliminators is important, and that the voltage output can be seriously affected by alterations here."

"But what about when the supply frequency is unusual? It would seem to be necessary to use more capacity in the reservoir on 25-cycle mains than on 50 cycles, so how much should the reservoir capacity be increased to maintain approximately the same voltage output from the rectifying circuit?"

You will find that reservoir capacity is specified in conjunction with supply frequency; and though the values of reservoir condensers commonly quoted are for 50-cycle mains, that is only because 50 is the commonest mains frequency. Different values are specified for mains of different periodicity.

Since the reservoir effect is proportional to frequency, there is a simple rule for calculating the alteration necessary to fit a 50-cycle arrangement for use on a 100-cycle supply or on any other unusual frequency. The rule is that if the supply frequency is doubled, the reservoir and filter-condenser capacities should be halved. Or, conversely, if the frequency is halved the capacities must be doubled.

If you have doubt or difficulty in applying the rule in a particular instance the rectifier manufacturers will assist in determining what the correct capacity is for any given arrangement.

### FOR LOUDEST POSSIBLE CRYSTAL RESULTS.

E. A. S. (Greenwich).—"Some time between now and Easter I am going down to Wantage, in Berkshire, to take a couple of pairs of phones and a crystal set to relatives living there. I rather rashly said it would work several pairs of phones, so they are looking forward to something pretty good."

"Valves are right out of the question, so the only way I can nurse volume is to have a good aerial and earth. All I know about this is that the aerial wire does not matter much provided it is high and reasonably long and not screened."

"And the earth (which cannot be a water-pipe in this case) should be buried in moist soil."

"Are there any other points I can watch with the idea of getting as much strength as possible from a crystal set?"

Yes. In the first place, we disagree that the "aerial wire does not matter much." This is a fallacy, and no radio engineer would think of using other than high-conductivity wire, such as good 7-strand copper, for the aerial.

The earth wire, too, warrants watching. Keep it quite short by having the set near to the earthing point. The best way is to place the set in or very near a window space, where the aerial can enter and the earth leave by short leads without wandering across a room.

The earth lead should be of fair thickness, too—the same wire as used for the aerial is O.K., but not anything thinner.

An important point is to avoid joins. The aerial should be an unbroken wire right from the farthest insulator to the aerial terminal on the set.

Keep the down lead three feet or more from any wall, roof, etc., near which it must pass. And don't be afraid of a good length of aerial—it will be very advantageous in the conditions you outline.

### A MIXED H.T. SUPPLY.

R. L. (Canterbury).—"Is there any objection to using a mains unit and an ordinary H.T. battery at the same time for the same set?"

Not really, though normally if one is using a mains unit one does so with the idea of obviating the necessity for a battery, so it is only in unusual circumstances that the two sources of H.T. supply are used together for the same set.

Many readers have mains units which, while they operate perfectly well under their normal load, are insufficient for the requirements of some particular set that is to be used temporarily; it seems a pity to go to the expense of buying or making a larger unit, and the obvious thing to do is to use a battery to supplement the unit.

The battery should be used to supply one (or more) of the valves used for H.F., detector or early L.F. stages, since here a dry battery meets the requirements very well.

(Continued on next page.)

## RADIOTORIAL QUESTIONS & ANSWERS

(Continued from previous page.)

### REGULATION OF A TRANSFORMER.

W. F. F. (Derby).—"As I shall have plenty of workshop facilities I thought I might be able to make my own mains transformers, all the mechanical problems which make home construction not worth while being absent when the making is done under proper workshop conditions. But now I am told that the 'regulation' of such amateur-constructed transformers is hopeless. What is meant by the 'regulation'?"

Broadly speaking, it may be defined as the ability of the transformer to maintain its rated output voltage with constancy, irrespective of variations in the load.

It is most important that the transformer should do this, over the limits of the working range. But the materials used, their relative spacing, quality and, in fact, almost every feature of the construction will have an effect on regulation; so it is not the constructional difficulties—as you suppose—that so often prevent successful manufacture at home, but the fundamental suitability of the instrument to the conditions of its operation. In other words, correct design.

The factory-made transformer scores in practice because it has been designed to have satisfactory regulation, and its output voltage is therefore to be relied upon.

### POTENTIOMETER TURNS THE WRONG WAY.

E. G. (Felpham, Sussex).—"At present my volume control is by means of a potentiometer, with the grid terminal of the first valve holder wired to the slider terminal.

## LONG WAVES AND THE S.T.600

On account of slight and inevitable differences in manufacturing methods, the long-wave station-naming on the "Spot-On" dial does not hold good for both makes of coils approved for the S.T.600 receiver.

It will be appreciated that with a dial such as the "Spot-On" it was not possible to make the readings applicable to more than one set of conditions. The chart was originally calibrated in conjunction with Wearite coils, and for the benefit of constructors who are using Colvern coils we hope to publish next week in "P.W." a re-calibrated long-wave section of the "Spot-On" dial, and it will be possible to cut this out and paste it in position on the existing dial.

May we remind readers that this does not affect the efficiency of the set in any way whatsoever, nor does it make any difference to the number of stations receivable on the long waves. It is simply and solely a matter of calibration, and, with the optional re-calibrated long-wave section, the "Spot-On" dial can be used successfully with either make of coil.

"One of the end terminals (the one on the right, as mounted on the panel) goes to that valve's grid-bias negative and to one secondary terminal; and the left-hand potentiometer terminal goes to the other secondary terminal.

"The trouble with this is that when I turn the control to the right (same movements as the hands of a clock) it decreases instead of increases the volume.

"All the other controls on the set do the opposite, and decrease when turned to the left. So I have schemed it out, and it seems to me that if I change over the wiring to the potentiometer's end terminals, leaving the slider as it is, I ought to get the opposite effect on turning the control.

"But I don't want to do it just for the sake of making all the controls act alike, and find I am running my grid bias out, or something like that."

Reversal of the leads which go to the ends of an ordinary potentiometer will not do the slightest damage, as the arrangement remains equivalent to the former circuit, but with the voltage applied

across the potentiometer in the opposite direction. In other words, by this means you will have "turned the potentiometer round" without affecting its panel position. This is exactly what you want, so go ahead with the alteration.

### SPARK WITHOUT A BATTERY.

"SPARKING" (Cleckheaton).—"I have discovered that the large condenser (4 mfd.) I use in my choke-output system will give a spark some hours after the set has been switched off. I always take the H.T. negative plug out when attending to wiring, checking over my leads, etc., and, feeling quite safe on this account, I accidentally put a screwdriver across and discharged this condenser, and got a really large spark. Quite startling!

"It was such a tremendous crack that I became curious when I discovered that the H.T. negative plug was out, so, preparing for the shock, I tried the screwdriver again. Nothing happened.

"I have found out since that it only happens once, after the set has been switched on. But even hours after it has been switched off I can get one fat spark. Is it O.K.?"

Perfectly O.K., and an indication that the condenser insulation is in good condition.

As you are using a really big condenser it will hold quite a large charge, which is sufficient to produce a spark some hours after the charging current has been removed.

Instead of pointing to something wrong, the spark proves that the insulation is thoroughly satisfactory.

### "IT SUDDENLY WENT WEAK."

A. K. L. (Brunswick Square, W.C.).—"Mine is a mains-driven four-valver, and the other evening it suddenly went weak for a moment or two, and then burst into full life again.

"Looking over it I found one of the coil units inside a screened compartment was wobbly, and small movements of this coil would cause the programme to fade out or in, according to pressure of the finger.

"So I packed the coil up against the screen again in the 'good' position with a cardboard packing, and it has gone perfectly since.

"What would have been the matter to cause this fade-out?"

The cause of the trouble is probably bad contact. It might be a partially touching "soldered" contact, or a wire loose under a terminal, or a switch contact.

There are other possibilities, too, such as trimming variations due to the movement of the coil in relation to the screen.

### THE LIGHTS AT THE MAST HEAD.

As considerable interest was aroused by the instance given in "P.W." of unaccountable lights being seen at the head of a mast in Lancashire, we have pleasure in giving the following extract from a letter clearing up the mystery.

It is from our original correspondent, Mr. J. Cliffe, of 15, Manor Place, Birnboro Pool, Nr. Birkenhead. Mr. Cliffe says:

"A few months ago I wrote you about two apparently electric lights on wireless pole, showing only occasionally. There has been a positive solution found for it, which I will explain as briefly as possible.

"The lights were caused by such a simple process as reflection from a gas light inside a neighbour's kitchen—I think from the glint of white paint on sashes of the window being shown on to the pole, it happening to be placed in suitable position, and accounting for visits of lights only occasionally.

"This was proved to be the case when blinds were not drawn tight across window, allowing reflection to reach pole. And when lights were not showing the blinds happened to be closed tight.

"This is positively proved, but the phenomenon caused a great deal of interest to those that saw—some saw with alarm. From one source came the suggestion of static corona, or north and south pole lights, and strangely enough they favoured north and south aspects.

"A telephone pole about three miles distant was affected in a similar way. 'P.W.' mentioned St. Elmo's Fire Balls—it is possible they arose from this type of cause."

## Easy Terms

ALL MANUFACTURERS' COMPONENTS and ACCESSORIES IN STOCK. SEND US YOUR ENQUIRIES

## W.B. STENTORIAN SENIOR

TYPE PMS1.

2/6  
DOWN

For Power, Pentode and Class B. Send only 2/6, balance in 11 monthly payments of 3/-. Cash or C.O.D. Carriage Paid, £2/2/0.



W.B. Stentorian Standard Model. Cash or C.O.D. Carriage Paid, £1/12/6, or 2/6 deposit and 11 monthly payments of 3/-. W.B. Stentorian Baby Model. Cash or C.O.D. Carriage Paid, £1/2/6, or 2/6 deposit and 9 monthly payments of 2/6.

## ATLAS ELIMINATOR

Model T10/30. For Class B and Q.P.P. A.C. 200/250 volts, 40/120 cycles. Three tapings: 10, 20 or 30 m.a. at 120/150 volts. Trickle charger incorporated. 2 volts, .5 amp.

5/-  
DOWN

Send only 5/-, balance in 12 monthly payments of 6/-. Cash or C.O.D. Carriage Paid, £3/9/6.



## B.R.G. S.T.600 KIT

EVERY PART GUARANTEED—MATCHED—PROVED—TESTED. Complete with FIRST Specified FORMO 2-GANG CONDENSER, COLVERN S.T.600 MAIN COIL ASSEMBLY AND COLVERN S.T.600 EXTRACTOR COIL, and with FREE FULL-SIZE BLUE PRINT and copy S.T.600 issue of "Popular Wireless", including S.T.'s 100 STATION SPOT-ON DIAL and other P.W. Gift.



"KIT 1" Comprising B.R.G. Kit of matched components, including specified Formo 2-gang condenser, with Colvern coils, Peto-Scott ready-drilled walnut-faced panel and terminal strip, with Metaplex baseboard, less valves, cabinet & speaker. Cash or C.O.D. Carriage Paid, £3/13/6.

DELIVERY FROM STOCK.

5/-  
DOWN

or deposit 5/- and 12 monthly payments of 7/-.  
KIT "2" As Kit "1" but including set of specified B.V.A. valves, less cabinet and speaker. Cash or C.O.D. Carriage Paid, £3/4/0, or deposit 7/6 and 12 monthly payments of 10/9.  
KIT "4." As Kit "1" but including B.V.A. valves and Peto-Scott console cabinet, less speaker. Cash or C.O.D. Carriage Paid, £7/19/0, or deposit 10/- and 12 monthly payments of 13/9.

## N.T.S. CLASS 'B' SPEAKER-AMPLIFIER

"JUST PLUGS-IN." GIVES SEVEN TIMES THE VOLUME, READY ASSEMBLED WITH CLASS B VALVE.

5/-  
DOWN

Send only 5/- and instantly convert your present set to Class B output. Balance in 9 monthly payments of 5/-. Cash or C.O.D. Carriage Paid, £2/5/0.



## Peto-Scott 1935 BATTERY 3

With Peto-Scott Moving-Coil Speaker, Air Cored coils, British Valves, Oldham H.T. and L.T. Batteries, full aerial equipment, modern cabinet. Send only 5/-, balance in 18 monthly payments of 6/-. Cash or C.O.D. Carriage Paid, £4/19/6.

5/-  
DOWN

PETO-SCOTT 1935 Screened Grid 3. Send only 5/-, balance in 18 monthly payments of 7/9. Paid, Cash or C.O.D. Carriage Paid, £4/6/0.



## New Times Sales Co.

56, LUDGATE HILL, LONDON, E.C.4.

# MAGNETISM

The power of attraction and repulsion, or, in other words, magnetism, is a force that comes very closely into our daily life. In this article some of the uses to which this valuable phenomenon is put in regard to radio are described  
By J. C. JEVONS.

SOME months ago it was announced that a Japanese scientist had discovered a new magnetic alloy which is so powerful that the ordinary permanent magnet, used on a moving-coil speaker, would in future be cut down to one-fifth its present size.

This, in itself, is a welcome development, because anything that will help to reduce the weight of the P.M. type of speaker is all to the good. But, in addition, the new discovery serves to draw attention to the growing importance of magnetism in modern wireless practice.

In the early days of broadcasting one heard frequent references to the "magnetic" appeal of wireless, meaning, of course, that it was attractive because of its novelty. Now that we are accustomed to taking the "marvel" of broadcasting more calmly, this magnetic side of it—in the strictly literal sense—is definitely coming more and more to the front.

### An Important Discovery.

The art of producing high-powered magnets dates back to the discovery of the peculiar properties of alloys made of iron, cobalt and nickel.

Permalloy—one of the first of these alloys—is now chiefly used for loading long-distance telephone wires. It led, in turn, to the discovery of cobalt steel, which first made it possible to fit a moving-coil speaker with a permanent magnet instead of having to use a separate source of current.

Although I am not acquainted with full particulars of the Japanese discovery, I understand that aluminium is an essential component, the other metals being made

### IN SPEAKER DESIGN

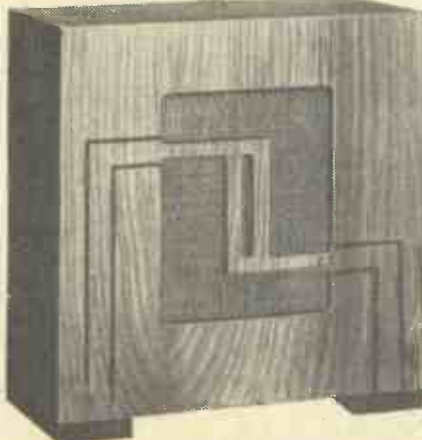

In loudspeaker construction magnetism plays a vital part. On the "strength" of the magnet depends to a large extent the efficiency of the instrument. This is a recent model of the Celestion P.M. range.

up of iron, nickel and either cobalt or molybdenum. The result is an alloy of high coercive force and enormous residual magnetism, the flux from two short rods of the material being equal to that produced by the heavy four-limbed magnet now used for P.M. speakers.

Another "magnetic" feature in modern circuit design is the use of iron-cored tuning coils, such as Ferrocart or Nicore, in place of the older air-cored type. Not only do these coils improve selectivity by reducing the ratio of ohmic resistance to inductance, but they are more compact and convenient to handle in every way.

Their action, of course, depends entirely

### ON THE H.F. SIDE OF RADIO

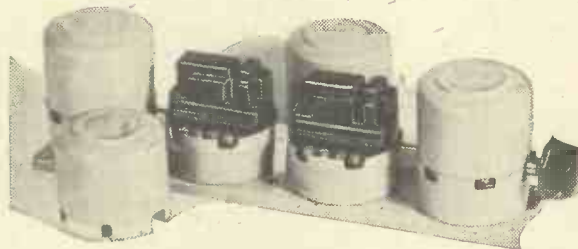

A group of "Ferrocart" coils in which high-permeability iron is employed to very great advantage.

upon the magnetic effect of the finely powdered iron core, which serves to "load" a circuit with the inductance required for tuning, without wasting precious signal energy in the form of eddy currents.

Again, in the broadcasting studio "magnetic" recorders such as the Blattner-phone or Marconi-Stillé apparatus are now indispensable as a means of bottling up events of outstanding importance, so that they can be repeated from time to time in the future.

Unlike the ordinary gramophone, the magnetic recorder is not limited to a performance of a few minutes, but can be "run" continuously for over half an hour on end. If necessary, a number of short "strips" can easily be joined together to make a "composite" programme.

### A School Experiment.

The speech or music is "stamped" by magnetic action on a continuous ribbon of steel. The action is based on an experiment which is often performed in the school lab: One takes a steel surface, such as the blade of a saw, and writes one's name on it with the end of a bar magnet. No trace remains that is visible to the eye until iron filings are sprinkled over the surface, when they at once "cling" to the signature and throw it into visible relief.

In the same way speech currents flowing through a coil are converted into magnetic

"patterns" on the steel ribbon of the magnetic recorder. When the ribbon is subsequently passed under a pair of electromagnets the reverse action takes place and the original speech or music is reproduced.

Such a record can be preserved as long and repeated as often as may be required. Finally the speech "pattern" can be completely wiped out, simply by passing the ribbon across a pair of magnets, leaving it free to take another impression.

Another remarkable magnetic effect is now being utilised as a substitute for the piezo-electric crystal for stabilising the frequency of H.F. generators. In these days of over-congestion in the ether it is absolutely essential that each station should transmit on the exact carrier-wave allotted to it. Any frequency "wobbling" is certain to cause a chorus of heterodyne "squeals" with its neighbours on the waveband range.

### Frequency Control.

Now it is not a simple matter to find a suitable control or "master oscillator" which can be used to hold the H.F. transmitter firmly in check. The piezo-electric crystal is one, but unfortunately it is liable to be shattered to bits by its own vibrations.

The "magneto-strictive" oscillator, on the other hand, is not subject to this defect, and is, in fact, the most robust high-frequency vibrator that has yet been found.

The molecules of a non-magnetised body are originally in a "higgledy-piggledy" (Continued on next page.)

### ANOTHER EXAMPLE

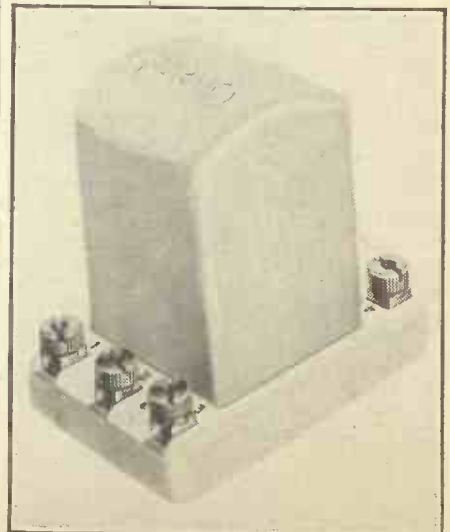

Special magnetic alloy is incorporated in the design of the latest Formo "Sensity" coils.



## MAGNETISM

(Continued from previous page.)

condition, but as soon as they come under the influence of a magnetising field they rearrange themselves in definite "line" with each other. In short, they develop north and south poles which tend to hold them in that position.

When the same body is placed in a transverse magnetic field it is found to expand and contract at a definite frequency, owing to the movement of its molecules. It expands as the molecules fall into line and contracts as they swing out of line under the action of the superposed field.

This mechanical vibration is of the same order as that of a piezo-electric crystal oscillator, and so can be used to "stabilise" a wireless transmitter.

A simple rod of iron-nickel-chrome alloy, when placed in the magnetic field inside an open coil, will oscillate steadily at frequencies up to 100,000 cycles per second, showing a temperature variation of only one in a million.

## SOME FACTS ABOUT L.F. TRANSFORMERS

(Continued from page 619.)

different amplification from soft ones, which results in "blasting" and overloading of subsequent stages.

It is, however, very important to realise that with good-class transformers both these faults are very rare and that the symptoms described are more likely to be due to faults in other parts of the circuit.

The term "L.F. transformers," of course, covers output transformers for speakers and, technically speaking, mains transformers as well.

The simple L.T. transformer for supplying heater current for A.C. valves offers a useful example of the change in "character" of watts effected by transformers.

If we have three valves to operate we shall require 3 amperes at 4 volts from the secondary winding.

### The Primary Current.

Therefore the power to be used will be :  
 $4 \times 3 \times k = 12 \cdot k$  watts.

Assuming an efficient transformer, we will ignore "k" and take it as equal to unity. The power used in heating the valves will therefore be 12 watts.

Now consider what will happen in the primary winding when we switch on.

The voltage here is that of the supply mains—say, 200 volts.

Therefore the current flowing in the primary must be :

$$\frac{12 \text{ watts}}{200 \text{ volts}} = \cdot 06 \text{ amperes, or } 60 \text{ milliamps.}$$

This change in "character" of our 12 watts can conveniently be shown as :

$$\frac{12 \text{ watts}}{200 \text{ volts}} \quad \text{(Primary)} \quad \frac{12 \text{ watts}}{4 \text{ volts}} \quad \text{(Secondary)}$$

$$200 \text{ volts} \times 60 \text{ Ma.} = 4 \text{ volts} \times 3 \text{ amps.}$$

From these figures the ratio of the transformer is easily found, for it is the same as the ratio of the primary and secondary voltages or currents :

$$\text{Ratio} = \frac{4 \text{ volts}}{200 \text{ volts}} = \frac{\cdot 06 \text{ amps.}}{3 \text{ amps.}} = \frac{1}{50}$$

—i.e. a step-down ratio of 50 : 1.



**AGAIN . . . Author's First Choice**

THIS TIME FOR ITS AMAZING SENSITIVITY.

Where reproduction is first consideration, the designers of "constructor" receivers almost invariably specify a W.B. Stentorian. Where sensitivity is required above all, again a Stentorian is chosen. Never before has a loudspeaker been so consistently and universally specified by leading technicians—

**SPECIFIED "FIRST" FOR THE W.L.S. SHORT-WAVE 2-VALVE SET**

—hear the amazing difference the Stentorian's exclusive features will bring to your set, and you will understand why. Ask for a demonstration to-day —you will be astounded.

Stentorian Senior (PMS1) - 42/-  
 100 per cent. dust protection.  
 Oversize cone.

Stentorian Standard (PMS2) - 32/6

Stentorian Baby (PMS6) - 22/6

Write for the new W.B. Stentorian leaflet.

**STENTORIAN**  
 PERMANENT MAGNET MOVING-COIL SPEAKERS

Whiteley

Electrical Radio Co., Ltd.

(Dept. P), Radio Works, Mansfield, Notts.

Sole Agents in Scotland: Radiovision Ltd., 233, Vincent

Street, Glasgow, C.2.

Sole Agents in I.F.S.: Kelly & Shiel, Ltd., 47, Fleet Street, Dublin.



## 6 Complete Song and Dance Hits

IN EVERY ISSUE OF

## POPULAR MUSIC

AND DANCING WEEKLY

Every Thursday. At all Newsagents and Bookstalls **3<sup>d</sup>**.

Edited by Jack Payne



## HIGHEST in QUALITY LOWEST in PRICE

Absolutely non-microphonic detector types. S.G. types of exceptionally low inter-electrode capacity. Output valve giving larger undistorted output than "luxury" price valves.

362 BATTERY VALVES. H, HL & L, 3/6. Power, 4/- Super Power, 4/6. S.G. & V.S., 7/6. V.P.2, 9/-. Pentode Type, 10/-. B.A. & B.X., 9/-.  
 362 A.C. MAINS. ACHL4, 7/6. ACPX4, 9/-. P.625, 8/-. ACSG4 & ACVS4, 12/6. ACME4 & ACHM4, 13/-. ACVP4, 13/-. Full Wave Rectifiers RB41, 7/6. RB42, 10/-.  
 If unobtainable from your dealer send P.O. to:—(DEPT. X), The 362 Radio Valve Co., Ltd., Stoneham Rd., London, E.5



H.L.2.  
**3/6**

**362**

THE VALVE WITH  
 THE 6 MONTHS'  
 GUARANTEE

PLEASE be sure to mention POPULAR WIRELESS when communicating with advertisers THANKS!

# Let Us Send You This 28-Page Booklet—Free



It gives all particulars of various Courses that cover every phase of Radio work.

The Radio Industry is progressing with amazing rapidity. Only by knowing thoroughly the basic principles can pace be kept with it. I.C.S. Instruction includes American broadcasting as well as British wireless practice. It is a modern education, covering every department of the industry.

### OUR COURSES

Included in the I.C.S. range are Courses dealing with the installing of radio sets and, in particular, with their Servicing, which to-day intimately concerns every wireless dealer and his employees. The Operating Course is vital to mastery of operating and transmitting.

There is also a Course for the Wireless Salesman. This, in addition to inculcating the art of salesmanship, provides that knowledge which enables the salesman to hold his own with the most technical of his customers.

Then there are Preparatory Courses for the City and Guilds and I.W.T. Exams.

We will be pleased to send you details and free advice on any or all of these Courses. Just fill in and post the coupon, or write in any other way.

International Correspondence Schools, Ltd.,  
Dept. 161, International Buildings,  
Kingsway, London, W.C.2

Without cost, or obligation, please send me your Radio booklet of information about the Courses I have marked X

- COMPLETE RADIO
- RADIO SERVICING
- RADIO EQUIPMENT
- RADIO SERVICING AND SALESMANSHIP
- WIRELESS ENGINEERING
- WIRELESS OPERATORS
- EXAMINATION (State which)

Name ..... Age .....

Address .....

## GETTING THE BEST FROM YOUR RADIO

Items that will help you to derive the utmost from your apparatus.

### A USEFUL TESTING UNIT.

IN the very early days of POPULAR WIRELESS we used to be able to ring up the London broadcasting station and ask them if they would mind continuing their afternoon (or morning) transmission for a little while so that we could complete our tests with a set!

We fear a similar request to-day would meet with a polite refusal. But then we do not now rely completely upon broadcast transmissions for our set tests. We have a very complete testing equipment which enables us to be quite independent of the broadcasters of this or any other country.

It is different with the amateur or the service man, for even if he could afford to buy the necessary gear the service man at least could hardly carry it around with him. Ordinary laboratory gear, that is.

But his tests and checking can be made every bit as complete as is ever necessary when servicing or adjusting a set, merely with the aid of two instruments of precision and great versatility made by the Automatic Coil Winder and Electrical Equipment Co., Ltd., of Winder House, Douglas Street, London, S.W.1.

The one instrument is known as the Universal Avometer, and no doubt all POPULAR WIRELESS readers will be acquainted with that excellent device. With it all the required voltage, current and resistance tests can be made.

And now, as the perfect accompaniment, there is the Avo-Oscillator. This is only the size of a fair-dimensioned meter of the multi-range type, and it is provided with a handle for carrying purposes. And yet it is a complete broadcasting station in miniature. In other words, it is an oscillator capable of emitting an H.F. frequency variable over the whole of the broadcast wavebands.

And this frequency can, if desired, be modulated, and that merely by a flick of the appropriate switch.

It is also to be noted that the output is variable, there being three different tappings giving a range of signals suitable to the testing of all types of sets.

Of course, the instrument can be used purely and simply as a wavemeter in order accurately to determine the wavelength of tuning positions and for identifying foreign stations. But, in addition, the

service man and constructor will find many other uses for it, including the checking of the frequencies

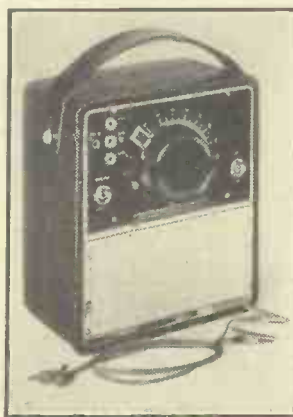

The Avo-Oscillator, which is a perfect companion to one of the popular Avo testing meters.

of intermediate transformers and their matching up in superhets, checking band-pass circuits,

ganging in all kinds of outfits and so on.

There can, in fact, hardly be anything more desirable to the experimenting amateur or the service man than an instrument of this nature. And yet, despite its usefulness and the fact that it really is a precision production, it costs only £5 10s. complete with valves and batteries. These, the valves and batteries, are contained all in the one compact case, and are easily accessible when it is desired to change them. The instrument, as you see it in the accompanying photo, is absolutely complete.

### AN AIR DIELECTRIC TRIMMER.

SHORT-WAVE enthusiasts are exacting in their requirements. The short waves themselves are exacting, and you cannot take the liberties with them that you can with medium and long waves.

It is for this reason that the apparatus made by the few successful suppliers of short-wave gear is on a plane above that obtaining for much of the ordinary components.

One realises this when one examines such an article as the Eddystone Air Dielectric Trimmer made by Messrs. Stratton & Co., of Eddystone Works, Bromsgrove Street, Birmingham.

This is a small variable condenser for baseboard or block or shelf mounting which has been designed especially for use with intermediate transformers, though quite obviously it can be used for all preset

and trimming purposes for which its capacity range makes it suitable.

It has the extremely low minimum capacity of 3 mmfd. and a maximum capacity of 65 mmfd.

It really is beautifully designed and made. There is a base of special insulating material which is provided with two small pillars, and all the metal work is of hard, high-quality brass, cleanly cut and brightly finished.

Adjustment is possible from either the bottom or top by means of the slotted spindle, and the movement has just the right compromise of "restrained smoothness" for permanent settings of a close nature to be obtained.

Short-wave constructors will find this Eddystone component of great value in their experiments, and there must be many

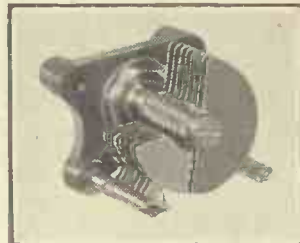

An extremely low minimum capacity is a feature of this Eddystone short-wave trimming condenser.

builders of ordinary sets who could include the article in their equipment with considerable advantage to themselves.

The price of the Eddystone Air Dielectric Trimmer is 3s. 6d. By the way, we have recently had the opportunity of examining the 1935 catalogue of short-wave components published by Messrs. Stratton & Co., Ltd. It is both comprehensive and interesting, and should be in the hands of all constructors.

## HIGH-VACUUM VALVES

The results of our tests with a selection of Hivac battery and A.C. valves.

WE have received for test a selection of Hivac battery and A.C. valves. The types were chosen at random as being typical of modern high-efficiency valves. The first is the L210, a battery valve of the "first L.F." variety. It has an impedance of 7,500 ohms and its amplification factor is 12, giving a mutual conductance of 1.6 ma/v. The price is 3s. 9d.

And now for a valve that has experienced great demand recently, the V.P.215, a 2-volter which can be obtained with either a four- or seven-pin base. It is a multi-mu screened pentode of excellent merits. On test in our test circuit the valve acted very well indeed as an H.F. amplifier, while those who wish to use it as a detector may rest assured that it will not let them down. The price is 10s. 6d.

### A Few of the Mains Types.

And now for a few A.C. valves that should be welcome to those of you who have mains receivers. As a start let us mention the AC/HL, a hot-stuff detector or first L.F. with a mutual conductance of 3.5 ma/v. The impedance is 10,000 ohms. The price is 9s. 6d. and it is an exceedingly fine valve.

A good Hivac valve to follow the AC/HL is the pentode AC/Y if transformer coupling is used, or the AC/Z when resistance coupling is preferred. The first has a greater grid swing and a less steep slope than the AC/Z. Both valves give a maximum undistorted output of 3,400 milliwatts, and cost 15s. 6d.

Preceding the AC/HL either the AC/HP or the AC/VP can be used—the first is a screen pentode of the "fixed" type, while the second is of the multi-mu variety. The price in each case is 13s. 6d. Both valves are extremely efficient and give a very high-stage gain when used with well-designed and suitable coils.

The valves mentioned above do not, of course, by any means exhaust the types of valves available from the High Vacuum Valve Co., whose address is 113-117 Farringdon Road, London, E.C.1. Class B valves, quiescent push-pull pentodes, double-diode-triodes and full-wave A.C. rectifiers are amongst the others also made, with similar high efficiency and low cost.

We have always found Hivac valves thoroughly reliable in use, and have no hesitation in recommending them.

# WHAT IS DISTORTION?

(Continued from page 607.)

suffer partial annihilation. Hence chronic distortion.

And, lastly, parasitic oscillation.

This trouble is not as prevalent as the two we have so far dealt with, but when it does crop up we get distortion *par excellence!*

The cause is generally capacitative or inductive coupling between plate and grid circuits of the L.F. portion of the receiver.

A strong signal in the anode circuit of the output valve may set up a strong magnetic field which will reach some part of the grid circuit of the same or previous stages.

The signal will then "run round the loop" and cause severe distortion—it usually ends up by generating a howl.

In push-pull and other super-efficient amplifiers H.F. oscillation can be set up in a similar manner: such oscillation is of very short wavelength (depending on the incidental H.F. constants of the circuit),

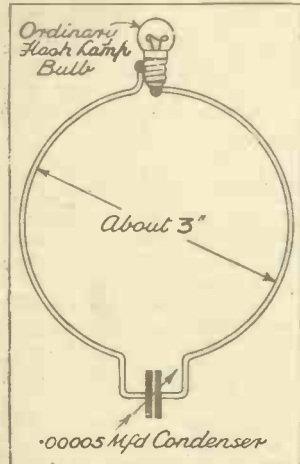

Fig. 3. A simple device for testing for H.F. parasitic oscillation. The loop is lowered into different parts of the amplifier in turn, and the condenser adjusted slowly until the lamp glows.

and causes distortion, loss of volume and increase of anode current.

Stray wiring capacities are sufficient to produce this state of affairs, and the seat of the trouble is often difficult to find.

The best test is to use an ordinary flash-lamp bulb connected to a 3-inch-diameter loop of wire and neutralising condenser (Figure 3).

Whilst oscillation is taking place the loop is lowered into different parts of the amplifier in turn and the condenser adjusted slowly from minimum to maximum.

When the loop is at the seat of the trouble the lamp will glow, due to the oscillating current being induced in the loop.

### The "Stopper" Resistance.

To cure this particular form of distortion it may be necessary to include a non-inductive "stopper" resistance in the grid lead to the last valve. It should be connected as close as possible to the grid terminal of the valve holder.

As I have said, the foregoing cover ninety-nine per cent of the causes of distortion, but it must be remembered that any of these troubles can be introduced in a receiver by indirect means.

For instance, a run-down H.T. battery (or lack of H.T. for any other reason) will produce the same state of affairs (all other things being normal) as over-biasing an amplifier valve, and therefore, when tracing distortion, careful thought is as valuable as a 2-guinea milliammeter.

# PROGRAMMES I ENJOYED

Our Broadcasting Critic Reviews Some Recent Radio Features.

**I** MAKE no apology for beginning my review of the Christmas broadcasting with the description of an outside broadcast from abroad. On Christmas Eve I was searching the ether for something which had a touch of the old-time Christmas—"when the snow lay on the ground, deep and crisp and even"—so persistently depicted on the present-day Christmas card.

Eventually I let the knobs of my set rest on the Vienna wave. It was 11 p.m. A *Turmbiasen* was in progress. No country has in the world a greater reverence for tradition than Austria. A brass band of no particular merit—but that mattered little—was playing a number of lieder and carols from the tower of the famous St. Stephen's Church. A huge concourse of folk was assembled in the square below. In fact, all Vienna was there. No Viennese will miss a *Turmbiasen*.

A narrator described the scene. The place was brilliantly illuminated, the crowd was orderly. But no snow was falling—an unusual circumstance for this occasion. So the narrator—probably for the benefit of the foreign listener—described a more normal occasion and the beautiful effects of the artificial light on the falling snowflakes.

Suddenly the narrator's voice was hushed. The band had begun to play "Stille Nacht heilige Nacht," a carol very sacred to Austrians and Germans alike. The *Turmbiasen* was quietly and reverently received, for I think this is the official intimation that the Christmas festival has begun. It was all wonderfully impressive.

### A Mountain Service.

It is now close on midnight. The scene is changed. We are taken 4,500 feet up, and the centre of our gaze is a tiny church called the *Tauernkirche*, nestling snugly in one of the valleys of the Tauern Mountains. Here snow has fallen and is still falling. Suddenly the landscape is dotted with innumerable lights. The lights, moving swiftly from all directions, converge on the tiny *Tauernkirche*, itself now resplendent with light. A narrator explains that these numberless lights are the torches carried by the peasant folk who are wending their way on skis to their tiny church to keep their midnight mass—their *Mettengang*.

The countless lights reaching the church add to the illumination of the church itself. A lonely light, rapidly moving, however, and still distant, is that of the proverbial latecomer. We enter the church, leaving our skis and torches outside. A wheezy organ is playing reasonable music. An occasional cough breaks the otherwise stillness of the scene. The priest enters. The worshipping peasants fall on their knees. The service begins.

It is a monotonous chant, happily relieved by some exquisite singing by a soprano of local origin, but now of repute in Vienna. The priest stops his chanting and the soprano her singing. There is a pause in which a few peasants cough. Otherwise all is still. The organ begins again. The peasants sing. Do you ask what? . . . "Stille Nacht heilige Nacht." It is all very moving. This over, the priest resumes his chanting and the soprano her singing. A memorable broadcast, this.

### The British Stations.

But what of the home broadcasts? Apart from a lean period on Christmas Day between the King's message and the evening programmes proper, the B.B.C. served us well. The comedians especially deserve the highest praise. There was a galaxy of talent in the Christmas Party, for instance. It was a mistake to put the "Red Shoes" item on before the party had really got going. It was much too long. But once things had warmed up the spirit of the party was completely in unison with that of the thousands of families listening.

The games were very popular. We could join in. The Charade may have got some listeners guessing, though I don't see why. The solution was obvious from the start. A. J. Alan was an unexpected treat. The Western Brothers were at the top of their form. By the way, a leading article in a daily paper observes that one seldom hears the word "cad" nowadays. Apparently the fame of the Western Brothers hasn't spread to Fleet Street. Elsie and Doris Waters were ripping and Claud Dampier funnier than ever.

"Blue Beard" was typical pantomime, the brunt of which was borne by Leonard Henry and Lawrence Baskcomb.

I frowned when I saw certain of the regular weekly features included in the Christmas week programmes. But I frowned unnecessarily. Gerald Heard cleverly chose as his subject in the "Science in the Making" series "The Vault of Heaven," and sounded quite reasonable. Desmond MacCarthy spoke on pantomimes of the past, and paid a great tribute to Dan Leno.

C. B.

# A BIG STEP UP

Q.P.P. is a big step up in obtaining good quality and volume from a battery set. The preceding L.F. Transformer needs a big "step-up" to give sufficient amplification. Careful design is essential if the quality of reproduction is to be of the best, and the Bulgin L.F.29 embodies the experience which has placed Bulgin L.F. Components in a class of their own.

L.F.29. Nickel-alloy Transformer with centre-tapped secondary. Ratio 1:0.

**15/-**

**CUT HERE.**

Please send me, post free, the New Bulgin 80-Page Catalogue No. 154 "P" for which I ENCLOSE THREEPENCE IN STAMPS.

NAME.....

ADDRESS.....

(Block letters, please.)

# BULGIN

## RADIO COMPONENTS

A. F. BULGIN & Co., Ltd.,  
 ABBEY ROAD, BARKING, ESSEX.

P.A.3.

### LOUD SPEAKERS REPAIRED 4/-

(Blue Spot a Speciality, 5/-.)

Transformers and Headphones, 4/-. Eliminators, Mains Transformers and Moving Coils quoted for. 24-Hour Service. Trade Discount. Clerkenwell 9069.

E. MASON, 44, EAST ROAD (nr. Old Street Tube Station), LONDON, N.1.

# MICROPHONE BUTTONS 1/-

**FUN WITH YOUR RADIO.**

Home broadcasting and recording with our new No. 11 Home Mike, 5/6. Superior P.W. 11a Table Microphone, bakelite case, containing H.R. transf., switch, plugs, and output terminals, new model, 15/-. Ericsson G.P.O. Standard Pedestal, with stand and mouthpiece, 4/6.

Ask for our Mike List "P." We are makers, and have the biggest and most varied stock in London. P.A. Mikes and complete outfits.

PARCELS of experimental odd coils, magnets, wire, chokes, condensers, switches, terminals, etc., post free.

10 lbs., 7/-; 7 lbs., 5/-.

1,000 other Bargains in New Sale List "P."

## ELECTRADIX RADIOS,

218, UPPER THAMES STREET, LONDON, E.C.4.

Telephone: Central 4611.

High Tension for your Radio from the Mains at 1/- PER YEAR

Model AC/TO. 150 volts at 30 milliamps, or 120 volts at 18 milliamps, with 8.G. and Detector Tappings. 2 volt 4 amp. Triplet Charger. Price 4/6. Send for full particulars.

**M.P.R. Ltd ROMFORD, ESSEX**

## FOR HEAVY DUTY



### CLIX NON-CORROSIVE SPADE TERMINAL (Heavy Duty Type)

In the furtherance of our policy of supplying the most perfect forms of contact, we have recently produced this larger and more robust type of Spade Terminal.

Aerial and Earth leads can now be taken direct to set terminals without any breaks or joins, as the special wiring device takes any insulated wire up to  $\frac{1}{8}$  overall. It is also excellent for L.T. leads and charging board connections.

Supplied Lead coated or Nickel plated.  
Red or Black insulators.

Price **3d.** Each



**LECTRO LINX LTD.**  
79a, Rochester Row, London, S.W.1

## CUT H.T. BILLS IN HALF

It is amazing the satisfaction you can get from a Standard Wet Battery. Gives pure steady current year in year out with cheap replenishment at intervals of a year or more. "I have had my present cells on a 3-v. set going 10 hrs. a day for 12 months. An ordinary dry Battery lasted 7 weeks," writes R.S. A money-saving source of H.T. No extra accumulators required. Recharges itself overnight. 120-v. 12.500 m.a. £2 carr. paid. Any voltage supplied. Write for details: **WET H.T. BATTERY CO.** (P.W.), 95, Dean Street, Oxford Street, W.1.

### Write for Illustrated Catalogue of RADIO - GRAMPHONE CABINETS

of exclusive modern design, made by craftsmen, in highly figured Oak, Walnut or Mahogany, post free.

#### REMARKABLE VALUES.

Cabinets made to order a speciality. Maker, under licence, of the **HOWE BOX RAFFLE.**

Recommended by the B.B.C. Full details on request.

#### GILBERT

Cabinet Maker, SWINDON.  
Est. 1866.

Figured Oak Cabinet on stand. £2/4/6



## 1935 EDITION... FREE!

A New and greatly enlarged edition of "ENGINEERING OPPORTUNITIES" is just off the Press. It describes the easy way in which you may become an A.M.I.C.E., A.M.I.Mech.E., A.M.I.E.E., A.M.I.A.E., A.M.I.W.T., etc., and contains the world's widest selection of courses in all branches of Civil, Mech., Elec., Motor, Aero., and Radio Engineering, Building, etc.

If you are earning less than £10 per week, you cannot afford to miss this unique guide to a first-class job.

**DON'T DELAY**—send for your FREE copy of the Handbook to-day. No cost or obligation of any kind.

**THE BRITISH INSTITUTE OF ENGINEERING TECHNOLOGY,**  
101, SHAFESBURY HOUSE,  
29/31, OXFORD ST. LONDON.

**268  
PAGES  
Free!**

## ROUND THE RECORDS

Some notes on a selection of the latest popular numbers that have been recorded.

ANOTHER year has been rung in, with joy or reluctance, according to our several natures, and we look forward with hopes of great things in the world of radio and record. And the battle between the gramophone companies goes on doggedly. Public acclaim is the prize, and it is a prize not easily won nowadays when we all expect so much from our gramophones.

Forging ahead still is Decca with excellent recordings of leading dance bands and well-known stars, among whom Ambrose heads the list in the matter of "high spots" in the recent releases.

But before I go on to write of the latest records let me get a grouse off my chest. It concerns comparatively few people, for it is a grumble about the bad finishing and the varying thicknesses of records—even of the same make—which result in the jamming of my automatic record changer. No company is exempt from my accusation that records are far too often badly finished, especially in regard to the bevelling of the edge—I have "duds" in every make.

It would be greatly appreciated by many people if the companies would only realise that there are such things as automatic record changers, and that the popularity of the device is rapidly increasing, and so is the percentage of "automatic dud records"! Now then, what about it? Let's have better bevelling, a more constant thickness and the finishing off groove properly taken towards the centre circle of the disc.

### The New Year's "Hit!"

I feel better now, and the recent holiday—to some extent that of a busman—has re-nerved me to withstand the New Year's "hit." We have had a short but hectic time with "Smoke Gets in Your Eyes," and at the time of writing we are due for a good dose of *June in January*. That is, if the prophets who should know are right: the number is a great success in the States, though that is not always a sure indication of a winner in this country.

Anyhow, the first records of *June in January* (a Bing Crosby film number!) have already arrived on the market, including Bing's Brunswick (01951). One is by The Street Singer, under the Decca aegis, No. F 5343; a second is by Roy Fox, on Decca F.5351. A third record is a Brunswick (01953), made by Guy Lombardo, whose band plays in its typical melodious style. By the time you read this no doubt there will be others.

You would not think that there was any great difficulty in getting crooners—or, more politely, for the sake of real singers, vocalists—but I am assured that the leading dance bands have no end of a job to get these now-essential dance-band accessories, and they even share their vocalists.

Perhaps real good vocalists, people who can sing, are rare, but "crooners" seem common enough. Anyhow, I have it on good authority that Roy Fox searched the country unceasingly after Al Bowly left him to join Lew Stone, and that it was over a year before he chanced on Denny Dennis, his present vocal star.

He quickly snapped him up, and has worked really hard on Dennis' development. The result is that to-day Roy Fox has one of the few really pleasing dance-band vocalists broadcasting.

Talking about "crooners" and "singers," have you ever heard a really good, "straight" tenor or baritone singing a vocal dance refrain? If not it will be of interest to you to hear Decca F.3369, a record made two years ago.

It holds Al Bowly singing a song chosen by Owen Bryngwyn—*Glorious Devon*—and the latter artist singing Al Bowly's song, *Let's Put Out the Lights and Go to Sleep*. Take notice of the effect of Al Bowly's style on the famous ballad, and also the unusual effect that resulted on the reverse side of the disc.

### A New Vocalist.

A new recording vocalist has made his voice heard above the tumult and babel of the world of wax. He is Lanny Ross, who came into prominence in the film "Melody in Spring." He has now joined the Brunswick stable, and his first record—of numbers from his new film, "College Rhythm"—is just out. The items are *Stay as Sweet as You Are* and *Let's Give Three Cheers for Love* (01936).

If you are a "hot" rhythm fan you should send a shilling to Decca—or take it to the local record dealer—for a copy of "A Short Survey of Modern Rhythm." It is an excellent piece of dance-band history, and to illustrate it Decca have recorded a series of special records. Whatever may be our opinion of the place of "hot" rhythm in our dance music, we should take the "new style" seriously.

It is undoubtedly firmly established, and a short study of the subject, as provided by the book and the records illustrating it, is of profound interest—and to the lowbrow, not a little surprising.

K. D. R.

## VALVES OR STAGES?

Notes of Interest to All

By Dr. J. H. T. ROBERTS, F.Inst.P.

EVER since broadcasting began it has been the custom to specify a receiver by the number of valves which it employs. Sometimes we specify "stages" instead of "valves," because the two terms are virtually synonymous. It was, therefore, a matter of indifference whether you spoke of a set with, say, one high-frequency and two low-frequency valves, or whether you described it as having one H.F. and two L.F. amplifier stages.

But since the coming of valves with several electrodes, or rather valves fulfilling the functions of more than one stage—for example, the double-diode pentode, which is equivalent to three valves—it is obviously quite misleading to speak of the number of valves in the set; what we ought to speak of is the number of stages, because in this case the number of valves may be entirely different from the number of stages.

### Multi-Electrode Valves.

Now that multi-electrode valves are being so very much more used in manufactured receivers it seems to me that we ought to revise our system of describing a receiving set on the lines indicated above. Who knows but that it may be possible in the very near future to have a one-valve set which includes two H.F. and three L.F. stages, with detector? It sounds fantastic at the moment, but I do not think it is at all impossible. I should, perhaps, mention, before leaving this point, that the set manufacturers are waking up to the fact that the specification should be altered, and some manufacturers already adopt the plan of specifying the number of stages as well as the number of valves.

Of course, it depends also on what a "stage" really means. It is assumed that a valve which comprises two stages, for instance, really does everything that two individual stages combined would do.

### Double-Diode Triode.

Amongst these valves with multiple electrodes the double-diode triode is probably the best known. This valve is generally used with one of the diodes acting as a detector, the other diode for automatic volume control and the triode part for the first stage of the low-frequency amplifier.

The diode tetrode includes the usual two-electrode detector and a screened-grid valve which serves the purpose of a low-frequency amplifier. The double-diode pentode, an ingenious valve, includes two diodes, as its name implies, these being for detector and automatic volume control, as in the double-diode triode, whilst the pentode is used as the low-frequency amplifier and has the advantage that it acts as a variable-mu valve. Properly used, this valve gives a more uniform volume, because the automatic volume control acts in both the H.F. and L.F. ends of the receiver.

(Continued on next page.)

## VALVES OR STAGES?

(Continued from previous page.)

A good deal of attention is being paid to multiple valves in the United States, and I occasionally get reports of still further developments in their construction and application. Valves are being specially developed for use in the superheterodyne type of receiver, which seems destined to play a more and more important part in radio reception as time goes on. It is pretty clear that we are very far from the final word in valve development, although, curiously enough, it is not more than four or five years ago that people were saying the valve was so perfected that we could never look for any further developments in it!

### Do You Use Fuses?

I do not know how many of you use fuses in your sets; I have often been surprised at the way in which this very simple safeguard is generally neglected. Small fuses for use in various ways in a radio receiver are now available on the market in all types and at a very small cost. It is a good plan to use them wherever possible. You can get an excellent fuse for sixpence, and this may well prevent several pounds' worth of damage to valves or other parts of the set.

It is important, however, to have a properly rated and properly made fuse; cheap or carelessly manufactured fuses are sometimes worse than nothing, because they give you a sense of security which may be entirely false.

### Peak Voltages and Surges.

One of the points which is to be noted in making a fuse is that it should be able not only to carry the steady current—I mean the normal current, whether it be D.C. or A.C.—but also to stand the momentary overload which often results from an A.C. peak voltage or the surge due to the presence of inductances and condensers in the circuit. To stand these momentary overloads the fuse should be sufficiently substantial, so that it takes a certain amount of time to "blow" even when the current passes the predetermined amount.

The standard practice with radio fuses is to make them blow instantly at approximately 50 per cent overload. It is better to use the highest value of fuse which will give adequate protection. In the high-tension circuit a fuse should be included in the negative lead, and, inasmuch as there are condensers in the circuit which have to be charged when switching on or plugging in, it is wise to use a fuse of a rating of not less than 150 milliamps. Some people go to the extra precaution of using a separate 60-milliamp or 150-milliamp fuse in each H.T. positive lead and a 60-milliamp fuse in the grid-bias negative lead.

### Protecting Mains Receivers.

With mains receivers it is a good plan to put a fuse in between the secondary of the mains input transformer and the rectifier; a suitable value for such a fuse is generally 150-milliamp rating. With a full-wave metal rectifier put a fuse in each of the two leads from the anodes of the rectifier to the mains transformer, whilst if you are using a half-wave metal rectifier,

or half-wave valve rectifier, you should put a fuse in the H.T. negative side between the rectifier and the mains transformer.

As I say, all kinds of fuses for all purposes can now be obtained, together with many neat holders and connectors for the same, and there is really no reason why anybody should have any destructive accident with his set if he makes proper use of them. I may mention that Messrs. Pelling-Lee, Limited, specialise in the making of radio fuses for all purposes, and you cannot do better than get particulars of these.

### Pick-up Troubles.

I said something the other day about the fact that when using a pick-up with a radio set you often find that, although the reproduction may be excellent on radio, it becomes poor on records. This is due to the fact that the erstwhile detector becomes, with the pick-up in circuit, the first low-frequency amplifier, and the conditions are so changed that it is unable to function properly. Several readers have written to say that they have experienced trouble in this way, so perhaps it will be as well if I say something further about it.

If you think about it for a moment you will see that the detector should not overload before the output valve; the output should overload first—if any overload is going to occur at all. The impedance of the valve, however, rises considerably when the pick-up is plugged in and grid bias applied, and its grid swing becomes restricted.

### Valve Overloading.

This means that the valve now overloads much more easily, and it may become overloaded long before the output valve is receiving anything like the load it is capable of carrying without distortion. The position is thus reversed, and, in order to keep within the bounds of decent reproduction, the output volume is reduced to perhaps half what it was on radio.

If a detector valve of lower impedance is used its grid swing will be correspondingly greater and it will be able to handle larger inputs from the pick-up. Although this sounds a simple way out of the trouble there is a snag, for it will lower the efficiency on radio and cause other complications as well.

If we could use two entirely separate valves and switch over from the one to the other, that would be best, but for general purposes it is out of the question, and we have to fall back upon making one valve serve both purposes.

### Use A Moderate Impedance Valve.

The best way, for all-round purposes, is to use a valve of moderate impedance, about 12,000-15,000 ohms, and adjust the anode voltage according to whether it is working on radio or records. For records you will want all the H.T. you have available, whilst for radio you may reduce to 100 volts or even less. This can easily be done by including a voltage-dropping resistance in the H.T. supply, this being arranged so that it can be shorted when not required.

The most important adjustment, when all is said and done, is, of course, the grid bias on that first valve.

## EASY TERMS

We specialise in the supply of all good quality Radio Sets, Components, and Accessories on easy terms. Send list of requirements and keen quotation will be sent promptly. Prompt delivery guaranteed. Cash and C.O.D. orders are dispatched by return of post.

### S.T.600

Complete kit of parts for this remarkable set, exactly as used by Mr. Scott-Taggart.

**7/6** KIT A. Complete parts. Cash or C.O.D., £4/19/6, or 7/6 secures delivery, balance by 11 monthly payments of 9/3.

**12/-** KIT B. Complete parts, including specified valves. Cash or C.O.D., £7/3/0 or 12/-, secures delivery, balance by 11 monthly payments of 13/-.

Any parts supplied C.O.D. by return, post free.

Revitalise your set with the new



**W.B. P.M. STENTORIAN SPEAKER**  
Senior P.M. Speaker.

Cash Price £2.2.0 or 2/6 with order and 11 monthly payments of 4/-.

Standard P.M. Speaker.  
Cash Price £1.12.6 or 2/6 with order and 11 monthly payments of 3/-.

**5/-** Atlas T 10/30 H.T. Eliminator and Trickle Charger combined. Cash Price £3.9.6 or 5/- with order and 12 monthly payments of 5/11.

All Carriage Paid.

Estd. 1925 THE LONDON RADIO SUPPLY COMPANY 1977

**THE LONDON RADIO SUPPLY COMPANY**

11 OAT LANE, NOBLE STREET, LONDON, E.C.2



There was a young fellow named Jim  
Complained that his Set had gone "dim"  
He found on inspection An "unsoldered" connection—  
So FLUXITE put THAT right for HIM!

See that FLUXITE is always by you—in the house—garage—workshop—anywhere where simple, speedy soldering is needed. Used for 30 years in Government Works and by the leading Engineers and Manufacturers. Of all ironmongers—in Tins: 4d., 8d., 1/4 and 2/8.

Ask to see the FLUXITE SMALL-SPACE SOLDERING SET—compact but substantial—complete with full instructions—7/6. Ask also for leaflet on CASE HARDENING STEEL and TEMPERING TOOLS with FLUXITE.

## THE FLUXITE GUN

(Registered.)

is a handy and economical tool that enables you to put the FLUXITE where you want it on the soldering job and is clean and simple to use. Nothing to remove—no mess—no trouble. Always READY FOR USE.

Also used to project grease into grease-cups, bearings, etc.

Just fill the nozzle portion—half fill the cup—put together and press as required. Price 1/6.



ALL MECHANICS WILL HAVE

# FLUXITE

IT SIMPLIFIES ALL SOLDERING

FLUXITE LTD. (DEPT. 324), DRAGON WORKS, BERNONSEY STREET, S.E.1.

## PREPAID MISCELLANEOUS ADVERTISEMENTS

### 3d. per Word

6d. per word for first words in heavy type

### Minimum Charge 3/-

Remittance must accompany order.

Advertisements for these columns are accepted up to first post WEDNESDAY MORNING for following week's issue.

Radio components and accessories advertised in these columns at below list price do not carry manufacturers' guarantee.

The Proprietors have the right to refuse or withdraw advertisements at their discretion.

Postal orders, in payment for advertisements, should be made payable to the Amalgamated Press, Ltd., and crossed.

All communications should be addressed to—Advertisement Department, "Popular Wireless," John Carpenter House, John Carpenter Street, London, E.C.4.

**PEARL & PEARL**, 190, Bishopsgate, London, E.C.2. All the following bargains guaranteed new goods. Cash or C.O.D. Carriage Paid.

**ELIMINATORS.** Special purchase of large quantity of Lincoln-Stewart Eliminators enables us to offer them at sacrifice prices. All models O.K. for 200-250 v. D.C. 25 milliamp output, 9/11; A.C. 30 milliamp output with Westinghouse Rectifier, etc., 24/11, or with half amp. Trickle Charger incorporated, price only 37/6. All fully guaranteed.

**MICROPHONES.** Super-sensitive mikes, complete on base with built-in transformer. Full instructions included. Our price 6/11.

**LISSEN L.N.5181** 3-ganged superhet coil units for A.C. or battery sets; with circuits and diagrams. Over 1,250 already sold to "P.W." readers. List price 30/-; now offered at special price, 6/6 only.

**LUCERNE COILS.** New Lucerne Dual-range Coils, 1/8 each. Screened iron-cored dual coils with circuits, 1/11 each.

**LOTUS COILS.** Lotus triple-ganged band-pass coil unit, complete. Suitable for mains or battery sets. Comprises 3 screened coils on metal base, wavechange and radiogram switch; all terminal connections shown engraved. Full instructions with every unit. List 27/6. An outstanding bargain at 12/11 each.

**LISSEN Cone Speakers**, complete, 5/11.

**ALL GUARANTEED NEW AND IN MAKERS' ORIGINAL CARTONS.**

**LARGE Receiver Cabinets**, highly polished, as used for "Cromwell" 8-valve Superhet. Measurements: 22 in. high, 17 in. wide, 11½ in. deep. Finished in contrasting rosewood and walnut veneers. Special additional baffle on speaker fret. Cost over £2 to make. Few only at 15/- each. Cash with order. Carriage forward.

**CABINETS.** 2,000 Cromwell Cabinets (for set and speaker combined) just secured on terms which enable us to offer them at the astoundingly low price of only 4/11 each. Horizontal type, 23 in. wide, 8 in. deep, 11½ in. high. Polished Walnut veneer, additional baffle behind speaker grille. Our price 4/11. Supplied for cash with order, Carriage forward. **FREE.** Our latest, fully revised Bargain List P, now ready. Send P.C. for your copy.

All Mail Orders Direct to

**PEARL & PEARL**,  
190, Bishopsgate, London, E.C.2.  
Telephone: Bishopsgate, 1212.

**EXPERIMENTERS' PARCELS—FREE VALVE** given with remaining 50 parcels, containing Wireless Components 30/- value for 5/6, postage 1/-. Purchaser writes: "Highly satisfied; send another two."—TAYLOR, Macaulay Street, Huddersfield.

### "SWIFT SERVICE."

Send to "SWIFT SERVICE" for your S.T.600 Kits and all Radio requirements. You WILL get prompt attention AND complete satisfaction.

"SWIFT" Kits and Components are **GUARANTEED.**

S.T.600 Battery Model, Kit "A," £4/5/0. (Kit "A" comprises all the necessary components required, with FREE panel; terminal strip and baseboards ready drilled.) Send for list.

"SWIFT" KITS DO NOT CONTAIN ANY SURPLUS OR SECOND-HAND COMPONENTS.

**HIVAC S.T.600 Battery Valves**, £1/11/3 per set.

"362" S.T.600 Battery Valves, £1/6/0 per set.

**WE CAN SUPPLY W.B.,** Rola, Colvern, Graham Farish, Varley, Wearite, Polar, Erie, T.C.C., Dubilier, Formo, Tungsram, Mullard, and all standard makes of components and accessories.

### "SWIFT" BARGAINS.

#### CONDENSERS.

**LOTUS** '0005 screened with disc drive, twin gang (14/-), 9/3.

**WAVEMASTER** Air Spaced Variables, '0005 Extenser type (15/6), 3/-, '0005 and '0003 slow-motion, 3/3. '00015 short-wave S/M, 6/3. Solid dielectric reaction type '00075, 1/9. '0005, '0003, 1/6. Differential '0001, '0003 and '00035, 1/6.

**AMPLION** Mansbridge, 4-mfd., 4/-, 2-mfd., 2/6, 1-mfd., 1/10.

**HYGRADE** 2-mfd., 1/8, 1-mfd., 1/4. Tubular Condensers, WEGO, 5-mfd., 1/6, 1-mfd., 1/3, '0003-mfd., 6d.

**COILS.** **AMPLION** D.R. aerial coils, 5/6. D.R. H.F. coils, 4/-, Dual-range air cored, 1/11. Air cored screened, 2/2. Iron cored screened, 2/6. All complete with wiring instructions.

**H.F. CHOKES.** Binocular, 1/3. Snap type, 10d. Short-wave, 9d.

**L.F. TRANSFORMERS.** **LOTUS** 3-1 and 5-1 (5/6), 3/6.

**RESISTANCES.** Wire End, all values, 1-watt type, Amplion, 9d. Athco, 4d.

**SWITCHES.** Push-pull type, 2 pt., 4d. 3 pt. 5d.

**RECTIFIERS.** **WESTINGHOUSE** H.T.8, 9/6. L.T.1 6 v. ½ amp., 3/9.

**VALVE HOLDERS.** Chassis type, 4/5-pin, 2½d. 7-pin, 6d.

**Pye** Short-wave, 4-pin, 2½d.

**AMPLION PICK-UP** (25/-) with tone-arm and volume control. 17/-.

**LOUDSPEAKERS.** **AMPLION** "Lion" P.M., 42/6.

Permanent Magnet, with 3-ratio transformer (27/6), 22/6. Lissen Plaque (15/-), 6/6.

**MICROPHONES.** Speech microphone on base complete with transformer (9/6), 7/9 Transformers, 100/1, 180/1, with terminals (4/6), 3/9. Microphone buttons, 7d.

Add YOUR name to the list of

#### OUR SATISFIED CUSTOMERS.

**TERMS.** Cash or C.O.D. Orders under 5/- cash only. Postage charged on orders under 10/-.

**THE SWIFT SERVICE & SUPPLY CO.** (P.19), 3, Featherstone Buildings, High Holborn, London, W.C.1. Tel.: Holborn 1336.

**WE** can supply complete Kits of specified components for the A.C. S.T.600 at a competitive price.

**ALL** other goods advertised in last week's issue still available.

**WARD**, 46, Farringdon Street, London, E.C.4. Telephone: Holborn 9703.

**BANKRUPT BARGAINS.**—List free. S.T.600 kit with specified coils and Formo 2 gang, £3. Mains sets from £4. 3v. kit, 15/0. Regentone A.C. 30 m.a. eliminators, 32/6. Celestion P.M., 11/0. Triotron valves from 3/0. Very large stock. Anything radio, Part exchange.—**BUTLIN**, 143B, Preston Road, Brighton.

### BETTER BARGAINS BY OLYMPIA RADIO, LTD.

**G.E.C.** 4-Valve A.C. Receiver in Pedestal Cabinet, ready to work. A Great Bargain. List price 18 Gns. Our price £6 19s. 6d.

**ATLAS** P.M. Speakers. One of the finest Moving Coils made. Complete with transformer. Suitable for Pentode or Power Valve. List price 42/6. Our price 14/11.

**MARCONI** 2-Valve Battery Receiver, complete with Valves and all Batteries. Self-contained Cabinet. List price 4 Guineas. Our price £2 2s. 6d.

**TELSEN** Matched Screened Coils, suitable for use as Aerial or Anode Coils. Can be embodied in any Circuit. List price 7/-. Our price 4/11.

**SET** of Telsen Band-pass Screened Oscillator Coil Units, comprising Band-pass Coils and Oscillator Coil. Complete with Wave-change Switch for Single-knob Control. List price 21/6. Our price 8/11 per Set.

**TELSEN** Radio-Grand Transformers, 3-1 ratio only. List price 7/6. Our price 4/3.

**TELSEN** Arc Transformers, 3-1 and 5-1. List price 5/6 each. Our price 3/9 each.

#### TELSEN—MORE COMPONENTS:

L.F. Coupling Units (4/6). L.F. Smoothing Chokes (3/11). Tapped Pentode Output Chokes (3/6). Class B Output Transformers (4/3). 313 Dsic Drive (2/3). Air Dielectric '0005 Condensers (1/11). Bakelite Dielectric Tuning Condensers, '0003 ONLY (1/-). Short-wave H.F. Chokes (1/9). Binocular H.F. Chokes (3/6), etc., etc.

**MOONBEAM** 4-Valve A.C./D.C. 7-Stage Superhet. A beautiful 1935 model. List price 10 Gns. Our price £7 12s 6d.

**EKCO** A.C. 74, a seven-stage Superhet, Delayed A.V.C., full-vision shadow tuning. Band-pass, and Moving Coil. List price 13 Guineas.

**WE ALLOW** £4 on your old set, no matter what it is.

**THIS** leaves a cash price of only 9/13/0. **GUARANTEED BRAND NEW IN ORIGINAL SEALED MAKER'S CARTON.**

**TELSEN** Band-pass Coil Unit, comprising pair of accurately matched Screened Band-pass Coils, complete with Wave-change Switch, Escutcheon and Knobs. List price 14/6. Our price 8/11 per Set.

**TELSEN** Set of Triple Matched Screened coils, suitable for Aerial and 2 H.F. Stages; or can be embodied in practically every modern circuit. List price 21/6. Our price 12/11 per Set.

**TERMS**—Cash with Order or C.O.D. All Goods Carriage Paid. Everything guaranteed O.K. Money refunded if not satisfactory. Please mention this paper when replying. Write for illustrated lists, post free.

**OLYMPIA RADIO, LTD.**, Mail Order Dept., 49a, Shudehill, Manchester.

Midland Depot:

29, Martineau St., Birmingham.

**BRANCHES** in all Principal Towns.

**G.P.O. ENGINEERING DEPT.** (No experience required.) Commencing £4 per week. Age 17-23. Excellent prospects. Free details of Entrance Exam. from **B.I.E.T.** (Dept. 568), 31, Oxford Street, W.1.

**WANTED FOR CASH.** Second-hand Wireless Parts, Sets, etc. Bring or send.—University Radio, 142, Drummond St., London, N.W.1. Nr. Euston Station (L.M.S.). Phone: MUSEum 3810.

**CHARGING WITHOUT MAINS.**—Wireless Batteries fully charged by your Car, Van, or Lorry when in use, 10/6 post free. Diagram only, 1/6.—**BENNETT**, Clock House Garage, Hampton, Malpas, Cheshire.

**500 GLADIOLI**, 3½-4 inch circ., in 10 named vars. 100 Anemones, 100 Ranunculus and 10 beautiful Lilies for only 10/- (C.O.D.), 10/6 carriage and duty free.  
**P. WALRAVEN**, STATIONSWEG, HILLE GOM, HOLLAND.

**SOUTHERN RADIO'S WIRELESS BARGAINS.**

**RECEIVERS:** BURGOYNE Class "B" Receivers, 1935 Series. Brand New in original sealed cartons. Complete with 3 Mullard Valves. Exide Batteries and Accumulator. P.M. Moving Coil Speaker. Contained in attractive Cabinet, magnificently finished with chromium fittings. £3/19/6 (List £6/10/0).

**COILS**—Igranic Superhet Set of Four (1 Osc., 2 I.F. with Pigtails, 1 L.F. Plain), 12/6. (List 50/-.)

Varley Constant Square Peak Coils B.P. 5, complete with all accessories in sealed cartons, 2/3. Lewcos B.P.F./R, T.B.F./C: O.S.C./126 (extensor), T.O.S./R, all at 3/6 each.

**PICK-UPS**—Marconi Model K25 (1935 issue), 21/- (List 32/6.)

**BIFLO** Static Cut-outs. Definitely Cuts Out All Electrical Interference and Unwanted Noises, without decreasing volume. Brand New and boxed with simple fixing instructions, 2/3 each. (List 12/6.) State whether A.C., D.C., or Battery Set.

**CONDENSERS.** Lotus, 3-gang, 12/6; 2-gang, 8/6. Fully Screened with Trimmers. Complete with Dials, Knobs, and Escutcheons. Plessey 4-gang Condensers, Superhet type. Fully Screened with Trimmers (less Dials), any standard dial will fit, 10/6 (List 45/-). Dubilier Block Condensers, 4 mfd. (2+1+1), 1,000-Volt, 2/9; 4.5 mfd. (2.25+2.25), 3/-; T.C.C., 0.1+0.01, 1/3 each.

**SPEAKERS.** Blue Spot 66R Units, brand new and boxed, 10/6 (List 35/-). Complete mounted on Blue Spot Chassis, 16/6 (List 45/-).

**BLUE SPOT** Permanent Magnet Moving Coil Speakers, with Universal Transformers for Class "B," Super-power, Power or Pentode. All Brand new 1935 series in original sealed cartons. Type 45 P.M., 26/- (List 45/-). 90P.M., 30/- (List 59/6). 62P.M., in Magnificent Cabinet, 38/- (List 67/6). 32P.M., in Exquisitely Finished Cabinet, 45/- (List 87/6).

**MISCELLANEOUS.** Westinghouse Metal Rectifiers. H.T. 6, 7, 8, 9/3. Morse Tapping Keys with Flash Signal and Buzzer, complete with battery and bulb, 2/-.

All goods guaranteed and sent post paid.

**BRANCHES** at 46, Lisle Street, W.C.2; 16, Leicester Street, W.; 271/275, High Road, Willesden Green, N.W.10.

All Mail orders to 323, Euston Road, N.W.1.

**SOUTHERN RADIO**, 323, Euston Road, London, N.W.1 (near Warren St. Tube).  
Phone: Museum 6324.

**PREMIER SUPPLY STORES** offers the following Bargains in Brand-new Guaranteed Valves, the surplus stock of a large Continental manufacturer.

**THE** following A.C. mains types, 4/6 each: H.F. Pen., Screen-grid, variable-mu screen-grid, H.L., L., directly-heated 1, 2, 4-watt pentodes, 250 v., 60 milliamp, full-wave rectifiers, 20 v., 18A. D.C. types, S.G., V.M., H.L., power, H.F. Pen.

**THE** following types, 5/6 each: 350 v., 120 ma. rectifier, 500 v., 120 ma. rectifier, indirectly-heated pentode.

**THE** following American types, 4/6 each: 80, 81, 210, 45, 250, 47, 46, 24, 35, 58, 37, 6A.7, 2A.7, 27.

**THE** following American types, 6/6 each: 51, 30, 78, 77, 38, 6A.4, 63, 2A.5, 2A.6, 6B.7, 2B.7, 6F.7, 6C.6, 6D.6, 30/44, 83, 523, 2525.

**SEND** for Catalogue of hundreds of Bargains in components. All post orders to Dept. P.A.,

**PREMIER SUPPLY STORES**, 20, High Street, Clapham, S.W.4. Callers to above address and 165, Fleet Street, E.C.4.

**CAN YOU BEAT THIS ?**

**ALTO SAXOPHONE, SUPER QUALITY**, wonderful tone and range, unparalleled beauty. Warranted 10 years. Yours for 5/- weekly.—Write for Illus. lists, HESSYS Ltd., Manchester Street, Liverpool.

**VAUXHALL.**—Radiophone Radiopack R.F. Superhet 535c. 110 or 117 kc., complete with volume control escutcheon plate, etc., and Station-named scale, 34/- . I.F. Transformers to suit the above Pack, complete with terminals on bases, 4/6 each. Radiophoné Midget Superhet or Straight Condensers, 10/- each.

**VAUXHALL.**—Magnavox permanent magnets, universal, suitable for Class B, power or pentode, 7-in. cone, 16/6; 10-in. cone, 23/-; mains energised, 2,500 or 6,500, 10-in. cone, 22/-; 7-in. cone, 15/3. Brand new, with humbucking coils; staté power or pentode transformer.

**VAUXHALL.**—Benjamin Class B transformers, 1-1½ to 1, 6/6; Radiophone, Class B, 10/-; volume controls; Radiophoné, with switch, 5,000 to 500,000, 3/6.

**VAUXHALL.**—Set Manufacturer's Surplus, Skeleton type Westinghouse rectifiers; H.T.8, 9/6; H.T.9, H.T.10, 10/-; Westectors, W.4, W.X.6, 5/9; mains transformers fitted with screened primary 300 + 300v., 30 m.a., 4v. 2½ a. 4v. 4a., impregnated windings.

**VAUXHALL.**—Rothermel Piezo electric pickups, 30 -; B.T.H. Minor, 16/6; senior needle armature, 20/-; B.T.H. Truspeed gramophone motors, 30/-; Collaro 32 model, 32/6; complete unit A.C.200-250v. with first quality pickup and volume control in sealed cartons, 48/-.

**VAUXHALL.**—Dubilier condensers, 4 or 8 mfd., dry electrolytic, 500v. working, 3/-; 50 mfd., 50v. working, 1/9; tubular non-inductive, 0.1, 9d., 0.05 6d., 0.002, 0.0002, 0.001, 0.0001, 4d. each; T.C.C., mica, 0.002, 2,000-volt test, 10d.; Ormond, 0.0001, 4d.; 0.001, 0.01, 1/-; 1-mfd. Mansbridge, 1/3.

**VAUXHALL.**—3-gang condensers and set iron-cored cells, specially matched for S.G., det., pentode, complete with dial, drive, escutcheon, etc., 35/-; as above, suitable for band-pass or R.F. superhet, 37/6; gramophone switches, 3/6; Utility dials and drives, complete with escutcheon, black or brown, 5/-.

**VAUXHALL.**—Dubilier resistance, 1-watt type, 7d. each, all values; Clix valve holders terminals, 7-pin, 9d.; 5-pin, 7d.; W.B. 5-pin 4½d.; post paid, 2/6 or over, or C.O.D.

**VAUXHALL UTILITIES.** 163a, Strand, W.C.2.; over Denby's the Booksellers. Temple Bar 9338. Send postcard for lists free.

**REWINDING.**—Loudspeakers, Transformers, Headphones, all makes, 3/6. M/C. Speech Coils, 5/-. Mains Transformers, Eliminators quoted for. Satisfaction Guaranteed.—BREEZE, Marden, Kent.

**UNIVERSAL** Transformers, 100v./250v., 4v./6a., 4v./2a., 260v./60 ma., 10/3. Lissen Detector Valves, 2v., 2/10. Mains Pentodes, AC/PT, 9/6. Junit holders, 4.5 pin, 3½d. **SERVICE RADIO**, 51, St. Loy's Road, Tottenham.

**SECONDHAND CHARGING BOARD** required, suitable for 6-volt batteries.—James & Son, Malt Street, S.E.1.

**HULBERT, 6, CONDUIT STREET, W.1.** Read below:

If you are requiring realistic reproduction at remarkable low cost, send for one of the following high-grade speakers. Repeat orders are coming in daily.

**10/6** only. Brand-new manufacturer's surplus moving-coil speakers, made by one of the best-known British makers. Energised, 2,000, 2,500, or 6,500 ohms field windings, power or pentode transformer, 8-in. cone, 10/6 each. **12/6** only. As above, but with 10-in. cone. A very powerful speaker capable of handling large outputs.

**15/6** only. Brand-new manufacturer's surplus moving-coil speakers, made by one of the best-known British makers. Permanent-magnet model of high efficiency with power or pentode transformer, 8-in. cone, 15/6 each. **17/6** only. As above, but with 10-in. cone. Ideal for use with quality receivers such as the S.T.600.

**2/9** only. Brand-new cabinets suitable for above speakers, 2/9 each only. Secure one of these amazing speaker bargains now. Repeat orders are coming in daily. Cash with order or C.O.D.

**HULBERT, 6, CONDUIT STREET, W.1.**

**UTILITY SALES.** Always something NEW, interesting. Write for full Lists.

**TELEVISION** with guaranteed results. Join us as experimenter. Complete Kit of Parts, Universal Mains. One hour to assemble: motor, lamp, disc, lens, everything is there. Write for list P.W.T. £3/12/6.

**VALVE EMISSION TESTER** kit parts with diagram and charts. Milliammeter, cabinet, panel, switch, etc., 12/6.

**MICROPHONES.** Amusing and interesting; learn to broadcast. Hanging 2/6. Table model (transformer in base) 8/6.

**SELECTIVITY!!** Replace your Coils by Screened Iron-core. 2/6 with circuits. Specially matched for S.G.

**STATIC** and Interference cut-out, 12/6 list. Simple to fix, efficient, 2/6. Limited quantity.

**IGRANIC** Band-Pass Screened Iron-Core Unit on Base, with Switch Diagram, 3-valve set, 14/6.

Cash with order, guaranteed 24 hours' Service. Your visit welcome for demonstrations.

**UTILITY SALES**, Feritone Corner, 57, Praed Street, London, Paddington 0251.

**500 GLADIOLI**, 3½-4-inch circ., in 10 named vars., 100 Montbretias, 100 Anemones, 100 Ranunculus, 100 Clover of Happiness for only 10/-, carriage and duty free to destination (C.O.D. 6d. extra).

**THE FIRST HILLEGOM BULB NURSERIES**, HILLEGOM, HOLLAND.

**1,000 GLADIOLI**, first size, 4-5-inch circ., in 10 named vars., for only 20/-, half lot 10/-, carriage and duty free to destination (C.O.D. 6d. extra).

**THE FIRST HILLEGOM BULB NURSERIES**, HILLEGOM, HOLLAND.

**ORDER FORM**

The Advertisement Manager, "Popular Wireless,"  
John Carpenter House, Whitefriars, London, E.C.4.

Please insert our/my advertisement in "Popular Wireless" for.....  
insertions at a charge of £ s. d. per insertion. Remittance herewith.

Signed.....

Address.....

Date.....



# "Bring in the Radio!"

Wherever you are you can take perfect radio with you, for Model 95 will give you the pick of the world's broadcasting *without aerial or earth*. The mains model needs only to be plugged into an electric light or power socket (A.C. or D.C.) in any room, whilst the battery model needs no external connections whatsoever! This handsome Ekco model gives you radio as you like it—when you like it—and where you like it.

*First payment of 27/- secures delivery.*

Model 95 Transportable 9-stage Superhet for Universal A.C./D.C. Mains and Battery Operation

## 15 GNS.

or initial payment of £1. 7. 0 and 12 monthly payments of £1. 7. 0. *Black and Chromium 10/6 extra.*

# EKCO Radio

To E. K. COLE LTD. (Dept. A.14), EKCO WORKS, SOUTHEND-ON-SEA. Please send me free illustrated literature.

NAME.....  
 ADDRESS.....



# TWO GREAT PRESENTS FOR READERS!

# Popular Wireless

No. 659.  
Vol. XXVI.  
January 19th,  
1935.

Gifts to the  
Value of

# 2/-

will be found  
in this issue

EVERY  
WEDNESDAY  
PRICE **3<sup>d</sup>**

## WON TIMES

### HOW TO BUILD THE 1935 KELSEY ADAPTOR and the "W.L.S." Short-Wave Masterpiece THE "B.C.L." TWO

Full Constructional Details  
Inside

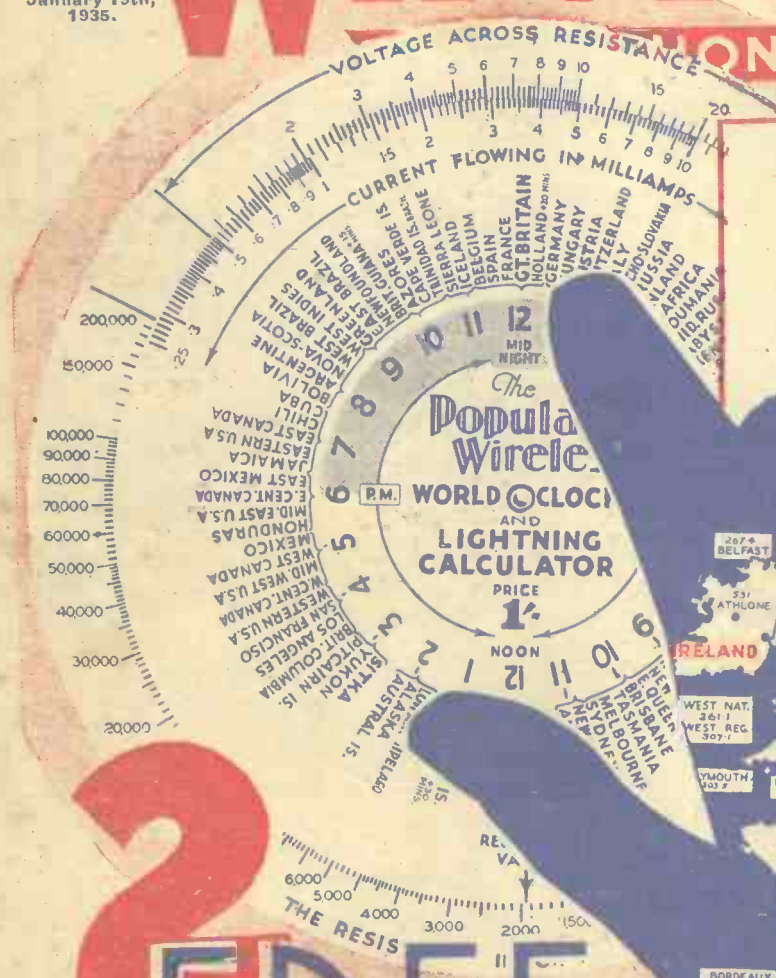

# 2 FREE GIFTS



Write for the new Dubilier booklet.

Dubilier's vast experience is always at the service of manufacturers who send details of their requirements.

No other Mica Condensers have so great a reputation as Dubilier. Their qualities of permanence of characteristics, long life with utmost efficiency, make them invaluable to radio manufacturers, designers and constructors alike.

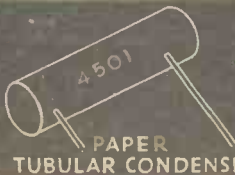

PAPER TUBULAR CONDENSER



MOULDED MICA CONDENSER



DRY ELECTROLYTIC CONDENSER



RESISTANCES

DUBILIER CONDENSER CO. (1925) LTD., DUCON WORKS, VICTORIA ROAD, N. ACTON, W.3.

*Another  
Opportunity  
to Secure*

**SCOTT-  
TAGGART'S  
LATEST  
AND  
GREATEST  
BOOK**

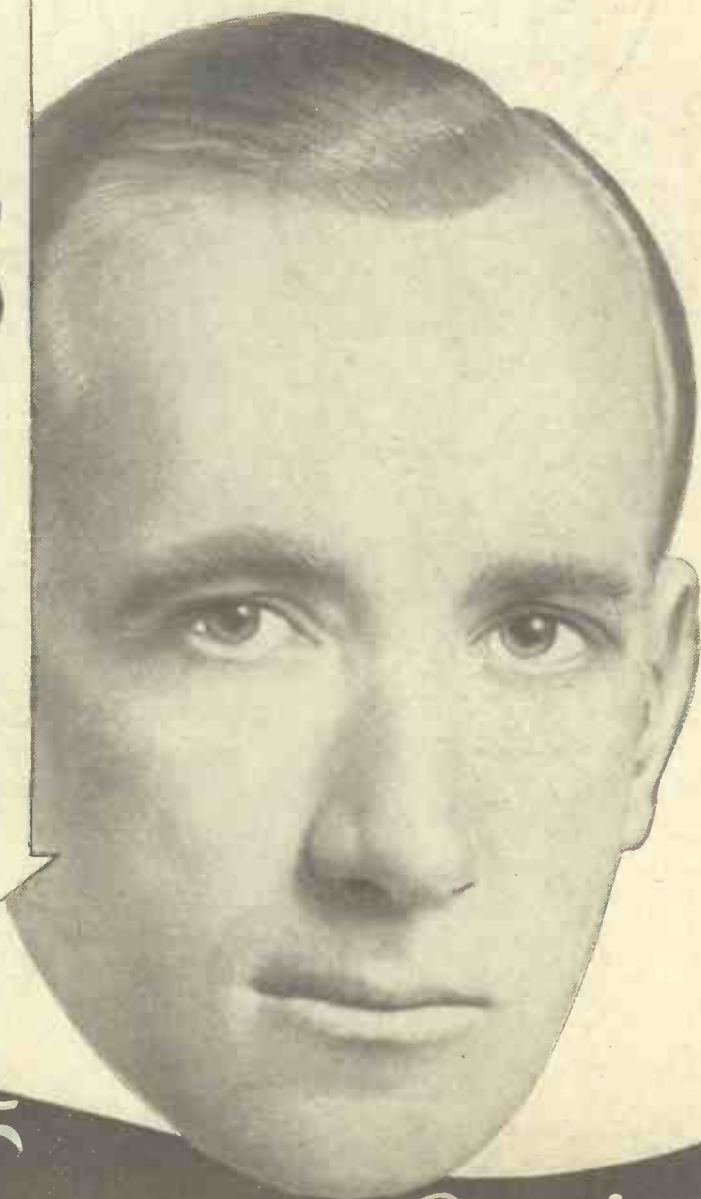

*A Master  
Book by a Master of Radio*

Every Reader of P.W. Can Still Obtain

This Wonderful  
**PRESENTATION  
BOOK**

**SEND IN YOUR  
APPLICATION  
NOW**

Fill in the Forms  
Page 632

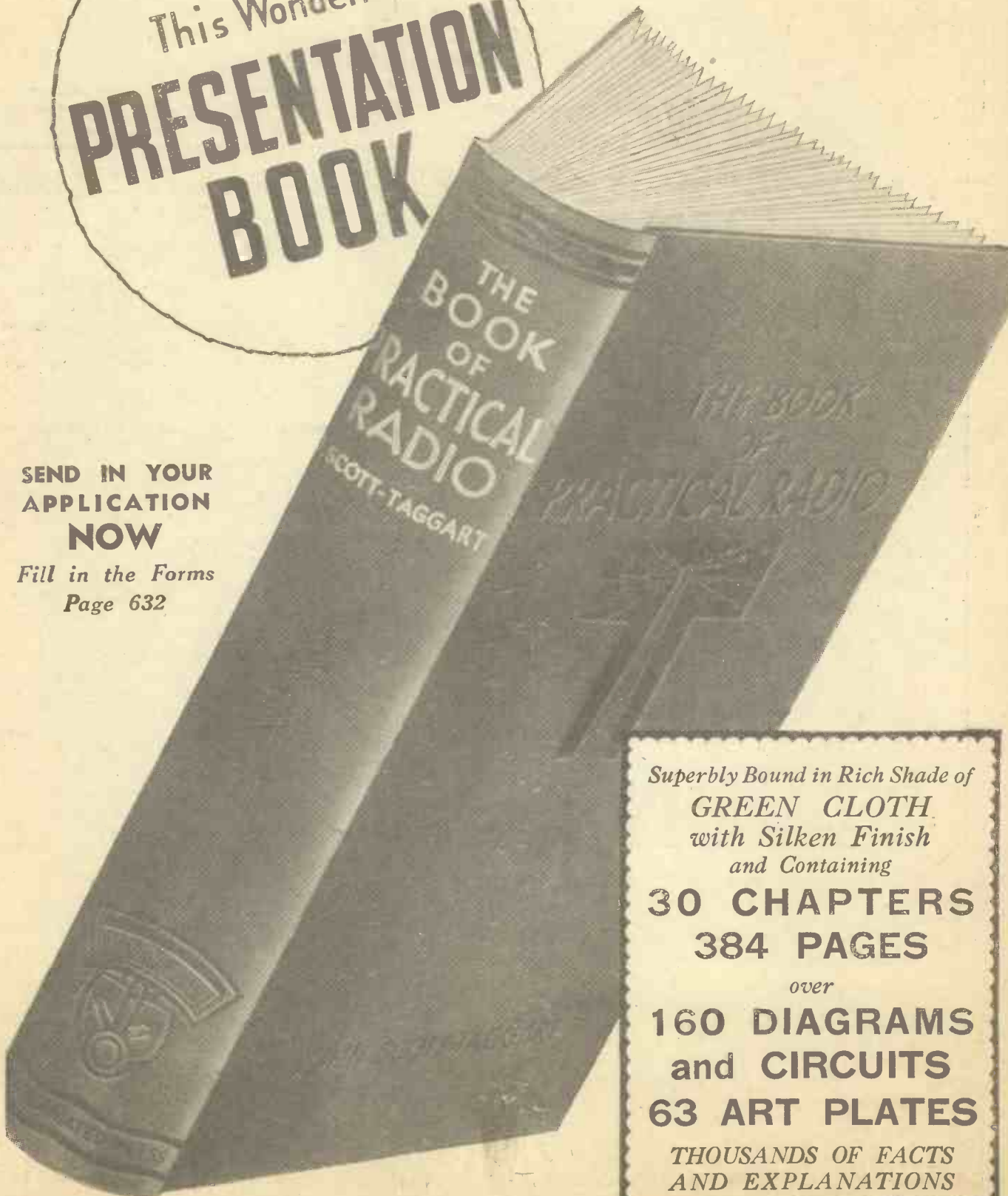

*Superbly Bound in Rich Shade of  
GREEN CLOTH  
with Silken Finish  
and Containing*

**30 CHAPTERS  
384 PAGES**

*over*

**160 DIAGRAMS  
and CIRCUITS  
63 ART PLATES**

**THOUSANDS OF FACTS  
AND EXPLANATIONS**

# JOHN SCOTT-TAGGART'S NEW MASTERPIECE THE BOOK OF PRACTICAL RADIO

SO many applications have been received from readers who failed to take advantage of our previous offer of Scott-Taggart's great radio masterpiece that we have decided to provide readers with a further opportunity to obtain this superb volume on bargain terms. If you want to take advantage of this new opportunity you must reserve your copy without delay.

"THE BOOK OF PRACTICAL RADIO" represents the essence of the author's 22 years of practical radio experience as applied to radio receivers.

Famed as an inventor and a pioneer of radio valve work, Mr. Scott-Taggart possesses a vast experience of handling, designing, experimenting with and—when necessary—"putting right" every possible kind of receiver.

To-day the public is offered in "The Book of Practical Radio" a complete compendium of all the really practical advice which Mr. Scott-Taggart has never previously made available.

Whether he is dealing with trimming a ganged condenser, advising on the tuning of a set or showing clearly how to trace an obscure fault, the reader at once realises that here is a master of detail who knows the practical side of his work from A to Z.

Implicit confidence is inspired in the reader from the opening paragraph. Every page, every sentence even, bears the imprint of a genuine understanding of the practical problems involved in radio. The author himself has so obviously done everything he writes about. There is no hearsay opinion, no slipshod advice, no evasion of a problem.

## EXPERT ADVICE.

If you obtain this book it will be like having John Scott-Taggart at your side showing you how to get the most out of your set, how to construct a design and how to put right a set which does not work correctly.

The author deals not only with general principles, but gives scores of examples of faults and how to trace and cure them speedily and effectively. The fault-finding section of this work is a veritable "Wireless Doctor."

In an incredibly short time you will be able to diagnose a fault, whether it is causing complete failure or weak signals, poor quality or indifferent selectivity.

Even if you do not think you need practical advice, the chances are that, once you have the book, you will get better results from your present set. And should a fault develop, John Scott-Taggart is there at your side, with his skill and long experience, ready to put things right.

Reserve your copy of the book immediately. Huge quantities are being printed, but the demand is tremendous. Over 50,000 copies of the author's "Manual of Modern Radio" were completely sold out, and there are thousands who cannot now obtain the book through delaying to accept our offer of last year. Fill up the forms to-day!

Although the book is absolutely self-contained, no one who already has the "Manual of Modern Radio" will want to miss this new book, printed and bound in the same way, which gives between its two covers all the practical information and advice which every person interested in radio requires.

## THE S.T. CIRCUITS.

Incidentally, there is a special section dealing with all the S.T. sets, so that, if you possess one or intend to do so, this book will be invaluable.

Delve into it at any page, and you will find some gem of advice which will give you better and cheaper radio, or enable you to put right some fault in your own or anyone else's set.

The professional service-man will also find the book of extreme help.

There is really no substitute for such a book, unless it be to serve a very long apprenticeship at the art of radio. Here is someone—and none other than one of the greatest radio authorities in the world—who has been through it all and written it down in such clear, easy-to-understand terms that the veriest tyro cannot help but understand and benefit.

The practical detail is amazing. Do you realise, for example, that there are twenty possible causes of hum in a mains receiver? Yet each is tabulated and discussed in this book.

## HOW TO TEST YOUR SET.

Do you know how to test a set and find a fault without a single instrument? Do you know how to test the insulation and capacity of a condenser without a single meter? Such matters are dealt with so as to cater for all classes of reader.

An extremely valuable and original feature of the book is the set of numbered fault tests which infallibly point the way to any kind of fault, however subtle or complex. These "analysis tables" alone are worth many times the cost of the book, and can be obtained nowhere else.

A great deal of the matter in this book has never even been discussed before by any other author, and every word is newly written by Mr. Scott-Taggart expressly for this volume.

There is a wealth of "how-to-do" sketches and photographs, and the whole atmosphere of the book is intensely practical.

## NUMEROUS ILLUSTRATIONS.

There are 384 pages with 63 art plates; sketches and diagrams accompany the text; and there is a wide variety of useful reference data at the end of the book. Truly a magnificent bargain is here being offered!

Above all, of course, is the fact that the book is by John Scott-Taggart, M.I.E.E., F.Inst.P., Fel.I.R.E. His other books have sold to the extent of 800,000 copies—the greatest possible tribute to his ability to write the kind of book that people read and appreciate.

John Scott-Taggart not only "knows how," but is a brilliant "explainer." When only nineteen years of age he was Chief Instructor in Wireless to the 1st Army, B.E.F. To-day he unquestionably ranks as the leading technical author in the country.

From the first paragraph of this book you will be lured on from chapter to chapter by the fascination of his style and the very practical information conveyed. Almost a lifetime's experience can be read in a week. And there will be scores of occasions when you will reach this handsome volume down from your bookshelves in order to obtain the free advice of a consulting engineer who has advised the greatest radio concerns on both sides of the Atlantic.

*Make this  
Wonderful  
Book YOURS!*

FILL IN YOUR  
RESERVATION  
FORMS TO-DAY

**WHAT TO DO**

Look carefully at the two forms on this page. First of all you must write your name and address on Form 1, which is just an ordinary label, on which you must stick a 3d. stamp. Then fill in Form 2, which is your reservation form. Then send these two forms to POPULAR WIRELESS. When they are received in our office, you will be sent a Gift Voucher on which to qualify for your "Book of Practical Radio."

There are six spaces on this Gift Voucher on which you will have to stick six Gift Tokens cut from the bottom left-hand corner of the last page of reading matter of POPULAR WIRELESS for six consecutive weeks. When this Gift Voucher is complete—i.e. after six weeks—you are asked to send a P.O. for 2/10 (2/6 with 4d. stamp attached). This 2/10 is to cover the cost of carriage and delivery to your door, cardboard container for packing, and insurance. "The Book of Practical Radio" can only be supplied to readers who complete the necessary Gift Voucher.

As this volume is only available to regular readers, if you have not placed a regular order for POPULAR WIRELESS you must do so at once. This offer applies only to readers residing in Great Britain and Northern Ireland. Overseas readers are not eligible. Irish Free State readers will be liable for any import duty imposed.

**Look at these chapter headings and see whether they do not embrace the Practical Essentials of Radio**

1. Operating wireless receivers.
2. Operating aerial coupler circuits.
3. How to work a reaction receiver.
4. Operating receivers using H.F. amplification.
5. Tuning multiple reaction circuits.
6. Operating ganged receivers.
7. Operating tone control devices.
8. Operating double reaction receivers which use a variable-mu valve.
9. Operating S.T. receivers.
10. Operating superheterodyne receivers.
11. Secrets of successful trimming.
12. How to identify foreign stations.
13. Installing a wireless receiver.
14. Aerial and earth faults.
15. How to test your components: (a) condensers, (b) inductance coils, (c) H.F. chokes, (d) L.F. chokes, (e) L.F. transformers, (f) mains transformers, (g) rheostats and potentiometers, (h) switches, (i) miscellaneous components.

16. Reaction faults remedied.
17. How to cure distortion and improve tone.
18. Nbsises and how to cure them.
19. Hum: its causes and cure.
20. How to read and use wireless circuits.
21. How to construct a wireless receiver.
22. Curing high-frequency instability.
23. Curing low-frequency instability.
24. How to turn weak signals into strong signals.
25. How to improve the selectivity of your receiver.
26. Systematic fault-finding.
27. Fault-finding without instruments.
28. Meters and testing equipment.
29. Rapid fault-finding guide and fault analysis tables.
30. Useful data for the practical man.

The chapter headings covering operating, installing, constructing and fault-finding indicate the practical scope of the book, but only give a hint of the mass of useful information which makes "The Book of Practical Radio" a treasure house of facts and advice.

**YOU MUST ACT  
AT ONCE**



**1**

3d. Stamp  
must be  
affixed here  
by YOU

Name.....

Full Address.....

.....

.....

**POST AT ONCE**

**RESERVATION FORM**

Applicants must complete label on left and affix halfpenny stamp in space provided. Fill in this Reservation Form and send with label to:

**POPULAR WIRELESS Presentation Book Dept. (G.P.O. Box No. 184a), Cobb's Court, Broadway, London, E.C.4.**

*I hereby apply for GIFT VOUCHER and request you to reserve for me in accordance with your special offer the presentation "Book of Practical Radio." I have given a standing order to my newsagent to supply POPULAR WIRELESS regularly each week.*

Reader's Name.....  
(State Mrs, Mrs. or Miss)

Full Address.....

.....

Reader's Signature.....

Newsagent.....

Address.....

PLEASE WRITE IN CAPITAL LETTERS.  
YOU MUST FILL IN LABEL ON LEFT and send with this Reservation Form in unsealed envelope bearing halfpenny stamp.

**For Office Use**

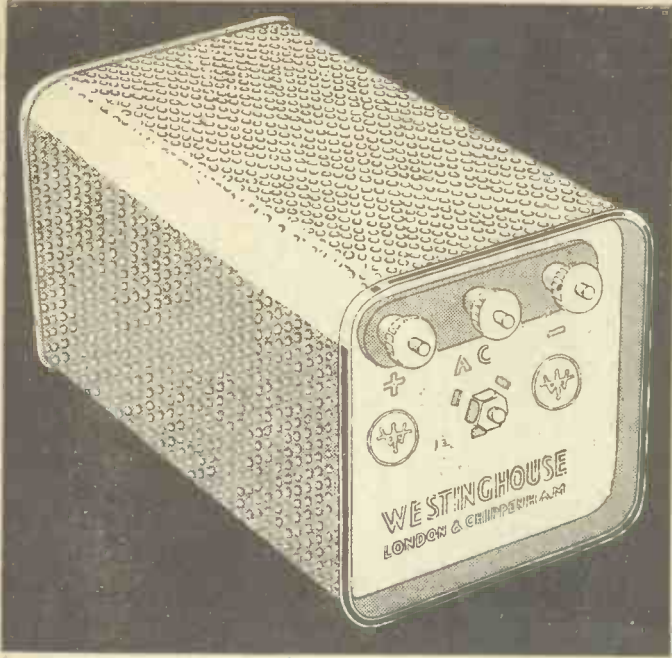

# Reliability for the 1935 KELSEY S/W ADAPTOR (MAINS MODEL)

Reliability cannot be too strongly stressed. A component which is likely to break down is of no use whatsoever to the discriminating constructor. One faulty component... and the whole set is unreliable.

Westinghouse Metal Rectifiers do not break down. Their excellent performance is maintained for all time. That is why an H.T.12 is specified for the 1935 Kelsey S/W Adaptor.

Send 3d. in Stamps and the Coupon to-day for full particulars and circuits.

Please send me the "All Metal Way," 1935, which contains full particulars and circuits for the use of Westinghouse Metal Rectifiers. I enclose 3d. in stamps.

NAME .....

ADDRESS .....

P.W. 19/1/35.



## METAL RECTIFIERS

The Westinghouse Brake & Saxby Signal Co., Ltd.,  
82, York Road, King's Cross, London, N.1.

# COSSOR

for

## UNIFORMITY EFFICIENCY DEPENDABILITY



### COSSOR 210 V.P.T.

Filament Volts 2. Filament Current (Amps) .1. Anode Volts (Max.) 150. Aux. Grid Volts (Max.) 80. Mutual Conductance 1.1 m.a./v. Grid Bias Volts (Variable) 0 to -9.

**PRICE 13/6**



**D**UE to its unique design and method of construction the Cossor 210 V.P.T.—a Variable-mu H.F. Pentode—has an exceptionally low inter-electrode capacity and is therefore capable of very high stable amplification. Like all Cossor Valves uniformity of characteristics is assured by strict adherence to laboratory principles during manufacture and the use of the famous Cossor Mica Bridge.

## FREE!

### A NEW WIRELESS BOOK

A 40-page book packed with useful and interesting information—latest circuits—technical terms—how a 'super' works, etc. Send now.

**PLEASE USE COUPON**

To A. C. COSSOR LTD., Melody Dept., Highbury Grove, London, N.5.  
Please send me free of charge, a copy of the Cossor 40-page Wireless Book.

Name .....

Address .....

**B.V.34** P.W. 19/1/35.





MANAGING EDITOR: N. EDWARDS.

TECHNICAL EDITOR: G. V. DOWDING ASSOC. I.E.E.

A BYRD RELAY  
AERO RADIO  
THE STEEL DOOR  
POLICE WIRELESS

## RADIO NOTES & NEWS

GOOD CAUSES  
ABOUT QUALITY  
ALL-NIGHT MEETING  
EARLY AWAKENING

### An Eye on the Ether.

RECENTLY I was bemoaning the fact that there was no truly scientific means of comparing one year's radio-reception conditions with those of another year. Now comes the news that the Brussels checking station is going to say good-bye to all that uncertainty.

Our old friend, M. Raymond Brailard, and his adviser, Professor Divoire, have devised special apparatus that automatically checks and records field strengths. If used continuously it could obviously give us some definite figures to go on.

The observations taken up to now support the contention that 1934 was a better year for long-distance listeners than its predecessor. Let's hope '35 continues the good work.

### A Modern Mark Tapley.

LISTEN to this tale of woe: A friend of mine saves up for eighteen months for the purpose of taking a trip to South Africa, and at first success attends him.

He has a delightful voyage. Table Mountain is sighted, and then—a tickling in the throat, a hasty visit to a doctor and the medico pronounces it diphtheria!

So now the poor chap lies in hospital, feeling equal to nothing on earth, his money melting like snow upon the desert's dusty face and all his dreams turned to nightmares of £ s. d. From out of those depths he writes to tell me he has just heard a relay, via the Cape Town station, of Admiral Byrd's Polar Expedition.

"You would have been tickled to death by it," he assures me. No, sir; far from home, ill and the unwilling host of diphtheria germs, I should not be feeling tickled about anything!

### Trans-World Greetings.

IT may be a bit late for New Year greetings by the time you read this, but I pass on some hearty ones to "all of 'P.W.'"—that's you—from M. J., of Gloucester Street, South Brisbane, Queensland.

He sends me a regular budget of news, and also asks me to entice the Technical Hounds to design "a set for Colonial conditions during the quiet season."

Alas! I have never known a quiet season

since "P.W." began; but, nevertheless, I will place the request in the proper quarter.

M. J. says what he could do with, out there in Brisbane, is "a set similar to the last S.T." The letters of appreciation we have published since he wrote will, I fear, make him want the set all the more.

### More Progress.

THOSE nervous souls who believe that our Government is snoring whilst others forge ahead in the air would be interested in the rumours I hear about the recent air-test station experiments at Martlesham. (*Ever heard of the Martlesham Lion, ye men of Suffolk?*)

importance to be left with its headquarters open to the mike-crashing fraternity.

### Look You!

TELEVISION continues to intrigue the general public by its infinite promise, but there has been a slight halt in the technical developments reported since Christmas.

Perhaps this has been due to the "lay-low-and-say-nuffin" policy that was favoured when the Television Committee's report seemed imminent. Anyhow, there is sure to be a spate of both fact and fiction in the near future.

On the authority of the "Daily Telegraph," scophony receivers for the high-definition broadcasts will be on the market at about thirty guineas each if all goes well. Readers will remember that articles on scophony television were published in POPULAR WIRELESS last year.

### Robert's Radio.

THAT wireless as an aid to police work is coming into its own is evident from many signs. Take the case of the West Riding.

Two years ago an experimental station was tried at Woolley, but it was realised that higher power was necessary to secure communication all over the Riding.

The Chief Constable now reports that the Marconi Co. has provided on loan a transmitting and receiving set and equipped two cars to send and receive.

The experiments have met with considerable success, and messages can now be sent to anywhere in the Riding. After further trial the C.C. is to come before his Committee with definite proposals on the matter.

This lines up with the Leicester experiments reported in "P.W." some months ago, and promises ill for provincial smashers and grabbers.

### Saar Hospitality.

WE have heard a lot about those Saar troubles, but did you notice the nice little touch of radio that, for a moment, made total strangers kin?

I refer to a Christmas incident in the Saar *Gasthaus*, in which the East Lanes.

(Continued on page 662.)

## OUR RECORD-BREAKING NUMBER

This week we are giving readers of "Popular Wireless" unprecedented value, both in regard to the two special free gifts and to the radio constructional fare that is on the succeeding pages.

The gifts will be found of untold value to listener and constructor alike, while to the set builder we offer, besides, a whole realm of new radio programmes which he can add to those already available with his present set.

We do not ask you to change your receiver in any way whatever; you are probably getting excellent results with it. Instead, we augment its value by virtue of the free radio map, and we increase its station-getting powers by means of the ingenious superhet adaptor described by G. T. Kelsey.

In addition, full details are given of a new W.L.S. "hot-stuff" complete short-wave receiver for those who prefer a separate set for listening below the normal broadcast wavelengths.

Never before has "P.W." offered such intrinsic value to its readers nor held out such possibilities of reception. We urge all of you to grasp the opportunities with both hands. The whole world of wireless is at your command—make full use of it.

The wireless equipment on these latest flyers is something to marvel at, they tell me, and the blind flying experiments have caused hardened aviators to shake their heads and sigh for the good old days when a pilot was a pilot.

Remembering this and also the Empire broadcast at Christmas, besides the success of the American Points-of-View relays, who can say that wireless progress is not a snowball of incalculable possibilities?

### Bolts and Bars.

SIR JOHN REITH remains properly unperturbed by the foolish fuss made in some quarters about the steel shutter which has been fitted, as a precaution, at the main entrance of Broadcasting House.

It seems to the unbiased listener to be a reasonable sort of precaution to take, since broadcasting is of far too much



### WHY NOT USE NEW YORK FOR YOUR ALTERNATIVE PROGRAMME?

*Short-wave reception is no longer the prerogative of the amateur. So great has been the increase in the number of stations available, and so far reaching have been the improvements in receiver technique generally, that world-wide loudspeaker reception is now within the reach of every ordinary broadcast listener. With simple and inexpensive apparatus the "alternative-programme" reception of the United States and other far-distant countries is an established fact, and great as are the attractions of this fascinating field to-day they are but "trailers" of the tremendous future possibilities that short waves hold in store. Now, then, is the time to step out of your European circle with its heterodynes and ether congestion, and to make the whole wide world your broadcast playground. And to set you on the right road you need look no further than this issue of "P.W.," for it has aptly been described as the short-wave event of the new year. And it is! On other pages you will find magnificent designs to cover every class of listener, and with the aid of the easy-to-follow constructional details which are provided you can proceed absolutely confident of success.*

# At last - SHORT-WAVES FOR ALL

**F**AMILIARITY with almost anything is apt to breed contempt. A few years ago the reception of European broadcasting was the most discussed subject of the day, simply because it was all so new and unlike any previous form of home entertainment. Distance alone counted for nothing, and the fascination was mainly in being able by one's own fireside to hear foreign tongues and broadcast customs.

To-day it may be said that we have reached the ultimate in European reception; indeed, if something is not done—and done quickly—about the present congested conditions there is likely to be a serious decline in the near future in the popularity of broadcast entertainment so far as Europe is concerned.

That is because familiarisation and vastly improved reception technique have combined to make us hypercritical. To be able simply to hear every station in Europe is no longer the be-all and end-all of distant reception. It is in terms of actual "programme value" that we assess the reception capabilities of a modern receiver, but not even the most skilfully designed apparatus enables us to overcome the fundamental difficulty of too many stations in a broadcast band of limited extent. The European "quart in a pint pot" is bad enough now—what the future may bring does not bear thinking about.

But out of the muddle of Europe there emerges one concrete fact. That is simply that the part that short waves are to play in

the future of broadcast entertainment is of rapidly increasing importance.

The position of short-wave reception to-day is in many respects comparable with that of European reception in the early days. There is an element of the "unknown" about it which creates tremendous fascination, but there is at the same time definite programme value in many of the transmissions now to be heard.

We would obviously not be so rash as to suggest that perfection has yet been reached. But at least the stage has been reached when the participation of every ordinary listener is a course that can be justified by results.

It has never been the policy of "P.W." to rush in where angels fear to tread, nor to misrepresent what is, in fact, the case. But in pursuance of our policy of blazing the trail and basing our contentions upon months of careful investigation, we sincerely believe that the time has arrived when every ordinary listener can with confidence attempt to make the world his broadcast playground.

The programmes are there. The apparatus with which to receive them is simple. Why not, then, enlist in the growing army of listeners who have freed themselves from Europe and who are experiencing unlimited fascination in selecting their programmes on a world-wide basis? With the publication in this special issue of designs intended particularly for the unskilled, the way is open. It is up to you to follow it.



# You Use Your Present Set, With The KELSEY ADAPTOR

**B**EWARE! I'm out after your blood! An ordinary listener, who, for the sake of his peace of mind, shall remain anonymous, recently challenged me to produce evidence that it was possible, as I had contended, to receive America on the loud-speaker with any ordinary broadcast receiver.

Perhaps it was fortunate that he picked the identical moment when the experimental model of my 1935 short-wave adaptor was undergoing its trials. At any rate, I took him at his word. He found me on the doorstep one evening with a hastily wrapped brown-paper parcel under my arm, and, far from politely requesting, I'm afraid I almost demanded the use of his broadcast set for half an hour.

### He Commenced Right Away.

I wonder how often he listens to Europe now that he can get America practically whenever he wants it! He wouldn't wait for this published description. He got busy with a pencil and paper before I left—perhaps I should say before I was allowed to leave his home. And that was after I had awakened the baby with the stentorian tones of the United States Army Band, or, rather, after he himself had awakened the baby, for he operated it himself from beginning to end while I engaged his wife in conversation. A good political move, that!

But he is only one convert. And to think that he required a practical demonstration to convince him!

I have no doubt at all that many of you will be thinking that I am pulling your legs. Well, I'm sorry to disappoint you, but I'm not! I relate the story because that incident alone leads me to believe that there must be many others who, like my dumbfounded critic, harbour the idea that short-wave reception is intended only for those of an experimental turn of mind. And the simple truth is that I am out to prove that it's not!

### Where Europe Fails.

Perhaps you are asking yourself why you should bother about short waves, anyway? Well, that depends upon to what extent you are content with the present state of affairs in Europe.

I'll wager that, in nine cases out of ten where a listener is concerned only with the

"Distance for ever lends enchantment!" And with this simple unit, which is both inexpensive to build and easy to operate, you can break down the barriers of Europe and, with your existing set, select your programmes on a world-wide basis. It is the latest and greatest achievement of the originator of the short-wave adaptor idea, Mr. G. T. Kelsey, who describes his 1935 version in detail in this article.

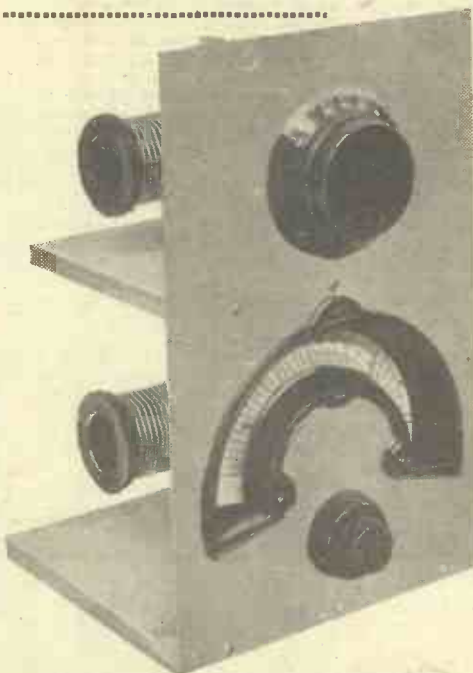

Here is the imposing front of the 1935 Kelsey Adaptor—a worthy successor to previous units designed by the originator of the short-wave adaptor system.

reception of the local stations, the reason is because there is so little, comparatively, from the other side of the Channel that is really worth hearing.

Few of us are good linguists. Even if we can hear foreign stations we can appreciate only the musical items. And how many

stations are there, when it is all boiled down, that provide us with programmes up to local-station standard? The stations are there right enough, I know, but the trouble is that there are too many of them, and to separate them in many cases is an impossibility.

Am I very far out when I suggest that it is the muddle in Europe which has been responsible for making listeners "local-station" minded? I think not.

### Freedom on Short Waves.

Am I holding up short waves as the one and only way of getting away from the monotony of the locals? Not exactly.

Why, then, all this concern that you should sample short-wave reception? I'll tell you.

On short waves there is freedom! You are not tied to, and solely dependent upon, Europe, with its heterodynes and cacophony when you seek to get away from the locals. Literally, the whole wide world becomes your broadcast playground; and although there is an atmosphere of uncertainty about it, it is in this case the unexpected which provides the fascination;

And it is fascination! Real fascination; indeed, once you have tried it, it becomes a disease. The fact is that you never know

what you are going to hear next. With the ordinary broadcast waves you may tune in an "unknown" station, but there's not much fascination about it, because you know at the back of your mind that it must be somewhere in Europe.

### English-speaking Stations.

On short waves it might be anywhere. One minute you are listening to Europe; the next you have jumped three thousand miles and are marvelling at the way in which the "Yanks" introduce the advertising into their sponsored programmes. It gets you, and to revert to listening to the locals seems a terrible thought.

And the great joy of it all is that so many of the countries that you hear are speaking to you in your own mother tongue:

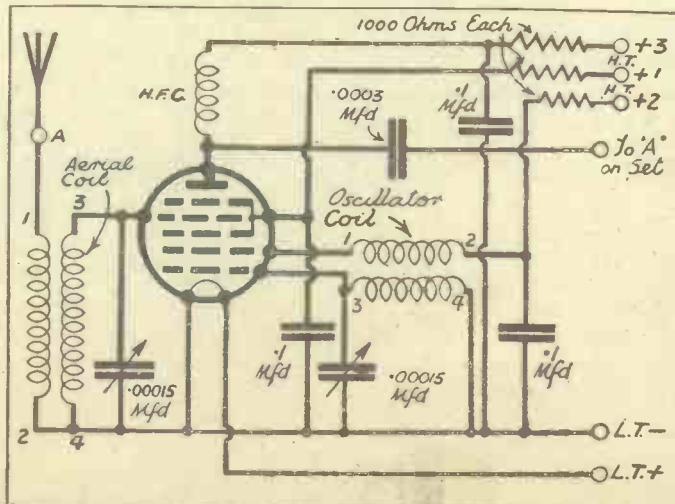

Apart from the orthodox battery connections (your existing batteries serve), there is only one connection between this unit and your set. It is the lead marked in the above diagram "to 'A' on set."

America, Africa, Canada, Australia—all English-speaking stations; all broadcasting programmes that you can understand and enjoy! And you wonder why I rave about short waves.

Then this question of alternative programmes. It seems all bunk, I know, to talk about American stations as "alternative programmes." Well, I say that it is not; at least, it is not if you are not hypercritical about it. Of course, if you

"... One minute you are listening to Europe; the next you have jumped three thousand miles and are marvelling at the way in which the 'Yanks' introduce advertising into their sponsored programmes. It gets you, and to revert to listening to the locals seems a terrible thought...."

want all frequencies from 50 to 10,000, no fading, no crackles and no uncertainty, then you would be well advised to leave short waves alone.

But if you think that you would get a real kick out of being able to hear America on the loudspeaker with reasonable certainty, with occasional fading and with periodical "dud" nights, then you are in for a treat from the moment you start with short waves.

I haven't underrated the case; I haven't overrated it. But all I can add is that for the last six weeks I have listened to America at sufficient strength and constancy to be able thoroughly to enjoy the programmes on nine evenings out of every ten. And the fascination has not ended there.

**Inexpensive to Build.**

I've heard Australia; I've heard Nairobi; I've listened to countries I had never even heard of before. And I'm telling you that there is undreamed-of fascination in it. European broadcasting pales into insignificance by comparison. It's as feeble as weak tea, and that's praising it.

If to participate in this grand and glorious pastime of world receiving cost a lot of money and involved complicated apparatus, then I should not be so keen to urge you on. But it is neither complicated nor expensive. At least, not if you use an adaptor.

The greatest attraction of this way of doing it is that you use your existing set. No alterations, no complications and, apart from the usual battery connections, only one wire to join up.

And in the design of my 1935 adaptor (the eighth or ninth since I first started

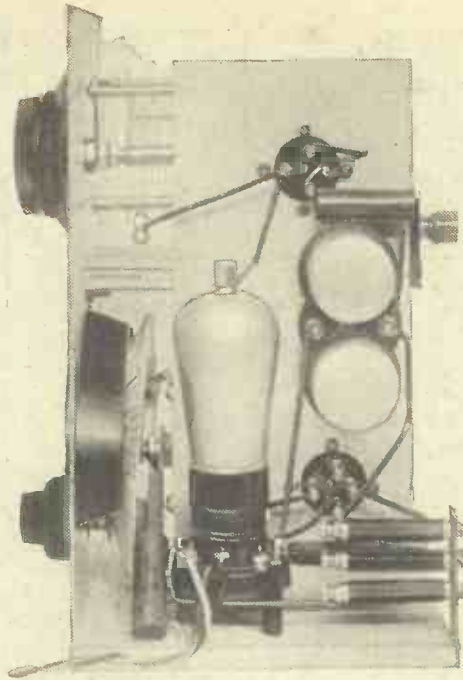

Simplicity combined with efficiency are the keynotes of Kelsey Adaptor construction. The superhet unit shown above is no exception to the rule.

this vogue in 1927) I have gone all out—purposely gone all out—for absolute simplicity of operation. To what extent I have succeeded I prefer to leave to your judgment. Suffice, therefore, for me to say that this latest model is virtually a one-dial set.

There are two controls on the panel, I know. But the tuning of the top one is so very flat that it can be looked upon almost as a sort of subsidiary vernier control. You can tune in stations without touching it,

This simple unit, inexpensive to build and amazingly simple to operate, can be used for converting any existing set, whether commercially built or home constructed, into a "world-getting" short-waver. It has been tried with great success in conjunction with almost all makes of commercial sets.

and it need be used only to bring them up to maximum strength.

It is perhaps significant that of all the adaptors I have designed this is the very first one to be of the superhet type. I could have done one before, but I have been waiting for valves, among other things. Simplicity is the keynote of the short-wave adaptor idea, in my opinion, and to have ventured before would have meant complications.

But now that I have tackled the superhet idea I'm one hundred per cent for it. It has paid to wait, for I can now make the claim—and I make it with all due modesty—that this 1935 model is by far and away the most efficient unit that I have ever designed. That I have been able to obtain such remarkable efficiency while retaining my much-sought-after simplicity is credit due entirely to the valve makers.

**Outstanding Performance.**

The combining of an oscillator and first detector in the one envelope is an idea of theirs upon which they are deserving of every credit. And that I should be so very bucked about it is because it has at last enabled me to arrive at the ultimate in short-wave adaptors, while retaining the simplicity.

This 1935 model is a joy to handle, and it is my claim that it can be used with any existing set. Its performance is particularly outstanding when it is used in conjunction with a superhet or with a straight set using one or more H.F. stages.

Although it can be used with an ordinary "det.-L.F." arrangement, I have not bothered myself very much

about this particular application, for I sincerely believe that there are very few of them about these days. Unless the design

**NO ALTERATIONS TO YOUR PRESENT SET—FITTED IN AN INSTANT!**

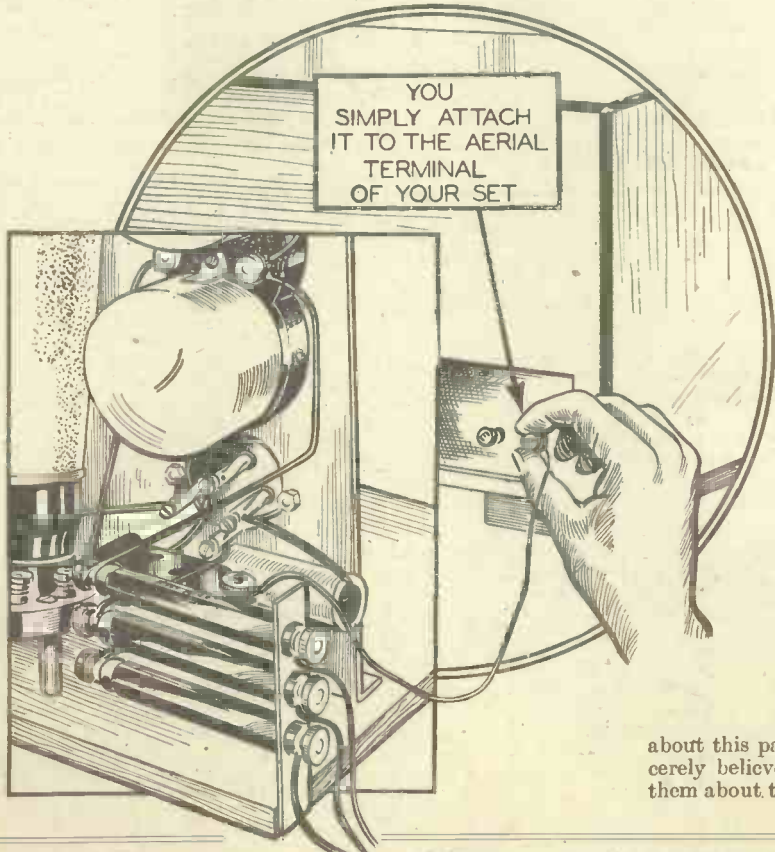

**THE WORLD ON THE LOUDSPEAKER!**

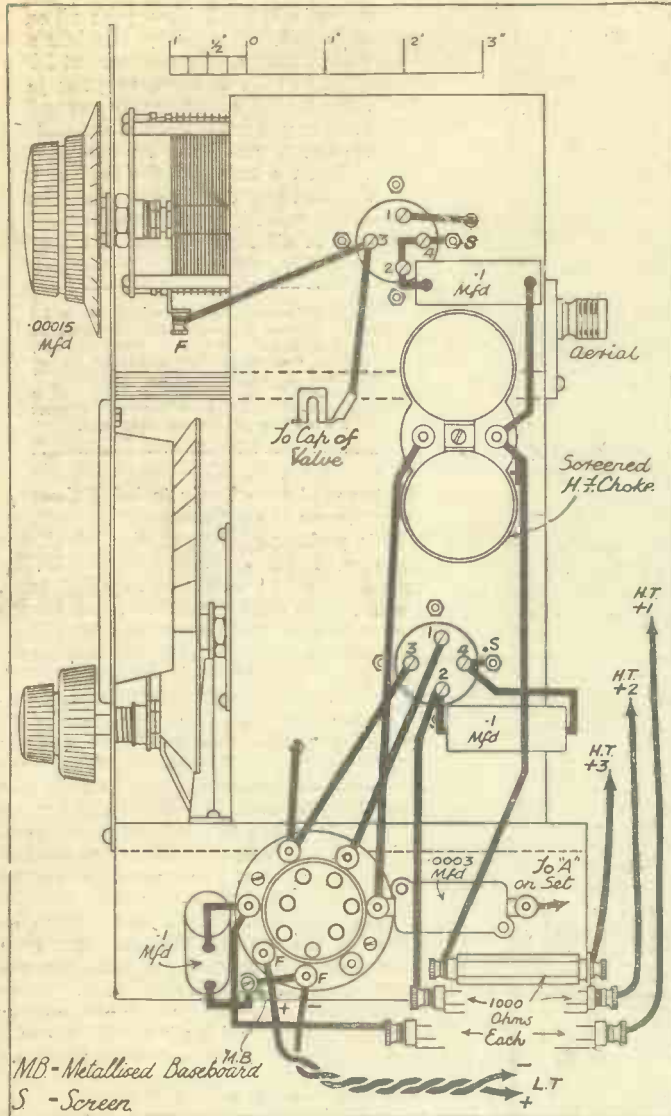

These two diagrams, although perhaps unconventional in appearance, are really quite simple to follow. To avoid complication they show the adaptor wiring from each side, and if they are used in conjunction with one another no difficulties are likely to arise.

is something exceptional, such sets are no good for modern conditions, and there is not much point in going backwards by designing an adaptor for sets that are out of date.

I have said that my new adaptor can be used with such sets. That is quite true, but under these conditions you must expect only a *pro rata* performance. My adaptor cannot put into your set what isn't there, and the success of the unit depends to a large extent upon the efficiency of the set with which it is to be used.

**Complete Kit Available.**

But if your set has one or more H.F. stages, or if it is of the superhet type, then you can go right ahead, confident absolutely of emulating my results. You can even use this battery adaptor in conjunction with mains sets, providing you use separate batteries for the unit. But for mains-set owners I recommend the mains model for best results.

I told you at the outset that I was out after your blood. May I hope, in passing to the constructional side, that I have succeeded? I ask no more than that you

forward job of assembly without complications.

Of course, if you would prefer to tackle the panel drilling, etc., yourself—well, by all means do so. And to simplify your job I am giving you in this article detailed dimensioned diagrams. But don't take liberties in your variations from the specified components. Certain alternatives are permissible, and I have indicated them; but the dimensioned diagrams are prepared in conjunction with the specified components, and if you make radical departures from my list, apart from the possibility of less efficient results, you must be prepared for a few misfits.

When you have collected your parts together, and assuming that the panel and screen are drilled, the following procedure in

should give this adaptor a trial, and if it leaves you other than completely satisfied I honestly want you to write and tell me about it.

Now about construction. Perhaps at first sight it looks a little difficult. Take it from me, it isn't. Drilling metal panels and screens isn't perhaps everybody's pastime, and there may be some of you who feel inclined to turn it down on that score alone.

You need have no fears. I am glad to tell my readers that I have been able to make arrangements with Messrs. Peto-Scott to supply the whole kit ready for assembly. The "Structakit" which you can obtain from this firm includes ready-drilled panel and screen, and the necessary "Metaplex" baseboard and shelf screen cut to size.

It therefore boils down to a straight-

construction will minimise the difficulties and will make it a straightforward job of assembly:

Start with the vertical aluminium screen, and fix the two chassis-mounting valve holders on it. The fixing nuts and bolts against pins 1, 2 and 3 (see wiring diagram) can be tightened right up, but the one in each case against pin 4 should be left only finger tight, as a wire has to be joined to it later.

**THESE ARE THE PARTS**

- 1 POLAR 00015-mfd. variable condenser (No. 4 reaction type).
  - 1 DUBILIER 0003-mfd. fixed condenser (type 670); or T.C.C., Graham Farish.
  - 1 POLAR 00015-mfd. variable condenser (short-wave type "C").
  - 1 BENJAMIN 7-pin valve holder; or Wearite, W.B.
  - 2 CLIX 4-pin valve holders (chassis-mounting type).
  - 1 DUBILIER 0003-mfd. fixed condenser (type 670); or T.C.C., Graham Farish.
  - 3 DUBILIER 1-mfd. tubular fixed condensers (type 4503); or T.M.C.-Hydra, T.C.C.
  - 1 GRAHAM FARISH screened choke (type L.M.S.); or Wearite, Belgim.
  - 3 GRAHAM FARISH 1,000-ohm "Ohmites" (without holders).
  - 1 PETO-SCOTT Kelsey "Structakit" type "B." (This includes panel, baseboard, screens, the two mounting pieces for aerial terminal and resistances, and the valve holder supports.)
  - 1 Set B.T.S. Kelsey adaptor coils.
  - 1 Ferranti heptode (type VHT2).
- Wire, sleeving, flex, screws, etc.

Next mount the bakelite semi-circular escutcheon on the aluminium panel and the condenser and knob and dial which go immediately above it. You can proceed by fixing the panel to the front edge of the "Metaplex" baseboard, but before you secure in position the vertical screen and the horizontal "Metaplex" shelf you will find it best to fix the lower variable condenser.

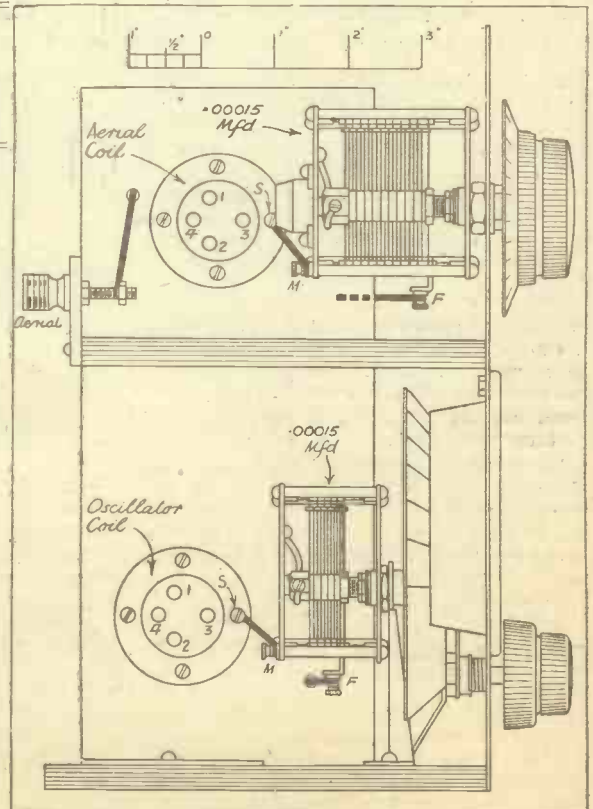

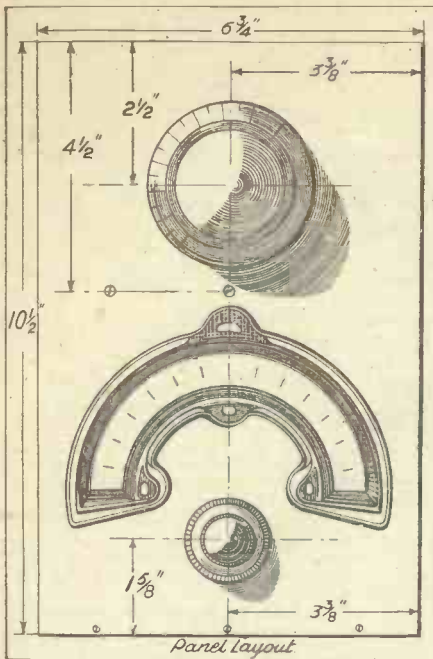

This panel can be obtained ready drilled in the "Structakit" (see component list); but for those who prefer to make their own the dimensions shown above should be closely followed.

At this juncture you will find that the panel is apt to be a bit wobbly. That doesn't matter. But be careful when you are fixing the mount to which the variable condenser is secured to see that the panel is quite vertical. The metal bracket to which the lower variable condenser is fixed, by the way, is supplied with the Polar micro-drive semi-circular dial.

It is an easy job to fix it in position, but make sure that it is fixed so that the actual spindle is at right angles to the panel. Otherwise the pointer, over part of its travel, may rub along the back of the bakelite escutcheon.

This task completed, the vertical screen and horizontal "Metaplex" shelf can be fixed in position, and these two, you will find, will make the panel absolutely rigid.

When you mount the 7-pin valve holder use ebonite or bakelite spacers to hold it clear of the baseboard. These spacers are supplied with the "Structakit," but otherwise the tops of wander-plugs will do so long as they are of the type with holes right through the centre.

#### A Few Final Details.

There is little else to worry you in the fixing of the remainder of the components, but there are one or two points in connection with the wiring to which I want to refer, although it is all very simple.

First with regard to the .1-mfd. tubular condensers. These are held in position solely by the wires which come out of the ends of them.

The .0003-mfd. condenser, from one terminal of which a lead is taken to the aerial terminal of your existing set, is held "floating" in the air by the tag at the opposite end of it. When you unpack the condenser you will find that a terminal is fitted to either end of it. Remove one of these terminals and place the tag over the appropriate terminal shank on the valve holder. Then, when you screw down the terminal head, you will find that it holds the condenser quite firmly in position. But do

not screw it down really tight until you have put on the other wire which goes to this particular valve-holder terminal.

The three Graham Farish "Ohmites" are held in position on the vertical fibre or ebonite strip by their own terminals. The three flex leads that go to your existing H.T. battery are also secured to these terminals.

#### Testing the Unit.

I am not going to tell you a great deal about the operation this week, for I want to deal with that question in detail in the next issue. But to enable you to give it a try out the following brief particulars will answer the purpose.

When the adaptor is completed first carefully check it over against the wiring diagram to make sure that your connections are all in order.

The two L.T. leads should first be connected to the appropriate plus and minus terminals on your existing accumulator. I am assuming that it is a two-volt accumulator, but should the voltage be greater, then join the L.T. minus lead to the usual L.T. minus terminal on the accumulator and tap off the plus L.T. lead at two volts.

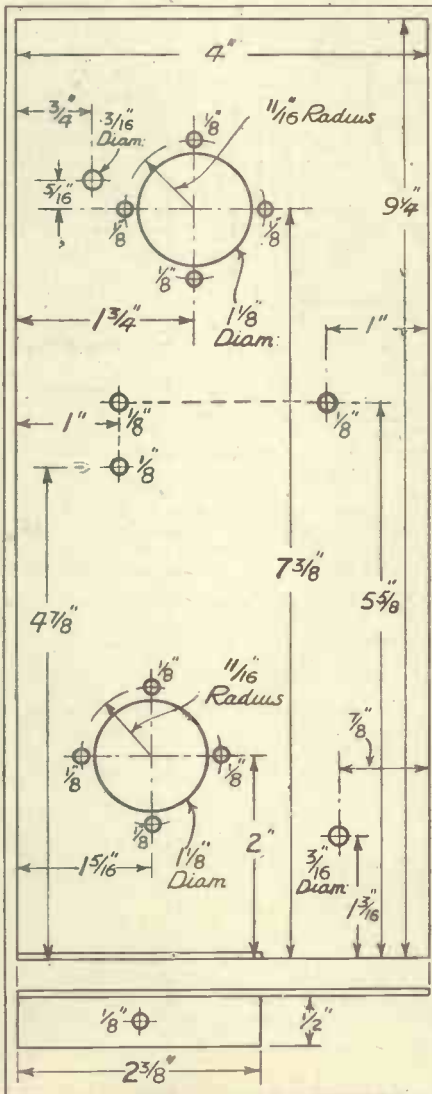

These screen details should be copied accurately by constructors who make their own. Incidentally, the screen supplied with the "Structakit" is ready drilled.

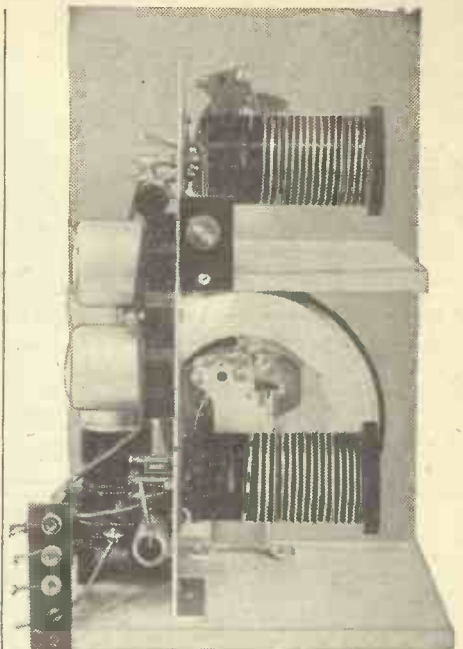

The H.T. leads are taken from the terminals on the left, which can also serve to hold the resistances in position.

With regard to the H.T. leads, H.T. plus 1 should be joined to a tapping somewhere between 70 and 90 volts on the battery, H.T. plus 2 to the 120-volt tapping, and, if your battery is of the 150-volt maximum type, H.T. plus 3 to 150 volts. Otherwise H.T. plus 3 should be connected to the 120-volt tapping. But I do not advise the use of less than 120 volts.

Leave the earth lead on your existing set earth terminal, but transfer the aerial lead-in from the existing set to the terminal on the adaptor marked "aerial." Next join the wire from the .0003 fixed condenser terminal (the one marked "to 'A' on set") to the aerial terminal on your existing set.

#### You Must Tune Slowly.

All is now ready to proceed. For this preliminary test I advise you to use the larger coils—one in each of the two chassis-mounting valve holders.

If you now *slowly* tune with the lower condenser, moving the upper one every now and then so as to keep the two very roughly in step, you should not experience any difficulty in tuning in stations.

As soon as you have tuned in a station with the lower condenser, then the upper one should be adjusted for best results.

Do not despair if at first you don't succeed. Try again! But you are almost bound to hear something right away, and the rest is all a matter of finding the stations and listening at the right times.

With these particular coils the Americans will probably be found somewhere in the neighbourhood of 140 degrees on the lower scale; but it is not much good trying before about ten p.m. If you want American loudspeaker reception earlier, then you will have to use the smaller coils; but more about that next week.

One last injunction. When you have connected the adaptor up do not forget to switch on your set before trying to receive stations! By the way, for best results set your receiver dials to about 2,000 metres. The reason will be explained in the next issue.

# The All-Electric KELSEY ADAPTOR

**INSTANTLY CONVERTS ANY A.C. MAINS SET,  
WHETHER COMMERCIAL-BUILT OR HOME-  
CONSTRUCTED, INTO A HIGHLY-EFFICIENT  
SHORT-WAVE SUPERHET**

**I**N the design of the all-electric version of my 1935 adaptor there were many problems to be overcome which did not arise with the battery model. I had to decide, for instance, whether I would attempt to draw the H.T. and L.T. supplies from the power pack of the set with which the adaptor is to be used, or whether it would be best to use separate arrangements.

On the score of cost, of course, the odds were heavily in favour of the use of the existing set's power-supply arrangement, but there was little point in "spoiling the ship" if the efficiency was to suffer as a result.

I therefore made several tests with various commercial receivers, and it was the practical experience thus accumulated which finally decided me against trying to kill the two birds with the one stone. For one thing, most modern receivers are made within fairly fine tolerance limits, and to increase the load upon the mains transformer incorporated is likely, in consequence, to upset the voltage regulation.

That was an important point, but perhaps the greatest difficulty was that of finding a way of "adapting" the adaptor which would hold good for all makes and types of sets, and which would not involve fiddling about inside the set for the purpose of making the necessary power connections.

I thought of a valve-holder adaptor, I thought of numerous gadget ideas that might have been used, and I explored every one of them. But the lack of standardisation between the various sets that I tried and the widely differing circuit arrangements employed made it patently obvious that the only universally satisfactory way of doing it was by means of a separate power pack in the adaptor itself.

### America as an Alternative.

Inevitably it has put the cost up, of course, but the advantages gained more than justify the increase in price. At least I can assure you now that the adaptor will work successfully with any type of A.C. mains receiver, because I do know that if you build it strictly in accordance with my specification the heptode will be working under identical conditions with my original, no matter with what set it is to be used.

Had I relied upon your existing set to provide the power supply to my adaptor, short of going round and examining every case individually, it would have been impossible to answer for its performance under the widely differing circumstances in which it is likely to be used.

Perhaps the greatest justification for the course that I have taken may be found in my present excitement to tell you all about it! And I make no secret of the fact that I am excited. Far from being new to me, short-

wave reception and all its implications have been an important part of my life for nearly ten years now, and yet I have never been so thrilled as I am over the results which have been obtained with this adaptor.

It is one thing to be able to claim that you

States at sufficient strength to necessitate the use of the set's volume control. And I have tried it with nine different sets as being representative of practically every type of set in existence to-day.

With what sets have I had the best results? Well, mainly, I must confess, with superhets, but the overall efficiency seems to suffer very little with any type of set providing, if it is not a superhet, that it has one or more H.F. stages.

With the ordinary four- and five-valve table-model commercial superhets it works remarkably well, and the ease with which distant programmes can be tuned in and the constancy with which they are received have surprised even me. That is because most sets these days incorporate automatic volume control, and with the scheme I have used in my 1935 adaptor, the automatic volume control is completely effective on short waves!

On many more occasions than one during my tests Pittsburgh, Pennsylvania, and Bound Brook, New Jersey, have been so very strong that for comfortable listening I have been obliged to cut the volume down to half. That claim is not exaggerated in the slightest, and if that does not qualify my "alternative programme" contention, then frankly I don't know what does!

I am content to leave you to judge for yourselves. What I have done you can do, for the operation of this adaptor is as

easy as that of any ordinary broadcast set. I concede that there is, for all that, an element of doubt when it comes to the mighty reception of America as an alternative, for undoubtedly conditions do vary. But, in the main, you can be certain almost always of results, and the strength and quality with which I have been getting the States have been far better, for instance, than Fécamp. And that is over a distance of something like 3,000 miles!

### Unlimited Fascination.

I am the last one to want you to build the adaptor and then to be disappointed, and if you want a "written guarantee" of absolute perfection, then you would be well advised to leave it alone. But if you want unlimited fascination—the fascination of tuning in, at any moment, a station from the other side of the world, a station that as likely as not will broadcast in the mother tongue—then build my adaptor by all means.

If you want to pass your own judgment upon the merits of America's sponsored programme system based upon first-hand knowledge, then build my adaptor. In other words, if you are content to put up with an occasional "dud" evening, then the scope of your entertainment with my adaptor is absolutely unlimited. And I mean every word of it.

Next week I am going to describe the all-electric adaptor in detail. In the meantime, I advise you to obtain the parts now.

G. T. K.

## GET YOUR PARTS NOW!

- 2 UTILITY .00015-mfd. standard variable condensers (type W187/15).
  - 2 UTILITY micro-dials.
  - 2 BULGIN 4/5-pin valve holders (type S.W.21); or Benjamin, Wearite.
  - 1 CLIX 7-pin valve holder (chassis-mounting type).
  - 1 WEARITE screened H.F. choke (type H.F.P.); or Graham Farish L.M.S.
  - 1 T.C.C. .0003-mfd. fixed condenser (flat type "S"); or Dubilier, Graham Farish.
  - 3 T.C.C. .1-mfd. tubular fixed condensers (type 250); or T.M.C.-Hydra, Dubilier.
  - 1 T.M.C.-Hydra .1-mfd. tubular fixed condenser (type T.24); or T.C.C., Dubilier.
  - 2 T.M.C.-Hydra 4-mfd. fixed condensers (type 25); or Dubilier, T.C.C.
  - 1 T.C.C. 4-mfd. fixed condenser (type 80); or T.M.C.-Hydra, Dubilier.
  - 1 ERIE 300-ohm resistance; or Amplion, Graham Farish, Dubilier.
  - 1 ERIE 20,000-ohm resistance; or Amplion, Graham Farish, Dubilier.
  - 2 ERIE 30,000-ohm resistances; or Amplion, Graham Farish, Dubilier.
  - 1 BULGIN L.F. choke (type L.F. 16).
  - 1 HEAYBERD special mains transformer (type K1) or B.T.S.
  - 1 WESTINGHOUSE metal rectifier (type H.T.12).
  - 1 PETO-SCOTT Kelsey Structakit type "M." (This includes chassis, panel, fixing strip for resistances and mains flex and plug).
  - 1 Set B.T.S. Kelsey adaptor coils.
  - 2 BELLING-LEE terminals (walnut, type R, engraved "Aerial" and "Earth"). Tinned copper wire and sleeving.
  - Flex, screws, etc.
  - 1 Ferranti heptode valve (type VHT4). Note.—Marconi, Osram and Cossor heptodes can be used, providing bias and voltage dropping resistances are changed in accordance with makers' recommendations.
- Optional: 1 Bulgin station-log, panel-mounting type.

can hear America and Australia, but it is a very much more attractive proposition to be able to proclaim them as alternative programmes! But I am afraid I am taxing your credulity rather a lot in asking you to swallow that lot

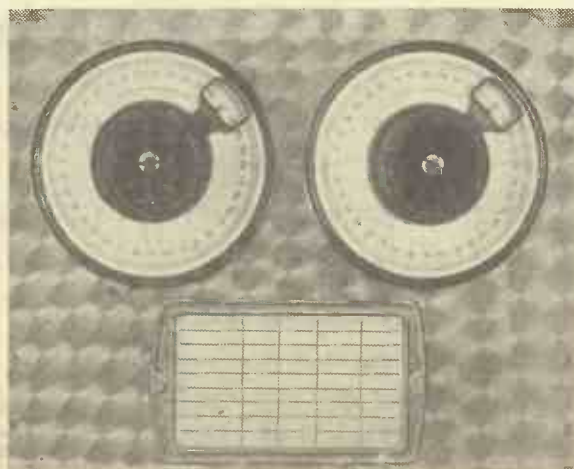

in one go, and, in any case, the very last thing I want to do is to misrepresent the facts.

But it is a fact that for nine evenings out of every ten during the last six weeks I have been able, with this particular model, to tune in the



# TELEVISION

## A SPECIAL PRACTICAL SERIES FOR ALL READERS

By L. H. Thomas

Notes on the projection of television pictures through a disc, and details of suitable tubes for the purpose, are included amongst the topics of general interest dealt with this week.

It is fairly safe to assume that every home constructor who takes up television starts off with a simple disc-type viewer. It is also equally certain, however, that there comes a time when he grows dissatisfied with his results and decides to install some more elaborate method of reception.

### A Considerable Improvement.

At the present time the favourite "second stage," so to speak, appears to be the scheme for projecting pictures through a disc. While this does not give the perfect pictures that one can obtain with a properly adjusted mirror drum, it does represent a considerable improvement on a direct viewer and causes far less eye-strain to the looker-in.

I have already dealt briefly with this system (December 15th issue), and one or two points arise as the result of correspondence received on the subject. First is the fact that the relatively high striking voltage that most "white-light" lamps require seems to be regarded as a tremendous disadvantage.

People jump to the conclusion that they will have to use a very large output valve which will stand the full voltage. This, as a matter of fact, is all wrong, and if you have an output stage to your receiver which already gives an adequate output at a comparatively low H.T. voltage you need not alter it at all.

### Easily Accomplished.

I have not yet scrapped my receiver, which runs from a 250-volt supply, but I have no difficulty in modulating either a "white-line" or a "T.I." lamp, simply by using the arrangement shown in the diagram on this page.

A 1:1 output transformer is very useful, although the same thing may be done with a push-pull output choke and two 2-mfd. condensers. The transformer is naturally a little more straightforward.

In series with the secondary of your lamp (whatever type you use). If it is an ordinary neon tube you may either use a separate supply of 250 volts or so, or you may "double back" and use the same supply that feeds the receiver. The neon tube probably will not consume more than 12 or 15 ma., and the mains unit will probably stand that amount of extra load.

For the white-light lamps a new eliminator giving 450 or 500 volts is required. This is not a tremendously expensive item, as the current demands upon it are quite low, and a metal rectifier is admirable for the purpose. The 25,000-ohm variable

resistance may be a wire-wound volume control of that rating, preferably one of the type with an on-off switch incorporated with it. This switch, of course, is simply connected in series with either of the leads to the volume control itself.

Complete kits of parts for projecting pictures through a disc may be obtained from British Television Supplies, Ltd. These comprise a T.I. lamp and stand, a concave mirror and five lenses with suitable mounts, together with a projection cabinet for fitting to the ordinary disc-type viewer.

I hope to give a test report on this kit shortly, together with diagrams and pictures showing its assembly.

Incidentally, I might mention that it is well worth while to rig up an extra H.T.

will shortly be at least five active stations in the newly allotted 10-metre amateur band.

This is somewhat poor consolation, since the stations concerned will be using fairly low power, and the 10-metre band is hardly noted for its carrying properties. Doubtless more of the amateur transmitting fraternity will be taking it up later on.

### No Change Likely Yet.

Most of them will use 30-line scanning, owing to the expense involved by high-definition apparatus. For 30-line work one can use an ordinary disc or mirror drum for the projector, and the expense incurred is not prohibitive. I have already seen a demonstration of an amateur 30-line transmitter, and results were very little short of those obtained on the B.B.C. transmissions. Photographs of well-known people were identified without the slightest hesitation.

All this brings up the eternal question of how long the 30-line television will remain with us. Many people seem to be afraid of spending any money on 30-line gear for fear that it will be superseded in a single night and replaced by some epoch-making invention.

I don't think anyone need have the slightest anxiety about that score. People who ought to know have told me that they give the present B.B.C. transmissions another two years at least, even if an additional high-definition service is started almost at once. As I have said before, there is a useful field for both.

### High "Notes" Essential.

Several readers suggest that I should describe, from A to Z, a suitable receiver for television work. I don't propose to do this—not at the moment, anyhow; but I will give a brief description of my own receiver within the next week or so. After all, anyone who takes up television ought to know how to make a receiver that gives respectable sound reproduction, and that is all that is really needed.

One mustn't attempt anything too selective, or one loses top, and it is better to put up with the effect of heterodynes from adjoining stations than to tolerate the poor definition that results from a lack of high "notes" in the output.

My "family" broadcast receiver (a three-year-old Ultra "Tiger"), which I generally use for reception of sound on Midland Regional, gives perfectly good results on vision, and I have used it as a stand-by more than once.

## FOR BLACK-AND-WHITE PICTURES

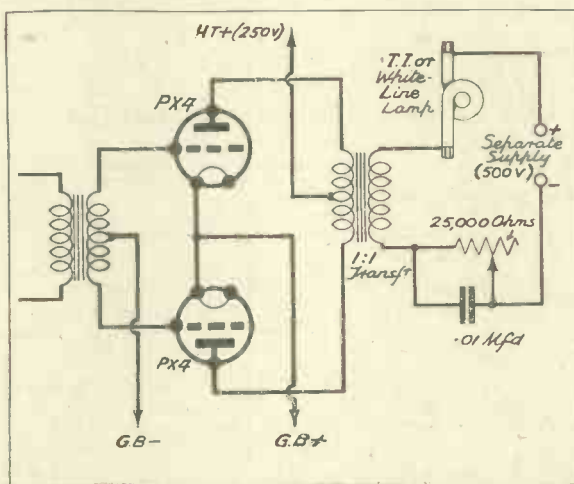

Although a comparatively high voltage is required for special tubes that give a whitish light, a large input for modulation purposes is not necessary. In this circuit a separate striking voltage is used for the tube.

supply as shown, even if one does not intend to project through a disc. A white-light lamp behind a disc that is directly viewed gives pictures of extraordinary brilliance—far superior to the dull orange glow obtained with the average neon tube.

### Amateur Television Transmissions.

Now, for a while, I want to talk about one or two more general points, mostly queries raised by readers. Several of them inquire whether there are any other 30-line transmissions that they can make use of for experimental work without having to wait patiently for Wednesday night or Saturday afternoon. Unfortunately, I am afraid such transmissions are very few and far between, but I understand that there

TELEVISION.—Page 2.

## TELEVISION JOTTINGS

High-definition mechanical scanning—An interesting light tube—The Television Committee's report.

THE view seems to be held in the U.S.A. that the scanning disc is not obsolete or even obsolescent. Now one of the leading experimenters across the Atlantic has definitely stated that he sees no reason why a disc should not be used for the reception of 120-, 180- or even 240-line pictures.

It is interesting to note that the same view has already been expressed in this country, and that the opinion in certain quarters is that the system of projection through a disc has been largely responsible for this rather startling change of opinion.

A 240-hole disc can most certainly be made, and there is no difficulty in causing it to revolve 25 times per second instead of 12½. The trouble, of course, is that the scanning aperture would be of such minute size that direct viewing would be altogether out of the question.

## The New Lamp.

Projection through it, by means of one of the new high-intensity lamps, however, would be quite feasible.

Difficulties would arise, no doubt. Lamps giving an even higher degree of illumination would be necessary; and that would call for the use of higher voltages and more power. But these things are all possible, and an improvement of the optical projection system would make it quite a straightforward matter to produce a picture of, say 3½ by 1½ in., or even 7 by 3 in., with an adequate amount of illumination.

The lamp shown in the photograph on this page is an interesting type that should prove popular with the home constructor who can provide a voltage of 450 or 500 for the last stage of the amplifier. It contains a mixture of neon and mercury vapour, and gives a light that is almost white.

## Even Illumination.

It was originally intended to give the line of light necessary for mirror-screw reception, and is altogether admirable for that purpose, but it may also be used with a disc. Placed in about the same position as the conventional neon tube, with a reflector behind it and a small piece of ground glass in front, it can be arranged to give uniform illumination of the scanning aperture, and the increase in illumination is very marked.

## THE MERVYN TUBE

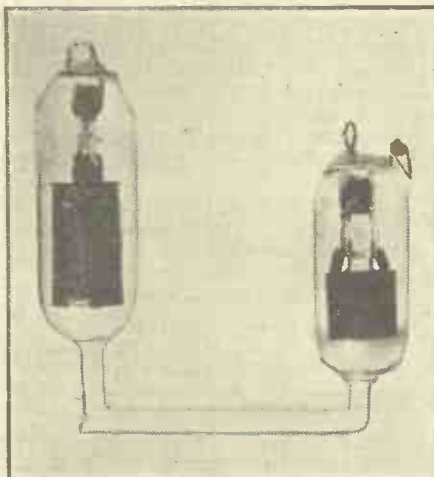

This tube contains a mixture of neon and mercury vapour and gives a light which is almost white. It is described in the text.

Further, the whitish light gives a much more satisfactory effect than the yellow-orange with which we have all become familiar. These lamps may be obtained from the Mervyn Sound and Vision Co., Ltd., or from the Radio Reconstruction Co., Ltd.

All television enthusiasts are still rather breathlessly awaiting the report of the Television Committee, though no one is quite clear about what it will involve when it is published. Recent questionnaires elicited the information that a very large percentage of interested people are in favour of retaining a low-definition system as well as a high. It is, indeed, almost certain that this will be done, since there is obviously room for both.

## Enthusiasts Getting Ready.

Meanwhile, quite a few enthusiasts are building themselves short-wave receivers in readiness for whatever may be released. Unfortunately, many of them seem to be doing this without a proper knowledge of the requirements of such a receiver. The general opinion seems to be that nothing but a superhet will be of the slightest use.

I find it somewhat difficult to believe this, and rather think that a straightforward receiver with a tuned H.F. stage, detector and suitable L.F. amplifier will come into favour as being less complicated and less costly.

Whatever turns out to be the case, the construction of a really adequate receiver for the reception of ultra-short-wave high-definition television is not going to be a particularly simple matter.

There is no point in describing a suitable receiver at length just yet, but readers may rest assured that "P.W." will have something ready for them as soon as there are any regular transmissions available.

L. H. T.

REPORTS of new stations seem to be pouring in these days. Several of them, however, are American commercials, whose habit of interchanging call-signs is well known. What is W 2 X B J one day may easily be W Q P the next, and the only safe scheme is to use a calibrated receiver and make sure of the frequencies.

Interesting stations reported include the following. I couldn't vouch for times of transmission, but I think the wavelengths are reasonably accurate:

Y V R, Maracay, Venezuela, on 16.4; H S P, Bangkok, on 16.92; O C J, Lima, Peru, on 19.2; K K Q, California, on 25.2; P K-Y B G, Sumatra, on 28.8; and P K-Y D A, Bandoeng, Java, on 49.02, the same wavelength as W 2 X E.

## Americans Coming Over Well.

At the time of writing the Americans on all bands are exceptionally good. 20-metre amateurs have been better than I have heard them for more than a year, and some of the telephony has been tremendous. As usual, W 2 Z C is about the best station in the 20-metre band. Other good ones are W 9 B H T, W 8 G H R and W 2 G O Q.

Rumour has it that an Australian broadcast may shortly be starting in the 19-metre band. This should be excellent for daylight working, as some of the Australian amateurs come in very well on 20 metres between noon and 2 p.m.

## SHORT-WAVE NEWS

The latest information about new stations, transmissions that are coming in well, and recent reception conditions.

The existing broadcasts on 31 metres are at their best in the early mornings, although they may sometimes be heard between 6 and 8 p.m. as well, if they happen to be transmitting.

I have repeatedly noticed a connection between a spell of good conditions and a period during which all signals seem to be subject to high-speed fading and a kind of "echo effect." For the last four days even W 8 X K, on 19.72 metres, has had a pronounced echo, and to-day, as I write this, he is coming through at a strength which can only be described by that much-misused word "colossal."

One or two readers have asked for particulars of the wavelengths on which the transatlantic liners may be heard using telephony. The recognised bands which are most frequently used are 22.5 to 24.5 metres and 33.9 to 36.6 metres approximately.

## Some Ship Call-signs.

The following can be heard when conditions are favourable: Olympic, G L S Q; Majestic, G F W V; Homeric, G D L J;

Empress of Britain, G M B J; Berengaria, G B Z W; Monarch of Bermuda, V Q J M; Leviathan, W S B N; Conte di Savoia, I B L I; and Ile de France, F N S M.

I believe a number of Swedish ships are also using telephony. If this is the case we ought to hear them, because those Swedish vessels that use the more usual I.C.W. are generally very strong indeed.

K N R A, the American schooner Seth Parker, transmits on 31.22 metres periodically, and the Byrd Expedition station at the South Pole, K F Z, has eight or nine wavelengths allotted. He has been logged in this country on 19.64 and 23 metres.

## Active Amateur Telephony.

Amateur telephony on the 75-85-metre band is very active these days, and several of the Americans come through in the early mornings. W 2 D C, in particular, is very strong when conditions are good. Atmospherics are more troublesome, however, on that band than on the others.

Fifty or sixty British amateurs may be heard every Sunday morning, and numerous Continental stations, including the well-known Dutchman, P A-o A S D, are also on the air regularly.

We are getting into the season of tests again, and the B.E.R.U. contests, always held in February, are probably going to be better supported than ever this year. I will publish full details before the events start.

W. L. S.

# SPECIFIED FOR THE "B.C.L." TWO SHORT WAVE RECEIVER — THIS TIME FOR ITS AMAZING SENSITIVITY

Never has a loud speaker been so frequently specified by important technicians for their published designs. The reason is a simple one — *now* for the first time is available a speaker which excels in all three important characteristics — realism of reproduction, ability to handle large inputs, and outstanding sensitivity. Thus whether a designer is constructing a "local station" set, an amplifier, or a "distance-getter" he *knows* that in each case the exclusive "Stentorian" magnet and the new "Whiteley" speech-coil will provide a performance totally out of the *ordinary* speaker's capabilities.

Whatever your set, a W.B. Stentorian cannot fail to improve your results out of all knowledge.

Your local dealer will be glad to prove these claims *to-day*. Ask for a demonstration — you will be astounded.

## READ WHAT USERS SAY

"It has given my set a new lease of life. I could not have believed my set (a home constructed 3-valve) capable of such vivid realism. I am proud of it now, thanks to your great achievement."  
—A.S., Berkhamstead.

"... In fact, no words of mine can express my feelings about this masterpiece of loudspeaker art and I can only say that from henceforth W. B. Stentorian is my motto, and I am proud of it."  
—A.H.K., Brierley Hill.

"I cannot speak too highly of this marvellous instrument."  
—G.H.N., Altricham.

"The claims you make are in every way justified. Reproduction is almost unbelievably natural."  
—D.D., Chesham

"I have at last got the perfection I have always wanted — through getting your W.B. Stentorian."  
—H. McA., Sheffield

"Extreme sensitivity . . . quality is all that could be desired . . . no resonance points could be detected . . . I congratulate you on a really first class instrument."  
—Hon. Sec., Kentish Town and District Radio Society:



Stentorian Senior (P.M.S.)  
42/- (100% dust protection  
Oversize cone).

Stentorian Standard  
(PMS2) - - 32/6

Stentorian Baby  
(PMS6) - - 22/6

Write to Information Dept.  
for the new W.B. Stentorian  
leaflet.

# STENTORIAN

PERMANENT-MAGNET MOVING-COIL SPEAKERS

Whiteley Electrical Radio Co., Ltd., Radio Works, Mansfield, Notts

Sole Agents in Scotland: Radiovision Ltd., 233, St. Vincent Street, Glasgow, C.2.

Sole Agents in L.F.S.: Kelly & Shiel, Ltd., 47, Fleet Street, Dublin

# See at once what's wrong!



A sudden silence in your set . . . or a baffling, aggravating noise! What is it? With the AvoMinor you can find out at once.

This ingenious scientific instrument is actually TEN testing instruments in one, giving ten different ranges of readings in milliamps, volts and ohms. It enables you to make every conceivable test with the ease and precision of the electrical engineer, but without his specialised knowledge and skill.

Supplied in handsome case with pair of leads, interchangeable crocodile clips and testing prods, and booklet of instructions showing diagrammatically how to make every test.

**40/-**

Deferred Terms if desired.

## THE D.C. AVOMINOR

REGD. TRADE MARK

TELLS THE WHOLE TRUTH

**CURRENT**  
0.6 m/amps.  
0-30 "  
0-120 "

**VOLTAGE**  
0.6 volts  
0-120 volts  
0-300 volts

**RESISTANCE**  
0-10,000 ohms  
0-60,000 "  
0-1,200,000 "  
0-3 megohms

### "RADIO SERVICING SIMPLIFIED"

Everyone should have this invaluable book. It explains every phase of fault-tracing step by step in non-technical language. The comprehensive information and numerous diagrams render testing and servicing a matter of straightforward procedure.

2/6

or post free. 2/9.

The testing of valves and valve circuits is no longer a tiresome business with your fingers getting in the way. The AvoDapter enables you to make every test with ease, under actual working conditions, but externally on the bench instead of grovelling about inside the set, and without having to sever any connections. You simply plug the valve under test into the AvoDapter base and insert the AvoDapter plug into the valve holder in your set. Supplied with comprehensive instruction book. Adaptable for 4-pin, 5-pin or 7-pin valves.

### The AVODAPTER...

Fully descriptive Folders post free.

The AUTOMATIC COIL WINDER & ELECTRICAL EQUIPMENT CO. LTD.  
Winder House, Douglas Street, LONDON, S.W.1. Tel. V.I.C. 3404-7.



Complete 25/-

The new 9-pin AvoCoupler 12/6

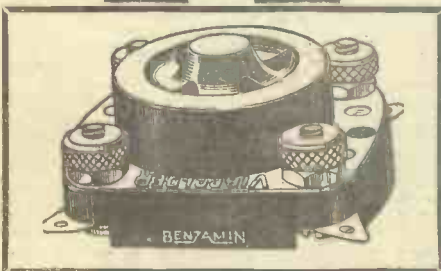
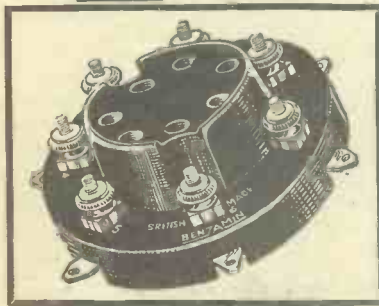

# BENJAMIN VALVE-HOLDERS

THE "B.C.L." TWO      THE KELSEY ADAPTOR

### FOUR-PIN TYPE

The famous Vibrolder, specified for The "B.C.L." Two. Anti-microphonic, dust-proof, with one-piece spiral springs and fitted with terminals and soldering tabs. **10d.**

### FIVE-PIN TYPE

Also specified for The "B.C.L." Two. In black polished bakelite with self-cleaning contacts, soldering tags and terminals. **10d.**

### SEVEN-PIN TYPE

Specified for the Kelsey Adaptor. In black polished bakelite, with self-cleaning contacts, soldering tags and terminals. **2/-**

OBTAINABLE FROM ALL GOOD-CLASS DEALERS

The Benjamin Electric Ltd., Tottenham, London, N.17

# OUR TWO GREAT GIFTS

Inserted in this copy of "Popular Wireless" you will find two magnificent free gifts—a Radio Map and a World Clock and Calculator. The valuable information which they give is described on this page.

**W**HAT station is that? Where is it situated? What bias resistance do I need for an A.C./P. valve?

What is the time in Australia? How many of my H.T. battery volts do I lose in the decoupling resistance? What are the chief stations in Austria?

What a lot of questions! They rather remind one of an examination paper on general knowledge. But no reader will deny that they are all of vital interest and importance to the listener.

And the two valuable gifts which we present to every reader this week will answer them all, and thousands of others like them, too. The POPULAR WIRELESS Radio Map and Chart and the POPULAR WIRELESS World Clock and Lightning Calculator have been produced at considerable cost and will prove of immense value to all listeners.

### Problems Solved at a Glance.

These two shilling-gifts are presented absolutely free to POPULAR WIRELESS readers, and, although fascinating and attractive in appearance, they are also of immense practical value. This will be proved over and over again in the solving of problems that are bound to face listeners and constructors from time to time.

The ways in which the gifts are used are so clearly apparent that anyone could employ them without previous explanations. Nevertheless, we propose to run over their various features to ensure that every reader is able to derive the fullest benefit from them.

First we will deal with the World Clock and Lightning Calculator. This consists of three concentric discs that can be rotated in relation to one another. The centre disc and the middle one are used to find the time in any part of the world, while the outer disc and the middle one are used to work out anything connected with Ohm's Law.

As you know, Ohm's Law is one of the most important laws in radio, and one which is continually cropping up. The photograph on this page shows the

Lightning Calculator being used to solve a problem connected with Ohm's Law.

Ohm's Law concerns the relationship of current, resistance and voltage, and the Lightning Calculator will tell you the relation in any particular case without calculations being necessary. It is to the radio enthusiast what the slide rule is to the engineer.

### Reading the Scales.

If you know the voltage and current of a circuit you can find the resistance; if you know the current and the resistance you can find the voltage; and similarly you can find the current if you know the voltage and resistance. And this is how it is done:

You will see that there are three scales. One is marked "Voltage Across Resistance" and another "The Resistance in Ohms to be Used." These two are on the outer disc. The third scale, marked "Current Flowing in Milliamps," is on the middle disc.

Suppose you want to find resistance. First of all you spot the voltage on the voltage scale, then you turn the middle disc until the right current on the current scale is opposite this voltage. The arrow marked "Required Value" will now point to the resistance.

If, on the other hand, you know the resistance you first point the arrow to it.

Then you find the voltage or the current (according to which you know) on the other appropriate scale and read off the answer in current or voltage opposite it. All you need is to know two of the items concerned.

### Finding Resistance Values.

Now let's consider an actual example. Suppose the current flowing to an L.F. valve is 3 milliamps at 120 volts according to the maker's data, and you wish to drop 150 volts from H.T. accumulators to 120 volts with a resistance. What voltage resistance do you use?

First find 3 milliamps on the current scale, then put this opposite 30 (150-120) volts on the voltage scale. The arrow points to 10,000 ohms, the required value.

Here's another example: An A.C. mains valve passes 12 milliamps and requires a bias voltage of 6; what G.B. resistance should you use? Find 12 on the current scale, put it opposite 6 on the voltage scale and read off the answer—namely, 500 ohms.

Should the answer come to an odd figure such as 1,150 ohms, choose the nearest available value in the make of resistance you desire to use.

And now for one more example—when the resistance is known. A set employs a 10,000-ohm decoupling resistance, and the valve whose H.T. is supplied via this resistance takes 2.5 milliamps, according to a milliammeter reading. What voltage is lost due to decoupling?

The answer is found thus: Put the arrow opposite 10,000 ohms, then find 2.5 on the current scale and read off the answer—25 volts—on the voltage scale.

### The World Clock and the Radio Map.

The World Clock is easily read. Put the time opposite the words "Gt. Britain" and the times opposite the other places will all be correct. Thus at 9 a.m. in Great Britain it is 8 p.m. in New Zealand and 4 a.m. in Eastern U.S.A.

Similarly, if you want to know what time it would be in England when it was 8 p.m. in New York, you proceed as follows: New York is in Eastern U.S.A., so you put 8 p.m. opposite the words "Eastern U.S.A." and then look at the time opposite "Great Britain." It will be 1 a.m.

Now just a word or two about the Radio Map and Chart. This gives all the principal broadcasting stations of Europe, and the stations printed on the map are dealt with in the small "boxes" at the side.

These boxes, which give the stations in alphabetical order, will enable stations to be identified in view of the valuable information given about powers, calls and interval signals.

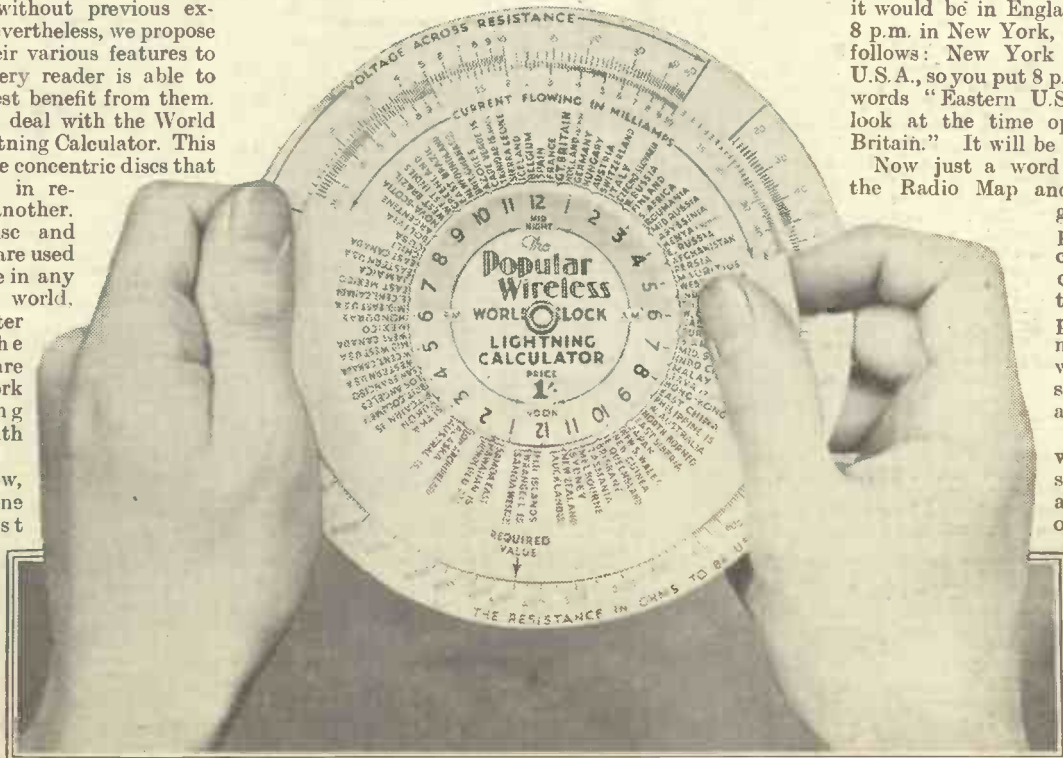

**WELL-KNOWN LINKED STATIONS**

ATHLONE (Ireland), 531 m., relayed by Dublin (222.6 m.) and Cork (241.9 m.).  
 BUDAPEST No. 1 (Hungary), 549.5 m., relayed by Budapest No. 2, 227.1 m., Miskolc, 208.6 m.; Pecs, 204.8 m., etc.  
 COPENHAGEN (Denmark), 255.1 m., relayed by Kalundborg, 1,261 m.  
 HAMBURG (Germany), 331.9 m., relayed by Bremen, Flensburg, Hanover, Stettin, Magdeburg (225.6 m.).  
 LEIPZIG (Germany), 382.2 m., relayed by Dresden, 233.5 m.  
 MUNICH (Germany), 405.4, relayed by Augsburg and Nurnberg (236.8 m.).  
 PARIS P.T.T. (France), 431.7 m., relayed by Eiffel Tower (1,395 m.), Algiers (318.8 m.), Bordeaux (278.6 m.), Strasbourg (349.2 m.), Toulouse (386.6 m.), etc.  
 ROME (Italy), 420.8 m., relayed by Milan No. 2. (222.6 m.) and Turin No. 2 (221.1 m.).  
 STOCKHOLM (Sweden), 426.1 m., relayed by Motala (1,389 m.), etc.

**RADIO MAP AND CHART**

**POPULAR**

**AND TELEVISION**

JAN. 1938

<b>ABERDEEN</b> (Scotland) Wavelength 233.5 m. Relays B.B.C. programmes on a power of 1 kilowatt. Shares wavelength with Dresden (Germany).	<b>ALGIERS</b> (Algeria) Wavelength 318.8 m. CALL: "Ici Radio P.T.T. Alger du Gouvernement Général..." Announcements usually in French.
<b>ATHLONE</b> (I. F. S.) Wavelength 531 m. Woman announcer. CALL: "Radio Atha Luain, Atha Cliath Agus Corcaighe" (announcements are also made in English).	<b>BARCELONA</b> (Spain) Wavelength 377.4 m. FULL CALL: "Aquí estación EAJI Unión Radio Barcelona, instalada en la combre del Tibidabo, Parque del Hotel Florida!"
<b>BARI</b> (Italy) Wavelength 283.3 m. CALL: "Ente Italiano Audizioni Radiofoniche Stazione di Bari!" Closes with "Signori e Signore, buona notte!"	<b>BELFAST</b> (Northern Ireland) Wavelength 267.4 m. B.B.C. station. Power 1 kw. Shares wavelength with Nyiregyháza (Hungary) and Alexandria (Egypt).
<b>BELGRADE</b> (Yugoslavia) Wavelength 437.3 m. CALL: "Ovde Radio Beograd!" Interval signal: First bar of a well-known folk-song.	<b>BERGEN</b> (Norway) Wavelength 352.9 m. Man announcer. CALL: "Dette er Bergen Kringkaster paa..." Interval signal "Bergen her!"
<b>BERLIN</b> (Germany) Wavelength 356.7 m. Man announcer. CALL: "Hier ist der Reichssender Berlin!" Closes with a German folk-song.	<b>BEROMÜNSTER</b> (Switzerland) Wavelength 539.6 m. CALL: "Hallo! Hier Schweizerischer Landessender Beromünster!" Followed by name of studio from which programme is being transmitted.
<b>BORDEAUX</b> (France) Wavelength 278.6 m. Lafayette 12 kw. Relays Paris P.T.T. Closes with French National Anthem.	<b>BOURNEMOUTH</b> (England) Wavelength 203.5 m. B.B.C. relay station. Power 1 kw. Shares wavelength with Plymouth.
<b>BRATISLAVA</b> (Czechoslovakia) Wavelength 298.8 m. Woman announcer. CALL: "Haló! Haló! Bratislava 'vysilá.'" Interval signal: Four chords on a harp.	<b>BRESLAU</b> (Germany) Wavelength 315.8 m. Man announcer. CALL: "Hier ist der Reichssender Breslau und seine Nebensender."
<b>BRNO</b> (Czechoslovakia) Wavelength 325.4 m. CALL: "Haló! Haló! Brno vysilá!" Interval signal: Four chords on the harp.	<b>BRUSSELS No. 1</b> (Belgium) Wavelength 483.9 m. CALL: "Ici Bruxelles I.N.R.!" is usual call. Interval signal: First bars (on chimes) of a Belgian popular song.
<b>BRUSSELS No. 2</b> (Belgium) Wavelength 321.9 m. CALL: "Hier Brussel N.I.R.!" Interval signal: First bars of Flemish popular song (announcements in Flemish).	<b>BUCHAREST</b> (Roumania) Wavelength 364.5 m. CALL: "Atentune! Aci Radio Bucuresti pe treisute sasezeci si patru virgula cinci metri!" (Repeated in 3 languages.)
<b>BUDAPEST No. 1</b> (Hungary) Wavelength 549.5 m. CALL: "Hallo! Hier Radio Budapest!" or "Hallo! Itt Radio Budapest."	<b>COLOGNE</b> (Germany) Wavelength 455.9 m. CALL: "Hier ist der Reichssender Köln!" Interval signal: The opening bars of the "Postilion Song."
<b>COPENHAGEN</b> (Denmark) Wavelength 255.1 m. CALL: "Kobenhavn-Kalundborg!" Interval signal: Melody from an old folk-song.	<b>DROITWICH</b> (England) Wavelength 1,500 m. B.B.C. high-power station (150 kw.) radiating the National programme.
<b>DUBLIN (I.F.S.)</b> Wavelength 222.6 m. CALL SIGN: 2 R.N. (For station announcement details see Athlone.)	<b>EIFFEL TOWER</b> (France) Wavelength 1,395 m. Power 13 kw. Transmitter is situated at the Eiffel Tower itself.
<b>FÉCAMP</b> (France) Wavelength 206 m. CALL: "Ici Radio Normandie!" Closes down with the tune of "Ma Normandie."	<b>FLORENCE</b> (Italy) Wavelength 492.6 m. CALL: "Ente Italiano Audizioni Radiofoniche EIAR, stazione di Firenze-Milano-Torino-Genova-Trieste!"



<b>FRANKFURT</b> (Germany) Wavelength 251 m. CALL: "Hier ist der Reichssender Frankfurt und seine Nebensender!"	<b>GENOA</b> (Italy) Wavelength 304.3 m. CALL: "Ente Italiano Audizioni Radiofoniche EIAR, stazione di Genova-Milano-Torino-Trieste-Firenze!"	<b>GRAZ</b> (Austria) Wavelength 338.6 m. CALL: "Hallo! Hallo! Radio Graz!" Metro-nome is used for interval (200 ticks a minute).	<b>HELSINKI</b> (Finland) Wavelength 335.2 m. Call is usually made in both Finnish and Swedish. Interval signal: Musical box.	<b>HÖRBY</b> (Sweden) Wavelength 265.3 m. Relay station for Stockholm. Identification signals as for Stockholm. Power 10 kw.	<b>KALUNDBORG</b> (Denmark) Wavelength 1,261 m. CALL: "Kobenhavn-Kalundborg" (relays Copenhagen). Interval signal: Folk-song melody.	<b>KAUNAS</b> (Lithuania) Wavelength 1,935 m. CALL: "Allé! Allé! Radio Kaunas! Lietuva, Lithuania!" Interval signal: Melody of popular song.	<b>LAHTI</b> (Finland) Wavelength 1,807 m. This station relays Helsinki (for station announcement details see Helsinki).	<b>LENINGRAD</b> (Russia) Wavelength 1,224 m. Call is often given in English and is: "The Leningrad Radio Station R.V.53 speaking!"	<b>LIMOGES</b> (France) Wavelength 335.2 m. Low-power station working on 0.5 kw. Relays Paris (Ecole Supérieure).
<b>GLEIWITZ</b> (Germany) Wavelength 243.7 m. Relays Breslau's programmes. CALL: The same as for Breslau. Power 5 kw.	<b>GÖTEBORG</b> (Sweden) Wavelength 318.8 m. Man announcer. CALL: "Göteborg Radio." Closes with "God natt, God natt, allesamman!"	<b>HAMBURG</b> (Germany) Wavelength 331.9 m. CALL: "Hier ist der Reichssender Hamburg und seine Nebensender!"	<b>HILVERSUM</b> (Holland) Wavelength 301.5 m. CALL: "Hier Hilversum Holland." Closes with "Goeden nacht, Dames en Heeren!"	<b>HUIZEN</b> (Holland) Wavelength 1,875 m. CALL: "Hier Huizen Holland." Usually closes down with "Goeden nacht. Welte rusten!"	<b>KATOWICE</b> (Poland) Wavelength 395.8 m. CALL: "Hallo! Hallo! Polskie Radio Katowice!" Interval signal: Hammer strokes on anvil.	<b>KÖNIGSBERG</b> (Germany) Wavelength 291 m. CALL: "Hier ist der Reichssender Königsberg und seine Nebensender!"	<b>LEIPZIG</b> (Germany) Wavelength 382.2 m. CALL: "Hier ist der Reichssender Leipzig und seine Nebensender!"	<b>LILLE</b> (France) Wavelength 247.3 m. CALL: "Allé! Allé! Ici Radio P.T.T. du Nord à Lille!"	<b>LISBON</b> (Portugal) Wavelength 476.9 m. Shares its wavelength with Trondelag (Norway). Power 15 kw.

**FREE WITH  
WIRELESS  
OPERATION TIMES**

**PRICE  
1/-**

**THE TIME SIGNALS**

At frequent intervals during the day the British National and London Regional programmes contain time signals. These are radiated for the most part at fixed times, except when important programmes are in course of transmission, and would be interrupted by the signal. In such events, the time is given at an early opportunity, at the full hour or on one of the quarters. THE GREENWICH TIME SIGNAL (six pips) is transmitted from both National and London Regional stations during week-days at 10.30 a.m., 1.00 p.m., 6.00 p.m., 9.00 p.m. or 10.00 p.m. and 11.30 p.m. National only, gives the "pips" at 4.45 p.m., and London Regional only, at 10.15 p.m. (when news is at this time). On Sundays the National only, gives the "pips" at 10.30 a.m., and both stations at 4.30 p.m. and 9.00 p.m. BIG BEN is broadcast by both stations on week-days at 10.15 a.m., 12.00 noon, 5.15 p.m., 6.30 p.m., and 12.00 midnight. On Sundays both stations give Big Ben at 12.30 p.m. and 10.30 p.m.

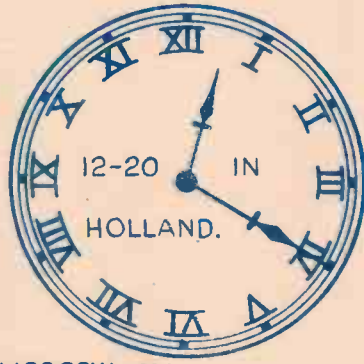

MOSCOW 1724 360-6

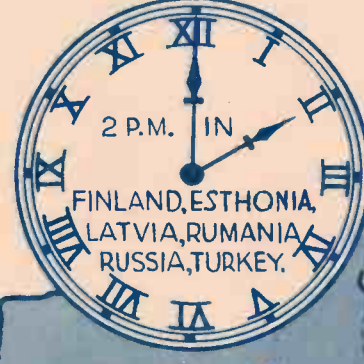

<p><b>WARSAW (Poland)</b> Wavelength 1,389 m. CALL: "Hallo! Hallo! Polskie Radjo Warszawa!" Opening signal: Letter W in Morse (- - -).</p>	<p><b>WEST NAT. and REG. (England)</b> Wavelength National 261.1 m. Regional 307.1 m. B.B.C. stations working on 50 kw.</p>
<p><b>VALENCIA (Spain)</b> Wavelength 352.9 m. Power 1.5 kw. Shares a common wave with Sofia, Porsgrund, Aalesund and Bergen.</p>	<p><b>VIENNA (Austria)</b> Wavelength 506.8 m. CALL: "Hallo! Hallo! Radio Wien!" Interval signal: Metronome, 270 beats per minute.</p>
<p><b>TRIESTE (Italy)</b> Wavelength 245.5 m. CALL: "Ente Italiano Audizioni Radiofoniche E I A R, Stazione di Trieste-Milano - Torino - Genova-Firenze!"</p>	<p><b>TURIN (Italy)</b> Wavelength 263.2 m. CALL: "Ente Italiano Audizioni Radiofoniche E I A R, Stazione di Torino-Milano - Genova - Trieste-Firenze!"</p>
<p><b>TALLINN (Esthonia)</b> Wavelength 410.4 m. CALL: "Hallo! Hallo! Tallinn ja Tartu." Announcements are made in Esthonian.</p>	<p><b>TOULOUSE (France)</b> Wavelength 320.0 m. CALL: "Allô! Ici Radio Toulouse!" The power is 60 kw.</p>
<p><b>STUTTGART (Germany)</b> Wavelength 522.6 m. CALL: "Hier ist der Reichsender Stuttgart!"</p>	<p><b>SUNDSVALL (Sweden)</b> Wavelength 499.2 m. Relays Stockholm on a power of 10 kw. Shares wavelength with Rabat (Morocco).</p>
<p><b>STOCKHOLM (Sweden)</b> Wavelength 426.1 m. CALL: "Stockholm Rundradio!" Closes down with the words "God Natt!"</p>	<p><b>STRASBOURG (France)</b> Wavelength 349.2 m. CALL: "Allô! Allô! Ici Radio Strasbourg."</p>
<p><b>SCOTTISH NAT. and REG. (Scotland)</b> Wavelength National 285.7 m. Regional 373.1 m. B.B.C. stations working on power of 50 kw</p>	<p><b>SOTTENS (France)</b> Wavelength 443.1 m. CALL: "Ici Emetteur National Suisse Romande."</p>
<p><b>ROME (Italy)</b> Wavelength 420.8 m. CALL: "Ente Italiano Audizioni Radiofoniche E I A R, Stazione di Roma!"</p>	<p><b>SAN SEBASTIAN (Spain)</b> Wavelength 238.5 m. CALL: "Esta es la estacion emisora E A J 8, Unión Radio..."</p>
<p><b>RADIO PARIS (France)</b> Wavelength 1,648 m. CALL: "Allô! Allô! Ici Radio Paris." These words are also used for the interval signal.</p>	<p><b>RIGA (Latvia)</b> Wavelength 514.6 m. CALL: "Hallo Latvija! Riga! Madona and Liepaja."</p>
<p><b>PRAGUE (Czechoslovakia)</b> Wavelength 470.2 m. CALL: "Halô! Radio-Praha vystia!"</p>	<p><b>RABAT (Morocco)</b> Wavelength 499.2 m. CALL: "Ici Radio-Moroc!" Interval signals metronome (60 beats per minute).</p>
<p><b>POSTE PARISIEN (France)</b> Wavelength 312.8 m. CALL: "Ici le Poste Parisien Paris!" Closes down with "La Marseillaise."</p>	<p><b>POZNAN (Poland)</b> Wavelength 345.6 m. Frequently opens with chimes from Poznan Town Hall or with a clock gong.</p>
<p><b>PECS (Hungary)</b> Wavelength 204.8 m. Relays Budapest No. 1 on a power of 1.25 kw.</p>	<p><b>PLYMOUTH (England)</b> Wavelength 203.5 m. B.B.C. relay station (0.3 kw.). Shares wavelength with Bournemouth.</p>
<p><b>PALERMO (Italy)</b> Wavelength 531 m. The opening signal is a bell, and the interval call "Radio Palermo."</p>	<p><b>PARIS P.T.T. (France)</b> Wavelength 431.7 m. CALL: "Allô! Allô! Ici le Poste Radiodiffusion de l'Ecole Supérieure des Postes et Telegraphes de Paris!"</p>

<p><b>LONDON NAT. and REG. (England)</b> Wavelength National 261.1 m. Regional 342.1 m. B.B.C. stations. Power 50 kw.</p>	<p><b>LWÓW (Poland)</b> Wavelength 377.4 m. CALL: "Hallo! Hallo! Polskie Radjo Lwów." Carols are used as interval signal.</p>	<p><b>MADRID (Spain)</b> Wavelength 274 m. CALL: "E A J 7 Unión Radio Madrid!" OPENING SIGNAL: Siegfried's bugle-call theme from the opera.</p>	<p><b>MIDLAND REG. (England)</b> Wavelength 391.1 m. B.B.C. station. Transmitter at present situated at Daventry, studios in Birmingham. Power 25 kw.</p>	<p><b>MISKOLC (Hungary)</b> Wavelength 208.6 m. Relays Budapest (No. 1) on a power of 1.25 kw.</p>	<p><b>MONTPELLIER (France)</b> Wavelength 224 m. Works on a power of 5 kw. Shares wavelength with Lodz (Poland).</p>	<p><b>MOSCOW No. 1 (Russia)</b> Wavelength 1,724 m. This station works on a power of 500 kw. Closes down with the "Internationale."</p>	<p><b>MUNICH (Germany)</b> Wavelength 405.4 m. CALL: "Hier ist der Reichsender München und seine Nebensender!" Power 100 kw.</p>	<p><b>NICE (France)</b> Wavelength 240.2 m. CALL: "Radio Nice-Cannes - Juan - les - Pins." Closes down with "La Marseillaise."</p>	<p><b>OSLO (Norway)</b> Wavelength 1,154 m. CALL: "Hallo! Hallo! Oslo Her!" Closes down with "God natt, God natt!"</p>
<p><b>LUXEMBOURG</b> Wavelength 1,304 m. Works on a power of 150 kw. Shares its wavelength with Ankara (Turkey).</p>	<p><b>LYONS (France)</b> Wavelength 463 m. CALL: "Allô! Allô! Ici la station de Radiodiffusion de Lyon La Doua!"</p>	<p><b>MARSEILLES (France)</b> Wavelength 400.5 m. CALL: "Allô! Allô! Ici la station de Radiodiffusion de Marseille!"</p>	<p><b>MILAN (Italy)</b> Wavelength 368.6 m. CALL: "Ente Italiano Audizioni Radiofoniche E I A R, stazione di Milano-Torino - Genova - Trieste - Firenze!"</p>	<p><b>MONTE CENERI (Switzerland)</b> Wavelength 257.1 m. CALL: "Radio Svizzera Italiana - Impianto nazionale, Monte Ceneri!"</p>	<p><b>MORAVSKA-OSTRAVA (Czechoslovakia)</b> Wavelength 269.5 m. CALL: "Halô, Moravská Ostrava vysiláni." Interval signal: Four chords on a harp.</p>	<p><b>MOTALA (Sweden)</b> Wavelength 1,389 m. CALL: "Motala!" Closes down with the words "God natt alle-samman."</p>	<p><b>NEWCASTLE (England)</b> Wavelength 209.9 m. B.B.C. relay station. Power 1 kw. Shares wavelength with Beziers (France).</p>	<p><b>NORTH NAT. and REG. (England)</b> Wavelength National 296.2 m. Regional 449.1 m. B.B.C. stations working on power of 50 kw.</p>	<p><b>NÜRNBERG (Germany)</b> Wavelength 236.8 m. Relays Munich. Shares wavelength with Augsburg (Germany). Power 2 kw.</p>

# NEW DISTINCTION FOR VALVE PIONEER

## Mr. John Scott-Taggart Elected Fellow of the Institute of Radio Engineers

RECOMMENDED BY THE MARCHESE MARCONI AND THREE PAST-PRESIDENTS

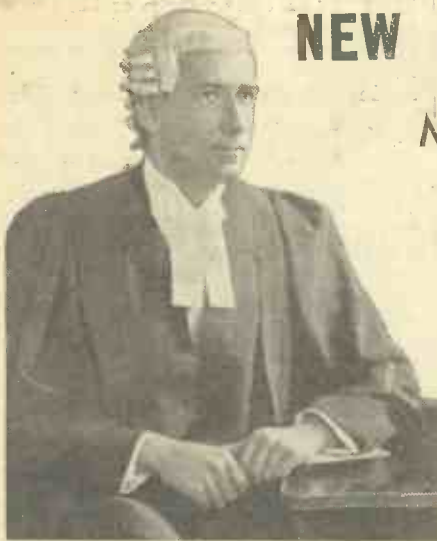

JOHN SCOTT-TAGGART, M.C., M.I.E.E., F.Inst.P., Fel.I.R.E. Although a qualified barrister-at-law, he has remained a consulting engineer and physicist.

IT is announced that Mr. John Scott-Taggart has been elected a Fellow of the Institute of Radio Engineers.

This distinction is very rarely granted, and only to those who have attained the highest eminence in radio engineering.

We feel sure readers will join us in heartily congratulating Mr. Scott-Taggart, who so richly deserves this tribute which has been paid to his work as a pioneer of the valve era, as a brilliant inventor and as a distinguished radio engineer.

To the public Mr. John Scott-Taggart is probably best known as Britain's leading radio designer; but many who use his inventions as a matter of course fail to realise that dozens of his valve manufacturing and circuit patents, many of them years

before their time, are part of the very structure of modern radio science. A practical proof of the utility and priority of these inventions is that the greatest radio concerns in Europe and America have acquired these patents.

The vast popularity of his writings—and his latest "Book of Practical Radio" is an example—is due to his rare skill as an explainer and originator, allied to professional credentials of the highest grade.

### Expert on Patent Law.

Mr. Scott-Taggart has specialised in inventions, and his interest in patent law led him to a study of the legal side. After obtaining a very high position in the Bar Final examinations he was called to the Bar in June, 1928. Although a qualified barrister-at-law, he has never practised as such, preferring to remain a consulting engineer, in which capacity he has advised the most prominent radio concerns in this country and America.

It is very significant of Mr. Scott-Taggart's eminence in purely technical and professional circles—as contrasted with his more "popular" activities—that he was recommended for this new distinction by his Excellency the

Marchese Marconi himself and three Past-Presidents of the Institute of Radio Engineers.

The "I.R.E." has its headquarters in New York, and its international prestige stands very high. Its Fellows include such famous names as Marconi, Alexandersen, Hazeltine, Armstrong and De Forest. We believe Mr. John Scott-Taggart is the youngest Fellow, just as he was the youngest Fellow of the Institute of Physics.

At thirty-seven he holds the three highest professional diplomas it is possible for a radio-scientist to obtain: in electrical engineering, the M.I.E.E. (Member of the Institution of Electrical Engineers); in physics, the F.Inst.P. (Fellow of the Institute of Physics); and in radio, the Fel.I.R.E. (Fellow of the Institute of Radio Engineers).

There is only one other in this country who possesses all three distinctions.

It is a matter of gratification to all who know the details of Mr. John Scott-Taggart's brilliant career that three such famous institutions have set the seal on his technical accomplishments by granting him the highest professional status it is in their power to award.

THE EDITOR.

I'VE a bone to pick with the Scottish Studio Orchestra. Having made a point of listening to one of its programmes because it contained a bit of Sullivan of which I am particularly fond, I was annoyed when it played some "Beggar's Opera" music instead.

In the same programme, too, it played three Scottish songs, although it was down to play two, neither of which was one of the three it actually did play. Stick to the programme, Scotland, if you please! Remember there are lots of listeners like me who plan their listening in advance.

Lately I've had the opportunity of listening to a good deal of dance and light music. Song writers seem to have produced a number of new and pleasing tunes for the Christmas and New Year festivities. But still not enough, for consecutive items have often dished up the same tunes. One could mention at least a dozen tunes that have literally been done to death. As long as dance-band leaders make no attempt to be exclusive in their repertoire, listening can never become a full-time job.

And didn't we have two different presentations of "Aladdin" in one week?

### The Standard Language.

I read this somewhere this week: "Growth in most things can only come of itself; it cannot be consciously forced." This is a truism which I am sure applies to language. I can't help feeling that Professor Lloyd James and his select committee of scholars are consciously forcing every time they bring out a fresh list of pronunciations.

If one studies the question one will find that language follows a popular development.

## OMISSION AND REPETITION

### Our Broadcasting Critic Reviews Some Recent Programme Characteristics

It always has done so, and I think very creditably. If, for instance, one thinks of the several popular lines of development of Vulgar Latin one must agree that the resultant languages—the Romance languages—are excellent achievements and are all quickly and easily understood in the localities where they are spoken.

The object of Professor Lloyd James' labours is, as he himself says, to bring about a quicker and easier mutual understanding among English-speaking peoples. Very praiseworthy, were it necessary. But, in my opinion, a standardised pronunciation isn't at all necessary for this purpose. Nor is it desirable. The Basils and the Cuthberts must be distinguished from the 'Arrys and the Berts. "In Town To-night" would lose most of its charm if the bootblack or the office charlady spoke exactly like the film-actor or the first woman announcer.

In spite of the cold water I am throwing on the efforts of the B.B.C. Committee to direct the development of our language I wouldn't like their efforts to stop, because it might also stop Prof. Lloyd James from broadcasting. And that would never do! Prof. Lloyd James stands in a class by himself. (Perhaps this

sounds a bit ambiguous in view of the professor's university work—but understand me aright, please.) Whether he is talking to children or to the man in the street his brand of humour never fails to appeal.

What's in a title? When applied to broadcasting the title is sometimes the best part of the whole. I think it might be said of "Carriages at Midnight" that the substance of this item didn't rise to the heights suggested by its title. On the other hand, "Entre Nous" as a title didn't do justice to the delightful entertainment that Stuart Robertson, Esther Coleman, Jan Van der Gucht and Helen Crerar, with two compères, provided.

### An Orgy of Handel.

I don't know whether an orgy of any one composer is good policy. Apparently the B.B.C. thinks it is. The Corporation likes to feel that an orgy of Bach once did much to popularise Bach. So much so that it has now embarked on an orgy of Handel. I am bound to confess that the prospect of ten weeks of Handel is more likely to sicken me of him than to make me enthusiastic.

"From the London Theatre" is the most eventful innovation we've had for some time. As I see it, this is the first definite link to be forged between the B.B.C. and the theatre proper. Actors and actresses are now coming from their theatres to the microphone to broadcast excerpts from their plays. For one thing, we are now always certain of hearing a meaty play. Trivial plots are the exception rather than the rule of theatre productions.

(Continued on page 669).



# WEARITE

REGD. TRADE MARK

## COMPONENTS

★ GET YOUR COPY OF THIS NEW WEARITE BOOK— PLEASE USE COUPON

for the

### S.T. 600

#### The WEARITE "UNIDA" COIL

### 12'6

As shown—two dual-range coils with ganged positive switching, complete with knob. Guaranteed to "S.T." specification.

#### For the A.C. Model

- One "Unida" Coil Assembly - - 12/6
- One Mains Transformer - - - 25/-
- One Smoothing Choke - - - 9/-
- One Potentiometer Q.V.C. - - 4/6
- One H.F. Choke, Type H.F.P. - - 3/6
- One H.F. Choke, Type H.F.P.J. - 2/-
- One Radiogram Switch, Type I.23 - 4/-

#### For the Battery Model

- One "Unida" Coil Assembly - - - 12/6
- One H.F. Choke, Type H.F.P. - - 3/6
- One H.F. Choke, Type H.F.P.J. - 2/-
- One Radiogram Switch, Type I.23 - - - 4/-

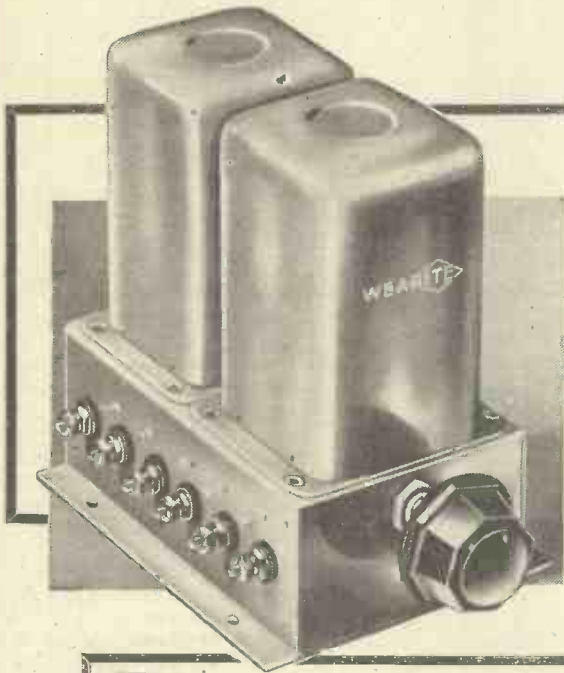

### for the 1935 KELSEY SHORT-WAVE ADAPTOR

#### The WEARITE H.F. CHOKE

Type H.F.P.

Self Cap., 4.5 m.mfds. Induct., 255,000 m.h.  
D.C. Resist., 300 ohms.

### 3'6

#### The WEARITE MAINS TRANSFORMER

Type T.21.A.

250-0-250 at 60 m/a, 2-0-2 v. at 1 amp., 2-0-2 v. at 3-4 amps. (with input selector as shown).

### 25'--

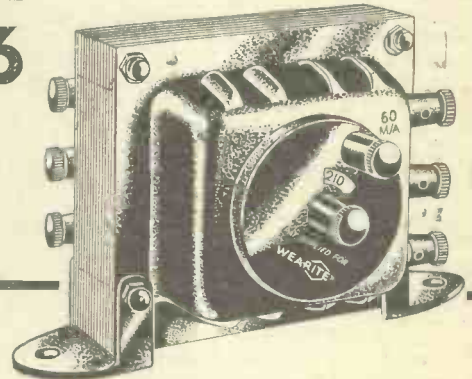
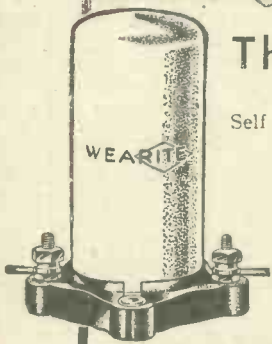

#### The FAMOUS WEARITE SCREENED UNIVERSAL COIL

Tunes 180-550 and 850-1950 metres. Specially designed to cover the Lucerne Plan. One type of Coil suitable for H.F. Aerial and Band Pass Tuning.

Price Per COIL **5'--**



#### COUPON

To WRIGHT & WEARE LTD.,  
740, High Road, Tottenham, N.17.

Please send me a copy of Catalogue 834 together with constructional details, Blue Prints, etc., of Wearite (L.P.) Teamster series of receivers and Power Packs, etc. I enclose three penny stamps to cover postage.

NAME.....

ADDRESS.....

P.W. 19/1/35

6274

IT is good news that the B.B.C. is going "all out" on the May 5th-12th Jubilee Week. I gather that the conception of programmes is the same as that which was associated some years ago with "Birthday Weeks" of the B.B.C. happening in November.

The whole world is to be raked for material for continuous all-star performances, and I have heard that as much as £15,000 will be spent on the "extras" for the week. The United States is putting up a special show, centring round President Roosevelt's tribute to the King. This will be arranged by the N.B.C.

#### Long-Term Music.

When Dr. Adrian Boult gets back from America in a few days one of the early jobs awaiting him will be the participation in a scheme of planning B.B.C. music five years in advance. Dr. Boult, who is the most statesmanlike of the big conductors, always looks after the "under-dog." I have heard it said on good authority that he gives the whole of the £3,000 a year he receives from the B.B.C. to deserving musical charities. More power to his elbow!

#### Chipping Campden v. Broadway.

Local rivalry will be a strong factor of the next "free discussion" which is to be broadcast from the Lygon Arms, at Broadway, for Midland and Regional listeners on Wednesday, January 30th. "Chipping Campden versus Broadway," as fought (verbally) between the local champions, should make a grand contest, particularly as Donald Russell will again be the chairman and host.

Chipping Campden is the older of these two old Cotswold towns, and at one time was a chief centre of the local wool trade. It is in Gloucestershire.

Broadway is in Worcestershire, and because it is better known to the average tourist, being more of a show place and perhaps more go-ahead, and certainly more accessible from the large centres, insists upon a recognition of its own importance.

Anyhow, it's not your fight or my fight, but we shall enjoy hearing it.

#### "Famous Trials."

Although the practice of "diagonalising" programmes has practically ceased during the last few months, two performances will be given of the fifth of the series of "Famous Trials" for Regional and National listeners on Monday and Tuesday, January 28th and 29th respectively.

The trial is that of Lady Alice Lisle, who was arraigned before Judge Jeffreys in 1685 for high treason against King James II a fortnight after the battle of Sedgemoor, her offence being that of sheltering two refugees from the Monmouth Army.

The trial has been reconstructed by Whitaker Wilson from a contemporary account given in the State Trials in the Guildhall.

#### "Joe" Lewis in Birmingham.

"Joe" Lewis is going back to Birmingham. Not permanently, as so many of his Midland admirers would like him to, but

for one day only, on Thursday, January 31st, when he will be the guest-conductor of the B.B.C. Midland Orchestra in a programme of all-British music. As Birmingham will never forget, Mr. Lewis was musical director at the B.B.C. station for seven years.



Mr. Percy Edgar, the popular Midland Regional director, who was recently awarded the O.B.E. For many years Mr. Edgar has been an enthusiastic and tireless worker in the interests of Midland listeners.

## £15,000 FOR SPECIAL PROGRAMMES

### The B.B.C.'s Big Effort During the King's Jubilee Week

Latest News from the "Big House."

#### For Western Listeners.

For some months Western listeners have been hearing several series of talks which, although peculiar to the Region, have dealt with subjects of such outstanding importance that their interest and influence have been felt well beyond the normal range of the Washford Cross transmitter.

On Wednesday, January 30th, a new series of twelve talks will be started under the general heading of "Workaday World," in which the whole field of industry in Wales and the south-west of England will be surveyed.

The opening broadcast of the series will take the form of a discussion between Professor H. A. Marquand, of University College, Cardiff—who directed the industrial survey of South Wales in 1931—and Professor George Knox, head of the Treforest School of Mining, who has been familiar with South Wales industry for many years.

They will first discuss the dependence of South Wales on coal, iron, steel and shipping, and go on to unemployment, low wages and failure to develop new industries and make the most scientific use of coal. Contrast will be made with the development

of light industries in the south-west of England, with the resulting smaller unemployment percentage.

#### "At the Langleys'."

Saturday night being the time when men are most at peace with the world and with themselves is also an excellent occasion to dispense hospitality and to enjoy the society of friends.

Maybe that is the underlying principle of a new series of occasional Saturday night entertainments which begins for Midland listeners on February 2nd.

The Langleys—father and son—keep "open house" in the good old style, and of course all kinds of interesting people who happen to be in Birmingham will "drop in." It is, I suppose, inevitable that such gatherings shall provide good, varied entertainment, and work on its preparation is now being carried out by a panel of writers. Don't miss "At the Langleys'."

#### Two Attractive Broadcasts.

A performance of Eden Phillpott's one-act play, "Something to Talk About," and some scenes from the pantomime "Dick Whittington," are two attractive outside broadcasts for Midland listeners on Tuesday, January 29th.

The play will be relayed from the Birmingham Repertory Theatre, where two of Eden Phillpott's Devonshire comedies had their premières, and will be produced by Herbert Prentice.

The pantomime broadcast will be taken from the Kemble Theatre at Hereford, and is a Reg Maddox production. The cast includes Jessica Page, Fred Wynne, Bertram Rogers and Mary Erne. The book is by E. Byam Wyke and the music by Frederick Humphries.

#### From Birmingham

Musical trips are not so fashionable as they once were to the programme builders, but I see that the Birmingham Hippodrome Orchestra is taking one on Sunday, January 27th.

Holland, Germany, Russia, Hungary, Austria, Italy, Spain and France are the countries to be "visited" in a programme of light music which is to be directed by Harry Pell, who, it will be remembered, was once on the staff of the B.B.C. at Newcastle.

#### Bryan Michie Again.

Bryan Michie has secured the services of two artists new to British listeners for the next of his feature programmes on Friday, January 25th.

Betty Laidlaw and Bob Liveley describe themselves as writers, composers and lyricists, and their "stuff" consists of a slick musical act at the piano. Being what they say they are, they write their own songs and sketches.

Betty Laidlaw provides another instance of a classical artist turning to the lighter side of the entertainment business; while Bob Liveley, who began his career as an actor and has worked in stock companies and vaudeville, has appeared in many Broadway productions. O. H. M.



SPECIFIED FOR THE "B.C.L." TWO

# V A R L E Y

# P E N T O D E

# N I C H O K E

# 11'6

(List No. D.P.24).

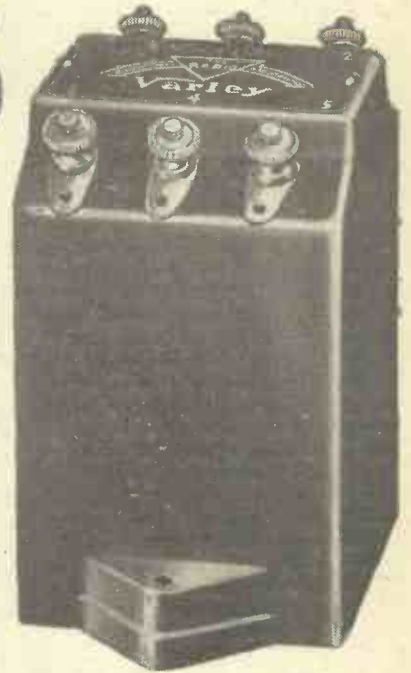

## "Frying-pan music"

is a so-and-so nuisance

### CUT THE CRACKLE OUT OF RADIO

Lots of technically-sound readers are getting on to something which even to them is quite new—the realisation that, in Interference, our old friend atmospherics is guilty only to the extent of about 5%.

The big noise in radio this season is that little thing of no-noise — the Belling-Lee Suppressor, sold at the shops for half-a-guinea.

It is designed to suppress unwanted noise, and it does the job—hushing pretty well everything short of infrequent atmospherics.

There is a book on the subject at 6d. per copy; and a free booklet. Use the coupon, making your own choice.

This popular Varley pentode output choke has been specified again — this time for the "Popular Wireless" "B.C.L." Two. Yet another testimony to the efficiency of Varley components. For the best results from all home constructed sets use Varley components—particularly the Varley Pentode Nichoke for the "B.C.L." Two.

**BELLING & LEE LTD**  
CAMBRIDGE ARTERIAL ROAD, ENFIELD, MIDDX

Tick off square which applies.

Please send the free booklet  I think I had better have the book. Here's 6d. remittance.

NAME .....

ADDRESS .....

P.W. 19.1.35. C



Bloomfield Road, Woolwich, London, S.E.18.  
Telephone: Woolwich 2345.

AS promised, it is my intention to deal with troubles and faults experienced with the S.T.600 for the guidance of service men and of constructors who are experiencing trouble of one kind or another. It is customary for manufacturers of commercial sets to issue fault-finding data for their receivers, but it is rather the practice of the technical Press to avoid publishing anything which might give a set a bad name.

My own feeling is that only good can come from dealing with all faults and troubles in a perfectly open manner. If a few misinterpret the advice as an admission of a set's defects that cannot be helped. If a few decide not to build a set because of the publicity given to faults that also cannot be helped.

#### Ensuring Maximum Efficiency.

The great majority of constructors are sensible people who realise that there will always be some element of risk and that the reputation of a designer depends considerably not on his skill in concealing the possibility of indifferent results, but on his anxiety to ensure maximum results in the maximum of cases.

Hence my intention in these bulletins to deal with all kinds and possibilities of trouble even though the chance of such trouble occurring is one case out of a thousand.

Faults in the S.T.600 seem to be largely concerned with components and valves. The first two valves, of course, are the most susceptible, and while I realise that there has been a shortage I have strongly disapproved of alternative makes. Cases, however, have been brought to our notice of samples of the specified four valves being defective.

As regards components, I am always a little worried about gang condensers and coils. Any misganging may be due to faults in either. But the constructor himself may be to blame owing to wrong adjustment of the trimmers (which, by the way, should both open and close correctly).

#### The Dial Card.

Some misgivings have been expressed on coils which are quite all right. The dial card was calibrated in station names with a Wearite coil assembly and a Formo condenser. The names are not intended to fit other coils or condensers. Hence it is no fault in the Colvern coils that the long-wave station names do not "fit." The efficiency of the coils is not affected in the slightest, and you can cover the long-wave portion of the dial with the special scale to be printed in POPULAR WIRELESS dated January 26th.

If you used the original components of my set and the names do not fit the probable fault would be:

- (1) Wrongly fitted pointer.
- (2) Rear trimmer wrongly adjusted.
- (3) Coils wrong.
- (4) Gang condenser wrong.

As regards the rear trimmer, this controls the position of the station names. For

# S.T.600

## SERVICE BULLETIN No. 1

By JOHN SCOTT-TAGGART

### General Remarks—Dial Calibrations—Break-through

example, if the rear trimmer is screwed up too tight the pointer, when receiving, say, Midland Regional, will be too low on the dial, i.e. too much to the left. If the trimmer is too far out the pointer will be too far to the right of the correct station name.

Of course, you cannot always correct matters by altering the rear trimmer, because you may thereby throw the set out of gang or perhaps miss Fécamp or Budapest. If you have too much rear trimmer you will find you cannot get Fécamp at all.

If the pointer will not cut the name of the station being received and there is no radical fault to account for this the practical solution is to bend the pointer so that it does. Bend it where the bend will not show, i.e., near the boss.

Calibration is done with the set receiving

the set is not worked properly. No complaint of break-through should be treated solely as such. The trouble may be due to bad ganging on the long waves, resulting in poor reception of the desired station, say Luxembourg. Anode reaction should normally be used on the S.T.600 to give the required selectivity. Poor reaction on Luxembourg would increase the break-through effect.

A complaint of break-through in Central London was traced to improper use of the controls. The aerial coupler should be kept at a low value and the volume control also at a medium value; anode reaction is used.

#### Preventing the Trouble.

The fact that break-through is obtained at the bottom of the long waves can be ignored, as it does not affect reception of any desired long-wave station. Likewise break-through with aerial coupler turned up and no anode reaction need not be a cause of worry, since these are not actual working conditions.

Any break-through experienced in spite of proper tuning and a properly built set requires a remedy. I have found that a Lissen Anti-Break Through choke in the aerial circuit is of very great benefit. Or a 300 plug-in coil (I have used a Lewcos in some tests) can be inserted between aerial and aerial terminal of the set. It is short-circuited when you work on the medium waveband. Such a coil may be permanently inserted in the set and a push-pull switch mounted on the terminal strip; this switch is for short-circuiting the coil when working on the medium waves.

#### Practical Results to Follow.

I advise anyone troubled with break-through to look for other causes first and then to try any sort of coil handy for insertion in the aerial circuit, e.g. an S.T.400 coil (the whole of the coil, i.e. medium and long-wave windings in series, being used), reaction choke, etc.

I hope to give some practical results next week; the trouble seems to be around North Regional, and I am going there to investigate a few cases personally. Meanwhile, will anyone who has tried these suggestions please write their results to me?

### VERY IMPORTANT ITEMS

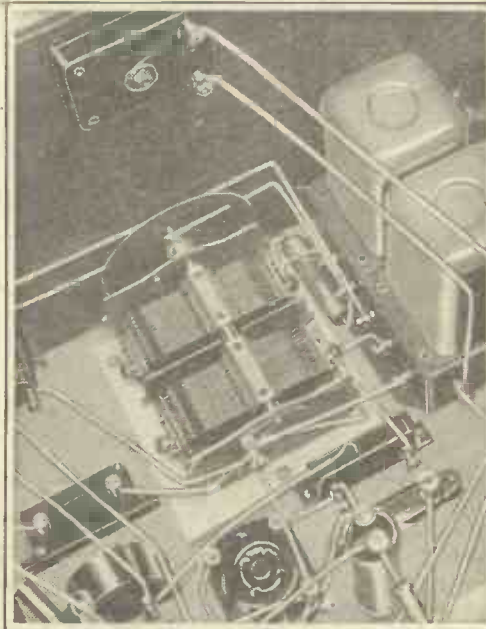

The two-coil assembly and the gang condenser are both important components in the S.T. 600, and it is very necessary to ensure that the latter is properly trimmed.

the desired station effectively, which will usually mean with anode reaction fairly critical and the volume control not turned up too much; aerial coupler position is not very important, but it should not be at zero (full left).

**Break-through.** Some complaints of break-through are being received, and this is worrying some readers, while apparently preventing others from receiving Oslo and Luxembourg on the long waves owing to the local Regional programme being received.

An investigation of these cases seems to

show that the Wearite coil assembly is considerably more prone to this than the Colvern. But most of the cases of break-through are either unimportant or due to other defects.

The S.T.600 is extremely sensitive, and any predisposition to break-through will be easily multiplied if

#### REMEMBER THAT—

JOHN SCOTT-TAGGART, M.I.E.E., F.Inst.P.,  
Fel.I.R.E.,

Britain's Greatest Set Designer,

writes for the home constructor

Exclusively in POPULAR WIRELESS

and our sister journal,

WIRELESS and Television Review.

# W.L.S. Presents His Short-Wave Masterpiece "The B.C.L. Two"

LAST week I did all that I could to persuade every reader of "On the Short Waves" that short waves were worth while. I ended by promising them that the very set for which they had been waiting would be described this week. And here it is—the "B.C.L." Two.

Let's clear that title up. "B.C.L." is a term that has been employed by the amateur transmitter for years to describe the "broadcast listener." It has a sort of contemptuous sound about it, I'm afraid, but that's pure imagination. And its meaning has changed round somewhat within the last year or so, until it now means chiefly the broadcast listener on short waves.

### Climbing the Ladder.

Are you a B.C.L.? Or would you like to be? Why not? There's nothing to be ashamed of, even though the old hand on short waves may tend to look down upon you from the dizzy heights that he has attained.

The quickest way to stop this "looking-down" turn is to climb up the heights yourself and meet him on his own ground, and I have been busy devising a suitable ladder for you for many moons.

To cut all this story short, my point is: This "B.C.L." Two is a perfectly good set for the oldest of short-wave listeners, and yet is an equally suitable set for the novice to use when introducing himself to the joys of short waves for the first time.

### Unconventional Circuit.

It is a little unconventional in its circuit, but there is nothing freakish about it. It is a little better than the last set I described, and yet no more difficult to construct and operate. In short, it is up-to-date. And still it need hold no hidden fears for the novice.

Let us proceed, then. The "B.C.L." Two uses a screened-grid detector and an output pentode, with parallel-fed transformer coupling between them. The S.G. detector has two strong points in its favour. It is very sensitive to weak signals, and its reaction control, when arranged in the particular way in which I have arranged it, is much better than that of a triode.

The step-up obtained by good transformer coupling is considerable, and the amplification given by the output pentode

is likewise quite large. By now you've guessed it—this is a loudspeaker set, although it can be used with headphones as well. It would be absurd to claim that it will operate a speaker on every short-

The panel is of single-sided "Metaplex" (with the "battered side" at the back) and the baseboard is of "Plymax," which is simply a  $\frac{3}{8}$ -in. thickness of plywood with a layer of metallic aluminium (as distinct from a metallic "spray") on top. Contrary to my usual practice, I have laid out the set with the metal on the top of the baseboard (I generally advise it underneath). Also, contrary to the usual practice in wiring chassis sets, I have left the whole of my detector wiring above the chassis.

The "B.C.L." Two is the ideal complete receiver for those who want to listen to short-wave broadcasting stations. It will work either a loudspeaker or telephones, and has been designed throughout by an expert. Simplicity of operation and construction combine with the other fine features to make it the most attractive receiver design for exploring the short-waves.

wave station that it is possible to get; but it will give loudspeaker results on all the better-known and more powerful stations.

The detector circuit that I have used is one which I described some four years ago in "P.W.," the reaction circuit being fed in series with the screen of the S.G. detector valve instead of being connected in the anode circuit. This has several advantages, chief of which are a quieter background and

Taking it all round, I think it is better to do this than to have "live" wires diving through the baseboard and going round corners which make them unnecessarily long. I have mounted the valve holder and the coil holder up in the air by using little ebonite spacers. Actually, I used the insulating portions of some old wander-plugs, but suitable spacers may be obtained specially for the purpose or may be improvised in some way.

Note that all the H.F. wiring really is short and direct. The most important lead in the average short-wave set is the detector grid lead. In this set there isn't one! Just look at the photograph that shows that particular corner of the wiring, and you will see that the grid condenser itself forms the lead from the grid terminal of the valve holder to the appropriate terminal on the coil holder.

### Important Trifles.

Note, too, that the lead from the coil holder to the fixed vanes of the tuning condenser is just about as short as it is possible to make it. No doubt these little points will seem very trifling matters to those readers who are strange to short waves; but, take it from me, they are important.

When you make a short-wave set the most important thing is to start off with simplicity. Easily the next most important is to lay it out properly. The best circuit in the world may be absolutely spoilt by a careless, straggly layout.

The wiring of the "B.C.L." Two is simplicity itself. I shall not be giving away State secrets if I tell you that, after I had finally decided on my circuit and layout, the actual construction of the set took me rather less than one morning's work. The actual wiring, after the parts had been mounted, took less than an hour.



PROOF OF SIMPLICITY.—W. L. S. writes: "I shall not be giving away State secrets if I tell you that, after I had finally decided on my circuit and layout, the actual construction of the set took me rather less than one morning's work. The actual wiring, after the parts had been mounted, took less than an hour."

a smoother reaction control—both very important points where short waves are concerned.

I will deal with the various parts of the circuit as they crop up. Just for the present I want to concentrate more on the constructional side of the set. I have always been in favour of the chassis type of layout for short-wave receivers, but as some readers still appear to think that an aluminium chassis offers great difficulties in construction I have stuck to wood this time.

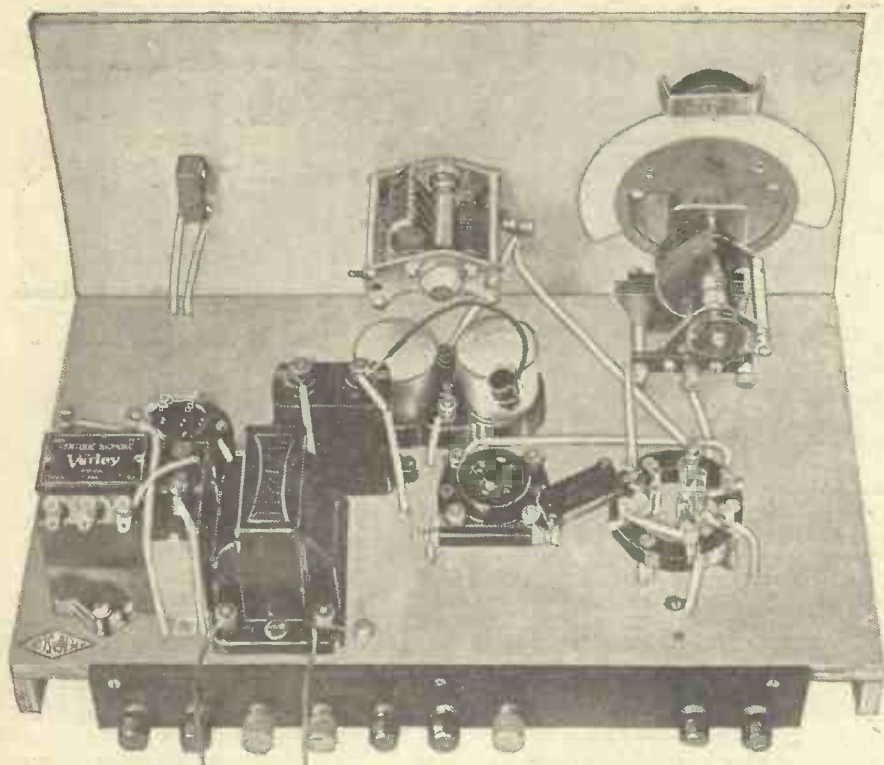

Careful layout is most important in a short-wave set, and has received special attention in the "B.C.L." Two. So try to make your set look as much like the original shown here as possible.

Now for a few remarks about some of the individual components. First, the tuning condenser. It is of .0001 capacity, which covers an ample band width and forms just about the best compromise between coverage and difficulty in tuning. I always like to have a smaller condenser (about .000015) mounted in parallel with it, but in this set the requirements have been covered by using a two-ratio dial instead. The knob nearer the panel gives a convenient reduction for tuning rapidly round from one band to another, and the smaller one gives a very slow drive for exploring every fraction of a degree when one has already set the condenser to something like the reading required.

**Perfect Reaction Control.**

A reaction condenser of .00015, also fitted with slow-motion drive, has been used. The value of slow motion on the reaction control can hardly be over-estimated, and a really beautiful control can be obtained on this set. It slides into oscillation with a gentle "breathing" noise—not the slightest suspicion of plop, hoot, squeak or any of the undesirable effects that we meet with so often.

The coils I have chosen are of the six-pin variety, each plug-in former carrying three separate windings for grid, reaction and aerial coupling. I usually prefer an inductively coupled aerial circuit, chiefly for the reason that if you give people a set

**ALL THE PARTS YOU NEED**

- 1 PETO-SCOTT "Plymax" chassis, 14 in. by 8 in., with terminal strip ready fitted.
- 1 PETO-SCOTT ply panel, 14 in. by 8 in., with "Metaplex" back.
- 1 EDDYSTONE six-pin baseboard-mounting coil holder (type 969); Colvern, Wearite, B.T.S.
- 1 EDDYSTONE set of coils, Nos. 6 LB, 6 Y and 6 R; Colvern, Wearite, B.T.S.
- 1 J.B. .0001 "Short-wave special" variable condenser; Polar.
- 1 J.B. two-ratio slow-motion dial; Polar.
- 1 POLAR .00015 slow-motion short-wave condenser (type C); J.B.
- 1 BENJAMIN four-pin vibroholder and 1 five-pin valve holder.
- 2 DUBILIER 1-mfd. paper condensers (type B.B.); T.C.C., T.M.C.-Hydra.
- 1 DUBILIER .0001 mica condenser (type 670); T.C.C., T.M.C.-Hydra.
- 1 GRAHAM FARISH H.F. choke (type L.M.S.); Bulgin, B.T.S., Wearite, shortwave chokes.
- 1 GRAHAM FARISH 5,000-ohm "Ohmite" resistance; Erie, Amplion.
- 1 GRAHAM FARISH 60,000 or 70,000-ohm "Ohmite" resistance; Erie, Amplion.
- 1 GRAHAM FARISH 2-megohm "Ohmite" grid leak; Erie, Amplion.
- 1 FERRANTI L.F. transformer (type A.F.B.); Varley, R.I.
- 1 VARLEY Nicheke pentode output choke; Wearite, Graham Farish, B.T.S.
- 1 T.M.C.-HYDRA 2-mid. condenser (type 25); Dubilier, T.C.C.
- 1 BULGIN Q.M.B. L.T. switch (type S.80).
- 9 terminals (Belling-Lee, type R); Bulgin, Clix.
- 5 CLIX wander plugs; Belling-Lee
- 2 CLIX spade battery tags; Belling-Lee. Wire, sleeving, screws, etc.
- 1 S.G. valve, Hivac S.G.220.
- 1 Output five-pin pentode, Osram P.T.2.

with capacity coupling they almost invariably use too tight a degree of coupling, make the set hopelessly inselctive and grumble at the designer.

With these coils the coupling is fixed for you. If you want to loosen it further you can use a little preset condenser outside the set, between the aerial terminal and the lead-in; but I haven't used one actually in the set, because it won't generally be necessary.

Only three coils are necessary to cover the short-wave band. The smallest, type 6LB, tunes from roughly 13 to 23 metres; the second, type 6Y, runs up from 21 to 43 metres; and the third, type 6R, completes the range by tuning from 41 to about 84 metres. The ranges shown on the leaflets accompanying the coils are 13-26, 22-47 and 41-94 metres, but these are with a .00015 condenser. A .0001 gives the necessary "overlap" between each coil and makes for easier tuning, so I have specified one for this set.

The tuning range may be extended upwards by using two more coils, 6W and 6P, which will tune respectively from 75 to 150 and 150 to 300 metres. These bands hardly come under the heading of "short waves," but it is just as well to know that you can cover the broadcast bands if you want to. Three more coils are listed, which will take you right up to 2,000 metres.

**The Constructional Details.**

For the purposes of this description, however, I am assuming that you are treating the "B.C.L." Two as a short-wave set pure and simple, and have only bought the three smallest coils.

About the other components in the set there is very little to say. The anode of the S.G. detector is fed from the full H.T. voltage, in series with a 60,000 or 70,000-ohm resistance, and the L.F. transformer is fed by a 1-mfd. condenser taken direct from the detector anode.

The pentode is provided with a tapped output choke, and the feed to its priming grid is decoupled with a 5,000-ohm resistance and a 1-mfd. condenser. These two components, together with the anode resistance for the detector, are all mounted underneath the chassis, the baseboard of which is raised one inch from the bottom edge of the panel by means of two small wooden "runners."

Most of the earth-return connections are made direct on to the metal layer on top of the baseboard. One important point to note is that the moving plates of the tuning condenser are normally insulated from the frame, and that a short wire connecting

(Continued on page 656.)

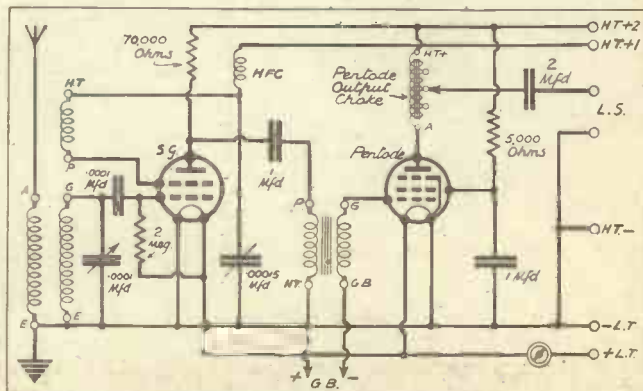

The circuit is an efficient combination of screened-grid detector and pentode-output valves coupled together by a parallel-fed L.F. transformer.

YOU CANNOT GO WRONG with a

# PILOT AUTHOR KIT EXACT TO SPECIFICATION

## "B.C.L." TWO SHORT WAYER

Don't be misled—ONLY PILOT AUTHOR KITS contain the identical parts as used by the designers of the "P.W." Boom Sets in BRAND NAMES as well as values. BUILD WITH A PILOT AUTHOR KIT and duplicate the "P.W." designers' results.

**IMMEDIATE DELIVERY**  
CASH - C.O.D. - H.P.

## 1935 KELSEY S.W. ADAPTOR BATTERY MODEL

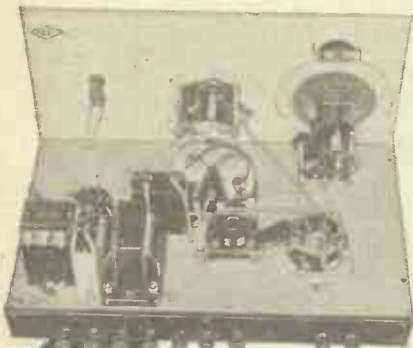

Yours for  
**7/6**  
DOWN

**KIT "A"**  
CASH or C.O.D.  
**£4-14-0**  
Carriage Paid.

and 11 monthly payments of 8/9.  
**KIT "A"** Author's Kit of First Specified Parts, less Valves and Cabinet.

**KIT "B"** As for Kit "A" but with set of specified Valves, less Cabinet. Cash or C.O.D. Carr. Paid, £5/18/0, or 12 monthly payments of 10/9.

**KIT "C"** As for Kit "A" but with set of 2 specified Valves and Peto-Scott Table Cabinet. Cash or C.O.D. Carr. Paid, £6/15/6, or 12 monthly payments of 12/6.

These are the Parts the Author Used

	s.	d.
1 Peto-Scott ready-drilled Plymax Chassis, 14" x 8"	4	0
1 Peto-Scott ready-drilled ebonite terminal strip, 14" x 12"	1	3
1 Peto-Scott walnut ply panel, ready-drilled and French polished, 14" x 8" x 3/8", with Metaplex back	2	9
1 Eddystone 5-pin baseboard mounting coil holder, type 969	2	3
1 Eddystone set of coils, Nos. 6LB, 6Y, and 6R	14	0
1 J.B. 0001 "Short-Wave Special" condenser	5	6
1 J.B. 2-ratio S/W slow-motion dial	6	6
1 Polar 00015-mfd. condenser, type "C"	10	0
1 Benjamin Vibroider type 4-pin valve holder	5	0
1 Benjamin standard type 5-pin valve holder	1	0
1 Dubilier 1-mfd. condensers, type B.B.	1	0
1 Dubilier 0001 mica condenser, type 670	4	6
1 Graham Farish H.F. choke, type L.M.S.	4	6
3 Graham Farish Ohmite resistances: 5,000, 70,000 ohms, 2 meghoms	4	6
1 Ferranti L.F. transformer, type AFB	11	6
1 Varley Pentode Nichoke, DP24	11	6
1 T.M.C. Hydra 2-mfd. condenser, type 25	3	0
1 Bulgin QMB L.T. switch, type S.80	1	6
9 Belling Lee terminals	2	3
1 Belling Lee anode connector	1	6
2 Peto-Scott valve supports and fixing screws	6	6
Connecting wire, screws, flex	2	6

"KIT A," (Cash or C.O.D. Carr. Paid) **£4 14 0**

1 Hivao S.G.220: 1 OSRAM-PT.2 ... **£1 4 0**

1 Peto-Scott B.C.L. TWO walnut table cabinet (Carriage and Packing, 2/6 extra) ... **17 6**

"B.C.L." TWO SHORT-WAYER  
**STRUCTAKIT**  
Comprising Peto-Scott walnut-faced ply panel with Metaplexed back; Plymax Chassis; Terminal strip (Postage 6d. extra) ... **8/-**

**FINISHED INSTRUMENT.** Cash or C.O.D. Carriage Paid, £7/7/0, or 15/- deposit and 11 monthly payments of 13/3.



## 1935 KELSEY SHORT-WAVE ADAPTOR FINISHED INSTRUMENT

(As Illustrated). Exact to Mr. G. T. Kelsey's First Specification. Aerial tested on actual broadcast. In Peto-Scott cabinet, as specified and used. Cash or C.O.D. Carriage Paid, £5/0/0, or 10/- deposit and 11 monthly payments of 9/3.

**10/-**  
DOWN

## PETO-SCOTT Walnut CABINET

As illustrated and first specified and used by Mr. G. T. Kelsey. Cash or C.O.D. ... **10/6**  
(Carriage and Packing, 2/6 extra.)

## 1935 KELSEY S.W. ADAPTOR TYPE "B" STRUCTAKIT

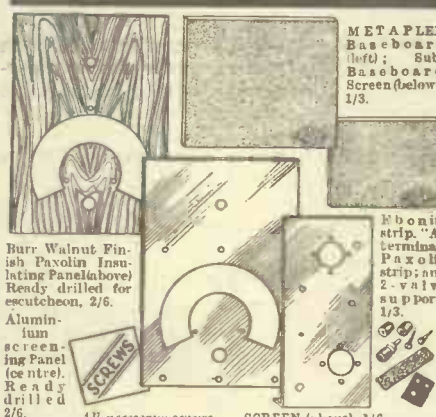

**COMPLETE TYPE "B" STRUCTAKIT,** comprising all the above parts ... **8/6**  
(Post 6d. extra.)



## KIT "A"

CASH or C.O.D.  
**£3-3-0**  
Carriage Paid.

Yours for  
**5/-**  
DOWN

and 11 monthly payments of 5/9.

## KIT "A" Author's Kit of First Specified Parts, less Valve and Cabinet.

**KIT "B"** As for Kit "A" but with specified Valve, less Cabinet. Cash or C.O.D. Carriage Paid, £4/1/6, or 12 monthly payments of 7/6.  
**KIT "C"** As for Kit "A" but with Valve and Peto-Scott Cabinet. Cash or C.O.D. Carriage Paid, £4/12/0, or 12 monthly payments of 8/6.

These are the Parts Mr. G. T. Kelsey Used

	s.	d.
1 Peto-Scott Kelsey Structakit, type "B," comprising:		
1 Metaplex Main baseboard, 5 1/2 x 4 in.		
1 Metaplex sub-baseboard, 6 x 6 1/2 in.	1	3
1 Ebonite strip with "A" terminal		
1 Paxolin strip, each ready-drilled, 2 valveholder supports, 12 fixing screws	1	3
1 Aluminium screen, ready-drilled	1	6
1 Aluminium screening panel, 10 1/2 x 6 1/2 in., ready drilled	2	0
1 Special burr walnut finish Paxolin insulating panel, ready-drilled	2	0
1 Polar 00015-mfd. (No. 4 reaction)	3	9
1 Polar micro-drive semi-circular dial	7	9
1 Polar 00015-mfd. variable condenser (short-wave type "C")	8	6
4 B.T.S. Kelsey adaptor coils	16	0
1 Benjamin 7-pin valve holder	2	0
2 Clix 4-pin valve holders (chassis-mounting type)	1	4
1 Dubilier type 670 condenser, 0003-mfd.	1	0
3 Dubilier type 4503 condensers, 1-mfd.	4	0
1 Graham Farish type B.M.S. H.F. choke	4	6
3 Graham Farish 1,000 ohms Ohmites	4	6
Connecting wire, screws, flex, 3 Wander plugs and 2 spade terminals	2	0

**Kit "A" Cash or C.O.D. Carriage Paid £3 3 0**

1 Ferranti VHT 2 ... **18 0**

1 Peto-Scott 1935 Kelsey Short-Wave Adaptor cabinet as specified ... **10 6**

Full detailed list of parts for MAINS VERSION upon application

## B.T.S. KELSEY SHORT-WAVE COILS SET OF 4 16/- POST FREE

**PETO-SCOTT CO. LTD.** 77, P.W.5, CITY ROAD, LONDON, E.C.1. *Phone: Clerkenwell 9406/7*  
West End Showrooms—62, HIGH HOLBORN, LONDON, W.C.1. *Phone: Holborn 3248*

ANY ITEM SUPPLIED SEPARATELY—ORDERS OVER 10/- SENT C.O.D. CARRIAGE AND POST CHARGES PAID

(Continued from page 654.)

the two terminals forms an essential part of the wiring.

If this wire is omitted it means that one relies solely on the contact between the "Metaplex" panel and the "Plymax" baseboard for the earth return from the reaction condenser. There is no need, however, to talk very much about the wiring, as it should be carried out in strict accordance with the diagram, which doesn't leave you any scope for going wrong.

#### The Coil Holder.

There is an important point to note about the coil holder. It is not marked in any way, and care must be taken that it is correctly placed before it is wired up. It carries six pins, two of which are more or less separated from the other four. It is these two pins that carry the wires for grid and earth, and the back-of-panel diagram shows you that the holder is mounted so that these two pins are on the side nearest the valve holder.

If you plug a coil in the holder the

I am going to deal in a later issue with the conversion of this set for working with mains valves.

About 120 volts of H.T. is sufficient. The full 120 is connected to the H.T. 2 terminal, and something between 45 and 60 to H.T.1, although this last figure may need adjusting to suit individual valves. I found reaction control smoothest with about 45 volts, but if a higher voltage is

or picture rail. Either take it straight across the room from corner to corner, or, if it must run round the sides of the room, keep it a few inches out from the wall by means of stand-off insulators or something similar.

I strongly recommend the use of headphones for preliminary searching unless you are already accustomed to short waves. You will have a lot to learn about operation, and you can't be expected to get perfect results on the loudspeaker straight away.

No volume control has been provided, as the reaction control is sufficient for that purpose when you are listening to telephony. I am not claiming that this is a suitable set for the headphone reception of amateur C.W. signals, as the amplification is rather too great for comfort.

#### What You Can Hear.

So far I have said nothing about short waves themselves, as all the space has been taken up in dealing with the essential features of the set. I don't intend to say a great deal about the actual operation of the set until next week, so as to give you plenty of time to make a really good job of it.

Don't be too eager to rush it through and get "on the air" straight away. Take pains over every single wire and connection, and don't tolerate anything loose or flimsy.

Don't rely on your fingers for the terminal connections—pliers are so cheap and so easy to use. And—perhaps most important of all—make sure that the panel is really rigidly fixed to the baseboard and the side runners. A panel that goes through evolutions every time you handle the tuning knobs is worse than hopeless—it bends wires and shifts the tuning, as well as causing all sorts of crackles.

Since you probably intend to be a "B.C.L.," I had better tell you just what

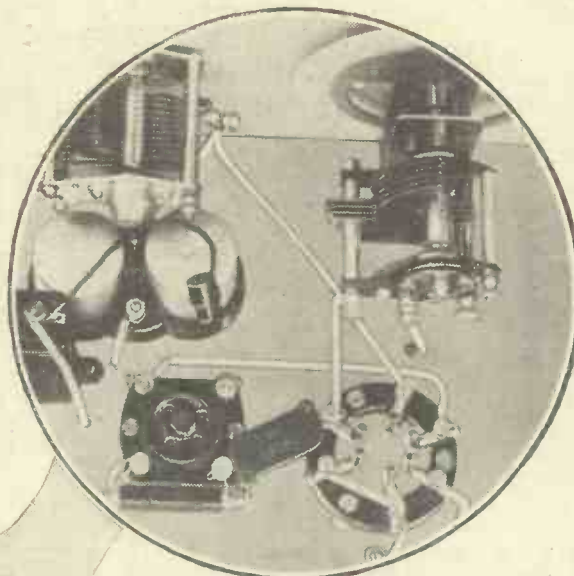

The design of the 6-pin coil holder is clearly seen in the photograph, which also shows how the grid condenser is joined directly to the valve holder.

#### A NEAT LAYOUT

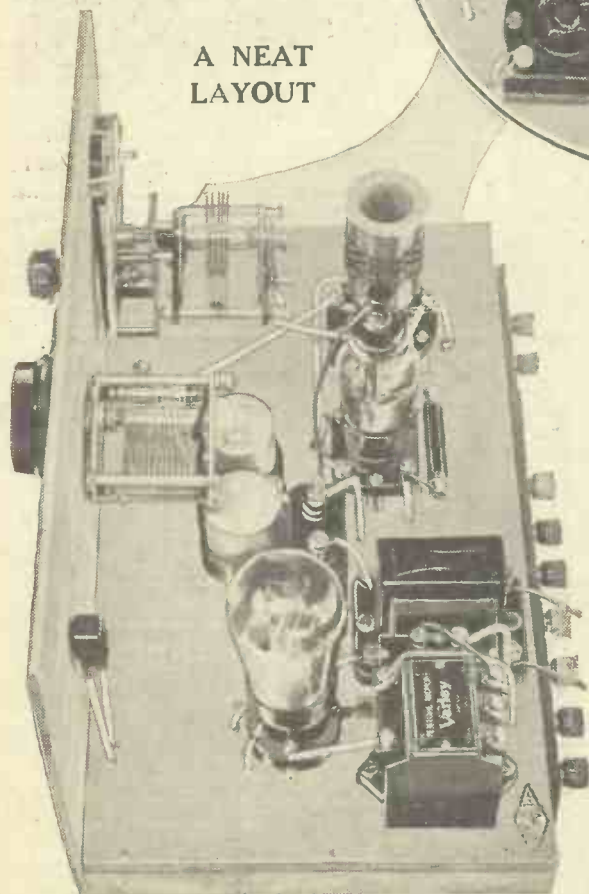

To avoid "live" H.F. wires passing through the baseboard, the whole of the detector circuit is wired above the "deck," and yet a remarkably "clean" effect is obtained.

coloured spot on the top of the coil comes midway between the two pins concerned. This spot should be facing the grid terminal of the valve holder. Just make a note of that and you can't possibly go wrong.

So much for the actual "innards" of the set. Now for some of the externals. You will require an S.G. valve and an output pentode of the five-pin type. Doubtless the two-volt type will be used, although

needed to make the detector oscillate all over the tuning range, control does not appear to suffer to a noticeable extent.

A direct earth connection should be used if the set is on the ground floor. If, however, you are high up in the house you will probably find it preferable not to use an earth connection at all. In any case it makes no difference whatever to signal strength—it is simply a question of ascertaining whether hand-capacity effects are present. If they are troublesome with an earth on the set, remove it and everything should be all right.

#### Aerial Considerations.

Don't try to use too large an aerial. If you have a long aerial that you wish to leave in place for broadcast reception you can make it function perfectly well by taking the hint I have al-

ready given and connecting a .0001-preset between the lead-in and the aerial terminal. You will find, however, that the best results will be obtained with not more than 20 or 30 feet of wire, as high and as clear of surrounding objects as possible.

Provided that you are not on the ground floor, you will find that 12 or 15 feet of indoor aerial gives admirable results; but don't use one that runs all round the wall

you may expect to hear and whereabouts on the dials it will be. The short-wave broadcast stations are mostly distributed about six fairly narrow wavebands, which we will call the 14-, 16-, 19-, 25-, 31- and 49-metre bands. The 14-metre band you can practically overlook, since the only really regular station working there is W8XK, Pittsburg, who can generally be heard at better strength on 19.72 metres.

#### The Various Ranges.

The smallest coil, type 6LB (blue spot), will give you the 14-metre band near the bottom of the condenser, the 16-metre band with it about "half-in." The 19-metre band comes at about 65 to 70 degrees, and the amateur 21-metre band, on which lots

(Continued on page 658.)

#### MANY PROGRAMMES

"It would be absurd to claim that it will operate a speaker on every short-wave station that it is possible to get; but it will give loudspeaker results on all the better-known and more powerful stations!"



# RECORDS

## BY NAME PRICE AND PERFORMANCE

If you want the cheapest valve with the finest performance insist on **Record Valves**, which are **Records** on every count. So the next time a valve goes replace it with a Record Valve—better still; treat yourself to a set of them, and **get them to-day.**



### BATTERY HEATED VALVES

- D.L.2. Special non-microphonic Detector.
- H.2. High Frequency Amplifier.
- L.2. Low Frequency Amplifier.
- L.P.2. Low Consumption small power P.2. Power (suitable in 2nd L.F. stage).
- S.P.2. Super Power.
- P.T.2. Pentode.
- S.2. Screen-Grid H.F. Amplifier and Det.

### INDIRECTLY

- HEATED A.C. VALVES
- AC/HL. A.C. Detector and Triode Amplifier.
- AC/S. A.C. Screen Grid H.F.
- AC/VS. A.C. Variable Mu.
- AC/PT. A.C. Pentode.
- AC/P. A.C. Power.
- RECTIFYING VALVE
- FW.350. Full Wave Rectifier (output 300 volts, 80 milliamperes).

PRICES FROM

**3/3**

From your wireless dealer or from any branch of Currys. If you have any difficulty write direct to:

**RECORD RADIO LTD.**  
ELDON ST. HOUSE, 2-3 ELDON STREET, LONDON, E.C.2  
Tel.: Bishopsgate 1301.

## The World's Best Fiction

EVERY month The ARGOSY Magazine provides the cream of literary entertainment—many superb examples of masterly short stories, all complete, by writers whose names are world famous. The February issue, now on sale, contains a selection of brilliant stories by

- W. W. JACOBS
- GEORGE R. PREEDY
- SIGRID UNDSSET
- ARNOLD BENNETT
- A. T. QUILLER-COUCH
- DANA BURNET
- G. H. STEVENSON
- PAUL ARENE
- FLORA ANNIE STEEL
- WILLIAM FAULKNER
- DENIS MACKAIL, etc.

8-Page Art Supplement

*The* **ARGOSY**  
MAGAZINE

February Issue Now on Sale - 1/-

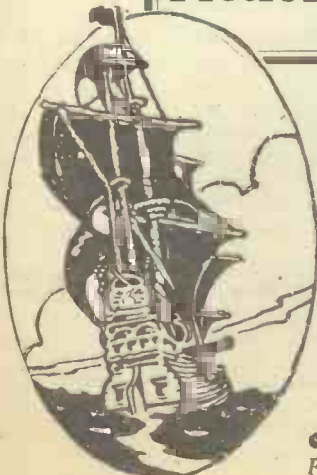

The slightest slip... a fractional error of judgment... and... disaster! On the trapeze, there is only one criterion... reliability... the reliability that comes from supreme skill. Remember that when next you buy condensers and you'll ask for T.M.C.-HYDRA condensers. For reliability and T.M.C.-HYDRA are synonymous. No other condensers are made so carefully and so skilfully... tested so stringently and so thoroughly.

## T.M.C. BRITISH MADE HYDRA CONDENSERS



The special method of sealing T.M.C.-HYDRA condensers definitely prevents the penetration of moisture and so preserves the high electrical properties of the condensers.

Write for a copy of the new illustrated price list.

**T.M.C.-HARWELL (SALES) LTD**  
Britannia House, 233 Shaftesbury Avenue  
London, W.C.2. (A few doors from New Oxford Street)

Telephone: Temple Bar 0055 (3 lines)

Made by TELEPHONE MANUFACTURING Co. Ltd.

(Continued from page 656.)

of American telephony can be heard, quite near the top of the scale.

The next coil, type 6Y (yellow spot), will give you the amateur band at the bottom end, the 25-metre broadcast band about a quarter in, and the 31-metre band

- SUITABLE ACCESSORIES**
- 2-volt L.T. ACCUMULATOR: Block, Exide.
  - 120-volt H.T. BATTERY: Ever Ready, Drydex, Lissen.
  - 9-volt G.B. BATTERY: Ever Ready, Lissen, Drydex.
  - LOUDSPEAKER: W.B., Rola, Amplion, Blue Spot, R. & A., Epoch.

round about 65 or 70 degrees. Right at the top is the amateur 42-metre band, which is found again on the third coil.

This red spot coil (type 6R) covers what is one of the most interesting bands of all, extending roughly from 45 to 50 metres; the broadcast stations occupying will probably be spread out roughly from 35 to 50 degrees on the condenser.

**On the Right Lines.**

All these readings, of course, are only approximate, but they will serve to put you on the right lines.

Finally, let me give just a broad hint on the subject of operating the set. Treat it very "gingerly"—make all your movements slowly. Don't try to

go rushing round the band, or you'll pass over ten stations without even hearing them; you may easily find two broadcast stations separated by less than half a degree, so you *must* use the slow-ratio tuning knob and handle it carefully.

Don't get the idea that tuning is going to be terribly difficult, because it isn't.

Next week I will go fully into the matter of handling the set, together with some advice on the best times at which to listen on the various bands. I'm not going to give a list of stations that you ought to hear, because any

**THE SIZES OF HOLES TO DRILL**

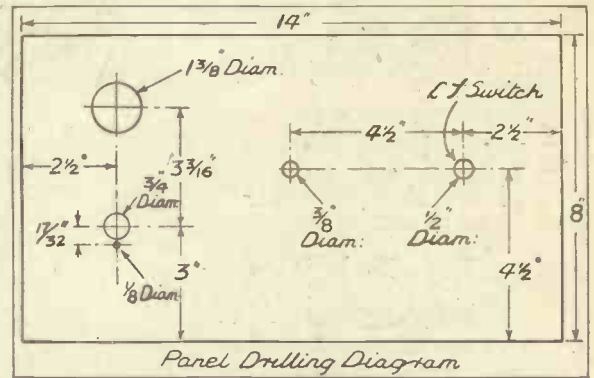

The positions and sizes of the holes for fixing the panel components are given in this diagram. Five holes are also required for wood screws to hold the panel in place.

**BELOW-THE-CHASSIS WIRING**

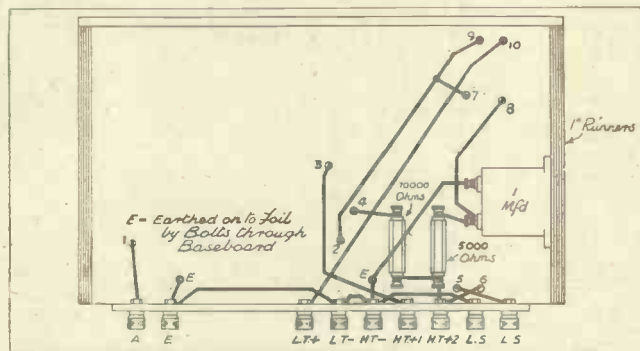

Employ this wiring diagram with the one below, but remember it will appear reversed from end to end since it shows the receiver from below.

short-wave station in the world is within your grasp if you operate carefully, listen at the right time and choose the right waveband to listen on.

You will find the "On the Short Waves" section which appears weekly in POPULAR WIRELESS, of great assistance in your listening. In view of the amount of space devoted to short waves this week, "On the Short Waves" has been omitted, but it will appear again next week. Make a point of following regularly. There is always "plerty doing" on short waves and only by regular reading can you hope to keep really au fait.

**PRACTICAL TIPS**

**A VARIABLE CONDENSER HINT.**

If you have a variable condenser in which one of the moving vanes touches a fixed vane, the following method of spotting the culprit will be found most effective: Cut a strip from a postcard or other similar material which just slips comfortably between a pair of correctly spaced vanes. Set the condenser in the position in which the vanes short. Slide the strip between the vanes in turn until you come to a pair between which it takes a little force to push the strip. Leaving the strip in place, the moving vane can then be eased away from the fixed vane with a knife blade.

**MOUNTING ESCUTCHEONS.**

AFTER boring the small holes round an escutcheon template, the ebonite between can be gently prised away with a pair of long-nosed pliers. If two or three sections are removed at each corner a hacksaw blade can then be inserted and the remainder cut away. A flat file will quickly smooth down the projections.

**DRILLING FOR SWITCHES.**

A DRILL that fits into an ordinary carpenter's brace can be used for enlarging the hole in a panel to take the barrel of a mains type switch. Reverse the drill in the holder and bore right through with the Bulgim S80 and similar models this results in a nice sliding fit. E.O.'M.

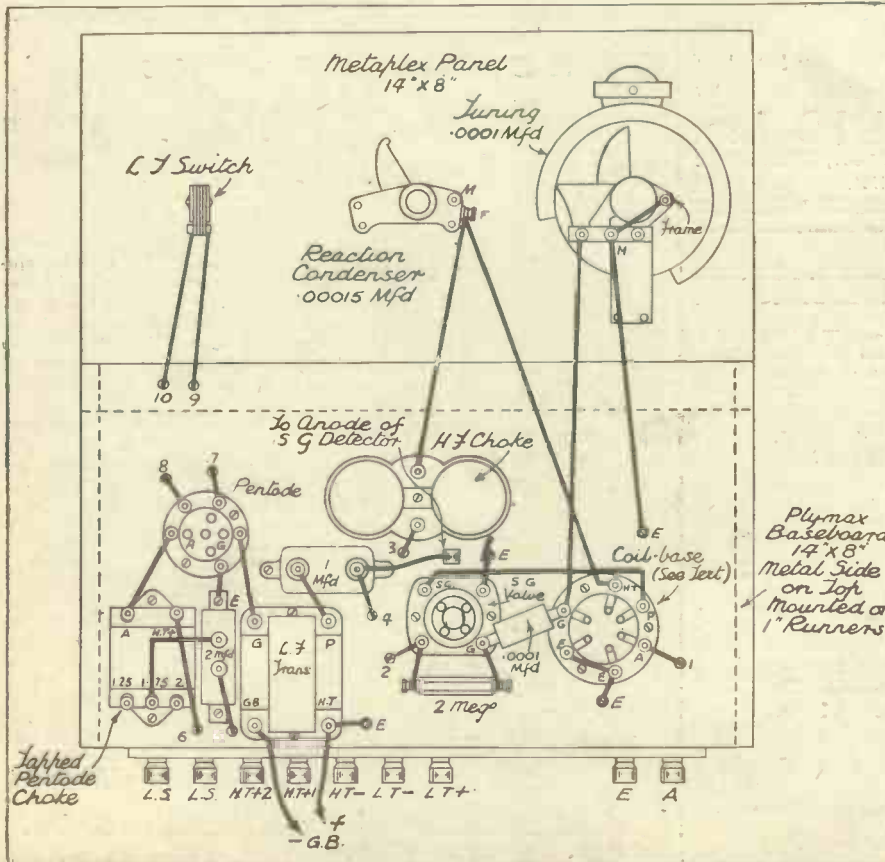

The diagrams on this page show how all the wiring is carried out. So that the leads may be clearly followed the holes in the baseboard are given numbers which correspond in the two diagrams.



**POLAR TYPE 'C' SHORT-WAVE CONDENSER**

Fast and slow motion. All Brass, Double Spacing, Silent phosphor bronze ball-bearings.

**REQUIRED:** One -00015 for 1935 KELSEY ADAPTOR. One -00015 for SHORT-WAVE RECEIVER. Price, each

Also made in -00025, 9/6d., and -0001, 8/3d.

**8/6**

SEND FOR NEW POLAR CATALOGUE

WINGROVE & ROGERS, LTD.,  
18B/9, STRAND, LONDON, W.C.2.  
Phone: Temple Bar 2244/5/6.  
Polar Works: Old Swan, Liverpool.

# POLAR

SPECIFIED for the  
1935 KELSEY ADAPTOR &  
The "B.C.L." TWO  
SHORT WAVE RECEIVER



**POLAR REACTION No. 4**

Compact air dielectric condensers. Aluminium with Brass Pillars, Ball Bearings.

**REQUIRED:** One -00015 for 1935 Kelsey Adaptor. Price

Also made in -00025, -0001 & -00004. Price

**3/9**

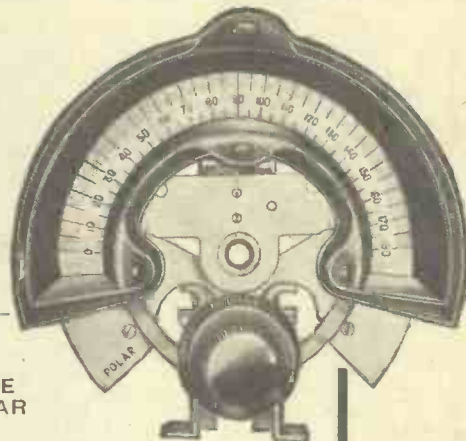

**POLAR MICRO DRIVE SEMI-CIRCULAR**

With two reduction Ratios 100:1 and 7: each operated independently by concentric knobs. Price

**7/9**

Also made: Micro Drive Arcuate 7/9d. Horizontal 7/9d. Moving Scale 6/6d.

CA 6230

## FULLER

### "SUNBEAM"

H.T. BATTERY

+

60v. 3/6

100v. 5/6

120v. 6/6



A NEW FULLER PRODUCT

*Reliability with Economy*

# FULLER

BATTERIES

H.T. and L.T. DRY CELLS AND ACCUMULATORS

Service Agents throughout the Country

FULLER ACCUMULATOR CO. (1926) LTD., Chadwell Heath, Essex

Phone: Seven Kings 1200

Grams: Fuller, Chadwell Heath

## Specified FOR THE "B.C.L." TWO SHORT WAVE SET



Eddystone Six-Pin Coils.

The Eddystone coils specified by the designer are made from the wonderful new Low Loss material —D.L.9 dielectric, specially developed for short wave high frequency use. They have the great advantage of being small and compact in size, giving a coil of high efficiency with a small external field. The short wave coils are space wound with 22g. enamelled copper wire, the formers being threaded to prevent the turns moving.

Type 6LB, 4/6. Type 6Y, 4/6. Type 6R, 5/-. Cat. No. 959.



Eddystone Six-Pin Coil Base.

A special Low Loss 6-pin Base is required to take these coils, the price being 2/3. Cat. No. 969.

**STRATTON & CO. LTD.,**  
Bromsgrove Street, BIRMINGHAM.  
London Service Depot: **WEBBS' RADIO STORES, 14, Soho Street, Oxford St., W.1.** Telephone: GERRARD 2985  
Glasgow Service: **JAMES R. HUNTER, 138, West Nile Street.**

## EDDYSTONE SHORT WAVE COMPONENTS

Are You Buying  
a New Set?

IN THE  
FEBRUARY NUMBER

Are You Interested  
in Modern Receivers?

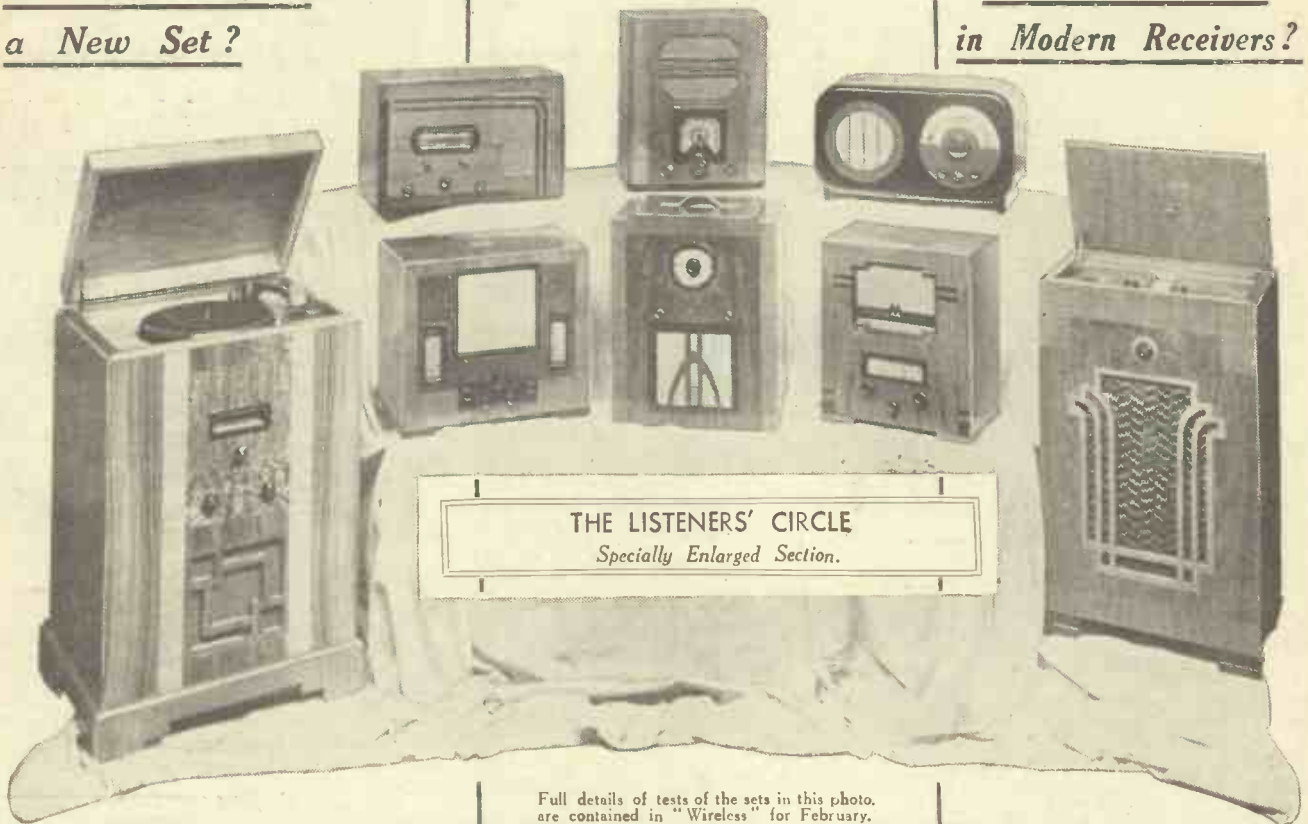

Full details of tests of the sets in this photo.  
are contained in "Wireless" for February.

BRITAIN'S LEADING  
RADIO MAGAZINE

THE "FERROGANG" FOUR  
*Full details for building.*

SOMETHING OF  
INTEREST TO EVERYONE

# WIRELESS

AND TELEVISION REVIEW

An outstanding feature of "Wireless" is the wide variety of radio aspects which are dealt with. The ordinary listener, home constructor and DX man are all catered for.

FROM MY ARMCHAIR  
*By John Scott-Taggart, M.I.E.E., F. Inst.P., Fel. I.R.E.*

Articles on Television, Short-Waves, Wireless in the Great War, B.B.C. News, Curious Radio Effects, Apparatus Tested, etc., etc., are all to be found in the February number.

NOW ON SALE—AT ALL BOOKSTALLS—PRICE SIXPENCE

# RECOMMENDED WRINKLES

## THAT EARTH LEAD.

WHEN an earth lead must be taken across a concrete path to reach the earthing tube the wire is apt to trip the feet whenever you walk over it.

Short of chiselling a channel in the concrete and cementing up the surface again, the best arrangement is to use a strip of metal instead of wire. A metal

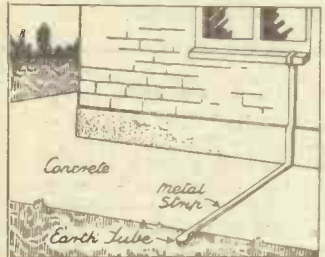

No one will trip over with this method of connecting up the earth.

ribbon, an inch or two wide, will lie fairly flat on the path without causing a stumbling block.

Naturally, copper is the nicest material for the purpose, but zinc is always a good substitute when the money factor counts!

## COUNTING COIL TURNS.

GREEN silk-covered wire, closely wound on a former, confuses the eye when you go to count the number of turns. Smear the silk with white chalk every time you complete, say, five turns. Afterwards you can add up in fives.

If it is an already-wound coil you are examining, don't prod the wires about in an effort to separate them while you count, or else you may cause a short-circuit. Better draw a line of chalk straight down the coil across the turns, then lightly flick off with a pencil as you go over each one.

## EARTHING CONDENSERS.

IT often happens that when assembling a set on a "Metaplex" or similar baseboard, one side of a component such as a fixed condenser has to be connected to the board itself. A quick and efficient way of doing this is as follows:

Take one of those thin clips often supplied with fixed condensers for

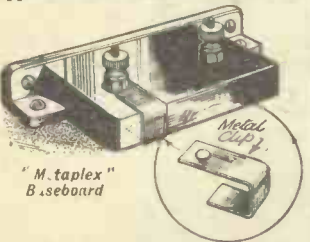

A simple method of earthing one side of a fixed condenser.

mounting grid leaks, and straighten it out. Slip one end over the terminal in the usual way, and bend the other end underneath the base of the component. When it is screwed down on to the baseboard a firm and effective connection is made.

## RENEWING OLD FILES.

WITH the advent of the metal chassis into the realm of the home constructor the file has become a tool of some importance on his work bench. Most of the files are small and soon become worn and filled with filings, rendering them useless. To prolong their life, however, is quite simple and inexpensive.

Make a solution of dilute nitric acid (five parts water to one part acid) and place in an old china bowl, or glass dish large enough to hold the files. Completely cover the files for about five minutes. Take out and wipe them lightly with a piece of cotton wool.

This leaves the acid between the teeth, but takes it off the cutting edges of the file. Leave for about an hour, then wash thoroughly in water. Presto! New files for old!

## "GETTING DOWN."

TO make a coil tune down lower a few metres or more as required, a piece of silver paper placed round



This dodge for reducing wavelength is quite effective.

the winding and held by a wide rubber band does the trick.

## INCREASING SPINDLE SIZE.

CONDENSER spindles are very often too small for the particular knob one wishes to fit them on, so that the following tip should prove useful.

Enlarge a spindle in the following manner: It is first bound with bare copper wire (gauge according to the size of spindle required) and then

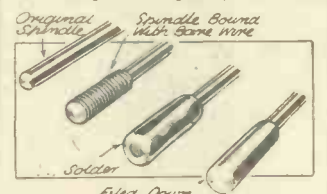

File down (if necessary) to correct size. The various stages of the scheme for increasing spindle size.

the whole of this wire is evenly covered with solder and the job is complete.

The spindle may now be a little too big, but it is a simple matter to file it down and thus obtain an excellent fit.

## EFFECTIVE TESTING PRODS.

WISHING to do some testing and not having any testing prods to hand, I made a pair of very simple, effective prods in the following manner, which is quite simple:

Obtain a couple of old fountain-pens (red and black, if possible) and remove nibs and also rubber tubes. The hole left by nib is enlarged, if necessary,

to take the metal part of a wander-plug; a hole should also be bored in top end of pen barrel.

A length of flex should be soldered on to metal plug and passed through pen barrel and out through hole in top of pen, after which connection is made to meter. If red and black pens cannot be obtained, red and black wire should be used instead.

## A SPARE VALVE CAP.

THE type of screened-grid and triode-pentode valve incorporated in the modern receiver is often constructed with a specially designed top, the actual connecting terminal being in the form of a cap and screw entirely independent of the valve itself. Such a cap cannot usually be found in the spares box, and, in consequence, much difficulty is likely to arise in the event of the original being mislaid.

An effective spare, however, can quite easily be improvised from a small flash-lamp holder, which, although slightly smaller in diameter than the valve top, can be utilised by cutting a slit in the side. This not only in-

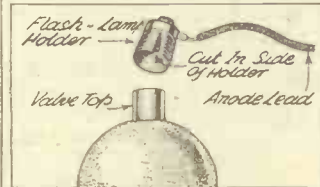

A firm connection is obtained with this valve-top connector.

creases the size to that required, but also gives the tension sufficient to ensure firm contact. A soldering tag can be fixed to the holder terminal as a means of securing the anode lead.

## A SPEAKER DUST COVER.

WHEN a moving-coil speaker mounted on a baffleboard is used alone, the back of the speaker should be covered by a cloth secured to the board with drawing-pins, in order to prevent

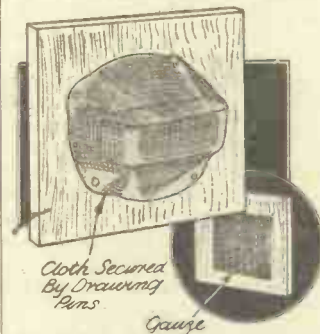

How to keep dust from the air gap of a moving-coil speaker.

## ONE GUINEA FOR THE BEST WRINKLE!

Readers are invited to send a short description, with sketch, of any original and practical radio idea. Each week £1.5s. will be paid for the best Wrinkle from a reader, and others published will be paid for at our usual rates.

Each hint must be on a separate piece of paper, written on one side of the page. Address your hints to the Technical Editor, "Popular Wireless," Tallis House, Tallis Street, E.C.4, marking the envelope "Recommended Wrinkles."

Will readers please note that the Editor cannot, in any circumstances, guarantee to return rejected Wrinkles, and that payment for published hints is not made until ten days after they appear?

The best contribution in our last selection of Wrinkles, published on December 22nd, was sent by Mr. G. Tyler, 3, Victoria St., Abergavenny.



dust and particles of metal from entering the air gap.

For the same reason a speaker gauze should be used at the front. The wires will have to be brought through a small hole in the cloth at the back.

## FOR SHORT-WAVE COILS.

I TAP the aerial on to the grid coil of my short-wave set by means of a crocodile clip; but as I first experienced trouble with this, owing to the

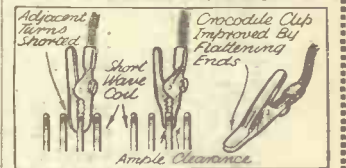

How to prevent a clip from shorting turns on a short-wave coil.

sides of the clip touching adjacent turns, I evolved the following simple dodge:

The end of each jaw (i.e. where it grips the coil) is flattened with a pair of pliers, and, as can be seen from the sketch, contact is quite as effective and there is now good clearance for the adjacent turns.

## A "CELLOPHANE" DUST COVER.

HAVING repeatedly to take my set out of the cabinet to dust it, I used the following idea to keep it free from dust:

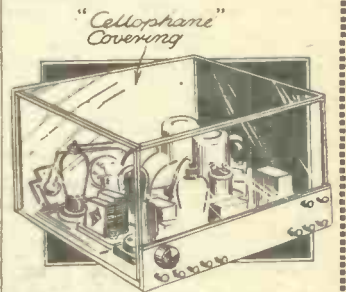

Inexpensiveness is a big feature of this transparent dust cover.

I first made a framework of thin wood to fit around the chassis and the height of the panel, with the lower back strip resting on the terminal strip.

I then procured a sheet of "Cellophane," which can be bought at any newsagent's for a few pence, and gummed it around the framework and to the top edge of panel and sides of chassis, making the set completely dustproof. "Cellophane," besides being dustproof, also has the advantage that one can still see the works, and, if one wishes, one can easily remove the top sheet to make alterations.

## SOLDER IN SCREW THREADS.

DON'T discard your bolts that have solder in running up the nuts.

Take the bolt and, holding it with pliers, heat well until the solder is soft. Now take an old toothbrush, or any brush with fine iron bristles, and while the bolt is still hot and keeping the solder soft, brush the thread quickly. This will soon free the thread.

## THE SURPRISING CASE OF THE MUSICAL STOVE

(Continued from page 635.)

Regiment had their officers' mess. The German owner had thoughtfully provided a wireless set there so that the King's Christmas message should be heard by his subjects in a foreign land.

That set not only showed a delightful sense of hospitality, but it emphasised again the great interest which the Royal speech inspired abroad. Rather wonderful, is it not, to think that those simple words and kindly, kingly sentiments went straight to the hearts of people all over the world?

### Radio without a Set.

**B**ILL CUNNINGHAM, of Aylmer, Ont., By the nine gods he swore, And vowed that without a cooking stove He'd sit at home no more.



By the nine gods he swore it, And took one home one day, But very much to Bill's surprise That stove began to play (tunes, and jazz and all that!).

This surprising episode—for first news of which I am indebted to a hawk-eyed reader—is apparently another of those queer instances where wireless programmes get themselves heard without any set or loudspeaker.

The newspapers generally regard such "incidents" as impossibilities, but the scientist is often not so sure. He knows that physics are often highly surprising, and that you can get queer effects from such common things as pipes and flames.

### Without a Stain.

"IS it true that Stainless Stephen was once in the Army?" asks a Widnes correspondent who signs himself "Winnie-the-Pooh."

(I say "himself" because the writing looks as masculine as Devant, so to speak. And Winnie-the-Pooh was no lady, anyhow.)

Concerning the query about the Immaculate Stephano, I believe I am right in

### "PICTURE PEOPLE"

Clayton Hutton has compiled another programme of film sound-tracks which will be presented in the Regional programme on January 22nd. It will be interesting to compare some of the song-hits sung on the film by the film stars themselves with the "Songs From the Films" programme by John Watt, which is announced for January 28th (National). Keep these two dates before you, for both programmes will be well worth hearing.

saying "yes." Unless I have been sadly misinformed, he was once a lance oblique stroke corporal comma, and must have been an acquisition indeed upon those dash route marches full stop.

He once trod on my corn in a B.B.C. lift, but otherwise our orbits have not intersected. (I should have liked to know him, too, because none of my present pals is addicted to stainlessness!)

### Good Causes.

**B**EFORE we forget all about 1934 in our endeavours to make something of 1935 I think a tribute is due to the B.B.C.'s handling during last year of the Week's Good Cause. It is remarkable how much suffering is alleviated by these short appeals.

Though in the aggregate considerable sums are collected, they have the widespread virtues of the widow's mite. I noticed that when Sir Gomer Berry appealed recently for funds for the Merthyr General Hospital the responses came from every class and condition.

For example, an old-age pensioner of Trowbridge sent 1s., a bridge player sent 10s. 6d. (apparently he realises that some of us get but little luck in Fortune's deal!) and "A Sympathetic Party" sent five bob.

It is to the credit of the B.B.C. that among their many tasks they find time to place sympathetic parties in touch with their needy brethren.

### 5 X X Quality.

**A** READER has written me two pages of aspersion on the quality of Droitwich.

He does not exactly call the B.B.C. untruthful, but he does imply that, in claiming Droitwich quality was better than Daventry 5 X X, they misrepresented the facts.

Not so, sir. In your own neighbourhood there are colliery-band enthusiasts who are so hot on quality that they would know by ear if the silver-trumpet player forgot to polish his instrument one day. Until they hear celestial music they will never actually compliment anyone, but they do say of Droitwich: "He's all reet." That testimony, added to B.B.C. figures and general experience, is incontrovertible.



### America on Med'um Waves.

**T**HE W. Middlesex and E. Buckinghamshire Branch of the Anglo-American Radio and Television Society has conspired to rob good citizens of their beauty'sleeps.

The indefatigable secretary, Mr. L. W. Orton, of "Kingsthorpe," Willowbank, Uxbridge, tells me that on January 19th the branch will hold a meeting which will commence at 11.45 and will go on until approximately 6 a.m. Some meeting!

During this session members will hear no end of medium-wave American stations. They will also be given the opportunity of tuning America in themselves. And Mr. Orton says: "I, who flatter myself that I know how to get the best out of America, will show those who want showing how to log such stations as WNK, WCCO, W A A B and also 100-watt stations."

Anyone interested is welcome, and should notify him at the above address that they will attend.

### The Yanks Are Coming.

**B**REATHES there a man with soul so dead Who never to himself hath said, Mine is the finest wireless set That it is possible to get?

No poet should mind the above misquotation, for it conveys a truth—the rightful pride we all take in the prowess of our sets.

One zealous correspondent of mine, carried away by his set's performance, informs me in a postscript: "Yesterday

### "TOY TOWN"

That famous city "Toy Town" is again in the news on January 29th, when the "citizens" are to give their own programme. Children who enjoyed the "Toy Town" pantomime at Christmas will be glad to meet again, in the Regional programme, many of the popular characters. "Toy Town" is becoming a very famous place.

was another fine 'DX' day, and I logged WNK, WABC, WTIC, W A A B, WCAU, WBZ, WLW, WEAF, WHAM, WTAM, WPG, WCCO, WIOD, WBT and heaps of unknown stations at good L.S. strength, audible over 50 yards."

As they used to say in war-time: "The Yanks ARE Coming."

### The Bare Idea.

**S**INCE a misprint occasionally serves to conjure up a good wide grin, a Birmingham reader wants me to mention one he has found in a television article.

It is to the effect that "From the practical television service point of view it is difficult to make comparisons, but the British research workers certainly have nothing to wear!"

This seems to be a perfect explanation of those delays in television development, of which we so often hear.

### Reveille.

**U**NEASILY stirring from my sleep the other morning, six-thirtyish, I was disturbed by a sort of dream voice burbling away somewhere at the back of beyond. I was just slipping off for another 39 winks when it suddenly changed to music quite clearly!

So I sat up in bed, in my nice striped pyjamas, and wondered what the heck was wrong.

Have you guessed? Yes, sir. I'd left the blessed set on in the room below. And one of those indefatigable German stations, to whose wave it was adjusted, was announcing a new day's programme.

So I had to toil down and get cold feet. Ever been caught like that on a frosty morning? The only consolation was that the set was not a battery model. ARIEL.



**AN EASILY-MADE  
LIGHT-CHOPPER DISC**

A LIGHT-CHOPPER is, of course, a device which is rotated in the path of a beam of light. It breaks up the light into pulses of equal or unequal length. The light pulses subsequently impinge upon the sensitive surface of a selenium or a photo-electric cell and thus give rise to corresponding pulses of current which are readily detectable by connecting a pair of headphones across the output circuit of the light-cell.

One of the best and simplest forms of "chopper disc" may be constructed from an old gramophone record. Place the record flat on the bench and, with a pair of compasses, a divider or a scribe, mark out a circle on the record at a suitable distance from its edge. Then, on this marked-on circle, drill a number of holes at equal or unequal distances, the holes, of course, going right through the record. The diameter of these holes is, to a large extent,

**MADE FROM A RECORD**



This useful device for the experimenter is made from an old record.

immaterial. Generally, however, holes a quarter of an inch or so in diameter will be the most suitable

In drilling the holes, use a high-speed drill and do not press too hard on the record material. This mode of drilling will give perfectly clean-cut holes without chipped edges.

Mount the record so drilled on a spindle or shaft by means of a suitable washer and nut placed at each side of it on the shaft. The chopper disc so made can now be rotated either by hand power or else by fixing up a drive from a clockwork or small electric motor.

It is interesting to stick small pieces of coloured gelatine over some of the holes in the disc. These, by colouring some of the light pulsations passing to the selenium or photo-electric cell, will completely alter the nature of the characteristic hum which is heard in the phones or amplifier-cum-loudspeaker connected across the output circuit of the light-cell.

J. S.



*Solely  
Specified  
for the*

**"B.C.L." TWO**



**S.G.220**

AGAIN chosen because their rigidity of construction and consistent performance make them ideal for short-wave reception.

Members of the oldest radio society in the world—the R.S.G.B.—pioneers in short-wave work—have tested and approved Hivac valves.

Short-wave enthusiasts in every part of the globe rely upon Hivac for world-wide reception.

Ask your dealer for

**HIVAC S.G.220 10/6**

*British made by the*  
**HIGH VACUUM VALVE CO. LTD.,**  
113-117 Farringdon Rd., London, E.C.1

Telephone: 01Erkenwell 7587 and 8054.

**AMPLE STOCKS FOR IMMEDIATE DELIVERY**

**The Paper for  
the Boy of To-day!**

Such is MODERN BOY. Its every issue is brimful with thrilling stories and articles on the very latest Invention, Adventure, Hobbies, etc. It is the paper for the youth of to-day. Buy it regularly.

**MODERN BOY**

At all Newsagents and Bookstalls. Every Saturday—2d.

# FERRANTI

## THE TRANSFORMER WITH A PEDIGREE



**THE  
AF8**

All over the world, wherever wireless men meet, the name Ferranti is synonymous with unflinching, unvarying quality. The use of sectional windings on non-hygroscopic bobbins; the many unique features of design, and the stringent electrical and mechanical tests which every Ferranti Transformer must pass before it is allowed to leave the works ensures almost absolute freedom from breakdown.

### YOU BUILD BETTER WHEN YOU BUILD WITH FERRANTI

Type	Ratio	Inductance	Price
AF3	1/3.5	220/60 hys. 0.6 m/A.	25/-
AF5	1/3.5	260/80 hys. 0.10 m/A.	30/-
AF6	1/7	85/50 hys. 0.6 m/A.	30/-
AF7	1/1.75	400/120 hys. 0.8 m/A.	30/-
AF8	1/3.5	42/20 hys. 0.6 m/A.	11/6
AF10	1/3	35/20 hys. 0.6 m/A.	8/6

**FERRANTI, LTD.,  
Hollinwood, Lancs.**

London: Bush House, Aldwych, W.C.2

## "THE BOOK OF PRACTICAL RADIO"

What Readers say about John Scott-Taggart's Great Work.

### "VERY, VERY INTERESTING."

Dear Sir,—My thanks for the prompt dispatch of POPULAR WIRELESS' astounding value in books—"The Book of Practical Radio."

I am but a recent convert to the ranks of Mr. Scott-Taggart's fans, but certainly a confirmed one. I have never had the pleasure, hitherto, of perusing any of his books, and I must say that he has certainly treated his subject in such a manner as to make the book's perusal and study very, very interesting to one with a distinctly "non-technical" mind.

Do I enjoy my weekly copy of Pop. WIRELESS? Or do I?

P. J. G., Woodstock Street, Athy, Co. Kildare.

### "HIGHLY DELIGHTED."

Dear Sir,—I beg to acknowledge receipt of "Book of Practical Radio," with which I am highly delighted; it will be a boon to all interested in wireless. A word of praise is due to the author for the splendid manner in which he has simplified all details. I also wish to thank your popular paper for the wonderful opportunity afforded its readers to possess such a marvellous book.

JAMES DICKSON, Agnes Villa, Keltymill Road, Keltly, Fife.

### "THE BOOK FOR WHICH I HAVE BEEN WAITING."

Dear Sir,—Mr. J. Scott-Taggart's "Book of Practical Radio" has reached me safely, and I am greatly pleased to have it. This is the book for which I have been waiting, not for six weeks, but for several years. Now it will be always within reach until Mr. Scott-Taggart writes a better one—if he can!

A. MONTAGUE, Penton, Crediton, N-Devon.

### "INVALUABLE TO EVERYBODY."

Dear Sir,—I have received my "Book of Practical Radio"; it is well named indeed. The few subjects that I have read so far are extremely clear in all the explanations: typical of all Mr. Scott-Taggart's writings.

Chapter 29 is, I am certain, the complete answer to any fault that is likely to puzzle anybody who builds or secures a wireless set.

The high-class paper and binding make it a handsome-looking volume.

In concluding I must congratulate everyone concerned in the book's production; it will prove invaluable to everybody interested in wireless construction, I am certain.

L. HESSEY, 1, Erlam Road, South Bermondsey, S.E.16.

### "A WONDERFUL BOOK."

Dear Sir,—Many thanks for S.-T.'s wonderful book; it certainly is the greatest radio bargain going to-day.

It goes very well with his last manual, and it's nice to be able to read S.-T.'s practical experience and compare it with your own.

G. F. SMALL, "Nithsdale," 39, Sunningfields Road, Hendon, N.W.4.

### "A BOOK THAT ALL CAN UNDERSTAND."

Dear Sir,—I am writing to thank you for the copy of "The Book of Practical Radio." It is in such everyday language that ALL can understand and put in practice.

I have been a reader of "P.W." since No. 1, and am still using the good old "Magic 3" with 6-pin coil in place of plug-in. Wishing you every success.

C. W. MARTIN, Wairoa Garage, Rydens Avenue, Walton-on-Thames, Surrey.

### "A FINE PRODUCTION."

Dear Sir,—It gives me pleasure to write you once again to convey my very best thanks for J. S.-T.'s "Book of Practical Radio" just received. It is in every way a worthy companion to the "Manual of Modern Radio," and the two should be in the possession of every reader of "P.W."—and, indeed, every radio enthusiast. Now I am hoping it will not be long before we readers will be able to secure yet another of these volumes, on either short waves or television, or both. With congratulations on such fine productions and many thanks.

W. E. ROBERTS, 58, Woodbridge Road, Guildford.

### "A SPLENDID GUIDE."

Dear Sir,—Please accept these few lines in grateful appreciation of the fine gift, viz. "The Book of Practical Radio."

It is indeed a veritable mine of information. Perhaps the word 'mine' is not just quite so apt as another word might be, because one does not require to "dig" to find what one requires, all subjects being classified, and each has a place of its own.

With this splendid guide at hand we folk who tinker at wireless need have no qualms when anything fails to function properly. Sincerely thanking you for such a useful book, and also Mr. Scott-Taggart for giving so freely of his experience, and wishing you all every success.

PETER WEIR, 53B, Millar Street, Motherwell, Scotland.

### "A VERY USEFUL VOLUME."

Dear Sir,—I have received "The Book of Practical Radio" (de-luxe edition), and am very pleased with it. It is a very useful volume, as well as being a nicely bound book.

I am always interested in Mr. Scott-Taggart's books (I also have the "Manual of Modern Radio") and articles, as well as the famous S.T. sets.

I am hoping to build the H.F. and detector side of the S.T.600 and couple it to my amplifier, which is used for gramophone work and following a crystal set for local work.

Best wishes for the future of POPULAR WIRELESS and many thanks for Mr. Scott-Taggart's book.

E. E. SIMS, "Walmer," 6, Bramber Road, North Finchley, N.12.

### "A BOOK ANYBODY SHOULD BE PROUD TO HAVE."

Dear Sir,—I wish to acknowledge receipt of my "Practical Radio" by J. Scott-Taggart. And what a book! It's a book anybody possessing a wireless receiver should be proud to have in his bookcase. It's so clearly written that anyone with any intelligence should be able to work any receiver from the hints given in it.

Thank you very much for so splendid a book, and here's wishing "P.W." and its readers further successes.

F. BOREHAM, 5, Hinguar Street, Shoebury-ness.



**RADIOTORIAL  
QUESTIONS  
AND ANSWERS**

**CRYSTAL SET WITH LONG RANGE.**

W. B. (Winton).—"Having a good aerial and earth, I want to try what I can do in the way of long-distance reception on a crystal set. I believe that a large home-made coil, with plenty of taps, is considered the best basis of such a circuit, but I don't know the best connections.

"My coil is wound on a 3½-in. diameter former, with thickish wire—No. 20, I believe. It is tapped every five turns, and has 60 turns in all.

"I have clips for making the connections to it, good 'phones, crystal and odds and ends. But what is the best circuit to use?"

"According to what has been said in 'P.W.', a crystal set with tapings can get continental and other distant stations night after night if the aerial and earth are good, and I should like to try this if you will give me a good circuit."

Your coil is suitable, and the following circuit is recommended: Aerial lead to coil clip, which will be connected about half-way along the coil.

Earth lead to one end of the coil, to the moving-

The Editor will be pleased to consider articles and photographs dealing with all radio subjects but cannot accept responsibility for manuscript, or photos. Every case will be taken to return MSS. not accepted for publication. A stamped, addressed envelope must be sent with every article.

All Editorial communications should be addressed to the Editor, POPULAR WIRELESS, Tallis House, Tallis Street, London, E.C.4.

All inquiries concerning advertising rates, etc., to be addressed to the Advertisement Offices, John Carpenter House, John Carpenter Street, London, E.C.4.

The constructional articles which appear from time to time in this journal are the outcome of research and experimental work carried out with a view to improving the technique of wireless reception. As much of the information given in the columns of this paper concerns the most recent developments in the radio world, some of the arrangements and specialities described may be the subjects of Letters Patent, and the amateur and the trader would be well advised to obtain permission of the patentees to use the patents before doing so.

vanes terminal of the tuning-condenser (0005 mfd.) and to one side of the 'phones.

Other side of 'phones to one side of the crystal detector. The remaining side of the crystal detector to another flex lead with clip, which will go to the coil at about its 50th turn.

Other terminal of the tuning condenser (fixed vanes) to the other end (60th turn) of the coil.

If you have a '0002- or '0003-mfd. condenser it may be wired across the 'phone terminals. Vary the clips till you find the best positions, and you should be able to hear many distant stations, though not with regularity, since you are outside their range of crystal-set service.

**GOOD CRYSTAL-SET CIRCUIT.**

A. S. (Ipswich).—"A small crystal set I possess seems incapable of reaching London at a distance of 70 miles.

"Could you suggest a suitable circuit designed to reach that station, giving particulars as to height and length of aerial and a suitable earth?"

London Regional station has a crystal-set range of not more than about half the distance you name; and London National has even less chance of serving the Ipswich district, since its power is the same as the Regional's, and its wavelength is not so suitable for reliable long-range results.

Droitwich (1,500 metres), on the other hand, is

(Continued on next page.)

**SPECIFIED and USED**

by **Mr. G. T. KELSEY** for his  
**1935 SHORT-WAVE ADAPTORS**



**FULL  
TRADE  
DISCOUNTS**

**B. T. S.  
SHORT-WAVE  
COILS**

Only B.T.S. Coils are good enough for Mr. G. T. Kelsey . . . only B.T.S. Coils will enable YOU to duplicate EXACTLY Mr. Kelsey's original Adaptor and results. Use only B.T.S. THERE ARE NO SUBSTITUTES.

SET of 4 COILS exactly as specified - **16/-**



**B. T. S. KELSEY MAINS  
TRANSFORMER**

Also specified, tested and approved by Mr. G. T. Kelsey. Terminals for both input and output.

**12/6**

Mr. Dealer: Full Trade Discounts.

OBTAINABLE FROM ALL GOOD RADIO DEALERS. In cases of difficulty, send direct.

SEND FOR ILLUSTRATED LISTS OF B.T.S. TELEVISION APPARATUS, SHORT-WAVE RECEIVER KITS and ADAPTORS.

**B. T. S.**



**BRITISH TELEVISION SUPPLIES, LTD. BUSH HOUSE, LONDON, W.C.2**  
Telephone: TEMPLE BAR 0134. Telegrams: TELEVIEW, BUSH, LONDON

**HIGHEST in QUALITY  
LOWEST in PRICE**

Absolutely non-microphonic detector types. S.G. types of exceptionally low inter-electrode capacity. Output valves giving larger undistorted output than "luxury" price valves.

- 362 BATTERY VALVES. H., HL & L. 3/6. Power, 4/-.
- Super Power, 4/6. S.G. & V.S., 7/6. V.P.2, 9/-.
- Peniode Type, 10/-.
- B.A. & B.X., 9/-.
- 362 A.C. MAINS. ACHL4, 7/6. P.625, 8/-.
- ACPX4, 9/-.
- ACSG4 & ACVS4, 12/6. ACME4 & ACHM4 13/-.
- ACVP4, 13/-.
- Full Wave Rectifiers RB41, 7/6. RB42, 10/-.

If unobtainable from your dealer send P.O. to:—(DEPT. X), The 362 Radio Valve Co., Ltd., Stoneham Rd., London, E.5



**S.G.2.  
7/6**

**362 THE VALVE WITH  
THE 6 MONTHS'  
GUARANTEE**

PLEASE

be sure to mention  
**POPULAR  
WIRELESS**  
when communicating  
with  
advertisers  
**THANKS!**

# Let Us Send You This 28-Page Booklet — Free



It gives all particulars of various Courses that cover every phase of Radio work.

The Radio Industry is progressing with amazing rapidity. Only by knowing thoroughly the basic principles can pace be kept with it. I.C.S. Instruction includes American broadcasting as well as British wireless practice. It is a modern education, covering every department of the industry.

### OUR COURSES

Included in the I.C.S. range are Courses dealing with the installing of radio sets and, in particular, with their Servicing, which to-day intimately concerns every wireless dealer and his employees. The Operating Course is vital to mastery of operating and transmitting.

There is also a Course for the Wireless Salesman. This, in addition to inculcating the art of salesmanship, provides that knowledge which enables the salesman to hold his own with the most technical of his customers.

Then there are Preparatory Courses for the City and Guilds and I.W.T. Exams.

We will be pleased to send you details and free advice on any or all of these Courses. Just fill in and post the coupon, or write in any other way.

International Correspondence Schools, Ltd.,  
Dept. 161, International Buildings,  
Kingsway, London, W.C.2

Without cost, or obligation, please send me your Radio booklet of information about the Courses I have marked X

- COMPLETE RADIO
- RADIO SERVICING
- RADIO EQUIPMENT
- RADIO SERVICING AND SALESMANSHIP
- WIRELESS ENGINEERING
- WIRELESS OPERATORS
- EXAMINATION (State which)

Name ..... Age.....

Address .....

## RADIOTORIAL QUESTIONS & ANSWERS

(Continued from previous page.)

Intended by the B.B.C. to serve the Ipswich area, and should be sufficiently well received on a crystal set to give a regular and satisfactory service.

You need not, therefore, be surprised that your set fails to get London well.

Nor would it be surprising if other crystal sets in your neighbourhood achieved much better reception from London than your own, since a very great deal depends on the aerial, earth, etc. We have frequently given hints on these subjects in "P.W." and if you improve your installation on the lines we then recommended you may get reasonably good reception, despite the fact that you are really out of range of the London stations. (For other points see the reply to O. B., Colchester).

### RUNNING A MAINS SET FROM BATTERIES.

H. W. C. (Gateshead).—"Owing to her husband's illness my sister has got to move into the country, where there is no electric light. Is there any hope of taking the wireless set by adapting it?"

"At present it is run from the mains (direct current), and as it was a very expensive and powerful set, of beautiful tone, she would miss it very much. Could she keep it by using batteries instead of the mains, or must she get a proper battery set?"

"She may have to sell it, as the illness is costing such a lot."

We are sorry to say that in all probability it will be impracticable to keep it. The cost of running a powerful mains set from batteries, in the country, would be prohibitive.

But we suggest that as the country aerial can usually be bigger than a town aerial, and reception conditions more favourable, a relatively simple battery set will give satisfaction. And it should be possible to buy this from the proceeds of the mains set.

### DIFFERENCES BETWEEN DIRECT AND ALTERNATING CURRENT.

O. B. (Colchester).—"Can you tell me: (1) Whether a single coil connected to a simple cell such as a dry battery or accumulator converts the direct current from the cell into alternating current?"

"I know that such an arrangement produces the effect of a magnet, and that if the current be direct the magnetic field is stationary, and if the current be alternating the magnetic field rises and falls.

"(2) Is a point reached in such an arrangement when, as turns are added to the single coil, the magnetic field changes from stationary to moving and the current becomes alternating?"

"(3) Does it depend on the thickness of the wire, how close the turns are together, whether there be an iron core or not, and the number of turns?"

"(4) At what point does the direct current turn to alternating?"

(1) No; the coil does not do any converting. It merely concentrates the magnetic effects of any current flowing, so that they can be more easily observed and appreciated than they would be if existing around the uncoiled wire.

Remember, also, that the magnetic field will rise and fall when the current (even a direct current) rises and falls. So the coil will display magnetic effects at the moment a direct current through it starts or stops.

(2) No; the coil, as stated above, merely displays in convenient and concentrated form what is happening in the wire. The effects would really be there exactly the same if the coil was untwisted into a straight wire.

It would then have the identical type of magnetic field around it, rising and falling as the current increased and decreased; but instead of this field being concentrated into a small space around the coil turns it would be disposed around the whole length of the uncoiled wire.

(3) Thickness of the wire allows the coil to be smaller, and thus the magnetic field around it to be concentrated into the smaller space, if it is made to carry the same current as a thicker wire. And the same considerations apply to the closeness of turns.

An iron core still further concentrates the field, and at low frequencies any changes in the current flow are, as it were, emphasised by the presence of an iron core, since it enables a given current to build up a greatly enhanced electro-magnetic effect.

(4) It doesn't. Though if a direct current is interrupted and started again, at a high frequency, its

effect will be that of a unidirectional pulsating current; and such a current has many points of resemblance with alternating current and is often confused with it.

If a buzzer were inserted in circuit with the coil, and operated from a battery, the fast making and breaking of the buzzer circuit would cause direct current to flow in pulses: starting and stopping, starting again and stopping again, continually, at a high frequency.

In the vicinity of the coil the magnetic field would rise and fall, rise again and fall again, continually, in sympathetic pulsations.

This would be very similar to the magnetic effects around a wire carrying alternating current; but there would be important differences. The chief of these would arise from the fact that an alternating current does not merely start and stop, in perfectly regular sequence—for each time it starts anew it flows in the opposite direction from the current which has just ceased.

Each pulse is in the opposite direction from the one that preceded it and from the one that will follow it. But that is not the case with intermittent direct current, which always flows in the same direction.

### SPACING OF A SCREENED DOWN-LEAD.

C. G. C. (Walkden).—"The advice is often given that a down-lead from the outdoor aerial should keep well clear of walls and gutters and other obstacles.

"Does this apply when a screened down-lead is in use?"

No. With the screened down-lead there is no harmful effect from adjacent stray "wall capacities."

### HUM IN MULTI-VALVE SET ON D.C. MAINS.

T. T. (Poplar).—"Most difficult of the faults that I meet are switch failures and hum on D.C. sets.

"The switches can be cured by fitting new

## LONG WAVES AND THE S.T.600

On account of slight and inevitable differences in manufacturing methods, the long-wave station-naming on the "Spot-On" dial does not hold good for both makes of coils approved for the S.T.600 receiver.

It will be appreciated that with a dial such as the "Spot-On" it was not possible to make the readings applicable to more than one set of conditions. The chart was originally calibrated in conjunction with Wearite coils, and for the benefit of constructors who are using Colvern coils we are publishing in "P.W." a re-calibrated long-wave section of the "Spot-On" dial, and it will be possible to cut this out and paste it in position on the existing dial.

May we remind readers that this does not affect the efficiency of the set in any way whatsoever, nor does it make any difference to the number of stations receivable on the long waves. It is simply and solely a matter of calibration, and, with the optional re-calibrated long-wave section, the "Spot-On" dial can be used successfully with either make of coil.

ones, and although that sometimes takes an awful lot of time and trouble the result generally speaks for itself. But hum on a D.C. mains set is far harder to get rid of.

"I have found that the best thing to do is to put a choke in one main (or in both mains) lead, with shunt condenser or condensers. And if this fails I try to improve the decoupling, especially of S.G. and early stages, and grid bias. (Condensers across the automatic bias resistances, etc.)

"What else can be done for obstinate cases?"

It is not easy to lay down hard-and-fast rules, since every set calls for specialised treatment, according to the particular circuit.

The following general rules, however, should be of assistance in determining likely cures in particular instances.

Use good-quality low-capacity valve holders, since otherwise trouble (usually hard to trace) may arise at this point.

Try for a specially well-smoothed detector H.T. feed (L.F. choke in the lead and condenser to earth) and good mains-unit decoupling.

(Continued on next page.)

## RADIOTORIAL QUESTIONS & ANSWERS

(Continued from previous page.)

In sets with pentode output it may be advantageous to improve the H.T. smoothing of the pentode's supply from the mains unit, since this often causes quite as much trouble as earlier valves.

Don't forget the grid circuits, for although one does not normally expect to find them causing hum, unless the obvious precautions of good spacing, etc., have been neglected, an inefficient grid circuit is a fruitful source of hum accentuation.

### WORKS THE SAME WITH ONE OF THE COMPONENTS MISSING.

F. E. D. (Shirley).—"The set is one built from a 'P.W.' blue print, namely No. 55, 'This Year's Magic Three.' And though it is supposed to be old-fashioned it has been giving very good results up to about a month ago.

"It then packed up, and I was called in to put it right. I found the trouble was a dud transformer, and when this had to be replaced I suggested it might be as well to renew some of the other parts that looked worse for wear, and valves.

"By mistake, there was no 20,000-ohm resistance among the new components when they came, but everything else. We made it all up ready, thinking to add the resistance at my next visit, when it would be there. But, just for curiosity, I connected up without the resistance by taking H.T. +1 to the H.T. + terminal on L.F.T. (1), which was formerly joined to the terminal on the 2-mfd. condenser.

"The result was very surprising. Owing, I suppose, to new valves, etc., the volume was

### S.T.600 QUERIES

We greatly regret that owing to the unusually large number of queries received during the last few weeks there has been a certain amount of delay in answering readers' questions by post. Steps have been taken to cope with the tremendous demand on the services of our Query Department, and although letters are still flooding in we can assure readers that every effort is being made to reduce the delay.

double what it had been, and wonderfully clear.

"In fact, it is now so good that he swears he will not have it touched whatever the blue print may say. So I thought I would ask you.

"Is it doing any harm like it is now? And why is it that it is perfect without the resistance?"

We are glad that the set is going so well without the resistance, but we still believe it to be necessary to fit the resistance, as we did, if the set is to give the best results of which it is capable.

You will understand this if we explain the purpose of the resistance in question.

In conjunction with the condenser C7, it forms a decoupling circuit for the detector valve. The great practical value of decoupling in "This Year's Magic Three" was that it preserved quality by enabling the H.T. battery to be used for longer periods without sign of distortion occurring.

In your test it was probably a new battery that was tried, and with a new battery the advantages of decoupling are often not apparent. But as soon as the battery begins to age a set that has good decoupling scores heavily over another set without it, because the latter shows distortion, etc., whereas the well-decoupled set does not.

In fact, the presence of the decoupling ensures that it is not necessary to renew the H.T. battery as frequently as would otherwise be required. So its small cost is saved over and over again by what the set owner would have been paying out on more frequent battery renewals.

You can probably test this out by letting the set continue as it is until the need for a new H.T. battery makes itself known by harsh and tinny reception. Instead of renewing it at once, try inserting the resistance, and much of the trouble will disappear, proving that decoupling preserves good quality, even with an ageing battery, as long as possible.

# BULGIN COMPONENTS

for the

## "B.C.L." TWO SHORT WAVE SET

Bulgin. S.W.21. Valveholders	- -	1/6 ea.
Bulgin. H.F.8. Midget Choke	- -	2/3 ca.
Bulgin. Wire End Resistances	- -	1/- ea.
Bulgin. S.80. Q.M.B. Switch	- -	1/6 ea.

for the

## 1935 "KELSEY" S/W Adaptor (Battery Model)

Bulgin. V.H.15. Valveholder	- -	1/6 ea.
Bulgin. V.H.10. Valveholder	- -	6d. ea.
Bulgin. H.F.8. Midget Choke	- -	2/3 ca.
Bulgin. Wire End Resistances	- -	1/- ea.

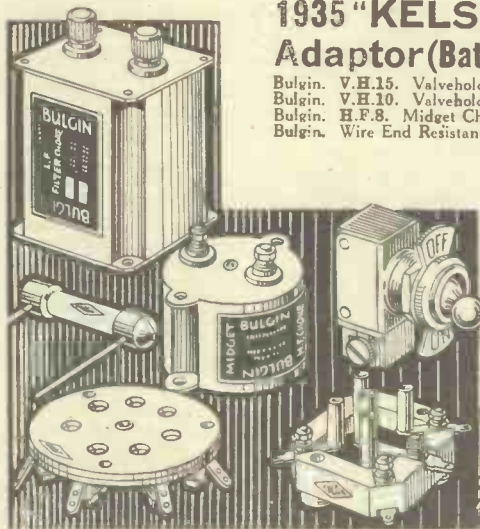

for the

## 1935 "KELSEY" S/W Adaptor (Mains Model)

Bulgin. S.W.21. Valveholders	- -	1/6 ea.
Bulgin. V.H.11. Valveholder	- -	6d. ea.
Bulgin. H.F.8. Standard Choke	- -	3/6 ca.
Bulgin. Wire End Resistances	- -	1/- ea.
Bulgin. L.F.16. L.F. Choke	- -	7/6 ea.

Large stocks available for immediate delivery.

**A.F. BULGIN & CO. LTD.**  
 ABBEY ROAD BARKING ESSEX  
 TELEPHONE: GRANGEWOOD 3266 7

# SPECIFIED

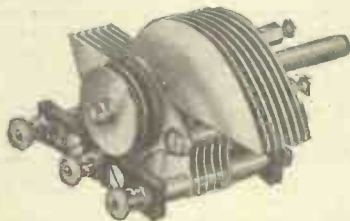

## "SHORT-WAVE SPECIAL"

**J.B. VARIABLE CONDENSER**  
 (Cat. No. 2042) - - - 5/9

This J.B. Condenser is an essential part of the "B.C.L." Two. Make sure of the best results by using J.B. components for this and all other home-constructed sets.

Write for full particulars now.

Also specified . . .

**2-RATIO SLOW MOTION DIAL**  
 (Cat. No. 2092) - - - 6/6



**PRECISION  
INSTRUMENTS**

Jackson Bros. (London) Ltd., 72 St. Thomas' Street, S.E.1. - - - Tel. Hop. 1837.

## FULL of INTEREST



Fully illustrated with constructional details for building Battery and Mains S.W. Receivers—6v. S.W. Superhet with A.V.C.—All Wave Wavemeter—5-metre Receiver—Simple 5-metre Transmitter—Crossfeeder Aerial System—Battery and Mains S.W. Converters—Amateur Bands Receiver—100 watt Transmitter—Eliminators, etc. COMPILED BY THE LEADING SHORT WAVE SPECIALISTS. Obtainable from your radio dealer, W. H. Smith, or in case of difficulty, STRATTON & Co., LTD. (Dept. 25), Broms-grove Street, Birmingham. London Service Depot: Webb's, 14 Soho St., W.1. Glasgow Service: J. R. Hunter, 138 West Nile Street. **PRICE 1/6**

# 1935 EDDYSTONE SHORT WAVE MANUAL

All applications for Advertising Space in POPULAR WIRELESS should be addressed to the Advertising Department, John Carpenter House, John Carpenter Street, London, E.C.4.

**BE BRITISH**  
**—BUY BRITISH**

**EPOCH**  
**REPRODUCERS**  
**& MICROPHONES**

are British down to the last nut.

USE ONE FOR THE  
**"B.C.L." TWO**

where it is important that your speaker is as sensitive as it is possible to obtain.

We shall be glad to send you an illustrated list giving you full details and prices by return. Drop us a card giving the make and model of your set and we shall be pleased to recommend the right speaker for your particular purpose.

**20th CENTURY' P.M.M.C.**

The recommended speaker for the "B.C.L." TWO. High cobalt steel magnet with very high flux density. Aluminium frame (copper plated), holding 8 1/2 in. diaphragm. Fitted with Universal Multivratio Transformer.



With universal transformer ready for use **35/-**  
 Fitted in handsome oak cabinet **47/6**

**EPOCH**  
**REPRODUCERS**  
**& MICROPHONES**

Made and Distributed by

**RADIO DEVELOPMENT CO.**  
 Aldwych House, Aldwych, London, W.C.2  
 Telephone: Holborn 9111.

**RESILIENCE**



*CLIX*  
*Points of*  
*Advantage*

Each individual socket in Clix Chassis Mounting Valveholders is formed with a definite waist which, in conjunction with the helical slots, affords unique resilience and gives perfect contact with every type of valve pin without possibility of collapse.

**CLIX**  
 Specified  
 for  
**1935 KELSEY**  
**SHORT-WAVE**  
**ADAPTORS.**

**CLIX**

Folder  
 "P" Free

**LECTRO LINX, LTD.**  
 79a Rochester Row, London, S.W.1

**SOME NEW COMPONENTS REVIEWED**

The results of "P.W.'s" tests on a "Droitwich Suppressor"—A Tapped Resistance for D.C. Mains work—and a Special Tone-Correcting Transformer.

**CUTTING OUT DROITWICH.**

**D**ROITWICH is a very good station. As radio engineering it is probably as good as, if not better than, any other transmitter in the world. But a very large number of listeners have found it too good for comfortable listening—from other stations.

Way down in the west country or in the north of Scotland it may take its place in the team of long-wave stations from which listeners can choose and be not much more powerful than some of the others.

Within a range of a score or two miles, however, and even further away from it than that, its spread is such that many find it difficult on their sets to cut through its excellent transmissions and get other stations.

Even in London the majority of the older types of sets are more or less flooded out by the long-wave Droitwich programmes. We were listening to one only a week or so ago. There was strong break-



This neat component is the Whiteley "Droitwich Suppressor," which has been specially designed for reducing long-wave interference. The device can be cut out of circuit when desired, by means of a switch.

through at the lower end of the dial when the set was switched over to long waves; but that would have been quite tolerable were it not for the fact that it joined right up with Droitwich spread, this occupying fully three-quarters of the dial.

In connection with this kind of trouble Messrs. Whiteley Electrical Radio Co., Ltd., of Radio Works, Victoria Street, Mansfield, Notts, have recently produced what they style a "Droitwich Suppressor."

While obviously designed in accordance with wave-trapping principles, this is not in any sense of the term a general-purpose wavetrap. It has been devised simply and solely for the reduction of interference from the long-wave Droitwich transmitter.

Its tuning range is therefore limited. The best Droitwich trapping position for normal circumstances (although there may be abnormal jamming) is clearly marked, as a glance at the accompanying photo shows, but the suppressor can be tuned to some extent to either side (above or below the wavelength) in order to deal with special circumstances.

It will also be observed that there is an off position for cutting the Suppressor out if desired.

By designing the Droitwich Suppressor specifically for the one important task it has been possible to achieve a high order of effectiveness, and so that it shall have a minimum effect on the overall efficiency of the receiver with which it is used.

The price is 8s. 6d., which is decidedly reasonable in view of the special character of this welcome device.

**A "SKELETON" RESISTANCE.**

**T**HE "skeleton" component movement was initiated by Messrs. Bulgin a year or two ago. It is true that there had been isolated skeleton components available, but we believe that it was Messrs. Bulgin who first produced anything like a complete range of them.

The idea has not yet been universally adopted, but there are plenty of signs to show that gradually it is soaking in.

There is one important aspect to be noted. There are "skeletons" and "skeletons." The Bulgin skeleton components are ordinary components without polished cases and other trimmings unnecessary to the jobs they do.

The "manufacturer's version" of a component may not always be quite the same sort of thing. By this we mean that it may be shorn of those things which make it an easy-to-handle and attractive component for home constructors. Such an article is not a "skeleton" as defined by the catalogue issued by the originators of the movement, i.e. Messrs. Bulgin.

A Bulgin skeleton has terminal screws for easy connection and satisfactory fittings for baseboard or panel mounting. As we have said, it is identical to its normal home-constructor counterpart, except for the fact that it has no polished case or other such refinements as appeal merely to the eye, and is, therefore, quite a deal cheaper.

And, after all, these things are a bit unnecessary in most cases, aren't they? The components of a set should not need their own individual polished boxes and cabinets. It might be suggested by some that

this viewpoint is wrong, because a home-constructor's set should look as nice inside as it does outside.

However, this can be countered by asking what is wrong with the appearance of a nicely made component. In a way, the suggestion that it is ugly really implies careless manufacture, doesn't it?

Take a variable condenser as an example. If the vanes are nicely cut and finished, as they invariably are these days, they will look every bit as nice as a metal box which might be used to enclose them. Don't take this example too far, though, because sometimes components must have cases for electrical reasons.

Perhaps a safer example is afforded by the Bulgin D.C. Mains Resistance which is illustrated herewith. This is a neat enough component, and it is actually an advantage to have it without a case, for there must obviously be better heat dissipation, though we must quickly add that it does not develop more heat than any other so long as it is not overrun.

Minus polished, ventilated casing, etc., this first-class component can be retailed at the most attractive price of 3s. 6d., and it is self-contained and complete and can do its job perfectly.

It is for use with indirectly-heated D.C. and Universal valves, and it is supplied in a comprehensive range suitable for various numbers of valves from 2 to 7 and for the different types.

It is excellent value, and should appeal strongly to all economically minded constructors.

**A TONE-CORRECTING TRANSFORMER.**

**A**LTHOUGH the subject of tone correction is receiving more attention than was once paid to it, there would seem to us to be ample room for further serious consideration of the matter.

Admittedly the response of to-day's average set is miles superior to even the set of a year or two ago, but this improvement is in our view an improvement rather incidental to other and perhaps greater advancements.

Is it that this so-called "man in the street" is easily satisfied in so far as tone is concerned? We rather believe that this must, to some extent, be the case, though that is all the more reason why those who cater for his radio needs should exercise care in meeting his requirements.

Ignorance may certainly often be bliss, but there are other reasons than those connected directly with economics why the "man in the street" should be given something just a bit better than he thinks he wants.

However, we must not stray too deeply into the ethics of tone; there is so much of a practical nature which ought to be said.

Tone correction? Practically every radio set could do with at least a little of that; many simply groan and jibber for a lot of it. Bass? Yes, there is certainly great room for improvement there,



The Bulgin D.C. Mains Resistance is intended for use with indirectly-heated D.C. and Universal valves. It is available in types suitable for sets employing from two to seven valves.

though we believe that the lack of high notes is the more serious. In the high notes lie the characteristics of musical instruments and the individualistic timbres of voices.

Without a good supply of the higher frequencies the string and treble and alto woodwind and brass instruments lose their "personalities," and all are reduced to a common level of flutelike piping.

Under such conditions you might just as well sack one half of every broadcast band and orchestra; groupings of violins, etc., become fantastically unnecessary.

What can be done about it? Tone correction supplies the answer. And as we have already suggested, we don't tone-correct half as much as we ought. The correction can be made in the set itself as part and parcel of the design—absolutely integral with it, in fact.

This is, of course, done in "P.W." sets, as readers will know. But there are conditions encountered where additional tone correction is periodically required.

For example, the application of reaction at once  
 (Continued on next page.)

## SOME NEW COMPONENTS REVIEWED

(Continued from previous page.)

upsets the tonal balance of a set, whatever may have been done generally to its design.

That is why so many only hear foreign and other distant stations in a mellow, blurred form. Probably many think that it is an essential concomitant of distant reception that the high notes should be pruned off and speakers sound almost guttural.

Actually, distant stations are receivable as crisply and clearly as local stations if there is proper tone correction.

"P.W.'s" Technical Editor was the technician who put paid to that old belief that distant stations must necessarily be tone-dimmed stations. He gave us automatic tone balance, which automatically rearranges the tonal response of a set to suit either normal and distant-station conditions.

It is a simple system, though mightily effective. The essential feature of it is an L.F. transformer of special construction which emphasises the high notes. This costs no more than an ordinary transformer.

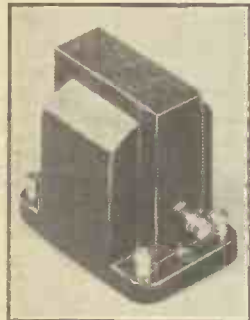

British Television Supplies, Ltd., Bush House, London, W.C.2, have an

The B.T.S. Tone-Correcting Transformer which sells at 8s. 6d. It can be used as an ordinary transformer or as a high-note corrector.

..... excellent one at 8s. 6d. It is styled the L.F. Audio Former, and merely

replaces an ordinary transformer in a set. It is made to act like an ordinary transformer by connecting a .01-mfd. fixed condenser across its primary winding. When this is disconnected the transformer applies its special high-note correcting qualities.

As a matter of fact, so many sets are sadly deficient in high notes, even on the local station, that many should use a tone-correcting transformer all the time.

For A.T.B., a self-shorting reaction condenser is required. This automatically brings the tone correction into action when reaction is applied. Alternatively, a simple switch can be used so that at any time the transformer can be made to tone-correct or not, just as required.

Frequently tone correction is desirable with gramophone records, for example.

The B.T.S. L.F. Audio Former does its job very well indeed. We can recommend it to our readers. Why not build your next set with one of these having a .01-mfd. fixed condenser connected across its primary? It won't cost you much, and you can then tone-correct or go over to A.T.B. at any time you desire in the future. It is a direct insurance against high-note loss.

## OMISSION AND REPETITION

(Continued from page 648.)

The question of radio technique is sure to crop up again, but it is a fact that "The Shining Hour" was easily followed and the situations grasped. I am very hopeful that soon we shall be treated to an act rather than one or two excerpts; then to two acts, and, if I dare say it, to the play in its entirety. If this did materialise I can see a solution to two problems at least that are worrying the B.B.C.: (a), the question of alternative programmes; and (b), the provision of adequate accommodation at Broadcasting House for television.

"You are doing a great service to people who like a good tune, Henry," said Peter Dawson to Henry Hall in one of the latter's guest-night programmes. Very true. But why did Henry then nullify this pretty compliment by playing "Black Jazz"? I give it up!

T. W. Cooper, the house canvasser, in an "In Town To-night" bill, struck me as a man with a flair for broadcasting. I envied him his sense of humour. I also envied Miss Anita Best, the singing dressmaker, in her obvious determination to get on. Mr. Kelly, the sandwich-board man, like most of his type, won our sympathy. Mr. Bray, the hobbies merchant, was unique in his praise of the G.P.O. I liked Capt. Bissett also. C. B.

# Better than Ever!

# SIMPSONS ELECTRIC TURNTABLE

## 1935 IMPROVED MODEL

### The PERFECT Gramophone Motor

**SILENT, SAFE and STRONG.  
NOTHING to WEAR OUT.  
NOTHING to GO WRONG.**

*The most efficient, reliable and economical, the quietest running gramophone motor obtainable.*

**ONE HOLE FIXING**



- Synchronous Motor
- No sparks
- No brushes
- No electrical interference or wear
- No complicated mechanism
- Nothing to understand
- CONSTANT SPEED
- ONE-HOLE FIXING
- Low consumption
- Darwin's Magnets

Brown felt-covered turntable. Depth under Motor Board 1". All metal parts bronze finished. A.C. MAINS ONLY. 100/150 or 200/250 volts. 50 cycles.

From all Good Dealers. In cases of difficulty, send direct to

SOLE WHOLESALE DISTRIBUTORS:

**THE BRITISH RADIOGRAMPHONE Co. Ltd.**

PILOT HOUSE, CHURCH STREET, STOKE NEWINGTON, N.16

Telephone: Clissold 6287/8

**RADIO GRAM CABINETS**  
*as supplied to B.B.C.*

**65/- Polished Cabinet for 35/-**  
**No Middle Profits!**

Famous maker offers finest Radio Furniture. As Supplied to B.B.C. A Quality and Value impossible to better. Beautifully hand polished! GUARANTEED Piano Tone Acoustically.

Trial Will Delight You! (Cash or 10/- Monthly.)

LIST FREE! From Makers—

**PICKETT'S**  
*Piano Tone*

Cabinet (P.W.) Works, Albion Rd., Bexleyheath, Nr. London.

**M.R. SUPPLIES**

Only offer "QUALITY" Microphones. Notwithstanding its very low price, the model illustrated is designed to give the maximum volume at good quality with the minimum of amplification. Even one stage is sufficient for good announcement strength. Therefore no special amplifier is necessary—if hooked up to any radio set the results will be highly satisfactory. For speech or music we guarantee that no other microphone on the market approaches it at the price.

**12/6**

Post Free  
Cash with order or C.O.D.

Complete with carefully matched modulation Transformer and polarising battery and full instructions. Believe us, we are in a position to judge, and we consider this the world's best Microphone Value. Satisfaction or cash refunded.

M.R. SUPPLIES, 29A, CHARING CROSS RD., LONDON, W.C.2.

## EASY TERMS

We specialise in the supply of all good quality Radio sets, components, and accessories. Send list of requirements and keen quotation will be sent promptly. Cash and C.O.D. orders despatched by return of post.

SEND  
7/-

### GARRARD RADIO-GRAM UNIT

Model A.C.6, complete with volume control, ready for use. This unit converts any radio receiver into a high-class radiogram for A.C. mains. Cash price £4 0 0, or 7/- with order and 11 monthly payments of 7/4.



SEND  
2/6

### W.B. STENTORIAN

SENIOR P.M. SPEAKER. Cash Price £2 2 0, or 2/6 with order and 11 monthly payments of 4/-.



STANDARD P.M. SPEAKER. Cash Price £1 12 6, or 2/6 with order and 11 monthly payments of 3/-.

SEND  
5/-

### ATLAS H.T. ELIMINATOR

Model T. 10/30, with trickle charger. For Q.P.P. and Class B and all types of sets. Output 30 Milliamperes, 3 H.T. tapings. Cash Price £3 9 6, or 5/- with order and 12 monthly payments of 5/11; for A.C. mains.



ALL CARRIAGE PAID.

Estd. 1925 THE LONDON RADIO SUPPLY COMPANY 1977  
PHONE: NATIONAL  
11, OAT LANE, NOBLE STREET, LONDON, E.C.2

## Obtain Your 1935 Kelsey Short-Wave Adaptor from Short-Wave Experts

### FINISHED INSTRUMENT

Complete instrument, ready built and aerial tested to Mr. G. T. Kelsey's specification, complete in walnut cabinet.

Battery Model. Cash or C.O.D. Mains Model. Carriage Paid. Less Valve. £3-15-0 £7-16-6

1 Set of 4 Unit Radio Short-wave Coils as approved for the 1935 Kelsey Adaptor. 12/- Per Set.

### THE "B.C.L." TWO SHORT-WAVE SET

Complete instrument built to specification, aerial tested. Complete in Walnut Cabinet. Less Valves. Cash or C.O.D. £5-17-6 Carriage Paid.

### THE UNIT RADIO 1935 CHASSIS BUILT SHORT-WAVE CONVERTER ADAPTOR.

For use with A.C., Battery, or D.C. Receivers. Simply plug-in. No extra batteries required. Range 12-60 metres. Complete in Walnut Cabinet. Cash or C.O.D. 39/6 Carr. Paid.

With switch for instantaneous change-over from short to ordinary reception, 42/6.

DE-LUXE MODEL, as above, but with 100-1 ratio micro-dial and change-over switch. Complete in Walnut Cabinet... 47/6

Send for Illustrated Leaflets.



UNIT RADIO

12, Pulteney St., London, N.1. Tel.: Terminus 5382

## ALUMINIUM'S ARTFUL AID

One of the most familiar metals in use in modern radio-receiver construction is the so-called "aluminium." Condenser vanes, screens and casings of all sorts are made from this material, though it is not really pure aluminium but a composite alloy of a number of elements. The discovery and growth of this universally popular metal is described below

By J. F. STIRLING.

TELL your brother radio fan that his set is devoid of any article or component of aluminium, and he will probably forthwith proceed to tell you many unpleasant and untrue things about your powers of observation.

But, as a matter of fact, your remark will be perfectly well founded. There is no pure aluminium used in radio construction these days. It is all aluminium alloy.

There are scores of aluminium alloys in practical use at the present day—alloys which have been brought into being by metallurgists in order to meet the very exacting demands of designers and technologists in the electrical, radio, automobile and other similar industries.

Pure aluminium is pretty wretched stuff from any practical point of view, despite the fact that it has the one good feature of possessing a good electrical conductivity. Apart from that, the pure metal corrodes when exposed to a moist atmosphere, it is difficult to cast, to machine, to polish or to work in any way at all. It possesses very little tensile strength, and in this pure condition the metal would be too unreliable to enter into any intricate detail of construction.

### Much to the Fore.

Hence, owing to the increasing demands of the electrical and the motor industries, aluminium alloys are now very much to the fore. You will, without doubt, have seen for yourself the enormous aid which these commercial alloys of aluminium have given to the design of radio receivers during the last decade.

And so, instead of consisting of pure aluminium, the "aluminium" panel or panel fittings of your receiver will most certainly contain an appreciable proportion of zinc and, perhaps, of copper as well. The thin condenser vanes of your set are cut from an aluminium-copper alloy, and they may contain a little magnesium and a trace of manganese.

If there are any heavy "aluminium" castings in your set's internals, these may contain zinc, silicon, copper and/or manganese.

Mind you, I'm not making these assertions in any *ex cathedra* fashion, for the exact composition of any piece of aluminium alloy is a secret hidden from all but the analytical chemist. Still, the odds relating to the composition of the "aluminium" components of your receiver, particularly if it is a modern one, are on the lines indicated above.

In pre-war days considerable quantities of commercially pure aluminium were used. Simple alloys of aluminium-zinc, aluminium-copper or of aluminium-zinc-copper were used in the electrical and in the early radio industry.

Then came the war, and with it a tremendous impetus to the development of light aluminium alloys for aeroplane and internal-combustion-engine work. An enormous amount of research work was done at this time on the subject of aluminium alloys. Radio design, so far as its constructional materials side is concerned, is now reaping the benefit of all this investigation.

### A Fascinating History.

Aluminium has a rather fascinating history. The metal was first produced in 1845, although it had been known to exist a long time before that. Between 1850 and 1855—that is to say, something like eighty years

## USED IN COMMERCIAL ALLOYS

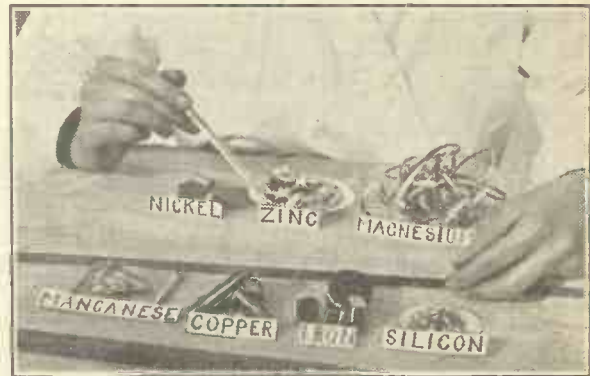

Here are the seven chief metallic elements that are alloyed with pure aluminium to form the commercial product so widely used in our radio sets.

ago—aluminium cost approximately £3 17s. 6d. per ounce. It was a chemical curiosity pure and simple, and it always excited a good deal of comment when it was exhibited at scientific lectures.

Towards the end of the nineteenth century, however, the introduction of electrolytic methods of manufacture brought down the price of this new metal by leaps and bounds. Before the twentieth century was ten years old, good-quality commercial aluminium cost £80 per ton.

### Found in Great Abundance.

An interesting fact concerning aluminium is that it is the third most abundant element in the earth—oxygen and silicon coming before it. Clays and rocks the world over contain aluminium in millions of tons. Wherever there is cheap electrical power

(Continued on next page.)

## ALUMINIUM'S ARTFUL AID

(Continued from previous page.)

and good facilities for the transport of suitable ore, aluminium can be produced nowadays with very little trouble.

You will have heard of "duralumin." It is the name given to a type of aluminium alloy of which there are quite a number of varieties. An average sample of duralumin gives the following analysis.

	Per cent.
Aluminium	94.5
Copper	4.0
Magnesium	.4
Manganese	1.1

I believe that alloys of the duralumin type (which, incidentally, were first worked out during the war for the construction of airship frames) have been used for the making of some radio components such as condenser end-plates, although, personally, I have never had the handling of them.

### "Y" Alloy.

Then there is the famous "Y" alloy, first produced at our own National Physical Laboratory at Teddington, Middlesex, but now more used for electrical-component construction in America.

A typical "Y" alloy contains the following ingredients:

	Per cent.
Aluminium	93.0
Copper	4.5
Nickel	1.5
Magnesium	1.0

"Y" alloy aluminium has a high electrical and heat conductivity. It is not brittle. It can be worked readily, and it possesses the tensile strength of something like 13 tons per square inch at ordinary temperatures, as against 5 tons per square inch tensile strength for commercially pure and unalloyed aluminium.

A good deal of this stuff, I am told, has found its way into receiver components on the other side of the Atlantic, although it has not made its appearance over here.

### Research Still Going On.

You will see, therefore, from these jottings that there is very little pure aluminium used nowadays. It is either hardened by alloying with zinc, silicon, manganese and sometimes nickel, or made rather less brittle by the incorporation of copper with it.

Research is still going on in the matter of aluminium alloys in the big metallurgical corporations. The modern tendency points in the direction of the production of extremely light aluminium alloys—alloys of aluminium and magnesium, and of the no-longer-rare-but-still-difficult-to-produce metal, beryllium.

I expect we shall hear a good deal of these very light aluminium alloys in radio-component design and construction during the next few years, though at the present juncture they are rather too expensive for the needs of mass production.

## The Volume Control that does a perfect job!

It does a perfect job because it is a perfect job. Erie knowledge—Erie precision—have produced the volume control that does not develop faults. Its bone-hard Erie element and nickel-silver contact give noiseless efficiency for a lifetime's use. All the leading designers are regularly specifying this unequalled Erie product. Ask for the ERIE Volume Control at all dealers.

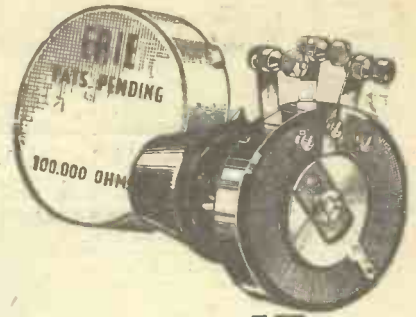

# ERIE VOLUME CONTROL

3/6 Or with built-in Mains-switch 5/-

When you buy Resistors—make sure you get ERIES

1/-

Per Watt in all values

Genuine Erie Resistors are hall-marked with the Erie label. Make sure you see it. Cheap resistances are definitely not the same thing; they are not an economy. Ask for Eries and make sure of satisfaction.

Erie Resistors are specified for the 1935 Kelsey Short-Wave Adaptor.

Write for the Free Erie Service Instruction Booklet.

THE RADIO RESISTOR CO., LTD.,

1 Golden Square, Piccadilly Circus, London, W.1.



## EASY PAYMENTS

"There's no place like HOLMES"

### W.B. SPEAKERS

This year's finest value	Deposit	Monthly Payment
STENTORIAN SENIOR	42/-	5/7 9 of 4/7
STENTORIAN STANDARD	32/6	4/5 7 of 4/5
STENTORIAN BABY	22/6	4/- 8 of 4/1

### KIT SETS

We strongly recommend	Deposit	Monthly Payment
LISSEN SKYSCRAPER 3	60/-	5/6 11 of 5/6
LISSEN SKYSCRAPER 4	112/6	10/- 11 of 10/3
COSSOR MELODY MAKER 352	118/-	10/10 11 of 10/10
COSSOR ALL ELECTRIC 357	159/-	14/7 11 of 14/7

### COMPLETE SETS

Unbeatable Value.	Deposit	Monthly Payment
COSSOR 3-VALVE 350	112/6	10/- 11 of 10/3
MARCONI 3-VALVE 234	£7.19.6	14/7 11 of 14/7
G.E.C. BATTERY COMPACT 3	117/6	10/9 11 of 10/9
FERRANT LANGASTRIA	£12.12	23/- 11 of 23/-

### ACCESSORIES

of merit and fine value.	Price	Monthly Payment
EXIDE H.T. ACC. 120v.	60/-	6/- 9 of 6/8
ATLAS ELIMINATOR T 10/30	£9.6	6/- 11 of 6/8
AVOMETER METER	40/-	5/3 7 of 5/6
B.T.H. LATEST PICK-UP	40/-	4/5 9 of 4/5

Parts for any set. Any make of speaker.

New goods obtained for every order. Send us a list of parts or valves you require or any speaker or set you may select and we will forward you a definite quotation. Ten years advertiser in the Wireless Press. Thousands of satisfied customers.

### H. W. HOLMES,

NEW ADDRESS:  
333, EUSTON ROAD, LONDON, N.W.1.  
Phone: Museum 1414.

### LOUD SPEAKERS REPAIRED 4/-

(Blue Spot a Speciality, 5/-)  
Transformers and Headphones, 4/-. Eliminators, Mains Transformers and Moving Coils quoted for. 24-Hour Service. Trade Discount, Clerkenwell 9069.  
E. MASON, 44, EAST ROAD (nr. Old Street Tube Station), LONDON, N.1.

## 1935 EDITION... FREE!

A New and greatly enlarged edition of "ENGINEERING OPPORTUNITIES" is just off the Press. It describes the easy way in which you may become an A.M.I.C.E., A.M.I.Mech.E., A.M.I.E.E., A.M.I.A.E., A.M.I.W.T., etc., and contains the world's widest selection of courses in all branches of Civil, Mech., Elec., Motor, Aero. and Radio Engineering, Building, etc.

If you are earning less than £10 per week, you cannot afford to miss this unique guide to a first-class job.



DON'T DELAY—send for your FREE copy of the Handbook to-day. No cost or obligation of any kind.

THE BRITISH INSTITUTE OF ENGINEERING TECHNOLOGY,  
101, SHAPTESBURY HOUSE,  
29/31, OXFORD ST. LONDON.

10,000 MOTORS, spring and electric, for Radiograms or Gramophones, in stock. Thousands of components—Tonearms, Soundboxes, Pick-ups, all types Horns, pedestal, portable Cabinets, Hinges, Lid-stays, Springs, Gears, Repairs. Portable Gramos, from 18/- Violins, Strings, Accordions, etc. 64-page cat. How to Make Them. 2d. 1935 70-page all brands Radio catal. 4d. Est. 30 years. The Regent Fittings Co. (P.W.), 120, Old Street, London, E.C.1.



PLEASE be sure to mention "POPULAR WIRELESS" when communicating with Advertisers. THANKS!

## THE ONE AERIAL FOR THE MODERN SET

# PIX INVISIBLE AERIAL

Neat  
Efficient  
Blends with furnishings  
Self-Adhesive

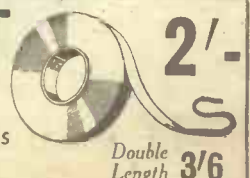

**W B'S** Latest and Greatest Achievement

**THE MARVELLOUS NEW "STENTORIAN" SPEAKER**

Will bring an unbelievable improvement to your set, because the exclusive new magnet gives nearly twice the volume of any previous commercial speaker, and a new method of speech coil assembly obtains astoundingly clear and faithful tone.



Also, an improved "Microcode" device provides accurate matching with any set, or when used as an extra speaker.

**SEND ONLY 2/6 AND TRY IT FOR 7 DAYS**

W.B. "STENTORIAN" SENIOR model PMS 1 sent to approved customers for 7 days' trial for only 2/6 deposit. If satisfied, pay further 2/6 at once; then 8 monthly payments of 5/- (Cash, in 7 days, 42/-).

W.B. "STENTORIAN" BABY model (as specified for the "B.C.L." Two Short Wave Set) sent to approved customers for 7 days' trial for only 2/6 deposit. If satisfied, pay further 2/6 at once; then 4 monthly payments of 5/- (Cash, in 7 days, 22/6.)

Full Postal Address:

**E. J. HERAUD LTD**

(Dept. P.W.36) EDMONTON, LONDON, N.18.  
Phone: Tottenham 2256. Established 35 Years.

**50 ohms to 100,000**

**WIRE-WOUND RESISTORS**



A DEFECTIVE Resistance can completely ruin the enjoyment of radio — and frequently does. Moreover, it is often difficult to trace the fault, as none but the most expensive testing equipment can definitely locate it.

When building your next set, or overhauling your present equipment, change over to Amplion resistors. They are colour coded, compact and sturdy, and all values are wire-wound, this method of construction giving the most reliable and constant form of resistance.

Price 1/- each; all values.

Specified for the 2-Valve S/W Set and S/W Adaptors.

**AMPLION**

**AMPLION (1932) LTD.**

87-84 Rosoman Street, Rosebery Avenue, London, E.C.1

**DO YOU KNOW?**

Some First-hand Information about a Technical and Commercial Radio College.

Do you know how to design any set, from a straight circuit to a superhet, including A.V.C. ? Do you know that there is an inexpensive correspondence course that can teach you, in six to nine months, how to design such sets, even if you have practically no knowledge of radio at present ?

We have just returned from a visit to The Technical and Commercial Radio College, where we have been glancing through one or two letters picked at random from a packed file of students' appreciations. The designing of sets as mentioned above was what one student offered to come and do before any "doubting Thomas."

Other letters which we saw came from those who had been enabled to obtain good positions in radio by virtue of the training they had received. Incidentally, the College gives valuable assistance in the finding of jobs for those who take the courses.

The basis of all the courses is the comprehensive technical training which has been prepared by experts particularly well qualified for the job. Other courses include, in addition to the technical training, a service course and a service and commercial course.

Some readers will remember that we originally reviewed the work of this College in POPULAR WIRELESS, November 25th, 1933, and our recent visit was occasioned by a desire to see how their work had progressed.

**Complete and Up to Date.**

We examined the syllabus as well as specimen lessons, and were pleased to see that the modern superhet, using the latest types of multi-electrode valves, is described in great detail. The whole subject of technical and commercial radio is dealt with in a most complete, up-to-date and interesting manner.

Particular attention is given to modern servicing work, as there are so many opportunities for the trained man to undertake this type of work, either as a spare-time occupation or as a preliminary to a full-time job. The training, incidentally, is as valuable and fascinating to the man whose interest in radio ends with it as a hobby as to those who desire to enter the radio profession either with a full-time or part-time job.

A feature of the training is that every student is treated as an individual. For instance, the order in which the lessons are sent out may be altered if this proves desirable to suit the particular student.

Before we left we had a look at the Employment Register, which shows the names of students for whom employment has been found. It is definite proof of the valuable assistance given by the College in this connection.

Finally, we would add that we can confidently recommend The Technical and Commercial Radio College to any reader who desires to increase his knowledge of radio. The address is Cromwell House, High Holborn, London, W.C.1.

**YOUR BATTERIES**

Jottings of interest to every listener.

By Dr. J. H. T. ROBERTS, F.Inst.P.

HERE are a few hints with regard to the care and maintenance of your batteries: the "old hands" will not need them, but they may be useful to the newcomers.

If you have a new accumulator and you want to keep it for some time before using it (perhaps someone had given it to you at Christmas) it is better to keep it in the dry state. So long as it has not been filled up with acid it will keep indefinitely. Once it has been filled, however, it requires attention, even though it is not being used. It is better to give it a charge once every month or so, to keep it in order. Remember that a battery, when filled with electrolyte, will run down steadily, whether current is being drawn from it or not. Don't imagine, therefore, that because you are not actually using it, it can be left without attention indefinitely.

**Storing a Cell.**

If you have a cell which has been in use, and you want to store it away for any length of time, it is best to empty it out, wash it out thoroughly with water, and then finally rinse out with distilled water. Shake all the water out, and then you can store the cell away without fear of any serious deterioration.

The charging rate is another important matter. Most users are well aware that the battery should not be used to supply more than a certain specified rate of current; but people often think that the charging rate is not so important as the discharge rate, and that, in a hurry, the specified charging rate can be exceeded with impunity.

**Low-consumption Valves.**

This is bad practice, however, and will undoubtedly damage the cell quickly. Many types of cell now in use for the modern low-consumption valves are fitted with thick plates, and are adapted for slow charge and discharge rates. If you try to force too much current through them, you only damage the plates. So stick to the charging rate specified on the label.

Dust and dirt often accumulate thickly on the top of an accumulator. This should be removed, and the top kept clean, as everything of this kind assists the leakage current which is always going on, and which accounts for a good deal of the total discharge.

**A Convenient Aerial-Earth Combination.**

Those of you who may be overhauling your aerial or earth in the near future may be interested to know (if you do not already) of the Kniveton complete aerial-and-earth equipment. This includes 75 feet of all-copper 7-strand aerial wire, two porcelain insulators and anchor wires, lead-in wire and earth wire. The insulators are all attached and everything is connected up ready for immediate use. It is claimed to

(Continued on next page.)



# ELECTRADIX

Home Broadcasting by your Family and Friends.

**A NEW PRACTICAL HOME MICROPHONE** for broadcasting at home. It is a general-purpose, robust mike, with solid bakelite body, back terminals, front metal grille. **No. 11.** New design, finely finished. . . . . 5/6

**No. 11A.** Special in solid brass body, unequalled at the price on speech and music, 7/6.

**P.W. No. 11 TABLE MIKE.** This is a splendid Microphone for speech and music. The bakelite case, containing a 2-in. mike and transformer, is on a bronze pedestal. Switch and plug socket are fitted on the case. It stands unrivalled for quality and price . . . . . 15/-



No. 11, 5/6

### Fun on Your Radio

Lesdix Microphones reproduce your voice amplified from your radio set to loud speaker.

### 5/- MICROPHONE BUTTONS for all purposes.

Usually sold at 3/6. Our price has always been 1/- . We have supplied thousands to home users. **1/-**



### Pedestal Microphones

**Lesdix No. 10B Pedestal,** 10 in. high, 12/6.

**Lesdix Superior No. 12BB Ring,** 14 in. Pedestal, 18/6. **W.E. Type Table Model,** 5 in. dia., for lectures, 35/- . **Studio Recording Mikes.** **B.T.H. Moving Coil P.M.,** £5; **Amplicon,** £5; **Browns D.,** £8; **Igranite Transverse,** £8; **Western Electric P.A.,** £10; **Siemens H. Ribbon,** £50 **Moving Coil for £15;** famous **Marconi-Reisz B.B.C. Model,** £18.

**CROONERS Lapel Mikes for Dance Bands.** American type model . . . 12/6

**STEELCLAD CHARGERS.** We have 25 models of Standard and special types for Service Charging at prices from £3. Multiple Charging on 3 to 6 lines with meters, Indicating Switches and Regulators. Dimmers, Cut-outs and Switches, for all purposes.

Ask for Charger Leaflet "P."

**ELECTRADIX RADIOS,**  
218, UPPER THAMES STREET, LONDON, E.C.4.  
Telephone: Central 4611.

## IRISH FREE STATE

For prompt delivery of your requirements of components and accessories for sets described in this paper post your orders to us. First specified parts only stocked. We carry stocks of Eddystone S.W. components, W.B. Speakers, Hivac Valves, etc.

W. B. KAY, 21, South King Street, DUBLIN.  
Phone 51975.

## Your EXTENSION SPEAKER must be a ROLA

THERE'S A REASON!  
Write for Chart just published showing Correct Extension Speaker for all British Receivers

THE BRITISH ROLA CO., LTD.  
MINERVA RD., PARK ROYAL, N.W.10.  
Phone: Willesden 4322-3-4-5-6

WE invite readers to support our Advertisers—care being taken to accept only announcements of reputable firms!

## YOUR BATTERIES

(Continued from previous page.)

be proof against corrosion and easily fixed, whilst the factory-made joints ensure continuity—a very important feature in an aerial. As regards the easy fixing, I can testify to this and also to the claim that this equipment gives better reception. It sells at 4s. complete, and is a very convenient outfit. The idea of supplying the whole thing ready wired up is certainly a good one.

### Screened Slewing.

The same people, by the way, make an air-spaced screened slewing, for screening leads to switches and so on. This is useful for general purposes where screened leads are concerned, and particularly for short-wave receivers.

Finally, perhaps I should mention the special type of earth, which consists of a length of metal tube, of the more or less conventional style, with spiked end for driving into the ground, but the tube is wrapped round, along its entire length, with a spiral wrapping of bare stranded copper wire. You will see that this provides innumerable interstices for the earth and the moisture to get into intimate contact with the metal. The idea of these special coiled-copper earth conductors strikes me as good, though I have not yet had the opportunity of trying them.

### Relay Services.

It is surprising the progress that is being made with radio relay services. As most of you know, this is the relaying of radio broadcasting from central exchanges by means of wires to subscribers' houses, in place of the use of individual radio-receiving sets. It is estimated that there are now nearly 300 radio-relay exchanges in this country; these supply some 200,000 subscribers with radio programmes at a cost to the subscriber of 9d. to 1s. 6d. per week. Some of the leading units in this new industry are Standard Radio Relay Services, Ltd.; Broadcast Relay Services, Ltd.; these two operating in a large number of towns in the North of England; Radio Central Exchange, Ltd., which operates about ten services, four of them in South Wales; British Wireless Exchange, Ltd., with twelve exchanges in the Metropolitan area; and Christy Bros. (Wireless Relays), Ltd., operating in the Essex district.

### Why Not a Radio Set?

You would think that radio-receiving sets are now so inexpensive and so reliable that they would meet all requirements. But evidently there is a considerable section of the listening public who are willing to pay 1s. or more per week to have their programmes just "laid on," like the gas, water and electric-light services, and without any trouble whatever. There is, of course, a good deal to be said for this, and I know, amongst my own circle of friends and acquaintances, several who make use of this service and who are very satisfied with it.

### How it Affects Trade.

You might also think that all this would react adversely on the sales of radio-receiving sets, but apparently this is not so. About half the subscribers would only have  
(Continued on next page.)

## Baby Ternus

ALL MANUFACTURERS' COMPONENTS and ACCESSORIES IN STOCK. SEND US YOUR ENQUIRIES.

## W.B. STENTORIAN SENIOR

TYPE PMS1.

**2/6 DOWN**

For Power, Pendulo and Class B. Send only 2/6, balance in 11 monthly payments of 4/-, Cash or C.O.D. Carriage Paid, £2/2/6.



W.B. Stentorian Standard Model. Cash or C.O.D. Carriage Paid, £1/12/6, or 2/6 deposit and 11 monthly payments of 3/- . W.B. Stentorian Baby Model. Cash or C.O.D. Carriage Paid, £1/2/6, or 2/6 deposit and 9 monthly payments of 2/6.

## SIMPSON'S 1935 ELECTRIC TURNTABLE

THE PERFECT GRAMOPHONE MOTOR AT LAST! Low consumption, constant speed, 1-HOLE FIXING, D. W. M. Magnet, A.C. Mains only, 100/150 or 200/250 volts, 50 cycles, 12-in. turntable. Send only 5/- for 7 days' trial; if approved, balance in 9 monthly payments of 4/6. Cash or C.O.D. Carriage Paid, £2/2/6.

**5/- DOWN**



## B.R.G. S.T. 600 KIT

EVERY PART GUARANTEED—MATCHED—PROVED—TESTED. Complete with FIRST Specified FORMO 2-GANG CONDENSER, COLVERN S.T. 600 MAIN COIL ASSEMBLY and COLVERN S.T. 600 EXTRACTOR COIL, and with FREE FULL-SIZE BLUE PRINT and copy S.T. 600 issue of "Popular Wireless," including S.T.'s 100 STATION SPOT-ON DIAL and other P.W. Gift.

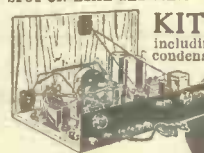

**KIT "1"** Comprising B.R.G. Kit of matched components, including specified Formo 2-gang condenser, with Colvern coils, Peto-Scott ready-faced panel and terminal strip, with Metaplex baseboard, lens valves, cabinet & speaker. Cash or C.O.D. Carriage Paid, £3/13/6, or deposit 5/- and 12 monthly payments of 7/- .

**5/- DOWN**

**KIT "2"** As Kit "1" but including B.V.A. valves and Peto-Scott cabinet and speaker. Cash or C.O.D. Carriage Paid, £2/11/6, or deposit 10/- and 12 monthly payments of 10/9 .

**KIT "4"** As Kit "1" but including B.V.A. valves and Peto-Scott console cabinet, less speaker. Cash or C.O.D. Carriage Paid, £7/19/0, or deposit 10/- and 12 monthly payments of 13/9 .

## GRAHAM FARISH RAIDER 3 KIT

Complete Kit of parts for building, less valves and cabinet. Send only 5/-, balance in 11 monthly payments of 6/3. Cash or C.O.D. Carriage Paid, £3/7/6. If valves and cabinet required, add £2/16/6 to Cash Price, or complete for 11/3 deposit and 11 monthly payments of 11/3.

## N.T.S. GUARANTEED H.T. ELIMINATORS

For A.C. Mains, 200/250 volts, 3 Tappings: S.G. 60-v. Detector 80-v. Power 120/150-v. Output 25 m.a. Incorporates Westinghouse rectifier. Send only 2/6. Balance in 9 monthly payments of 4/-, Cash or C.O.D. Carriage Paid, £1/15/0.

D.C. Model for D.C. Mains only. Similar specification, but without rectifier. Cash or C.O.D. Carriage Paid, 17/6, or 2/6 deposit and 7 monthly payments of 2/6.

SEND FOR LATEST LISTS

**New Times Sales Co.**  
56, P.W.1, LUDGATE HILL, LONDON, E.C.4.

# MAINS TRANSFORMER DESIGNED AND SPECIFIED FOR THE KELSEY "1935 S/W ADAPTOR"



MODEL K.1.  
PRICE 15/-

Send for FREE illustrated leaflets of NEW Heayberd Mains Apparatus.

Mr. ....

Address.....

P. W.

**F. C. HEYBERD & Co.,**  
**10, Finsbury St., London, E.C.2.**

## INDEX TO ADVERTISERS

Amplion (1932) Ltd. . . . .	PAGE
Argosy Magazine . . . . .	672
Automatic Coil Winder Co., Ltd. . . . .	646
Belling & Lee, Ltd. . . . .	651
Benjamin Electric Ltd. . . . .	646
Book of Practical Radio . . . . .	629-632
British Institute of Engineering Technology . . . . .	671
British Radio Gramophone Co., Ltd. . . . .	669
British Rola Co., Ltd. . . . .	673
British Television Supplies, Ltd. . . . .	665
Bulgin, A. F. & Co., Ltd. . . . .	667
Cossor, A. C., Ltd. . . . .	634
Dubilier Condenser Co. (1925), Ltd. . . . .	Cover ii
Electradix Radios . . . . .	673
Ferranti, Ltd. . . . .	664
Fuller Accumulator Co. (1926), Ltd . . . . .	659
General Electric Co., Ltd. . . . .	Cover iv
Heyberd, F. C. & Co. . . . .	674
Heraud, E. J. . . . .	672
High Vacuum Valve Co., Ltd. . . . .	663
Holmes, H. W. . . . .	671
International Correspondence Schools, Ltd. . . . .	666
Jackson Bros. (London), Ltd. . . . .	667
Kay, W. B. . . . .	673
Lectro Linx, Ltd. . . . .	668
London Radio Supply Co. . . . .	670
Mason, E. . . . .	671
Modern Boy . . . . .	663
M. R. Supplies . . . . .	669
New Times Sales Co. . . . .	673
Peto-Scott Co., Ltd. . . . .	655
Pickett Bros. (Cabinets) . . . . .	669
Pix . . . . .	671
Radio Development Co. . . . .	668
Radio Resistor Co., Ltd. . . . .	671
Record Radio, Ltd. . . . .	657
Regent Fittings Co. . . . .	671
Stratton & Co., Ltd. . . . .	659 & 667
Telephone Manfg. Co., Ltd. . . . .	657
The 362 Radio Valve Co., Ltd. . . . .	665
Unit Radio . . . . .	670
Varley Products . . . . .	651
Westinghouse Brake & Saxby Signal Co., Ltd. . . . .	633
Whiteley Electrical Radio Co., Ltd. . . . .	645
Wingrove & Rogers, Ltd. . . . .	659
Wireless and Television Review . . . . .	660
Wright & Weaire, Ltd. . . . .	649

## YOUR BATTERIES

(Continued from previous page.)

the relay service, and would not have the responsibility of an ordinary receiver, anyway, whilst the other half have an ordinary radio as well as the relay.

In fact, it is contended, and evidently with a good deal of reason, that the relay system helps to popularise radio, and so assists the industry generally.

### The Droitwich Station.

Many listeners living in the West Country have found that the new Droitwich station is not an unmixed blessing; in fact, some of them apply quite a different description. Some say that it prevents them from receiving the West Regional—or interferes with it—whilst others do not mind that so much, but find that Droitwich is not reliable, in that it fades badly.

This trouble, which is being investigated actively by B.B.C. engineers, is apparently due to the transmissions from the two stations, Droitwich and Washford Cross, reacting on one another.

### Long and Medium Waves.

The long waves seem to have the effect of upsetting the reflecting layer upon which the other transmission to a large extent works, whilst at the same time the long waves, either from the same cause or from

use automatic volume control by the aid of this short-base variable-mu valve.

### "Fancy" Aerials.

A reader asks me whether it is any advantage to attach radial wires to his aerial, and whether the various types of "fancy" aerial (as he calls them) are really any better than an ordinary single wire.

It is very difficult to answer this. There are, or have been, various "unconventional" aerials, in the form of a cage, spider and so on, and advantages have been claimed for each of them. I have no doubt that in some conditions these claims have been found to be justified. But the fact is that we know so little of the actual means by which the aerial picks up the signal—or absorbs the H.F. energy from the surrounding ether, if you like—that we cannot lay down any hard-and-fast rule. He would be a bold man who would predict the behaviour of any new-fashioned aerial without a chance of trying it! Aerials behave in strange ways and the only rule with a new idea is "Try it." Remembering always, of course, that the same aerial will act quite differently in different conditions!

### Interacting Components.

In these days, when sets have to be so compact and the components consequently all in very close proximity, there is the danger of microphonic and interference effects being set up. In the old days valves

## NEXT WEEK

### A TRIPLE FEATURE NUMBER

Details of an All-Wave Four-Valve Superhet

How to Build the 1935 All-Electric Kelsey Adaptor

Operating the "B.C.L." Two

ORDER YOUR COPY NOW

## POPULAR WIRELESS

THE LEADING JOURNAL WHEREVER ENGLISH IS SPOKEN

some interaction with the medium waves, are made to fade. The effect is apparently worse for those districts that are in a straight line with the two stations, and this is why Devonshire and Cornwall suffer most.

The whole thing is rather mysterious at present, but, as I say, it is being actively investigated and a remedy will no doubt be found in due course. It is no easy matter putting new stations into operation these days, especially of the power and wavelength of Droitwich, and repercussions must be expected at first.

### Short-Base Valves.

I have more than once been asked what is meant by a short-base variable-mu valve. This valve was developed principally for automatic volume control, and, as the name suggests, it has a short grid-voltage base in its characteristic. The effect of this is that only a relatively small variation in grid-bias voltage is necessary to produce a variation in its amplifying properties from maximum to minimum. In simple sets, which give only a small amount of high-frequency amplification, it is possible to

were normally microphonic, that is, set up a ringing sound if tapped or jarred in any way, and we had to take all sorts of special precautions to avoid the trouble, such as using resilient valve holders and so on. Nowadays valves are inherently anti-microphonic, but occasionally you will come across a bad one. Probably you will be troubled with a kind of low-frequency feedback, the vibrations from the loudspeaker reacting upon the faulty valve and causing the trouble. You can easily find out which valve is the culprit by giving each valve in turn a short but gentle flick with the finger and listening for the effect.

### Defective Valves.

Another trouble, which is very bad when it occurs, but which fortunately does not happen very often, is contacting between adjacent electrodes. When this happens it causes the most fearful noises in the set, so you could hardly mistake it. Associated with this trouble, you will occasionally come across a valve in which the vacuum is defective. This will show itself by excessive anode current and bad distortion.

(Continued on next page.)

## YOUR BATTERIES

(Continued from previous page.)

### New Pentode Types.

During the past year or so great steps have been made in the direction of large loudspeaker output with the minimum of H.T. consumption. Two well-known ways are Class B amplification and quiescent push-pull.

But more recently a type of pentode output valve has been developed which, whilst more or less conventional in design, can give large outputs and handle large input grid voltages. An example of this type of valve is the Mullard P.M. 22.c. With 150-volts H.T. this valve will give an A.C. output up to 1½ watts, the output being roughly proportional to the H.T. voltage applied, between about 100 and 150 volts.

### A Question of Grid Bias.

The way in which the valve is operated so as to economise H.T. current is as follows: In the first place a large grid bias is applied which, of course, has the effect of keeping the "steady" current to a low value; at the same time, however, the valve cannot, in these conditions, handle heavily modulated signals. This state of affairs is overcome by means of a Westector metal rectifier. The latter is incorporated in the well-known and popular battery economiser circuit which, as readers know, is so arranged that the grid bias is automatically reduced when a strongly modulated signal comes along. In this way the valve changes its characteristics, as it were, according to requirements, and the need for "standing by" (with heavy H.T. current) for deeply modulated passages is avoided.

### Using a Frame Aerial.

If you are using a set with a frame aerial included in the cabinet, remember that, as a rule, the designer has relied a good deal upon the frame for selectivity—and for sensitivity, too, for that matter. To get the strongest signals on the station you want to receive, and also to cut out adjacent unwanted stations, your frame aerial should be pointing towards the wanted station. If it is not, then you may go searching about with the tuner and fail entirely to pick up the station you are looking for. It is important, therefore, to try the frame turned in different directions, just as much as it is to turn the tuning knob.

### Tuning Not Sufficient.

Once you have got your frame pointing in the direction of the incoming waves and the set properly tuned you will get maximum volume of reception and also minimum interference or overlap from other stations. As a matter of fact, the frame is a remarkably good way of achieving selectivity, and when it is used with a superhet, as it generally is, the combination has extraordinarily fine selective powers.

I should, perhaps, mention that the direction of arrival of the waves at the set is not necessarily the same as the "bearing" of the transmitting station (owing to deflection of the waves by steel buildings and so on), so you cannot rely upon knowing the direction of the station and must get the best setting of the frame by trial.

## PREPAID MISCELLANEOUS ADVERTISEMENTS

3d. per Word

6d. per word for first words in heavy type

Minimum Charge 3/-

Remittance must accompany order.

Advertisements for these columns are accepted up to first post WEDNESDAY MORNING for following week's issue.

Radio components and accessories advertised in these columns at below list price do not carry manufacturers' guarantee.

The Proprietors have the right to refuse or withdraw advertisements at their discretion.

Postal orders, in payment for advertisements, should be made payable to the Amalgamated Press, Ltd., and crossed.

All communications should be addressed to:—Advertisement Department, "Popular Wireless," John Carpenter House, John Carpenter Street, London, E.C.4.

**PEARL & PEARL**, 190, Bishopsgate, London, E.C.2. All the following bargains guaranteed new goods. Cash or C.O.D. Carriage paid.

**TONASTAT** selectivity unit gives additional selectivity to any set. Can be used with or without aerial. 6 different circuit wiring diagrams supplied. List 3/6, our price 1/10.

**LINCOLN-STEWART**. Screened dual-range iron-cored coils; complete with circuits and wiring diagrams. List price 6/6; our price 2/6.

**LOTUS COILS**. Lotus triple-ganged band-pass coil unit, complete. Suitable for mains or battery sets. Comprises 3 screened coils on metal base, wavechange and radiogram switch; all terminal connections shown engraved. Full instructions with every unit. List 27/6. An outstanding bargain at 12/11 each.

**CONDENSERS**. Lotus variable (2-gang .0005) condensers, screened; complete with illuminated friction drive dial, knob and trimmers. Our prices: 2-gang 8/6, 3-gang 11/6.

**TRANSFORMERS**. Igranic Class B Transformers, tapped 1-1 and 1½-1. List price 11/6. Our price 4/11. Amplion Class B Output Chokes, tapped 1-1, 1½-1 and 3-1. Ideal for matching m/c speakers. List 9/6; our price 4/11.

**ELIMINATORS**. Special purchase of large quantity of Lincoln-Stewart Eliminators enables us to offer them at sacrifice prices. All models O.K. for 200-250 v. D.C. 25 milliamp output, 9/11; A.C. 30 milliamp output with Westinghouse Rectifier, etc., 24/11, or with half amp. Trickle Charger incorporated, price only 37/6. All fully guaranteed.

**BIFLO** static cut-outs definitely clear interference and all those unwanted background noises, without affecting volume. Complete with fixing instructions. List 12/6; our price 2/3.

**LISSEN L.N.5181** 3-ganged superhet coil units for A.C. or battery sets; with circuits and diagrams. Over 1,250 already sold to "P.W." readers. List price 30/-; now offered at special price, 6/6 only.

**ALL ABOVE POST PAID AND GUARANTEED NEW IN MAKERS' ORIGINAL CARTONS.**

**CABINETS**. Cash with order. Carriage forward.

**CROMWELL** Cabinets (for set and speaker combined). Horizontal type, 23 in. wide, 8 in. deep, 11½ in. high. Polished Walnut veneer, additional baffle behind speaker grille. Just secured on terms which enable us to offer them at the astoundingly low price of only 4/11 each.

**LARGE** Receiver Cabinets, highly polished, as used for "Cromwell" 8-valve Superhet. Measurements; 22 in. high, 17 in. wide.

(Continued at top of next column.)

(Continued from foot of previous column.)

11½ in. deep. Finished in contrasting rose-wood and walnut veneers. Special additional baffle on speaker fret. Cost over £2 to make. Last few at 15/- each.

**FREE**. Our latest, fully revised Bargain List P now ready. Send P.C. for your copy. All Mail Orders Direct to

**PEARL & PEARL**,  
190, Bishopsgate, London, E.C.2.  
Telephone: Bishopsgate, 1212.

**DEGALLIER'S** Offer Brand New 1935 Receivers, Midgets and otherwise; every set guaranteed in this country against faulty workmanship for 12 months; each in handsome walnut cabinet, complete in every detail, ready to plug in; receivers covering ultra short-wave bands; guaranteed to get stations on those bands, including America; illustrated lists available of sets advertised over £6/5; S.A.E. with all inquiries.

£4/5.—Emerson "Midget" T.R.F., 5-valve, A.C./D.C. 100-240 volts, M.C. speaker, M. and L. wave, illuminated dial, M.C. speaker tone control, P.U. terminals, cabinet 11¼ × 5½ × 7; carriage 1/6.

£3/12.—Limited number 4-valve T.R.F., very selective, medium wave only, complete; carriage 1/6.

£6/5.—R.C.A. "Midget" 5-valve superhet, A.C./D.C. 100-250 volts, M. and L. wave, A.V.C. tone control, illuminated dial, M.C. speaker, approx. 50 stations; carriage 2/6.

£7/10.—R.C.A. "Midget," operates on A.C./D.C. 200-250 volts, approx. 80 stations, 6-valve superhet, 18-50, 190-550, and 1,000-2,000 metres, illuminated dial, A.V.C. tone control, pick-up terminals, M.C. speaker, cabinet 12 × 8½ × 6. 2 watts undistorted, supplied less cabinet at £7/5; carriage 2/6.

£7/5.—R.C.A. "Table Model" 14 × 16 × 10½, A.C., 200-250 volts, 190-550 and 1,000-2,000 metres, approx. 90 stations, 3½ watts undistorted, 5-valve, 7-stage superhet A.V.C.; illuminated airplane dial, P.U. terminals, 8-in. M.C. speaker, carriage 4/9; universal model, available A.C./D.C., 200-250 volts, at £7/10; without cabinet deduct 12/- each model.

£9/5.—R.C.A. "Table Model," 19 × 16 × 10½, A.C. 200-250 volts, 6-valve, 8-stage superhet, 15-50, 190-550, and 1,000-2,000 metres, illuminated airplane dial, delayed A.V.C. tone control, 8-in. M.C. speaker, uses 2 H.F. pentodes, heptode frequency changer, double diode triode, 3 watts undistorted, sensitivity 1 microvolt absolute; carriage 5/9; also supplied in A.C./D.C. 200-250 volts universal at £9/10; approx. 100 stations; without cabinet deduct 15/-.

£15.—R.C.A. "Table Model" De Luxe, 21 × 11½ × 17, in A.C. only, 200-250 volts, specification as above but covering 4 wave bands instead of 3, world's first double intermediate superhet; by means of this revolutionary system of switching (from 125 to 456), it is possible to obtain maximum efficiency on all 4 bands; sensitivity better than ¼ microvolt absolute, 4 watts undistorted; over 120 stations; without cabinet deduct 25/-; carriage 6/-.

**DEGALLIER'S**, 6, Coryton House, 21, Upper Marylebone St., London, W.1. Museum 7795. Nearest stations, Oxford Circus, Great Portland St.; also omnibuses 3, 59, 58 and 137 pass street.

**BANKRUPT BARGAINS**. List free. S.T.600 kit with specified coils and 2-gang, all quality goods, £3. There is nothing as good at the price. Regentone 30 m.a. A.C. eliminators, 32/6. Mains sets from £4. Amplion stockist. Best part exchange allowances. Triotron valves from 2/9. P.M. speakers from 8/6. Large stock at the right prices. Part exchange. **BUTLIN**, 143B, Preston Road, Brighton.

Miscellaneous Advertisements continued on next page.





# Give Your Set a Tonic!

## Get improved long range reception

A falling off in the sensitivity of a Set which makes reception of distant stations increasingly difficult probably indicates that the mutual conductance of the screen-grid valve has fallen below standard. In an H.F. Amplifier the overall magnification per stage is a function of the mutual conductance of the valve coupled with its interelectrode capacity.

The design of modern OSRAM Screen-Grid Valves maintains an exact balance between these characteristics and a type is available for every class of Receiver. You would not run your car with the brakes on—make sure that you are not operating your Set with a worn-out screen-grid valve, thus limiting its full capabilities with the risk of losing a foreign programme of particular interest.

Fit a new OSRAM Screen-Grid Valve for long range reception.



**Osram  
Valves**

MADE IN  
ENGLAND

Sold By All Radio Dealers.

**A TONIC TO ANY SET**

### OSRAM SCREEN-GRID VALVES

<b>S 23</b>	For 2-volt Battery Kit Sets and Portables	12/6
<b>V S 24</b>	For 2-volt Battery Sets with variable mu grid control	12/6
<b>M S 4 B</b>	For all A.C. Mains Sets with single stage H.F.	17/6
	OR <b>M S 4 B</b> CATKIN	
<b>M S 4</b>	For A.C. Mains Sets with two stages H.F.	17/6
<b>V M S 4</b>	For A.C. Mains Sets with variable mu grid control	17/6
	OR <b>V M S 4</b> CATKIN	
<b>D S B</b>	For 0.25 amp. D.C. Sets	17/6
<b>V D S</b>	For 0.25 amp. D.C. Sets (variable mu)	17/6

WRITE for the OSRAM VALVE GUIDE (1934 Edition). Sent post free.

ALAN HUNTER TO WRITE FOR "P.W." (SEE PAGE 679)

# Popular Wireless

AND TELEVISION TIMES

FIRST ARTICLE By  
THE  
EXPERIMENTER  
★ ★  
MY THIRD  
S.T.600 TOUR  
By  
JOHN  
SCOTT-TAGGART

No. 660.  
Vol. XXVI.  
January 26th,  
1935.

EVERY  
WEDNESDAY  
PRICE 3<sup>d</sup>.

*The*  
*All-Electric*  
**1935**  
**KELSEY**  
**ADAPTOR**



*and*



*Our Special*  
**Four-Valve**  
**Superhet**  
*for*  
*All-Wave*  
*Reception*



“When was Aunt Martha  
here?”



“Wasn't it the day you got that Drydex?”

“So it was—that's a long time ago.”

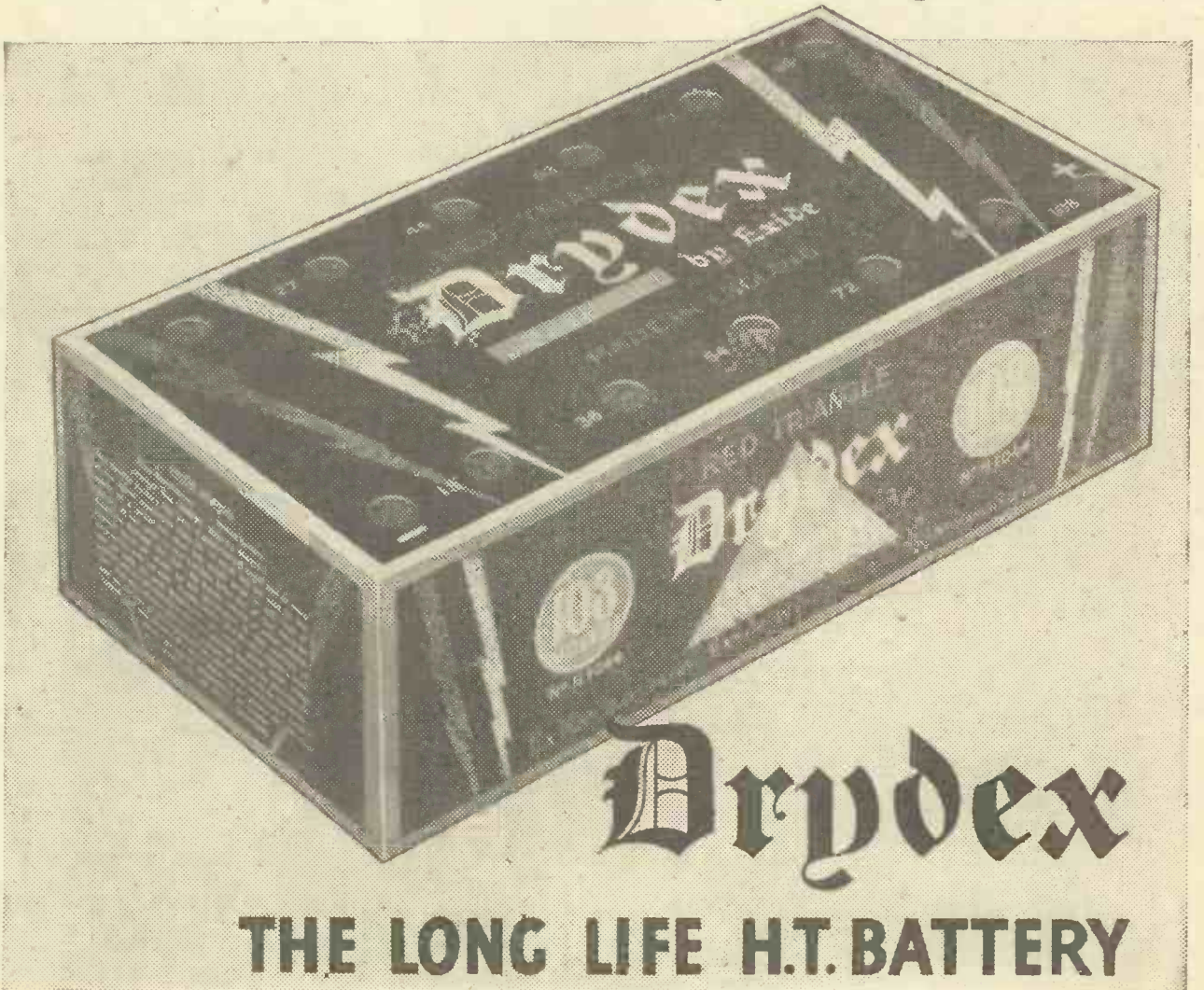

“Still keeps going when the rest have stopped”

From Exide Service Stations and all good dealers. EXIDE BATTERIES, Exide Works, Clifton Junction, near Manchester.  
Branches: London, Manchester, Birmingham, Bristol, Glasgow, Dublin and Belfast

DX126





MANAGING EDITOR: N.F. EDWARDS.

TECHNICAL EDITOR: G.V. DOWDING ASSOC. I.E.E.

**THE BARD CENSORED  
RADIO CITY  
BEHIND THE B.B.C.  
FULL VALUE**

# RADIO NOTES & NEWS

**ARIEL'S HALO  
SINGLE SIDEBANDS  
WHY NOT WALES?  
A "FINE" SCHEME**

### Droitwich Results.

**T**HE testing of the new Midland Regional transmitter at Droitwich has not yet lured me from underneath the old crazy-work quilt and blankets in the small hours. Has anybody any interesting news of transmission?

I am told tests will take place on 296.2 metres, the wavelength now used by North National. But so far nobody has written to affirm that the newcomer has fluttered down his aerial during a maiden flight.

### Adapting Shakespeare.

**H**OW things do work round, to be sure! Here's an American radio official looking for good plays to adapt for the microphone and finding the work of one William Shakespeare.

He likes it. Sob stuff, sword clashing, strong love interest, psychological angles, supernatural situations—all there in good measure.

But just one little grumble, he confesses. Those comedies—swell radio material, admittedly, but *many of the gags have to be blue-pencilled!*

And—would you believe it?—no sooner was this pronouncement known to the public than they began to ask booksellers for Shakespeare's comedies!

### Radio Promotion.

**I**F you ever tune to the medley of Morse on the shipping wavelengths, do you wonder what all the messages are about? Occasionally SOS's,

of course—as when the Norwegian steamer Sisto was in distress. A few days after that wireless drama was played out an ordinary wireless message went through to the liner New York to say that Second Officer Weisen, hero of the Sisto rescue, had been promoted to Chief Officer.

A nice touch to send the news by radio like that.

### Up the Garden.

**S**ENDING me some very interesting particulars of the arrangements and adornments of Radio City, New York, a correspondent adds that it is proposed to maintain beautiful gardens, in mid-air, on the skyscraper roof, rather on the lines of the hanging gardens of

Babylon. He says that for the old-English garden hundreds of tons of rock from the Lake District have now been hoisted.

### "Deplorable Broadcasting House."

**R**EADING a paper on "London from the Pavement," the well-known artist, Mr. Hanslip Fletcher, referred to the "unsightly backs" given to some modern buildings in London.

"There may be differences of opinion in regard to their fronts," he said, "but

### ON OTHER PAGES

An All-Wave Four-Valve Superhet - - - - -	Page 681
My Third S.T.600 Tour - - - - -	683
The All-Electric 1935 Kelsey Adaptor - - - - -	693

no one can deny that the appearance of Broadcasting House from Langham Place is deplorable."

It is not too pretty, admittedly, but when all is said and done who is going to stand gazing at the B.B.C. from Langham Place—itsself no great advertisement for beauty?

### An Aerial on Fire!

**S**URELY one of the queerest wireless happenings was that related recently by a B.B.C. official of early days at Daventry.

### S.T.600 KITS FOR IRELAND



The huge success of the S.T.600 has created an unprecedented demand for kits of parts. Here is a consignment of Pilot Author Kits for Irish constructors being taken aboard at Heston Aerodrome. Mr. W. Scott-Worthington, the Managing Director of Peto-Scott, Ltd. (right), is seen personally supervising the loading operations.

He tells of an occasion when the night watchman burst into the transmitting house shouting that the aerial was on fire! There was a dash for the door, and the astonished engineers beheld the best part of a hundred yards of "thin red line" leading up into the night.

It was a temporary down-lead rendered red hot by H.F. currents struggling against high resistance!

### All-Day Listening.

**S**OME of our Continental neighbours have prepared statistics showing how many hours of the day are spent in listening to wireless by average families.

So far as I know, the B.B.C. has never committed itself to a statement on the number of hours a day the average British listener spends at his loudspeaker. But some licensees get full value for their ten shillings, for when I raised the question in "P.W." some years ago several cases of twelve-hours-a-day listening were brought to light.

One invalid claimed a regular daily fourteen hours of programmes. Has this figure ever been surpassed by a "P.W." reader?

### Eiffel Tower's New Wavelength.

**F**URTHER news from France confirms the report that Eiffel Tower will soon be on the air on *medium* waves. The new wavelength will probably be 206 metres, and it is expected that some of the broadcasts will be of an experimental nature. The first tests should be heard in about ten or twelve weeks from the time this number of "P.W." appears.

Some four weeks before Eiffel Tower's tests the new Paris P.T.T. station at Villejust is due on the air. This station is to use a power of 120 kilowatts in June, when its tests are concluded.

### Cairo Calling.

**T**HE new Cairo station seems to be making good use of its 20 kilowatts, for several readers have reported excellent reception on 483.9 metres.

This wavelength is shared between Cairo and Brussels No. 1, and it is only when the latter is off duty that Cairo can

*(Continued on next page.)*

## WALES STILL WAITING FOR HER TRANSMITTER

be identified clearly. Incidentally, the long reach of Cairo's programmes explains why so many complaints have been made that the quality of Brussels No. 1 has deteriorated. The fault should not be attributed to Brussels, but to Egypt's 20 kilowatts.

### Phonetic Clues.

A CORRESPONDENT of one of the daily papers claims that he has collected seven mispronunciations by B.B.C. announcers in two evenings. The examples he quoted include "decisive" (second syllable rhymed with miss) and "sugar" (rhyming with rigger).



So if you sit in a restaurant and the gentleman opposite asks you to "pass the sugger" you will know he is probably an announcer. Give him a cold glare and a de-ciss-ive NO.

War and Peace.

SIGNING himself "Pacifist," a Plymouth reader sends me the most bellicose and threatening letter it has been my lot to receive since Christmas.

He asks me why I do not use my great influence—that's how he describes it—to further the cause of "peace on earth, good will to men."

If I were a huffy sort of chap I should be offended by that question, for nobody can advocate good will and a quiet life more sincerely than I do—as the back numbers of "P.W." will testify.

Moreover, my partiality for peace was strengthened off Plymouth one black, freezing night when the ship ahead of the one I was in went up sky-high with a torpedo amidships. I lost a lot of sleep that night, but gained a desire for peace quite as strong as "Pacifist's," I'm sure!

### "No Connection . . ."

IN a recent critical survey of the B.B.C. a "P.W." contributor raised a question about Ariel "sporting a halo." He meant the Shakespearean Ariel, the sprite who is portrayed in stone on the walls of Broadcasting House. But oh! the sarcastic letters I've had since about my halo.

So I hereby give notice that I cannot undertake any responsibility for my namesake. He used to wave a magic wand to do his stuff. I have to push a pen and burn the midnight oil, and both of these pursuits are ruinous to any hope of halos.

### A Victorian Choir Boy.

LISTENING on the wireless to the fine singing from King's College Chapel, Cambridge, a reader of "P.W." tells me it reminded him of the time he sang at

a Cambridge choir festival *fifty odd years ago!*

Probably his voice is a bit shaky nowadays, but he well remembers how the late Canon Woodard made him sharpen his ideas when picking him for the solo in a Christmas carol in 1882!

I am sure all the young chaps of "P.W." will bear with me for a couple of lines while I doff my hat to this veteran vocalist. He lives near Flamborough Head Lighthouse, and I hope he will see it winking cheerily at him for many a long year to come.

### Phantom Wavelengths.

THERE has been a good deal of speculation about the hush-hush experiments of B.B.C. engineers in connection with new methods of single-sideband working.

## BROADCASTING BREVITIES

The total number of hours of transmission from B.B.C. stations (excluding the Empire station) during 1934 was 63,109 hours 20 minutes. And the average breakdown percentage was only '022, i.e. something less than 14 hours.

Several new stations are in hand. For example, there is the new Regional station in Northern Ireland which will be put into operation towards the end of this year.

Then there are the North Scottish Regional at Burghhead, near Elgin, which is to provide a good service to the populated parts of the Highlands; and the North-East Regional station which will replace the existing low-power transmitter serving Newcastle.

Last, but not least, there is the new Midland Regional transmitter which is due to take over the Midland Regional service from Daventry shortly.

One newspaper man said that a broadcasting official explained to him that by the new process one wavelength could be used for two programmes—one on the real wavelength and the other on a "phantom" circuit. And on the strength of that statement all sorts of queer reports have been going round.

What it all amounts to is that single-sideband working—which had long ago been described in "P.W."—is getting more and more attention. Marconi's say it is easily operated, and tests have proved it to be reliable. This latter statement will be of special interest to the many Chelmsford district readers who stumbled on single-sideband programmes when tuning in on long waves.

### A Welsh Rarebit.

ONE of the men of Newport, Mon., has snipped a piece out of the "Western Morning News" and posted it on to me. It reads:

"In the B.B.C. Year Book for 1933 the B.B.C. very lucidly gives some sound and just reasons why a transmitter should not be given to North Scotland, the first being:

"It would obviously be wrong to build and run expensive transmitting plant merely to serve a sparsely populated area.

"Secondly:

"Even if a wavelength were available a transmitting station placed near, say,

Inverness would serve only a very small part of the Highlands because of the physical conformation of the country."

To which my correspondent adds: "Scotland now gets its new station AND WALES CAN DO NOTHING!"

Wales seems to have got in a very neat back-hander in this instance!

### At Breakfast Time.

APPARENTLY mistaking me for that short-wave juggler and kilocycle king who writes in "P.W." as W. L. S., a Plymouth reader asks me which is the best time to listen for Australian amateurs. H'm! This wants thinking about.

First removing my old school tie and putting on a W. L. S. knitted muffler, I suggest early morning as the best hour.

Mother-in-law is then talking to the milkman and the Aussies are actively key-thumping. Eight a.m. is not too early, though interference from bacon-sizzling is then often rather obtrusive. When you hear an Australian write and ask him to send you a card.

### In the "Kitty."

THE Rochester, N.Y., station, W H A M, has evolved an ingenious scheme for keeping its control staff on the alert.

A scale of fines has been worked out, and any engineer who makes a mistake on duty has to pay so much per fault into a common fund as penalty. The amounts are all added at the end of the month, and are then handed over to the engineer who has made fewest errors.

The public approves of this idea because it means better listening; and the engineers like it because each hopes to clear up the "kitty" at the end of the month.

### Beginning Young.

OUR old friend Radio Normandie has acquired a place in the limelight by putting up a candidate for the position of world's youngest broadcaster. Not just an infant squawking, but a genuine turn, telling funny stories and singing a song—and yet only three years old!

This prodigy rejoices in the name of Claude, and those who heard him broadcast, say he was genuinely good.

It will be interesting to see if any station can snatch an entertainer who is even closer to his cradle than Claude was.

Surely America, the home of screen prodigies, will not allow this challenge to her infants to go unanswered!

ARIEL.





# EXPERIMENTER

**"LET'S GET DOWN TO EARTH!"**

**B**EFORE I get down to earth—in more ways than one—may I introduce myself? Not as a technical "pro," if you please, but as one who takes an interest in radio from the amateur's point of view.

Technically speaking, my qualifications began with a schoolboy interest in physics. They continued when by a lucky chance I played the Experimenter with bells and coherers. Then broadcasting burst upon a wondering world. I have grown up with radio, then.

My idea is briefly this: You read plenty of articles by acknowledged experts and theorists, from whom, no doubt, you benefit exceedingly. On the other hand, it seems to me that there is a dearth of people writing for amateurs in an informal way.

**Real-Life Experiences.**

I hope to show we can learn without betaking unto ourselves an aura of learnedness. Let's agree right away we will not pretend to know everything—or to be infallible.

Let us keep these Experimenter articles jolly records of odd tests and real-life experiences. If I do have to draw upon text books now and then you must stop me becoming "text booky."

We must not sniff at theory, mind you. The more theory you can cram into your noddle the more interest you will derive from radio—so long as it doesn't leave you in the clouds, lost in a mental fog.

This radio started, you know, with a mathematician's theory. James Clerk Maxwell, by finding the link between light and electricity, calmly assumed the necessity of wireless waves twenty-three years before Heinrich Hertz actually developed them in the laboratory.

Clerk Maxwell, the mathematical genius, was the true prophet of wireless. "Maxwell prophesied, Hertz discovered, Marconi gave the increase," as Haslett so neatly puts it.

**Blind Theory or Practice?**

My reason for side-tracking is not to ram history down your throats, but to remind you that at the back of radio is mathematics. Some of it is of a peculiarly frightening kind to me—but don't let us be intimidated.

We will wave aside the Calculus and all that, contenting ourselves with the reflection that if we cannot all be Clerk Maxwells we can at least try to emulate Hertz, discovering new aspects of truth with practical experiments.

Let us, by way of introduction, get down to earth this week, leaving more detailed experiments until I know you all a little

better. Looking up from my typewriter, I behold a motley array of large and small tomes on wireless. Some very useful, because I can understand them. Others not so useful—I won't say why. None of them, curiously enough, has much to say about the earth connection.

Which is a very good reason why we experimenters should dig up the facts—if not the earth itself. Goodness knows, enough has been written in articles about the earth. The great idea seems to be a low-resistance earth. Without that, we are told, wireless is a poor thing.

Every now and then, though, your blue-blooded technician comes up against some

**A NEW "STAR" FOR "P.W."**



We are very pleased to announce this week that we have made arrangements for that well-known radio journalist and technician, Mr. Alan Hunter (whose picture you see above), to write regularly for "P.W." For some time past Mr. Hunter has been writing for an esteemed contemporary; and in particular he originated—some months ago—a special feature, "With the Experimenters." Mr. Hunter, under the nom de plume of "Experimenter," begins a new series of articles in this issue, and we feel sure our readers will welcome him and his brilliant contributions to our editorial pages.  
**THE EDITOR.**

simpleton who obstinately refuses to disbelieve the evidence of his ears—when that evidence clearly shows his reception to be just as good without an earth as with one.

The truth is that an earth can sometimes be done without quite nicely. Only the other day an artist friend of mine implored me to help him fix his set up at a new Hampstead flat. He was intensely worried because his flat was on the third storey.

Wouldn't it be a terribly long earth lead? No, for the simple reason that we soon had his two-valve set bringing in the Brookmans twins without any earth. A picture-rail aerial picked up more than enough energy for their local-station reception needs.

**"Just Didn't Matter."**

You see, an earth just didn't matter to them. They were living in an area of enormously high field strength and had purely local-station tastes. An earth on that set, which was a ruggedly designed detector and low-frequency amplifier affair, would merely have swamped the tuning dial with interference.

That artist, still to his amazement, does without an earth because I refused to be stampeded into complying with a rule of thumb irrespective of the circumstances.

To some diehards I may seem a bit of an iconoclast. Actually, I am not trying to break up any images—even though the earth, according to theory, is but an image of the aerial. No, the earth still goes—in spite of the Experimenter.

For the earthing of the aerial takes us back to the very beginnings of commercial wireless. The Marchese Marconi himself can claim to have been the first to see how the earth would enormously increase the range of wireless communication.

Hertz, you must remember, had sent out wireless waves over distances of only a few feet. Two vertical conductors, he used, forming the now-famous Hertzian aerial system. With leads going from these conductors to two near-by points of potential difference.

**The Aerial's "Image."**

In doing this laboratory experiment Hertz proved wireless communication possible. But it took the Marchese Marconi to prove it practicable. He saw that great distances might be covered if only sufficiently large electrical vibrations could be communicated to the ether.

From many points of view it was necessary to fix the signal generator at the centre of the radiating system. With a horizontal aerial this was not too difficult. The trouble was that the earth below absorbed too much of the energy.

A vertical aerial was obviously the thing. But to put the generator at the centre of a vertical aerial of any respectable height would have involved a flying-trapeze act that might well daunt even a daring young man—and Marconi was all that.

Came the brilliant idea: a vertical wire upwards from the ground-level generator and an image of that aerial down in the earth. When Marconi earthed the aerial wireless was on its way.

*(Continued on page 701.)*

W. L. S. Tells  
You How To  
Operate

# "The B.C.L." Two

**A**FTER carefully reading over last week's article I have come to the conclusion that there is nothing more to be said about the construction of the "B.C.L." Two. All the necessary details were given, and, apart from warning you once more not to depart from the published layout, I can safely leave the construction of the set in your hands.

One word, however, about the alternative coils mentioned in the list of components. There is no other coil that is instantly interchangeable with the "Eddystone" coils used in the actual set. Every other make of coil will require its own particular type of holder and connections, and, starting next week, I am going to show diagrams with the appropriate arrangements for the various alternative makes.

Several of them will require a slight modification of the aerial coupling, which will have to be made capacitive instead of inductive. The only additional component required for this is a neutralising condenser or a preset condenser of .0001 maximum.

### Very Sharp Tuning.

So now for some operating instructions. Here is No. 1, which I trust you will go on reading until it has really sunk in: **TUNE SLOWLY!** If you've never had any experience of short waves at all the sharp tuning will come as a surprise to you. One sweep of the tuning condenser (although it is only a .0001) will cover a frequency band several times wider than the band that you have been accustomed to tuning with a .0005.

The smallest (light-blue spot) coil, for instance, takes in all wavelengths between 13 metres (23,080 kc.) and 23 metres (13,040 kc.)—a frequency band of just over 10,000 kc., compared with the 1,000 kc. between 200 and 600 metres.

This means, obviously enough, that a medium-wave broadcast station covering 10 kc., which will occupy about

Last week full details for building this efficient short-wave broadcast receiver were given, and now, in this article, the designer tells you how to get the best from it, and gives some useful advice on just when to listen for certain stations.

1 degree on the average receiver, is considerably easier to tune in than a short-wave station, which will occupy about one-tenth of that space. The largest of the three short-wave coils, covering 41 to 84 metres, gives a band-width of about 4,000 kc., tuning being progressively easier as you go up the scale.

### Easy To Handle.

But why should we worry about this? All that one needs is a set free from hand-capacity troubles and a good slow-motion dial, and there's nothing to be alarmed about. The two-ratio dial specified is quite slow enough for anyone to handle.

But—as I said before—**TUNE SLOWLY!** Otherwise you will go shooting right across

an interesting station without hearing any more than a slight chirp. Adjust the H.T. supply to the screening grid of the detector to the lowest value that gives oscillation right round the dial, and reaction control should then be beautifully smooth.

Mount the set somewhere where you can sit down really comfortably for an hour or so, get out your pencil and paper and note down everything you hear. The wavelength ranges that I gave last week are pretty accurate, and now I'm going to tell you what to listen for.

Assuming that it's getting on for 11 p.m., I suggest that you plug in your 6R (red spot) coil, covering 41 to 84 metres. Take your tuning condenser up to about 35 degrees and have a good look at every degree on the scale between that and 50. This sweep should take in the broadcast band of 45-50 metres, and you will probably find Moscow, at the top, right away. He's usually pretty strong at that time of night.

### Receiving The Americans.

A few degrees below him you will probably find the Empire Station (G S A) on 49.6 metres. If you're lucky at your first go, in between the two you might hear Boston, Massachusetts, W I X A L; but if you don't you will almost certainly be able to find Pittsburg (W 8 X K, 48.86 metres) a few degrees lower down. Other Americans in between Daventry and W 8 X K—a space of 90 kc., although it's less than one metre—include Bound Brook (W 3 X A L), Wayne, N.J. (W 2 X E), Chicago (W 9 X F), Philadelphia (W 3 X A U) and Cincinnati (W 8 X A L).

Don't expect to hear them all at once, because it doesn't follow that they all transmit at the same time. I have actually heard five of them on together, but usually you won't find more than three.

There is also a number of South  
(Continued on page 706.)

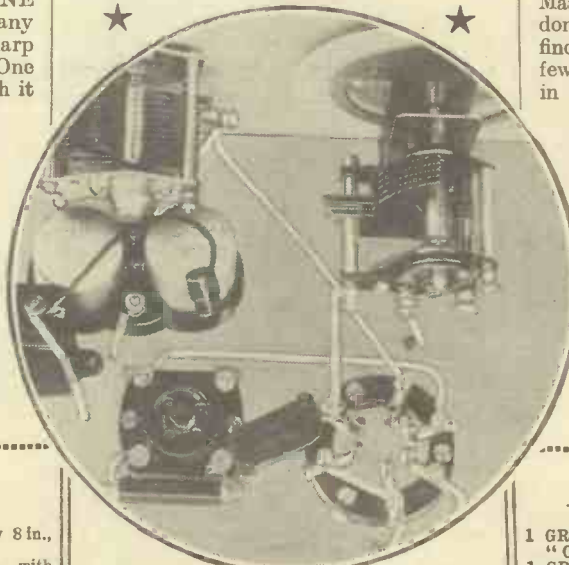

A close up of the all-important detector section of the "B.C.L." Two. Note the positions of the sockets on the coil holder.

### BUILD YOUR SET—

- 1 PETO-SCOTT "Plymax" chassis, 14 in. by 8 in., with terminal strip ready fitted.
- 1 PETO-SCOTT ply panel, 14 in. by 8 in., with "Metaplex" back.
- 1 EDDYSTONE six-pin baseboard-mounting coil holder (type 989); Colvern, Wearite, B.T.S.
- 1 EDDYSTONE set of coils, Nos. 6 LB, 6 Y and 6R; Colvern, Wearite, B.T.S.
- 1 J.B. .0001 "Short-wave special" variable condenser; Polar.
- 1 J.B. two-ratio slow-motion dial; Polar.
- 1 POLAR .00015 slow-motion short-wave condenser (type C); J.B.
- 1 BENJAMIN four-pin Vibroider and 1 five-pin valve holder.
- 2 DUBILIER 1-mfd. paper condensers (type B.B.); T.C.C., T.M.C.-Hydra.

### —WITH THESE PARTS

- 1 DUBILIER .0001 mica condenser (type 670); T.C.C., T.M.C.-Hydra.
- 1 GRAHAM FARISH H.F. choke (type L.M.S.); Bulgin, B.T.S., Wearite, short-wave chokes.
- 1 GRAHAM FARISH 5,000-ohm "Ohmite" resistance; Erie, Amplion.

- 1 GRAHAM FARISH 60,000 or 70,000-ohm "Ohmite" resistance; Erie, Amplion.
- 1 GRAHAM FARISH 2-megohm "Ohmite" grid leak; Erie, Amplion.
- 1 FERRANTI L.F. transformer (type A.F.3); Varley, R.I.
- 1 VARLEY Nichoke pentode output choke; Wearite, Graham Farish, B.T.S.
- 1 T.M.C.-HYDRA 2-mfd. condenser (type 25); Dubilier, T.C.C.
- 1 BULGIN Q.M.B. L.T. switch (type S.80).
- 9 terminals (Belling-Lee type R); Bulgin, Clix.
- 5 CLIX wander plugs; Belling-Lee.
- 2 CLIX spade battery tags; Belling-Lee. Wire, sleeving, screws, etc.
- 1 S.G. valve, Hivac S.G.220.
- 1 Output five-pin pentode, Osram P.T.2.



## AN ALL-WAVE FOUR-VALVE SUPERHET

(Continued from previous page.)

coil method of waveband selection for  $V_2$ —the broadcast heptode valve—or (b) to use an elaborate switching scheme for changing this valve over from short waves to the "broadcast bands," and vice-versa.

The second method was to use a separate heptode for short waves, and either switch it in or out as required, using first one heptode and then the other, or to use two heptodes for short waves—"double supering"—and cut out the first heptode when on the "broadcast bands."

Not a particularly economical scheme! The double super is excellent for short waves, and I have retained that method of reception. But I have not "thrown away" the heptode ( $V_1$ ) when the set is switched to medium or long waves.

### An Ingenious Change Over

I have kept both heptodes working, but the first I change from a heptode to an S.G. valve for use on medium and long waves. All very simple, but very effective and not a little valuable. The result on medium and long waves is that I get a large measure of pre-mixer H.F. amplification, a particularly valuable feature when one is using a band-pass input scheme to the mixer valve, and always an aid to selectivity and sensitivity.

But the scheme does not quite end there. The first heptode works on short waves as a mixer-oscillator, with a tuned oscillator circuit and an aperiodic aerial input. The aperiodicity is provided by a short-wave choke.

On long waves the oscillator circuit is broken on the anode side so that the valve no longer oscillates, and we are left with a tetrode into whose grid input circuit has also been switched a long-wave choke in series with the short-wave inductance. So far, so good.

Now, an S.G. valve with a tuned anode (in this case the first circuit of the band-pass arrangement) and an aperiodic input will give a good degree of H.F. amplification especially on long waves. But it may give slightly less amplification on medium waves if the same input circuit is used.

Obviously, if the long-wave choke is left in circuit when the set is to be tuned to 200-500 metres there will be slightly

less H.F. amplification from the heptode-S.G. valve than it would give on 1,000-2,000 metres. Sometimes this can be improved.

In cases where fairly high capacity aerials are employed it is sometimes found that the short-wave choke alone, plus the aerial and valve capacity, will tune to somewhere on the medium waveband. The choke has about 100-150 turns, and the aerial-earth capacity is about 0.002-0.003 mfd. So we should hit a wavelength somewhere in the region of 400-500 metres.

This fact can be utilised if local conditions permit, though I don't recommend the process for normal working. But the switch that controls  $V_1$  can be used if desired on medium waves to remove or include the long-wave choke in the aerial circuit. This is



A back view of the All-Wave Four-Valve Superhet with the batteries removed to show the loudspeaker. Note the two condensers, value .002 mfd each, across the terminals of the loudspeaker.

absolutely optional, and the user of the set must choose for himself either the full aperiodic circuit or the "semi-tuned" system on medium waves.

When the switch is pulled out we get the heptode valve, with its oscillator circuit oscillating at "short-wave" frequency and its grid input aperiodic to short waves and roughly tuned to the medium band. The result is that we get S.G. amplification of medium-wave stations plus a superhet effect of short-wave stations. These latter are not wanted while the set is tuned to medium waves on the main tuning system (second heptode), so a position on the short-wave dial where no short-wave stations are heard must in this case be found.

I should stress the point that the "semi-tuned" scheme is quite a secondary affair, and will only be found useful in certain cases. Normally I prefer the short-wave switch to be "in" on long and medium waves.

### Short-Wave Working

On short waves, naturally, the switch is pulled out to make contact, and the oscillator condenser is used to tune in the short-wave stations. In this event the main portion of the set is tuned to long waves at round about 1,800-2,000 metres. Then full double-super effects are obtained and, of course, no medium-wave reception takes place.

I hope I have made this clear, for operators of this set will find the variations of the  $V_1$  heptode very useful. The patent

application lies in the alteration of the heptode's action from heptode to tetrode, of course, the medium-wave tuning effect of the short-wave choke being purely an interesting additional phenomenon.

This, then, is the "All-Wave Super": a double superhet for short waves with an initial H.F. stage super for medium-wave and long-wave reception, the H.F. amplification of the first valve being variable apart from the multi-mu control, by virtue of the phenomenon outlined above.

Volume control of the set is carried out by a multi-mu control actuating on the first three valves; thus, whether or not  $V_1$  is acting as heptode or tetrode, its amplification can be continuously varied in the same way as can the "power" of the second heptode and of the intermediate-frequency amplifier  $V_3$ .

The rest of the circuit is normal. I have already mentioned the band-pass input to the second heptode ( $V_2$ ), and this valve is followed by two band-pass circuits in the intermediate-amplifier stages. Thus plenty of selectivity is available, and the sensitivity of the set is such that a different station comes in on the medium waveband at practically each degree of the dial. But more about the set next week.

## WHAT YOU WILL REQUIRE TO BUILD THE RECEIVER

- Utility 3-gang superhet tuning condenser, type W 349/3.
- Utility drive for above, type W350. (This can be obtained without micro drive if desired, type W346.)
- Colvern 3-gang superhet coil unit, types K61, K62, K63.
- Colvern intermediate transformers, type 110.
- Clix 7-pin valve holders, chassis-mounting type, with screw terminals.
- W.B. four-pin universal valve holder.
- Graham Farish screened H.F. chokes, type L.M.S.
- T.M.C.-Hydra 1-mfd. fixed condensers, type 25.
- T.C.C. 1-mfd. tubular condensers, type 250.
- Dubilier 1-mfd. tubular condensers, type 4404.
- Dubilier 1-mfd. tubular condensers, type 4403.
- Dubilier .01-mfd. condenser, type 610.
- Dubilier .002-mfd. condensers, type 670.
- Dubilier .001-mfd. condenser, type 620.
- Dubilier .0002-mfd. condenser, type 620.
- T.C.C. .0001-mfd. condenser, type 34.
- T.M.C.-Hydra .0002-mfd. tubular condenser.
- Graham Farish .25-meg. "Ohmite" resistances in

- vertical holders.
- Graham Farish .25-meg. "Ohmite" resistance in horizontal holder.
- Graham Farish 100,000-ohm "Ohmite" resistance.
- Graham Farish 5,000-ohm "Ohmite" resistance in vertical holder.
- Graham Farish 2,500-ohm "Ohmite" resistance in vertical holder.
- Graham Farish 1,000-ohm "Ohmite" resistances in vertical holders.
- Dubilier 250,000-ohm. resistances, 1-watt type.
- Bulgin 50,000-ohm potentiometer with three-point shooting switch, type VM36.
- Bulgin short-wave H.F. choke, type HF3.
- Bulgin double-pole double-throw switch, type S98, with radiogram indicating plate.
- Bulgin push-pull four-spring switch, type S29.
- Polar .00015-mfd. variable condenser, type C.
- Westector type W6.
- Varley Class B input transformer, type DP40.
- Peto-Scott "Metaplex" (both sides) baseboard, 10 in. by 12 in., with wood runners 12 in. by 3½ in.

- Peto-Scott terminal strip, 7 in. by 1½ in.
- Peto-Scott brackets, type 22/1.
- Peto-Scott bracket, type 23.
- 3-foot Goltone spiral screened sleeving.
- Coils B.R.G. "Quikon" connecting wire.
- B.T.S. Kelsey adaptor coil No. 1.
- B.T.S. Kelsey adaptor coil No. 2.
- Clix terminals, type A.
- Clix L.T. spade terminals.
- Belling-Lee wander fuse.
- Belling-Lee wander plugs.
- Screws, flex, etc.

### VALVES AND ACCESSORIES

- Valves:  $V_1$  Cossor 210P.G.,  $V_2$  Cossor 210P.G.,  $V_3$  Osram V.P.21,  $V_4$  Hivac D.B.240.  
Batteries: H.T. 120 volts: Ever Ready Standard.  
L.T. 2 volts: Exide IFG-C.  
G.B. 16½ volts: Lissen, Drydex, Ever Ready.  
Loudspeaker: W.B. Stentorian Standard.  
Cabinet: Peto-Scott type Classic Consolette.

## S.T.600 SERVICE BULLETIN No. 2

# MY THIRD S.T.600 TOUR

By

**JOHN SCOTT-TAGGART, M.I.E.E., F.Inst.P., Fel.I.R.E.**

The designer of the phenomenally successful S.T.600 has been on a special tour of inspection of sets built by readers, and here records his opinions and gives his advice.

TO design a set is one thing; to see that every builder gets good results is another. Normally a designer feels his work is done when he has produced a good set, but I don't agree. It is his duty, as I conceive it, to examine all complaints and to give "after-sales" service in so far as it is possible for one man to do so.

In the ordinary way it is the work of the Query Department to deal with questions, but obviously the designer knows most about the set and must keep in the closest touch, as, in fact, I am doing. Moreover, the great scheme of service men—not perfect by any means, since all the service men are not as experienced as they might be—calls for expert guidance.

I do not wish to appear self-righteous but perhaps I feel a little more than most designers a very deep sense of responsibility to every builder of one of my designs. Were I manufacturing sets it would be my prime consideration to see that every receiver went through the most stringent tests to see it came up to the mark. As a designer for the Press, however, I only give you a few pages of paper and a blue print. The rest is up to you and the component and valve manufacturers.

How have you and they fulfilled the responsibility? I determined to set out once more and find out.

**Read Every Word.**

Letters alone are an insufficient guide. The constructor with little experience can rarely diagnose the illness of his set. He may say "signals are weak" or "selectivity is bad," but frankly that means nothing to us—or rather it means so many things that we can offer little help.

There are two very important preliminary suggestions I would make to every builder of the S.T.600—one is that he should read every single word published on this set and, secondly, that he should read my new volume "The Book of Practical Radio." There is no fault that can occur on the S.T.600 which is not explained in this manual.

Naturally this article is directed to those in trouble. I determined to visit a number of homes, sometimes accompanied by a local service man, to "see for myself."

This is what I saw.

Troubles came under three headings:

- (a) Faulty components and valves.
- (b) Faulty operation and adjustment.
- (c) Faulty construction.

Usually a man constructs his set quite well, I find. His chief troubles in this direction are bad contacts at terminals or batteries. His batteries, H.T. at any rate, are in half the cases badly run down before he starts to build the S.T.600. He then complains of distortion, poor reaction, weak

the envy of that French abbé who, if the stars foretell anything at all, is due to figure in the newspapers any day now with his revolutionary nutshell receiver.

A constructional fault I noticed once was that the gang condenser had been badly fitted, probably due to the shaft having difficulty with its appropriate hole. Any stress on the shaft or twisting of the condenser is liable to upset ganging. In another case the concentric front trimmer made a friction contact with the main knob, and the two did not work absolutely independently of each other as they should. Sometimes the .00005-mfd. detector grid condenser is not raised as I instructed.

Respecting components, the parts I suspect most are the coils and gang condenser as regards proper ganging. In the case of the type of condenser used in my set some of the rear terminals of the gang condensers are too short to accommodate five wires, although the intention to fit five wires was known. A tip in such cases is not to pass all the wires round the terminal screw, as is usual with ordinary terminals; but the use of the castelling is not a solution in all cases.

**The Volume Control.**

A considerable amount of trouble has been caused by faulty volume controls. Sometimes the switch does not work at all, while at a house in Preston Street, Bradford, I found the contact arm a quarter of an inch away from the resistor! The service man with me—Mr. Marshall—told me he had had four or five other cases. On an experimental model of the S.T.600 I found that if you "switched off" slowly, you didn't switch off at all. By switching off quickly the switch worked perfectly with a click; this is not a general fault, but worth mentioning.

By altering the volume control you should get a smooth and wide variation of volume. If you don't the fault may be in the switch. If the switch is faulty send it to the manufacturers with the kind of letter you never hesitate to send to me.

Valves? Well we've had a fair number

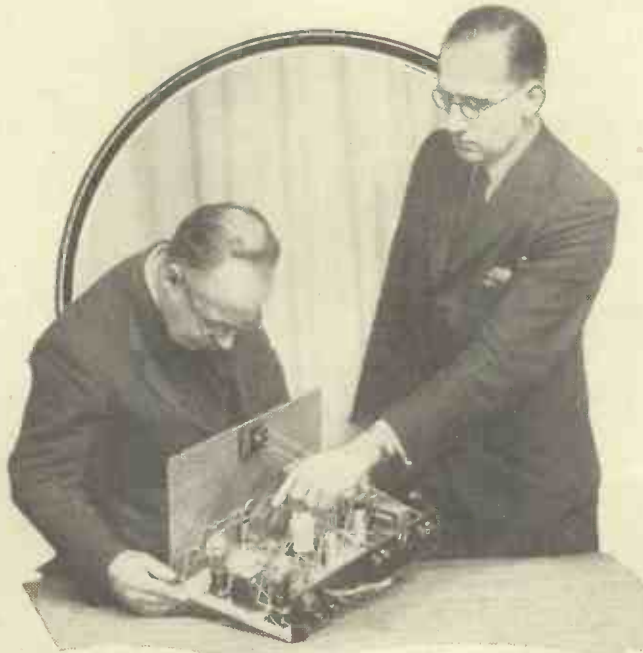

Mr. Scott-Taggart says that one of the most likely faults in the S.T.600 is incorrect ganging. In this article he gives some very valuable information on remedying possible faults from this source.

signals, poor selectivity. I should darn well think so! He deserves all he gets. He is rarely ignorant; he is mean and dishonest.

Annoyed? Of course I am. One of my visitees had an H.T. battery, nominally 120 volts, actually 60 volts. The battery was so small that I am sure it would excite

# OBTAINING CORRECT "SPOT-ON" DIAL SETTINGS

of complaints—poor emission and short life. Microphony is complained of on some sets. The pentode detector is to blame, but note I used a Benjamin vibrolder. I heard no microphony on my tour but I've experienced it during experiments. I found a heavy rubber grommet (something like a large umbrella ring) fitted over the top terminal of the pentode detector was an excellent cure. Peto-Scott's can supply this if you have trouble. Plasticine moulded round the terminal will, by weighting the valve, also effect a cure. But try changing round the first two valves. This is worth trying on all S.T.600 sets, even if there is no microphony.

## Test With Batteries.

Mains units? I got some excellent results with these, but I would never test a faulty set with anything but an H.T. battery. I advise all service men to follow suit. And see the accumulator is properly charged.

Operation and adjustment were in all cases I visited definitely poor. As a matter of fact, faulty trimming (the usual fault) did not, owing to the huge reserve of sensitivity, prevent very successful results being obtained in some cases. But what it did do was to increase breakthrough. (See later remarks.)

If asked what fault is most likely on the S.T.600 I should say ganging. This, of course, was a risk I foresaw, and I implored both coil manufacturers and gang-condenser manufacturers to keep to strict limits in their tests. Unfortunately, it is none too easy to say which is at fault in a given case, but it is perfectly easy to test for faulty ganging as a whole. You do this:

Tune to a station as you think, using both main knob and front trimmer and employing reaction; the aerial coupler knob may be about a quarter of a turn to the right. The station should not be too loud, and you use the volume control to reduce it, but anode reaction must be brought up to keep selectivity high.

## Checking the Trimming.

Now move the main knob a little to each side; signals should weaken. Leaving the main knob at the best position, move the front trimmer knob a little to the right and then to the left. In each case signals should weaken. If signals remain the same strength as you move the front trimmer to the right or if they get louder, you were not trimmed. You should theoretically get a true maximum tuning point on the front trimmer at whatever point on the dial you do the test, and whether on the medium waves or long waves.

However, some of the sets worked exceedingly well when the front trimmer was at zero (full open), i.e. with the knob fully to the right. Probably they were very nearly trimmed, but I was not satisfied. Actually I am very doubtful whether the ideal conditions can always be realised, and the failure of my test on some part of the dial would not justify uneasiness if the set appears to be working very well.

The trimming fault when you have to have the front trimmer knob fully right is

that the rear trimmer needs closing more. Turn the star wheel to do this, taking care to see that you turn it the right way to make the trimmer plate approach the frame. Preferably, switch the set off when turning the trimmer star wheel, and turn it a bit at a time. After each bit of a turn retune the station and keep tightening up the rear trimmer until you get signals loudest with the front trimmer *not* at absolute maximum. If the rear trimmer is absolutely tightly closed and the front trimmer still gives loudest signals with the front trimmer fully right, you are certainly "out of gang." If this occurs at all points of the dial I should condemn the set. Probably the two coils of the coil assembly or the two valves of the gang condenser are improperly matched. I think I should have the coils tested first.

The position can, however, be put right in a way by connecting a very small condenser across the anode tuned circuit of the set. There are several points where you can connect the condenser to give the required result. I myself used a .00005-mfd. J.B. baseboard trimmer (of the kind used in the

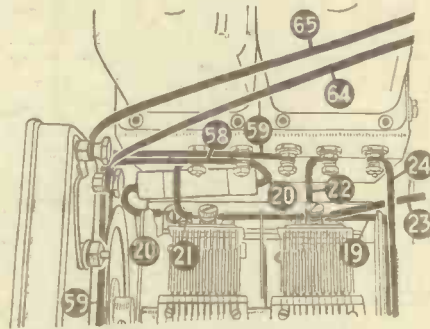

Mr. Scott-Taggart suggests that in certain cases a small preset condenser should be joined across terminals 9 and 10 on the coil unit. The two terminals in question are those to which wires numbers 22 and 24 go in the above sketch.

S.T.500 as a phase reverser preset), and connected it "in the air" by the aid of two one-inch long wires connected to terminals 9 and 10 on the coil assembly.

Having failed to get a maximum tuning point on the front trimmer even with the rear trimmer fully closed up, I started with the .00005 mfd. fully open and then closed it by degrees until I got proper tuning on the front trimmer. The set worked excellently then, but I am afraid a few of the small stations (including Fécamp) at the bottom end of the dial had "slipped off." Also the station-name dial was no good.

A hint for bringing a station under the control of the front trimmer, if this has to be full right, is to decrease the aerial coupler by turning nearly or wholly to the left. If signals are not too much reduced (you may turn up the volume control) you may now find that you can get a maximum tuning point on the front trimmer.

Since without aerial reaction the first tuned circuit may be a little flat in tuning it is always possible for the set to be trimmed or very nearly so with the front trimmer making little audible difference when near its full-right position.

The sensible test is: Does the set work well?

Very closely associated with the question of trimming is the station-name dial. This has not proved a universal success. This is a pity, because the idea is perfectly sound provided the coils and condensers used are accurate. They must, of course, be the same make as in my original set. The Colvern coil and other condensers than Formo may upset the names. The long-wave names when using the Colvern coil will be found in the wrong place, but this is no reflection on a very good coil.

## Concerning Calibration.

But even with the "Wearite" coil assembly and Formo condenser a number of dials do not "come right." This is chiefly because of trimming operations. The position of the names is governed by the tuned anode circuit of the receiver, and the tuning of this is altered by adjustments of the rear trimmer. Tightening the rear trimmer will cause the pointer to cut the station name nearer to the left-hand side of the name, and if the trimmer has to be fully closed the pointer may be completely to the left of the name of the station being received.

Unfortunately, you may have to tighten the rear trimmer in order to get the set working properly. In such cases you have to sacrifice the luxury of the station names. One man I visited preferred the station names to be correct rather than that the set should be properly trimmed. So I adjusted his rear trimmer so that the pointer crossed all station names well to the left, but not off the lines under the names. On some stations the front trimmer did not tune, indicating a lack of perfect ganging, but I must say the set worked very well indeed in spite of my dubious head-shakes!

A further possible disadvantage of tightening up the rear trimmer is that a station, or possibly more, may be lost at the bottom of the medium waveband. This may not worry many constructors if the set works perfectly otherwise.

## Importance of Proper Operation.

All these "troubles" are caused by manufacturers not working to sufficient accuracy. I certainly found that getting Fécamp, adjusting station names and perfecting the trimming was like those puzzles where you have to wobble three steel balls into three sunken holes. It's easy getting two right.

Of course, all my experiences were with faulty sets, and I may be a little too gloomy. But as an engineer I regard proper operation as more important than the station names. After all, that's a luxury, and neither I (and certainly not the dial people who merely copied the paper dial) are to blame. The Formo condenser, of course, already has a dial marked in degrees on which you can fall back if necessary.

You can, of course, reset the position of the pointer so that it makes the station names correct—or even bend the pointer. But you will find the end of the pointer may touch a control knob when around Budapest.

A considerable number of complaints



# HOW YOU CAN CUT OUT BREAKTHROUGH

have been received regarding breakthrough of the local medium-wave Regional station on to the lower end of the long waveband. Luxembourg—Sunday's favourite in many homes otherwise models of Sabbatarianism!—if jammed by North Regional will result in an express message to Tallis House, E.C.4.

Nearly all these letters came from the North Region. This is natural, since the N.R. station wavelength is higher than the others and therefore nearer the long-wave band.

The complaints have been in connection with the coils used in my original set and not with the Colvern assembly. I determined to investigate this breakthrough complaint thoroughly, and both around London and around the North Regional station carried out tests in the homes of complainants, and I probably now know more about breakthrough than anyone in the country!

The fact is that there is some tendency to breakthrough, but that, in every case I have come across, improper operation and/or improper trimming adjustment is at the root of the trouble. I did not find breakthrough on my original tours, and now that I have specially looked for it I find that Luxembourg and Kalundborg (which is lower on the dial than Luxembourg) are obtainable certainly up to nine miles of North Regional (the worst district for breakthrough) without break-through.

### A Sensitivity Effect.

The breakthrough below Oslo is of no consequence, but I mention this because even a trace of breakthrough there has worried a few readers and made them suspect their coils. There is one thing to remember: The S.T.600 is dozens of times as sensitive as most other sets, and so any breakthrough will be enormously magnified, but this only matters if the set is wrong.

Practically every case of breakthrough is due to something else wrong. For example, if you are misganged, Luxembourg will be greatly weakened and perhaps not even be obtained. But misganging does not weaken breakthrough—as the wavelength of the breakthrough is vastly different anyway. The result is that the breakthrough is perhaps ten times as strong as Luxembourg, whereas Luxembourg should be more than ten times as strong as breakthrough.

As soon as you trim correctly on the rear trimmer Luxembourg drowns all trace of breakthrough. If, of course, your set cannot be trimmed, due to radically

incorrect components, you will be unable to avoid breakthrough on Luxembourg.

Another cause of breakthrough is improper anode reaction. On the S.T.600 reaction is always advised for selectivity. Reaction greatly brings up the desired station, but leaves any breakthrough at its former strength.

### Adjusting the Controls.

By reducing the aerial coupler and volume control and bringing up reaction you can cut out the breakthrough completely. This is the ordinary proper way to operate the S.T.600 on any station, but it is essential if you are experiencing breakthrough. I have found that it is better to reduce the volume control than to reduce the aerial coupler too much.

The fact that with plenty of aerial coupler and plenty of volume control you

other terminal of the breakthrough choke is connected to the aerial terminal of the set. It is essential to use it only when working on the long-wave band. When you switch over to the medium waves you should short-circuit the breakthrough choke.

I tried twenty-three chokes at Manchester, Rochdale and Bradford, and found the best of all anti-breakthrough coils was an S.T.300 or S.T.400 or S.T.500 coil (either aerial or anode type in each case). You use the whole coil—that is, the medium-wave winding in series with the long-wave winding. This means you ignore all other terminals and connect the aerial to terminal No. 1, and connect terminal No. 6 to the aerial terminal on the S.T.600 in the case of an anode coil; with an aerial coil you use terminals Nos. 2 and 5.

Probably any tuning coil used in a wireless receiver would work well. It would be well worth trying any disused tuning coil.

The next best choke was the Lissen Anti-breakthrough Choke (Type L.N. 5145), which is far more compact and gives excellent results, and which is now sold at 2/6. Other chokes were a failure.

Some caution is needed if the breakthrough choke is inserted in the set as a permanency. It should not be too close to other components or wiring, e.g. too near the extractor condenser. Moreover, the aerial lead should be able to go direct to the choke and not have to go near the extractor condenser.

### The Best Position.

I suggest a good place for the Lissen choke would be on the baseboard next to the terminal strip and below the H.T.+1 and H.T.+2 terminal.

The aerial terminal would be shifted to below the two H.T. terminals mentioned. The wire from the aerial coupler would be shifted and connected to one side of the breakthrough choke, the other side of the breakthrough choke being connected to the newly positioned aerial terminal. A two-point switch could be mounted on the terminal strip to short-circuit the choke when medium waves are received. This switch needs to be of low capacity.

With the tuning coil or anti-breakthrough choke, which should always be first tried outside the set as suggested, you can have faulty trimming, faulty reaction and faulty operation, and you will still get Luxembourg! So there is a good deal to be said for recommending the choke wherever in the country there is any breakthrough.

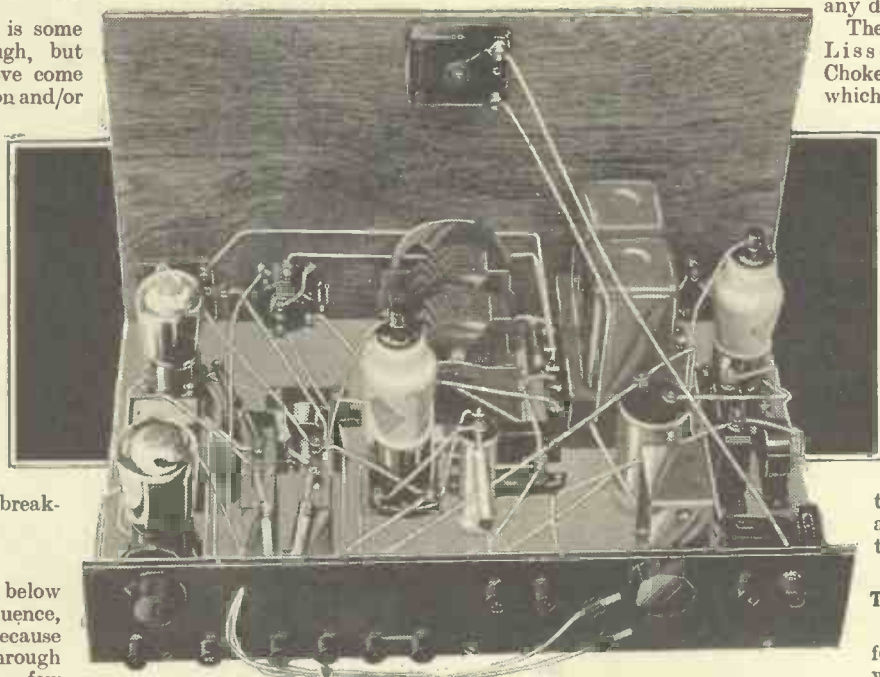

The S.T.600 as seen from behind the panel. Those who adopt the designer's suggestion of a breakthrough choke should try this first connected externally to the set. That is, between the aerial lead and the aerial terminal on the terminal strip.

can get loud breakthrough does not mean a thing. Those are not the conditions under which you will operate the receiver, and so anything that happens then does not matter.

### Use of a Choke.

The remedies for cutting out breakthrough certainly involve reducing the volume of Luxembourg and other stations at the lower end of the scale. They also involve more careful tuning. Both can be avoided by using a breakthrough choke, which is simply a suitable inductance coil connected in the aerial lead. You can connect this coil next to the aerial terminal outside the set.

The aerial lead is connected to one terminal of the breakthrough choke, while the

# An Evening with the KELSEY ADAPTOR

The many readers who have built the 1935 Kelsey Adaptor described last week, and the many more who are now building it, will welcome the hints and tips on its operation contained in this contribution by the designer.

**W**ELL, and what do you think of short waves?

Last week, in the description of my new adaptor, I did my best to urge you to give them a trial. I do not know how many of you acted upon that advice—at least, not yet, for there has not been time for correspondence on the subject. But what I do know is that not for many weeks past have conditions been better than since the constructional details appeared.

There hasn't been a single "dud" night, and those of you who acted immediately and who have had an opportunity of trying the adaptor will have had ample facilities for sampling "globe-trotting" almost at its best.

As a matter of fact, I've had my original adaptor on every night since I wrote the last article, and without exception I have been able to receive the States at remarkable loudspeaker strength. Most of the well-known American short-wave stations have been available at strength sufficient to sit down and listen to—and I mean *really* to sit down and listen to—but the star-turn performer of all has been W8XK on 48'86 metres.

#### Volume Control Needed.

With this particular station I have had to use the volume control on almost every occasion when I have heard it *in order to obtain comfortable room strength!*

The "existing set" throughout these tests has been a four-valve superhet of more or less conventional design, but from past experience with this particular adaptor I can assure you that similar results would have been possible with any reasonably good modern set, superhet or otherwise.

As a matter of interest you may like to know that the whole of my tests in the early stages with this new adaptor were carried out with an H.F.-Det.-L.F. three-valver which, by comparison with modern standards, was distinctly *below* the average.

There was a reason for that. I knew that if I could get satisfactory results under those conditions there would be little chance of anybody getting poor results when the final model was published. Following these preliminary tests, and when the model as published was ready, I tried it in conjunction with practically every type of modern battery set, and without exception it worked excellently.

So that the mere fact that my tests during the last week have been made when using the adaptor in conjunction with a superhet

is of no particular significance in relation to the results that I have been getting.

It is simply that conditions have been good—very good—but, even so, not by any means freakish. And what I have been able to do—well, so should you.

But to many of you who, I hope, are building, or who have built, my new adaptor short-wave reception and the unlimited scope for entertainment that it offers will be something entirely new. With a view, therefore, to giving you some idea of what

in a proper understanding of the way to go about it, and whereas it is by no means difficult there are one or two pitfalls into which the unwary are likely to stumble.

I have already said in previous articles that this new adaptor can be used in conjunction with any battery set, and whereas that claim is perfectly true I think that a little amplification of the statement might not be amiss.

In the first case, I have attempted to make it quite clear that I am not particularly enamoured with the idea of using it in conjunction with a straightforward "det.-L.F." arrangement, simply because under these conditions its capabilities are so limited. It will work, and I suppose one could say successfully. But that type of set doesn't represent the majority to-day, and I have catered for the masses.

The adaptor undoubtedly shows up to best advantage when used in conjunction with a set using one or more H.F. stages or when coupled to a superhet. And those are the types of sets for which it has been designed.

The actual set with which you use it comes into the operation very little, but there are one or two points in the preliminary adjustments for which you must watch out.

#### Using Reaction.

For instance, if you intend using the adaptor with a set other than a superhet—then for best results it is desirable to make use of the existing set's reaction control—that is, if it has one.

Set the tuning controls of the actual set to a wavelength of somewhere around 2,000 metres, and adjust the reaction control to the point immediately below where the set goes into oscillation. You will note that I say somewhere around 2,000 metres.

The actual wavelength is of little consequence so long as the one chosen is clear of long-wave broadcasting stations.

Then there is the question of sets using band-passing in the aerial stage. The ganging in such cases is done making due allowances for the loading effect of the aerial; and when the aerial is removed and the adaptor output lead connected instead there is just the possibility that the ganging will in consequence be thrown out slightly.

This may tend slightly to reduce the efficiency of the combined arrangement of set and adaptor, but it is an easy matter to overcome. Instead of joining the output lead from the adaptor direct to the aerial terminal of your set, join it instead direct to

(Continued on page 688.)

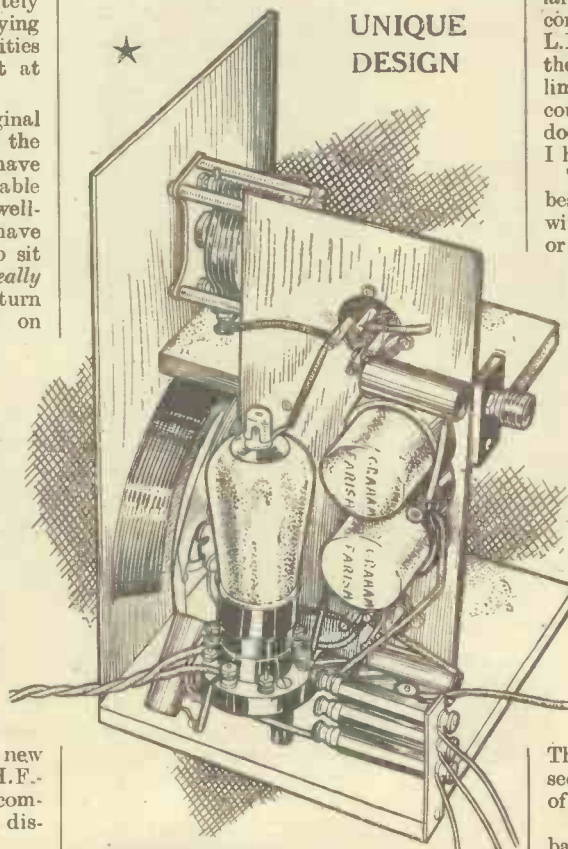

The unusual design of the 1935 Kelsey Adaptor has been adopted from considerations of efficiency. At the same time it adds attractiveness to the unit without introducing any complications.

you may reasonably expect I am going to tell you something of my experiences during a recent evening spent with the adaptor on short waves.

But just before I commence, and so that you shall be thoroughly familiar with general operating procedure, I want first to supplement my remarks at the conclusion of the last article. The secret of success lies

There Is Still Time To Secure Our Great New

# PRESENTATION VOLUME

RESERVE  
YOUR  
COPY  
NOW

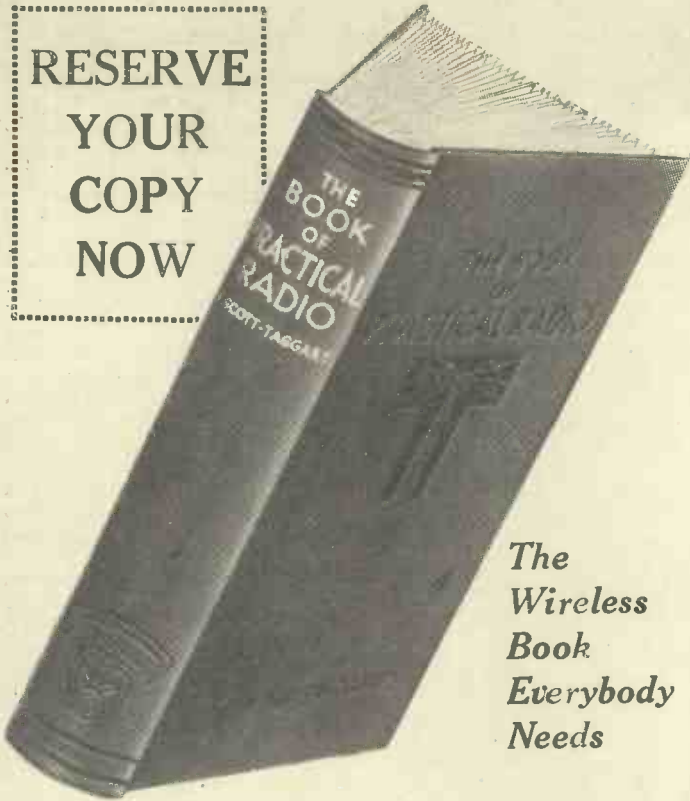

The  
Wireless  
Book  
Everybody  
Needs

## JOHN SCOTT-TAGGART'S BOOK of PRACTICAL RADIO

"THE BOOK OF PRACTICAL RADIO" represents the essence of the author's 22 years of practical radio experience as applied to radio receivers.

If you obtain this book it will be like having John-Scott-Taggart at your side, showing you how to get the most out of your set, how to construct a design and how to put right a set which does not work correctly.

Over 50,000 copies of the author's "Manual of Modern Radio" were completely sold out, and there are thousands who cannot now obtain the book through delaying to accept our offer of last year. Fill up the forms to-day!

Although this book is absolutely self-contained, no one who already has the "Manual of Modern Radio" will want to miss this new book. It is beautifully bound in green cloth and printed in clear type, and gives practical information and advice which every person interested in radio requires.

Incidentally, there is a special section dealing with all the S.T. sets, so that, if you possess one or intend to do so, this book will be invaluable.

There is a wealth of "how-to-do" sketches and photographs, and the whole atmosphere of the book is intensely practical.

There are 384 pages with 63 art plates; sketches and diagrams accompany the text.

### HOW TO OBTAIN THIS BOOK

First of all you must write your name and address on Form 1, which is just an ordinary label, on which you must stick a 1d. stamp. Then fill in Form 2, which is your reservation form. Then send these two forms to POPULAR WIRELESS. When they are received in our office, you will be sent a Gift Voucher on which to qualify for your "Book of Practical Radio."

There are six spaces on this Gift Voucher on which you will have to stick six Gift Tokens cut from the bottom left-hand corner of the last page of reading matter of POPULAR WIRELESS for six consecutive weeks. When this Gift Voucher is complete—i.e. after six weeks—you are asked to send a P.O. for 2/10 (2/6 with 1d. stamp attached). This 2/10 is to cover the cost of carriage and delivery to your door, cardboard container for packing, and insurance. "The Book of Practical Radio" can only be supplied to readers who complete the necessary Gift Voucher.

As this volume is only available to regular readers, if you have not placed a regular order for POPULAR WIRELESS you must do so at once. This offer applies only to readers residing in Great Britain and Northern Ireland. Overseas readers are not eligible. Irish Free State readers will be liable for any import duty imposed.

HAVE you applied for your copy of "THE BOOK OF PRACTICAL RADIO" yet? Time is drawing short, and if you want to secure this marvellous new work you must APPLY NOW!

"THE BOOK OF PRACTICAL RADIO," has been acclaimed as the finest all-round book on radio yet offered to the public. Every radio enthusiast needs this book; it is a sure guide to knowledge and success in everything connected with the practical side of wireless, written by a man whose qualifications are unrivalled, the greatest living expert in set designing to-day.

Over 800,000 copies of John Scott-Taggart's books have been bought by the wireless public!



1d. Stamp  
must be  
affixed here  
by YOU

Name.....

Full Address .....

### POST AT ONCE

### RESERVATION FORM

Applicants must complete label above and affix halfpenny stamp in space provided. Fill in this Reservation Form and send with label to:

POPULAR WIRELESS Presentation Book Dept. (G.P.O. Box No. 184a), Cobb's Court, Broadway, London, E.C.4.

I hereby apply for GIFT VOUCHER and request you to reserve for me in accordance with your special offer the presentation "Book of Practical Radio." I have given a standing order to my newsagent to supply POPULAR WIRELESS regularly each week.

Reader's Name.....  
(State Mr., Mrs. or Miss)

Full Address.....

Reader's Signature.....

Newsagent .....

Address .....

PLEASE WRITE IN CAPITAL LETTERS.  
YOU MUST FILL IN LABEL ABOVE and send with the Reservation Form in unsealed envelope bearing halfpenny stamp.

For Office Use



## AN EVENING WITH THE 1935 KELSEY ADAPTOR

(Continued from page 686.)

the grid terminal of the valve holder belonging to the first H.F. valve in the set, leaving the existing connections exactly as they are.

But this will only be necessary in certain cases, and if you find that it makes little or no difference, then it will be apparent that all is well with the adaptor output lead connected in the usual way.

I should perhaps explain that the operation of the adaptor is dependent absolutely upon the oscillator being maintained in a state of constant oscillation throughout the wave-range that is covered. The adaptor has been designed in such a way as to ensure that condition and allowing reasonable latitude for variations in individual construction.

All the same, it isn't absolutely outside the realms of possibility that one or two readers may encounter difficulty in this respect, due, as I have said, to slight variations in construction. But the fault is easily detected, and it is almost as easily overcome.

### The Oscillator Circuit.

You cannot, of course, actually hear the adaptor oscillating any more than you can with any ordinary superhet. But you can determine when it is in that condition by the general liveliness of the adaptor.

If it is "dead—that is to say, no background and no Morse—then you can be pretty certain that it is not oscillating, in which case you should try increasing the H.T. voltage on H.T. plus 2, which is the anode of the oscillator section of the heptode.

But "deadness" is not always an infallible sign. It may be that it is just a poor evening for reception, but you should at least hear one or two "chirps," and those will tell you that all is well.

I am not going to suggest for one moment that any of you are likely to get coils with wrong connections to the bases; but if you have reason to believe that the oscillator is not oscillating, and if increasing the H.T. voltage does not help matters, it might be worth while changing over the two coils.

None of us is infallible, and a reversed aerial coupling winding will not have such disastrous effects as a reversed oscillator winding. But I can hardly think that any of you will find this to be necessary.

I think I have now covered the ground fairly thoroughly, but I should like again to stress the importance of operating the adaptor dials slowly. It really is most important.

The top dial need not worry you very much, since in a sense it is only a sort of subsidiary control. But I recommend you to move it up by a corresponding amount after about every ten degrees of travel of the oscillator, or lower dial.

It is only when you have actually tuned in a station that the top dial comes into use,

and you will find then that by readjusting it louder results will be obtained. You can make the tuning of this top dial even flatter than it is by connecting the aerial lead-in direct to the top of the coil in the aerial section—that is to say, direct to the turn nearest the top of the former on the top coil. In certain circumstances this dodge may also improve signal strength.

### Wavelength Ranges.

But enough of generalities. And now I want to tell you about my evening—my particular evening—with the adaptor itself.

I started off with the smaller coils—that is to say, with the number one coils in the adaptor. In this connection it is perhaps opportune to say a word or two about coil ranges, for the relation of wavelength to time of day is rather more important than most people imagine.

In general I do not believe that there is any great advantage in being able to receive much below about 16 metres or appreciably above 60 metres. Whereas it is true that there are one or two stations

## IT WILL WORK WITH YOUR RECEIVER



No matter what the design of your set, the Kelsey Adaptor will turn it into a short-wave receiver of world-wide range.

below 16 metres, the tuning is so very critical that for the ordinary listener, at any rate, I think they are best left alone. And as for above 60 metres—well, there are only about four stations at present available, and they use such small powers that it is doubtful whether they would be received in this country, anyway.

So that I have arranged in the design of my coils to cover from 16 to 60 metres in two "hops," since it is not possible with a .00015-mfd. variable condenser to cover the band with only one coil. The number one or smaller coils tune from approximately 16 to 38 metres, while the larger coils cover the band from 28 to 60 metres.

### Wide Overlap.

You will notice that there is a fairly wide overlap between the two sets of coils, and that has been done intentionally. For one thing, it permits of the reception of the 31-metre band (on which there is a great number of stations) on both sets of coils, and it also obviates the necessity of using the condensers right at the top and right at the bottom when changing from one range to the other

Incidentally, I noticed in the advertisement for the B.T.S. coils for my adaptor, which appeared in the last issue, that the range of the larger ones was inadvertently given as from 28 to 55 metres. I have measured these coils, and actually the range covered is from 28 to well over 60 metres, and I have since been asked by the makers to draw attention to and to correct the statement as to wave range given in the issue in question.

To revert to the question of "my evening"—and I'm afraid that in my efforts to give you as much information as possible it must appear by now to be a very "interrupted evening"—I started with the smaller coils because in general there is little doing on the 45-50-metre band during the early evening. That is why it is important to use the right coils at the right time of day.

The first station I struck—a really useful "landmark" station—was Moscow R W 59 on 25 metres exactly. Strength terrific, fading nil and general background noise almost non-existent. Having located

Moscow (and it is particularly easy to find), I knew that it would be a simple matter to find and, subject to conditions being average, to listen to several other stations that are to be found just above 25 metres.

And I did!

### Pittsburg and Rome.

A fraction above Moscow was Pittsburg (Pennsylvania) W 8 X K on 25.27 metres. It was certainly not so strong as Moscow and the "mush" level was higher, but even so Pittsburg was well up to what I call "listening standard," and I heard several items before passing on to Rome 2 R O, which, on the dial, is about as far from Pittsburg as the latter is from Moscow.

Rome is almost always good; in fact, when conditions otherwise are thoroughly bad this Italian "giant" can usually be relied upon as a real programme alternative.

On the evening to which I am referring he was certainly no exception to the rule, and I had to put back the set volume control to save my ears.

The next station I struck, still with the smaller coils in use, was Madrid E A Q on 30.43 metres. I had hoped to log Buenos

(Continued on page 700.)

## THESE ARE THE PARTS

- 1 POLAR .00015-mfd. variable condenser (No. 4 reaction type).
  - 1 POLAR micro-drive semi-circular dial.
  - 1 POLAR .00015-mfd. variable condenser (short-wave type "C").
  - 1 BENJAMIN 7-pin valve holder; or Wearite W.B.
  - 2 CLIX 4-pin valve holders (chassis-mounting type).
  - 1 DUBILIER .0003-mfd. fixed condenser (type 670); or T.C.C., Graham Farish.
  - 3 DUBILIER .1-mfd. tubular fixed condensers (type 4503); or T.M.C.-Hydra, T.C.C.
  - 1 GRAHAM FARISH screened choke (type L.M.S.); or Wearite, Bulgin.
  - 3 GRAHAM FARISH 1,000-ohm "Ohmites" (without holders).
  - 1 PETO-SCOTT Kelsey "Structakit" type "B." (This includes panel, baseboard, screens, the two mounting pieces for aerial terminal and resistances, and the valve-holder supports.)
  - 1 Set B.T.S. Kelsey A adaptor coils.
  - 1 Ferranti heptode (type VHT2).
- Wire, sleeving, flex, screws, etc.

# For vivid realism get a

**M**ODERN receivers have reached a high standard of technical efficiency both as regards sensitivity and selectivity. But your ultimate enjoyment of radio entertainment rests with the loudspeaker. For years Blue Spot Speakers have been renowned for the quality of their reproduction. The Blue Spot Star Speakers have achieved a vivid realism that is literally astounding to those who have been "making do" with less perfect reproduction. For your own sake make a point of hearing Blue Spot Star Speakers without delay.

A combination of brilliant modern design, with new technical features, make this speaker the most brilliant performer amongst moderately priced moving coil speakers. It can be matched to suit any receiver in a second, and possesses many quite unique features.

Price: Chassis 70/-. Cabinet Model in walnut and chromium 98/-.

## BLUE SPOT "STAR"

### BLUE SPOT REMOTE VOLUME CONTROL

This convenient control takes the place of the standard on/off switch on the Blue Spot Star. It enables the listener to control the volume of the speaker from his armchair, and to switch it on or off as desired.

Price complete 10/6

### BLUE SPOT PICK-UP

Tracking error reduced to vanishing point. Head lifts back for easy needle changing without risk of damaging records. Perfect reproduction of all frequencies without overloading. Screened leads. Earth connection provided. Special volume control giving silent adjustment.

Price £1.7.6

or without volume control £1.1.6

➡ Send for free pamphlet P.W.3 about Blue Spot Speakers ◀

It is full of interesting information and tells how Blue Spot can improve your entertainment.

**THE BRITISH-BLUE SPOT COMPANY LTD**

BLUE SPOT HOUSE · 94/96 ROSOMAN STREET · ROSEBERY AVENUE · LONDON · E.C.1

Distributors for Northern England, Scotland and North Wales: H. C. RAWSON (Sheffield and London), Ltd., SHEFFIELD 22; St. Mary's Parsonage, Manchester; Strawberry Lane, Gallow Gate, Newcastle-upon-Tyne; 37, 38, 39, Clyde Place, Glasgow; 45, Springbank, Hull.



## SPEAKER

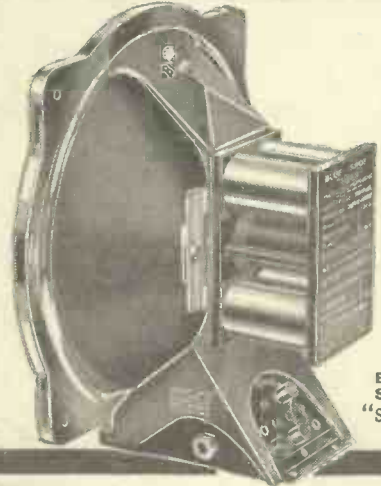

Blue Spot "STAR"

## For a cool, rich smoke...



**10<sup>D</sup> PER OZ.**

ALSO AIRMAN MIXTURE  
and AIRMAN FLAKE 10<sup>oz</sup>  
AIRMAN NAVY CUT DE-LUXE  
11<sup>P</sup>oz.

## HIGHEST in QUALITY LOWEST in PRICE



Absolutely non-microphonic detector types. S.G. types of exceptionally low inter-electrode capacity. Output valves giving larger undistorted output than "luxury" price valves.

362 BATTERY VALVES. H, HL & L, 3/6. Power, 4/-.  
Super Power, 4/6. S.G. & V.S., 7/6. V.P.2, 9/-.  
Pentode Type, 10/-.  
B.A. & B.X., 9/-.

362 A.C. MAINS. ACHL4, 7/6. P.625, 8/-.  
ACPX4, 9/-.  
ACSG4 & ACV54, 12/6. ACME4 & ACHM4 13/-.  
ACVP4, 13/-.  
Full Wave Rectifiers RB41, 7/6. RB42, 10/-.

If unobtainable from your dealer send P.O. to:—(DEPT. X),  
The 362 Radio Valve Co., Ltd., Stoneham Rd., London, E.5

SUPER  
POWER  
4/6

**362**

THE VALVE WITH  
THE 6 MONTHS'  
GUARANTEE

**The Paper  
for the Boy  
of To-day!**

Such is MODERN BOY. Its every issue is brimful of thrilling stories and articles on the very latest Inventions, Adventures, Hobbies, etc. It is the paper for the youth of to-day. Buy it regularly.

## MODERN BOY

Every Saturday. At all Newsagents and Bookstalls—2d.

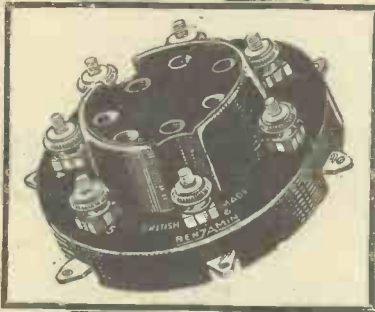
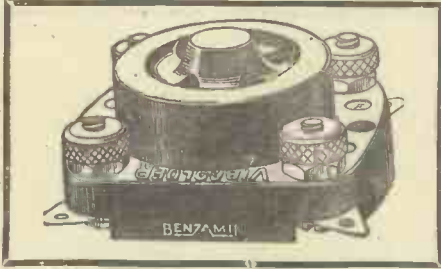

# BENJAMIN VALVE-HOLDERS

IN THE

"B.C.L." TWO AND THE KELSEY ADAPTOR

### FOUR-PIN TYPE

The famous Vibrolider, specified for The "B.C.L." Two. Anti-microphonic, dust-proof, with one-piece spiral springs and fitted with terminals and soldering tabs. **10d.**

### FIVE-PIN TYPE

Also specified for The "B.C.L." Two. In black polished bakelite with self-cleaning contacts, soldering tags and terminals. **10d.**

### SEVEN-PIN TYPE

Specified for the Kelsey Adaptor. In black polished bakelite, with self-cleaning contacts, soldering tags and terminals. **2/-**

OBTAINABLE FROM ALL GOOD - CLASS DEALERS

The Benjamin Electric Ltd., Tottenham, London, N.17

*6 Complete Song  
and Dance Hits  
for 3<sup>d</sup>*

**THE VERY THOUGHT OF YOU  
TROUBLE IN PARADISE  
ROCKIN' CHAIR : MY SWEET  
That Ripping Waltz : You're Just Unfair**



*All these big Numbers in the next issue of:*

*Edited by*  
**JACK PAYNE**

*On Sale Thurs.,  
Jan. 24, at all  
Newsagents &  
Bookstalls.*

**POPULAR MUSIC  
AND  
DANCING WEEKLY**

**3<sup>d</sup>.**

# TELEVISION

A SPECIAL PRACTICAL SERIES FOR ALL READERS

By L. H. Thomas

Some enthusiasts who have tried mirror screws consider them ideal, while others have little time for them. Their advantages and disadvantages and methods of using them are discussed this week.

THE mirror-screw method of television reception seems to be one that is regarded with very mixed feelings. Some enthusiasts—probably those who have been lucky with their first shot at it—declare that it is easily the best and most simple system for the home constructor. Others assert with equal emphasis that it isn't the slightest use to anyone, and is a lot of trouble for nothing.

The fact of the matter, of course, is that the mirror screw holds enormous possibilities, as it is one of the few scanning devices which can be arranged, relatively easily, to receive high-definition television.

First of all, what is a mirror screw? Imagine thirty flat plates of metal laid on top of one another, each one being at an angle of twelve degrees with its neighbour. By the time you get to the thirtieth you will have a kind of spiral staircase which has described one complete revolution.

### Setting the Blades.

Now arrange so that the vertical parts of the stairs are reflecting surfaces, and that they are only a small fraction of the horizontal parts. In one particular mirror screw that I am thinking of the "stairs" are half an inch wide and about one-sixteenth of an inch thick. The third dimension—length—is about four inches.

The reflecting surface is usually provided by means of chromium plating, and needs only occasional polishing.

Now imagine the mirror screw set up as shown in Fig. 1, mounted straight on the end of a motor shaft. The motor should, of course, be fitted with the usual synchronising gear, and must be capable of driving the screw at 750 r.p.m. I mention this because the slight "fly-wheel" effect of the scanning disc is now absent. One motor that I had on test was beautifully steady with a disc, but I couldn't get it anywhere near the correct speed with a mirror screw.

In the illustration imagine that the "step" nearest the motor has its reflecting surface towards you and vertical; the next leaning over to you at an angle of twelve degrees with the first; the second at twenty-four degrees; third at thirty-six, and so on. The strip in the centre has its reflecting surface pointing straight away from you, and you see only the back view—probably dull black enamel.

### Neon or White Line?

The strip at the extreme left-hand end makes an angle of twelve degrees with the first one. Now if you have a lamp mounted in the position shown, with a "line" of light directed on to the mirror screw, as you start that rotating, you will see a

familiar sight. The reflections of the light will reach you in the form of a rapidly moving light spot, gradually speeding up until you have a correctly proportioned scanning area.

It seems to be the fashion among home constructors to view their mirror screws direct, but excellent results may be obtained by projecting on to a screen. I have had quite moderate success with this, using a "White-Line" lamp. Others, I know, use a suitable projection lamp and a Kerr

If you think your qualities for holding a statuesque attitude are sufficiently high, and therefore intend to attempt direct viewing, it is not absolutely essential to use a mercury-vapour lamp. If you have a flat-plate neon tube, whether of the Baird or the "Nu-Glo" type, you can convert it temporarily into a line of light by masking it.

Ordinary sticky insulating tape is crude but effective. Black paper, held in position with a ring of insulating tape at each end, is even better. The dimensions of the illuminated rectangle given by the screw I have been experimenting with are roughly 1½ in. by 4 in., so that a line of light about two inches long is required.

### A Special Television Test.

The width of the aperture that you leave along the side of your neon tube should not be more than a quarter of an inch, and may be somewhat less. It is a matter for experiment.

So much, then, for the mirror screw. There are now some more general remarks that I want to clear up. How many readers happened to be "looking-in" during the programme at 11.15 on Wednesday, January 2nd? Those who decided not to were missing a most interesting transmission.

After "Shifting Shadows," which was in itself a very clever turn, lookers-in were shown round the television studios and control-room, and were given one or two tests on which to check up their receivers.

There was a perfect circle for checking the ratio of height and width of the scanning area; there was a chequered pattern as a test for bass response; and there was an ingenious cone, made up of separate black lines, as a test for top response.

My own receiver was proved to be sadly lacking in bass, but I found that it was due to a substitute valve that I had had to put in rather hurriedly, owing to the failure of my usual first L.F. stage.

### The Selectivity Problem.

The main trouble in television receivers—in mine, at all events—occurs in the H.F. part of the set. Most modern receivers, when "ganged" in such a way as to give maximum selectivity, give a decidedly prickly response curve. One can almost invariably hear a change in the quality of the output as one makes quite a small movement with the tuning control.

My own feelings at the moment are rather in favour of scrapping the H.F. stage and putting up with troublesome beat notes rather than risking bad quality on account of the difficulty in obtaining really accurate "trimming."

### MIRROR-SCREW DETAILS

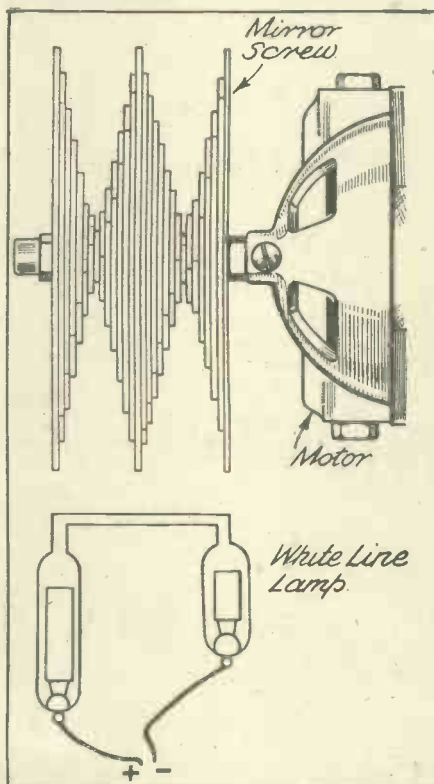

Showing how a white-line lamp is disposed for reception of television by means of a thirty-line mirror screw.

cell, and obtain a picture quite comparable with that usually associated with mirror-drum reception.

There is, of course, a distinct disadvantage about the direct-view method; one has to stand like a statue. The slightest movement of the viewing position loses the picture or else sends it "out of frame." But if you happen to be interested in something a little more advanced than a disc this mirror-screw business is rather intriguing.

THE campaign that has been conducted for three years by the joint forces of the B.B.C., Post Office and Foreign Office against the broadcasting in English of sponsored programmes from the Continent seems likely to bear fruit before long. Continental governments are taking action, notably France, Italy and Belgium.

It looks as if Spain soon will be the stronghold of the sponsored-programme movement, and pressure is being exercised also in that quarter. That will leave Luxembourg and the Irish Free State only.

#### B.B.C. and the Press.

The official invitation of the Empire Press Union to the B.B.C. to send a senior representative to the forthcoming Conference of the Union in South Africa marks an important forward stage in the relations of the B.B.C. with the newspapers as a whole. The B.B.C. acquires this status in another industry not only because of its news services but also because of its publications.

#### Jubilee "Peak" Programmes.

As already indicated in these columns, the B.B.C. is going "all-out" over the King's Jubilee in May. There is, however, not to be a "special week" of programmes as originally planned. Instead, there will be two or three days of special programmes, and then a sequence of "peaks" throughout May, June and July. This change of plan is well advised. It is better calculated to fit in with other arrangements for the celebration. Also, it will sustain interest in broadcasting during a period of normal decline.

#### Eddie Cantor: Aftermath.

Eddie Cantor's material and microphone manner made a profound impression on the B.B.C. His striking of the serious note about road accidents was extraordinarily effective, both as serious propaganda and as entertainment. One result is that the programme chiefs at Broadcasting House are considering how the same kind of thing can be introduced regularly into the British programmes. We are likely, therefore, to have a regular weekly feature on Eddie Cantor lines before long.

#### Indian Broadcasting.

The Government of India is seriously engaged in planning a national broadcasting system. A chief executive is to be appointed, probably from the staff of the B.B.C. Mr. Lionel Fielden and Mr. Gerald Beadle are the "favourites." It will be an important and difficult job.

#### A Boxing Commentary.

Boxing enthusiasts will be pleased to learn that arrangements have been made for Lionel Seccombe to give a running commentary on the fight between Petersen and Neusel which is to be staged at the Empire Pool and Sports Arena, Wembley, on Monday, February 4th. This will not be a championship contest, but an international heavy-weight fight that forms a sequel to the previous Harvey v. Petersen fight, upon which a running commentary was also broadcast.

#### B.B.C. Orchestra in Bristol.

So much interest is being shown in the visit of the B.B.C. Symphony Orchestra to Bristol on Wednesday, February 13th, that the B.B.C. has already received an inquiry for a block of 400 tickets for one



John Burnaby, son of the famous Davy of Co-Optimist fame, who plays the piano in Austen Groom-Johnson's "Soft Lights and Sweet Music" series.

school. This is exactly the type of interest that the tour aims to secure, musical and educational aspects being first considera-

#### George Allison: February 6th.

Arrangements are now complete for George Allison, the well-known Manager of the Arsenal Club, to broadcast a running commentary on the second half of the International Association football match between England and Ireland, which is to be played at Liverpool on Wednesday, February 6th. The broadcast will begin at about 3.15 p.m.

#### Big Ulster Concert.

Four hundred singers drawn from the City of Belfast, the Ulster, Alpha, Belfast Excelsior, Argyle, City Y.M.C.A., Castleton, Donaghadee, Queen's Island, Victoria, Dun-Lin Select and Woodvale Male Voice Choirs, who took part in the St. Patrick's night programme from Northern Ireland, are to broadcast again on Friday, February 1st, during a concert to be relayed from the Ulster Hall, Belfast. The concert is being given by the B.B.C. in co-operation with the Belfast Corporation, and the solo artist will be Astrá Desmond. Charles J. Brennan and John Vine will be the choral conductors.

#### Gipsy Song Recital.

Madame Spiridovitch, who is to give a song recital for National listeners on Sunday, February 10th, is a well-known Russian singer of her native gipsy and folk songs.

She has an extraordinary voice, rich and warm, with a range of over three octaves. But Madame Spiridovitch is not only distinguished for her singing. She was a "Laureate" of the Moscow Conservatoire.

During the war she sang to the wounded in intervals of nursing, and after the Revolution, when difficulties of escape were accentuated by her husband being chief of the Emperor's personal bodyguard, she concentrated exclusively on singing. She has a great following in Paris.

Her recital on February 10th will include a group of Neopolitan folk songs and some pieces by Gretchaninoff, as well as some Russian folk songs.

#### "Ten a Penny."

You may remember that quite recently the Midlands tried an experiment in producing "The Princess of Paraphernalia" as a matinee and also as an evening performance on the same day.

Apparently the idea was so successful that it is to be repeated with "Ten a Penny," a new play with music which will be heard on Thursday, February 7th. The matinee will be given at 4 o'clock, and the evening performance—for the Regional, as well as the Midland programme—will begin at 6.30 p.m. The book is by Geoffrey Bryant (otherwise Victoria Marsh, a West End actress who is living in Birmingham, and who has appeared in several Martyn Webster radio productions), and the music and lyrics by Wilfred Southworth, a cinema organist who has been heard by listeners.

The cast will include Hugh Morton, Alma Vane, Janet Joye and Helmar Fernback. The Masque Players Band, which plays at a Birmingham dance hall, will also make its first appearance before the microphone in this show.

O. H. M.

## ADVERTISING FROM THE CONTINENT

The future of sponsored programmes and other news and views of radio interest

tions. The orchestra, which incidentally is the biggest permanent musical combination in Europe, is to visit Birmingham on February 27th, Dundee on April 2nd and Brussels on March 12th.

#### On the Air next week:

**Regional and National. Jan. 28th and 29th.** The fifth of "The Famous Trials"—that of Lady Alice Lisle before Judge Jeffreys. Reconstructed by Whitaker-Wilson. A revelation of old English court methods.

**Midland Regional. Jan. 27th.** "A Musical Trip Round Europe," by the Birmingham Hippodrome Orchestra. Good light entertainment.

**Midland Regional. Jan. 29th.** Eden Phillpott's Devonshire one-act play, "Something to Talk About."

**Western Regional. Jan. 29th.** Acts 1 and 2 of Bizet's opera, "Carmen," relayed from the Pavilion, Torquay, and played by the Royal Carl Rosa Opera Company.

**North Regional. Feb. 2nd.** The pantomime "Mother Goose" will be relayed from the Theatre Royal, Leeds.



# CONSTRUCTING

## The All-Electric

# KELSEY ADAPTOR

In this article Mr. G. T. Kelsey gives full details for building a short-wave adaptor which will greatly enhance the value of any commercially-built or home-constructed A.C. mains receiver. It is run entirely from the mains and no alterations to the receiver to which it is attached are required.

LAST week I told you the reasons which prompted me in the design of the all-electric version of my adaptor to provide it with its own power pack.

I do not propose to cover that ground again, nor do I want to devote very much of my space this week to generalities, because there is rather a lot in connection with the construction that I want to talk about instead.

But I do just want to say a word or two about the overall efficiency of this all-electric model, for I know of nothing to touch it for results.

It must be common knowledge that with mains valves, where the question of power consumption is not of primary consideration, efficiency generally is usually of a higher order than is the case with battery models. The heptode which I have used in my mains adaptor is no exception to the rule, and although in this case there is not such a lot in it, there is undoubtedly a difference.

### A Remarkable Unit.

Now, I do not say that with a view to discouraging the battery-ites in the slightest degree, nor is it intended to detract one iota from the claims which I have made relative to the capabilities of the battery version. In the light of tests which I have made since the description of the battery model was published I would say with even greater conviction all that I have already said concerning its capabilities *and some more besides!* Thanks mainly to recent technical developments, it is indeed a very remarkable unit, and I say that without the slightest desire that you should hand me the laurels. Pass judgment yourselves, and I shall be perfectly happy to accept your verdicts.

But the main point in mentioning the relative efficiencies of the mains and battery heptodes is simply to enable the mains user to assess the capabilities of the unit without going all through the introduction again. Bearing in mind what I said last week about the performance of the battery model—and I meant every word of it—you will be able to make a pretty shrewd guess as to what I think of the mains model.

It's a world-getter with a vengeance, and the great joy of it is that I can't think of a single commercial receiver with which it cannot be used. True, the scope of its

appeal is limited to listeners who are on A.C. mains, but they constitute the majority and in any case there would not appear to be much point in designing an adaptor for a type of supply which even now is rapidly dwindling and which, as time goes on, will become rarer.

In these circumstances it is obviously best for D.C. users to make an adaptor as cheaply as possible, and their best course lies in the use of the battery version with separate batteries to supply the necessary power to the unit.

### READY TO TOUR THE WORLD

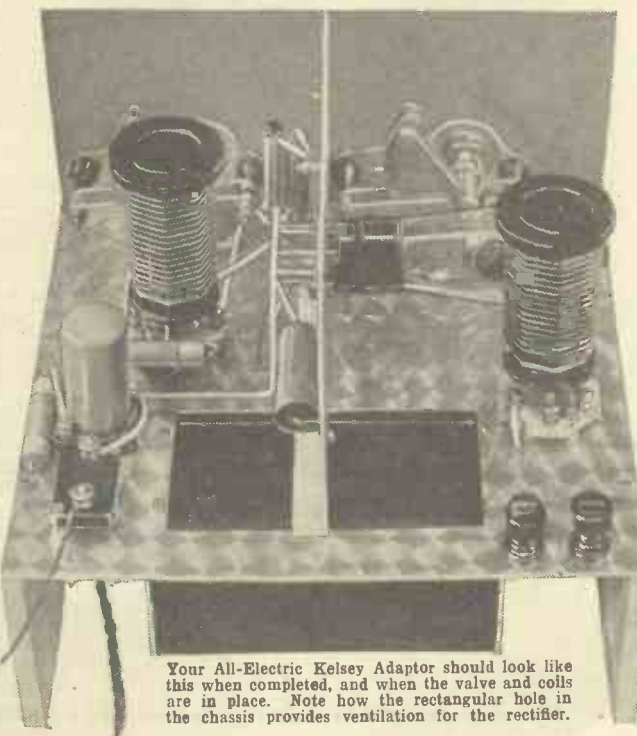

Your All-Electric Kelsey Adaptor should look like this when completed, and when the valve and coils are in place. Note how the rectangular hole in the chassis provides ventilation for the rectifier.

But for all those listeners who are using sets of the A.C. mains variety the all-electric version of my adaptor is eminently suitable, and in order to receive any short-wave station in the world on your existing set it is only necessary to make two simple connections between the adaptor and the set!

You do not have to touch the inside of your set, nor do you have to make any alterations whatsoever. It can be con-

nected up in an instant, and the ease with which it enables you to tune in programmes thousands of miles away will amaze you.

Ordinarily, there is little that can be done to a commercially-built mains set with a view either to improving it or to increasing its range. Once you have bought it, then you must be content with it as it is, and if broadcasting conditions change—well, there is little that can be done about it short of buying a new set.

But that is where my short-wave adaptor comes into the limelight, for it is one of the few things that you can add to a commercially built—or for that matter to any other type—mains receiver to open up an entirely new field of reception. And *what* a field!

I would like a pound for every hour that I have spent on short waves with this adaptor. And it is surely obvious that there must be a reason for that. There is. It is all so new and vast. You never get a dull moment, and there is absolutely no limit either to the number or to the variety of stations that can be received.

### You'll Get a Thrill.

It has its shortcomings, I know, but what are they by comparison with hearing programmes from all parts of the world—programmes which, for the most part at any rate, are in the mother tongue?

But I'm not going to say any more about it for fear you should think I am trying to foist short-wave reception upon you. I'm certainly not. We English are much of a kind in our likes and dislikes, and if I can get all this thrill out of exploring to the ends of the earth—well, I'm telling you! Please yourselves, but I'll wager that you will thank me afterwards if you decide to give them, and it, a trial.

It is the "it" with which I am going to be concerned from now onwards, and I am going to endeavour to describe the construction in such

a way that every single reader, whether technical or otherwise, will be able to follow it with ease.

I am not going to say that it is difficult, because it certainly isn't. But the facility with which you are able to construct it will depend entirely upon the way in which you set to work. I know. I made the original from beginning to end myself, and

(Continued on next page.)

# THE ALLELECTRIC 1935 KELSEY ADAPTOR

(Continued from previous page.)

I struck, and duly overcame, all the snags as they came along. So that I can at least write first hand and from actual experience.

Follow the procedure as I give it, and you will find the construction of this mains adaptor as straightforward as it could be.

First a word about the chassis, the panel and the screen. I am afraid that I don't regard the cutting and drilling of aluminium as a particularly easy job from the point of view of the average home constructor. I had a few words to say about it myself when I had to do it, and my wife said a few more words besides!

### Obtainable Ready Cut and Drilled.

But you can obviate all that if you want to, and I strongly recommend that you do. I have made arrangements with the Peto-Scott Co., Ltd., to supply these parts ready cut and drilled and all prepared for assembly, and the cost is very reasonable commensurate with the work involved. That is because they can turn them out by mass-production methods.

If you want to make them yourself—well, by all means do. And to assist you there are detailed and dimensioned diagrams accompanying this article.

A word or two about components. I am not going to pretend, in this case, that the ones I have used are the only ones that will give satisfactory results. But you will have to be very careful indeed if you do make variations, because I have purposely aimed at keeping the adaptor compact, and there is very little room to play with under the chassis.

I have indicated certain alternatives which will fit in, but, a part from these, I think you will do best not to make experiments. Do as I have done, and you will not land yourself in any difficulties.

When you have collected the components together the first part of the construction should consist of fixing the "baseboard" to its two "Metaplex" runners ("Metaplex" coating on the inside), after which you can fix the panel to the chassis. The screws which hold the panel in position are driven home into the ends

of the wooden runners which support the "baseboard."

The order in which you mount the components both underneath and on top of the metal "baseboard" is of some considerable importance, and in order that you shall not go wrong I am going to deal with each in turn.

## HERE ARE THE COMPONENTS USED

- 2 UTILITY '00015-mfd. standard variable condensers (type W187/15).
- 2 UTILITY micro-dials.
- 1 BULGIN 4/5-pin valve holders (type S.W.21); or Benjamin, Wearite.
- 1 CLIX 7-pin valve holder (chassis-mounting type).
- 1 WEARITE screened H.F. choke (type H.F.P.); or Graham Farish L.M.S.
- 1 T.C.C. '0003-mfd. fixed condenser (flat type "S"); or Dubilier, Graham Farish.
- 3 T.C.C. 1-mfd. tubular fixed condensers (type 250); or T.M.C.-Hydra, Dubilier.
- 1 T.M.C.-Hydra 1-mfd. tubular fixed condenser (type T.24); or T.C.C. Dubilier.
- 2 T.M.C.-Hydra 4-mfd. fixed condensers (type 25); or Dubilier, T.C.C.
- 1 T.C.C. 4-mfd. fixed condenser (type 80); or T.M.C.-Hydra, Dubilier.
- 1 ERIE 300-ohm resistance; or Amplion, Graham Farish, Dubilier.
- 1 ERIE 20,000-ohm resistance; or Amplion, Graham Farish, Dubilier.
- 2 ERIE 30,000-ohm resistances; or Amplion, Graham Farish, Dubilier.
- 1 BULGIN L.F. choke (Type L.F. 16).
- 1 HEAYBERD special mains transformer (type K1) or B.T.S.
- 1 WESTINGHOUSE metal rectifier (type H.T.12).
- 1 PETO-SCOTT Kelsey Structakit-type "M." (This includes chassis, panel, fixing strip for resistances and mains flex and plug).
- 1 Set B.T.S. Kelsey adaptor coils.
- 2 BELLING-LEE terminals (walnut, type B, engraved "Aerial" and "Earth").
- Tinned copper wire and sleeving.
- Flex, screws, etc.
- 1 Ferranti heptode valve (type VHT4). Note.—Marconi, Osram and Cossor heptodes can be used, providing bias and voltage dropping resistances are changed in accordance with makers' recommendations.
- Optional: 1 Bulgin station-log, panel-mounting type.

First of all, mount the mains transformer. It is held in position by two small wood-screws driven into the side of the "runner" on which it is fixed. You may think it preferable actually to remove the runner on which it is fixed for this operation, but I did not find it necessary, as I found it possible to get a small screwdriver down behind the transformer.

You will find it best next to mount the two Bulgin valve holders which are eventually to accommodate the coils, but before finally securing them I advise you in each case to remove the fifth or centre socket, since it will not be required. To do that it is only necessary to remove the terminal which holds the crossbar on either side. As a matter of fact, I used these terminals for mounting the valve holders to the chassis, for they are just about the right length.

### An Important Point.

There is a bit of wiring that should be done at the same time that you fix these valve holders in position. As you will see from the top-of-chassis wiring diagram, the "grid" and one "filament" terminal of the first one—the one nearest the aerial terminal—are both joined to one of the bolts which holds the valve holder to the chassis, and in the case of the second one it is just the "grid" terminal which is joined to the fixing bolt.

This done, you can proceed to mount the rest of the components on the top side of the chassis, including the variable condensers, but do not at this stage mount the screen. The reason for that will be apparent later.

With regard to the variable condensers it is essential to use an ebonite or fibre-spacing washer on the inside of the panel in order to get the slow-motion dials to function correctly. These washers, which

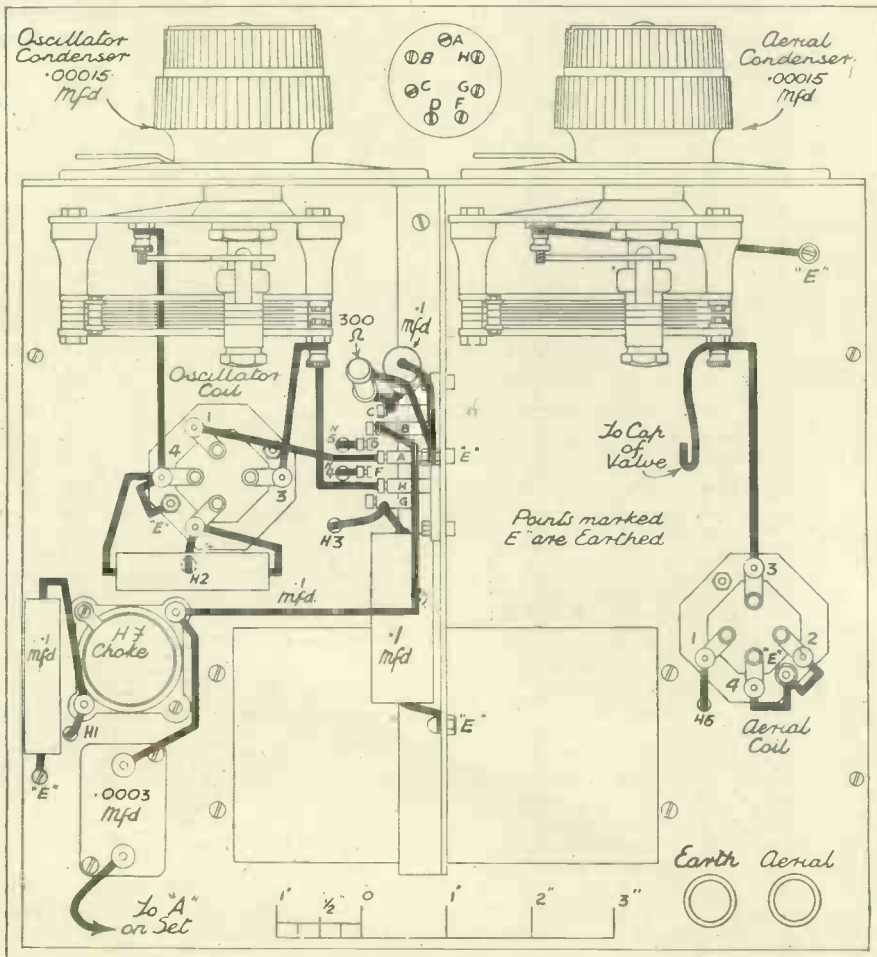

This diagram shows the wiring above the chassis. The points marked H1, H2 and so on are holes where wires pass through the metal "baseboard" to components below.

are being supplied with the condensers, are not intended to insulate the condensers from the panel, but are simply for spacing. But they are indispensable, and if by any chance they are not included with your condensers, write to Messrs. Wilkins & Wright explaining the purpose for which you want them, and they will be supplied free of charge and without question.

Another point: In fixing the T.C.C. .0003-mfd. flat-type "S" fixed condenser put a couple of nuts or some washers between the condenser and the metal chassis to raise it up a bit.

The panel-mounting station log is an optional component. But it certainly improves the appearance, and, moreover, I have found it extremely useful. So that, if you decide to use it, it should be the next thing to mount.

**The Screen.**

The screen should be the next thing to come in for attention, but first it should be prepared by fixing the 7-pin valve holder to it and by fixing and wiring the vertical .1-mfd. fixed condenser and the 300-ohm resistance. One side of each is joined to the valve leg marked C in the diagram. The two remaining sides are both joined to the screen by means of a nut and bolt and a couple of washers.

That completed, the screen can be fixed in position. But notice that the fixing bolt nearest the panel also serves, on the underside of the chassis, to hold one side of the Bulgin L.F. choke. With the screen in position secure the remaining side of the L.F. choke, and proceed by wiring up the heater circuit of the valve. That consists of joining the two lowest valve legs of the 7-pin valve holder (the ones marked D and F in the appropriate diagram) to the appropriate terminals on the mains transformer (see diagram).

**Under-Chassis Components.**

Before fixing the remainder of the under-chassis components you will find it best to attach wires to the plugs which go into the sockets of the mains transformer (excepting the actual mains leads); and leaving them loose at the remote ends ready for connection. They can be cut to the right lengths afterwards.

The remainder of the under-chassis components should be mounted in this order: First, the two T.M.C.-Hydra 4-mfd fixed condensers, and then the T.C.C. 4-mfd. fixed condenser. But do not at this stage mount the rectifier.

It will be a lot easier if you first secure one end of each of the three remaining resistances to the ebonite strip, as shown in the diagram, taking from each nut and bolt which is used for securing a flex lead. Then make the connection between the terminal

on the T.C.C. 4-mfd. condenser (by which the ebonite strip is held rigid) to the appropriate terminal on the T.M.C.-Hydra condenser nearest to it. That done, you can fix the ebonite "anchor" in position and proceed to wire up the flex leads, as indicated in the diagram.

Let the mounting of the rectifier and

Incidentally, while on the subject, perhaps I should mention that the "moving-plate" lead to the condenser on the valve side of the screen is secured to the chassis by one of the bolts that holds the T.C.C. 4-mfd. condenser in position.

Perhaps, in connection with the wiring, it will help if I just describe the connections to the 7-pin valve holder. You already know what happens to valve legs C, D and F. As for the rest, .B goes to one side of the Wearite H.F. choke, A goes to the "filament" terminal nearest the panel of the valve holder next to the H.F. choke, H goes to the fixed vanes of the oscillator variable condenser (the one on the choke side of the screen), and G goes to one side of a .1-mfd. fixed condenser and, via a flex lead, to one of the resistance securing-bolts on the underside of the chassis.

**Check Your Wiring.**

When you have secured and wired the rectifier your adaptor should be complete and ready for testing. But first give the wiring a very careful check against the diagrams, marking off each lead as you go along.

With regard to the mains leads the sockets on the transformer to be used in your case will depend upon the voltage of the local supply mains. In this connection the adaptor is designed to cover all voltages from 200 to 250, but you must be careful to use the right sockets for your particular circumstances.

The probability is that you already know the voltage of your own mains. If not, then either inquire from the local supply company or alternatively have a look at the meter in your house. The voltage of the supply is usually stamped on that.

Having determined the voltage, the next thing is to determine the correct sockets on the mains transformer. That is

(Continued on next page.)

**HOW THE HEPTODE IS USED**

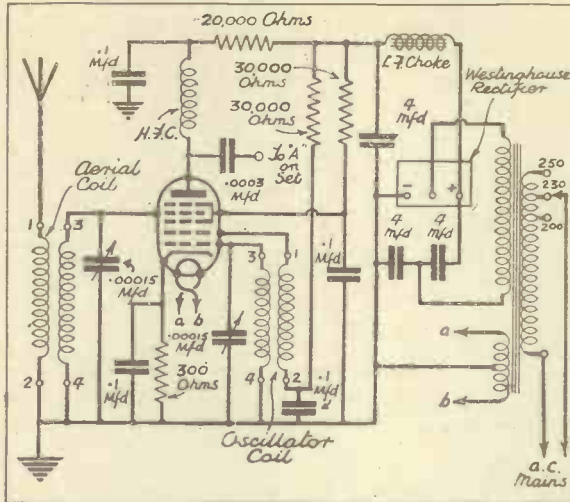

From this diagram you can see how the heptode, which is a combined oscillator and mixer valve, is connected into the circuit. The connections for the components supplying H.T. and L.T. can also be followed.

the wiring to it be the last job of all, and in the meantime carry on with the remainder of the wiring. You may wonder why I have bothered to wire the moving plates of the variable condensers when their frameworks are joined electrically to the panel. Principally to obviate "noises." It's just a wise precaution.

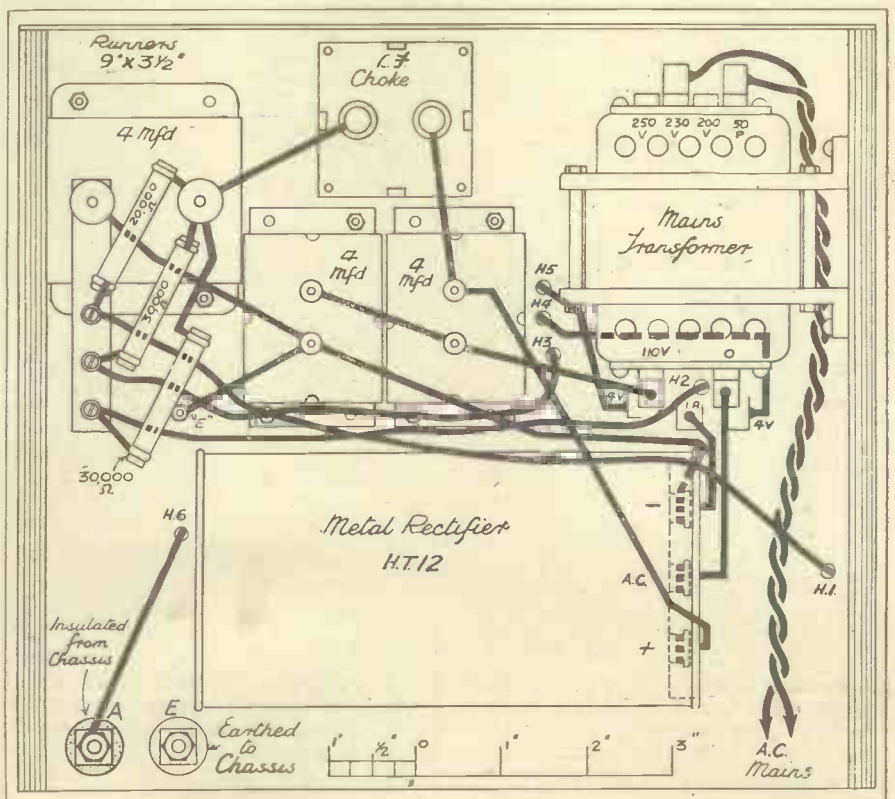

Here is the below-chassis wiring. The components seen here are all connected with the power supply, both L.T. and H.T., and make the adaptor completely self-contained.

## THE ALL-ELECTRIC 1935 KELSEY ADAPTOR

(Continued from previous page.)

easily done, for they are all marked. One of them is green; the other three are black. The green one is common, and one of your flex leads which is to feed the mains to the adaptor should therefore be connected to that. With regard to the other flex lead, put it in the black socket most nearly corresponding with your local supply voltage.

These three black sockets are marked "200," "230" and "250." If your voltage is 200, then the remaining flex lead must go in the first one. If, on the other hand, it is higher than that, then you must use whichever one of the remaining two sockets that applies to your circumstances.

Should your voltage be 215 or 240, you may be in doubt as to which of the sockets to use. In cases like this, always use the higher voltage tapping.

But the whole time that you are making adjustments to these sockets on the mains side of the transformer you *must* be careful to see that it is completely disconnected from the mains. The same precaution applies when you make any adjustment whatsoever to the adaptor.

### Perfectly Safe.

The adaptor has been designed in accordance with standard electrical practice, and it is perfectly safe in use. But, like all other electrical apparatus, it is not permissible to tinker about inside without first disconnecting it from the mains. Remember this simple precaution, and all will be well.

### PANEL DIMENSIONS

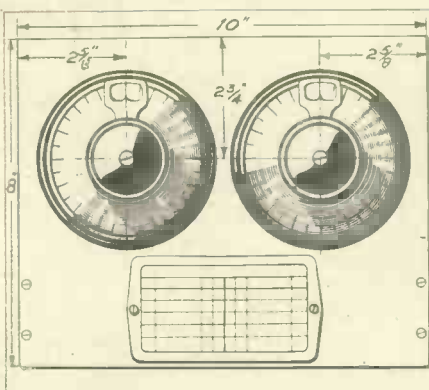

As in the case of the screen, the panel is ready drilled in the Peto-Scott "Structakit," which includes chassis, panel, fixing strip for resistances, and mains flex and plug.

I do not intend in this article to go into the question of operation in detail. It's a lengthy subject, and I did not want to curtail the constructional information in order to crowd it in. Next week I am going to tell you all about it, but in order that you may not have to kick your heels when

your adaptor is finished, I want to tell you just sufficient this week to enable you to give it a preliminary try-out.

First, then, a few words as to the way in which you should connect it to your existing set—a very simple matter. Leave the earth lead connected to the earth terminal on your set, but join a wire from that terminal to the terminal on the adaptor which is correspondingly marked.

### Connecting Up.

But the aerial lead-in should be removed entirely from the aerial terminal of your set and should be connected instead to the aerial terminal of the unit. The only other connection necessary, apart from the mains lead, is the one that goes from the adaptor to the aerial terminal of the set. This is the lead that is marked in diagrams "To 'A' on set."

These connections made, set the tuning dial (or dials) of your set to a wavelength of approximately 2,000 metres, switch on

remember that the right-hand dial must always be moved very, very slowly. The other one is not nearly so important and may be looked upon simply as a vernier tuning control.

### SCREEN DETAILS

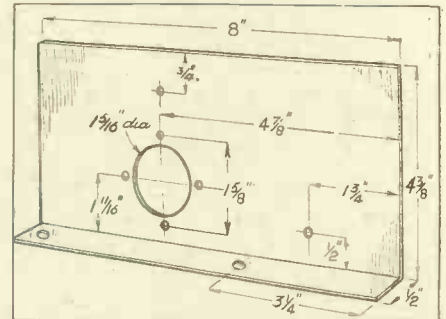

These details are for those who wish to make their own screen. Purchasers of the "Structakit" will find the screen already drilled for them.

### BENEATH THE CHASSIS

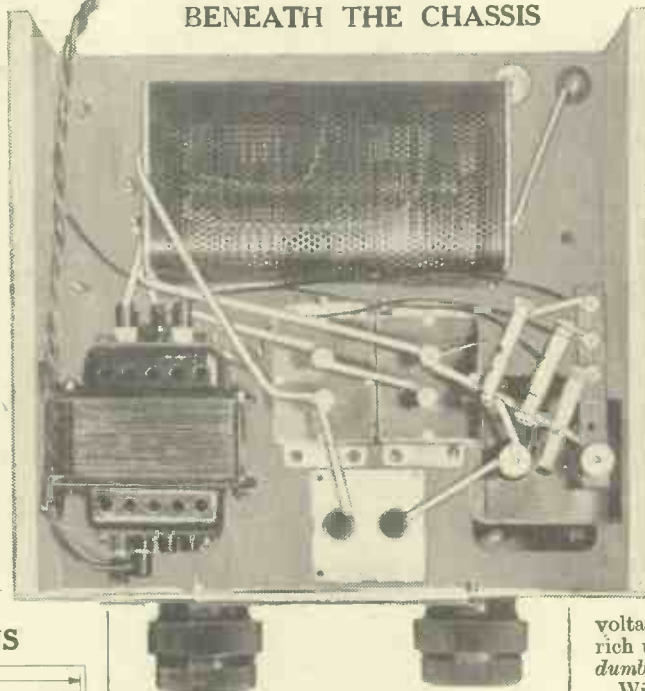

Next week I shall be dealing with this matter in detail.

## A MISFORTUNE AND A MORAL

MY set employs Class B output. This is fed to an extra speaker some distance away, and, to save expense, I ran the leads direct from the set without isolating the H.T. voltage.

And I used cotton-covered wire, wretch that I am.

What befell this foolish procedure you have yet to learn, and a sad tale it is, for my set was silenced just when I had invited a prosperous uncle to share its delights.

I had worked the set earlier in the day, but with some notion of keeping up the H.T. battery's

voltage I did not switch on again until the rich uncle had arrived. The set was almost dumb, being only a shade of its normal self.

With mumbled apologies I dug into the depths of the set. Soon the table was littered with transformers, condensers, valves, etc. My uncle kept up a show of interest, but finally looked at his watch and said he had to go.

### Those Extension Leads.

About half an hour after he had left I had the set connected up again and playing perfectly. And then I made a discovery. When I connected up the extension leads the set again became dumb.

Now, I had taken particular trouble when laying those extension leads to keep them well spaced. Only in one place did they approach at all closely. This was on a landing, so thither I repaired.

This is where the use of cotton-covered wire let me down, for bridging the three wires was a blob of soap, presumably left there by the charwoman. The soap being quite soft had penetrated the cotton covering of the wire and formed a path of low resistance between the wires. If they had had a glazed covering the same thing would not have happened.

W. N.

the set and plug in the adaptor mains lead.

I advise you to make the first test with the larger coils in the adaptor, and, by the way, put them in *before* you make the mains connection.

Having allowed time for the valves to "warm up," you can set about giving your adaptor its first test. This will not be a difficult matter, for, although there are two dials on the adaptor panel, only one of them is reasonably sharply tuned. That is the right-hand one looking from the front.

Start with both dials set at zero, and slowly—*very* slowly—advance the right-hand one for five degrees. Follow this up by a corresponding advancement of the left-hand dial. Then move the right-hand one another five degrees—again very slowly, and repeat the process with the left-hand one.

It is the movement of the right-hand dial which will enable you to tune in the stations, and as soon as you hear one, then it is simply necessary to adjust the other dial for best results.

It is of the greatest importance to



**WARNING!** Don't be misled—ONLY PILOT AUTHOR KITS contain the identical parts as used by the designers of the "P.W." Boom Sets in BRAND NAMES as well as valves. BUILD WITH A PILOT AUTHOR KIT and duplicate the "P.W." designers' results.



# PILOT AUTHOR KIT EXACT TO SPECIFICATION

## STENTORIAN SENIOR

TYPE PMS1.

**2/6**  
DOWN.

For Power, Pentode and Class B. Send only 2/6, balance in 11 monthly payments of 4/-. Cash or C.O.D. Carriage Paid, £2/2/0.



W.B. Stentorian Standard Model. Cash or C.O.D. Carriage Paid, £1/12/6, or 2/6 deposit and 11 monthly payments of 3/-.  
W.B. Stentorian Baby Model. Cash or C.O.D. Carriage Paid, £1/12/6, or 2/6 deposit and 9 monthly payments of 2/6.

## Peto-Scott LUCERNE S.G.3

Complete Kit of Parts for building, less Valves and Cabinet. Send only 2/6; balance in 11 monthly payments of 3/6. Cash or C.O.D. Carriage Paid, £1/19/6. Complete with Valves and Peto-Scott Walnut Table Cabinet. Cash or C.O.D. Carriage Paid, £4/2/0. Send only 5/-, balance in 11 monthly payments of 7/5.

**2/6**  
DOWN

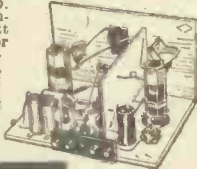

## BATTERY ST.600 VERSION

**KIT "A"** Comprising complete kit of components, as first specified by Mr. John Scott-Taggart, including Peto-Scott Ready-drilled Walnut-faced Panel, Metaplex baseboard, Ready-drilled plywood platform and Terminal Strip, and copy of "Popular Wireless" with free full-size blue print and S.T.'s 100-STATION "SPOT-ON" DIAL and other "P.W." FREE GIFT, less valves, cabinet and speaker. Cash or C.O.D. Carriage Paid, £4/19/6.

**YOURS FOR 7/6**

**KIT "B"** As for Kit "A", but including set of 4 first specified valves, less cabinet and speaker. Cash or C.O.D. Carriage Paid, £7/4/0, or 12 monthly payments of 13/3.

**KIT "CT"** As for Kit "A", but including valves and Peto-Scott S.T.600 table cabinet, less speaker. Cash or C.O.D. Carriage Paid, £8/1/6, or 12 monthly payments of 14/9.

**KIT "CC"** As for Kit "A", but including valves and Peto-Scott S.T.600 console cabinet with speaker baffle and battery shelf, less speaker. Cash or C.O.D. Carriage Paid, £8/19/0, or 12 monthly payments of 16/6.

## SIMPSON'S 1935 ELECTRIC TURNTABLE

THE PERFECT GRAMOPHONE MOTOR AT LAST! Low consumption, CONSTANT SPEED 1-HOLE FIXING, Darwin's Magnets, A.C. Mains only, 100/150 or 200/250 volts, 50 cycles, 12-in. turntable. Send only 5/-. Balance in 9 monthly payments of 4/6. Cash or C.O.D. Carriage Paid, £2/2/0.

**5/-**  
DOWN



## Peto-Scott Guaranteed H.T. ELIMINATORS

For A.C. Mains, 200/250 volts, 3 Tappings: 5.6, 60-v., Detector 80-v. Power 120/150-v. Output 25 ma. Incorporates Westinghouse rectifier. Send only 2/6. Balance in 9 monthly payments of 4/-. Cash or C.O.D. Carriage Paid, £1/15/0.

**2/6**  
DOWN



D.C. Model for D.C. Mains only. Similar specification, but without rectifier. Cash or C.O.D. Carriage Paid, 17/6, or 2/6 deposit and 7 monthly payments of 2/6.

# 1935 KELSEY S.W. ADAPTORS

MAINS VERSION

BATTERY VERSION



**KIT "A" CASH or C.O.D. Car. Paid £6:11:6**

Author's Kit of First Specified Parts, including Peto-Scott Type "M" Kelsey Structakit and set of 4 B.T.S. Coils, less Valve and Cabinet. **YOURS FOR 12/-** and 11 monthly payments of 12/-.

**KIT "B"** As for Kit "A", but including specified valve, less cabinet. Cash or C.O.D. Carriage Paid, £7/11/6, or 12 monthly payments of 14/-.

**KIT "C"** As for Kit "A", but including valve and Peto-Scott cabinet. Cash or C.O.D. Carriage Paid, £8/4/0, or 12 monthly payments of 15/-.

1 Ferranti VHT4 Specified Valve .. £1 0 0.  
If B.T.S. Mains Transformer required, deduct 2/6 from above Kit prices or 3d. from each monthly payment.

**KIT "A"**  
CASH or C.O.D.

**£3-3-0**  
Carriage Paid

Yours for **5/-**  
DOWN

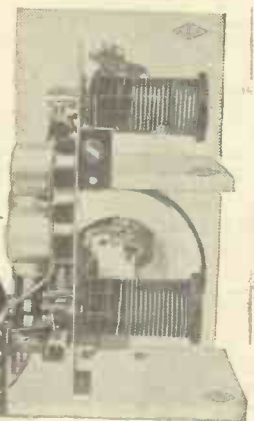

and 11 monthly payments of 5/9.

**KIT "A"** Author's Kit of First Specified Parts, less Valve and Cabinet.

**KIT "B"** As for Kit "A", but with specified Valve, less Cabinet. Cash or C.O.D. Carriage Paid, £8/12/0, or 12 monthly payments of 7/6.

**KIT "C"** As for Kit "A", but with Valve and Peto-Scott Cabinet. Cash or C.O.D. Carriage Paid, £8/12/0, or 12 monthly payments of 8/6.

1 FERRANTI VHT2 Specified Valve .. 18/6.

# STRUCTAKITS

MAINS VERSION

BATTERY VERSION

Complete Kelsey Type "M" Structakit, comprising 1 ready-drilled lacquered engine-turned aluminium Panel, 10 ins. x 8 ins., 3/-; 1 ready-drilled aluminium chassis, 10 ins. x 9 ins. x 3 1/2 ins., 4/9; 1 ready-drilled Screen, 8 ins. x 4 1/2 ins. x 1/6; 1 ready-drilled ebonite Strip, 3 ins. x 1 in., 3d. Mains Adaptor and Plex if required, 1/6 extra. **8/9**

Complete Kelsey Type "B" Structakit, comprising Burr Walnut Finish Paxolin Insulating Panel, ready drilled for eusectheon, 2 6; aluminium Screening Panel, ready drilled, 2/6; METAPLEX Baseboard, and Sub-baseboard Screen 1/3; Ebonite strip, "A" terminal, Paxolin strip, 2 valve supports, 1/3; 12 fixing screws. **8/6**

MAINS VERSION

# FINISHED INSTRUMENTS

BATTERY VERSION

Exact to Mr. G. T. Kelsey's First Specification. Aerial tested on actual broadcast. In Peto-Scott cabinet, as illustrated, specified and used. Complete with Ferranti VHT4 valve. Cash or C.O.D. Carriage Paid £9/0/0 or 17/6 deposit and 11 monthly payments of 16/6. **17/6**

Exact to Mr. G. T. Kelsey's First Specification. Aerial tested on actual broadcast. In Peto-Scott cabinet, Complete with Ferranti VHT 2 valve. Cash or C.O.D. Carriage Paid, £5/0/0, or 10/- deposit and 11 monthly payments of 9/3. **10/6**

MAINS VERSION

# CABINETS

BATTERY VERSION

**PETO-SCOTT Walnut CABINET** As illustrated and first specified and used by Mr. G. T. Kelsey. Cash or C.O.D. (Carriage and Packing, 2/6 extra.) **12/6**

**PETO-SCOTT Walnut CABINET** As first specified and used by Mr. G. T. Kelsey. Cash or C.O.D. (Carriage and Packing, 2/6 extra.) **10/6**

For full detailed list of parts of Battery Version, see our last week's advertisement.

# "B.C.L." TWO SHORT-WAVER

**KIT "A" £4:14:0**  
CASH or C.O.D. OR YOURS FOR Carriage Paid.

Author's Kit of First Specified Parts, less Valves and Cabinet. **7/6** and 11 monthly payments of 8/9.

For full detailed list of parts and Structakit, see our last week's advertisement.

**KIT "B"** As for Kit "A", but with set of 2 specified Valves, less Cabinet. Cash or C.O.D. Carr. Paid, £5/18/0, or 12 monthly payments of 10/9.

**KIT "C"** As for Kit "A", but with set of 2 specified Valves and Peto-Scott Table Cabinet. Cash or C.O.D. Carr. Paid, £6/15/6, or 12 monthly payments of 12/6.

**FINISHED INSTRUMENT.** Cash or C.O.D. Carriage Paid, complete with 2 specified Valves, £7/7/0, or 15/- deposit and 11 monthly payments of 13/3.

**PETO-SCOTT Co. LTD.** 77, P.W.6, CITY ROAD, LONDON, E.C.1. Phone: Clerkenwell 9406/7. West End Showrooms—62, HIGH HOLBORN, LONDON, W.C.1. Phone: Holborn 3248.

ANY ITEM SUPPLIED SEPARATELY—ORDERS OVER 10/. SENT C.O.D. CARRIAGE AND POST CHARGES PAID

# RADIOTORIAL

The Editor will be pleased to consider articles and photographs dealing with all radio subjects, but cannot accept responsibility for manuscripts or photos. Every care will be taken to return MSS. not accepted for publication. A stamped, addressed envelope must be sent with every article.

All Editorial communications should be addressed to the Editor, POPULAR WIRELESS, Tallis House, Tallis Street, London, E.C.4.

All inquiries concerning advertising rates, etc., to be addressed to the Advertisement Offices, John Carpenter House, John Carpenter Street, London, E.C.4.

The constructional articles which appear from time to time in this journal are the outcome of research and experimental work carried out with a view to improving the technique of wireless reception. As much of the information given in the columns of this paper concerns the most recent developments in the radio world, some of the arrangements and specialities described may be the subjects of Letters Patent, and the amateur and the trader would be well advised to obtain permission of the patentees to use the patents before doing so.

## QUESTIONS AND ANSWERS

### SPECIAL H.F. CHOKES FOR MAINS WORKING.

H. A. (Bristol).—"The list says 'Two H.F. chokes, special mains type.' Not having these on hand, will it be O.K. if I try ordinary H.F. chokes, as I have several by me, and could use two in series if that would be better?"

No, you must use the special mains type, as specified—in fact, it would be dangerous to do as you suggest. Ordinary chokes might burn out.

Unless you play fair by the set designer and keep to the parts he recommends you cannot expect to get results like the ones he obtained. This is especially important in the construction of sets running from the mains, where a departure from specification is always unwise and sometimes dangerous.

### FITTING FUSES TO A MAINS UNIT.

J. F. B. (Winchmore Hill).—"The main<sup>s</sup> unit is a metal-enclosed box, with full-wave rectifying valve, of American make. There is a slide for getting at the valve, when necessary, but most of the wiring is closed in, so I am not sure that the unit contains fuses."

"There are four flex leads, two for input and two for output, these latter being H.T. —

and H.T. +. Could I put fuses in these leads, in case there are none inside? If so, what values should they be?"

"I use a four-valve set, S.G., Det., L.F. and Super-Power."

It will be quite in order to insert fuses in the external leads, and provided they are placed right up close to the unit they will be as well there as inside it.

For your set a 150-mill-amp fuse will do for the H.T. Fit this in the H.T. negative lead.

On the input side it is advisable to use two fuses, one in each lead. Those that blow at 1 amp will be satisfactory.

### NEITHER IN NOR OUT!

D. W. (Bournemouth).—"I am keenly interested in the theory of electricity, and try to worry out the simpler problems, with the aid of what I learn at school."

"Can you help me to understand something that has been puzzling me a lot? It is about watts."

"I had copied down the formula for this, namely 'watts = volts × amps.' But now I have come across another formula for watts which is quite different, the second one being 'watts = amps<sup>2</sup> × ohms.'"

"I cannot see any connection between these two statements for the same thing (watts). Is there any connection, or is one of them wrong?"

"At first I thought one must be wrong if the other was right, but I have had it explained that they may both be right. I wish you could explain this, as it is very confusing to me."

Both formulae are correct, one being for use when you know the voltage and the current flowing (amps), and the other for use when, instead of the voltage, the resistance (ohms) is known.

You will see how they are related if you take a simple example and apply Ohm's Law.

Your first formula says watts = volts × amps. In practical form, suppose we had 4 volts and the current flowing was 2 amps; the number of watts will be 8, since  $4 \times 2 = 8$ .

Now, Ohm's Law states that volts, amps and ohms are all inter-related, and if the volts and amps are known you can always tell how many ohms are concerned.

In the instance given above we do know the volts and the amps; so, according to the late Mr. Ohm, we can find the number of ohms concerned from the information given. His law states  $\text{Ohms} = \frac{\text{Volts}}{\text{Amps}}$

Therefore, in our particular instance, there must have been 2 ohms in the circuit, since  $\frac{4}{2} = 2$ .

Armed with this information, we can check the second formula to see if it agrees with the first. The second formula is  $\text{amps}^2 \times \text{ohms} = \text{watts}$ .

Working this out with our values (2 amps and 2 ohms) obtained as above, we square the amps ( $2 \times 2$ ) and get 4, which, when multiplied by the 2 ohms, gives 8 watts as the answer.

As you see, this confirms the first result. (Since the related quantities can always be worked out in this way, you may wonder why the answer, instead of being obtainable from several formulae, in several ways, is not always worked out from the one fundamental formula.)

It is merely a matter of convenience, and the engineer may have as many as a dozen formulae in common use for obtaining an answer; they are all different expressions of the same rules, and all of them lead to the same answer, their variety merely representing the variety of ways in which the problem may present itself in practice.)

### THE BEST L.T. SUPPLY.

"JANUS" (Kent).—"The only trouble with my set during the past three years has been L.T. current supply. Can you tell me of any means by which the 2 volts could be obtained without recourse to charging stations or mains current?"

"I hire an accumulator (a) for a week, 6d. In two days it is useless."

"Taking (a) to be recharged, borrow (b), 6d. Finally, pay for (a), 6d. on return—1s. 6d. weekly!"

(Continued on next page.)

## THE S.T.600

The accompanying scale shows the long-wave portion of the "Spot-On" dial with the station positions corrected to suit the Colvern coil unit. S.T.600 constructors should note that the scale is full-size.

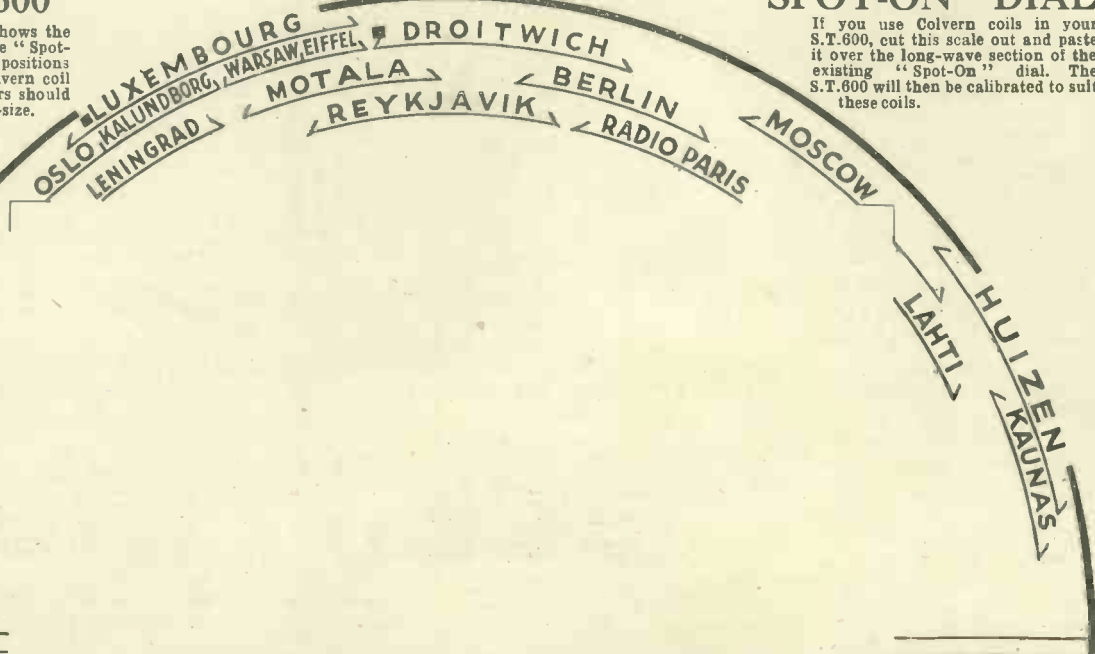

## "SPOT-ON" DIAL

If you use Colvern coils in your S.T.600, cut this scale out and paste it over the long-wave section of the existing "Spot-On" dial. The S.T.600 will then be calibrated to suit these coils.

## RADIOTORIAL QUESTIONS & ANSWERS

(Continued from previous page.)

"H.T. only costs me 3d. per week and gives timely warning for replacement.

"How did Mr. Marconi get current for his experiments in 1895? There were no motors running about with accumulators and no electric supply within twelve miles. Also how was the P.O. telegraph worked in, say, 1870?

"Is it impossible to get shot of these accumulator people at any cost?"

We are not surprised that you are feeling sore about it, for you appear to be paying far too much. However, there are other possibilities.

You do not say what sort of set yours is, or whether it is working all day long or for only several hours, like most people's. If we can assume that your requirements are only like those of the average listener the trouble would appear to be either that

(a) Your set is faulty, so that when the newly charged accumulator is connected it is wrongfully run down by faulty wiring or something of the kind. Or

(b) The accumulators which are being supplied are far too small for the purpose.

Either of these explanations would account for your experience, so you must first determine what is wrong.

This should not be difficult, especially if you know of anybody in your neighbourhood using a set similar to your own. Compare the cost of his charging with yours (you should find it much lower, for you are paying much more than would appear to be warranted), and then, if possible, change over to the same form of supply as he uses.

Or, if you know of no such neighbour, drop a line to the Technical Department of one of the leading battery firms, explaining what sort of set you use

### S.T.600 QUERIES

We greatly regret that owing to the unusually large number of queries received during the last few weeks there has been a certain amount of delay in answering readers' questions by post. Steps have been taken to cope with the tremendous demand on the services of our Query Department, and although letters are still flooding in we can assure readers that every effort is being made to reduce the delay.

and asking what battery of theirs will suit it best. (They can tell from the valves used how often their battery will require recharging, and they can work out for you just what it should cost you per month.)

We advise either of these courses in preference to other means of obtaining L.T., because they are easier and sure to be satisfactory. Despite your experience, the modern L.T. battery is a very economical proposition. As the result of listeners' demands it is far in advance of the older-fashioned batteries, being more robust in use and cheaper than other forms of L.T. supply.

This only applies, of course, where the battery suits the set, because an unsuitable battery is always more expensive than the proper one.

By changing over to a supply known to be satisfactory for your type of set you would either get immediate improvement in the service rendered, or else prove that the set itself was wrong, in which event the remedy would be obvious.

If, however, you were to try the earlier forms of primary battery, such as used in the last century, you would be throwing away the benefits of all the progress made since then.

We are sure you will be satisfied if you get a good modern L.T. battery of suitable type, for it will run at least a week at a time without recharging, and can be recharged for a few pence.

### INSTABILITY ON LONG WAVES.

A. G. W. (Leicester).—"I get a soft motor-boating effect on long waves, but the quality on medium waves is first class. Also the stability on medium waves.

"With the idea of improving stability on long waves I took the hint given in 'P.W.' and fitted an extra H.F. choke in the S.G.'s anode lead, so there are now two there instead of one. It was much less troublesome after this, so I am on right lines.

"Would a second choke in the detector circuit be likely to do any good? And is there anything else I can try to stop the

(Continued on next page.)

# EXCLUSIVELY SPECIFIED FOR THE "4-valve Super"



MODEL PMS1

### WHAT SOME USERS SAY:

"It has given my set a new lease of life. I could not have believed my set (a home constructed 3-valve) capable of such vivid realism. I am proud of it now, thanks to your great achievement."  
—A.S., Berkhamstead.

"... In fact, no words of mine can express my feelings about this masterpiece of loudspeaker art and I can only say that from henceforth W.B. Stentorian is my motto, and I am proud of it."  
—A.H.K., Brierley Hill.

"I cannot speak too highly of this marvellous instrument."  
—G.H.N., Altrincham.

"The claims you make are in every way justified. Reproduction is almost unbelievably natural."  
—D.D., Chesham.

"I have at last got the perfection I have always wanted—through getting your W.B. Stentorian."  
—H. McA., Sheffield.

"Extreme sensitivity . . . quality is all that could be desired . . . no resonance points could be detected . . . I congratulate you on a really first class instrument."  
—Hon. Sec., Kentish Town and District Radio Society.

Ask your dealer about the newest "Stentorian" model, the "Baby," complete in walnut-veneered cabinet at the astounding price of 29/6.



It is a remarkable fact that of the designers of the many constructor receivers published in various journals since August last, over 95% have specified a W.B. "Stentorian" speaker as author's first or exclusive choice.

This revolutionary instrument marks as important a step forward in speaker design as has ever been known. The exclusive magnetic material, giving double sensitivity at equal cost, and the unique Whiteley speech-coil, with the vivid new realism it brings, must make an amazing difference to any set.

The consistent manner in which famous technicians have pinned their faith to W.B. Stentorians should be sufficient proof of these statements. If you want further evidence, ask your dealer to demonstrate. You will never again be satisfied with anything else!

Stentorian Senior (PMS1) - - 42/-  
(100% dust protection. Oversize cone)  
Stentorian Standard (PMS2) - 32/6  
Stentorian Baby (PMS6) - - 22/6

Write to Information Department for the new Stentorian Leaflet.

# STENTORIAN

## PERMANENT MAGNET MOVING-COIL SPEAKERS

Whiteley Electrical Radio Co., Ltd., Dept. A, Radio Works, Mansfield, Notts.  
Sole Agents in Scotland: Radiovision Ltd., 233, St. Vincent Street, Glasgow, C.2.  
Sole Agents in I.F.S.: Kelly & Shiel, Ltd., 47, Fleet Street, Dublin.

# INTERNATIONAL RADIO BUREAU

take pleasure in announcing the following additions to the range of kits awarded their **DIPLOMA OF MERIT**, and which are available from the Bureau's Supplies Department with the **DIPLOMA-GUARANTEE**—an additional safeguard guaranteeing **EVERY COMPONENT** in the kit.

The **DIPLOMA "B.C.L." 2-Valve Short-Wave Kit**, guaranteed packed **EXACTLY** to Author's **FIRST** specifications throughout. **NO SUBSTITUTES**.

- |                                |   |    |    |
|--------------------------------|---|----|----|
| <b>DIPLOMA "B.C.L." Kit A</b>  | £ | s. | d. |
| (no valves)                    | 4 | 14 | 0  |
| <b>DIPLOMA "B.C.L." Kit AV</b> |   |    |    |
| (with valves)                  | 5 | 18 | 0  |

The **DIPLOMA "KELSEY" 1935 S/W Adaptor Kit**, guaranteed as above.

- |                                       |   |    |    |
|---------------------------------------|---|----|----|
| <b>DIPLOMA "KELSEY" Battery Kit A</b> | £ | s. | d. |
| (no valve)                            | 3 | 3  | 0  |
| <b>Kit AV</b>                         | 4 | 1  | 6  |
| (with V.H.T.2 valve)                  |   |    |    |

- |                                     |   |    |    |
|-------------------------------------|---|----|----|
| <b>DIPLOMA "KELSEY" Mains Kit A</b> | £ | s. | d. |
| (no valve)                          | 6 | 10 | 0  |
| <b>Kit AV</b>                       | 7 | 10 | 0  |
| (with V.H.T.4 valve)                |   |    |    |

And, for the first time, a good-class **Experimental Kit** for **Television Enthusiasts**—an ideal **Beginner's Kit**, easily assembled:—

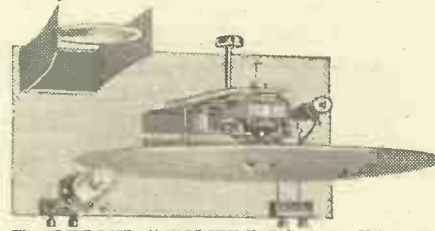

- The **DIPLOMA "WOLSEY" Television Kit**, comprising:
- 1 Eight-letter Stroboscopic Scanning Disc for B.B.C. Broadcasts.
  - 1 Universal A.C.—D.C. Motor.
  - 1 Mervyn NU—GLO Lamp.
  - 1 Pair Motor Brackets.
  - 1 Superfine 4-inch Lens.
  - 1 Variable Motor Control.
  - 1 Fixed Resistance.
  - 1 Lensholder. 1 Baseboard.
  - 1 Lampholder. 1 Lamp Bracket.
  - 2 Terminal Blocks. 2 pairs Terminals.
  - Sundry Screws. Circuit Diagrams.
- Full instructions. (Leaflet 14d. stamp).
- DIPLOMA "WOLSEY" TELEVISION Kit. COMPLETE** in two Packages: 72/6.

**DIPLOMA S.T.600 Kit A** (see "Popular Wireless" 27/10/34, page 252 £4 : 19 : 6 Complete Battery Kit (without valves) to Scott-Taggart's first Specification.

**IMMEDIATE DELIVERY — ORDER TO-DAY ● ALL GOODS CARRIAGE PAID FREE ● CASH WITH ORDER OR C.O.D.**

**EVERY RADIO — NO SUBSTITUTES**

EVERY RADIO REQUIREMENT: VALVES — SPEAKERS — SETS — COMPONENTS, etc. Order your needs to-day from the postal service specialists; all goods brand new, guaranteed, delivered immediately, cart. paid, list prices for cash with order or C.O.D. (Pay the postman).

**INTERNATIONAL RADIO BUREAU** 260, DEANS GATE MANCHESTER.

## RADIOTORIAL QUESTIONS & ANSWERS

(Continued from previous page.)

trouble and get good reception on the long as well as on medium waves?"

If the extra choke made considerable difference we think it is probable that if you proceed on the same lines (i.e. keep the H.F. component out of the L.F. stages) you will clear up the fault.

The extra detector choke is well worth trying, and also a by-passing condenser of about .0002 mfd. between the anode side of the choke and earth. We assume this valve is well decoupled; if it is not, a decoupling resistance and condenser should be fitted.

### ADJUSTING ANODE DISSIPATION.

E. C. (Grantham).—"According to the makers, the correct anode dissipation is obtained when the valve's bias is adjusted so that the anode current in milliamps corresponds with the ratio: Ia (m.a.)=

$$\text{Max. permissible dissipation (watts)} \times 1,000$$

Anode volts

"I do not understand this. What does the 'Ia (m.a.)' part mean? How can Ia be milliamps, which I take 'm.a.' to mean?"

The various terms used in radio engineering are often rather puzzling, and this at first sight is one of them. The capital "I" indicates current, and the small "a" stands for anode, so "Ia" means anode current. Thus the formula states that if the maximum permissible dissipation (in watts) of the valve in question is multiplied by 1,000, and the product is divided by the anode volts applied, the answer should be the same as the number of milliamps in the plate circuit.

We think that re-statement will clear up the difficulty.

## AN EVENING WITH THE 1935 KELSEY ADAPTOR

(Continued from page 688.)

Aires LSX on 28.98 metres, but I am convinced that he could not have been on this particular evening because usually I can hear him quite well.

Just above EAQ I found Daventry GSC, and although there is not much interest in listening to our own Empire transmitters I waited sufficiently long to identify the station simply because it is on the identical setting that VK3LR, Lindhurst, Victoria, Australia, is tuned in from 8.15 a.m. to 12.30 p.m. daily.

On Sunday's, too, another Australian station, VK2ME, Sydney, can usually be heard quite well a fraction below this setting.

"Going up" I next found Zeesen, or perhaps I should say that Zeesen found me, for this German station on 31.38 is so very strong that it is absolutely impossible to miss it. Incidentally, announcements are made in English quite often.

After a spasm of very mediocre W2XAF, I changed over to the larger coils and tuned immediately to 140 degrees on the oscillator condenser. That's the place to find the best stations on these coils and the very first one I logged was W8XK, Pittsburg, Pennsylvania, on 48.86 metres. This station was received literally at terrific strength, and I was forced to use the set volume control to obtain comfortable listening conditions.

I found several other stations within a few degrees above and below 140 degrees, among which may be mentioned Moscow RW72 on 45.38 metres, Bound Brook, New Jersey, on 46.09 metres (WXAL), Chicago W9XF on 49.18 metres and Rome 2RO on 49.3 metres.

## THOSE INEVITABLE COMPARISONS

Dance-band crooners—both sexes — are discussed among other subjects this week, by our broadcasting critic.

MR. BRENT WOOD of the north isn't the only dance-band enthusiast who studies the methods of the different bands. I do it myself. If all dance bands will play the same tunes it is only to be expected that we listeners will compare them. Before Mr. Wood enlightened us on his studies I had come to the conclusion that few of the men crooners could hold the candle to one lady crooner in that number "My Kid's a Crooner." In fact, some of the male versions of this popular song are very crude. One in particular shows a total misunderstanding of the *boo boo boos* and the *che che ches* that appear in the lines. This male cannot know much about "kid" language. Now, the female crooner has surely justified her existence—even if she hadn't before. In my opinion, the best version of "My Kid's a Crooner" is that of Henry Hall's lady.

The relay from the Argyll Theatre, Birkenhead, is now augmented by a turn from the *compère*. Mr. Herbert Aldridge told a number of stories the other night, some good and others not so good. The relay was, as usual, good—better, perhaps, than the reception down south.

The gramophone is no doubt the biggest broadcaster of all. At home, as well as abroad, it appears every day. What an extensive repertoire it has, too! It doesn't always please, but what broadcaster does? It was on the Regional the other night, with a group of songs labelled "Country Roundabout." This was a first-rate selection. I may have doubts about Delius' "Song Before Sunrise," although that's a question of taste. The announcer on this occasion was obviously as impressed as I was, and at the end quoted some lines which he thought were a fitting epilogue to the programme. I reproduce them here: "We have been to the same country; we have seen the same flowers; we have heard the same songs we are friends."

The two small plays of the week, "A Farewell Supper," by Arthur Schnitzler, and "In the Shadow," by Horton Giddy, were enough to remind us of the Drama Department's existence and that something big may be in the offing. I thought "In the Shadow" had all the ingredients of a first-rate short story. As a play it provided the Effects Dept. with a really good night out. They overcame their difficulties with much ingenuity. Mr. Horton Giddy appears to possess considerable first-hand knowledge of the sea in general and of destroyers in particular. This was the play's main interest.

We welcome Monsieur Stéphan back to the studio after several weeks' absence through illness.

A welcome also to Mr. S. R. Littlewood, who is making his first appearance. He follows distinguished people in the talks on the theatre. He made a good impression in his first talk. He has both age and experience of his subject to his credit, and his professed interest in the doings of repertory and amateur companies made me fall for him at once. There seems to be no very soft spot at the B.B.C. for the amateur player. I hope that all amateurs will support Mr. Littlewood by lending him their ears throughout the session.

I was also impressed by Miss E. M. Delafield, who talked about new novels. She speaks fearlessly and plainly, and gives us just the information we want about the very books we want to hear discussed. She is careful, too, to warn the squeamish when necessary. A very useful service, this!

I wished one or two turns in "One Crowded Hour" could have been crowded right out. I have no grouse against the speed of the show. I am all for speed in this sort of thing, but the quality of some of the turns was terribly below standard. The well-tried favourites were quite up to scratch, however. Some of the newcomers made promising debuts.

It is no enviable job to succeed a personality like Gerald Heard. I've often wondered what percentage of non-scientific listeners have listened to these "Science in the Making" talks regularly. Don't let the title scare you. These talks are meant for the layman as much as for the budding scientist. I always found Mr. Izard intensely interesting.

Dr. John Baker, who steps into Mr. Heard's shoes, has a rare sense of humour. He forestalled the listener in his opening talk on the "Salivary Glands

(Continued on next page.)



## THOSE INEVITABLE COMPARISONS

(Continued from previous page.)

of the Insects" by jeering himself. "But wait a moment," he seemed to say. We did, and to our advantage, too. I can't help feeling that Dr. John Baker is going to be one of the big hits of the New Year.

"The Life of Offenbach," like its forerunners in the series, proved an attractive way of advancing our musical knowledge. "The Life" was quite well done, although it came as a bit of a shock to me to hear the famous composer at the age of 17 speak with a piping soprano voice. Is this historically correct?

After the excitement of the Christmas season broadcasts the week's fare struck me as being more than usually unimaginative. It has been a return to ordinary routine work with a vengeance. But this is inevitable and, perhaps, as it should be. We wouldn't enjoy the B.B.C.'s red-letter days half as much if its calendar were full of them. All the same, I think a relay of one of the Cup-tie matches wouldn't have come amiss. The eye-witness accounts, good as they are, are a poor substitute.

C. B.

## WITH THE EXPERIMENTER

(Continued from page 679.)

This theory of the aerial being reflected as a sort of image in the earth is still held. The image is not perfect, because the earth is not a perfect conductor.

Connecting to earth does make an enormous amount of difference to signal strength. A transmitter would be a sorry performer without an earth—except in some special short-wave arrangements.

### Those Bad Contacts.

It is on the receiving side that the invariable necessity for an earth might be questioned, I think. Most of the resistance of the usual type of aerial-earth system is in the earth itself—and this is where losses occur if the earth is poorly made.

Conditions of reception to-day are quite different from what they were when Marconi first earthed his transmitting aerial. Stations have vastly increased their powers. Receivers have equally stepped up their sensitivity.

The use of an earth is as theoretically valid to-day as it was way back in 1895, when Marconi startled the world by transmitting over a mile by wireless near Bologna, Italy. But in practice it is obvious that the invariable necessity for an earth has vanished.

Just think of some of the ghastly aerial and earth systems you personally know about. Corroded and pitifully thin leads going perhaps 50 ft. or more to a problematical earth connection. To a tube or plate having the lead twisted—not soldered—to some ineffective part of the mildewy metal. Awful!

### When No Earth is Better.

No wonder I hear listeners so often remarking: "My set works just as well without the earth—so I have scrapped it." This, by the way, pleases the wife no end. It means one less trailing wire for her to contend with.

If bad earths suffered this fate always I, for one, would not lose any sleep. The trouble is that they are often left connected, doing all kinds of damage to reception. Flat tuning, for instance. Crackles, for another thing. Failure to oscillate, for a third. And so on. Better no earth than

(Continued on next page.)

# BULGIN COMPONENTS

for the  
"B.C.L." TWO  
SHORT WAVE SET

Bulgin. S.W.21. Valveholders	- - 1/6 ea.
Bulgin. H.F.8. Midget Choke	- - 2/3 ea.
Bulgin. Wire-end Resistances	- - 1/- ea.
Bulgin. S.80. Q.M.B. Switch	- - 1/6 ea.

The word "BULGIN" is in itself almost a complete specification. It denotes good design, proved performance and reliability. Use Bulgin components wherever possible and be assured of securing maximum results—entire satisfaction.

for the  
1935 "KELSEY" S/W  
Adaptor (Battery Model)

Bulgin. V.H.22. Valveholder	- - 1/6 ea.
Bulgin. V.H.10. Valveholders	- - 6d. ea.
Bulgin. H.F.8. Midget Choke	- - 2/3 ea.
Bulgin. Wire-end Resistances	- - 1/- ea.

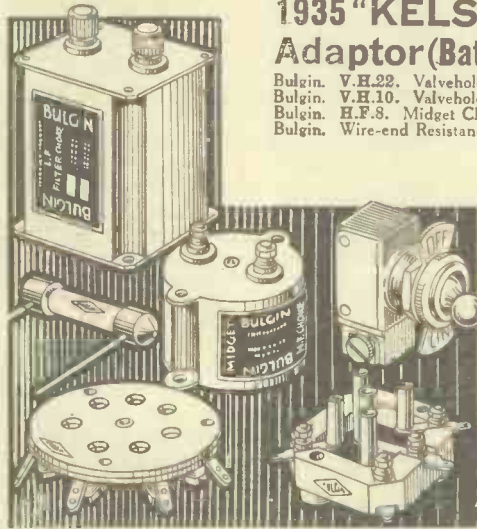

for the  
1935 "KELSEY" S/W  
Adaptor (Mains Model)

Bulgin. S.W.21. Valveholders	- - 1/6 ea.
Bulgin. V.H.11. Valveholder	- - 9d. ea.
Bulgin. H.F.9. Standard Choke	- - 3/6 ea.
Bulgin. Wire-end Resistances	- - 1/- ea.
Bulgin. L.F.16. L.F. Choke	- - 7/6 ea.

Large stocks available for immediate delivery.

**A.F. BULGIN & CO. LTD.**  
 ABBEY ROAD BARKING ESSEX  
 TELEPHONE: GRANGEWOOD 3766-7

## 1935 EDITION... FREE!

A New and greatly enlarged edition of "ENGINEERING OPPORTUNITIES" is just off the Press. It describes the easy way in which you may become an A.M.I.C.E., A.M.I.Mech.E., A.M.I.E.E., A.M.I.A.E., A.M.I.W.T., etc., and contains the world's widest selection of courses in all branches of Civil, Mech., Elec., Motor, Aero., and Radio Engineering, Building, etc.

If you are earning less than £10 per week, you cannot afford to miss this unique guide to a first-class job.

**268 PAGES!**  
**Free!**

**DON'T DELAY**—send for your FREE copy of the Handbook to-day. No cost or obligation of any kind.

**THE BRITISH INSTITUTE OF ENGINEERING TECHNOLOGY,**  
 101, SHAFESBURY HOUSE,  
 29/31, OXFORD ST., LONDON.

WE invite readers to support our Advertisers—care being taken to accept only announcements of reputable firms!

Your **EXTENSION SPEAKER** must be a **ROLA**

**THERE'S A REASON!**  
 Write for Chart just published showing Correct Extension Speaker for all British Receivers

THE BRITISH ROLA CO., LTD.  
 MINERVA RD., PARK ROYAL, N.W.10.  
 Phone: Willersden 4322-3-4-5-6

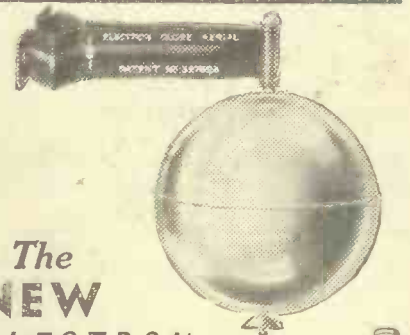

The **NEW ELECTRON-GLOBE AERIAL**

is specially designed for modern sets in particular.

Gives a much more selective and better balanced reception on all mains than any other aerial without reducing volume. Electrical interference practically, if not completely, eliminated. Attractive appearance. Easily fixed anywhere.

**STANDARD ALL COPPER MODEL 15/-**  
**DE LUXE CHROMIUM PLATED MODEL 21/-** Carriage Paid

Obtainable from Wireless dealers or send remittance direct to:  
**THE NEW LONDON ELECTRON WORKS LTD.,**  
 East Ham, London, E.8.

# EASY TERMS

We specialise in the supply of all good quality Radio sets, components, and accessories. Send list of requirements and keen quotation will be sent promptly. Cash and C.O.D. orders despatched by return of post.

## SEND 7/- GARRARD RADIO-GRAM UNIT

Model A.C.6, complete with volume control, ready for use. This unit converts any radio receiver into a high-class radiogram for A.C. mains. Cash price £4 0 0, or 7/- with order and 11 monthly payments of 7/4.



## SEND 2/6 W.B. STENTORIAN

SENIOR P.M. SPEAKER. Cash Price £2 2 0, or 2/6 with order and 11 monthly payments of 4/-.



STANDARD P.M. SPEAKER. Cash Price £1 12 6, or 2/6 with order and 11 monthly payments of 3/-.

## SEND 5/- ATLAS H.T. ELIMINATOR

Model T. 10.30, with trickle charger. For Q.P.P. and Class B and all types of sets. Output 30 Milliamps, 3 H.T. tappings. Cash Price £3 9 6, or 5/- with order and 12 monthly payments of 5/11; for A.C. mains.



ALL CARRIAGE PAID.

Estd. 1925 THE LONDON RADIO SUPPLY COMPANY 'PHONE NATIONAL 1977

# LONDON RADIO SUPPLY COMPANY

11 OAT LANE - NOBLE STREET - LONDON, E.C.2

## LOUD SPEAKERS REPAIRED 4/-

(Blue Spot a Speciality, 5/-) Transformers and Headphones, 4/-, Eliminators, Mains Transformers and Moving Coils quoted for. 24-Hour Service. Trade Discount. Clerkenwell 9069. E. MASON, 44, EAST ROAD (near Old Street Tube Station), LONDON, N.1.

## Obtain Your 1935 Kelsey Short-Wave Adaptor from Short-Wave Experts

FINISHED INSTRUMENT

Complete instrument, ready built and aerial tested to Mr. G. T. Kelsey's specification, complete in walnut cabinet.

Battery Model. Cash or C.O.D. Mains Model. £3-15-0 Carriage Paid. £7-16-6 Less Valve.

1 Set of 4 Unit Radio Short-wave Coils as approved for the 1935 Kelsey Adaptor. 12/- Per Set.

## THE "B.C.L." TWO SHORT-WAVE SET

Complete instrument built to specification, aerial tested. Complete in Walnut Cabinet. Less Valves.

Cash or C.O.D. £5-17-6 Carriage Paid.

Send for Illustrated Leaflets.

## UNIT RADIO 12, Pulteney St., London, N.1.

Tel: Terminus 5382.

PLEASE be sure to mention "POPULAR WIRELESS" when communicating with Advertisers. THANKS!

## WITH THE EXPERIMENTER

(Continued from previous page.)

a bad one. That, at least, can be said without fear of raising a storm.

What is a good earth? Perhaps the nearest approach is a large metal plate arranged just above the earth, but insulated from it. An impracticable arrangement, I fear. But some clever research men have shown that the same result can be obtained with an earth screen, which can consist of two wires 30 ft. apart erected two or three feet above the earth.

If these are placed symmetrically each side of the horizontal portion of the aerial wire the total resistance of the system need not be more than a few ohms; whereas a poor earth connection can send up the resistance to as much as 50 ohms.

### Very Treacherous Things.

Even quite efficient-looking earths can be veritable snakes in the grass. One man I know nearly went into a decline because of the queer effects produced by his water-pipe earth. I found his wife's washing machine was connected to the same system. As was, incidentally, the telephone.

He cured the cross interference only when he took Voltaire's advice and dug in his garden—dug until there was a big enough hole to bury a copper plate with seven-stranded earth lead.

Some bright fan will tell me that an earth is essential with a mains set to stop the hum. Quite true—when the smoothing is poor. One of the finest ways to show up inadequate smoothing is to take the earth off. All the same, with any mains apparatus I am inclined to advise earthing.

## TWO VALUABLE COMPONENTS

### THE FERRANTI REJECTOR.

THE problem of interference becomes more and more acute with the increases of power of the various stations, and during the winter the condition is aggravated by the greater facility with which the transmissions "come over."

When, in due course, Droitwich broadcasts on medium waves many listeners will find themselves thinking of the necessity of doing something drastic.

Such simple expedients as using a small-series condenser in the aerial circuit and physically shortening the aerial are seldom very satisfactory, because to obtain the desired effect in this way often means a great reduction in the sensitivity of the set and the consequent loss of volume and programmes.

But there is a method of cutting out or reducing the strength of unwanted stations, and this is to use a wavetrap. Though not any wavetrap, for there can be nothing in which varying effectivenesses are so marked as in wavetraps.

The experiences of many listeners with wavetraps may have been unfortunate for this reason, but the effect of using a really good one can be surprising.

Of the several different types of wavetrap the rejector type is the most successful. It comprises a complete tuned circuit in series with the aerial. When this circuit is tuned to the wavelength of the interfering station it offers a high impedance to it. In so far as that one particular station is concerned the rejector is to all intents and purposes an H.F. choke.

Its efficiency will depend upon its efficiency as a tuned circuit, and we presume it is in forgetting this and thinking of a wavetrap as merely a "little coil and a little condenser" that so many wavetrap producers go wrong.

In a way it is rather amusing that Ferranti, Ltd., producers of million-volt man-made lightning and colossal grid-scheme machines, should include in their recent activity the issue of a wavetrap (weight, 8 ounces); but the comparison between an untemper K.V.A. generator or transformer as big as a house (or cottage, anyway) and a wavetrap on the score of dimensions is not fair, for who is there to say that the Ferranti Rejector is of less import to the public at large?

Being Ferranti, it is a scientific manufacture, an

article designed to do a certain job and able to do that job as well as it can be done.

And it costs 7s. 6d., and is therefore as cheap as, if not cheaper than, any other rejector.

The wave-range of the Ferranti Rejector is limited to about 100 metres, because it is not possible to obtain such a high efficiency as has been obtained in it unless this is done. But the rejector is available in various ranges, so that you give the wavelength of the station you want to cut out when you order the rejector.



There are two terminal plugs to this Ferranti rejector and by altering the position of one of the plugs the unit can be cut in or out of circuit.

For example, it might be 479 metres, in which case you would be supplied with a rejector having a tuning range of 440 to 550 metres.

If you want to cut out two stations you can use two of these fine rejectors in series.

We tested our sample Ferranti Rejector after dark, using an insensitive set on which the local spurs in the swamps in; but the Ferranti Rejector silenced it easily enough and, moreover, left the receiver with its full distance-piercing powers, except for a tiny tuning patch embracing adjacent tuning channels.

The Ferranti Rejector is an accessory listeners can recommend to their friends in trouble with local-station interference, with the assurance that there will be very full thanks and no "come-back" from their helpful action.

### STOPPING CORROSION.

THE usefulness and reliability of a well-made accumulator cannot be denied. It will supply a steady and unfluctuating current for the heating of valve filaments without the slightest trouble, so long as it is looked after at least moderately carefully.

But there is one drawback in the kind most commonly employed, and this is the presence of a corrosive fluid, i.e. sulphuric acid. Mind you, the sulphuric acid in an accumulator is not by a long way as fiercely dangerous as some people would seem to think.

It is used in a fairly weak solution, and so it doesn't usually eat away things with the rapidity required of the fluid by villains in novels.

As a matter of fact, if you have on hand, or, at any rate, available somewhere in the house, either some ammonia or some bicarbonate of soda, you can generally quite successfully deal with any slight spilling or splashing of the acid solution on to carpets, etc.

A new Clix spade terminal which is coated with lead to resist corrosion when used on an accumulator.



Should you get a little on the hand, merely holding the hand under a running tap will generally suffice to prevent skin discoloration. We don't even mention "burns," you will note! You'd have to let the solution rest on the hand for a period before you would get these occurring, and we don't suppose anyone would be so foolish as to do that.

But, when all this is said and done, there still remains the fact that the sulphuric-acid solution of an accumulator is sufficiently potent to work havoc on terminals and other such things by corrosion (and corrosion, if slow, is insidious).

At least, on some terminals, for you can obtain a special kind which completely resists an attack by acid which might get to it by creeping or spraying.

We refer particularly to a new Non-Corrosive Spade Terminal of a heavy-duty type made by Messrs. Lectrolinx, Ltd., of 79, Rochester Row, London, S.W.1. It bears the familiar brand name of "Clix."

This spade terminal is coated with lead, and lead is the best possible safeguard against acid attack. With either a red or black insulating portion to denote the polarity of the lead with which it is used, it costs only three pence, and we might mention that it is also obtainable nickel plated.

Now it should be noted that this terminal has been designed to take wire up to a diameter of 3/16th in., and so, while it is ideal for accumulators, especially charging installations, it is also very useful for aerial and earth leads, as it enables these to be taken straight to the set without a break.



AS I write it is snowing hard, the wind is blowing and—Turner Layton is singing *June in January!* It wants a little imagination to feel as warmed up as the singer would have us, but though I am not so struck with the melody of this number as I was with "Smoke Gets in Your Eyes" I agree with the gramophone pundits that they have got another hit. The fact that Bing Crosby sings the number in his latest film—yet to be released over here—is a good recommendation, for Bing rarely backs an "also-ran."

This record of Layton is excellently recorded, and whether or not you like to mix winter and summer you should hear the other side of the disc, on which some technical gymnastics with the voices of Layton and Johnstone have been done. And done very well, too! The recording starts off with the famous duettists singing *I'm Lonesome for You, Caroline*, and all goes as usual till the last chorus, when a "quartette" takes up the harmony. The voices are unmistakably those of Layton and Johnstone plus—Layton and Johnstone! Another double recording most successfully carried out. (Col. DB 1485.)

Albert Sandler's records are always good for some light musical entertainment, and his latest—*Melody at Dusk* and *Daybreak*, both by Reginald King, who plays the piano on the record—is no exception. It is good—but why the introductory ballyhoo? The name of the composer is on the disc, it needs no further emphasis, but I, for one, welcome this record to my light orchestral records. (Col. DB 1480.)

**Alfreda Plays Straus Items.**

Equally welcome is the *Memories of Old Vienna*, in which gems by that genius Straus are played by Alfredo and his Orchestra on H.M.V. B 8256. As one would expect, it is a tuneful record, and one that can be played over and over again without losing its charm. Truly Straus is of the immortals!

*One Good Tune Deserves Another*, by Geraldo and his Orchestra, is quite a pleasing number, even though its vocal refrain is guilty of certain inaccuracies in natural history. Presumably the cuckoo, who does sing "on the wing," would hardly express the writer's sentiment, but I have yet to discover a nightingale that prefers to be anything but practically motionless while serenading his lady love. (Col. CB 812.)

The B.B.C. Dance Orchestra, directed by Henry Hall, is still churning out its regular dose of Columbia discs. *Dust on the Moon* is among its latest, and it has no vocal refrain. Not an exciting tune.

A merry tune, well played by Jack Jackson and his Orchestra on an H.M.V. record, is *I'm Dancing with a Ghost*—no, it's not morbid, as you would expect, but almost brimful of *joie de vivre*. The other side, *I'm on a See-Saw*, is another lively number. I am sorry the vocalist does not sing the verse, for it has a peculiarly haunting melody, though it is a real teaser to sing. The chorus is quite straightforward.

Harry Jacobson is neat and fairly conventional in his *Piano Medley in Dance Rhythm* on H.M.V. B 8257. A pleasant interlude to a programme of dance music.

I do not remember hearing before Richard Himber and his Ritz-Carlton Orchestra, but I can recommend his *If I had a Million Dollars* on H.M.V. 6563 to readers. The orchestration is "straight," but the band is clear cut and quite "snappy." It is an excellent disc to dance to.

**Some Popular Light Numbers.**

Before we leave the very light items let me draw your attention to a few Octacros records that are worthy of notice. Joe Loss and his Kit-Cat Band have recorded two at the Astoria's Dance Salon. Here they are: *The Continental*, with *La Cucaracha*, *Just a Wearyin' for You* and *Don't Forget*. Lastly, by C. H. Cooksey on the organ, there is Gershwin's *Rhapsody in Blue*. The numbers are 1106, 1104 and 1091 respectively. The recording is good, but not quite good enough, in my opinion, for such a classic as the last-named. But Octacros are improving—the last records are better than the first I heard, though still there is lack of bass and a tendency to peakiness.

Thousands of readers will welcome another record of that consummate artist John McCormack. He has recorded *The Dawning of the Day* and *Terence's Farewell to Kathleen*—two Irish ballads that he sings to perfection. I recommend all lovers of tenor ballad-singing to get it. (H.M.V. DA 1396.)

"The New Mayfair Orchestra, with vocalists" is the description given by H.M.V. to their *Ballad Memories* which has just been published. I should

(Continued on next page.)

**FOR THE "B.C.L." TWO**

This popular Varley pentode output choke has been specified again—this time for the "Popular Wireless" "B.C.L." Two. Yet another testimony to the efficiency of Varley components. For the best results from all home constructed sets use Varley components—particularly the Varley Pentode Nichoke for the "B.C.L." Two.

**PENTODE NICHOKÉ**  
List No. DP24 11/6

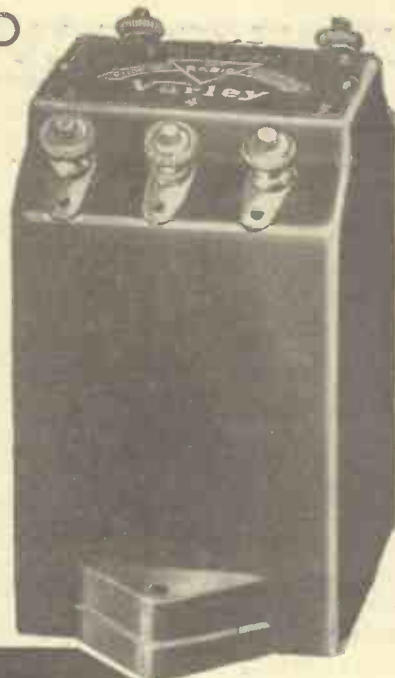

Write now for free illustrated catalogue!

Bloomfield Road, Woolwich, London, S.E.18.

Telephone: Woolwich 2345.

**ELECTRADIX**

**TELEPHONES.** The cheapest tester is a pair of 2/9 Sullivan phones and a 6d. cell for any circuit. Brown's "A" reed for short-wave sets, 1,500 ohms, 21G, 120 ohms, 17/6, Western Elec., 2,000 ohms, 4/3 pair.

**MEGERS AND OHMMETERS.** Ever-shed Bridge with decade res. box, 10,000 ohms. Sever Meggers, 100 volts, 250 volts and 500 volts, and small MED. for D.O. mains. N.C.S. Ohmer, 500 volts to 20 megs. Ev. Edg. Metrohm, 250 volts, .01 to 20 megs. Silvertown Portable Test Set. Bridge type, .001 ohm to 1 meg.

**WAVEMETERS.** McLachlan, S.G. Valve, 20 to 5,000 metres and charts. Gambrell, type D, 220 to 5,000 metres. Long Range Gambrell, 75 to 12,000 metres. Sullivan Het. in metal case, 300 to 16,000.

**LOUD SPEAKERS.** Two Siemens' Giant Riffels, 26in. X 11in. Heard two miles away, 40/- each.

**DIX-MIPANTA VEST POCKET TESTER.** A wonderfully versatile moving-iron multi-range meter for service on A.C. or D.C. jobs. No projecting terminals. THREE ranges of volts: 0-7.5, 0-150, 0-300. Used for MILLIAMPS, reads: 0-12½ mA and 0-75 mA. In black bakelite case. Measures only 2½in. X 2½in., with pair of test leads and plugs. Leaflet "N" gives full information. 19/6

**WRITE FOR LATEST RADIO BARGAIN LIST "N"** We are able to offer from stock STAMPINGS FOR CHOKES AND TRANSFORMERS of 15 sizes and shapes at 50% off list price. Samples of any pair of stampings sent on receipt of envelope with 1ld. stamp.

**PARCELS** of useful oddments for the experimenter who wants a junk-box of Coils, Magnets, Wire, Chokes, Condensers, Switches, etc., mostly ex W.D., parts worth a lot more than 10 lbs. 7/-, or 7 lbs. for 5/-, post free. British Isles only.

**ELECTRADIX RADIOS,**  
218, UPPER THAMES STREET, E.C.4  
Central 4611.



There was a young fellow named Jim Complained that his Set had gone "dim"; He found on inspection An unsoldered connection— So FLUXITE put THAT right for HIM!

See that FLUXITE is always by you—in the home—garage—workshop—anywhere where simple, speedy soldering is needed. Used for 30 years in Government Works and by the leading Engineers and Manufacturers. Of all Ironmongers —In Tins: 4d., 8d., 1/4 and 2/8. Ask to see the FLUXITE SMALL-SPACE SOLDERING SET—compact but substantial—complete with full instructions—7/6. Ask also for leaflet on CASE HARDENING STEEL and TEMPERING TOOLS with FLUXITE.

**THE FLUXITE GUN**

(Registered.) is a handy and economical tool that enables you to put the FLUXITE where you want it on the soldering job and is clean and simple to use. Nothing to remove—no mess—no trouble. Always READY FOR USE.

Also used to project grease into grease-cups, bearings, etc.

Just fill the nozzle portion—half fill the cup—put together and press as required. Price 1/6.



ALL MECHANICS WILL HAVE

**FLUXITE**

IT SIMPLIFIES ALL SOLDERING

FLUXITE LTD. (DEPT. 324), DRAGON WORKS, BERMONDSEY STREET, S.E.I.

All applications for Advertising Space in POPULAR WIRELESS must be addressed to the Advertising Department, John Carpenter House, John Carpenter Street, London, E.C.4.

# Let Us Send You This 28-Page Booklet — Free



It gives all particulars of various Courses that cover every phase of Radio work.

The Radio Industry is progressing with amazing rapidity. Only by knowing thoroughly the basic principles can pace be kept with it. I.C.S. Instruction includes American broadcasting as well as British wireless practice. It is a modern education, covering every department of the industry.

### OUR COURSES

Included in the I.C.S. range are Courses dealing with the installing of radio sets and, in particular, with their Servicing, which to-day intimately concerns every wireless dealer and his employees. The Operating Course is vital to mastery of operating and transmitting.

There is also a Course for the Wireless Salesman. This, in addition to inculcating the art of salesmanship, provides that knowledge which enables the salesman to hold his own with the most technical of his customers.

Then there are Preparatory Courses for the City and Guilds and I.W.T. Exams.

We will be pleased to send you details and free advice on any or all of these Courses. Just fill in and post the coupon, or write in any other way.

International Correspondence Schools, Ltd.,  
Dept. 161, International Buildings,  
Kingsway, London, W.C.2.

Without cost, or obligation, please send me your Radio booklet of information about the Courses I have marked X.

- COMPLETE RADIO
- RADIO SERVICING
- RADIO EQUIPMENT
- RADIO SERVICING AND SALESMANSHIP
- WIRELESS ENGINEERING
- WIRELESS OPERATORS
- EXAMINATION (State which)

Name ..... Age .....

Address .....

## ROUND THE RECORDS

(Continued from previous page.)

say "Vocalists with the New Mayfair Orchestra" fitted the bill better, for the former certainly have the major part to do. And they do it well, too. The record is a most pleasing one of old favourites. Don't miss it if you want something to fit in with a quiet Sunday mood of reminiscence. (C. 2716.)

*Scherzo Tarantelle* (Op. 16 by Wien'awski) is one of the pieces chosen by Heifetz for his H.M.V. record DB 2219. The other composition played by the famous violinist is *Largo on G String* by Elerambault.

If you want to shake up your radiogram and rattle the windows, or bring the ceiling plaster down, put on Columbia DX 654 at full blast. But don't blame me if the neighbours complain. The item is the "1812" *Overture*, played by Quentin Maclean on the organ of the Trocadero Cinema, Elephant and Castle, London, S.E.

Maclean knows how to get the best—and most—out of these modern wonders, and this record lets you have it with a vengeance. It is certainly one of the outstanding organ recordings and will test your radiogram to the full. But if you are not satisfied with the quality of the result—blame the set; the record is not at fault. **K. D. R.**

## A "TALKING" ACCUMULATOR

WE have seen Exide Indicating Accumulators before, and we have actually used one in the Research Department for some months, but our admiration for the originality of the principle remains entirely undimmed.

The Exide Indicator system is unique. There have been other systems, all in their way quite satisfactory, but the Exide is the only one which comes right down to the solid seen-at-a-glance basis of words.

As you can see in the photo, there is a large pointer and three words written in big block capitals. These words are FULL, HALF and EMPTY.

By the pointer pointing to the words you know at once exactly the condition of the cell. When it comes back from charging the pointer indicates FULL (or ought to if the charging has been properly carried out), and the needle moves farther and farther down towards EMPTY as the electrical charge of the cell is exhausted.

Voltmeters and hydrometers are unnecessary to listeners having one of these ingenious Exide batteries.

To be able to see always and at any time how the accumulator is faring at once removes half the possibility of "ire" out of wireless.

But such an excellent system would be wasted on an accumulator unable to give good service. Happily, with this one the very name is coincident with service. We have seen Exides being made at the huge works which are devoted to that splendid purpose, and we have also used many Exide batteries, and are therefore able to say that, if better accumulators can ever be made,



The Exide battery shows at a glance exactly the condition of its charge. The hydrometer - pointer gives ample warning when a visit to the charging station is required.

Exide will be making them.

The Exide Indicating system was first applied to a small cell suitable only for rather small radio outfits, but since then it has appeared on quite a wide range of types.

We were recently sent one styled the Exide I.F.G.C. This is a two-volt cell having a capacity of 45 ampere hours on slow discharge, or 27 ampere hours at a 100-hour rate (which means a discharge spread over that number of hours).

It is a substantial cell in a glass case, eminently suitable for all ordinary kinds of home-receiver outfits.

An attractive feature is that a convenient carrying handle is supplied, and this handle is of metal. It is held in position by the shouldering moulded into the case of the cell.

Therefore there is no risk at all of its breaking or of its slipping off and letting the cell fall while it is being used.

Substantial terminals are fitted, and there is a robust screw top for the filler hole.

We can thoroughly recommend the cell to all our readers, both on account of its extremely useful Indicator and its qualities purely and simply as an accumulator which is able to give trouble-free service.

## TECHNICAL NOTES

Jottings of interest to all.

By Dr. J. H. T. ROBERTS, F.Inst.P.

WHEN you are using a highly sensitive receiver, especially of the short-wave type, you will sometimes find it necessary to readjust the tuning dial for any given station, say a quarter of an hour or half an hour after the set is first switched on. Some people think that this apparent shift of the frequency is due to fading or to some "creep" of the transmitter wavelength; it is probably due, however, to the circuit itself, especially if a superheterodyne.

When the set is switched on, the valves and various resistances begin to warm up the air inside the cabinet, with the result that the components become warmed and expansions take place.

### Changes in the Components.

It may be a microscopic shift in the condenser plates, or the relatively larger movement of the electrodes of the valves, but if the set is extremely selective these very small changes may be sufficient to produce an appreciable shift in the tuning, requiring a corresponding adjustment of the tuning dial. The effect will occur regularly when first switching the set on from "cold," but will not recur if the set, after having got into steady working conditions, is switched off for a short time and then switched on again. If the effect behaves in this way, it is a pretty good indication that the cause is as mentioned above.

### Make Your Own Charger.

Readers ask me from time to time whether they can make a tantalum rectifier or charger for recharging their low-tension batteries at home. This type of charger was very popular a few years ago; but it is not now on the market, so far as I know, having been superseded by the more convenient copper-oxide "metal" rectifier. The tantalum rectifier is, however, a very efficient and extremely reliable device, its only drawbacks being that it contains liquid and that it requires occasional topping-up with distilled water; these drawbacks, however, are precisely the same as those of any ordinary battery, and therefore do not amount to anything if the rectifier is to be used in conjunction with the battery, which is usually the case.

### Using a Tantalum Rectifier.

You can very easily make a rectifier by means of a strip of tantalum, which should be three or four inches in length and about one-eighth of an inch in width. This forms one electrode of the rectifier, the other electrode being a piece of lead strip or rod. These two electrodes dip into the electrolyte, which consists of dilute sulphuric acid (ordinary battery strength), in which is dissolved ferrous sulphate (a pale green crystalline substance obtainable very cheaply from any chemist), the amount of sulphate being about one teaspoonful of crystals to a pint of the dilute acid. The

(Continued on next page.)

## TECHNICAL NOTES

(Continued from previous page.)

rectifier will work in the dilute acid without the addition of the ferrous sulphate; but this latter salt has the effect of steadying the operation of the rectifier very considerably and also increasing its conductivity—that is to say, enabling it to pass more rectified current under given conditions. Further than all this, the presence of the ferrous sulphate in the electrolyte appears to prolong the life of the tantalum electrode, by minimising pitting.

The rectifier mentioned above may be contained in an old celluloid battery case or in a glass jar. If it is contained in a celluloid case, a piece of rubber should be attached to the lower extremity of the tantalum electrode so as to prevent this from resting in contact with the celluloid case, otherwise there is a possibility of minute sparks at the tip of the electrode eating through the celluloid.

### Single- and Double-Wave Rectification.

The rectifier so arranged is connected in series with the secondary or output winding of a suitable stepdown transformer, and when it is intended to be used to charge a 6-volt battery you will find that some 15 to 20 volts A.C. output from the transformer will be necessary. If you use, say, 20 volts you can introduce a small rheostat in series so as to regulate the charging current. An arrangement of the kind described is suitable for charging a battery 2, 4 or 6 volts at a rate of about  $\frac{1}{2}$  to  $1\frac{1}{2}$  amps; if a larger rating is required, you want to use a somewhat broader strip of tantalum and a slightly larger output voltage from the secondary of the transformer.

### Centre-tapped Secondary.

This arrangement gives single-wave rectification. If you want full-wave rectification you can use a centre-tapped secondary of the transformer, each half giving the necessary 20 volts or so, connecting the centre tapping of the secondary to the lead electrode of the rectifier and using two tantalum electrodes connected respectively to the two ends of the transformer secondary. For charging in this case, the battery is introduced between the centre tapping of the transformer and the lead electrode.

Remember in all cases that the current enters the rectifier at the lead electrode and passes out at the tantalum, but cannot flow in the opposite direction.

I should also say that you cannot solder on to tantalum, and therefore you will require a lead casting around the upper end of it or some form of clip.

### Surface Conduction of H.F. Currents.

In the early days of radio we used to hear a lot about the fact that H.F. currents tend to flow on the surface of a conductor rather than to penetrate throughout the whole body of it. For this reason we were always strongly advised to use stranded wire for the aerial and also to use reasonably thick conductors for the wiring up of the set.

As time has gone on these precautions have become rather neglected, probably because the efficiency of the modern receiver has been so enormously increased that the need for special care in regard to the conductors is not so important.

But high-frequency currents still travel on the surface of conductors, just as they did years ago, and if you want real refinement in efficiency you should be careful to use conductors of a reasonable surface area, where high-frequency currents are concerned.

### Aerial Wires.

For aerial wires the well-known stranded cable, consisting of seven strands of No. 22 wire, gives a large surface in relation to the amount of copper in the wire, and to that extent has the advantage of offering a lower resistance to high-frequency currents than the same amount of copper used in the form of a single conductor.

It goes without saying that the importance of this surface effect increases with the frequency of the H.F. currents, so that for very short waves (that is very high frequencies) it is a matter of quite practical importance.

### New Transmission System.

You will have read elsewhere in this issue that the B.B.C. is investigating a new system of transmission, results of which have lately been communicated to an International Conference. At present details of the work on this new method and on the results which have been obtained are being kept secret, but the whole matter is being considered by experts of the principal European countries, and the results will be made public in due course. Whether the new method will actually be adopted has not yet been decided, although in some respects it has important advantages over the system which is at present universally used.

### H.F. Amplification and Stability.

One of the difficulties with high-frequency amplification, ever since the early days of wireless, has been to avoid instability. It is very difficult to use an ordinary three-electrode valve efficiently in this position, and in the earlier receivers there was really relatively little high-frequency amplification, particularly on medium wavelengths. Some of you may remember that the neutrodyne arrangement was introduced quite early on and this helped a good deal, but it had the disadvantage that it was only effective over a limited wavelength range.

Comparatively recently we had the screen-grid valve, which was a great step forward, but which suffered from distortion. A development of this valve soon appeared in the shape of the variable-mu, and this was hailed as completely overcoming all previous difficulties. The progress did not stop, however, with the variable-mu, because it was found that unless the screening-grid was kept at a uniform potential the valve was liable to suffer from self-oscillation.

### The High-Frequency Pentode.

More recently we have the still further development of the screen-grid valve, and that is the high-frequency pentode. This valve is practically the same as the screen-grid and variable-mu valves, except that it has a third grid inserted between the anode and the screening grid, this third grid being connected internally to the cathode. The result is that the instability is entirely got over, and, in addition to this, the amplifying properties of the valve are greatly improved.

# Easy Terms

ALL MANUFACTURERS' COMPONENTS and ACCESSORIES in STOCK. SEND US YOUR ENQUIRIES

## W.B. STENTORIAN STANDARD

SENT ON 7 DAYS' TRIAL.  
For Power, Pentode and Class B. Send only 2/6 for 7 days' trial. If approved, balance in 11 monthly payments of 3/-, Cash or O.O.D. Carriage Paid, £1/12/6.  
W.B. Stentorian Senior. Cash or O.O.D. Carriage Paid, £2/2/0, or 2/6 deposit and 11 monthly payments of 4/-.  
W.B. Stentorian Baby. Cash or O.O.D. Carriage Paid, £1/2/6, or 2/6 deposit and 9 monthly payments of 2/6.



## SIMPSON'S 1935 ELECTRIC TURNTABLE

THE PERFECT GRAMPHONE MOTOR at LAST! Low consumption, CONSTANT SPEED, 1-HOLE FIXING, Darwin's Magnets, A.C. Mains only, 100/150 or 200/250 volts, 50 cycles, 12-in. turntable. Send only 5/- for 7 days' trial; if approved, balance in 9 monthly payments of 4/6, Cash or O.O.D. Carriage Paid, £2/2/0.



## B.T.S. 1935 SHORT WAVE ADAPTOR

MAKE YOUR SET an



### ALL-WAVE SET!

and receive AMERICA direct  
The famous B.T.S. SHORT-WAVE ADAPTOR on EASY TERMS! N.T.S. bring the wonderful thrill of world-wide reception, made possible with this noted Adaptor, within the reach of all. Simply plugs into your present Battery or A.C. Mains set. The only metres. Extra coils, 40- orating 100-1 ratio aerial tuning and slow-motion reaction; for use either as Plug-in or Superhet Short-Wave Adaptor; Air Dielectric Reaction and Tuning Condensers; Walnut Grained Bakelite Panel; Walnut Finished Cabinet. Send for fully descriptive leaflet.

Cash or O.O.D. Carr. Pd. With 2 plug-in coils, 13-28 A.C. Mains set. The only adaptor at the price incorporating 100-1 ratio aerial tuning and slow-motion reaction; for use either as Plug-in or Superhet Short-Wave Adaptor; Air Dielectric Reaction and Tuning Condensers; Walnut Grained Bakelite Panel; Walnut Finished Cabinet. Send for fully descriptive leaflet.

52/6 and 10 monthly payments of 5/-

## GARRARD No. 30 DOUBLE SPRING MOTOR

Complete with 12-in. Plush-covered Turntable, Brake, Speed Indicator, Patent Winding Crank. Will play 2 sides of a 12in. record at one wind. Send only 2/6; balance in 10 monthly payments of 2/6. Cash or O.O.D. Carriage Paid, £1/5/0.



## ATLAS ELIMINATOR

SENT ON 7 DAYS' TRIAL  
Model T10/30. For Class B and G.P.P. A.G. 200/250 volts 40/120 cycles. Three tappings 10, 20, or 30 m.s. at 120/150 volts.  
Triokle charger incorporated. 5 amp. Send only 5/- for 7 days' trial; if approved, balance in 12 monthly payments of 8/-. Cash or O.O.D. Carriage Paid, £3/9/6.  
Atlas Model C.A.25. Cash or O.O.D. Carriage Paid, £2/19/6, or 5/- deposit and 11 monthly payments of 5/6.



SEND FOR LATEST LISTS

# New Times Sales Co.

56, P.W.2, LUDGATE HILL, LONDON, E.C.4.

MODEL  
K.1.

PRICE 15/-

## MAINS TRANSFORMER DESIGNED AND SPECIFIED FOR THE KELSEY

### "1935 S'W ADAPTOR"

And used by the author in all his original experiments.

**INSIST ON—HEYBERD**

Send NOW with 3d. in stamps for our latest 1935 Handbook, "Mains Power for your Radio."

Mr. ....

Address.....

P.W.

**F. C. HEYBERD & CO.** 10, FINSBURY ST.,  
LONDON, E.C.2.

## INDEX TO ADVERTISERS.

	PAGE
Benjamin Electric Ltd.	690
Book of Practical Radio	687
British Blue Spot Co., Ltd.	689
British Institute of Engineering Technology	701
British Rola Co., Ltd.	701
Bulgin A. F. & Co., Ltd.	701
Electradix Radios	703
Exide Batteries	Cover ii
Fluxite, Ltd.	703
Forbat, Eugen J.	706
Heyberd, F. C., & Co.	706
International Correspondence Schools, Ltd.	704
International Radio Bureau	700
London Radio Supply Co.	702
Mason, E.	702
Modern Boy	689
New London Electron Works, Ltd.	701
New Times Sales Co.	705
Peto-Scott Co., Ltd.	697
Players Airman Tobacco	689
Popular Music	690
The 362 Radio Valve Co., Ltd.	689
Unit Radio	702
Universal High Voltage Radio, Ltd.	706
Varley Products	703
Whiteley Electrical Radio Co., Ltd.	699
Wireless and Television Review	Cover iv

## OPERATING THE "B.C.L." TWO

(Continued from page 680.)

American stations, mostly in Colombia and Venezuela. It is safe to say that any Spanish-speaking station in this band is a South American.

Go down to zero on the dial, and between there and 10 or 15 degrees you will have the 40-metre amateur band. Probably it will be full of Morse late at night, but on any Sunday morning you ought to hear dozens of European amateurs on telephony. There are active stations in practically every big town in this country, so you can count on a "local" who will nearly knock the 'phones off your head.

The instructions I have given for "scouring" the 49-metre band hold good for the other broadcast bands, and I won't go into great detail. The best time to listen on 31 metres (yellow-spot coil, 65 or 70 degrees) is between 8 and 11 p.m., and—great occasion!—early on Sunday mornings, when

don't hear anything about 7 p.m. or thereabouts.

The best time for the American "phones" on this band is the afternoon, particularly at week-ends.

The same band will be found again near the top of the dial with the light-blue spot (6LB) coil in action. Probably you will find it easier to tune with that coil—at least, you will if your set has a trace of hand capacity about it. It shouldn't have, but one never knows.

### The 19-Metre Band.

Farther down with this coil you will strike one of the most interesting of the broadcast bands, round about 19 metres. Unfortunately, there are not very many stations working there, but it gives you the chance of real loudspeaker reception of America. W 8 X K (yes, again!) works on 19.72 and W 2 X A D (Schenectady) on 19.56. Both come in at tremendous strength when conditions are favourable, particularly just before sunset.

Still lower down is W 3 X A L on 16.87 metres, and right at the bottom is W 8 X K

## SPECIAL FEATURES NEXT WEEK

### THIS DROITWICH FADING

An interview with NOEL ASHBRIDGE, the Chief Engineer of the B.B.C.,  
by ALAN HUNTER.

### Using Alternative Coils in THE "B.C.L." TWO

AND

Full Constructional Details for  
THE ALL-WAVE FOUR-VALVE SUPERHET  
**OUT ON WEDNESDAY.**

Price 3d. as usual.

V K 2 M E, Sydney, puts out his famous transmissions.

He is practically always good at about 7 a.m., and when conditions are right he lasts at fine strength until 9 or 9.30. But it's worth turning out at 7, unless it's a very cold morning—and even if it is you will be rewarded with the thrill of your life.

The 25-metre band is one of the least interesting, but Pittsburg (W 8 X K again) is generally pretty strong during the evenings. He is on 25.27 metres, and should be found with the yellow-spot coil between 20 and 30 degrees. Right at the bottom of the dial is the 20-metre amateur band.

This is a band used almost exclusively for "DX" work, and most of it is carried out on C.W. telegraphy. About one-third of the band, however (100 kc.), is allotted to U.S.A. amateurs using telephony, and many of them use very high power and beam aerials pointing towards Europe. It is more or less a daylight wave, and at the time you read this the fade-out on "20" will be occurring quite early in the evening. So don't feel worried if you

(no, I won't mention him any more, I promise you) on 13.93. This last transmission is more or less experimental, but it is regular, and may be heard at the most fantastic strength when conditions are really good for that wave.

Now about these "conditions." They are the one real snag about short waves, and yet, curiously enough, they supply them with a good deal of their fascination. It's not a bit of use your supposing that because you have received W 3 X A L to-night you will hear him again to-morrow. Indeed, if you go so far as to invite Uncle Charles round to hear him it's about ten to one that you won't get him at all!

### Conditions Sometimes Vary.

Seriously, though, it isn't as bad as all that. But conditions do sometimes vary from day to day in the most extraordinary way. One day in five may be almost blank on one particular waveband—but you've always got the others to search in.

Don't start pulling your set to bits if it suddenly seems to go dead. It's probably

(Continued on next page.)

## SPAN the ATLANTIC with HYVOLTSTAR UNIVERSAL AC/DC Receivers—13 to 2,000 Metres—All Waves, All Mains

HYVOLTSTAR Universal Superhets are supreme. Any Mains, A.C. or D.C. Superb performance on all Wavebands. America tuned-in at full loudspeaker strength. Refinements include silent Fluidlight tuning and A.V.C. Test HYVOLTSTAR superiority, have a Receiver on approval! Write for interesting leaflet D.

**UNIVERSAL HIGH VOLTAGE RADIO LTD.,**

### NOTE THE LOW PRICES!

Universal All-Waves Super 5 (19 to 2,000 m.). Chassis and Valves, 14 gns. Complete Table Model, 18 gns. Table Radiogram, 24 gns.

Universal All-Waves Super 7 (13 to 2,000 m.). Chassis and Valves, 22 gns. Table Radiogram Model, 30 gns. Table Model, 26 gns. Console Radiogram with automatic Record-changer, 40 gns.

28-29, Southampton St., Strand, W.C.2.  
Telephone: TEMple Bar 4985.

## Let us MODERNISE your set!

Whatever its type or make we can convert your present Set to an up-to-date UNIVERSAL A.C./D.C. ALL-MAINS RECEIVER with Oster-Ganz High Voltage Valves at little cost. The improvement will astonish you. Send your Set Carriage Paid, and we will quote you free. Or write for full particulars to the CONVERSION DEPT.

**Universal KITS** A comprehensive range is available, including Universal S.T.600. All-wave Superhets, Radiograms and Amplifiers. Ask for leaflet D, giving full details.

**EUGEN J. FORBAT, Sole Agent,**  
28-29, Southampton Street, Strand, W.C.2.  
Telephone: TEMple Bar 8608.

## OPERATING THE "B.C.L." TWO

(Continued from previous page.)

our dear old friend "conditions." I could go on for pages and pages telling you of the curious things that sometimes happen—those days when you think you've tuned in the local and find it's some station that no one has ever heard of before, and those other days when nothing is happening at 5 p.m. and at 5.15 the band's full of "Yanks."

Find all that out for yourself, and you'll enjoy your short-wave medicine far more. If you really are new to it you will probably have moments of disgust when you think the game isn't worth the candle. But don't

### SUITABLE ACCESSORIES

- 2-volt L.T. ACCUMULATOR: Block, Exide.
- 120-volt H.T. BATTERY: Ever Ready, Drydex, Lissen.
- 9-volt G.B. BATTERY: Ever Ready, Lissen, Drydex.
- LOUDSPEAKER: W.B., Rola, Amplion, Blue Spot, R. & A., Epoch.

give up. After all, it isn't something to take the place of your old game of broadcast reception—it is supplementary to it. If you don't fancy short waves one day you can always go back to your old love.

Take this warning, though—the bite of the short-wave bug is deadly. Once you're bitten you'll never recover, and the luke-warm short-wave novice of to-day is the raving "fan" of to-morrow.

I seem to have come off the subject of the "B.C.L." Two somewhat, but there really isn't any more to say about the set until I start dealing with the alternative makes of coils. So get down to it, and good hunting to you.

### OUR "ON THE SHORT WAVES" FEATURE.

We regret that, owing to the pressure on our space this week, W. L. S.'s weekly article, "On the Short Waves," has been unavoidably held over. Readers may rest assured, however, that this very popular feature will be resumed next week.

### MISCELLANEOUS ADVERTISEMENTS

**SPEAKER** repairs, new cones, coils and centres fitted 5/-. Complete rewinding service, mains transformers, etc. Work guaranteed. Write Dept. X, Weedon P.L.R. Co., 80, Lonsdale Avenue, London, E.6. (Grangewood 1837.)

**WANTED**—Large quantity moving-coil speakers and wireless parts.—**RADIO RENTALS**, Newton, Porthcawl.

**500 GLADIOLI**, 3½–4-inch circ., in 10 named vars., 100 Montbretias, 100 Anemones, 100 Ranunculus, 100 Clover of Happiness, for only 10/-. carriage and duty free to destination (C.O.D. 6d. extra).

**THE FIRST HILLEGOM BULB NURSERIES**, HILLEGOM, HOLLAND.

**1,000 GLADIOLI**, first size, 4–5-inch circ., in 10 named vars., for only 20/-. half lot 10/-. carriage and duty free to destination (C.O.D. 6d. extra).

**THE FIRST HILLEGOM BULB NURSERIES**, HILLEGOM, HOLLAND.

## MISCELLANEOUS ADVERTISEMENTS

3d. per Word 6d. per word for first words in heavy type

Minimum Charge 3/-

Remittance must accompany order.

Advertisements for these columns are accepted up to first post WEDNESDAY MORNING for following week's issue.

Radio components and accessories advertised in these columns at below list price do not carry manufacturers' guarantee.

All communications should be addressed to:—Advertisement Department, "Popular Wireless," John Carpenter House, John Carpenter Street, London, E.C.4.

### PEARL & PEARL,

190, Bishopsgate, London, E.C.2. All the following bargains guaranteed new goods. Cash or C.O.D. Carriage Paid.

**RECEIVERS, 3-VALVE CLASS B. BURGOYNE RECEIVERS.** Complete with Mullard valves; Exide H.T. and L.T. batteries. M/c speaker. Artistic cabinet of highly polished walnut. Chromium fittings. Brand new in original cartons; 1935 Model. List £6 10. Our price £3 19 6. Carr. Paid.

**SPEAKERS.** Lissen plaque speakers, wonderful tone. List 15/-. Our price 5/11. Lotus permanent magnet, with universal transformer giving 10 alternative tapings. Eight-inch cone, wonderful tone. List 27/6. Our price 14/11.

**CONDENSERS.** British Radiophone '0005 ganged, screened variable condensers with trimmers. 2-gang 6/6. 3-gang 8/6.

**VALVES.** Triotron (all types) G.P. 3/6. Power 4/6. S.G. 9/6; clear or metallised; all in makers' sealed cartons.

**RADIOPAK** by British Radiophone (Type 535 C). Comprising 3 matched coils and 3-gang condenser with trimmers. Clearly engraved scale marked in metres, pilot light fitting, engraved terminal strip, showing all connections. The whole mounted on grey metal chassis. Guaranteed new. Limited quantity only, at special low price of 29/6 complete.

**ELIMINATORS.** Special purchase of large quantity of Lincoln-Stewart Eliminators enables us to offer them at sacrifice prices. All models O.K. for 200-250 v. D.C. 25 milliamp output, 9/11; A.C. 30 milliamp output with Westinghouse Rectifier, etc., 24/11, or with half-amp. Trickle Charger incorporated, price only 37/6. All fully guaranteed.

**COILS.** Lincoln-Stewart screened dual-range iron-cored coils; complete with circuits and wiring diagrams. List price 6/6, our price 2/6. Lotus triple-ganged bandpass coil unit, complete. Suitable for mains or battery sets.

Comprises 3 screened coils on metal base, wave-change and radiogram switch; all terminal connections shown engraved. Full instructions with every unit. List 27/6. An outstanding bargain at 12/11 each. Lissen L.N.5181 3-ganged superhet coil units for A.C. or battery sets; with circuits and diagrams. Over 1,500 already sold to "P.W." readers. List price 30/-; now offered at special price, 6/6 only. ALL above post paid and guaranteed new in makers' original cartons. New Lucerne coils 1/8 each.

**CONDENSERS.** Lotus variable (2-gang '0005) condensers, screened; complete with illuminated friction drive dial, knob and trimmers. Our price, 2-gang 8/6, 3-gang 11/6.

**TRANSFORMERS.** Igranic Class B Transformers, tapped 1-1 and 1½-1. List price 11/6. Our price 4/11. Amplion Class B Output Chokes, tapped 1-1, 1½-1 and 3-1. Ideal for matching m/c speakers. List price 9/6. Our price 4/11.

**CABINETS.** Ultra polished walnut receiver cabinets (for set and speaker combined). Height 17in. Width 15 in. Depth 8 in. Only 5/11 each.

(Continued at top of next column.)

(Continued from foot of previous column.)

**CROMWELL** Cabinets (for set and speaker combined). Horizontal type, 23 in. wide, 8 in. deep, 11½ in. high. Polished walnut veneer, additional baffle behind speaker grille. Just secured on terms which enable us to offer them at the astoundingly low price of only 4/11 each. **LARGE** Receiver Cabinets, highly polished, as used for "Cromwell" 8-valve Superhet. Measurements: 22 in. high, 17 in. wide, 11½ in. deep. Finished in contrasting rosewood and walnut veneers. Special additional baffle on speaker fret. Cost over £2 to make. 15/- each. Only a few left.

**NOTE.** All Cabinets supplied for Cash with order only and sent carriage forward.

### SPECIAL SUNDRY BARGAINS.

These special bargains are sent for Cash with order only. Please add 3d. for postage.

Tonastat Selectivity Unit, 1/10; Biffo static cut-out, 2/3. Igranic 1-mfd. condensers 1/3 each; 2-mfd. 1/9 each. Table Microphone complete with transformer in base, 6/11. Triotron electrolytic condensers, 8-mfd., 450 volt working, 2/11 each; 25-mfd., 350-volt working, 3/6 each. Triotron Class B. Valves, type E220B. List 10/6; our price 5/11. Amplion Binocular H.F. Chokes. Totally enclosed in bakelite case. List 4/6. Our price 2/3. Lots of 3 dozen assorted Dubilier fixed condensers, 1/9 each lot. 4-pin chassis mounting valve holders, 5d. each; 6 for 2/-. Variable tuning condensers, '0003-mfd., 1/- each. Igranic 2-pole rotary switches, 1/- each. Igranic Short-wave chokes, 1/- each. Double-reading voltmeters, 1/9 each. Accumulator Hydrometers, complete with float, 1/- each. Sovereign lightning arresters, 6d. each.

**A.E.E.** Our latest, fully revised Bargain List "P," now ready. Send P.C. for your copy.

All Mail Orders Direct to

**PEARL & PEARL,**

190, Bishopsgate, London, E.C.2.

Telephone: Bishopsgate 1212.

**PREMIER SUPPLY STORES** Announce the Purchase of the Complete Stock of a World Famous Continental valve manufacturer, all the following standard main types, fully guaranteed, 4/6 each; H.F. Pentodes, Variable-Mu H.F. Pentodes, H.L., L. power, medium, high, low mag. and variable-mu screen-rids, one, three and four watt A.C. output directly-heated pentodes, 250v. 60 m.a. full-wave rectifiers, D.C. types, 20v. 18 amp., filaments, screen-grid V.M., H., H.L. Power, Pentodes, H.F. Pentodes, Variable-Mu H.F. Pentodes.

The Following Types, 5/6 each: H.F. Pentodes, Variable-Mu H.F. Pentodes, 350v. 120 m.a., full-wave rectifier, 500v. 120 m.a., full-wave rectifier, 2½ watt indirectly-heated pentode.

The Following American Types, 4/6: 250, 112, 171, 210, 245, 226, 47, 46, 24, 35, 51, 57, 58, 55, 37, 80, 6A7, 2A7, 83, 27.

The Following Types, 6/6 each: 42, 77, 78, 25Z5, 36, 38, 83, 39, 44, 53, 6B7, 2A5, 2A6, 267, 5Z3, 6C6, 6A4, 6D6, 6F7, 43, 59. Send for Complete Valve List.

**PREMIER SUPPLY STORES** (Dept. P.A.), 20-22, High St., Clapham, S.W.4. Phone: Macaulay 2188. Nearest station: Clapham North, Underground.

**S.T. 600.** Complete Specified Kit, £3/19/6. A.C. Model, £7/16/0, fully guaranteed. Old components taken in part exchange for new. Let us quote your requirements.—**SERVWELL WIRELESS SUPPLIES**, 64, Prestbury Road, London, E.7.

**WANTED FOR CASH.** Second-hand Wireless Parts, Sets, etc. Bring or send.—University Radio, 142, Drummond St., London, N.W.1. Nr. Euston Station (L.M.S.). Phone: MUScum 3810.

Miscellaneous Advertisements continued on next page.

## MISCELLANEOUS ADVERTISEMENTS

(Continued from previous page.)

### BIRMINGHAM RADIOMART.

Brand-new components, prompt delivery, guaranteed satisfaction. A square deal always.

**RADIOMART.** British Radiophone, fully screened 2-gang., '0005 top trimmers, latest compact type, 5/11.

**RADIOMART.** Radiophone 3-gang as above, 8/6; Radiophone 4-gang superhet, 9/6.

**RADIOMART.** Radiophone I.F. transformers, top trimmers, 2/6; also few 117 and 126 kc.

**RADIOMART.** Utility super 2-gang '0005, ball bearing, fully screened, with trimmers, 5/11; with Disc dial, 6/11.

**RADIOMART.** Utility 3-gang as above, straight or superhet, 6/11; with dial, 7/11.

**RADIOMART.** Set three screened band-pass superhet coils; made Igranic for Bush, 4/11; Ganged switch, 1/6.

**RADIOMART.** Famous make 8-mfd. dry electrolytics, 500 v., 2/11; N.S.F. ditto, 8 x 8 mfd., 500 v., 3/6.

**RADIOMART.** B.T.H. 7" latest 2,500-ohm moving coils, humbucker, 4-watt model, 12/6.

**RADIOMART.** Sonochorde super-sensitive P.M.'s "Class B," or Universal (ideal battery sets), 16/6.

**RADIOMART.** Genuine 30-ohm Clarostat humdingers; remove hum; brand new (list, 2/6), 9d.

**RADIOMART.** Pushback—the wire used by set makers; ready tinned and sleeved, 6 yds., 9d.

**RADIOMART.** Screened flex H.F. or pick-up: single, 6d. yd.; twin, 9d. yd.

**RADIOMART.** Resintored solder, 9 ft., 6d.; Bulgin lamp fuses, 2d.; Bulgin twin fuse-holders, 4d.

**RADIOMART.** Non-inductive tubulars, 1,500 vt., '0003, '002, 4d.; '01, '02, '04, '05, 0.1, 6d.; '2, '25, 8d.; '5, 9d.

**RADIOMART.** Differentials: Telsen, '0001, '00015, 1/-; Polar, '0003, 1/3; Ebonite Panels, 16 x 8, 1/6.

**RADIOMART.** Telsen 1-watt wire-ended resistors, 6d.; Telsen cartridge resistances, tubular condensers, 6d.

**RADIOMART.** Telsen latest reaction, '0001, '00015, 10d.; Lotus, '0003, 1/-; Utility, '0005, 1/3.

**RADIOMART.** Special offer dozen assorted wire-ended resistances, all different—Famous makes, N.S.F., etc. Our selection only 2/6.

**RADIOMART.** Triotron "Class B" units complete driver transformer, new B.V.A. valve (list, 64/-), 32/-; less valve, 25/-.

**RADIOMART.** Regentone latest 30 ma. A.C. eliminators (list £3 7s. 6d.), 39/6; Telsen 28 ma., with 4 VAC. (list, £3 7s. 6d.), 37/6.

**RADIOMART.** Lissen 12/6 chokes, 25 hy., 70 ma., 4/6; 32 hy. output, 4/6; 3-1 pentode output transformers, 4/6.

**RADIOMART.** Brand-new condensers, eminent makers, 500 v. working 4 mfd., 3/6; 2 mfd., 1/10; 1 mfd., 1/6.

**RADIOMART.** 350 v. working 4 mfd., 2/9; 2 mfd., 1/8; 1 mfd., 1/4; 250 v. working 4 mfd., 2/3; 1 mfd., 1/2; 0.5 mfd., 9d.; 0.1 x 0.1 mfd., 9d.

**RADIOMART.** Supremus battery economisers, incorporating Westinghouse rectifier, halves consumption (list, 27/6), 7/6.

**RADIOMART.** Stal tapped "Class B" chokes (list, 9/6), 3/6; Igranic driver transformers, 1/11.

**RADIOMART.** Transformers: Igranic, 8/6;

(Continued at top of next column.)

(Continued from foot of previous column.)

Parvo, boxod, 3/6; Ericsson (15/-), 1/3; Microphone, 2/6.

**RADIOMART.** Air-suspended variable condensers: '0005, 1/9; bakelite, 1/3; Philips' tubular, '0001, '001, 2d.

**RADIOMART.** Screened iron-cored dual-range coils with reaction circuit, 2/11; Igranic short-wave iron-core dual range, 3/3.

**RADIOMART.** Telsen, Radiophone, dolly toggle switches, 6d.; Lotus radiogram switches, 9d.

**RADIOMART.** Radiophone H.F. chokes (manufacturers'), honeycomb wound, 1/-; Metvick, 9d.

**RADIOMART.** Years of transmitting experience makes possible a specialised service in short-wave material which can be relied upon.

**RADIOMART.** G.E.C. all-brass '0003 condensers with real slow motion, Ideal short wave (listed over £1), 2/9.

**RADIOMART.** Limited number as above, but double spaced, '00015, 3/9. The finest condensers ever made.

**RADIOMART.** Brass ball-bearing 100-mfd. short-wave pigtail noiseless, 1/6; brass band-spread or neutralising micro-variables, 1/-; extension brackets, 3d.

**RADIOMART.** Government £6 6s. polarised relays, beautiful instruments, perfect, 8/6; Morse practise key, 3/6.

**RADIOMART.** Pye loloss short-wave valve-holders, 4d.; 1½ in. coil forms, 4-prong, 1/3; 6-prong, 1/6.

**RADIOMART.** Western Electric 21/- microphone, 2/9; transformer, 2/6; Telsen dual-range short-wave coils, 3/6.

**RADIOMART.** Milliammeters, flush 2½ in., 5/9; 2½ in., 6/9. All ranges above 25 ma.

**RADIOMART.** "Black 3" slow-motion dials, similar Indigraph, 1/-; Lissen coil mounts, 2d.

**RADIOMART.** Purchase over-produced stock leading Continental valve maker. Super valves; sensational prices.

**RADIOMART.** A.C. types at 4/6; H.F. Pen., M.H., M.H.L., V.M.S.G., P.T.4, S.G.L.A., S.G.H.A., 2 volt, from 2/11.

**RADIOMART.** American types at 4/6: U.X.250, U.X.245, U.X.210, U.Y.35, U.Y.24, U.Y.27.46, 2A.7., 6A.7, 80, 81, 56, 43.

**RADIOMART.** January Catalogue gives characteristics, and hundreds of bargains. Catalogue sent and inquiries answered only when stamp enclosed.

**RADIOMART.** Orders over 6/- post free. The Square Dealers, 19, John Bright Street, BIRMINGHAM.

**BANKRUPT BARGAINS.** List free with 3-v. diagram. S.T.600 kit with specified coils, Formo 2-gang, Graham Farish variables, Lotus transformer, ebonite panel, Bulgin potentiometer, all details and modern parts, £3, or with set of Hivacs, 85/-.

Regentone A.C. eliminators 30 ma., 32/6. Triotron valves from 2/9; transformers, 1/6. 3-v. kit, 15/-.

Lissen 2-v. mains sets, 50/-.

Lotus Universal 3 pentode M.C. complete, £6. 2 pentode type, £4. Sunbeam Universal 5-v. Super Het, £5-5-0. Shop-soiled Philips A.C. 588A 12 gn. type, £8-8-0. Part exchange. 5 years advertiser. Be safe with BUTLIN, 143B, Preston Road, Brighton.

**EXPERIMENTER'S EXTRAORDINARY OPPORTUNITY.** Parcels containing 40-value Wireless Components, 5/6. Carriage 1/-.

**EXPERIMENTER'S EXTRAORDINARY OPPORTUNITY.** Bargain Bulletin supplied Free. 10/- Gift Voucher presented first Twenty applicants daily.—TAYLOR'S, Radio House, Macaulay Street, Huddersfield.

**PLEASE BE SURE** to mention POPULAR WIRELESS when replying to advertisers.

## SOUTHERN RADIO'S WIRELESS BARGAINS.

**RECEIVERS.**—OSRAM 4 Valves (Actual) Sets. Complete with Four Osram Valves, Moving-Coil Speakers, Pedestal Cabinet. Ready for use on all Voltages A.C. In sealed cartons, £6. (List £15/15/0.)

**BURGOYNE CLASS "B"** Sets. With Three Mullard Valves. Exide Batteries and Accumulators. Moving-Coil Speakers. In modern Cabinet, beautifully finished in Chromium plate. Ready for use. In sealed cartons, £3/18/6. (List £6/10/0.)

**LISSEN** 2-Valve D.C. Sets, complete with Valves. Speakers in attractive Bakelite Cabinet. Ready for use on all Voltages D.C., £2/15/0. (List £7/7/0.)

**TELSEN** Macnamara "Golden Voice" De Luxe Model. Three Valves (Actual), complete with Three Mazda Valves. Moving-Coil Speaker. Ready for use A.C., £6/19/6. (List £15/15/0.)

**FERGUSON RADIO MIDGET SETS.**—4 Valves (Actual) T.R.F. Complete with Moving-Coil Speaker. Valves. Ready for use on all Voltages A.C. or D.C. In sealed cartons, £3/12/0. (List £3/8/0.)

**COILS.**—IGRANIC SUPER-HET FOUR COILS (1 Osc., 2 I.F., WITH PIGTAILS, 1 I.F. Plain), 9/- per set. (List 50/-)

**VARLEY** Constant Square Peak Coils B.P.5, with all accessories, 2/3.

**PICK-UPS.**—MARCONI Model K25 (1935 Issue), 21/- (List 32/6.)

**CONDENSERS.**—PLESSY FOUR-GANG CONDENSERS, with Oscillator Section for Superhet. Fully Screened with trimmers, 7/3 each. (List 45/-.) LOTUS Three-Gang, 12/6. Two-Gang, 8/6. All Lotus Condensers are complete with Dials, Escutchions. Fully screened with trimmers. Dubilier 4-Mfd. (2 + 1 + 1), 1,000-Volt, 2/9 each. 4.5-Mfd (2.25 + 2.25), 3/-. T.C.C., 0.1 + 0.1 1/3. Dubilier 0.1, 9d.

**SPEAKERS.**—BLUE SPOT 66R UNITS, 10/6. Mounted on Blue Spot Chassis, 16/6. (List 45/-) Blue Spot Permanent-Magnet Moving-Coil Speakers. Universal Transformers for Power, Super-Power, Pentode, and Class "B," All Brand New 1935 Series in sealed cartons, Type 99 P.M., 30/-. (List 59/6.) 45 P.M., 24/-. (List 45/-.) 62 P.M. (in Cabinet), 38/-. (List 67/6.) 32 P.M. in magnificent cabinet, 45/-. (List 87/6.)

**W.B. STENTORIAN SPEAKERS** (12 only) Permanent-Magnet Speakers with Universal Transformers, 21/- each. (List 32/6.)

**ELIMINATORS.**—Regentone Eliminators, W.5a. Complete with Trickle Charger for 200/250 Volts, 39/6. (List £3/17/6.) A small quantity only of EKCO ELIMINATORS for 100/125 Volts only, Type K25, with Trickle Charger. Output 25 m.a., 35/-. (List £4/12/6.) Type K.18 with Trickle Charger Output 18 m.a., 32/6. (List £4/7/6.) All Brand New in original sealed cartons.

**MISCELLANEOUS.**—Westinghouse Metal Rectifiers, H.T. 6, 7, 8, 9/3 each. Morse Tapping Keys, with flash signal and buzzer. Complete with Battery and Bulb, 2/-. Biflo Static Cut-Outs. Definitely eliminates noise and interference, 2/3. (List 12/6.) Telsen Binocular H.F. Chokes, 2/4. (List 4/6.) Variable Volume Controls, all capacities, 2/- each. Lewcos Spaghetti Resistances, all capacities. New and boxed, 1/6 dozen assorted. Many More Bargains at our various Branches. EVERY ARTICLE GUARANTEED AND SENT POST PAID.

**BRANCHES** at 46, Lisle Street, W.C.2; 271-275, High Road, Willesden Green, N.W.10. All Mail Orders to 323, Euston Road, N.W.1.

**SOUTHERN RADIO, 323, EUSTON ROAD, N.W.1.** (Near Warren Street Tube). Phone: Museum 6324.





Are You Buying  
a New Set?

IN THE  
FEBRUARY NUMBER

Are You Interested  
in Modern Receivers?

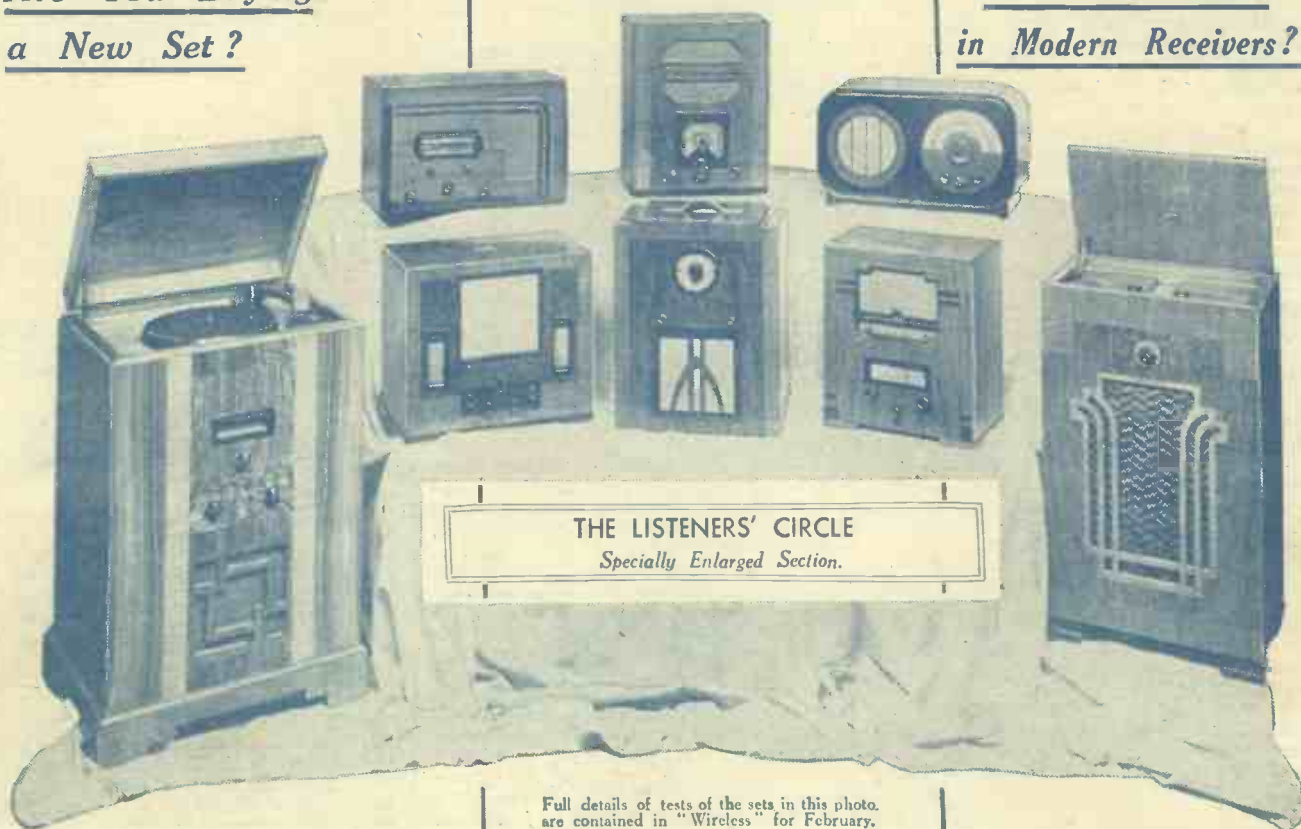

THE LISTENERS' CIRCLE  
*Specially Enlarged Section.*

Full details of tests of the sets in this photo.  
are contained in "Wireless" for February.

BRITAIN'S LEADING  
RADIO MAGAZINE

THE "FERROGANG" FOUR  
*Full details for building.*

SOMETHING OF  
INTEREST TO EVERYONE

# WIRELESS

## AND TELEVISION REVIEW

An outstanding feature of "Wireless" is the wide variety of radio aspects which are dealt with. The ordinary listener, home constructor and DX man are all catered for.

FROM MY ARMCHAIR  
*By John Scott-Taggart, M.I.E.E., F. Inst.P., Fel. I.R.E.*

Articles on Television, Short-Waves, Wireless in the Great War, B.B.C. News, Curious Radio Effects, Apparatus Tested, etc., etc., are all to be found in the February number.

NOW ON SALE—AT ALL BOOKSTALLS—PRICE SIXPENCE