

“P.W.” TELEPHONES AMERICA.

Popular Wireless

Every Thursday

PRICE

3d.

No. 259. Vol. XI.

INCORPORATING “WIRELESS”

May 21st, 1927.

LOFTIN-WHITE DEVELOPMENTS

Inventor Speaks from Washington
to Mr. P. W. Harris

NEW CIRCUIT DESCRIBED

(Special to “P.W.” Readers)

OTHER FEATURES IN THIS ISSUE

A “Four-Point” Crystal Detector

Scenery Out of Sound. Radio Actors in Training

A ONE-VALVE PORTABLE SET

The “Riddle Circuit.” A Radio-Active Microphone

Playing the Gramophone Electrically—By Capt. H. J. Round, M.I.E.E.

LOTUS COMPONENTS PREFERRED



"Lotus" Terminal
Valve Holder, 2/6

"Lotus"
Single Coil
Block, 8d.

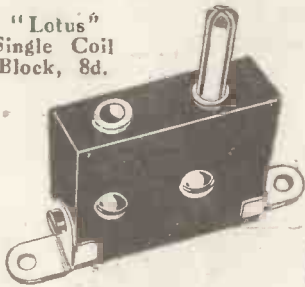

"Lotus" Plug
2/-

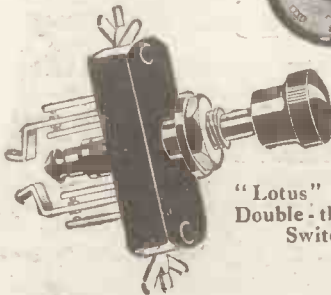

"Lotus" Double-pole
Double-throw Jack
Switch, 4/-

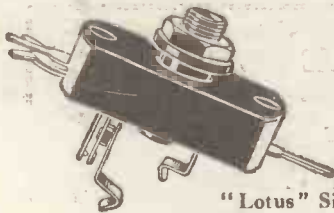

"Lotus" Single
Filament Jack, 2/6

"Radio for the Million" Circuits are prepared by technical experts and show great skill and care.

Only the best components are good enough, and that is why "Lotus" Valve Holders, Jacks, Switches and Plugs are used.

By using substitutes the same good results are not guaranteed.

Specify

LOTUS COMPONENTS

and you get the best

GARNETT, WHITELEY & CO., LTD.
Lotus Works, Broadgreen Road, Liverpool.

A Satisfactory Home-Built Set

The illustrations show an excellent and easily constructed set, for three valves and resistance capacity coupling built entirely of

Cosmos

(Components & Valves)

Prices are given for the whole range of types and sizes of each of the components used. ASK YOUR DEALER FOR A COPY OF THE CONSTRUCTION LEAFLET, No. 7117.1, COMPLETE WITH DRILLING TEMPLATE.

Satisfactory to build
Satisfactory to hear
Satisfactory in cost

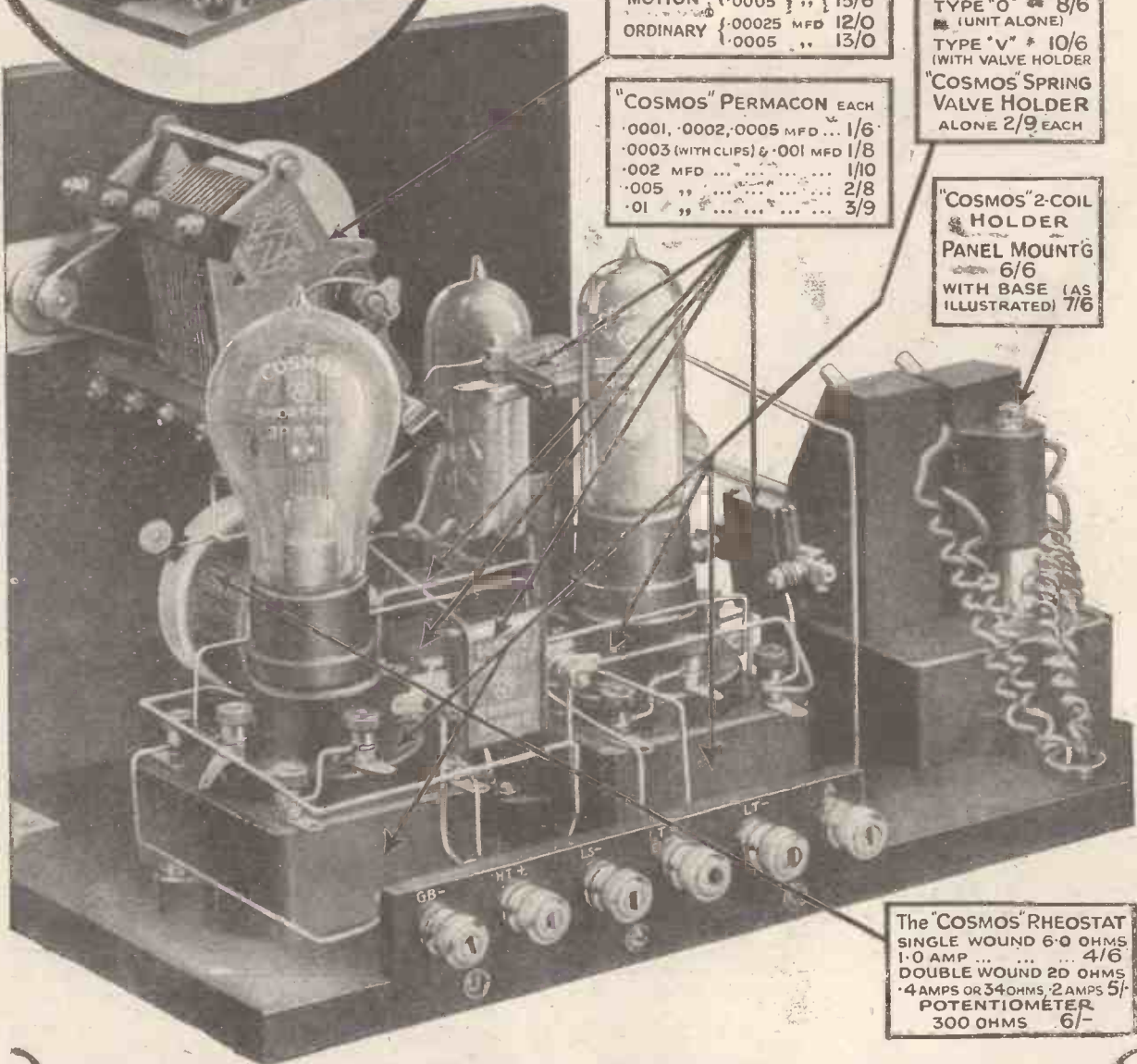

"COSMOS" LOW LOSS SQUARE LAW CONDENSER
SLOW MOTION { .00025 MFD 14/9
 .0005 " " 15/6
ORDINARY { .00025 MFD 12/0
 .0005 " " 13/0

"COSMOS" RESISTANCE COUPLING UNIT
TYPE "O" * 8/6
(UNIT ALONE)
TYPE "V" * 10/6
(WITH VALVE HOLDER)
"COSMOS" SPRING VALVE HOLDER ALONE 2/9 EACH

"COSMOS" PERMACON EACH
.0001, .0002, .0005 MFD ... 1/6
.0003 (WITH CLIPS) & .001 MFD 1/8
.002 MFD ... 1/10
.005 " " ... 2/8
.01 " " ... 3/9

"COSMOS" 2-COIL HOLDER
PANEL MOUNT'G
6/6
WITH BASE (AS ILLUSTRATED) 7/6

The "COSMOS" RHEOSTAT
SINGLE WOUND 6.0 OHMS
1.0 AMP ... 4/6
DOUBLE WOUND 20 OHMS
4 AMPS OR 34 OHMS 2 AMPS 5/-
POTENTIOMETER
300 OHMS 6/-

Music Lovers call it "The Melody Maker"

WHEN Cossor Valves are used Radio music becomes infinitely more true-to-life. The terrific emission given off by the Kalenised filament makes it possible to reproduce the liquid tones of the Cornet, the sweet high notes of the Violin, the majesty of the 'Cello, the throbbing of the Drums, the deep chords of the Organ, and the rich harmony of the Piano. Nothing is lost—nothing is added. Every note is

heard in all its natural beauty—every instrument is re-created with a wealth of colour and atmosphere, surprisingly beautiful and true in detail.

If you have still to purchase your first Cossor Valves a great musical treat awaits you. No other Valve can give you such a perfect reproduction of broadcast music—because no other valve has a Kalenised filament. Be sure, therefore, to accept no substitute.

Available in
4 distinct types

For 2, 4 and 6-volt
Accumulators



COSSOR

Popular Wireless



Scientific Adviser :
 Sir OLIVER LODGE, F.R.S.
 Editor :
 NORMAN EDWARDS, M.Inst.R.E., M.R.S.L., F.R.G.S.
 Technical Editor : G. V. DOWDING, Grad.I.E.E.
 Assistant Technical Editors : K. D. ROGERS, P. R. BIRD,
 G. P. KENDALL, B.Sc., A. JOHNSON RANDALL.

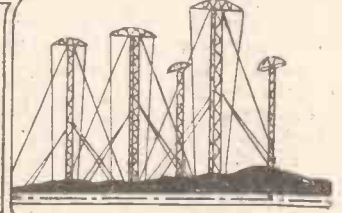

RADIO NOTES AND NEWS.

“Mike Fright” —A Shame—“Stop the Rot” —Popularising Radio—Another Exhibition to Note—Portable Sets—Cast-iron Filaments—“Johore Calling.”

“Mike Fright.”

THE recent failure of the Dorset man to do his dialect turn at 2 L O, which occurred not long after the break-down, after broadcasting, on the part of a charming actress, makes me wonder whether the B.B.C. could not devise something less likely to affect the nerves than that queer-looking, naked microphone. A psychological research is indicated. Surely this should tempt the controlling committee.

A Shame.

SO we have lost the “Celeste Octet.” First Mr. De Groot and now Mr. J. H. Squire retires from broadcasting. Well, is it to be Mr. Sandler next? This won't do at all. Two undoubted “bill toppers” have been lost to listeners because of dissatisfaction with their remuneration. The B.B.C. has an answer, of course. It always has an answer, which is couched in under-secretarial diction; but the answers are not good enough.

“Stop the Rot.”

DE GROOT and Squire are reasonable men. If they were not, nobody at all would engage their services. They knew listeners appreciated their art, a fact no artiste despises. Broadcasting meant publicity, a thing neither would scorn. Yet they cannot agree as to terms with the B.B.C. “Something is rotten in the state of Denmark,” say I. I hope the B.B.C. will realise that successful artistes are not bricklayers, with a fixed scale of wages, and that in fending off the variety lords with one hand and scaring off top-hole performers with the other, they are asking for trouble.

Popularising Radio.

FIRST of all, let me express surprise that radio is not popular in Italy. Considering that at one end of the process is Marconi and at the other end Music, I should have thought radio would flourish there. But no! And, to make it popular, the Government proposes to impose a small tax on all householders whether they listen-in or not. Surely a desperate remedy!

Another Exhibition to Note.

THE “Yorkshire Evening Post” Wireless Exhibition will be held at the Fenton Street Drill Hall, Leeds, from Tuesday, November 15th, to Saturday, November 26th. Anyone interested and desiring to communicate with the organisers should address: Provincial Exhibitions, Ltd., 46, Emerson Chambers, Blackett Street, Newcastle-on-Tyne.

Portable Sets.

WHILST in a commercial vein, I may say that, according to my observations, “the trade” is to make a determined attack with portable sets this summer. My opinion—though I must not be accused of trying to “crab” business—is that portable sets have to contend with the unfortunate fact that we have about seven months per annum for fireside radio and only five—or say four—when it is possible to get well and truly out of doors and bask in sun and open air. And one does not want to bask to the sound of a loud speaker. Nevertheless, a little sentimental music at the witching hour of sunrise or moonrise sometimes works wonders.

Cast-Iron Filaments.

NO, Archibald! I do not refer to a new invention, but to five Mullard P.M. valves which took a trip on a motor-

cycle from London to Land's End, a ride of 600 miles—not on velvet. All their filaments stood up and functioned properly after the trial. Nobody has yet put a valve inside a Cup-tie football, but I live in hopes.

“Johore Calling.”

FROM an Australian paper I gather that Mr. Rannall (3 A B), Amber Estate, Johore, Malaya, is desirous of testing with amateurs on 45 metres. I expect he would be glad to hear a few dots from Blighty. Johore is a slow show and a long way from anywhere that is anything. I once tried to hunt panthers there, but was myself hunted—by mosquitoes as hefty as small parrots. (*No memoirs, please.*—Ed. “P.W.”)

Wilkins Calling.

CAPT. WILKINS is on an expedition in Alaska, exploring by means of aeroplanes, and it is interesting to learn that an Adelaide amateur, Mr. Phillips, of Glenely, has succeeded in acting as go-between for Capt. Wilkins and his mother by picking up a message from the expedition on 42 metres. Does radio knock the romance out of exploring, or add romance to it? A knotty point.

(Continued on next page.)



The studio at the new Cork broadcasting station.

NOTES AND NEWS.

(Continued from previous page.)

DX Extraordinary.

TWO-WAY working over 2,500 miles, using 0.925 watt power, is the remarkable achievement of Mr. O. B. Kellett, of Southport (G 5 K L). On a wavelength of 45 metres, he has succeeded in working with Mr. S. H. Appleton, of Nova Scotia (NC 1 D M). There's skill behind a job like that, on both sides, though such communication must owe a lot to favourable conditions. That is a point to be well weighed by amateur transmitters. Were it not so, the Marconi Company would use stations of a few watts, and Rugby would be a bigger joke than ever.

Picture Telegraphy.

WE see a good deal in the Press nowadays about picture radio-telegraphy, but how many of us realise that a regular public service is in force between England and America? The Marconi Company is doing quite a brisk trade in that way, transmitting and receiving to and from New York photographs of fashion plates, new models of automobiles, and so forth. Their new facsimile telegraphy system has now reached a stage of development which is good enough for commercial purposes. I saw recently a page of shorthand which had been sent by wireless by that system. It was a perfect reproduction, and "went over" in a few minutes only.

Still They Come.

A 3 kw. (Geneva rating) broadcasting station has been ordered from Kosica (Kassa), Czecho-Slovakia. It will be built by the Standard Telephones and Cables, Ltd. As of books, it may be said that of the making of radio stations there is no end. Will some future war be waged because of radio "invasion"?

Through the Fog.

IF Mr. Baird's "dark light"—which is the "invisible light" long known to physics—is successfully adapted, much anxiety will be saved to ship captains and aviators. Mr. Baird has a long row to hoe, but I sincerely hope he will reach the end of it. Then, perhaps, it will be possible to read the newspaper in a third-class smoking compartment.

New Paris Station.

RADIO-VITUS, Paris, is transmitting on Sundays, Wednesdays and Fridays, from 9.0 p.m. till 10.30 p.m., on 308 metres. Reports on its reception by British listeners will be welcomed by the Station Director, 90, Rue Damremont, Paris, especially as regards the quality of modulating, power and purity of reception.

The Genie in the Bottle.

MR. VICTOR LAFORCE is reported to have built a receiver in a bottle. He is a car checker on the Canadian National Railways, but ought to be a conjuror. Perhaps he is thinking how to use bottles when Prohibition reaches Canada. But, joking apart, isn't this sort of ingenuity worthy of a more sensible object? Insulation is all he has gained—and what of it?

Radio Telepathy.

THE result of the great so-called telepathy experiment is disappointing. Even Sir Oliver Lodge, who consented to honour the test with his assistance, sees little in the results on which to form an opinion favourable to the hope that telepathy was not uncommon.

Voice Test.

THE telepathy test was worth trying, but to my mind the voice test, when listeners were invited to judge the ages, occupations, etc., of various speakers, was useless. It was like asking one the price of penny buns. What, I may ask, has been gained as an outcome of the test? Simply this—that some guessers were nearly right in certain cases, and some quite wrong. And the Celeste Octet has been lost for the want of a few pounds. If the late General O. Cromwell were here, he would say "Enough of this fooling."

Amateur Tests.

MR. L. W. HOOKE (G 5 X H), 87a, Haverhill Road, Balham S.W.12, is conducting a series of tests on 44 to 46 metres and asks for reports, giving weather conditions, signal strength (max. and min.), time of reception, etc. Unfortunately, as the notice given to us was not sufficient, only a few days of the test, which closes on May 23rd, will remain after these lines appear. Perhaps Mr. Hooke will continue the test for another week.

A Windfall.

MR. A. J. SABOURIN, 12, Hitherfield Road, Streatham, S.W.16, has for disposal "P.W." Nos. 17-200, and "Wireless Constructor" from No. 1 to

SHORT WAVES.

Salesman: "Yes, sir, these are exceptionally good reproducers."
Customer: "That may be, but I don't want a lot of little loud speakers running about the house."

Since the passing of the Wireless Telegraph Act, 1925, 487 persons have been summoned for installing or corking wireless apparatus without a licence.—Daily Paper.
Well, you can't blame them for "putting a cork in it" sometimes.

A Scots exile in New York writes to tell me he has heard on his radio across the Atlantic a Scots tenor, and selections by a pipe band. He suggests that next year a Burns supper should be broadcast, because, in the arid wastes of America, he wants to hear "the orations and the gurgles."—The Bulletin & Scots Pictorial.

It has been suggested that birthday parties including the games played, such as Postman's Knock, etc., should be broadcast, thus brightening many lonely homes. This would be rather difficult, though, owing to the oscillation that would be set up.

The broadcasting of operatic and other good music will mean a new revolution in the rural life of Russia.—Investor's Chronicle and Money Market Review.
We're not surprised.

Listeners-in appear determined to take arms against a B.B.C. of troubles.—Daily Mirror.

"Life is always changing" is a hackneyed phrase, I know.
The er-lemonade is not so good as twenty years ago;
The miracles of Science bring new beauty into life—
You switch on your loud speaker so you cannot hear the wife.
G. B., "Yorkshire Observer."

March this year. He will exchange them for a pound of radium or give them to anyone, but preferably to a radio beginner, who cares to call or send sufficient postage. Individual numbers cannot be picked out—it's all or nothing. Go in and win.

Suggested League.

AS to a League to compel the B.B.C. to study the majority when framing programmes, well, Mr. S., the only expression of taste I have seen in bulk was the result of the "Daily Mail" Ballot, a useful indicator, but not necessarily an index of the majority. I think the B.B.C.'s real problem is to find what the majority want. I don't know. And then, minorities have their rights. That's awkward, too. No, I insist that three alternative programmes must be the solution.

Special for Short-Wave Men.

MR. F. DEARLOVE tells me that he is sailing for Newfoundland about May 18th, and will have a short-wave station at work before the end of June. He will try to communicate with Great Britain from Labrador on 43 metres or thereabouts. In the absence of an official call he will use the letters WTG, and will operate from St. Anthony, North Newfoundland. He would be glad if anyone picking up his signals would write with details to Park View, Gomersal, near Leeds, and on his return he will send back Q S L cards.

That "Oscillating" Crystal.

MR. J. F. CORRIGAN, M.Sc., kindly passes me a very interesting letter from D. C. H. (Northampton), in which reference is made to the "oscillating" detector which I mentioned in my Notes of April 30th. Our reader appears to have got to the bottom of the mystery, which is just a crystal. Perhaps it was called "oscillating" because a part of the gadget has to be rotated for a fresh contact. I have reason to believe that the wording of the advertisement has been altered, and so I leave it.

One-Valve Results.

THE same reader (D C H) says that with one valve he can receive all the B.B.C. main stations, three relays, and some forty European stations. His motto is "Collect more energy and magnify less." The results certainly justify his slogan.

Referred Back.

MR. G. (Bonnybridge) sends me a diagram of a simple crystal detector circuit with variometer, and says that he has obtained oscillations with it. "I discovered that it oscillated when I tuned in what proved to be Bournemouth," adds W. G. Will he tell me how he knew it was oscillating? I am glad to have his letter, but I fear that possibly our ideas as to what an oscillating crystal circuit is are different.

Mars Again.

PROFESSOR E. V. APPLETON is reported to have told the Royal Institution that in any attempt to communicate with Mars the best wavelength would probably be one metre. I should have put it much shorter myself and then have wondered how we are going to get enough energy out of the aerial.

ARIEL.

"P.W." RADIOPHONES TO AMERICA

THE recent articles we have published by Mr. Percy Harris dealing with the Loftin-White Circuits—circuits designed by two well-known American engineers, Mr. Edward H. Loftin and Mr. S. Young White—have created a considerable amount of interest among our readers. Since the publication of the articles we have received many hundreds of queries from experimenters asking us for further details and urging Mr. Harris to continue his articles on these new and interesting circuits.

The other day I received a letter from Mr. Edward H. Loftin which I will quote in full. He wrote:

"I note with interest the article in your number of April 9th, 1927, concerning the radio-frequency amplifier system of Mr. S. Young White and myself, and appreciate the consideration you have given to our system in your valuable columns. I also note the frankness and liberality with which Mr. Harris, the author of the article, has attributed this particular bit of development to Mr. White and myself, and this feature is also greatly appreciated, and I will be pleased to have you convey our thanks to the author.

"We believe that the system has merit in the directions discussed by Mr. Harris, and find that our belief is being more generally confirmed as engineers have opportunity to try out the system for the features we claim for it.

"I note that Mr. Harris intends to continue his articles, and if it will not inconvenience you, we should be pleased to have copies of such numbers as include his discussions."

Quick Work.

A few days ago Mr. Harris came into my room and we discussed the best way to meet the demand from our readers for further details about the Loftin-White Circuits, and in the course of the discussion Mr. Harris said, rather wistfully, how he would very much like the opportunity of a chat with Mr. Loftin, as there were many little things in connection with these Loftin-White Circuits which he would like to talk about, and which could be dealt with more effectively that way than by correspondence.

There were also several problems from readers in connection with the circuit about which Mr. Harris said he would like to consult Mr. Loftin.

We discussed the possibility of sending Mr. Loftin a cable, but when we drafted it out we found that it would require several more cables in order to get the necessary questions and answers dealt with effectively, and, further, as Mr. Harris pointed out,

By THE EDITOR.

cabling a man was not half so satisfactory, in a case like this, as having a few minutes' talk with him.

We almost decided that the only way to deal with the problem was to write Mr. Loftin a detailed letter or to send him a cablegram, which would necessitate a reply from him, followed by another cable from us and another reply from him. Just as we had decided upon this, Mr. Harris jumped up and said: "Why not talk with him by the Transatlantic Telephone?"

No sooner said than done—almost, for we at once put a call through to Mr. Loftin's office in New York. The Post Office advised us that conditions were good, and at 3.15 p.m. we booked the call, about 10 o'clock in the morning in New York.



Mr. P. W. Harris speaking to Mr. Loftin via the transatlantic radiophone.

We were informed that we should be through to New York within twenty minutes as there were only two other calls to be dealt with before our turn came, and just about half-past three we were advised by the Post Office that they had been in touch with Mr. Loftin's office in New York but that that gentleman was in Washington.

"That," I said to Mr. Harris, "washes out your idea." But as I spoke the telephone again rang, and the Post Office informed us

that they had been in touch again with New York, and New York had been on to Washington, and that within twenty minutes they hoped to ring us and inform us that they had found Mr. Loftin!

This seemed highly improbable, for Mr. Loftin might have been anywhere in Washington; he might have been, for instance, at the Bureau of Standards, at his hotel, or at the Navy Yard.

Red Hot News.

The twenty minutes went by, and we were not called; but, after a further delay, somewhere about five o'clock, another call came through. They had found Mr. Loftin in Washington, and in twenty minutes he would be at the 'phone ready to speak! Sharp at twenty-five minutes past five the telephone bell rang and Mr. Harris, with the very briefest delay, was in conversation with Mr. Loftin in Washington.

The result of that conversation you will find dealt with in Mr. Harris's article in this issue. Mr. Harris sat at the 'phone, and, having been to America, he thought it advisable to adopt an American accent, which he did, I must admit, with considerable success! For several minutes he and Mr. Loftin discussed the latest developments of the Loftin-White Circuits, with the result that we are now able to place shortly before our readers information many days before it would have been available had we waited for another letter from Mr. Loftin.

Throughout the conversation it was obvious that Mr. Harris was clearly following Mr. Loftin, and that, after the first minute or so, Mr. Loftin was clearly following Mr. Harris. The transmission seems to have been excellent, and, as Mr. Harris told me afterwards, he had no real difficulty at all in following Mr. Loftin's conversation.

£5 a Minute!

Transatlantic telephony, however, is rather an expensive matter, and the conversation has to be made "snappy." Just at the end of the conversation, though, it was possible to ask Mr. Loftin whether Captain Nungesser, the French airman, had arrived in America. According to Mr. Loftin, he hadn't.

Wishing him the compliments of POPULAR WIRELESS, and expressing the wish that we should hear further from him by letter, Mr. Harris closed the conversation.

As he pointed out afterwards, it was rather a pity that he had to (but five pounds a minute is rather steep!) because Mr. Loftin was just getting warmed up and was unburdening himself of a considerable

(Continued on page 506.)

TECHNICAL NOTES

By Dr. J. H. T. ROBERTS, F.Inst.P.

A RADIO-ACTIVE MICROPHONE

THE NEON RECTIFIER—SUMMER PORTABLES—THE "DEATH" OF "MIKE"—DAY AND NIGHT EFFECTS—HOW MUCH AMPLIFICATION?

Duplex Valve.

A NEW three-electrode valve, which really has four electrodes, has been produced by the Magnavox Company and may be used either as detector or amplifier (H.F. or L.F.). The grid is divided into two parts, really like two separate spirals placed parallel to one another. The filament is arranged as an inverted U, passing up through one grid spiral, over a hook, and down through the other. There is thus a single filament, but it operates in two separate parts; the two grids are entirely separate mechanically, but are, of course, electrically connected together; whilst the whole of the filament and grid assembly is surrounded by a single anode. The valve is rated at 5 volts 0.25 ampere with up to 90 volts on the anode.

Radio-active Microphone.

A patent has been lately granted to an American experimenter for a curious microphone on a somewhat novel principle. The microphone consists briefly of two metal plates arranged horizontally one above the other, one of them being charged on the "inner" face with a radio active material. One plate is connected through the primary of a transformer and through a battery of suitable voltage (fairly high) to the other plate. There is thus a voltage applied across the plates to drive the electrified particles across the intervening space and the current so produced passes through the primary of the transformer. The secondary of the transformer is connected to a detector valve and so to an amplifying circuit in the usual way. When sound-waves enter the space between the two plates they influence the amount of current which is flowing (due to the radio activity), and as this current is influenced in a way which is characteristic of the sound waves, it is evidently possible to amplify up and reproduce the sound by the usual methods.

Complications.

I have not examined this arrangement, but it would seem likely to involve certain considerable manipulative difficulties, one of which is due to the small amount of emission from any suitable radio active material—or, to put the matter in another way, the very high impedance of the microphone, whilst another difficulty would be due to the many complications which one would expect with an arrangement of this sort in the open atmosphere. It is, of course, impossible to enclose the device in an evacuated vessel, as the sound waves would not gain access to it.

It is, however, an interesting and suggestive device.

The Neon Rectifier.

The brilliant red electric signs which one now sees at night-time in many parts of

London are made with neon-filled tubes through which a high-tension electrical discharge is passed. Neon which, as my readers are no doubt aware, is a comparatively rare gas, has some very interesting and important electrical properties; by that I mean that, when introduced in a fairly rarefied condition into a tube, it behaves in a rather special way under an electrical discharge. For this reason it has been put to many scientific and industrial uses and one of the latest is in connection with a gas-filled rectifying valve for use with high-tension battery eliminators.

The particular valve which I have before me at the moment is a single-wave rectifier, and delivers up to 40 milliamps without overloading.

Summer Portables.

With the approach of the summer season and the greater demand for portable sets, frame aerials will be coming into their own once more. I have a letter from Messrs.

that the microphone in front of him had "died." It appears that the cause of the trouble was the short-circuiting of some wires by the accidental movement of a piece of scenery on the stage. Various methods have been suggested for ensuring that a recurrence of this kind of accident shall be impossible.

Of course, in this country, B.B.C. engineers have not one but several methods of knowing when the whole of the transmission gear is operating effectively.

Day and Night Effects.

As a result of some experiments upon the mode of transmission of wireless waves during daylight and night-time, it has been found that during the day the waves travel mostly over the surface of the earth and are prevented from penetrating high into the upper atmosphere owing to the ionisation produced by the sun's rays. The ionisation is believed to be due more particularly to the action of the ultra-violet portion of the solar radiation, either directly upon the air molecules or upon suspended dust or water particles.

At night-time the air is much less ionised from this cause and the waves are able to penetrate to the upper conducting layer or region known as the Heaviside layer, and to travel by its aid over considerable distances. The extra travel at night-time in this way is further facilitated by the fact that the various diffracting or scattering obstacles on the earth's surface are avoided.

How Much Amplification?

What is the actual amplification obtained

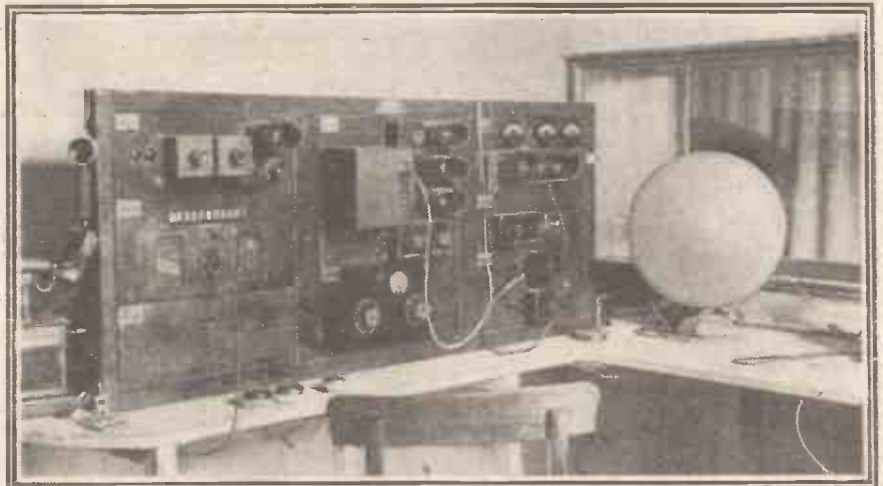

The control-room at the new Cork broadcasting station.

London Electric Co., Ltd. (Lewcos), with reference to their special frame aerial wire which is supplied in a variety of colours. They have also sent me some samples of the wire, and these appear to be of excellent quality and very suitable for the purpose. Experimenters and constructors who are considering the making of frame aerials for their summer portables will no doubt be interested to know of this wire which is made specially for the purpose, and which, as I mentioned, can be had in many different qualities and colours.

The "Death" of "Mike."

A curious situation arose recently in the United States, when the President was speaking at a public meeting. After he had been speaking some time it was discovered

with each high-frequency or low-frequency stage in a receiver? Has it ever occurred to you to wonder what is the amplification in actual figures? We hear of valves having amplification factors up to 30 or more, but when it comes to estimating the actual overall amplification in the set, it is very probable that in the vast majority of cases the amplification falls much below the present value.

The well-known Stromberg Carlson Company, of Rochester, N.Y., publish some interesting determinations of amplifications actually obtained. With an ordinary six-valve set—three high frequency, detector, and two low frequency—the amplification is given as 55,296, which is obtained in this way: Aerial coupler amplification 2, first

(Continued on page 507.)

A ONE VALVE PORTABLE SET



TO please most people a portable set must have advantages besides mere portability if it is to be worth the trouble and expense of making. Money spent upon an elaborate case or costly components may be regarded as money thrown away unless one is going to get plenty of pleasure from the set after it is finished,

An out-of-doors receiver for the listener or the experimenter.
 By P. R. BIRD.
 (Asst. Technical Editor.)

In fact, the constructional work is extremely easy, with just sufficient novelty about it to make it interesting.

LIST OF COMPONENTS.

- 1 Potentiometer (Lissen), 400 ohms.
 - 1 Valve holder, "Precision" (C. Ede).
 - 1 Rheostat 15 (ohms).
 - 1 Panel, 8½ in. x 8½ in. x ½ in.
 - 2 Wooden side-pieces, 8½ in. x 3 in. x ½ in.
 - 1 .001 Variable condenser (General Radio Co.) type G.R.C. 63.
 - 2 .001 Fixed condensers (T.C.C., Dubilier, Lissen, etc.).
 - 1 2½ in. Ebonite tube, for coils, not less than 6½ in. long, 2½ in. external diameter, 2¼ in. internal diameter.
 - ¼ lb. No. 22 D.C.C. wire for coils.
 - 7 Terminals.
 - Wire, screws, transfers, etc.
- (The attaché case used had an internal depth of 3 in. The lid measured 14 in. x 9 in., the case itself 13½ in. x 8½ in.)

The rheostat, potentiometer, and .001 fixed condensers given in the list of components are all parts likely to be on hand, or can be obtained cheaply. The only specially "portable" piece of apparatus is the variable condenser, and this, being of the type with all its "works" contained in the dial, easily fits into a shallow case.

The panel is largely cut away, so a second-hand one is quite suitable, and was, indeed, used upon the original model. Failing an old panel, a piece of ¼-in. dry wood could be used instead, and in all probability results would be equally good.

Besides the panel, two side-pieces of wood are used, and the whole of the parts are thus supported upon a framework that only requires four or five screws to make secure.

Two considerations governed the choice of circuit—firstly, low-battery requirements, and secondly, the desire for a really interesting circuit to try out. (It was felt that to take out a perfectly ordinary one-valve set, when already one has an ordinary two-, three-, or four-valver at home, would be rather like picnicking on a push-bike and leaving the car at home!)

For the set to be really diverting the
(Continued on next page.)

and it was with this aspect of the question in view that the receiver now to be described was constructed.

The cost of the set is low, and it has no "cabinet," but fits into an ordinary attaché case, such as is to be found in most homes. This case is not cut or marked in any way, so when not required the set is lifted out, and the attaché case can be used for its original purpose.

Interesting Circuit to Try.

It has the usual advantages of any portable one-valve set, being capable of tuning in the local station at very good phone strength, and, in addition, foreign stations can be received upon it with quite a make-shift aerial, so that in sensitivity the set leaves nothing to be desired. The coils are home-made, and only cost about three shillings.



The set, with batteries, packs inside a small attaché-case.

A ONE-VALVE PORTABLE SET.

(Continued from previous page.)

circuit must be unusual, and right out of the ordinary. Just how unusual it is, and how far out of the ordinary it goes, can be seen from Fig. 1, the theoretical circuit. Here it

POINT-TO-POINT CONNECTIONS.

A, terminal to centre tap on L_1 .
 A terminal to one end of L_1 , to .001 fixed condenser, and to one filament socket of valve.

Other side of .001 fixed condenser to .001 variable condenser.

E terminal to other end of L_1 , to L.T. neg. (flex lead), to remaining side of variable condenser, to one end of potentiometer, and to bias neg. terminal. The bias-positive-and-H.T.-negative terminal is connected to the other end of the potentiometer.

The slider of the potentiometer is joined to the plate contact of the valve holder.

One side of rheostat (by a flexible lead) to L.T. plus.

Remaining side of the rheostat to L_2 .
 Other end of L_2 to remaining filament socket of valve holder. Grid socket of valve holder to L_2 .

Remaining side of L_2 to other .001 fixed condenser and to 'phone terminal. Remaining 'phone terminal to remaining side of .001 'phone condenser, and (by a flex lead) to H.T. plus.

will be seen that the H.T. plus, 'phones, and reaction circuit are connected to grid instead of to plate. To make matters apparently worse, the plate goes to earth, or at most it gets a few volts "grid bias," which in the circumstances is really "plate bias." Finally, the filament is tuned (both legs!), so that a more topsyturvy looking scheme it would be difficult to imagine.

Having thus disregarded every rule in radio, the set—which readers will by now have recognised as a "P.W." Filadyne variation—not only works, but pulls in stations that an ordinary one-valver never even heard of! Apart from its being portable, the interest to be got from such an attaché-case-full of mystery is endless, so this set is well worth the consideration of the constructor who in the ordinary way has "no time for a portable." When not in use the set affords a complete stand-by receiver, capable

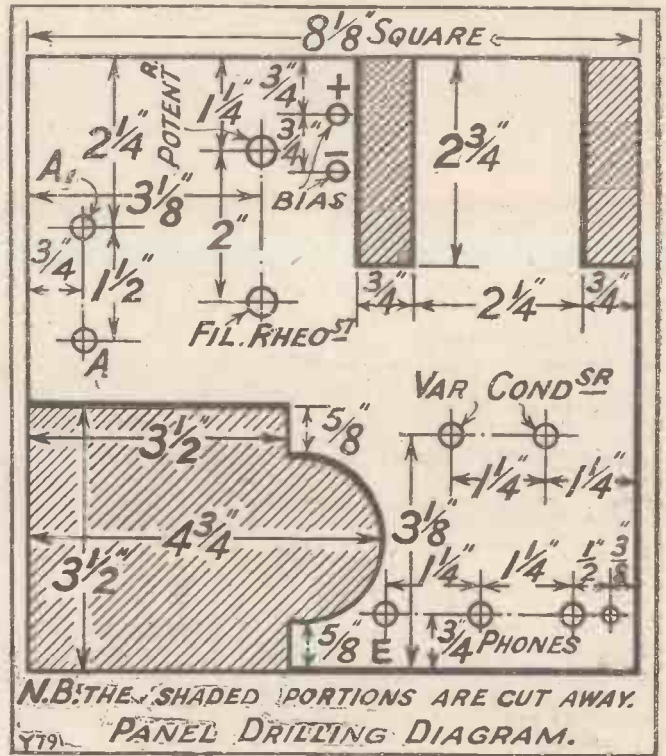

N.B! THE SHADED PORTIONS ARE CUT AWAY.
 PANEL DRILLING DIAGRAM.

of running from dry batteries at a moment's notice, if the main set breaks down.

The Valve to Use.

At this point I can imagine the cautious reader asking: "But where is the snag? If it is so much better than the ordinary one-valve set, why use the latter at all?" The answer is that, unlike the ordinary one-valver, the Filadyne is rather particular about the valve employed. Not every type of valve will "go" perfectly, but fortunately some of the commonest and most-used types work excellently in the Filadyne circuit. In the 2-volt class—which is particularly suitable for portable work—the best valve is the Marconi or Osram D.E.2 L.F., or the

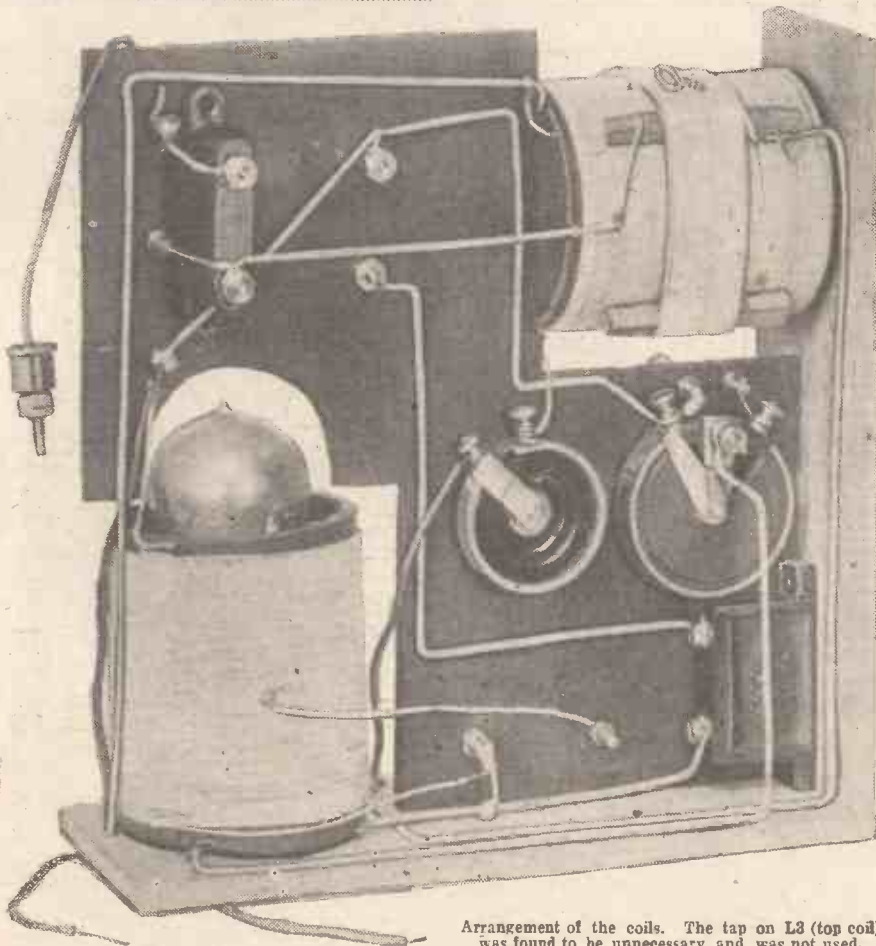

Arrangement of the coils. The tap on L_3 (top coil) was found to be unnecessary, and was not used.

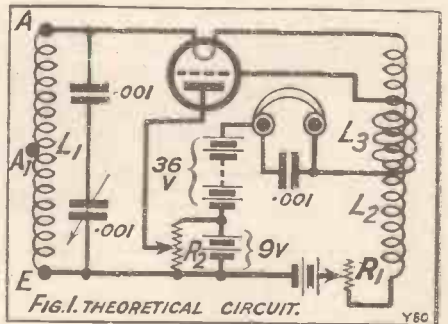

FIG. 1. THEORETICAL CIRCUIT.

old D.E.6, any of which will give extraordinary volume. Certain cheap foreign valves having tubular "plates" also give excellent results. Equal to the D.E.2 L.F., but in the 4-volt class, is the B.T.H. B.5, which, taking only .06 amp. filament current, is the ideal valve for a portable set, to be run from dry cells only.

Other valves which work well—though not so well as the foregoing—are the old Cleartron C.T.15 and the Cosmos S.P.18 Blue Spot. The Ediswan R.C.2 also oscillated well, but for some reason was not so good for long-distance work or for

(Continued on next page.)

A ONE-VALVE PORTABLE SET.

(Continued from previous page.)

volume as the others named, though possibly a little "juggling" with component values might have improved results with this particular valve.



An aerial of the type being erected here gives good results.

The D.E.6, the B.T.H. B.5, and the D.E.2 L.F. all seem to work much better in the Filadyne circuit than they do when connected up in the normal one-valve circuit, and as H.T. and L.T. voltages can be run below the normal requirements, these valves should have a long life under such conditions.

Before construction is actually commenced it is a good plan to assemble the H.T. and L.T. batteries ready for use, so that a good fit inside the case is assured. Amongst the finds in the "junk-box" when the parts were being chosen was a small H.T. battery case, intended to hold eight dry cells, and, as this happened to fit perfectly, it was used to hold the dry cells for H.T. Such a case is not essential, so, if preferred, the dry cells may be stood side by side without a case and connected together by battery clips.

Winding the Coils.

In addition to the 36-volt H.T. battery, two other dry cells are needed for the 9-volt bias battery, across which the potentiometer is connected. As the bias and H.T. battery are connected in series (see Fig. 1), a single battery of 45 or more volts will do for both H.T. and bias when tapped at 9 volts; but it is really advantageous to have two separate cells for bias, as shown, because they supply more current than the

neighbouring cells (which are not connected across the potentiometer), and when separate are easily replaceable.

The advantage of using ebonite-tube formers for the coils is its greater rigidity, and the fact that a 2½-in. tube fits exactly over the valve holder, being supported in place by the latter when this component is screwed on to the wooden side-piece. (The valve, as will be seen from the photographs, is held inside the aerial coil, the panel being recessed suitably to allow it to be inserted and withdrawn.)

The aerial coil (L_1) consists of 73 turns of the 22 gauge D.C.C. wire, and the winding will measure nearly 2½ in. wide. The beginning and end of the wire can be anchored to the former by means of holes drilled therein, or small slots cut in the edge with a hacksaw. When completed, fit the valve holder inside this coil and cut four small slots through which the soldering tags of the valve holder can project, for making the valve connections.

Wavelength Range.

The other coil (L_2) is similar, but it has 77 turns. When these have been laid on and secured, the coil L_3 is wound over L_2 , on four wooden spacing blocks. These blocks measure about 1½ in. long by ¼ in. by ¼ in.

They are first held in place over L_2 by string, and when the 21 turns which constitute L_3 have been wound round them and fixed, the string can be removed. Note that to shorten the wiring the coil L_3 is wound in the opposite direction to the coil L_2 , and that it is placed approximately around the centre of the latter.



The panel with its wooden side-pieces removed from the case.

These coils cover the ordinary broadcasting wave-lengths, but being in series with the filament they are not replaceable by larger coils, so the receiver cannot tune above 600 metres or so.

The panel is cut as shown in the panel diagram. When the shaded portions at the top right-hand have been cut away, it will

(Continued on next page.)

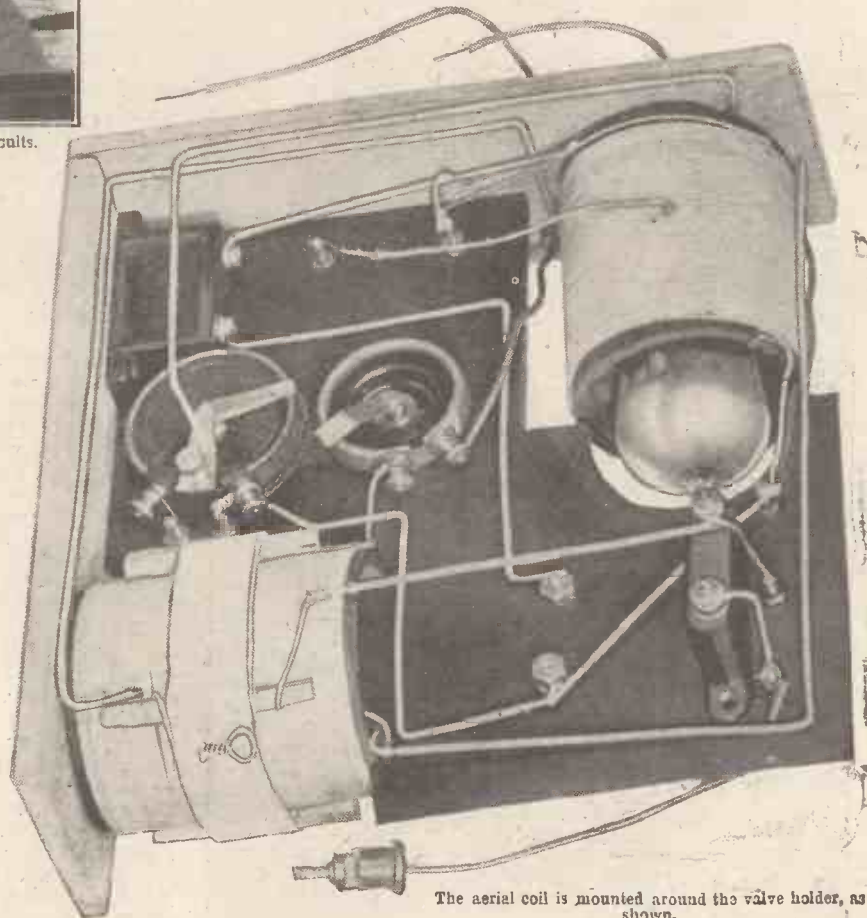

The aerial coil is mounted around the valve holder, as shown.

A ONE-VALVE PORTABLE SET.

(Continued from previous page.)

be found that the coil L_2 will just fit over the projecting tongue, which thus holds it securely in place.

If the lower portion of the panel is cut away as shown, there will be room to insert any ordinary valve, but of course the shape and size of the recess may be varied if required. Batteries, panel, coils, and side-pieces may now be fitted into the case, to make sure of clearance room.

It will be noted that an Oldham "non-spill" portable accumulator (type DL) has been used for L.T., but, as stated previously, if a B.T.H. B.5 valve is to be used, requiring more than 2 volts, dry cells may be employed instead.

Securing the Panel.

The general arrangement of the set will now be perfectly clear to the constructor, and the drilling of the panel may be proceeded with. The variable condenser, rheostat, and potentiometer are mounted upon the panel, the .001 fixed condenser upon one of the wooden side-pieces, and the valve holder upon the other.

The valve holder is mounted so that when the aerial coil (L_1) is fitted over it the edge of the coil is exactly level with the top of the side-piece. The .001 fixed condenser is mounted upon the other side-piece in such a position that when the panel rests upon it for support the top of the panel is exactly 1 in. below the top of the side-piece. If now the remaining .001 fixed condenser is placed across the 'phone terminals, this corner of the panel will rest upon the 'phone condenser, thus making a perfectly rigid job of the panel

supports. A couple of wood screws hold the two side-pieces together at the corner where they overlap. About half-way along each side-piece a $\frac{1}{4}$ in. or $\frac{3}{8}$ in. wood screw is driven through the wood into the ebonite panel, after the latter has been drilled to

over from the point-to-point connections.

The working of the set is simplicity itself, but in such an interesting receiver there are several points that call for special mention. Unlike the original Filadyne circuits, separate filament chokes are un-

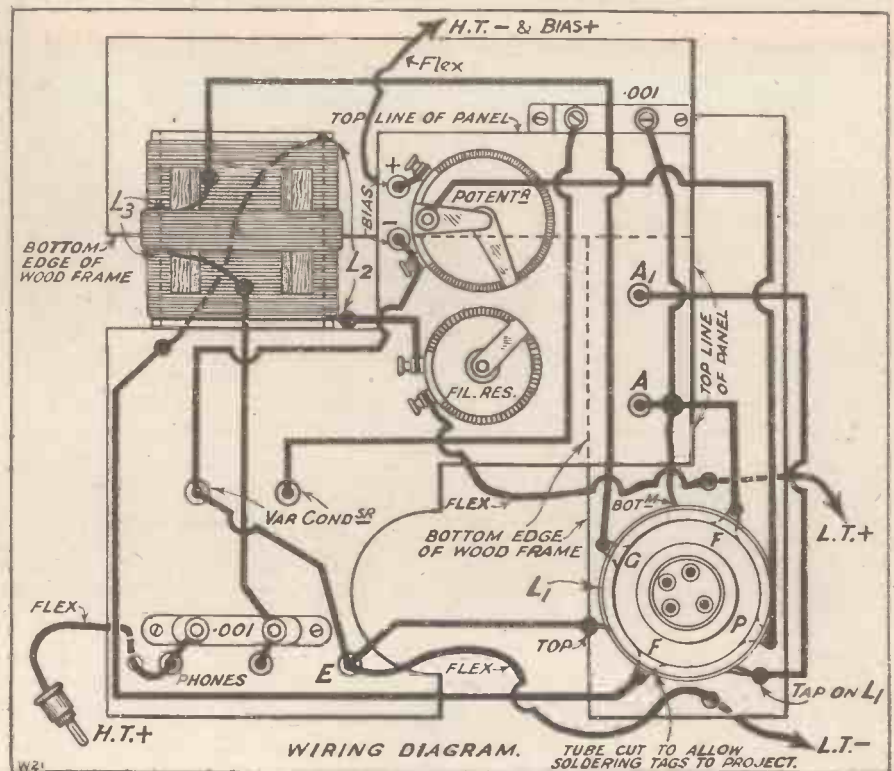

receive it. The wood screw will cut its own thread into the ebonite if, instead of being screwed straight into the hole, the screw is driven in just a little way—say half a turn—and then the screwdriver is turned backwards and forwards half a dozen times or so. After this the screw is advanced another half-turn, twisted backwards and forwards again, and so on, until it can be driven right home.

When the panel and two side-pieces have been fitted rigidly together, the wiring can be carried out as shown in the wiring diagram. (Owing to the valve holder being mounted upon the wooden side-piece, the wiring diagram cannot be arranged to show an ordinary "looking-down" view of the completed wiring. To make the valve-connections clear, the side-piece has had to be shown as though it were tilted, but the actual arrangement of a flat panel and upright side-pieces will be clear from the photographs.)

When the wiring is completed, check it

necessary, the tuned coils L_1 and L_2 serving the same purpose. As these coils are of fairly thick wire and relatively small number of turns, there is no appreciable voltage drop from L.T. battery to valve, and practically the full filament voltage is available at the valve legs, even though a 2-volt L.T. battery is employed.

Reaction Control.

Generally, the aerial lead should be taken to the A_1 terminal (centre tap), but occasionally it may be desirable to try connecting the aerial to the end of the aerial coil (L_1), in which case it may be connected to the terminal marked A.

Another point which may puzzle the constructor is the use of two .001 condensers in series across the aerial coil. This is not a kind of Loftin-White effect, as might be imagined at first glance, but is merely an easy method of reducing the effective capacity of the special variable condenser, as this type can only be obtained in the .001 size. This (.001 mfd.) is too great a capacity for the Filadyne circuit tuning, so it is reduced by placing the fixed condenser in series. Otherwise the circuit is similar to that described in "P.W." No. 256 (April 30th, 1927), so the hints given there by Mr. English will be of interest.

Tuning will be found to be very sharp with the arrangement given, reaction being controlled by the potentiometer. Unlike a conventional one-valver, the filament resistance affords an extra degree of critical adjustment, and the best position for both rheostat and potentiometer will vary with different aeriels and tuning adjustments.



Listening-in to London on the One-Valve Portable Set.

The Work of the Wireless Classes of the Royal Academy of Dramatic Art.

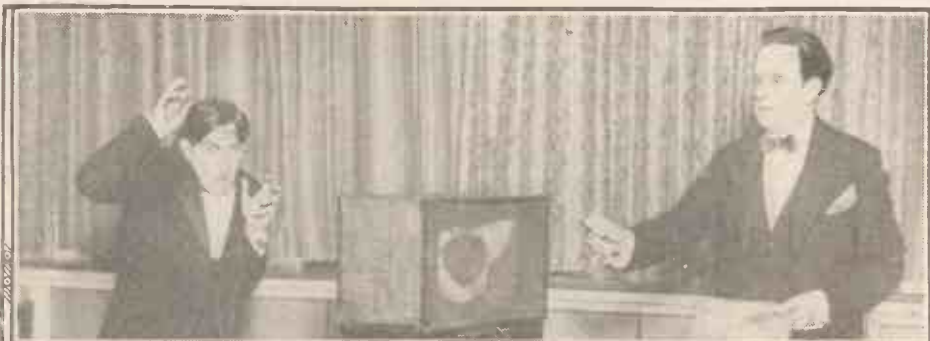

An interesting article describing how our budding broadcasters are being developed.

By "ARIEL."

Radio Actors in Training

THESE training classes for acting by radio and, in fact, for anything connected with talking before the microphone, are in their very early stages, and are, as yet, enough of a novelty to cause a wave of excitement to pass through the ranks of the students of the Academy every Tuesday morning when they are held.

At the express invitation of Mr. Kenneth Barnes, the Administrator of the Academy, I went along to Gower Street last Tuesday in order to witness the work of some of our coming wireless "stars." I wish I could have taken some of the readers of POPULAR WIRELESS with me, but as that was impossible, let me describe in detail one of the most interesting



Mr. Kenneth Barnes.

mornings I have recently spent.

The students in this particular branch of the Academy's work are under the immediate direction of Mr. Barnes, and the classes take place partly in his comfortable private office on the ground floor and partly in a small room on the top floor of the building.

Some twenty students, young men and women, were assembled in the room when I came in.

Potential Stars.

Mr. Barnes explained to me that only advanced students of the Academy are allowed to take part in these classes, and that I was in the presence of a number of young people of whom at least one or two might be expected to make a name for themselves in the world of the drama.

I was then introduced to a new arrival, Mr. Lloyd James, Secretary of the Pronunciation Committee of the B.B.C., the gentleman who has coached every announcer

on the staff of Savoy Hill. He is present at a good many of the classes, and assists Mr. Barnes with criticism and practical hints.

"This," said the Administrator, pointing to a species of loud speaker that stood on a shelf in one corner of the room, "is connected with the microphone which has been installed in the upstairs room. Of course, there is a direct connection between the two, but it has been so fitted up under the direction of the B.B.C. that the results heard are exactly the same as those that would be obtained with the use of transmitting and receiving aerials.

Hard at Work.

"Now," he went on, turning to the class, who sat waiting with books in their hands, "we will take a scene from 'As You Like It' first."

Parts were assigned, and two of the students left the room and went upstairs to the "studio." Another tutor was in-

stalled up there, Mr. Barnes communicating with him through a speaking tube. The word to commence was given.

Immediately two girls began a piece of dialogue, while we in the lower rooms listened intently to them. They were not allowed to carry on for very long uninterrupted.

Mr. Barnes seized the speaking tube. "Miss D.'s diction is not clear," he said, "her voice is coming through unevenly and too highly pitched."

A fresh start was made, and at the end of about five minutes the actors were called down to hear how they had impressed us.

"You were quite good, Miss D. and Miss A.," they were told, "but your voices are not suitable to conduct a radio dialogue. Their timbre is so similar that it is difficult to detect which speaker is which, and when a change of speaker takes place. Also, you took up your cues rather too quickly.

(Continued on next page.)



Mr. Kenneth Barnes showing some pupils how to speak into the microphone.

RADIO ACTORS IN TRAINING.

(Continued from previous page.)

You must bear in mind that you must make a distinct pause at the end of each speech so as to indicate to your audience when the change comes."

Another "cast" was chosen and they went up.

But these students seemed to have taken Mr. Barnes' remarks too much to heart. They placed so much emphasis upon their pauses, and spoke so slowly that they sounded quite unnatural. They proved an excellent couple to work together, inasmuch as their voices were entirely different and one had no difficulty in determining which character was speaking.

Hard to Laugh.

Next, a scene from the "Merry Wives of Windsor" was tried. Here it was necessary that those taking part should talk in rollicking tones, interspersing their conversation with bursts of laughter.

Did you know that it is one of the most tricky things in the world to laugh naturally by Radio? It is. Hardly any of the laughter sounded real, and yet these were people who had been trained in the art of laughing in the most approved stage manner. Too low pitched, a laugh sounds like a devilish chuckle; too shrill, it cracks and



Sir Gerald du Maurier, the well-known actor, broadcasting from 2 L O.

bangs through the loud speaker in a most distressing manner.

The students taking part in the above scene knew their words by heart, so the next thing was a scene from "Coriolanus," with which they were unfamiliar.

The result was a strong point in favour of Wireless actors learning their words instead of reading them off from the manuscript. The latter is the method now generally practised at most of the broadcasting stations, and I have no hesitation in saying that the quality of radio drama would be greatly improved if the cast were made to commit their speeches to memory.

It follows, as Mr. Barnes said, that if people have to bother themselves with keeping their eyes on a certain place in a book, they cannot throw themselves wholeheartedly into their parts and pay due attention to their voices as well.

Also, when the reading method is used it



Mr. Bransby Williams, who has an excellent broadcasting voice.

is much more difficult to distinguish between the voices. The wireless "star" of the future will have to learn his part in the same way as the legitimate actor and actress.

I was then taken by Mr. Barnes up into the "studio." It had a similar microphone to those used at the broadcasting stations, but the room lacked the heavy draperies usually seen. There was only one strip of thick material hung on the wall immediately behind the microphone.

Valuable Work.

At the Academy a great deal of importance is attached to the position of the speakers in relation to the position of the microphone. Mr. Lloyd James, I was informed, spends hours experimenting with different positions, moving the students this way and that, to one side of the microphone and to the other.

There can be no doubt that the Academy is doing most valuable work in teaching the technique of speaking before the microphone. They are training not only actors, but announcers, lecturers, readers, and speakers of all kinds as well. The B.B.C. gives four prizes annually of £10 each to two girl and two men students who are successful at special broadcasting tests which take place from time to time.

The work is also under the direct supervision of Mr. R. E. Jeffrey, Productions Director of the B.B.C. Students are charged no extra fees for the privilege of attending these classes and competing for the prizes.

Up to the present, it cannot truthfully be said that broadcast drama has met with a great deal of success from the point of view of the "listening" public, and there are those who think that the radio is an entirely unsuitable medium for the performing of plays. Among these we have the "Showman King," Mr. Charles B. Cochran.

Mr. Barnes and his staff, however, do not subscribe to this. They are confident that this form of drama has a great future before it, and they ascribe the lukewarm reception which it has met with so far to the fact that no specially-trained actors and actresses have been included in the casts either at 2 L O or other stations.

"It is far too early to judge the possibilities of broadcast plays as yet," Mr. Barnes said. "I would ask listeners not to form any conclusive opinion until we get some of the best of our 'microphone-trained' students into the stations. I am sure that many adverse opinions will become favourable ones then."

I am inclined to think his request a reasonable one. The success of "The White Chateau," which was originally a broadcast play, and is now crowding the St. Martin's Theatre every night, shows that the material is forthcoming if only adequate interpreters can be obtained. That deficiency the radio section of the Academy of Dramatic Art is doing its best to remedy.



Mr. Henry Ainley and Miss Gladys Cooper before the microphone.

PLAYING THE GRAMOPHONE ELECTRICALLY

By Capt. H. J. ROUND, M.I.E.E.



MANY may desire to play their gramophone through their loud speaker, and if the latter is of the modern cone type, then they are likely to get better quality than with the old-fashioned type of gramophone.

A microphone such as is used in the ordinary telephone service, if held in front of a gramophone and connected to one's loud speaker through an amplifier, will give some sort of electrical playing, but it is not very likely to be satisfactory, and the reason is not far to seek. First of all, we have gramophone distortion, and then, superimposed upon it, the microphone

of what was on the record. Some time after seeing this apparatus I constructed a simple magnetic pick-up device, which gave very fair results, and has been used until recently by the Marconi demonstration engineers. A gramophone record has impressed on it a wavy line which represents the original sound made in the air, more or less faithfully. At least over a very fair proportion of the musical range the modern records are fairly faithful. But we must examine fairly exactly what faithful means.

"Under Ideal Circumstances."

A sound wave in air produces rise and fall of pressure at any point, and the air particles move backwards and forwards with a certain speed. Under ideal circumstances

so that such a piece of apparatus will produce a correct result, as we are after a voltage proportional to the original sound-wave pressure or air-particle speed.

Again, if we move a piece of iron near a magnet, and round the iron is a coil of wire, the coil not actually moving, the resulting voltage will be, within certain limits, correct.

But if our needle-point actuated the plates of a condenser, and the condenser, supplied with a polarising voltage, was placed in series with a resistance, the voltage generated across the resistance would follow a different law to those in the magnetic cases, because the voltage given by such a condenser is proportional to the total movement and not to the speed, so that in designing such electrostatic arrangements, to obtain the correct voltage from the motion of the needle, we shall probably have to arrange for some correcting device.

A. "Condenser Microphone."

A cell of carbon granules, compressed more or less by the motion of the needle, would behave more like a condenser than like a magnetic arrangement, and the result would be that we should again have to correct the effect we had obtained to get the right result. This correction is not too difficult, but at the same time it tends to

(Continued on next page.)

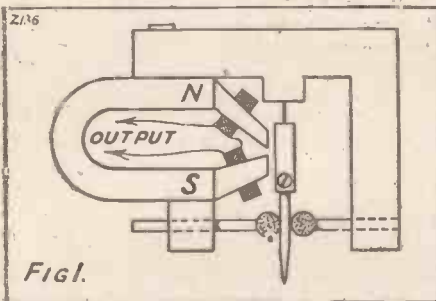

distortion, and it was quite early recognised that these two operations will have to be eliminated or simplified if we are to get really first-class results, and the advent of properly recorded gramophone records has made it quite well worth while.

Early Apparatus.

The first time I saw what might be called a direct electrical player, the operation was performed with a piece of piezo-electric crystal, and the instrument was designed by Messrs. Russell & Cotton, but the exact details of the construction I never found out, and I am not sure whether the resulting currents from such an arrangement were a correct reproduction

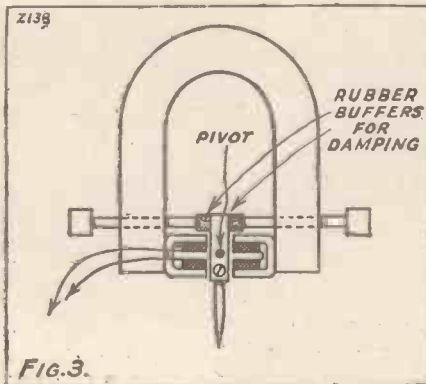

the speed of the air particles is proportional to the rise and fall of pressure. Our record, to be faithful, must have a wavy line impressed upon it which is similar to this air-particle motion. And this means that the needle must be moved by the groove with a speed proportional to the speed of the air-particles.

Records are now made constructed over most of the frequency range with this law. We have to bear these facts in mind because we have to reproduce at the end of our amplifier voltage proportional to the original air-particle speed, and we want to see in any piece of apparatus what its operations will give us.

For instance, if the needle is connected to a coil of wire, and the coil of wire can be imagined as moving with the needle-point, we know that if we bring a magnet near that coil, the resulting voltage induced in the coil will be proportional to the speed,

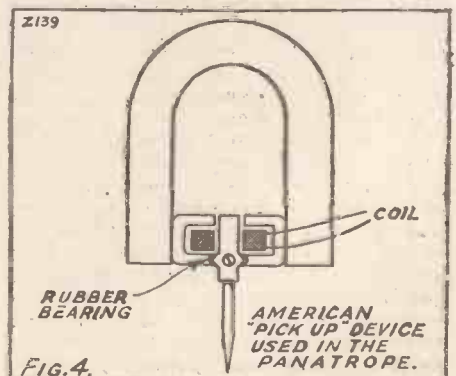
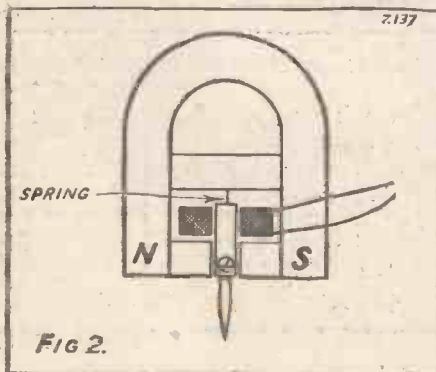

FIG. 4.

AMERICAN PICK UP DEVICE USED IN THE PANATROPE.

PLAYING THE GRAMOPHONE ELECTRICALLY.

(Continued from previous page.)

make one choose a piece of apparatus which is right to start with, unless, of course, this piece of apparatus has other great disadvantages.

A set of condenser plates, with mica separation, might make a very effective playing apparatus after electrical correction, but it is very doubtful whether carbon granules would not have troubles due to the general vibration that takes place in such a system. For this reason I will only discuss the magnetic devices, and of the two arrangements I mentioned—the moving

The whole electrical sound-box system must also have sufficient weight to keep the needle in the groove and, of course, a weight roughly the same as the ordinary sound-box is correct. When we come to the problem of what we are going to do with the moving iron, there are several schemes to choose from, which I illustrate. Fig. 1 might be called a Brown reed system; Fig. 2 a simple form of balanced polarised relay; Fig. 3 a better form of balanced polarised relay; and Fig. 4 a modification of this latter, which has several points of extreme ingenuity.

The "Pick-up" Winding.

Of course, it is necessary that any such arrangement should be made up so that it is easy to replace the needle, and this is probably the most difficult part of the problem. It is then also necessary to apply some form of rubber damping to the armature, because it is found that frequently the natural resonance of this armature greatly exaggerates the scratch, unless this damping is arranged for.

In Fig. 5 is an exact drawing of the first player system I used, which was not built particularly for sensitiveness; in fact, it is very insensitive. This is a curious form of polarised relay, which is not actually a good magnetic circuit, but I illustrate it to show more or less the dimensions of the armature system one should use to get good results. In Fig. 6 I indicate how any of these pieces of apparatus can be fixed on to the ordinary tone-arm and, barring the fact that the tone-arm requirements must be kept in mind, the designer has pretty good

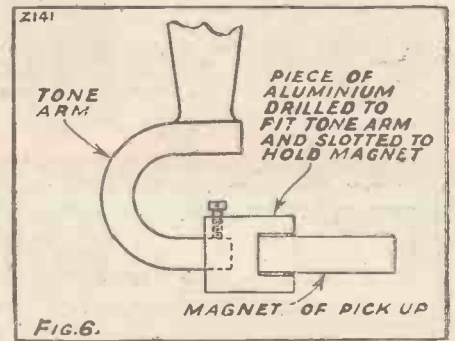

licence as to his magnetic system. sizes shown in one or two of the drawings of No. 42 wire will be satisfactory. The magnetic system can be a home-made permanent magnet, if necessary, shaped up and made of hardened steel, and magnetised by flashing with a battery, or one can be bought. Some kind of rubber damping seems quite essential and suggestions can be obtained from some of the drawings, but when one has made up the armature and magnetic system, a few experiments will indicate where to put the rubber to cut out the whistling high tones otherwise obtained.

How to connect this to a wireless receiver is the next problem. The most satisfactory way is undoubtedly by an auto-transformer. The way I invariably use is to take an Ideal transformer, neglect the primary winding, and tap one end of the connecting cord to the bottom of the secondary, and then test which tapping of the four sections of the secondary give most satisfactory results.

The Amplifier.

If one chooses a 2-7 to 1 transformer, if the two secondary windings give very different results, try tapping on the primary, and throughout the whole experiment the secondary of the transformer which is connected on the grid of the valve, should have a shunt of about 25,000 ohms (an ordinary lead pencil carbon leak is quite all right); this will prevent any transformer resonance. If the player is well constructed and sensitive, a three-valve amplifier will give nearly all that is required. Such an arrangement I illustrate in Fig. 7.

The choice of a loud speaker for use with this gramophone arrangement is, of course, of considerable importance. It is quite useless to choose a loud speaker which is of gramophony nature already, and at the present moment one can only recommend some speaker of the cone type such as the standard "Kone," or a Rice-Kellogg cone, if it is possible to obtain one. The American Panatrope consists of a combination of electrical player and a Rice-Kellogg cone.

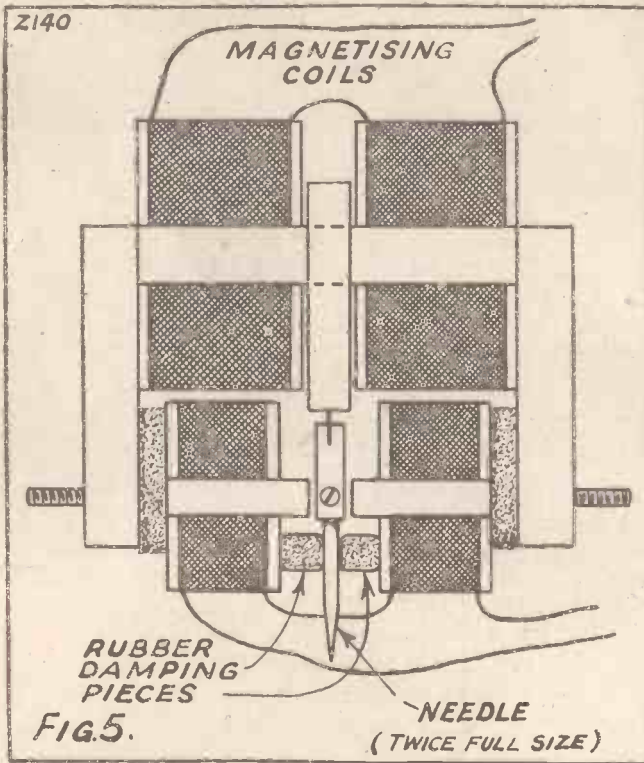

coil and the moving iron—only the moving-iron one, because this is by far the easier to construct in some form or other.

Question of Weight.

First of all, one must recognise that any attempt to move a large mass of iron will result in serious forces on the needle point, tending to wear the record and the needle, as the forces may possibly approach a ton per square inch, and possibly the needle-point will refuse to follow the grooves correctly, so that the thing we move must be reduced to quite small dimensions, and this piece of moving iron we must pivot either with a spring or with actual pivots, and then the pivot system must be held in some way on the gramophone tone arm, so that the position of the needle is right and the angle of the needle right, and the whole arrangement held with sufficient rigidity, so that the pivot remains relatively fixed compared with the needle-point.

With regard to the pick-up winding, it is not a matter of much importance. Too fine a wire should not be used, otherwise the connecting cord from the player will produce capacity effects, but coils of the

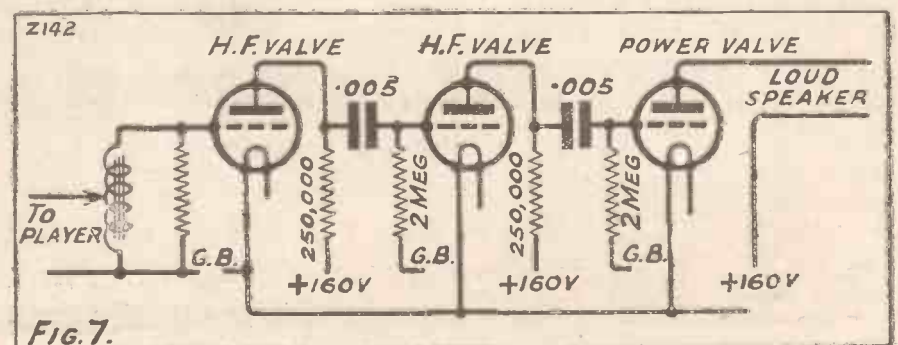

PUTS POWER INTO YOUR SET

YOUR valves and loud speaker have real power and clean smooth-flowing energy behind them if you are using a Lissen New Process H.T. Battery in your set. This strengthens the electronic emission of each valve and makes volume bigger, loud-speaker tone fresher, and reproduction smoother and more life-like than you have ever known it before. The power of the Lissen New Process Battery never lessens, even under the drain of the longest programme.

Before marketing the Lissen New Process Battery we introduced our new policy of direct-to-dealer distribution. This cut out all wholesalers' profits and we were able to put the battery on the market at 10/6. Not satisfied with this, the next step we took was a very bold one. We cut down our own profits on this battery and asked our retail friends to take less profit also. We then drastically cut the price of the battery to 7/11. This battery then became the best value-for-money battery available, and the response from the buying public was so overwhelming that we had to discontinue advertising. Trade orders were cut down in every direction. Strenuous efforts for the past few months have enabled us to overtake arrears. Trade orders are now being executed in full and you should be able to get the Lissen New Process Battery from any good dealer. If you have any difficulty, send direct to the factory; no postage charged, but please mention dealer's name and address.



LISSEN NEW PROCESS HIGH TENSION BATTERY

66 volt. Size 9½ by 3½ in.

Comes direct from factory—reaches you fresh and packed full of new energy
LISSEN LTD., 8-16 Friars Lane, Richmond, Surrey

Managing Director - **THOMAS N. COLE**



The Fellows Junior
LOUD SPEAKER

13/6

*Test this amazing
Loud Speaker free!*

The Fellows Junior Loud Speaker is 19 in. high, beautiful in appearance, and will fill any ordinary sized room with crystal clear reproduction. It is fitted with a volume control and can be obtained on 7 days' approval against cash.

**FELLOWS
WIRELESS**

HEAD OFFICE: Park Royal, N.W.10.

LONDON: 20, Store Street,
Tottenham Court Rd., W.C.

BIRMINGHAM: 248, Cor-
poration Street.

BRIGHTON: 31, Queen's Rd.
BRISTOL: 36, Narrow Wine
Street.

CARDIFF: Dominions Ar-
cade, Queen Street.

GLASGOW: 4, Wellington St.
LEEDS: 65, Park Lane.

LIVERPOOL: 37, Moorfields.

MANCHESTER: 33, John
Dalton Street.

NEWCASTLE: 36, Grey St.

NOTTINGHAM: 30, Bridle-
smith Gate.

PORTSMOUTH: Pearl Build-
ings, Commercial Road.

SHEFFIELD: 11, Waingate.

TONBRIDGE: 34, Quarry
Hill.

M.C.355.



*Use These Condensers
in Your R.C. Sets*

Many Resistance Capacity circuits of the "B.B.C." type require condensers of comparatively large capacity, whose insulation shall be sufficient to withstand anode potentials of several hundred volts.

Feeling the need for efficient condensers of this type, we introduce a new range of Dubilier Mica Condensers whose appearance is similar to that shown above.

These condensers carry the full Dubilier guarantee, and capacities range from 0.02 mfd. to 0.3 mfd., at prices between 5/6 and 22/6.

Your usual Dealer carries stocks of these, but in case of any difficulty we shall be pleased to supply you direct.

Write for our fully illustrated catalogue.



*Aut. of the Dubilier Condenser Co. (1925), Ltd., Ducon Works,
Victoria Road, North Acton, W.3*

M.C. 278

A "FOUR-POINT" CRYSTAL DETECTOR

DURING the past few weeks I have been experimenting with my "three-electrode" crystal scheme again, and I have come to the conclusion that it deserves a good many hours more of close study. Before I deal with my latest activities in this direction, let me refresh your memories concerning the system.

A straightforward crystal "hook up" is generally on the lines of Fig. 1. A coil connected in series with the aerial is tuned by means of a variable condenser. Across

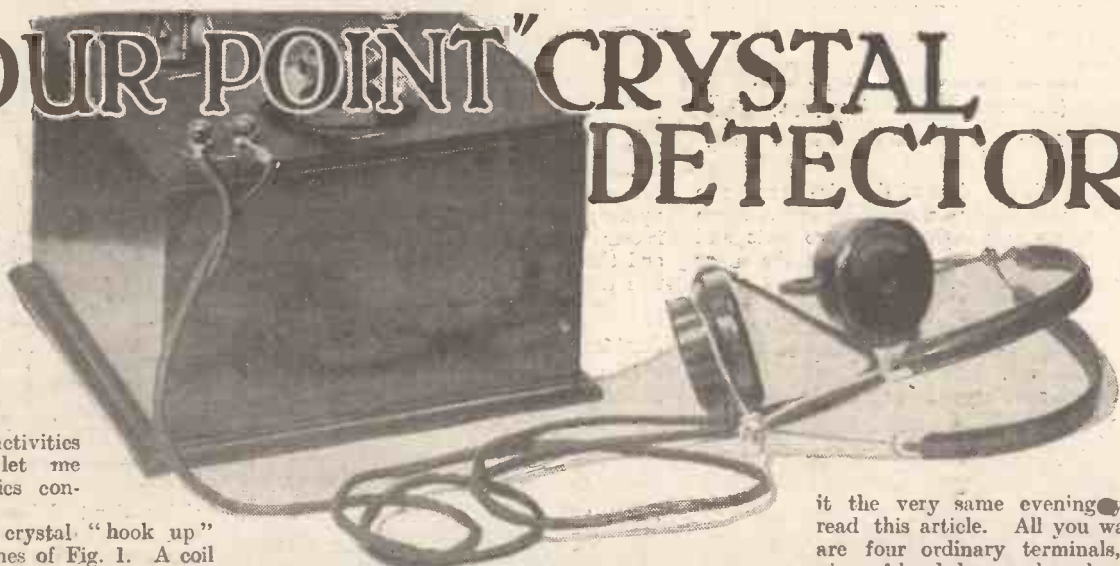

it the very same evening you read this article. All you want are four ordinary terminals, a piece of hard dry wood or ebonite measuring about 3 in. by 1 1/2 in., and a few inches of steel or other wire of a fairly fine gauge. A strand of the steel used in "Electron" wire will prove quite suitable.

An article describing some novel detectors and circuits.
By G. V. DOWDING, Grad.I.E.E.
(Technical Editor.)

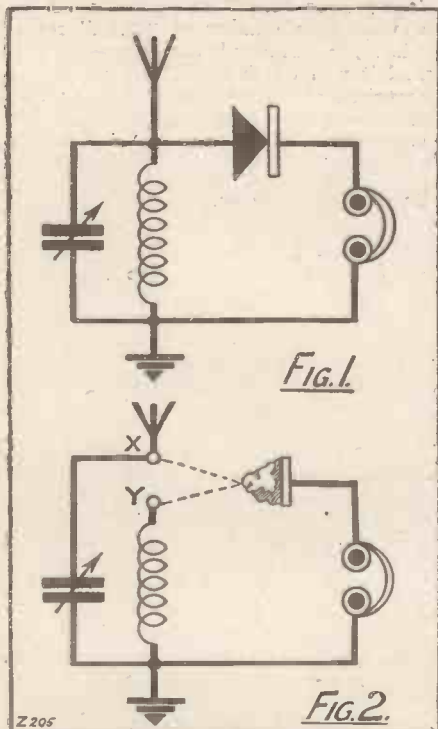

X and Y represents one continuous piece of wire—a sort of double cat's-whisker. It will be noted that all the received energy flowing in the aerial circuit *must* pass that delicate point of contact. That is O.K. as far as it goes, and the scheme sounds very nice, does it not? But the snag is to design a detector that will carry this little theory into practice. Readers who remember my original three-point crystal detector will also remember that it was rather a clumsy affair. But even so I obtained results with it far above the average. However, I am afraid that at the time I paid more attention to the theory than to the application of the scheme. It was certainly an absorbing theory to ponder over!

The Simplest Detector.

However, I am going to describe the construction of a "three-point" crystal detector which any of you can run together in a few minutes. It must be the simplest detector ever described. You will be able to build it and try out some circuits with

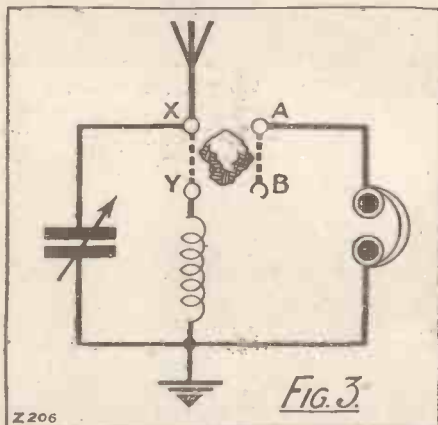

Scratch two lines (don't use a pencil) across the piece of wood 3/4 in. apart. These lines mark the centres of the terminals. Now refer to the photograph of the four terminal detector and you will see how the terminals are mounted. One pair is spaced 1 1/2 in. and the other 2 3/4 in.

(Continued on next page.)

the coil are connected a crystal detector and a pair of telephone receivers. Now it is generally accepted these days that a crystal detector operates more or less on the principle of the thermo-junction. That is, the H.F. current flowing across its metal-crystal contact generates heat which in turn produces a uni-directional flow of electricity. If this is not the case and some atomic activity of a different nature takes place, that does not affect my argument, which is that optimum results should obtain when *all* the available oscillating current due to the received radio waves passes the point of contact between the metal and crystal.

"An Absorbing Theory."

Thus the "three-electrode" detector. Refer to Fig. 2. The dotted line between

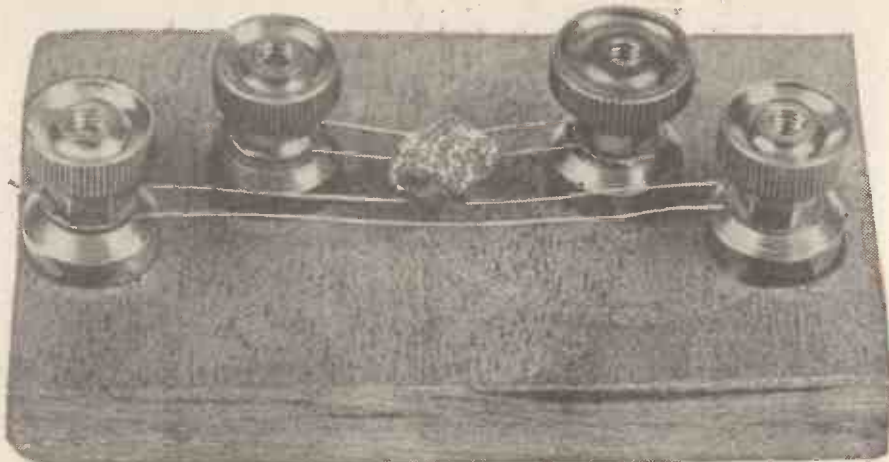

This simple detector can be assembled in a few minutes, but gives excellent results when used in the manner suggested.

A "FOUR-POINT" CRYSTAL DETECTOR.

(Continued from previous page.)

Now wind a piece of the wire round one pair, thus forming a complete loop. Keep this loop in position with two nuts and washers. Fix another loop on the other pair of terminals. The detector is ready for use! Neither loop must touch the other one or the other pair of terminals, and the wire must be drawn up tightly so that it does not sag.

A piece of crystal—any of the synthetic

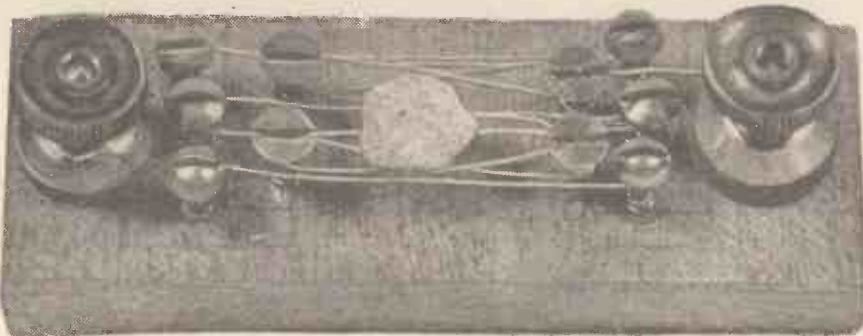

The "Mattress" detector mentioned in the accompanying article.

brands will do—should be balanced on the two centre strands of wire. The outer two are merely to prevent the crystal rolling off on to the baseboard when the detector is being adjusted.

A "Three-Point" Hookup.

This is really a four-point detector, and as such offers an even wider field of research than a three point. Used as an ordinary two-point detector I found it gave excellent results. The crystal should not be touched during adjustments. The whole detector should be tilted about and the crystal rolled along. Needless to say many fascinating experiments with various kinds and gauges of wire and different crystals can be carried out.

A straightforward "three point" hookup for this detector is shown in Fig. 3. The letters X and Y represent one pair of terminals and A and B the other. With this arrangement I registered an increase of 20 microamps, which is not at all bad, and was quite an audible increase in strength.

One of the four-point circuits I have tried is shown in Fig. 4. Another coil of about 75 turns was joined in series with the 'phones, and one loop of wire. The coil was tightly coupled and the effect of tuning it was tried. Very excellent signals resulted, although the improvement was not great.

More Elaborate Detector.

An increase of selectivity was noted, but this is not an all-important factor. Anyway, all "three-point" circuits appear to possess greater selectivity than conventional hook-ups. But what I am after is a really noteworthy increase in volume, and I am sure it can be obtained.

I made up another detector somewhat more elaborate than the one described above. It is shown in another photograph

accompanying this article. I have styled it the "Mattress," for it really does resemble a tiny spring bed! Have a look at the photograph. You will see that a number of wires pass between some screws driven into a piece of wood. The wires passing around and across between the round-headed screws are not anywhere in actual contact with any of the wires which join up the countersinking screws. One terminal is connected to these countersinking screws, and the other to the round-headed screws. The third contact can be taken by means of a small clip to any of the screwheads.

Alas for Elaboration!

Alas for elaboration, this detector was not as good as the simple four terminal one!

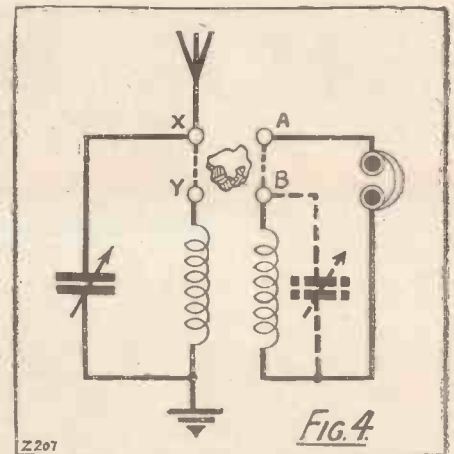

elaboration! I found that tinfoil served just as well as silver, but I must add that this detector worked really well, although again the simple four terminal one was just as good. What a triumph for simplicity!

As a matter of fact, I am warming to that "Four Point" considerably. I hope a very large number of "P.W." readers will make this simple device up—they will find it well worth while. I shall be very surprised and disappointed if many weird and wonderful circuits are not evolved, some of which may be "the goods" in capital letters!

Applying Local Energy.

In conclusion, just a few words in respect of possible applications and developments of such a detector. In valve-crystal combinations the increased selectivity of the device becomes most apparent, and there are a number of different methods of wiring it which will be obvious to the experimenter.

Also many interesting experiments can be carried out in respect of applying local current. With a potentiometer and a battery varying voltages of small orders can be brought across various points, and with a potentiometer or a variable resistance, the effect of heating currents passed through one or other of the contact wires can be observed. In cases, decreases of signal strength will result, but experimenters must expect this to happen and not be disappointed by such setbacks!

A third detector I constructed received the name of the "Hopper," for an obvious reason as you will see by referring to its photograph. Here we have a small container affair made of hard wood and sheet silver through which passes a silver wire. Each end of this wire is soldered to a screw, which acts as a bearing contact and is joined to a terminal. A third terminal is connected to the silver sheeting of the container by means of a small flexible lead.

A Triumph for Simplicity.

The operation of this detector is simple. One piece or two or more pieces of crystal are dropped into the "Hopper," and are thus in contact with the silver wire and the silver side or sides. The "Hopper" is rocked to and fro until maximum signal strength is obtained. Alas, again, for

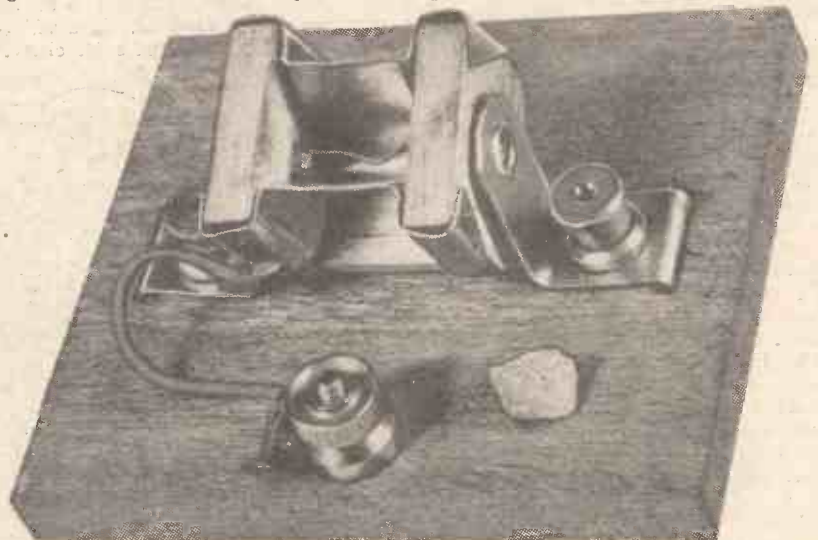

The more ambitious "Hopper" rectifier which failed to give better results than the simpler types.

A NEW LOFTIN-WHITE DEVELOPMENT.

The romantic story of a Transatlantic Telephone call, by means of which "P.W." was able to secure for readers some advance information direct from the inventor.

By **PERCY W. HARRIS, M.I.R.E.**
(Editor of the "Wireless Constructor.")

THE interest aroused by the publication in POPULAR WIRELESS of the real facts relating to the Loftin-White circuit for constant coupling has been quite phenomenal. Theoretical and practical working details have already been published in these pages, in previous articles (April 9th, 16th and 23rd), and this week I am pleased to be able to give readers news of some very important further developments.

During tests in the laboratory a number of points of interest have been discovered, both in the direction of elaborations of the circuit and in its development along lines particularly applicable to the requirements of British listeners. I have, for example, paid particular attention to the single-valve circuit for constant regeneration invented by Messrs. Loftin and White and described in a recent issue of POPULAR WIRELESS. A laboratory "hook-up" of this circuit was prepared and quite good results obtained with it (see POPULAR WIRELESS, April 23rd, 1927). Such a receiver can be made

After this interval the telephone bell in the Editor's office rang. "Mr. Loftin is not in his New York Office," the operator informed me. "We have ascertained that he is now in Washington. We are trying to find him in Washington and will let you know later!"

The Editor and I looked at one another! There was a real thrill in this announcement, particularly for me, as I have vivid recollections of leaving New York quite early in the morning and not arriving in Washington until tea-time! Also, Washington is a big city, and one could not help admiring the enterprise of a service which would hunt for a missing subscriber in a city hundreds of miles from its office to tell him that he is wanted at the other end of an invisible telephone line. I also began to wonder what Mr. Loftin would think about it!

At five o'clock the bell rang again. "We have found Mr. Loftin in Washington," came the voice. "He will speak to you in half an hour's time!"

And in half an hour, almost to the minute, I lifted the receiver to hear the operator announce, "Your American call!" and sure enough, there was Mr. Edward H. Loftin at the other end speaking to me, his voice being much clearer than many of the telephone conversations I have had on lines in London. I could hear every word he said perfectly, although I am inclined to think at first he did not hear me

so well. This may have been due to his unfamiliarity with an English voice!

The novelty of the experience had not made me forget that such speech is not merely golden, for a crisp five-pound note floats away for every minute of conversation! We therefore had to be brief.

"Good Afternoon, Mr. Loftin!"

"Good-afternoon, Mr. Loftin. This is POPULAR WIRELESS, of London, England, speaking. Thank you for your letter. Have you any new developments in the Loftin-White circuit?"

"Yes, Mr. Harris. Did you get that information I sent you about the use of high 'mu' tubes?"

"Yes, it arrived this morning. What are the values of inductance and capacity when used with these tubes?" (The information Mr. Loftin had sent me related to the use of

(Continued on next page.)

NEXT WEEK

Mr. Harris will give practical details of the circuit communicated by Mr. Loftin via the Transatlantic Radio Telephone.

ORDER YOUR COPY OF "P.W." NOW

very economically, and its extreme sensitivity and selectivity were bound to have a wide appeal. At the same time I did not feel that the best was being obtained from its possibilities, and had Messrs. Loftin and White been available I should have seized the opportunity of discussing the circuit with them.

But why were they not available? The Editor of "P.W." had just received a letter from Mr. Edward H. Loftin in New York, and on his letter paper appeared his address and his New York telephone number. Here, obviously, was an opportunity of testing the efficacy of the transatlantic telephone. Perhaps the inventors could give me a new and further improved circuit for POPULAR WIRELESS readers. Why not try?

"Your American Call!"

Accordingly on the afternoon of May 9th an inquiry was put through to the transatlantic telephone department of the General Post Office eliciting the fact that conditions for transatlantic speech were perfectly satisfactory. A call was therefore made to Mr. Edward H. Loftin in his New York office.

"There will be about twenty minutes' delay," a polite telephonist informed us. "We will ring you later."

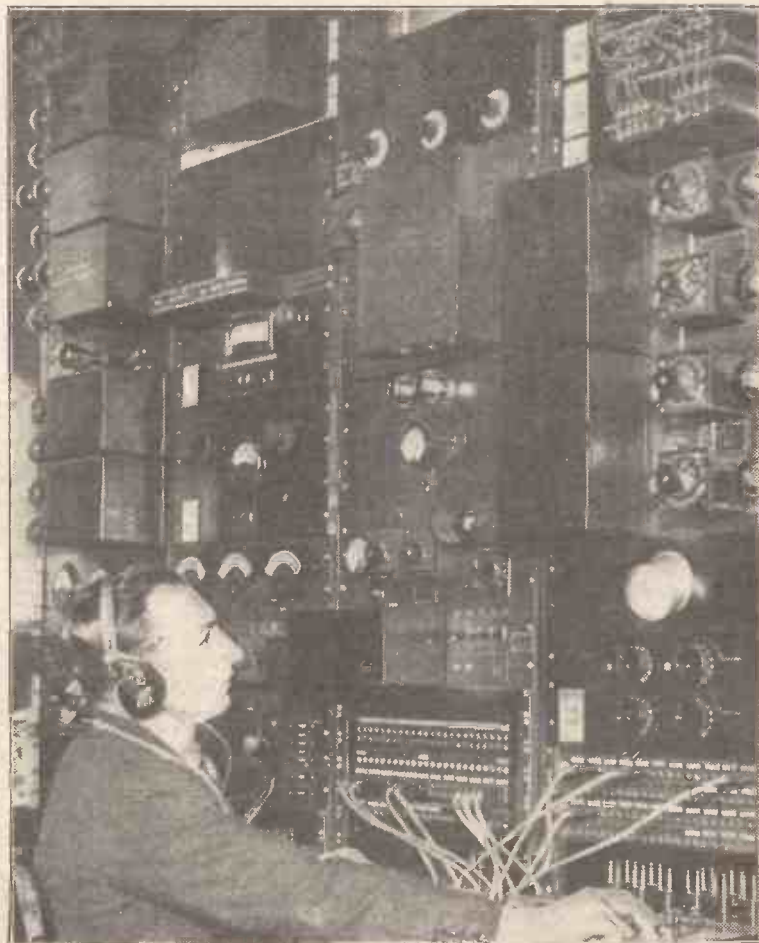

The London control board where transatlantic telephone conversations receive a "polishing up" before being handed over to Rugby.

A NEW LOFTIN-WHITE DEVELOPMENT.

(Continued from previous page.)

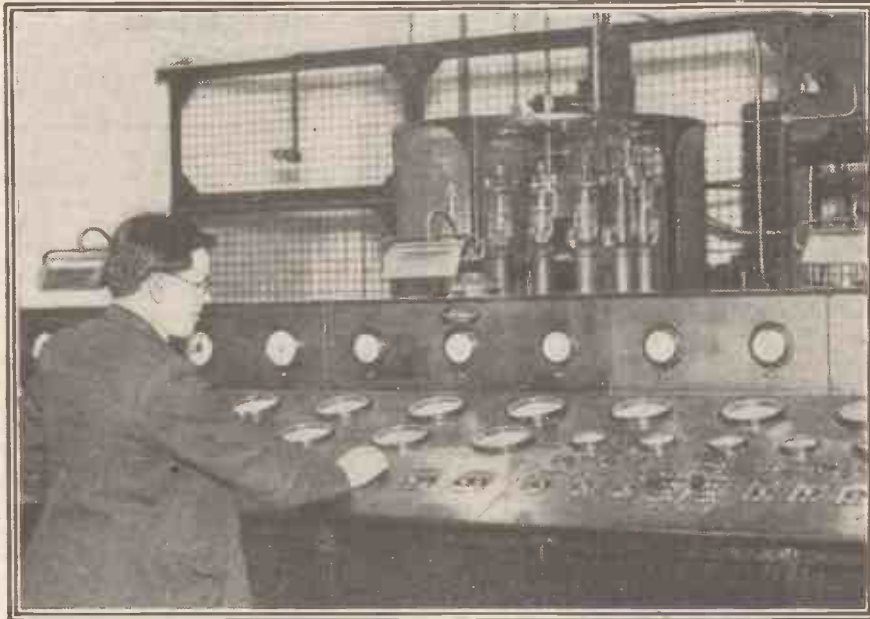

Checking the transmission at the Rugby station from whence Mr. Harris's voice was thrown via the ether to the United States.

the American high magnification valves and is particularly interesting as we have such valves over here in even more efficient form than in the States.)

"Use the same values as before," replied Mr. Loftin, "but be sure you increase the plate voltage very considerably. You will find these valves work excellently with the Loftin-White circuit and bring about a marked increase in selectivity."

"Thank you. I have been doing a good deal of experimenting with your 'single-valve regenerative receiver with resistance-controlled reaction. This circuit is likely to be very useful in England, as single-valve sets are very popular over here. I should like your views on the choice of certain values." (I then briefly ran over some of the points I had previously noted.)

For "P.W." Readers.

"Well, over here single-valve sets are very rarely used. The Loftin-White circuit is being used almost exclusively for high-frequency coupling as single-valve sets are practically dead, but I can give you a new single-valve circuit which will probably be very useful to your readers," went on Mr. Loftin. "It is remarkably selective and sensitive."

Mr. Loftin then proceeded to give me details of a circuit utilising the tuned anode method. This is probably the most remarkable single-valve circuit I have met, and POPULAR WIRELESS will have the first publication of this circuit either in America or in England. It is a single-valve tuned plate circuit with a constant coupling feedback for the purpose of oscillation control. Previous acquaintance with the Loftin-White circuit enabled me to take down full particulars and sketch it on a pad of paper as it was described and while this was

being done the telephonist informed us that our time was up. A continuation of the call was at once booked (this is done automatically if you do not cut off), and the description of the circuit was completed and arrangements made for posting to

POPULAR WIRELESS of further Loftin-White details by the first mail.

"Good-bye, Mr. Loftin! Best wishes from POPULAR WIRELESS."

Without a moment's delay the draughtsman was instructed, this article dictated into the dictaphone, transcribed by a waiting stenographer, and the article set in type. The circuit is now being tested in my laboratory, and next week full working details will be given.

So POPULAR WIRELESS readers will be in possession of an up-to-the-minute circuit specially telephoned from Washington to New York and thence three thousand miles across the ocean on to my writing pad!

And such is the difference of time that Mr. Loftin went out to lunch and I went out to tea!

STOP PRESS.

Just as we go to press we learn that Mr. P. W. Harris has now fully tested the Loftin-White One-Valver, and in his own words, "It works wonderfully." (See next week's "P.W." for full details.)

WINDING INDUCTANCES.

By I. K. S.

WIND your inductance on a dry cardboard tubes. It is cheap and quite good. In general, the larger the coil the lower the resistance it will be for the same inductance.

Litz wire is, of course, best for all normal waves, but for waves under 200 metres solid wire is just as good, and even for the longer waves most amateurs will use ordinary wire.

It is no advantage to use wire thicker than a certain gauge; in fact, it may be a disadvantage. A rough rule is to use a gauge which will give about 1 ohm of D.C. resistance per 100 microhenries. If the wire can be wound in one layer and spaced it will be the best coil, but if the coil required is small, and with a lot of inductance, it must not be wound in layers like a magnet, because this will result in serious losses and in a big self-capacity which will prevent the coil giving the full range of wave-length.

The easiest way to wind such a coil is to "random pile" wind it.

Thus, suppose 1,000 turns are to be put on a 2-in. length of tube, divide the winding space into 10 sections, marking the sections out with a pencil. Then wind a pile of 100 turns in each one of these sections.

This is an excellent way of winding an H.F. choke. Always wind any coil wanted with more turns than you think will be necessary and then reduce them down to the value required, as it is easier to subtract than add winding.

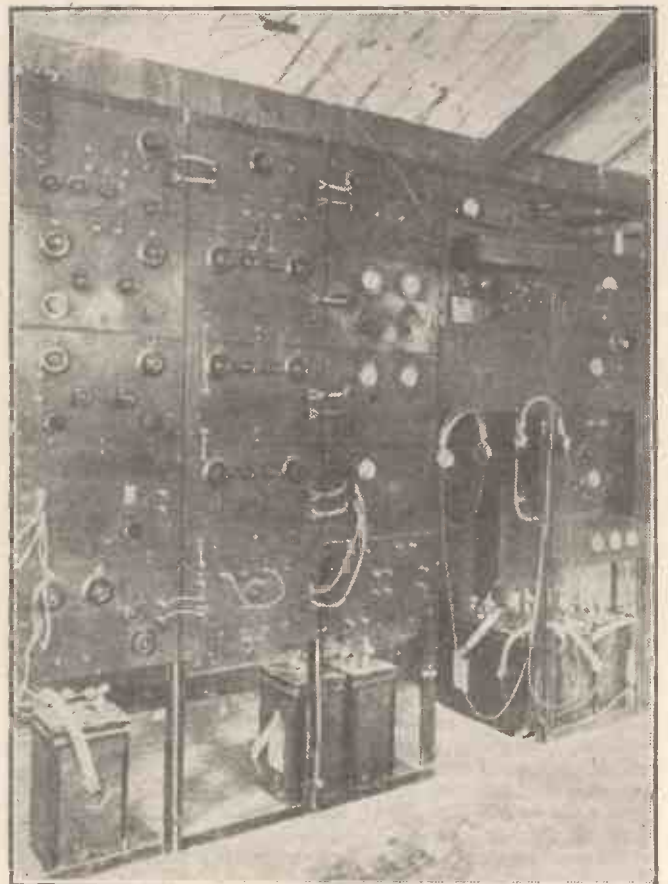

The receiving installation at Wroughton, one of the links in the transoceanic telephone system.

THE "RIDDLE."

The Editor, POPULAR WIRELESS.

Dear Sir,—In trying to simplify the tuning of multi-valve H.F. circuits, I have hit on a circuit which, with only two variable single condensers for tuning the H.F. circuits, gives a most remarkable H.F. amplification. As it is hardly to be expected that I have hit on the most efficient form of the circuit, and as I have not the means here in Egypt to experiment with six or seven H.F. valves coupled up on the same principle—with only one condenser to tune their H.F. circuits—I send you diagrams herewith and trust that you will give the circuit publicity in your Correspondence columns. By this means experimenters will tackle the circuit and improve it quickly.

I am a regular reader of "P.W." and that since the first number. In regard to the circuit, the following notes will be of use to experimenters: (1) The value of H.T. on H.F. valves is fairly critical for best working; as is also the filament temperature of the H.F. valves. (2) Cosmor 2-volt valves were used in my set. (3) The anode tuning condenser was placed near—three inches distant—the grid condenser. (4) Tuning condensers, .0003 mfd. were across the 400 un-tuned anode coils, but were set at zero—their small "zero" capacities might effect results, however. (5) Tuning of the grid and anode condensers is easy, but very critical. Signals will be faint just off tune, but come in with a boom when correct tune is found. The coupling between reaction and grid coils is also critical, but is easy to attain. Reaction is very steady. Connections to

CORRESPONDENCE.

THE "RIDDLE" CIRCUIT

CONCERNING "COSMOS" CURVES. MORE VALVE DATA WANTED.

Letters from readers discussing interesting and topical wireless events, or recording unusual experiences, are always welcomed; but it must be clearly understood that the publication of such does in no way indicate that we associate ourselves with the views expressed by our correspondents, and we cannot accept any responsibility for information given.—Editor.

manufactured article, then the conditions under which it was tested have been such as to invite distortion.

The valve used in the test was totally unsuitable, having a very low impedance, thus causing saturation. The plate current, 6 millamps, was two to three times greater than it should have been to do

note that he considers the amplification-frequency curve of our "Cosmos" Resistance Coupling Unit is remarkably good. It is obtained, as most users know, by the use of reasonably low anode resistances, high capacity coupling condensers and average values of grid leaks. By the use of items of such value the loss of amplification on the low notes due to insufficient coupling condenser and the loss of amplification on the high notes due to the valve capacity shunting the anode resistance is avoided. The low impedance high voltage factor valve on the short-path principle permitting these values to be used while retaining a good amplification per stage.

With reference to our choice of a valve for the transformer test, we might point out that there is no evidence from the curve to allow the assumption that the transformer is saturated by the steady anode current. In fact, tests were made on various anode currents to actually check this effect, and the actual alteration in magnification from 2 millamps to 7 millamps at 25 cycles varied from 13 to 10 only.

In a test on another transformer an actual improvement in amplification was obtained by using a higher anode current than 6 millamps, showing that the iron was not saturated. Mr. Walker advocates the use of a higher impedance valve of 15,000 to 20,000 ohms. If such a valve had been used it is obvious that the impedance of the primary at the lower frequencies would be a much smaller proportion of the valve impedance, and lower amplification would have resulted at the low frequencies with an even worse amplification-frequency curve, although an overall amplification due to increased voltage factor may have resulted.

We were not concerned so much with actual amplification per stage as the shape of the amplification-frequency curve. A very low impedance valve was used with the transformer especially to give the transformer the best conditions at the low frequency where insufficient primary impedance relative to valve impedance shows up.

In conclusion, the point raised by Mr. Walker was very carefully watched during the tests, and his suggestions for using a higher impedance valve would have made our case even stronger, which, out of fairness, we tried to avoid.

Yours faithfully,
METRO-VICK SUPPLIES LIMITED,
ARTHUR E. DU PASQUIER,
(Manager, Publicity Dept.)

Trafford Park,
Manchester.

MORE VALVE DATA WANTED.

The Editor, POPULAR WIRELESS.

Dear Sir,—Valve manufacturers are certainly better than they used to be in giving particulars of the characteristics of their valves, but there is still a point upon which they could well supply information on the cartons containing the valves.

I refer, in particular, to the valves designed for the intermediate stages of L.F. amplification. We are told, for example, that such and such a valve is suitable for transformer coupling, and that another is suitable for resistance coupling; but, with two exceptions, we are not supplied with such obviously useful information as to what transformer ratio or value of resistance is best suited to a particular valve. Seeing that there is such a vast difference in valves of various makes designed for the same purpose, one would have thought that manufacturers would state the best value of coupling, so that they could be assured of users getting the best possible results. It is equally as unsatisfactory to use a 70,000 ohm valve with a 50,000 ohm resistance as it is to use a 7,000 ohm valve with, say, a 27 to 1 ratio transformer; yet such a thing is quite likely to happen to an amateur who is not in the know, and a good valve may consequently be wrongly condemned simply because it is a square peg in a round hole.

Yours faithfully,
KENNETH BOWLES.

7, Colston Avenue
Carshalton, Surrey;

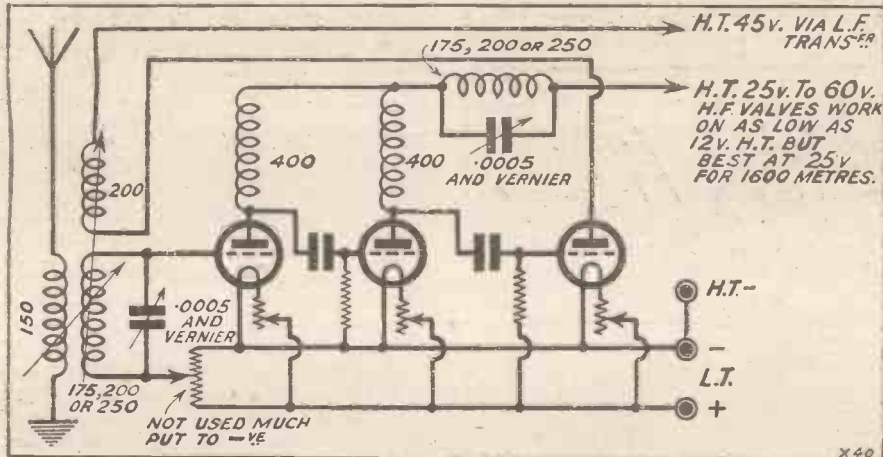

reaction coil should be changed over if set is not giving good results; reaction coil may be wrongly connected for this set. It is interesting to note that the ease of reaction control gives a feeling to the operator that he is working a Reinartz set. (6) There seems to be a point for every signal at which the various reactions occurring in the set blend together to give pure results. Anywhere off this "balance" results in feeble signals.

Anyone possessing a receiver having two tuned anode H.F. stages with reaction on the grid coil of first H.F. valve can easily alter it to conform with the new circuit. Place anode coil holder, break the H.F. H.T. lead and place tuned anode coil, with .0005 mfd. in parallel, in series with it. The H.T. voltage across the H.F. valves should be capable of variation irrespective of the H.T. values applied to the other valves. The aerial circuit should be of the so-called "aperiodic type—aerial coil, "untuned," loose-coupled to grid coil of first H.F. valve. The coupling between grid and aerial coils should be varied from "loose" to "tight" as this affects the stability of set. Wishing "P.W." the best of good luck!

Yours sincerely,

N. BROWNE RIDDLE.

P.S.—You may term the circuit "Riddle," its action is a real puzzle to me.
P.O.B. 17, Mallawi
Upper Egypt.

CONCERNING "COSMOS" AND CURVES.

The Editor, POPULAR WIRELESS.

Dear Sir,—The advertisement of Metro-Vick Supplies, Ltd., in "P.W.," April 23rd, comparing amplification-frequency curves of the "Cosmos" R.C. coupling unit and transformer coupling is, I think, somewhat misleading to your readers.

The curve of the "Cosmos" unit is remarkably good for a commercial product and, if correct, great credit is due to the firm for putting on the market an inexpensive unit that will give reasonably pure amplification for the ordinary constructor who does not make such components up from his own calculations.

The transformer curve, on the other hand, gives no credit to improvements in L.F. transformer design that have obviously taken place within the last year or two.

If the transformer tested is an experimental model, then it is certainly of bad design. If it is a

justice to the transformer, and if a valve having an impedance of 15,000 to 20,000 ohms had been used a far different curve would have resulted, with much greater amplification.

I am sorry to have taken all this time and space, but I think the above facts should be brought to the notice of "P.W." readers, particularly the non-technical reader.

Yours truly,

T. H. WALKER.

123, Cross Green Lane, Leeds.

EDITORIAL NOTE.—A copy of Mr. Walker's letter was sent to Messrs. Metro-Vick Supplies, Ltd., and their comments are included in the following letter:

The Editor, POPULAR WIRELESS.

Dear Sir,—With reference to Mr. T. H. Walker's criticism on our advertisement, we are pleased to

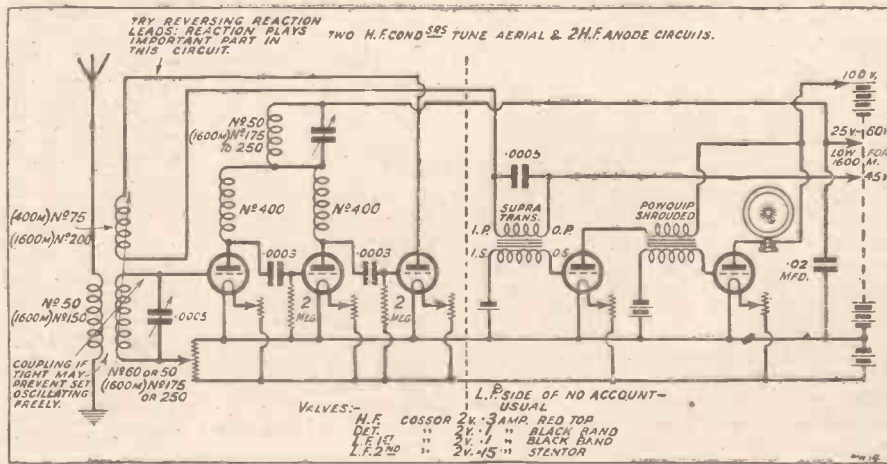

BROADCAST NOTES.

By OUR BROADCASTING CORRESPONDENTS.

Empire Day Broadcasts—North of England Music—The Nightingale Again—A Borstal Talk—Professor Turner on the Eclipse—Peace Demonstration Broadcast at Edinburgh—Lighter Programmes—The Variety Mystery—Where America Leads—A Big Band Competition—National Wireless Week Again.

"Bubbly" Revived.

M. ANDRE CHARLOT has consented to arrange a repeat performance of the wartime revue "Bubbly," adapted for radio. This will be given on Wednesday, June 8th.

Empire Day Broadcasts.

From 6 to 6.30 and from 6.45 to 7 p.m., on Empire Day, May 24th, the B.B.C. will broadcast the great Community singing festival in Hyde Park. During the broadcast Dame Clara Butt will give "Land of Hope and Glory," "Jerusalem," "Rule Britannia," and "O God Our Help in Ages Past." The community singing broadcast will include "Tipperary," "Annie Laurie," and "Drink to Me only with Thine Eyes." Subsequently, a special concert has been arranged in the Kingsway Hall at popular prices. The Wireless Orchestra will play patriotic airs, and there will be special items by Percy Heming (baritone), Leslie England (Australian pianist), Elsie Playfair (Canadian violinist), and Stella Murray (New Zealand contralto). At 9 o'clock the Prime Minister will broadcast a special message to the Empire.

North of England Music.

The North of England Musical Tournament is this year uncovering some exceptional new talent. Its concluding portion will be relayed from the Town Hall, Newcastle, on Saturday, June 4th.

The Nightingale Again.

For a few minutes on an evening towards the end of this month the now customary annual attempt is to be made to broadcast the song of the nightingale from the beautiful garden of Miss Beatrice Harrison in the Surrey woods at Oxted. This is probably the only programme feature now that keeps listeners up late on the "off-chance." As on previous occasions, Miss Beatrice Harrison will use the 'cello to coax the nightingale into song. Lyrical items will be tried this time.

A Borstal Talk.

Miss Lillian Barker, C.B.E., Governor of H.M. Borstal Institute, Aylesbury, will talk on the human side of her work among girl prisoners from London on Tuesday, May 31st. Miss Barker is the only woman governor of a prison institution. She was Lady Superintendent of Woolwich Arsenal during the war.

Professor Turner on the Eclipse.

Professor H. H. Turner will say many interesting things about the forthcoming total eclipse of the sun in his talk from London on Tuesday, May 31st. The B.B.C. are co-operating whole-heartedly with the scientific authorities in exploiting all the possibilities of the eclipse. It is hoped, for instance, through the auxiliary efforts of the B.B.C., to throw some new light on the

Einstein theory of relativity and its subsequent modifications.

Peace Demonstration Broadcast at Edinburgh.

One of the most interesting of the many important services to be held in Edinburgh during the meetings of the General Assemblies of the Scottish Churches is a special United Service and Demonstration in favour of International Peace, which is to be broadcast on May 29th, at 7.45 p.m. The Very Rev. James Weatherhead, D.D., will preside, and the chief speakers will be



This is the name given to an efficient four-valve receiver described in the May issue of "Modern Wireless," which is on sale everywhere, price 1s.

Lord Meston and Sir Frederick Whyte. It is denied that the occasion will be turned to account by the announcement of a *rapprochement* between the Campbells and the Camerons!

Lighter Programmes.

This year, for the first time, the Savoy Hill people have really succeeded in lightening the programmes in a seasonable fashion. No doubt the "Daily Mail" ballot helped; but the fact is evident that "more fun" in the programmes is the present order of the day. There is, of course, a growing angry clamour from those who share the serious views of the Wireless Correspondent of the "Observer." But

there can be no turning back now. All that can be hoped is that there will not be much change in the autumn and winter. "More fun" is not a slogan for summer alone.

The Variety Mystery.

An impenetrable veil appears to have fallen over the music hall B.B.C. negotiations which were understood to be in progress. Mr. Gulliver, Sir Oswald Stoll, and some other kings of entertainment offered to take some substantial portions of the licence revenue. The B.B.C. said they would talk about it. Then other entertainment and opera kings and minor chieftains intervened and said they, too, would be glad to help by taking some more B.B.C. licence revenue. So they all got together—that is, the takers—and they were understood to be framing draft proposals to present to the B.B.C., which, meanwhile, was "standing-by."

Days, weeks, and months have slid by: and no further murmur from anywhere. It is not like the B.B.C. to allow a tactical advantage to be dissipated by procrastination or indecision. But, whatever the cause, the Savoy Hill people have let an important opportunity slide, and the resultant impression is distinctly depressing.

Where America Leads.

The new home of the National Broadcasting Company of U.S.A., in Fifth Avenue, New York City, is apparently far ahead of any other similar structure either built or contemplated.

It is a great pity that the B.B.C. has allowed itself to be put in the shade by an organisation that is only about one quarter as old, and barely half as wealthy. The old B.B.C. had talked about a new building in Kingsway, but there was nothing but talk. It is not known whether the new B.B.C. has done anything more in the matter. Meanwhile, the accommodation at Savoy Hill is notoriously bad in every way. The programmes are suffering. The place is quite unworthy to be the headquarters of a great national service such as broadcasting aspires to be in this country. If there is no move soon from the B.B.C. or the P.M.G. Parliament should take a hand in a matter which concerns Imperial prestige.

A Big Band Competition.

The B.B.C. are understood to have promised to co-operate in a big dance band competition. The idea is that all the leading dance bands will be invited to play before a committee of independent but competent judges, and that when the number of competitors has been reduced to about four, the listening public will vote for and choose the winner from among the semi-finalists and finalists. This is a good feature for summer, and the B.B.C. are to be congratulated for taking it up so readily.

National Wireless Week Again.

Although it remains for the Trade Committee on Broadcasting to give their blessing to the scheme, there seems no doubt that there will be another National Wireless Week this year. Last year the National Wireless Week was appropriately synchronised with the B.B.C. Birthday Week, at the middle of November. It was a tremendous success, and there is no reason why even better results should not be achieved this year.



Why Waste Energy? Keep Your H.F. in its Place

As most experimenters know, it is necessary, in certain circuits, to restrict the high frequency current to certain paths.

This restriction is effected by interposing a H.F. Choke, but this unit must fulfil certain Technical conditions.

It must have a high inductance, a low self capacity, and must efficiently deal with "long" or "short" wave frequencies.

The NEW **MH** H.F. CHOKE

scientifically designed to meet these conditions is a genuine advance on all existing types. The reduction in diameter of the end windings deals in a graduated manner with the higher frequencies, and the central portion with the lower frequencies. With an inductance of 60,000 microhenries, a self capacity of negligible value, and a D.C. resistance of 130 ohms, it is the ideal Choke for all purposes.

Price 9/- each.

Demand of your dealer **MH** Components.

BRITISH, BEST AND CHEAPEST IN THE LONG RUN.

Telephone: **L.M. MICHAEL LTD** Slough
441-442. Manufacturers of Wireless and Scientific Apparatus Slough.
WEXHAM ROAD, SLOUGH, BUCKS.
Irish Agents: B.N.B. Wireless Ltd., DUBLIN AND BELFAST.

AN
UNTUNED H.F. STAGE FOR **MH** 5
VALVE SUPERSONIC BLOCK UNIT

A stage of H.F. Amplification before the first detector in your Super-Het., will considerably increase its range. The diagram shows you how to incorporate it.

The components necessary are :-

- L1. Centre Tapped Frame.
- L2. **MH** H.F. Choke.
- C1. .0005 uF Variable Condenser.
- C2. **MH** Balancing Condenser.
- C3. .0003 uF Variable Condenser.



LATEST WIRELESS INVENTION

For Crystal and Valve Set Users.



The NON-VALVE Magnetic Microphone

BAR AMPLIFIER (Patent No. 248581-25.)

Will operate a **LOUD SPEAKER** from your **CRYSTAL SET**. Makes weak **CRYSTAL OR VALVE RECEPTION** **LOUD AND CLEAR** in Headphones. Enables even very deaf persons to hear from Crystal Sets. Operates perfectly on one or two dry cells.

NO Valves, Accumulators or H.T. Batteries. : : **NO FRAGILE PARTS.**

EASY TO ADJUST. NOTHING TO GET OUT OF ORDER.

COMPLETE AMPLIFIER, post free **34/-** **2 DRY CELLS** (post free) ..extra **4/-**

Microphone and other parts of Amplifier also supplied separately.

FULLY ILLUSTRATED LISTS FREE.

Obtainable from your Dealer or from Sole Manufacturers and Patentees:

NEW WILSON ELECTRICAL MANUFACTURING CO., Ltd.,
18, FITZROY STREET, LONDON, W.1 Telephone: Museum 8974

Ridley for Radio



The M.A.E. H.T. Battery is breaking all records for sales, due entirely to the remarkable performance given, in length of life, and steady voltage.

Add 7d. for postage.

4/11

Components by the following supplied lists free on request.

Ericsson, Igranic, Lotus, Bretwood, Formo, Electron, Jackson-Bros., Benjamin, K.I., Brandes, Edison Bell, Marconi, Sterling, Belling-Lee, Watmet, B.T.H., Lissen. Loud Speakers by Amplion, Sterling, Brown, etc.

ACCUMULATORS. 4 volt 60, 17/-; 4 volt 80, 22/6; 6 volt 60, 25/6; 6 volt 80, 32/6. Postage 1/- each.

- "Triotron" Power Valves ... each 7/6
- "Sifam" Double-reading Voltmeters, each 7/6
- Coil plugs on base, ea. 6d.
- "Trix" Switches, S.P.D.T., ea. 6d.
- D.P.D.T., 9d.
- (China) S.P.D.T., 9d.
- D.P.D.T., 1/-
- Patent Outside Frame Aerials, each 17/6
- "Alterno" Battery Chargers ... each 21/-
- Anti-Microphonic Valve-holders ... each 1/-
- Flash Batteries, doz. 3/4
- "Easie-Clips" for Battery connections, doz. 3d.
- Lettered "Osglim" Type Lamps, any letter ... each 1/-
- 1-lb. reels S.W.G. Wire, D.C.C., 16, 6d.; 18, 6d.; 20, 6d.; 22, 6d.; 24, 9d.; 26, 10d.; 28, 1/-; 30, 1/-.
- Aerials—100 ft. 7/22
- hard drawn, 1/11;
- extra heavy, 2/2;
- Phosfor, 49 strands, 1/-.
- Electron in stock.
- Rubber Lead-in, 10 yds., 1/-; Extra heavy, 2d. & 3d. yd.
- Twin Flex, 6 yds, 9d.; 12 yds, 1/4.
- Insulating Hooks, 2 for 1d.
- Egg Insulators, 2 for 1d.
- Insulating Staples, 4 for 1d.
- Earth Tubes (copper), each 2/3
- Climax Earth Tubes, each 5/-
- Headphone Cords, 1/3
- and 1/6
- Loud Speaker Cords, 1/9
- TERMINALS, etc.—**
- Nickel, W.O. Phone, Pillar, 1/- doz, 3 for 4d.
- Brass ditto, doz. 10d.
- Nickel Valve Legs, 2 for 1d.
- Stop Pins, 2 for 1d.
- Spade Tags, 6 for 1d.
- Soldering Tags, doz. 3d.
- Ormond Nuts, doz. 2d.
- Washers, 12 for 1d.
- 2 and 4 B.A. Rod, ft. 8d.
- Screw Spades, 2 for 1d.
- Pins, same price.
- Valve Pins, 2 for 1d.
- Voltmeters, 0/6 and 1/- each 3/-

POST ORDERS. Goods to the value of 20/- sent post free. Lists of special parts on application. Cash with Order or C.O.D.

CECIL RIDLEY

"RADIO HOUSE," MIDDLESBROUGH

A SHILLING WELL INVESTED.

The Special Summer Number of

"MODERN WIRELESS"

deals extensively with portable sets and radio in open spaces both from the constructor's and the listener's point of view. But, additionally, there are many other attractive features, including articles by

SIR OLIVER LODGE, F.R.S., CAPT. P. P. ECKERSLEY, and many other well-known people.

This issue, which is profusely illustrated, touches radio in all its phases, from simple sets to multi-valvers.

"Modern Wireless" Secure your copy for May now. Price 1/-

Scenery Out of Sound

Showing how the problems of broadcast "effects" are being solved.

By F. G. BAILEY.



NOT the least important personage in the radio drama group is the man who builds scenery out of sound.

It is not enough, in the production of a play by radio, to announce at the beginning of an act that the action takes place indoors or outdoors, at the shore or in the woods. The listener must gain his mental picture of the setting from the lines of the play and from supplementary sounds. These sounds are usually produced by the use of "props," but sometimes the most striking effect is gained by importing the sounds from the scene depicted. There are effects, however, that might be difficult of importation. For example, a forest fire might not always synchronise with a play. At W G Y some time ago a most realistic forest fire was created by the use of a plumber's blow torch for the sound of flame and wind, and by breaking up matches to simulate sound of cracking, breaking, burning tree limbs.

Since the listener is unable to see anyone enter a scene, the character's presence is generally denoted by the closing of a door or by the lines. For this reason the doors in all the homes of the radio drama characters are apt to be squeaky affairs and the slamming of doors which has won many a boy or girl a corrective word from parents, becomes a necessity.

The Most Difficult Problem.

Ten Eyck Clay, director of the W G Y Players, of the G.E.C. of America, is a seasoned actor of the legitimate stage, and he has a working knowledge of the stage "prop." He has found that the most difficult problem in the radio drama, demanding most in time and energy, is the production of sound-scenery. Actors readily throw themselves into character, and in the radio production it is not necessary to memorise lines. At most, two rehearsals of a cast are sufficient for a worthy radio performance.

The scenery, according to Mr. Clay, is another question entirely, for the obvious sound is not always the most suitable to produce a certain effect. Hours and hours are sometimes devoted to devising a fairly accurate sound production. After the "props" necessary to create the sound have been found or built, radio rehearsals must be held in co-operation with radio engineers.

The stage "prop" is very rarely suitable for radio use, though the wind and thunder machine of the stage are usually used for the thunderstorm effect. In the movies the spectator sees the locomotive and the supplementary sounds produced in the

orchestra pit need not be very accurate to emphasise the effect the picture has registered in the mind of the spectator. On the stage also, "prop"-produced noises are often poor imitations of the real thing. The radio microphone is so sensitive that the motion picture theatre or stage props are practically useless. The passing train must sound like a train and not a motorcycle or a tug boat.

A "Synthetic" Train.

One of the most stubborn "sound" problems that Mr. Clay has faced was the production of the sound of a speeding express train. This particular train was supposed to be on a one-track road, where the road-bed was none too smooth, and where a flat wheel or two was not considered an offence. The player-director proceeded to make a sound study of railway trains, and after he was satisfied that he had learned all the sounds in their proper sequence, he tackled the problem of producing those sounds so faithfully that the listener many miles away would know that he was listening to the passing of a steam-engine drawn train.

A real locomotive bell and a creditable whistle were readily produced. To these were added boards covered with sandpaper which when rubbed one against the other produced what may be described as the chug-chug of the engine. A flour sieve helped to define the sharp first sound heard as the engine puffs.

Then came the problem of producing

the roars of the passing train and the pounding or bumping of the wheels on uneven track. A metal panel, five feet long and an eighth of an inch thick was decided upon for the road-bed. A couple of young youngsters on roller skates speeding over the uneven surface of the pavement suggested the rolling stock, and a pair of roller skates was utilised as a train.

In the first rehearsal, Russel Hoff, chief of the control-room crew suggested that a couple of heavy cords be stretched over the metal panel. As the roller skates passed over the panel one couldn't tell the sound from that of a train bumping over uneven rails. The volume of sound was regulated in the control-room. The listener first heard the distant whistle and the muffled roar, and each second the control-room crew built up the volume until the heavy train veritably thundered past the little country railway station. An added effect, familiar to those who live near passing trains, was the rattling of window glass. Six people were required to produce the train effect—one to whistle, one to chug, one to operate the roller skates, one to make the windows rattle and another to sound the bell, and the sixth, the control-room operator, to control the sound volume.

The best recipe for a fast train then is: two short pieces of wood covered with sandpaper, a flour sieve, a pair of roller skates, a metal panel, a whistle, a bell and two pieces of heavy cord.



Some of the "effects" properties used at a German broadcasting station.



Traders and manufacturers are invited to submit wireless sets and components to the "P.W." Technical Dept. for test. All tests are carried out with strict impartiality in the "P.W." test-room, under the supervision of the Technical Editor, and the general reader is asked to note that this weekly article is also intended to provide a reliable and unbiased guide as to what to buy and what to avoid.—EDITOR.

A WET H.T. BATTERY.

THE use of "wet" H.T. batteries consisting of groups of small Leclanché cells appears to be coming more and more popular. And with the increasing demand an increasing number of firms are specialising in their production. There is a lot to be said for this method of obtaining H.T., the outstanding advantage being the ease with which replacements can be made. When a whole dozen zincs "pack up" they can be replaced for a matter of a few pence, and such a battery will run for months before even this is necessary. But unless precautions are taken both by the manufacturer and user, wet H.T.'s can be very troublesome. The great bug-bear is "creeping."

The solution spreads upwards over carbon-caps and connections causing corrosion and leakage and general decay. In a few months a nice bright battery can resolve

itself into a mass of green corruption. Constant cleaning of the metal parts and the smearing of these with vaseline will prevent the trouble, and with the more modern Leclanché H.T. outfits the manufacturers employ special preventative paints and compounds still further to diminish the effects of creeping and the creeping itself. For instance, we note that the battery recently sent us for examination and test by The Tromba Electrical Co., 17, White Hart Lane, London, N.17, is started out in life well protected by non-metallic paint and vaseline. The battery includes cells of the standard sac-Leclanché pattern of a size corresponding with the cells in high capacity dry batteries. They are capable of providing currents up to about 15 milliamps. for extended periods.

There are several features of interest in the battery. For example, it is contained in a much better class of case than is usual

for this type of battery, and insulating strips are provided between each row of cells. The battery includes 48 cells, and provides a pressure of about 70 volts. We have had it in use on a three-valve set for several weeks purposely leaving it in circuit for periods running into many hours at a time, and so far it has given no trouble at all. We have had it on discharge at 20 milliamps, and it could hold this although the makers advise a maximum of 12 milliamps.

This particular battery or one consisting of any other number of cells, is obtainable in parts at a very reasonable figure. The work of assembly is very simple, indeed, and amateurs interested should write to the above mentioned address for full details and price list.

AN EFFICIENT HYDROMETER.

A voltmeter can be very misleading at times, more especially when it is used for testing accumulators. That a cell shows two volts is no guarantee that it is in good condition, and for this reason, every amateur should make a practice of checking up the specific gravity of the acid solution in his accumulators at frequent intervals. In this connection it is interesting to note that Messrs. A. H. Hunt, of Croydon, have recently placed a line of hydrometers on

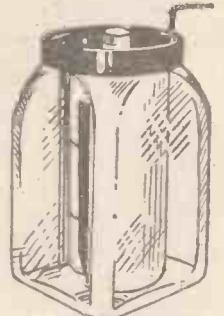

The type of cell used in the "Tromba" battery.

(Continued on page 500.)

Ashley Radio

Guaranteed Components for high efficiency Sets.

Guaranteed to be manufactured of materials which have secured the approbation of experts associated with this and other journals Ashley Components can pass any examination with distinction. Cheaper than others they may be, but nevertheless they are a repeated feature in many valuable sets.

JACKS

JACK No. 1. Single Circuit (Open) 1/3

JACK No. 2. Single Circuit (Closed) 1/6

JACK No. 3. Double Circuit 1/9

JACKS No. 4 and 5 for Filament Single and Double Control 1/9 and 2/3 respectively

Positive in action, these Jacks were designed by telephone engineers whose experience in other directions has enabled them to simplify the movements; embody refinements, and to recommend the materials and methods for their construction. Tags are tinned and spread fanwise for easy soldering.

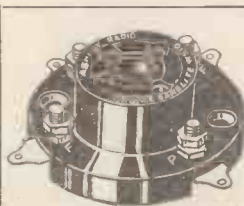

VALVE HOLDER

This Valve Holder has been adopted by B.T.H. for their R.K. Loud Speakers, a tribute to its high insulation and anti-capacity properties. Bakelite. 1/3 each.



Patented construction differing from all others and undoubtedly superior. each 2/6
50,000 W. to 2 megohm. Bakelite Base. 1/-

STANDARD TELEPHONE PLUG

The neatest finish to any pair of leads. Equally adaptable to spade or pin tags, rigid or flexible wire. 1/6 each



RESISTORS

The modern method of ensuring correct and unvarying L.T. Supply. Obtainable in any desired value for inserting in circuit with any make of valve. Guaranteed accurate to within 2%.

The base is moulded of genuine Bakelite, with nickelled Phosphor-bronze clips, which grip with firm contact but permit of easy extraction.

All Standard values 1/6
Base - - - 1/-

**ASHLEY WIRELESS TELEPHONE CO. (1925) LTD.,
17, FINCH PLACE, LONDON ROAD, LIVERPOOL.**

If unobtainable mention local dealer and we will send post free.

TRANSFORMER VERSUS RESISTANCE COUPLING.

Statements are being published in advertisements which are either inaccurate or misleading.

WHAT YOU WANT TO KNOW IS HOW EACH COUPLING WOULD COMPARE IN YOUR SET.

The curves below show the amplification obtained with a

FERRANTI A.F.3 TRANSFORMER

and with a well-known resistance unit under similar conditions.

NOTE THE VARIATION OF AMPLIFICATION—

WITH THE FERRANTI A.F.3 15 points on the scale.
 WITH THE RESISTANCE UNIT 20 points on the scale.

AND WITH THE FERRANTI A.F.3 THE AMPLIFICATION IS GREATER

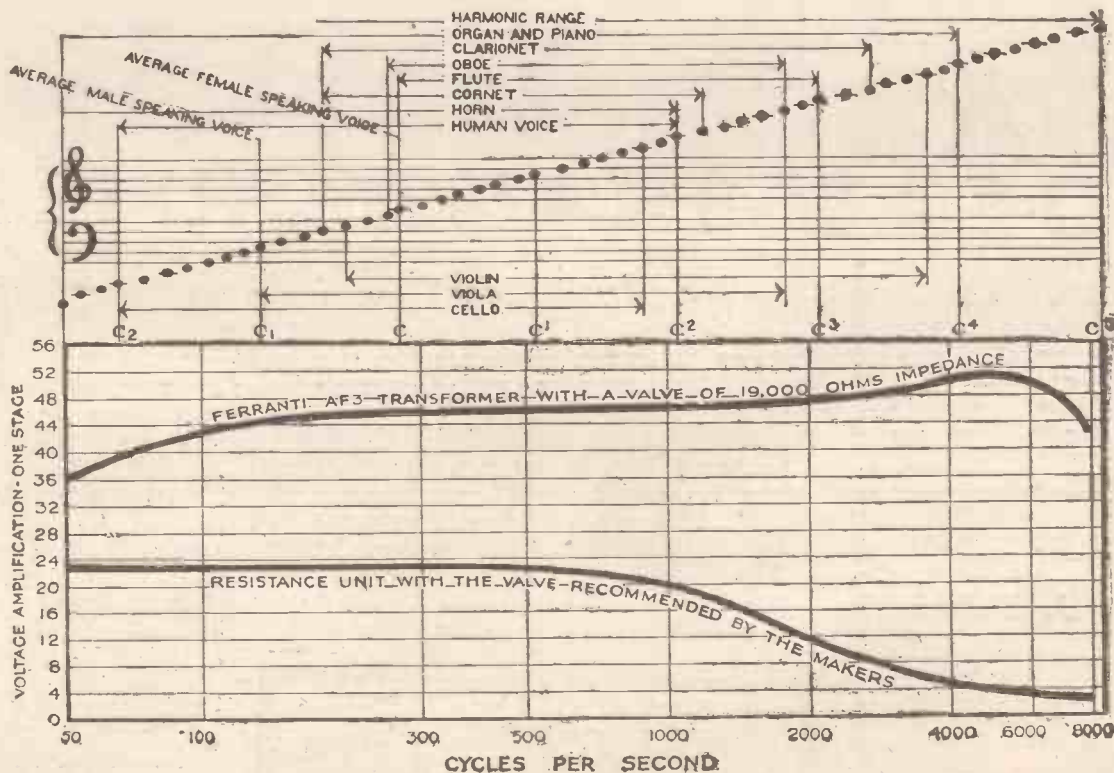

FERRANTI LTD.,
 Hollinwood
 Lancashire.

FERRANTI ELECTRIC LIMITED.
 Toronto,
 Canada.

FERRANTI INC.,
 130, West 42nd Street,
 New York, U.S.A.

APPARATUS TESTED.

(Continued from page 498.)

the market. Several models are available, and of these the "Ala B" appears to be the one most suitable for radio amateurs. It sells at 3s., and is of generous proportions. As a matter of fact, it makes rather a nice acid filler, as it sucks up quite a large quantity of the liquid! The float is correspondingly massive, and the readings on it are very clearly visible and are nicely spaced out. S.G. markings are given as well as the usual "Fully charged," "Half charged," etc. We checked the "Ala" up against a laboratory hydrometer and found it to be accurate.

THE "LOTUS" REMOTE CONTROL.

Remote control is a luxury, but it is a luxury which no listener can ignore if he desires to obtain optimum enjoyment from a radio outfit. It is well worth while to permanently install such a system and as rooms are being re-papered it is a good scheme to have loud-speaker extension leads "built in." It is not a difficult task, and builders do not charge much to carry it out. Many amateurs do the work themselves, for all that has to be done is to run channels in the plaster to the points where the sockets are situated, and to take up a floor board or two.

But extension leads to loud speakers should always consist of four-way cable, so that a pair of wires is available for operating a switch relay, enabling the set to be switched off and on at any of the various points. Messrs. Garnett, Whiteley,

whose "Lotus" components will be well-known to "P.W." readers, have recently introduced a complete remote control extension lead outfit at a very moderate price. Both to fit up and to operate it is simplicity itself. An adequate length of four-way cable, which is light but strong, is supplied together with wall-sockets, plugs, and a switch-relay. This last is connected in the L.T. leads of the set, and does not require an extra battery. When wired up the system is quite an automatic one. When the first loud-speaker plug is inserted, the set is switched on, and when the last plug is withdrawn the set switches off. Any number of points can be wired up, and all can be used together if required.

The outfit complete for two rooms costs 30s., additional rooms can be catered for at 7s. 6d. each extra. The relay is a neat, enclosed little object, and can be fitted into and wired permanently inside a set if desired. We tested it carefully on an existing four-wire system which includes some very long leads, and it proved to be perfectly satisfactory. It took up to four amperes of filament current without the slightest signs of "sticking." These four amperes were not required to operate the

device, the current required for this is negligible, but that amount of current could be switched on and off with safety. Most receivers these days use much less L.T. than that.

We can certainly recommend the "Lotus" remote control to all loud-speaker enthusiasts. It is eminently practical in its simplicity, effectiveness, and apparent reliability.

GRIPSCO PERMANENT CRYSTAL DETECTOR.

Messrs. A. W. Griffin and Co., of Redditch, are desirous of obtaining information from users of GripSCO detectors in respect of the performance of these under varying conditions in different localities.



The new studio at the 3 L O broadcasting station of Melbourne, Australia.

MARCONIPHONE 'IDEAL' TRANSFORMERS

The amplification curve of the Marconiphone "Ideal" speaks for itself. Its straightness tells of voluminous and distortionless reproduction throughout the range of audible frequencies. Used after the detector valve, speech or music, song or orchestra are reproduced with vivid naturalness and an extraordinary increase in volume. Every "Ideal" transformer is guaranteed to possess an amplification within 5 per cent. of the standard curve, and each one carries a year's guarantee of reliability and performance.

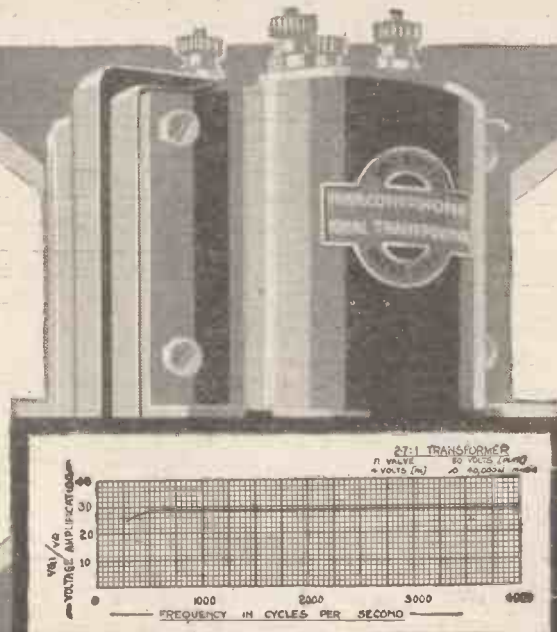

The Marconiphone "Ideal" Transformer is supplied in four ratios:

2.7 to 1 6 to 1
4 to 1 8 to 1

PRICE - 25/- ALL RATIOS

Publication No. 453 giving full particulars and guaranteed curves of Marconiphone "Ideal" Transformers sent on request. Please mention "Popular Wireless."

THE MARCONIPHONE COMPANY, LIMITED.

Head Office:
210-212, Tottenham Court Road, London, W.1.

Regd. Office: Marconi House, Strand, London, W.2.

Invaluable to
EVERY Amateur
and Constructor.

The "POPULAR WIRELESS"

BLUE PRINTS
of TESTED CIRCUITS

The following is a complete list of the "P.W." 6d. Blue Prints for Constructors, showing the different circuits available.

P.W. BLUE PRINT
Number

1. DETECTOR VALVE WITH REACTION.
2. UNIDYNE DETECTOR VALVE WITH REACTION.
3. 1-VALVE L.F. AMPLIFIER.
4. CRYSTAL DETECTOR WITH L.F. AMPLIFIER.
5. H.F. (Tuned Anode) AND CRYSTAL, WITH REACTION.
6. H.F. AND CRYSTAL. (Transformer Coupled, without Reaction).
7. 1-VALVE REFLEX WITH CRYSTAL DETECTOR (Tuned Anode).
8. 1-VALVE REFLEX AND CRYSTAL DETECTOR (Employing H.F. Transformer, without Reaction).
9. H.F. AND DETECTOR (Tuned Anode Coupling, with Reaction on Anode).
10. H.F. AND DETECTOR. (Transformer Coupled, with Reaction).
11. DETECTOR AND L.F. (with Switch to Cut Out L.F. Valve).
12. DETECTOR AND L.F. UNIDYNE (with Switch to Cut Out L.F. Valve).
13. 2-VALVE REFLEX (Employing Valve-Detector).
14. 2-VALVE L.F. AMPLIFIER (Transformer Coupled, with Switch to Cut Out Last Valve).
15. 2-VALVE L.F. AMPLIFIER (Transformer-Resistance Coupled, with Switch for Cutting Out Last Valve).
16. H.F. (Tuned Anode), CRYSTAL DETECTOR AND L.F. (with Switch for Last Valve).
17. CRYSTAL DETECTOR WITH TWO L.F. AMPLIFIERS (with Switching).
18. 1-VALVE REFLEX AND CRYSTAL DETECTOR, with 1-VALVE L.F. AMPLIFIER, Controlled by Switch.
19. H.F. DETECTOR AND L.F. (with Switch to Cut Out the Last Valve).
20. DETECTOR AND 2 L.F. AMPLIFIERS (with Switches for 1, 2, or 3 Valves).
21. THE 2-VALVE LODGE "N."
22. "THE GUARANTEED REFLEX."
23. THE 1-VALVE "CHITOS."
24. THE "SPANSACE THREE." Three-Valve Receiver employing 1 Neutralised H.F. Valve, Detector with Non-Radiating Reaction Control, and 1 L.F. Valve.
25. 2-VALVE REINARTZ (Det. and L.F.).
26. A "STRAIGHT" 4-VALVER (H.F., Det., and 2 L.F. with Switching).
27. A "MODERN WIRELESS" 4-VALVER (2 H.F., Det., and L.F.).
28. A "MODERN WIRELESS" 5-VALVER (H.F., Det., and 3 L.F.).

ALL "POPULAR WIRELESS"
BLUE PRINTS—6d. EACH

All orders for these Blue Prints should be sent direct to the "Popular Wireless" Queries Department, Fleetway House, Farringdon Street, London, E.C.4, enclosing a stamped addressed envelope and a postal order for 6d. for each Blue Print Ordered.

The presence,
in a Drawing Room, of a
Brown Q-type
Loud Speaker
stamps the
Owner as a
Man of excel-
lent discrimina-
tion. £15. 15s.
is not a high
price to pay for
such a luxury



Brown Q
Loud Speaker
tells the truth

S G. BROWN, Ltd., Western Avenue, N. Acton, W.3
Retail Showrooms: 19, Mortimer Street, W.1; 15, Moorfields, Liverpool;
67, High Street, Southampton. Wholesale Depots throughout the Country

RADIO TUTORIAL

All Editorial Communications to be addressed to The Editor, POPULAR WIRELESS, The Fleetway House, Farringdon Street, London, E.C.4.

Editor:
NORMAN EDWARDS, M.Inst.R.E., M.R.S.L., F.R.G.S.
 Technical Editor:
G. V. DOWDING, Grad.I.E.E.
 Assistant Technical Editors:
K. D. ROGERS, P. R. BIRD.
G. P. KENDALL, B.Sc.
 Scientific Adviser:
Sir OLIVER LODGE, F.R.S.
 Staff Consultants:
Dr. J. H. T. ROBERTS, F.Inst.P.; **J. F. CORRIGAN**, M.Sc., A.I.C.; **C. E. FIELD**, B.Sc.; **E. J. SIMMONDS**, M.I.R.E., F.R.S.A.
 Foreign Correspondents:
F. M. DELANO, Paris; **Dr. ALFRED GRADENWITZ**, Berlin; **L. W. CORBETT**, New York; **P. F. MARTIN**, Italy; **W. PEETERS**, Holland.

The Editor will be pleased to consider articles and photographs dealing with all subjects appertaining to wireless work. The Editor cannot accept responsibility for manuscripts and photos. Every care will be taken to return MSS. not accepted for publication. A stamped and addressed envelope must be sent with every article. All enquiries concerning advertising rates, etc., to be addressed to the Sole Agents, Messrs. John H. Lile, Ltd., 4, Ludgate Circus, London, E.C.4.

As much of the information given in the columns of this paper concerns the most recent developments in the Radio world, some of the arrangements and specialities described may be the subject of Letters Patent, and the amateur and the trader would be well advised to obtain permission of the patentees to use the patents before doing so.

Readers' letters dealing with patent questions, if sent to the Editor, will be forwarded to our own patent advisers, where every facility and help will be afforded to readers. The envelope should be clearly marked: "Patent advice."

Questions and Answers

THE "ALL-WAVE" TWO.

S. O. A. (Rotherhithe, S.E.)—“Re the coil unit used in the 'All-Wave' Two, I notice that the makers of the 'All-Purpose' Coil recommend that only the aerial lead should

be connected to A₁, the other 'A' connections being taken from A₂. Is this the best method?”

The object of A₁ is to place a small fixed condenser in series with A₂, and so reduce the wave-length and minimise damping. It will generally be found beneficial to connect the aerial lead only to A₁, and the variable condenser and 0002 grid condenser to A₂.

A FILADYNE THAT FAILS TO OSCILLATE.

“FILADYNE” (Southgate Road, London, N.1).—“I made up the Filadyne set, described in your issue of April 30th, but the strength of the signals is only poor crystal, and I cannot get the set to oscillate. I have stuck to the specifications all through, and I should be glad if you suggest anything to improve matters. My aerial is a basket type, of about 100 feet high, up on the roof. Earth, a water-pipe 20 ft. away. As I am only two miles from 2 L.O., I feel I ought to get better results. Is it possible to build a one valve to work a loud speaker at that distance?”

You omit to mention the valve used, and this is generally a very important factor with a Filadyne set. Loud-speaker results are, of course, obtainable at only short distances when a one-valve set is employed, but moderate loud-speaker volume has been reported by many one-valve Filadyne-set owners situated up to ten miles, using fairly efficient outdoor aerials. Analysis shows that the best valves for such results are—2 volt, D.E.2 L.F. (Marconi or Osram); 4 volts, B.5 (B.T.H. Co.).

(It is interesting to note that certain of the cheaper foreign valves, having tubular anodes, will also give loud-speaker results.)

In your case the failure to oscillate is probably caused either by an unsuitable valve; incorrectly wound coil, incorrect bias via potentiometer, or by the basket aerial. (Results with home-made aerials of this kind are frequently erratic, though at two miles it should be quite O.K. if a good specimen of its type.)

If it has not already been tried, the leads to the reaction coil L₂ should be reversed, as this may prove to be all that is necessary to make the set oscillate.

The correct bias (via potentiometer) varies with different valves, and it is advisable to try up to 0 volts

(Continued on page 504.)



FORMO
ARTHUR PREEN & CO. LTD.

TRUE TUNING

“INDIVIDUAL-GANG” CONTROL CONDENSER

again to the fore!

FIRST we gave our customers a highly efficient and low-priced Variable Condenser and L.F. Transformer. Now we lead in the design of a Gang Control Condenser with individual adjustment which has all the advantages of the ordinary Gang and Single Condensers without ANY of their disadvantages.

CROWN WORKS, Dept. 6,
 Cricklewood Lane, N.W. 2.
 Phone: 1787 Hampstead.
 Manchester: Mr. J. B. Levee, 23, Hartley St.,
 Levenshulme. Phone: Heaton Moor 475.



TWIN-GANG ... £2: 12: 6
 TRIPLE-GANG ... £3: 3: 0

TUNE with the centre dial until you hear your station.
 ADJUST with the side dials for maximum signal strength.

IT'S SIMPLE!
 IT'S EFFICIENT!!
 IT'S GOOD!!!
 IT'S FORMO!!!!

Don't forget to use

GLAZITE

BRITISH MADE REGD.

COLOURED CONNECTING WIRE

[RED · YELLOW · BLUE · BLACK · WHITE and GREEN]

Write for descriptive leaflet to
 The LONDON ELECTRIC WIRE CO. & SMITHS LTD.
 Playhouse Yard, Golden Lane, London, E.C.1

Makers of Electric Wire  for over 40 years

JUDD.

BURNT OUT?

Never mind. Pack it up and send it to us together with remittance and we will return it as good as new.

ELIMINATE ALL H.T. BATTERIES FREE

Send a Postcard TO-DAY for particulars of the latest method of abolishing ALL BATTERIES. Absolutely Free of Charge.

ALL TYPES OF VALVES REPAIRED AT HALF LIST PRICES (Minimum Charge 5/-).

Weco, S.P.'s and low capacity types not repairable. Minimum D.E. current 0.15 amp. when repaired.

SATISFACTION GUARANTEED OR MONEY REFUNDED.



VALCO LTD., Dept. P.W., Tabor Grove, Wimbledon, S.W.19.

Cabinets of distinction



These handsome moderately priced cabinets are made in styles to suit any furnishing either to customers own designs or to standard designs as illustrated.

An illustrated folder containing prices and specimen cabinets, or quotations for private orders gladly given on application. Deferred payments can be arranged.

North Country Readers should visit our Stand No. 13 at the Better Housekeeping Exhibition, City Hall, Deansgate, Manchester.

V. C. BOND & SONS,
61, The Grove, Mare
Street, Hackney,
London, E.8

Phone: Clissold 0883.
Established 1899.

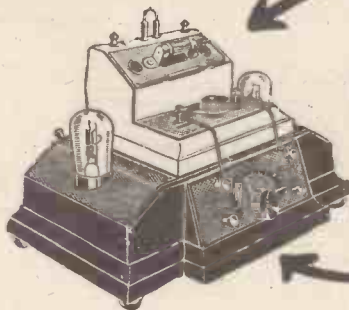

THIS
BROWNE FAMOUS
CRYSTAL SET @ 10/6
plus
THAT

BROWNE COMPLETE
2-NOTE AMPLIFIER @ 63/

give you perfect
yet inexpensive
Loud-speaker!
Volume ———!

WRITE FOR FREE BOOKLET No. 51.

BROWNE WIRELESS COMPANY (G.B.) LIMITED
NELSON STREET WORKS, MORNINGTON CRESCENT, N.W.1



TWO ASTOUNDING OFFERS!

WE OFFER YOU highest class British-made Dull Emitter Valves at HALF USUAL PRICES because there are NO Middleman's Profits to pay. WE OFFER YOU three days' FREE TRIAL—on your own wireless set—at home—because we want you to satisfy yourself that SILVER DOME Valves are what we claim them to be—the Pinnacle of Radio Perfection.

NO OBLIGATION TO PURCHASE.

H.F. Det., L.F., 7/- (worth 14/-)
POWER VALVES, 9/6 (worth 18/6.)

All voltages—2v., 4v., 6v. Test at home before you buy. Send 3/6 deposit (5/- for Power Valve), which includes 6d. for postage and packing. This deposit will be returned to you if after 3 days' Trial you decide not to buy. If you keep the Valve then you simply forward the balance to us, viz., 4/- (5/- for power).

VALVES FREE—Full details with every valve purchased. Every "Silver Dome" Valve is Fully Guaranteed.

Sole Manufacturers

THE LONDON & MIDLAND MFG. CO., LTD.,
(Dept. P.W.), Alderman's Walk, Bishopsgate, E.C.



THE "J.B."
TRUE TUNING S.L.F. Patented

THE "FINAL" CONDENSER!
Final in Efficiency, Accuracy and Finish. The "J.B." S.L.F. Condensers improve not only the efficiency but the appearance of any set, and what is more important the temper of the owner. No fumbling for the stations but absolutely there first time.

PRICES: Complete with 4 in. dial.

The "J.B." True Tuning S.L.F.—'0005 mfd. 16/6. '00035 mfd. 15/6. '00025 mfd. 15/-.	The "J.B." S.L.F.—'0005 mfd. 11/6. '00035 mfd. 10/6. '00025 mfd. 10/-.
For Short Wave Receivers, '00015 mfd. 15/-	For Short Wave Receivers, '00015 mfd. 10/-

JACKSON BROS.
8. POLAND ST.-OXFORD ST. Telephone:—, GERRARD 7414
LONDON - W.1

NOW ON SALE

The JUNE issue of THE

"Wireless Constructor"

Edited By Percy W. Harris, M.I.R.E.

Packed, as usual, with interesting constructional and practical articles, — this number includes —

Another "Radiano" Receiver

A two-valver capable of doing wonders on the short waves and which is — simplicity itself to construct —

OBTAIN YOUR COPY NOW.

The "Wireless Constructor" is on sale everywhere
Price - - 6d.

RADIOTORIAL QUESTIONS AND ANSWERS

(Continued from page 502.)

across the potentiometer, and also the effect of very little or no bias at all (i.e. disconnect the anode bias plug from the battery). In certain cases a reversal of the L.T. battery leads will assist the set to oscillate, and as this is very easily done it should certainly be tried.

If after attention to the foregoing points the set still refuses to oscillate we are afraid that one of your components or accessories is a "dud."

BEST LENGTH FOR A COIL.

"WINDER" (Revelstoke Road, London, S.W.19).—"If a given reel or length of insulated wire is wound into a solenoid coil, will the inductance value be the same whether the coil is wound as a long thin coil or whether it is wound as a comparatively short "fat" coil? If different, what kind of former gives the greatest inductance for the minimum of wire used?"

Although the length of wire used to form different coils may be the same, the respective inductance values will depend upon the dimensions of the former, or rather upon the ratio of its length to the diameter. The arrangement which gives the maximum inductance for the minimum of wire used is when the diameter of the coil is approximately 2½ times the length of the winding. (To be exact, the diameter of the coil should be 2.414 times its length.)

LECLANCHÉ TYPE CELLS.

E. S. G. (Woolwich, S.E.18).—"Are the Leclanché type cells used for H.T. batteries built exactly like the original Leclanché cells, that are commonly used for ringing bells, etc.?"

Not exactly. Several modifications have been introduced to economise space, and to give a steadier and comparatively larger output. In these small H.T. cells, the zinc rod and porous pot are replaced by a zinc "shield" surrounding but not touching a sac element. This reduces the internal resistance, and such cells are capable of giving a steady output

without noticeable de-polarisation for comparatively long periods, whereas in the original Leclanché type cell de-polarisation sets in fairly quickly. (For this reason the original-type is particularly suitable for ringing bells and similar intermittent work, as the long rests between use enable the cells to recover.)

LENGTH OF COIL FORMERS.

C. J. S. (Sawbridgeworth, Essex).—"I have been experimenting with home-made solenoid coils for different wave-lengths, and I find it difficult to calculate how long the coil former should be for any given number of turns. Generally, I use either 22 D.C.C. or 30 enamelled, and often I find the former is too long, and have to cut off a piece of the former when the coil is on it (so loosening the winding), or else I find I cannot get quite as many turns on as I expected. What is the proper method of ascertaining the length of former required?"

You should consult a wire table showing the diameter of the wire used, and then simple division will show you how many times this diameter will go into a given length—i.e. how many turns will lie side by side on a given length of coil former.

In the cases named, 22 D.C.C. measures .036 in. in diameter, and No. 30 enamelled measures (approx.) .017 in.

Thus to find how many turns of the 22 D.C.C. will go on a former 3 in. long, divide 3 by .036, which gives approx. 86 turns.

Similarly, to find how many turns of the 30 enamelled wire can be wound on 4½ inches of former, divide 4½ by the wire's diameter (.017 in.), which gives approximately 264 turns. In all cases allowance should be made for rather less turns than given by the figures, as it is hardly possible to wind the wire so well that extra spacing is not required owing to slight bends, etc.

HUMMING INTERFERENCE.

"BUZZ" (Birkenhead).—"I have put in a crystal set, but all the time I can hear a loud buzz, whether the programme is on or not. Why is this?"

You are picking up interference from electric light or power mains. If the house is fitted with electric light, make sure that none of the leads to or from the set go near to the house wiring (the latter may be

concealed in the walls). If re-spacing does not improve matters probably you will find that either your aerial, lead-in, or earth wire is running too close to wires carrying electric light or power.

HOME-MADE H.F. CHOKE FOR SHORT WAVES.

"CAPACITY CONTROLLED" (Hollinwood, Lanes).—"Finding that the ordinary large plug-in coil does not make a good H.F. choke for use during short-wave reception, I should like to wind a good choke for myself if this can be done efficiently. Which is the best method?"

We should wind the choke upon an ordinary glass test-tube, six inches or more in length and about half an inch in diameter. Such a tube can be mounted by securing a cork that fits the tube to the baseboard, and then pushing the tube over the cork in the ordinary way.

For the choke use No. 32 gauge D.S.C. wire (of which at least one-hundred turns will be required), securing the ends by a small dab of shellac varnish, or by binding.

Instead of winding the turns on side by side, the wire should be wound on at the same time as a thread of about the same thickness, the thread serving to space each turn from the next. This spacing thread can be removed when the choke is finished.

REACTION CONTROL OF SCHNELL CIRCUIT.

S. R. (Tewkesbury, Glos).—"I have been trying the Schnell circuit but am rather nervous of shorting my H.T. accumulator through the plates of the variable condenser touching. The condenser is a .0002 and I thought of placing a .001 fixed in series with it. If I do this to protect the battery from short-circuit, what effect will this extra condenser have upon the capacity of the variable reaction condenser?"

In effect it would reduce the capacity of the variable condenser to .00016 mfd. As this would be a considerable reduction, for controlling the circuit named we should use a fixed condenser of .002 or more. In this case the reduction would be to .00018, or less if a larger series capacity is used.

(Continued on next page.)

"EKCO" UNITS

Derive Current for Wireless Receivers from Electric Supply Mains (D.C. & A.C.) by just attaching adaptor to lampholder!

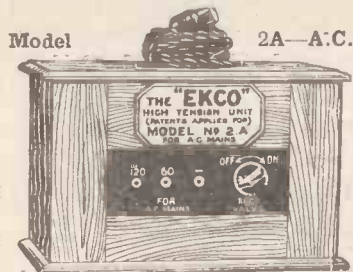

(British Letters Patent Nos. 262567 & 148129)

PROVIDES HIGH TENSION.

I Tapping of 60

I " " 120 or 100

PRICE £6:10:0

(Royalty 12/6 extra.)

SAFE!

SILENT!
SOUND!

"The First—
The Best—
The Pick—
of the Bunch!"

MODELS FOR H.T. AND COMBINED H.T.—L.T.—G.B. ILLUSTRATED FOLDER describing the 10 "EKCO" Models for each A.C. and D.C. Mains POST FREE.

Prices from 42/6

Obtainable at all the leading wireless stores or direct from:—

F.K. COLE LTD (DEPT. A) 513, LONDON RD., WESTCLIFF-ON-SEA.



Each set of Transformers is complete with instruction booklet, illustrating how to construct a 7-valve set.

PERFECT REPRODUCTION

To secure perfect reproduction and not Mush, you must use Bowyer-Lowe Super-Heterodyne Transformers—world-famous for their silent background.

Send for full particulars.

Set of 4 Transformers - - £4.0.0

Interchangeable Oscillator Couplers

300—600 metres - £1.0.0

550—2000 " - 1.0.0

Base - - - 4.0

Constructor's Kit containing principal components for building a 7-valve set £10.0.0

BOWYER-LOWE
TESTED RADIO APPARATUS

ANNOUNCEMENT BY THE BOWYER-LOWE CO. LTD. LETCHWORTH HERTS

RADIOTORIAL QUESTIONS AND ANSWERS

(Continued from previous page.)

"H.R. TO L.R. PHONES."

Many correspondents have written in the same strain regarding the above subject, so one of the letters has been chosen as being representative, and is answered below:

"I notice that on page 219 of the April 2nd issue of 'P.W.', in the article 'H.R. to L.R. Phones,' your correspondent states that if two 4,000 ohm earpieces be connected in parallel the resistance of the headset 'can be reduced to one having a resistance of 2,000 ohms, which, needless to say, is less liable to be burnt out than the former (connected in series to give 8,000 ohms)."

"Burn outs' are caused by the passage of too much current through the conductor, and

$$\text{by Ohm's Law } C = \frac{E}{R}$$

"If E (voltage of H.T. battery) be kept constant, the current passing through the phones is represented thus:

$$\text{"For 'series,' 8,000 ohms resistance } C = \frac{E}{8000}$$

$$\text{"For 'parallel,' 2,000 ohms resistance } C = \frac{E}{2000}$$

THE TECHNICAL QUERY DEPARTMENT

Is Your Set "Going Good"?

Perhaps some mysterious noise has appeared and is spoiling your radio reception?—Or one of the batteries seems to run down much faster than formerly?—Or you want a Blue Print?

Whatever your radio problem may be, remember that the Technical Query Department is thoroughly equipped to assist our readers, and offers an unrivalled service.

Full details, including a revised scale of charges, can be obtained direct from the Technical Query Dept., "Popular Wireless," Fleetway House, Farringdon Street, London, E.C.4.

A postcard will do: On receipt of this an Application Form will be sent to you, free and post free, immediately. This application will place you under no obligation whatever, but having the form you will know exactly what information we require to have before us in order completely to solve your problems.

"But in the second case we need only consider one earphone, the current of which is represented as $C = \frac{E}{4000}$.

"Hence it can be seen that twice as much current is passed through the wire when the earpieces are connected in parallel than when they are connected in series. Hence the combination of the earpieces to give 8,000 ohms must be LESS liable to be burnt out than if the resistance is 2,000 ohms.

"Surely your correspondent realises that a resistance of 500 ohms or so placed in series with the H.T. negative lead obviates the risk of accidentally shorting the H.T. battery through the filaments of the valves." (Vide Mr. J. English's article "Home-Made Variable Resistances," "P.W.," October 2nd, 1926.) "Your correspondent would no doubt connect his resistance in parallel with the

(Continued on next page.)

CAXTON WIRELESS CABINETS

THOUSANDS OF SATISFIED CUSTOMERS.

All Polished with new enamel that gives a glass hard surface that cannot be soiled or scratched. Ebonite or Radion Panels Supplied and Perfectly Fitted at low extra cost. SENT FREE—Catalogue of Standard Wireless Cabinets in various sizes and woods.

Elstree "Solodyne"

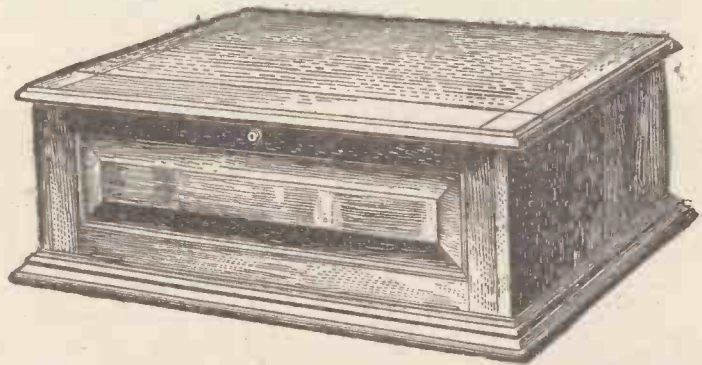

Specially designed for this famous Radio Press Circuit. All details and dimensions conform to their specification, enabling constructors to follow the layout without difficulty.

PRICES:

Light Fumed Oak 61/- Dark or Jacobean Oak 65/- Real Mahogany 68/-

Prices include either "full front" with handsome solid raised panel, as illustrated, or beaded doors, allowing ample space for tuning controls, etc. Glass panelled doors can also be supplied at 3/- extra.

CASH WITH ORDER. CARRIAGE PAID U.K. PROMPT DELIVERY.

Packing Case 5/- extra repaid if Case returned within 14 days Carriage paid to Works.

CAXTON WOOD TURNERY CO., MARKET HARBOUROUGH.

HEADPHONES REPAIRED

Rewound and re-magnetised 4/- per pair. Loud Speakers repaired 4/-: Transformers re-wound 5/- each. All work guaranteed and tested before delivery. Write for Trade Prices. Phone: Clerk. 1795. MASON & CO., 44, East Rd., City Rd., N.1.

EASY PAYMENTS

LOUD-SPEAKERS, HEADPHONES, H.T. ACCUMULATORS, Anything Wireless.

Send a list of the parts you are requiring, and we will send you a quotation on monthly payments. H. W. HOLMES, 29, FOLEY STREET, Phone: Museum 1414. Gt. Portland St. W.1.

RUSSELL'S OSCILLATING DETECTOR



INCREASES RANGE
Enjoy permanence of Valve-set range & volume fitted to any Crystal set in a few moments
POST PAID. 2/9 Satisfaction or money returned.
RUSSELL LABORATORIES, Hill St., Birmingham

WIRELESS WAREHOUSE

Buy your Wireless parts direct from the Warehouse at Warehouse prices.

Every known component in stock Write NOW for list.



BUSH HOUSE, 35, Shudehill, MANCHESTER.

BATTERY CORDS VERY HIGHLY INSULATED.

Each wire a different colour.
4-way. 5-way. 6-way. 7-way. 8-way.
2/3 2/7 3/- 3/6 4/2
Sent C.O.D. The Best on the Market. — FLEXIBLE ELECTRIC CORDS LTD. PONDERS END, MIDDLESEX.

BUILD A LOUDSPEAKER

WITH OUR SEAMLESS MOULDED CONE (Prov. Patent 25089) and DOUBLE-ACTING REED UNIT, or a LISSENOLA, or BROWN A, you can successfully construct an ultra-efficient Loudspeaker. Specialities separately or complete. Illustrated lists and full particulars for stamp. GOODMAN'S, 27 FARRINGDON ST., E.C.4. Also Spencer's Stores, 4-5, Mason's Ave., E.C.2.



STANDARD WET H.T. BATTERIES

Separate Parts	
Jars (waxed)	1/3 doz
Zincs	1/0 ..
Sac No. 1	1/6 ..
Do. with terminals	2/3 ..
Sac No. 2	3/0 ..
Do. with terminals	3/9 ..
Electrolyte for 20 cells	9d.
Box Rubber Bands for 12 Sacs No. 1	6d.
Rubber Bands for No. 2 Sacs	6d.

(Leclanche Type) 1½ volts each cell.
Size, 11 in. by 17½ ins.
60 cell, 90 volt battery—Price of complete set. £1 1 0. Varnished Mahogany Tray 9/6 extra.
Each Cell comprises Jar (Waxed), Zinc, Sac Element with rubber-insulating bands and electrolyte
NO CHARGING—ECONOMICAL—PERMANENT—SILENT.
Send 1ld. stamp for illustrated list giving full particulars, maintenance hints, and useful information. We shall be pleased to advise the best battery to suit your set on receipt of full details.

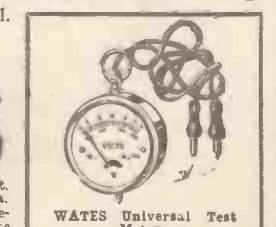

WATES Universal Test Meter.
For testing H.T. and L.T. Battery and CURRENT taken by H.T. Battery in millamps. Price with full instructions 7/6

WET H.T. BATTERY CO., 12, Brownlow Street, High Holborn, W.C.2. By First Avenue Hotel.

Please be sure to mention "POPULAR WIRELESS" when replying to Advertisers THANKS

Control your set from where you sit

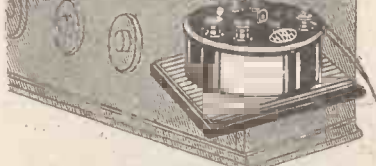

The H.B.H. REMOTE CONTROL SWITCH gives real armchair control. You can take the Loud Speaker to any room and switch on and off without moving from your chair. Infinitely superior to any other type of Remote Control, because—

The control is in your hand. No consumption of current, however many Loud Speakers in use. Suitable for 2, 4, or 6 volts.

SIMPLE — EFFICIENT — ECONOMICAL.
Send to-day.

Satisfaction Guaranteed **21/-** or money refunded.

Post Free.
H.B.H. PRODUCTS, LTD.,
11, Tavistock Sq., London, W.C.1
Phone: Museum 3908.

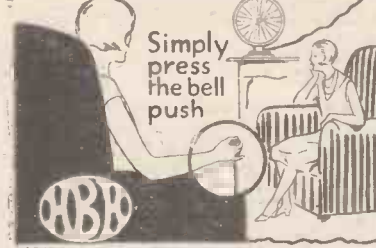

Simply press the bell push

RADIOTORIAL QUESTIONS AND ANSWERS

(Continued from previous page.)

H.T. battery to save his valves from being accidentally burnt out; perhaps he would perform the experiment and tell us his results!
"Excuse me for criticising your excellent journal. This is the first fault I have found with it."

In the case given—the current through the 'phones which is being considered is a direct current, so that Ohm's Law is applicable. But Ohm's Law is so beautifully simple that it is quite easy to apply it wrongly, as has been done in the letter quoted above!

The author of "H.K. to L.K. 'Phones'" states explicitly that the conversion is to enable the 'phones to be used on a valve set, so it is obvious that the resistance of the valve must be taken into account. (Ohm's Law always gives the current through the whole of the circuit across which the voltage is applied.)

To take a practical case, suppose a 100-volt H.T. battery is connected to a head-set having a resistance of 8,000 ohms. The circuit is completed through a valve, the resistance of which may be taken as 10,000 ohms. (As the battery and other resistances are very small they can be ignored, for the purposes of explanation.)

The total resistance of valve and 'phones will be 100 = 18,000 ohms, so Ohm's Law gives $C = \frac{100}{18,000} = 5.5$ milliamps.

Thus, with the head-set arranged "in series," each ear-piece would be called upon to pass over 5.5 milliamps.

If now the earpieces are placed "in parallel," and connected up again, the total resistance of the circuit will be 12,000 ohms. So Ohm's Law now gives $C = \frac{100}{12,000} = 8.3$ milliamps.

But now each earpiece carries only half the current flowing through the circuit, so each earpiece will be called upon to pass 4.15 milliamps instead of over 5 milliamps as formerly. Obviously this will be better for the 'phones.

Looked at from a voltage or pressure point of view, the advantage of the "parallel" connection is equally obvious.

When the 'phones are 8,000 ohms, and the valve 10,000 ohms, the whole pressure in the circuit is across 18,000 ohms, and obviously the head-set has to stand $\frac{1}{3}$ ths of this total pressure.

When the 'phones are 2,000 ohms, and the valve 10,000 ohms, the whole pressure in the circuit is across 12,000 ohms. Thus the total pressure is relatively greater, but obviously the head-set now bears only $\frac{1}{6}$ ths of this total pressure.

The only case in which the reasoning of your letter would hold good is in the case of 'phones placed straight across the H.T. battery!

CALLER'S COLUMN

ADD 2d. IN EACH 1/- (OR PART) FOR POST ORDERS FROM THIS COLUMN (POST FREE OVER 10/-).

POST ORDERS must be not less than 2/6 in value FROM THIS COLUMN.

NOT SENT ABROAD.

AERIALS.—10 ft. 7/22 Hard drawn, 1/11. Extra heavy, 2/2. Phosphor 49 strands, 1/-. Electron stocked. Special INDOOR Aerials, phosphor, with ebonite, separator and rubber rings (12 ft. x 8 strands), total 100 ft. 4/6. O.V., 2/6. Rubber Lead-in, highest quality, 10 yds. 1/-; 10 yds. 1/3; 10 yds. 1/6. Extra heavy, 2d. and 3d. yd. R. & B. Twin Flow (best), 6 yds. 10d.; 12 yds. 1/6; 36 yds. 4/-.

INS. Hooks, 2 for 1d. Egg Insulator, 2 for 1d. Ins. Staples, 4 a 1d. Earth Tubes, Copper, extra value, 2/3. Climax, 5/- (also at 2/6).

EASY FIX AERIALS, with 2" insulator and lead in, 1/3. **EBONITE GRADE A.** Stock sizes, 6 x 6 and 7 x 5, 1/3; 8 x 6, 1/6; 9 x 6, 1/8; 10 x 8, 2/8; 12 x 6, 2/8; 12 x 8, 3/6; 12 x 9, 4/-; 14 x 7, 4/6. **ALSO CUT TO SIZE** while you wait at 1d. per sq. inch 5/16th and 3d. per sq. inch for 1d. Special cheap panels for Crystal Sets.

TERMINALS. Nickel W.O. Pillar, 'Phone, 1/1 doz. (3 for 4d. with N. and W.). Brass do., 10d. doz. (1d. each with N. and W.), all high quality. Valve-Pins, with nuts, 2 a 1d. Ormond Screws, 6 or 4 B.A., 6d. dozen with nuts, washers 12 a 1d. Red and Black Spades, screw at side, 3d. pr. Plug and Socket, Red or Black, 3d. Wander Plug, Red or Black, 3d. pr. (Large) good. 'Phone Connectors, 1d. Plus panel sockets and nuts, 4 for 4d., 10d. dozen. Brass Spade Tags, 6 a 1d. Nickel Solder Tags, 4 a 1d., 2 and 4 B.A. Rod, 3d. foot. Nickel Valve Legs and Nuts, 1d.; 8d. dozen. Stop Pins, 2 a 1d. **H.T. BATTERIES.** Highest quality Adco (T.P.D.T.) 60-v. (also given) 60-v., 6/-; 100-v., 11/9. Thera, 60-v., 5/6; 100-v., 10/-. Everready, 66-v., 9/6; 108-v., 15/6. Others in 5/-, 1-5 L.P. Hellesen's, 2/6. Adco, 1/8; B.T.H., 2/-; Flag, 2/-; British, 1/6. **SOLDER,** with Resin, 2d. foot. 1/16 sq. Bus Bar, 2 ft. 1d. Tinned copper, 16 and 18 gauge, round, 9d. per lb. D.C.O. 1-lb. 20 gauge, 8d.; 22 gauge, 9d.; 24 gauge, 10d.; 26 gauge, 11d.; 28 gauge, 1-3 30 gauge, 1/2. **MANSBRIDGE CONDENSERS.** "Hydra" 1 mfd., 2/9; 2 mfd., 3/9. 0-1, 1/9; .25 and .5, 2/3. **SWITCHES** on Porcelain, D.P.D.T. 1/3; S.P.D.T. 8d. and 10d. Sound quality. Panel switches, with Ebonite handle, worth double S.P.D.T. 1/-; D.P.D.T. 1/6. Insulating Tape, 4 1/2d. Copperfoil, 4d. foot (6 in. wide). Grid, Bias Clips, 6d. Panel Brackets, 9d., 1/- pr. Shorting Plug, 3d. **PERMANENT DETECTOR,** Red Diamond (a topper, 2/-; Lion Micro (latest, cannot be equalled), 2/6. Brownie, 3/-.

Enclosed Kay Ray, 1/-, 1/3. Service Microphone, with crystal, 2/9; 4/6. **CRYSTALS.** Super-zito, 1/6; Shaw's sealed genuine Herizite, 8d., 1/-; Wray, 1/6. **HEADPHONE CORDS.** Good, 1/-, 1/3, 1/6. L.S. Cord, 1/6, 1/9. 4-way H.F. and L.T. Leads, 1/9, 2/-.

LEWCOS STOCKED. COIL PLUGS. Ebonite on Base, 6d., 7d., Lotus, 8d., Burn, 1/9. Jones, 1/9. Low Loss, 8d. Panel, 6 1/2d. Various stocked. **GEARED COIL STANDS.** 2-way, 2/3, 2/6, 2/11 up to 3-way, grand value 5/11. Back panel from 2/11. All ebonite.

IMPORTANT LEADING DISTRIBUTOR OF LESSEN, G.E.C., BURDETT, WEARIE, DUBLIER, EDISON BELL, COSMOS, MUL-LARD, COSSOR, EDISWAN, B.T.H., MARCONI, SPERLING, GANRELL, MAGNUM, EVER-READY, RESISTON, T.O.G., IGRANIC, FERRANTI, LEWCOS, "J.B." BENJAMIN, LOTUS, NEWBY, PYE, G.E. PRECISION, BUREKA, UTILITY, FORMO, BOWYER-LOWE, COLVERN, I.R.L., PEERLESS, ETC., ETC.

WE HAVE THE GOODS!!!
KITS OF PARTS FOR LATEST CIRCUITS AT MARVELLOUS PRICES. QUOTATIONS FREE. STATE REQUIREMENTS.

LEWCOS, BOWYER-LOWE, FINSTON, COLVERN, WATMEL, MAGNUM SCREENED COILS, S.T. VALVES

LOW LOSS SQUARE LAW
#003 and #005 **4/11 each.**
By Post 5/11
1/- extra.

SETS REPAIRED OR RECONSTRUCTED. Nickel W.O. Drilled. Low Charges.

RADIO MICRO (Guaranteed genuine). 3.5-v. .06-a., G.P. 5/11. 1.8-v. .2-a., G.P. 5/11. 1.8-v. .1-a., Power 9/6. 1.8-v. .2-a. 10/6. Post 6d. each (3, 9d.).

ALL CIRCUITS, PARTS, COILS & SETS STOCKED.

AMERICAN CABINETS. Oak, Hinged Lid, Base-board, 8 x 6 x 8, 6/11; 10 x 8 x 8, 7/11; 12 x 8 x 8, 9/-, 10/6 (also extra good quality 14/6). Post 1/6 each. Send for lists.

THE DUNHAM "ALL WAVE" TUNER will enable you to dispense finally with troublesome Vernier coil-holders and sets of coils. It is adaptable to any set already made, and covers all wave lengths from 150 to 2,000 metres, and is complete with reaction. "Allwave" Tuner, 9/6, Complete with full instructions and blue prints.

GIVEN AWAY WEEKLY UNTIL FURTHER NOTICE
2-VALVE SET
SEE WINDOWS FOR PARTICULARS

STOCK TAKING ALL NEW. (Post extra.) **HEADPHONES, 4,000 OHMS.**

BRUNET, genuine - 8/6
TELEFUNKEN, genuine 10/11
Dr. NESPER, non-adj. - 5/11
4" "A.B." good, adj. 6/6
2-VALVE SETS (Tax pd.) 35/-
1-VALVE AMPLIFIERS 12/11
2" D.L.F. - 22/6
S.L.E. '0005, '0003, with Dial - 4/9
MONODIAL H.F.S.P. - 3/-
NON-MICRO VALVE - 1/-
D.R.V. METERS (high & low) - 4/6
H.F. TRANSFORMERS
B Type - 4/9
10 "G.B." LOW SPEAKERS - 8/11
ACCUMULATORS, 2v. 40 6/11 (Few only) 2v. 60 7/11
2v. 06 VALVES (Phillips) 5/9
3.5v. '06 - 5/6

THOUSANDS OF ODDMENTS FOR CALLERS.

X COILS. 60X 2/11; 250X, 4/3. Can be used in all circuits where X Coils needed.

ALL ORMOND PARTS STOCKED.

PRICE LISTS FREE.

BE SURE OF NAME

K. RAYMOND

27 & 28a, LISLE ST., LEICESTER SQ., W.C.2
Nearest Tube, Leicester Sq. Phone: Gerrard 4637
OPEN 9.30-8 p.m. SUNDAY 11-1

THE PERFECT WET H.T.

Assured with our new Insulating Liner, Jars, 1/3 doz. plain, 1/6 doz. waxed; Special Zincs, 1/- doz.; High-Capacity Sacs, 1/6 doz.; Perforated Liners, 4d. doz. Post Free on three dozen and over, including special divided carton suitable as a container. Send for sample complete unit, particulars and instructions. We Stock Seamless Moulded Cone Parts, also the Wonderful Rolls Portable Set.

SPENCERS STORES LTD.,
4-5, MASON'S AVENUE, COLEMAN ST., LONDON, E.C.2
(Nr. Bank.)

BUILD THE SOLODYNE ELSTREE VI MONODIAL ETC.

Easy Terms

SECURES **£1** DOWN

WORTH OF PARTS **£10**

Woolridge Radio Co., Ltd., 26 & 29, Lisle Street, W.

RELIABILITY VERNIER 2-COIL HOLDER

Slide Action.

For Baseboard 3/6 or Panel.

Postage 7d.

Send for FREE Guide Now

J.H. TAYLOR & CO
4-RADIO HOUSE
MACAULAY ST., HUDDERSFIELD

Trade Enquiries Solicited.

21/- H.T. ELIMINATORS with tappings, flex and adaptor with full instructions for use, for D.C. Current, fully guaranteed, 7 days' trial against cash. Postage 1/-.

State mains voltage when ordering.

RADIOMAINS Co., 107, The Grove, Stratford, E.15

SILENT H.T.

"TROMBA" Units give a pure and steady H.T. supply. Work on Leclanché principle. Made in all capacities, in single cells, or complete batteries, new design. Send 3d. stamp for descriptive folders, or 1/- for complete samples of all capacities to

TROMBA ELECTRICAL CO
17, WHITE HART LANE, TOTTENHAM, N.17

OF ALL DEALERS OR DIRECT 6

"P.W." RADIOPHONES TO AMERICA.

(Continued from page 477.)

amount of technical data, which would probably have turned out to be extremely interesting.

Future Possibilities.

However, the fact remains that we have been able to obtain for the first time by Transatlantic Telephony advance details of a new development in Loftin-White Circuits, and to place those details before our readers before any other journal in this country. POPULAR WIRELESS has always endeavoured, regardless of expense, to give its readers the best, and in this case we feel that the very heavy fees which this conversation entailed have been amply justified by the results.

We intend in future to make further use of the Transatlantic Telephone should the occasion demand, and by such means we hope to be able to place before our readers the personal opinions and the latest news regarding the latest developments of technical matters in America days, or weeks, as the case may be, before any other journal in this country.

TECHNICAL NOTES.

(Continued from page 478.)

high-frequency stage amplification 6, second high-frequency stage amplification 6, detector amplification 2, first low-frequency amplification 32, second low-frequency amplification 12. With a Stromberg Carlson set with untuned aerial the amplifications were as follows: First high-frequency stage amplification 10, second high-frequency stage amplification 10, detector amplification 2, first L.F. stage 32, second L.F. 12. The tuned aerial arrangement is considered to give an amplification of 10, so that the total overall amplification with this five-valve set is 768,000 times.

Remember that the amplification obtained from a valve depends not only on the valve characteristics, but also upon the characteristics of the circuit with which it is used, and the high amplification per stage obtained in the five-valve set mentioned above is attributed largely to the use of perfectly balanced shielded circuits.

Amplification and Purity.

It is most important to ensure that the highest amplification—consistent with quality of reproduction and other requirements—should be obtained from each valve, as otherwise it means that an unnecessarily large number of valves is being used where a smaller number could do the work, with consequent reduction in first and upkeep costs.

At the same time, the quest for efficiency in amplification per stage should not be pushed too far, for better quality is often obtainable by distributing the amplification over a number of stages, instead of trying to force the last ounce of amplification from any individual stage. Shielding and proper balancing of circuits are particularly important.

Helix The Condenser.

I see that still another new type of variable condenser has been designed with which it is claimed that spacing between stations is obtainable ten times greater than with the conventional types of condenser.

In this new condenser the rotor and stator are each in the form of a screw or helix. If you have ever seen a metal turner, or, better still, an automatic lathe, turning down the end of a metal job, you will probably have noticed pieces of metal coming off in the form of spiral ribbon—with the ribbon edgewise to the axis. This will give you a rough idea of the way in which the rotor and stator of the new condenser are made. The stator is mounted upon a threaded shaft, the pitch of the thread being the same as the pitch of the convolutions of the rotor and stator. The result is that as the rotor is turned the blades or convolutions gradually enter or mesh with those of the stator, but, of course, without any contact. Consequently it requires several turns of the shaft for complete engagement or disengagement of the rotor and stator.

Accurate Tuning.

Although I spoke of the "blades," there is in reality only one continuous blade or vane in the stator and the same in the

(Continued on next page.)

TUNGSTONE 60 VOLT 3 A.H. HIGH TENSION FOR WIRELESS

NO CRACKLING OR PARASITICAL NOISES ON WIRELESS PHONES OR LOUD SPEAKER. NO FROTHING, FOAMING, HEAT and OTHER TROUBLES

Tungstone (Patented) Tapping-Off Cell-Connector. By means of the Wander Plug supplied free, Tappings can be taken off as required at any two-volt cell, or any varying series of cells.

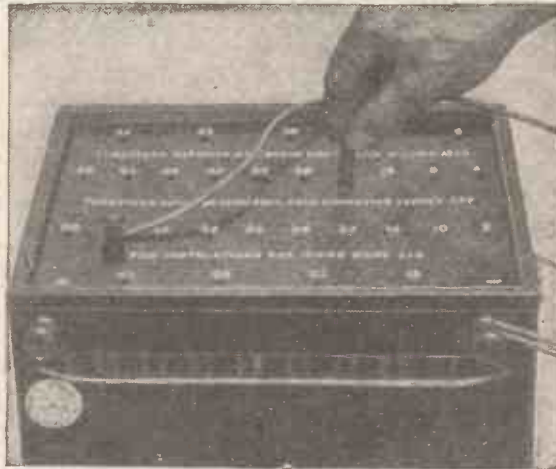

TUNGSTONE 60 Volt 3 A.H. is more efficient than a 100 Volt Dry Battery. Will outlive hundreds of Dry Batteries.

TUNGSTONE at £5 15s. includes a Free first partial charge and a Polished Teak Box, also Glass Filler—only 1/11 a volt for a 3 a.h. Inclusive weight 23 lbs. only. Carriage Paid in U.K. SAVES BUYING A SELECTOR SWITCH COSTING £1-17-6. SAVES COST OF FIRST CHARGE

COMPETITORS sell at 3/3 per volt, including a first charge; also a Selector Switch necessary costing £1 17s. 6d. making total cost of £9 15s.

TUNGSTONE creates a World's record for lowest price, minimum weight (only 23 lbs.) portability, accessibility, compactness, perfect rubber insulation, long periods between re-charges, no self-discharge nor sudden drop of voltage. Ideal for Hot Climates, and can be sent Overseas with Free first partial charge, without acid.

Under normal working conditions the calculated plate life is at least Four Years, and for a 3 or 4 valve set estimated to require recharging about every three months. First FREE charge lasts one month.

TUNGSTONE High Tension 60 Volt Battery 3 a.h. is sold in the United Kingdom on Monthly payments over extended period. Apply for particulars. Further interesting information on points of this advertisement are to be found on pages 58, 59, and 67 of the Illustrated Booklet "Photography tells the Story" which will be sent free on application to the—

TUNGSTONE ACCUMULATOR CO., LTD., St. Bride's House, Salisbury Square, Fleet Street, London, E.C.4.

T.41

GLASS CELLS
for H.T. & L.T. Accumulators

Our New Design, Reg. No. 727, 693.

No. 1, Square. Dia. Hgt. Size 1" x 1" x 3" 2/6 Per Dozen. 24/- gross quantities.

No. 2, Oblong. Dia. Hgt. Size 1" x 2" x 3" 3/- Per Dozen. 30/- gross quantities. Package & Carriage free. Samples sent, 3d. each. Special Trade Terms.

I. ISAACS & CO.,
North London Glass Works, 106, Midland Rd., N.W.1. Estd. 100 years. Phone Museum 4209.

Inside ribs to separate Plates

REPAIRS

to HEADPHONES, LOUDSPEAKERS, TRANSFORMERS, COILS.

First-class workmanship only. This is just the vital difference. We are specialists with almost 30 years' experience in every form of intricate and accurate coil winding, and we guarantee that work entrusted to us will be returned to you as good as new, if not better. This is no idle claim, but the unsolicited opinion of scores of satisfied clients.

THE VARLEY MAGNET COMPANY
(Proprietors: Gitter Pell Control, Ltd.)
BLOOMFIELD ROAD, WOOLWICH, S.E.18.
Telephone: Woolwich 0888.

ALL APPLICATIONS FOR ADVERTISING SPACE IN "POPULAR WIRELESS" MUST BE MADE TO THE SOLE ADVERTISING AGENTS JOHN H. LILE, LTD., 4, LUDGATE CIRCUS, LONDON, E.C.4.

The HOME for your WIRELESS SET

OUR STANDARD CABINETS

are DUSTPROOF and house the whole apparatus, leaving no parts to be interfered with. All you do is

UNLOCK & TUNE IN.

Made on mass production lines, hence the low price. Provision is made to take panel, from 16 by 7 up to 30 by 18 in.

Carriage paid and packed free England and Wales. Thousands supplied with full satisfaction.

MAKERIMPORT Co.
Dept. 5, Melville Chambers, 30a, Lord St., LIVERPOOL.



From £4 15 0. Write to-day for descriptive pamphlet and suggestions for adapting your receiver or panel in our Standard Cabinet. Immediate Delivery.

H.T. POROUS POTS, JARS SACS

The Pioneers of the Square Glass Jar are now manufacturing a Porous Pot, highly efficient, size 2 in. by 1 in., guaranteed filling. Non-conductive Jars, Sacs, Zincs, Terminals, Enamels, Wax Cases, Rubber Rings. Everything for Wet H.T. in Stock. Prices (per doz.): Jars, 1/4 to 2/1; Porous Pots (filled), 3/-; Zincs, 10d. to 1/6; Sacs, 1/3 to 3/4, etc. All sizes. Non-solder Zinc connectors a speciality. Send 1/4 stamp for Price List and Instructions. Carriage and Packing extra.—**BGM/NOTE, W1, or THE ETON GLASS BATTERY CO., 46, ST. MARY'S ROAD, E.10., the actual makers.**

THE WORLD'S BEST OSCILLATION DETECTOR
Best Value. Best Results
3/6 each. Post Free.

THETA, 256, Brearley St., BIRMINGHAM.



PLEASE be sure to mention "POPULAR WIRELESS" when communicating with Advertisers. THANKS!

Radiodomies

the most handsome and up-to-date terminal indicators. Keep terminals tight. All windings. Ask your dealer for them or write for list

MONEY HICKS & MILLS
2, Gray's Inn Road, W.C.1 and Wimbledon: Rd. Dn. 7169



Only 2d. each

AMPLIFIERS: 1-VALVE, 10/-; 2-VALVE, 30/-
2-Valve All-Station Set, £4. Approval willingly. Wet H.T. Batteries—Jars, Zincs and Sacs complete, 3/6 per doz. (18 volts). Post 9d. extra. Sample 6d. 3 doz. upwards post free, in divided cartons. Bargain List Free.

P. Taylor, 57, Studley Rd., Stockwell, London.

REMARKABLE OFFER ENGLISH DULL EMITTER VALVES

5/- each. All one price 5/-. All guaranteed.

(Uncle Tom) PAYNE & HORNSBY, LTD.,
Roker Av., SUNDERLAND, Camden St., NORTH SHIELDS, 10, Queen Victoria St., LEEDS. Gallowgate, NEWCASTLE-ON-TYNE. (All postal orders to Newcastle, Dept. 2.) 3d extra per valve for postage must be included.

TRANSFORMERS REWOUND

Transformers, Phones, Loud Speakers repaired to maximum efficiency. All one price, 4/- post free. A 12 months' guarantee accompanies each repair. Your transformer can also be rewound to multi-ratio type. Write giving particulars. Trade invited.

REPAIRS, 115, LINKS ROAD, Tooting, LONDON, S.W. 17

TECHNICAL NOTES.

(Continued from previous page.)

rotor, and these gradually feeding the one into the other, produce what is claimed to be the most sensitive and minute variation of capacity that has ever been obtained with a wireless variable condenser. The condenser is appropriately called the "Helicon," the name presumably being derived from the two words "helix" and "condenser." It is calculated that a point on the edge of an ordinary dial of about 4 in. diameter moves through a total linear distance of about 6 1/4 in. when tuning from maximum to minimum capacity. With this new condenser, however, and the multiple revolution dial, it is calculated that a point on the dial moves through a total of 62 1/2 in., or more than 5 feet, whilst the condenser capacity is varied from maximum to minimum. A special 4-in. dial is provided with a sliding indicator which not only records the total number of revolutions of the dial, but also the position in each revolution.

I do not know how this condenser is manufactured, but I imagine it must be die-cast, and it would certainly appear to represent an interesting and important development in variable condensers for wireless receivers.

Soldering Hints.

Often you will find difficulty in reaching obscure corners by means of the ordinary soldering iron. A simple way to overcome this difficulty is to make an extension to the soldering iron in the shape of a small copper tip. This is conveniently done by taking a length of a few inches of stout bare copper wire, say No. 10 to No. 14 gauge, and winding it tightly around the copper "bit" of the soldering iron, the consecutive turns of wire being in contact with one another, finishing with a short projection, say, 1/4 in. to 1/2 in. beyond the tip of the soldering iron itself. The iron is then heated in the usual way, and, of course, the heat is stored in the soldering iron as before, but is communicated to the wrapping of copper wire and travels along the extended tip. This arrangement, however, is only useful for very tiny work, and you will find that if you try to use it for a job which is too large the heat will not be conducted along the extended piece of the copper wire rapidly enough. For very small work, however, the arrangement is quite a practical one, and if the end of the copper wire is sharpened to a point, little soldering jobs can be done in this way which would be practically impossible with the tip of the soldering iron itself.

PIRTOID TUBES

Do you want to know where to obtain the above, so much recommended by the Radio Technical Experts for making your Solenoid Coils, H.F. Transformers, etc.?

Why! from the actual manufacturers: **H. CLARKE & CO. (McR.) LTD.,** Insulation Specialists and Radio Engineers, Atlas Works, Old Trafford, Manchester.

GRAVES

2-VALVE LOUD SPEAKER BARGAIN.

10/6 NOW



This highly efficient 2-Valve Loud-Speaker Set is the finest wireless value ever offered.

It gives a volume and quality of tone unattained by any instrument of a similar price, and is the essence of simplicity. Fitted with coils covering all the British wave-lengths, including Daventry.

THE CABINET is of beautifully polished Oak, & all components are of the highest quality. Dull Emitter Valves with patent valve holders, &c.; H.T. Battery, 2-volt accumulator and complete Aerial Outfit. **LOUD SPEAKER** of exclusive design with unique magnetic system and improved mica diaphragm. Price **£7:17:6**

TERMS: Our Bargain Price is for deferred payments. Send 10/6 now, & complete purchase in 14 monthly payments of 10/6. If you wish to pay cash, 5 percent discount is allowed. Catalogue Post Free. Up-to-date Crystal & Valve sets at keenest prices.

J. C. Graves Ltd. Sheffield

of proved efficiency



Fulltest Approval

WHEN replying to advertisements please mention "Popular Wireless" to ensure prompt attention. THANKS!

KATHANODE

for better wireless reception



GREAT BRITISH RADIO AMALGAMATION To help every Wireless Amateur

The amalgamation of R.I. Ltd. and the wireless section of the Varley Magnet Company marks a tremendous advance in radio in this country. Here we have two firms, both with extensive experience in the design and manufacture of radio products, joining forces to supplement and improve existing design, to afford each other unlimited use of their Patents and Rights, and to utilise to the best advantage, either collectively or individually, manufacturing processes of both firms.

Those who have used the famous Varley Bi-duplex Wire-wound Anode Resistances and H.F. Chokes will realise the tremendous advantages to be gained by the extension of this wonderful winding to wireless products made by the combined firms.

Again, R.I. Ltd. have specialised in L.F. Transformer Coupled circuits, Varley in Resistance Capacity Coupling; so that wireless amateurs will get the very best in L.F. amplifiers whether they be transformer or resistance capacity coupled. Extensive research in L.F. amplification has resulted in a wonderful new product which will undoubtedly revolutionize radio.

Then consider for a moment the existing R.I. and Varley H.F. Chokes—the unique advantages of both designs will now be incorporated in the new R.I. and Varley H.F. Choke, which is far and away superior to any on the market to-day.

The close co-operation in every detail between two firms with such wide experience will immensely improve radio reception, and be a real help to wireless amateurs.

The growing popularity of modern valves with their exacting drain on the H.T. Battery has made an H.T. Eliminator almost essential. Here again previous experience enables us to market the cheapest and most efficient unit available to-day.

The super-excellence of R.I. and Varley products will bear the stamp of the combined resources of the technical and manufacturing specialists of two firms, a large number of whose staff can claim over twenty years' experience in electrical and radio engineering.



Kingsway House,

103, Kingsway, W.C.2.

THE DIFFERENCE!

In this photograph the matched electrode construction of the P.M.6 is disclosed with the anode displaced. Note the great length of the wonderful P.M. Filament.

The grids illustrated give a striking example of the matched electrode system in the case of only two of the series of Mullard P.M. Valves.

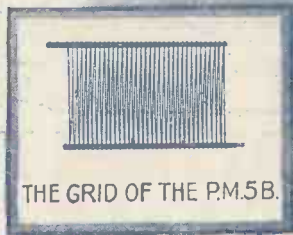

THE GRID OF THE P.M.5B.

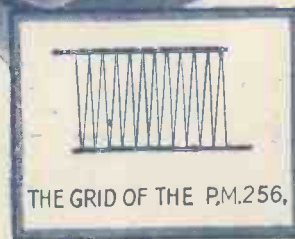

THE GRID OF THE P.M.256.

MATCHED ELECTRODES

combined with the wonderful P.M. FILAMENT

MORE than a supreme filament in Mullard P.M. Valves . . . more than a master filament that has set a new standard for long life, toughness, economy and power . . . the wonderful P.M. Filament . . .

A system of matched electrodes, designed by Mullard Engineers to produce unequalled performance in every type of valve operation by completely utilising the vast energy of this master P.M. Filament to the best advantage in each case.

The result of this special P.M. construction and design is that a series of P.M. Valves has been produced from which, no matter what type of circuit you employ, positively pure and powerful amplification is assured from the first to the last stage, culminating in a final reproduction that is a delight and a revelation.

Consult your radio dealer to-day about the correct Mullard P.M. Valves for your receiver.

Mullard

THE MASTER VALVE

For 2-volt accumulator

P.M.1 H.F.	0.1 amp. 14/-
P.M.1 L.F.	0.1 amp. 14/-
P.M.1A	
(Resist. Capacity)	0.1 amp. 14/-
P.M.2 (Power)	0.15 amp. 18/6

For 4-volt accumulator or 3 dry cells

P.M.3 (General Purpose)	0.1 amp. 14/-
P.M.3A (Resist. Capacity)	0.1 amp. 14/-
P.M.4 (Power)	0.1 amp. 18/6

For 6-volt accumulator or 4 dry cells

P.M.5X (General Purpose)	0.1 amp. 14/-
P.M.5B (Resist. Capacity)	0.1 amp. 14/-
P.M.6 (Power)	0.1 amp. 18/6

Super power valves for last L.F. Stage

P.M.254	(4 volts, 0.25 amp.) 22/6
P.M.256	(6 volts, 0.25 amp.) 22/6

ADVT. THE MULLARD WIRELESS SERVICE CO. LTD., MULLARD HOUSE, DENMARK STREET, W.C.2