

MAKING A CRYSTAL SET: P.W.'S PHOTOGRAPHIC GUIDE.

POPULAR WIRELESS

No. 171. Vol. VIII.
September 5th, 1925.

and Wireless Review

PRICE 3d.
EVERY THURSDAY.

Scientific Adviser: SIR OLIVER LODGE, F.R.S., D.Sc.

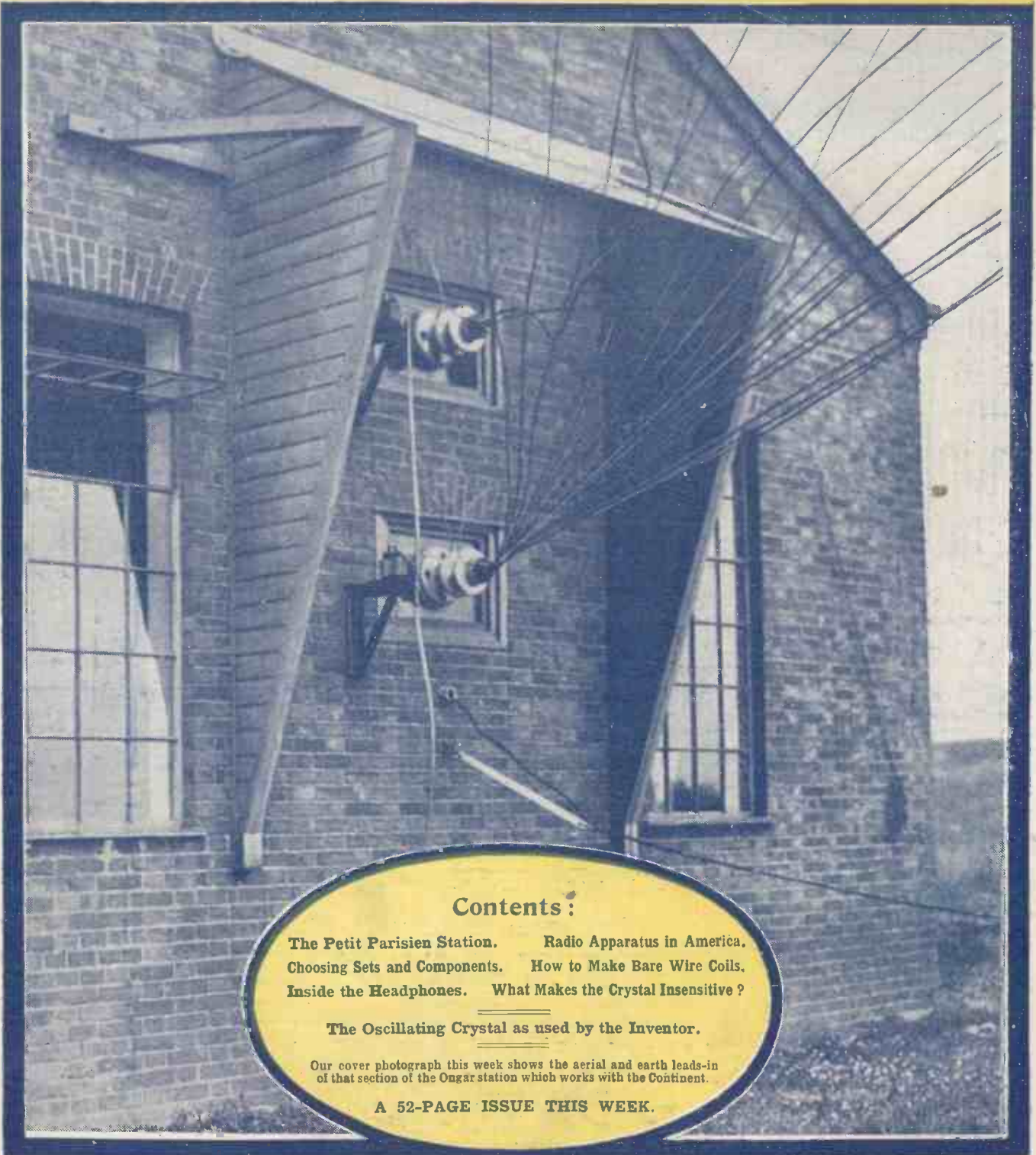

Contents:

The Petit Parisien Station. Radio Apparatus in America.
 Choosing Sets and Components. How to Make Bare Wire Coils.
 Inside the Headphones. What Makes the Crystal Insensitive?

The Oscillating Crystal as used by the Inventor.

Our cover photograph this week shows the aerial and earth leads-in of that section of the Ongar station which works with the Continent.

A 52-PAGE ISSUE THIS WEEK.

Give your Loudspeaker the Best—



A Good Loudspeaker

can be spoilt by the use of inferior valves.
End extravagant power consumption
and weak results by getting
real loudspeaker valves.

MULLARD Double Green Ring
Valves only require 3 amps. at 2 volts ;
give increased volume ; reduce current.

Accumulators last twice as long.

For still greater volume use—

MULLARD D.F.A. Master Valves
fullest capacity without distortion—ask
your dealer.

Loudspeaker Valves

- Mullard L.F. Double Green Ring Valves
- Type D.3 for 2 volt accumulators - 14/-
- Type D.06 for (2 or 3 dry cells or 4
volt accumulators) - - - 16/6
- Mullard D.F.A.0 - - - 22/6
(for 4 volt accumulators)
- Mullard D.F.A.1 - - - 22/6
(for 6 volt accumulators)
- Mullard D.F.A.3 - - - 24/6
(for 6 volt dry cells or accumulators)

NOTE—The D.06 and D.F.A.3 take only 60 milli-
amperes filament current. Ask for leaflet V.R.25

Mullard

THE MASTER VALVE



Our Business.

Because we value our reputation, and because we take a genuine pride in our manufactures apart from their function as profit-makers, we are always exerting ourselves to the utmost to maintain the high standard that it has always been our aim to achieve. For this reason, therefore, the two words—"Specify Dubilier"—are buttressed by all the moral weight and all the material resources of the world's largest Condenser Manufacturing Firm. A Dubilier Guarantee is a genuine guarantee, and a Dubilier Product is the best of its kind.

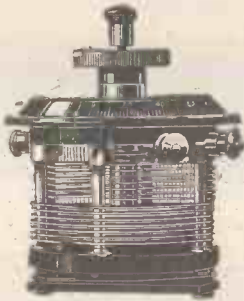

The Double Vanicon.

A Dubilier Variable Condenser giving simultaneous control of two tuned anode circuits. This is a very useful condenser to the experimenter. Capacity of each side 0.00025 mfd. complete with balancing plate

Price 25/6

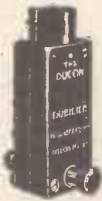

The Ducon.

An aerial adaptor made by Dubilier, it is inserted in an electric lamp socket and connected to your set, thus converting your wiring system into an aerial and doing away with outside aerials.

Price 10/-



The Dubrescon.

A new Dubilier device that protects valves from being burnt out by insertion in the holder the wrong way round. Connected in an H.T. lead it is a permanent protection, and is not a fuse.

Price 6/-



The Minicap.

A Dubilier Anti-Capacity Switch for use in all types of receiving circuits for switching in and out Valves, Transformers, Series-parallel switching, etc. Soundly made and thoroughly reliable, it is strongly recommended.

Price 8/-



Anode Resistances and Grid Leaks.

These Dubilier resistances are very carefully made and graded; they can be relied upon to maintain their values indefinitely and are tested on 200 volts D.C. and 100 volts D.C. respectively.

N.B.—They must not be tested at higher voltages.

Anode Resistances, 20,000—100,000 ohms.

Complete with holder 5/6
Grid Leaks 0.5—5 megohms 2/6

The Dubilier Condenser Company (1925) Ltd., manufactures:—

Fixed Mica Condensers—Types 577, 600, 600a, 610 and 620.

Vanicon Variable Condensers—the Vanicon, the Double Vanicon, the Duwatcon and the Vanicon Square Law.

Anode Resistances and Grid Leaks, the Ducon, the Minicap Switch, the Mansbridge Variometer and the Dubrescon.

Specify Dubilier.

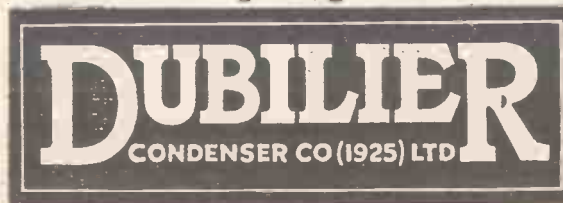

Type 577 Mica Condens. rs.

A very good quality condenser for use everywhere in wireless receiving sets. This condenser is supplied in a polished metal case, and is provided with tags for soldering. It can also be supplied with flexible wire leads if required. All capacities from 0.0001 mfd. to 0.01 mfd.

Price 7/6

130 HOURS OF BROADCASTING INSTEAD OF 17



This advertisement is directed particularly towards those tens of thousands of wireless enthusiasts who are still continuing to use bright emitter valves. Now that the wonderful Wuncell Valve has been reduced to 14/- there can be only two reasons why a man persists in using a bright emitter. He must do it either because he has never appreciated the tremendous economy that can be effected with Wuncells or else because he believes that not even Cossor can produce a dull emitter as good as the Cossor Bright Emitter. Here's our reply to both of these points.

The average bright emitter has a current consumption of .75 amp.—a three-valve set consuming, therefore, about 2.25 amps. A six-volt 40 amp. hrs. accumulator for this set would last about 17 hours on a charge. Now substitute three Wuncells and see how many more hours you will get. The Wuncell works best at 1.8 volts and consumes .3 amps. If the cells of the same accumulator are connected in parallel to give two volts its capacity will be 120 amp. hrs. Thus, with the three Wuncells consuming in all .9 amp., and an accumulator with its capacity practically tripled, no fewer than 130 hours of broadcasting can be enjoyed without re-charging. See how much Wuncells will save you in your own case—you will be astonished at the money you have wasted during the past few months.

But there are still those who assume that all dull emitters are inferior in efficiency to bright emitters—they think that not even the Wuncell can be as good as the Cossor P1 or P2. To these we say that the Wuncell is unique among valves. Owing to its special filament—the like of which is not to be found in any other valve—it is responsible for music and speech reproduction of rare beauty and mellowness. While the Cossor design permits practically the whole of the electron stream being used to obtain extreme sensitivity to weak signals. Take our word for it—the Wuncell is emphatically the equal of the Cossor Bright Emitter in every respect.

Eventually you'll use dull emitters—why not try out the Wuncell now and start saving money in accumulator re-charging from to-day?

Cossor Valves

"Cost less to run—and last longer"

Popular Wireless

Scientific Adviser:
Sir OLIVER LODGE,
F.R.S.
Consultants:
Dr. J. H. T. ROBERTS
F.Inst.P.
J.F. CORRIGAN, M.Sc.
C. E. FIELD, B.S.

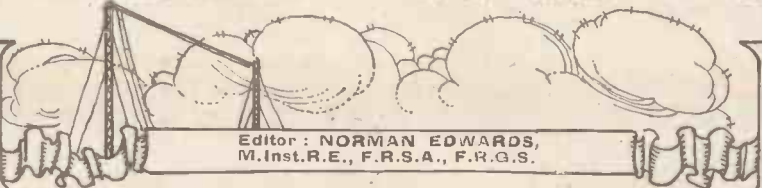

Technical Editor:
G. V. DOWDING
Grad.I.E.E.
Assistant Technical
Editors:
K. D. ROGERS
P. R. BIRD

Editor: NORMAN EDWARDS,
M.Inst.R.E., F.R.S.A., F.R.G.S.

The Radio Weekly with the largest Circulation

RADIO NOTES AND NEWS.

Our New York Correspondent—2 N M's Triumphs—Channel Swimmer and Radio—The Winter Zest—Long Distance Plans—The Radio Revel—The Concert Industry and the B.B.C.

The Duke of Sutherland's Broadcast.

GREAT interest has been aroused in America by the announcement that the Duke of Sutherland has consented to open the Radio Exposition in New York, by means of radio from London. The Exposition is being held at the Grand Central Palace on September 12th. The authorities there will receive and re-broadcast the Duke's speech, the transmission of which is now being arranged on this side by the Radio Association.

Our New York Correspondent.

ON the other hand, British listeners need never be surprised to hear "P.W." speaking from America now, for the U.S.A. broadcasting authorities are decidedly partial to the idea, which makes for good understanding between the two countries. As a matter of fact, they appreciate the compliment paid by this journal in having a special correspondent resident in New York to keep readers in touch with American developments. And when our representative is broadcasting from any of their stations he is introduced as "Mr. Lawrence W. Corbett, New York Representative of POPULAR WIRELESS, London, England." I shall always be glad to hear from any reader tuning-in one of these talks.

Programme Ballots.

WHAT kind of programmes do the public really want? Admittedly this is a very difficult question to answer, but the scheme put forward by a South Shields reader of POPULAR WIRELESS presents an ingenious solution to the problem. Briefly stated, his idea is that each application form for a licence should be a kind of ballot paper also, on which every

listener, as he pays his fee, can vote for the class of entertainment that he prefers. It could be arranged in several ways, such as a cross against one or more items, or a blank space to write remarks in; but, in any case, each licence-holder would feel he had a choice in the programmes he had purchased. The extra cost would be negligible, and I pass on the idea to the authorities as one worthy of their very careful consideration.

Channel Swimmer and Radio.

THE recent attempt to swim the Channel, by the plucky American girl swimmer, Miss Ederle, was reported by radio. On the tug which accompanied her was installed a small spark transmitter, which enabled a reporter on board to keep in touch with the coast stations by wireless.

His messages were relayed to London and then dispatched by radio to New York. Readers of newspapers in Canada and the U.S.A. were thus appraised of her progress hour by hour—and incidentally listeners who could read Morse were doubtless overhearing the messages in the Dover district, and "watching" the Channel swim by wireless.

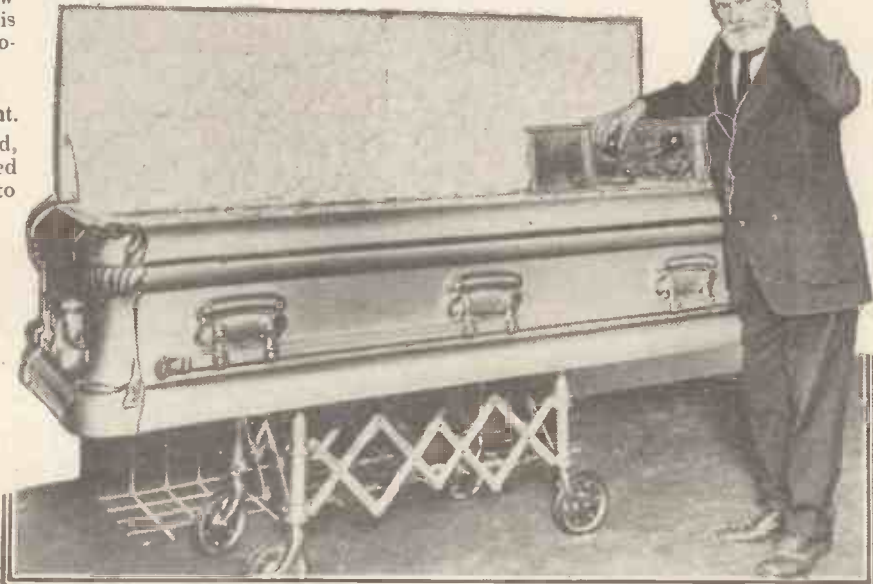

Mr. Kimball is 79 years old. He is an American with a \$1,200 steel coffin installed with a radio set. When he is laid to rest he hopes "to keep in touch with things mundane." He is seen here beside his coffin, testing his radio set.

A Coincidence.

A CURIOUS coincidence of the ether is related by Mr. F. Mayer, whose station, 2 L Z, is situated at Wickford, Essex. In response to a C Q (all stations) call, on 45 metres, he was answered by the

2 N M's Triumphs.

MR. GERALD MARCUSE, of Caterham, better known "on the air" as 2 N M—tells me that since his remarkable record of communicating with a ship at sea by telephony over a distance of 12,000 miles, he has scored another daylight-talk triumph.

This time he has been having a little chat with Mosul, in Irak, using the same apparatus as before, which is rated at 400 watts.

The wave-length used was 54 metres, and the distance—mostly overland in this instance—is approximately 2,050 nautical miles!

American warship "Seattle," which was lying in Wellington Harbour (New Zealand). After the usual compliments, Mr. Mayer asked the American if he could pass on a message to that well-known Antipodean amateur transmitter, Mr. O'Meara, of Gisborne (from whom Mr. Mayer had taken a message a few days before).

The American vessel's operator agreed, and explained that it would not be necessary for him to forward the message as Mr. O'Meara was actually on board the "Seattle" for the purpose of inspecting her wireless equipment! I think readers will agree that is a curious case of coincidence.

(Continued on page 36.)

NOTES AND NEWS.

(Continued from page 35.)

Radio in China.

RECENT troubles in China have taken such a serious turn that I suspect "Least said, soonest mended," is the best way to deal with wireless developments there. But I have just received a letter which evidently escaped the censor, and though I have decided to suppress most of the information given, the following extract will interest all long-distance listeners. "The Chilean amateur, I E G, is received here every evening (distance 11,000 miles) on 38 metres. We find POPULAR WIRELESS very helpful and instructive, and my circuit is a modification of that used by Mr. Cyril Goyder, of Mill Hill School, described in one of your articles some time ago."

The Winter Zest.

IT is at this time of the year that I begin to open my letters from readers with renewed zest. For the cool evenings and shorter days are turning thoughts more and more towards plans for winter wireless. And the long-distance reception reports are already coming in. The most startling success in this week's mail is claimed by Mr. E. Harris, 2, Arthur Street, Newport, Mon. Noticing the recent reports of one-valve Unidyne reception, he writes an outline of his experiences with a two-valve set.

Johannesburg Received.

MR. E. HARRIS says: "I have had a two-valve set since January, and have had splendid results. All B.B.C. stations, and many continentals, but my best was *Johannesburg!*" He goes on to say that the South African station was tuned-in upon an aerial which is only 15 ft. high at the lead-in end, the aerial sloping downwards to the free end, which is only about 12 ft. from the ground. It will be interesting to discover if other readers in the Newport, Mon., district have experienced exceptional D X (long distance) results with the Unidyne, and if so the kind of aerial used.

Nottingham Exhibition.

NOTTINGHAM'S second wireless exhibition is being held from September 19th to September 26th this year, and I hear that the excitement has already commenced. As is well known, Nottingham has taken to radio with special gusto, and it is an open secret that several of the "main" stations would have liked to equal the records set up by 5 N G, which is only a relay station. A special feature of the exhibition will be a Constructors Competition, at which POPULAR WIRELESS is presenting two silver cups. At the moment of writing details are not fixed, so they will be announced later. But it is already clear that Nottingham's second radio show is going to be a great success.

Radio in Bournemouth.

WHAT is the matter with broadcasting in Bournemouth? Staying there recently for a short holiday, I was surprised to notice that whilst visitors to the town seemed keenly interested in wire-

less, the residents appeared to be extremely apathetic. There are no crowds round the radio shop windows (as in most "B.B.C. towns"), but yet the visitors seemed to be enthusiasts. For instance, I saw one charabanc unload in the town, and two of the passengers—with only a few hours to stay—walked straight over to a wireless shop window, and spent half of their seaside time inspecting variometers. It is true that the popular motor-boat trips advertise "Wireless Concerts Aboard," but the appreciative passengers all appeared to be holiday-makers, and not townspeople. Wake up, Bournemouth!

SHORT WAVES.

"People are pining for wireless humour."—Mr. George Grossmith (writing in the "Radio Times").

"The B.B.C. has done its pioneer work well, and not the least of its achievements has been the admission from wireless experts in the U.S.A. that this country possesses the model of what a broadcasting service should be."—"Yorkshire Post."

"Radio broadcasting is only three years old, yet the radio industry is the sixth largest in America, and equals the automobile industry. The sales in America alone this year will be at least £100,000,000."—Mr. Wm. Dubilier (writing in the "Leicester Illustrated Chronicle").

(Apropos of the appointment of the Broadcasting Committee, the question of a patron saint for wireless is being discussed.)

They want a saint for wireless?

I hope they'll get one soon!

The need for one occurred to me

On Sunday afternoon.

I have a two-valve set, sir,

And am not one to shirk;

Three hours I spent upon the thing,

But could not make it work.

They seek a saint for wireless?

By gad, the news is fine!

Here's luck to them! for I know this:

It needs a saint for mine!

—W. H. B. (writing in the "Morning Post").

"Remember, above all things, that in nearly all cases 'another little valve wouldn't do you any harm'; then you needn't oscillate, and your sister, or your mother, or anyone with no technical knowledge at all will be able to turn it all on and listen—dare it be whispered?—for one night in peace!"—Capt. Eckersley (writing in "Lloyd's Sunday News").

Accumulator Charging.

A WRITER in the well-known trade journal "Electrical Industries" has been investigating the figures for accumulator charging—a subject of perennial interest to listeners. Working out the cost from the dealers' point of view, and allowing ample for first cost and depreciation, he arrives at the following conclusion:

"A charge, therefore, of one shilling per battery of six volts 40 ampere hours would give a clear profit of fifty per cent on the outlay, and the figure of twopence per volt on batteries of this size is thus a fair one. Other sizes should be priced pro rata; that is to say, a penny per volt for 20-ampere-hour batteries and threepence per volt for 60-ampere-hour batteries."

Leeds Sub-Station.

FOR the improvement of simultaneous broadcasting, the new sub-relay station at Leeds is being rapidly completed, and it will probably be in operation by the end of next week, or the week after. The idea underlying the sub-relay station is to shorten the landlines used for S.B.

work. Instead of the distant stations all plugging-in to London by separate lines, as at present, there will be a convergence of the lines upon the centrally-situated sub-relay.

London's programme will therefore be "on tap" permanently at Leeds, where it will be specially amplified and purified for the benefit of the northern stations. If Scotland, Manchester, Sheffield, or the other stations concerned are taking 2-L O's programme, they will not use the expensive and inefficient method of separate lines, but will plug-in at Leeds for London.

Long-Distance Plans.

SEPTEMBER is likely to prove an important month to listeners, for during the next few weeks the B.B.C.'s long-distance plans will come to maturity. The Kentish listening-post at Hayes is now equipped to reach out for the foreign programmes, and it will be diverting to discover how many stations abroad can be tuned-in regularly by the B.B.C.

All the programmes that are received with sufficient clarity can be put on the air immediately by 5 X X, so that for Britain the international broadcasting era may be said to have commenced this month. If all goes well we shall be having regular foreign and Dominion programmes to choose from very shortly.

The Radio Revel.

THE great Radio Revel, originally announced to take place shortly in the Albert Hall, has now been postponed until December 15th. Accommodation will be provided in the main ballroom at Olympia, where it is estimated that 5,000 people can attend the Revel in comfort.

Listeners will be able to meet popular radio stars in the flesh, and several of the best bands in the country have been engaged to provide the dance music. In other parts of the country similar arrangements are being made in connection with the various B.B.C. stations, and the proceeds will be devoted to the wireless equipment of hospitals.

The Concert Industry and the B.B.C.

THE heads of the concert industry are still very cross about broadcasting, which, by taking entertainment direct into the home, has deflected many a crisp banknote from their box-offices. Most of the eminent concert artistes cannot sing before the microphone until an agreement with the B.B.C. is made, similar to that arranged recently with the theatres.

But there is little hope of such a settlement at present. All the proposals put forward by the B.B.C. are promptly turned down; but listeners can afford to wait patiently, for the artiste's need of a public is greater than the public's need of the artiste.

America on One Valve.

THOUSANDS of listeners have already accomplished the above feat, and it will be much easier this year, for several transatlantic stations have increased their power greatly. The most interesting alteration has taken place at the Schenectady station (W G Y) which has now been rebuilt as a super-broadcasting station, with a power rated about three times as high as that employed by 5 X X.

ARIEL.

THE CHOICE OF SETS AND COMPONENTS

(Continued from page 37.)

if not, use a substantial earth clip, and subject it to a periodical inspection and cleaning.

If you employ a natural earth, see that it is in damp soil and at least eighteen inches below the surface. In exceptionally dry weather, water the earth plate copiously with water in which rock salt has been dissolved. Connections to earth plates should be soldered in several places, and the joints protected with a thick coat of paint, but confine the painting process to the joints.

An excellent earth plate can be made up from about 3 yards of ordinary galvanised netting about 18 inches wide. Fold the netting to make a square mat and then lace it from edge to centre in about 6 or 8 places with tinned copper wire, soldering the wire to the netting in several places. Solder the earth wire to the intersection of the lacing wires and protect all soldered joints with paint. Bury the mat at least eighteen inches below the surface.

If you are troubled with interference from earth currents due to local electric rail or tramways, use a counterpoise earth, consisting of four or more wires stretched below the aerial about eighteen inches apart and at about eight feet from the ground, these wires being insulated carefully at both ends.

Concerning Indoor Aerials.

In erecting your aerial secure a light line to the last insulator in addition to the halyard, and let this pass over the pulley block and be secured at the lower end with sufficient slack to allow the aerial to drop to the ground in case of the halyard breaking. This permits of fitting a new halyard without climbing or unstepping the mast.

If you attempt short-wave reception, take care that the aerial is sufficiently taut to keep it from swaying and altering its natural wave-length. This can be ensured by the provision of a counterweight at the far end of the aerial.

If you use rope halyards or guys, remember that a rope tightened on a bright day will shorten considerably with the inevitable rain, and may snap. It is better to use covered steel cable or Electron wire for these purposes. Grease your pulley blocks well before erection.

Make your aerial as high as possible. An additional ten feet on the height of your aerial is often nearly equivalent to the addition of a valve to your set.

If you are in the unfortunate position of being compelled to use an indoor aerial, put this as high in the house as possible. Twenty feet of wire in the loft is worth more than a considerably greater length on the ground floor. The best form that the aerial can take is a single wire stretched the full length of the house, and supported in such a position as to be at least a foot clear of all tiles and beams or rafters. The ends of this aerial need as careful insulation as the corresponding ends of an outdoor aerial.

If an aerial in the loft is impossible, good results can be obtained from four or more parallel wires about 18 inches apart

stretched across the room and insulated at their ends, a leading-in wire being taken from the same end of each wire, and these leading-in wires joined near the aerial terminal of the set. Frame aerials may be used in exceptional circumstances, but must not be expected to give the same results as a good outdoor aerial.

One is constantly reading of astonishing results being obtained from crude aerial systems, but it must be remembered that these results are *really* astonishing, and not to be expected, and that in every case better results would have been obtained with a well-designed aerial. Therefore, it is well worth while to spend a little care and forethought on the installation of your aerial system.

Choice of Circuits.

The final choice of a set or circuit is determined by the finances, ambitions, and qualifications of the amateur; but in every case it is true economy to think ahead before coming to a decision. Your ambitions and qualifications will grow with

with a loose-coupled circuit, and this type, by virtue of its greater selectivity, will have a special appeal to seaside dwellers and others residing in districts where interference from short-wave Morse stations is experienced.

Improving Reflex Circuits.

If you have limited finances but boundless ambitions, you should choose either a "straight" 3-valve set with reaction (1-v-1), or a 2-valve reflex circuit. If you choose the latter, arrange your set so that you can obtain reaction effects between the aerial and anode circuits, as this will be found of great advantage on distant reception, and will also sharpen the tuning on your local station. In many reflex circuits the secondary of the reflexing L.F. transformer is connected between the earth terminal and L.T. This means that the H.T. and L.T. batteries, the valve filament circuits, and the loud speaker or 'phones are at a varying potential with relation to the earth, and may cause the set to scream if the 'phones or loud speaker



One of the operators at work in the wireless cabin of the R.M.S. "Chitral," the new P. & O. liner.

your experience of radio reception, and you should therefore consider the adaptability of the set or components purchased.

If you desire only to receive your local station well, you will probably choose a crystal set, with the possible addition of note magnifiers for loud-speaker working. In this case the writer would advise a well-made variometer set, but would caution purchasers against the cardboard tube atrocities frequently sold under this name.

Variometers and Loose-Couplers.

With a cardboard tube variometer, the coupling between the fixed and moving windings is necessarily very loose, thus limiting the range of wave-lengths obtained, whilst the mechanical design of these components leaves much to be desired, particularly in the attachment of the moving element to the spindle and in the arrangement of the connections to the moving winding.

If the owner is prepared to spend a little more time and care on the adjustment of his set, excellent results can be obtained

are connected to the set by long extension wires; while it will almost certainly cause loss of signal strength if there is any leakage between the batteries and earth.

This fault can be partially removed by increasing the value of the by-pass condenser connected across the secondary, or can be entirely removed without sacrifice of signal strength by modifying the connections, as shown in the diagram (Fig. 1). Reflex receivers are admirably adapted for economical reception of local stations, and occasional reception of distant stations, but the writer has a distinct preference for the straight type of circuit, which provides more flexibility and sensitivity in the hands of the skilled operator.

Reflex receivers incorporating a crystal as detector introduce particularly heavy damping in the anode circuit of the first valve, and thus render the tuning very blunt. This can be remedied to a certain extent by tapping the anode coil (or the secondary of the anode H.F. transformer) at approximately its middle point, and

(Continued on page 79.)



By OSWALD J. RANKIN.

THE apparatus to be described was designed to be used in conjunction with other experimental apparatus as a convenient and effective means of varying the values of grid leaks and condensers in rectifying circuits, changing over from fixed to variable grid leak or vice versa, and placing either type of leak across

As will be seen from the diagram (Fig. 1), the system employed is extremely simple and easily arranged as a separate cabinet unit, with four terminals for making the necessary circuit connections. The plug A engages the two sockets which are joined to the upper ends of the fixed and variable grid leaks, F and V, and the plug B engages the three sockets marked "P" (parallel), "negative," and "positive." Thus it is possible to place either leak in parallel with the grid condenser, G C, or to give either leak a negative [or positive] potential, according to requirements, by simply adjusting the plug B, and to change over from the fixed to the variable leak by means of the plug A when making final adjustments.

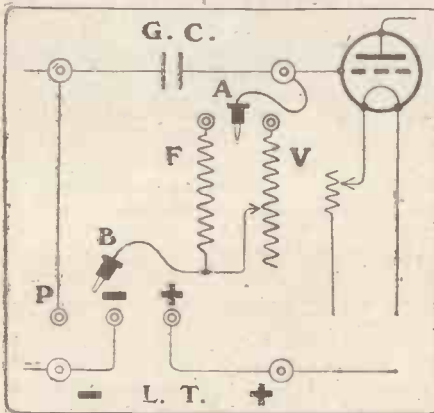

Fig. 1.—The circuit diagram of the device.

the grid condenser or to negative or positive L.T. as desired, and as such it has proved to be highly successful. The idea is embodied in an experimental system yet to be described, but owing to its great utility, and since many readers may only be interested in small cabinet components, it is thought that a description of the device as a self-contained unit may be helpful.

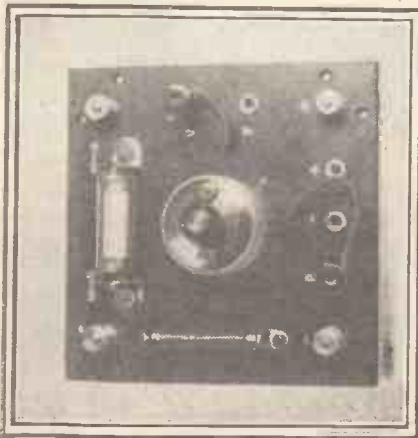

Fig. 2.—The panel "lay-out."

The Parts Required.

To construct the unit the following materials and parts will be required: A $\frac{1}{8}$ in. ebonite panel $4\frac{1}{2}$ in. square; a suitable cabinet for same; four terminals; one .0003 and one .00025 mfd. fixed condenser (Wates "K" type); one 1-megohm and one 2-megohms fixed grid leak with clips; a Watmel variable leak; five sockets (flush type); two plugs with flexible leads; and some odd lengths of bus bar connecting wire.

The front and back views of the panel are shown in Figs. 2 and 3 respectively, where the panel lay-out and wiring arrangement is clearly outlined. The diagram, Fig. 1, may be taken as a guide for wiring up the panel, this showing all connections as viewed from the front of the panel in Fig. 2. The transfers are attached as shown to correspond with the marking in Fig. 1. Arrows can be seen against the two top terminals, and indicate the position of the panel in circuit on the experimental bench, the left-hand terminal being connected to the A.T.I. or plate of the H.F. valve, as the case may be, and the right-hand terminal to the grid of the rectifying valve. The two lower terminals are, of course, connected to L.T. negative and positive

Fig. 4 shows a general view of the instrument. In the present instance the only available cabinet was a small condenser

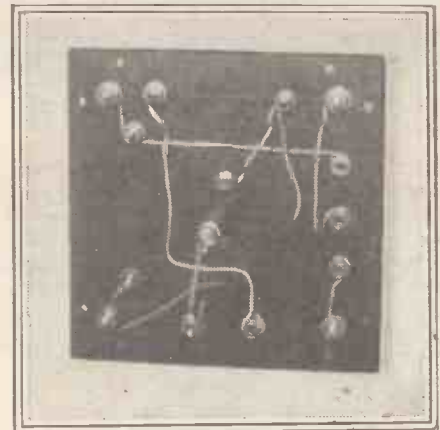

Fig. 3.—The wiring beneath the panel.

case having an internal depth of $1\frac{1}{4}$ in., and thus it became necessary to fit a spacing lug under the flange of the variable grid leak,

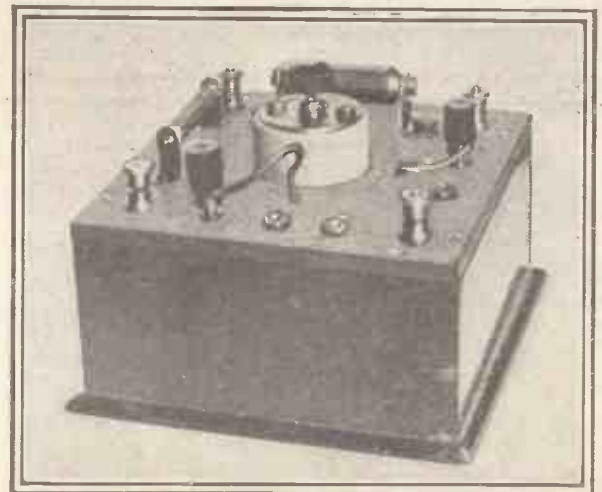

Fig. 4.—A view of the completed instrument.

this consisting of the base of a small wooden pill-box which is bored to take the body of the leak and drilled for the fixing bolts, which are made from lengths of 6 B.A. brass studding. This, of course, will not be necessary if the cabinet is sufficiently deep to clear the end of the leak when same is bolted flush with the panel. For the sake of compactness, however, I would recommend the shallow cabinet and the mysterious-looking pill-box.

The Petit Parisien Station

By OUR PARIS CORRESPONDENT.

ALTHOUGH Radio-Paris, Eiffel Tower, and the P.T.T. stations of Paris have been getting the credit for most of the French broadcasting, another station in the city has been making itself not only heard but quite popular with the French radio amateurs. This is the station of the "Petit Parisien," the largest French daily newspaper (with a total circulation of about 1,600,000), the pet of Senator Paul Dupuy.

The station is located in the building of the journal itself, down on the rue d'Enghien, in the centre of one of the busiest districts of Paris. The aerial masts are erected on the roof of the building, a task which proved very delicate, as the roof (or roofs, for it is actually on two) were not made for such extra weight. The two masts are, because of the fact that they are on two roofs, different in height, one being 24 metres (about 74 ft.) and one 25 metres (about 77 feet) tall. The weight of each is 2½ tons.

Details of the Transmitter.

The aerial itself is 35 metres (about 114 ft.) in length, of three wires, flat shape. The actual radiation of the aerial is 500 watts, although the input is 1,500 watts. The station works on a 340-metre wavelength.

Instead of using a direct earth connection they have been obliged to employ a counterpoise, formed by ten wires which make a sort of "mat" under the aerial. The difficulty with the earth connection would have been that the building is made of reinforced concrete, which presents a considerable "earth" problem. Also, because of the various motors of the printing presses, heavy parasitic disturb-

ance would have been probable. The counterpoise has given excellent radiation and very pure transmission.

The station transmitter proper is a Western Electric, similar to the one at present in use at the High School of the Postes, Télégraphes, and Telephones (P.T.T.), of which only five or six are to be

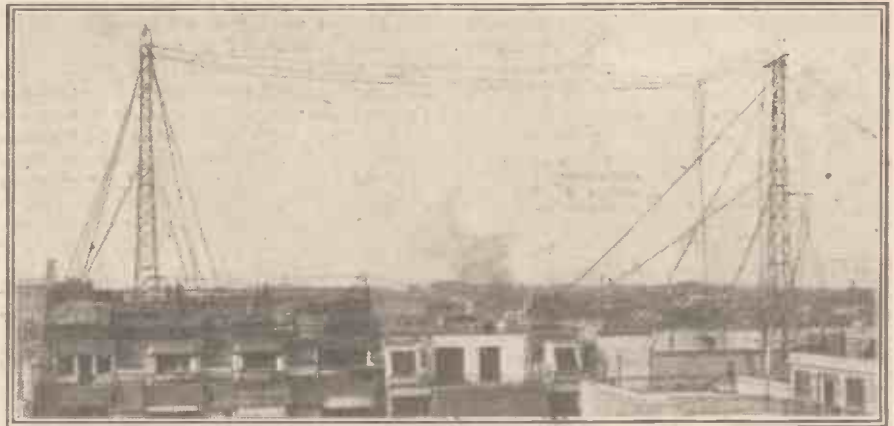

The aerial, which is erected on the roof of the "Petit Parisien" building, right in the centre of the busiest part of Paris.

found in Europe. The microphone is of the differential type, allowing for a very broad sound range, having a double carbon diaphragm very taut, so that the fundamental vibrations are much higher than those of the sounds to be transmitted, thus avoiding distortion. It is specially modelled to transmit voice frequencies of 200 up to the highest frequencies of the piano, which ranges just below 5,000 cycles per second.

This "sensitivity" of the microphone calls for an immediate amplification of the sounds transmitted by it. For this purpose are used three stages of audio-frequency amplification before the modulating unit is reached by the sound. Besides this the degree of amplification can be regulated by varying the coupling by means of a potentiometer. A loud speaker connected to the terminals of

the amplifiers allows for a control over this phase by an operator.

Sound-proof Studio.

The modulations of the current thus amplified operate on the continuous (carrier) waves of the station proper. The valves used are of the new type of platinum filament covered with oxides of metals, allowing for a high electron emission with minimum filament current. The filament current is 6.25 amperes under a tension of 14.5 volts. The plate pressure is 1,600 volts.

Power is furnished by the city power line, driving two generators which supply the anode current and the filament current respectively. A control system allows for a careful checking up by the control engineers, so that not only is the primary amplification watched constantly, but also

the modulation and other parts of the transmission.

Considerable care has been devoted to the construction of the studio to avoid to the greatest degree distortion from this source. The walls and ceiling are covered with cloth (actually carpet), and are arranged so that to a certain extent the absorptive quality of these walls can be varied according to the type of transmission. Results so far have proved very satisfactory, and interest in this station is growing rapidly.

For example, a letter comes from Norway reporting reception of the "Petit Parisien" station clearly on two valves, and numerous other amateurs in the Scandinavian countries have written praising the excellent modulation and purity of tone of the station. In Algeria the concerts are followed regularly (some 750 miles to the south of Paris); likewise from Barcelona and from Germany come reports of good results.

But perhaps most interesting of all is one from London of an amateur who has heard the Paris journal on a simple crystal set.

Readers are invited to submit photographs of wireless interest for publication in "Popular Wireless." Every photograph accepted and published will be paid for at the rate of 10/6 per photo.

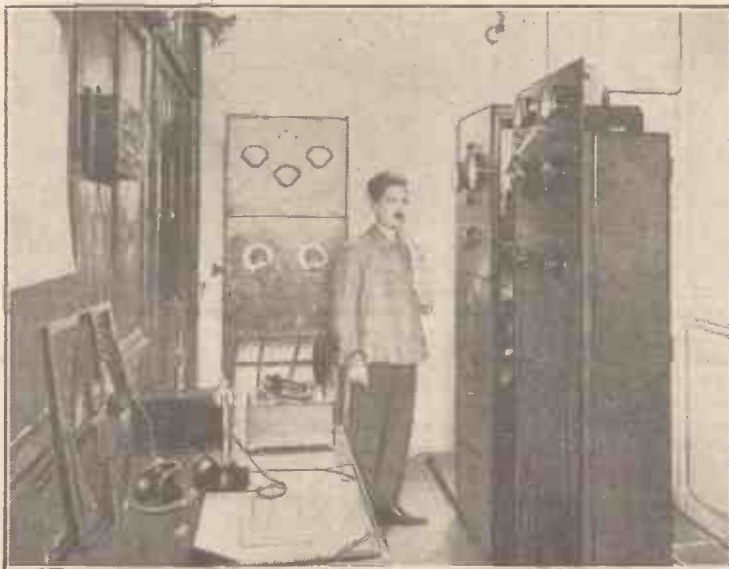

The rectifying units and transmitting panels.

HOW TO MAKE A CRYSTAL SET.

"P.W.'s" PHOTOGRAPHIC GUIDE.

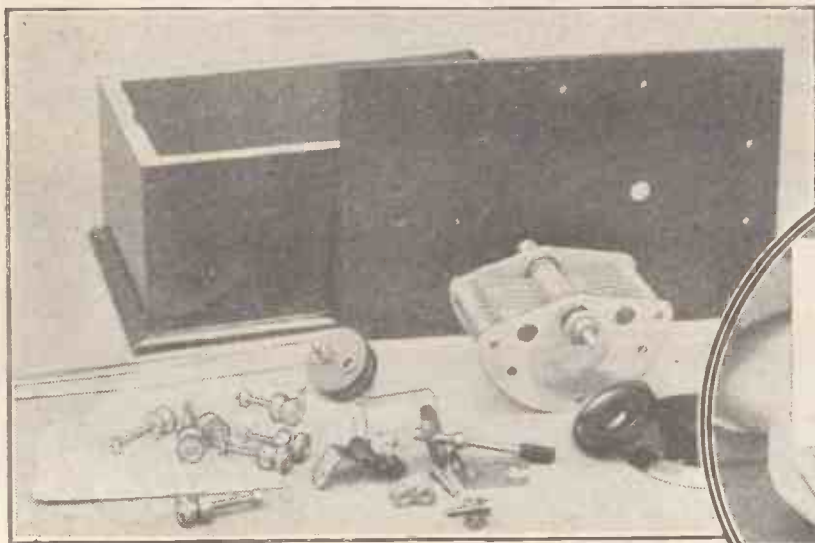

1. The complete set of parts and materials required. The cabinet measures 8" x 5" x 3 1/2" outside. The variable condenser should be of .0005 mfd. capacity.

2. (Right) Marking out the panel. It should measure 8 1/2" x 5 1/2" x 1/8".



3. Drilling the panel.



4. Mounting the terminals.

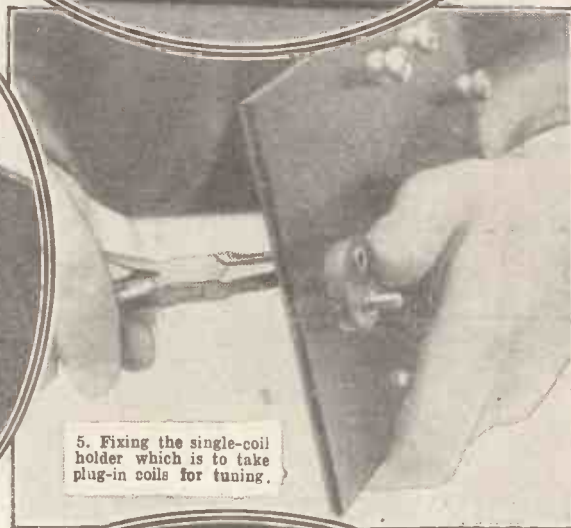

5. Fixing the single-coil holder which is to take plug-in coils for tuning.

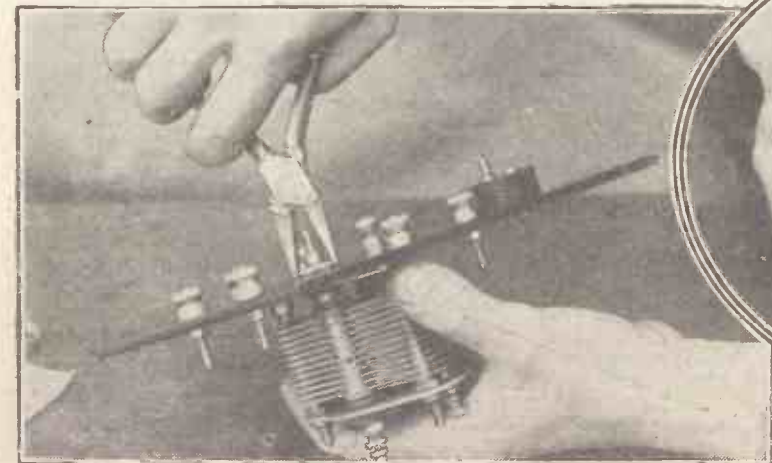

6. Mounting the variable condenser.

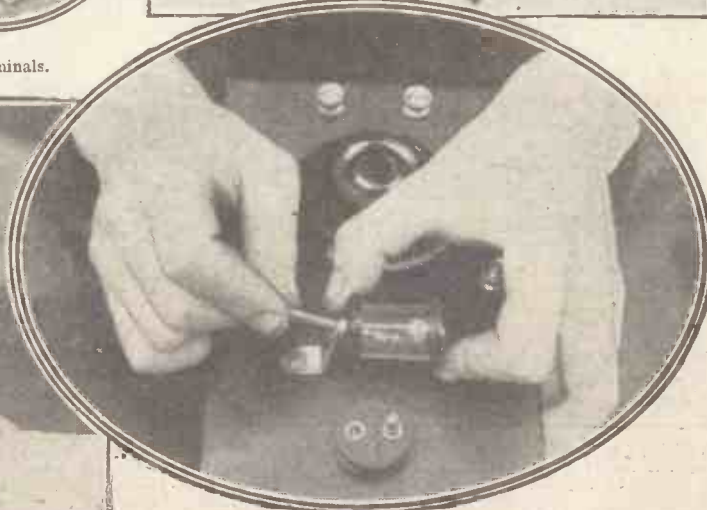

7. Fixing a panel mounting crystal detector into position.



POINT TO POINT CONNECTIONS.

Parallel aerial terminal (right-hand side looking down on underside of panel with aerial coil plug away from you) to crystal side of crystal detector, to plug side of aerial coil holder, and to the fixed vanes of the variable condenser. Cat's-whisker of crystal detector to bottom "Output" terminal and to left-hand 'phone terminal. Series aerial terminal to moving vanes of variable condenser. Socket side of aerial coil to top "Output" terminal, to right-hand telephone terminal, and to earth terminal.

9. A further stage in the wiring.

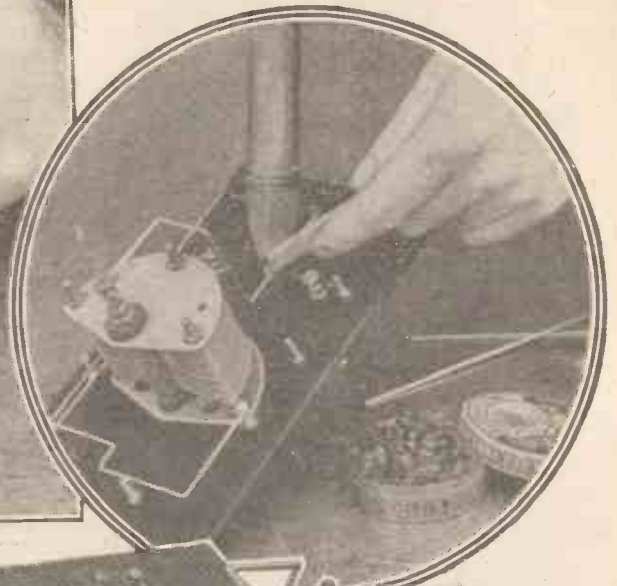
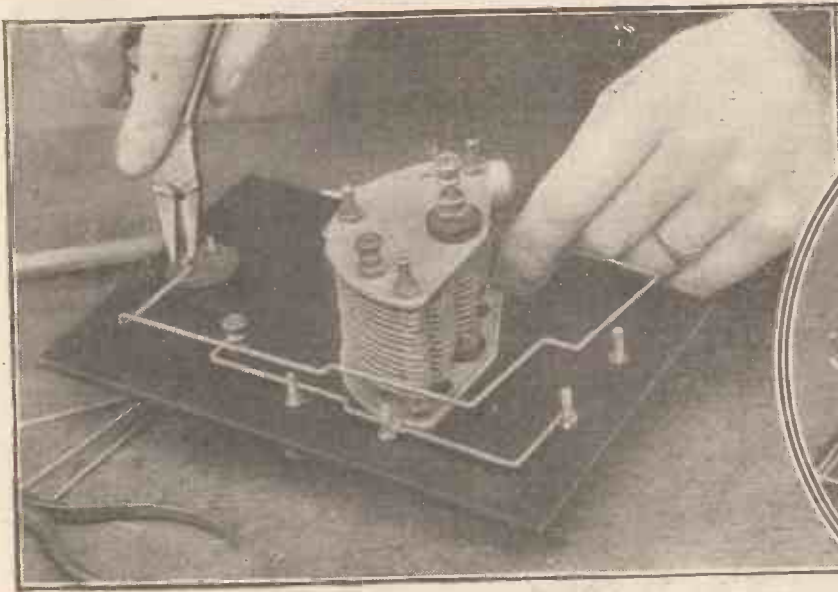

8. (Above) Commencing the wiring. Cat's-whisker side of detector is connected to bottom "output" terminal and one phone terminal and one side of coil plug is being connected to earth terminal, etc. (See point to point connections on other page.)

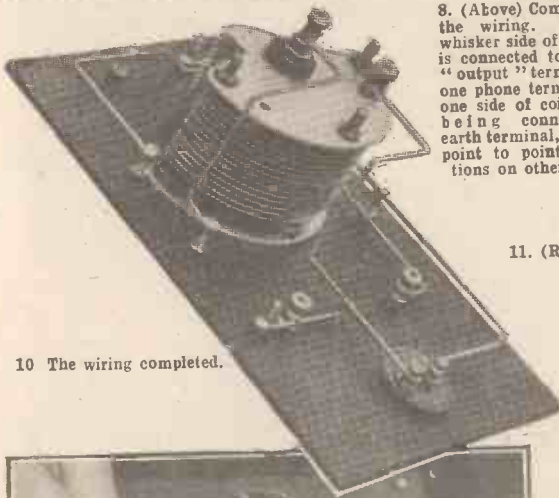

10 The wiring completed.

11. (Right). The wiring completed —another view.

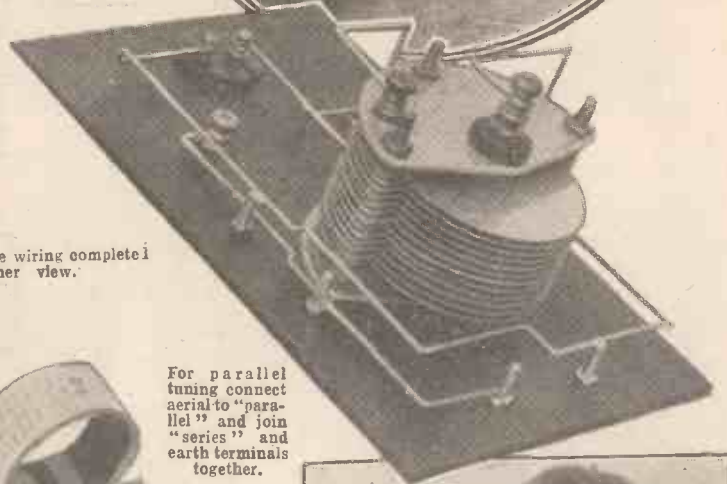

For parallel tuning connect aerial to "parallel" and join "series" and earth terminals together.



12. Fixing the transfers in position. Output is for amplifier or extra pair of telephones.



13. The completed set with coil in position. A 200-turn coil is necessary for 5 X X—parallel aerial tuning.



14. Tuning in 2 L O. A 75-turn coil and "series" tuning are employed.

The Brandola!

Experts in radio acoustics since 1908

To capture an electrical impulse and transform it to audible sound is easily accomplished in this age of advanced radio. To reproduce that sound in its original purity and texture, without a suggestion of alien influence, is quite another matter. Our long and intimate association with the "voice of radio" has, of course, necessitated minute and exacting study of acoustics—the science of sound.

Radio acoustics is the science of transforming the electrical impulse into audible sound, and Brandes have been engaged in this absorbing study of *real* reproduction of voice and music since 1908. The expert knowledge thus accumulated shows itself in the unique principles embodied in the *Brandola*, our latest and most perfectly developed Speaker.

Any reputable dealer stocks Brandes.

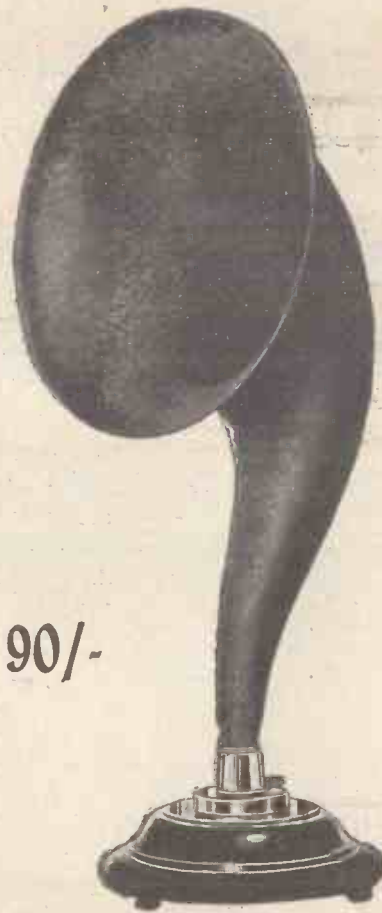

Our most perfectly developed "speaker"

The *Brandola* will be for those who demand supreme performance. Its large adjustable diaphragm gives new rounded fullness to the low registers and new clarified lightness to the high, together with luxuriant depth of volume. Special constructional features ensure greatest volume with minimum current input and exceptional clarity over the full frequency range. The semi-gooseneck horn has a distinguished "antique finish," and is constructed of non-resonant material which defeats harsh or metallic resonance. The base is of polished walnut with electro-plated fittings. Substantially, yet elegantly built, the *Brandola* will harmonise effectively with any decorative scheme. Height 26½ ins., diameter of bell 12½ ins.,

Ask your dealer for the *Brandola*.

Brandes

Brandes, Limited, 296, Regent Street, W.1. Works: Slough, Bucks.

Three other famous Brandes products

The Table Talker.



Re-designed gooseneck horn which produces clear, more rounded and mellow tones. Constructed of special material which defeats any suggestion of metallic resonance. The adjustment lever, located at the rear of base, controls the volume and sensitivity. 18" high, diameter of bell 10". **30/-**

Matched Tone Headphones.

Every pair of Brandes 'phones is matched in tone by special apparatus so that the two receivers produce exactly the same sound at the same instant. Comfortable and light in weight with clutch on headband giving perfect adjustment to any head. Included in the leading types of completely equipped receiving sets ... **20/-**



Audio Transformer.

Ratio 1 to 5. Developed along sound engineering lines to give high amplification of applied voltage with straight line amplification - frequency curve. Well protected mechanically with shielding such that interaction is eliminated. With outside soldering tags, screw terminals and screw mounting base. On comparative test the extra volume and clearness of this transformer are immediately noticeable



17/6

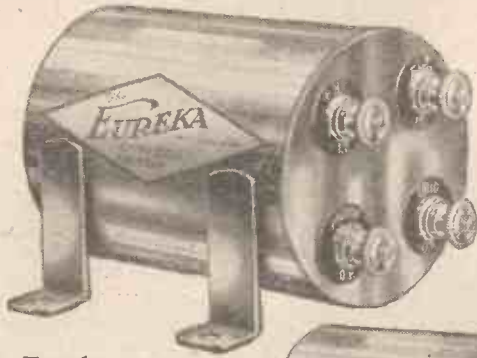

Eureka Concert Grand



Eureka No. 2

Eureka Concert Grand
The well-known Eureka Transformer selected by experienced radio engineers for its wonderful amplification with a complete absence of distortion. Unconditionally guaranteed. Price 25/-

Eureka No. 2
Specially designed for use as a second stage transformer with the Concert Grand. Unconditionally guaranteed. Price 21/-

Eureka

introduces three new Transformers

Eureka Baby Grand No. 1

A new and inexpensive first stage Transformer embodying all the well-proved Eureka principles. Unconditionally guaranteed. Price - - - - 15/-

Eureka Baby Grand No. 2

Specially designed to follow the Baby Grand No. 1 when two stages of l.f. amplification are wanted. Unconditionally guaranteed. Price - - - - 15/-

Eureka Reflex Transformer

The first Transformer ever to be placed on the market as being specially designed for reflex work. This fine quality instrument will give considerably more volume in a reflex circuit than any standard transformer. Unconditionally guaranteed. Price 15/-



Eureka Baby Grand



Eureka Baby Grand No. 2

Important Price reduction
Eureka Concert Grand now reduced to 25/-
Eureka No. 2 reduced to 21/-

Everyone can now afford a real Eureka

THE comparative high price of the Eureka Concert Grand and the Eureka No. 2—due to their costly and intricate manufacture—has undoubtedly prevented many who would otherwise have chosen them, from buying. In order, however, to reach the many hundreds of thousands of wireless enthusiasts who want a good transformer capable of big amplification, and who are prepared to sacrifice some of the exquisite tonal qualities of the Concert Grand, we have introduced the Eureka Baby Grand No. 1 and No. 2.

These two fine transformers represent wonderful value for money, and are made possible at the price only because of the immense manufacturing and purchasing facilities enjoyed by this Company.

There is a big future for the new Eureka Reflex—the first real Reflex Transformer. If you are an S.T.100 enthusiast take out the transformer you are using in the first stage and substitute a Eureka Reflex. You will be amazed at the increased volume and improved tone. All these fine quality Transformers can be obtained from your Dealer. No matter which set you are going to build, you improve it by using a Eureka Transformer.

Eureka Radio Products
(Portable Utilities Co. Ltd.)
Eureka House, Fisher St., London, W.C.1.



Eureka Reflex

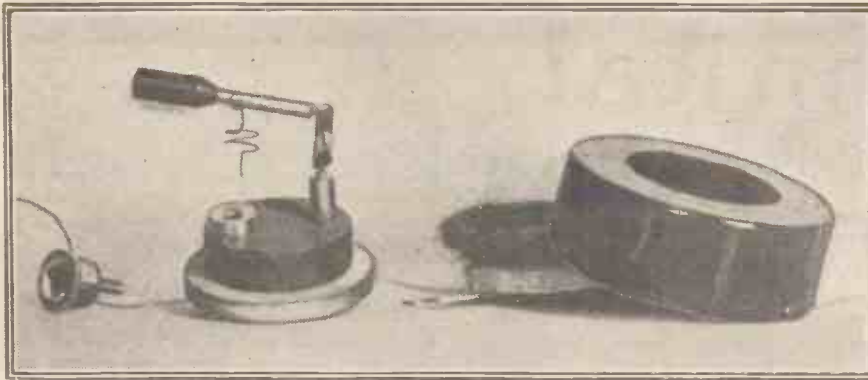
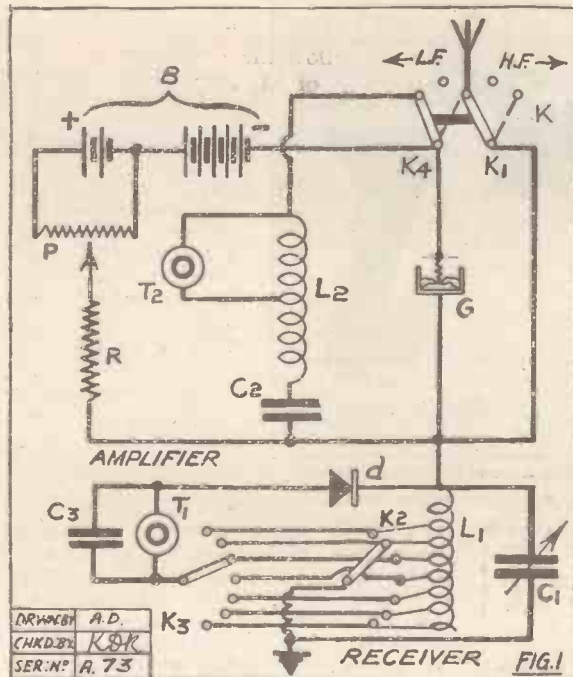

Fig. 4.—The crystal oscillator dismantled, showing the special wire-supported crystal cup.

THERE has been a great deal of discussion, pro and con, regarding the principle of the Cristadyne circuit. Many of the leading radio engineers predict a brilliant future for this invention; while

of the diagram is an ordinary crystal receiver, including the adjustable inductance L_1 and the variable capacity C_1 .

The battery B gives 12 volts, of which four are shunted by the potentiometer P, of about 400 ohms. The polarity should be observed carefully. The inductance resistance R should be of 1,000 ohms and considerable inductance. The capacity C_2 is equal to 0.25 mfd., the inductance L_2 is of 35 millihenrys, and its resistance is of about 30 to 50 ohms.



Oscillation Control.

It is, above all, necessary to find the generator point, by placing the switch K in the position L.F. (audio frequency), and listening to its musical note in the telephone T_2 . In searching a satisfactory point, and in moving the potentiometer slide tuner P, the sound is easily obtained. As soon as a good, pure, continuous note is obtained, the circuit L_2-C_2 is disconnected by placing the switch K in the position H.F. (radio frequency); when one listens in the telephone T_1 of the actual receiving set, tune the circuit L_1-C_1 on the wave-length by the switch K_2 and the

others are decidedly sceptical, calling the oscillating crystal merely a scientific curiosity of no practical value.

Details of the Circuit.

While the writer does not wish to take up the actual defence of this circuit (which, it may be added, is becoming more and more popular in Russia), he feels that a fair description of the zincite mounting may not only be useful to the amateur experimenter, but may also aid in proving through the latter whether the circuit is of actual value.

From Fig. 1 we note that the zincite is set directly in the antenna receiving circuit, in order to reduce to zero the effective resistance of the receiver, due to its negative resistance.

The switch K_1 cuts the amplifier out of the circuit; while the switch K_4 , united with the first, includes the crystal in the audio-frequency circuit L_2-C_2 , utilised during the time of searching the crystal for sensitive spots. The lower part

of the diagram is an ordinary crystal receiver, including the adjustable inductance L_1 and the variable capacity C_1 .

To obtain the amplification both pure and powerful the zincite crystal oscillations should be damped by moving the slide tuner of the switch K_3 towards the bottom. The same result can be obtained by modifying the position of the potentiometer, varying the negative resistance of the crystal; but it is obviously better to work by increasing the coupling, for in this way a larger amount of energy is put into the telephone T_1 . In practice it is a good idea to increase even the negative resistance of the circuit by slightly moving the potentiometer P. This is the reason for having a variably coupled receiver, as is shown in Fig. 1. The maximum of amplification is obtained, as in valve regenerative receivers, at

THE OSCILLATING CRYSTAL.

As Used By Its Inventor.

By C. NICOLAIEFF
(Engineer in the Laboratory of M. Lossev).

This important article by an assistant of the inventor of the oscillating crystal method is exclusive to "P.W.," and is one of great interest to all experimenters.

the very limit of the oscillations of the zincite crystal.

Fig. 2 shows the variation of the crystal resistance under the influence of the current running through it. This current is evidently the function of the potentiometer P; the

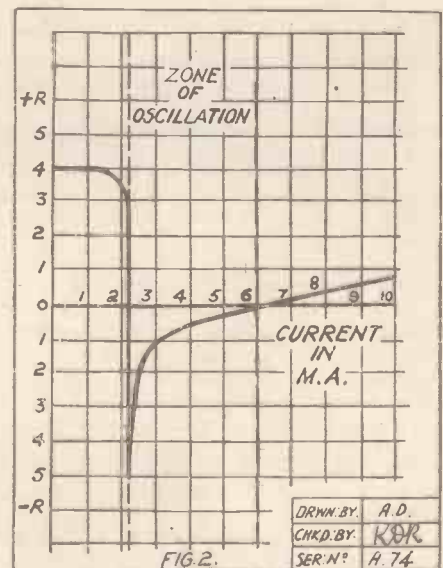

more the potentiometer is moved to the right the stronger the current becomes. It is to be observed that in proportion to the amount the current increases from zero to a certain value, the crystal resistance (Continued on page 46.)



Fig. 3.—This photograph clearly shows the method of mounting the oscillating crystal.



Conducted by our Staff Consultant, J. H. T. ROBERTS, D.Sc., F.Inst.P.

THE remarkably rapid progress of wireless science since the advent of broadcasting is indicated in the refinement of broadcast receiving apparatus; almost every month, certainly every season, considerable improvements are announced in circuits and in apparatus. There will always be, of course, a large amount of business to be done in the manufacture of more or less "ordinary" components, but the larger and more enterprising manufacturers are more and more conscious of the need for further research and experiment and, in many cases, the larger manufacturers have now provided themselves, if not with "research" laboratories, at any rate with "testing departments," in which a certain amount of experimental work, of sorts, is carried out. It still remains for only the very largest manufacturers to maintain true research laboratories, the reason being that such laboratories are very expensive to run, and that the return for the outlay may be long delayed.

Commercial Research Laboratories.

The fact that research really pays has been proved beyond the shadow of doubt, particularly in the electrical industry; even the most conservative of manufacturers and the most conservative of traders, are at last admitting that research (like advertising) pays in the long run.

The United States was some year or two ahead of us in the matter of broadcasting, and consequently it is only to be expected that many developments are to be found there which have not yet properly established themselves in this country. I have in mind, in particular, the commercial research institutions which are rapidly springing up in the United States, and of which, from time to time, one sees announcements in the American press.

This seems to me a very good arrangement, for, with the establishment of independent research organisations, a comparatively small manufacturer, who could not afford to maintain his own laboratory or staff of experts, may have his problems solved as they arise and in the meantime is under no expense. It is easy, of course, to foresee difficulties and complications arising with regard to the agreements or disagreements between the parties as to their relative shares in the final product.

A Valuable Enterprise.

But experience has shown that there are ways of overcoming even these difficulties, and it seems likely that this system will come more and more into vogue; probably in the next year or two it will establish itself over here. The *raison d'être* of such organisations is very simply summed up in the opening words, which I extract from an advertisement of such an institution: "Radio manufacturers are con-

stantly faced with scientific problems due to the discovery of new principles and the

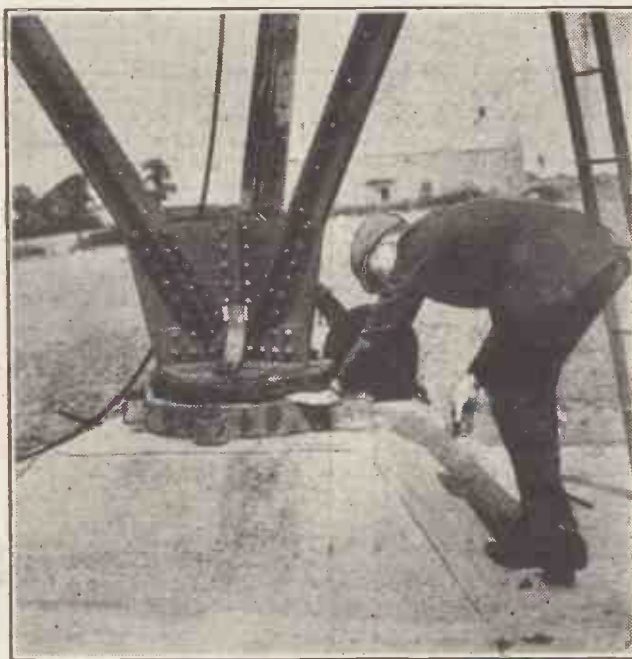

Examining the base of one of the 500-foot masts at the Daventry station.

THE OSCILLATING CRYSTAL.

(Continued from page 45.)

remains positive; but as soon as the current passes the value the resistance changes abruptly and becomes strongly negative. It is at this moment that the oscillations reappear.

In proportion as the current increases under the influence of the potentiometer P, the negative resistance diminishes, the oscillations becoming weaker or even stopping at a certain moment; when for a certain value of the current, the resistance becomes again positive after having passed a zero value.

A glance at the curve (Fig. 2) shows how the following rule necessary for the satisfactory adjustment of the potentiometer P can be established. *Once the oscillations are established, all increase of the tension furnished by the potentiometer diminishes the intensity of the oscillations; and, to the contrary, all diminution of this tension increases the intensity of the oscillations, that is, of course, if one remains in the zone of negative resistances.*

The most practical form for the construc-

necessity for keeping their product in the front rank of radio's rapid advance."

I think there would be no difficulty in setting up a commercial research organisation for the wireless trade in this country, and I venture to predict that, properly organised and conducted, both internally and in its relations with the trade, such an enterprise would prove not only very valuable to the industry but eminently profitable to its promoters.

Transmission of Photographs.

The encouragement which is being given in the States to amateur experiment in the

transmission and reception of pictures by wireless is indicated by the announcement, just made by the Commissioner of the Department of Commerce, that radio amateurs may use apparatus for picture transmission, connected to their regular transmission sets, under their existing licences and on any of the wave-lengths authorised for amateur use.

I think I have already mentioned that the Jenkins laboratories are offering for sale complete apparatus for the transmission and reception of pictures, being sold at a very low price in order to stimulate amateur experiment in this direction.

(Continued on page 80.)

tion of the oscillating crystal detector is shown in the photograph, Fig. 3. The base of the detector is placed in a small box filled with felt or rubber-wool. The detector itself is connected by very fine and extremely supple wires to the contact terminals situated on the box. This method of mounting helps to avoid all vibratory interference in the adjustment of the detector. Fig. 4 shows the detector removed from its box, with the little crystal holder also removed.

The cat's-whisker is of 0.2 mm. steel wire, but to increase its elasticity another wire of 0.3 mm. is wound in the upper part of the first, the smaller one being longer by about 1 mm. than the second one.

The quality of the zincite crystal plays an all important rôle in this circuit. Natural crystal should *always* be re-melted in a furnace or an arc; when with a good detector an amplification of about ten times can be had, weak signals being amplified the most.

All Cristadyne mountings work better with aerials of large capacity, even if fairly low. The writer has obtained good results with a single insulated wire stretched between the four corners of the house, and many Russian amateurs use such things as metallic roofs, telephone and telegraph wires, or even electric light wire (this latter only when a condenser of 2 or 4 mfd. is set between it and the set).

THE amicable agreement reached between the B.B.C. and the theatres a few weeks ago has, I hope, definitely settled the controversy which has raged with more or less fierceness ever since the inception of the British Broadcasting Company. Being an actress myself I have naturally watched the result of the negotiations between the B.B.C. and the theatre managers with considerable interest, and with, perhaps, even greater interest the experiences of the several well-known members of my profession who have broadcast.

Broadcasting Beneficial to Theatres.

I have been asked to write this short article, giving a few observations in general on the question of radio plays, and, although at the time of writing I have not broadcast myself, it is not because of any prejudice I have against this new art. In fact, I have always failed to see how the broadcasting of excerpts from plays could do the theatres any harm; if my memory serves me right the evidence already obtained in connection with plays which have been broadcast proves that the judicious broadcasting of excerpts from plays is beneficial to the theatres.

This, I believe, is now fairly widely recognised: anyway, the B.B.C. and the theatre managers have, as everybody knows, agreed that 26 excerpts from theatrical plays shall be broadcast in a year, and to my mind (and if the right excerpts are chosen) the theatres will find broadcasting an ideal form of publicity, and box office receipts should attain that satisfactory degree of opulence which is chiefly responsible for the contented smile one may see on the face of any box office manager.

In the cinema you see but do not hear; in broadcasting you hear but do not see; and the interesting question arises—can you interest a big "listening" public just as it is possible to interest a big "seeing" public? I feel sure it can be done.

Holding Listeners' Attention.

For instance, just as Pirandello can draw a large English speaking audience to his Italian plays—and I suppose very few playgoers understand Italian—so the personalities of players in broadcast plays should hold the attention and interest of the hundreds and thousands of people who listen-in.

RADIO PLAYS.

The Theatre, via Wireless.

By FRANCES CARSON.

This short article gives the impressions of a well-known actress on the question of the Broadcast Play.

Specially written plays for broadcasting purposes will certainly have to concentrate on providing a dialogue for the various characters which will command attention. Dialogue which necessitates facial expressions, movement, and the aid of vision, is obviously useless in broadcasting plays. Every word spoken in a radio play should be an essential word—and the players' "lines" must be sufficiently interesting to hold the attention of the listener. Mr. Galsworthy's plays are a good example of what I mean. For instance, perhaps some of my readers will remember one of the classic opening lines, "I believe," by Mr. George Bernard Shaw. I think it began, "H— said the Duchess."

Radio Comedy Essentials.

Now, if you opened a book and found the opening sentence as above, I think it would hold your attention. This may be rather an extreme example, but, at any rate, you would want to read on. The sentence is intriguing. The exclamation of the word spoken by the duchess is not an unusual one, but the idea of a duchess exclaiming it, rightly or wrongly, is somewhat unusual. It is unexpected.

It is like George Robey telling a Sunday-school story: you don't expect it, and the unexpected and unusual contradiction of your own anticipation makes you interested in what follows. Witty dialogue, epigrammatic and to the point, seems to be absolutely essential for the radio comedy, and, of course, the fewer the characters in the play the better, otherwise the listener will have difficulty in remembering the names of the characters and correctly

linking them to the various "unseen" voices.

The length of a radio play is another important point. Twenty minutes at the outside is, to my mind, sufficient. I notice that the B.B.C. sometimes give two or three radio plays in one evening, and I cannot help thinking this is rather a mistake. I may be quite wrong, but my personal opinion of listening-in is that variety is essential, and two or three plays following each other are likely to impose too much of a strain upon one's attention however interesting the plays may be.

There is undoubtedly a wonderful new art awaiting exploration in connection with radio plays. The broadcasting of excerpts from theatres may have its drawback, but, on the other hand, listeners do undoubtedly get an excellent idea of the atmosphere of the theatre, although I should say that the broadcasting of musical plays will probably be more successful than the broadcasting of what is technically known as excerpts from "legitimate" plays.

Definite Place for Wireless.

There isn't any reason why radio plays should not have a wide appeal, in spite of their limitation, from a technical point of view. To those of us to whom, as Hamlet says "The play's the thing," the drawback of not seeing the actors and watching action on the stage (which is certainly a large part of the modern play, where long speeches are rare and one has to act more than speak) "listening-in" to a play will far from satisfy.

But there are always the classics that are so rarely done these days where one hears a beautiful voice uttering lovely verse, which is as much a part of the play as its drama. Then I feel, sentimentally, for those whom the great joy of seeing is unknown. Think of what the theatre can mean to them by way of the radio.

Personally, I long to broadcast. It would mean playing to the largest audience one has ever had and, from an acting point of view, think how carefully and with what expression one would have to speak with just the voice to do it all.

Yes, the theatre, via wireless, has a definite place, and I hope the managers and the B.B.C. will co-operate and benefit by it.

A NOVEL DRILL STAND.

IT is a good plan to keep a set of twist drills exclusively for drilling ebonite and other soft materials, and those sold on stalls, etc., at the very low price of one shilling or so per set will be found quite suitable for this purpose. The accompanying photograph shows a very appropriate stand for a set of "ebonite" drills, this consisting of a piece of 1/4 in. sheet ebonite 4 in. long by 1 1/2 in. wide, which is drilled as shown to take the shanks of the drills. Another row of holes is drilled near the front edge of the ebonite, each hole corresponding in size to the adjoining hole in the back row, so that the ebonite forms a combined stand and drilling or tapping gauge, it being possible to find the correct size of drill for

any screw or tap by fitting the latter into the duplicate holes and then selecting the

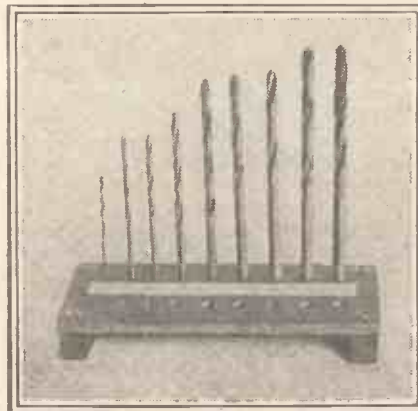

adjoining drill. The ebonite is screwed to two small strips of wood, a third strip being

screwed between them, under the back row of holes, to support the drills.

The writer purchased a set of cheap drills ranging from 1/8 in. to 1/2 in. in diameter (as shown), which were sewn to a card with their sizes marked directly beneath them. By means of the dividers the holes in the ebonite were marked off to correspond with these figures so that when the marked portion of the card was cut out and glued to the ebonite, the size of any drill, or gauge hole, was known at a glance. The stand, being made of ebonite, is an excellent "ebonite only" reminder, and the busy amateur would do well to adopt the idea.

PHOTOGRAPHS.

Readers are invited to submit photographs of wireless interest for publication in "Popular Wireless." Every photograph accepted and published will be paid for at the rate of 10/6 per photo.

FOREIGN NEWS.

From OUR OWN CORRESPONDENTS.

Paris—Wireless Conducted Automobile Meets With Accident.

AN experiment was made in Paris recently with an automobile controlled by wireless. The test took place in the early hours of the morning on the Champs Elysées, but it ended in disaster. Near the Etoile the car came into collision with a motor-van and was smashed. The inventor of the directing apparatus was following in a second car a short distance behind, but he refused to make any statement regarding the cause of the mishap.

Copenhagen—New Danish Station in Far North.

The Danish Government proposes to erect a wireless station on the East coast of Greenland, and has secured the consent of the Icelandic Government, Iceland being now a self-governing dominion, to put up three stations on the West and North-West coasts of Iceland.

The main purpose of these stations will be to help broadcast meteorological information and to help the large fishing fleets of all nations that frequent these waters.

It is expected that three of the stations will be ready before the end of the year.

Paris Time Signals.

M. Bigourdan has presented to the French Academy a proposal to simplify the transmission of time signals from the Eiffel Tower radio station. This system, which it is expected will be put into operation within a short time, will be both more efficient and more rapid, it is claimed.

Bangkok—Siam May Go In For Radio.

The Siamese Government, it is stated, is considering setting up a wireless station in the vicinity of the capital. So far, there is not a single wireless set in the country.

Berlin—German Local Dues Are Abolished.

The German Government has decided that no local authority will be henceforth empowered to levy any toll or due on radio amateurs for the right to use a receiving set. These dues have been enforced in many places, but they are now declared to be illegal.

In the statement issued on the subject, the Minister of the Interior informs radio amateurs that, while these levies were illegal, and must cease, no action to recover amounts paid in already will be entertained.

Berlin—"Stereoscopic" Broadcasting is a Success.

The experiments made by the Rundfunk Company in "stereoscopic" broadcasting have proved a brilliant success. The method used was to install two different microphones in the studio; one of them connects with the neighbouring Magdeburger Platz transmitting station, and the other with the Koenigsvusterhausen station.

If the listener picks up both these wave-lengths and listens in with a 'phone con-

nected with the Magdeburger Platz at one ear and another connected with Wusterhausen at the other, he will obtain a full, normal hearing effect which develops a beautiful quality of tone.

With the ordinary, non-stereoscopic broadcasting the listener in either uses one ear-piece or a headphone, or, hears out of a loud speaker. In the case of the headphone he hears the sounds simultaneously with both ears. In the case of the loud speaker there is always a refraction from walls or other obstacles. In the case of the single ear-piece, the hearing is as imperfect as is sight with one eye. The "stereoscopic" method is the only one which gives the full natural effect.

Paris—Franco-Austrian Radio Service Opened.

The French post office authorities announce that, owing to a convention recently

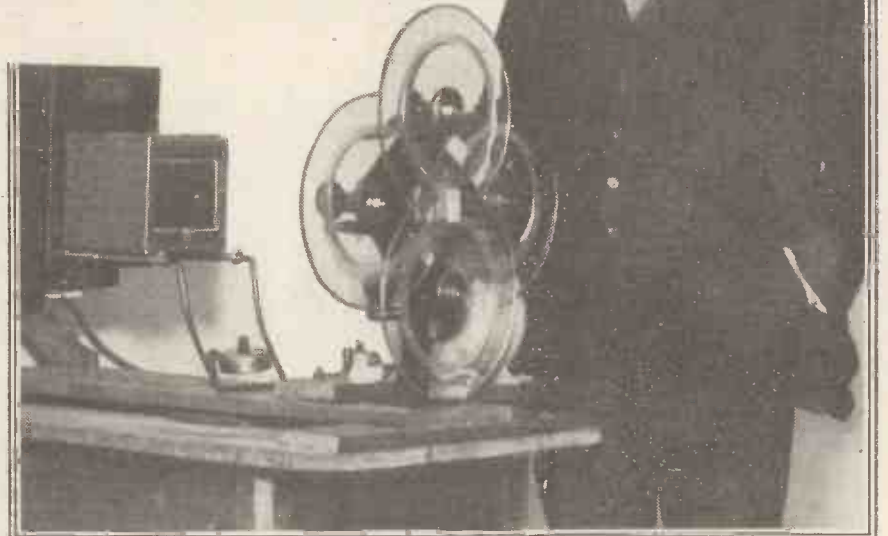

Mr. C. Francis Jenkins, the American inventor whose television experiments have created world-wide interest. This photo—one of the latest—shows Mr. Jenkins with part of his television apparatus.

signed between France and Austria, it is now possible to exchange telegraphic messages through the Radio-France company between France and Austria.

The rates will be the same as by the ordinary telegraphic route.

Prague.

The rapid progress made by radio in Czecho-Slovakia is shown by the fact that the National Radio Company, Ltd., of Prague, which last year had a deficit of 221,861 kronen, has this year made a very substantial profit, and has decided to increase its capital from 500,000 to 1,000,000 kronen.

The Government is taking over 51 per cent of the shares, the remainder being subscribed by various industrial concerns. The board of directors is to be recast, and will comprise one representative of the Czech radio sets manufacturers Radioslavia, the Czech Union of Journalists, the Federation

of Radio Industries, and four delegates nominated by the Government.

Berlin—Amateur Transmitters.

New regulations will shortly be issued for German radio amateur senders. It is understood that the main provisions will be as follows:

The maximum wave-length allowed will be 120 metres, and the maximum power 500 watts. Transmission will only be allowed at nights, and a monthly fee will be paid to the German postal and telegraph administration. Before receiving a licence, the applicant will have to undergo a Morse test of a rigorous character. It will be forbidden to broadcast news items, general

information, advertisements, lectures, or concerts.

New York.

The Radio Corporation of America has reported a loss of \$391,000 for the last quarter, as compared with a profit of nearly \$2,000,000 in the March quarter. The gross income diminished from \$15,000,000 to \$4,584,000.

Paris.

It is announced here that the Turkish Government has given a French firm the contract for the building of two wireless stations, one at Angora, which will be the most powerful in Asia, and one at Constantinople. The news has created some surprise, as it had been announced three months ago that the contract was practically secure for the Radio Corporation of

(Continued on page 79.)

A wonderful achievement



The new Brown A 'phones now at a price within the reach of all

IT is doubtful if there is a single wireless enthusiast who has not heard of Brown A-type Headphones. Not everyone, however, who has coveted them has been able to buy them—in fact, owing to their comparative high price, only a small proportion have been able to enjoy their advantages.

Brown A-type—with their famous super-sensitive tuned reed mechanism—have always been acknowledged to be the world's best headphones and in a class apart from competition. Governments, shipping and telegraph companies have all paid tribute to their wonderful efficiency and have taken the bulk of the available supplies.

But the insistent demand for a cheaper instrument compelled us to consider the production of a modified A-type Headphone suitable for mass production on a large scale.

Twelve months have been spent in designing the new Brown A-type. We can now guarantee that they contain all the essential details of the famous tuned reed mechanism—that in sensitivity they are still without equal—that the same superb Brown standard of workmanship is maintained. That in short, although produced in huge quantities by the aid of the most elaborate and costly machinery, they are in every way comparable to the world-renowned standard Brown A-type.

Their production at the amazing price of 30/- is a truly remarkable achievement—one of the greatest, perhaps, in the whole wireless industry during 1925. The demand for them will be immense—order a pair from your Dealer at once.

TO THE TRADE

We want you to have adequate stocks of these Headphones and all the new Brown Loud Speakers. In case of difficulty write us immediately and we will see that you are supplied.

S. G. BROWN, LTD
Head Office & Works :
Victoria Rd., N. Acton,
W.3

Retail Showrooms:
19 Mortimer St., W.1
15 Moorfields, Liverpool
67 High St., Southampton

Brown

Headphones and Loud Speakers

All the new Brown Loud Speakers may be seen, heard and bought at the Works or at our Showrooms.

Depots (Wholesale only):
13 Bushy Park, Bristol
Cross House, Westgate Road, Newcastle

Gilbert Ad. 312A

TUNGSTALITE

A GREAT DISCOVERY



At last! a ROUND Crystal

THE days of irregular shaped crystals of uncertain behaviour will soon belong to the past. TUNGSTALITE have discovered how to produce crystals which are sensitive all over, through and through, and which secure clear results over distances inaccessible with other products. You can try any specimen of TUNGSTALITE (Blue or Gold Label) and the results will astonish you. But this is not all! The new product known as

1/6 TUNGSTALITE 1/6
Round Type Crystal

is the first crystal to be made in perfectly cylindrical form.

It fits instantly and snugly into all ordinary crystal cups without fracturing or splintering.

It is sensitive at every point of both its cut and rounded surface.

Every specimen possesses an equal and perfect sensitivity, and has a useful surface not equalled by any other product.

Secure your specimen to-day 1/6.

From all dealers or direct from

TUNGSTALITE, LTD.,
47, FARRINGTON ROAD, LONDON,
or 41, CALL LANE, LEEDS.

Six Sixty

The Best Dull Emmitter

WITH THE REAL ADVANTAGE

in its Patented

MOLYBDENUM THORIUM COVERED FILAMENT

the "Six-Sixty" Filament is 100% efficient electron emitting. That is the all-important fact.

14/-

If your local dealer cannot supply send direct to us. Please give dealer's name and address.



FILAMENT
VOLTS 1.5-2

FILAMENT
CURRENT
·3 AMPS.

British Made.
B.B.C. Stamped

Valves differ in detail, but only the "Six-Sixty" can offer you the greater range and increased power attendant upon the use of a Molybdenum Filament, completely Thorium covered. Get a "Six-Sixty" and test it in every stage.

How to
increase
accumulator
capacity
10 times



This free folder will interest you. It tells all about the unique filament of the "Six-Sixty," and shows how with it great economy of current may be effected whilst actually gaining in range and volume. Send a post-card for it to-day.

ELECTRON
LTD

Triumph House,
189, Regent Street,
London, W.1.

Phone: Regent 5335

What Makes the Crystal Insensitive?

IT is not without a blush of shame or a hidden pang of remorse that many a crystal user slowly and deliberately inserts his first finger and thumb into the sacred crystal cup of his set, and, having guiltily grasped the mineral inhabitant of that vessel between the aforementioned digits, turns it over again and again in order to inspect its condition and to determine whether a fresh area of crystal surface may be put into active use.

A Popular Theory.

It is very often, I repeat, that it is only with feelings of the deepest guilt that this operation is carried out by a large number of enthusiastic crystal users, for, according to our popular and conventional standards, the handling of crystals in any way at all is, after deliberate and persistent oscillation, the most heinous and unpardonable of all the Seven Deadly Sins of Radio.

It would be interesting to no mean extent if the origin and progress of the crystal-fingering myth—for that is practically all the theory would seem to amount to—could be traced out and set down for the benefit of crystal experimenters as a whole. We all know, of course, that the idea concerning one of the causes of the decrease in sensitivity of many radio crystals which is very often accepted is that during the handling of the crystal a small deposit of grease is laid upon the crystal surface, and that it is this oily exudation of the skin which is responsible in a very large way for the gradual decrease in the crystal's rectifying powers.

Such is the explanation of the detrimental effect which is supposed to occur with crystals which have been unduly handled, and, as in many instances the theory is able to account very conveniently for observed diminutions in crystal sensitivity, it has gained popular acceptance to a very large extent indeed.

Quite a Fallacy.

Unfortunately, however, little experimental evidence can be obtained to support this theory. In fact, the accumulated evidence rather points the other way, inasmuch as it can be shown by careful experiment that ordinary greases and oils of a reasonable purity do not exert any appreciable effect upon the crystal's functions.

In the first place, a piece of sensitive galena may be broken up into several pieces, and these pieces may be distributed amongst several individuals, each person being instructed to handle the crystal between his fingers as much as possible.

After a few days' handling, the crystals may be collected and carefully digested with a little warm ether. The result of this experiment will be that no trace of grease or oil will be able to be discovered, that is, of course, provided that the crystal fragments were handled by persons possessing

AN INTERESTING
ARTICLE OF A
PRACTICAL NATURE.
By J. F. CORRIGAN, M.Sc., A.I.C.
(Staff Consultant, "Popular Wireless.")

hands and fingers of average cleanliness. Again, microscopic examination of such crystals will fail to reveal any trace of grease.

Now, on the other hand, suppose we take an ordinary sensitive piece of galena and cover it with a layer of some pure grease or oil, such as olive oil, vaseline, and so forth, we shall find upon subsequent testing of

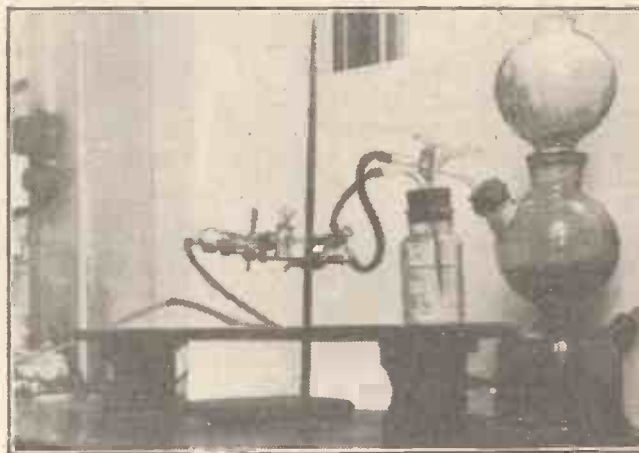

Fig. 1. Type of apparatus used for showing the effect of gases and vapours on crystals.

the crystal that none of its sensitive properties have been interfered with in any way at all. In fact, such a grease-treated crystal will give rather better results, for the cat's-whisker will have a better hold on it, and the crystal surface will be kept out of contact with the air, and thus atmospheric contamination will be prevented.

Effect of Oxidation.

Oxidisable oils, such as turpentine, however, whilst they do not affect the sensitivity of the crystal at first, rapidly produce a desensitising effect owing to oxidation products being set up on the face of the crystal and thus insulating or altering the nature of the contact.

Experiments such as these, therefore—and there are many similar ones which can easily be devised and conducted by the interested amateur—go to prove that ordinary pure greases and oils do not affect crystal sensitivity, and, therefore, that if any decrease in sensitivity becomes apparent after a crystal has been handled, the cause of such a phenomenon cannot very well

be ascribed to the action of grease. After all, it is very improbable that the high-frequency current which passes across the crystal contact would be insulated by an extremely minute grease film. Even the current from an ordinary dry battery would possess sufficient strength to overcome the insulating effect of such a film.

Inadvisable Experiments.

It has been suggested also that if a crystal becomes insensitive after handling, the effect may be due to the action of slight traces of fatty acids exuded by the skin on to the surface of the crystal. Again, however, very recent experiments would seem to prove that this supposition is incorrect. A crystal, after prolonged immersion in dilute ether or alcoholic solutions of skin acids, is not decreased in sensitivity. It is on record also that certain

medical individuals who are interested from an amateur standpoint in crystal reception and theory have even buried small pieces of highly crystalline galena in various portions of the bodies of dead animals, but all subsequent tests have failed to detect any decrease in sensitivity of the crystal.

There are many inorganic saline solutions which may be applied to the crystal surface without any loss in sensitivity resulting from the process. It is well known, of course, that substances

such as alum solution, or a strong solution of sodium thiosulphate (the photographer's "hypo" in a pure form), will very often increase a crystal's sensitivity. A solution of sulphuretted hydrogen in water or glycerine is also able to increase crystal sensitivity, but owing to the abominable smell of these solutions, the amateur is not advised to make experiments in this direction, or at any rate it would not be well to carry them out within odorous distance of the drawing-room or living apartments.

A Point to Note.

All these solutions act by dissolving off the surface layer of the crystal and thus exposing a fresh surface to the contact of the cat's-whisker. The point to note, however, is that any chemical or physical attack upon the crystal's surface does not necessarily result in a decrease of its radio-sensitivity. Indeed, as we have just seen, the reverse may very often be the case.

Dust has been another suggested cause of crystal insensitivity, and without a doubt

(Continued on page 52.)

WHAT MAKES THE CRYSTAL INSENSITIVE.

(Continued from page 51).

there is a large element of truth in this supposition. However, before one can ascribe a crystal's insensitivity to dust deposits on its surface, it is necessary to know more or less the exact nature of the dust.

Soot and Strong Signals.

For instance, a layer of fine sand upon a crystal would not destroy its sensitivity. Neither would a deposit of finely powdered inorganic insulating material. However, dust which contains particles of soot has an appreciable effect upon the strength of crystal reception, for when it is deposited upon the surface of the crystal it provides an alternative conducting path for the current. City atmospheres inevitably contain a large percentage of sooty matter in suspension, and this, settling upon the crystal surface, takes away from its sensitivity. It should be noted, however, that a crystal so stricken will nearly always regain its original sensitive powers after a little cleaning and treatment with thiosulphate or alum solution.

It would be interesting if some crystal enthusiast could collect statistics of the number of cases of crystal insensitivity which occur in various regions. For instance, if the sooty and organic components of town dust are responsible to some extent for the decrease in a crystal's sensitivity, it would be expected that crystal users in towns like Bournemouth and Aberdeen would be more exempt from these troubles than crystal-set listeners-in in cities such as Manchester, Birmingham, and Cardiff.

Exceptionally strong signals are also considered to detrimentally affect a crystal's sensitivity. In passing, however, it may be remarked that oscillatory discharges from Leyden jars have been passed through many commercial rectifying crystals and minerals without exerting any noticeable influence on their sensitivity.

To be brief, however, very little is known with regard to the fundamental causes of crystal insensitivity. Apart from the detrimental effect which some types of dust can be shown to exert, it is probable that one cause of crystal insensitivity is due to the disintegration of the crystal surface by continual abrasion by the cat's-whisker. Most galena crystals possess a soft surface which is easily indented by the constant adjustment of the contact point, and this indentation, destroying the regular crystal surface, may be responsible for the resultant decrease in sensitivity.

Effect of Gases.

The atmospheric effect on the surface of crystals is also concerned with the loss in sensitivity which is observed with many of them. Especially is this true of the very coarse-grained crystals. Some plain cubical varieties of galena very quickly lose their initial sensitivity, the almost flat surface of the crystal becoming covered with a layer of tarnish. Some experiments which have been carried out recently on the subject of crystal insensitivity are very interesting in

this connection, and they will well bear a brief description.

If, for instance, a current of moist air containing from three to ten per cent of carbon dioxide (carbonic acid gas) is passed over the surface of a number of galena crystals, the crystals, after a prolonged exposure, will exhibit a decreased sensitivity of between 15 and 30 per cent approximately. Furthermore, the coarser the grain of the crystal, the more rapidly will its sensitivity be decreased.



A portable four-valve Unidyne receiver constructed by R. Hansen, c/o Nedrej Allé 22, Trondhjem.

If the air and carbon dioxide are perfectly dry the crystal is but little affected, while if the moist gases are passed over heated crystals the sensitivity is very much reduced.

Exposure to Air.

The type of apparatus used for determining the effect of these gases, and various others, on crystals, is illustrated in Fig. 1, from which it will be seen that it is simple in construction, and can be easily rigged up by the amateur who possesses or can obtain access to a chemical laboratory. The crystals are contained in a tube through which the gas passes.

Similar results can be obtained by soaking sensitive crystals in an aqueous solution of

carbon dioxide, such as soda-water, for instance.

Experiments such as these go to prove that prolonged exposure to air containing varying amounts of carbon dioxide, which, incidentally, is a constituent of most atmospheres, can affect the crystal sensitivity by forming a film of lead carbonate or sub-carbonate on the surface of the crystal. This film acts, not by virtue of the increased resistance which it offers to the passage of the high-frequency current, but by changing

the actual nature of the rectifying contact, with the result that a detecting combination of weaker powers is set up.

Crystal sensitivity, therefore, cannot be said to be detrimentally affected by any one cause. Rather, a number of possible causes must be investigated before the problem can be considered to be finally solved.

In this article I have merely dealt with various theories which have been put forward from time to time to explain the vexing question, and

I have regarded them more or less in a critical light. Meanwhile the search for the solution of the problem goes on.

It is an interesting field of investigation, and it is one which can very readily be undertaken by the serious crystal experimenter. And last, but not least, it may be added that the crystal amateur who was able to devise a permanently sensitive natural or synthetic crystal would not only materially benefit as a result of his experiments, but he would also incur a very great debt of gratitude on the part of the many thousands of listeners-in who rely upon the humble and often despised crystal set to put them in touch with the outside radio world.

BOOK REVIEW.

Admiralty Handbook of Wireless Telegraphy (1925).

This book is a standard work on Wireless Telegraphy, published for the information and guidance of officers and men of H.M. Fleet. It is a large, bound volume of about 550 pages containing many illustrations and diagrams. There are also valuable appendices, which include tables of all sorts of wireless information in a handy form. The price is 5/- net.

Divided into nineteen chapters, the work is an authoritative outline of the whole art of wireless transmission and reception. The language is clear and concise, and the essential facts are presented to the general reader with striking success.

The book is arranged in self-contained chapters, consisting of complete numbered paragraphs. In this way information upon any particular branch of the subject can be extracted from the volume easily, and its

use as a work of reference is thereby enhanced. Copious cross references to other pages also assist in making the explanations comprehensive.

In view of the scope of the subject dealt with the book is a marvel of clear exposition. It is true that one or two errors were noticed in the mass of figures presented to the reader, and it is perhaps a pity that a correction slip was not enclosed, so that new copies could be amended by the owners before being brought into use. But in view of the fact that such errors are easily seen by the student, whilst nowhere else can he obtain cheaply such a mass of valuable wireless information upon wireless theory, no serious complaint can be made upon this head.

No experimenter, who wishes to get the most from his hobby, can fail to find the book invaluable as a work of reference, and its very low price makes it one of the most attractive radio bargains on the market.

It is obtainable direct from H.M. Stationary Office, Adastral House, Kingsway, London, W.C.2; 28, Abingdon Street, London, S.W.1; or through any bookseller.

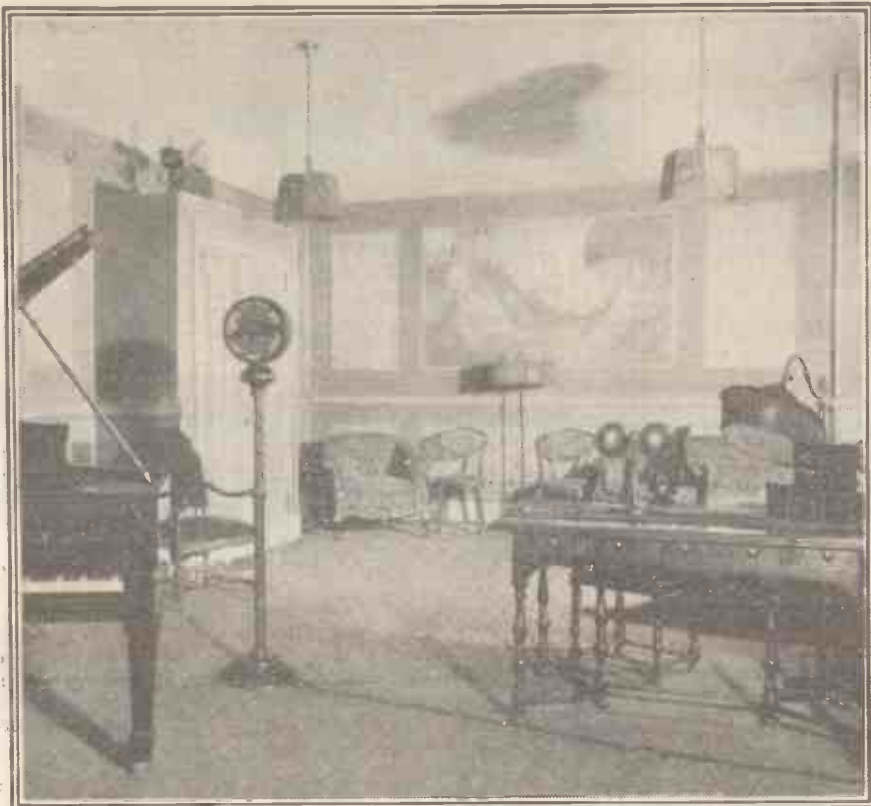

The palatial studio at W J Y, the station of the Radio Corporation of America, New York.

IN the very early days of wireless, regulations in the British Isles prevented the installation of a transmitter, and only in very special cases were licences granted. In America, however, anybody was at liberty to rig up a transmitter without the slightest fear of being a law breaker. Naturally, when broadcasting was first instituted in the States it was found necessary to licence all amateurs, but in the



Fig. 1—A gear-controlled variable condenser manufactured by the General Radio Co. of America.

years previous to the licensing regulations, much valuable experience was gained by the many amateurs, which proved to be of greatest value when the first broadcasting started.

This is one reason why American apparatus is sometimes more advanced than British goods, for many of the early

amateurs in the States are now prosperous manufacturers with more years of experience than the British manufacturer.

I don't wish to infer that British apparatus is not good, or not as good as the American, but it cannot be denied that the American manufacturers are often a little more advanced than their cousins across the water. By which I mean, while most of the U.S. people are using Ultra low-loss condensers, the British fan is still managing with the ordinary type of condenser.

Variable Condensers.

I am quite aware that the best of low-loss variable condensers are now obtainable from any wireless dealer in the British Isles, but they were in general use in the States many months before they appeared in Europe. However, comparing the British and American condenser, they are both as efficient as one another, although there is a great deal more variety of type as regards the vernier pattern in the States.

The first picture illustrating this article shows a very excellent variable condenser manufactured by the General Radio Co. of America. A separate knob, shown in the picture, is employed for fine tuning and, as will be seen, a geared arrangement facilitates this. This particular instrument is not of the square law type, although such a condenser is supplied by the same concern.

The instrument is very popular in the States, and many fans choose this condenser in preference to others. I think that I am correct in saying that there is no condenser on the British market similar in type to the one illustrated, although it is certain that there will be one soon, probably just as good.

Another very popular American condenser, not a low vernier one this time, is shown in my second picture. This instru-

RADIO COMPONENTS IN AMERICA.

DETAILS OF SOME NOVEL APPARATUS.

By L. W. CORBETT

(Formerly on the London Staff of "P.W.," and now our resident correspondent in New York).

This interesting article has been specially prepared by our New York Correspondent and gives British readers an excellent idea of what novelties are popular in America just now.

ment, manufactured by the Phoenix Radio Corporation of America, is known as the "ultra-low-loss" condenser, and low-loss it certainly is.

Scientifically Designed.

The special design and cut of the stator plates produces a straight line wave-length curve, separating stations evenly on the dial, while the minimum of metal in the field and frame of high resistance material reduces eddy current losses. There is only one strip of insulation material, and this alone is the cause of considerably reduced leakage. This particular condenser finds



Fig. 2—An Ultra low-loss condenser due to the Phoenix Corporation.

a ready market at five dollars, the equivalent of nearly 25s.

Vernier Dials.

Vernier dials are very popular in the States, and one of these may be screwed to the spindle of any condenser. It is not necessary for me to describe this instrument as I know many of American manufacture have already appeared on the market in London and other large cities. The third photograph illustrates a very good form of this type of geared dial. By turning the small knob, the black pointer is caused to rotate across the face of the stationary dial

(Continued on page 54.)

RADIO COMPONENTS IN AMERICA.

(Continued from page 53)

and the call letters of each station may be pencilled on the face once the station is found. - This dial is also supplied by the Phoenix Radio Corporation of 114E 25th Street, New York City.

Much time and expense has been given by manufacturers in America to the low-loss

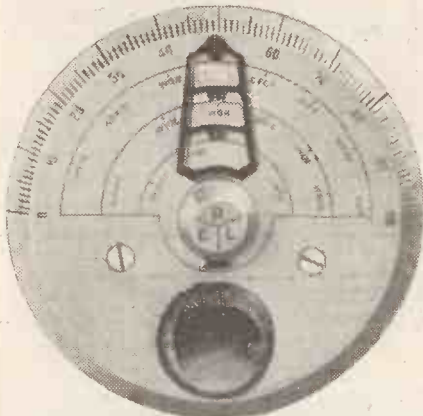

Fig. 3—A vernier dial produced by the Phoenix Corporation.

coil question, and many and varied are the types now obtainable in all American radio stores. Witness that shown in my fourth picture. It is the very latest in American coils, manufactured by the Electrical Research Laboratories at Chicago. The particular coil shown is an H.F. transformer, with N, G, F, B lettering. It is known as the Balloon Circloid, and I can vouch for its efficiency, having had the opportunity to test same myself.

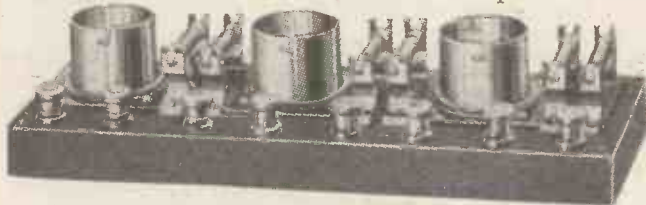

Fig. 5—A three valve resistance coupled amplifier manufactured by the Daven Radio Corporation.

The call for a really efficient H.F. transformer is very great over here (in America), for tuned anode coupling of H.F. stages is rarely employed.

The Erla "Balloon Circloid" Coil.

The "Circloid" coil is characterized by its entirely self-contained field and total im-

munity to external influences with consequent elimination of both outside interference and distortion creating feedbacks. Most people are aware that broad tuning is often caused by H.F. coils acting as pick-up devices for broadcast signals, but with the "Erla" Circloid coils this is entirely impossible, for the magnetic field is entirely self-contained.

Low-loss coils are of so many different forms and, in fact, have been elaborated on before in this journal, that I will not attempt to describe any more of American pattern, as they do not differ much from those manufactured in European countries; but I thought that the Circloid was deserving of special mention, as it is entirely different from anything I have seen before.

Resistance coupled amplification is becoming exceeding popular on the "gun" side of the Atlantic, chiefly, I believe, because it has circulated widely from New York City to Frisco that the B.B.C. engineers chose resistance coupled L.F. amplification for his Majesty King George's set.

The fifth picture shows a popular form of three "tube" resistance coupled amplifier manufactured by the Daven Radio Corporation of Newark, N.J.

Many and varied are the types of loud speakers our American cousins have to choose from. The cone type of instrument is becoming exceedingly popular, and it is said that it

will respond to a larger band of frequencies than will the horn type.

On some frequencies the cone type is certainly more pure in tone. The one illustrated is known as the "Musicone," and is manufactured by the Crossley Radio Corporation of Chicago.

As regards valves, it is difficult to say

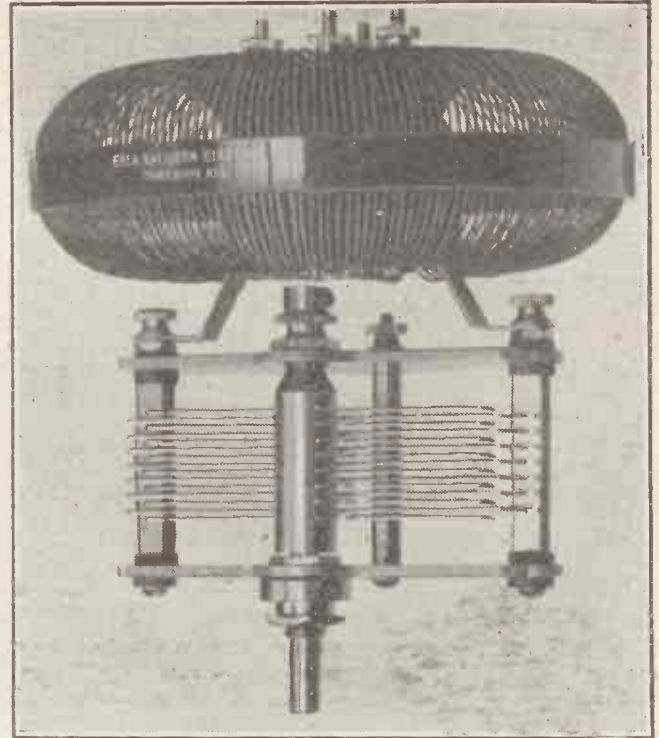

Fig. 4—A "Balloon Circloid" coil used as an H.F. transformer.

much about these, for there are so many on the market.

I have paid as little as the equivalent of "two" shillings for a valve and as much as 17s. 6d. The two shilling one was all right as long as it lasted, but that was not long.

Valve Price Reductions.

The Radio Corporation of America have recently reduced valve prices to 12s. 6d. The prices are the same for the .25 amp. and the .06 type.

It is interesting to note that two British products at least, have a very large sale in the United States. I refer to the Amplion loud speaker and the Bretwood variable grid leak.

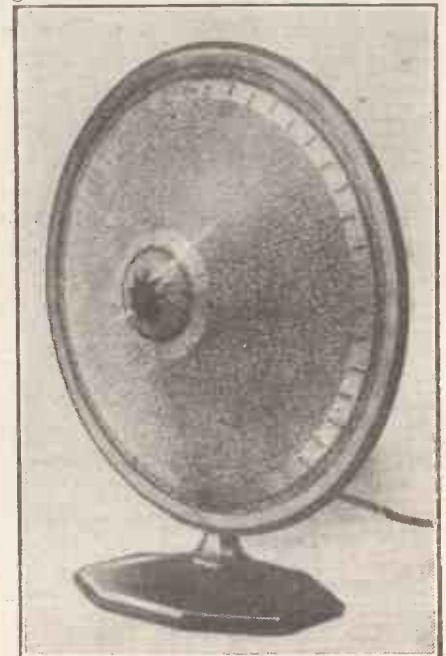

Fig. 7—The Crossley "Musicone" loud speaker.

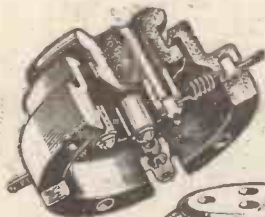

Fig. 6—The "Ultradyné," one of the most popular of modern American receivers.

Components for the amateur who always buys the best

Choose from the extensive Burndept range

BEFORE you start building your wireless set, be sure to give careful consideration to components. Remember that the efficiency of the set you build depends chiefly upon the components you use. If they bear the name "Burndept" you are absolutely sure of satisfaction—they are fully guaranteed.



The Anti-Phonic Valve Holder illustrated on left is a novel device that affords a valve complete protection from shock. This valve holder has proved a boon to all valve users. The Super-Vernier Dial illustrated below is a new feature of the ever-growing Burndept range. Very fine adjustment of condensers, etc., can be obtained by means of this dial.

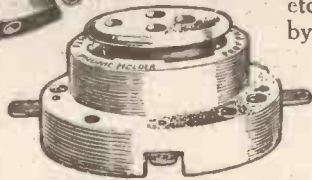

The above illustration shows a sectional view of the Anti-Phonic Valve Holder.

No. 401 Burndept Anti-Phonic Valve Holder, 5/-

The mechanism is an epicyclic gear, which gives a 7:1 reduction.

There are two models, No. 905, Model A, for $\frac{1}{4}$ " spindles (where there are no projections above the panel), with knob, etc., 7/6.

No. 906, Model B, for $\frac{3}{16}$ " and $\frac{1}{4}$ " spindles (one-hole fixing condensers, etc.), with knob, distance ring, etc., 8/6.

Be sure to visit our Stands at the N.A.R.M.A.T. Wireless Exhibition and see the extensive range of Burndept receivers and components, including the new Super Valves—on sale shortly.

Write for our latest Catalogue.

STANDS
11 and 12
Boxes 74 & 75

At the N.A.R.M.A.T. Wireless Exhibition, Royal Albert Hall, September 12th to 23rd.



The Burndept Super-Vernier Dial.

BURNDEPT

WIRELESS SUPPLIES

Head Office:

Aldine House, Bedford Street, Strand, W.C.2

Telephone: Gerrard 9072. Telegrams: Burndept, Westrand, London.

BRANCHES at Birmingham, Brighton, Bristol, Cardiff, Exeter, Glasgow, Leeds, Liverpool, Manchester, Newcastle, Northampton and Nottingham.



Another "Cosmos" Development

THE latest product of the "Cosmos" organisation, this compact New-Model Three-Valve Radio Set possesses a number of distinctive features, giving perfect reproduction with the minimum of controls.

A reflex circuit with resistance-capacity coupling is employed and Interchangeable Coil Units cover Wavelengths (i) 250 to 550 Metres and (ii) 1,300 to 3,000 Metres.

Anti-vibration valve holders are fitted and a dual rheostat with battery switch allows for the use of either Bright or Dull Emitter Valves.

The approximate range with a Loud Speaker is 50 miles from an ordinary B.B.C. Station and 150 miles from the High Power Station.

PRICE:

"Cosmos" 3-Valve Set, complete with B.B.C. Band Coil Unit, Valves, Batteries, Aerial and Earthing Equipment, Earth Switch, and Amplion AR Loud Speaker (50/-), including royalties, £1 17s. 6d.

£15 - 5 - 3

See the "Cosmos" Stand at the N.A.R.M.A.T. Wireless Exhibition ROYAL ALBERT HALL | Stand 8 | Sept. 12th to Sept. 23rd.—

The "Cosmos" Three-Valve Set is manufactured by the Metropolitan-Vickers Electrical Co., Ltd., and distributed by

METRO-VICK SUPPLIES LTD.

(Proprietors, Metropolitan-Vickers Elec. Co., Ltd.)

4, Central Buildings, Westminster, London, S.W.1.

:: Obtainable from most Wireless Dealers ::

Far and away the most satisfied

To possess a 'Kone' is to
 that no more perfectly satisfied
 Speaker can be obtained through
 the whole world.

HERE is the latest Loud Speaker that scientific research and experiment can offer, and which will prove a milestone on the road of advancement in the wireless art.

Special characteristics of the "Kone" Loud Speaker are as follows:

- Freedom from distortion.
- Greater purity of tone than any other Loud Speaker at present on the market.
- Even distribution of sound over wide area.
- Distinctive appearance.

Do not order your new Loud Speaker until you have heard a "Kone." You will save yourself disappointment.

Western Electric Company Limited.

CONNAUGHT HOUSE, ALDWYCH, LONDON, W.C.2.

CENTRAL : 7315 (9 lines).

Works : N. Woolwich, New Southgate, Bexley Heath, Hendon.

Branches : Birmingham, Leeds, Manchester, Newcastle, Glasgow, Cardiff, Southampton, Liverpool, Dublin.

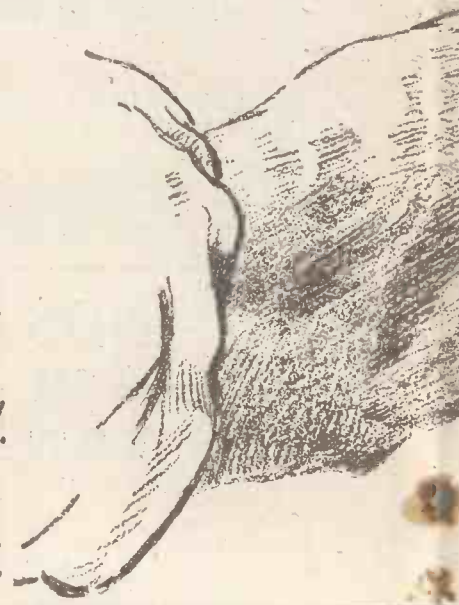

The wireless me

Best factory speaker ever invented

to know
satisfactory
throughout

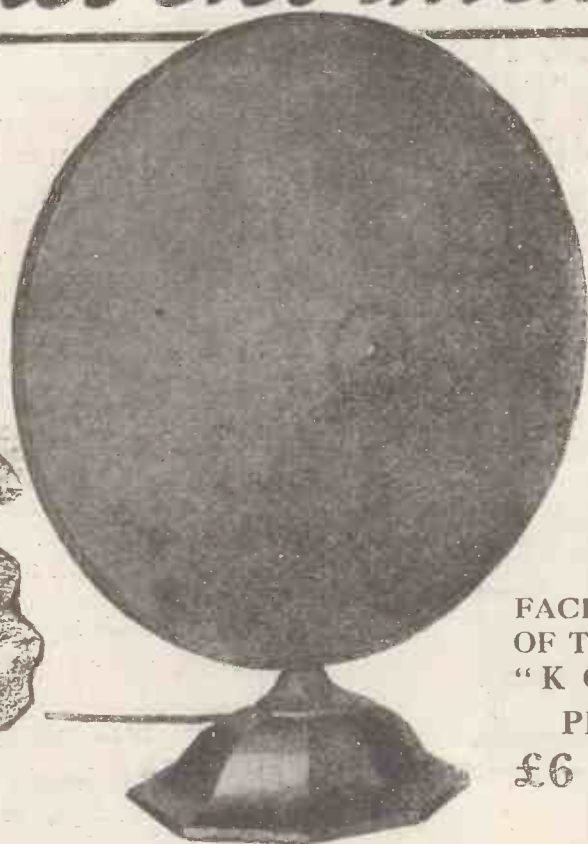

FACE VIEW
OF THE NEW
"K O N E"
PRICE
£6 : 6 : 0

PERFECT AMPLIFICATION

The "Kone" Amplifier gives really wonderful results used in combination with the "Kone" Speaker, or any other standard Loud Speaker of good design. Supplied as illustrated for inclusion in any existing furniture or encased in a handsome mahogany cabinet as a separate unit

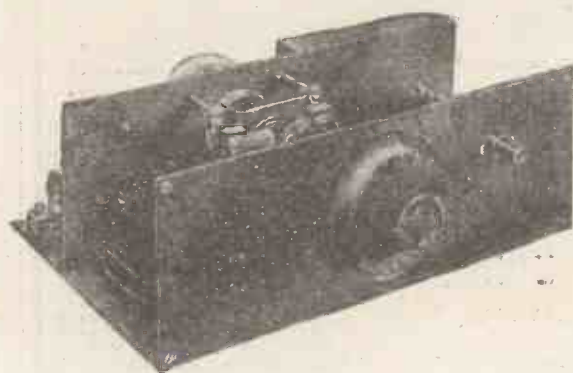

Marvel of 1925

It's here!

THE NEW SUPER "FULSTOP" CONDENSER

—the greatest advance in
variable condenser construction
since the introduction of wireless



The new Super Fulstop condenser is fitted with dual gearing. It has two operating knobs. One has a gear ratio of 2 to 1 and is used for first adjustment. The second—a small vernier knob—is geared 125 to 1 and is used for final critical tuning.

The dial is graduated round the whole circumference from 0 to 100. These graduations are again divided giving 200 actual readings. Each reading is capable of an infinite number of adjustments by means of the vernier gearing.

The clockwork multigear is made by watchmakers for the sake of accuracy and is quite free from backlash. It is a no-loss condenser, is perfectly square law and has brass vanes.

It is positively unapproached by any other variable condenser made.

Guaranteed to Abolish Hand Capacity

Super Fulstop		Standard Fulstop	
*00025	25/6	*0002	9/6
*0005	28/6	*0003	10/3
*001	30/6	*0005	11/3
The Standard Fulstop, geared 2 to 1, is still in great demand.		*001	13/6

There is also a plain Fulstop without gearing.

Send for full descriptive leaflet free.

Protected throughout the World.

If any difficulty in obtaining write
us and we will send direct post free.

J. H. NAYLOR LTD., WIGAN

Fulstop
VARIABLE
CONDENSER

Here is a new and better connecting wire!

With "Glazite"—the new coloured connecting wire—you can easily make the most complicated circuits without any chance of short circuits, or any difficulty in connecting up.

"Glazite" is made in four colours, Red, Blue, Yellow and Black, so that you can see at a glance the different parts of your circuit.

"Glazite" Connecting Wire consists of a tinned copper wire covered first with cotton and then with a film of heavy insulating material which is flame-proof and impervious to moisture. It has a high di-electric strength and is flexible.

Made in four colours—Red, Blue, Yellow and Black. Obtainable from all radio dealers, packed as follows:

10 ft. coils ($\frac{1}{18}$ s.w.g.) price 1/2 per coil.

2 ft. lengths ($\frac{1}{16}$ s.w.g.), 4 lengths in an envelope, assorted colours, price 1/- per packet.

Write for Glazite leaflet and name of nearest stockist.

GLAZITE

REGD.
THE NEW COLOURED CONNECTING WIRE

Our mark is a



guarantee of quality.

THE
**LONDON ELECTRIC WIRE CO.
& SMITHS, LTD.,**

Playhouse Yard, Golden Lane, London, E.C.1.

Telegrams :
Electric, London.

Telephone : Clerkenwell
1388, 1389, 1390, 1391



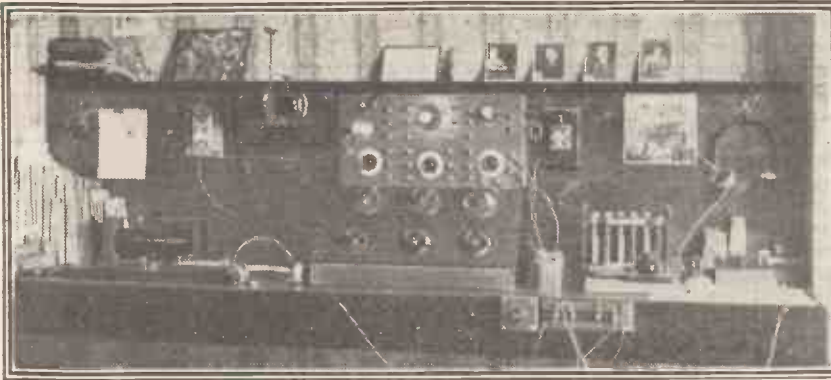

An experimental unit receiver and other apparatus made by Mr. W. Blackledge, 321, Tonge Moor Road, Bolton.

“INSIDE THE HEADPHONES.”

Have you ever stopped to think what a wonderful scientific instrument the head-
phone really is? This article gives you
some very interesting information on this
important subject.

(From a Scientific Correspondent.)

THE headphone is a tiny vibratory electric motor which transforms electrical energy into mechanical or sound energy. The permanent magnet is usually provided with mild steel pole-pieces, around which are placed the windings through which the incoming signal current is passed. The iron or stallo diaphragm is under a constant magnetic pull and is therefore normally deflected from its plane position.

an inch). In some cases the diaphragm is only about half this thickness. When the diaphragm is correctly mounted upon its seating, the central portion of the diaphragm should be separated from the magnet pole-pieces by a distance of about 10 mils, that is, one-hundredth of an inch.

Diaphragm's Mechanical Properties.

The mechanical properties of the diaphragm also have an important bearing upon the sensitiveness of the receiver. The sensitiveness of the diaphragm depends upon its diameter and thickness, and upon the density and elastic properties of the material of which it is made. In particular, the type of diaphragm used for a telephone receiver should have a natural frequency of vibration somewhere between 500 and 1,000 vibrations per second.

The actual energy delivered into a telephone receiver in the ordinary way may be of the order of 10 microwatts (10^{-5} watts), although it has been found that signals can be heard in the receiver when the energy is less than one-thousand-millionth of the above amount (10^{-11} watts).

Investigations of the strength of the alternating current in a telephone receiver required to produce the minimum audible sound have been made by the late Lord Rayleigh, and also by Wien. The maximum sensitiveness was attained for currents having a frequency between 600 and 700. These observations have been used in connection with spark telegraphy.

A Misleading Description.

The extent of motion of the telephone diaphragm, even when the latter is emitting a loud sound, is almost inconceivably small. Different investigators have examined the minimum amplitude necessary for the

production of an audible sound; this, of course, depends to some extent upon the frequency. According to experiments by Rayleigh, the minimum amplitude of vibration which could be perceived by the human ear was about 10^{-9} centimetres; that is, one thousand-millionth of a centimetre. Other observers have found the minimum amplitude for audibility to be as small as 10^{-12} centimetres; that is, a millionth of a millionth of a centimetre.

Of course, in practice the amplitude commonly occurring may be thousands of times the minimum amplitude. It is evident that when the diaphragm begins to strike the pole pieces, its amplitude is of the order of one-hundredth of an inch, but distortion of the sound occurs long before amplitudes of this magnitude are reached.

An ordinary low-resistance telephone receiver, such as is used on a line telephone,

(Continued on page 60.)

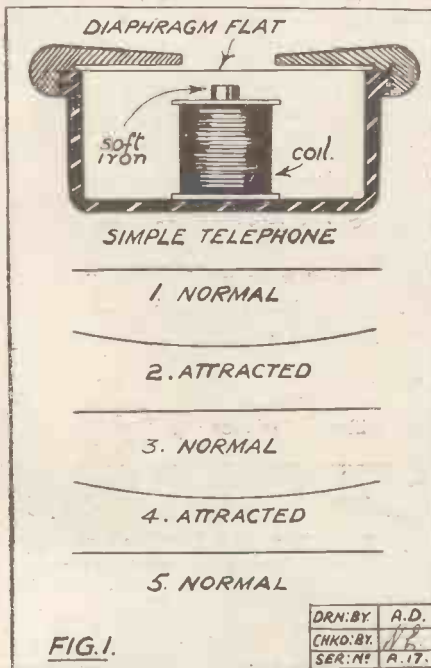

What the action of a telephone receiver would be if it employed a soft iron core magnet. Note the position of the diaphragm on the reception of telephony signals, which arrive in the form of current impulses of varying intensity.

When speech currents are received in the telephone windings they have the effect of alternately increasing and decreasing the permanent magnetic force, and thus causing the diaphragm to vibrate in a manner which corresponds to the variations in the incoming speech currents. The diaphragm, by its vibrations, produces sound waves in the air, and in this simple way the transformation of the energy from the electrical to the acoustical form is completed.

Some Diaphragm Details.

The diaphragm is usually of ferrotype iron or stallo, and about 12 mils thick (1 mil is equal to one-thousandth of

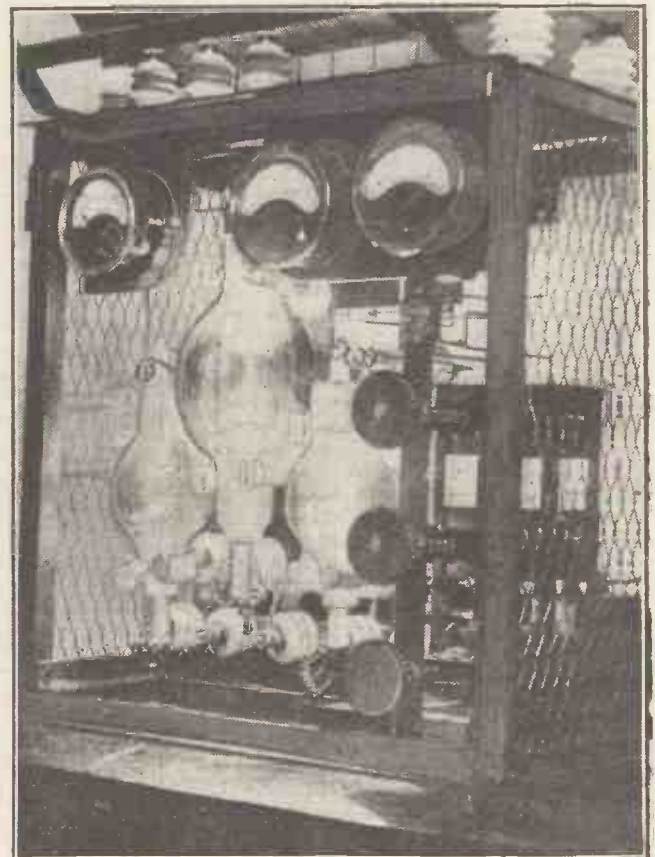

The 1-kw. C.W. transmitter on the new P. & O liner R.M.S. "Chitral."

**"INSIDE THE HEAD-
PHONES."**

(Continued from page 59.)

may have a direct current resistance of about 70 ohms and an alternating current resistance at 800 cycles (impedance) of 250 ohms. It is important to point out that the direct-current resistance of a telephone receiver gives very little information as to its behaviour when used

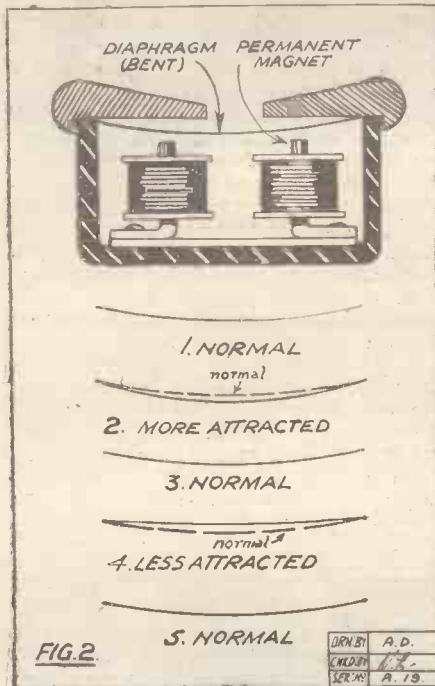

"Bias" given to the diaphragm by employing a permanent magnet. The diaphragm is more or less attracted according to the varying intensity of the signal current.

for the reception of comparatively high-frequency variable current.

The prevalent practice of specifying a telephone receiver by this direct current resistance has little or no justification, since the impedance or alternating current resistance at normal speech frequencies may be from 3 to 10 times the direct current resistance. In some cases, in fact, where high resistance telephones have been specified for a particular purpose, makers have actually been known to employ high resistance wire (for example, nickel-silver) so as to increase the D.C. resistance of the coils. The desired A.C. resistance should be obtained by winding the coils with a sufficient number of turns of copper wire, and if this cannot be done, it is preferable to use a lower resistance telephone.

Resistance No Advantage.

As already stated above, the effective A.C. ampere-turns should be a maximum, and an ideal winding would, in fact, have a negligible D.C. resistance. The proper way to specify a telephone receiver is by its impedance (when damped) at speech frequencies—say, at 800 cycles.

Readers are aware that in using telephones in a high resistance circuit (such

as a wireless crystal or valve circuit) the telephones themselves should be of high resistance, the best condition being when the effective resistance of the telephones is equal to that of the remainder of the circuit. The reason for using high resistance telephones is frequently misunderstood, and questions are often asked as to the advantage of high resistance.

I think it will be useful to explain this point more fully.

First of all, resistance, *as such*, is of no advantage, and has the effect, in this case as in other cases, of reducing the current which can flow through the circuit. What we really aim at is securing the greatest number of effective ampere-turns in the telephone windings. Since low-resistance wire is thicker, it will not be possible to wind so many turns of it in the available space in the telephone receiver. If we wish to wind a greater number of turns, we must employ finer wire. The first limiting condition is the convenient mechanical size of the telephone receiver. As we use finer wire and a larger number of turns, we increase the ampere-turns for a given current; but beyond a certain point further increase in the number of turns (and the use of still finer wire) increases the resistance of the circuit to a greater extent than it increases the effective ampere-turns.

Value of Ampere-turns.

A simple illustration will probably make the matter clearer. In the following illustration we are considering direct current for the sake of simplicity, whereas in the actual case of the telephone receiver we have to deal, not merely with D.C. resistance, but with impedance. Suppose we have two telephones, one 10 ohms resistance and the other 1,000 ohms, and a crystal circuit in which the resistance of the crystal is 10,000 ohms, we will say.

Let us assume, further, that the 1,000 ohm telephone has 1,000 turns of fine wire, while the 10 ohm telephone has 10 turns of wire. If we employ the 1,000

ohm telephone in the crystal circuit, we increase the resistance from 10,000 ohms to 11,000 ohms, and thus have ten-elevenths of the original current flowing through 1,000 turns; that is, the ampere-turns are $10/11 \times 1,000$, or approximately 1,000 C where C is the original current.

If, however, we substitute the 10 ohms telephones, we have increased the resistance of the circuit by a negligible amount, and we have practically the original current flowing through 10 turns; that is, the ampere-turns are approximately 10 C.

In this case the ampere-turns in the high-resistance telephones are about 100 times as great as in the low-resistance telephones, and the advantage of the high-resistance telephone in the high-resistance circuit is apparent.

Unavoidable Evil.

Now, suppose we have a low-resistance circuit in which the resistance is, say, 10 ohms. If we introduce the high-resistance telephones, we raise the total resistance of the circuit from 10 to 1,010 ohms, and so reduce the current to about one-thousandth, the ampere-turns then being $1,000 \times 1/1000$; that is, about C.

If we substitute the low-resistance telephones, we raise the resistance of the circuit from 10 to 20, and this reduces the current in the circuit to one-half, which, multiplied by the 10 turns, gives 5 C ampere-turns.

The above illustration, although somewhat crude and omitting certain factors which arise in the practical case, shows in a general way why high-resistance phones are specified for high-resistance circuits; the advantage is not in the high resistance, but in the securing of ampere-turns.

The simultaneous production of high resistance is a necessary evil, the disadvantage of which is more than counter-balanced by the increase in ampere-turns if the telephones have been properly and scientifically designed.

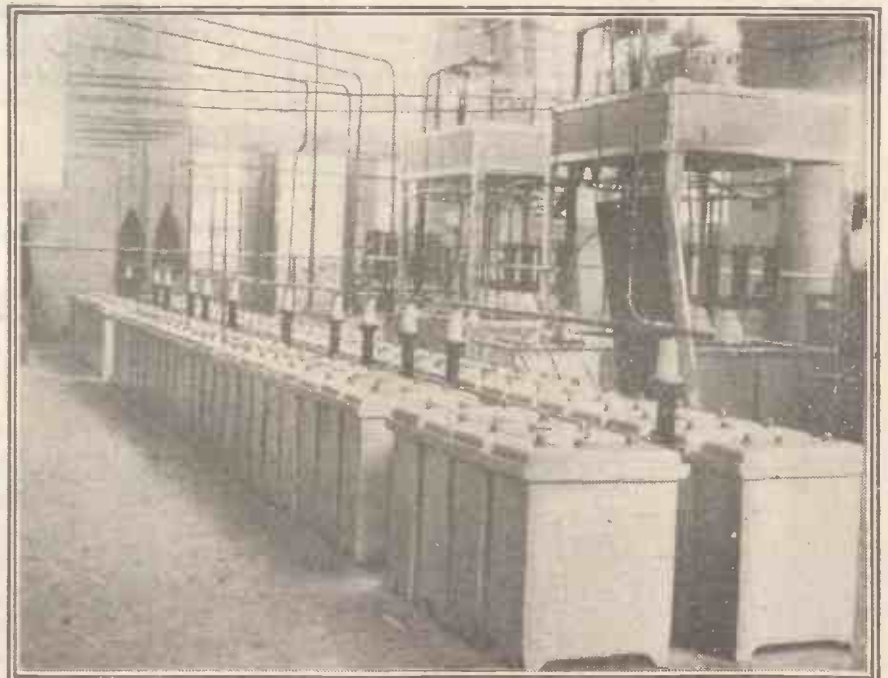

The condenser banks at 5 X X, the new high-power station at Daventry.

PORTO RICO CALLING.

A series of special photographs of a well-known South American Broadcaster.

SINCE December, 1922, the voice of W K A Q has been heard in the crowded ether by the radio fans of the world. It is a powerful voice, quite different from the more delicate sounds of the radio fans' old friends, K D K A, W G Y, W G N, K G O, etc., in the United States. It is in Porto Rico, "the Island of Enchantment" itself speaking through W K A Q.

The photos on this page show the aerial, studio, and control room. The last photo shows a Porto Rico amateur's set, call sign 4 J E.

The Porto Rico transmitter is the standard Western Electric 500 watts output. Actual radiation on 880 kilocycles is 6-7 amps. The studio walls are covered with layers of blanket material under-curtains to deaden echo. The reception room is right under the steel tower on top of the building.

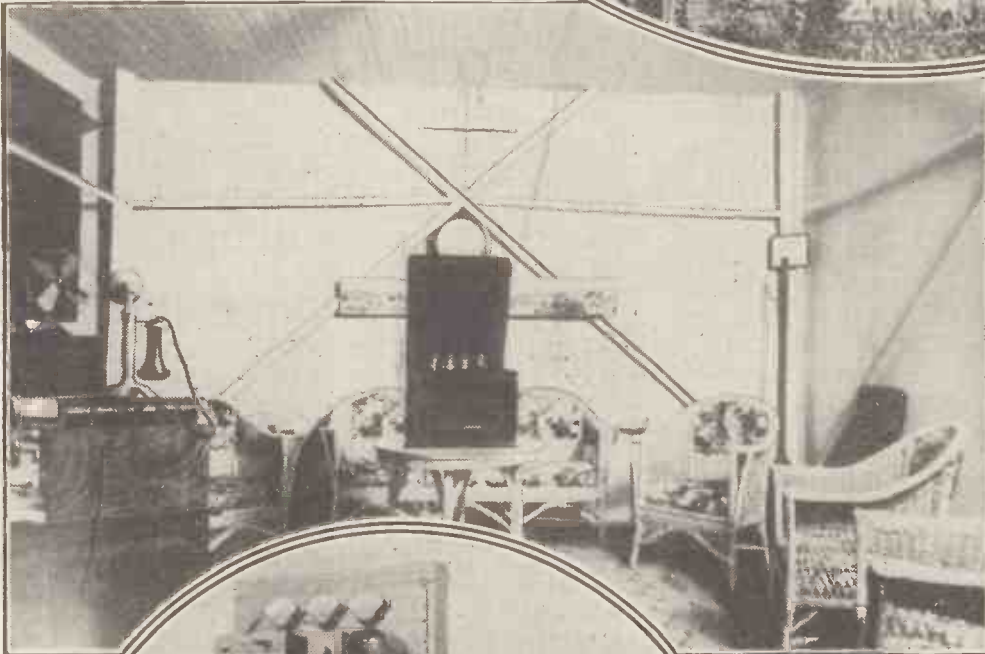

In general, W K A Q is broadcasting at present Sundays and Wednesdays, 8 to 10 p.m.; band concerts from the Plaza Baldorioty de Castro, and Thursdays, 8.30 to 10 p.m. from Café le Cafetera (the Coffee Pot). All the hours are Porto Rican time, which is one hour later than E.S.T.

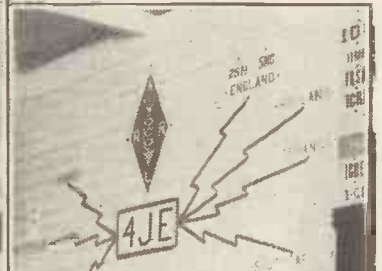



CURRENT TOPICS

BY THE EDITOR

The Radio Association Examination—Some Typical Questions—A New Invention—The Heaviside Layer.

IN a recent article we made reference to the Stanley Gold Medal—a wireless award for inventors, offered by the Chairman of the Wireless League. We had occasion to criticise the claims made for the value of this medal as to its indication of the holder's ability as an inventor, and we suggested that this medal would not be taken seriously unless the judges were recognised radio authorities.

This week we feel compelled to draw attention to the examination for the Fellowship of the Radio Association.

We have always had the friendliest feelings for the Radio Association. We have, from time to time, helped it to the best of our ability.

The F.R.A.

But it is with irritation and no little surprise that we notice that the Radio Association is in a fair way to ruin its own chances of being taken seriously. It is primarily an association for the amateur and listener; it is, in reality, the original Wireless League (compare the newly born Wireless League's rules, etc., with those of the Radio Association) and as such did not clash with the Radio Society of Great Britain, or attempt to set itself up as a technical arbiter.

We have heard of the Fellowship of the Radio Association before, and thought the idea a good one, inasmuch as it stimulated an interest in the ranks of wireless amateurs, and gave the Association an opportunity of encouraging amateur radio practice. But we have recently seen the examination papers for this Fellowship, and we have no hesitation in saying—reluctant as we are to do so—that, as papers for amateurs, they are ludicrous.

Some of the questions convince us that many of the gentlemen at present holding the "degree" of Fellow of the Radio Association must have received that degree as a gift. Certainly we are aware of Fellows whose technical knowledge would not have enabled them to pass the examination papers we have before us.

Some Typical Questions.

We cannot understand the attitude of the Radio Association in preparing such papers for candidates of the amateur status. If they reply that the F.R.A. is for advanced students, etc., then they are meddling with what does not concern them. Bona fide fellowships of this nature should be left to the Institute of Radio Engineers and the Institution of Electrical Engineers (Radio Section). We publish here a typical extract from the specimen examination papers sent to us by the Radio Association:

1. Deduce an expression for the frequency of free oscillation of an elastic system in which the restoring force is proportional to the displacement from the mean position, and there is negligible damping, in terms of the elastic co-efficient and the inertia co-efficient. In what way does such a system resemble an electrical circuit consisting of an inductance and a condenser and what is the analogous expression in the electrical case?

2. A sinusoidal voltage is applied to a certain circuit consisting of resistance R in parallel with a leaky condenser. The letter may be represented by a perfect condenser of capacitance C and a series resistance S . Determine the impedance and admittance of this circuit by the vector operator method and the current in each branch, using suitable symbols to differentiate between any vector and scalar quantities employed.

3. An alternating P.D. of 2 volts at 250,000 f. is applied to the primary of an air core transformer, the resistance (H.F.) of the primary being 60 ohms and its inductance 600 micro-henries. The mutual inductance between primary and secondary being 150 micro-henries, what will be the voltage across the secondary or open circuit? If, upon actual measurement, the observed voltage did not agree with that calculated from the above quantities, to what would you attribute the discrepancy?

A stream of particles of mass m grammes is attracted to a plate of mass M grammes with a steady force of p dynes from rest at a distance of S cms. If the particles are embedded in the plate when they impinge and the S.H. of the metal is H gm cal per °C, calculate the temperature rise produced. [mech. equiv. of heat 426.9 m kg/kg cal.]

Revolutionary Claims.

We venture to observe that the above questions are entirely unsuitable for a Radio Association examination. Men who could answer the above questions would not bother about the letters "F.R.A."—they would try for the A.M.I.E.E. or something equivalent. And the practice of scattering Honorary "F.R.A.'s" will not tend to improve the status of the Fellowship.

Publicity has been given in the Press to a new wireless invention the principles of which have been worked out by Mr. H. E. Chapman, Technical Director of Messrs. Autoveyors, Ltd. We quote from the "Daily Express":

"Long-distance wireless transmission and reception without valves or coils—as these are usually understood—short-wave communication every hour of every day between any two points in the world with apparatus that costs less than £50; perfect reproduction of broadcast music and speech without rectification; satisfactory reception in England of programmes from any station in Europe with apparatus that is extremely simple and cheap; a directional ray of transmission which can be aimed at a given point, regardless of distance, with a degree of accuracy that will give almost perfect secrecy; the removal once and for all of those bugbears of radio, fading and atmospherics—these are the revolutionary claims made for the new system."

We have received details of the new receiving circuit from Mr. Chapman, and also two examples of the new valve, neces-

sary for use in connection with the circuit.

In the meantime, we would, in all friendliness, urge Mr. Chapman to refrain from making claims until he is ready to give a conclusive demonstration of his invention.

If his invention is all that he claims for it (although at the moment of writing the technical staff, who have fitted up a special set embodying the circuit as given by Mr. Chapman, have failed completely to obtain satisfactory results) we would not wish to see the inventor suffer from excessive and exuberant publicity.

We have in mind publicity given to Messrs. Autoveyors a year or so ago, concerning the transmission of power by wireless. We would remind them of this, and the fact that further details are still awaited—and have been for some time.

* * *

In connection with the above invention we note, from the journal we have already quoted from, the following:

"Mr. Chapman, who is the technical director of Autoveyors, Ltd., and a wireless engineer of long experience, begins with a revolutionary theory which, if it does not contradict, at least modifies considerably the theory of the existence of the 'Heaviside Layer'—that is, a layer in the upper atmosphere named after the man who discovered it, which deflects wireless waves. There is no layer, says Mr. Chapman in effect. Instead there is a dense electronic field enveloping the earth whose density varies with the density and the temperature of the atmosphere and with its distance from the earth's surface.

"Whereas the earth's magnetic field has its orbit in a latitudinal plane, this electronic field has its orbit in a longitudinal plane.

"By concentrating the output of a transmitter into a ray or beam, and aiming it at a given angle into the electronic and magnetic fields—which is what Mr. Chapman's apparatus is stated to do—it can be directed to any receiver anywhere in the world with such a degree of precision that it cannot be picked up anywhere else except in the close vicinity of the receiver itself, and perhaps within a few hundred yards of the transmitter."

More Claims.

This theory of Mr. Chapman's is quite interesting, especially when compared with the following, which we quote from the "Daily Chronicle":

"Of immense interest to radio devotees is the discovery of the reason for 'skip distances'—the intervening of dead spaces of non-reception—and 'fading.' It has been established by investigators at the Naval Research Laboratory in Washington and the Carnegie Institute of Washington that these phenomena are caused by a deflecting 'roof'—the spherical shell, zone or stratum of maximum atmospheric 'resistance'—in other words, the ceiling of the dome of the heavens."

In other words, the "Daily Chronicle" reports that definite proof of the existence of the Heaviside Layer has been obtained.

We would strongly urge Autoveyors, Ltd., to give a proper demonstration to the Press and to the real technical experts—men like Sir Oliver Lodge, Dr. Eccles, and others.

We shall look forward to such a demonstration with interest.

Introducing

CLEARTRON

BRITISH  MADE.

RADIO VALVES



**AN EVERY
PURPOSE POWER
VALVE**

C.T. 25.

Fil. Volts, 5.
Fil. Current, 0.25 amp.
Anode Volts, 30-150.
Anode Impedance, 10,000.
Amplification Factor, 9.

15/-

**FOR RESISTANCE
CAPACITY
COUPLED
AMPLIFIER**

C.T. 25B.

Fil. Volts, 5.
Fil. Current, 0.25 amp.
Anode Volts, 90-200.
Anode Impedance, 20,000.
Amplification Factor, 20.
Power Amp. Factor, 20.

15/-

Supplied English or
American Bases.

Cleartron—America's biggest selling independent wireless valve—is now manufactured at the Cleartron Works in Birmingham—Britain's newest and most recently equipped radio factory.

CLEARTRON VALVES possess UNUSUAL RECEPTION QUALITIES through which they have achieved their great reputation and sale in America.

VASTLY INCREASED VOLUME
FAR GREATER DISTANCE
OPERATIC PURITY OF TONE
KEENER SELECTIVITY

[Sold under an Ironclad Guarantee

**POSITIVE PERFORMANCE
OR INSTANT REPLACEMENT**

Full technical data on request or sample valves sent post free, together with our Ironclad Guarantee, on receipt of remittance and name of nearest Dealer.



**AN EVERY
PURPOSE
VOLUME VALVE**
C.T. 08.

Fil. Volts, 3.
Fil. Current, 0.08 amp.
Anode Volts, 30-150.
Anode Impedance, 17,500.
Amplification Factor, 8.75.

12/6

**AN EVERY
PURPOSE
VOLUME VALVE**
C.T. 15.

Fil. Volts, 1.8.
Fil. Current, 0.15 amp.
Anode Volts, 30-160.
Anode Impedance, 20,000.
Amplification Factor, 10.

12/6

Also
**CLEARTRON VALVES
FOR AMERICAN SETS
AND KITS.**

**C.T. 199 (Dry Cells) and
C.T. 201a (Accumulators).**

15/- each.

CLEARTRON RADIO LIMITED
1, CHARING CROSS, LONDON, S.W.1

And BIRMINGHAM.

'Phones—
REGENT 2231/2.

'Grams—
CLEARTRON, WESTRAND, LONDON.

I AM more optimistic this week than I was last week. I was then depressed by the feeling that there seemed to be an unavoidable interregnum, during which British broadcasting would stand still while the Government Committee was determining its future.

Fortunately, however, there are unmistakable signs that the resilience which comes to the rescue of typically British crises has again manifested itself. There is now much less likelihood of the exercise of the "dead-hand" in the literal acceptance. For one thing, the rehearsal of the new scheme of European wave-length allocation is taking place as arranged. Then, again, the speeches at the League of Nations Assembly are to be broadcast, if only by wireless link. Moreover, the attitude of crystal listeners in Essex, North Kent, and on the South



A recent photo of Mr. Marconi boarding his yacht "Elettra."

East Coast, who have suffered because of the removal of the high power station to Daventry, is receiving more sympathetic consideration.

It is quite true that the Daventry station can be justified on the grounds of the "greatest good for the greatest number," but this is singularly inadequate consolation for those who are deprived of their programs in the East and South East.

Administration Expenses.

The softening of the official attitude is, I believe, a preliminary to a granting of those essential facilities upon which the British Broadcasting system depends, if it is to obtain its objective.—So far so good. We have much to be thankful for, and the prospects are reasonably sound. But there is one thing that really needs emphasis at this juncture, and that is that the Big Idea shall prevail. There is a real danger that, in the course of self-preservation, the B.B.C. will be disposed to pay too much attention to explaining away the minor difficulties of organisation for the benefit of the Broadcasting Committee. In this connection I think it is perhaps worth mentioning that there are two sides to the interpretation of the recent analysis of B.B.C. expenditure.



From the angle of economy, the fact that only about 7 per cent of current revenue was devoted to administration appeared eminently satisfactory. But I am not so sure that the proportion is really sound. I have a very definite impression that on its administrative side the B.B.C. is starving itself in the interests of false economy.

I took the trouble the other day to ask an independent financier, who has behind him a great deal of useful experience, to assess the commercial value of the position of executive chief of the B.B.C. His reply was £10,000 a year.

High Standard of Efficiency.

Now, I do not profess to know what the Managing Director of the B.B.C. gets in the way of salary, but I do know that he deserves £10,000 a year, and his staff should be paid in proportion. I know also that actuality falls a great deal short of this standard. Now all this may seem quite immaterial to the listener. But it is in point of fact a very relevant consideration. We have here the greatest potential agent of distribution of ideas and entertainment that civilisation so far has devised.

In Great Britain we have developed a system of which we are justly proud, because of its clear margin of superiority. It is of cardinal importance that big conceptions and a generous attitude should prevail in our broadcasting system. The immensity of its possibilities needs no elaboration. There is no talent too good for employment in this service. I think we are extremely fortunate in the standard of talent so far employed. That it should be rewarded adequately is a necessary corollary.

And if listeners are to maintain their interest and control, they would be well advised to pay some little attention to the general organisation and the rates of pay of the B.B.C. officials. Assuming a reasonable decision on the part of the Government Broadcasting Committee, and I can see a considerable extension of the frontiers of broadcasting. There will, of course, be devised more adequate safeguards in various directions, but I believe there is no doubt that the scope of broadcasting will be considerably enlarged.

The Future News Bulletin.

A prominent newspaper editor was telling me the other day that his proprietors had already reconciled themselves to an exten-

sion of the broadcast news service. They were, in fact, laying their plans with a view to strengthening the comments and explanatory features which would replace some of the news features hitherto regarded as important auxiliaries to circulation. My friend was perfectly frank. He put it in this way. "We would much rather that wireless broadcasting had never been, but now that it has come, and has established itself, we must admit, that at least in the way it has been administered in this country, it has damaged us very little in comparison with what it might have done under a different regime.

"Nevertheless, even assuming, as we do, that substantially the present regime will be continued, we see that the time is not far distant when 'red hot' news will find its normal venue through the medium of broadcasting.

Two Interesting Suggestions.

"We are not silly enough to imagine that the broadcast news service will always be confined to the present bulletins which come out at seven and ten o'clock every night. We are prepared to face the inevitable development of big stories breaking on the wireless almost immediately they happen.

But we realise that we still have a great advantage in the permanence of our record, and in the opportunity we have for interpretation and explanation. We believe that we can still hold our own by adaptation."

And now I want to put two suggestions to the B.B.C. I always intended to be constructive, but I have found it so easy to comment and criticise that I readily admit I have been insufficiently constructive. My first suggestion is that the B.B.C. should signalise St. Cecilia's Day, 22nd November. St. Cecilia is Patron Saint of Music and Patron Saint of the Blind—enough said. We want a specially big programme on this day and the case is irresistible.

My second suggestion is, I confess, more challenging. It is that on December 15th, the date of the National Radio Revel, there should be a preliminary broadcast of Dean Inge's address at St. Martin-in-the-Fields on the occasion of the special service in



M. Pouishnoti, the "Mystery Pianist" who will broadcast again from 2 L O.

connection with the work of the world Alliance of the Churches.

I understand that Dean Inge is prepared to allow this broadcast even if under protest. I don't quite see how he could do otherwise in view of his recent broadcast in the States. Still it would be worth doing on this occasion, and I am by no means sure it would not be a real stroke of imagination.

Do it well!

The knowledge that you will be putting your best into the sets you make is one big reason why The Bowyer-Lowe Company never sends an untried article out of its factory. We do our work well because we should not expect you to be satisfied with inefficient components.

Many a wireless set is spoilt for a ha'porth of tar. Insist that the components you buy are worthy of the skill with which you build—say "Bowyer-Lowe" to your dealer, and mean it.



COIL PLUG & SOCKET

Three types made. One for baseboard mounting with top connection. One mounted on circular ebonite flange for wood panel and cabinet mounting. Plug and socket only for panel mounting. Base-board or flange type, 2/6. Panel Mounting Type **9d.**

MATCHED H.F. TRANSFORMERS

Every Bowyer-Lowe Transformer is individually matched against standards so that every one of a range is precisely like every other. No special selection for H.F. Stages is necessary. All ranges from 150 to 2000 metres and up, and special Neurodyne Unit, 300 to 600 metres, at uniform price. Each **7/-**
ALL RANGES



"ANTIPONG" VALVE HOLDER



Non-microphonic, low loss and shock absorbing this valve holder is the most efficient devised. It prevents all noises in Dull Emitters and protects ordinary valves from jars. Valve legs surrounded by air are mounted on phosphor-bronze springs and attached to a non-inflammable bakelite ring. Universal fitting. Screws provided. Price **3/-**

Bowyer-Lowe Tested Components

Send the coupon below for a free copy of our Special "Radio News" Exhibition Catalogue of Components and Sets.
BOWYER-LOWE CO., LTD., LETCHWORTH.

WIRELESS EXHIBITION

ALBERT HALL,
September
12 to 23.

COUPON

BOWYER-LOWE CO., LTD., LETCHWORTH.

Please send your special **EXHIBITION CATALOGUE.**

Name.....

Address.....

FLETCHER AD

Get Yesly Tuning for CONCENTRATION

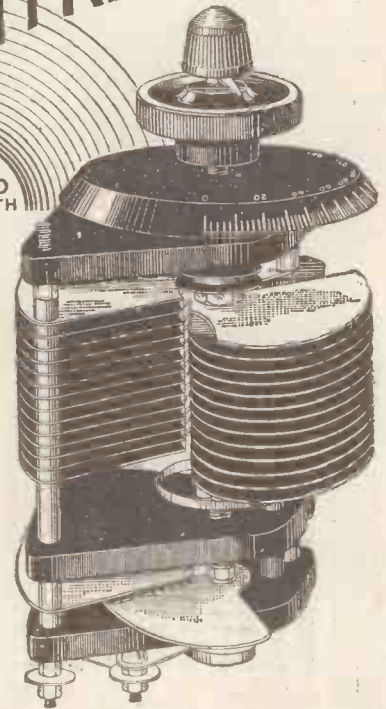
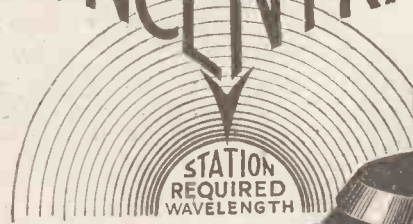

**BETTER TUNING
GREATER VOLUME**

Clean cut signals are the direct results of accurate tuning. 50% to 100% improvement in the volume of reception can be obtained with improved tuning apparatus.

With **YESLY TUNING** each individual station can be isolated so as to obtain the full strength of its signals without interruption.

The accuracy required for this concentrated tuning is **THE** feature of the **Yesly Square Law Variable Condenser.**

Ask for Leaflet C1 giving full information.

NOTE

- | | | |
|--|--------------|---------|
| (1) The first-class GENERAL FINISH. | Plain. | Vernier |
| (2) The pure EBONITE highly polished plates. | ·001 - 11/6 | ·15/- |
| (3) The coiled SPRING MOVING contacts. | ·0005 - 10/6 | ·14/- |
| (4) The ONE HOLE FIXING with embedded nut to eliminate all backlash and spindle play. | ·0003 - 10/- | ·13/- |
| (5) The special panel pin to prevent bodily rotation. | ·00025 9/6 | ·12/6 |
| (6) The ROBUST CONSTRUCTION. | ·0002 - 9/- | ·12/- |
| (7) The MODERATE PRICES. | | |

The highest possible standard in Aerial tuning demands **YESLY COMPONENTS.**

LOOK FOR THE NAME



Obtainable from your local dealer. If you have any difficulty write to—
ENGINEERING SUPPLIES Ltd.
235, Blackfriars Road, London, S.E., England

BARE WIRE COILS.

BARE wire coils have such obvious advantages over the usual cotton-covered types that the little extra trouble entailed in making the following very efficient coil, especially for short waves, is well worth while. In the construction the writer has aimed at rigidity and efficiency, while using the smallest amount of insulating material consistent with mechanical strength. The result is a coil of extremely low self-capacity.

The former is of ebonite, $\frac{1}{2}$ in. in breadth and 1 in. in diameter, and can be bought

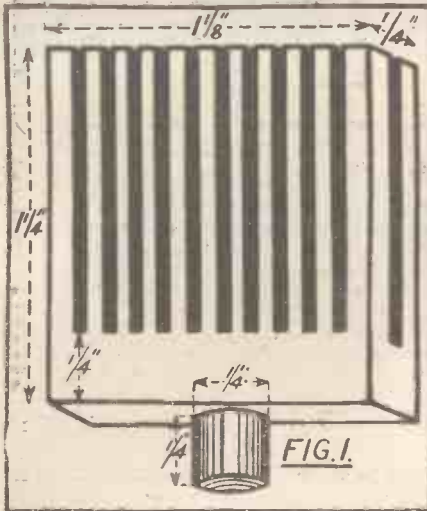

for a few pence. The coil is supported by five ebonite supports—made from scrap ebonite, distributed round the former at five equidistant points, rendering the coil pentagonal in shape when completed.

Tinned Copper Wire Best.

Each support is made to the dimensions in Fig. 1. In cutting them out of the ebonite the small plug at the base is left continuous with the rest of the structure. Ten slots are then cut with a fret-saw—or hack-saw—to within $\frac{1}{4}$ in. of the base. Another slot is then cut longitudinally through the edge of the support, also to within $\frac{1}{4}$ in. of the base. This will be quite clear by referring to Fig. 1.

Five holes, each $\frac{1}{4}$ in. in diameter, are then drilled round the former in the middle line, at an equal distance from each other. The supports are then plugged into these holes, the short plugs being filed round

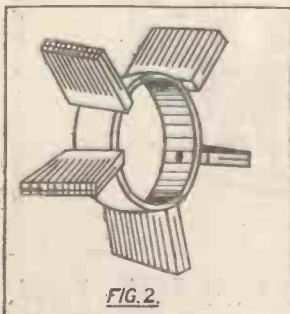

till they are a tight fit in the holes. Fig. 2 shows the arrangement of the coil at this stage.

The most suitable wire to use is No. 24 gauge tinned copper. The beginning of the wire is fixed through a small hole drilled in the edge of the former. The turns are passed through the slots until ten turns in all have been wound (Fig. 3).

Turns Well Spaced.

Before winding on the next layer, small, thin distance pieces of fibre or ebonite, $1\frac{1}{2}$ in. long and $\frac{1}{8}$ in. broad, are pushed into the longitudinal slots in the supports, and they should be sufficiently firm to prevent them falling out when the next layer of wire is being wound on. In this way each layer is separated from the preceding one by $\frac{1}{8}$ in., being the breadth of each distance piece, and each turn is separated from its neighbour.

The maximum number of turns which can be wound on the former of the dimensions given is about 60. Should a greater number be required the height of the supports should be increased accordingly. Fifty turns with a .0005 mfd. variable condenser in parallel in the aerial circuit are ample for all B.B.C. stations. Sixty to seventy-five are sufficient for reaction.

Care should be taken that the wire is wound on as tightly as possible. The method of mounting is shown in Fig. 4.

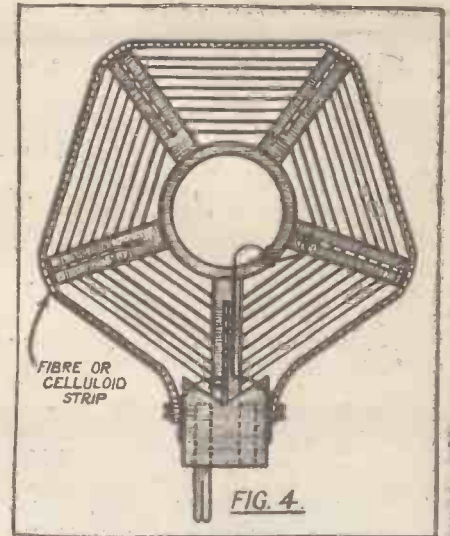
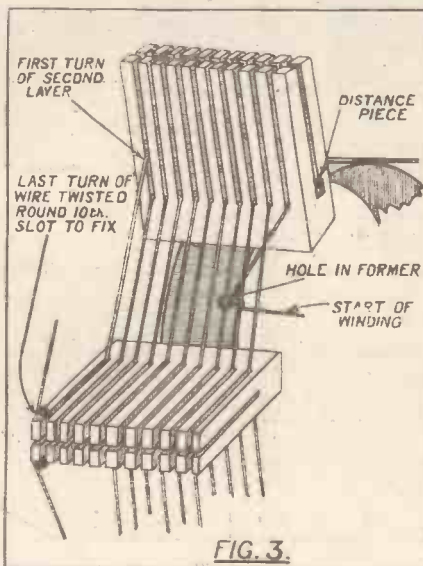

A HINT FOR CRYSTAL USERS.

WIRELESS enthusiasts who carry out experiments on various rectifying minerals and crystals often experience some considerable difficulty in clamping the crystal in its cup owing to the screws of the crystal cup being situated too near the level of the panel.

It is difficult to manipulate rapidly the screws of the crystal cup in these circumstances, and the performance of the operation very often results in a scratched and unsightly panel in the neighbourhood of the cup.

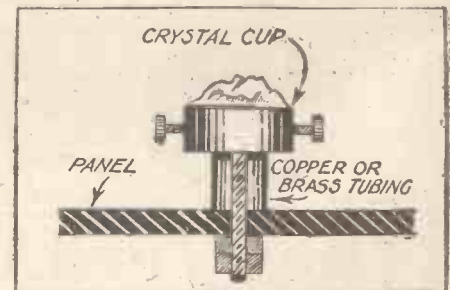

However, there is a very simple means of getting over this difficulty. After removing the connection from the underside of the crystal cup, withdraw the cup from the panel. Now obtain a small piece of copper or brass tubing, a little less in diameter than the size of the crystal cup. Mount this on the surface of the panel below the crystal cup, replace the screw and re-solder the wire-connection below.

It is possible to raise the cup of the crystal to any desired height above the surface of the panel by this method, and, if the crystal cup screw is found to be too short for the purpose, the amateur will generally be able to obtain another one having a longer shaft.

The screws in the side of a crystal cup which is so raised above the panel can be quickly manipulated by means of a suitable screw-driver without any danger of the panel being scratched during the proceeding.

SOME IMPORTANT POINTS.

NOW that the winter and wet weather are returning listeners should look once more to their outdoor equipment—the aerial and earth system—and make sure everything is in order to withstand the storms likely to come during the next six months. Insulators should be examined, cracked ones replaced, and all should be cleaned thoroughly, unless the new self-cleaning insulators, known as "Winsulators," are in use, when no such examination would be necessary.

Halyards and other supports should be overhauled, and if rope halyards are used these should be replaced if any indication of fraying is noticed.

T. W. THOMPSON & CO.

GOVERNMENT SURPLUS DEPOT

39-43, LONDON ST., GREENWICH, S.E.10.

Telephone: Greenwich 1259.
Premises close 1 p.m. Thursday.

Agent for Brighton District: A. S. HILL & CO., 8, YORK HILL, BRIGHTON.

LARGE CLEARANCE SALE. Large stock of all goods below.

BARGAIN CLEARANCE OF COMPLETE MARCONI 2-VALVE SETS. Our last advertisement for these sets was outnumbered with orders, but we have now been able to purchase another large supply of these sets from the Government. These sets comprise: Mahogany canvas-covered portable case, containing 2 high-grade Transformers, Condensers, Fil. Rheostat, non-capacity Valve Holders, Tuning Coil. Beautifully engraved Ebonite Panels and other necessary fittings, completely wired, and all brand new. Also 1 pair 4,000 ohm new Lightweight Headphones, one brand new 4 volt 40 amp. Chloride Accumulator, 2 brand new R Valves, one 66 volt H.T. battery, and necessary Plugs, etc. The retail price of the accessories alone is £3. Our offer is for the complete set, with all accessories as above, £3 10s. each. Passenger train, 3/6. All Sets guaranteed new and perfect.

EX-NAVAL LOUD SPEAKERS, 2,000 ohms, complete with Horns. All tested perfect before dispatch. Given-away price, 10/- each, post 1/-.

R.A.F. MARCONI OSRAM AMPLIFYING R VALVES. Standard fitting, all brand new. Fil. voltage 4 volt; anode 40-60 volt. These are, without doubt, the loudest valve to be obtained at the above voltages. Price, to clear, 5/- each, post 6d. Guaranteed.

CHOKE COILS. Iron enclosed core, as used in thousands of sets for resistance coupled sets, smoothing, filters, etc., etc. Sizes 1,000 ohms, 9d.; 500 ohms, 9d.; 250 ohms, 9d. Worth 8/- each, post 3d.

CHLORIDE UNSPILLABLE ACCUMULATORS. These accumulators are brand new, with 3 months' guarantee. Specially designed to prevent acid spilling or bubbling over the top. At Given-away prices: 2 volt 40 amp., 7/-, post 6d.; 4 volt 40 amp., 14/-, post 1/-; 6 volt 40 amp., 20/-, post 1/3; 2 volt 100 amp., 14/-; 4 volt 100 amp., in case, 28/-; 6 volt 100 amp., 40/-. All Celluloid cases.

D.III WATCH PATTERN MICROPHONES. Useful for Speech amplifying, etc., 2/- each, post 3d.

VULCANISED FLEXES AND WIRES at half retail prices. Heavy Maroon Twin Flex, 2/6 doz. yds., post 3d. Light Twin Flex, 2/- doz. yds., post 3d. 4-way Telephone Flex, 3/- doz. yds., post 4d. 22, 23 and 24 gauge Instrument Wire, 1/3 lb., post 6d. 36 gauge Enamelled Instrument Wire, in 3 lb. reels only, 7/- per reel, post 1/-. 7/22 Enamelled Aerial Wire, 2/6 per 100 ft. 7/20 super Aerial Wire, 4/- 100 ft., post 6d. Rubber and Vulcanised Lead-in Wire, 2/6 per doz. yds., post 3d. 1/18 Single Wire, already covered for wiring sets, 1/6 doz. yds., post 3d. Red and Black Positive and Negative coloured Flex, 2/6 doz. yds., post 3d. 1/18 Vulcanised Cable, Black, 5/6 100 yds. coil, post 1/-, etc., etc. All above are highest grade makers and brand new stock.

TRANSMITTING SETS R.A.F. These sets are high-class instruments, containing 1-in. Sterling spark coil, wound with 3 lb. 38 gauge silk wire, Ebonite panels, high-grade Aluminium Spark Gap, mounted on Ebonite, with adjuster, mica dielectric condenser, Ebonite panel. Helix variable tuning, 0-600 metres wavelength. Terminals and other sundry fittings. All above are mounted in ebonite panelled case. Ebonite alone is worth more than we ask for completed article. Cost £15 each. Price, to clear, 12/- each, post 1/6. Useful to all experimenters for parts, etc. Anyone can purchase one of these sets.

HIGH GRADE LABORATORY INSTRUMENTS, all brand new. Accuracy guaranteed. Laboratory combined moving coil, readings, 0-10 volt, 0-100 volt, 0-5 amp., 0-5 milliamps. Lowest reading 1-10th part of a milliamp., 57/6 each, post 1/-.

MILLIAMPMETERS. Moving coil, panel mounting, reading 0-50, 17/6 each, post 6d.

AMP. METERS. Centre zero, panel mounting, dead beat. 10-0-10 amps., 15-0-15 amps., 8/- each, post 6d.

MOVING COIL VOLTMETERS. 0-50 volt, 0-120 volt, 0-200 volt, 0-250 volt, 30/- each, post 1/-.

MIRROR REFLECTING 0-1,000 MOVING COIL VOLTMETERS, 50/- each, post 1/6.

INSULATION TESTERS, with Hand Generator, £5 10s. each.

SWITCHBOARD AMPMETERS AND VOLTMETERS, 4-5 in. dial, 0-30 amps., 22/- each, post 1/-; 0-50 amps., 24/- each, post 1/-; 0-80 volts, 24/-, post 1/-.

MICRO AMPMETERS, mirror reflecting, beautiful clear reading, £7 10s. each.

POCKET VOLTMETERS, 0-12 volts, clear scale, 5/6 each, post 6d.

AERIAL AMPMETERS, 1-5 amp., 7/6 each, panel mounting.

CHARGING AND LIGHTING DYNAMOS. Shunt wound, 30 volt 5 amps. Ball brushes, Carbon brushes, solid built commutator, drum armature. All brand new. Every machine fully tested before dispatch, price £3, passenger train 5/-.

PETROL ELECTRIC COUPLED GENERATING SETS. A B C Sets, 50 volt 20 amp., £20. Austin 4 cyl., 3 1/2 kw., 110 volt 32 amps., £40. Austin 2 cyl., 2 1/2 kw., 110 volt 23 amp., £35. Switchboards quoted for separately; state requirements.

GENERATORS--D.C. Shunt Wound, .75 volt 40 amp., 4-pole, £12; 110 volt 65 amp., £18; 400 volt 12 amp. motors, £15; 220 volt 8 H.P. motors, £15, and various other motors and generators in stock; state requirements.

4,000 OHM HEADPHONES. High grade make, retail price, 15/-. Our price, to clear, all brand new, 7/6 per pair, post 9d.

FULLER'S ACCUMULATORS. Brand new, especially designed for heavy or light discharges, without sulphating or shedding of plates, 2 volt 120 amp., 14/-, post 1/-; 4 volt 120 amp., 28/-; 6 volt 120 amp., 40/-.

MICROPHONES. Western Electric Wireless transmitting, with handle, very sensitive, 15/- each.

TRANSMITTING VARIABLE CONDENSERS. Ex-Naval, capacity .001. Heavy type, in glass case, 5,000 volt, 25/- each, post 1/6.

T.V.T. H.T. GENERATORS. These sets contain high voltage mica dielectric Condensers, high voltage stepping-up vibrator, etc., etc.; contained in case. Input 6-10 volt D.C., output, 1,000 volt 30 milliamps., D.C. output. Cost £15. Price to clear, 12/6 each, post 1/-.

LABORATORY BRIDGE CONDENSERS, 5,000 volt mica dielectric, and contain 7 separate condensers. Any condenser can be plugged-in separate; and any combination of capacities can be obtained. Condensers all in 3 1/2 mfd., £2 each.

AMPLIFIERS, M.III and M.IV. Containing 3 Intervalve Transformers and 1 Telephone Transformer, Stud Switch, Fil. Rheostat, etc., etc. These are well known as perfect amplifiers, price 50/-, post 1/6.

M.III SINGLE VALVE TRANSMITTERS, range 300-1,450 metres, containing tuning coil with stud tapping, 2 Variometers, Variometer reaction and Variometer tuning, with ratchet movement. All coils wound on heavy ebonite. Condenser .01. Wound leak and condenser. Multiple switch, lamp, heavy key, aerial ammeter, etc., etc., 1/2 in. ebonite panel. Cost £15. Price to clear, 30/- each. With slight alteration these can be used for receiving, microphone to suit, 2/6. Passenger train, 2/6. Brand new sets.

COPPER EARTH MATS. Size 20 ft. by 2 ft., 12/6 each, post 1/6.

OTHER GOODS IN LARGE STOCKS:

Dewar Switches, 2/- each. Plugs and Jacks, 2/- pair. Plugs, spare, 1/- each. Condensers, 1 mfd., 1/6; 2 mfd., 2/6; .05, 6d. Terminals, 7-piece, 2/- per doz. Telephone Cords, 6-8 ft. long, 6 cords, 1/-.

Buzzers, 2/6 each. Brown's Headbands, 2/6 each. Egg insulators, 1/- doz. Telephone earcaps, 2/- doz.

Exchange boards, 10-line cordlers, new, 70/- each. Wave-meters, range 100-3,500 metres, £5 each. 2-ton brass oddments, screws, nuts, washers and various parts, 9d. lb., post 6d. 66 volt H.T. Batteries, new, 7/6 each, post 1/-.

Marconi 2-volt receiving valves, 2/6 each. Marconi 2-volt P.F.2 receiving Valves, 4/- each. Single Earphones, 1/3 each.

ACCUMULATOR PLATES. Standard, 4 by 3 1/2 in., positive plates, 10d. each; negative, 7d., post 3d.

GALVANOMETERS, 12/6. Fuller's Dull Emitter Leclanché cells, new, 2/6 each.

NAVAL MULTIPLE TUNERS, 100-1,000 metres, 12/6 each. Chater Lea terminals, 2/- per gross. Variometers, broadcasting, 3/- each. Morse practise keys, 1/6 each. Fixed condensers with grid leak, .0001, .0002, .0003, .0005, 9d. each. Fallon Variometers, all moulded, list price 10/6, to clear, 5/-.

Fallon Condensers at half prices, .0005 Standard, 4/-, post 6d.; Square Law, .0005, 5/-, post 6d. And thousands of other accessories in stock.

Foreign Orders must be accompanied by extra postage.

RADIO TUTORIAL

All Editorial Communications to be addressed The Editor, POPULAR WIRELESS, The Fleetway House, Farringdon Street, London, E.C.4.

Editor :
NORMAN EDWARDS, M.Inst.R.E., F.R.S.A.,
F.R.G.S.

Technical Editor :
G. V. DOWDING, Grad.I.E.E.

Assistant Technical Editors :
K. D. ROGERS. P. R. BIRD.

Scientific Adviser :
Sir OLIVER LODGE, F.R.S.

Staff Consultants :
Dr. J. H. T. ROBERTS, F.Inst.P.; J. F.
CORRIGAN, M.Sc., A.I.C.; C. E. FIELD, B.Sc.

Foreign Correspondents :
F. M. DELANO, Paris; Dr. ALFRED
GRADENWITZ, Berlin; L. W. CORBETT,
New York; P. F. MARTIN, Italy; W.
PEETERS, Holland.

The Editor will be pleased to consider articles and photographs dealing with all subjects appertaining to wireless work. The Editor cannot accept responsibility for manuscripts and photos. Every care will be taken to return MSS. not accepted for publication. A stamped and addressed envelope must be sent with every article. All contributions to be addressed to The Editor, POPULAR WIRELESS AND WIRELESS

REVIEW, The Fleetway House, Farringdon Street, London, E.C. 4. All inquiries concerning advertising rates, etc., to be addressed to the Sole Agents, Messrs. John H. Lile, Ltd., 4, Ludgate Circus, London, E.C. 4.

PATENT ADVICE FOR READERS.

The Editor will be very pleased to recommend readers of POPULAR WIRELESS who have any inventions to patent, or who desire advice on patent questions, to our patent agent. Letters dealing with patent questions if sent to the Editor, will be forwarded to our own patent advisers, where every facility and help will be afforded to readers.

TECHNICAL QUERIES.

Letters should be addressed to :
Technical Query Dept.,
"Popular Wireless,"
The Fleetway House,
Farringdon Street,
London, E.C.4.

They should be written on one side of the paper only, and MUST be accompanied by a stamped addressed envelope.

Queries should be asked in the form of the numbered questions : (1), (2), (3), etc., but may be accompanied by a short letter giving any necessary additional particulars as briefly as possible.

For every question asked a fee of 6d. should be enclosed. A copy of the numbered questions should

be kept, so that the replies may be given under the numbers. (It is not possible to reproduce the question in the answer.)

IMPORTANT.—If a wiring diagram, panel lay-out or point-to-point wiring is required an additional fee of 1/- must be enclosed.

Wiring diagrams of commercial apparatus, such as sets of any particular manufacture, etc., cannot be supplied. (Such particulars can only be obtained from the makers.)

Readers may submit their own diagrams, etc., for correction or for criticism. The fee is 1/- per diagram, and these should be large, and as clear as possible.

No questions can be answered by 'phone.

Remittances should be in the form of Postal Orders.

Questions and Answers

SUITABLE SETS.

J. N. (Liverpool).—I intend building a set, but before doing so, I should like your advice as to the most suitable combination of valves and the number of same. My requirements are as follow: I wish to receive the local station at fair loud-speaker strength and other stations if possible, also at the same strength. As I intend using the set out of doors occasionally, I should also like to be able to get a very large volume, but which can be cut down when not required.

We think your best plan would be to build a 4-valve set, having one H.F. valve, one detector, and two L.F. valves.

The H.F. and the second L.F. valves should be so arranged that they can be cut out with switches when not required.

(Continued on page 70.)

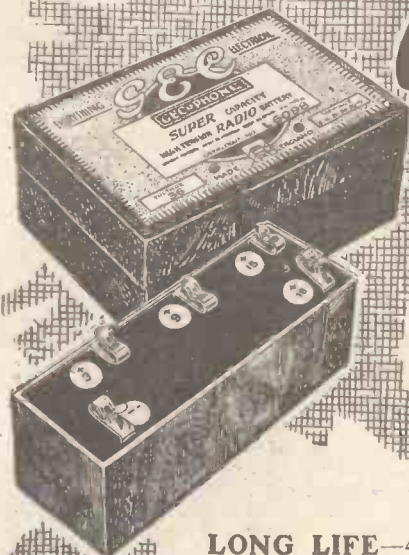

LONG LIFE—4 to 5 times as long as others.

LARGE CAPACITY
SILENCE IN USE

These merits are worth your consideration. Ask your dealer about them.

(Manufacturers, wholesale only)

THE GENERAL ELECTRIC Co., Ltd. Head Office: Magnet House, Kingsway, London, W.C.2.

A New Battery OF OUTSTANDING MERITS

GECOPHONE

Super-Capacity High-Tension

RADIO BATTERIES

These Batteries are the latest development in British Battery manufacture and have been specially designed to meet the needs of users of valve sets who desire to improve reception and to eliminate the annoyance of frequent renewals and the "sizzling" noises hitherto experienced.

These super-capacity Radio Batteries will undoubtedly fill a long-felt want; they are destined to become the standard H.T. Batteries for wireless.

Prices from 7/6 to 27/6

SOLD BY ALL GECOPHONE SERVICE DEPOTS, WIRELESS DEALERS, STORES, ETC.

Silvertown Wireless Accessories



B 500.

INTERVAL TRANSFORMER.

Guaranteed for 12 months.
Price 21/- each.

This Transformer has been adopted by leading manufacturers of Wireless Receiving Sets and discriminating amateurs in all parts of the world.

Excellent results have been obtained on tests carried out by the National Physical Laboratory. Copy of the curve can be had on application.

SILVERTOWN VERNIOMETER.

(Patent applied for.) No. B 601.

The Silvertown Verniometer is a most ingenious device for applying slow motion to variable condensers, variometers, etc., consisting of an ebonite dial and knob (6-180°)



fitted with worm wheel, bracket and worm spindle, micrometer barrel and pointer, complete with fixing screws. Gear ratio 240-1. Fitted with instantaneous release. Backlash entirely eliminated. Hand capacity reduced to a minimum. Suitable for the following makes of condensers:— Silvertown, Burndept, Sterling, Ormond ordinary and Ormond Low Loss. State type of condenser for which they are required when ordering. Price 6/- each.

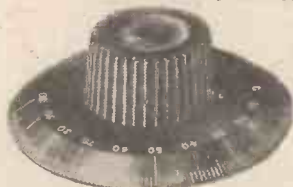

EBONITE CONDENSER DIALS AND KNOBS.

In one piece, graduated in white, 0-1800, highly finished, complete with fixing screw, dial approximately 3 in. diameter. Complete 1/3 each. Dials only, 10d. each.

AN AID TO ENTHUSIASTS.

We have prepared a logging chart for recording wave-lengths, condenser settings, etc., of those stations which require careful calibration to tune in. A copy of this chart, printed on stiff card, with hanger, can be obtained free of charge at any of our Branches or from any high-class dealer.

MAKERS :

THE SILVERTOWN COMPANY
106, CANNON STREET, LONDON, E.C.4

Works : SILVERTOWN, LONDON, E.16.

BELFAST: 75, Ann Street.
BIRMINGHAM: 15, Martineau St.
BRISTOL: 4, Victoria Street.
CARDIFF: Pier Head Chambers, Bute Docks.
DUBLIN: 70, Middle Abbey St.
GLASGOW: 15, Royal Exchange Square.
LEEDS: 1, New York Road.
LIVERPOOL: 54, Castle Street.
LONDON: 100 and 102, Cannon Street.
MANCHESTER: 16, John Dalton Street.
NEWCASTLE-ON-TYNE: 59, Westgate Road.
PORTSMOUTH: 49, High Street.
SHEFFIELD: 88-90, Queen St.



Ashley Radio JACKS AND JACK SWITCHES

A complete range of Jacks for every purpose. The use of these components saves labour and dispenses with the need for complicated switches.



Jack No. 1.
Single Circuit
(Open)

2/-



Jack No. 2.
Single Circuit
(Closed)

2/3



Jack No. 3.
Filament
Single Control

2/6



Jack No. 4.
Double Circuit;

2/6



Jack No. 5.
Filament
Double Circuit;

3/6



Jack Switch
No. 6.
Single Pole,
Single Throw

2/9



Jack Switch
No. 7.
Single Pole;
Double Throw

3/6



Jack Switch
No. 8.
Double Pole,
Single Throw

3/6



Jack Switch
No. 9.
Double Pole;
Double Throw

4/-



Two-Way Jack
Plug.

3/-

**ASHLEY WIRELESS
TELEPHONE COMPANY**
69 Renshaw Street, Liverpool
Telephone: 4628 Royal. Telegrams: "Rotary, Liverpool."

London and Southern Counties :

Pettigrew and Merriman, Ltd., 122, Tooley Street, London, S.E.1.

RADIOTORIAL QUESTIONS & ANSWERS.

(Continued from page 63.)

For receiving the local stations at moderate loud-speaker strength the detector and one L.F. valve are all that is required, the H.F. and second L.F. valves being cut out.

If greater volume is required, the second L.F. valve is switched in.

For receiving a distant station, the second L.F. valves should be cut out, the H.F. valve put in (not forgetting to reverse the leads to the reaction coil if it is coupled to the aerial coil) and the station tuned-in on the 'phones.

Should the settings on the dials for the distant station be known, however, it will not be necessary to use the 'phones, and both low-frequency valves can then be used.

Should interference be caused by the local station, we suggest you employ loose coupling—that is, primary and secondary and couple the reaction coil to the secondary.

Greater selectivity can be obtained by employing an H.F. transformer and tuning its secondary with a .0003 variable condenser. In this case it will be advisable to incorporate verniers on all the variable condensers used in the set.

H.F. TRANSFORMERS.

F. D. S. (Eastbourne).—I wish to construct a three-valve H.F. amplifier, transformer coupled, but am in doubt as to the details of transformer to use, and as to how many turns they should have. I wish to use plug-in transformers.

The transformers should be wound on small ebonite bobbins similar in appearance to grooved pulley wheels. The two windings, primary and secondary, are both wound in the same groove, each consisting of an exactly similar number of turns.

Opposite valve legs are used for each of the windings.

The secondary winding should have about 10 per cent more turns than the primary.

In order to obtain fine tuning, a small variable condenser of the order of .0002 mfd. is placed in parallel with the primary winding. The above value

will prove quite suitable to cover the band of wavelengths for each transformer detailed in the following table:

Turns Pri./Sec.	Inside Flange Diameter, Inches	Outside Flange Diameter, Inches	Wavelength (110 mtrs.)
30/30	1½	2	190-240
45/45	"	2½	240-300
55/55	"	2¾	300-400
75/75	"	3	350-500
100/125	"	3½	550-750
200/225	"	3¾	950-1200
400/450	"	3½	2500-3500

Using 38 S.W.G. ebonite ¼-in. thick.

CRYSTALS IN REFLEX SETS.

H. W. (Bristol).—I notice that when the "cat's-whisker" is lifted from my crystal in a reflex circuit, sometimes the set "howls," and at other times signals are received clearly but rather weaker than usual. Can you explain?

The reason that the set "howls" is because when the circuit is broken at the cat's-whisker contact there is a momentary collapse of the magnetic field, which has been maintained around the coil by the current from the battery. The effect of this collapse is an induced current impulse, which, in certain conditions, is sufficient to act as a "trigger," and to set the circuit oscillating. If, however, the trigger action is not sufficient to start the howl, the received signals are naturally weakened because the circuit is only working then under disadvantageous conditions.

H.T. BATTERY NOISES.

M. J. N. (Hornsey).—My single-valve set has been giving excellent results until lately, but now I am troubled by an intermittent crackling noise which spoils reception. Sometimes the interruptions are not frequent, whilst at others they are almost continuous, but whenever they occur they are loud enough to completely spoil the programme. As the set is almost entirely home-constructed I am sure that good components are used throughout. What is probably the cause of this?

Your H.T. connections have become faulty and need a careful overhaul. You will probably find

(Continued on page 76.)

JUNIOR Loud Speakers with SENIOR performance

THEY incorporate all the patented—and therefore exclusive—features embodied in the design and construction of the AMPLION Standard "Dragon" model; and by experience and tests against much larger and more expensive models of other makes, they have been proved supreme in every respect.

Handy in size, highly-finished in appearance, and superlative in performance, they uphold to the full the world-wide reputation of

THE
WORLD'S
STANDARD

AMPLION

WIRELESS
LOUD
SPEAKER

For Better Radio Reproduction

Obtainable from AMPLION STOCKISTS and Wireless Dealers everywhere.

Patentees and
Manufacturers: ALFRED GRAHAM & CO. (E. A. GRAHAM),
St. Andrew's Works, Crofton Park, London, S.E. 4.

Demonstrations gladly given at 25-26, Savile Row, W.1, and 79-82, High Street, Clapham, S.W. 4.

Scottish Depot: 101, St. Vincent Street, Glasgow.



Type
AR. 111



Type
AR. 114

Illustrated are two of the most popular models of AMPLIONS, the "New" Junior Type AR. 111, at £2 : 10 : 0 and the "New" Junior-de-Luxe Type AR. 114, at £3 : 5 : 0

SQUARE LAW	
.001	9/6
.00075	8/-
.0005	8/-
.0003	6/9
.00025	6/9
.0002	5/3
.0001	4/6
Vernier	4/6
STANDARD	
.001	8/6
.00075	8/-
.0005	7/-
.0003	5/9
.00025	5/9
.0002	5/-
.0001	4/9
Vernier	4/-
J.B. SQUARE LAW WITH VERNIER	
.001	14/-
.0005	12/6
.0003	11/3
.00025	11/3

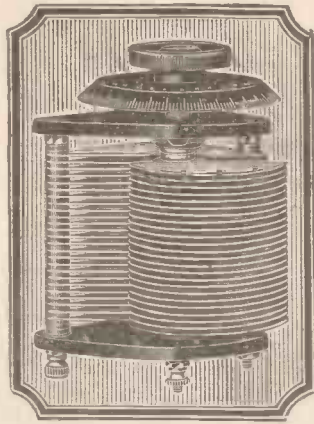

For Better Condensers

Here is a new consideration for every set constructor. The time, labour, and patience which every set builder puts into his set deserves something better than the ordinary type of condenser.

Utmost tuning efficiency is an achievement which J.B. Condensers will yield to every set builder.

Better Condensers help you towards perfect reception. If you are seeking the best you will have found it when you incorporate J.B. condensers in your set. Whether it be capacity, dielectric losses, or mechanical construction, every detail which makes for utmost tuning efficiency is embodied in J.B. condensers. Therefore fit J.B.—the better condenser.

JACKSON BROS.
 R POLAND ST-OXFORD ST Telephone:-
 LONDON - W.1 GERRARD 7414
 (First Floor)

Barclays Ad.

The Crystal for the Connoisseur



—For the expert whose delicate adjustment is made at a touch

Russell's Hertzite

The L. G. RUSSELL Laboratories, 1-7, Hill Street, Birmingham (Opposite-Empire Theatre.)

Two Grades in sealed boxes
 1/- & 1/6



CLIXIE makes his bow and commences author

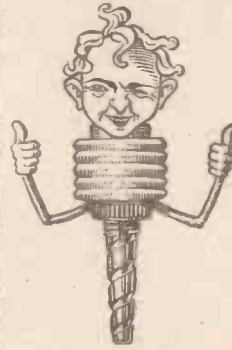

"CLIXIE"

Meet me at THE ALBERT HALL Sept. 12-23 STANDS 41 and 76.

Retail Prices:—

- CLIX with Locknut 3d.
- CLIX Adapter with Locknut 2d.
- CLIX Insulators (6 colours) 1d. each.
- CLIX Bushes (6 colours) 1d. pair.

"I'm only a little chap," says CLIXIE, "but that's no handicap. So was Napoleon.

"I'm O.C. Radio Circuits. Keeping connections up to scratch is my job. Though I shouldn't say so, I'm better at it than anyone else in the world.

"There's no false modesty about me, so when they ask me to take over the advertising of CLIX the plug-socket, I say, Righto!

"There can't be many of you that don't know all about CLIX already; but while I'm explaining why CLIX have superseded all forms of terminals, plugs and switches, I think I can manage to keep you interested, elevated and amused.

"Look out for me here again in a fortnight's time. *Au revoir!*"

Are you well connected? Try

CLIX

The Electro-Link with 159 Uses

AUTOVEYORS LTD., 84 VICTORIA STREET, LONDON, S.W. 1

DON'T BLAME THE SET!



Nine times out of ten there is a fault in the circuit which can be put right in a minute or two with the aid of FLUXITE.

Solder all joins with FLUXITE, and they cease to be joins, but become one unbroken piece of metal. No

chance of leakage there! It's so easy, too. A child could do it. No wireless enthusiast should dream of making joins any other way.

Ask your Ironmonger or Hardware Dealer to show you the neat little

FLUXITE SOLDERING SET

It is perfectly simple to use, and will last for years in constant use. It contains a special "small space" Soldering Iron with non-heating metal handle, a Pocket Blow-lamp, FLUXITE, solder, etc., and full instructions. Price 7/6. Write to us should you be unable to obtain it.

Price 7/6



FLUXITE SIMPLIFIES SOLDERING

All Hardware and Ironmongery Stores sell FLUXITE in tins, price 8d., 1/4 & 2/8.

Buy a Tin To-day.

FLUXITE LTD. (Dept. 324), West Lane Works, Rotherhithe, S.E.16.

ANOTHER USE FOR FLUXITE. Hardening Tools & Case Hardening. ASK FOR LEAFLET on improved methods.



Traders and manufacturers are invited to submit wireless sets and component parts to the "P.W." Technical Dept. for test. All tests are carried out with strict impartiality in the "P.W." Test Room under the supervision of the Technical Editor, and the general reader is asked to note that this weekly article is also intended to provide a reliable and unbiased guide as to what to buy and what to avoid.—THE EDITOR.

MESSRS. The Benjamin Electric, Ltd., Brantwood Works, Tariff Road, Tottenham, London, N.17, have sent us one of their Clearer Tone Valve Holders. It is primarily an "Anti-Microphonic" production, but embraces other noteworthy features in its design. For instance, no rubber is used, but an ingenious system is introduced whereby continuous metal connections form springs in the centres and valve sockets and soldering tags at the ends. Additionally to the latter, screw terminals are supplied.

The whole device is excellently planned and undoubtedly most efficient in use. The insulating material is high class Bakelite, which is, of course, above suspicion. The "Clearer Tone" is for baseboard mounting, but only two screws are required to hold it firmly in position. It sells at 2s. 9d., a

price at which it will be readily welcomed by constructors.

Three new components have been placed in production by Messrs. Lissen—a wire-wound anode resistance, an H.F. choke and a key switch. The Lissen wire-wound anode resistance has a value of 80,000 ohms, is wound non-inductively in sections and has a very low self-capacity. It is primarily intended for use in resistance-capacity coupled L.F. amplifying stages, although it is, of course, quite suitable in H.F. stages for higher wave-length work.

The Lissen H.F. choke is designed with a high inductance value so that its impedance is constant up to 4,000 metres.

The Lissen key switch is in effect a make-and-break working on the push-pull principle, but the plug or "key" is completely

removable. Thus a set fitted with this component cannot be switched on until the "key" is inserted. It is not quite a "Yale" in action, for any metal rod of something under $\frac{1}{2}$ in. in diameter could be inserted and would replace the "key," but nevertheless it is useful merely as a switch. It is very nicely made, and only one hole in the panel has to be drilled when mounting it.

Of the above three items that one which appeals to us as being the most useful is the anode resistance, for a component of this nature, wire wound and stable in action, which will not collapse under really heavy work, is a universal requirement. Under close observation in an experimental circuit, Messrs. Lissen's resistance was very distinctly promising, notwithstanding the unusually high impedance. We must mention, however, that a careful choice of valve is necessary, naturally those of high impedance being most suitable.

From Messrs. Partridge, Ltd., 115-117, Northwood Street, Birmingham, we have received samples of a new patented connection. It consists of a small metal bridge through which passes a screw carrying an oblong nut. It can be obtained complete with spade terminal in either 2 or 4 B.A. sizes. Thus the complete under-panel wiring, including terminal points and cross connections, can be carried out expeditiously and rigidly with these connectors and a small screwdriver. Particularly well do they adapt themselves to square section wire. Either pattern sells at 2d. each, or in boxes of one dozen assorted at 2s. per box.

(Continued on page 74.)

Have you entered for the "Sylverex" Radio Crystal Prize Scheme?

The Competition is simple—you merely put twelve B.B.C. "turns" in order of popularity. And every competitor receives a prize, the chief prizes going to those competitors giving the nearest to the correct list according to total voting; the other competitors all receive Consolation Prizes.

Ask your Wireless Dealer for Full Details— or send a Postcard to—Sylverex Ltd. (Dept. B), 25, Victoria Street, London, S.W.1.

Sylverex is a natural Crystal and is a revelation in sensitivity. It is subjected to the fullest tests of any crystal on the market, and as a consequence is fully guaranteed.



Entrants for the Sylverex Prize Scheme are asked to write down the following list of "turns" in their order of popularity. Put down first which item you consider most popular; then the item you consider second in popularity, and so on. Write only the items listed here. Prizes will be awarded to those entries most nearly in accordance with the total voting of all competitors.

Covent Garden Opera.
Symphony Orchestra.
The Children's Hour.
The Savoy Bands.
The Wireless Drama.
"Celebrity" Speeches.
Sports Talk.
Humorous Entertainers.
De Groot and Piccadilly Orchestra.
Concert Parties.
"Star" Musicians and Vocalists.
News and Weather Reports.

Your list of items must be written on the plain side (back) of the printed direction slip enclosed with each packet of Sylverex Crystal.

£200

in Cash Prizes

1st Prize - £100 Cash
2nd Prize - £50 Cash
3rd Prize - £25 Cash
50 Prizes of 10/- each

Numerous additional prizes, consisting of Valve Sets, Crystal Sets, Loudspeakers, etc., and thousands of Consolation Prizes of copies of popular published songs.

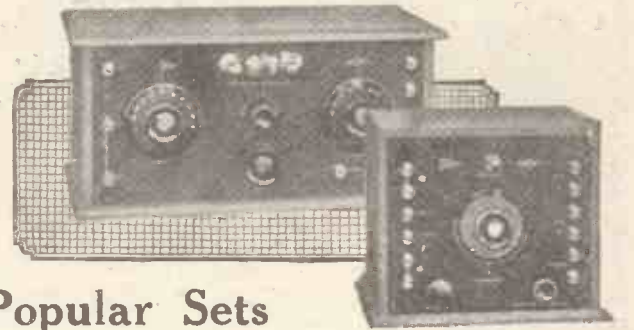

Popular Sets designed by "Popular Wireless."

Whichever Set you decide to build you cannot go far wrong if you select one of the Pilot Sets designed by the Editorial Staff of "Popular Wireless." The large single-valve Reflex Set illustrated above will cover most British Broadcasting Stations with ease on the headphones, and work a Loud Speaker within 20 miles or so from the nearest one. Cheap to buy—simple to manipulate—and economical to run—that is what you may expect from Pilot Receiving Sets. If you want something more ambitious, send 3d. for a copy of our Pilot Chart, showing illustrations of more than 30 easy-to-build Receivers. Should you be interested in Super Heterodynes, send 2d. for an instructive folder on the Keystone equipment. All amateurs need our 48-page Catalogue of Components (post free 3d.) and Peto-Scott's Wireless Book (post free 1/5).

PETO-SCOTT CO., Ltd.,
Registered Offices, Mail Order, and Showroom:
77, CITY ROAD, LONDON, E.C.1.
Branches: LONDON—62, High Holborn,
W.C.1. WALTHAMSTOW—230, Wood St.
PLYMOUTH—4, Bank of England Place.
LIVERPOOL—5, Manchester St.

'BEST WAY' 1-VALVE REFLEX.

	£ s. d.
2 Peto-Scott square law Condensers	16 3
1 "Gravity" Detector	6 6
1 Microstat Filament resistance	2 9
1 2-coil Holder	5 6
10 terminals, Mark III	1 9
1 Valve Holder	1 3
1 Max-Amp. Shrouded Transformer	19 6
2 Peto-Scott fixed Condensers	2 9
Wire, screws, etc.	9
1 "Red Triangle" Ebonite Panel, drilled and engraved	9 0
Polished Mahogany Cabinet with base-board	1 1 0
	£4 7 0

87/- buys all the parts.

P.S. 3429.

Why is



THE HALL MARK OF "QUALITY" EBONITE?
Because it is made from finest rubber and sulphur

IT HAS PROVED ITSELF. ITS POLISH SPEAKS FOR ITSELF

All branded panels are guaranteed free from surface leakage.

See **STAND 15** at the N.A.R.M.A.T. Wireless Exhibition, Royal Albert Hall, September 12 to 23.

The BRITISH EBONITE CO., Ltd., HANWELL, LONDON, W.7

Rods, Tubes and Mouldings

SAXON GUIDE TO WIRELESS

THIS IS THE BEST BOOK OBTAINABLE, AND ENABLES ANYONE WITHOUT PREVIOUS EXPERIENCE TO MAKE WIRELESS SETS WHICH ARE UNEQUALLED IN PRICE, QUALITY, OR EFFICIENCY.

Everything connected with Wireless is clearly and simply explained, and full instructions, WITH CLEAR WIRING DIAGRAMS, are given for making: TWO SUPER EFFICIENT CRYSTAL SETS, ONE AND TWO-VALVE DUAL AMPLIFICATION RECEIVERS, ONE AND TWO-VALVE AMPLIFIERS; ALSO THE VERY LATEST TYPES OF TWO THREE FOUR AND FIVE-VALVE TUNED ANODE RECEIVING SETS.

THE CHAPTER ON TESTING WIRELESS COMPONENTS IS ALONE WORTH THE PRICE OF THE BOOK.

NO SOLDERING, NO SPECIAL TOOLS, NO TROUBLE. Simply follow instructions and you will make a better set for one-fourth the price you would pay for an inferior instrument.

Satisfaction guaranteed or money refunded.

SAXON RADIO CO. (Dept. 14), SOUTH SHORE, BLACKPOOL.

176 PAGES PRICE

1/3 POST FREE

IF YOU WANT

Sharp Tuning
 Clear Speech &
 Maximum Strength

use **"TANGENT"**
TUNING COILS
 The coils with the lowest losses

Catalogue and name of nearest dealer on request



GENT & CO., Ltd. Est. 1872
 Faraday Works, LEICESTER
 London: 25, Victoria Street, S.W. 1
 Newcastle-on-Tyne: "Tangent House," Blakett Street



The Symbol of Perfect Service & Reliability.

"RENOWN"

THE L.F. INTERVALVE TRANSFORMER with the definite PUBLISHED GUARANTEE

ALL RATIOS, 8/4

Used by all discriminating Manufacturers and Constructors.

40,000 Turn Chokes, 8/4

Write for descriptive literature

We Repair ANY MAKE of L.F. Intervalve Transformer, 5/-

TRANSFORMER REPAIR COMPANY, HAY STREET, PORTSMOUTH

BONTONE 'PHONES

"The 'Phones shown here are Britain's best: By name they are 'Bontone'; The world admits they stand the test For Quality, Ease, and Tone."



POST FREE

British made, sold under guarantee, a famous 'phone at a popular price.
 "Bontone" Lightweights 14/6
 " " Originals - 13/6
 Post free.

May be purchased from all Stores or Radio Dealers, or direct from

B. D. & Co. (Ed. A. Boynton),
 167-173, Goswell Rd., London, E.C.1.

FOR EFFICIENCY AND ELEGANCE

The "Scientific"
 NON-METALLIC HORNS

Cannot be Beaten.

Two of our Latest Models.

Approx.

No.	Ht.	Flare.	Price.	Post
508	24"	14"	15/6	1/9
506	—	14"	15/6	1/9

Trade enquiries invited.

SCIENTIFIC SUPPLY STORES,



555 506



555 508

'Phone: Hop 4177. 126, NEWINGTON CAUSEWAY, LONDON, S.E.1.
 Branches: 80, Newington Causeway, S.E.1.; 7, St. George's Circus, S.E.1.; 16, Manette St., Charing Cross Rd., W.1.; 291, Edgware Rd., W.2.; 84, Church Rd., Upper Norwood, S.E.23.

APPARATUS TESTED.

(Continued from page 72.)

A point well worth noticing is that the screws have milled as well as slotted heads so that temporary connections can be made with the fingers. Personally we prefer



The "Kenmac Book" crystal receiving set.

soldering, but recognise that this is something of an "art" that the "one set" constructor might prefer, not to acquire, and for him such connectors as those of Messrs. Partidge will prove decidedly useful.

* * *

The "Advance" Machinery Co., of C.-on-M., Manchester, have sent us one of their "Advance" lead-in tubes. It consists of a stout ebonite tube through which passes a brass rod connecting two solid brass terminals. The latter are arranged so that the wires are connected at each end in a direct line with the tube, that is, the terminals have holes drilled through them "vertically" and not in their sides. This feature is apparently the only original one possessed by the "Advance" lead-in

The "Advance" Machinery Co., of C.-on-M., Manchester, have sent us one of their "Advance" lead-in tubes.

tube, but nevertheless it is quite a good one. The article is strongly made and nicely finished.

In their elements crystal receivers do not vary much from year to year, and a pre-war circuit is accepted to-day as quite standard practice. In practical design, however, there appears to be more scope for originality. The "Kenmac Book" crystal receiving set, a sample of which we recently received from the Kenmac Radio Ltd., Dalling Road, Hammersmith, London, W.6, is not entirely original in design, but nevertheless it forms quite an artistic departure from common practice.

As the photographs show, its external appearance resembles that of a small book, and laid casually on a table and viewed from a little distance it is quite a passable imitation. It can be opened easily, and in this position the illusion disappears and nothing but a very efficient-looking wireless instrument remains.

The craftsmanship is good, but we do not like the words on the "cover." We understand, however, that sets can be supplied at little or no extra cost with any lettering individual purchasers desire. This should prove useful at Christmas, and demands for lettering such as "From Uncle to George" will no doubt be considerable.

The little receiver on test gave splendid results, as good as any we have heard. Provision is made for taking a loading coil for 5 X X, and this station as well as 2 L O came in with excellent strength.

The adjustment of the crystal detector is easier and the action of it better than we should have thought judging by appearances

only, while the inductance slide moves smoothly and gives positive contact throughout.

Tuning is fairly sharp and the coil comfortably covers the normal broadcast band of wave-lengths. There are one or two little points in the design of this receiver to which we take exception, but these the manufacturers can easily modify. They can ensure, for instance, that the crystal detector arm and inductance slide are given covering insulation, and that it is made impossible for the crystal detector adjusting arm to cause a shorting of the 'phones by coming into contact with one of the 'phone terminals. Having done this they will have produced a first-class receiver



The "Kenmac Book" receiver opened and ready for use.

which, owing to its artistic appeal and its electrical efficiency, should meet with success on the market.

Two types are available, one in red, blue or green leather at £1 1s., and the other in non-flammable imitation tortoiseshell at £2 2s.

A CONVINCING ENDORSEMENT.

What THE EXPERTS THINK of "LOTUS" Coil Holders.

"We used this instrument on test in a short-wave set—with magnetic reaction by means of plug-in coils—where the reaction control is extremely critical, and success depends more or less on the coil-holder itself.

"A beautifully smooth control was obtainable with this coil-holder, for both coarse and very fine adjustments, by means of the gearing, were to be obtained.

"In a receiver designed for use on the broadcast wave-lengths with reaction on the 'tuned anode,' the 'Lotus' coil-holder materially assisted adjustments when bringing in distant stations—in fact, this delicate operation, which can be so exasperating

with the usual type of coil-holder, was accomplished without any trouble using the 'Lotus.'"

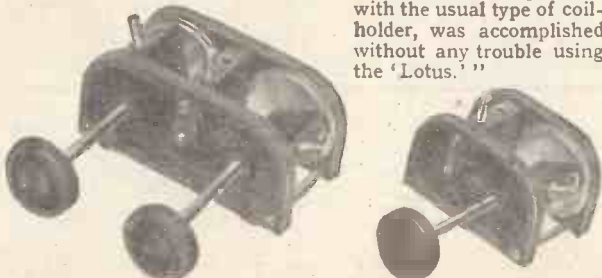

Vernier Movement actuated by Three Sets of Encased Precision Cut Gears. Representing a Reduction of 8 to 1. Perfect Reception at Last! Made from Bakelite Mouldings with nickel-plated parts.

The "LOTUS" Cut Gearing Vernier COIL HOLDERS
(Provisional Patent 23897)

Moving Block Cannot Fall!

RETAIL SELLING PRICES: 2-way, 7/-; 3-way, 10/6.

GARNETT, WHITELEY & Co., Ltd.
Lotus Works, Broadgreen Road, LIVERPOOL.

A new and better "BROWNIE"

EMBODYING all the features of the Standard "Brownie" this model is of unique and pleasing appearance, moderate price and capable of resisting extreme climatic conditions. The outer casing is hydraulically moulded under a pressure of 60 tons, forming a pleasing and substantially designed piece of apparatus. The receiver has a

natural wave-length up to 600 metres and a standard plug and socket coil attachment, which, with the aid of suitable coils, makes the set adaptable to 5XX or any other wave-length. The complete set is mounted on rubber shock-absorbing buffers, and all fittings are nickelled.

PRICE 10/6

BROWNIE WIRELESS MODEL No. 2

The Standard "Brownie" will not be superseded but is to be as successful as ever. Complete, with moulded cap and base and all fittings nickelled. PRICE 7/6

THE BROWNIE WIRELESS Co. (OF GT. BRITAIN) Ltd., (Incorporating the J.W.B. Wireless Co.) 310a-312a, Euston Road, N.W.1. Facing Warren St. Tube Station. 'Phone: Museum 3747.



Ask your dealer to show you these and other "Brownie" specialties, including the famous D.L.5 Crystal.

THE PANEL DE LUXE

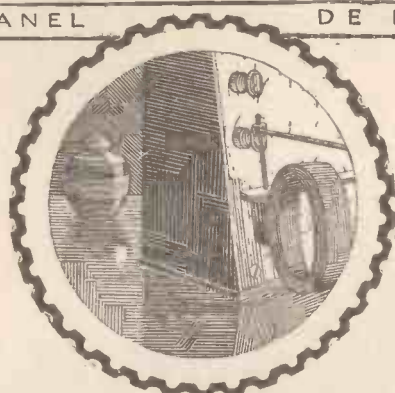

SUCCESS in Wireless is ever dependent upon trifles. One man will succeed where another will fail. No component can exercise such influence for good or ill as the panel. Start with a Radion Panel and you will be sure that your foundation is correct. Radion is recognised throughout the wireless industry as the highest grade ebonite panel it is possible to make—and its superb surface will add considerably to the appearance of any Receiver.

RADION is available in 21 different sizes in black and mahogany. Radion can also be supplied in any special size. Black 1d. per square inch, mahogany 1 1/2d. per square inch.

American Hard Rubber Company (Britain) Ltd.

Head Office: 13a Fore Street, London, E.C.2
 Depots: 120 Wellington Street, Glasgow, 116 Snow Hill, Birmingham.
 Irish Agents: 8 Corporation Street, Belfast

Gilbert Ad. 3432



"I'm glad you've come"

said the coil, "couldn't get good results with the other condenser that used to be here. I can see you're different."
 "Yes," murmured the Watmel, "I've been built to give a more efficient condenser service. They've made me round to eliminate edge losses and you should see the way my mica sheets are clamped and riveted between the plates. You can't make MY capacity vary."

Watmel Fixed Condensers are quality productions throughout. Mounted in a bakelite case, they are easily mounted by means of the one-hole fixing. For better results ask your Dealer for—



FIXED CONDENSERS.
 Guaranteed Correct Within 5 per cent.

THE WATMEL WIRELESS CO. LTD.
 332a, Goswell Rd., London, E.C.1. Tel: Clerkenwell 7990
 Lancashire & Cheshire Representative: Mr. J. B. Levee,
 25, Hartley Street, Levenshulme, MANCHESTER.

Standard capacities. Any other size can be supplied at short notice.

GRID CONDENSER.

- .00005
 - .0001
 - .0002
 - .0003
 - .0004
 - .00025
 - .0005
- 2/6 each.

STANDARD FIXED CONDENSER.

- .002 } 2/6 each.
- .001 }
- .0025 } 3/6 each.
- .006 }

COMBINED GRID LEAK & CONDENSER
 3/-

Can you discover the reason?



Patent applied for.

The New **MARS COIL**

Still supreme—the MARS AERIAL

National Physical Laboratory Test. "Mars" Aerial Wire: Resistance per metre .17 ohms 7/22's Aerial Wire: Resistance per metre 1.72 ohms—proof of the ten-fold superiority of the Mars.

The "Mars" Aerial consists of 84 strands of hand-drawn phosphor bronze wire **SPIRALLY WOUND**. The whole secret is in the spiral spin. There are many multi-strand aerials on the market, often labelled "Ma" or "Pa", designed to sell substitutes for the successful "Mars" Aerial Wire but they lack the "Mars" essential feature—the patented, inimitable spiral spin.

The price of the "Mars" is still 9/6 per 100 ft. Good quality 7/22's can be had for 2/- per 100 ft. But the "Mars" gives ten times better results.

Full particulars of the "Mars" specialities may be obtained, free, on request to: **E. & W. G. MAKINSON LTD.** (Patentees and Sole Manufacturers) Wellington Works, Wellfield Rd., PRESTON. Who will supply the "Mars" products by post if unobtainable from local dealer. But please enquire locally before writing to us.

The new "Mars" Coil, here advertised for the first time, is technically 25% more efficient than any other coil known.

The use of Mars triple-conductor wire and a novel method of winding, account for this superiority.

But the experts who have proved this claim report something much more extraordinary for which they cannot suggest a reason—

naturally the "Mars" Coil is at least 75% better than any other. And infinitely more musical.

Here then is an invention which will vastly enhance the pleasure of non-expert listeners, command the enthusiasm of the expert and provide a problem for the theorist.

The illustration of the "Mars" coil suggests its super efficiency. Useless fittings which bring about shrouding and so increase capacity are eliminated.

Absence of resistance, absence of dielectric capacities secured by the use of "Mars" Coil Wire and the unique way of winding, constitute the basis of this super low-loss coil.

Compare the "Mars" Coil, test it thoroughly and you will endorse the opinion of the many experts who have copied it. It is by far the most efficient coil obtainable.

Now on sale at leading wireless depots.

NOTE: Those who prefer to wind coils their own way will appreciate "Mars" Coil Wire. It is easy to handle, flexible as string yet adequately rigid when made up. And it has the patented spiral spin and triple-conductor features which make a world of difference. Obtainable in standard gauges. Costs more than ordinary wire; well worth the extra.



THE BURTON LOW-LOSS CRYSTAL DETECTOR AND RECTIFIER

(Pat. No. 233,118.)

FOR VALVE & CRYSTAL SETS

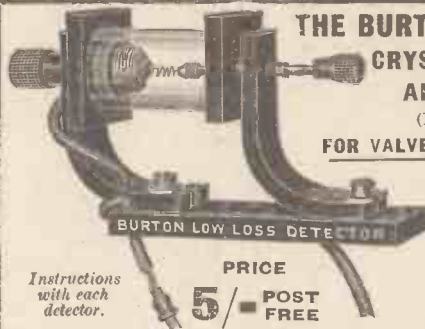

Instructions with each detector.

PRICE

5/- POST FREE

GUARANTEED to give perfect reception by cutting out interference by oscillation which ensures 100% efficiency in valve and crystal sets. Easily fixed to old or new sets.

Member of the Institute of Patentees.

THE BRITISH GENERAL TRADING CO., LTD.,
 9, HOWLAND STREET, TOTTENHAM COURT ROAD, W.1.
 Telephone No.: Museum 6857.

Quality RADIO COMPONENTS

Profusely illustrated thirty page CATALOGUE just out. If your dealer cannot give you one send us a card with his name and address to receive it direct FREE and POST FREE.

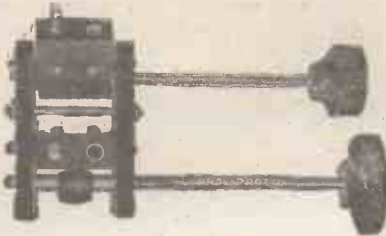

Prov. Protected.

CAM-VERNIER COIL HOLDER

Price 9/-; on base 1/- extra.

With Reaction Reverse and Shorting Switch incorporated, 12/6; postage 4d.

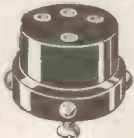

LEGLESS VALVE HOLDERS

1/6
post
2d.

Acts
as
own
drilling
jig.

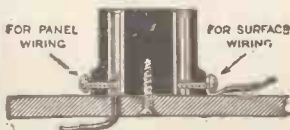

BASKET COIL HOLDER.

1/3 postage 2d.



PANEL COIL HOLDER

(no base)

Back connections eliminating flex.
2-way 3/-,
3-way 5/-,
N.P. 2-way 6d.,
3-way 1/- extra.
Post 3d.

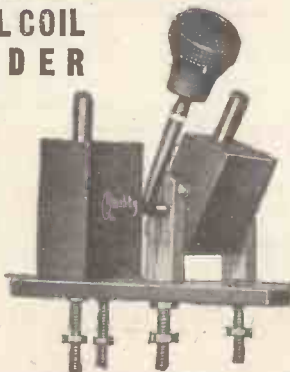

Drilling template with all.

If your dealer has not got them we send post free if you mention his name and address.

**GOSWELL
ENGINEERING CO., LTD.**
95/8, WHITE LION ST., LONDON, N.1.

RADIOTORIAL QUESTIONS AND ANSWERS.

(Continued from page 70.)

that a wire which appears O.K. has broken and is making imperfect contact, or that one of the soldered connections did not "take" and has loosened. If the noises do not completely disappear when good contacts have been secured, the insulation of the battery itself and of the leads should be improved.

SOLDERING TO WATER PIPE.

G. W. (Melton Constable).—I have been told that it is much more satisfactory to solder the earth lead to the water pipe than to use a clip. I am, however, at a loss to do this. Whenever I attempt to solder to the pipe, after carefully cleaning it, the lead pipe just turns black. What is the best method of soldering a lead to a water pipe?

If the earth wire is soldered to the water pipe between the tap and the tank, the following is the best procedure. Turn the water off at the main, and allow the water to drain out of the pipe; carefully clean the place at which the earth wire is to be joined, and smear with some soldering paste and then "tin." The earth wire should then be soldered to the pipe in about three places, and, after a good joint is made, the soldered connections should be covered with insulated tape.

NEXT WEEK.

The Winter Radio Season Begins for "P.W." Readers.

Special Features include:

The Radio Exhibition at the Albert Hall: Part I of an article reviewing the Exhibits.

The "P.W." Constructors' Series: No. 1.—A Crystal or Valve Receiver, and How to Make a Three Valve Combination Reflex Receiver.

And many other important Features.

ORDER YOUR COPY NOW.

Calculating Wave-length.

G. N. H. (Swiss Cottage).—What is the easiest way of calculating the wave-length of a coil and aerial system?

There is no really *easy* way of calculating the wave-length of a coil and aerial system, but the following will probably be the quickest.

First calculate the coil's inductance in microhenries and add this to the inductance of the aerial, taking the capacity of the aerial in microfarads and applying the formula:

$$\text{Wave-length} = 1,885 \sqrt{K (\text{mfds.}) \times L (\text{mhs.})}$$

As the result will only be approximate the capacity of the average aerial used for broadcast reception can be taken as .002, or .0003 mfd., while the inductance will be about 15 mhs. This latter can be checked roughly by multiplying the length of the aerial in feet (plus lead-in) by 1.5, the result being in metres wave-length. Then, if we call this W and apply the formula below we shall have the inductance in mhs.

$$W = \frac{K}{L} (K = .0002) = L$$

This then gives us K and L for the aerial as nearly accurate as is necessary, and we have found the inductance of the coil alone by means of the formula $L = 0.8 D^2 N^2 L K$, mhs., where D = diameter

of coil in cms.; N = number of turns per cm.; L = length of coil in cms.; K = correction factor, based on the ratio of the length of coil to the diameter. This can be found from coil tables, or else roughly calculated for the following data. The factor varies from .96 (where the diameter is .1 of the length) to .2 (where the length is .1 of the diameter). If diameter = length the factor is .60. If $L = 2D$, $K = .82$, and if $L = 5D$, $K = .92$.

The answer in mhs. from the above is then added to the inductance of the aerial, and the capacity of the latter is taken and the first formula is applied, i.e., $1,885 \sqrt{KL}$, which gives the total wave-length of coil and aerial. Any parallel capacity across the coil can be added before the final equation is worked out.

Correspondence

Letters from readers discussing interesting and topical wireless events or recording unusual experiences are always welcomed, but it must be clearly understood that the publication of such does in no way indicate that we associate ourselves with the views expressed by our correspondents, and we cannot accept any responsibility for information given.—Editor.

A NEW ULTRA-AUDION.

The Editor, POPULAR WIRELESS.

Dear Sir,—I was interested in the article which appeared in "P.W." a short while ago, entitled "Some Ultra-Audion Modifications": and thought perhaps some of your readers might be interested in the "Ultra-Audion" Circuit which appears below.

The modification in the above circuit was the outcome of some experiments conducted during the latter

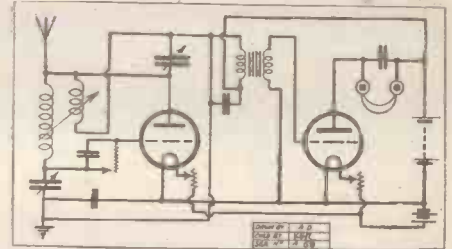

part of 1923. Apart from sharp tuning, the circuit certainly gave some good results, and is worth the attention of circuit enthusiasts.

It seems odd that such an old circuit as the Ultra-Audion should still attract the attention of amateurs: and, judging from recent correspondence from "P.W." readers, it seems to be a favourite among many of them.

Yours faithfully,

L. R. EVERARD.

"Fernlea," 70, Waterhouse Street, Chelmsford.

THE SAN SEBASTIAN STATION.

The Editor, POPULAR WIRELESS.

Dear Sir,—May I inform your readers that the wave-length of "Radio Catalana" has been raised up to 460 metres to avoid clashing with Rome.

Also the new Spanish station, "San Sebastian" should be received here very strongly. I received him during his testing transmissions when calling the Western Electric Co., London, on three valves, O-V-2. The volume on loud speaker was nearly equal to the local station half a mile away—this on a very short indoor aerial about 15 foot high.

I remain,

Yours faithfully,

H. HIZETT.

45, Mushroom Lane, Sheffield.

The Editor, POPULAR WIRELESS.

Dear Sir,—Referring to the note in your issue of July 25th of a reader receiving San Sebastian of July 10th, it may be interesting to note that I got it on July 8th and afterwards confirmed. The wave-length is 360 metres and the Western Electric Co.'s 500 watt equipment. I agree with and endorse your Manchester correspondent's reference to the wonderful tonal quality of the transmission and great strength (readable on small L.S.). Atmospherics and fading nil. Set used Reinartz Det. and L.F. Indoor aerial.

Regarding your Mr. K. D. Rogers' article "Is 5 P Y a failure" I beg in reply to quote the slogan of Mr. Vivian Foster (absolutely without his permission), "Yes, I think so!"

The station might well be scrapped and its power be handed over to 5 R N, a local amateur who would do much better with the material at their disposal and give more satisfaction to crystal users.

Recently we had a splendid example of "land-line" trouble. And is there anything worse?

Now could any of your readers advise me how to make a "Chapman" coil to cover 5 X X and not be too large and unwieldy? Wishing "P.W." all the success it so fully merits.

Yours faithfully,

W. J. SLOMAN.

7, Cotehele Villas, Devonport.

THE SILENT NIGHT.

The Editor, POPULAR WIRELESS.

Dear Sir,—It is very gratifying to see you taking up the cudgels on behalf of the D X Experimenters. Your recent article in "P.W." must echo the opinion of a great number of readers of all kinds of technical journals. The B.B.C. ought to realise that these D X Experimenters are also licence-holders, and as such, are entitled to their fair share of consideration from the B.B.C. If your

(Continued on page 78.)

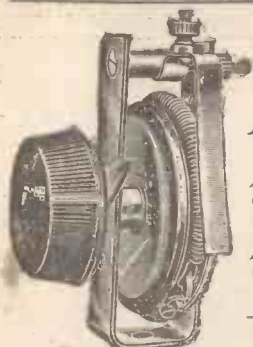

IGRANIC Filament Rheostat
(Plain type) Patent No. 193903.

Experiment with wireless but not with components

—use Igranic and be sure of the results your efforts deserve.

Igranic Rheostats, remarkable for their extremely smooth action, critical control of filament current and absolute reliability, are particularly valuable components for the wireless enthusiast engaging in experimental work. These filament Rheostats are constructed for panel mounting and can readily be adjusted for panels of from one-eighth to one-half an inch in thickness. Positive travel stops are provided so that the main Rheostat body comes to rest at zero and at full resistance positions. The Rheostat is made in two types, vernier and plain. The vernier type is recommended for detector valves.

The Igranic "D.E." type filament Rheostat is suitable for controlling all types of Dull Emitter valves. It is smoothly and evenly variable over its whole resistance range and permits of very fine adjustment.

IGRANIC RADIO DEVICES include: Honeycomb Duolateral Coils, Variable Condensers, Fixed Condensers, Filament Rheostats, Intervalve Transformers, Vernier Grid-Leaks, Variometers, Vario-couplers, Coil Holders, Potentiometers, Variable Tuning Devices, Switches, etc. All carry the IGRANIC guarantee.

Write for **COMPANY** List Z693.

BIRMINGHAM.
CARDIFF.
GLASGOW.

LEEDS.
MANCHESTER.
NEWCASTLE.

149, Queen
Victoria Street, London.



Works: Eedford.

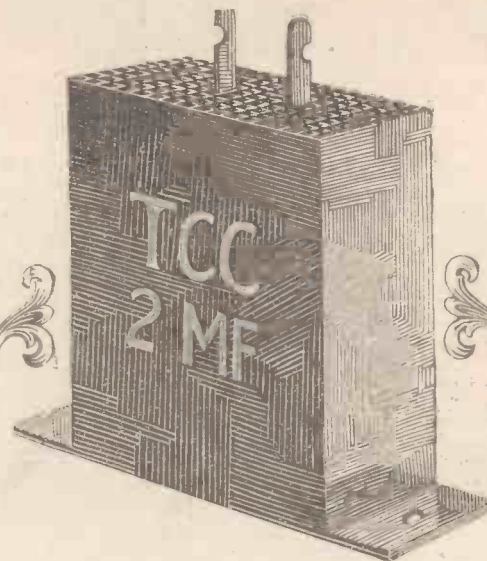

1905—1925

FOR more than twenty years T.C.C. Mansbridge Condensers have been the standard fixed condensers for all electrical requirements. First in telegraphy—afterwards in wireless telegraphy—now in Broadcast reception, their dependability and accuracy have always earned unstinted praise.

Among all your wireless friends you will never have known one who has ever been disappointed with a T.C.C. Mansbridge Condenser. And, after all, this feeling of supreme confidence is a great thing. It means that you can accept a T.C.C. Mansbridge Condenser, place it in the circuit, and know that its capacity is exactly as marked and that it cannot possibly short circuit. The most frequent and rigorous tests that can be devised safeguard both of these points for you.

But not all green condensers are T.C.C., and not all condensers produced to imitate the T.C.C. are of the genuine Mansbridge pattern. In fact, very few of them are. But you are always safe if you see the letters T.C.C. stamped on the side of the case.

T.C.C. Mansbridge Condensers

In all values from all Dealers

Telegraph Condenser Co. Ltd.
Mortlake Road, Kew

Internal Metal
Check to grip 14 to 44 gauge wire or flex.
Price:
Plug 4d.
Socket 2d.
Indicating Ring 1d.



BELLING-LEE INDICATING TERMINALS & "MULTY-KONTACT" PLUGS & SOCKETS

(Handles and dome-shaped Indicating Rings in Red or Black) Stocked in the following indications:

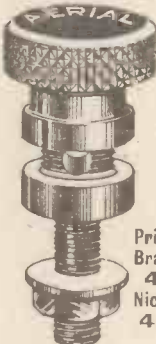

Price:
Brass 4d.
Nickel 4½d.

PATENTED

DIAL INDICATORS

H.F. TUNER
Solid cast metal, with raised, polished letters showing white on a black background. Single hole fixing, complete with nut. Stocked in Tuner, Filament, Reaction, Aerial, Anode, H. F. Tuner, Secondary, Rejector.
Price - 6d. each.

Aerial, Earth, Phones+, Phones-, L.T. +, L.T. -, H.T. +, H.T. -, Input +, Input -, Output +, Output -, L.S. +, L.S. -, Grid +, Grid -, A.T.I., Reaction, Ap. Aerial, H.T. Medium, and Blanks.

Every high-class dealer stocks them, but in case of difficulty send to **BELLING & LEE, Ltd.** Queensway Works, Ponder's End, Midx.

SUB-CONNECTORS

Eliminate Soldering.



Perfect connection; lowest possible self-capacity; low resistance; connection changed in an instant. Tapped to screw on to 2, 4, 5 and 6 B.A. threads; also T-connectors for joining wires.

Price 1d. each.

RAYMOND

HULLO EVERYBODY!

ALL GOODS POST FREE U.K. except where stated. Foreign orders over £10 post free otherwise please send ample for post, etc. Trade orders U.K. less 20% Post extra. Open all day Saturday.

SUNDRIES

- Aerial 7/22, 100ft. 2/6
- 2-way coil stands 2/8
- 3-way coil stands 4/6
- 2-way nickel 3/6
- 3-way nickel 4/6
- 2-way geared 5/6
- 2-way Shipton cam 6/-
- 3-way Shipton cam 7/6
- 2-way Polar cam 6/1
- 3-way Polar cam 7/1
- vernier 9/-
- 2-way cam vernier 3/6
- Coil plugs, plain...

REFLEX COILS

- Make under licence
- Burndept. Patent No. 162943
- No. 35 150/200 8d.
- No. 50 200/500 9d.
- No. 75 300/750 1/-
- No. 100 400/1,000 1/1
- No. 150 600/1,500 1/8
- No. 200 800/2,000 2/6
- No. 250 900/2,500 3/3
- Post 2d. each.

LOUD SPEAKERS

- O.A.V. Tom-Tit. 30/-
- O.A.V. Junior 55/-
- Sterling Baby 55/-
- Sterling Hinkle 30/-
- Amplion Junior 27/6
- Amplion Dragon 5/-
- Amplion Do. III 50/-
- Amplion De Luxe 65/-
- Amplion AR19 105/-
- Dulcevox 42/-
- True Music Minor 21/-
- Ultra 27/6

TRANSFORMERS L.F.

- Eureka Concert
- Grand Second 22/6
- Stage 22/6
- Igranite Shrouded
- New Model 21/-
- Formo Shrouded 10/6
- General Radio 93 15/-
- Super Success (black) 21/-
- Brunet shrouded
- 4 or 5-1 13/6
- Croix 12/6
- Wates Supra 9/6
- Terminals complete
- Pillar, doz. 1/1, 1/3
- W.O. 1/1, 1/3
- Phone 1/1
- Nickel 9d. doz. extra
- Voltmeter, each 5/6
- Rheostat & Dial 2/3

ADJUSTABLE

- 22in. Phone Cords 1/11
- 7/2in. Phone Cords 1/11
- Eureka Gravit 1/11
- Detector 6/6
- D.P.D.T. Panel 1/3
- S.P.D.T. 1/3
- Lissen Minor 3/8
- Lissenat 7/6
- Universal 10/6
- Switch 2-way 2/9
- Series Parallel 3/9
- Anode Res. 1/6
- Var. Grid Leak 2/6
- Choke 10/6
- Lissen L.F. T.1 30/6
- Lissen L.F. T.2 25/6
- Lissen L.F. T.3 15/6

IGRANITE COILS

- Coils—25 5/6, 35 5/6, 100 5/2, 75 5/6, 100 7/1, 150 7/10, 200 9/8, 250 9/10, 300 9/8, 400 10/3, Rheostat 4/6 30 ohms 7/-

ORMOND

- L.F. Transformer 14/-
- Special Rheostat 21/-

STERLING

- Variable condensers, with vernier.
- 0005 25/6
- 0002 22/6
- Non-Pon V.H. 4/3
- Phones 20/- & 22/6
- Primax Loud Speaker 47 15

ERICSSON E.V.

- (Continental)
- 4,000 ohms, 12/-

HEADPHONES

- British, 4,000 ohms
- Sterling 20/6
- B.T.H. 20/6
- Drands 20/-
- Brown's 'E' type 20/-
- Ericsson's 22/6
- Microm vernier 2/6
- Gambrell coils stocked
- Paragon panels obtained
- Watmel grid leak 2/6
- Watmel anode 3/6
- Watmel 10,000 to 100,000 3/6
- 100,000 3/6
- Ditto wood 3/6
- Britto anode 3/6
- Colvern Precision Variable
- 0005 20/-
- 0005 21/-
- Glazite 10,000 1/2

POLAR

- R.C.C. Unit 15/-
- Micrometer 5/6
- 0005 or 0003 10/6
- EVER-READY
- 100 volts H.T. 20/-
- 66 volts H.T. 12/6

WEST-END LEADING STOCKIST

For Edlson Bell, Jackson's (J.B.), Polar, Igranite, Elwell, Peerless, Eureka, Magnum, Burndept, Lotus, Dublier, Marconi, Dorwood, Sterling, Success, B.T.H., McMichael, Lissen, Woodhall, Utility, R.I., Bowyer-Lowe, Amplion, Formo, Brunet, Ormond, Peter Curtis, etc. SEND FOR LISTS AND I WILL QUOTE YOU LOWEST PRICES. MANY GOODS PRACTICALLY UNOBTAINABLE ELSEWHERE CAN BE SUPPLIED AT SHORT NOTICE TO RETAIL CUSTOMERS.

RAYMOND

Variable Condensers

- SQUARE LAW LOW-LOSS
- One hole fixing. Ebonite ends.
- With Vernier. Without Vernier.
- 001 .. 8/6 001 .. 7/6
- 0005 .. 7/6 0005 .. 5/9
- 0003 .. 7/- 0003 .. 5/3
- Including knob and dial. Post 3d. set.

STANDARD.

- 001 7/6
- 0005 6/-
- 0003 5/6
- 0002 5/-
- Take up tiny space.
- Knob & dial free. All with knob & dial.

ORMOND "AMERICAN"

- Square Law Low Loss. Skeleton ends, knob and dial.
- 001 9/-; 0005 8/-; 0003 7/6; 00025 6/6 (with vernier 1/6 each ex.)

JACKSON BROS. "J.B."

- Square Law Square Law with vernier
- 001 9/6 001 13/6
- 0005 8/- 0005 11/6
- 0003 6/9 0003 11/6
- 00025 6/6 00025 11/3
- "J.B." { 001 8/6 0005 7/6
- Standard 0003 5/9 0002 5/1
- ALL with knob and dial. Post free.

ACCUMULATORS.

- 2-v. 40-amp. 9/6
- 2-v. 60-amp. 11/6
- 4-v. 40-amp 15/11
- 4-v. 60-amp. 19/6
- 4-v. 80-amp. 24/6
- 6-v. 60-amp. 29/6
- 6-v. 80-amp. 35/9
- All new, best makes.
- Harts also stocked.
- Goswell (quality) Mounted Coils
- 25 1/6, 35 1/9, 50 2/1, 75 2/3, 100 2/9, 150 3/-, 200 3/8, 250 5/3, 300 6/-
- 2-way Panel 3/-
- 3-way, 5/-; 2-way cam vernier, 9/-
- Electric Soldering Set 5/6
- All parts stocked.

"LOTUS"

- Gears 8.1 2-way 7/-; 3-knob 10/6
- McMichael's Triple Rheostat 22/6
- Dual Rheostat 7/6
- H.P. Transformers each 10/- (All w/e-lengths)
- Potentiometer 7/6
- Fixed Condensers. All parts stocked

BURNDEPT PARTS.

- Rheostats: Gen. Purposes 5/-, Dual 7/6, Detector 4/-, Rheostats 5/-, 7/6, Antiphonic V.H. 5/-
- Success choke 10/6
- Athol V.H. 1/3
- Athol Coil Plug 1/3
- T.O.B. 6 ohms 4/-
- T.O.B. 30 ohms 4/-
- T.O.B. Potentiometer (300) 5/-
- Shipton ditto (600) 4/6
- Shipton 30 or 60 ohms 3/-
- Woodhall Bars stocked
- Dublier Variables, Dublier Fixed 610 type.

POLAR

- R.C.C. Unit 15/-
- Micrometer 5/6
- 0005 or 0003 10/6
- EVER-READY
- 100 volts H.T. 20/-
- 66 volts H.T. 12/6

IF WANTING ANY GOODS MAKE OUT LIST AND I WILL QUOTE LOWEST INCLUSIVE PRICES.

- VALVES To encourage you to use British Valves I am willing to purchase one burnt-out valve for each valve you purchase.
- Prices given range from 1/2 to 5/6 according to valve you buy.
- YOUR PANEL DRILLED FREE WITH 25/- order (retail)

CALLERS COLUMN ONLY

All Post Orders from Other Columns.

H.T. BATTERIES

- (Various makers).
- 60-v. 5/6, 6/6, 6/11
- 66-v. Ever Ready, 12/6
- 100-v. 20/6
- 60v., B.B.C. 8/11
- 38-v. 5/6
- 16.5-v. 2/8
- 9v. (grid bias) 2/-

ORMOND "No. 3"

- Ebonite Ends. Sq. law with vernier.
- 001 10/6
- 0005 9/6
- 0003 9/-
- Also without vernier, 1/6 each less.
- All with knob & dial.

Square Law

- Variable Condensers.
- 0005 5/- 0003 4/6
- Including knob & dial

D.P.D.T. Panel

- 1/-
- S.P.D.T. 10/6
- D.P.D.T. china 1/3
- Terminals, 1d. 10/6
- doz. 10d.
- Nickel 1d.
- Valve sockets, 4 for 3d.
- Stop or valve pins 4 d.
- Washers 12 a 1d.
- Nuts 6 a 1d.
- Spade tags 6 a 1d.
- Spade terminals, 1d.
- 2-v. 2 for 1d.
- Pin terminals, 2 for 1d.
- Do. Red or Black, 1d.
- Copper foil, foot, 3d
- Red and black tape, 1/6
- Aerial, 7/22 100ft. 1/11
- Battery Clips, 3 a 1d.
- Sleeving, yard, 3d.
- Wander plugs, 2d.
- Contact studs complete, 2 a 1d.
- Phone cords, 6 ft., 1/3
- Knobs and Dials, 10d.
- Empire Tape, 12 yds. 6d.
- Valve Holders, 8d.
- Flux and socket, red 3d.
- 7/22 grid, 50 ft. 1/11
- Ins. Hooks, 2 for 1d.
- Loud speaker cords

THORPE K4

- (Undriven 5-pin)
- VALVES
- Genuine, each 1/4-
- 5-pin valve holder.
- Set Parts (one valve) 46/6
- Ditto (two valves) 66/6
- (Including valves).

EBONITE

- Cut to size
- 3/16th 3d. sq. inch
- 1/4 d. sq. inch.
- "WONDER" AERIAL Phosphor Bronze, 100 ft. 3/3
- Indoor, outdoor or frame, 49 strands.

"UTILITY"

- 2 pole c/o knob. 4-
- 4 pole c/o knob. 6/-
- 2 pole c/o lever. 5/-
- 4 pole c/o lever. 7/-
- Nickel 6d. ea. ex.
- Variable condensers at list prices.

SECOND-HAND DEPT.

- Quantities of nearly new and second-hand goods on sale.
- Cheap prices.
- Old parts bought or taken in part exchange.

IMPOSSIBLE

- to advertise all lines here. Send name and address (postcard, please) to Edlson Bell, 54, Harrow Road, Bournbrook, near Birmingham. BRUNET 4,000 ohm 'phones 13/11
- Ebonite Coil Plugs Fitted Fibre 7d.
- Shaped Fibre 4d.
- Edlson Bell 11d.
- Loud speakers, 15/9
- 4,000 ohm 'phones, 6/6
- 3-way coil stands, 3/6
- Special rheostats, 1/-
- Crystals, best, 6d
- Enclosed detector 8d.
- Extra large do. 1/-
- 2-v. 40 accumulator 7/6

Stock sizes 3/16th.

- 8 x 6 - 7 x 5 each 1/2
- 10 x 8 - 9 x 6 each 1/10
- 10 x 8 - 12 x 6 3/-
- 12 x 9 4/3
- 12 x 12 5/6
- 14 x 10 5/6
- 4-in. also stocked.

CALLERS - we stock everything you require.

CORRESPONDENCE.

(Continued from page 76.)

suggestion of a silent night for every one of the B.R.C. stations was put into force, I am sure that it would go a great way in solving the problem of oscillation, as the majority of "fans" would be content with one free night a week.

And with the knowledge that they would have the ether to themselves one night a week, the inducement to try and receive distant stations would not be so great on other nights.

I am using a four-valve set, loose-coupled aerial circuit, with reaction on to the tuned anode coil, and even with this arrangement I find it very difficult to receive any other station while 2 V.L.O is working. I certainly like to hear a decent programme from the local station sometimes. But too much of it palls. I, for one, unless I can get facilities for developing my hobby in the direction which appeals to me most, shall give it up altogether. If all experimenters are of the same opinion as myself this would mean a serious loss to the B.B.C. in licence fees.

I am, yours faithfully,
EDWARD H. PRINNER.

57, Durlston Road,
Clapton, E.5.

UNIDYNE RESULTS.

The Editor, POPULAR WIRELESS.
Dear Sirs,—I thought it might interest "Unidyne" enthusiasts to know that while spending a week-end in the neighbourhood of Lewes recently, I was able to pick up, with my 'two-valve Unidyne' (Det. and L.F.) London and Bournemouth very clearly, using three pairs of 'phones in series, aerial being a length of "Electron Wire" simply laid along the grass on which we sat. Some three or four other stations could be located, but not readable.

Best wishes to Messrs. Dowding and Rogers for the simplest and best portable valve set—the Unidyne.

Faithfully yours,
E. W. BACKHOUSE.

North Row, Warminster,
Wilts.

UNUSUAL "STATICS."

The Editor, POPULAR WIRELESS.
Dear Sir,—Perhaps my recent experience of "statics" may be unique. Violent scratchings in one 'phone led to an extensive examination of connections, etc., with no result, so I concluded that one earpiece was more sensitive than the other, and endured it for one transmission.

Finding it the same the next day I again undid the earcap, and found parading around the diaphragm—an earwig! That must have hidden under the magnets during my previous examination.

Its entrance must have been through the hole for the 'phone cords—a tight fit.

I am, sir,
Yours faithfully,
J. E. DU MERTON.

The "Star" Inn,
Standon, Herts.

SIMPLIFIED "P.W." REFLEX.

The Editor, POPULAR WIRELESS.
Dear Sir,—You will, no doubt, be interested to hear of the results I have obtained with my one-valve reflex set, the simplified "P.W." combination receiver. I have not, as yet, read of any reports of the same in your "Correspondence" column.

I had a little trouble at first, but after experimenting with the coils, and careful adjustment of the tuning condensers, I have been able to log many stations. Below are a few of the principal ones.

The local station, 5 IT, is excellent loud speaker strength.

London and Nottingham (relay) are the next best, signals at R. 6.

Bournemouth, Manchester, and Glasgow, I receive at R. 4. Aberdeen I can receive only when the local station has closed down, while Cardiff, considered the worst station to receive in this district, I receive at R. 4 only, of course, when the local station has closed down.

With regard to foreign stations, I have been able to receive Petit Parisien, Radio-Toulouse, Hamburg, and many others, the call signs which have so far eluded me.

During last winter I received two American stations, but reception was very bad owing to heavy atmospherics.

There are many other stations I've received, but the above are the ones I've succeeded in identifying. Trusting this letter will be of interest to you, I will close wishing "P.W." every success.

Yours sincerely,
DENNIS BAKER.

54, Harrow Road,
Bournbrook, Birmingham.

WHEN replying to advertisements please mention "Popular Wireless and Wireless Review" to ensure prompt attention. **THANKS!**

7 GRAPE STREET SHAFTESBURY AVENUE, W.C.2

New Oxford Street end. 1 minute Tottenham Court Road Tube.
NOTE! Grape Street is between Prince's Theatre and Mudge's Library. 3 minutes Holborn Tube.
DAILY 9 a.m. to 8 p.m. 2 minutes Palace Theatre.
SUNDAYS 11 to 1 p.m.
All day Saturday.

HOURS OF BUSINESS

Daily 9 a.m. to 8 p.m.
Sundays, 11 to 1.
Open all day Saturday.
Two shops, one always open.
Telephone (private line) Gerrard 2821.

THE CHOICE OF RECEIVING SETS AND COMPONENTS.

(Continued from page 38.)

applying only half of the available H.F. voltage for rectification (see Fig. 2). This results in considerably greater selectivity without appreciable loss in signal strength.

If you are ambitious and in the happy position of being unhampered by considerations of economy, you should choose a four or five valve straight circuit (1-v-2 or 2-v-2), or a multi-valve Armstrong super-heterodyne. The latter circuit, of course, offers considerable advantages in ease of use, although it is somewhat expensive, both in first and in running costs.

In all cases let your choice be guided by a judicial examination of the components for mechanical and electrical defects in the light of the criticism given below under the name of each component.

Unless absolutely unskilled, avoid highly damped H.F. couplings and choose a set with sharply tuned "tuned anode" coupling. This takes a little longer to get used to, but amply repays the time spent. See that really good (not merely well-advertised) transformers are fitted for L.F. amplification, and that provision is made for the use of grid bias batteries in the second and subsequent stages. Preferably have separate H.T. + terminals for each valve; they are easily linked together if not required, and are of inestimable convenience when trying different combinations of valves. Avoid the use of plugs, jacks or Dewar switches, particularly in the H.F. stages.

Ebonite and Panel Materials.

Many inferior materials are offered under the name of ebonite to the unsuspecting amateur, and it is high time that this most important material should be sold under a guarantee, say as conforming to the specification of the British Engineering Standards Committee. In the absence of such guarantee, the amateur is left to decide for himself without the assistance of the electrical tests available to the manufacturer. The best course, in the circumstances, is to insist on a guarantee of the manufacturer's name, and to watch the advertisement columns of the wireless press for copies of certificates of test from the National Physical Laboratory.

(To be continued.)

FOREIGN NEWS.

(Continued from page 48.)

America. Among other competitors were the Telefunken and Marconi's.

The Angora station will be approximately of the same type as those of Sainte Assise, Warsaw, and Coltano. It will use 250 kilowatts, provided with a Diesel motor of 600 h.p. The antennae will be supported by six pylons of 200 metres in height and will be in regular touch with all leading European and American stations. The Constantinople station will replace the old and somewhat ineffective one existing at present at Osmanié. Two alternators, each of 25 kilowatts, will be used. A Diesel 150-h.p. motor and the water-power station of the Sweet Waters of Europe at the head of the

(Continued on page 80.)

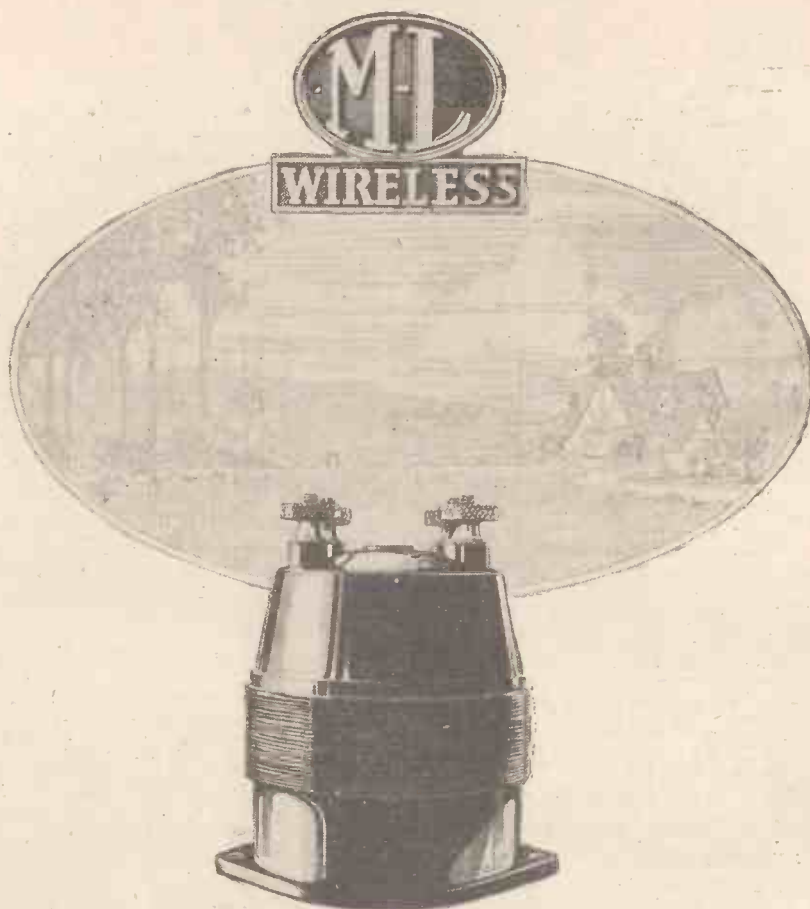

Verb. Sap.



I have tried practically every transformer on the market and your transformers certainly are by far the best, both for ordinary use and for Power Amplification and, what is very important, they are the most convenient for mounting.

"Their chief advantages over others are strength, clearness of speech and music, and entire absence of howling even when placed very close to each other.

"In the hands of amateurs, they should also be splendid for their freedom from self-capacity effects."

In these words a prominent West London Wireless Firm gives its unsolicited opinion of the M-L Low Frequency Transformer. Their satisfaction can easily be shared by you—M-L Transformers only cost 25/- each, and the name "M-L Wireless" appears conspicuously on the container.

The 1:6 ratio is used for amplification after a crystal rectifier. The 1:4 ratio is used for single stage L-F Amplification. The 1:2:6 and 1:4 ratios are used respectively in the first and second stages of two-stage amplification.

S. SMITH & SONS (M.A) LTD.
179-185, Great Portland Street, London, W.1

Telephone: Langham 2323 Telegrams: "Speedomet, Telew, London"
Also at Birmingham, Manchester, Glasgow and Belfast.

S. SMITH & SONS (M.A) LTD

E.P.S.2.

3 to 10-fold AMPLIFICATION WITHOUT VALVES
 at small cost, by the NEW MAGNETIC MICROPHONE BAR.
 (Prov. Patent No. 957425).



It clings to the Magnets of any Wireless Receiver and amplifies direct from them. No Microphone Button. No Diaphragms whatsoever. No distortion. A three-volt Dry Battery only required. Full particulars from

New Wilson Electrical Manufacturing Co., Ltd.,
 18, Fitzroy St., Euston Rd., London, W.1.
 Phone: Museum 2703.

RADIO "CROXSONIA" PANELS
 Money back guarantee that each and all Panels are free from surface leakage, Meggar test infinity.

8" x 5", 1/2; 7" x 6", 1/3; 9" x 6", 1/7; 10" x 8", 2/1; 11" x 8", 2/3; 10" x 9", 2/4; 12" x 8", 2/8; 11" x 9", 2/7; 12" x 9", 2/10; 12" x 10", 3/1; 14" x 10", 3/5; 14" x 12", 4/1; 7" x 5", 1/- thick. Post Free.

Callers, cut any size, and quote by Post.
 Sample, and prices, post free to the Trade.

CROXSONIA CO., 10, South St., MOORGATE, E.C.2

PLUGS & JACKS, 3/- pair.

Dewar Switches, 3-way, 12 pt. .. 2/6
 Mansbridge Condenser, 2 m.f. .. 2/-
 Modulation Transformers .. 5/-

all Ex-W.D. Post Free.
 A. ROBERTS & Co., 42, Bedford Hill, S.W.12

ACCUMULATOR BARGAINS.
 C.A.V. & Fullers, soiled, but guaranteed 12 months.
 Sent on approval against cash

2v-40a ... 9/8 4v-80a ... 2/8 6v-60a ... 32/8
 4v-40a ... 17/- 4v-100a ... 32/8 6v-80a ... 40/-
 4v-60a ... 21/8 6v-40a ... 25/- 6v-100a ... 46/-

MAUDE RUBBER CO., 58, PRAED ST., W.

VALVES 7/6
DULL EMITTING
BRITISH MADE EACH

1.8 Volts. 0.22 Amps.
EVERY VALVE GUARANTEED.
 Money returned if dissatisfied.

2 Valves for 14/- postage 6d.
RADICON 7, JAMAICA ROW,
BIRMINGHAM.

2-VALVE AMPLIFIER, 35/-

1-Valve Amplifier, 20/-, both perfect as new;
 Valves, 4/6 each; smart Headphones, 7/6 pair;
 new 4-Volt Accumulator, celluloid case, 13/-; new
 60-Volt H.T. Battery, guaranteed, 6/-; 2-Valve
 All-Station Set, £4. Approval willingly.
 P. TAYLOR, 57, Studley Road, Stockwell, LONDON.

Picketts Cabinets Model-de-Luxe Polished

SENT ON APPROVAL.
 Beautifully Polished Mahogany

For 12 x 12 Panel .. 45/-
 " 12 x 15 " .. 55/-
 " 12 x 18 " .. 65/-

Estimates and Lists free—Send Sizes!
 Panels and Complete Accessories—Post Free.
 Picketts Cabinet (P.W.) Works, Bexleyheath, S.E.



FOREIGN NEWS.

(Continued from page 79.)

Golden Horn will be used. Radiophone installations will be set up both in Angora and Constantinople, of a 20-kilowatt force, and with an action radius of over 1,500 kilometres.

Paris—New Aerodrome Stations.

Only aerodrome near Paris has been fitted with a radio installation, and this will be extended gradually to all French aerodromes.

The purpose is to keep aeroplanes informed of meteorological bulletins and any information that may be of use to the flyers. The Only station is of 2 kilowatts power and has four pylons of 30 metres height. Transmission can be effected either by telegraphy or telephone. The wave-lengths to be used are 2,350 metres, 1,680 metres, 1,400 metres, 900 metres, and 600 metres. Saint Cyr aerodrome already possesses a similar station, and this is linked up with Villacoublay aerodrome.

Among the next aerodromes to be thus equipped are Marignane, Algiers, Tunis, Casablanca, Cherbourg, Berre de Hourtin, and Cuers-Pierrefeu.

TECHNICAL NOTES

(Continued from page 46.)

The old idea of a wireless clock which shall set itself correct automatically by the reception of time-signals is to take a more practical form, if certain recommendations of the Radio Association take effect. At a recent meeting of the Association, Dr. Fournier d'Albe, the well-known scientist, outlined a scheme by which time-signals, on a special wave-length, should be sent out simultaneously from different stations throughout the world every minute during the twenty-four hours. Special clocks could then easily be arranged so that a form of trip gear could be actuated by the time-signals and the clock thus kept correct.

It seems to me that if the activities of the Radio Association result in the establishment of a special time-signal, even once every hour, suitable for the operation of clocks of this kind, the Association will have rendered a valuable service. What a boon it would be if private individuals could have installed in their homes clocks which could always be relied upon to indicate Greenwich time.

'PHONES STRENGTHENED!!

NEW SECRET METHOD.

of magnetising and adjusting improves new or old 'phones 20 per cent to 200 per cent. 2/- pair. Guaranteed results. New method of layer-wound rewinding renews useless 'phones and makes them better than new. 5/- pair. Every class of repair to 'phones, loudspeakers and transformers. All work guaranteed. Ready same day. Post, 6d. pair. Prospectus P. gratis. JOHN W. MILLER, 68, FARRINGTON ST., E.C.7. Phone: Central 1950.

UNIDYNE D.E.'s

These valves are improved pless type, and have characteristic curves issued with them (see "P.W." July 4th, page 862, Correspondence column).

PHILIPS 4-Electrode D.E. 1'8 volt '16 amp. 25/-
 PHILIPS Bright Emitter 1 volt '5 amp. .. 11/-
 THORPE K.4 (5-pin holder 1/3 extra) .. 14/-
 BREWOOD LEAK .. 3/- MICROSTAT .. 2/9

TRADE SUPPLIED. POST FREE.
 Responsibility for breakage accepted if valves are returned within 24 hours of receipt.

ANELOY PRODUCTS,
 Eton Works, Upland Road, London, S.E.22.

SPECIAL OFFER OF BLOW-LAMPS

Strongly made, size 4 x 3 1/2. Gives powerful flame, removes paint, etc. solders without iron. Simple, safe, economical. Worth 3/6. Satisfaction guaranteed or money back. 1/6 each, 3 for 4/-, post free. Trade Enquiries Invited.

WILKINSON & SON, 24, North Road, Clapham, S.W.



HEADPHONE REPAIRS.

Rewound, re-magnetised and readjusted. Lowest prices quoted on receipt of telephone. Delivery three days.—THE VARLEY MAGNET CO., London, S.E.18. Phone 888-9 Woolwich. Est. 26 years.

'PHONE REPAIR SERVICE

ALL MAKES OF 'PHONES REWOUND. 4,000 ohms, 5/- per pair; 6 ft. 6 in. leads fitted. 2/- Remagnetising and adjusting, 2/-; postage. 6d. Transformers rewound any ratio, from 5/-.

The H.R.P., 46, St. Mary's Road, Leyton, E.10

THE "WONDER" CRYSTAL.

The wonder of the age. Brings in stations you have never heard before. As good as an extra valve. Ask your dealer, or send P.O. 1/3 to THE LEONFIELD ENGINEERING CO., 23a, Leonfield Road, London, N.5.

EASY PAYMENTS

LOUD SPEAKERS. Any make. Your selection. Ampion, Brown, Sparta, Sterling, etc. Quarter deposit. Balance six monthly payments.

Headphones and Parts similar terms. Send a list of the parts you are requiring and we will forward you a quotation on the hire purchase system.

ACCUMULATORS. Best quality. Guaranteed.

Three m'thly		Three m'thly	
Cash.	payments	Cash.	payments
4 v.-40	17/-	6 v.-40	25/-
4 v.-60	22/6	6 v.-60	32/-
4 v.-80	27/-	6 v.-80	38/6
4 v.-100	32/-	6 v.-100	45/-

Carr. and Packing, 1/6 any size.
 H. W. HOLMES, 29, Foley Street, Great Portland Street, W.1. Phone: Museum 1414.

REMEMBER! POPULAR WIRELESS HAS THE LARGEST SALE OF ANY WEEKLY WIRELESS JOURNAL IN GREAT BRITAIN!!



Shove!

it any old where—on picture rail or over a door, its high capacity and perfect insulation make

THE Ariane

POCKET AERIAL.

the most efficient Portable Aerial to-day. Taken down in a moment and fits the pocket snugly. Ideal for Flats, Picnics and Boating.

B.E.N. PATENTS LIMITED
 100, VICTORIA STREET LONDON, S.W.1

Ask your Dealer or send direct with his name and address.
 TRADE ENQUIRIES PLEASE.

POST FREE
12/6

WHY BUY ACCUMULATORS ??

If you add depreciation to the expense and inconvenience of having your own accumulators unskillfully recharged, it costs you considerably more than our Inclusive Hire Service !!

AVAIL yourself of our Real Hire Service. Punctual weekly or fortnightly deliveries of Rotax Wireless Accumulators (Greater London Area) from 9/6 per quarter. If you have your own accumulators, let us maintain them. Always clean, fully charged and guaranteed satisfaction.

RADIO DOCTOR AT YOUR SERVICE.

If your set gives poor reception, our Wireless Specialist will call at your house and examine it for a small fee (Greater London Area) and if necessary estimate for repairs or re-construction.

RADIO SERVICE CO.,
 AVENUE, KENTISH TOWN, N.W.5.

REAL SERVICE-HIRE OR MAINTENANCE

Write for Folder Z5. Phone: North 4161 & 4162.

The Name -



The hall-mark of a piece of gold, the name of a famous author, or a distinguished painter's signature, are mere passports to assure the prosperity of a particular article.

In radio the little circular monogram stands for much; it is recognised universally as the label of more than one excellent product, and many times it has been the certain passport to better wireless reception.

For example take the R.I. Transformer. For the reception of orchestral music, if you substitute an R.I. for any other make of transformer you will be pleasantly surprised: the orchestra has grown, instruments you never heard before are easily picked out—in other words, you are now obtaining the overtones.

Or again, take the Retroactive Tuner, so much talked about of late. This component completely obviates the use of plug-in coils and ensures correct and efficient aerial reaction over a wavelength range of from 175-4,000 metres.

In Permanent Detectors there is only one for absolute satisfaction; in rheostats, superheterodyne components, condensers, in fact, for anything in Radio, R.I. is the name, and every time you buy, ask to see the R.I. product—we know how you will decide.



The mark of better radio.

Advt. R.I., Ltd., 12, Hyde Street, New Oxford Street, London, W.C.1.



25/-

Write for R.I. Catalogue, free on application.

Visit our Stand No. 36 at the All-British Wireless Exhibition, Albert Hall, September 12th—September 23rd.



LISSENIUM.

The Popular Reinartz Circuit

The extreme selectivity and smoothness of reaction control obtainable with "semi-aperiodic" aerial coupling and Reinartz reaction has made this type of circuit extremely popular

The aerial coil for a Reinartz circuit must be tapped; the old disadvantage of having to wind special coils, however, no longer exists now that LISSENAGON X COILS are available and an extremely efficient

receiver can be built up with LISSENAGON X COILS and other standard LISSEN PARTS. OFTEN IT IS QUITE A SIMPLE MATTER TO ADAPT AN EXISTING RECEIVER.

LISSENAGON X COILS are similar to standard LISSENAGON COILS, but have the addition of two tapping points near the socket end of the coil. The position of the tappings has been selected carefully, and LISSENAGON X COILS will be found highly efficient for Reinartz circuits, aperiodic aerial tuning, neutrodyne sets, auto-coupled tuned anode circuits, etc.

LISSENAGON X COILS possess all the uses and high efficiency of standard LISSENAGON COILS and when it is not desired to use them in special circuits, such as those mentioned above, they can be used as standard coils.

LISSENAGON X COILS are made in four sizes: Nos. 50, 60, 75 and 250. LISSENAGON X COIL No. 60 covers the broadcast wavelengths, but in order to obtain the best coil combinations for all conditions of reception, LISSENAGON X COILS Nos. 50 and 75 are recommended for the lower and higher broadcast wavelengths respectively. LISSENAGON X COIL No. 250 covers the Daventry and Radio-Paris wavelengths.

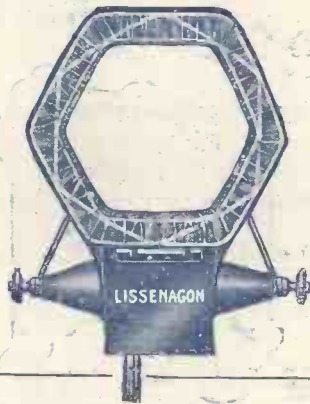

The experimenter usually buys the complete set.

LISSENAGON X COIL No. 50	6/-
LISSENAGON X COIL No. 60	6/4
LISSENAGON X COIL No. 75	6/4
LISSENAGON X COIL No. 250	9/9

Readers of this magazine are invited to send for interesting leaflet describing the uses of Lissenagon X Coils. A copy of the Lissen Text Book will be sent also.

BUILD WITH ALL LISSEN PARTS AND YOUR RECEIVER WILL GIVE RESULTS WHICH WOULD NEVER BE POSSIBLE WITH MIXED PARTS

LISSEN LIMITED

LISSENIUM WORKS,

8-16, FRIARS LANE, RICHMOND, SURREY.

'Phone: Richmond 2285 (4-lines).

'Grams: "LISSENIUM, LONDON."

LISSEN PARTS—WELL THOUGHT OUT, THEN WELL MADE

Printed and published every Thursday by the Proprietors, The Amalgamated Press (1922), Ltd., The Fleetway House, Farringdon St., London, E.C.4. Advertisement Offices, Messrs. J. H. Lile, Ltd., 4, Ludgate Circus, London, E.C.4. Registered as a newspaper, and for transmission by Canadian Magazine Post. Subscription rates. Inland and Abroad, 19/6 per annum, 9/9 for six months. Sole agents for South Africa: Central News Agency, Ltd. Sole agents for Australia and New Zealand: Messrs. Gordon & Gotch, Ltd.; and for Canada: The Imperial News Co. (Canada), Ltd. Saturday, September 5th, 1925.

All applications for Advertisement Space in POPULAR WIRELESS AND WIRELESS REVIEW to be made to JOHN H. LILE, LTD. (Sole Agents), 4, Ludgate Circus, London, E.C.4. Phone: City 7281 (2 Lines).

H 6 19

No. 1 OF A NEW CONSTRUCTORS' SERIES.

POPULAR WIRELESS

No. 172. Vol. VIII.
September 12th, 1925.

and *Wireless Review*

PRICE 3d.
EVERY THURSDAY.

Scientific Adviser: SIR OLIVER LODGE, F.R.S., D.Sc.

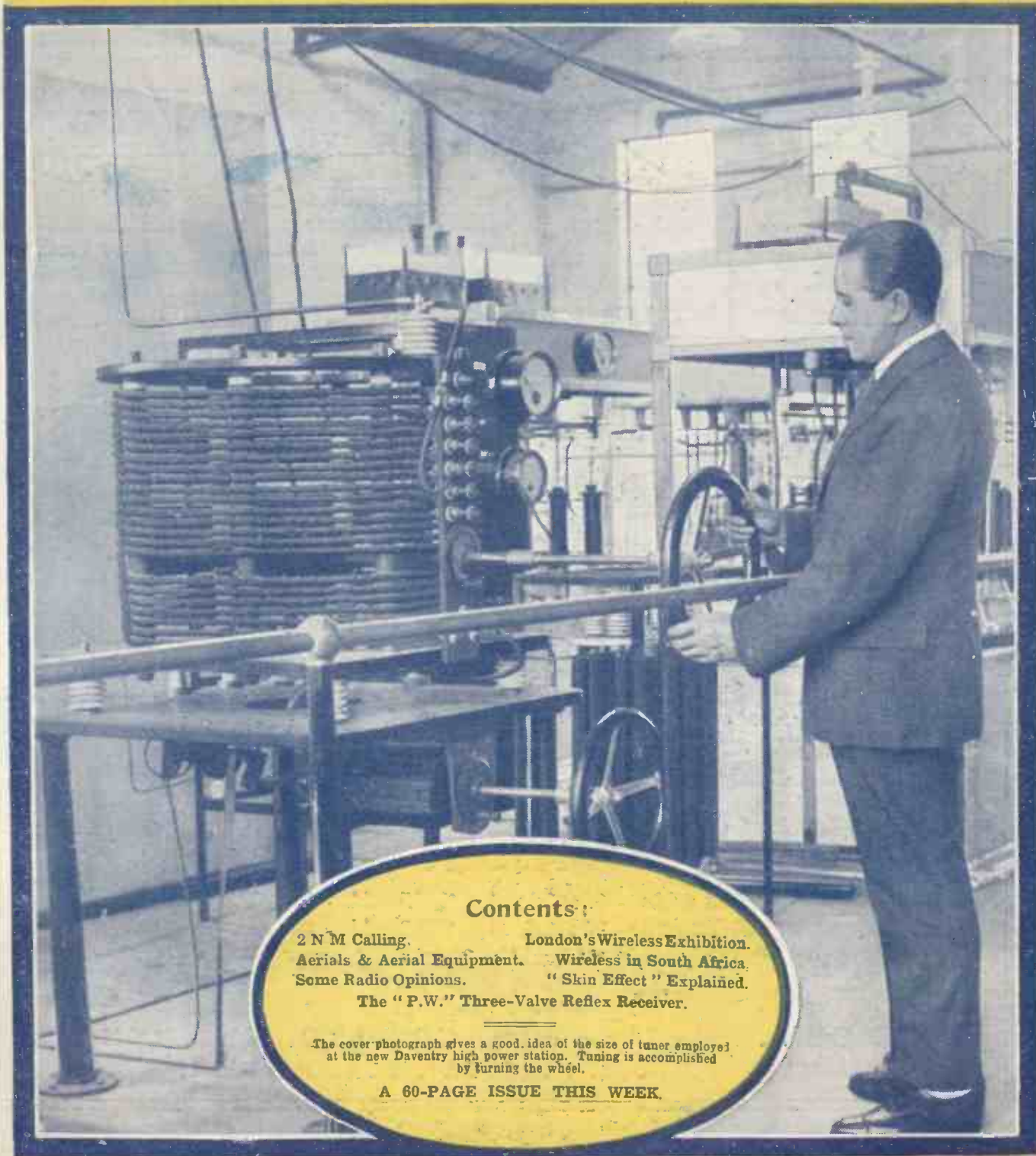

Contents:

- 2 N M Calling.
- Aerials & Aerial Equipment.
- Some Radio Opinions.
- London's Wireless Exhibition.
- Wireless in South Africa.
- "Skin Effect" Explained.
- The "P.W." Three-Valve Reflex Receiver.

The cover photograph gives a good idea of the size of tuner employed at the new Daventry high power station. Tuning is accomplished by turning the wheel.

A 60-PAGE ISSUE THIS WEEK.

An Entirely New Wireless Condenser

GECOPHONE

LOW LOSS-SLOW MOTION VARIABLE CONDENSER



THE large control knob, rotating in the same direction as the dial, easily allows the most minute adjustments to be made.

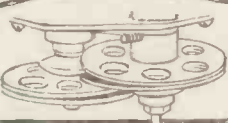

THE patent reduction mechanism, giving micrometer adjustment without backlash. Dead silent, velvety movement in operation.

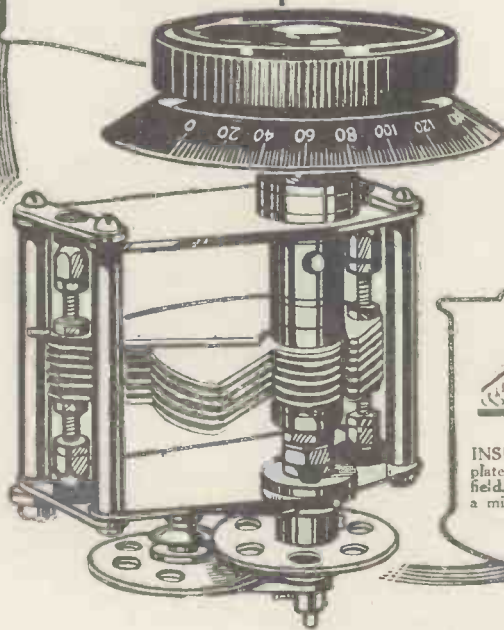

INSULATION of fixed plates outside electrostatic field. This reduces losses to a minimum.

The GECOPHONE Low-Loss Slow-Motion Variable Condenser provides micrometer adjustment, absolutely without backlash. Minimum capacity is uniquely low, hand-capacity eliminated, and dielectric losses are the smallest possible. The condenser is adapted for one-hole fixing, and can be mounted on a metal panel without insulation.

Sold by all GECOPHONE Service depots, wireless dealers and stores.

PRICES :

·0002 mfd. - 22s. 0d.		·0005 mfd. - 27s. 6d.
·00025 mfd. - 23s. 0d.		·0003 mfd. - 24s. 0d.
·001 mfd. - 32s. 6d.		

(Manufacturers—Wholesale only) :

THE GENERAL ELECTRIC CO., LTD., Head Office:
MAGNET HOUSE, KINGSWAY, LONDON, W.C.2.

Brown

The incomparable Brown in four superb new Models



The New HQ
(Height 20 ins.)



The New H3
(Height 15 ins.)



The New H4
(Height 20 ins.)

OF all the Loud Speakers on the market to-day one is unique. One—by a brilliant application of an entirely original principle—achieves results which can be obtained in no other Loud Speaker. The **Brown**. Here is an instrument which steadily—month by month—has so grown in public favour that it is now recognised as the one great interpreter of true radio music.

Brown principles of design and construction can be found only in **Brown** Loud Speakers. The famous tuned-reed mechanism which permits the use of a super-sensitive cone-shaped aluminium diaphragm as thin as paper is responsible for a tonal purity and mellowness which must be heard to be fully appreciated.

The new Cabinet **Brown** marks a sensible innovation which will instantly appeal to many. A really perfect Loud Speaker capable of a volume equal to the more conventional type is now available in a model which will readily harmonise with the appointments of any room.

The new **HQ** (height 20 inches) is an instrument which will conform to to-day's demands for a

more handsome Loud Speaker in which efficiency has not been sacrificed at the shrine of beauty. Equipped with the same fine quality **Brown** reproducing mechanism, the **HQ** will readily command respect for its wonderful volume wherever it is used.

The new **H3** (height 15 inches) is a successful effort to produce a high-grade Loud Speaker at a moderate price, while the new **H4** is a truly remarkable manufacturing achievement. Here for the first time is a genuine **Brown** Loud Speaker available at the price of a pair of high-grade headphones.

Types and Prices :

CABINET MODEL	
2000 or 4000 ohms	£6 6 0
TYPE HQ	
2000 or 4000 ohms	£6 0 0
TYPE H3	
2000 or 4000 ohms	£3 0 0
TYPE H4	
2000 ohms	£1 10 0

In addition to the above we are still manufacturing the standard **H1**, the **H2**, the **Q**, and the **Crystavox**. All can be seen and heard at your dealers.

Make arrangements to hear these splendid instruments at your Dealer's. He may not have all of them in stock. Owing to the immense demand we are having difficulties in filling orders, but we are working hard to fill all orders with the greatest possible despatch.

All **Brown** Wireless Instruments are **British** throughout.

S. G. Brown, Ltd., N. Acton, London, W.3

Showrooms : 19 Mortimer Street, W. 1. 15 Moorfields, Liverpool.
67 High Street, Southampton.

Depots (Wholesale only) : 13 Bushy Park, Bristol.
Cross House, Westgate Road, Newcastle.

That precious thing called Goodwill



In our business we are proud of the valves we make and the unique reputation they have earned. To make one good valve is not difficult—to make a hundred is not difficult, either—but to produce *every working day* thousands of valves of the highest possible quality, all absolutely uniform in characteristics, is a task of the greatest magnitude. Yet it is a task which is being successfully accomplished thanks to the loyal co-operation of the hundreds of workers in the big Cossor factory.

When you bought your first Cossor valve you bought it entirely on faith. You hoped for good service and long life—and because you were not disappointed you continued to buy Cossor valves. The wave of popularity which has swept this country has brought the sales of Cossor valves from a paltry few hundreds per week to many, many thousands. It has made the Cossor the largest-selling British valve.

It is a national characteristic of ours that, if we buy an article and it serves us well, we are glad to tell others about it. In this way goodwill is built. By every post we receive letters from satisfied Cossor users. Some praise its long life, others its greater sensitiveness—while, many referring to the Wuncell, speak highly of its exceptional robustness, so rare with other Dull Emitters. Of the dozens who write, there are hundreds who do not put pen to paper. We know that they are satisfied because Cossor sales mount higher

and higher—each month witnessing new records.

But occasionally something goes wrong. One worker—being human—makes a mistake. And a bad valve is the result. Even then we safeguard you. A team of workers, whose sole duty it is to find faults, examine each Cossor valve and put it to a whole series of critical electrical tests. Rarely indeed does a Cossor valve go out that is not up to the accepted Cossor standard of excellence. Should we hear of it, we are always glad to make honourable amends—because every Cossor Bright Emitter or Wuncell Dull Emitter is fully guaranteed to give you perfect satisfaction provided you use the correct voltage for which the valve is designed. It is a matter of honour with us to replace any Cossor valve brought to our notice which has failed to give satisfactory service owing to any defect in manufacture. Such straightforward honest dealing is reflected in the unswerving loyalty of Cossor users throughout the country.

Cossor Valves

"Cost less to run—and last longer"

Popular Wireless

Scientific Adviser :
Sir OLIVER LODGE,
 F.R.S.
 Consultants :
Dr. J. H. T. ROBERTS,
 F.Inst.P.
J. F. CORRIGAN, M.Sc.,
 A.I.C.
C. E. FIELD, B.Sc.



Editor: **NORMAN EDWARDS, M.Inst.R.E., F.R.S.A., F.R.G.S.**

Technical Editor :
G. V. DOWDING,
 Grad.I.E.E.
 Assistant Technical
 Editors :
K. D. ROGERS,
P. R. BIRD.

RADIO NOTES AND NEWS.

Beam Stations—After-Dinner Speeches—Radio Thieves—An Invitation from U.S.—Europe's Wavelength Tests—Breathing-space in the Ether.

“Beam Stations.”

THE site for the receiving station for the new “beam” services with Australia and India has been placed by the Postmaster-General at the disposal of the contractors. The beam will terminate at Winthorpe, near Skegness, and transmissions will take place from a site near Grimsby, which is already in the hands of the builders. Under the contract the stations are due to be completed by May 8th, 1926.

After-Dinner Speeches.

THE first club to have its after-dinner speeches broadcast by the B.B.C. will in all probability be a woman's club. This will be on October 1st, at the annual dinner of the authors and journalists' section of the Forum Club. Miss Sheila Kaye-Smith will be in the chair, and Sir Philip Gibbs and other notable men and women writers will speak to the great public for whom they generally write.

The Bournemouth Station.

THE Bournemouth station of the B.B.C. is ideally situated on the fringe of woods, high above sea-level. During the summer the light from the transmitting valves has a great attraction for moths, and scores of them are electrocuted during the evening programmes, whilst conducting their investigations. On one occasion a big moth wedged itself between the plates of a condenser! In addition to shortening its life, this shorted the plates, so the transmitter had to be closed down whilst the suicide's body was removed.

Radio Thieves.

I SEE that thieves have stolen two wireless sets which were on the way to the King of Italy and Signor Mussolini. The sets were in transit from New York to Rome, and were stolen at Havre. This is the kind

of trouble that could have been prevented by a good copper shielding!

Reinartz Again.

WONDERFUL long-distance results are still being reported by John L. Reinartz, the famous American amateur-experimenter who is operating the

a Moravian mission vessel, and the “Strathcona II,” which is working on behalf of the Royal National Mission to Deep Sea Fishermen.

Radio in the Air.

PASSENGERS in one of the big air expresses, flying from Paris to London, had a curious experience recently. The plane rose above the clouds in France, and came down through them again at Croydon, but during the whole flight the ground was invisible! Captain F. C. Barnard, the famous Imperial Airways pilot (and winner of this year's race round Britain for the King's Cup), was besieged by the passengers when alighting at Croydon, and asked how he managed to find his way. He explained that the Croydon wireless operators gave him bearings on which to fly as he crossed the Channel, and finally advised him when he was over

The First of a Series of Important Announcements.

Mr. Gerald Marcuse To Write Exclusively For “Popular Wireless.”

2 N M's Special Articles.

WE are pleased to announce that arrangements have been made to publish an exclusive series of articles by the foremost British Amateur—Mr. Gerald Marcuse, whose call sign, 2 N M, is known all over the world.

MR. MARCUSE will contribute a fortnightly article to this journal right through the winter. His articles will be essentially practical and will cover many phases of experimental radio work.

NEWS concerning the activities and new records set up by his own station will also be published ONLY in “Popular Wireless.”

MR. MARCUSE'S first article will be published in next week's issue, which, we would remind readers, will also contain special supplementary pages containing 250 Radio Questions and Answers.

main wireless set of the MacMillan Arctic Expedition. Whilst his vessel, the “Bowdoin,” was in the vicinity of Greenland, Commdr. MacMillan has been in direct touch with New Zealand and Australia. During a 12,000 mile talk to a Sydney amateur, Commdr. MacMillan sent the following message to the Governor-General: “My compliments to you from the other antipode, almost half-way round the world. We are in a Fairyland of ice, less than 12 degrees from the North Pole.—Donald MacMillan, Commander.”

The “Bowdoin.”

THE “BOWDOIN” and the Expedition's other wireless installations on planes, etc., do not have the Arctic ether all to themselves, for there are at least two radio-equipped mission-ships working in the Polar regions. These are the “Harmony,”

the aerodrome.

DX. with a Reflex.

BY adding another H.F. valve to the “P.W.” 3-valve Reflex Receiver, a Battersea reader has succeeded in obtaining some wonderful long-distance loud speaker reception. Without aerial or earth the set is powerful enough to tune in 2 L O and Daventry at full loud speaker strength! And by stabilizing the two H.F. stages by the neutrodyne method, it will tune easily from 250 to 600 metres without going into oscillation.

Stations Logged.

AMONGST the stations which can be regularly received at loud-speaker strength are Hilversum and Radio-Paris, but my correspondent does not give

(Continued on page 84.)

NOTES AND NEWS.

(Continued from page 83.)

particulars of his long-wave alterations. I notice, however, that his crystal is of the perikon type, which, on account of its reliability, is gaining favour as a detector in dual circuits. Radio-Toulouse is his best long-distance loud speaker station. Can any other London reader beat this?

A P.C. from 2 N M.

MY recent references to the record-breaking feat of 2 N M did not, by any means, tell all the story. I have since received a postcard from Mr. Gerald Marcuse (who owns the Caterham station), which says "You may be interested to know that I have just completed the 7th day running of perfect telephonic transmissions to the U.S.S. 'Seattle,' lying in Wellington Harbour (New Zealand)." Schedules are to be continued when the vessel resumes her voyage, so even this fine record may be exceeded on the run to Samoa!

Radio on Railways.

THERE is every prospect that British railways may soon be equipped with wireless. A call-box on the train would connect up with the Post Office Telephone system, and passengers travelling at sixty miles per hour will be able to speak to friends, or transact their business en route. The L.M.S. Railway is watching Continental experiments very closely, and the Chief General Superintendent will probably cross to Germany shortly to investigate developments there.

Short Waves From Manchester.

MANCHESTER Wireless Society is taking seriously to the problem of short waves, and a regular schedule of transmissions has been prepared as follows: Saturday, 6.30 to 7 p.m. G.M.T., 45 metres; Sunday, 7 to 7.30 p.m. G.M.T., 90 metres; Wednesday, 5 to 6 a.m. G.M.T., 25 metres. Special tests can be arranged by the Hon. Sec., 66, Oxford Road, Manchester, to whom reports of reception should be addressed. A particularly interesting offer made by the Society is to co-operate with experimenters in tests on 3 to 5 metres, but applications for such facilities must be made immediately.

An Invitation from U.S.

WE have received a letter from "Radio Broadcast Magazine" of America saying that they would like to get in touch with an English amateur with a view to carrying on trans-Atlantic tests with telegraphy. The call-sign of the Radio Broadcast station is 2 G Y, the power 50 watts. At present the wave-length employed is 40 metres, but this can be adjusted if other bands are found more suitable. Amateurs interested are requested to communicate with our New York Correspondent, Mr. L. W. Corbett, Radio Broadcast Magazine, Garden City, Long Island, U.S.A., giving fullest particulars as to wave-length, power, times of transmission, etc.

A Question of Copyright.

PENDING the trial of an action, the B.B.C. moved for an interim injunction in the Vacation Court recently, to restrain the Wireless League Gazette Publishing Co., Ltd., from infringing their copyright. Saying that he was not satisfied that the Wireless League Gazette Publishing Co., Ltd., were right, and would ultimately succeed, Mr. Justice Finlay stated there were serious and difficult questions of copyright to be tried, and facilities will be given for an early trial of the action.

A New Valve.

A NEW dull-emitter filament has been evolved at the Tilburg works of the Radium Radio-Valve Manufacturing Co., according to a message from Amsterdam. The new filament is specially prepared, and thorium does not in any way enter into its composition. Introduced into the trade under the name 5 X X (a compliment to Daventry), the new filament is claimed to have a much greater mechanical strength than the usual thorium-tungsten type.

SHORT WAVES.

"It was only the other day that we were receiving the first faint whispers from across the world, and now steps are afoot for a regular exchange of national programmes which will soon be without geographical limits. If intolerance is not eliminated from a broadcast-bound world, it will, at any rate, have fewer excuses."—The Observer.

"It may interest those who are continually criticising broadcasting methods in Britain to know that in this connection you are in a much better position here than we in America.

"The conditions in New York City are intolerably worse than those of London."—Mr. W. Dubilier.

"Broadcasting is no longer a luxury or a fad. It is a potent form of service—educational and recreative. It has transformed to a great extent the habits of millions of people. It has brought new influences to bear upon their minds; opened up new possibilities of knowledge, enlightenment, and amusement."—Daily Dispatch.

"Newly-married man (busy with wireless construction): 'Sweetheart, have we any tweezers in the house?'"

"Wife: 'I'll run and look dearest—er, what is it that dearest wants to tweeze?'"

"Punch."

Wireless and the I.E.E.

SOME valuable suggestions have emerged from the recent correspondence and Press comments regarding the admission of wireless engineers to membership of the Institution of Electrical Engineers. The Wireless Section Committee of the I.E.E. has considered the whole question in the light of the points raised, and they consider there is no need for the formation of a new society. It is possible for an engineer to become a member of the institution with qualifications of a purely wireless nature, and details of the examinations, etc., will be forwarded upon application to the secretary.

The Elberfeld Station.

I AM indebted to a Hawick reader, Mr. J. B. Inglis, for details of the exact wave-length of the German station at Elberfeld, recently referred to in "P.W." The station is now working upon 270 metres, and signals at Hawick come through at loud-speaker strength, using a straight 3-valve set (H.F., Det., and L.F.).

Europe's Wave-length Tests.

REPORTS of the first tests in the great wave-length experiments show that British stations were fairly free from trouble. Bournemouth was jammed by Oslo, Edinburgh by Helsingfors, and Glasgow had a bit of trouble with Munich. Hull's programme did not mix at all well with Petit Parisien's, and Liverpool and Hamburg—old rivals on the watery waves—contended in the ether rather more than listeners liked.

The British Family.

A PART from these instances British stations kept themselves nicely aloof, and behaved with that dignity, circumspection, and freedom from flirting with other waves, that is expected of a really well-trained broadcasting transmitter. They all sang out well, and kept in tune like good girls, and no doubt the B.B.C. mother of twenty-one!—was very proud of the British family's performance.

A Final Fling.

THE last test of European stations for the great broadcasting wave-length shuffle is due to take place on Monday next, the 14th inst. This will be the Big Noise of Europe, for each station will transmit on full power, with full modulation. Announcers will shout the call-sign at frequent intervals, accompanists will thump the ivories, bandsmen will blow their hardest, all music will be played fortissimo, and, in a word, there will be the very Dickens to pay in the European ether!

Breathing Space in the Ether.

THE object of this pandemonium is—in one word—JAM. Every station will expand its ethereal chest to the utmost and modulate for all it is worth, in order to find out once and for all who is jamming which. Some of the greatest sinners may prove to be more jammed against than jamming, but listeners all over Europe will have their ears on Europe's chest, and every wheezy, heterodyning sound of interference will be reported to headquarters at Geneva. Here the experts will assemble, and after considering everybody's report upon everybody else, they will designate an exact wave-length for every station, so arranged that it gives ample breathing space, but not a fraction of a metre to spare.

And then Europe will sit back and enjoy its winter wireless entertainments absolutely free from interruptions—perhaps!

ARIEL.

"P.W." STAFF VACANCIES.

The Editor announces that a limited number of vacancies still exist on the "P.W." Technical Staff, for amateur constructors of experience and skill. Applicants should be from 18 to 20 years of age, well-educated and used to constructional work in all its branches. In the first place written application should be made to the Editor, "Popular Wireless," Fleetway House, Farringdon Street, E.C.4, stating age and full particulars of experience.



This interview was given to Mr. K. D. Rogers, Assistant Technical Editor, and will serve as an introduction to the special and exclusive articles Mr. Marcuse will contribute to "P.W." throughout the autumn and winter months. We shall publish the first article by Mr. Marcuse in our next issue—Editor.

A GREAT many listeners, and wireless amateurs too, seem to be of the opinion that the comparatively small band of enthusiasts designated as "amateur transmitters," and whose cheery "Hullo, old man!" we used to hear, on about 440 metres every evening, have practically "shut up shop" since broadcasting has been in full swing, or, at any rate, now confine their experiments to the winter months only. That this is not the case can be easily proved by anyone who possesses and can operate a receiver capable of picking up C.W. and telephony on 45 metres or lower.

Low Wave-length Tests.

For that is where all those old friends of the early listeners have gone, down and down the wave-length band until very few remain above 100 metres. Most of them have reached 40 metres or lower, and are carrying out their tests on the extremely high frequencies. Their activities are very restricted by the numerous regulations enforced by the Post Office, but, in spite of difficulties, they carry on with their researches, acting in co-operation with each other all over the world.

Recently I was fortunate enough to be invited to spend an evening at 2 N M, the well-known station of Mr. Gerald Marcuse at Caterham, and there I learned what a really strenuous time these enthusiasts lead, for no sooner had I arrived than Mr. Marcuse said, "You'll stay the night of course? All the fun starts at about 4 a.m." I was determined not to miss anything, so heartily agreed to the proposal, though I did not dream that the "fun" would be so well worth getting up for.

No Suitable Valves.

At dinner Mr. Marcuse explained that the greatest problem he was then tackling was the transmission of really good telephony on short waves—about 45 metres. "I can't get a bottle to stand up to it," he explained, "they all go up in smoke, and so I am having several specially made to see if they can stand the terrific plate frequencies. I have burnt out all my best meters, owing to the anode leads of the valves fusing. I suppose that someday we shall be able to get more robust valves, but I have been having a trying time with them lately."

He explained that many notable wireless engineers had come to down see his gear, and were surprised at the way the valves gave up. During dinner I asked 2 N M what he thought of the "silent night" policy recently brought forward in "P.W.," whereby it

was suggested that every B.B.C. station should close down for one night per week. "Well," he replied, "it doesn't affect us at all really; we operate on wave-lengths right away from the B.B.C., and do not often listen to broadcasting. In any case, I think people who want to carry out DX reception should have a receiver capable of cutting out the local station. The super het. will do it quite O.K."

I asked if he used the super-het. for his trans-Continental tests, and he said he would like to, at any rate, for telephony reception, but found difficulty in making it operate below 50 metres in an efficient manner.

After dinner Mr. Marcuse took me round his grounds—he owns a lovely house sur-

round the various stations, 2 L O, about 15 miles away, proving no bother at all.

When the broadcasting stations closed down my host suggested that we should "turn in for an hour or so," and get up early in the morning in time for the American and Australian amateur tests.

Commencing Operations.

After a few hours' sleep I was called, and we went into the transmitting room adjoining the one where the main receivers are housed, and containing, besides the transmitter, a two-valve short-wave receiver, distant control switches connected to the generators outside, and a mass of QSL cards from all over the world. Practically every country except South Africa was represented

among the array of cards, smothering two of the sides of the room and part of the sloping ceiling, the chief ones from the Antipodes and the Rice Expedition being in a corner by themselves.

We listened for a few minutes, and then 2 N M switched on his generators and rapped out a call to all stations in Australia, repeating it for three or four minutes. We listened again, and though we heard A 2 Y I busy calling C Q, we heard no answer to our call. We tried again, but with no success—as far

as 2 Y I was concerned; Australia seemed to be deaf, though we could hear several others out there piping away in an endeavour to get into touch with Great Britain.

Telephony Tests with U.S.A.

Then all of a sudden a loud note came through the 'phones, "2 N M, 2 N M, 2 N M, G U 2 A F M, U 2 A F M," repeated again and, again. Some American amateur had picked up our call and wanted to get into touch.

2 N M obligingly answered, and then, when two-way communication was established, suggested that he should try telephony.

(Continued on page 86.)



Mr. Gerald Marcuse operating the 8-valve super-het, mentioned in the article.

rounded by a huge garden, right on the top of Caterham Hill—and said that he attributed a large amount of his success to his situation—600 feet above sea-level. "I ought to get results," he laughed, "especially with that." He pointed to a huge sausage aerial held aloft by a 90-foot lattice mast at one end and a 30-foot mast on the house at the other. He showed me his generating plant, tucked neatly away in a specially built lean-to at the back of the house, and then we went up to the radio den and spent the evening listening on the super-het. to the various British and Continental broadcast transmissions, it being a simple matter, in spite of several delicate adjustments, to

FOUR USEFUL IDEAS.

A Panel Drilling Board.

THIS gadget obviates the annoyance of a panel twisting about when drilling, and provision is made for renewal of board after being roughened by frequent penetrations of the drill.

It may be made to any dimensions the

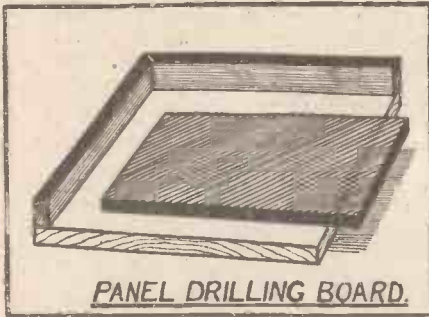

PANEL DRILLING BOARD.

constructor fancies; 20 in. by 20 in. is a useful all-round size. The fig. shows a base-board with two strips screwed on to two sides adjacent; the panel to be drilled being laid on board in corner thus formed.

A loose board underneath provides a renewable drilling support.

Winding Lorenz Coils.

The construction of a jig on which to wind Lorenz coils is shown by sketch. The design allows of easy removal of coil when wound.

It consists of a wooden base-board provided with a concentric row of pins. In that described they are pieces of heavy motor-cycle spoke. A sheet of strong card-

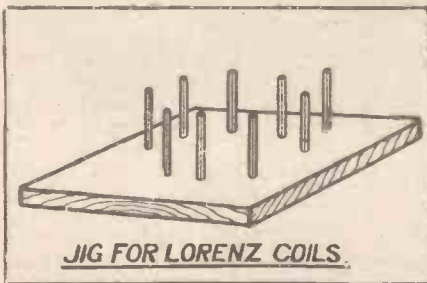

JIG FOR LORENZ COILS.

board a little larger than the base has holes in it to correspond with the pins. This is slipped over these and rests on the board whilst coil is being wound. On completion, lifting up the cardboard removes the coil.

Bit Cleaning Pad.

Soldering and tinning cannot be done properly unless the soldering bit is perfectly clean. To achieve this condition the device described is ideal and convenient.

Obtain a small pot about 2 in. deep and sufficient asbestos yarn to nearly fill it when pushed in tightly. Make up a strong solution of sal ammoniac in a larger jar and stand the small pot in it for an hour or so. Remove and drain off surplus solution.

The bit, after being wiped on the saturated pad, will be perfectly clean.

Vice Clamps For Ebonite.

This handy device, as shown, consists of a piece of hard wood A, $\frac{1}{2}$ in. thick, and a piece of the same wood, B, but only 1 in. deep, screwed to the side flush with one edge. This rests on top of the vice jaw.

The screws holding this should be of such a length as not to penetrate A, otherwise

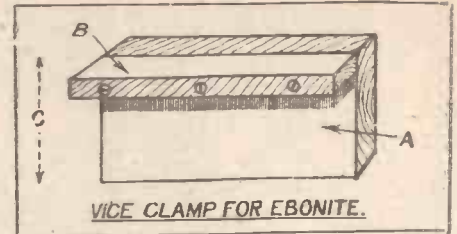

VICE CLAMP FOR EBONITE.

there is risk of scratching the panel being held.

Dimension C should be arranged according to depth of vice in use. A pair of these clamps are very useful while sawing or filing up the edge of a panel.

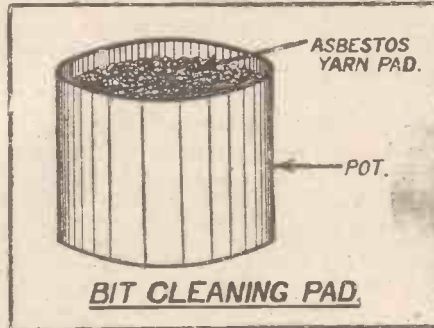

BIT CLEANING PAD.

NEXT WEEK: 250 Radio Questions and Answers.

Specially Compiled by the "P.W."
Technical Staff.

AND

The "P.W." 4-Valve Set.

Order Your Next Week's
Copy Now.

"2 N M CALLING!"

Continued from page 85.

The Yank agreed to listen for it, and Mr. Marcuse switched on the modulating valves and commenced that peculiar series of "Hullo" and figures beloved by all radio experimenters.

Then he switched over and listened for the reply. It came almost at once—in C.W., for 2 N M is one of the pioneers on short-wave amateur telephony—stating that static was so bad that he had been unable to get all the speech, but what he had heard was "sure the stuff."

Then followed some more telephony, and various pleasantries were passed until U 2 A F M had to close down.

Australia was now coming over very strongly, several stations being logged, but they were apparently not listening on 45 metres—2 N M's transmitting wave—for no success at two-way communication was achieved.

Success Achieved.

"I was much more lucky than this last Sunday," Mr. Marcuse said, "for I managed telephony communication with an amateur in New Zealand; though he could not answer by telephony, he said he could get me perfectly. We are trying again next Sunday. Let's try some more C.W. We might be able to get the 'Seattle' again. I had them yesterday when they were in Wellington Harbour."

He switched over to C.W. and called N R R L for some time before he went over to "receive" again and waited for the results of his efforts. They came in the form of a strong signal from Mr. Schnell, traffic

manager of the American Radio Relay League, who is on board the "Seattle," saying that "sigs. were O.K." and asking 2 N M to try "voice."

Another pause while Mr. Marcuse switched on his modulators, and then began the real test of the evening—or, rather, morning—while he called Mr. Schnell consistently for about five minutes. The answer came back on C.W.; success had been achieved, and excitement at 2 N M was intense.

Enthusiastic Experimenters.

The gramophone was fetched, and for some considerable time dance records were sent out over the ether to the listeners in Wellington Harbour. Then, as dawn further increased and the sun began to pour down upon the house on Caterham Hill, signals faded, and, after a last message of goodwill, appointments were made for a further test, and 2 N M "closed down."

And so the hours had rushed by, and before we knew where we were the breakfast gong had sounded.

But we were not to escape the atmosphere of radio even at breakfast, and no sooner had 2 N M finished his massive pile of correspondence—all concerning wireless matters—than several other well-known amateurs rang him up to congratulate him on his telephony and to give results of tests they had been carrying out at the same time.

When at last I left for London I realised more than ever what tremendous enthusiasm pervades the whole of that little band who are willing to sit up night after night in order that they may unravel some of the secrets wrapt up in the ultra-short waves. And unravel them they will, for success is following success, and at 2 N M regular communication with N R R L has been carried out on telephony and C.W. A very notable achievement, and one which deserves the highest commendation.

LONDON'S Wireless Exhibition

We publish below the first instalment of a review of the exhibits at the Wireless Exhibition at the Albert Hall. The second and concluding instalment will appear in next week's issue.

THE site of the Wireless Show of last September proved such a successful one that the organisers have decided to hold this year's exhibition in the same building—the Royal Albert Hall. Though

that this is exceptionally useful for ultra short-wave work, and it employs valves of an unusual design. The famous "Clix" electro-links will be shown, of course, among the more general components.

A. W. GAMAGE, LTD.
Stand No. 39.

The outstanding feature to be shown by Messrs. A. W. Gamage, Ltd., is a remote control switch for wireless sets. This little instrument is self-contained, and when connected to the set enables the listener to switch the receiver on or off by just pressing a push button in the room where the loud speaker is—enabling him to have the set permanently installed in one room. Messrs. Gamage are also putting forward their hire purchase system of selling wireless sets, and are undertaking orders at the show for the supply of any make of set that is on show at the Royal Albert Hall, embodying their "pay as you listen" scheme. A complete range of receiving sets will also be shown by Messrs. Gamage, and this stand should be very interesting.

BERTRAM DAY & CO., LTD.
Stand No. 48.

A study of the methods of wireless firms whose names are now household words clearly shows the vital importance of advertising—especially to the small radio manufacturer—in the great race for supremacy. In this connection Stand No. 48 will be of considerable interest, for here are to be seen specimens of the advertising that has built up many a flourishing concern.

Messrs. Bertram Day & Co., Ltd., who were responsible for the first All-British Wireless Exhibition and

who are closely associated with this present exhibition, are the oldest-established Advertising Agency in England specialising in Wireless Accounts. We understand that this year the managing director will be present in person at Stand No. 48 to discuss the prospect of advertising with any manufacturer who cares to avail himself of a visit.

THE BRITISH THOMSON-HOUSTON CO., LTD.

Stand No. 1,
Boxes 59 and 60.

As is to be expected when considering the exhibits of a large concern like Messrs. B. T. H. Co., Ltd., it is not an easy task to pick out the items likely to draw the most attention, for all are interesting.

This stand deserves a careful scrutiny, for besides the various types of valves and components to be shown there are also two examples of the latest developments in radio reception—the super-heterodyne system. These take the form of a portable 3-valve super-set, and a 6-valve cabinet de luxe receiver operating on the same principle.

Neither set requires aerial or earth, and both are extremely sensitive. The aerials are enclosed in the

sets, though other types can be used if desired, while the 6-valve has two frames at right angles to each other to obviate the necessity of turning the set round in order to get directional effects. Either aerial can be used at will.

Among the more recent developments to be shown are a 2-valve set with a very convenient form of reaction, so arranged as to have no effect upon the aerial tuning, while a new loud speaker, to meet the demand for a cheap but efficient instrument, is to be shown among the components. Worthy of special mention is a new I.T. transformer for which is claimed "uniform amplification over the whole range of audible frequencies." This transformer is made in two ratios so that either 4:1 or 2:1 can be obtained.

BEARD & FITCH, LTD.
Stand No. 23.

This stand will be wholly devoted to the display of the famous "Success" components with the one or two exceptions, the most notable of which is a Super-Grand Cabinet super-heterodyne receiver. This is a set de luxe for it is made up in Louis XIV style, and contains 8 valves, frame aerial, batteries, etc.

A new component to be shown is designed to be a companion to the "Superformer" heterodyne transformer, and is called the "Success" Oscillator Unit, being tunable between about 250 and 600 metres. Other exhibits include the "Success" tuner, L.F. transformers, anode tuner, anti-capacity coil holder, and lead-in switch.

BURNDIPT WIRELESS, LTD.
Stands 11 and 12, Boxes 74, 75.

A very large selection of apparatus of all sorts will be seen on Messrs. Burndipt's stands; a novel note being struck is that all Ethophone receivers are sold complete with special "super" valves of Burndipt manufacture. A useful system of classification has been adopted in the case of these valves, which are new additions to the wireless market, so that there can be no confusion of ideas as to how any one valve should be used. Various other components are being shown, and among the complete sets a new 7-valve super-hot is to be exhibited.

(Continued on page 88.)

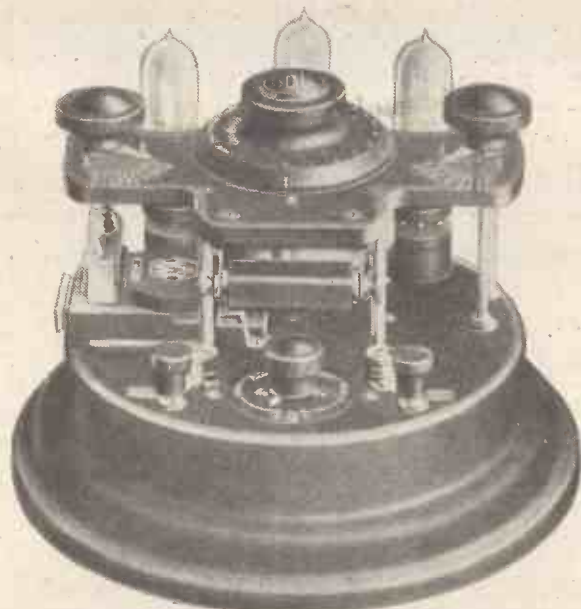

A new type of 3-valve set made by Messrs. Metro-Vickers, Ltd., and for which a high degree of efficiency is claimed.

rather an unusual site for such a gathering, the Albert Hall is undoubtedly a convenient one, and is a great improvement upon Olympia with its tiring journey to and fro.

In all there will be close upon sixty firms represented in the show, to be opened on Saturday, September 12th, and though there is no development of a revolutionary nature on the programme of exhibits the various stands should certainly be worth a visit.

As arrangements are not yet completed we cannot give any opinion upon the general appearance and "lay out" of the hall, but the following details that we have obtained will be of interest to all readers, whether they are able to go to Kensington or not.

A. J. STEVENS & CO., LTD.
Stand E37, Loggia Box No. 46.

Already well known in the motor trade, this firm are rapidly coming to the fore in the production of wireless apparatus, and are showing a full range of components besides several of their latest receivers and loud speakers. The receivers have been re-designed with a view to making them more "fool-proof" and increasing their selectivity, two points of extreme importance to the non-technical listener. In the loud speaker section an innovation is being made with the "Pedestal" loud speaker, a novel idea well worth attention.

Wireless masts are also being tackled by Messrs. A. J. S., Ltd., and exhibits of these will be made. They are of tubular construction and are telescopic, the total length being arranged to be either 35 or 50 ft., telescoping to 18 ft. 3 in. and 19 ft. 6 in. when ready for transit. No erecting gear or climbing is required, and the 50 ft. mast can be erected by two men in twenty minutes. Sold at a reasonable price, these masts should form an attractive proposition to all amateurs.

AUTOVEYORS, LTD.
Stand (Not allotted).

Amongst the novelties to be exhibited on this stand is a new system of H.F. amplification. It is claimed



A photograph of one of the C.A.V. exhibits, showing the construction of the accumulator cells.

LONDON'S WIRELESS EXHIBITION.

(Continued from page 87.)

CABLES & ELECTRICAL SUPPLIES. Stand No. 2.

A comprehensive range of loud speakers, headphones and components of various makes are being shown on Stand No. 2, in addition to the "Cable" sets and components made by the above company. These latter items comprise sets ranging from crystal sets to 4-valve receivers and amplifiers. All valve



This three-valve (V-2) receiver is the product of the National Wireless Co., Ltd.

sets are comprehensive as regards tuning, and do not need extra coils, the wave-length covering two bands, 300-600 and 1,400-2,000 metres.

The components of "Cable" manufacture include the "Cable" headphones, "O.V." Indoor Aerials, and coil holders. No insulators are said to be required for the aerials, which range from about 11 ft. to 12 ft. in length, and are of either sausage or flat type.

THE COLONIAL TECHNICAL PRESS, LTD. Stand (not allotted).

At this stand, copies will be seen of the leading wireless papers of the world—for all of which the Colonial Technical Press, Ltd., are sole agents for Great Britain, and, in the majority of cases, the U.S.A. These papers cover Ireland, France, Spain, Portugal, Holland, Norway, Sweden, Denmark, Italy, Belgium, Germany, Roumania, Poland, Czechoslovakia, Australia, New Zealand, Canada, the U.S.A., South America, South Africa, India, China and Japan.

The progress made by this company is demonstrated by the fact that at the time of last year's exhibition their range of papers covered only Ireland, France, Spain, Holland, Sweden, Australia, Canada, China and Japan. They are now sole agents for over fifty publications.

THE CHLORIDE ELECTRICAL STORAGE CO., LTD. Stand (not allotted).

Both high- and low-tension accumulators will be on view at the stand of the makers of the famous Exide batteries, suitable types for every possible radio purpose being shown. Exide batteries have many times justified their popularity, and this stand should be well worth a few minutes' attention. Apart

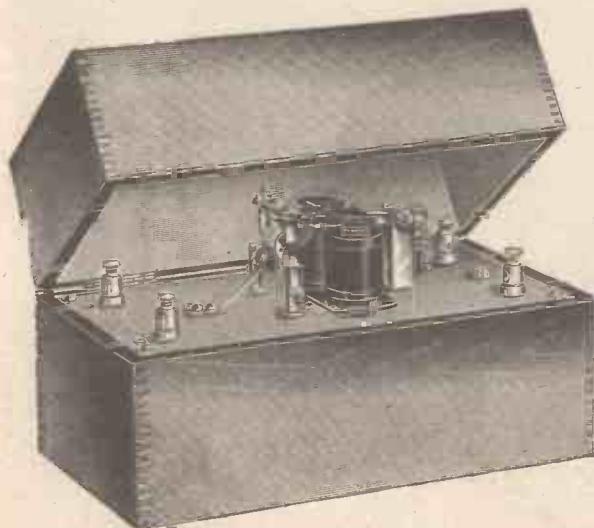

The new "distant control" unit introduced for the first time at the exhibition by Messrs. A. W. Gamage.

from the usual batteries, we understand that a new H.T. accumulator is to be shown here for the first time, the "W.H." type, having exceptionally long life.

C. A. VANDERVELL & CO., LTD. Stand No. 33, Box 58.

Long known as manufacturers of accumulators and motor-car lighting and ignition sets, Messrs. C. A. Vandervell & Co., Ltd., have but recently come into the limelight of the radio world, but as their stand at the Royal Albert Hall will show, they have not confined themselves to the "ignition" side of wireless. Among their exhibits the accumulators, both for H.T. and L.T., will probably be predominant, though the display of loud speakers and transformers will run them very close.

Among the latter, a specially designed intermediate transformer is making its debut, while other fresh items are the C.A.V. gramophone L.S. attachment at an extremely moderate price, while filament rheostats, tuning inductances, and anti-capacity and "anti-pong" valve holders, will also be on view.

CLIMAX RADIO ELECTRIC, LTD. Stand (not allotted).

The famous Climax "Monovalve" sets of Climax Patents, Ltd., now incorporated in the above concern, will be on view among other receivers and components on this stand. Many of the components and sets will have been seen before, but there will also be a large number of new "lines" well worth the attention of the visitor. Messrs. Climax Radio Electric, Ltd., have many new sets under preparation, covering nearly everything from a 12s. 6d. crystal set to a super-heterodyne at nearly £40.

A low-loss aerial is another new venture, while all sorts of components, including tuning units, transformers, valve sockets, super-heterodyne parts and loud speakers are promised, if not at the show, early in the forthcoming radio season.

THE EAGLE ENGINEERING CO., LTD.

Stands No. 68 and 69.

The main exhibits on these stands will be the "Chakophone" receiving sets, ranging from the crystal to a de luxe pedestal cabinet 4-valver. An outstanding feature is a new valve set of antique design, built on the style of the old-fashioned "tea-caddy"—there being nothing to show from the outside that it is a wireless receiver. Another interesting set is the 2-valve No. 9 receiver which is obtainable for the small sum of £6 15s., royalties paid. All coils are built into the set and cover a range of wave-lengths of 300-2,000 metres.

Components are also to be on view, and these comprise a very full range, including a constructor's unit system, new pattern plug-in coils, coil holders, a novel tuner and reaction unit, and a complete range of variable condensers.

J. J. EASTICK & SONS.

Stand No. 21.

Owing to a recent transfer of offices and works, Messrs. Eastick & Sons will be unable to show as many new lines as they had wished, but for the benefit of those unable to go to Kensington a special exhibition of their lines is being arranged at Exech House, Bunhill Row, where a large variety of apparatus will be on show.

FALK, STADELMANN & CO., LTD.

Stand No. 34.

"Efescaphone" sets are naturally one of the chief exhibits here, a full range of receivers being on view; but a new series of tapped coils will probably form the main attraction to a great many radio enthusiasts. These have been specially designed for the home constructor, and embody aerial tuning units, H.F. transformers, reactance, etc., all self-contained and arranged for one-hole fixing.

Low-frequency transformers are also making their appearance with one-hole fixing, a boon to those who have not yet succumbed to the "American type" of receiver and employ panel mounting for all their components.

A series parallel condenser of novel design deserves special mention, for it appears to be quite a new departure in the manufacture of variable condensers and embodies an automatic switching device whereby during the first 180° rotation of the vanes the condenser is in series, and during the second 180° it is in parallel.

THE GENERAL ELECTRIC CO., LTD. Stand (not allotted).

The General Electric Co., Ltd., will be exhibiting a wide range of wireless apparatus, accessories and components at the forthcoming exhibition, their stand being readily recognisable from the large magnet—the trade mark—incorporated in its design. Complete Geophone sets, from the crystal type to



The four-valve "Nelson Grand" Efescaphone receiver.

super-heterodynes, and a number of fresh lines in accessories will be on show. The stand of this progressive firm will have distinctive features that is sure to prove a "magnet."

ALFRED GRAHAM & CO.

Stand No. 40.

In the very centre of the main hall ground floor will be found the home of the loud speaker, as typified by the "Amplion" exhibits. Famous throughout the world these loud speakers will be well represented, though they will perform be dumb, no practical demonstrations being allowed at the Albert Hall.

All the principle types of Amplions are to be shown, including the well-known "Dragon" range, while details of the very latest in loud-speaker design and construction will be available for the interested visitor at stand No. 40.

For those who desire more practical proof of the quality of the "Amplion" loud speakers than is available in the exhibition, Messrs. Graham have arranged a special "show" of their own within three minutes of the Albert Hall.

Here—in the Amplion Suite, Kensington Palace Mansions, De Vere Gardens—demonstrations of reception and loud-speaker reproduction under "home" conditions will be given so that the prospective purchaser can hear for himself what kind of reception he is likely to have if he buys an "Amplion" loud speaker. This private show should be well worth a visit.

HART ACCUMULATOR CO., LTD.

Boxes No. 62 and 63.

As might be expected, with the exception of a few side lines of general interest, the whole of the exhibits shown by Messrs. Hart & Co. will be storage batteries. All sorts of accumulators are to be on view—from the large ones used in ships for transmission, to the tiny batteries designed for portable purposes. There will even be a special grid bias accumulator exhibited, having special features to make it eminently suitable for that purpose.

All batteries are labelled with the "actual" capacity for constant discharge, based on a discharge at the 10-hour rate. This is an important point as it enables the purchaser to calculate exactly how long any one battery would last him under given conditions without wanting to be recharged.

HIRST BROS. & CO., LTD.

Stand (not allotted).

A great variety of apparatus is to be seen on this stand, the most interesting of which, in our opinion, is a new pedestal loud speaker. The average loud speaker, however excellent it may be from a reproduction point of view, cannot lay claim to much beauty and symmetry of design. In the "Tane-side Pedestal" speaker, an effort has been made to break away from stereotyped designs with a view to producing an ornamental speaker which would satisfy the requirements of the most fastidious.

That this effort has been highly successful is amply evidenced by the reproduction here given of this speaker. Of pleasing proportions, and highly finished in Jacobean oak or polished mahogany, this pedestal would enhance the appearance of any drawing-room, while the cone and semi-circular

(Continued on page 89).

LONDON'S WIRELESS EXHIBITION.

(Continued from page 88.)

apertures at the mouth of the pedestal ensure the most perfect and even distribution of sound. Other items include a range of 1-4-valve sets and a large number of components.

THE EDISON SWAN ELECTRIC CO., LTD.
Stand No. 26.

The Edison Swan Electric Co., Ltd., have a very representative show of all types of apparatus. As one of the largest valve manufacturers in the country, Edison valves are naturally well represented, and it is interesting to note the many new



This 4-valve Sterling cabinet receiver has a range of 40-5,000 metres.

additions to the famous series since the last exhibition. In the bright emitter types the famous A.R. is now made especially for H.F. and L.F. work, the distinguishing marking being a red line for H.F. and a green line for L.F. The other type of bright emitter, the R, is retained as an all-round "general purpose" valve. In dull emitters, the A.R.D.E. (2-volt) and the A.R.06 (3-volt) are both made for H.F. and L.F.

Another interesting point about these valves is the new method of sealing which is employed, which ensures that the purchaser receives an absolutely new valve. The device consists of a glass tube fitted over the anode pin, to which it is attached by means of a sealed thread.

There is the usual fine array of Edison sets and components, all of which are notable for their splendid design and finish. We were particularly interested in a new two-valve receiver which the company are just placing on the market. This type of receiver has been evolved with the idea of supplying a highly efficient receiver at a remarkably low price. The circuit is the well-known Detector, one L.F. with reaction, and it is claimed that excellent loud speaker results are obtained up to 25 miles, and with headphones stations over 100 miles away are well received.

The set is of a circular pattern in moulded insulation material, the valves being mounted close together on a centre-raised pillar, the L.F. transformer and connections being inside the pillar. All controls are arranged radially from the centre pillar, a flat type condenser being contained in the base. The filament is arranged for dual control, so that either bright or dull emitter valves may be used. The coils are of the well-known plug-in type.

Other exhibits are a series of dry H.T. batteries, dry batteries for use with dull emitter valves, the two Edison loud speakers, the "Televox" and "Dulcevox" and headphones.

A novelty in loud speakers. The "Tameside" Pedestal.

DUBILIER CONDENSER CO. (1925), LTD.

Stand No. 28, Loggia No. 50.

Examples of all types of condensers, both fixed and variable, will be seen at the Dubilier stand, a complete range of the well-known fixed mica dielectric condensers being well to the fore. Among the variable condensers the new "Duwateon" is certainly the most interesting, for it is so arranged that when a series-parallel switch is employed a little extra rotation of the moving vanes in the condenser will cover the usual "gap" in wave-lengths experienced when the ordinary condenser is switched from series to parallel.



The Duwateon variable condenser.

A new variometer is also well worth looking at, for this is made in an extremely compact manner and employs the "D"-shaped coils introduced some time ago. It is suitable for broadcast wave-lengths, and with the addition of a small fixed condenser will go up to about 1,800 metres. Exhibits of typical types of transmitting condensers are also made.

SELFRIDGE & CO., LTD.

Stand (not allotted).

Messrs. Selfridge & Co., Ltd., have arranged their stand to show a representative collection of wireless apparatus of the kind most likely to appeal to the man-in-the-street—the ordinary listener as distinct from the home constructor or amateur. The outstanding features are Geophone sets and components, Amplion loud speakers, R.C.C. and Metro-Vickers sets and components, various loading coils, and Cosmo valves. Cash purchases can be made at this stand, and the goods so bought can be taken away at once. The chief idea is that the stand is there for the benefit of people who wish to make purchases on the spot, and take their goods away, and we understand that Messrs. Selfridge will endeavour to supply sets or parts of any make in addition to those mentioned above.



Distortionless amplification is claimed for this new B.T.H. transformer.

THE NATIONAL WIRELESS & ELECTRIC CO.

Stands Nos. 56 & 57.

Besides the varied models of the "Gnat" crystal set the main exhibits on these stands are the 3-valve portable receiver and a series of valve sets of from one to four valves. Taking the latter receivers first, we find that they are all fitted with the "National" tuner, having aerial reaction and covering wave-lengths from 300 to 3,000 metres. No plug-in coils are necessary for average work, therefore, and as all batteries, etc., are completely enclosed in the cabinet, the receivers form quite attractive propositions. The larger sets have glass doors in front of the panels, the cabinets being of the now popular "American" design.



A new M.-L. L.F. transformer.

The portable 3-valve requires no aerial or earth, and is completely self-contained, measuring 12 in. by 12 in. by 8 1/2 in., and weighing about 17 lb.

Various components are on show, including crystal detectors, loud speakers, tuners, and transformers, the detector being a new model with micrometer adjustment.

AUTO SUNDRIES, LTD.

Stand No. 10.

There are four main exhibits to be seen on the stand of Messrs. Auto Sundries, Ltd., the chief of which being the Radio Sun loud speaker. This is already well known in the radio world, and needs no further introduction. Two models are being shown, one in sunlit mahogany finish, and one in crystallized black.

A square law variable condenser with a gearing of 20-1 is on view, special vanes being used to prevent hand capacity. A novel cam switch is also a noteworthy exhibit for this is designed so that the experimenter can make his own contact variations by simply slotting the cam as he requires. By this means any of 191 switch changes are claimed to be possible. Finally, an interchangeable rheostat is worth mentioning, for which two resistance units are available for bright or dull emitter valves.

HOUGHTON'S, LTD.

Stands Nos. 30-31.

Well known as a wholesale house, Messrs. Houghton are devoting their two stands to the interests of the radio dealer only. No apparatus is being shown, the stands being utilised purely in a "trade" capacity, wireless dealers being invited to make them a meeting-place during their visits to the Royal Albert Hall.

PELL, CAHILL & CO., LTD.

Stand No. 27 and Loggia Box 49.

A new range of 1926 models is being shown by Messrs. Pell, Cahill & Co., Ltd., manufacturers of the "Pellean" radio receivers. The most prominent exhibit is a 4-valve set, designed to receive high or low wave-lengths without the use of a loading coil or any other attachment. The change from high to low, and vice versa, is made by a change-over switch. Two distinct bands are provided for, so as to incorporate most of the broadcasting of any interest to the British listener, the wave-lengths covered being from 300-500 metres and from 1,000-1,800 metres. A loud speaker is incorporated in the case, so that the receiver is self-contained, and for general use, to give loud-speaker reproduction on at least two stations, no external aerial is necessary, though this can be used if really long range is required. Control has been simplified as far as possible, and though high-frequency amplification and reaction are employed, only one tuning control is necessary.

A 3-valve receiver on similar lines, but without the loud speaker, is also on show, and is built with portability as its main object.

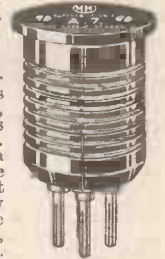

An example of H.F. transformer (L. McMichael, Ltd.).

RADIAX, LTD.

Stand No. 21.

In the outer circle on the left of the organ at the Royal Albert Hall is found the stand of Messrs. Radiax, Ltd., where a varied display of sets and components is to be seen. The sets are remarkably cheap, an outstanding model being the 2-valve 'loud-speaker set, which is available for under £5.

Low loss coils are also on show among a galaxy of variable condensers, H.F. transformers, reaction units, and last but not least, a special set of super-heterodyne components. This latter is offered at a tempting price, and is sold complete with copious instructions and diagrams, covering the needs of constructors who desire sets of 5, 6, 7-valves and upwards. A new frame aerial also makes its appearance on Stand No. 21, designed on a "low loss" principle, with tappings for ready adjustment of wave-lengths, while provision is made for the use of capacity reaction.

RADIO COMMUNICATION CO., LTD.

Stand No. 5 and Loggia Box No. 67.

Makers of the famous "Polar" components, Messrs. Radio Communication Co., Ltd., are exhibiting at two places in the Royal Albert Hall this year, a comprehensive selection of their most noted lines being on view. The Cam vernier coil holders will appear in two forms, while the "Polar" variable condenser reappears in an improved form. Provision has been made for a bevelled dial, moving on the spindle, and the abolition of the pointer. The dial has been designed as an anti-capacity shield, and is therefore made of metal. A further type of junior condenser is also on show, constructed to meet the demand for a cheap but reliable condenser; made in three sizes, it is built upon the same lines as the original "Polar" model.

The "Polar Blok" sets are being shown again, at considerably reduced prices, it being possible to get them ready assembled and complete in every detail if desired.

(To be continued next week.)



Technical Notes

Conducted by our Staff Consultant, J. H. T. ROBERTS, D.Sc., F.Inst.P.

Important Points to Remember.

MANY amateur constructors make the mistake of applying insulating varnishes to their coils, and questions often reach me as to the reason for the advice which is often given to the effect that varnishes and insulating compounds should be avoided, so far as H.F. coils are concerned.

This question is bound up with that of self-capacity, which is also a matter which appears to puzzle a considerable number of readers. For this reason I have often thought that a simple explanation of this matter might be of use. In the first place, the capacity referred to in "self-capacity" is precisely the same kind of capacity as that of a condenser, and it is, in fact, just because a coil of wire acts like a condenser that its capacity has to be taken into account. If you consider a coil of wire, such as an H.F. coil of a wireless set, you will see that when a current is passing through it there is a drop or "gradient" of potential along the wire of the coil, and consequently there is a difference of potential between each turn and its neighbours. The turns of wire are thus, in fact, "plates" of a condenser, and there is an electrostatic capacity effect between them. If the coil were carrying direct current this capacity effect would be of no importance (at any rate, under ordinary circumstances), but when the current in the coil is alternating, a certain amount of current is able to pass (or perhaps it would be more correct to say that a certain amount of the energy represented by the current is able to pass) from one turn to another, without going round the wire in the ordinary way. This effect increases with the frequency of the alternating current, and in the case of the very high frequencies dealt with in wireless the effect becomes important.

Capacity Leakage and H.T. Resistance.

Now, when the turns of the coil are separated by air and are a fair distance apart, the effect is relatively small, but if the turns are placed close together the effect is naturally increased. The capacity between turns depends (just as does the capacity of a condenser of the conventional kind) upon the specific inductive capacity, or "dielectric constant," of the medium between them, and since the dielectric constant of varnishes and insulating compounds generally is much higher than that of air, it follows that when the coil is thickly loaded with varnish the capacity effect is much increased.

It is for a somewhat similar reason that it is inadvisable to run the down-lead of the aerial near to a wall or, indeed, to any other object, particularly if that object be connected to earth. The wiring of the set should also be kept from "paralleling" as much

as possible, and the wires should be spaced as far apart as convenience permits.

When a H.T. battery has been in use for some weeks or months, it generally tends to fall off in voltage, and, furthermore, the internal resistance increases, owing to the drying up of one or more of the individual cells or units within the battery. If the battery is tested with a voltmeter this internal resistance will not always be apparent, for the extent to which it shows

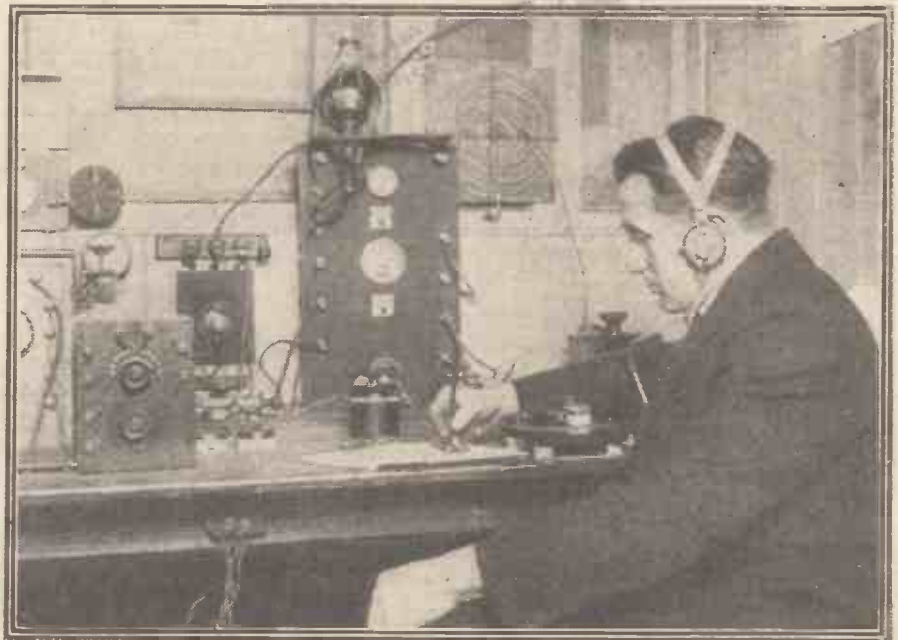

Mr. J. A. Partridge, at work at his station, G 2 KF, which has many DX records to its credit.

itself on the voltmeter depends upon the resistance of the meter. The battery may give a fairly good reading of voltage on the meter, and yet its internal resistance may be too high for the efficient working of the set, particularly if the latter be of the multi-valve variety. It is a well-known and useful plan to connect a large capacity condenser (or "blocking condenser") across the ends of the battery, say one or two microfarads. This has the effect of preventing the crackling noises (and even flowing) which are liable to be set up as a result of increase in the internal resistance of the battery.

Correct Method of Drilling.

When drilling an ebonite panel it is sometimes recommended to mount the ebonite in the vice, so that it is in a vertical plane, and to use the breast-drill in that perhaps more convenient position. This method should, however, be avoided, as there is invariably a tendency for the drill to drift downwards when starting, the error produced in this way often amounting

to as much as 1-32 of an inch. The proper way to drill the panel is to lay the latter down upon the bench and drill in the horizontal position, marking out the drilling positions fairly deeply beforehand, so that there shall be no tendency for the drill to wander.

A New Type of Reproducer.

I have already mentioned in these Notes the fact that quartz, owing to its piezo-electric properties, has been used for the purpose both of a telephone transmitter (microphone) and of a receiver (loud speaker). It is now reported that experiments are in progress in the famous laboratories of the General Electric Co., of America, which may result in the quartz reproducer entirely displacing and superseding the electro-magnetic type, at any rate for wireless reception purposes. The exact nature of these experiments is at present kept secret, but methods have been found for producing piezo-electric quartz on a large

scale, whereas hitherto one of the difficulties has been that quartz suitable for this purpose was only found in relatively small percentage in natural quartz.

A "Crystal Operated" Loud Speaker.

What is described as the "simplest loud speaker in the world" has now made its appearance: it is based on the principle of piezo-electricity. The new loud speaker consists essentially of a large concave metal "mirror" (which, in fact, is the reproducing "diaphragm") which is attached to the end of a crystal of Rochelle salt (the latter substance being one which exhibits the piezo-effect in a very marked degree). The crystal is provided with metallic coatings, in the way I have described before, and the signal currents are fed into these metal coatings. The result is that the crystal suffers small increases and decreases in length, in accordance with the signal variations impressed upon it, and the metal diaphragm is vibrated in the same way, giving rise to sound-waves.

(Continued on page 139.)

B.T.H. RADIO APPARATUS & VALVES



Bijou Crystal Set



New Type 2 Valve Set



Type C8 Loud Speaker



Table Lamp Loud Speaker



Type D Loud Speaker



Head Telephone Selector Switch



Gramophone Attachment



Type C2 Loud Speaker



Type C1 Loud Speaker

2 Valve Power Amplifier



3 Valve Super Hot Portable Set



New Type 1 Valve Amplifier

2 Valve Set



3 Valve Cabinet Set with enclosed Loud Speaker

See them all at

STAND No. 1

and Boxes 59 & 60

at the

N. A. R. M. A. T. WIRELESS EXHIBITION

Albert Hall, London.

Sept. 12th to Sept. 23rd, 1925.

Advert of The British



Thomson Houston Co. Ltd.



1 Valve Unit Amplifier



L.F. Transformer (Ratios 4:1 & 2:1)



"Model A" Crystal Set



Portable Loud Speaker and Amplifier



6 Valve Super Hot Cabinet with enclosed Loud Speaker



Head Telephones

Variable Condensers (.001, .0005, .00025)



Standard Vernier Square Law

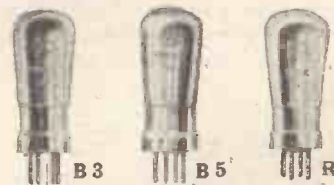

General Purpose Valves



Power Amplifying Valves



**He never gets
let down now!**

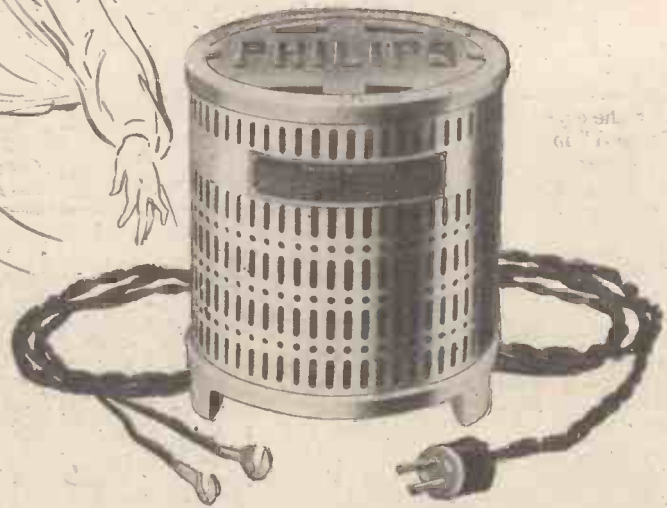

**THAT "BOUND-TO-COME"
SORT OF FEELING!**

YOU know it, and I know it, and one day it will come!
No current—no wireless!

There's only one satisfactory solution—always have your accumulators ready charged, and when you think of chargers remember there is only one that will give complete satisfaction.

The PHILIPS RECTIFIER works off any A.C. supply, requires no supervision whatever, works silently, and automatically regulates the current supply.

There are no objectionable chemicals, no buzzing noises, and you have, in fact, a most reliable battery feeder with an extraordinarily low running cost.

**SIMPLE, CONVENIENT, EFFICIENT.
IT CHARGES WHILE YOU SLEEP.**

£4.15.0
COMPLETE

Write for leaflet P.W., free on application.

Trade enquiries invited.

**PHILIPS
RECTIFIER**

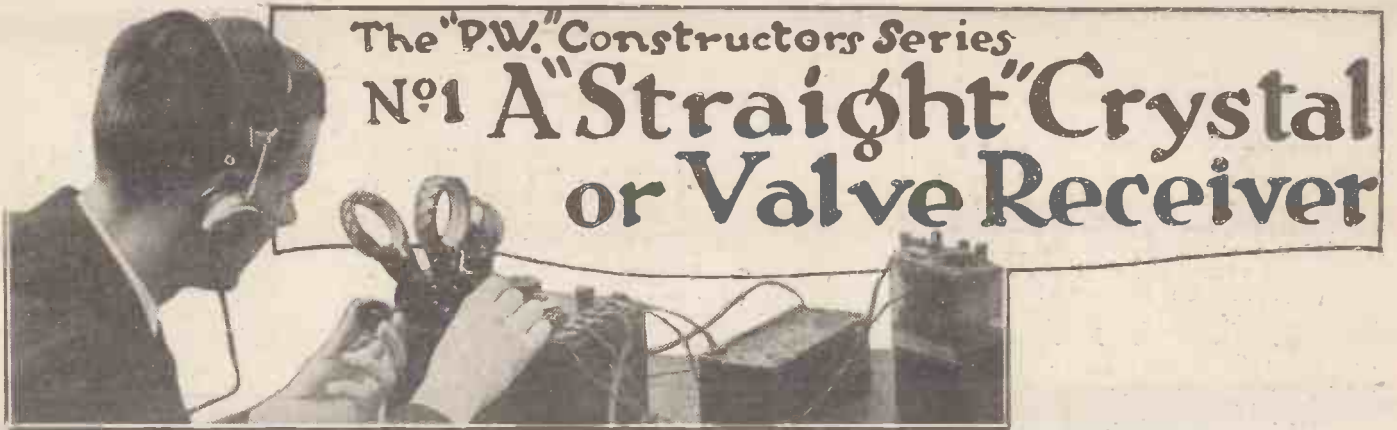

The "P.W." Constructors Series No. 1 A "Straight" Crystal or Valve Receiver

How to construct a Combination Crystal-Valve Receiver—the set designed by the Technical Editor and built by the "P.W." Technical Staff. Here is a set we can thoroughly recommend to our readers.

THERE are many listeners and constructors who, though attracted by the economy and purity of reproduction of the crystal set, yet feel that they are "cramped" in their results if they have such a receiver. They do not necessarily wish for louder signals, but they feel that they would like to reach out and pick up other stations—usually an impossibility with a crystal set.

At the same time, however, the listener feels that he is not justified in using a valve for his local station—it is sheer waste of juice. The crystal gives all he wants in the way of signal strength, and yet he would like to get further afield.

The obvious thing to do in such a case is to combine the two types of receiver in such a way that by a simple switch either crystal or valve may be used—i.e. either the local or more distant stations can be received. It is a combination of this type that is provided in the set described below, the change over from one to the other being accomplished by a simple switch and the batteries, etc., not being touched.

The theoretical circuit diagram is given in Fig. 1, and the same diagram is shown in pictorial form in Fig. 2.

The necessary parts are few, and the cost of the receiver, less batteries, coils and valve, if built with the parts mentioned, should not exceed £2 10s.

The components required are as follows:

- 1 Panel 8 in. x 6 in. x 1/4 in. and s. d. cabinet to fit. Radion Mahoganite 6 8
- 1 Two-way coil holder. Lotus... 7 0
- 1 Variable condenser, .0005 mfd. Atlas 11 6

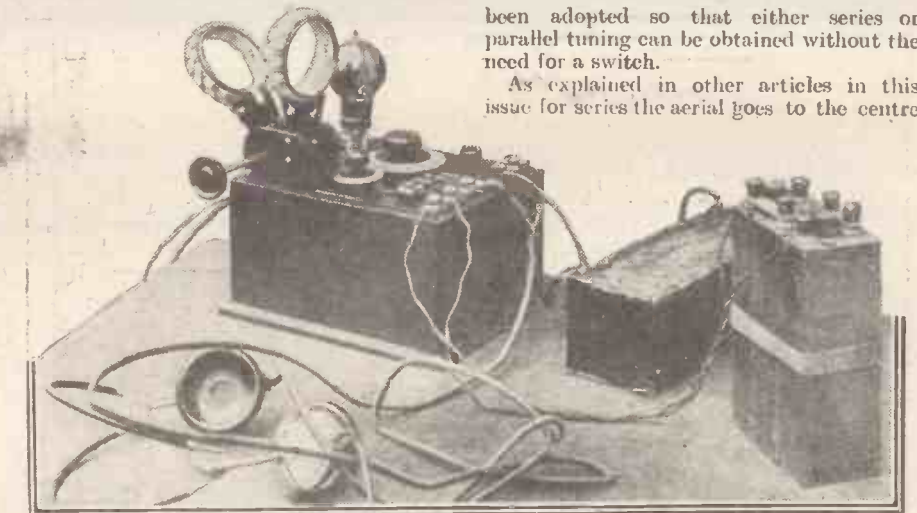

The completed receiver wired up ready for use. An ordinary 6-volt valve is in use, but D.E. valves are quite efficient.

- 1 Valve holder (4 valve legs) 9
- 1 Filament rheostat. Atlas 5 6
- 1 Grid leak and condenser, .0002 and 2 ohm (Dubilier) 5 0
- 1 D.P.D.T. switch. Nesthill 2 0
- 1 Crystal detector (R.I.) 7 6
- 9 W.O. terminals, wire, etc. 1 9
- L.T. and H.T. batteries, coils, telephones and valve will also be needed.

The lay-out of the panel is shown in Fig. 3, together with measurements for drilling, etc. The three-terminal aerial-earth system has

been adopted so that either series or parallel tuning can be obtained without the need for a switch.

As explained in other articles in this issue for series the aerial goes to the centre

terminal and the earth to earth, the first terminal (parallel) being left unconnected. For parallel connections the aerial goes to the latter terminal (marked AP) and the series terminal is shunted by a piece of wire or a brass strip to the earth terminal. The earth connection is, of course, left where it is.

Before drilling the panel make sure that the chonite has been cut to size properly—
(Continued on page 94.)

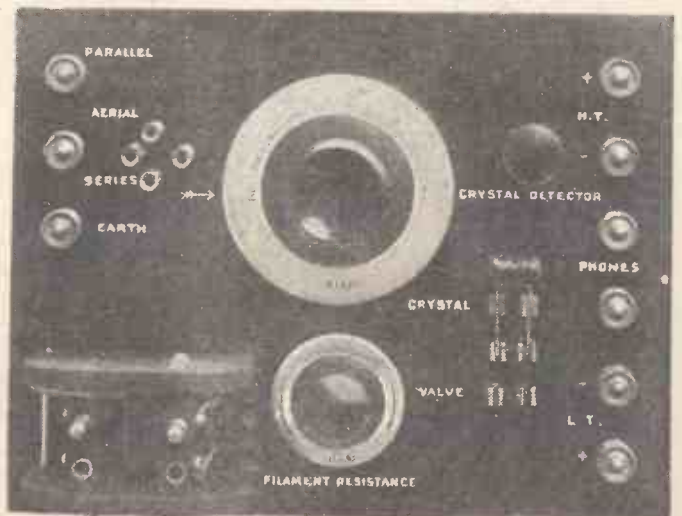
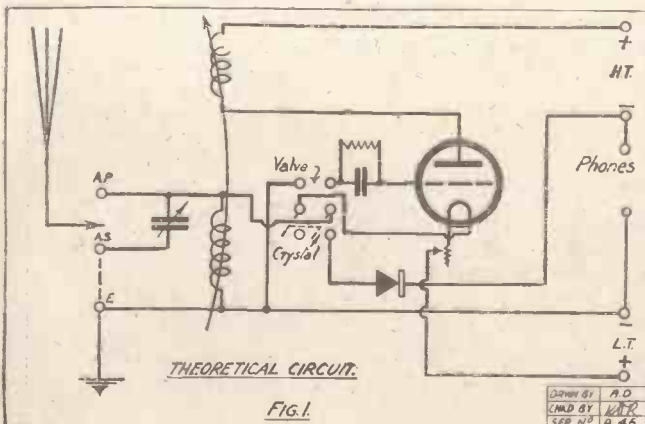

Front of panel view of the crystal-valve set showing the lay-out of components.

A COMBINATION CRYSTAL-VALVE RECEIVER.

(Continued from page 93.)

many dealers only cut it roughly and the constructor may have to file it down to make it square and ensure that it fits the cabinet. After this the panel may be drilled according to Fig. 3, the hole for the variable condenser being reamed out if a large drill is not available, and then the panel should be "dressed" unless it happens to be of the "guaranteed" variety.

Preparing the Panel Surface.

The cheaper ebonite, if of the glossy type, often contains traces of tin foil on its

surface, and unless "guaranteed" should be rubbed over with emery cloth (No. 00) until a matt surface is obtained, and then finally given a rub over with a soft cloth and a little machine oil. This procedure ensures that the ebonite will be free from surface leakage.

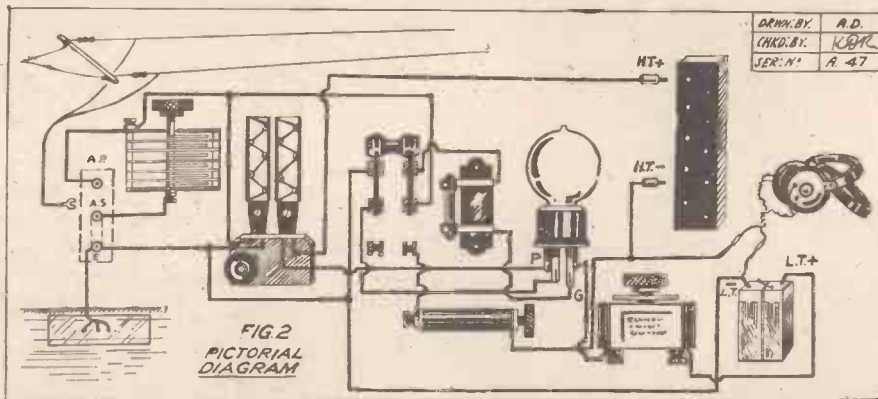

DRWN. BY:	A. D.
CHKD. BY:	K. B. H.
SER. NO.:	A. 47

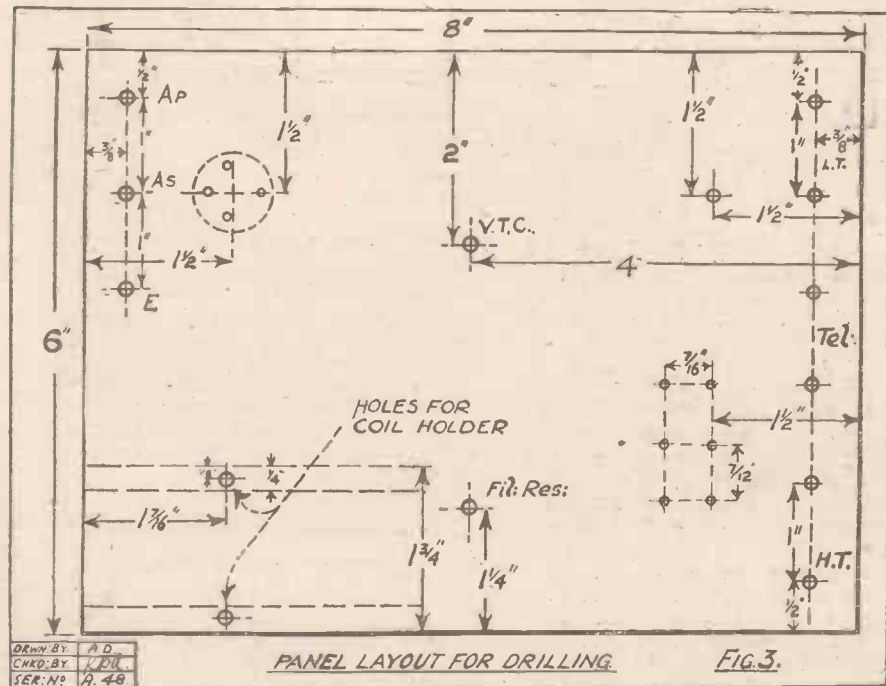

DRWN. BY:	A. D.
CHKD. BY:	K. B. H.
SER. NO.:	A. 48

surface, and unless "guaranteed" should be rubbed over with emery cloth (No. 00) until a matt surface is obtained, and then finally given a rub over with a soft cloth and a little machine oil. This procedure ensures that the ebonite will be free from surface leakage.

Mounting the Components.

The mounting of components may now be done, care being taken that the terminals and valve legs are tightened up properly—the former can be tapped into the panel if the constructor has a set of taps, but this is not necessary though it helps to keep the terminals firmly in position. It will be noticed in the photographs that "Tangent" coils have been used; this is not because these are the only ones suitable for the set (other makes of coils can be used with success, if desired), but merely because these coils can be looked upon as reliable and can be recommended to give satisfaction. Home-made coils can be employed if the constructor wishes, and the set shown in the photographs has been tested with home-made basket or spider coils with very good results.

For the purpose and costing about 1/3 each. For the benefit of those who would like to buy or make a set of coils to cover all the various stations likely to be heard on the set a list of coils and the stations is given at the end of the article.

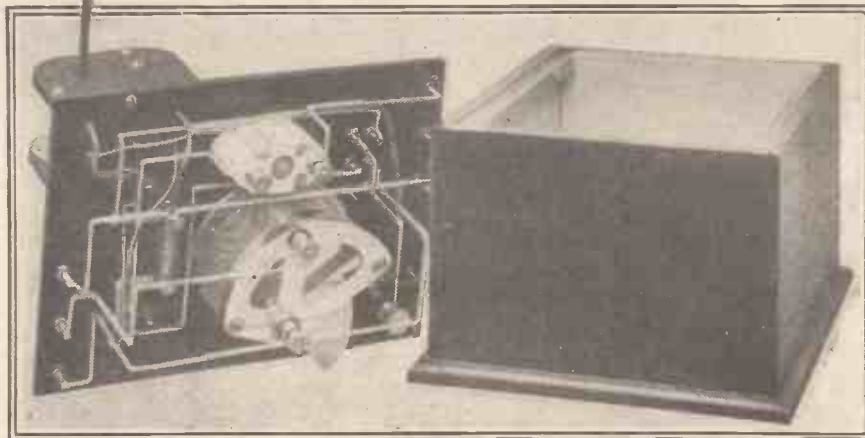

The finished set removed from its case. When mounted properly the moving vanes of the condenser easily clear the sides of the cabinet.

We left the panel with all the components mounted, so that the wiring up can now be carried out. The necessary connections can be clearly seen from Fig. 5 and from the photographs, though as a further check the point-to-point connections are given below! All joints must be firmly made, so that there is no danger of their working loose, and soldered connections should be employed whenever possible.

Point-to-Point Connections (Back of Panel with Fil. Res. at Top).

Aerial (parallel) terminal to moving plates of variable condenser and to one end of coil holder fixed side (plug connection) and to right-hand centre of S.P.D.T. switch. Aerial (series) terminal to fixed plates of variable condenser. Earth to other connection of coil holder (fixed side, socket connection) and thence to one terminal of 'phones. Top right-hand side of switch to grid leak and condenser, other side of grid leak and condenser to grid of valve. Plate of valve to socket of moving part of coil holder and plug of moving coil holder to H.T. + terminal. H.T. - terminal to remaining 'phone terminal and to one side of crystal detector. Other side of crystal detector to bottom right-hand side of switch. L.T. + terminal to filament rheostat, filament rheostat to one filament socket of valve holder, other filament socket of valve holder to left-hand centre contact of switch. Top left-hand contact of switch to - L.T. terminal.

All connections should be checked carefully, and then the batteries can be connected up, the valve inserted (before H.T. + is placed in battery), the aerial and earth connected and the switch placed in

(Continued on page 95.)

A COMBINATION CRYSTAL-VALVE RECEIVER.

(Continued from page 94).

"crystal" position. Adjustment of crystal and variable condenser should bring in signals if the right sizes of coils according to chart are being used. The range of the receiver or crystal will be the same as for the ordinary crystal set, about 15-20 miles from a main B.B.C. station and 100 miles from 5 X X.

Tuning in Distant Transmissions.

Now turn on the filament rheostat and place switch in "valve" position; leave variable condenser set and adjust the reaction control. This should now bring in the

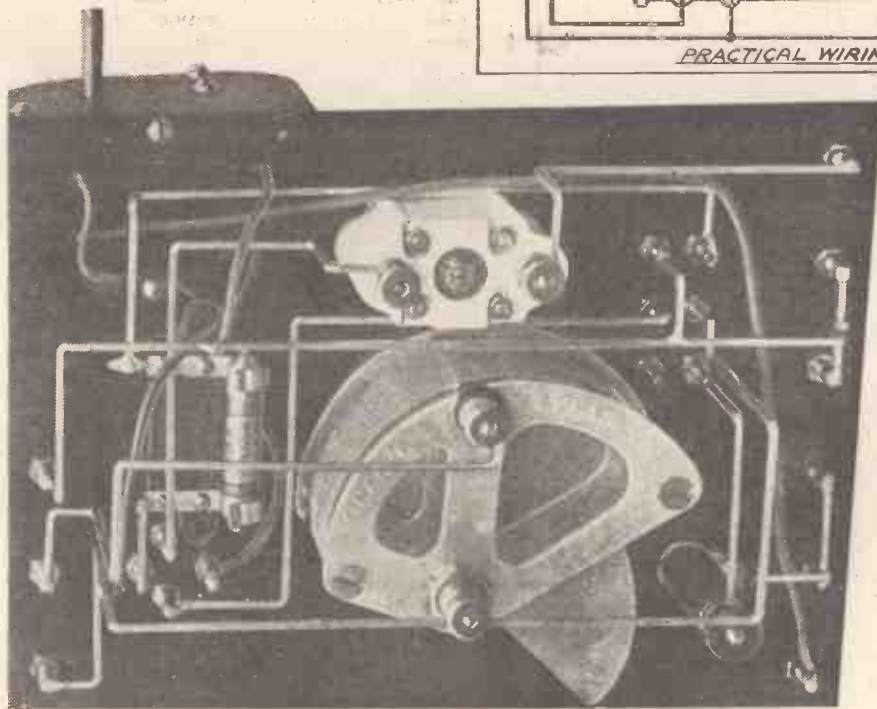
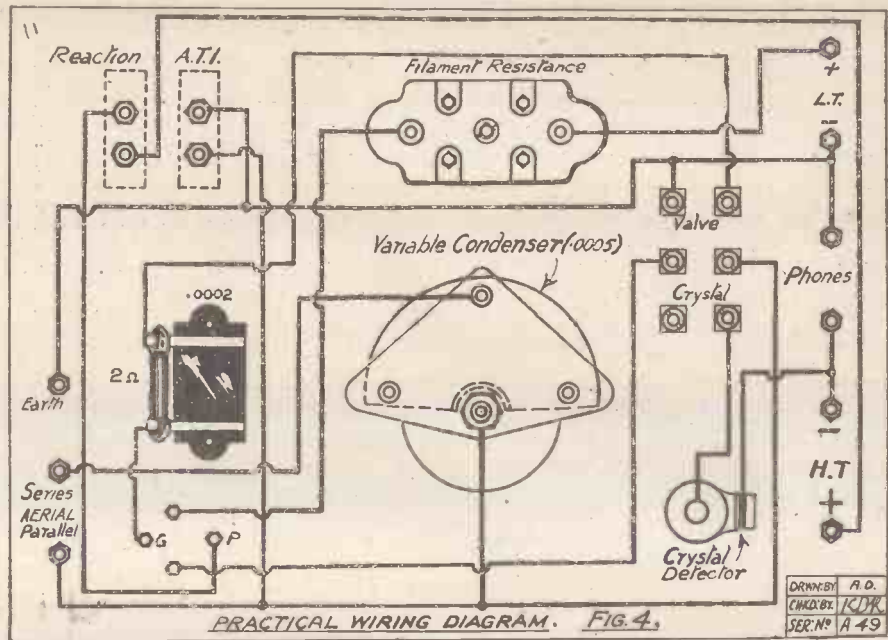

A close up of the rear of the panel, showing how the various components are connected up.

same station much louder, or readjustment of the variable condenser slightly will be necessary.

Variation of the condenser and the reaction control will now enable the constructor to tune in more distant stations, and after a little practice it should not be difficult to tune in most of the B.B.C. stations and several continental transmissions, provided he has a fairly efficient aerial and earth system.

The Best Coils to Use.

One last word about the series-parallel arrangement. It is usually advisable to use the series connections for all stations below 600 metres and the parallel above that wave-length. The chart given shows the approximate sizes of coils necessary, the length of the aerial being the determining factor in each case. Where two sizes are given the larger coil should be tried first.

SIZES OF COILS ADVISED.

Station and Wave-length Range.	Aerial Coil. (S. or P. denotes Series or Parallel Connections.)	Reaction Coil. Try smaller one first.
B.B.C. stations 260-350 ..	50 (S.)	75
B.B.C. stations, 340-500 ..	75 (S.)	75-100
Paris (Petit-Parisien), 340 ..	75-50 (S.)	75-100
Paris (Ecole Supérieure), 450 ..	75 (S.)	75-100
Radiola, 1,780 ..	150-200 (P.)	150-200
Eiffel Tower, 2,600 ..	300 (P.)	200-250
Daventry (5 X X), 1,600 ..	150-200 (P.)	150-200
Madrid, 395 ..	75 (S.)	75-100
Brussels, 265 ..	50 (S.)	75
German stations, 260-350 ..	50 (S.)	75
German stations, 340-500 ..	75 (S.)	75-100

A TONE UNIT.

THIS little piece of apparatus about to be described is extremely useful to the experimenter. Obtain a piece of $\frac{1}{8}$ ebonite and square off the edges. Five holes are then drilled to take tapping studs, and one for the switch arm. In each of the four corners holes are drilled to take terminals.

The studs, arm, and terminals are the only pieces of apparatus seen on top of the panel.

Now beneath the panel mount five fixed

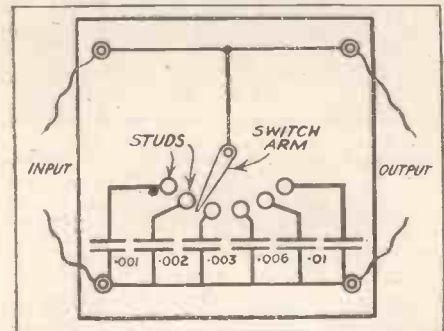

condensers, .001, .002, .003, .006, .01, and connect up from the circuit shown.

The apparatus having been connected up, the panel may be mounted in a small cabinet.

This little instrument has many uses. (1) For altering the tone of the loud speaker or telephones, and so obtaining the best results.

(2) When making a new set one is often in doubt as to the right value of fixed condenser to use.

(3) As a telephone distribution board with tone selector combined when extended telephone leads are used.

A great many other uses will probably occur to the experimenter.

A grid leak control may be made in exactly the same way as the condenser unit only substituting different values of grid leaks for the condensers. The circuit is the same. The values the writer used were $\frac{1}{2}$ mg., $1\frac{1}{2}$ mg., 2 mg., and 5 mg.

BROADCAST NOTES.

By O. H. M.

B.B.C. and the Concert Industry—Relieving the Deadlock—The News Bulletins and Radio Publishing—"Britain at Work"—Psychological Factors.

I AM glad to be able to say that I have authoritative information from the concert industry that there is a revival of activity in the direction of relieving the present deadlock on broadcasting. The last development I had to report was a temporary victory for the diehards of the concert industry. By representing that they could bring such influence to bear on the Government Broadcasting Committee that they would stand a good chance of shackling broadcasting, these diehards succeeded in putting a stop to the negotiations which had been going on for some time.

But now the inevitable is happening. Further reflection has induced those who are controlling the policy of the concert industry to realise that a policy of recalcitrance at this juncture will probably damage their interests seriously in future. The idea now is to get an early agreement with the B.B.C. on reasonable terms.

I cannot say, of course, whether this agreement will eventuate; but it is an extremely good sign that an attitude of moderation has supervened. The B.B.C., of course, will warmly reciprocate, and it will be all the easier to re-open negotiations for the reason that the B.B.C. people have sedulously declined to associate themselves with any general attack on the concert industry.

I need hardly say that, from the point of view of listeners, any reasonable agreement between the B.B.C. and the concert industry would be of cardinal importance. It would mean a very considerable strengthening of the programmes during the coming season.

The American System.

Recent proceedings in the Vacation Court have called attention to the problem of the extent to which broadcasters should engage in publishing.

American practice appears to have advanced a good deal further than British practice in this respect. Not only do American broadcasters enter seriously into the publishing business, but the newspapers and publishers generally enter even more seriously into the field of broadcasting.

The "Chicago Tribune," for instance, broadcasts a news bulletin every half hour through station WGN in Chicago. On the other side the Radio Corporation of America send out hourly news bulletins, which appear to be particularly popular on passenger ships at sea. Some of the big liners that maintain their own printing plant publish these despatches as newspapers.

The Hearst papers of Chicago broadcast frequent news bulletins through Station K Y W. Moreover, many of the leading American broadcasting companies publish elaborate journals containing their programme, magazine features, and as much advertising as they can get.

The development of this side of American broadcasting does not appear to have damaged the publishing interests as a whole,

but it certainly has tended to modify the character of daily journalism.

Of course, the position in Britain is entirely different in this respect. In this country broadcasting so far has had no damaging effect on newspapers. In fact, owing to the agreement which is part of the charter of the B.B.C., and owing to the policy of friendly co-operation to which the B.B.C. has consistently adhered, the newspapers and other periodicals have been able to develop wireless and broadcasting features which are of real value to circulation.

NEXT WEEK—
**250 RADIO QUESTIONS
ANSWERED.**
ORDER YOUR COPY NOW!

The news bulletins broadcast at present at 7 and 10 p.m. each day are confined to narrow limits. Their preparation is left entirely in the hands of the news agencies which owe their existence to the newspaper

of many provincial evening papers. Now, if a London newspaper, or group of London newspapers, were given a free hand to exploit the broadcasting of news, these same provincial papers would really begin to feel "the draught." I believe they are alive to the danger, and it would not surprise me to see a great rallying of the provincial Press and most of the London Press to support the B.B.C. in any attack on it with the object in view of securing separate facilities for the broadcasting of news.

A New Series of Broadcasts.

"Britain at Work," is the general title of a new series of outside broadcasts which the B.B.C. is evolving. One of the most interesting of these takes place on September 17th, when all the characteristic noises of the production of a newspaper will be broadcast from Carmelite House. This introduction to the atmosphere of the newspaper industry will be followed by similar introductions to other industries. These broadcasts are, of course, considered entirely on their programme merits, and the factor of advertising is incidental.

It is, of course, impossible to draw a hard and fast line between what is advertising and what is not advertising. In fact, nearly every broadcasting of any interest contains an element of advertising. I think the B.B.C. is well advised in not sacrificing the variety and interest of its programmes to a rigid formula in this respect. As long as programme interest is the dominating factor, there should be no reluctance to go ahead with new enterprises.

There is another point of view of particu-

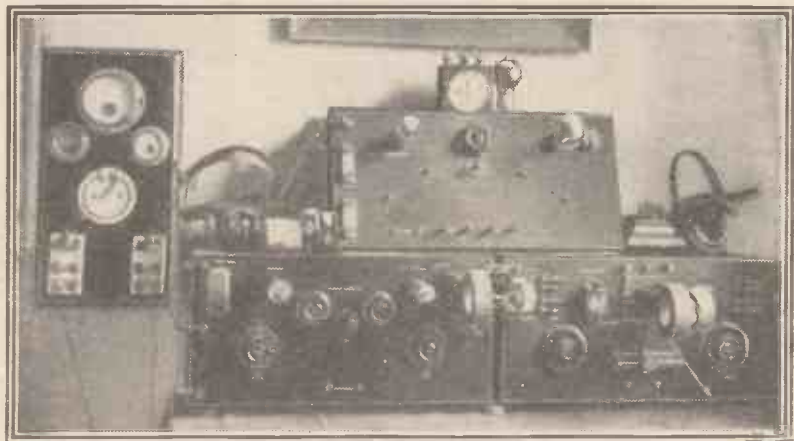

A good example of neat design and workmanship, belonging to Mr. C. V. Carpenter, 126, Nansen Road, Birmingham.

interests. That there should be some extension of the British broadcast news service seems inevitable. This is bound to be one of the big points to engage the attention of the Government Committee. The probability is that certain leading newspapers will seek facilities to enable them to conduct their own broadcasting news service such as is the case in America.

But my opinion is that the main body of the British Press will offer a more vigorous resistance to proposals of this kind than they will to a reasonable extension of the present news broadcasting facilities of the B.B.C. Provincial newspapers already complain of the effect of broadcasting. For instance, the fact that the results of the last two races are put out by the B.B.C. is supposed to have reduced the circulation

lar application to the present series of "Britain at Work." This is the kind of thing which might make a valuable contribution to the maintenance of the national morale. There is prevalent just now much too much pessimism. The weary reiteration of the figures of unemployment is in itself a depressing influence. People are apt to forget that there are still more people in employment in this country than there were before the war, and that we really have many tremendous and active industries.

The broadcasting of the atmosphere of these industries should do something to dispel pessimism, and to restore a sense of proportion. Psychological factors are sometimes a determining influence in a period of change from slump to boom.



By J. H. T. ROBERTS, D.Sc.,
F.Inst.P.

(Staff Consultant, "Popular Wireless.")

The words "low loss" have lately become the slogan of a radio cult, and in many cases, as our consultant points out in this article, it has been very much overdone. Amateurs will appreciate the reason when they read this article.

DURING the past year or so a new cry has arisen with respect to wireless components—the cry of "low loss." It is difficult to know whether to call it a cult or a parrot cry. It has been repeated and re-echoed in many cases without being properly understood. In a considerable proportion of cases there would seem to be little or no justification for its use.

Like many catch phrases, however, it has been found to be valuable for "boosting" purposes, and in consequence has come perilously near being worked to death. We have low-loss condensers, low-loss transformers, low-loss coils—in fact, everything seems to be low loss, except perhaps rheostats, which unfortunately are definitely intended to be loss-producers; no doubt before long some misguided manufacturer will come cheerfully forward with a low-loss rheostat!

A Necessary Warning.

The fact of the matter is that this low-loss idea has been very considerably overdone. The power of propaganda and of suggestion are such that the average wireless amateur has found himself hypnotised into the belief that unless all, or most, of his components are of the alleged low-loss variety, he may as well give up any idea of ever getting any sort of useful results from his set. In fact, the campaign has gone so far that a well-known American writer recently thought it necessary to raise a note of warning and, to a large extent, I must say that I agree with him, and I feel sure that all serious manufacturers and amateurs will agree with him as well.

In saying all this by way of introduction, I do not want my readers to think that in what follows I am going indiscriminately to "throw cold water" on the low-loss principle—far from it. It would be idle to deny that losses occur in the components of the set, and that by ingenious and careful methods of design and manufacture these losses, which materially interfere with the efficiency of the set, may be reduced.

When the description "low loss" accompanies the product of a serious and reliable manufacturer, you may rightly take note of it. It is then the deliberate statement of a man who knows what he is talking about and who has been careful to consider his

words. It is such manufacturers as these—the established and proved manufacturers—who have given the description "low loss" its value and goodwill, and it is precisely for the same reason that some of the less careful traders have quickly attached the same label to their wares without considering whether they are technically or otherwise entitled to use the description.

The amateur and prospective purchaser is naturally at a loss to know exactly when

endeavour to reduce energy losses by legitimate means, and he sought, equally honestly, to distinguish his goods by emphasising their particular characteristics. He was followed by others, also animated by a laudable desire to keep abreast of the times and to improve their product by any legitimate means—even by imitation.

How It Began.

So it started and, so far as it went, it was

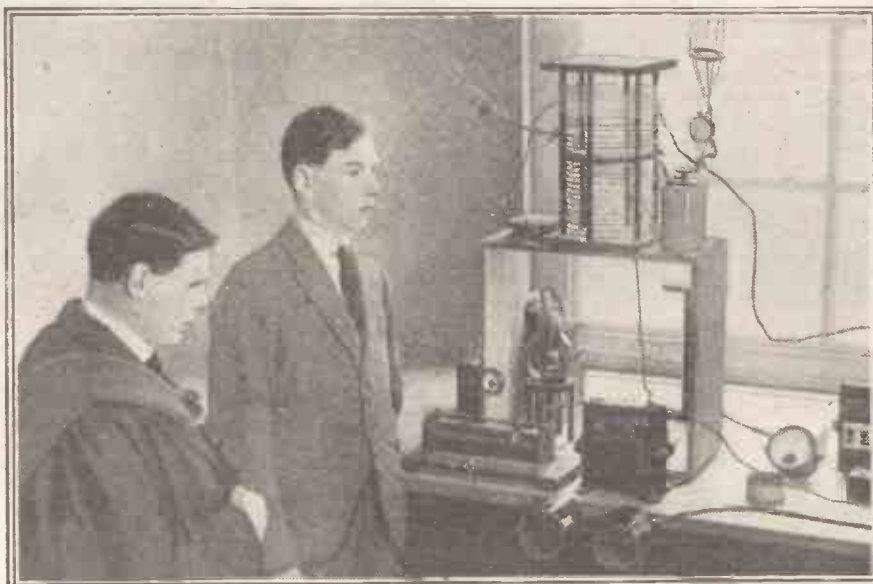

Mr. W. H. Brown and Mr. C. W. Goyder, of G 2 S Z, the well-known amateur station at Mill Hill School.

to believe it and when not to do so. Probably he never stops to ask himself what is really meant, or supposed to be meant, by "low loss," but if one condenser—for example—is advertised as being of the low-loss variety, whilst another—which may be a better article—omits to lay claim to this virtue, he is tempted almost unconsciously to believe that the former has some important superiority over the latter.

I do not suggest that the original manufacturer—or whoever it was—who started this low-loss idea did so in any way with his tongue in his cheek. He may have been, and probably was, perfectly honest in his

perfectly good. But it was observed to bring, and rightly to bring, increased business to those who were enterprising enough to adopt it. Then came the mere crier—the man who simply applied the description without perhaps even troubling to make the smallest modification in his product, without making it in any way different from what it was before it graduated into the low-loss ranks; in other words, the man who neither knew nor cared what "low loss" meant, but who perceived that it was a fine parrot cry, and one that "went down" well with the public. And, in consequence,

(Continued on page 98.)

"LOW LOSS."

(Continued from page 97.)

many amateurs have been badly "bitten" by having foisted upon them—to use a mixed metaphor—articles which, to put it plainly, were not true to their description.

In order to help the reader to understand when the low-loss description is likely to be correct and when it is not, it may be useful to consider cases where the reduction of losses of energy has definitely and intelligently been studied, and where real means have been found for carrying it into effect.

Probably the most notable case of the kind is that of the high-frequency coil. Here the self-capacity of the coil, as well as the high-frequency resistance, are causes of energy losses and consequent inefficiency. In order to overcome or minimise the effect of the self-capacity, high-frequency coils have been wound in certain special ways. Some of these "patent" ways of making coils, however, so far from minimising the self-capacity, actually have the effect of increasing it, or, if they do not do that, of introducing losses of other kinds which may more than counterbalance the reduction in capacity losses.

H.F. Resistance.

A point which requires constantly to be borne in mind is the question of high-frequency resistance. Every coil is bound to have direct-current resistance and, owing to the high frequencies of the currents dealt with in this part of the circuit, the "skin effect" plays an important part, the high-frequency resistance bearing a relation to the direct-current resistance which it is practically impossible for the amateur to calculate.

The high-frequency resistance naturally means loss of energy, and the loss from this cause may to some extent be reduced by using heavy-gauge wire. But the seekers after minimum self-capacity are in many cases apt to overlook the consideration of high-frequency resistance in their zeal for the reduction of capacity losses.

The Variable Condenser.

The variable condenser is a component which has had quite an important share of the low-loss praise. One is continually told of the dielectric losses in the insulating end-plates and the advantages of metal end-plates. The resistance—or leakage—losses between the two sets of vanes also provide a great outlet for the eloquence of the low-loss advocate. I have even known much talk made of the distribution of the electrostatic field about a variable condenser—a most complicated matter, and one the introduction of which into a popular description of a condenser I regard—if I may be permitted to use a vulgar phrase—as mere "eyewash."

The fact is that both metal and insulating end-plates have their advantages, and there should not be any appreciable leakage between the two sets of vanes. But if the leakage between the vanes is reduced to a very minute quantity, surely that is what would reasonably be expected, and hardly seems a matter for self-congratula-

tion. There is about as much sense in praising a condenser for the fact that it does not leak, as there would be in praising a motor-car for the fact that it could actually be got to go!

Leaky Ebonite.

Valve holders and valve caps have been improved by the removal of as much as possible of the ebonite between the pins; this means substituting air for the solid dielectric, and undoubtedly it is a good move. But its importance should not be exaggerated. It should be remembered that the losses due to the inter-electrode capacity—in so far as they arise from the presence of solid dielectric between the pins or sockets—are a small fraction of the losses in other parts of the circuit.

Low-loss ebonite is also made much of. The results of tests on the insulation of the material are given frequently, and convincing proof of the high insulation resistance is supposed thereby to be provided. But first of all it should be remembered that it is not the "body" resistance of the ebonite

but there is still room for improvement in this direction.

Before concluding these remarks on what has become in my opinion to some extent a misguided campaign, I should say that similar remarks apply to the square-law campaign. There has been lately a great vogue in "square-law" condensers, and so far as they go they no doubt represent perfectly good and legitimate attempts to improve the variable condenser.

The Square Law Condenser.

What I take exception to is the exaggerated claims made as to the advantages of the square-law condenser over the ordinary type. By the time the amateur has read all the descriptions of square-law condensers he may quite well be forgiven if he concludes that all his ordinary condensers are only fit to be thrown away. The fact is that a so-called "square-law" condenser—and, by the way, no two manufacturers seem to have exactly the same idea as to what is meant by a square-law condenser—is in some cases a little more convenient to

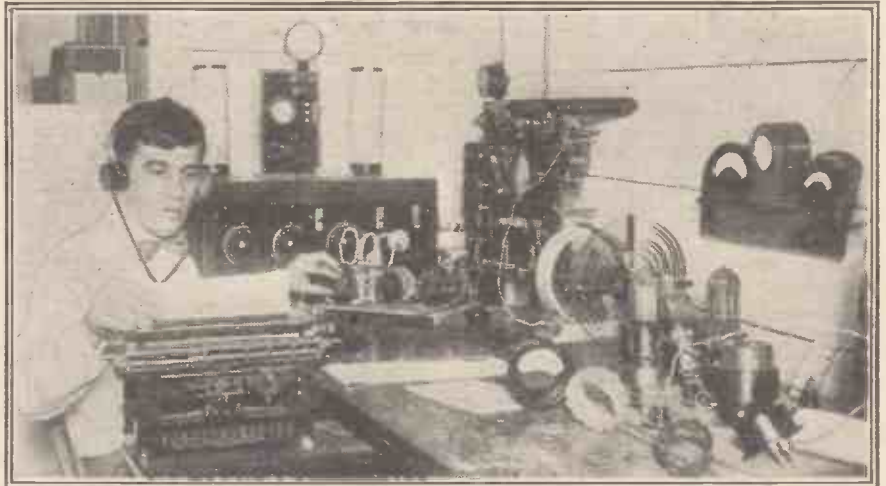

Mr. J. W. Holland, of Brooklyn, N.Y., who has been carrying out tests with the MacMillan Arctic Expedition.

that matters; what counts most in a wireless set is the surface leakage.

If a manufacturer could tell you that under average conditions his ebonite did not condense moisture more than such-and-such an amount, or that the total leakage, including surface leakage, was less than such-and-such an amount, there would be more reason in it.

And, moreover, it has been proved that results can be obtained with ebonite substitutes practically as good as those with the best ebonite, if proper precautions are not observed with the latter. Or to put the matter in a nutshell, the whole description of ebonite is frequently wide of the mark, and the most important point, surface leakage, is often ignored.

L.F. Transformer Failings.

If more attention were devoted to the reduction of losses in the places where the greatest losses occur, there would be a great deal more real value in this low-loss campaign. For example, a real low-loss inter-valve transformer would be an excellent thing, and, for the matter of that, so would a really low-loss high-frequency transformer. I know there are some excellent L.F. transformers on the market,

work with in that the scale is less crowded at one part.

Real Low-Loss Advantageous.

But for most purposes an ordinary condenser, particularly if fitted with vernier, is perfectly suitable. In fact, for a certain range of tuning I should doubt very much whether you could tell what sort of a condenser you were using—whether it was of the square-law or the ordinary kind.

In conclusion, I should like to repeat that I have no desire in any way to throw cold water on a movement for the improvement of wireless apparatus; there is no doubt that real low-loss components are—to that extent—better than components in which the losses are not reduced to the minimum. But do not allow yourself to be hypnotised, or a cult to become a mania. Keep a balanced judgment and a sense of proportion.

PHOTOGRAPHS.

Readers are invited to submit photographs of wireless interest for publication in "Popular Wireless." Every photograph accepted and published will be paid for at the rate of 10/6 per photo.

SUPER - EXCELLENCE

THIS is the essential characteristic of the "Cosmos" Radio Receiving Sets and Accessories on display at the N.A.R.M.A.T. Wireless Exhibition. Not content merely with the attainment of all-round excellence, the designers have advanced to something better—beyond perfect reception, to perfect reproduction—beyond loudness, to loudness without distortion—beyond long distance range, to long distance range with the minimum of controls—beyond attractive appearance, to a design embodying refined taste—beyond good workmanship, to excellent workmanship in every detail whether hidden or visible—in brief—beyond excellence to SUPER-EXCELLENCE.

The "Cosmos" exhibits for these reasons, claims your special attention. Make a point of seeing the following:—

The "Cosmos" Universal 5-Valve Set in various types of Cabinet.

The "Cosmos" New Model 3-Valve Set—a compact set of novel design.

The "Cosmos" All-wavelengths Crystal Set—for High Power Station and ordinary B.B.C.

The "Cosmos" Low Loss-Square Law Variable Condensers with slow motion attachment.

The "Cosmos" Strip Inductance Coils.

The "Cosmos" Anti-Vibration Valve Holders.

The "Cosmos" Bright Valve A.45. An excellent general-purpose Valve.

The "Cosmos" Dull Emitter Valve D.E.11. For Dry Cell or two volt accumulators.

The "Cosmos" Short-path Valve S.P.18. Extraordinarily efficient.

All Super-Excellent.

METRO-VICK SUPPLIES LTD.

(Proprietors: Metropolitan Vickers Electrical Company Ltd.)

4, Central Buildings, Westminster, London, S.W.1.

Obtainable from most Wireless Dealers.

Ask for copies of latest "Cosmos" Lists.

**COSMOS
THREE VALVE
NEW MODEL
RADIO
SET**

**COSMOS
ALL WAVE LENGTHS
CRYSTAL
SET**

**COSMOS
FIVE VALVE
UNIVERSAL
RADIO
SET**

Stand Number:

8

The First-Fruits of Gigantic Research Collaboration-



THE combined forces of the Philips and Mullard Technical Research Organisations have achieved the first of many wonderful developments in the perfection of radio valves.

The first objective of this gigantic research collaboration was to produce a master loud-speaker valve with vastly increased life and reduced current consumption. The P.M.4 Valve is the result of their labours. No finer valve has ever been offered to the British radio public.

The Laboratories from which this master valve has emanated employ the services of over a hundred skilled technical radio experts. From end to end the P.M.4 Valve will be entirely of British manufacture.

For complete information ask your dealer for Leaflet V.R. 28.

Mullard

THE MASTER VALVE

The Finest Loudspeaker Valve ever produced

THE P.M.4 Master Loudspeaker Valve stands triumphantly alone above the accepted standard in valves for loudspeaker reception.

It is the NEW "N" FILAMENT VALVE! Behind its design and performance lies the most advanced knowledge in Europe.

The most striking departure in the production of the P.M.4 is the filament. This filament is prepared by an entirely new process, whereby the special coating is obtained in an extremely adherent condition, making it capable of giving considerable electron emission at very low temperatures.

There are *four* supports to this unique "N" filament. It is absolutely non-microphonic. The low current consumption of only 100 milli-amperes means vastly increased valve life and longer battery service without re-charging.

The whole construction is one of extreme rigidity and power, there being eight electrode supports. Only a 4-volt accumulator or three dry cells are required for the P.M.4 Master Valve.

Try one in your set to-night and note the wonderful purity of tone and volume you will obtain from your loudspeaker.

PRICE 22/6 each

A giant model of this wonderful P.M.4 Valve will be shown at Stand No. 10—All British Wireless Exhibition. September 12—23, 1925

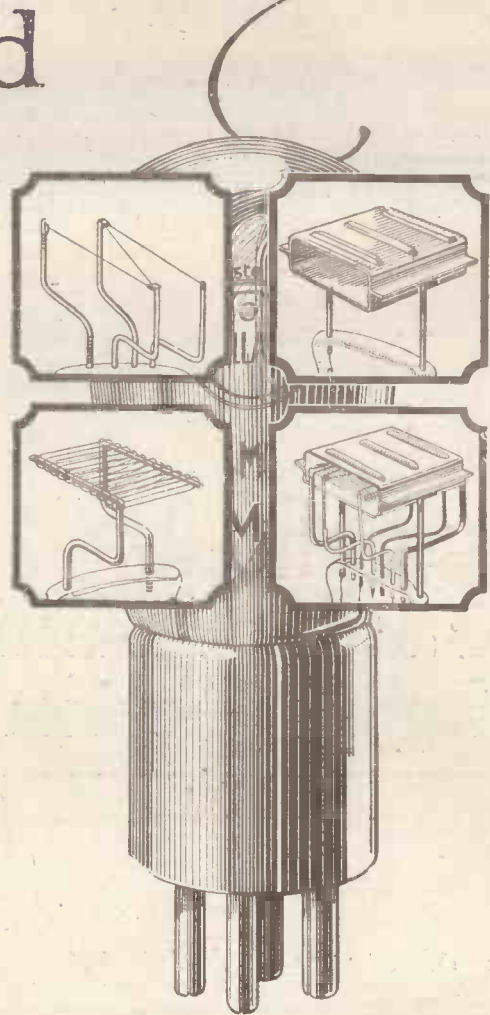

Mullard

THE MASTER VALVE



JUNIOR
de Luxe type
A.R. 114, £3:5

The Loud Speaker Supreme

Amplion Loud Speakers are world-famous for sensitivity, full volume, clear and natural tone. These superlative qualities are due to the many patented and, therefore, exclusive features incorporated in the design.

The World's Standard

AMPLION Wireless Loud Speaker

for Better Radio Reproduction

**RADIO EXHIBITION
ROYAL ALBERT HALL**

September 12-23, 1925.

The full range of AMPLION models—including NOVEL TYPES OF OUTSTANDING INTEREST—can be seen on **STAND 40** in the main hall or heard, under home conditions, at the AMPLION Suite, 3, de Vere Gardens—a few hundred yards away.

All AMPLION MODELS are obtainable from AMPLION STOCKISTS, Radio Dealers and Stores.

Patentees and Manufacturers—

ALFRED GRAHAM & CO. (E. A. GRAHAM),
St. Andrew's Works, Crofton Park,
LONDON, S.E.4.

Scottish Depôt: 101, St. Vincent Street, GLASGOW.

—of Special Interest to Visitors to the Exhibition

Any Wireless Set or Components (to the Value of £5 upwards) on view at the Exhibition may be purchased on

GAMAGES

POPULAR EASY PAYMENT SYSTEM

A small deposit secures immediate delivery of your requirements. Full particulars can be obtained at Stand No. 39, Main Hall, or from Messrs. Gamages Holborn Showrooms.

The Gamage "Remote" Control Switch

(for Valve Sets).

On view at the Wireless Exhibition for the **FIRST TIME**

Get one and you can **CONTROL YOUR SET FROM ANY ROOM IN THE HOUSE!**

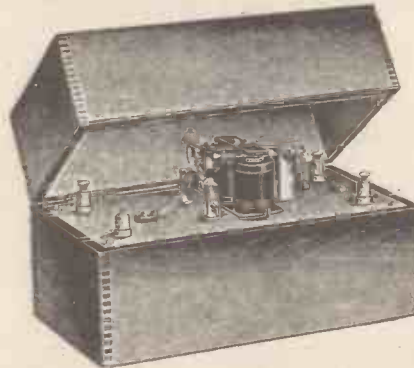

This switch is the very latest invention in accessories for the control of Wireless Sets. The object of the switch is to enable the owner of a valve set to switch it off or on from any point without having to go to the set. It is of considerable value to the owner of a wireless set operating a Loud Speaker which is being used in various rooms by means of

extensions already fitted. To switch the set on and off requires a journey to the actual instrument on each occasion. This, however, is not so when the Gamage "Remote" Control Switch is used. By fitting this unique device the set can be controlled from any room by means of a small switch and considerable saving of battery current is effected by switching off your set during items which do not interest you. The whole instrument is contained in a neat polished box, in the base of which is the control battery. The length of lead in the Low Tension supply of the Receiving Set is not increased or affected, and the switch can be fitted without affecting the operation of the set in any way. Terminals are fitted for all connections.

27/6

Gamage Super One Valve Receiver

The finest value ever offered in Wireless Sets. Covers all Broadcasting Stations, including Daventry without loading coils, whilst its operation is simplicity itself. Beautifully made and finished throughout—every part guaranteed to give every satisfaction. Cabinet only

£4 4s.

Complete with all Accessories, ready for use. Price **£7 8s.**

Write for Leaflet for full details of Wireless Sets and all your requirements.



Hundreds of Testimonials

entirely unsolicited, have been received in praise of

PERMANITE

The World's Best Crystal.

Originals may be seen at any time. Let us know what your experience is with PERMANITE. Extract from TESTIMONIAL.

LOUD SPEAKER ON CRYSTAL SET.

Dear Sir,—I am still using the piece of Permanite I purchased 18 months ago, and it has been exposed to dust, etc., the whole of the time and in use every day.

Besides receiving the local station, 2 Z Y, I am able to listen to the Liverpool Sln. (Relay), which is 35 miles away; Daventry, 95 miles; and occasionally Birmingham and Bournemouth, on a straight Crystal Set. With the aid of two L.F. Amplifiers I have received Glasgow, Newcastle, Cardiff, and Sheffield (Relay), and with Crystal Set alone a large loud speaker can be heard distinctly 4 yards away.

I have tried many crystals, but none are equal in efficiency to "Permanite." There is a Lancashire word which I think is suitable for expressing its efficiency—a "gradely" Crystal.

Yours faithfully, C. E. B.
Manchester, 10th August, 1925.

Complete with Silver Cat's 1/- Extra large piece, 1/6
whisker in Box. Price easily broken. Price 1/6



—STAND No. 39—
GAMAGES, HOLBORN, LONDON, E.C.1
City Branch:—Benetfinks, Cheapside, E.C.2

We are pleased to publish an article by a leading South African Amateur describing the progress of broadcasting and amateur wireless in 'a great British Colony. The photograph used in the head is one of Durban's magnificent Town Hall.

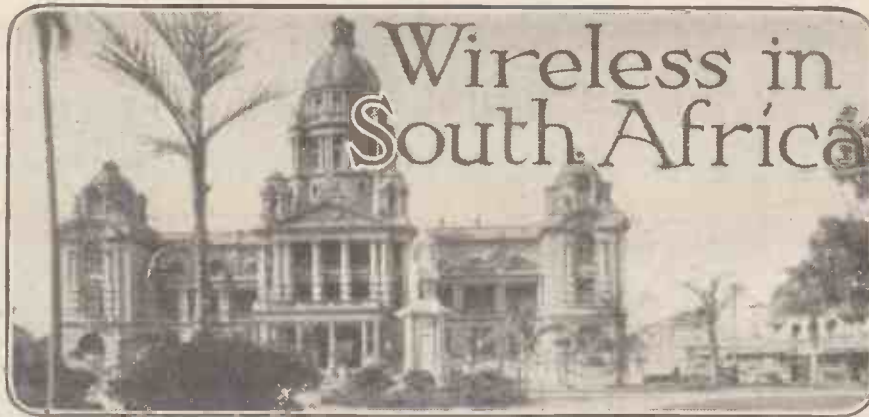

This article has been specially written for "Popular Wireless" by Mr. A. C. Davidson, who lives in Natal, South Africa, and has been closely associated with the progress of wireless in the Union. His account of wireless there will interest all "P.W." readers.

LONG before the late war we in South Africa had our bunch of wireless enthusiasts, and the writer claims the honour of being numbered amongst that bunch who worked with coherer, and later with the crystal, when one was looked upon as a wizard so long as one dabbled in wireless.

But after the war many more joined our ranks, and the first telephony actually transmitted from Durban was by N9A, the experimental station belonging to the Radio Society of Natal, and these transmissions took place just a little over a year ago.

The Birth of Broadcasting.

Things at this time were just beginning to look up, and one or two firms were beginning to import wireless components. It being only natural we had to follow the lead of Johannesburg, where 20B (now A3Y), and Cape Town A1A (now A4Z) amateur stations had for some time been working on telephony, doing good work and spreading the gospel of wireless in their respective areas.

There were, of course, others, but consulting my log the two stations mentioned were credited with the long distance honours before the present JB station was working. A1A, a distance of approximately 800 miles from my station, being picked up clearly on I-V-1.

On several occasions the output of A1A was, I believe, 50 watts.

Just a little over a year ago the Railways and Harbours Institute in Johannesburg were responsible for the first broadcasting under modern conditions with a Western Electric 500 watts set. Their purpose was to raise funds for the Wembley Exhibition, as there was no idea of that institute purchasing the plant. It says much for the enterprise of the Western Electric officials of this country in importing the plant. However, after a few broadcast pro-

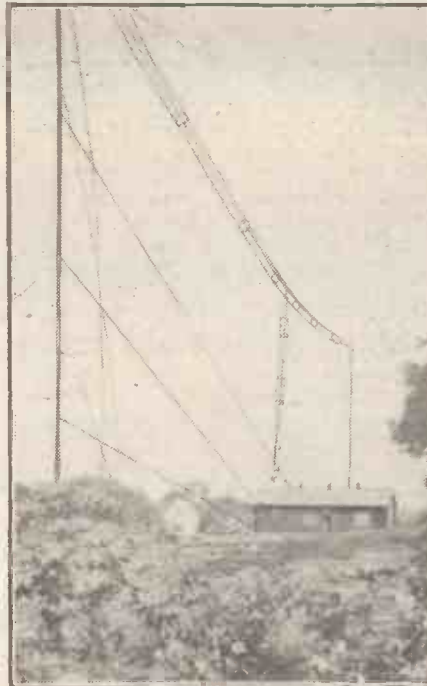

The transmitting station at the Ridge, Durban.

grammes the set was dismantled; but the enthusiasts' appetites were whetted, and the

silence of that efficient set left an empty feeling amongst the now large number of enthusiasts in South Africa. For those programmes were heard distinctly throughout the length and breadth of this large country.

Eventually the Technical and Scientific Society of South Africa took over the plant, with the call-sign of JB, and a wave-length of 438 metres. This was the first official broadcasting station in South Africa. JB has maintained its reputation up to the present day for its quality of transmission and programmes, and can claim the honour, through its enterprise, of making it possible for two other stations to start operations. Cape Town "called" some months after through the public spirit shown by Sir David Graaf in obtaining plant (Marconi 1½ kilowatt) and license, first offering it to the Cape Town Municipality, which offer was refused, and later offering it to the Cape Town Publicity Association, who accepted gratefully. The correct wave-length is 332 metres, and the call-sign "Cape Town Calling."

The New Durban Station.

Just over seven months ago there was erected in Durban, on what is called the Ridge, a Marconi 1½ kilowatt station. Its position overlooks the whole town and extensive harbour, and looking inland as far as the eye can see the evergreen valleys and beautiful hills meet the view of the observer. There is no screening whatever; the position of the transmitting station must be the envy of all radio engineers who see it. The studio is in the centre of the town on the top floor of the municipal offices, or town hall, being connected by a land-line of about two miles.

Shortly after the opening of the Durban station it met with tremendous criticism.

Our programmes have been heard on several occasions by amateurs in Australia, they having

(Continued on page 104.)



A view of the interior of the studio, which is draped in much the same way as those at the B.E.C. stations.

WIRELESS IN SOUTH AFRICA.

(Continued from page 103.)

submitted for confirmation complete "logs," and when winter again sets in in England we expect to hear of amateurs reporting reception. Remember we are two hours ahead of G.M.T.

Bournemouth is constantly received in Durban, while 5 X X has never been reported. The broadcasting fees in this country are £2 5s. per year—the 5s. going to the P.M.G.—which comes rather heavy. Up to the time of writing only 1,500 have paid their licences, and this number includes Grahamstown area, so it will be seen that Durban station has been working against great odds, by far the greater number of listeners-in in Durban's area being out-and-out pirates.

Licences on the Instalment System.

Recently the reaction restrictions have been removed, and an instalment system for paying fees brought into vogue, which it is hoped will induce the thousands of pirates to become legal listeners-in, before the P.M.G. and broadcasters make an example of a number. Another drawback which we have to contend with are the terrible atmospheric nine months out of the year, which (unless you are within reasonable distance of the transmitter) makes listening to our stations anything but a pleasant pastime, unless one happens to be an enthusiast of the first calibre.

A Broadcasting Advisory Committee now assists the Durban station, the officials and this body working hand in hand for the benefit of Durban's station and the listeners-in. We have a military band and a municipal orchestra second to none, under the direction of Mr. Lyell-Taylor, late of Brighton, whose performances are broadcast on certain days. Truly Durban has a station that must soon hold its own amongst the stations of the world.

Thanks to the untiring and unselfish



The valve panels in the transmitting room at the Durban station.

efforts of Mr. R. Coombs, of Johannesburg, on behalf of the South African wireless experimenters, he has succeeded in placing before us in concrete form the South African Radio Relay League. Through the lack of reliable information the activities of the South African amateur transmitters have occupied little or no space in English publications, yet members of the above league have some outstanding exploits to their credit.

Short-Wave Work.

POPULAR WIRELESS, through its enterprise and large circulation in this country, has arranged for a correspondent on the spot, who will supply readers at regular intervals with first hand accurate information of wireless activities in this part of the Empire. This article is really an introduction to Radio in our country.

We intend to have South Africa amongst the front places of DX. and experimental honours. Two-way communication has been established between A 4 Z, J. S. Streeter, Cape Town, and the Argentine on many occasions. Other members of the league are

receiving reports from all over the world of their reception.

As we have now many stations working below 100 metres, English amateurs should listen-in for us after 10.30 p.m. or 8.30 G.M.T. Our call-signs are from A 3 A to A 3 Z, A 4 A to A 4 Z, and A 5 A to A 5 Z. K D K A has been successfully relayed from J B with the assistance of amateurs. K F K X has been picked up by several here, although so far I have noticed no reference to this station in English wireless journals.

The favourite circuits for the low-wave stations appear to be D. and L.F. With this type of circuit K D K A is picked up here, so that he is perfectly audible any morning (evening in America) whenever he is "on the air." Our conditions, if it were not for awful atmospheric, would be perfect for reception, and this can be borne out by the fact that it is a nightly occurrence to pick up telephony from the broadcasting stations 800 miles away on a simple crystal set. It has been proved beyond any possible doubt that re-radiation does not enter the question.

There is something in our atmosphere that places it out of the ordinary for reception. We certainly expect good loud-speaker results from any of the stations, and from any point in South Africa, with a good four-valve set 1-V-2, and we get it.

And look at the size of our country—473,096 square miles—exceeding the united areas of France, Germany, Switzerland and Portugal. Of the activities of our more prominent amateurs and the Radio Relay League more will be said at a later date.

The "P.W." Technical Assistance Department.

No other wireless journal offers the amateur in trouble with his set such opportunities for obtaining help and advice as "P.W." All types of sets are tested; we do not refuse to test sets other than those described in "P.W." Turn to the Radiatorial pages for full details of the "P.W." Technical Assistance Department.

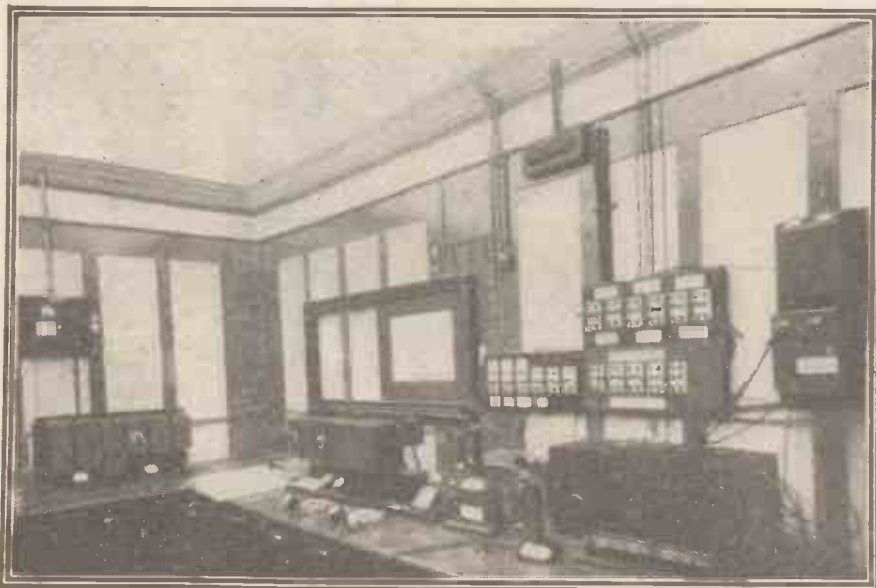

The control and modulating room at Durban, South Africa's latest broadcasting station.

AERIALS & AERIAL EQUIPMENT

A Comprehensive Résumé of Important Facts about Aerials.
By J. ENGLISH.

SPRING and summer are times when the experimenter should overhaul his aerial and make good any defects due to the inclemencies of winter, and it is hoped that these brief notes, which are the outcome of the writer's own experience, will be of assistance both to the fully fledged amateur and to those who are about to commence the installation of radio apparatus.

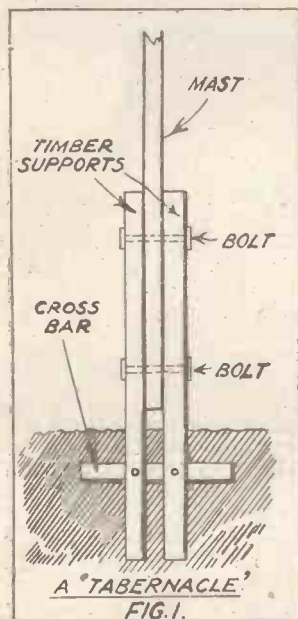

any future time if necessary.

Where there is not much room behind the mast for stay wires, the scheme of Fig. 2 has much to commend it, especially if a high mast is to be erected. The method of splicing is shown in Fig. 3, while the back strut is a 5-foot length of "barrel" or gas piping screwed to the back of the mast, and a length of galvanised wire rope running from the top through the end of the back strut to the base of the mast will keep the latter taut and rigid under all conditions.

Erecting the Aerial.

If the down lead is to be brought in somewhere below a convenient chimney-stack, a pole should be erected on the latter, if possible, and the scheme of Fig. 4 has been used with success, the mast in this case being a 15-foot length of channel or "U"-shaped iron.

Of the several types of aerial perhaps the inverted L and the T shapes are the most

suitable for amateur requirements, as it is nearly always possible to erect one of these types whatever the conditions of space, etc., may be, and, while it would be out of place here to enlarge upon the points to be observed in designing and erecting an aerial, the amateur will not go far wrong if he erects it as high as possible, well away from trees and walls, and takes care that the lead-in comes down as far as possible away from the nearest wall, guttering, or rain pipes.

A Method of Suspension.

As regards the suspension and insulation of the aerial wire, it is advisable to use plenty of insulators, unless the new self-cleaning "Winsulators" as shown in the illustrated head are employed, when two will be sufficient. All wire that is used for joining together insulators, or pulleys, to mastheads, etc., should be stout, galvanised iron wire which weathers well. Avoid, if possible, twisting together wires of different metals, as the chemical action set up by wet and smoke will quickly eat through the splicing. Also, ordinary iron attachments, such as hooks, rings, etc., should be avoided, as unless $\frac{1}{4}$ in. thick they will rust through in a year and the aerial wire will come tumbling down.

For halliards, the best material to use is undoubtedly some form of stranded steel wire covered with an insulating coating, such as that known as "Electron" wire, which is quite flexible and very strong.

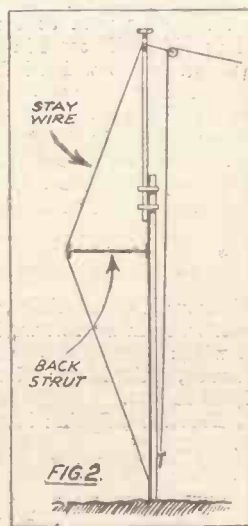

Sufficient should be purchased to make an endless or double halliard, so that if the aerial insulators break off the halliard will not run through the pulley.

A method of suspending the down-lead end of a single-wire aerial of the inverted L type is shown in Fig. 5. This provides effective insulation, avoids bends and corners in the aerial wire itself, and brings the lead-

in well away from nearby walls. The length of wire separating the bridle insulator and main insulators depends upon the distance at which the lead-in is to be brought down

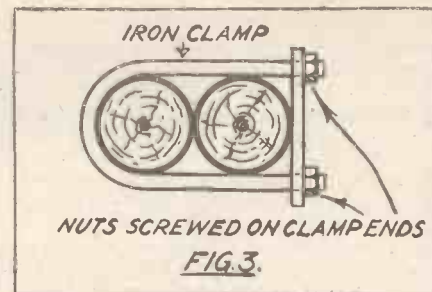

from the wall of the house. Usually this wire will be about 10 feet long.

Down-lead Considerations.

If a double aerial is to be erected the same scheme may be followed, placing the stretchers in the position depicted in Fig. 6. Three or more wires can be erected on this system, each wire being provided with a separate bridle and insulator, while when conditions permit one to erect a T-shaped aerial, the same method in a simplified form can be applied to the point where the lead-in is taken down, as shown in Fig. 7. Both arms of the T, which must be of equal length, are separate, unbroken wires, thus avoiding soldered joints at the branch of the

(Continued on page 106.)

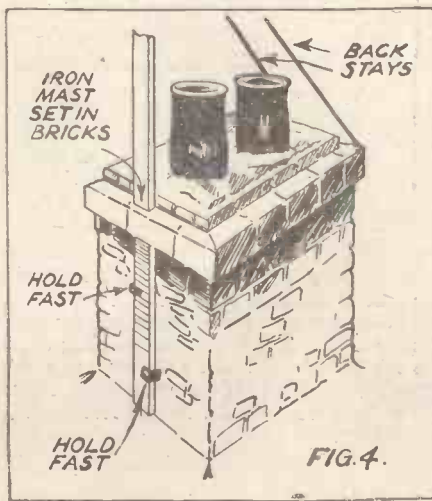

AERIALS AND AERIAL EQUIPMENT.

(Continued from page 105).

lead-in, which is now a double wire having a resistance less than that of a single wire.

Earthing Switch Advisable.

The aerial wire should run in an unbroken length from the extreme end right into the

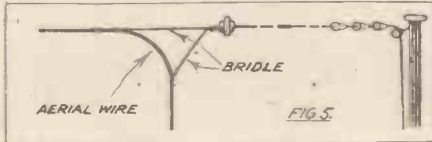

aerial terminal of the receiver, thus avoiding all soldered joints and other contacts in the path of the H.F. currents, as these joints become sources of loss in course of time. The lead-in insulator should be situated as nearly as possible directly under the down lead, and the aerial wire should be taken straight through the centre of the insulator, then, by the shortest path, to the aerial terminal of the set. A scheme for mounting such an insulator is depicted in Fig. 8.

A piece of rubber tubing placed on the wire where it enters the insulator will prevent it being chafed through when swaying in windy weather. A lightning arrester or earthing switch should always be fitted and provided with a separate earthing point, outside the building for preference, so that the path from aerial to earth is straight, vertically.

Obtaining an Efficient Earth.

In conclusion a few notes are added regarding the earth lead. This should be of heavy gauge wire and as short as possible,

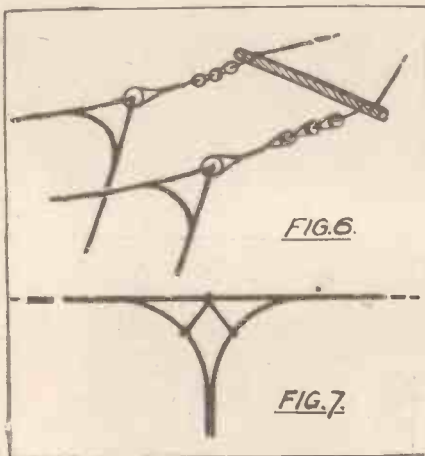

while in many cases the most convenient point of earthing is the nearest water main. If the distance to this is greater than 6 feet, it is better to use another earthing device, such as a buried zinc plate or an earthing spike, provided, of course, that the latter can be grounded less than 6 feet from the receiver.

A convenient form of earth spike is a

four- or five-foot length of gas-piping one inch or more in diameter, with a few holes bored at intervals in its length. The earth lead is soldered to one end and the pipe driven into the ground. During dry weather water poured down the pipe will percolate through the holes and moisten the surrounding soil.

There is no doubt that, if the experimenter carefully erects his aerial with reliable materials following the lines indicated above, it should remain sound and efficient for several years with but an occasional overhaul.

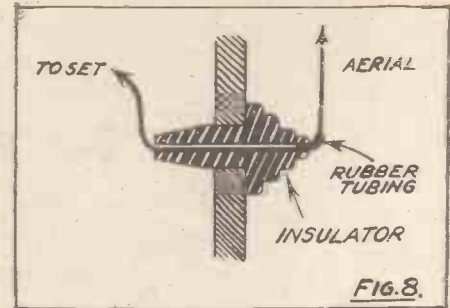

FOREIGN NEWS.

From OUR OWN CORRESPONDENTS.

Lisbon.

A day or two after the last of the periodical attempts at revolution in Portugal, the police visited each of the five Portuguese private stations, and informed them that amateur transmission would be forbidden in future, "as in times of revolution false news by this means might be sent abroad."

The amateur, whose call number is P I A C, solemnly loaded his entire apparatus on a mock funeral carriage, and, followed by his colleagues and friends as "mourners," conveyed it to a shop selling wireless apparatus on one of the main streets of Lisbon. In the shop window a mock funeral chapel was erected. There, on a black-draped bier, lay all that remained of P I A C, with wreaths and burning candles. Following the continental custom of sending out heavily black-bordered death notices to friends, letters were printed and sent out, earning a whole crop of replies expressing condolences and heartfelt sympathy in this severe bereavement.

* * *

Paris.

Professor Lakowsky, who is well known for his therapeutic work with short wave-lengths similar to those utilised in radio work, attached to the famous Salpetriere hospital in Paris, was conducting some experiments with short wave-lengths in his own private laboratory with his wireless set, in order to study some point of resemblance between these and the ones used at the Salpetriere, when he accidentally came into contact with the current cables which had a tension of 1,200 volts. The parts affected were the back and the arms; these latter were on examination found to be temporarily paralysed. Professor Lakowsky, who received immediate treatment, will recover the use of his arms in a few months, it is expected.

* * *

Paris.

Among changes in wave-lengths intimated by prominent stations within the last week or two are the following:

Koenigswusterhausen, Germany: New uniform length, 1,300 metres.

Radio-Catalana, Barcelona, Spain: New length, 460 metres.

Dortmund, Germany: New length, 265 metres.

Cointrin, Geneva: Experimental length, 1,100 metres.

Schenectady, U.S.A.: New lengths, 1,660 metres, 380 metres, 109 metres and 38 metres.

Nottingham, England: New length, 325 metres.

* * *

Geneva.

Three new stations are being opened in Switzerland, at Bale, Geneva, and Berne. The Bale one, about which no details are forthcoming yet, will not come into operation till October at the earliest.

The new Geneva station has already entered upon the experimental transmission stage, on a 1,100 metres wave-length, daily from 8.15 p.m. The station will be called Cointrin-Geneve, and has been built by the Marconi people. The musical studio in connection with it is in the Hotel Metro-pole in Geneva itself.

Marconi's are also responsible for the construction of the new Berne station, which will be opened in November. The enterprise is a joint affair between the Federal Government, the city of Berne and the Kursaal company, and the board of directors was elected on August 15th. The federal contribution to the capital of the concern is 150,000 Swiss francs.

The station will be modelled on that of Rome, the studio will be in the Schanzli Kursaal, and the sending station at Minchenbuchsee, where the Marconi people already have a post of their own for telegram transmission.

* * *

Madrid.

The new station at San Sebastian will shortly begin broadcasting, the test having given excellent results on wave-lengths varying between 390 and 425 metres. The actual wave-length to be used has not yet been definitely decided on, but will be somewhere between the two figures indicated.

The power used is 500 watts and the call number E A J 8, while the official designation of the post will be Radio-Saint-Sebastian.

* * *

Madrid.

The recently opened new Madrid station is trying an experiment in late broadcasting of concert programmes. These will start at 11 p.m. and go on till 1 a.m. daily.

(Continued on page 137.)



Our Business.

Because we value our reputation, and because we take a genuine pride in our manufactures apart from their function as profit-makers, we are always exerting ourselves to the utmost to maintain the high standard that it has always been our aim to achieve. For this reason, therefore, the two words—"Specify Dubilier"—are buttressed by all the moral weight and all the material resources of the world's largest Condenser Manufacturing Firm. A Dubilier Guarantee is a genuine guarantee, and a Dubilier Product is the best of its kind.

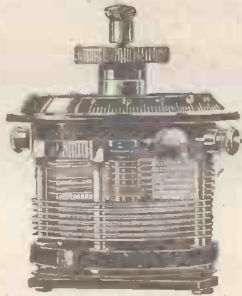

The Double Vanicon.

A Dubilier Variable Condenser giving simultaneous control of two tuned anode circuits. This is a very useful condenser to the experimenter. Capacity of each side 0.00025 mfd. complete with balancing plate

Price 25/6



The Ducon.

An aerial adaptor made by Dubilier, it is inserted in an electric lamp socket and connected to your set, thus converting your wiring system into an aerial and doing away with outside aerials.

Price 10/-



The Dubrescon.

A new Dubilier device that protects valves from being burnt out by insertion in the holder the wrong way round. Connected in an H.T. lead it is a permanent protection, and is not a fuse.

Price 6/-



The Minicap.

A Dubilier Anti-Capacity Switch for use in all types of receiving circuits for switching in and out Valves, Transformers, Series-parallel switching, etc. Soundly made and thoroughly reliable, it is strongly recommended.

Price 8/-



Anode Resistances and Grid Leaks.

These Dubilier resistances are very carefully made and graded; they can be relied upon to maintain their values indefinitely and are tested on 200 volts D.C. and 100 volts D.C. respectively.

N.B.—They must not be tested at higher voltages.

Anode Resistances, 20,000—100,000 ohms.

Complete with holder 5/6
Grid Leaks 0.5—5 megohms 2/6



Type 577 Mica Condensers.

A very good quality condenser for use everywhere in wireless receiving sets. This condenser is supplied in a polished metal case, and is provided with tags for soldering. It can also be supplied with flexible wire leads if required. All capacities from 0.0001 mfd. to 0.01 mfd.

Price 7/6

The Dubilier Condenser Company (1925) Ltd., manufactures:—

Fixed Mica Condensers—Types 577, 600, 600a, 610 and 620.

Vanicon Variable Condensers—the Vanicon, the Double Vanicon, the Duwatcon and the Vanicon Square Law.

Anode Resistances and Grid Leaks, the Ducon, the Minicap Switch, the Mansbridge Variometer and the Dubrescon.

Specify Dubilier

We are exhibiting at the N.A.R.M.A.T. Wireless Exhibition, Royal Albert Hall, Sept. 12th-23rd.

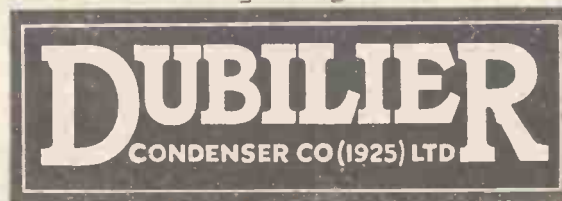

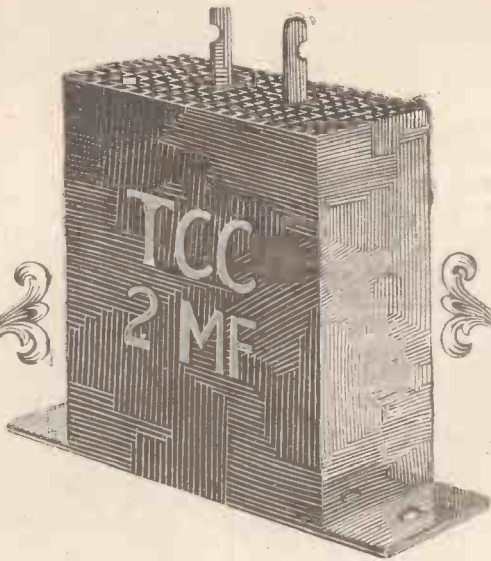

1905—1925

FOR more than twenty years T.C.C. Mansbridge Condensers have been the standard fixed condensers for all electrical requirements. First in telegraphy—afterwards in wireless telegraphy—now in Broadcast reception, their dependability and accuracy have always earned unstinted praise.

Among all your wireless friends you will never have known one who has ever been disappointed with a T.C.C. Mansbridge Condenser. And, after all, this feeling of supreme confidence is a great thing. It means that you can accept a T.C.C. Mansbridge Condenser, place it in the circuit, and know that its capacity is exactly as marked and that it cannot possibly short circuit. The most frequent and rigorous tests that can be devised safeguard both of these points for you.

But not all green condensers are T.C.C., and not all condensers produced to imitate the T.C.C. are of the genuine Mansbridge pattern. In fact, very few of them are. But you are always safe if you see the letters T.C.C. stamped on the side of the case.

T.C.C. Mansbridge Condensers

·0001 to ·004 mfd. T.C.C. Mica.
·005 to 2 mfd. T.C.C. Mansbridge.

Telegraph Condenser Co. Ltd.
Mortlake Road, Kew



No. 1

Fifty Years Ago Old-Fashioned Virtues!

THE firm of Ericsson was established in a generation when Inverness capes and broadcloth coats were built to last a lifetime, and the unassuming carpet-bag had not yet given place to the unsubstantial glories of imitation leather. And throughout fifty years, Ericsson's have exercised the old-fashioned virtues of honesty, accuracy and hard work.

First-quality material, painstaking craftsmanship and long practical experience in the problems of telephony have made Ericsson Headphones what they are—unrivalled for volume and uniform purity of tone, as for length of service.

All Resistances **22/6**
(There are three—120, 2000, 4000)

Though we have reduced our prices
the quality remains supreme.

THE
BRITISH ERICSSON
Mfg Co., Ltd.

65-73, KINGSWAY,
LONDON,
W.C.2.

Ericsson
(BRITISH)
Telephones



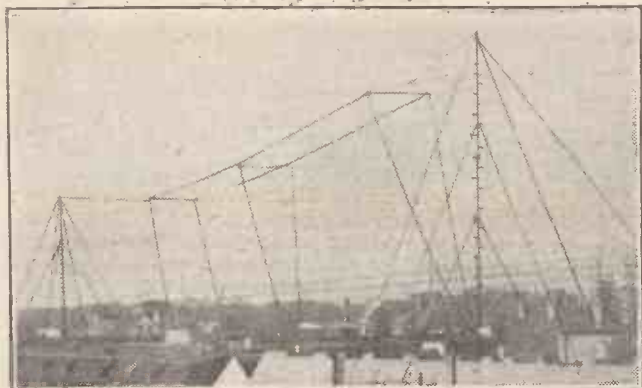

The aerial system of one of Berlin's latest broadcasting stations, Welle, which works on 430 metres.

THERE are few wireless troubles which are so exasperating, and possibly so difficult to trace, as *silence in the headphones*. If we are troubled by harsh noises, we have a clue to the defect, and can search for bad contacts, broken leads, etc.; howling will at once suggest some cause for self-oscillation, and so forth. But silence suggests little, and might mean anything.

It is possible, however, to make simple tests by which the cause of silence in the headphones can be run to earth.

series, in which case a single pair would need to be connected to the two outer terminals, and not to two adjacent ones.

Having carefully checked all external wiring, we should then disconnect the positive high-tension battery lead, and scrape it gently against its terminal, with the valves turned off, when a slight grating noise should be heard in the 'phones. If no sound is heard, there is the probability of a fault either in the headphones or the high-tension battery. The former may be tested by touching the leads on to the low-

to look at the wiring, for a little tug will often reveal a fault which would otherwise pass undetected. For instance, when a wire has been soldered on to a valve leg or terminal screw, the "joint" may consist of a little cap of solder lying idly on the brass, which has not been properly tinned.

There are many points in a receiving circuit at which a broken lead or a disconnection will only reduce the quality or strength of the signals without producing silence. In Fig. 1, however, those points at which a break in the wiring would prevent any sound from reaching the headphones are indicated by arrows.

Faulty Components.

If the fault still remains undiscovered, it will be necessary to examine the components of the set, but first we should endeavour to find out whether the fault lies in the high-frequency or the low-frequency portion of the circuit. In cases where a switch is fitted to provide for the use of, say, two, three or four valves, it is a simple matter to discover at what point the circuit ceases to operate, but if no such switch is provided we should work through from the detector to the last valve, and find out just where signals cease.

Firstly, the 'phones should be joined between the plate of the detector and the positive high-tension terminal—i.e. they

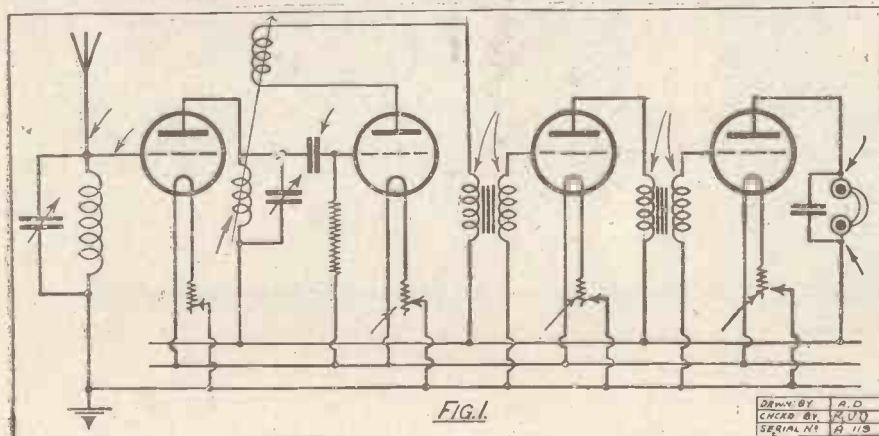

Let us suppose that we own a 4-valve set, employing tuned-anode high-frequency coupling, and two transformer-coupled note magnifiers, the circuit diagram being as shown in Fig. 1, this being selected as it is, perhaps, the most popular multi-valve circuit in general use among amateurs. We have connected it up for the first time, but nothing can be heard.

Examine the Connections.

We should first of all make sure that all the external connections are correct. For instance, the aerial-earthing switch may easily be incorrectly wired, but it should be noted that neither an exchange of aerial and earth leads, nor a reversal of the low-tension connections, would cause the trouble. On the other hand, a reversal of the high-tension battery leads would effectively prevent any output from the receiver, as would also an incorrect coupling of the units composing the battery.

It might happen that four telephone terminals were provided, the two centre ones being strapped together to allow of the use of two pairs of 'phones connected in

tension terminals, and the latter by lightly brushing the high-tension leads together, when there should be a vicious little spark.

If, however, a sound is heard when the high-tension lead is scraped on to its terminal, the process should be repeated with the valves lit, when the noise should become uncomfortably loud. If this is not the case, and the results are the same as before, the indication is that the last valve is not operating. This may be due to a fault in the valve itself, which can be checked by the substitution of another valve, or to a break in the lead joining the telephone terminal to the valve leg.

Another possibility is a short circuit in the telephone condenser.

The Internal Wiring.

If these tests reveal no fault, all external tuners or plug-in coils should be examined for broken connections or open circuits, the flexible leads to a moving reaction coil calling for special attention.

The next step will be to examine the internal wiring of the set for broken wires or faulty joints. It is not sufficient merely

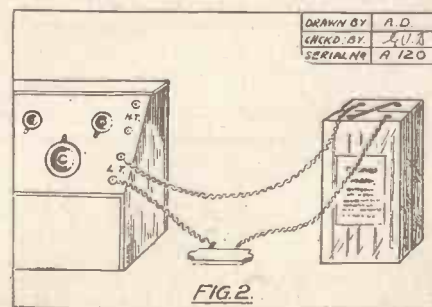

should be connected so as to replace the primary winding of the first intervalve transformer.

If no signals can be tuned in, the fault may lie in either of the first two valves, in the intervalve coupling, or in the aerial tuning system. There may be a break in the winding of the anode or reaction coil, or a short circuit in the aerial or anode tuning condenser. The latter trouble, however, would almost certainly have given rise to

(Continued on page 110.)

"SILENCE."

THE MOST EXASPERATING TROUBLE IN YOUR SET.

By C. E. FIELD, B.Sc.

(Staff Consultant, "Popular Wireless.")

Here is an article which will come home to most amateurs. Dead silence in the 'phones—it suggests so little and yet means so much!

WIRELESS IN NEW ZEALAND.

WHAT THE AMATEURS ARE DOING.

From Our Own Correspondent.

WHEN 2 O D came back right away recently in answer to a daylight call from station 4 A G, Mr. R. Slade, of station 4 A G, Dunedin, N.Z., smiled a smile of satisfaction. Australian 2 C M, Mr. C. D. Maclurgan, of Sydney, had been heard conducting heart-to-heart talks with 2 O D for some time past; but 4 A G had not heard 2 O D responding.

At the first call 2 O D answered, and an official message of welcome and congratulations from the Radio Society of Great Britain to the "New Zealand Radio Society" on the first daylight transmission on 20 metres was flashed across. (There are seven radio societies in New Zealand, but no "Radio Society of New Zealand.") Signals were of remarkable strength at 4 A G, Mr. Slade giving their strength as 5-6, maximum being 10, on a 1 X A M receiver, using detector only.

Aerial Carries Away.

The next day communication was again established about five o'clock in the afternoon, and continued for nearly an hour.

On the next afternoon the writer went along and picked up 2 O D about 4.40. There was a gusty wind blowing past 4 A G, and signals, though loud, were unsteady. Mr. Simmonds complained that conditions were stormy at his end also. The signal strength was about 4-5. Things were just going nicely when the aerial at 4 A G carried away.

Mr. Slade soon got to work transposing connections, however, and in less than five minutes a call was radiating from the counterpoise, which had temporarily been pressed into service as an aerial. The counterpoise consists of a wire, insulated at each end, about 50 feet long and about 15 feet from the ground. A spare counterpoise was used in place of the original.

Mr. Simmonds came back right away, but his signals were very unsteady, though still as loud as before. It was evident that he could read 4 A G, as he came back with long bursts of code; but he was unreadable through unsteadiness.

Reinartz Receiver.

Station 4 A G is using the four-coil Meissner circuit, everything being made as low-loss as possible. The station is by no means an elaborate affair, having mostly been constructed by the owner. The average input on 20 metres is about 100 watts. Then plate supply is obtained from two series transformers delivering 2,500 volts to the electrolytic rectifier, which puts about 2,000 volts on to the plate. No filter is used. The filament is lighted through a step-down transformer from the power supply—230 volts, 50-cycle A.C. The keying is done in the centre-tap of the transformer.

The aerial coils are made of $\frac{1}{4}$ -in. copper tubing, wound to a diameter of $5\frac{1}{2}$ in., the grid and plate coils being suspended inside them by the leads. The grid and plate coils are wound low-loss fashion to a

diameter of about $2\frac{3}{4}$ in. The four condensers used are ordinary .001 variable with the plates double-spaced to prevent flashing over; the spacing out of the plates gives each a maximum capacity of .00025 mfd.

The receiver is a copy of that in use at

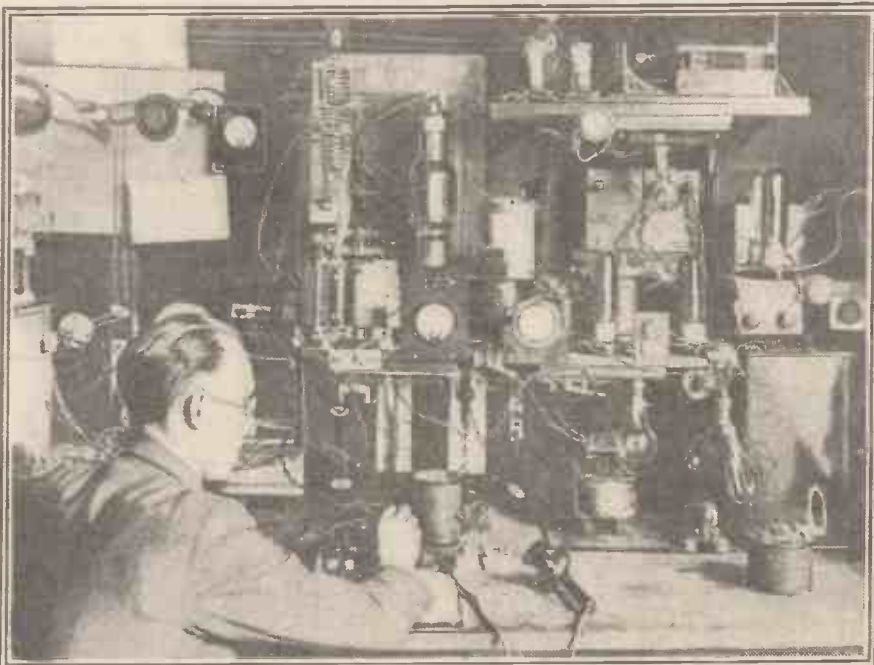

A well-known Australian amateur, Mr. Maclurgan, 2 C M of Sydney, who is mentioned in this article.

"SILENCE."

(Continued from page 109.)

scrapping noises rather than to absolute silence.

The grid condenser might be short-circuited, and should be tested by connecting it between a low-tension terminal and the corresponding battery lead, as shown in Fig. 2. If the condenser is short-circuited internally, the valves will light up as usual. Another possible, but by no means probable, cause of the trouble is a short-circuited grid leak. Very faint, or fading, signals should be received with the leak removed, if this is at fault.

Testing the Detector.

If, however, we can receive signals when the 'phones are connected in the detector plate circuit, as described above, the transformer should be re-connected, and the telephone tags held on to the secondary terminals, when an absence of sound will denote a faulty winding. The presence of signals, on the other hand, will show that

United States 1 X A M, owned and operated by Mr. John L. Reinartz. Detector valve only is used for all work.

Peculiar Insulators.

The aerial is (or was!) a single-wire effort about 50 ft. high, the over-all length being about 90 or 100 feet. Novel insulators are employed. These consist of slabs of thick plate glass about 2 ft. long by 4 in. wide, holes being made about 2 in. from each end to take the aerial and the halyard. These have been in use for several weeks now, and despite being coated with frost appear to give very good insulation.

Mr. Slade is keeping a look out for any other British "hams" on 20 metres.

there is an input to the first note magnifier, so that the next step is to ascertain whether there is any output from this valve, or any input to the last one, by testing the second transformer in the manner previously described.

The L.F. Transformer.

Should it be found that a transformer is faulty, it then remains to discover the faulty winding. Perhaps the safest method of carrying this out is to disconnect the primary winding from the high-tension battery, and connect the headphones in the circuit at that point, so that any current passing through the transformer primary must also pass through the 'phones. The presence of signals will then indicate a faulty secondary winding, while silence will denote a faulty primary.

When carrying out these tests, any condenser that may be joined in parallel with either transformer winding should be disconnected, for a short circuit in such a condenser might be the source of the trouble.

It is obviously impossible here to discuss all the possible causes of silence in any receiver, but the most common faults have been outlined, and the methods of tracing them are applicable to most of the receivers in general use.

The "P.W." 3 Valve Reflex



This Receiver has been built and tested in the "P. W." Laboratory. It is a set which "P. W." guarantees.

Designed and Described by
K. D. ROGERS

(Assistant Technical Editor, "Popular Wireless").

Constructional Work by
G. V. COLLE

(Technical Staff, "Popular Wireless").

It is doubtful whether any other type of set has enjoyed such popularity as the reflex or dual amplification receiver, and though this has been superseded to a large extent by the Neutrodyne and super-het. in America, it has still a great many faithful adherents in this country.

The reflex system of reception has many

two D.P.D.T. switches together with one or two extra components, a series of alternative circuits, either straight or reflex, have been provided. By manipulation of the switches alone the following combinations are possible, so that a set to meet practically every need is available at any moment: H.F. and Det., Dual and Detector, Detector

clearly explained by our Staff Consultant, Mr. C. E. Field, B.Sc., when he introduced the circuit to readers of POPULAR WIRELESS in our issue of July 18th, (No. 164), and it is with the constructional details and important points of operation that we must concern ourselves in this article.

In case of operation and neatness of



The complete receiver has an imposing appearance, as can be seen from the above photograph.

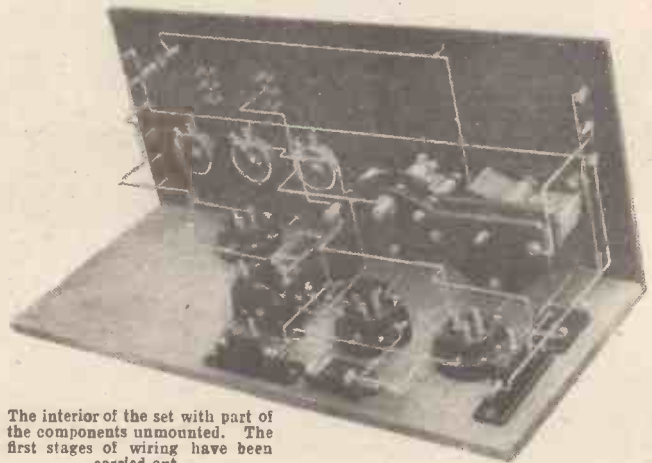

The interior of the set with part of the components unmounted. The first stages of wiring have been carried out.

points to recommend it, but unfortunately it is not a method that will give good results under all conditions, and it is in this respect that it comes just short of the "straight" circuit.

The latter will always give good results—if enough valves are used—and under all conditions it is a standard type, and can be thoroughly relied upon. But it is not always economical, and very often the same results can be obtained more cheaply by making one or more of the valves do double duty, i.e. by using a reflex arrangement.

Six Circuits Available.

Balancing these two facts together, the disadvantages of one against the other, and vice versa, we come to the obvious conclusion that the two circuits should be combined as nearly as possible in one receiver, so that either type of circuit may be employed to best suit the exigencies of the moment.

This is what has been done in the set described herewith, and a 3-valve straight circuit—H.F., Det. and L.F.—has been taken as the unfailing "standard," and then by the simple procedure of adding

alone, and either of these three plus a note magnifier (see figs. 1 and 2).

There is no need to discuss the theory of the receiver here, as this has been

appearance it is difficult to improve upon the American method of arranging a receiver, and so this type of construction has

(Continued on page 112.)

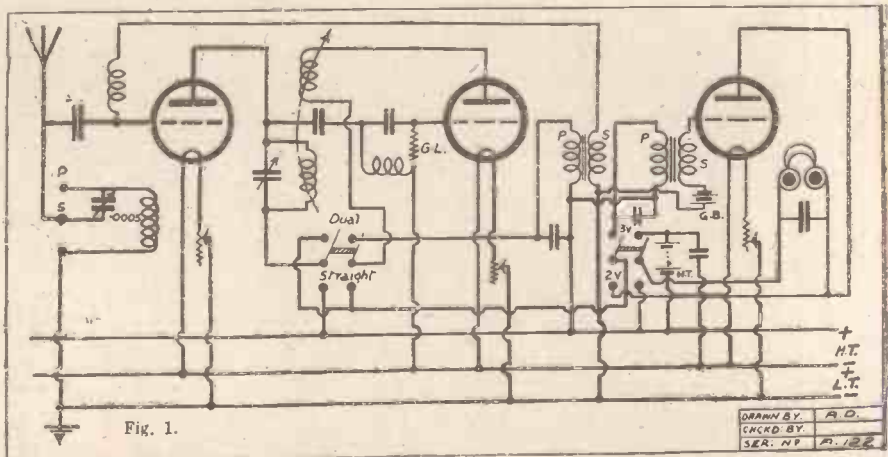

Fig. 1.

DRAWN BY A.D.
CHECKED BY
SER. NO. A. 122

THE "P.W." 3-VALVE REFLEX.

(Continued from page 111.)

been followed in the building of the 3-valve reflex set. The case is large enough to take a panel 18 in. by 8 in. (the smallest allowing anything like an efficient layout to be obtained,) while instead of the variometer shown in Fig. 1 of the theoretical description in our July 18th issue, a coil and condenser with series or parallel tuning has been adopted in order to give a greater range of wave-lengths, to ensure the set being capable of receiving 5 X X and other long-wave stations. All coils used are of the plug-in variety, so that any band of wave-lengths may be covered, down to about 150

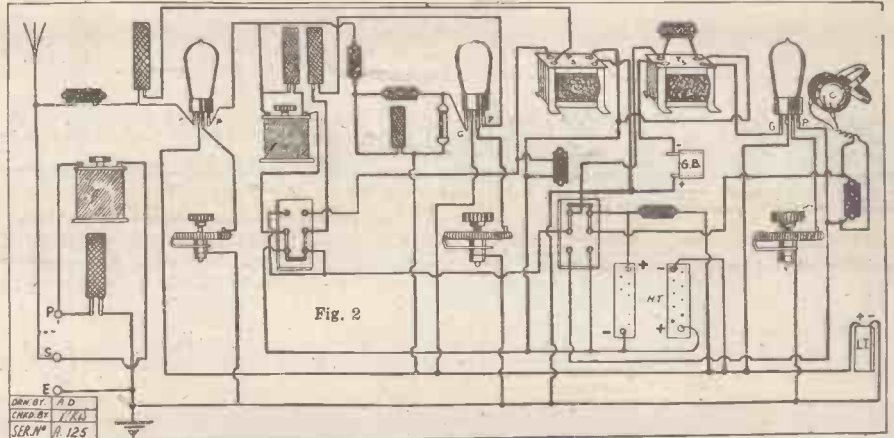

DRWN. BY A.D.
CHKD. BY P.R.B.
SER. NO. R. 125

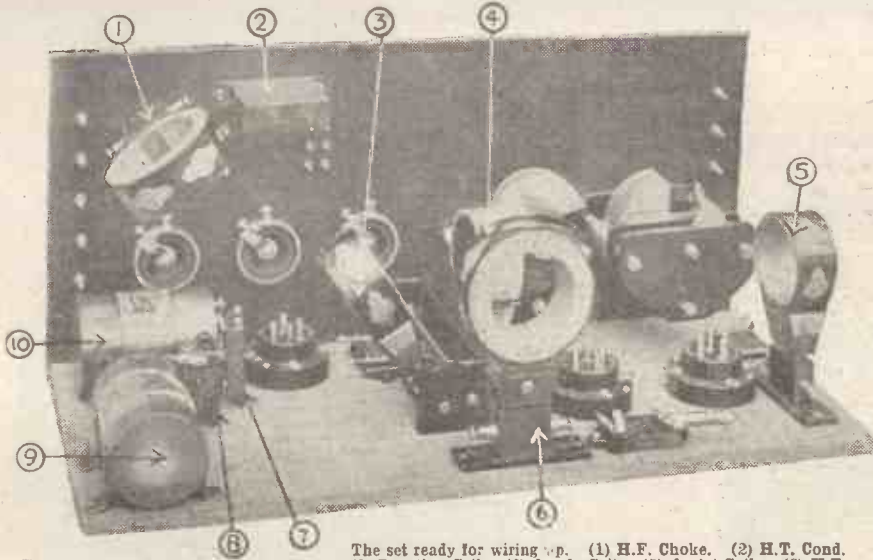

The set ready for wiring up. (1) H.F. Choke. (2) H.T. Cond. (3) Reaction Coil. (4) Anode Coil. (5) Aerial Coil. (6) H.F. Choke. (7 & 8) Fixed Condensers .002 mfd. (9) Eureka No. 2. (10) Eureka Grand.

metres. Below this it is not advisable to go, as H.F. losses would tend to make the set inefficient, while the reflex side of it might become rather unstable.

A Compact Receiver.

There is no need to keep absolutely to the list of components given on the next page as long as thoroughly reliable components are used, but constructors should note that if different apparatus is employed the layout will have to be altered, and the drilling measurements, etc., will no longer hold good. Wide divergence in size of components should be avoided at all cost, as if apparatus much larger is utilised the spacing will become cramped and results will suffer. The marking out and drilling of the panel will present no difficulties if the diagram given in Fig. 3 is studied carefully, while the baseboard layout is also an easy one to follow.

The arrangement of components on the latter is an extremely important detail, and has close bearing upon the final results obtained from the receiver.

(Continued on page 115.)

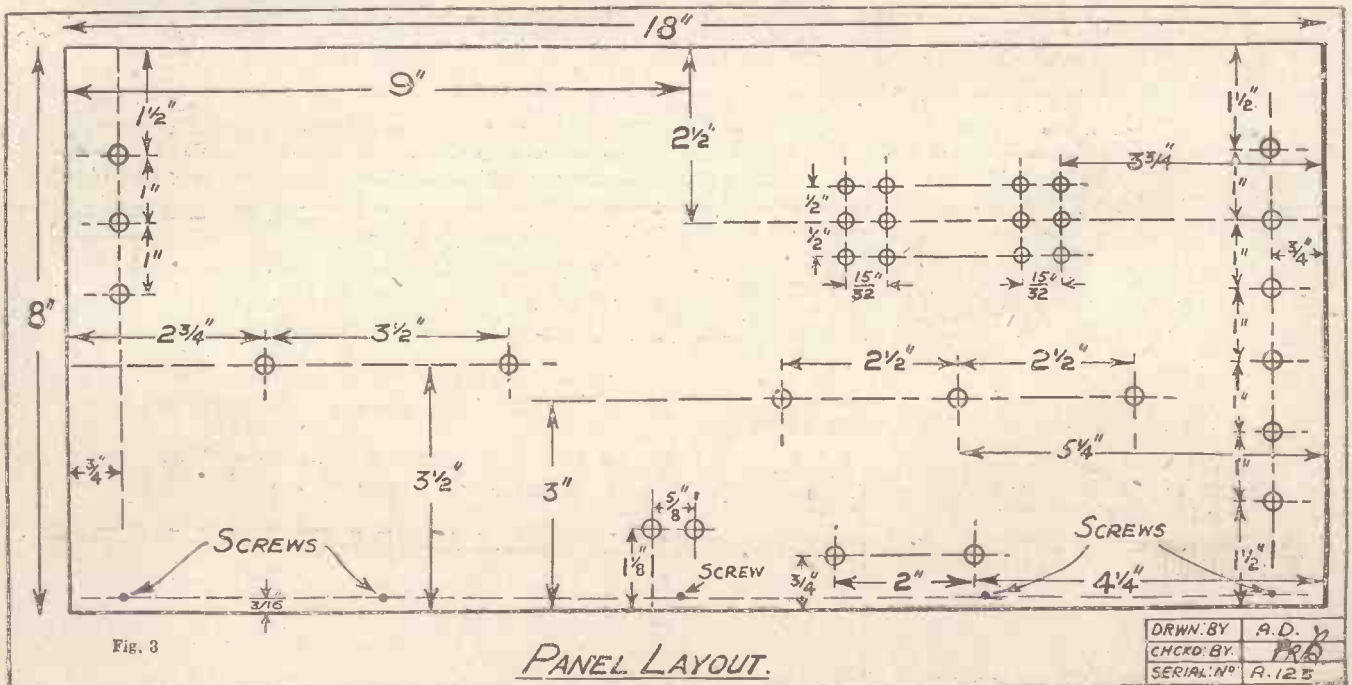

Fig. 3

PANEL LAYOUT.

DRWN. BY A.D.
CHKD. BY P.R.B.
SERIAL NO. R. 125

Highest attainment in wireless production

V A L V E S



THE improved "Wecovalve" has been fitted with a tape filament which enhances the life and performance of the valve. We can justly claim that it is the most robust dull emitter valve at present on the market.

In full operation the current used is so small that the filament glows in the dark at a dull red heat only. In daylight it would appear that the valve was not in use.

The "Wecovalve" is especially marked for service as follows, and to obtain the best results, valves should be selected for the function they are designed to perform.

- Red Spot. H.F. Amplifier.
- Orange Spot. L.F. Amplifier.
- Green Spot. Detector

Operating Characteristics:

- Filament current, 0.25 amps.
- Filament voltage, 0.8 to 1.1 volts.
- Detector Plate Voltage, 15 to 22 volts.
- Amplifier Plate Voltage, 22 to 60 volts.
- Amplification Factor, 5 to 6.5.

Ask for our Booklet No. W. 546 which gives full details of our new season's apparatus.



Western Electric Company Limited.
Connaught House, Aldwych, London, W.C.2:
 CENTRAL 7345 (9 lines.)

Works: N. Woolwich, New Southgate, Bexley Heath, Hendon.
 Branches: Birmingham, Leeds, Manchester, Newcastle, Glasgow,
 Cardiff, Southampton, Liverpool, Dublin

P.A. + Valve,
 for Power
 Amplification.

The valve with the tape filament

EFESCA

Regenerative

AERIAL TUNER



The Efesca Regenerative Aerial Tuner is the natural development of the extremely convenient series of Efesca One-Hole Fixing Tapped Coils. It is a specially designed form of Tapped

Aerial Coil incorporating Aerial Reaction in a self-contained unit. Reaction is effected by means of a rotor revolving in a separately wound section of the aerial coil thereby effecting maximum and uniform reaction over the whole wave band covered by the coil. Wavelength range 150 to 2,600 metres in conjunction with a .0005 Variable Condenser in parallel. Price complete with split switch, knob, pointer and scale, 32/- each.

Other components in the Efesca Series of One-hole Fixing Tapped Coils are the H.F. Transformer, and Anode Tuner (illustrated), Aerial Tuner, and H.F. Reactance Coil. Home Constructors can employ these units with every confidence, and will find that the task of assembling is greatly simplified and the completed set will have a finish that is unobtainable by the use of conventional components. Furthermore, no coils or external tuning accessories are required.

Efesca Components are sold by all Wireless Dealers and Electricians.

Send for Catalogue No. 559. Describing the whole range of



EFESCA

COMPONENTS

WHOLESALE ONLY

FALK STADELMANN & Co., Ltd.,
83/93, Farringdon Road, London, E.C.1

Also at Glasgow, Manchester and Birmingham.

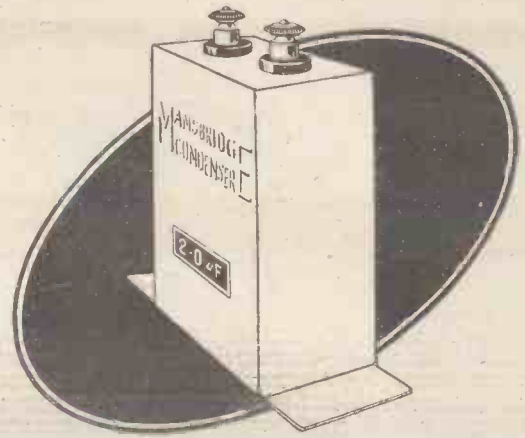

THE MANSBRIDGE CONDENSER

We have pleasure in announcing that the genuine Mansbridge Condenser originated and designed by G. F. Mansbridge, Esq., over 20 years ago, will now be manufactured by the Mansbridge Condenser Co., under the aegis of G. F. Mansbridge, Esq., himself, and marketed with the full backing of the Dubilier Condenser Co.

No condenser of the "Mansbridge Type" is a genuine Mansbridge product unless the words "Mansbridge Condenser" are plainly embossed on the metal case. The colour of the case is Maroon.

The capacity is plainly marked and is accurate to within fine limits, and nickel-plated screw terminals are provided for making connections. In your own interests you should see that when you require condensers of this type you

Specify Mansbridge.

PRICES AND CAPACITIES.

Capacity.	Prices.
0.05 mfd.	2s. 6d.
0.10 "	2s. 6d.
0.20 "	2s. 8d.
0.25 "	3s. 0d.
0.30 "	3s. 0d.
0.40 "	3s. 3d.
0.50 "	3s. 6d.
1.00 "	4s. 0d.
2.00 "	5s. 0d.

The Mansbridge Condenser can be seen at the Dubilier Condenser Co.'s Stands, Nos. 28 and 50, at the N.A.R.M.A.T. Exhibition, Royal Albert Hall, September 12th to 23rd

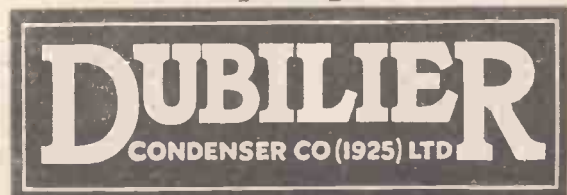

THE "P.W." 3-VALVE REFLEX.

(Continued from page 112.)

The measurements of the cabinet and panel have been cut down to as small as possible so that no waste space is available, and the method of mounting the components and wiring them up must be rigorously followed, or chaos in the latter will result and inter-action between the components and their connections will be inevitable.

There is often no harm in crowding a

receiver if it is carried out with due regard to the type of components employed and the likely results are kept well before the notice of the constructor; it is when "unorganised" bunching is indulged in that trouble occurs, and it is surprising what a large number of receivers come to our notice where the only cause of failure to give satis-

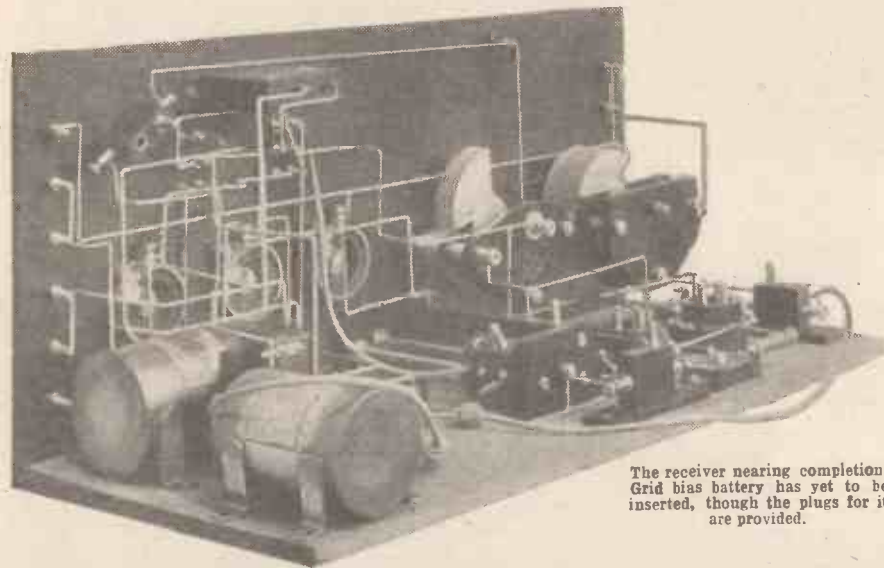
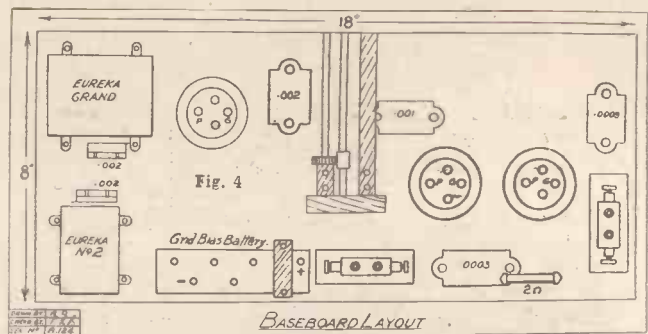

The receiver nearing completion. Grid bias battery has yet to be inserted, though the plugs for it are provided.

factory results is the poor arrangement and thoughtless wiring of components.

The components used in this set are as follow:

	£	s.	d.
1 panel and case (8 in. by 18 in., Peto Scott)	1	17	6
1 two-coil holder (Peto Scott)	12	6	
3 fil. rheostats (30 ohm. precision)	9	0	
1 variable condenser .0005 (Peto Scott)	10	6	
1 variable condenser .00025 (Peto Scott)	9	3	
2 L.F. transformers (Eureka)	2	12	6
2 D.P.D.T. switches (Nesthill)	4	0	
2 .0003 mfd. condensers (Dubilier)	5	0	
3 .002 mfd. condensers (Dubilier)	3	0	
1 .001 mfd. condenser (Dubilier)	3	0	
1 .005 mfd. condenser (Dubilier)	3	0	
1 0.5 mfd. condenser (T.C.C.)	3	6	
3 anti-phonie valve holders ("Magnum")	15	0	
1 grid leak and condenser (Dubilier)	5	0	
9 volt grid bias battery (Siemens)	1	9	
2 60-volt H.T. batteries (approx.)	1	10	0
11 W.O. terminals, transfers, etc.	1	6	
Coils to suit wave-lengths and 2 chokes of 400 and 600 turns respectively.			

(Continued on page 116.)

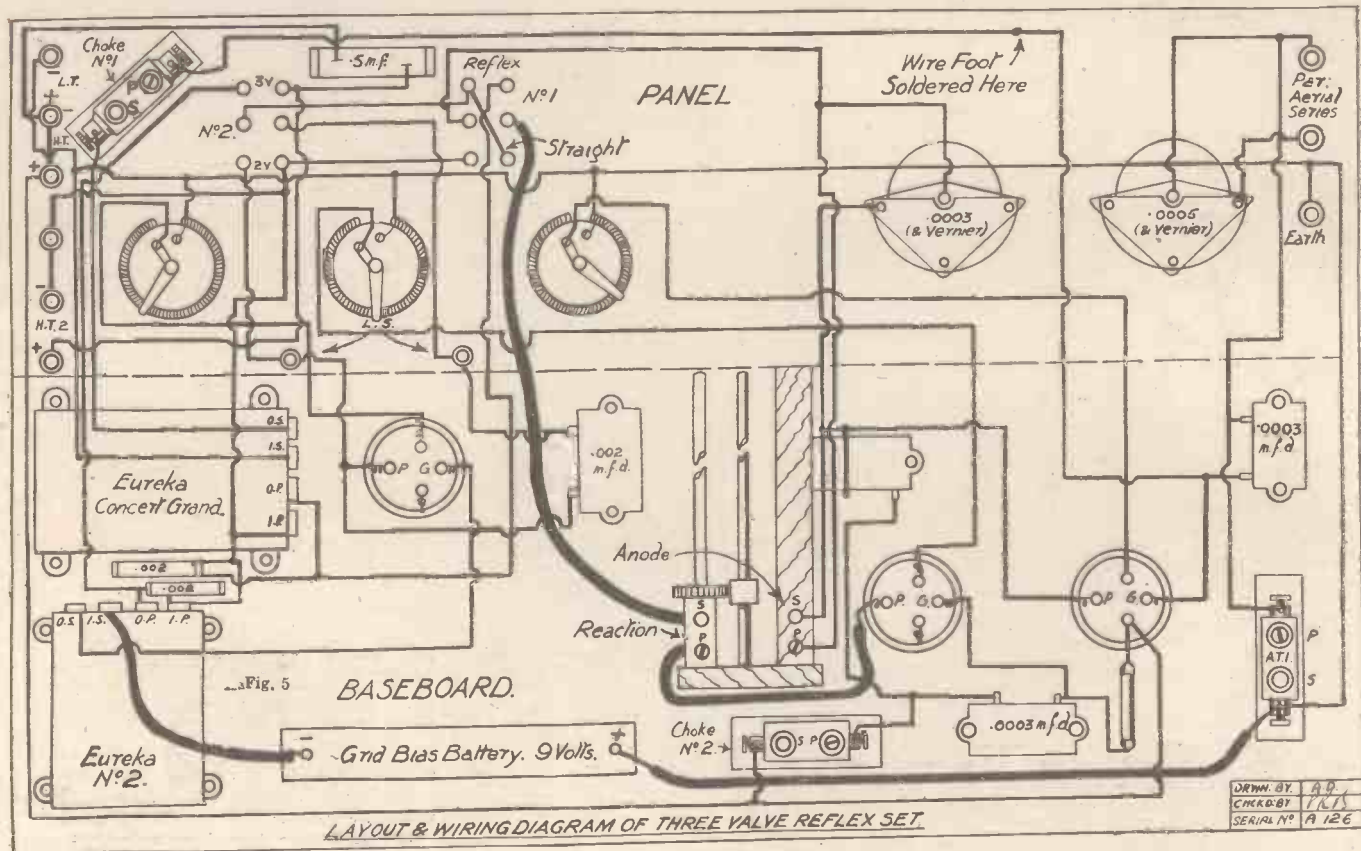

DRWN. BY: A.D.
CHKD. BY: T.K.S.
SERIAL NO: A 126

THE "P.W." 3-VALVE REFLEX.

(Continued from page 115.)

The positions of the chokes (photographs and fig. 5) should be noted, as it is essential that unwanted inter-action between the various coils—and there are five altogether—should be avoided.

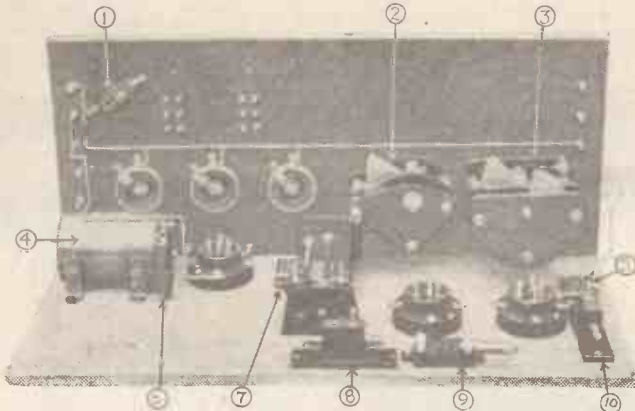

Another view of the set before wiring was commenced. (1) H.F. choke holder. (2) Anode cond. (3) A.T.C. (4) Eureka Grand. (5) Grid cond. for 1st valve. (6) .002 cond. (7) Tel. cond. (8) Choke holder. (9) Grid cond. and leak. (10) Aerial coil holder.

When the drilling has been carried out and all the components have been placed in position temporarily, the question of the wiring comes up. This, as will be seen, is not an easy task, and the constructor should not fix the components permanently in place until he has studied the point to point description of the wiring process. In this an

account of the actual procedure adopted in the set photographed is given, and it will be seen that some of the components were removed until certain sections of the wiring had been carried out.

In the first place, all components were mounted as shown in fig. 4, but only the following were tightened up permanently,

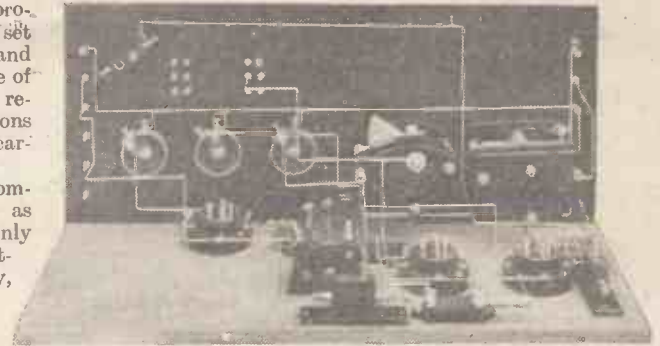

A photograph of the Reflex Receiver taken after the first stages of wiring had been carried out.

the others being removed and replaced as required: Two variable condensers, filament rheostats, terminals, coil holder, and three valve holders.

The L.T. wiring was undertaken, and the wiring carried out in the following order (see fig. 5):

L.T. — terminal to

denser and to grid contact of first valve holder. (Note. — A small wire foot is soldered to this lead to keep it from touching the L.T. — lead.)

Aerial (parallel) terminal to moving vanes of the .0005 variable condenser, to other tag of first .0003 fixed condenser and to plug side of aerial coil holder.

Aerial (series) terminal to fixed vanes of the .0005 variable condenser.

Socket side of aerial coil holder to the earth terminal.

Plate contact of first valve holder to fixed vanes of the .0003 variable condenser,

one contact of each filament rheostat, and to earth terminal.

L.T. + terminal to H.T. — terminal, and to one filament contact on each valve holder.

Plug side of first choke to one tag of first .0003 fixed con-

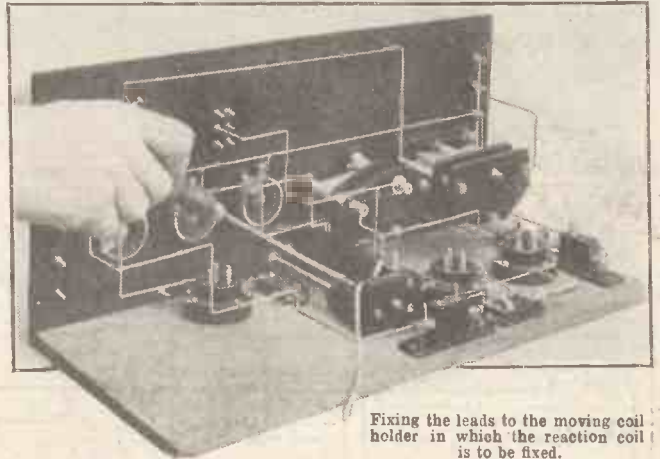

Fixing the leads to the moving coil holder in which the reaction coil is to be fixed.

to one tag of the .001 fixed condenser and to socket of anode coil holder (fixed coil plug on two-way coil holder).

Other tag of the .001 fixed condenser to plug side of the second choke and to one side of the .0003 grid condenser (No. 2).

Other side of the second .0003 grid condenser to grid leak and to grid of second valve. Other side of grid leak to L.T. + lead.

The Eureka Concert Grand L.F. transformer is now mounted.

Socket of first choke to O.S. of Eureka Grand L.F. transformer.

Completing the Wiring.

Plug side of anode coil (fixed one on two-way coil holder) to moving vanes of the .0003 variable condenser and to left-hand centre contact of the first D.P.D.T. switch.

Bottom right and top left-hand contacts of first switch to centre left-hand contact of the second D.P.D.T. switch.

I.S. of L.F. transformer (Eureka Grand) to L.T. — lead.

O.P. of same transformer to top right-hand contact of first switch.

(Continued on page 136.)

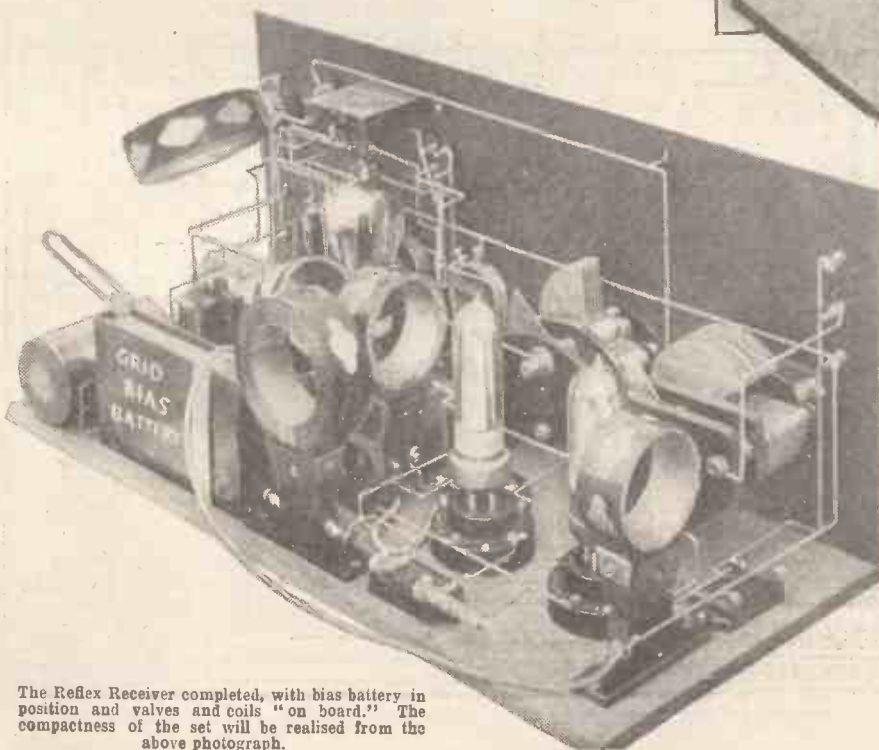

The Reflex Receiver completed, with bias battery in position and valves and coils "on board." The compactness of the set will be realised from the above photograph.

See the Latest Valve Developments at Stand No. 26.

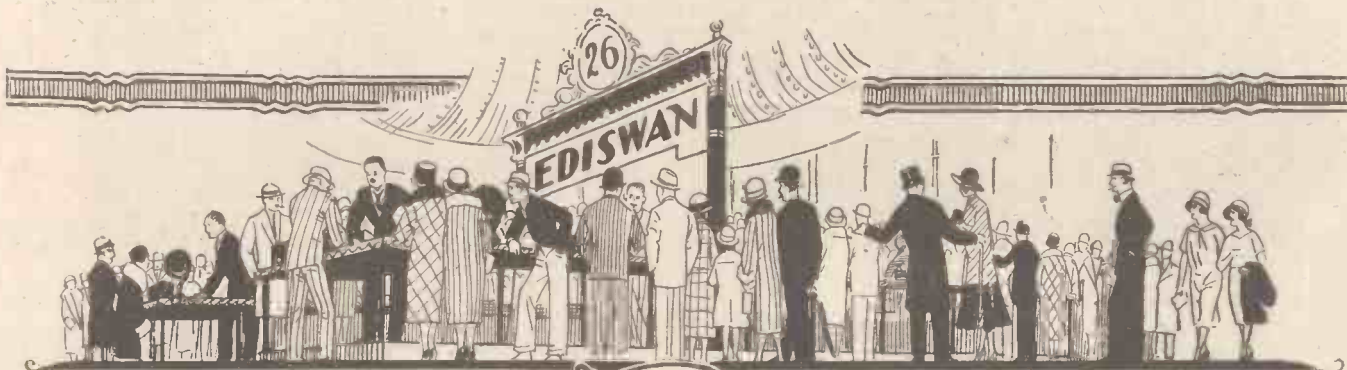

All the recent additions to the famous Ediswan Valves series, embodying new and exclusive features, are on view at Stand 26. These improvements have been adopted only after lengthy experimenting had proved their worth.

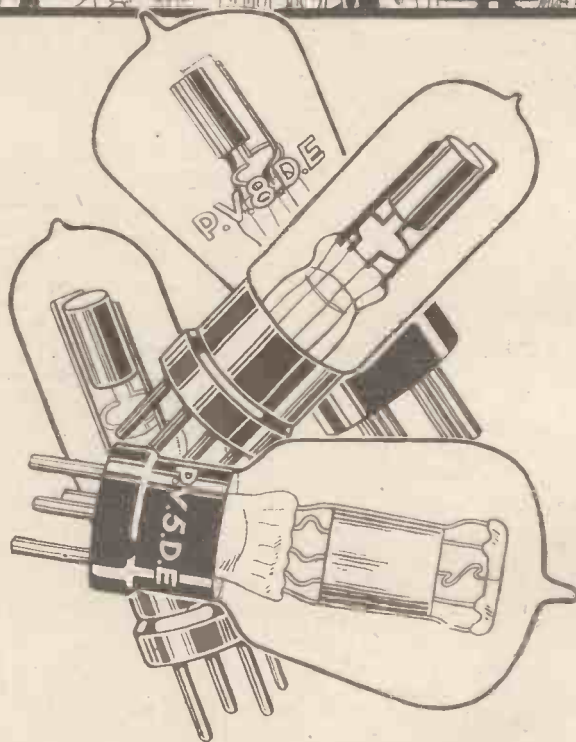

Wireless enthusiasts will undoubtedly find the Ediswan Stand the most interesting at the Exhibition. If there's any problem puzzling you — ask the Ediswan experts. They'll be glad to enlighten you.

EDISWAN VALVES

Will Improve
ANY Set

SEE THE EDISWAN STAND—No. 26.

N.A.R.M.A.T. WIRELESS EXHIBITION, SEPT. 12th to 23rd, 1925,
ROYAL ALBERT HALL.

THE EDISON SWAN ELECTRIC CO., LTD., 123, QUEEN VICTORIA STREET, LONDON, E.C.4.

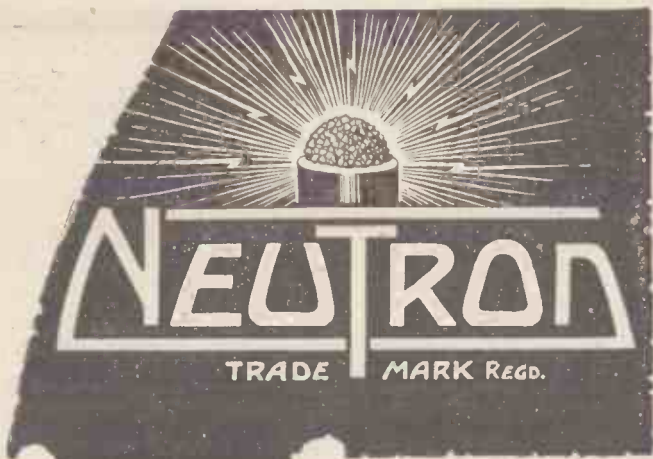

The
World's
Greatest
Radio
Crystal

"The Super Crystal"

"Your advert. certainly proves the value of the contents of one of those small boxes of NEUTRON."

"I thank sellers of this super crystal — having tried every crystal I have seen, I claim Neutron to be *the* Crystal."

Testimonial No. 776

The
Crystal
with
Valve
Power

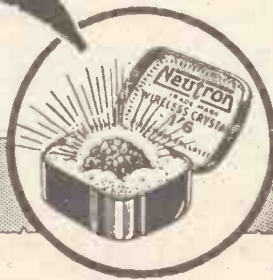

Ask your Dealer for it.

Sole Distributors:
NEUTRON DISTRIBUTORS,
Sentinel House, Southampton Row, London, W.C.1
Phone: MUSEUM 8340.
A product of NEUTRON Ltd., Sentinel House, Southampton Row, W.C.1

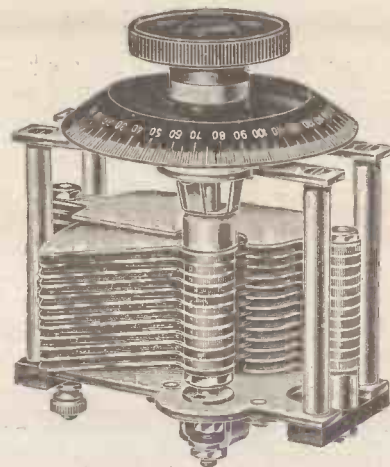

J.B. LOW LOSS	
'001	13/-
'00075	11/9
'0005	10/6
'0003	9/-
'00025	8/9
'0002	8/6
'0001	8/3

J.B. LOW LOSS GEARED VERNIER	
'001	17/6
'00075	16/3
'0005	15/-
'0003	13/6
'00025	13/3
'0002	14/-
'0001	12/0

Post. One 6d.
Two 9d. Three 1/-

Deliveries in
strict rotation
as and from
Sept. 15, 1925

Announcing the *New* J.B. Condensers

THE name J.B. holds an enviable position in radio. Consistently from the earliest days the J.B. trade mark has been synonymous with better radio condensers. The new model J.B. Condensers here announced embody vital improvements, each of which is the outcome of our own practical experiments. They will perform thoroughly and in every way fulfil the high standard of quality and efficiency for which J.B. stands.

FEATURES:
Losses absolutely negligible ('02 ohms at a million cycles '005 mfd.
Plates rigidly supported at two points. Pigtail connection.
Earthed Rotor and Frame (giving perfect freedom from hand capacity).
Minimum solid dielectric.
Ingeniously designed Frame (giving exceptional rigidity).
Metal End plates. Conforming to modern practice. Minimum capacity scarcely affected.
Correct Square Law. Gear Ratio 60-1.

JACKSON BROS.
8, POLAND ST.-OXFORD ST.
LONDON - W.1.
(First Floor) Telephone: GERRARD 7414

BONTONE 'PHONES

"The 'Phones shown here are Britain's best;
By name they are 'Bontone';
The world admits they stand the test
For Quality, Ease, and Tone."



POST
FREE

British made, sold under guarantee,
a famous 'phone at a popular price.
"Bontone" Lightweights 14/6
" " Originals - 13/6
Post free.

May be purchased from all Stores
or Radio Dealers, or direct from
B. D. & Co. (Ed. A. Boynton),
167-173, Goswell Rd., London, E.C.1.

You won't have to apologise
for "plummy" speech and indifferent music

if you refit your set with
"TANGENT" TUNING COILS

your friends will be charmed with the perfect performance.

Price 4/3 to 10/-
according to wave-length
covering all Broadcast-
ing wave-lengths.



List and
name of
dealer on
request.

GENT & Co. Ltd. (Est. 1872)
"Faraday Works," **LEICESTER**

Miss Gladys Cooper:

"WHEN I start thinking and talking about wireless, I find it very hard to express myself adequately, because the whole of modern wireless is such a miraculous, amazing thing. For quite a long time I've been the owner of a wireless set—one of those portable sets that can be carried about in a small case. I like to have it in my dressing-room at the theatre, and it



Miss Gladys Cooper.

will never cease to amaze me that in my waits I am able to tune in and listen to the latest news, or to some fine singer or instrumentalist, without moving outside my own dressing-room.

"Once, when I was making up for my own performance I was able to listen-in to a concert in Paris, without the slightest trouble. It was all perfectly clear—and I have not got an aerial! My son and daughter are fond of listening-in, too; and sometimes after my matinees they come to the theatre and we have a special "concert" for them. When I went to the B.B.C. studios recently, to broadcast for the first time, I was terrified.

"Singers who are in the habit of making gramophone records do not find broadcasting so difficult, because they are accustomed to the knowledge that one false note ruins a song—and that it cannot be corrected! The same applies to wireless performances; and I knew that if I hesitated or stumbled over my words thousands and thousands of people would hear, and I could never put it right. The 'Petér Pan' scenes I did from memory, but I read the Garden Scene from 'Paolo and Francesca,' which helped to increase my nervousness, as I think reading aloud is difficult at all times.

"I would far rather speak lines any time, but in this case it was impossible, so I had to read them. It did not damp my enthusiasm, however, and my experience of broadcasting has helped to increase the deep interest I take in wireless."

Mr. H. M. Bateman (the famous humorous artist):

"I like wireless, but I'm afraid I'm rather a failure where my own set is concerned. The truth is that I am not of a very mechanical turn of mind; and to be a true wireless enthusiast I think one requires a certain flair for mechanics. I had a wireless set, and used it quite a lot, and it worked splendidly. But somehow I let it get out of order—the batteries ran down, or something. That is about a year ago, and I haven't got a set now. Sheer laziness on my part, I expect.

"When I had my wireless set I discovered that someone else always turned up who could "tune in" far better than I could—



Mr. H. M. Bateman.

SOME RADIO OPINIONS.

A Symposium of the Views of some well-known People of To-day.

Collected by "ARIEL."

or believed they could. They used to tinker with the thing; and the end of it was that I had to climb out of my comfortable arm-chair and do a little tinkering and twisting on my own account, and before long we were arguing loudly enough to drown the loud speaker itself.

"One thing I did appreciate immensely, and that was the circulation of news, red hot, by means of wireless. To me it is a wonderful thing that people who live away from a city, as I do, can hear the latest news without moving out of their own drawing-room; and I am sure that the most important developments of broadcasting will take place where the news service is concerned.

"For the entertainment side, may I confess that if I want to hear a singer, or see a play, I would far rather go to the trouble of taking myself to a concert hall or theatre, and so beholding the people who are entertaining me in the flesh."



Miss Sybil Thorndike.

Miss Sybil Thorndike (the great tragedienne):

"For listening-in purposes wireless interests me only moderately, but from a broadcasting standpoint I find it full of interest. When I am listening-in—we have a wireless set, and as a family we make considerable use of it—I get much the same sort of feeling as I do over a telephone conversation. It is a negative, unsatisfactory feeling to me. I dislike the absence of personality, which must be missing inevitably when one talks by telephone or listens-in by wireless.

"From a working point of view, I like broadcasting immensely, partly because it gives me great pleasure to work under restrictions and see how much I can overcome them. I feel the same thing about film work, in which certain parts of the body are used to create an effect, while others remain passive.

"At first I found the atmosphere and conditions of the broadcasting studio rather deadening—the absence of noise is strange, after the commotion of life behind the scenes. Then, too, one must of necessity be much more still than on the stage, though modern conditions in broadcasting studios allow greater freedom in this respect than we met at first. And to me it is a great blank not to have any audience in front of

me; I get so much from them always. But the letters I have had from wireless listeners all over the country are most encouraging, and make me feel I want to go on broadcasting.

"My own boy heard me the other day on his training ship, the Worcester. He was allowed to go into the captain's quarters as a special treat, and wrote afterwards to say he felt he was in the stalls at the theatre."

Mr. Charles B. Cochran (the well-known theatrical manager):

"I have recognised from the first that wireless is a powerful rival to the theatre. For wireless to retain its popularity it needs the theatre.

"Like the gramophone and the moving picture, wireless should become a profitable by-product and, in this wise, compensate the manager, the dramatist, the composer, and the player for what they may lose through wireless as a counter-attraction. Wireless will need the best works, dramatic and operatic, as well as the best artists, to retain its popularity. Its programmes will have to be varied, and arranged by one who can see in advance of the public taste. They will need to be presented with showmanship; and, above all, wireless must be prepared to pay the biggest prices for the best goods from our market."



Mr. C. B. Cochran.

Miss Carrie Tubb (the well-known singer):

"Broadcasting is a source of real pleasure to me, now that I am beginning to get over my original terror of it. At first I was so petrified with fear at the novelty of it all, and also at the thought of the thousands of people who were waiting to hear me, that I didn't know what I did, or how I did it. My first broadcasting concert took place just before Christmas, 1924; since then I have done a good deal of singing by wireless, and am gradually beginning to feel more at home. To me broadcasting is easier than making gramophone records; 'recording' for a gramophone always strikes me as one of the most difficult things a vocalist can attempt.

"The first time I appeared for the B.B.C. I sang the Bach-Gounod 'Ave Maria,' and afterwards, by request, 'Alleluia,' the old Easter hymn that is so popular everywhere. I had my accompanist, and a violinist as well; but when I try to recall my impressions of that first appearance I made in the canvas-hung broadcasting studio, I can only remember my extreme terror—and the rest is a blank. There is a funny little story attached to that first performance of mine.

(Continued on page 120.)



Miss Carrie Tubb.

SOME RADIO OPINIONS.

(Continued from page 119.)

When it was over, shoals of letters reached me; among them, one from a man in a certain northern town where I sing a great deal. He wrote to tell me that when he heard I was to broadcast he gathered the whole of his family together, and several friends, telling them all they *must* come and hear Carrie Tubb sing. He arranged them round his loud speaker—aunts, uncles, cousins, grandchildren, even grandparents.

"There they waited for the big event, and when your voice came over the wireless waves," his letter concluded, "*it was too appalling for words!*" And the meeting

broke up in confusion, I gathered. Not long afterwards I was at a big dinner in the same town, and my correspondent got up and told this story in front of me. I thought the audience would never stop laughing. Of



Mr. Gilbert Frankau.

course, I've got a wireless set of my own, and listen-in whenever I can spare the time."

Mr. Gilbert Frankau (the well-known novelist):

"I do not possess a wireless instrument, as my time, I am afraid, is too fully occupied for me to make any great use of it. Naturally, all new inventions appeal to me; and if I did possess a wireless set the first thing I should suggest would be the broadcasting of theatrical entertainments. This would save me endless trouble, as I could then find out which entertainments were worth visiting before paying my good money for seats."

(Since Mr. Frankau wrote the above the new arrangement between the theatrical managers and the B.B.C. concerning the broadcasting of plays is a step in the direction he indicates.)

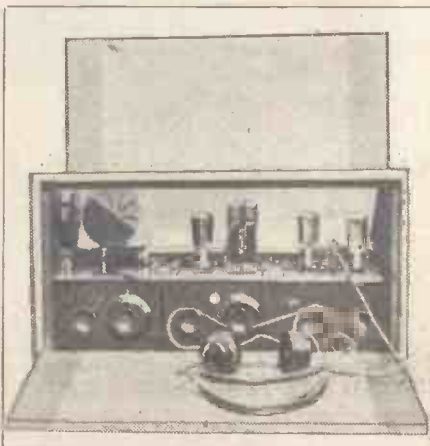

A unit set manufactured by Messrs. Gambrell Bros., Ltd., which was taken by the Michael Ferry Australian Expedition for chronometer checking purposes in connection with special survey work.

MINIMISING SCREENING LOSSES.

By Lieutenant-Commander H. W. SHOVE, D.S.O., R.N.

IT is always desirable to keep the aerial as far as possible from metal objects, such as rainwater pipes, guttering, etc. But very often it is necessary for some part of it, generally the lead-in, to approach them more or less closely. The question then arises as to their effect on the efficiency of the aerial. It is often assumed that this is most detrimental when the metal is

altogether a "dead" loss. On the other hand, objects connected to earth through a high-resistance path—i.e. objects "leaky" to earth, have a different effect. Currents will be induced in them, which will be expended, not in re-radiation, but in heating the resistance path. It is therefore important, if metal objects near the aerial cannot be perfectly insulated (so preventing the

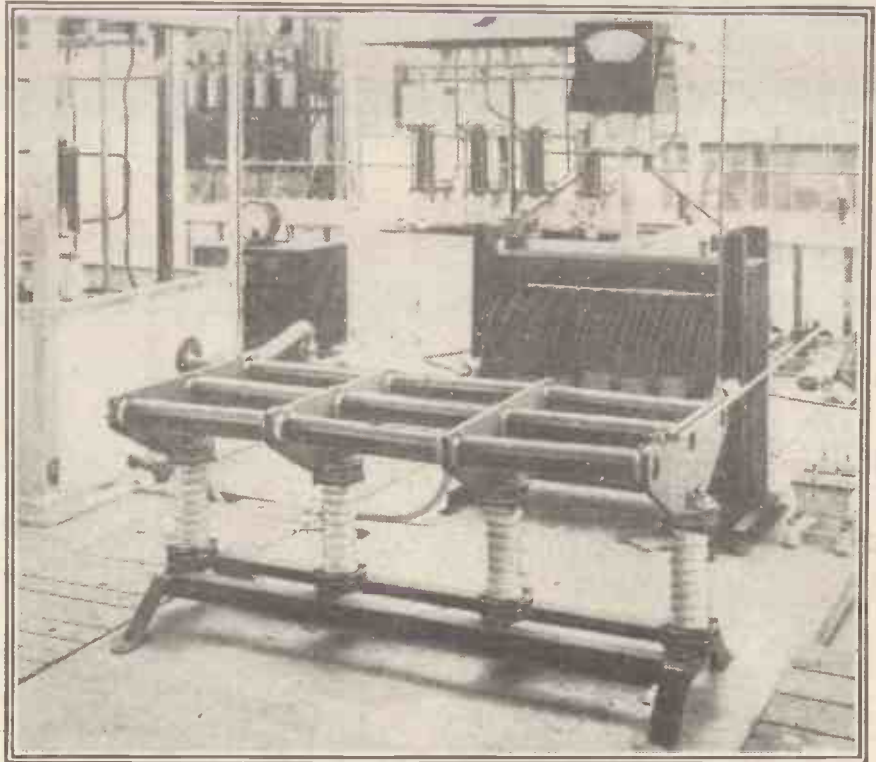

One of the high-frequency choke coils at the high-power station 5 X X, at Daventry.

directly connected to earth through a low-resistance path. But this is not necessarily the case.

Alternative Remedies.

The proximity of a moderate-sized metal object insulated from earth will not be very detrimental to aerial efficiency. Its chief effect will be to alter the natural wavelength, and therefore the tuning conditions. But it will not give rise to serious losses. Such objects as window clasps, screws in window frames, metal "ties" in brickwork, etc., are thus generally unimportant from a wireless point of view if the surrounding non-metallic substances are dry. But if there is a path to earth, the effect is different and varies with the resistance of the connection. Well-earthed objects act as a "screen," reflecting the incoming waves so that their energy is lost to the aerial.

They may be considered as simply "cutting off" a proportion of energy. But that which they themselves absorb causes currents in them which in turn give rise to re-radiation, some of which will be picked up by the aerial. The loss is thus not

flow of current to earth altogether), that they should be earthed through a negligible resistance.

Guttering, lead capping on roof ridges, etc., are generally only very imperfectly earthed. Joints in the guttering and between it and stackpipes, etc., are almost invariably rusty and of high resistance. On the other hand, really good insulation of such masses is not usually practicable. It is therefore worth while to consider the practicability, whenever any part of the aerial or lead-in passes in their vicinity, of providing a perfect earth by soldering short lengths of wire across these joints.

This may have the effect of improving or of reducing signal strength. In the first case the amateur will know that there were losses through heating, which he has now eliminated. In the second, the insulation must originally have been good enough to prevent the flow of any serious current. In this event, the shorting leads should be removed and every effort then made to maintain and, if possible, improve the insulation. In fact, the thing to avoid is the "half-way house" of poor insulation.

American Types
C.T. 201A, C.T.199

British Types
C.T.25, C.T.08

CLEARTRON CROSSES THE WATER TO THE NEWEST BRITISH FACTORY

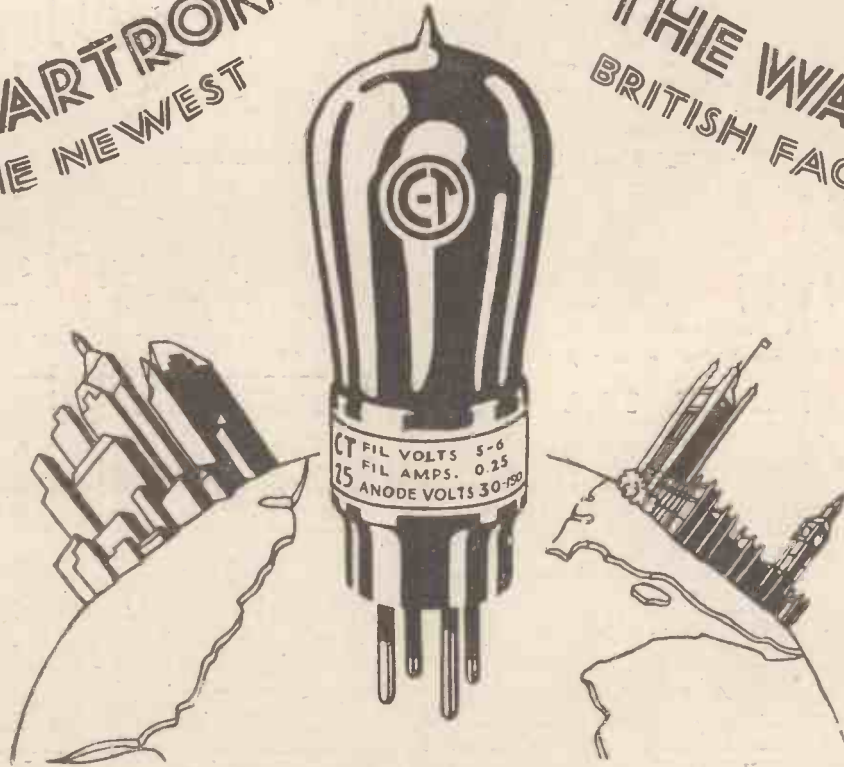

An every purpose Power volume valve.

CLEARTRON—the perfect Radio Valve

DISTANCE, tone, quality, selectivity, all depend on the valve. A valve receiver is no better than its valves, and valves backed by an iron-clad guarantee are the kind you want for proper reception.

An Iron-Clad Guarantee

All radio valves vary slightly. Only by rigid inspection backed by a rigid promise to make good can this be cut to a minimum. Cleartron has made good because it fulfils these requirements. Every valve is truly tested; every valve carries an Iron-Clad Guarantee.

Cleartron valves come in four regulation types: C.T.08, C.T.15, C.T.25 and C.T.25B. They retail at 12/6 and 15/- each, performance guaranteed. If your dealer does not yet carry Cleartron, order direct from us provided you send your dealer's name and address.

15/=

C.T. 25
C.T. 25B and
American
types
C.T. 201A
C.T. 199

12/6

C.T. 08 and
C.T. 15
Every
purpose
volume
valves.

CLEARTRON RADIO Ltd., 1 CHARING CROSS, LONDON, S.W.1
'Phone: Regent 2231/2. AND BIRMINGHAM. 'Grams: Cleartron, Westrand, London.

CLEARTRON

BRITISH



MADE

At last!

—a coil that does eliminate capacity losses

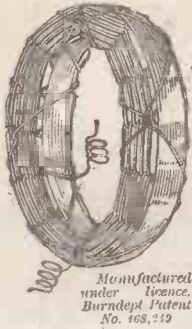

Wireless enthusiasts! Here's the only successful self-supporting coil on the market. The demand is exceptional. You have only to use a REFLEX COIL to appreciate the great progress it represents in efficient tuning.

PRICES:

Wave-length with '0005 in parallel (approx.)			
No. 25, 100-250	8d.	No. 250, 900-2500	3/3
No. 35, 150-300	8d.	No. 300, 1200-3000	4/3
No. 50, 200-500	9d.	No. 400, 1500-4000	5/-
No. 75, 300-750	1/-	No. 500, 2000-5000	5/6
No. 100, 400-1000	1/2	No. 600, 2500-6000	6/-
No. 125, 500-1250	1/6	No. 750, 3000-8000	7/-
No. 150, 600-1500	1/8	No. 1000, 4000-10500	8/-
No. 175, 740-1750	2/3	No. 1250, 5000-15000	9/-
No. 200, 800-2000	2/9	No. 1500, 6000-18000	10/-

5 X X Loading for Crystal Sets, 1/6

Reflex Coils can be obtained from all good wireless retailers.

The REFLEX COIL PLUG

Users of Reflex Coils will find they obtain the best results by using the specially designed Reflex Coil Plug. Finest grade lapped Ebonite only used. Nickel plated fittings. Each packed in separate carton. PRICE 1/-.

The whole of the materials used are BRITISH throughout. Trade inquiries invited.

THE REFLEX RADIO CO.,
45, Stamford Hill, London, N.16

Telephone: Clissold 3428. Cables: "Reftrad, Stoke, London."

Why is

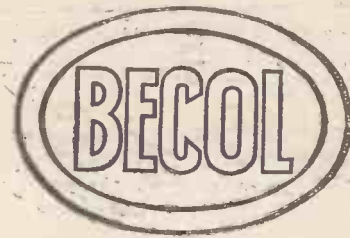

THE HALL MARK OF "QUALITY" EBONITE?

Because it is made from finest rubber and sulphur

IT HAS PROVED ITSELF ITS POLISH SPEAKS FOR ITSELF

All branded panels are *guaranteed* free from surface leakage.

See **STAND 15** at the N.A.R.M.A.T. Wireless Exhibition, Royal Albert Hall, September 12 to 23.

The BRITISH EBONITE CO., Ltd.,
HANWELL, LONDON, W.7

Rods, Tubes and Mouldings

SUPER-HETERODYNE KIT

A SET of the essential Super Het. components comprising:-

Intermediate Frequency Transformer. Filter. Oscillator. Oscillator Coupler with a splendidly clear diagram of connections, list of components and values, and a wealth of information on building and using a set.

Remember RADIAX is famous for inter-valve couplings.

- 5-Valve outfit, 52/6
- 6-Valve outfit, 64/6
- 7-Valve outfit, 77/6



Send 3d. stamps for Complete Catalogue of all Components.

RADIAX H.E. LOW-LOSS COILS

THESE wonderful coils are tremendously and deservedly popular. They improve tuning, volume and selectivity, and make the most of weak signals.

They are beautifully made and of appealing appearance, rigid and strong, packed in individual containers. Due to improved construction they are not unwieldy in the large sizes.



Radiax H.E. Coils also supplied un-mounted. The Box of 6 coils including 5 X X with Special Mount, 7/9 Post 3d.

No. 25	1/6	No. 150	3/-
35	1/9	200	4/3
50	2/-	250	4/9
75	2/3	300	5/3
100	2/9	Set of 9	26/6

Insist on Radiax Coils from your Dealer, and see that our Trade Mark appears on the mount. If he cannot supply, send to us.

RADIAX LTD., Radio House, 4, Percy St., Tottenham Court Road., London, W.1
Phone: Museum 490.

RADIAX
WE SATISFY YOU



The Symbol of Perfect Service & Reliability.

"RENOWN"

THE L.F. INTERVALVE TRANSFORMER

with the definite PUBLISHED GUARANTEE

ALL RATIOS, 8/4

Used by all discriminating Manufacturers and Constructors.

40,000 Turn Chokes, 8/4

Write for descriptive literature

We Repair ANY MAKE of L.F. Intervalve Transformer, 5/-

TRANSFORMER REPAIR COMPANY,
HAY STREET, PORTSMOUTH

“SKIN EFFECT” EXPLAINED

THERE are a few phrases used in connection with wireless science which are sometimes rather apt to puzzle the amateur radio enthusiast, especially if he be a comparatively new recruit to the pastime. What is known as the “skin effect” of high-frequency alternating or oscillatory currents is one of these phrases, the precise understanding of which sometimes involves the amateur in difficulties. And yet this effect which is exhibited by all these currents is a phenomenon which is of the very greatest significance in wireless transmission and reception.

A wireless receiving installation which, in its design, did not take into consideration the importance of these effects, and which

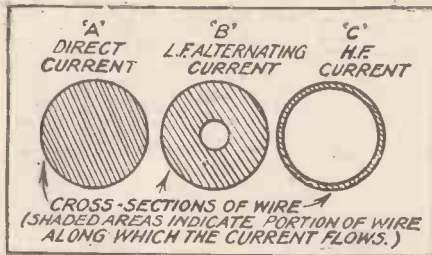

did not therefore allow for them, would not produce satisfactory results, especially when long-range transmissions were being dealt with. Current losses would be plentiful, and the normal range of reception would be diminished.

Short-Wave Set Design.

It follows, therefore, that it is of the utmost importance that the serious radio amateur should obtain a clear appreciation of the nature of the skin effects of H.F. currents so that he can allow for their inevitable presence in the design and operation of any receiving instrument or equipment upon which he may be engaged.

In short, the “skin effect” of a high-frequency oscillatory current is a term which is used to designate the tendency which such a current shows of always flowing along the outer surface of a metallic conductor, and not through the whole mass of the conductor. Like the familiar Pond-skater and Whirligig beetle of our country lakes and streams, a high-frequency current skins along the surface of the medium through which it is transmitted, penetrating to hardly any depth in the conductor.

The greater the frequency of the current, the more entirely does it confine itself to the surface of the conductor only. Therefore, when receiving transmissions of short wave-length, the skin effect is more in evidence than it is in the case of long-wave transmissions. This is a point which ought always to be taken into consideration in

An article describing an important factor, and how it should be considered in the design and construction of efficient receivers.

By J. F. CORRIGAN, M.Sc., A.I.C.
(Staff Consultant to “P.W.”)

the design of sets which are intended to work on short wave-lengths only.

Consider the diagram shown at Fig. 1. The cross-sections of three copper wires of uniform thickness are shown there. Through the wire A an ordinary direct or unidirectional current is passed. Through the wire B a low-frequency alternating current is transmitted, whilst a high-frequency current is sent through the conductor C. The shaded portions of the diagram indicate in each case the degree to which the currents penetrate the body of the conductor.

Reducing Resistance Losses.

Thus it will be seen that, in the case of a direct current, the current travels through all parts of the wire at the same rate. A low-frequency alternating current, however, does not penetrate to the very centre of the conductor, and, in the case of a high-frequency current, the electron flow is confined to the surface area of the conductor only.

Thus high-frequency currents skim along the mere surface of the conductor. The higher the frequency, and therefore the

shorter the wave-length, the more essential it is that the conductor should possess the maximum of surface area in order that resistance losses may be cut down to an absolute minimum.

Effect on Different Metals.

The skin effect of a high-frequency current is more intense in some conductors than in others. For instance, the effect is more noticeable in the case of an iron wire than with a copper or a brass one. In the case of an iron wire, the high-frequency current truly travels entirely along the uppermost surface skin of the conductor. With a copper wire, the current penetrates a little more below the surface of the wire, and with a lead conductor the penetration is still further increased.

Now, if we wish to increase the efficiency of any electrical circuit, one of the first steps we take towards the attainment of that end is to decrease the resistance of the circuit as a whole. Thus, when we are dealing with ordinary direct currents, we increase the thickness of the wire we are using, and the resistance goes down in consequence, for the simple reason that the resistance of a conductor depends upon the area of its cross-section, other things, of course, being equal.

In the case of high-frequency currents, however, this simple law does not hold. The resistance which a wire offers to these

(Continued on page 124.)

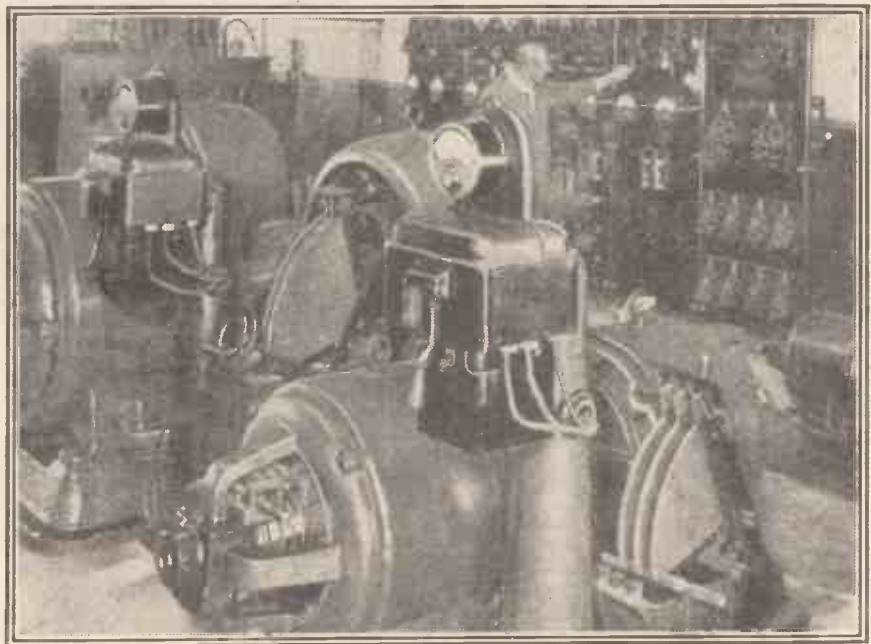

The generating room of the Australian high-power station at Pennant Hills, near Sydney.

"SKIN EFFECT" EXPLAINED.

(Continued from page 123.)

currents is, as we have seen, not primarily dependent upon the thickness of the wire, but upon the amount of surface which it possesses. If the wire is flattened out so as to increase the amount of surface area which it displays, the high-frequency resistance will go down in consequence.

It is for this reason that stranded and braided wires are employed in wireless constructional work, especially for the erection of aerials and earth leads. Seven strands of No. 22 wire have a much greater surface than a conductor possessing an equal amount of metal rolled into one wire. However, in order to obtain the utmost degree of efficiency with a stranded cable it is very important that each of the separate wires should be insulated from one another. The insulation need not be of the highest order. It is sufficient that the surfaces of the separate wires in a stranded conductor be prevented from coming into electrical contact with one another.

Noticeable on the "DX" work.

For this reason, ordinary bare 7/22 copper wire is not so efficient in actual use as might at first sight be expected. Some of the wires touch one another, and therefore the amount of surface in the cable is decreased. Thus the resistance of the cable to high-frequency currents goes up, and its efficiency is decreased in consequence.

It follows, therefore, that, for the very best work, and for long-range reception, an aerial wire ought to be composed of 7/22 enamelled wire so that the wire surfaces are, as it were, completely surrounded with ether, and not in actual contact with one another.

The superior results accruing from the use of this type of aerial wire may not, perhaps, be greatly evident when merely local transmissions are being received, but the increased range of reception will be very marked when the experimenter is searching for DX stations.

Besides these facts, of course, enamelled aerial wire is able to resist the corrosive influences of city atmospheres for a much longer period than is the case with ordinary bare stranded wire.

Practical Application.

The utmost efficiency in a set is obtained (other factors being constant) by decreasing the resistance of the circuit and coils as much as possible. It is for this reason that, in many commercial instruments, Litzendraht wire is employed in the windings. This wire consists essentially of about forty, or sometimes even more, insulated wires arranged together to form one cable of wire. The wire is not used to a very great extent in ordinary amateur work, no doubt on account of its expense, and perhaps more so because it is a very tedious operation to solder all the separate strands of the wire to the connections.

Now let us endeavour to consider the underlying reason of these high-frequency skin effects. When a high-frequency oscillatory current flows along the wire it sets up in the body of the conductor a

certain proportion of what are known as "eddy currents." These eddy currents represent a certain amount of wastage of the current, for they cannot be collected and made to do useful work. The eddy currents tend to inhibit the free passage of the high-frequency current through the wire, and therefore the current, taking the path of least resistance in accordance with the universal law, travels along the portion of the wire which is the most free from their presence. This happens to be the surface of the conductor.

The higher the frequency of the current the greater the number of eddy currents which accompany it. Thus, the greater the frequency of the current, that is to say, the shorter its wave-length, the more does the high-frequency current confine its passage along the wire to the surface only.



Timing a station erecting squad during a competition held recently in conjunction with a Golders Green wireless club "field day" activities.

When a wire is coiled into a solenoid form or into some other similar shape, the proportion of eddy currents set up increases. Thus the more completely are the high-frequency impulses of current driven to the surface of the conductor.

Now let us consider some of the above facts and their application to practical wireless work. Since high-frequency currents flow practically solely upon the surface of a conductor it is obvious that the high-frequency resistance of a conductor will be greater than its low-frequency resistance. One does not decrease the resistance of a conductor to high-frequency currents by increasing the thickness of a wire, but rather by increasing its surface area. It is for this reason that stranded wires are so very greatly used in all kinds of radio constructional work.

Points to be Noted.

Summing up, we may now gather that, for any given wireless circuit to work at its maximum efficiency, its high-frequency resistance must be cut down to the lowest possible minimum.

To obtain this, there are several points which should be noted:

1. Stranded wires, insulated from one another, should be used so far as possible in the construction of the set and its aerial and earth equipment. Failing this, reasonably thick wires which have been flattened out to some extent may be used for winding large air-spaced coils, and for under-the-panel connections. Square-sectioned wire may also be used with equal effect to cut down the high-frequency resistance of the circuit.

Important in Crystal Sets.

2. The skin effect of the current is greater when it flows through a coil of wire than when it merely passes along a straight piece of wire. For this reason, it is essential that the wire from which the various coils of the set are made should possess as much surface area as possible. On this account

Litz wire is highly efficient for constructing coils for the reception of weak signals, but, as this material is difficult to work with, the thickest possible wire, consistent with their bulk and convenience in actual use, should be used for winding the coils.

3. The skin effect of the current becomes greater as the wave-length received is shorter. For DX reception on short wave-lengths it therefore follows that every care should be taken to impart to the various wires and connections of the set the maximum of surface so that the resistance losses may be cut down to an absolute minimum, and that the sensitivity of the set as a whole may be increased.

Crystal users should bear these points in mind also, for it will be remembered that a crystal set is dependent solely upon the energy received by the aerial. Therefore, in order to get the best results in crystal reception it is of the greatest importance that the resistance losses in the set be reduced in every possible way. This can only be effected by designing the construction and wiring of the set, and the aerial and earth systems to which it is connected, with due regard to the above laws of the skin effect.



CLIMAX ▲ RADIO ▲

UP-TO-DATE

Yesterday—To-day—and To-morrow. The experiences of yesterday in the light of the knowledge of to-day point clearly to the practices of to-morrow. (See the Climax Magazine Catalogue.)

THE MAGAZINE CATALOGUE.

A New Idea in Radio.

Prof. A. M. Low
on
"The Possibilities
of Television."

W. B. Medlam,
B.Sc., A.M.I.E.E.
"Building a
Superheterodyne."

Articles on "Building a
Wireless Set," "Upkeep
of a Crystal Set," "Those
Microphone 'No'ses,'"
"Dodging the Aerial,"
and many others.

Full details of all the
NEW
CLIMAX RADIO COM-
PONENTS AND SETS.

THE CLIMAX RADIO EARTH—the low-loss direct tubular earth. Far better than the old-fashioned water-pipe or gas-pipe earth. The latest pattern is provided with flanges which break up the earth round the tube, thereby preventing any rocking of the tube in the ground. In addition, the projections on the surface of the tube provide watercourses which make for perfect electrical contact. Ready for use. Easily fitted. Maximum efficiency. Length approx 30 ins., 5/-; Climax Insulated Low-Loss Earth Lead, 20 ft., 1/8.

THE NEW CLIMAX AERIAL INSULATOR (Registered Design No. 708718). This will stand four times the flash-over voltage of the ordinary cheap shell or egg insulator, while it has far less capacity to earth. It is made of the same High-Tension vitreous porcelain as the 100,000-volt insulators on High-Power transmission lines. It will stand a direct pull of hundreds of pounds. It is entirely non-hygroscopic. It cannot absorb moisture even if fractured. **IT INSULATES PERFECTLY DURING RAINFALL.** It is self-cleaning on all surfaces. Price per pair, 1/-.

THE CLIMAX INSULATED SHOCK ABSORBER SET. Comprising set of four Climax low-loss aerial insulators and two Climax Aerial Shock Absorbers, 3/- per box.

CLIMAX RESISTANCE CAPACITY UNIT FOR L.F. AMPLIFICATION. A new, convenient design of Resistance Capacity coupling unit, embodying the Climax fixed Mica Condenser, the Climax Wire-wound Anode Resistance, and the Climax New System Grid Leak. Each item is readily replaceable and interchangeable, so that the discriminating user has complete freedom of control.

PRICE 12/6.

If you believe in metal—and who does not?—use exclusively **CLIMAX RHEOSTATS and POTENTIOMETERS.** They are wire-wound on metal cooling cores with vitreous enamel insulation. **PRICE:**

CLIMAX RHEOSTATS, 6-ohm pattern, for one, two, or three bright valves.....3/-

CLIMAX RHEOSTATS, 30-ohm pattern, universal pattern for D.P. or bright valves.....4/-

CLIMAX POTENTIOMETERS, 300-ohm pattern.....5/-

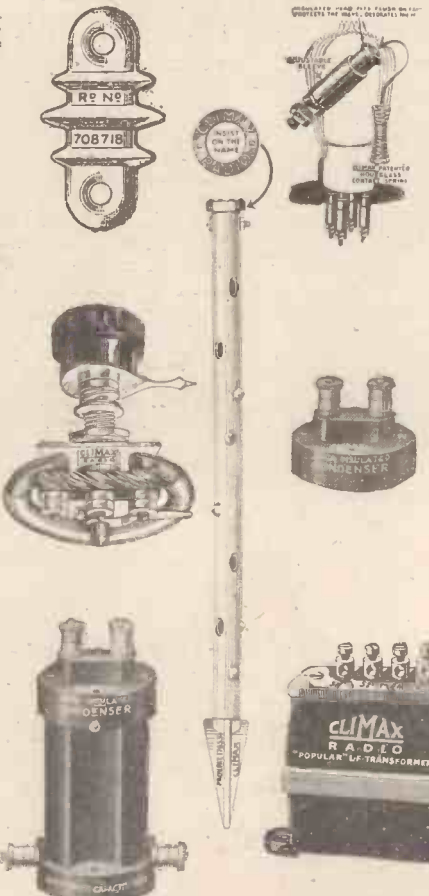

THE CLIMAX ANTI-MICROPHONIC VALVE SOCKETS. No larger than the old-fashioned solid sockets. Readily fitted to any existing panel. They fit flush with the panel and give a particularly attractive appearance, and protect the valve from accidental damage. Each socket is fitted with the Climax patented hour-glass spring contacts which give a truly anti-microphonic support to the valve. The valve floats on metal springs. Perfect electrical contact. Set of four Climax Anti-Microphonic Valve Sockets, per box, 2/-.

CLIMAX FIXED MICA CONDENSER. Manufactured of the finest mica having extremely high insulation resistance and the lowest possible dielectric losses. Fitted with substantial terminals and mounted in vitreous porcelain containers of the highest grade. *Guaranteed accurate within 5 per cent.*
PRICE: .0001 mfd. to .0009 mfd., 2/- each. .001 mfd to .005 mfd., 2/6 each.

THE CLIMAX POPULAR L.F. TRANSFORMER. A highly efficient transformer for general low-frequency amplification. Specially designed to give uniform amplification over the widest possible range of frequencies. Reproduction of speech and musical notes is therefore exceptionally good and pure. **PRICE 17/6.**

INSIST ON THE NAME "CLIMAX." REFUSE SUBSTITUTES. Every Climax product is clearly marked with the name "Climax." In case of difficulty, or if substitutes are offered you, send your order direct to us, together with P.O., and we will send the goods by return.

CLIMAX RADIO ELECTRIC LIMITED

Head Office and Works: Quill Works, Putney, London, S.W.15.
Telephone—Putney 2599. All Communications to Head Office.
Showrooms: 257, High Holborn, London, W.C.1. Telephone—2538.





CURRENT TOPICS

BY THE EDITOR

The Wave-length Tests—Dr. de Forest on British Broadcasting—
—“P.W.’s” Winter Features—The
Wireless Exhibition.

THE wave-length experiments carried out by the British and Continental broadcasting stations, commencing on August 31st, seem to have proved a very great success. The B.B.C. telegraphed the International Radiophone Bureau at Geneva that during the test Bournemouth was jammed by Oslo, Edinburgh by Helsingfors, Glasgow by Munich, Hull by the Petit Parisien station, Liverpool by Hamburg, while all the other stations were clear of interference.

It would seem that five British broadcasting stations were subjected to more or less severe interference on the first night, but we understand that modifications in the wave-lengths of certain of these stations will have the effect of rendering the British broadcasting stations practically immune from interference from the Continent.

The B.B.C. consider that the test was a decisive and successful one. It is, at any rate, a striking example of the value of co-operation and unity between the British and the Continental broadcasting concerns, and we sincerely hope that other questions which will undoubtedly arise from time to time, affecting the interests of British and Continental listeners, will be dealt with in the same effective way which has characterised the work of the International Radiophone Bureau on the question of wave-lengths and interference.

Dr. de Forest on British Broadcasting.

Readers will remember that a few weeks ago we published two important interviews with Dr. Lee de Forest, the chief consulting engineer of the De Forest Radio Company, and more familiarly known as “the man who put the grid in the valve.” Dr. de Forest recently returned to America after a visit to this country and Europe, where he made a close study of radio conditions in England, France, Germany and Italy.

Our New York Correspondent informs us that Dr. de Forest, on being interviewed on his return to America, said, “The public interest in radio throughout Europe just now is at a very high point. It is, of course, somewhat restricted, owing to the scarcity of broadcasting stations, but this is rapidly being eliminated by the constant erection of new and powerful ones. The interest is greatest in England, however, probably due to the fact that there the programmes are more diversified than in the rest of the European countries.

“France, of all nations, pays the least attention to the programmes, and, with the possible exception of one or two French stations, very little musical matter is broadcast. For that reason, French listeners

build receivers capable of hearing the English stations, where better balanced programmes are offered.

“Most of the receiving apparatus is home-made, listeners preferring to make their own, much the same as the American public did at first. The English market offers to the builder a very wide selection. I personally noted over 87 different makes of vacuum tubes, or valves, as they are termed there, all of very high quality, and many of them being sold at considerably lower prices than on this side.

“Many manufacturers vie with each other in the number of types that are made, and it is not unusual for them to place from 18 to 20 different styles on the market. Of course, every other manufacturer follows suit, and the result is one that would puzzle even the most hard-boiled American fans. One item of considerable note, however, is that there is absolutely no cutting of prices.

“In the matter of broadcasting, America is much further advanced than any of the European nations, none of which seems to have the ability to offer what is known here as a well-balanced programme. Considering that the listeners are taxed, this is a surprising fact. But as Europe is still in its infant stages in this regard, I am of opinion that it is only a matter of time and adjustment to conditions. The English stations which I had the opportunity of inspecting are all admirably equipped to give high-class programmes, especially the newly erected B.B.C. station at Daventry, the most powerful station in the United Kingdom.”

On the whole Dr. de Forest seems to have obtained a favourable impression of broadcasting conditions in this country, although we note, with some amusement, that the variety of valves on sale in this country seems to have afforded him some bewilderment!

The P.W. Winter Season.

With this issue of POPULAR WIRELESS we commence what we may call the “P.W.” winter season. The time has now arrived when the great hobby of radio wakes up from its summer sleep. All over the country there is an awakening of interest in wireless. Amateurs are viewing their present receivers rather askance, and are wondering what to build in place of them, and the advent of London’s Wireless Exhibition at the Albert Hall is always an event of considerable interest to amateurs. We can assure our readers that this year’s exhibition is a much greater improvement on last year’s exhibition, excellent though that was. The organisers are to be congratulated (for we have had advance information as to the

scope of their activities) on the very excellent show they have got together, and no praise could be warm enough for the various firms who are exhibiting at the exhibition. The technical progress has truly been most satisfactory. There seems a sounder and more sane element in radio manufacturing to-day, and a scarcity of “stunt merchants,” which is all to the good.

Our Special Numbers.

In this number we include the first of a series of two articles, reviewing the chief exhibits at the exhibition. These exhibits have been written up in advance of the exhibition, and we wish to offer our thanks to the various manufacturers concerned for their courtesy in affording us facility to inspect their latest apparatus, etc., before the exhibition officially opened, so that we might publish an early review for the benefit of our readers.

We are also starting in this issue a new series for the constructor, and readers will have noticed on Page 83 an important announcement regarding Mr. Gerald Marcuse, the famous British amateur. Arrangements have been made with Mr. Marcuse whereby he contributes exclusively to this journal throughout the winter months. We should like to make it quite clear to our readers that no information concerning Mr. Marcuse’s activities in the wireless world, and especially in connection with his amateur transmissions, will be made public except through the media of the columns of POPULAR WIRELESS.

Mr. Marcuse will also contribute a series of very interesting articles for the benefit of our readers, and we shall be able to include the first of these articles in our next week’s issue. As a preliminary we publish in this issue a special interview granted by Mr. Marcuse to Mr. K. D. Rogers.

A Novel Surprise.

It would not be policy to divulge at this moment the many important features and other arrangements we have made for the benefit of readers throughout the coming months, for, in these days of competition, a certain amount of secrecy has to be retained; but we have no hesitation in saying that “P.W.,” quite apart from its editorial features, has several surprises “up its sleeve,” so to speak, which will create a tremendous interest throughout the country when the details are announced.

For over two months now negotiations have been carried out in a certain quarter, and which we are now glad to announce have reached a successful conclusion. We shall give full details in an early issue and in the daily press. More cannot be said at the moment; but we can promise readers a very novel surprise in the near future.

In next week’s issue we are printing, as an ordinary editorial feature of the paper, a specially compiled list of 250 radio questions and answers. These questions and answers are not being given away as a separate book. With regard to books, we have other plans in view, but these 250 questions and answers, specially compiled by the Technical Staff, will undoubtedly prove a great attractive feature and of considerable value to readers. Special constructional articles will also be a feature of interest in next week’s issue, which will be dated week ending September 19th. For our issue dated September 26th other important announcements will be made.

Sat. Sept. 12th
to Wed. Sept. 23rd

NARMAT WIRELESS EXHIBITION

Latest Radio Developments

10.30 a.m. to 10 p.m.
Daily

What has been described as the most picturesque and interesting of the many Exhibitions held in London every year is the All-British Wireless Exhibition, housed within that historic monument—The Royal Albert Hall.

The Exhibition, which will be held under the auspices of the National Association of Radio Manufacturers and Traders, is representative of the rapid progress and solid excellence of Radio Broadcast Reception in the Home. There Makers and Traders will display the best that Britain

produces in an alluring array calculated to please the eye and tempt the acquisitive faculties, the gallery this year being used in addition to the ground floor. Entertainment with Education for every home, and to suit every pocket, is the keynote of this unique show.

Everyone knows the Royal Albert Hall. You can get there from any Underground Station. Buses pass the door. Be sure to go early, for there you will find the means by which to make delightful our long winter evenings.

ROYAL ALBERT HALL



Special Salons are set apart for Loud Speaker demonstrations. Organ Recitals will be given daily during the morning, and in the afternoons and evenings there will be performances by THE BAND OF H.M. ROYAL AIR FORCE.

Admission 1/6



BUY BRITISH GOODS.

Internal Metal Chuck to grip 14 to 44 gauge wire or flex.
Price: Plug 4d. Socket 2d. Indicating Ring 1d.

BELLING-LEE INDICATING TERMINALS & "MULTY-KONTACT" PLUGS & SOCKETS

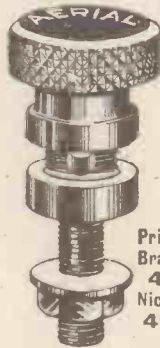

Price: Brass 4d. Nickel 4½d.

(Handles and dome-shaped Indicating Rings in Red or Black) Stocked in the following indications:



DIAL INDICATORS

H.F. TUNER
Solid cast metal, with raised, polished letters showing white on a black background. Single hole fixing, complete with nut. Stocked in Tuner, Filament, Reaction, Aerial, Anode, H. F. Tuner, Secondary, Rejector.
Price - 6d. each.

Aerial, Earth, Phones+, Phones-, L.T. +, L.T. -, H.T. +, H.T. -, Input +, Input -, Output +, Output -, L. S. +, L. S. -, Grid +, Grid -, A. T. I., Reaction, Ap. Aerial, H.T. Medium, and Blanks.

Every high-class dealer stocks them, but in case of difficulty send to **BELLING & LEE, Ltd.** Queensway Works, Ponder's End, Midx.

SUB-CONNECTORS

Eliminate Soldering.

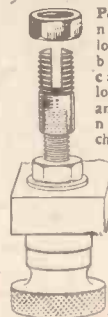

Price 1d. each.

Perfect connection; lowest possible self-capacity; low resistance; connection changed in an instant. Tapped to screw on to 2, 4, 5 and 6 B.A. threads; also T connectors for joining wires.



The Right Resistance

There is always just one value of the grid leak best suited to the characteristics of your detector valve. Tone quality, signal strength, good reception, all depend in no small measure upon this correct resistance being obtained—and maintained. Don't handicap your receiver—use a Watmel and make sure of obtaining the exact value. Send for descriptive folder.

GRID LEAK (Black knob)	ANODE Resistance (Red knob)
5 to 5 megohms	50,000 to 100,000 ohms
2/6	3/6
10,000 to 50,000 ohms (Green knob)	

The **Watmel** Wireless Co., Ltd.
332a, Goswell Road,
London, E.C.1.

TEL.: Clerkenwell 7990.
LANCASHIRE & CHESHIRE REPRESENTATIVE
Mr. J. B. Levee, 23, Hartley Street,
Lancashire, MANCHESTER.



it into your pocket when you take your set on a picnic—it fits snugly, altho' there's nearly a MILE OF WIRE. Hang it on a tree, punt pole, or car hood—anywhere—and connect direct to set. You can be sure of splendid results, and need carry no extra insulators.

THE Ariane POCKET AERIAL

winds on an insulating bobbin; every inch of wire is insulated. No tangling or trouble. Strongly recommended by "Popular Wireless."



B. E. N. PATENTS LIMITED
100, VICTORIA STREET
LONDON, S.W.1

Ask your Dealer or send direct with his name and address.
TRADE ENQUIRIES PLEASE.

POST FREE
12/6

RADIO TORIAL

All Editorial Communications to be addressed The Editor, POPULAR WIRELESS, The Fleetway House, Farringdon Street, London, E.C.4.

Editor:
NORMAN EDWARDS, M.Inst.R.E., F.R.S.A., F.R.G.S.

Technical Editor:
G. V. DOWDING, Grad.I.E.E.

Assistant Technical Editors:
K. D. ROGERS. P. R. BIRD.

Scientific Adviser:
Sir OLIVER LODGE, F.R.S.

Staff Consultants:
Dr. J. H. T. ROBERTS, F.Inst.P.; J. F. CORRIGAN, M.Sc., A.I.C.; C. E. FIELD, B.Sc.

Foreign Correspondents:
F. M. DELANO, Paris; Dr. ALFRED GRADENWITZ, Berlin; L. W. CORBETT, New York; P. F. MARTIN, Italy; W. PEETERS, Holland.

The Editor will be pleased to consider articles and photographs dealing with all subjects appertaining to wireless work. The Editor cannot accept responsibility for manuscripts and photos. Every care will be taken to return MSS. not accepted for publication. A stamped and addressed envelope must be sent with every article. All contributions to be addressed to The Editor, POPULAR WIRELESS AND WIRELESS

REVIEW, The Fleetway House, Farringdon Street, London, E.C. 4. All inquiries concerning advertising rates, etc. to be addressed to the Sole Agents, Messrs. John H. Lile, Ltd., 4, Ludgate Circus, London, E.C. 4.

PATENT ADVICE FOR READERS.

The Editor will be very pleased to recommend readers of POPULAR WIRELESS who have any inventions to patent, or who desire advice on patent questions, to our patent agent. Letters dealing with patent questions if sent to the Editor, will be forwarded to our own patent advisers, where every facility and help will be afforded to readers.

TECHNICAL QUERIES.

Letters should be addressed to:

Technical Query Dept.,

"Popular Wireless,"

The Fleetway House,

Farringdon Street,

London, E.C.4.

They should be written on one side of the paper only, and MUST be accompanied by a stamped addressed envelope.

Queries should be asked in the form of the numbered questions: (1), (2), (3), etc., but may be accompanied by a short letter giving any necessary additional particulars as briefly as possible.

For every question asked a fee of 6d. should be enclosed. A copy of the numbered questions should

be kept, so that the replies may be given under the numbers. (It is not possible to reproduce the question in the answer.)

IMPORTANT.—If a wiring diagram, panel lay-out or point-to-point wiring is required an additional fee of 1/- must be enclosed.

Wiring diagrams of commercial apparatus, such as sets of any particular manufacture, etc., cannot be supplied. (Such particulars can only be obtained from the makers.)

Readers may submit their own diagrams, etc., for correction or for criticism. The fee is 1/- per diagram, and these should be large, and as clear as possible.

No questions can be answered by phone. Remittances should be in the form of Postal Orders.

Questions and Answers

LOW-LOSS LONG-WAVE COIL.

"CRYSTAL SET CONSTRUCTOR" (Sandown, Isle of Wight).—Shall I be able to receive 2 L O or Daventry at Wells-next-the-Sea, on the Norfolk coast? The distance from Daventry is about 100 miles, and I am told that I shall need a low-loss coil in order to get good reception. (I have not seen any descriptions of low-loss coils for long wavelengths, but I presume that these would be similar to the short-wave low-loss coils, but larger.)

Whilst it is not possible to foretell the results obtainable with any real degree of accuracy, it is possible to say that crystal reception from Daventry is generally very good in Norfolk, despite the distance. A very great deal depends upon the aerial and earth, the exact position of the set, and other local conditions (which can only be appreciated and allowed for on the spot).

(Continued on page 130.)



"SPARTA" is a speaker that does its own sales talk. Its tone appeals at the first hearing. The reason lies in a construction that is different. That difference is the outcome of long experiment.

The large "Sparta" has a unique feature—an additional tone selector which enables very delicate refinement of tone values. The smaller "Sparta" model has the usual single-adjustment only.

Type	Ohms
A	120
HA	2,000
HHA	4,000
	£4: 15: 0
B	120
	£5: 15: 0
HB	2,000
HHB	4,000
	£6: 0: 0
J	120
H.J.	2,000
H.H.J.	4,000
	£2: 15: 0

London Depot:
176, Tottenham
Court Road, W.1.

FULLER'S UNITED ELECTRIC WORKS, LTD.,
Chadwell Heath Essex;
Telephone: 11ford 1200. Telegrams: "Fuller, Chadwell Heath."

-sells on the test of tone

WARNING

**MARCONI'S WIRELESS TELEGRAPH
COMPANY LIMITED**

v.

BURNE JONES COMPANY LIMITED

On the 31st July, 1925, an Injunction was granted by Mr. Justice Tomlin in an action brought by Marconi's Wireless Telegraph Co. Ltd., against Burne Jones & Co. Ltd., for the infringement of certain of the Marconi Company's Patents by the sale of receivers or sets of parts for the home construction of receivers, with an invitation to the Purchasers to use the sets of parts in such a way as to infringe the Letters Patent referred to above.

The Marconi Company have agreed to grant Burne Jones & Co. Ltd. a licence.

Proceedings will be forthwith instituted against all Infringers, including those who offer sets of parts of receivers infringing the Marconi Company's Patents.

The New MAXEL Accumulator

Specially designed for Wireless.
GUARANTEED TWELVE MONTHS.
If you live too far away to call and see the Battery Mail your Order to us for the size you want. We will willingly return your money if you are dissatisfied.

	AMPS.			
	40	60	80	110
2 VOLT ..	7/8	9/8	11/8	14/-
4 VOLT ..	15/-	18/6	22/-	25/8
6 VOLT ..	22/6	27/-	32/6	37/6

Packing 1/- extra per battery.

H.T BATTERIES 60 VOLT 7/6 post free

MAXEL ELECTRICAL CO. 28, Clipstone Street, Great Portland Street, W.1.
Telephone: MUSEUM 708.

FREE! FREE! FREE!

"UNCLE TOM'S" (Newcastle's First Station Director) New Catalogue, over 900 priced articles. Write for one FREE. Largest and most varied stock in England. All goods despatched by return post or cash refunded.

WHOLESALE & RETAIL.

To clear large stocks:—English Headphones, 4,000 ohms, 10/6; English Valves, 4/-; Fixed Condensers, all capacities, 6d. each; Crystal Sets, 6/6; Detector Parts, brass, 4d., Nickel, 6d.; Insulated Hooks, 9d. dozen; Variometers, 1/3 each, etc., etc.

Send ample postage, excess will be returned.

PAYNE & HORNSBY LTD.,
Gallowgate, NEWCASTLE-ON-TYNE.
and at Leeds, Belfast, Notts, Sunderland, North & South Shields.

The Experts Know

the value of perfect filament control.
That is why the

WATES' MICROSTAT

FILAMENT RESISTANCE

has received lavish praise in the Radio Press: Users also are loud in their praises, as a number of letters in our file prove. Silky, silent action. No "jumping" from step to step. One-hole fixing. Small underpanel space. "Packing" impossible. Resistance range from zero to 100 ohms. Wates' products are sold by all discriminating Radio Dealers, who will willingly demonstrate. We can supply carriage paid, but your Dealer's name must be enclosed with order.

Send for our latest Illustrated Catalogue.

PRICE 2/9

WATES

BROS. LIMITED, Head Office: 13-14, Gt. Queen St., Kingsway, W.C.2. Phone: Gerrard 575. 576. Grams: Zywateseng. Westcent. WORKS: LONDON, BIRMINGHAM & WESTLIFE.

British and Guaranteed

Acknowledged by experts and amateurs to be unrivalled for clarity, magnification and entire freedom from distortion, the U.S. Super Transformer claims to be the finest on the market, irrespective of price.

18/6

Standard model, guaranteed ratio 5:1. New model for second stage work, 3:1. Obtainable from all good dealers, or direct from the manufacturers.

Super Transformer

U.S. RADIO CO., LTD.,
(Dept. 3), Radio Works, Tyrwhitt Rd., Brockley, S.E.4.

RADIOTORIAL QUESTIONS & ANSWERS.

(Continued from page 128.)

As regards the reception of 2 L.O. this appears to be unlikely, considering the power used by the London station and the distance to be covered. Nevertheless there are instances of fairly good, regular reception from this station at points situated near the Wash.

The construction of a large "low-loss" coil to cover a 1,600 metre wave-length is not recommended.

The comparative efficiency of such coils falls off rapidly as the wave-length increases. Although there is often a decided gain by using cumbrous low-loss coils on the short waves, they are not worth while on the longer wave-lengths, and any good plug-in coil will give similar results, whilst occupying only a fraction of the space required by the low-loss type.

UNPAID QUERIES.

F. G. (Battersea), R. P. A. (Christchurch, Hants), N. R. (Wolverhampton), and others who have forwarded queries to be answered, but have not enclosed the requisite fee, as per the announcement at the head of the "Radiatorial" columns.

As your queries are not of sufficient general interest to be reproduced in these columns, no reply can be given unless the rules of the Technical Queries Department are observed. It should be clearly understood that the questions and answers reproduced in these columns are *not* free answers to questions sent in without pre-payment, but are samples of queries received, the answers to which are likely to be useful to other readers.

SQUARE-LAW CONDENSERS.

J. P. W. (Barrow-in-Furness).—Has an ordinary semi-circular-plate variable condenser any advantage over the square-law type? I have been informed that the latter kind embody all the essential features of the old-fashioned type, together with the ad-

vantage that tuning is simplified. Is this correct?

Yes; all the advantages of the old-fashioned type of condenser can be embodied in the square-law type, and the latter possesses the valuable property

THE "P.W." TECHNICAL ASSISTANCE DEPT.

Personal Help for Amateurs in Trouble With Their Sets.

DURING the autumn months, and until further notice, readers of "Popular Wireless" may obtain personal interviews with the Queries Editor or one of his staff on Mondays, Wednesdays and Fridays.

Just as a patient may talk over his troubles with a medical specialist, so it is now possible for readers to make an appointment with a "P.W." radio specialist and, on advance payment of a fee of 2/6, have a ten minutes' interview in order to discuss troubles verbally—a much more satisfactory and expeditious method than asking for assistance by post. Also, in special cases, and on payment of a fee of 10/6, plus all expenses, a member of the "P.W." Queries Staff will visit the home of any reader of "P.W." within a radius of twenty miles of London, and will give advice on wireless sets already installed, or on the installation of receivers, aerials, etc., etc. Hours of visit can be obtained on written application to the Queries Editor.

Readers also desirous of having their sets completely overhauled, tested, and certificated by "P.W." according to merit, may on application, and by forwarding a fee of 10/6, send their receivers to the "P.W." Testing Room.

In the latter case sets must be brought by readers and taken away again after test. Sets cannot be received by post.

All queries in connection with this new "P.W." Technical Assistance Dept. should be addressed to the Queries Editor, "Popular Wireless," Fleetway House, Farringdon Street, London, E.C.4. Appointments and testing of readers' sets will be dealt with in strict rotation.

of spacing-out the frequencies which were formerly crowded near the position of minimum capacity.

Accumulator Capacity.

P. L. E. (Atherton, near Manchester).—How long should a small accumulator last when dull emitter valves are used, before it requires recharging?

This depends upon the type and size of accumulator employed, and the current consumption of the valve. The capacity of the former is given as so many actual ampere-hours, so that if you divide the capacity by the total current you require—sum of the consumption value of the valves—you will have a good idea as to how long the cell will last.

H.F. Amplification.

"Adding H.F." (Cranbrook Park, Ilford).—I have been using a crystal set to receive the Daventry and London stations. Recently I added a tuned-anode H.F. amplifier, with the result that whilst the Daventry signals have been greatly improved by this addition, it does not seem to have had much strengthening effect as far as 2 L.O. is concerned. Why is this?

Possibly the amplifier is not as efficient upon the short waves as upon the longer, in which case the size of the anode coil should be varied to make sure that you are able to "tune-through" the London station. (This simply means that the set should be capable of adjustment which will bring in 2 L.O. weakly at first, then stronger as the movement of dial is continued, and then weaker again, as you pass or "tune-through" the correct tuning adjustment.)

Apart from inefficient tuning upon the shorter wave-length, there is another reason why the increase due to the H.F. amplifier may not be as noticeable upon 2 L.O.'s signals as upon those from 5 X X. This is certain to be the case if with the crystal set only in use the Daventry signals are of good strength whilst the London signals are decidedly weaker. The effect of H.F. amplification is to increase the strength of *weak* signals, and this effect will therefore always be more pronounced upon the comparatively feeble stations. Therefore it is quite likely that with equal long-wave and short-wave efficiency in H.F. amplification the increase obtainable would be greater in the case of the distant station than in that of the comparatively strong signals from the local station.

WIRELESS MEN! Make Your Hobby Pay

Let us show you how to commence a new and fascinating business in your own home—by your own fireside.

Without expensive machinery or previous experience you can start at once manufacturing an article in constant and increasing demand by **WIRELESS** and other users.

Royal Letters Patent protect the article you make and good profits are assured.

We have shown others—we will show YOU—how to turn spare time into money.

Full particulars will be sent to all readers of this paper without obligation. Merely write enclosing 1½d. stamp to cover postage.

THE ENGLAND-RICHARDS CO.
3K, KING'S LYNN, NORFOLK

'AD' AIR DEPOLARISING HIGH TENSION BATTERIES

Noiseless, Regenerative,
Visible Connections.



60 Cell Battery.

One Pair Wander Plugs free with each battery.

20 Cell - 10/-
40 " - 18/6
60 " - 27/6

Place your order with your Dealer early.

LARGE PRIMARY CELLS FOR VALVE HEATING

'A D' Radio Cell (No. 222.)

500 ampere hour capacity. Accumulator charging eliminated. Used with sal-ammoniac like a house bell battery. Ask your supplier for full particulars.



Container. Zinc. Carbon Electrode.

MANUFACTURERS of all types of PRIMARY CELLS.
LE CARBONE,
Coventry House, South Place, London, E.C.2.
Works: Portslade, Sussex.

The "KENMAC" BOOK Crystal Receiving Set

(Pat. Pending.)



(CLOSED)

PRICE :
Int. Tortoise-shell
(Non. Inflam.)
£2-2-0

Leather Covered
(Red, Green, Blue),
£1-1-0

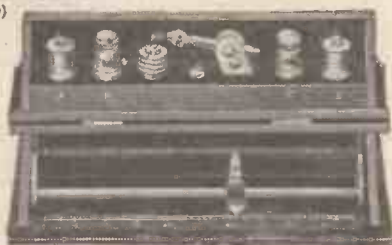

(OPEN)

Actual size 4 1/4" x 3 1/2" x 1".

The Latest Novelty
in Crystal Sets.
Efficient, Compact.
Guaranteed to give
Every Satisfaction.
Provision made
for 5 X X Load-
ing Coil.

THE KENMAC RADIO LTD.,
(DEPT. P),
Dalling Road, Hammersmith, London, W.6

Good News for every Crystal user THE LEADING NATURAL GALENA CRYSTAL

Gil-Ray

is now reduced
in price to—

1/-

Increased output and most advantageous contracts for supplies of galena, enables "Gil-Ray," the famous Crystal, formerly sold at 1/6, to become available to every listener, in all parts of Great Britain, at the price of 1/-

You now obtain, at the price of an unreliable and unguaranteed, inferior crystal, a high-grade Crystal with a definite guarantee of complete sensitiveness.

GIL-RAY CRYSTAL
is natural—not synthetic, nor sensitised galena. Every piece is tested and sold under a guarantee of replacement if not found satisfactory.

Look for the buff Tin—containing liberal piece of Gil-Ray, full directions and guarantee slip.

Sold by all Wireless Dealers.



In case of difficulty, send P.O. 1/-, with Dealer's name to:

GIL-RAY TRADING CORPORATION LTD.

Sicilian House, LONDON, W.C.1.
Phone: Museum 3206.

VALVE VALUE—

Secure Philips' Valves while they are obtainable.

Philips' '06 Gen. Purpose	12/6	'TRIOTRON' 2 amp. 2 volt	7/6
Philips' "E" Bright		'PLIOTRON' '06, 3 volt	11/-
Emitter for last L.F. positions	7/6	'A.P.' DUTCH 'R' 4 v. 5a.	4/-
Philips' D, Gen. Pur. B.E.	6/-	THORPE K4 Valve	14/-
Philips' 4-Electrode Bright Emitter for Unidyne	11/-	5-Pin Holder	1/8
Special Vernier Coil-holder for Unidyne, one-hole fixing	5/-	Wates' Microstat	2/9
		Bretwood Leak	3/-
		Selected Set of Parts for 1-Valve Unidyne Set, including Valve	46/6

All goods 48 hours' approval, post and packing free. Full responsibility for damage in transit accepted.

ANELOY PRODUCTS, ETON WORKS,
Upland Road, London, S.E.22.

What the "Saxon" stands for!



The "SAXON GUIDE" enables any beginner to make Wireless Sets unequalled in price, quality or EFFICIENCY.
HOW TO ERECT, CONNECT, MAKE AND TEST all kinds of Wireless apparatus, including Super Crystal Sets, Single Valve Sets, One- and Two-Valve Amplifiers, Dual-amplification Sets; also the very latest types of Two-, Three-, Four- and Five-Valve Tuned Anode All-Wave Receivers.
NO SOLDERING NO SPECIAL TOOLS—NO TROUBLE

SAXON GUIDE TO WIRELESS

contains 176 pages of sound, practical information and is the best book obtainable. Price 1/3 post free.

Satisfaction guaranteed or money returned.
SAXON RADIO CO. (Dept. 14), South Shore, BLACKPOOL

PRICE 1/3
Post Free

"POPULAR WIRELESS" ADVERTISEMENT RATES

WHOLE PAGE £40:0:0 | QUARTER PAGE £10:0:0
HALF PAGE £20:0:0 | EIGHTH PAGE £5:0:0

Narrow Column Advs. (3 cols. to page) per inch 30/-
Minimum Space accepted - - half inch 15/-

SPECIAL POSITIONS BY ARRANGEMENT. NO SERIES DISCOUNTS, ALL ADVERTISEMENT COPY SUBJECT TO EDITORIAL APPROVAL.

Cover pages close for press 11 days prior to day of issue.
Inside pages close for press 9 days prior to day of issue.

COPY AND BLOCKS MUST BE IN HAND AT LEAST 3 DAYS EARLIER TO ENSURE PROOFS.

"POPULAR WIRELESS" HAS THE LARGEST SALE OF ANY WIRELESS WEEKLY IN GREAT BRITAIN.

ALL communications respecting advertising must be made to the

SOLE ADVERTISEMENT AGENTS—

JOHN H. LILE LTD.

4 Ludgate Circus
London, E.C.4.

Note New Phone No.
CITY 7261 (2 lines)



Traders and manufacturers are invited to submit wireless sets and component parts to the "P.W." Technical Dept. for test. All tests are carried out with strict impartiality in the "P.W." Test Room under the supervision of the Technical Editor, and the general reader is asked to note that this weekly article is also intended to provide a reliable and unbiased guide as to what to buy and what to avoid.—THE EDITOR.

ANOTHER valve, or, rather, another series of valves, has now been introduced to the British market. Known as the "Cleartron," five types, all dull emitters, are available at 12s. 6d. and 15s. each. Judging by the specifications they are all eminently useful types and should prove popular. The "Cleartron" is an American valve, and has achieved a considerable success in the States, but the "Cleartron" valves to be sold in this country will be British made throughout.

Of particular interest to DX amateurs is the Silvertown "Verniometer," a sample of which was recently handed to us by a representative of Messrs. The Silvertown Co. As its name suggests, it is an attachment for providing "vernier" control of

variable condensers, variometers, or other adjustable tuning devices. It consists of a dial beneath which a large fine-toothed cog-wheel is fitted, a "worm" and control spindle. The "worm" is, of course, permanently fixed to the control spindle, and engages the cog-wheel on the dial. It can, however, by means of an ingenious mechanical movement, be placed in or out of "gear" according to whether coarse or "vernier" control is required.

It can be very easily mounted on a panel, as the spindle bracket can be employed as a drilling template. The gear ratio is 240-1, and, owing to the principle employed, there can be no back-lash or "looseness." One advantage the device possesses to which its manufacturers do not appear to give prominence is that when in "gear" the

"Verniometer" acts as a positive dial lock, and this feature is one that should appeal strongly to amateurs.

The "Verniometer" is priced at 6s., and can be used with Ormond, Sterling, Burndept, and Silvertown components, although other sizes will shortly be available.

We have also received from the Silvertown Co. a 10-way inductance or capacity switch for under-panel mounting. A moving sector "shorts" successive studs from one to the full number. Therefore, if the switch is used in conjunction with a tapped inductance coil, those sections of the winding not in use are "shorted." Again, it can be employed with a number of fixed condensers as a capacity "selector," and any number up to the maximum of the condensers brought into circuit by this means. It retails at 5s. 6d.

The new season's catalogue issued by Messrs. The Goswell Engineering Co., Ltd., who have recently moved to larger premises in White Lion Street, is of particular interest in that some 16 new, original and ingenious "lines" are listed, and considerable price reductions are made in a number of their existing well-known components. Readers can obtain this catalogue free, and we advise them to take advantage of the offer, as it is very well worth perusing.

Of coil holders there are in existence types many and varied, but, nevertheless, there is room for more of careful and efficient design. There are a great number of really bad coil holders on the market, but (Continued on page 134.)

THE EXHIBITION

After you have seen the Wireless Exhibition at the Albert Hall, there is still much to be seen of the World's finest Wireless Productions, which alone make for perfection in radio reception.

Our Great Display

of the latest American productions can be viewed, entirely without obligation to purchase, at

DAYZITE, LTD.,
18 & 19, Lisle St., Leicester Sq., London, W.C.2

Phone: Regent 4577. Grams: "Titles, Westrand, London."

Write at once for our new Catalogue, post free by mentioning this paper.

SWC RHEOSTATS

A vernier adjustment rheostat of extremely sturdy manufacture. Occupies very little panel space.

4/6 EACH

One-hole fixing. Terminal connections. 2, 6, 15 and 30 ohm resistances.

Particulars of the complete SWC range of Components will interest you. A postcard brings you a copy.

SWC

JACK TERMINALS

Box of 6 complete sets, 2/3 (12 for 4/6), with soldering tags.

Special non-soldering tags, 2d. each. Complete set of 12 with these tags, 6/-

SWC

ANTI-CAPACITY VALVE HOLDER

Maximum efficiency with low cost.

Weight of metal is only 1/27th of an ounce. In envelope containers with 4 legs and ebonite disc, 8 1/2d. each. Baseboard type 10 1/2d. each.

MANUFACTURERS

S. WILDING COLE LTD

116 SNOW HILL BIRMINGHAM

PHONE: CENTRAL 3151

LONDON'S FINEST RADIO SHOWROOMS & SERVICE DEPOT.

Now Open!

The New **A.J.S.** LONDON OFFICES
SHOW & DEMONSTRATION ROOMS.

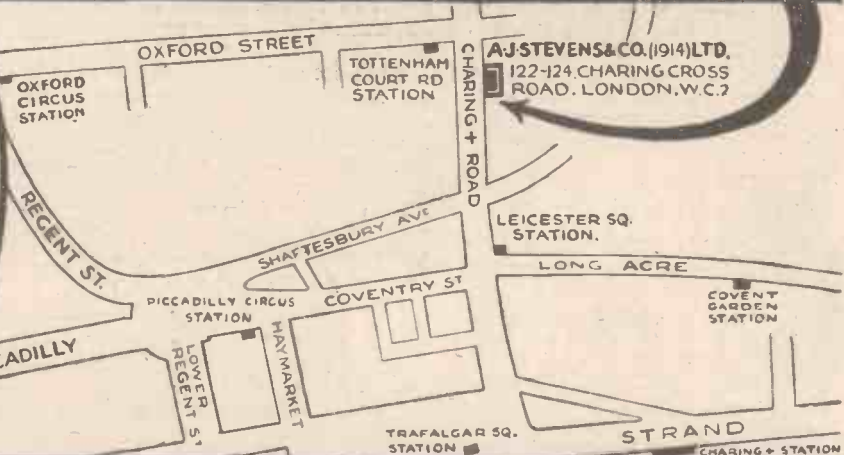

Telephone: REGENT-5167.

A.J. STEVENS & CO. (1914) LTD, LONDON OFFICES

Telegrams: AJAYESSCO WESTCENT, LONDON

122-124, CHARING CROSS ROAD, LONDON. W.C.2

HEAD OFFICE: — WOLVERHAMPTON.

Be sure to visit Stand No. E37 at the N.A.R.M.A.T. Wireless Exhibition, Royal Albert Hall, Sept. 12th to 23rd.

ETHERPLUS

RADIO ACCESSORIES
— ENSURE PERFECT RECEPTION

VARIABLE BRASS VANED LOW LOSS CONDENSERS

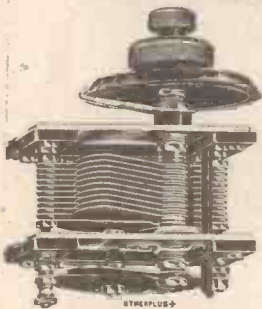

Brass Pointer under Dial. Heavy Gauge Brass Vanes. Brass Pig Tail Spring Connection on Rotor. Latest type Friction Washer. All metal parts highly polished. Loss is practically negligible. Construction and finish of the highest grade.

RETAIL PRICES:

WITHOUT VERNIER			WITH VERNIER		
No.	Capacity	Price	No.	Capacity	Price
W/83	.00025	10/-	W/87V	.00025	11/6
W/84	.0003	11/-	W/88V	.0003	12/6
W/85	.0005	11/6	W/89V	.0005	12/6
W/86	.001	14/-	W/90V	.001	15/6

From all dealers or post free from

M.AND.AW., 9-15, Whitecross Street, London, E.C.1

Full illustrated list of "Etherplus" + Components post free on application

CLIXIE'S at home

Albert Hall, September 12-23



"CLIXIE"

Are you
well
connected?
Try
CLIX!

"This is just to tell you of two specialties that you'll find at my stands at the Show," says CLIXIE.

The Bridge Condenser (.0003 and .0005 mfd. one-hole fixing) gives you the maximum of selectivity without finicking little adjustments. Simplicity and certainty of manipulation is ensured by the alternatively single or dual control of the two movable electrodes. Low loss-square law.

Radio Condit is wire with the middle cut out, so to speak. Everybody knows that electric currents function only on the skin of conductors. In Radio Condit only the skin is left. Hence minimum H.F. resistance, minimum capacity, minimum energy-loss and maximum all-round efficiency. Tinned in 24" lengths (equivalent to 16 S.W.G.) in packets of 6 lengths, 2/- per packet.

See it at STANDS 41 & 76

Obtainable (like CLIX) from all Wireless Dealers or Direct from the Patentees:

AUTOVEYORS LTD., 84 VICTORIA STREET, LONDON, S.W.1

APPARATUS TESTED.

(Continued from page 132.)

most of them bear no name and may be—we hope so, at least—of foreign manufacture.

The B.W.R. coil holder, a product of Messrs. Burge, Warren & Ridgley, Ltd., 91 and 92, Gt. Saffron Hill, London, E.C., a sample of which was recently sent us, is a high-class component that introduces novel features. Its movement is that of positively operating screws, one provid-



The B.W.R. coil holder mentioned in these columns.

ing a "coarse" adjustment and the other a "vernier," both operating independently, the latter through the hollow spindle of the former.

The action is "push-pull," the control knobs working at right angles to the moving coil. Owing to the introduction of the screw method, however large or heavy the coil plugged into the moving holder is, the

latter cannot move until the control knobs are turned, and annoying "slipping" cannot possibly occur. This feature is, of course, one that a coil holder to be styled "high class" must essentially possess.

Four screws permanently fixed into the frame and provided with nuts render panel mounting a simple task, and one ensures rigidity of fixing.

The B.W.R. two-way coil holder is priced at 7s. 6d., and is well worth the inspection of prospective constructors.

Bracket type back-of-panel valve holders are not particularly popular, but where space is limited they are rather useful. Also wiring can be reduced considerably, and efficiency increased by their judicious use.

However, for those constructors to whom such components appeal, and they possess certain advantages, the Back-o'-Panel due to Messrs. John Moores & Co., of Raval Street Works, Salford, a sample of which was recently to hand, should prove distinctly useful. It is not made of ebonite, but the material employed, a bituminous compound is quite a good insulator.

A novelty in the design is the introduction of a spring clip for shorting the metal cap of a valve to L.T. minus and thence, of course, to earth.

Very accessible soldering tags are provided for connecting purposes, and the metal sockets are "sunk" to prevent any possibility of filament—H.T. accidents.

The "Back-o'-Panel" is retailed at 1s. 6d.

"Soldo" is a new substance that should prove popular among wireless constructors.

A product of The Soldo Co., of Sicilian House, Southampton Row, W.C. 1, it is a patent cleaning-tinning-soldering compound sold in tins at 1s. 6d. each.

Rusty, corroded and greasy surfaces of practically any metal except aluminium can be attacked without any cleaning, and a good joint obtained. "Soldo" is in the form of a greyish powder, and is quite easy to handle. Although it is "non-acid" in nature, it appears to "bite" through dirty surfaces and amalgamate with the metal as readily as ordinary solder does after the usual careful cleaning and tinning.

We tested the sample submitted to us very completely, and our conclusions are in absolute agreement with those of the National Physical Laboratory, who have rendered an almost enthusiastic report on the substance to the manufacturers.

It makes soldering an almost foolproof operation, and mechanically and electrically sound joints can be made without any previous knowledge of workshop practice at all.

From Messrs. The Burwood Concessionaires, Ltd., of 41, Gt. Queen Street, London, W.C.2, we have received a number of Burwood Minimum Capacity valve holders. They are essentially for baseboard mounting, consisting as they do of neat round ebonite bases upon which are situated nickel-plated valve sockets. Soldering tags are provided, and two screw holes for fixing purposes. They are nicely made, and their straightforward design and simplicity are bound to appeal to constructors as much as the low price at which they are retailed—1s. 3d. each.

just a ball, a metal plate—and no cats-whisker—

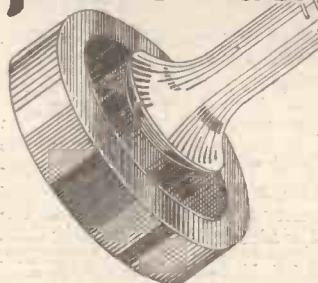

Abolish your Crystal and Cat's-whisker and adopt this trouble-free method of detection. Not a permanent detector, but a readily adjustable one, with zinc ball making contact with a smooth plate coated with mineral compounds.

—and the volume of pure reproduction is extraordinary.

Kathoxyd consists of a smooth metal plate in a brass mount, which fits your Crystal cup. It is supplied with two contacts—one a ball of zinc iron,

for local station use, the other a fine graphitic point for long-distance work. Each contact is readily fixed in place of your ordinary cat's-whisker.

METAL PLATE
Kathoxyd
RADIO DETECTOR
CRYSTAL

Supplied in sealed boxes, containing one Kathoxyd Element, one Ball Contact, and one Long-distance Contact. From all Wireless Dealers. Price **1/6**

Wholesale from all reputable Factors. All enquiries welcomed by—

KATHOXYD, LTD., 41, High Holborn, London, W.C.1

If unobtainable locally, send 1/6 and Dealer's name and address, when the Crystal will be sent by return post.



Make your Set
Micro-Selective

BE able to get those elusive DX stations readily, clear and loud. Simply replace your dials with Pelican UNIVERNIERS

without otherwise altering your set, or drilling the panel, and then see what a marvellous difference it will make to your tuning.

It does away with Vernier Condensers

Buy good plain condensers and fit with Pelican Univernier dials. The Pelican Univernier will make the finest receiver 100% more efficient. The large single knob gives a 12 to 1 reduction. The 12 to 1 ratio is proved the most efficient for selective control.

Pelican UNIVERNIER complete, 6/- at your dealer or post paid on receipt of P.O.

PELL, CAHILL & CO., LTD.
64 NEWMAN STREET
LONDON, W.1



Telephone: Museum 9236

Telegrams: Pelcarad, Wesdo, London



"WE HAVE FOUND NO OTHER UNIT IN EUROPE."



"E.M.C." FILAMENT DIMMER. "E.M.C." GRID LEAK
2/5 Meg. ... 3/6
5/10 Meg. ... 4/-
0.5 ohms 3/6 0.20 4/- Recommended by "P.W."
0.10 ohms 3/9 0.30 4/3 for UNIDYNE Circuits.

"E.M.C." SPECIAL ANODE Resistance for SUPER SELECTIVE CIRCUIT.
5000/15,000 ohms 4/- Spare Cartridges 1/6 each.

American Inventors say:—
New York City May 16, 1925.
We wish to compliment you upon the design of your variable resistance unit for use in the Filter Tuner or Super Selective Circuit, as it has been called in England. Smooth and delicate control is essential in this important part of the circuit, and we have found no other unit in Europe which performs this function so well.

(Signed) Paul McGinnis,
J. P. J. Maher.



"BARRIE'S" ANTI-VIBRATE VALVE HOLDER. 1/9 each.

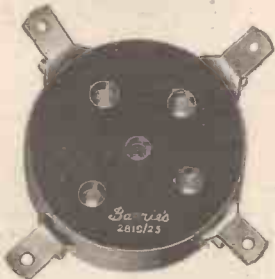

"BARRIE'S" LOW CAPACITY VALVE HOLDER. 1/3 each.

Write at once for LEAFLET No. 84.

**ENTERPRISE MFG. CO., LTD.,
ELECTRIC HOUSE, GRAPE STREET, LONDON, W.C.2**

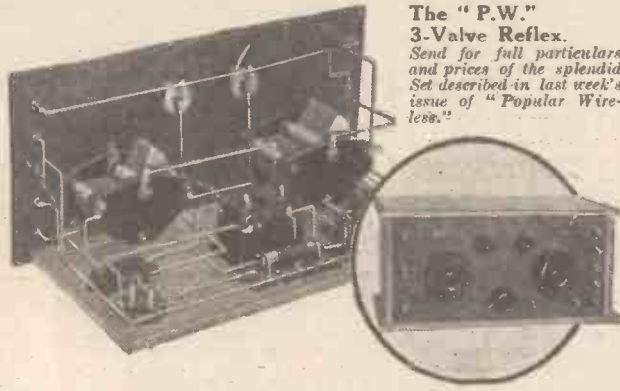

The "P.W." 3-Valve Reflex.
Send for full particulars and prices of the splendid Set described in last week's issue of "Popular Wireless."

Now you can buy a splendid 2-Valve Set for 68/- a Crystal Set is not worth while.

NO need to spend a lot of money on a ready-built receiver when you can build the splendid "Popular Wireless" 2-Valve Continental Set shown above for just over £3. This is a wonderful Set for long-distance reception. Now that valves have been reduced in price no one can say that a Valve Receiver is costly to build or expensive to run.

The splendid Set shown here is only one of many shown in the Pilot Chart (post free 3d). Send for your copy to-day, and see what you save when you build your own Set.

**PETO-SCOTT CO., Ltd.,
77, CITY ROAD, LONDON, E.C.1.**
Also at 62, High Holborn, London, W.C.1. WALTHAMSTOW—320, Wood St. PLYMOUTH—4, Bank of England Place. LIVERPOOL—4, Manchester St. P.S. 3471

- | | |
|---------------------------------|--------|
| 1 Peto-Scott Square Law & s. d. | |
| Condenser, '0005 | 8 0 |
| 1 Peto-Scott Square Law | |
| Condenser, '0003 | 6 9 |
| 2 Microstats | 5 6 |
| 1 Two-Coil Holder, Board | |
| Mounting | 5 6 |
| 2 Anti-capacity Valve | |
| Holders | 2 6 |
| 1 Board Mounting Coil | |
| Holder | 1 6 |
| 1 2-Meg. Leak and Fixed | |
| Condenser (Peto-Scott) | 3 6 |
| 1 '002 Fixed Condenser | |
| (Peto-Scott) | 1 6 |
| 10 Mark III. Terminals | 1 8 |
| 6 2 ft. Lengths 1/16 Bus | |
| Bar, Nuts, Screws, etc. | 1 1 |
| 1 Packet Panel Transfers | |
| Plain Panel "Red Tri- | |
| angle," 13" x 6" x 6" | 5 0 |
| Panel drilled, extra | 2 0 |
| Panel engraved, extra | 2 0 |
| CABINET, 13" x 6" x | |
| 6", with Baseboard, | |
| Mahogany | 1 0 |
| | £3 8 0 |

More about the wonderful new 'Mars' Coil



Patent applied for.

The New MARS COIL

still supreme—the MARS AERIAL

The "Mars" Aerial is simply the best for expert and amateur alike. National Physical Laboratory Tests have proved its ten-fold superiority. It is an Aerial that gives valve-set volume to the most elementary crystal set—the Aerial that enables valve set users to tune in those distant elusive stations more sweetly and clearly. Price 9/6 per 100 feet—and worth it. Beware of imitations; they cannot have the patented "Mars" feature, which makes all the difference.

The New 'Mars' Coil does at least two things better than any other coil on the market.

It reproduces music as music, because each turn of the wire, the exact spot in which one wire crosses another, is determined in accordance with the principles of harmonic vibrations. The purity of tone obtained with "Mars" Coils adds immeasurably to the pleasure of listening-in. The other "Mars" superiority is the extra volume the Coils give—at least 75% stronger signals. The purely technical superiority of the "Mars" on test is 25%.

Look for no spectacular fittings when you buy the "Mars." It has been stripped of all efficiency reducing ornament. Useless fittings which bring about shrouding and so increase capacity are eliminated.

The basis of this super low-loss coil is absence of resistance, absence of dielectric capacities secured by the use of the "Mars" Coil.

Trade experts who have tested the "Mars" agree that it will be the Coil of the season.

Now on sale at all the leading Wireless dealers. Look for the orange and blue carton.

"MARS" COIL WIRE.

Is obtainable separately for those who prefer to wind Coils their own way. Make a couple of simple Coils for your Crystal set. Even this set will prove the super efficiency of the "Mars" Coil Wire patented spiral spin and triple-conductor features.



Full particulars of the "Mars" specialities may be obtained, free, on request to:
E. & W. G. MAKINSON LTD.,
(Patentees and Sole Manufacturers) Wellington Works, Wellfield Rd., PRESTON.
Who will supply the "Mars" products by post if unobtainable from local dealer. But please enquire locally before writing to us.



TRADE **DECKO** MARK

LOCK IT!!!

A NEW SWITCH COMBINING THE FEATURES OF THE BEST BATTERY SWITCHES AND THE WORLD'S FINEST LOCKS.

Obtainable from all the best dealers.

Price **2/9** each with One Key.

PREVENTS ANYONE FROM USING YOUR SET, WITHOUT THE AID OF THE KEY.

A.F. BULGIN & CO
8-11 CURSTON STREET
LONDON, W.C.2

3-VALVE COMBINATION RECEIVER.

(Continued from page 116.)

I.P. of L.F. transformer (Eureka Grand) to the first H.T. + terminal; and the second H.T. — terminal.

A .002 fixed condenser is connected across the primary of the above L.F. transformer.

Plate contact of the second valve holder to plug side of moving coil plug (on two-way coil holder).

Socket side of moving coil plug to centre right-hand contact of the first D.P.D.T. switch.

The Eureka No. 2 L.F. transformer is now mounted.

Socket of second choke to L.T. + lead. Grid contact of the third valve holder to O.S. of Eureka No. 2 L.F. transformer. I.P. to first H.T. + lead. O.P. to top left-hand contact of the second D.P.D.T. switch.

Top right-hand contact of the second D.P.D.T. switch to the second H.T. + terminal. A .5 mfd. fixed condenser is connected across the first H.T. — and the second H.T. + terminals, and another .002 fixed condenser across the primary of the Eureka No. 2 L.F. transformer.

Bottom left-hand contact of the second D.P.D.T. switch to one 'phone terminal, to plate contact of the third valve holder, and to one tag of the .002 'phone condenser (fixed).

Bottom left-hand contact of first D.P.D.T. switch and bottom right-hand contact of second switch to first H.T. + lead.

L.T. — lead to red plug (from earth side of aerial coil [A.T.I.] holder).

I.S. of the Eureka No. 2 L.F. transformer to black plug. These plugs engage with the grid bias battery, or, if the battery is not used, are connected together.

Top right-hand contact of the second D.P.D.T. switch to the second H.T. + terminal. A .5 mfd. fixed condenser is connected across the first H.T. — and the second H.T. + terminals, and another .002 fixed condenser across the primary of the Eureka No. 2 L.F. transformer.

Bottom left-hand contact of the second D.P.D.T. switch to one 'phone terminal, to plate contact of the third valve holder, and to one tag of the .002 'phone condenser (fixed).

Bottom left-hand contact of first D.P.D.T. switch and bottom right-hand contact of second switch to first H.T. + lead.

L.T. — lead to red plug (from earth side of aerial coil [A.T.I.] holder).

I.S. of the Eureka No. 2 L.F. transformer to black plug. These plugs engage with the grid bias battery, or, if the battery is not used, are connected together.

FINAL POINTS IN CONSTRUCTION.

There are four main points of importance that have to be watched when wiring up this receiver, and of these two concern the actual spacing of the connections. In the first place, the leads round the moving coil holder must be arranged so that ample room for a coil of 200 turns is left. The coil must be capable of being moved so that it is at right angles to the anode coil without it pressing or touching any of the connections.

The second point concerns the fixed condensers across the primaries of the L.F. transformers, and these should be situated so that the reaction coil does not touch them when in its lowest position.

The grid leak shown in the photograph was held in position by a springy piece of wire at its free end, but if a leak and condenser, so arranged as to allow the leak to be taken to L.T., then this wire is omitted, and the usual connection to the terminal of the grid leak and condenser is made. However the leak is fixed it must be firmly secured, and it must be connected between the grid of the valve and the filament circuit.

It will be noted in some of the photographs—and this is the fourth point to which we would like to draw attention—that the lead from the left-hand choke (mounted on panel back) to the grid of the first valve has a small wire "foot" soldered on just before the point where it is bent down to pass between the variable condensers. This "foot" is arranged so that the wire, being a long one, cannot approach the panel close enough to make contact with the lead between earth and L.T. negative.

In operation the set is easy to handle, and gives very good results. When testing for the first time the switches should be arranged so that the H.F. and detector valves only are used—that is, both switches down. Then, when everything has proved to be O.K., and reaction is operating properly, the L.T. should be switched in by placing the right-hand switch in the top position.

If reaction does not work, the connections to the moving coil socket should be reversed.

TUNING-IN DISTANT STATIONS.

The movement up or down of the right-hand switch automatically brings in or cuts out the extra H.T. battery, which is connected to the H.T. 2 terminals, the other battery going to those marked H.T. 1. Finally, if still further volume is required, the "reflex" position of Switch No. 1 (left-hand) should be tried, and the set readjusted as to filament of first two valves and the aerial and anode condenser settings. Reaction on the "reflex" part of the set will probably be a little less strong than when the straight circuit is being employed—a point that is beneficial rather than detrimental to the operation of the receiver.

For all but the local station the straight circuit should be used until maximum results are obtained, and then the "reflex" employed to still further bring up the signal strength. If the reflex is used at the outset it may be difficult to tune-in distant transmissions.

As regards chokes and valves, we found the 400 and 600-turn chokes best, the 400 being in the holder situated by the L.T. terminals, while any good combination of valves will do. Those used on test were of the dull emitter-type, with a power valve in the last stage, about 7½-9 volts grid bias being used, the total H.T. on the last anode being 120 volts.

MOUNTS IN MORE WAYS than any other

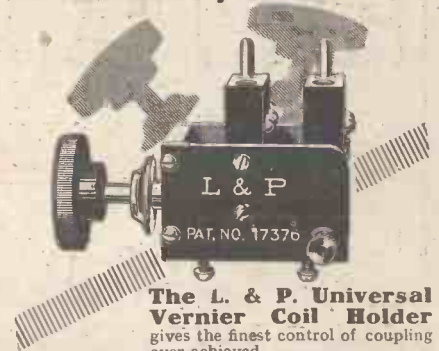

The L. & P. Universal Vernier Coil Holder

gives the finest control of coupling ever achieved.

Designed for "one-hole" panel mounting. Easily fitted back or front of panel. The action of the moving coil holder is on the worm and pinion principle, together with a special patented spring which balances the weight of the moving coil. This combination gives a smoothness and delicacy of control not to be experienced with any other device whatsoever.

Every part of the workmanship is superb. All metal heavily plated. Only PURE ebonite used — no mouldings.

This device will make all the difference between "getting" a distant station and "just missing it."

Do not buy a coil holder of any kind until you have had our list. Sent free on request. Mention name of dealer when writing.

LONDON & PROVINCIAL RADIO COMPANY, LTD., 35, Colne Lane, Colne, Lancs.

FREE

WIRELESS EXHIBITION
Albert Hall
Sept.
12th to 23rd

Stop that continued vibration of the filament!

USE the Clearer Tone Valve Holder and float your valves—secure from the ever-present, tone - destroying vibrations caused by street traffic, indoor footsteps and the hundred and one other microphonic disturbances. So thoroughly does this new holder cushion the valve that foreign noises are completely dissipated.

The springs, though delicately adjusted, are immensely strong and the tightest valve can be inserted without fear of damaging them. Each spring has one turn only. Bakelite construction of the body of the holder ensures high insulation, low capacity and sturdiness.

each 2/9



There are terminal connections for the experimenter and soldering tags for the permanent set.

2/9 each.



The springs themselves form the valve pin sockets. No soldered joints—all one solid metal piece from tag to valve leg. No flexible wire connections. The spring supports are not affected by stiff bus-bar wiring. For good reception with Dull Emitter Valves, Benjamin Clearer Tone Anti-Microphonic Valve Holders are essential.

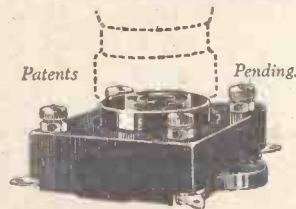

BRITISH BENJAMIN MADE CLEARER TONE VALVE HOLDER (ANTI-MICROPHONIC)

From your Dealer or Direct from THE BENJAMIN ELECTRIC Ltd., Brantwood Works, Tariff Road, Tottenham, N.17.

The Benjamin Battery Switch gives perfect current control, 2/- each.

Picketts Cabinets *Model de-Luxe Polished*

SENT ON APPROVAL.
Beautifully Polished Mahogany

For 12 x 12 Panel ..	45/-
" 12 x 15 ..	55/-
" 12 x 18 ..	65/-

Estimates and Lists free—Send Sizes!

Panels and Complete Accessories—Post Free.
picketts Cabinet (P.W.) Works, Bexleyheath, S.E.

ACCUMULATOR BARGAINS.
O.A.V. & Fullers, solled, but guaranteed 12 months.
Sent on approval against cash.

2v-40a ..	9/6	4v-50a ..	27/6	6v-60a ..	32/6
4v-40a ..	17/-	4v-100a ..	32/6	6v-80a ..	40/-
4v-60a ..	21/9	6v-40a ..	25/-	6v-100a ..	46/-

MAUDE RUBBER CO., 58, FRAED ST., W.

DULL EMITTERS REPAIRED

Each concert tested, 7/6. .06 Valves, 9/6. Bright, 4/9. Guaranteed quick delivery. Send remittance with valve to W. G. Eames, 15, Red Lion St., London, W.O.1. 'Phone: Chancery 7750.

Wireless Aerial Masts
IN STRONG GALVANISED STEEL TUBE

Supplied up to 50 feet high, in two and three lengths, with steel erecting base, stakes and guy ropes. Price 1/- per foot inclusive. **SHORT CHIMNEY MASTS** also at 1/- per foot. Masts well galvanised throughout. **STEEL CHIMNEY STRAPS** 4/6 per set complete. Carriage Paid England & Wales.

Makers: THE DISTRICT IRON & STEEL CO., LIMITED (P.W.) SMETHWICK, STAFFS

1/- Per Foot

The MICROHM VERNIER CONDENSER
for sharp and accurate tuning

2/6

GET ONE TO-DAY
Postage 3d.

MICROHM ENGINEERING Co., Varsity Works, College St., London, E.9. Tel: Clissold 2887

FOREIGN NEWS.

(Continued from page 106.)

Tunis.

The French military post at Tunis, North Africa, is making a series of daily tests with 120 metres and 45 metres wave-length during the three weeks starting on August 13th.

The hours of transmission are 1 a.m., 7.30 a.m., and 6.30 p.m. for the 45 metres length, and 10.20 a.m., 1.20 p.m. and 9.30 p.m. for the 120 metres length.

* * *

Berlin.

The North German Lloyd Company on August 11th made an interesting experiment in broadcasting from their liner Munich at sea. Over the first 500 kilometres of its journey the ship broadcast messages regarding the progress of the voyage, with musical intervals provided by the orchestra on board. These were relayed by a land-wire station to the big radio transmission posts at Frankfurt, Cassel, Bremen, Hanover and Muenster.

The Munich had a 2-watt sending post and used a wave-length of 85 metres. The experiment was entirely successful, the transmission in all cases being very clear. The company's object was to demonstrate to the public with what ease a modern liner can remain in touch with shore.

The Dutch are making an experiment of a similar nature, but on a much more ambitious scale. They aim at establishing a regular subscription service for Dutch receiving amateurs, linking them up with Dutch and foreign liners at sea, so that personal communication may be maintained with friends on board from one's own house during the entire voyage. A system of relays will have to be adopted and is being studied, since the extreme effective range is 300 miles. It has been found that wave-lengths varying between 800 and 900 metres are best.

* * *

Berlin.

The custom for local radio amateurs' clubs to found a sending station of their own, which every member has the right to make use of, is spreading rapidly. The latest addition to the list is the Radio Club at Schoenebek on the Elbe, which has opened a telephonic sending station with a 280 metres wave-length. The days and hours of transmission are Wednesdays and Saturdays from 11 p.m. till midnight, and Sunday from 10 to 11 a.m. Amateurs picking up any messages are requested to communicate with the Funktechnischer Verein, Krausegasse, 9, Schoenebek-an-der-Elbe, Germany.

* * *

Vienna.

It is announced that the new station at Rosenhigen, with a 5-watt power, will be opened for regular broadcasting in October.

* * *

Paris.

President Doumergue of France, whose keen interest in radio matters is well known, has had a new receiving set installed in the summer residence of the French chiefs of state in the Chateau de Rambouillet.

The receiving set is cunningly concealed in an elegant rosewood writing-table of English make.

(Continued on page 138.)



Electricity at your finger tips

EIGHT VOLUMES EACH MEASURING 5¾ by 8½ ins.

WRITTEN AND SIMPLIFIED BY 28 SPECIALISTS AND CONTAINING 4,100 PAGES, 3,300 ILLUSTRATIONS, TABLES, WORKING DIAGRAMS, Etc.

Here is the quickest, easiest, cheapest way to master electricity. Think of it! A complete electrical course in Book form. No tiresome lessons with a lot of mathematics. Just plain everyday electrical facts—the very things and the only things you need to know. You can succeed in electricity. It's one of the best paying fields open to young men who KNOW.

The Electrician will find in these books a veritable mine of information. He will not have to wait till he is put on a job before he can learn something of it; "APPLIED ELECTRICITY" will teach him ALL about it, and all about every other job in the industry. The Working Diagrams, Tables, Blue-print Inserts to be found in the books will be of intense practical value to him when actively engaged, and will ensure accuracy.

To the student these books will give a wide, general insight into the Electrical Industry, and will help him to decide which branch he will enter. They will teach him how to study for a position, and will provide the matter to study.

Student and Electrician, Novice and Experienced Man, will all find in these books much they would never have known by years of practical experience alone.

SOME OF THE CONTENTS PARTICULARS FREE

BLUE-PRINT INSERTS A SPECIAL FEATURE.

Elements of Electricity—Principles of Direct Current Machinery—Commercial Applications—Alternating-Current Machinery—Electric Power Systems—Armature Windings—Alternators—Steam Turbine-Driven Alternators—Economy Factors in Alternators—Rating and Overload Capacities—Alternating Current Testing—Ideal Transformer Action Graphically Represented—Conversion of Alternating into Direct Current—Design of D.C. Dynamos—Classes of Armatures—Winding Tables for Armature Windings—Design of Small Motors—Illustrating Diagrams changing Characteristics of Motor by Re-winding—Automobile Starting and Lighting Equipment—Design of 10,000 Volt Transformer—Electrical Measurements and Meter Reading—Electric Elevators—Railway Signalling, etc.

WHAT OTHERS SAY:

"I am in receipt of your Cyclopaedia of 'APPLIED ELECTRICITY', 8 volumes, and I might say that I am absolutely delighted with them, and with the manner in which the study of Electricity is explained with careful detail. I myself have passed a B.Sc. course in Electrical work, but I find that your books convey things to me much better than any I have already seen."

SEND THIS COUPON NOW.

A booklet has been prepared describing the contents of "APPLIED ELECTRICITY." It also contains a specimen Blue-print Insert.

Write a simple request on a postcard, or fill in and send to us the form below, and we will send you a copy free of charge and any obligation to purchase the books.

FILL IN THIS COUPON AND POST IT NOW. IT PUTS YOU UNDER NO OBLIGATION.

SALES DEPT., P.W., P.O. Box 147.
THE AMERICAN TECHNICAL SOCIETY,
42, Theobald's Road,
LONDON, W.C.1

Dear Sirs,
Please send me FREE a copy of the booklet describing "APPLIED ELECTRICITY" as published in eight volumes, its price and terms of easy payments.

NAME.....

ADDRESS.....

FOREIGN NEWS.

(Continued from page 137.)



Verb. Sap.



WE have tried practically every transformer on the market and your transformers certainly are by far the best, both for ordinary use and for Power Amplification and, what is very important, they are the most convenient for mounting.

"Their chief advantages over others are strength, clearness of speech and music, and entire absence of howling even when placed very close to each other.

"In the hands of amateurs, they should also be splendid for their freedom from self-capacity effects."

In these words a prominent West London Wireless Firm gives its unsolicited opinion of the M-L Low Frequency Transformer. Their satisfaction can easily be shared by you—M-L Transformers only cost 25/- each, and the name "M-L Wireless" appears conspicuously on the container.

The 1:6 ratio is used for amplification after a crystal rectifier. The 1:4 ratio is used for single stage L-F Amplification. The 1:2:6 and 1:4 ratios are used respectively in the first and second stages of two-stage amplification.

S. SMITH & SONS (M.A) LTD.
179-185, Great Portland Street, London, W.1

Telephone: Langham 2323 Telegrams: "Speedomet, Telew. London"
Also at Birmingham, Manchester, Glasgow and Belfast.

S. SMITH & SONS (M.A) LTD

E.P.S.a.

Moscow.

The amazing progress of radio in Russia within the past few months is strikingly shown in the official figures just published, that over 6,000 workers' clubs and nearly 12,000 public reading-rooms in Russia have been fitted with radio receiving sets.

Incidentally, Russia at present is a very good market for sets and accessories, as the demand is largely in excess of the supply.

* * *

Madrid.

It is announced that the Madrid exhibition of Radio Telegraphy and Telephony will be opened on November 15th. It will be held in the Palais de Glace, and will, it is said, be one of the most important shows of the kind ever held in Europe.

* * *

Milan.

The Unione Radiofonica Italiana, of Rome, is building a new transmission station at Milan with 1.5 kilowatts, which will use a 308 metre wave-length.

NEXT WEEK.**Special Features.**

250 Radio Questions
Answered.

* * *

How to Make a Four-
Valve Set.

AND

The First of a Special
Series of Articles by
Britain's Leading Amateur,
Mr. GERALD MARCUSE.

* * *

Order Your Copy Now.

The broadcasting tests will start towards the beginning of September.

* * *

Radio-Toulouse.

Radio-Toulouse is experimenting on 1,100 metres nightly from 8.15 to 9.30, Sundays excepted. This station will relay the concerts of the "Petit Parisien" once a week, starting in October.

* * *

More DX Results.

The 115-metre transmitting set, installed at the Eiffel Tower, Paris, has been heard in Cape Town and New Zealand.

* * *

A Persian Station?

A large broadcasting station is reported to be under construction in Teheran (Persia), and in the provinces six relay stations are proposed.

* * *

Kursaal Concerts at Scheveningen.

Hilversum has been broadcasting the Kursaal concerts at Scheveningen during the summer months.

TECHNICAL NOTES

(Continued from page 90.)

The development of the practical applications of the piezo-effect have been principally made in the laboratories of the Western Electric Co. (U.S.A.), but whether this latest type of loud speaker is a product of that company I am not able to say. There is nothing new in the principle, or in the application of it in such ways as this: the object of the research work has been to secure a large effect, efficiency, permanency, and the other qualities which are necessary before a principle can be made the basis of manufacturing operations. One of the main discoveries on the part of the Western Electric Co. is the method of "growing" crystals of sufficient size and the necessary regularity and piezo-electric properties. I am informed that crystals can now be made up to three inches in length.

Toroidal Coils.

In these notes, some little time ago, the toroidal coil was discussed, this coil having the principal advantage that the magnetic field is restricted in a special way. The shape of the toroidal coil is similar to that of a balloon tyre of a motor-car, and on this point the "Radio World" (New York) has some interesting remarks to make. It is pointed out that the toroidal coil is the only balloon-tyre-shaped thing in radio and that, owing to the great popularity of the latter in the motor field, and the effect of suggestion upon the public mind, the balloon tyre coil has achieved an enhanced popularity. This theory is ingenious, but it is difficult to believe that the psychological effect in this case can account for very much.

Certainly it would not do much permanent good if the coil itself were not efficient. It is stated, however, that the coil in question has been the subject of much research work by the leading radio manufacturers in the States, and that, with the new coils, interference is negligible at a distance of about one inch from the coil. The toroidal coil has no undue distributed capacity, but its resistance is usually greater than that of other types of coil, owing to the larger amount of wire required to produce a given inductance value.

Effects of Grid Bias.

The value of a grid-bias battery, not only in improving the quality of reception, but also in reducing the plate current, and thus prolonging the life of the H.T. battery, is well known, but in this connection it may be interesting to have some figures which have been arrived at as a result of actual test. Measurements of the plate current were made with a 5-valve neutrodyne set, and it was found that the average current was of the order of about 20 milli-amps., the current in some cases, however, being as much as 30 milli-amps. By the proper use of grid bias batteries this current could be reduced to 10 milli-amps., with an obvious saving of considerable importance.

The use of the grid bias on the L.F. side has, as already mentioned, the effect of reducing the plate current and also of improving the quality of reception. The grid bias may also be used on the H.F. side, in which case it has the effect of reducing the plate current, but not of influencing the

(Continued on page 140.)

K. RAYMOND

HULLO EVERYBODY!

ALL GOODS POST FREE U.K. except where stated. Foreign orders over £10 post free otherwise please send ample for post, etc. Trade orders U.K. less 20% Post extra. Open all day Saturday.

SUNDRIES

- Aerial, 7/22, 100ft. 2/6
2-way coil stands 2/8
3-way coil stands 4/6
2-way nickel 3/6
3-way nickel 4/11
2-way geared 5/18
2-way Shipton cam 7/6
3-way Shipton cam 7/6
2-way Polar cam 6/1
3-way Polar cam 9/1
2-way cam vernier 3/6
Coil plugs, plain... 1/3
Shaped wedge 2 for 1/6
Do. Edison Bell 2 for 2/1
Do. Nickel sides 2 for 1/6
Do. fitted fibre 2 for 1/6
Ebonite do. 4/11
Edison Bell do. 10/1
Fixed Condensers: Edison Bell, .001 1/3
.001 up to .0005 1/3
.002 up to .006 2/1
Grid leak & clips 1/3
.0003 & grid leak 2/6
Dublier .0001 to .0005 each 2/6
.001 to .006 each 3/1
2 or 3 meg Grid Leak 2/6
Anode res. on stand 5/6
150, 70, 100,000 ohms. 4/8
2 mfd. T.O.C. 4/8
1 mfd. T.O.C. 3/10
25 T.O.C. 3/8
Spade tags, .6d. Bus Bar, 1 1/16th sq. 12 ft. 1/1
Solid Rod Valve Holders do. 1/3
Pretwood do. 1/9
H.T.C. under panel 1/6
H.T.C. over panel 1/9
Raymond Rheostat 1/6
R.L. Detector Cords 6/1
Twin Flex, 12yd. 1/9
Red & Black, 12 yds. 2/1
72in. Phone Cords 1/11
Loud Speaker Cords 1/11
Eureka Gravity Detector 6/6
D.P.D.T. Panel 1/3
S.P.D.T. 1/1

TRANSFORMERS L.F.

- Bureka Concert Grand. 30/2
Eureka Second Stage. 30/2
Igranite Shrouded New Model. 21/1
Formo Shrouded. 10/6
General Radio 85 15/6
Super Success (black). 21/1
Brunet shrouded. 3/1 or 5-1 13/6
Wates Supra. 9/6
Terminal complete. Pillar, doz. 3/1-1/3
W.O. 1/1
'Phone' Nickel 9d. doz. extra. Voltmeter March. 2/3
Rheostat & Dial. 2/1

ADJUSTABLE

- (4,000 ohms) Dr. Nepper. 12/6
Bright, B.E. .06 and 1/16. 12/6
Telefunken. 16/11
Both genuine.

VALVES

- B.T.H., Ediswan, Mullard, Cossor, Marconi, Bright, B.E. .06 and power valves all stocked.

IGRANIC COILS

- Coils-25 5/1, 35 5/1, 50 5/2, 75 5/6, 100 7/1, 150 7/10, 200 8/8, 250 9/1, 300 9/8, 400 10/3, Rheostat 4/6 30 ohms 7/1.

ORMOND

- L.F. Transformers. 14/1
Special Rheostat. 2/1

STERLING

- Variable condensers, with vernier. .0005. 25/6
.00025. 22/6
Non-Polar. 4/3
Phones 20/- & 22/6
Primax Loud Speaker 47 15

Ericsson E.V.

- (Continental) 4,000 ohms. 12/-

HEADPHONES

- British, 4,000 ohms. B.T.H. 22/6
Brands. 20/-
Brown's 'P' type 20/-
Ericsson's. 22/6

VARIOUS.

- American. Accrating dials. 17/6
Pico 20-1. 6/9
Ultra Vernier. 13/6
Success Microtuno 6/6
Success-net. parts stocked or obtained. 9/1
Westminster coil winder. 4/-
Coil winder. 4/6
Speakers. 1/6
A B C Wave Trap Former. 3/3
Igranite Ultituno minor. 7/6
Ditto major. 9/1

WEST-END LEADING STOCKIST for Ediswan, Bell, Jackson's (J.B.), Polar, Igranite, Elwell, Peerless, Bureka, Magnum, Burndept, Lotus, Dublier, Marconi, Dorwood, Sterling, Success, B.T.H., McMichael, Lissen, Woodhall, Utility, R.I., Bowyer-Lowe, Amplion, Formo, Brunet, Ormond, Peter Carls parts, etc. SEND YOUR LISTS AND I WILL QUOTE YOU LOWEST PRICES. MANY GOODS PRACTICALLY UNOBTAINABLE ELSEWHERE CAN BE SUPPLIED AT SHORT NOTICE TO RETAIL CUSTOMERS.

RAYMOND Variable Condensers

- SQUARE LAW LOW-LOSS One hole fixings. Ebonite ends. With Vernier Without Vernier
.001 .. 8/6 .001 .. 7/6
.0005 .. 7/6 .0005 .. 5/9
.0003 .. 7/- .0003 .. 5/3
Including knob and dial. Post 3d. set.

STANDARD.

- .001 .. 7/6
.0005 .. 6/-
.0003 .. 5/6
.0002 .. 5/-
Take up tiny space. Knob & dial free. All with knob & dial.

ORMOND "AMERICAN"

- Square Law Low Loss. Skeleton ends, knob and dial. .001, 9/-; .0005, 8/-; .0003, 7/6; .00025, 6/6 (with vernier 1/6 each exl.)

JACKSON BROS. "J.B."

- Square Law with vernier. .001 .. 9/6
.0005 .. 8/1
.0003 .. 6/9
.00025 .. 6/6
"J.B." .001 .. 8/6
Standard .0003 .. 5/9
ALL with knob and dial. Post free.

ACCUMULATORS.

- 2-v. 40-amp. 9/6
2-v. 60-amp. 14/6
4-v. 40-amp. 15/11
4-v. 60-amp. 19/6
4-v. 80-amp. 24/6
6-v. 80-amp. 35/9
All new, best makes. Harts also stocked. Goswell (quality) Mounted Coils. 25 1/6, 35 1/9, 50 2/1, 75 2/3, 100 2/9, 150 3/1, 200 3/9, 250 5/3, 300 6/-.

THORPE K4

- (Ulvindye 5-pin) VALVES. Genuine, each 14/-
5-pin valve holder, 1/3
Set Parts (one valve) 4s 6/6
Ditto (two valves) 6s 6/6
(Including valves).

EBONITE

- Cut to size. 3/16th sq. sq. inch 1 1/4 sq. inch.

"WONDER" AERIAL

- Phosphor Bronze. 100 ft. 3/3
Indoor, outdoor or frame. 49 strands.

"UTILITY"

- 2 pole c/o knob. 4/-
4 pole c/o knob. 5/-
4 pole c/o lever. 5/-
Nickel 6d. ea. ex. Variable transformers at list prices.

SECOND-HAND DEPT.

- Quantities of nearly new and second-hand goods on sale. Cheap prices. Old parts bought or taken in part exchange.

IMPOSSIBLE

to advertise all lines here. Send name and address (postcard, please) for illustrated folder. Special offers not obtainable elsewhere.

IF WANTING ANY GOODS MAKE OUT LIST AND I WILL QUOTE LOWEST INCLUSIVE PRICES.

VALVES

- To encourage you to use British Valves I am willing to purchase one burnt-out valve for each valve you purchase. Prices given range from 1/3 to 4/- according to valve you buy.

YOUR PANEL DRILLED FREE WITH 25/- order (retail)

CALLERS COLUMN ONLY

- All Post Orders from Other Columns. H.T. BATTERIES (well-known makers). 60v. 5/6, 8/6, 11/11
66v. Ever Ready. 12/6
108v. 20/
60v. B.E.O. 8/11
165v. 5/6
9v. (grid bias) 2/-
Accumulators (well-known makes) 2v. 40a. 7/6, 8/6
4v. 40a. 13/11, 15/11
4v. 60a. 17/6, 18/3
4v. 80a. 22/6, 23/6
Cover coil, foot. 3/6
6v. 80a. 33/6
6v. 100a. 38/6

Square Law Variable Condensers.

- .0005, 5/- .0003, 4/6
Including knob & dial.

D.P.D.T. Panel.

- 1/-
S.P.D.T. 10/6
S.P.D.T. chins 1/3
S.P.D.T. 10/6
Terminals, 1d. Nickel doz. 10d.

Valve sockets for 3rd.

- Stop or valve plus. 1d. Washers. 12 a 1d. Nuts. 6 a 1d. Spade terminals. 2 for 1d.

Pinterminals 2 for 1d.

- Do. Red or Black, 1d. Shorting clips, 3 a 1d. Sheerling wire. 3d. Red and black flex. 12 yards, 1/6

Edison 7/22 100ft. 1/11

- Phone cords, 6 ft. 1/3
Knobs and Dials. 10d. Empire Tapo. 12 yds. 6d.

Valve Holders. 8d.

- Plug and socket, red or black. 3d. 7/22 Aerial, 50 ft. 1/11
Ins. Hooks, 2 for 1d. Loud speaker cords. 1/4, 1/6

Rheostats, special. 9d.

- Vernier condensers, 1/9
Tumbler switches 10d.
Shorting plugs 3d.
Erg insulators, 4 for 3d.
Variometer 250/650 1/6
Anticap ditto. 10d.

Solid rod standard 1/1

- Extra large do. 5/1d. Hank 1/16th sq. Bus Bar 6d. Lead-in (10 yds.) 1/-

Ebonite dials. 8d.

- Unbreakable knobs 3/6
Adhesive tape, roll, 2/6
Tape aerial, 100ft. 1/10
TWIN Bell Wire, per 100 yds. 2s.

BRUNN 4,000 ohm 'phones' 13/11

- Ebonite Coil Plugs Fitted Fibre. 7d. Plain. 4d. Shaped. 6d. & 7d. Edison Bell. 11d.

Loud speakers. 15/9

- 4,000 ohm phones, 6/6
3-way coil stands, 3/6
Special rheostats, 1/6
Crystals, best. 6d.
Encl. auto detectors, 8d.
Extra large do. 5/1d.
2v. 40 accumulator. 7/6

Ebonite Stock sizes 3/16th.

- 6 x 6 x 7 5 each 1/2
8 x 6-9 x 6 each 1/10
10 x 8-12 x 6. 3/3
12 x 12. 4/3
12 x 12. 5/6
14 x 10. 5/6
4-in. also stocked.

NO CONNECTION WITH ANY OTHER FIRM WITH A SIMILAR LIST.

BE SURE YOU ARE AT RAYMOND'S

77 GRAPE STREET SHAFTESBURY AVENUE, W.C.2

New Oxford Street end. 1 minute Tottenham Court Road Tube. NOTE! Grape Street is between Prince's Theatre and Muddie's Library. DAILY 9 a.m. to 8 p.m. SUNDAYS 11 to 1 p.m. All day Saturday. 3 minutes Holborn Tube. 2 minutes Palace Theatre.

HOURS OF BUSINESS

Daily 9 a.m. to 8 p.m. Sundays, 11 to 1. Open all day Saturday. Two shops, one always open. Telephone (private line) Gerrard 2821.

Quality RADIO COMPONENTS

Profusely illustrated thirty page CATALOGUE just out. If your dealer cannot give you one send us a card with his name and address to receive it direct FREE and POST FREE.

ECENTRIC VERNIER COIL HOLDER.

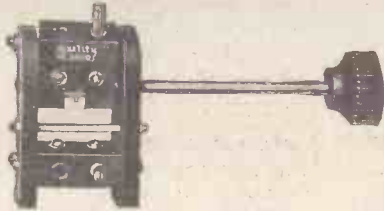

Both broad and fine vernier tuning controlled by one knob giving a small amount of fine adjustment at any position.

2 way, 6/-, 3 way, 8/-
N.P. 2 way, 6d., 3 way, 1/- extra.
Postage 4d. each.

INSULATED VALVE SOCKETS

Set of 4, including 1 red for Plate, with drilling template, 1/- Post 2d.

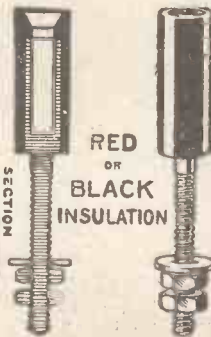

RED OR BLACK INSULATION

Quality RADIO ANTI-CAPACITY HANDLES



A



C

Fits by suction on standard condenser knob. On and off in a moment, stops all hand capacity effects.

2/- each. Post 3d.

If your dealer has not got them we send post free if you mention his name and address.

GOSWELL ENGINEERING CO., LTD.
95/8, WHITE LION ST., LONDON, N.1.

TECHNICAL NOTES. (Continued from page 139).

distance of reception, that is, the sensitiveness of the set, nor the quality of reproduction. In fact, it is on the L.F. side that the grid bias "pays" best. A neodyne circuit with grid bias on the H.F. side is more difficult to balance than without the grid bias battery.

A New Variometer.

The new Dubilier-Mansbridge variometer is an interesting and useful component which should find considerable use amongst constructors. It is of the flat type, with four "D"-shaped coils, two of which may be rotated by means of the knob of the instrument, so as to vary the coupling. The coils may be connected in series or parallel and are of the low-capacity construction.

By means of this variometer, a wide range of inductance is obtainable, which is useful for a wide range of wave-length, using a condenser. This component is very adaptable, and as regards efficiency and manufacture is up to the usual Dubilier standard.

Measuring Thickness of Wire.

A simple emergency method for finding the diameter of a piece of wire in case you do not happen to have a micrometer gauge, is as follows. It necessitates the use of a straight-edge and a steel rule. These two are placed together, edge to edge, and tied fairly tight at one end with string, cotton thread, or fine wire. A piece of wire of known gauge or diameter is then inserted between the two, and pushed towards the tied end until it is gripped fairly firmly. The straight-edge and the steel rule are then held in a V-shaped formation. The piece of wire to be gauged is now introduced between the "jaws" of a "V" formed in this way, and moved along towards the closed end until it is gently gripped.

The diameter required then bears the same relation to that of the standard wire, as the distance of the unknown wire from the end of the rule bears to the distance of the known wire. For example, suppose the known wire has a diameter of 1 mm., and it is fixed at a distance of 1 inch from the closed end of the "V," and that the unknown wire becomes fixed at a distance of 3 inches from the closed end of the "V"; then the diameter of the unknown wire is 3 mm.

HEADPHONE REPAIRS.

Rewound, re-magnetised and readjusted. Lowest prices quoted on receipt of telephones. Delivery three days.—THE VARLEY MAGNET CO., London, S.E.18. Phone 888-9 Woolwich. Est. 26 years.

'PHONES STRENGTHENED!!

NEW SECRET METHOD.

of magnetising and adjusting improves new or old 'phones 20 per cent to 200 per cent. 2/- pair. Guaranteed result. New method of layer-wound rewinding renews useless 'phones and makes them better than new. 5/- pair. Every class of repair to 'phones, loudspeakers and transformers. All work guaranteed. Ready same day. Post, 6d. pair. Prospectus P. gratis. JOHN W. MILLER, 68, Farringdon St., E.C.4. Phone: Central 1950.

EASY PAYMENTS

LOUD SPEAKERS. Any make. Your selection. Amplion, Brown, Sparta, Sterling, etc. Quarter deposit. Balance six monthly payments.
Headphones and Parts similar terms. Send a list of the parts you are requiring and we will forward you a quotation on the hire purchase system.
ACCUMULATORS. Best quality. Guaranteed.
Three m'thly Cash. payments Three m'thly Cash. payments
4 v.-40 17/- 8/3 6 v.-40 25/- 9/-
4 v.-60 22/6 8/3 6 v.-60 32/- 11/6
4 v.-80 27/- 9/9 6 v.-80 38/8 14/-
4 v.-100 32/- 11/6 6 v.-100 45/- 16/-
Carr. and Packing, 1/6 any size.
H. W. HOLMES, 29, Foley Street, Great Portland Street, W.1. Phone: Museum 1414

C.A.V.

See our new range of WIRELESS PRODUCTIONS

STAND 33

Albert Hall

C.A.V. Vandervell & Co. Ltd.

WARPLE WAY ACTON LONDON W3

END YOUR EARTHLY TROUBLES.

By using
ZIG ZAG
ELECTRODES OR EARTH PLATES

Electrical & General Sundries Ltd.
14 Victoria Street, S.W.1.

PATENTS, TRADE MARKS, INVENTIONS
ADVICE, HANDBOOK & CONSULTATIONS FREE
B. T. KING, C.I.M.E., Regd. Patent Agent (G.B. U.S. & Canada), 146a, Queen Victoria Street, London, E.C.4. 39 years' references.

RADIO "CROXSONIA" PANELS

Money back guarantee that each and all Panels are free from surface leakage, Meggar test Infinity. 5" x 5", 1/2; 7" x 6", 1/3; 9" x 6", 1/7; 10" x 8", 2/1; 11" x 8", 2/3; 10" x 9", 2/4; 12" x 8", 2/6; 11" x 9", 2/7; 12" x 9", 2/10; 12" x 10", 3/-; 14" x 10", 3/5; 14" x 12", 4/-; 7" x 5", 1/- 1/8 thick. Post Free. Callers, cut any size, and quote by Post. Sample, and prices, post free to the Trade.

CROXSONIA CO., 10, South St., MOORGATE, E.C.2

STEEL MASTS

NAVY PATTERN DESIGNED AND MANUFACTURED BY **HAMILTON MAY**
CATALOGUE WEYBRIDGE, SURREY. Tel: 784
"B" post free.

DREADNOUGHT BRAND

THE "WONDER" CRYSTAL

The wonder of the age. Brings in stations you have never heard before. As good as an extra valve. Ask your dealer, or send P.O. 1/3 to **THE LEONFELD ENGINEERING CO., 23a, Leonfeld Road, London, N.5.**

CRITICAL TUNING MADE EASY

The WINDSOR VERNIER COIL HOLDER moves like silk, no back lash, holds any coil.
The only coil holder for KDKA.

2-way.....6/- **WINDSOR WIRELESS WORKS**
3-way.....9/-
Post Free. 413a, Brighton Rd., South Croydon

2-VALVE AMPLIFIER, 35/-

1-Valve Amplifier, 20/-, both perfect as new. Valves, 4/6 each; smart Headphones, 7/6 pair; new 4-Volt Accumulator, celluloid case, 13/-; new 60-Volt H.T. Battery, guaranteed, 6/-; 2-Valves All-Station Set, £4. Approval willing! P. TAYLOR, 57, Studley Road, Stockwell, LONDON.

The Home for Your Wireless Set!

MORRIS SOLID OAK STANDARD CABINET with Locks,

to lock up any set and batteries with panel up to 36" x 18".

Sent on approval. Trade supplied.

Price carriage paid and packing free:

22" wide inside.	£4 15
25"	£5 0
25" model de Luxe	£5 15
36"	£8 0

MAKERIMPORT CO. (Dept. 5)
50a, Lord Street, LIVERPOOL.

WHY THE **R.I.** CURVE IS RIGHT



For Symphony or Solo

The first essential of the skilled orchestral conductor is the power to maintain correct balance among all his instruments. The note frequencies of these instruments may vary anywhere between 30-30,000 cycles per sec. The predominance of any one instrument or frequency would upset the whole theme of his music.

The Radio Transformer is faced with exactly the same situation. The wide range of note frequencies that are presented through the medium of broadcasting must be amplified without emphasis on any particular instrument or frequency or else the resulting reproduction will be imperfect in value and distorted.

Even in the case of a solo the amplification must preserve the minute overtones that give character to the rendering.

This problem of perfect amplification calls for years of research and difficult experiment.

Any transformer will give you electrical amplification. It takes the R.I. Transformer with 25 years of experience behind it to give **TRUE** musical amplification.



25/-

Write for R.I. Catalogue, free on application.

Visit our Stand No. 36 at the All-British Wireless Exhibition, Albert Hall, September 12th—September 23rd.



LISSENIUM.

A High Grade Component

With the first glance at the new LISSEN WIRE RHEOSTAT, the clean, well-thought-out design is evident.

Features which, in other rheostats, are a prolific source of trouble, have been eliminated in the LISSEN WIRE RHEOSTAT by care and ingenuity.

No electrical leaks—no mechanical faults—every small detail of the complete component made and fitted with such thought and care as to place the LISSEN WIRE RHEOSTAT in a class entirely its own.

Examine it—notice the smoothness and certainty of action, the firm grip of the contact arm as it slides over the resistance element. The whole rheostat so accurately made that smooth, positive contact is obtained without the use of springs or a flimsy contact arm. There is no risk of chattering or uneven pressure—no chance of arc-ing, noise or flickering.

Look at the way in which the resistance element is wound and mounted; see how the turns are prevented from moving and shorting—no possibility of the effective resistance being altered by movement in use.

You will be pleased with the accessible terminals, the neat photo-engraved dial and the unique type of combined knob and pointer which fits down flush with the dial when mounted.

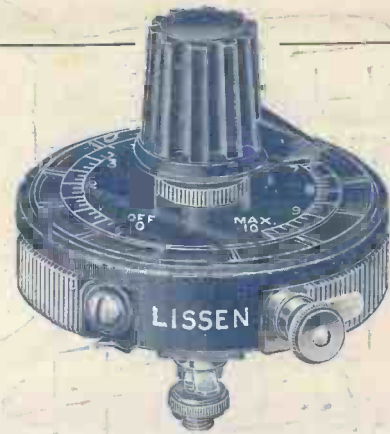

THE LISSEN WIRE RHEOSTAT.

7 ohms	- - - - -	4/-
35 "	- - - - -	4/-
Dual	- - - - -	6/-

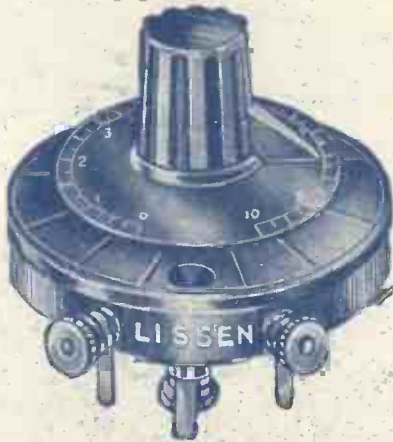

The Lissen Potentiometer

There is, too, THE LISSEN POTENTIOMETER. All the unique features of the *Lissen Wire Rheostat* are embodied in its design. The total resistance is 400 ohms.

YOU WILL LIKE THE LISSEN WIRE RHEOSTAT AND LISSEN POTENTIOMETER AND BOTH ARE NECESSARY IN A WELL SELECTED EXPERIMENTAL KIT.

If you experience any difficulty in obtaining them locally, ask your usual dealer to order them for you, or send direct.

THE LISSEN POTENTIOMETER.
400 ohms - - - - - 4/6
Lissen One-hole Fixing, of course.

LISSEN LIMITED

LISSENIUM WORKS, 8-16, FRIARS LANE, RICHMOND, SURREY.

'Phone: Richmond 2285 (4 lines).

'Grams: "LISSENIUM, LONDON."

Write for TEXT BOOK of LISSEN PARTS—free to readers of this magazine.

LISSEN PARTS—WELL THOUGHT OUT, THEN WELL MADE

All applications for Advertisement Space in POPULAR WIRELESS AND WIRELESS REVIEW to be made to JOHN H. LILE, LTD. (Sole Agents), 4, Ludgate Circus, London, E.C.4. Phone: City 7261 (2 Lines).

MORE ABOUT THE WIRELESS EXHIBITION.

POPULAR WIRELESS

No. 173. Vol. VIII.
September 19th, 1925.

and Wireless Review

PRICE 3d.
EVERY THURSDAY.

Scientific Adviser: SIR OLIVER LODGE, F.R.S., D.Sc.

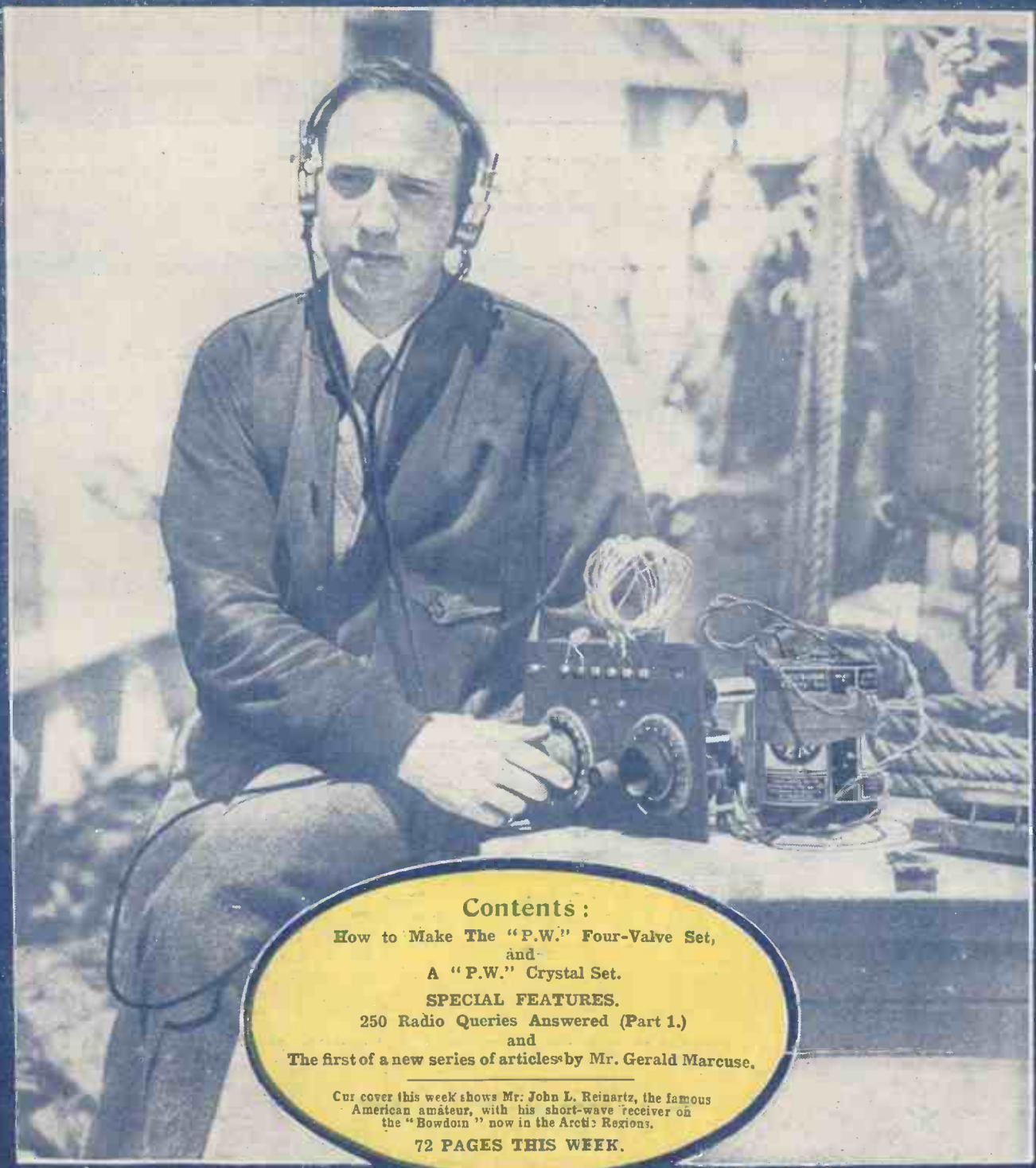

Contents :
 How to Make The "P.W." Four-Valve Set,
 and
 A "P.W." Crystal Set.
SPECIAL FEATURES.
 250 Radio Queries Answered (Part 1.)
 and
 The first of a new series of articles by Mr. Gerald Marcuse.

Our cover this week shows Mr. John L. Reinartz, the famous American amateur, with his short-wave receiver on the "Bowdoin" now in the Arctic Regions.

72 PAGES THIS WEEK.

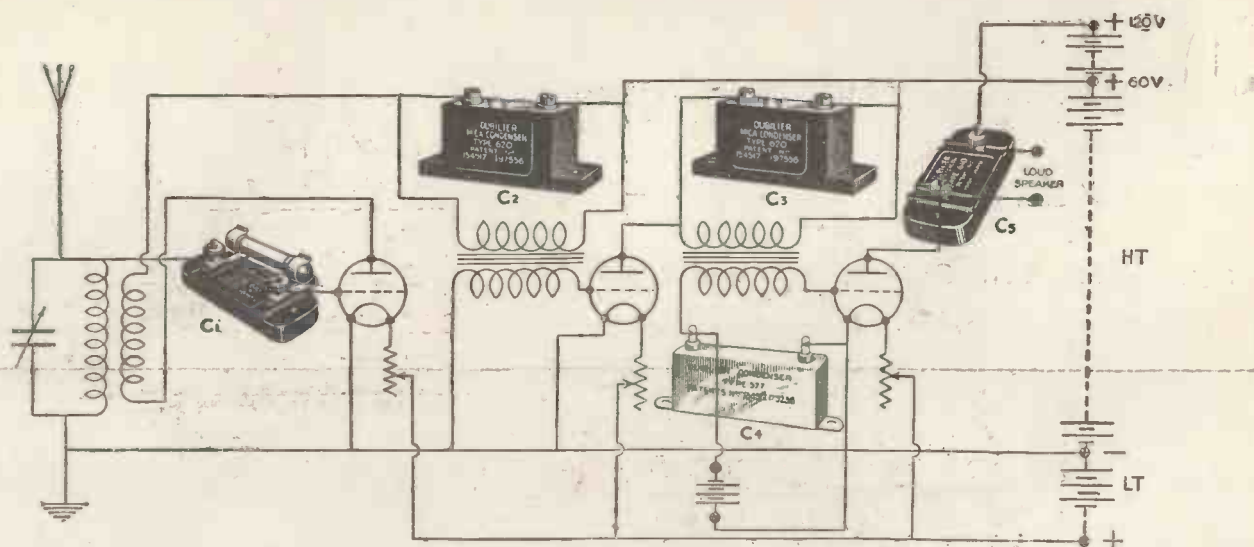

THE RIGHT THING in THE RIGHT PLACE



ALTHOUGH the experience of the average man with wireless matters has been comparatively short, it has certainly been intensive. In the summer of 1922 an aerial outside a house was a rarity. In 1925, on the other hand, it is the house without one that is the exception. Literally millions of people nowadays know quite a lot about the theoretical and practical sides of wireless. Above all they now realise that a successful set must be fitted with good condensers, and in every case the name Dubilier is generally recognised as the hall mark of condensers both fixed and variable, Anode Resistances, and Grid Leaks, and other similar products.

In the illustration above, we show some examples of the right thing in the right place:—

at C1 a Dubilier Type 610 Mica Condenser (from 3/-) with Grid Leak (2/6)

at C2 & C3 Dubilier Type 620 Mica Condensers (from 3/-)

at C4 a Dubilier Type 600a Mica Condenser (from 2/6)

at C5 a Dubilier Type 610 Mica Condenser (from 3/-)

Dubilier Condensers are made in a very wide range of capacities, and the Grid Leaks in several values. Every wireless Dealer stocks Dubilier products, and they are used in every good wireless set.

Always remember that 'quality tells, and make sure you specify—

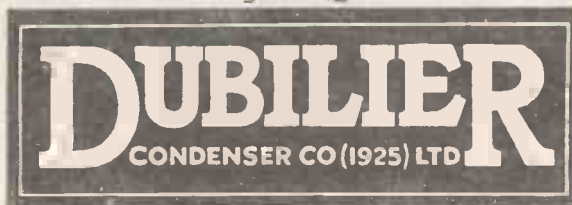

We are exhibiting at the N.A.R.M.A.T. Wireless Exhibition, Royal Albert Hall, September 12th—23rd. Stand Nos. 28 & 50.

A Revelation in Radio Reproduction

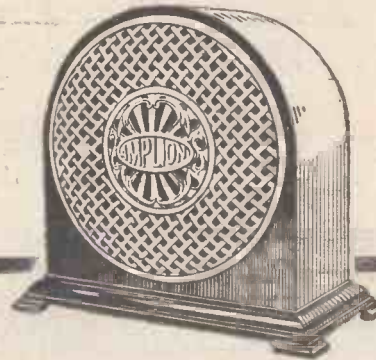

The **RADIOLUX AMPLION**
Large Mahogany Cabinet Model.

The **AMPLION** **Radiolux Series**

of hornless Loud Speakers introduces the nearest approach to the ever-present ideal—perfect reproduction of Radio Broadcast.

This new masterpiece blends the art of furniture design with the science of electro-acoustics.

Here the living voice and true perspective in musical reproduction are within the immediate reach of all interested in Radio. Sensitive to a degree, loud in its fullest measure, with unequalled brilliance and clarity, *real music* at last enters the home upon the trail of the Wireless Wave, providing an **AMPLION** is there to voice its accents.

The Radiolux series of cabinet styles is available in several alternative forms of varying

capacity at "utmost value" prices ranging from £4 15 0.

For those who may still wish to procure the hitherto standard horn models, available in the junior variety at even lower costs, the manufacturers continue to offer the famous "Dragon" range, a series known in every quarter of the globe.

It is a business principle of the House of Graham that every **AMPLION** user shall secure the best possible results, and an unconditional guarantee of satisfaction with the advantage of free service is extended to every purchaser of a genuine

THE
WORLD'S
STANDARD

AMPLION

WIRELESS
LOUD
SPEAKER

FOR BETTER RADIO REPRODUCTION

Patentees and Manufacturers :

ALFRED GRAHAM & CO. (E. A. GRAHAM),
ST. ANDREW'S WORKS, CROFTON PARK, LONDON, S.E.4

Demonstrations gladly given during business hours at the Graham Showrooms :
25-26, Savile Row, Regent Street, W.1; 79-82, High Street, Clapham, S.W.4; and at the recently opened Scottish Depot, 101, St. Vincent Street, Glasgow.

SEE THEM AT THE RADIO EXHIBITION

ROYAL ALBERT HALL, SEPT. 12th-23rd, **AMPLION STAND**, No. 40, MAIN HALL.

Demonstrations will be given continuously during the Exhibition period at the **AMPLION Suite**—Kensington Palace Mansions, 3, De Vere Gardens (a few hundred yards from Albert Hall).



Beneath the umbrella's shade,
Upon the beach sat man and
maid ;

He watched a sail.

Her vision saw the newest hat
And silk and lace and dresses
at

The latest sale.

Until she thought the time
was near
To try her arts upon the dear
Deluded male.

* * * * *

He vowed his love with pas-
sion's aid,
His fortune at her feet he laid.
He never knew 'twas she who
made

Him tell the tale.

Player's Navy Cut Cigarettes.

WITH OR WITHOUT
CORK TIPS

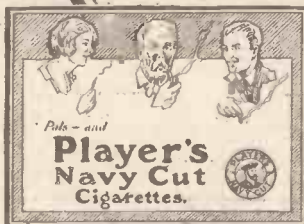

P1217



Brown



CABINET MODEL
2000 or 4000 ohms £6 6 0

The incomparable Brown in four superb new Models



The New HQ
(Height 20 ins.)
2000 or 4000 ohms - £6 0 0



The New H3
(Height 15 ins.)
2000 or 4000 ohms - £3 0 0



The New H4
(Height 20 ins.)
2000 ohms - £1 10 0

OF all the Loud Speakers on the market to-day one is unique. One—by a brilliant application of an entirely original principle—achieves results which can be obtained in no other Loud Speaker. The **Brown**. Here is an instrument which steadily—month by month—has so grown in public favour that it is now recognised as the one great interpreter of true radio music.

Brown principles of design and construction can be found only in **Brown** Loud Speakers. The famous tuned-reed mechanism which permits the use of a super-sensitive cone-shaped aluminium diaphragm as thin as paper is responsible for a tonal purity and mellowness which must be heard to be fully appreciated.

The new Cabinet **Brown** marks a sensible innovation which will instantly appeal to many. A really perfect Loud Speaker capable of a volume equal to the more conventional type is now available in a model which will readily harmonise with the appointments of any room.

The new **HQ** (height 20 inches) is an instrument which will conform to to-day's demands for a

more handsome Loud Speaker in which efficiency has not been sacrificed at the shrine of beauty. Equipped with the same fine quality **Brown** reproducing mechanism, the **HQ** will readily command respect for its wonderful volume wherever it is used.

The new **H3** (height 15 inches) is a successful effort to produce a high-grade Loud Speaker at a moderate price, while the new **H4** is a truly remarkable manufacturing achievement. Here for the first time is a genuine **Brown** Loud Speaker available at the price of a pair of high-grade headphones.

Make arrangements to hear these splendid instruments at your Dealer's. He may not have all of them in stock. Owing to the immense demand we are having difficulties in filling orders, but we are working hard to fill all orders with the greatest possible despatch.

See **Brown** Wireless Apparatus at the Royal Albert Hall Exhibition Stand No. 3.

All the new **Brown** Loud Speakers and the new **Brown** A-type Headphones (30/-) will be on view for the first time at this Exhibition.

S. G. Brown, Ltd., N. Acton, London, W. 3

Showrooms: 19 Mortimer Street, W. 1. 15 Moorfields, Liverpool.
67 High Street, Southampton.

Depots (Wholesale only): 13 Bushy Park, Bristol.
Cross House, Westgate Road, Newcastle.



Like wine, the Wuncell improves with age—

IT is a remarkable fact that the Wuncell—alone among Dull Emitters—actually improves with age. Whereas in most dull emitters the filament loses much of its emission through course of time, that used in the Wuncell actually gains in productivity of electrons.

The Wuncell filament is unique. It is built up layer upon layer under an entirely new process. As a result it is exceptionally robust. When next you get the opportunity to examine a Wuncell compare its filament with that used in any other dull emitter—or even in any bright emitter. You will be amazed at its thickness. It is practically as stout as that used in the average

bright emitter. Yet its wonderful economy of current will enable a six-volt accumulator (with its cells re-connected in parallel to give 2 volts) to give 70 hours' use where it gave but 9 before.

Couple that exceptional economy with the fact that the filament never gets hotter than a very dull red and you will readily realise that even if Wuncells cost twice as much they would be much cheaper in the long run than any bright emitter.

Eventually you'll use Wuncells—why not begin now? Buy them one by one as your present valves become useless. If they will save you money in a month's time, they will save you money now.



The Wuncell Dull Emitter

Voltage 1·8 volts. Consumption ·3 amp.
 W1 for Detector and L.F. 14/-
 W2 for H.F. amplification 14/-
 W3 Cossor Loud Speaker Valve
 Voltage 1·8 volts. Consumption ·5 amp.
 Price 18, 6

Cossor

Popular Wireless

Scientific Adviser :
 Sir OLIVER LODGE,
 F.R.S.
 Consultants :
 Dr. J. H. T. ROBERTS,
 F.Inst.P.
 J. F. CORRIGAN, M.Sc.,
 A.I.C.
 C. E. FIELD, B.Sc.



Editor: NORMAN EDWARDS, M.Inst.R.E., F.R.S.A., F.R.G.S.

Technical Editor :
 G. V. DOWDING,
 Grad.I.E.E.
 Assistant Technical
 Editors :
 K. D. ROGERS.
 P. R. BIRD.

RADIO NOTES AND NEWS.

Tango Bands—The Geneva Station—"P.W." Silver Cups—That Extra Two Shillings—The Wavelength Tests—World's First Set—A Wireless Parliament.

Next Year's Conference.

INTEREST in the Geneva Broadcasting Congress has been very keen in the United States, and now the American State Department has issued invitations to 42 foreign governments to attend a Radio Conference next spring. The increased supervision of broadcasting, elimination of interference, and kindred problems will be the main source of discussion.

Tango Bands.

FOLLOWING the Prince of Wales' visit to South America, where he set a fashion for English ways, it seems probable that there will be quite a vogue for things South American in this country during the coming season. This is specially true of music and dancing, and there is a rumour that the Savoy Hotel has already arranged to import a Tango Band from Buenos Aires. If so, no doubt listeners will be given an opportunity of hearing them ere long if it can be arranged—and I hope it can, for a little variety now and then is relished by the wisest men (whether they are crystal-gazers or crystal-scratchers!).

The Geneva Station.

HAVE you heard the new broadcasting station at Geneva, which has just started transmitting regularly on 1,100 metres? I picked up the signals recently at quite good strength—in fact, I thought it was Hilversum, and did not pay it the attention that a new station deserves. The power used is 1½ kilowatts, and if any reader succeeds in logging the station clearly a report upon reception will be welcomed by the Station Director, Radio-Geneve, Hotel Metropole, Geneva.

The "Eletra's" Cruise.

CRUISING over the treacherous Goodwin Sands at the mouth of the Thames

estuary is not a form of entertainment that would appeal to everybody. But the party of Government, shipping and Press representatives which went out recently on Senator Marconi's yacht (the "Eletra") were too interested in the wireless experiments being carried out to worry about the Goodwin Sands.

charts marked with the various letters, it was possible to tell the position of the ship with respect to the lighthouse. The wavelength used was six metres, and consequently there was no interference from ships wireless, nor from the powerful coast station at North Foreland, whose Morse "voice" is familiar to most listeners in Kent and Essex. The tests were a great success, and will hasten the day when invisible wireless beams sweep a warning all round our coasts for the safety of life at sea.

Nottingham's Exhibition.

NOTTINGHAM readers who fail to enter for the Constructor's Competition at the Nottingham Wireless Exhibition cannot say they lost the chance of winning a silver cup because the conditions were difficult. There are just a few simple rules to be observed, and every amateur set-builder will have a fair chance, for the competition is divided into two sections. In this way juniors and seniors will be judged separately, so a schoolboy

need not fear that his crystal set will suffer because his father is also competing with a posh three-valver.

The "P.W." Silver Cups.

IN each section the first prize will be the POPULAR WIRELESS Silver Cup, the second a Gold Medal, and the third prize a Silver Medal. Intending competitors should apply for an entry form at the Exhibition Offices, 71, Upper Parliament Street, Nottingham. Each competitor is allowed to enter one set only, made entirely by himself, and he must not be connected in any way with the wireless industry.

Radio in Germany.

ONLY two years ago Germany seemed hopelessly behind in the race for radio supremacy in Europe. Now she

(Continued on page 146.)

NEXT WEEK

HOW TO CONSTRUCT

THE CHEAPEST ONE-VALVE SET

AND

THE "P.W." VARIOMETER CRYSTAL RECEIVER

We shall announce in next week's issue details concerning two magnificent gift numbers which will appeal to every class of radio amateur, and also the first details of a new and fascinating competition which will interest amateurs and listeners throughout the country.

Look out for "P.W.'s" Great Surprise and order your next week's copy NOW.

Beam Tests.

IT had been arranged that at dawn, when the great light from the South Foreland lighthouse was extinguished, wireless beams should be sent out instead, and the "Eletra" was to cruise for seven hours and take bearings by the wireless-beams, which are unaffected by foggy or hazy weather. On shore a rotating aerial "flashed" the beam intermittently to all points of the compass. But instead of a flickering light being visible on the ship, its loud speaker announced a letter at intervals, and the position of the ship could be determined according to which letter was picked up.

Safety at Sea.

AS the ship shifted from point to point, so the loud speaker announced a different letter. And, by means of

NOTES AND NEWS.

(Continued from page 145.)

is challenging Britain at all points, and in some directions forging ahead. Already schemes are afoot to place German liners in telephonic touch with the shore next summer, in a way that seems far beyond anything contemplated in this country. And great attention is being paid to short-wave working—a field in which British amateurs have shone, but which has been officially neglected and belittled. When is a British short-wave station going to take the air?

The Biggest Lie Broadcast.

WHAT is supposed to be the biggest lie ever broadcast was recently sent out by the Queensland Government broadcasting station at Brisbane. An alleged "news message" contained some cock-and-bull story about British ships-of-war and troops mobilising; and listeners' hair was raised (where the headphones permitted it to stand up between the bands) by a story of the war-like "intentions" of the British Government. The Federal Postal Department, which controls the station, has promised an immediate investigation—and presumably the Australian equivalent of "Exchange Telegraph and Central News" is "for it."

That Extra Two Shillings.

LEEDS ratepayers who own wireless sets are protesting against the demands of the Leeds Corporation, which is asking for an insurance premium of two shillings if municipal houses are fitted with wireless aerials. As most insurance companies consider the increased risk negligible, and make no extra charge whatever for covering property where an aerial has been erected, the tenants naturally want to know why they should pay two shillings extra to enjoy what other people can get for the cost of the licence only?

Mr. Partridge's Appointment.

I HEAR that Mr. J. A. Partridge, one of the best-known record-breaking experimenters in this country, has been appointed chief resident engineer-in-charge of the B.B.C.'s new reception station at Keston. Special experimental aerials are being erected there for the purpose of picking up long-distance programmes, which will be passed though to London over the newly installed land-lines and thence re-distributed to all the British stations.

Many listeners will envy Mr. Partridge his new job—but everyone admits that it is a well-earned distinction.

2 O D Still Working.

AT the foot of a letter I received the other day from Mr. E. J. Simmonds—the famous amateur-experimenter of Gerrard's Cross—was the following laconic postscript: "I'm still working daily with New Zealand and Australia on 45 metres."

Only a year ago at this time of the year the feat would have been regarded as impossible, but 2 O D doesn't know the meaning of that word.

The Hayes Station.

THE site of the new B.B.C. receiving station at Keston (near Hayes, Kent) is several hundred feet above sea-level on a flat plateau, about 30 acres in extent. At the moment of writing two masts are erected, each 60 ft. high and 120 ft.

apart. Two small wooden huts have been built to provide room for the receiving apparatus, office, sleeping accommodation, etc., and a third hut contains the batteries and necessary charging plant. Aerials in the neighbourhood are few and far between, and the spot is one of the most isolated it is possible to find near London.

The Wave-Length Tests.

AN interesting point about the recent wave-length tests was the fact that Hamburg and Munich, the two German stations who are rumoured to have increased their power recently to 10 kilowatts, were respectively responsible for jamming Liverpool and Glasgow. This clearly shows the need for co-operation in the ether, and I was glad to see that the B.B.C. made a

SHORT WAVES.

"Some people definitely barred their works from being broadcast, notably Kipling, Barrie, and Shaw, and in music the great bulk of Gilbert and Sullivan is forbidden."—Mr. B. E. Nicholls of 2 Z Y (reported in the "Manchester Guardian").

"Photography is going to marry Miss Wireless, and Heaven help everybody when they are married. Life will be very complicated."—Mr. Marcus Adams (reported in the "Observer").

"We conduct all kinds of house insurance without any extra insurance premium, so long as the aerial is in order and efficiently earthed. Risk from lightning is then negligible."—An official of a large Insurance Co. (interviewed by the "Daily Mail").

"The Riff war is said to be interfering with our wireless. We feel sure that when the belligerents are aware of the inconvenience caused they will arrange to confine operations to hours that don't clash with the programmes of the B.B.C."—"Punch."

handsome acknowledgment of the help which they received during the tests, through the ready co-operation of listeners all over the country.

The Geneva Broadcast.

THE broadcasting of the inaugural address of M. Painleve, French Prime Minister and President of the Assembly of the League of Nations at Geneva, afforded listeners the opportunity to hear the handiwork of the Keston receiving station. The signals from Eiffel Tower were picked up there and relayed to London for transmission, the first stage of the journey from Geneva to Paris having been accomplished by land-line.

Despite the fact that Paris is a near-by station, Keston was unable to cut out a lot of interference on the long wave, and I'm afraid that the circuit-selectivity will have to be greatly improved before we get those regular trans-world programmes!

The 3-Valve Reflex: A Correction.

AN unfortunate discrepancy between the theoretical and wiring diagrams occurred in the description of the 3-Valve Reflex, published in last week's POPULAR WIRELESS, (No. 172). In the wiring diagram the lower filament tags of valves 2 and 3 should have been connected together and joined to the L.T.+ lead. In the top left-hand corner of this diagram the terminals should have been marked (from top to bottom) L.T.—, L.T.+ , H.T.—, H.T.+ , but the connections themselves are O.K. as shown. In both Figs. 1 and 2 the aerial and grid connections are as follows: Grid condenser (side not connected to

choke and grid) to P terminal, to one side of condenser, and to aerial coil. Other side of aerial coil to earth and —L.T.; other side of variable condenser to series terminal. (The aerial lead is, of course, connected to "parallel" or "series" as required.)

World's First Set.

THE Radió exhibition season has set in with a vengeance, and in addition to the great London show now on at the Albert Hall, both Nottingham and Liverpool are holding exhibitions. Abroad there are shows at Oslo and Montreal, but the plum of all the exhibits is to be seen at the Albert Hall, where the National Association of Radio Manufacturers and Traders has arranged for Mr. Marconi's first receiving set to be on view. It is so valuable that it will have to be specially guarded.

F 2 Y U.

HAVE you heard 2 Y U working C.W. or telephony between 150 and 200 metres? Reports of the reception of this station will be gladly received by Mr. Maurice H. Wilkinson, "Southerlea," off Batter Lane, Rawdon, near Leeds, who notifies me that he will willingly cooperate with amateur transmitters applying to the above address.

China Calling.

THE French station F 8 Q Q, to which reference was made in these Notes recently, has now been officially licensed as F 8 J L. The latter call-sign will be on the air from November onwards; although the call-letter is apparently French, the station is far more interesting than a mere cross-Channel one, for it is located in French-Indo-China. Reports should be addressed to Mons. R. Jamas, 21, rue Richard, Saigon.

A Wireless Parliament.

THE New South Wales Cabinet is considering a scheme whereby Parliamentary proceedings will be wirelessed to ministers, thereby enabling them to avoid attendance in the House, according to an Exchange Telegraph message from Melbourne. It is suggested that both transmitting and receiving sets will be installed, so that Ministers can debate in the air. The message adds—somewhat naively, I think—"If the House adopts the proposal, Parliamentary proceedings will be revolutionised."

Trans-World Telephony.

CLAIMING to have received both 2 L O and 5 X X in Australia, Mr. Patrick J. Brady, of "Gilberts," Sale, Victoria, states that 2 L O was very sharp, but 5 X X was quite easy to tune!

The set he uses is a 4-valver—H.F., Det., 2 L.F., with reaction on the anode—and the time was between four and six a.m. in Australia. Mr. Brady would like to correspond with readers residing in this country, so further details of this remarkable feat may be obtained direct from Australia.

Albert Hall Exhibit

AS we go to press we learn that the Mullard Stand at the London Exhibition should be Number 16—instead of 10, as previously stated—and that the firm's transmitting valves are on view in the gallery (Stands 22 and 23).

ARIEL.



PRIOR to commencing a series of articles in POPULAR WIRELESS, perhaps it would be more interesting to readers if I were to detail briefly the history of 2 N M's experimental station, about which you will have read from time to time. At the same time I think it might prove interesting to give a brief outline of the experimental work carried out by amateurs in this country since 1912.

My radio interests started way back in 1910 whilst returning from a prospecting trip off the beaten track in Central America and Mexico. I was travelling along the coast on a small American steamer fitted with a half kilowatt spark set and crystal receiver, and although, at that time of the year, reception was practically impossible, excepting when in short range of shore stations, owing to heavy static, I realised that the possibility of radio development would have a distinct bearing on the world's progress in a few years to come.

First Attempts.

I decided to start to experiment as soon as I saw a possible chance of settling down ; but I was determined to travel for a few years, and it was not till 1913 that I found myself in a position to commence operations with a one-inch spark coil and crystal receiver—and a very crude affair it was, too ! But what a thrill it was when I was able to talk by morse with that spark coil to a friend five miles away ! Five miles !

There was not much in those days to listen to ; Paris time signals and news each evening at 8 o'clock. Many a sheet of paper has been filled with the news I received from F L. It was certainly good morse practice ! One could also hear ship and shore stations, Admiralty stations, and Nordeitsch, in Germany. I also remember one enthusiastic London amateur who used to play tunes by means of various musical sparks.

Clocks were always carefully set to F L on Sundays at 10 o'clock, and quite a number of people in the neighbourhood used to gather around for "clock setting." Of course, wireless in those days was looked upon as something quite weird, and I think a good many people thought that we were beyond hope, as they do nowadays !

And so we drifted on to that never-forgotten eve in August, 1914, and I well remember the last message I received from

This is the first of a new and exclusive series of articles by the foremost British Amateur. Mr. Marcuse is Vice-President of the International Amateur Radio Union and A.R.R.L. manager for the British Isles. His call sign, 2 N M, is known all over the world, and we feel sure that readers will welcome his articles in this journal.—The Editor.

No. 1. INTRODUCTORY REMARKS.

Nordeitsch to the effect that the greatest excitement prevailed there in view of war being declared.

The next morning a portly gentleman in blue was at the door, and politely but firmly requested me to dismantle my aerial and elaborate aerial system of four wires on bamboo poles, rigged on the chimneys.

I was also ordered to place all my gear in a box, which was promptly sealed up with red tape. I dread to think what would happen now to my station and a good many others should this action be necessary again. I should need a four-ton lorry !

However, my box with my valued treasures were whisked away one morning—whither no one knew, not even the driver, and it was a year or so later that I received a receipt.

Thus we amateurs all called a halt, excepting those who saw service in the special wireless branches of the services during the war.

Recommencing Operations.

After 1919, when things again settled down, and our friends at the Post Office realised that somewhere stored away in hidden chambers they had some cherished possessions of certain individuals, and, after repeated applications from certain quarters, we were asked where we required our gear to be sent. Eventually we received it—more or less ! With some difficulty we were allotted licences and call letters for 10 watts and for 1,000 metres C.W. and telephony, and 180 metres for spark. At that time one could "spark away" all day without let or hindrance, and it was with difficulty one could get any other amateur to

work with, except by arrangement. What a difference nowadays !

When we eventually got speech going, we were very gratified if we succeeded in reaching out 100 miles, and 2 N M was delighted many a time when he received reports from Wolverhampton and Southampton on his telephony experiments. I forgot to mention that 2 N M was first erected in Bristol, and 100 miles range on a nominal 10 watts was thought wonderful in those days. Now we are quite used to 3,000 miles on 10 watts. I have received reports of one New Zealand amateur being in communication with this country on 3 watts ! This was on a short wave-length, of course.

The First Broadcast Concert.

In those happy days there was no thought of a broadcasting service, although we did have one very fine concert from Chelmsford ; but I understood that the authorities would not allow any more, otherwise we Britishers might have been the first in the field with broadcasting, as I am under the impression that this was the first high-power broadcasting ever accomplished up to that date.

The amateurs in this country, 2 N M included, used, in those days, to send out regular concerts, and greatly appreciated they were by those amateurs who numbered perhaps only 5,000 in the whole country.

I also well remember our old friend P C G G in Holland starting up—and how we used to enjoy those Sunday afternoon concerts !

How "Writtle" Began.

At last the British radio enthusiasts commenced to realise that we ought to have a weekly concert, at any rate, and I can well remember attending a mass meeting of the R S G B at which a petition to the P.M.G. was signed, for a station to be erected in England from which weekly concerts would be given, and also calibration waves sent out. Eventually we were advised that gracious permission was to be granted to the Marconi Co. to transmit music and speech from Writtle (2 M T) once a week for ten minutes, and ten minutes C.W. calibration waves. This took place on 700 metres at first, and afterwards on 400, owing to the jamming from 600-metre ship stations.

(Continued on page 148.)

2 N M CALLING.

(Continued from page 147.)

Those old-time amateur enthusiasts will well remember how Capt. Eckersley used to entertain us.

Valves and all components were, in those days, very difficult to buy, and we had to make up L.F. transformers, condensers, grid leaks, coils, etc., unless we were lucky enough to pick up any Government surplus.

The poor old amateur did not last long on 1,000 metres, as Croydon aerodrome started up on 900 metres, and used to experience jamming from amateur stations, especially on Sunday mornings. We up in the west used to laugh to ourselves when we heard Croydon operator telling amateurs in London to get off their wave.

Start of DX Work.

Touching on Croydon aerodrome, here is one incident which is rather interesting. I used to transmit on 440 metres "dead," and this used to cause a multiple on Croydon's receiver, so that my telephony jammed his reception. As soon as I moved down to 400 metres no jamming was experienced. I just mention this in passing.

So our 1,000-metre licences were cancelled, and 440 metres substituted, also a further wave-length of 150 to 200 was also allotted, the authorities having decided that wave-lengths below 200 were commercially not practical. But they are just waking up, however, since they have learnt that signals on 90 metres from my experimental station, using 500 watts, were regularly received in Japan last spring!

We discovered that we could, on 10 watts, and on 150-200 metres, cover the whole of Europe on morse and telephony, using small inputs of 10-100 watts input to anode of valves, and I daresay many of my readers used to hear me calling various foreign amateurs in their native tongues. I used to get regular reports from an amateur on the Adriatic who used to receive my telephony every Sunday on one valve, and regular telephony tests were carried out with our old friend 8 B F in Orleans, France.

Transatlantic Tests.

Then came the American tests organised by the American Radio Relay League on the one side, and the Radio Society of Great Britain on the other side. I remember the first winter sitting up for nights with patience and cold feet, and not hearing a sound, and so did a good many others!

The A.R.R.L. sent over one of their experts with a special set, and he located himself in a tent in Scotland, exposed to the rigours of our climate, often up to his knees in slush, but he was successful, and so we had to look to our laurels. From that day we commenced to receive American amateur signals, and the next thing was to erect two stations over here to attempt two-way communication. Permits were issued to the R.S.G.B. and the Manchester Wireless Society to erect 1-kilowatt stations, and although they were both successful in getting signals across, no success was met in two-way communication.

In December, 1923, members of the R.S.G.B. decided to erect several higher

power stations with a view to spanning the Atlantic, and licences were forthcoming from the P.M.G., and we were fairly successful. I remember that I was in great spirits when I heard my call sign coming back from 1 X W on 100 metres as having been heard over there in the U.S.A., and regularly every night at 00.00 U 1 X W used to send back the reception reports of the 200-metre tests.

First Low-Wave Experiments.

The highest power that I could raise for the 200-metre tests was 200 watts input, and I was successful in getting across on

Partridge (2 K F), overheard these tests and tried for himself and was successful, and was thus the first British amateur to span the Atlantic "both ways."

After the completion of the 200-metre tests early in January my wave-length was reduced to 100 metres, and from this historical month in the annals of amateur radio assisted in the experiments which proved that amateurs, working with home-made apparatus, could accomplish on short waves and 200 watts what stations using many kilowatts could not do in the past. Rapid strides were made by us in 1924. And so endeth my first article. It is really

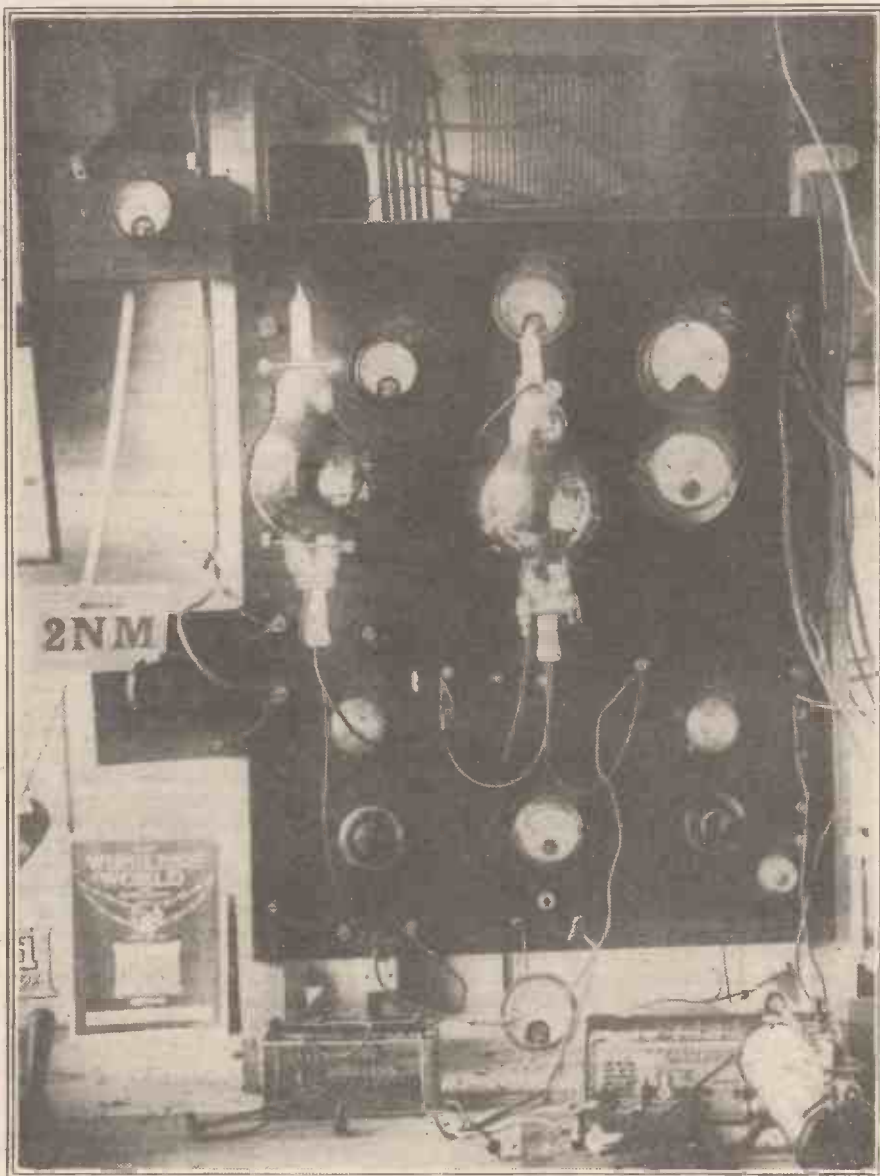

Part of the transmitter at 2 N M. The modulating valves used in telephony tests are on the left-on another panel.

five nights. It was at this time that our good friend Leon Deloy (8 A B), who had just returned from a trip over to America, and had visited the headquarters of the American Radio Relay League, and arranged with them to try two-way communication on 100 metres approximately, and we really owe the first two-way communication between America and Europe to F 8 A B. Our good friend and colleague,

'an introduction; in future articles I hope to deal with practical aspects of amateur radio work which, I hope, will be of interest and assistance to readers of this journal.

Details of the receiving apparatus will also be given as soon as possible, so that those really enthusiastic and capable of operating on less than 100 metres can try their luck on the "low waves."



This Low-Loss Crystal Set has been designed by G. V. Dowding, A.C.G.I., Grad.I.E.E., Technical Editor, and constructed and tested by G. V. Colle and P. R. Bird, Technical Staff, "Popular Wireless." Constructors will find it an extremely efficient receiver.

IN the design and construction of a set relying solely upon the energy picked up by the receiving aerial, there are a number of things to be remembered. The first is that the energy available is extremely small, and the second, more important still, is that this energy is all that is available for operating the set. It cannot be increased by local power, as in the case of a valve set, and so the best must be made of that supplied by the aerial. If this is poor the energy available will be extremely small, and as there are always losses occurring in the aerial system, however well

designed, we must cut out, as far as possible, all losses in the set itself.

This is no easy matter, and would entail expensive apparatus, while to do away with all losses would be an impossibility. A compromise must be made, therefore, so that losses are cut down as far as may be, still keeping the apparatus required as simple yet as efficient as possible.

without sacrificing results in any way. The circuit is shown in Figs. 1 and 2.

An Efficient Type of Coil.

It will be noted that a solenoid coil is used and an enclosed detector is advised. The former is undoubtedly the most efficient form of coil where it can be used conveniently, and the latter has many advantages over the cat's-whisker type of de-



A photograph of the completed receiver. The shorting plug for the coil holder is seen in the foreground.

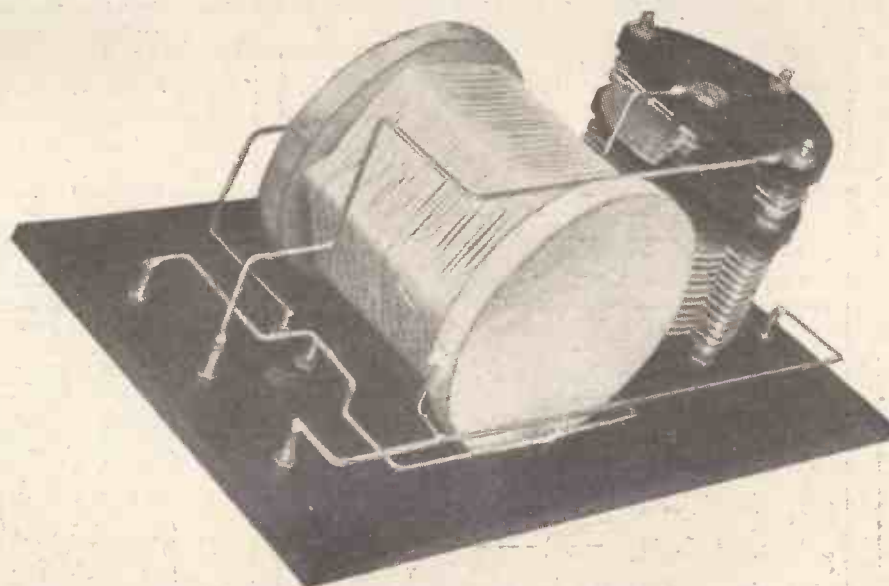

A view of the underneath of the panel after the set has been wired up. The simplicity of the connections is easily seen.

The receiver discussed in this article has been designed with a view to cutting down losses and at the same time avoiding any complicated or expensive apparatus, thus keeping the construction remarkably simple,

detector, not the least being its low damping effect upon the aerial circuit.

Series-parallel tuning is employed without switches, because switches, however good, (Continued on page 150.)

A "P.W." CRYSTAL SET.

(Continued from page 149.)

will always tend to decrease the efficiency of a receiver, due to contact losses and H.F. leakages, while the system employed in this receiver is not only efficient, but simple and inexpensive—three terminals instead of the usual two being the only alteration from conventional practice. These will be explained later.

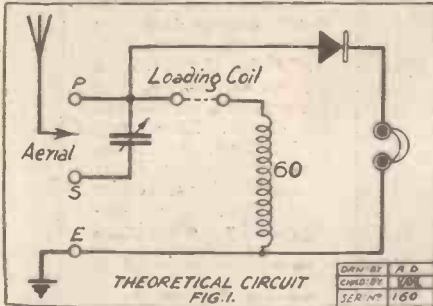

The parts required for this set are as follow:

- Panel $6\frac{1}{2} \times 10 \times \frac{1}{2}$ in. (Peto Scott).
- Variable condenser, Wates "K."
- Box to fit panel, (Peto Scott).
- Enclosed detector, such as the Radiax.
- $\frac{1}{2}$ lb. 20 gauge D.C.C. wire.
- 1 coil and shorting strip plug.

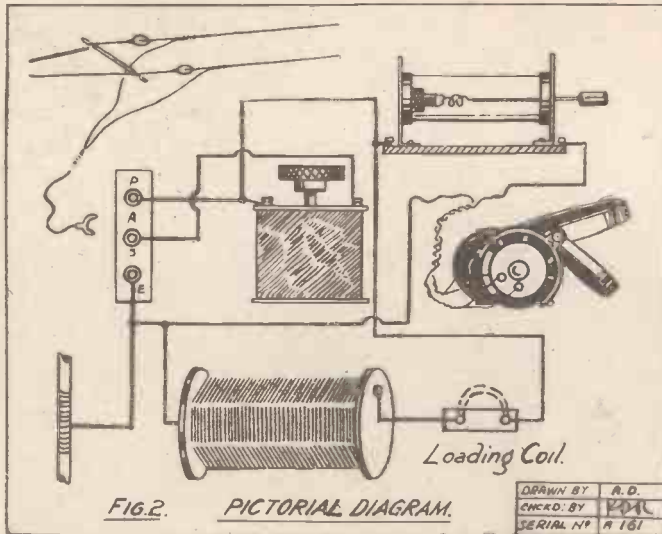

- 5 W.O. type terminals.
- Square section 16 gauge wire.
- 1 set of transfers.
- Wood, screws, solder, &c.

The first thing to do in the construction of this set is to prepare the panel. If this is of the very glossy type it should be carefully matted with fine sand-paper, finishing off with fine emery cloth, say No. 00. If of matt finish, this process, of

course, can be avoided.

The panel should next be trimmed up carefully with a set square, and all the angles and edges prepared with a file and finished off with sand-paper.

Drilling of the panel should be carried out according to Fig. 3, which shows the exact positions for the various components, provided the components used in the list given are employed. When the panel has been drilled, the attention (Continued on p. 151).



A photograph showing the tuning coil just before it was placed in position on the panel.

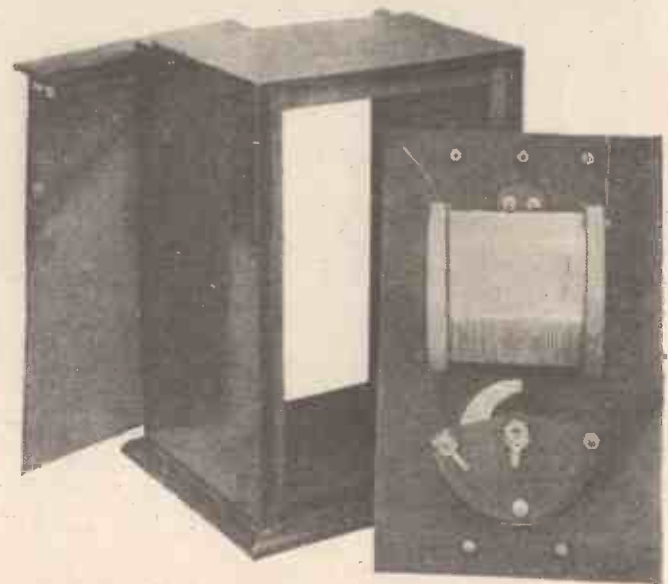
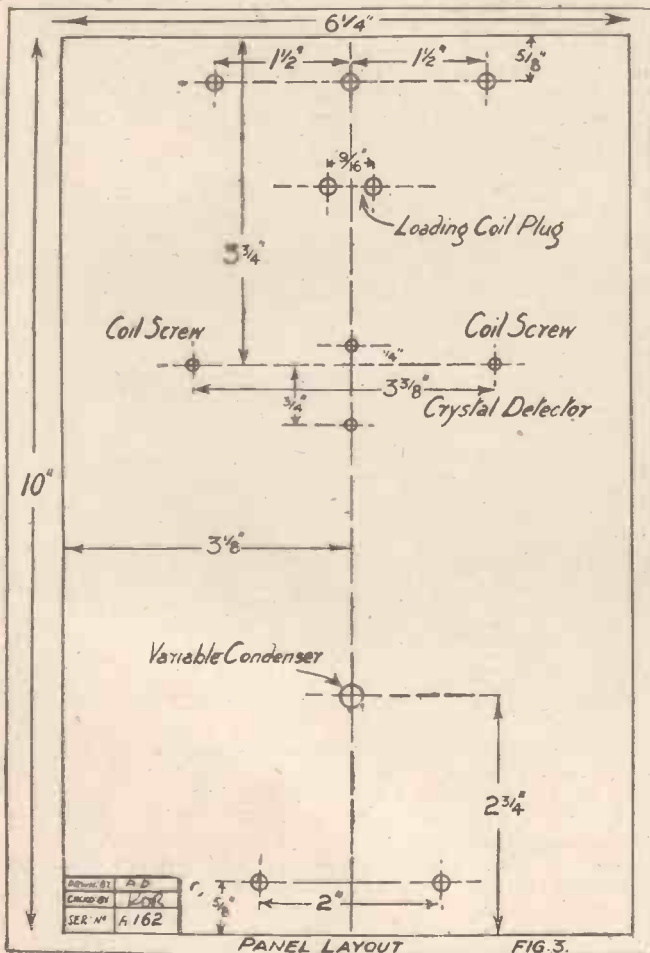

The panel after the components have been mounted. Note the unusual vanes of the square-law condenser.

A "P.W." CRYSTAL SET

(Continued from page 150.)

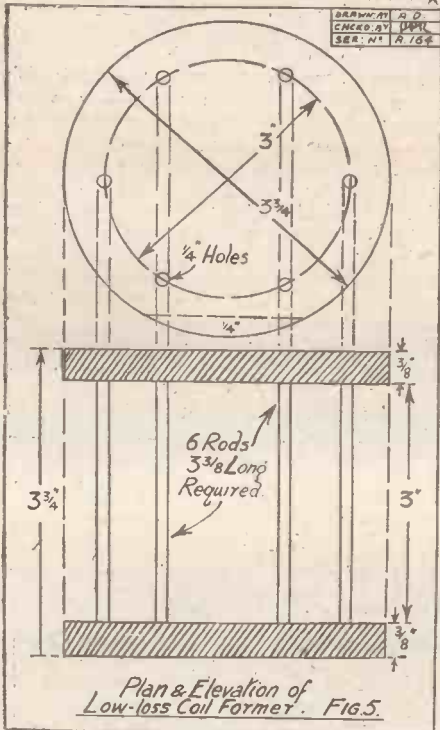

of the constructor should be turned towards the making of the coil.

The photograph shows the completed set with the aerial being connected in the parallel position. Note the shorting strip between "series" and "earth."

The coil former consists of 6 wooden or fibre rods of about 1/4 in.

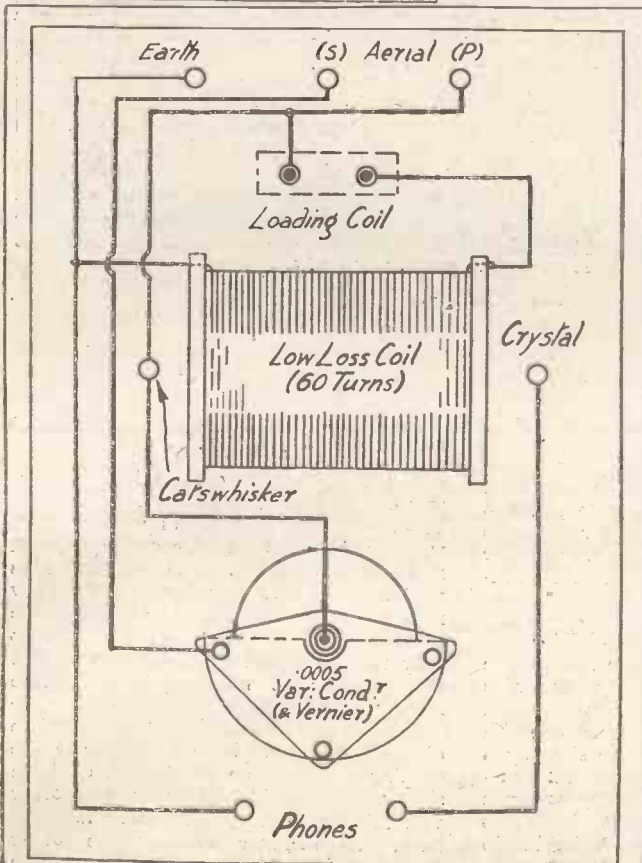
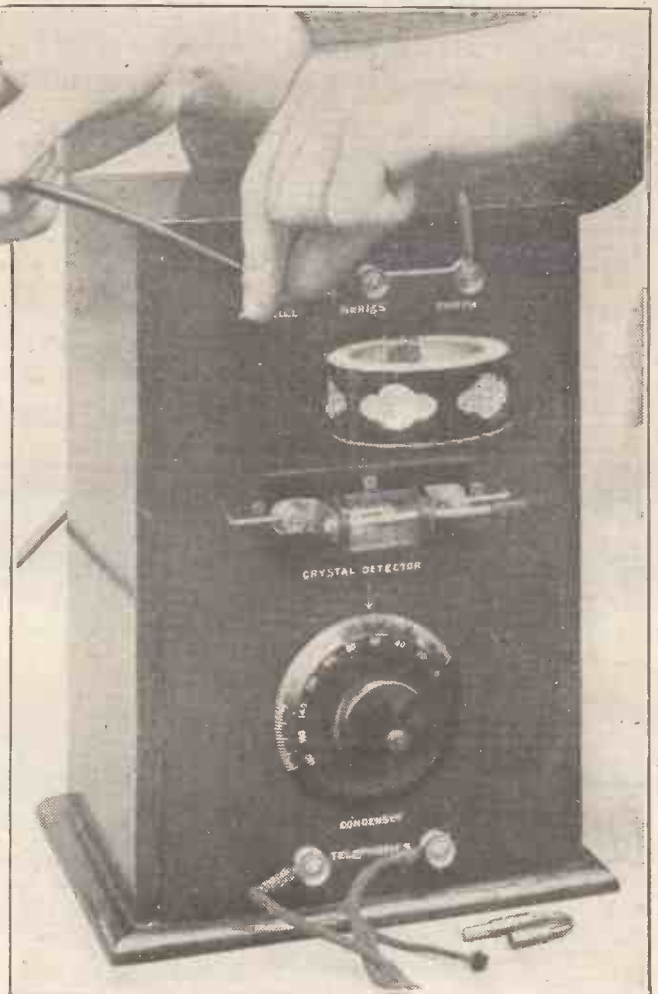

WIRING DIAGRAM
FIG. 4.

DRAWN BY A.D.
CHECKED BY W.D.R.
SER. NO. A 163

diameter and 3 1/4 in. in length fixed equidistantly round a diameter of 3 in. into 2 end pieces of 3/4 in. wood (See Fig. 5), these end pieces being either square or round, the round type, however, giving a better appearance to the coil. The wood should be carefully dried before use.

The fixing of the wooden pegs should present no difficulty, holes merely being drilled in the end pieces, so that the pegs are a tight fit when driven in, while they can be finally secured by glue. While the coil former is setting, the constructor can be mounting the various components on the panel.

It will be noted that the variable condenser is of the single-hole mounting type, although this point is not essential, and any other type of variable condenser which has really reliable contacts can be used, the drilling diagram (Fig. 3), of course, having to be altered to suit the type employed.

Having mounted the components we can turn our attention to the coil again. Winding is carried out with 20 gauge D.C.C. wire, 60 turns being wound round in solenoid fashion, and being finished off at each end by passing it round one of the pegs. Enough wire should be left at each end of the coil for connections to the required terminals, say about 8 in., and a hole of about 2 B.A. should be drilled in the centre of one end piece for mounting the coil to the panel. As it is advantageous to cut down losses in a crystal set to a minimum, the coil should not be shellaced, the wire being simply left as it is.

Wiring up the Set.

The mounting of the coil on the panel is a very simple matter and merely consists of two countersunk wood screws being passed through the panel and into the end pieces of the coil, clamping the coil on to the panel in a horizontal position (see photograph).

A full wiring diagram is given in Fig. 4, but, for the benefit of those to whom wiring diagrams may be a little puzzling, the point-to-point connections will be given. It has been previously mentioned that three terminals are given for the aerial and earth connections. This is done so that either a parallel or series position of the aerial tuning condenser can be obtained without the need of any complicated switching method. There are two aerial terminals, marked "parallel" and "series,"

(Continued on page 207.)



Technical Notes

Conducted by our Staff Consultant, J. H. T. ROBERTS, D.Sc., F.Inst.P.

SOME useful experiments have lately been carried out by Mr. J. Strachan, F.Inst.P., the well-known British authority on crystals as applied to wireless detection. It is well known, or, rather, it is generally supposed, that it is only the actual spot of contact between a cat's-whisker and a crystal that takes any important part in the mechanism of rectification, and since most of the best rectifiers are metallic sulphides, it naturally suggests itself that a mere speck of sulphide might do just as well as a large lump,

Interesting Results.

Acting on this idea, Mr. Strachan has made experiments in which a piece of metal is coated with sulphide at its surface, or at some particular point, by any convenient method, for example, by exposure to moist sulphuretted hydrogen. He has found that a detector may be formed in this way which is quite efficient: usually such a detector works better with an applied potential. He has used in this way lead, silver, copper, and brass.

Incidentally, many amateurs will know that often reception on a crystal set may be obtained when the crystal is removed from the crystal cup and the cat's-whisker allowed to touch the metal, or apparently to touch the metal. It is probably that what happens is that the metal becomes coated with an exceedingly thin film of oxide or sulphide, and that it is this film that is instrumental in producing the rectifying power.

Thus, although the crystal is removed from the crystal cup, there is still something there which serves precisely the same function as the crystal. When the two metals are cleaned, there is little rectifying action.

The Care of Headphones.

When the headphones have been worn for some considerable time, moisture from the ears is apt to condense upon the diaphragms of the 'phones, and, in course of time, the diaphragms become rusted, with a consequent decrease in their sensitivity and general interference with their proper functioning. In order to restore the diaphragms to their proper condition, they should be removed and laid upon a perfectly flat surface (preferably upon a piece of paper gummed against a small sheet of plate glass), and carefully rubbed with powder until clean.

The greatest care must be taken not to bend or buckle the diaphragms in any way as, if bent, they will be permanently damaged. Sometimes it may be found that a diaphragm will work better one way round than the other. This is usually due to a very slight bulge in the diaphragm, which has the effect of decreasing the clearance between the diaphragm and the magnet polepieces.

In the case of a good pair of 'phones, how-

ever, it is always a question for consideration whether it is better to avoid unscrewing the caps, or to remove the moisture and rust. Some diaphragms are oxidised by the makers, with a view to protecting them against the trouble we have been considering. If an amateur cleans his diaphragms, it is a good plan to coat them, before reassembling, with a thin coat of celluloid varnish, or other protective paint, but the coating must be extremely thin, and no

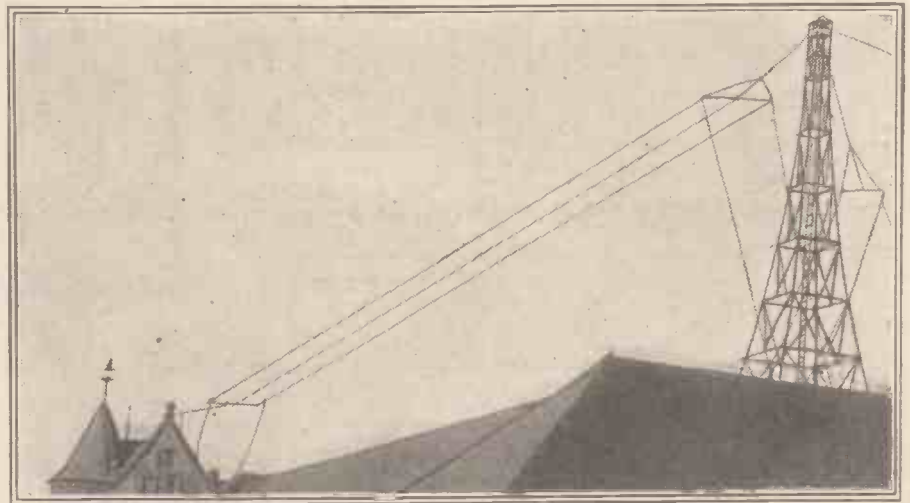

The aerial of the German broadcasting station at Munchen.

blobs or other irregularities must be allowed to remain upon the diaphragm.

The Mansbridge condenser is popularly supposed to be merely a "paper condenser," and many amateurs imagine that any paper condenser (that is, any condenser in which paper sheets are used for insulation) is of the Mansbridge type. This, however, is not the case. The Mansbridge condenser, it is true, is a "paper" condenser, but special paper is used, and moreover the Mansbridge condenser has certain particular advantages due to the manner of its construction.

Construction of Mansbridge Condensers.

The essential feature of the Mansbridge condenser is the metallised paper strips which form the "plates." A strip of tough, thin paper is taken, and this is coated with a fine deposit of metal on one side, by a special process. Some of the metal penetrates the pores of the paper, and so forms short circuits through it, but this effect is overcome by passing the metallised strip between rollers maintained at a suitably high difference of potential, so that the weak spots are automatically punctured out.

In making up a condenser, two metallised strips are taken and two paper strips, and these are made of the correct length to

give the required capacity in the finished condenser. The interleaved strips are then rolled together, and the roll pressed flat and embedded in wax. I may mention that the T.C.C. manufacture genuine Mansbridge condensers, under the Mansbridge patents.

Repairing Valve Connections.

A useful method of making contact with a broken-off leading-in wire of a valve (more particularly of an experimental valve, such as those used by experimenters provided with means for valve exhaustion) is given by Dr. D. A. Wells in the "Journal of the Optical Society of America." He first of all cleans carefully the remaining projecting point of the wire, by means of a drop of nitric acid, and then "amalgamates" it with mercury, the latter "wetting" the metal and facilitating contact of a copper wire, without the need of solder (soldering being out of the question, on account of the liability to break the glass).

A small drop of mercury left in contact with the wire tip adheres thereto, and a

fine copper wire secured in position (for example, by being bound to the glass tube by means of insulating tape) is brought round until it makes contact with the mercury globule. In this way a valve may be salvaged which would otherwise be useless.

Mercury Variable Condenser.

When the mercury variable condenser was described in these notes some months back, a number of readers wrote to ask whether such a type of condenser would really be practicable. The fact that it is practicable is now abundantly proved by its appearance on the market: it is in three different capacity ranges, is enclosed in a very neatly formed case, and has passed through all the necessary tests before manufacture.

It will be remembered that the principle of the mercury variable condenser is the dipping of a single vane, coated on both sides with celluloid varnish or some other very thin layer of insulation, into a mercury bath, the mercury forming the other electrode of the condenser. Owing to the extreme thinness of the insulation between the vane and the mercury, the usual capacity of an ordinary variable air condenser is obtained with one "plate" only. This

(Continued on page 208.)

Brandes Audio Transformer

*successful engineering research achieves
greater volume and clearer tone*

Brandes engineers have long been engaged in a close study of radio acoustics. There can be no angle of thought or experiment which has not been investigated in their efforts to obtain perfect reproduction of voice or music. Consequently, all Brandes radio equipment for bringing the receiver to life has unique constructional principles which mean vast improvements. Acoustics is the science of sound. Radio acoustics is the science of transforming electrical impulse into audible sound, and with the knowledge of seventeen years research in this direction, Brandes have come near to perfection in the reproduction of radio transmission of sound. The new *Audio Transformer* as a step to purity and greater volume is a definite achievement.

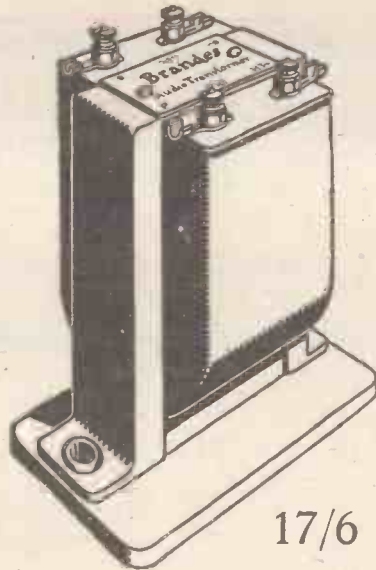

17/6

Ratio: 1 to 5.

The *Brandes Audio Transformer* has been developed along sound engineering lines, the main objects in view being a high amplification of applied voltage, together with a straight line amplification-frequency curve. That is to say, for a given input voltage, the amplification is constant over a wide band of frequencies, and thus resonance is eliminated. Comparative tests have authentically established a greater and more uniform relative amplification as against existing transformers. The unit is well protected mechanically, and the shielding is such that the Transformers may be placed close together without any interaction. It is an ideal first stage Transformer and is equally suitable for second stage work.

*Any good dealer stocks
Brandes Products.*

*Ask your dealer for
Brandes.*

Brandes

Experts in radio acoustics since 1908

Brandes Limited, 296, Regent Street, W.1. Works: Slough, Bucks.

Three other famous Brandes products.

The Table-Talker



Re-designed goose-neck horn which produces clear, more rounded and mellow tones. Constructed of special material which defeats any suggestion of metallic resonance. The adjustment lever, located at the rear of base, controls the volume and sensitivity. 18" high, diameter of bell 10". **30/-**

Matched Tone Headphones

Every pair of Brandes 'phones is matched in tone by special apparatus so that the two receivers produce exactly the same sound at the same instant. Comfortable and light in weight, with clutch on headband giving perfect adjustment to any head. Included in the leading types of completely equipped receiving sets **20/-**



The Brandola

Special constructional features ensure greatest volume with minimum current input and exceptional clarity over full frequency range. Adjustable semi-goose-neck horn of patent non-resonant material, electroplated fittings and polished walnut plinth. 20" high; 12" bell. **90/-**





**THE
MAGAZINE
CATALOGUE**
Ask for a copy
today
FREE
on
Application

Prof. A. M. Low
on "The Possibility of
Television."

W. B. Medlam, B.Sc.,
A.M.I.E.E.
on Building a Super-
hetrodyne."

Articles on "Building a Wireless
Set," "Upkeep of a Crystal Set,"
"Those Microphonic Noises,"
"Dodging the Aerial," and
many others.

Full details of all the
new **CLIMAX RADIO**
COMPONENTS and
SETS.

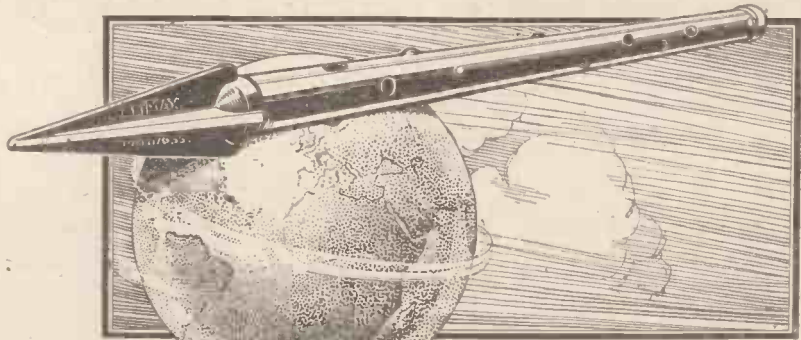

The Best earth on Earth

The Climax Earth gets right to the root of the matter, does its job thoroughly and cuts out all possibility of any loss, and to-day the best earth on earth is

THE CLIMAX RADIO EARTH.

(Prov. Pat. 17653.)—The low-loss direct tubular earth. Far better than the old-fashioned water-pipe or gas-pipe earth. The latest pattern is provided with flanges which break up and help to fill in the earth around the tube, thereby preventing any rocking of the tube in the ground. In addition, the projections on the surface of the tube provide water courses which make for a perfect electrical contact. Ready for use. Easily fitted. Maximum efficiency. Length approx. 30 in. Price 5/-
Climax Insulated Low-Loss Earth Lead, 20 ft. Price 1/8

THE NEW CLIMAX AERIAL INSULATOR.

(Regd. Design No. 708718)—This will stand four times the flash-over voltage of the ordinary cheap shell or egg insulator, while it has far less capacity to earth. It is made of the same High-Tension vitreous porcelain as the 100,000-volt insulators on High Power transmission lines. It will stand a direct pull of hundreds of pounds. It is entirely non-hygroscopic. It cannot absorb moisture even if fractured. It insulates perfectly during rain-fall. It is self-cleaning on all surfaces Price per pair 1/-
The Climax Insulated Shock Absorber Set for Aerial Insulation De-Luxe, comprising Set of Four Insulators and Two Climax Aerial Shock Absorbers Price per box, 3/-

THE CLIMAX LIGHTNING ARRESTER.

Made on the multi-gap, quenched spark principle. Provides atmospheric space charges and lightning discharges with a straight path to earth of very low reluctance. Protects the set whether in use or not. **NO SWITCHES NECESSARY.** The mica insulating discs and series multiple gaps ensure complete ab-



sense of shunting effect, leaving your signals at maximum strength. The glass cover protects the gaps from becoming semi-conducting due to dirt, damp or other interference. Equipped with a Climax Lightning Arrester, an aerial is a positive protection against lightning, instead of being a source of danger. Price 7/6 complete, ready to fix.



CLIMAX RADIO

Insist on the name "CLIMAX," refuse substitutes. Every Climax product is clearly marked with the name "CLIMAX." In case of difficulty, or if substitutes are offered you, send your order direct to us, together with P.O. and we will send the goods by return.

Head Office and Works:

CLIMAX RADIO ELECTRIC LTD., QUILL WORKS, PUTNEY, LONDON, S.W.15

Telephone: Putney 2599.

All Communications to Head Office.

Showrooms:

257, HIGH HOLBORN, LONDON, W.C.1.

Telephone:—Holborn 2538.

250 RADIO QUERIES ANSWERED.

Useful Information For Amateurs.

COLLECTED BY THE "P.W." TECHNICAL STAFF.

PART I.

We publish below the first part of 250 Radio Queries and Answers collected and brought up to date by the members of the "P.W." Technical Staff. A further instalment will be published next week.

The Aerial System.

Q.—When an aerial is to be erected, what is the most important factor to bear in mind, having regard to the efficiency of the installation?

A.—In ordinary circumstances the chief requisite is height, and generally the higher an aerial can be made the more efficient it becomes.

Q.—Is a "single-wire" or "twin" aerial better for broadcast reception, and should the wire be insulated or bare in order to give best results?

A.—There is little to choose between "single" or "twin," and no law can be laid down, because the best form for the aerial to erect depends upon the local conditions—i.e. surrounding buildings or trees, height from ground, etc. A good wire is 7/22 copper, or a larger wire if single stranded, No. 16 S.W.G. if possible. It need not be insulated, but it is certainly advantageous to use enamelled wire, because the coating is a protection against corrosion, although this insulation would not affect average reception in any way.

Q.—My aerial will be a fairly long one, and 35 ft. high, but will be partly surrounded by tall trees. What effect will this have upon reception?

A.—The trees will partly "screen" the aerial, and this will result in a loss of signal strength, which will be chiefly noticeable in the summer, when the trees are leafy and full of sap. A screened aerial is often responsible for flat tuning.

Q.—Is there any relation between the length of an aerial and its natural wave-length? What is the latter (approx.) for an average P.M.G. aerial?

A.—The natural wave-length is generally about 4½ times the length of the aerial, and if the aerial is 100 ft. long its natural wave-length is about 450 ft., which is equivalent to about 135 metres.

Effect of Lightning.

Q.—Should the aerial wire be made of copper, or are other metals efficient?

A.—Stranded phosphor-bronze wire is considered better than copper, whilst silicon-bronze is light, tough, and strong. If copper is used it is advantageous to employ enamelled wire in order to resist corrosion, etc., especially if the aerial is near the sea.

Q.—Must the wires of an aerial be parallel to one another, and is there any advantage in having a number of wires so arranged as in the "cage" aerial?

A.—The wires need not be parallel, but they should be of exactly the same length. For broadcast reception there is generally no advantage in the "cage" or "sausage" aerial unless only a very limited span is available.

Q.—Is there any danger from an aerial being struck by lightning; or would a lightning conductor on the mast prevent this?

A.—The aerial itself forms a lightning conductor, and is therefore actually a safeguard if it is directly earthed. The down-lead should go to earth in a straight line without entering the house, and this can easily be arranged with an outdoor switch (which connects up the instruments when desired, but is normally "shorting" between aerial and earth leads). In these circumstances a lightning conductor on the mast is hardly necessary, but, of course, it can be erected if desired.

Q.—Should the aerial wire and insulators be cleaned periodically?

A.—There is little, if any, advantage in cleaning aerial wire, but, unless Winsulators are used, the insulators should be periodically examined and their surfaces polished, because a coating of dirt helps moisture to settle, and thus impairs the insulation.

Directional Aerials.

Q.—Is the "natural" wave-length of a frame aerial about 4½ times the length of the wire used, as in an ordinary single-wire aerial?

A.—Much depends upon the spacing of the frame wires, but with the usual ½ in. spacing the natural wave-

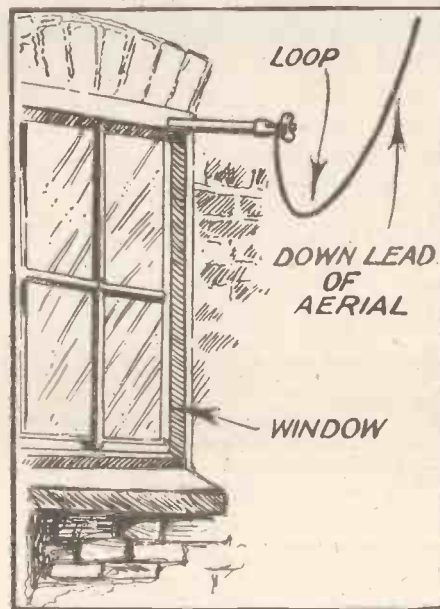

A method of preventing rain from percolating through the lead-in tube due to its running down the down-lead. The water drips off at the loop instead of running to the lead-in tube.

length of the frame aerial would be about 7 or 8 times the length of the wire used.

Q.—How is the "length" of an aerial calculated, when it partly consists of two or more wires branching off from a central point, or when some of its wires are in parallel?

A.—The length of an aerial is independent of the number of wires used, as it is simply the distance from the farthest point of the aerial to earth. In the case of a single-wire aerial this will be equivalent to the length of the wire used, whether erected vertically, horizontally, or in the usual form of a horizontal span with vertical "lead-in." But in the case of a T aerial the length is the length of the lead-in plus that of the longer arm.

Q.—Is there a loss of efficiency by using an iron mast to support an aerial instead of a wooden pole?

A.—Iron is quite as efficient as wood, provided that the aerial is well insulated, and it possesses the advantage of durability. Although dry wood is a fair insulator the average mast has no insulating properties,

owing to its exposure to moisture, and an aerial supported by a wooden mast needs just as careful insulation as one supported by iron or steel.

Q.—When is an aerial "directional," and is this an advantage or otherwise for broadcast reception?

A.—A directional aerial is one which receives signals from one particular direction more strongly than from others. This is the case with an "inverted L" aerial, which will receive best from the lead-in end of the direction in which the horizontal portion lies, and to which it points.

The effect is not very marked on the short wave-lengths used for broadcasting, and is generally unimportant compared with considerations of height, screening, etc.

Screening Effects.

Q.—My neighbour's aerial is parallel to my own and we share the same mast. When my three-valve set is tuned to the local station his signals are greatly increased, apparently by interaction, but he is unable to tune out and listen to other stations. How can this effect be lessened?

A.—To reduce interaction, the aerials should run at right angles instead of parallel, and reaction should not be used on either aerial or secondary circuit. Where aerials are separated only by a few feet it is impossible to avoid a certain amount of interaction between them.

Q.—Why is the insulation of an aerial so important when the currents dealt with are only weak?

A.—It is precisely because the currents are so weak that good insulation is vital. The energy available to operate the receiving instruments is far less than that used in ordinary electrical work, and the slightest leakage should be prevented by efficient insulation.

Lead-in Precautions.

Q.—Is there any objection to a long indoor lead-in if the wire is well insulated?

A.—The long lead-in is detrimental, because it is impossible to insulate wireless in the same way as other electrical leads, and the currents will pass across small spaces or insulators very readily. Consequently, any neighbouring surface, such as a damp wall which is close to the lead, may act like a condenser, and leakage will result.

Q.—What is meant by the "natural" wave-length of an aerial?

A.—The "natural" or fundamental wave-length of an aerial is that wave-length which it possesses, and to which it will respond without "tuning." Wave-length is readily altered by inductance (in the form of a coil) or by capacity (in the form of a condenser), but if neither coil nor condenser is used every aerial has a certain inductance and capacity of its own, and it is the product of these two properties that determines its wave-length.

Q.—I had been getting fairly good results on an aerial 26 ft. high, but, reading that an aerial should always be placed as high as possible, I took the wire to the other end of my garden and fastened it to a gasometer, at a height of about 50 ft. Instead of being an improvement, signals have ceased altogether. Why is this?

A.—You have screened your aerial by the only thing which wireless waves will not pass through—an earthed metal shield. Keep the aerial as far away from the gasometer as you possibly can.

(Continued on page 156.)

250 RADIO QUERIES ANSWERED.

(Continued from page 155.)

Q.—Who first used an aerial and earth for wireless work?

A.—Senatore Marconi discovered the advantages of an "aerial" and of an "earth" connection, and his early successes were largely due to these discoveries.

Q.—At the side of my garden run ten or twelve telephone wires. Will they affect the aerial which I am going to erect?

A.—If the aerial is placed close to the wires it will be screened, and its efficiency impaired. Keep it at right angles to the wires if you can, and as far away from them as possible.

Q.—Can the down-lead be taken from any convenient point along the aerial, or should it be taken from one end?

A.—The down-lead must come from one end of the horizontal span or from its centre, in order that all

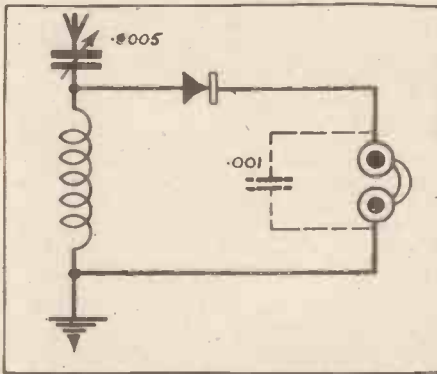

The simplest form of crystal set, and one which is not easily beaten for results.

the oscillatory currents set up in the aerial system shall be of the same wave-length.

Earth Connections.

Q.—What is the best earthing arrangement for a receiving set?

A.—The lead from the tuner should be as short and direct as possible, of the same wire as used for aeriels, and should have a large metallic contact with moist earth. A water-tap generally makes an excellent earth if the lead goes to the "mains" side of the pipes, and a large metal plate buried several feet deep in moist soil has about the same efficiency.

Q.—Would two or more earth leads give better results than only one?

A.—Unless the wires were of exactly the same length, the two earth leads would be a disadvantage, and if the present "earth" is a good one there would be no improvement gained by adding another.

Q.—Should the earth wire be insulated up to the point where it enters the ground, and does it matter if it runs side by side with the lead-in?

A.—The wire need not be insulated if it is a short one, but to run the lead-in close to the earth wire is a very undesirable arrangement which must be avoided whenever possible.

Q.—What is the best way to fix the earth connection to a water-pipe?

A.—Good contact is essential here, and may be obtained by soldering, or by one of the special clips sold, which can be tightened by screws. If a soldered connection is made, and the wire is splayed out and well soldered in several places, there will be no resistance losses due to corrosion.

Q.—When a buried earth is used, how deep should it be placed, and what size should it be?

A.—The sheets of galvanised iron used for roofing

sheds, etc., make an ideal earth, as their area is large, and the corrugations are an advantage.

If the earth is moist they should be placed about 3 ft. deep in a slightly slanting position, with the earth wires splayed out and soldered in several places.

Q.—What is an "automatic earth-switch" or "earth-arrester"?

A.—An arrangement of metal plates connected to aerial and earth, but separated by a very small air-gap. It is placed at the point where the aerial enters the house, and the earth wire goes straight from it to the ground. If the aerial became charged during a thunderstorm the electricity would spark directly across the small gap to earth, instead of passing through the receiving instruments in the ordinary way.

Counterpoise Aerials.

Q.—What is a "counterpoise" earth, and has it any advantages over the ordinary earth connection?

A.—The "counterpoise" takes the place of a direct earth in cases where the latter cannot easily be made, or where it is undesirable owing to the presence of earth currents from neighbouring electric power plant.

It generally takes the form of a second multi-wire aerial of similar length to the other, placed directly underneath it but near the ground (say, 7 ft. high). Insulation should be good, and the counterpoise often sharpens tuning of the set, as well as minimising local interference.

Q.—My aerial enters the house through a bedroom window and leads are taken downstairs for reception. Does it matter if the set is upstairs, using long telephone leads, or would a long lead-in with set downstairs be more efficient?

A.—Generally, the set should be placed as near the ground as possible, but where the lead-in has to pass through several walls it is sometimes better to have the set upstairs and use long telephone leads instead. No rule holds good for all circumstances, so both positions should be tried.

Q.—I am unable to erect an outdoor aerial, and have been told that I can use the electric light mains instead. Would this be an effective substitute, and is there any danger from shock in such circumstances?

A.—The results obtainable with an "aerial" of this kind can only be ascertained by test, as they are sometimes fairly good and sometimes very disappointing. There is no danger, providing that one of the specially constructed connectors of reliable make is used, and that the instructions are carefully followed.

Indoor Aerials.

Q.—What is the best position and shape for an indoor aerial, and how should the lead-in be arranged for best results? Are these aeriels generally satisfactory when used with a crystal set?

A.—They are generally quite satisfactory up to a distance of about 10 miles from the full-power broadcasting stations, but an outdoor aerial is much more efficient. The best position is found by experiment, and a good arrangement consists of four parallel wires, one foot apart, suspended 18 inches from the ceiling, with the lead-in taken from the end nearest to the broadcasting station.

The wire used can be single-strand insulated copper, size 18 or 20 S.W.G., and the leads should be as long as the available space permits. Good results are often obtained with such an aerial in a large attic or roof-space.

Q.—I am living within a mile of the Glasgow station and cannot erect an outdoor aerial, nor use the lighting mains in conjunction with the special instrument sold for that purpose. Can I use a frame aerial with a crystal set instead?

A.—No, even at that short distance away from the station a frame aerial

would be of little use for the purpose. An ordinary indoor aerial would be O.K.

Q.—Has a frame aerial any advantage over an outdoor aerial?

A.—It is far less efficient than a good outdoor aerial and is useless for crystal set or single valve working except under very special conditions.

Its disadvantages can be overcome with the aid of several stages of H.F. amplification, and then the strong directional properties of the frame aerial are sometimes of great value.

"Frame" Reception.

Q.—What size frame should I use, number of turns, size of wire, etc., for a frame aerial to receive the broadcast programmes?

A.—A square frame is best, with sides four feet in length. The size of the wire is not important so long as fine wire is avoided, but number 20 S.W.G. enamelled is generally considered as most efficient. Five turns should be wound, spaced 1/2 inch apart, and a small variable condenser (say, not larger than .0002) across the terminals will give fine tuning.

Q.—Should the wire of a frame aerial be stranded, and is an earth connection an advantage or otherwise with this type of aerial?

A.—There is no noticeable benefit in using stranded wires for the frame.

The earth connection should be tried, because it sometimes increases signal strength, and sometimes has the effect of stabilising a set which is prone to oscillate too readily.

Q.—Is the insulation of a frame aerial as important as that of an outdoor aerial?

A.—It is quite as important, and ebonite spacers should be used between the turns of wire. A frame aerial functions more efficiently upstairs than downstairs, because of the increased effective height given.

Dual Aerials.

Q.—Is it possible to support two separate aeriels (for crystal sets) from one mast?

A.—The two aeriels can be attached to one spreader, but the distance between them must not be less than six feet, whilst any greater spacing is an advantage.

With this arrangement signals are generally somewhat weaker on both sets.

Q.—Can one aerial be used to receive two stations (working on different wave-lengths) at the same time?

A.—It is possible to use two receiving sets attached to one aerial, but as adjustments on one set affect the tuning of the other, the method is not generally a practicable one.

Q.—What is an accumulator made of, and what measuring instruments are necessary for the care of accumulators?

A.—An accumulator consists of the container, the electrolyte, and the plates. The container is

(Continued on page 157.)

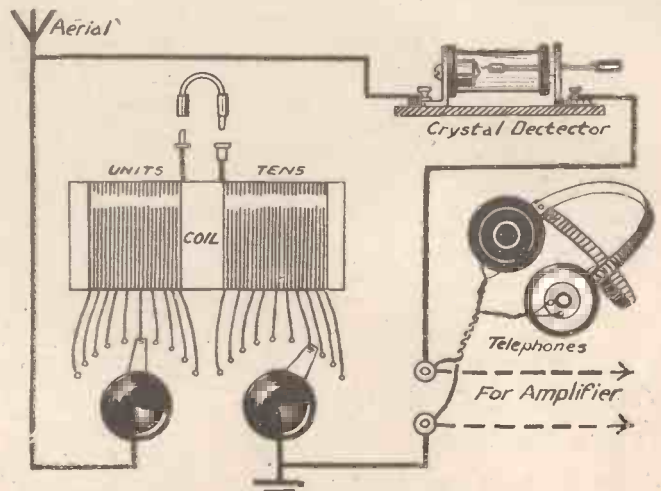

The "P.W." Ultra crystal set. A receiver which is specially sensitive.

250 RADIO QUERIES ANSWERED.

(Continued from page 156.)

generally made of celluloid or glass, and the electrolyte is sulphuric acid, diluted with distilled water. The plates are made of prepared lead, and the positive are spaced from the negative plates by wooden separators. A voltmeter is necessary to measure the voltage, and a hydrometer to test the density of the acid.

Q.—What is the maximum rate at which an accumulator should be discharged?

A.—A good rule is to never discharge an accumulator at a rate of more than one-tenth of the actual ampere-

A.—An accumulator is designed to produce a certain current (reckoned in amperes) for a certain time (reckoned in hours), and the product of these two factors is called its ampere-hour capacity.

If the actual capacity is 20 ampere-hours it means that the accumulator will give 1 ampere of current for 20 hours (or $\frac{1}{2}$ an ampere for 40 hours) before recharging is necessary.

Q.—What is the difference between the "ignition" rating and the "actual" ampere-hour capacity?

A.—The "actual" ampere-hour capacity is the one which affects wireless accumulators, as it means the actual capacity when the cell is *continuously* in use, such as when lighting a valve. If intermittent discharges were made the capacity appears much higher than is actually the case, the "ignition" rating being about double the "actual" rate.

Q.—Can a 4-volt battery be used to light valves which are supposed to take only three volts?

A.—The voltage of the battery is in effect lowered to three volts, if a suitable filament resistance is used. Great care should be taken not to apply too high a voltage, especially to the new low-consumption dull-emitter valves.

Q.—My accumulator is stored in a rather warm room, and the loss by evaporation is now noticeable. Should this be made good by ordinary clean water?

A.—The accumulator must *not* be kept in a warm room, but should be stored in a cool dry place instead. The loss by evaporation should be made good by distilled water and not by ordinary tap water, which contains invisible impurities that would ruin the cell.

Charging Batteries.

Q.—What is the most economical way to charge an accumulator from the D.C. lighting mains?

A.—Connect the cells in the lead coming from the house lamps back to the main fuse. When a lamp is switched on the current will pass through the accumulator also, but the lamp will not be seriously dimmed.

Great care must be taken to connect the accumulator the right way round (positive to positive of mains), or it will be rapidly discharged and spoilt.

Q.—Can an accumulator be adapted for use with dull-emitter valves?

A.—If the cells of an accumulator are arranged in parallel instead of in series, the voltage may be made suitable for certain types of dull-emitters. An accumulator connected in this way provides a very steady and satisfactory L.T. supply.

Q.—How many hours should a 6-volt 40 amp. accumulator last when used for a 3-valve set?

A.—This can be easily calculated when the current taken by each valve is known. (It is always stated by the makers.) If the consumption averages .7 each, the three valves will take 2.1 amperes, and this figure divided into the "ampere-hour" capacity will give the number of hours—in this case

$$\frac{40}{2.1} = 19 \text{ hours (approx.)}$$

It will be seen that for three valves a 60 ampere-hour battery is necessary to avoid the necessity for frequent recharging.

"Sulphating."

Q.—How can the celluloid case of an accumulator be repaired to stop a small leak which takes place when the cell is tilted in carrying?

A.—Small chips of celluloid should be dissolved in any acetate, a small quantity of which can be obtained from a chemist. This will form a paste which can be used to fill small holes or cracks in the case.

Q.—The terminals of my accumulator have been attacked by the acid and spoilt. How should I protect the new terminals?

A.—All that is necessary is an occasional coating of vasoline to cover them, and ordinary care in handling to keep them free from acid.

Q.—What is the cause of sulphating in an accumulator, and how should it be prevented?

A.—Sulphating is generally caused by discharging a cell below the limits stated by the makers, or by allowing partially discharged cells to remain idle for a long period.

If the specific gravity of the acid is frequently tested, the tendency to sulphate is readily discovered, and extra charging will remedy the trouble.

Care of Accumulators.

Q.—I notice that a kind of sediment has formed at the bottom of my accumulator. Does this denote a fault?

A.—Owing to the constant charging and discharging, small particles become in time detached from the plates and settle at the bottom of the accumulator. They must not be allowed to touch the plates or bridge across between plates, as this would quickly ruin the accumulator. It is not a "fault"

Q.—I have discovered and removed a kind of growth on one of the negative plates of my accumulator. Was this caused by defective material used in the manufacture?

A.—It was probably only a piece of the positive plate setting up a local action.

When the cell is charged, a flake of this kind becomes spongy, and increases in size when the cell is active, finally short-circuiting the plates.

Q.—How does a hydrometer assist in the care of accumulators?

A.—The condition of an accumulator is indicated by the density of the acid (electrolyte), and the hydrometer is an instrument for measuring this density. There are several types, the most popular being in the form of a glass tube containing small glass beads.

The electrolyte is drawn up into the tube, and the density of the acid can be seen at a glance by the position in which the beads float or sink.

Charging with A.C.

Q.—Why are two separate batteries necessary to operate a valve?

A.—Because two different conditions are necessary in order for the valve to work. In the first place, its filament must be heated in order to liberate electrons (this is done by the L.T. battery).

Secondly, there must be a large difference of potential between the heated filament (which is negative) and the plate of the valve. This potential difference is supplied by the H.T. battery:

(Continued on page 158.)

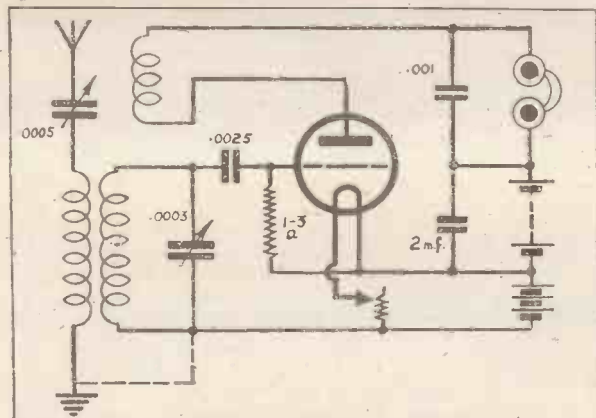

A loose-coupled one-valve set. The coils are of the plug-in type and the dotted line shows an alternative connection for stabilising purposes.

hour capacity. For instance, if a battery is rated by the makers as 20 (actual) ampere-hours, it should not be called upon to give more than 20 amperes when in use.

Q.—How can the positive plates of an accumulator be distinguished from the negative plates?

A.—There is a difference in the number of plates, the negative side having one more plate than the positive.

Q.—What is the correct specific gravity of the acid in an accumulator, and should the density vary from time to time?

A.—The specific gravity of a fully charged cell is generally 1.2. As the cell is discharged the density falls, and when the cell is fully discharged the specific gravity drops to 1.17. It should never be allowed to fall below the 1.18 limit, or to remain long at this point without recharging.

Q.—Can I charge a four-volt accumulator from a battery of Daniell cells?

A.—It is possible to do so, but not advisable where ordinary charging facilities are available.

You would need not less than 6 large cells connected in series with the accumulator.

Q.—Should the acid in an accumulator be kept above the level of the plates, at the same height as when the cells are new, or can it safely be allowed to fall a little?

A.—The loss by evaporation should be made good (using distilled water) in order to keep the level of the acid $\frac{1}{2}$ inch above the top of the plates.

Q.—What are the general rules for keeping accumulators in good condition?

A.—The golden rule is to abide carefully by the maker's instructions, especially as regards the rate of charging and discharging.

Keep the cells clean and dry, and be very careful of the vessel used to hold the acid if it is necessary to use fresh electrolyte at any time. In such a case a lead or glass vessel should be used.

Capacity of Accumulators.

Q.—What is meant by the "capacity" of accumulators?

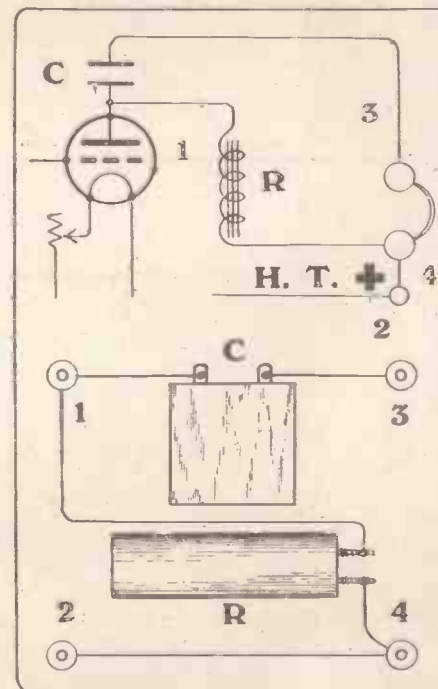

This diagram shows a method of by-passing the steady plate current of a valve so that only the signal impulses go through the 'phonos or loud speaker (C) 5 mfd. (R) iron core choke.

250 RADIO QUERIES ANSWERED.

(Continued from page 157.)

Q.—How is it possible to charge an accumulator from alternating current mains? If the current continually reverses its direction, would not this first charge and then discharge the accumulator in accordance with each alternation?

A.—Rectifiers must be used which suppress the current in one direction and only allow intermittent pulses of direct current to reach the accumulator.

Q.—What is a Nodén valve rectifier, and how is it used?

A.—The Noden valve is a chemical rectifier, generally consisting of aluminium and lead plates immersed in a solution of ammonium phosphate. It is

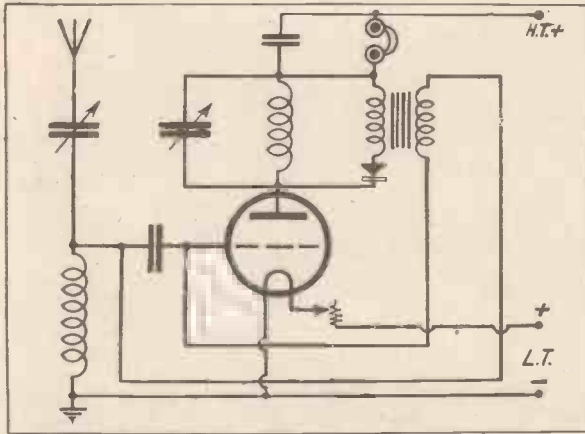

A popular type of circuit. The one-valve crystal reflex. This is useful for local loud-speaker work or for distant reception on headphones.

used when charging accumulators from alternating current, and when in series with the mains it only passes current from the lead to the aluminium, and not in the reverse direction.

Q.—What is the difference between a high-tension battery and a low-tension battery?

A.—In essentials they are alike, but the H.T. battery is required to deliver a very small current at a high potential, whilst the L.T. battery gives a comparatively large current at a low voltage.

A large number of cells are necessary in the former case, but they can be of small size, whilst for the L.T. battery only a few cells are required, but they must be larger.

Q.—Why are dry cells not suitable for the L.T. supply of ordinary valves of the R type?

A.—The ordinary valve will only liberate a sufficient supply of electrons when its filament is almost white hot, and a fairly large current is necessary in order to heat the filament to this degree.

Although dry cells can give a good intermittent current, they are not able to supply continuously for several hours a sufficient current for the bright-emitter valves in the way that an accumulator does.

Q.—Can Leclanché cells be used for H.T. or L.T. batteries?

A.—The Leclanché cell is not sufficiently constant in operation for use as an L.T. battery with ordinary valves, which also require more current than it can supply. 06 low-consumption valves can be run from Leclanché cells satisfactorily, and connected in series a number of these cells make a good H.T. battery, although the cost would exceed that of dry cells.

“Flashlamp” H.T.

Q.—Is it an advantage to employ fairly large cells for the H.T. battery, instead of using small dry cells?

A.—Theoretically, a large cell is preferable, but in practice the small cell is very satisfactory, and its cheapness and convenience have led to its general adoption.

Q.—I wish to build up my own H.T. battery from small “flash-lamp” cells. Does it matter what kind I purchase?

A.—You should be careful to buy cells that have not been in stock for long—the better kind have a date indication marked upon them. Buy reliable cells, as the lowest price is not always the most economical.

A Crystal Set's Range.

Q.—What is the average range of a crystal set?

A.—This will vary a great deal, as local conditions, height of aerial, and efficiency of the apparatus, etc., play a very important part. We do not, however, recommend a crystal set for distances exceeding 15 to 20 miles from a main broadcasting station, although it is not uncommon for satisfactory results to be obtained up to 30 or so miles.

Q.—What is the advantage of using a silver or gold cat's-whisker in preference to one of copper or other cheaper metal?

A.—The copper cat's-whisker is liable to oxidise, and then poor contact will be made with the crystal, while the gold or silver will not be affected in this respect.

Q.—Is there any method whereby I can amplify my signals other than by the use of a valve? I am at present using a crystal set.

A.—A microphone amplifier, if carefully constructed and adjusted, will prove very useful in this capacity; but valves are preferable, as they are not so sensitive to mechanical vibration.

Q.—Why is it that I am unable to get any signals with my crystal set, using an indoor aerial, although I am only seven miles from the Sheffield relay station?

A.—The range of the Sheffield relay station for a crystal is only a few miles, probably even less than seven, with an outdoor aerial, on account of the low power employed, so you cannot expect signals under the conditions in which you are working.

Q.—Is it necessary to use a battery with a crystal set?

A.—A battery is not required except when a potentiometer is being used, and this latter is only included in a crystal set employing a carborundum detector.

Carborundum Detectors.

Q.—I have a variometer-tuned crystal set. Would a condenser improve it?

A.—If the variometer is of good make tuning should be sharp enough; but the inclusion of a variable condenser across a variometer employing cylindrical formers which probably do not permit of very fine tuning, should improve reception.

Q.—What are the connections for a crystal set employing the following apparatus: A variometer with two terminals for connections, a crystal detector also with two terminals, and a pair of 'phones?

A.—The apparatus should be wired up in the following manner. Aerial to one terminal of variometer and earth to the other terminal. The first terminal of variometer is also connected to one side of the crystal detector, while the remaining side of the detector is connected to one of the 'phone tags. The remaining connection to the 'phones is taken to the second mentioned variometer terminal.

Crystal Set Limitations.

Q.—How can I prevent my neighbour from overhearing my conversation in his 'phones during the intervals of the programme? We are both using simple crystal sets.

A.—Alter the position of

your aerial, and get it further away from, and at right angles to, your neighbour's. Failing this—disconnect the aerial from your set during the interval.

Perikon Detectors.

Q.—What crystals will work together to form a Perikon detector?

A.—Zincite with copper pyrites or bornite is perhaps the best-known combination. Tellurium may also be used with zincite, while galena and graphite or tellurium also will work together.

Q.—What are the connections for a crystal set employing a solenoid coil for tuner, with two sliders?

A.—The following connections should be employed: Aerial to one end of coil and to one terminal of the crystal detector. Other side of detector to one 'phone terminal, the second 'phone terminal going to one of the sliders. The remaining slider is connected to earth. It is sometimes advantageous to take the remaining end of coil also to earth.

Q.—How should a crystal be fixed into its cup if no screws are arranged to hold it?

A.—There are various methods of doing this, but it should be borne in mind that the crystal should never be soldered into its cup, as the heat of the solder is liable to greatly reduce its efficient rectifying properties. Wood's metal, which melts at a very low temperature, is usually employed for this; but if the crystal is packed tightly into its cup with tin foil, it should be just as satisfactory.

Q.—Should high or low resistance 'phones be used with a crystal set if a telephone transformer is not going to be included in circuit?

A.—High-resistance 'phones should be employed in a crystal circuit; 'phones of about 4,000 ohms are generally used.

Interference from Nearby Aerials.

Q.—How can I prevent a scratching noise in my 'phone every time my neighbour adjusts his crystal? We are both using crystal sets.

A.—If your aerial is close to that of your neighbour, which it probably is, try and separate it by as great a distance as possible, erecting it at right angles to the other one, if possible. Failing this, suggest to your neighbour that he tries one of the crystal detectors now on the market which remain set and require no adjustment.

Q.—What is the cause of a complete stoppage of signals on my crystal set at about the same time nearly every night, although previous to this stoppage signals are coming through perfectly?

A.—Quite possibly this is due to a faulty crystal, but improbable, because the trouble comes at the same time always. It looks as if a powerful receiver is being used in the immediate neighbourhood, and no care is being taken to prevent it energising the aerial. The only thing to do is to try and find out who the offender is, and carry out experiments with him until it can be definitely discovered how he is causing the trouble—probably innocently.

Q.—What is the best cure for microphonic valves?

A.—Mount the set on a rubber base (a rubber sponge will do) so as to minimise vibration, or mount the valves in anti-pong valve holders.

Q.—What is meant by reaction?

A.—A method whereby the reaction in the plate circuit of a valve is made to decrease the resistance of the grid circuit of that or another preceding valve and thereby allow more energy to pass through. The process is known as applying negative resistance to the grid circuit.

(To be continued.)

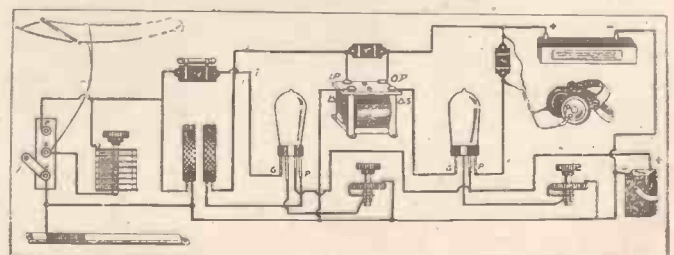

A useful 2-valve circuit which is capable of picking-up distant stations on the 'phones or of reception of the local transmissions on the loud speaker.



The History of the Detector

A Short Historical Outline of the Technical Development of Wireless Detectors.

By Lieutenant-Commander H. W. SHOVE, D.S.O., R.N.

THE great army of wireless enthusiasts who have enrolled themselves since the advent of broadcasting are the product of "The Age of Valves." Although by far the greater number of those who habitually "listen in" employ crystal sets, on the score of cheapness and simplicity, and because the infection of "radio-mania" spreads rapidly near a broadcasting station, where such sets can be effectively employed even by a novice, it is nevertheless the fact

purely as a detector that enables us to receive weaker signals, even with a single-valve set, than we can with a crystal. And the original valve was in existence a long time before it could compete successfully with the other methods of detection.

What really brought the valve to the fore was the discovery of reaction, which is essentially nothing more than a means of providing H.F. amplification by means of the detecting valve itself, in addition to the L.F. amplification inherent in the 3-electrode, though not in the original Fleming 2-electrode detecting valve.

Visible Detection.

Before the discovery of reaction the valve, even the 3-electrode valve, was comparatively "small potatoes." In the 1911 edition of the "Admiralty Manual of Wireless Telegraphy," a book of some 370 pages, the whole subject of valves, which had been in existence some time, even, in the case of the Fleming valve, a long time, is dismissed in a single page! The "Audion," as the 3-electrode valve is there called, is condemned because of the necessity (reaction being unknown) of burning the filament so brightly, to obtain the maximum sensitivity, that the life of the valve is very short, and the valve detector, therefore, too expensive for general adoption!

What, then, were the detectors that had been used up to that time, and with which, unaided by amplification, signals were received over hundreds of miles, even across the Atlantic?

Historically, the first method employed was the observation of the minute sparks jumping the gap in a nearly closed circuit. Since the pressure produced in an aerial by even the most powerful signals is exceedingly small, it will be understood that this gap, across which the pressure had to force the sparks, was necessarily very narrow. So nearly had the ends to be joined that the use of a microscope was tried to watch for the sparks! This, the original detector, was naturally very insensitive and not very practical.

The Coherer.

A great stride was made with the introduction of the "coherer," the first standard detector used in the Navy. There were a number of such devices, the best known being that invented by Marconi.

This consisted of a glass tube exhausted of air, and containing a small pinch of nickel and silver filings between two silver plugs. The loose filings offered a fairly high resistance to the passage of a direct current, but had the property of "cohering," or sticking together, when an oscillating current was applied. The resistance then fell, and the

current from a small local battery was enabled to pass. This current was used to operate a machine, known as the "inker," which recorded the signals on a tape, in the same way as the familiar "tape machine."

There were two grave disadvantages to this method. Firstly, the coherer required to be "tapped," by a special mechanical device, to shake the filings apart after each "long" or "short" had been recorded, and, secondly, the inker recorded atmospheric and other interferences as well as signals. Sir Oliver Lodge produced a coherer which did not require to be tapped, but the whole system was rendered obsolete by the invention, by Marconi, of the "magnetic detector."

Marconi's Magnetic Detector.

This was a very ingenious device, depending on the fact that iron, when magnetised or de-magnetised by passage through a permanent magnetic field, does not either take up or part with its magnetism immediately. This property is the well-known "hysteresis," the loss due to which we have to deal with in L.F. transformers, etc. Marconi made use of it in this way:

An endless, flexible iron wire was made, by a suitable arrangement of clockwork, to move at a uniform speed through a small glass tube. On this tube were two wind-

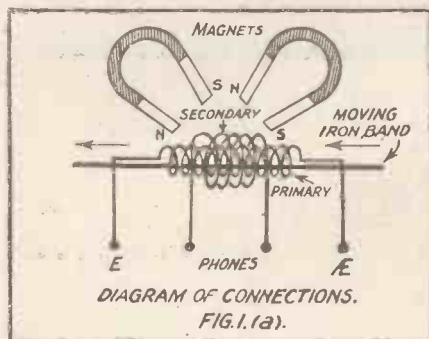

that at least 90 per cent of those whose interest in the subject extends beyond merely listening to concerts think "in terms of valves," either as detectors or as amplifiers or both.

Range of the Crystal.

Of course, were it not for the valve, wireless telephony, as we know it, would never have been born. Though attempts were made in the early days to employ an "Arc System," the valve is necessary in all the present-day practical systems of transmission. And owing to its amplifying effect, the valve becomes an almost indispensable adjunct for the comparatively distant listener who desires to hear the transmissions on what are really the very low powers used in ordinary broadcasting.

The advent of 5XX has, of course, opened the eyes of the "man in the street" to the fact that the "range" of a crystal set depends on the power of the transmission, and not on any inherent "range of reception" of the receiver. Before that the writer met several crystal users who were under the impression that "a crystal couldn't receive farther than 15 miles." The fact that signalling was for years carried on commercially over very long distances by the use of receivers much less sensitive than the crystal, and without the aid of any amplifiers whatever, was news to them.

It is of course the amplifying property of the valve and not any great superiority

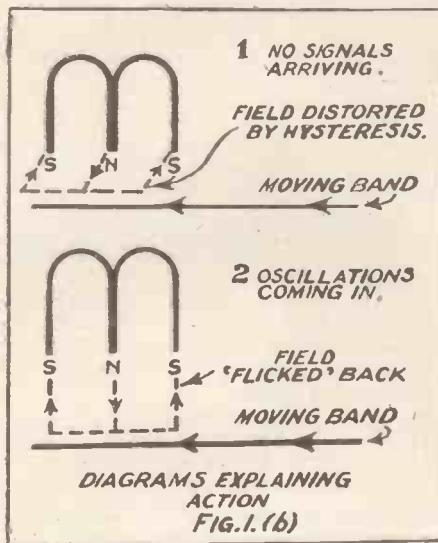

ings, the primary being in series with the aerial, and therefore carrying the current due to the incoming signals. The secondary was connected to a pair of headphones. It is interesting to note that the familiar "phone condenser" makes its appearance in this early circuit, being used to "sharpen" signals.

The iron wire, where it passed through the glass tube, was in the field of two horseshoe magnets, and its motion distorted the field, which "stuck" to the iron, so to speak, through hysteresis. The effect of a train of oscillations in the primary coil was to destroy the hysteresis and allow the field to "flick" back to its normal position (Fig. 1, B). This induced a current in the secondary and caused a sound in the 'phones, so that signals were heard in the way now familiar to us (Fig. 1, A).

(Continued on page 160.)

THE HISTORY OF THE DETECTOR.

(Continued from page 150.)

The magnetic detector had a long and honoured reign. It was rather complicated and not very sensitive, but it was thoroughly reliable. For this reason it held its own for some time even against the crystal, which, as we all know, requires adjustment somewhat frequently, and gives no outward manifestation of having fallen out of adjustment. It was, however, the crystal, on account of its simplicity and sensitivity, which finally killed the magnetic detector.

Contemporary with the magnetic detector were two other competing systems, the thermal and the electrolytic.

Two Interesting Methods.

In the thermal detectors, which were really introduced for use with "arc" systems of transmission (the forerunners of the modern "C.W."), and were not at their best when dealing with the ordinary "spark," a very short, fine wire (in a vacuum tube) was connected in series with the aerial. The current due to the incoming signals heated this wire, and the heat was detected in various ways, of which the most practical was Fessenden's. He made use of the difference in the resistance of the wire at varying temperatures to cause changes in the current supplied by a local battery to a pair of 'phones, and thus to enable signals to be heard.

The electrolytic method is one which even now, in the writer's opinion, retains considerable interest. The principle is that a very fine wire, preferably tipped with platinum, is adjusted so as just to touch the surface of a small quantity of acid in a lead cup. This adjustment can be made in a very similar way to the ordinary cat's-whisker adjustment of a crystal detector. A small battery and a pair of 'phones are connected with this arrangement, as shown in Fig. 2, the whole circuit being exactly similar to that of a carborundum crystal detector, except that the detector and 'phones are in parallel. The potentiometer is used to adjust the detector, the process being rather delicate, and there being no space to describe it in detail here.

Scope for Development.

When adjusted, the effect of the current from the battery is to cause a tiny bubble of oxygen to form on the platinum point of the cat's-whisker. This bubble (being an insulator) stops the further flow of current. The arrival of signals upsets the equilibrium of the arrangement, knocking the bubble off the cat's-whisker, so that the battery sends a momentary current through the 'phones, and the signal is heard.

Directly the oscillations cease, the bubble of course re-forms, and the detector resets itself. This detector is very sensitive, but for obvious reasons it did not lend itself very readily to employment at sea. But it is still well worth the "crystal" experimenter's notice.

The discovery of the "unilateral conductivity" of certain substances brought in the crystal detector, which is too well known to need description. It and the electrolytic are the only ones of these old

methods which are of present-day practical interest.

It is to be noted that there is this difference between them. In the crystal detector, the sound in the 'phones is actually produced by the feeble aerial currents. Thus there is no possibility of amplification. This is true of all the early systems considered above, except Fessenden's thermal method and the electrolytic. In these, as in the valve, the aerial currents serve to release the energy of the local battery, and these currents cause the sounds we hear.

We have control of these currents to a greater or less degree, so that it might be possible to get a reaction or amplifying effect. Once we do that we are in the

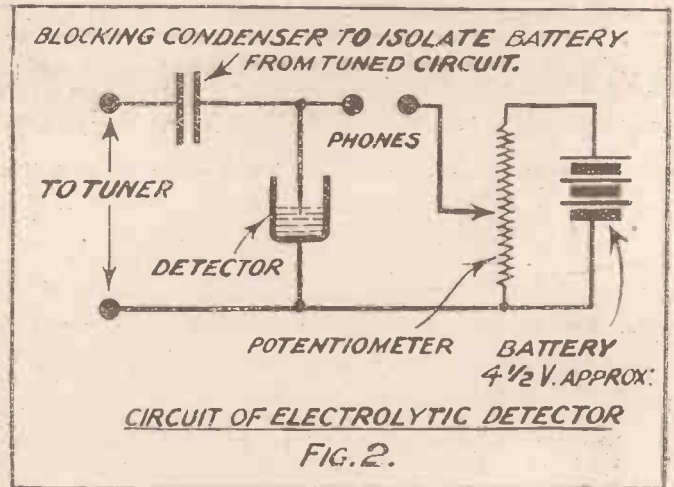

region of possible competition with the valve. With the crystal, of course, attempts at reaction are really attempts to get "something for nothing." The writer commends this line of thought to investigators who are not convinced of the finality of the valve.

SIMPLE NEUTRODYNE CONDENSER.

THE sketch shows how a simple and efficient neutralising condenser can be made up from a few odd fittings at the cost of a few pence. The parts consist of a brass pointer, A; the spindle

and ball socket, B, of an old crystal detector; a sheet brass disc, C; and a piece of sheet brass cut to the shape indicated at D.

The disc C, which is $\frac{3}{4}$ in. in diameter, represents the moving plate, and the piece D the fixed plate, this being shaped as shown so that when bent at the dotted lines it can be bolted to the under-side of the panel in such a way that the disc portion is perfectly parallel with the panel and at a dis-

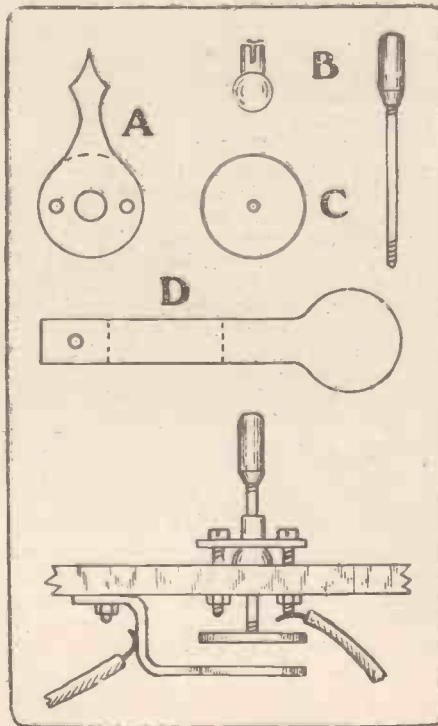

TO OUR READERS.

Practical wiring diagrams, panel-layouts, or point-to-point wiring sketches are supplied by the "P.W." Queries Dept., price 1s. each.

All communications should be sent to The Technical Queries Editor, "Popular Wireless," Fleetway House, London, E.C.4.

tance of about 1 in. from same. The extension piece should be about $1\frac{1}{2}$ in. long.

The end of the spindle is soldered to the exact centre of the movable disc. Reference to the lower sketch should make the idea quite clear; the ball socket carrying the spindle and moving plate is clamped very firmly and in an upright position into a countersunk hole in the panel, the pointer being cut off at the dotted line and used as a clamping disc. Adjustments are made by sliding the spindle up and down in the ball socket.

SUPER - EXCELLENCE

THIS is the essential characteristic of the "Cosmos" Radio Receiving Sets and Accessories on display at the N.A.R.M.A.T. Wireless Exhibition. Not content merely with the attainment of all-round excellence, the designers have advanced to something better—beyond perfect reception, to perfect reproduction—beyond loudness, to loudness without distortion—beyond long distance range, to long distance range with the minimum of controls—beyond attractive appearance, to a design embodying refined taste—beyond good workmanship, to excellent workmanship in every detail whether hidden or visible—in brief—beyond excellence to SUPER-EXCELLENCE.

The "Cosmos" exhibits for these reasons, claims your special attention. Make a point of seeing the following:—

The "Cosmos" Universal 5-Valve Set in various types of Cabinet.

The "Cosmos" All-wavelengths Crystal Set—for High Power Station and ordinary B.B.C.

The "Cosmos" Strip Inductance Coils.

The "Cosmos" Bright Valve A.45. An excellent general-purpose Valve:

The "Cosmos" Dull Emitter Valve D.E.11. For Dry Cell or two volt accumulators.

All Super-Excellent.

The "Cosmos" New Model 3-Valve Set—a compact set of novel design.

The "Cosmos" Low Loss-Square Law Variable Condensers with slow motion attachment.

The "Cosmos" Anti-Vibration Valve Holders.

The "Cosmos" Short-path Valve S.P.18. Extraordinarily efficient.

METRO-VICK SUPPLIES LTD.

(Proprietors: Metropolitan Vickers Electrical Company Ltd.)

4, Central Buildings, Westminster, London, S.W.1.

Obtainable from most Wireless Dealers.

Ask for copies of latest "Cosmos" List.

**COSMOS
THREE VALVE
NEW MODEL
RADIO
SET**

**COSMOS
ALL WAVE LENGTHS
CRYSTAL
SET**

**COSMOS
FIVE VALVE
UNIVERSAL
RADIO
SET**

Stand Number:

8

Ashley Radio JACKS AND JACK SWITCHES

A complete range of Jacks for every purpose. The use of these components saves labour and dispenses with the need for complicated switches.



Jack No. 1
Single Circuit
(Open)

2/-



Jack No. 2
Single Circuit
(Closed)

2/3



Jack No. 3
Filament Control

2/6



Jack No. 4
Double Circuit

2/6



Jack No. 5
Filament Double Circuit

3/6



Jack Switch
No. 6
Single Pole,
Single Throw

2/9



Jack Switch
No. 7
Single Pole,
Double Throw

3/6



Jack Switch
No. 8
Double Pole,
Single Throw

3/6

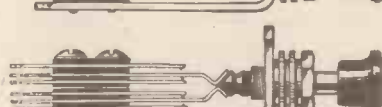

Jack Switch
No. 8
Double Pole,
Double Throw

4/-



Two-Way Jack
Plug

3/-

ASHLEY WIRELESS TELEPHONE COMPANY
69 Renshaw Street, Liverpool
Telephone: 4628 Royal. Telegrams: "Rotary, Liverpool."

London and Southern Counties:
Pettigrew and Merriman, Ltd., 122, Tooley Street, London, S.E.1.

GAMAGES

Offer to Exhibition Visitors and to all other Radio Enthusiasts!

Any Wireless Set or Components (to the Value of £5 upwards) on view at the Exhibition may be purchased on **OUR EASY PAYMENT SYSTEM**

Full particulars from Stand 39, Main Hall, or Messrs. Gamages' Holborn Showrooms.

The "Gamage" Mercury Contact VARIABLE CONDENSER

Chief Features:—

VANES so designed to give a straight wave-length curve (Square Law)
MINIMUM CAPACITY of '0003 Mfd. only '000006 Mfd.

Tested by the N.P.L. for losses on 90 and 300 metres with the following results:—

Wave Length - 90 metres. Power Factor - 0.0013
" " " " 300 metres " " " " 0.0002

The above particulars are taken from our report received from the N.P.L.

Its other points of interest are as follows:

The Moving Vane Connection is obtained by the Moving Vane Spindle projecting into a cup of mercury, the mercury also travelling part way up the inside of the centre spindle, thus insuring a perfect contact.

All edges are rounded and buffed, and the spacing of the Vanes liberal, these points being most essential for a true low loss. An ingenious Vernier movement is incorporated, giving a ratio of 100 to 1, or by turning the Vernier knob slower, a very much finer movement is obtained. The Control knob for the Vernier stands clear of the Main Control and Condenser, an obvious advantage in critical circuits.

When the Vernier is in use the slightest movement is at once seen on the indicator which is already mounted close to the dial. To mount this Condenser on a panel it is necessary to drill one hole only.

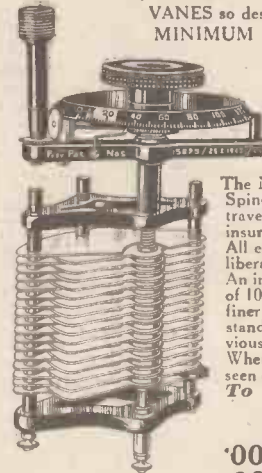

Capacity	Price Complete	Without Vernier
'0005 Mfd.	16/-	12/9
'0003 Mfd.	15/3	12/-

BROWNIE No. 2 Crystal Receiver

which embodies all the qualities of the Brownie Standard Model, is the result of an effort to produce an instrument solid in construction and unaffected by climatic conditions, to resist all wear and tear, at a price within the reach of all. The tuning principle is of the highest efficiency and utmost simplicity.

With an unscreened outdoor aerial and efficient earth, will receive clearly at the following distances:—

- From 2 LO, 30 35 miles.
- .. Ordinary Broadcasting Stations, 25 30 miles.
- .. Relay Stations, 8 10 miles.
- .. 5XX, 120 miles.

But numerous cases are reported of satisfactory results at greater distances.

10/6

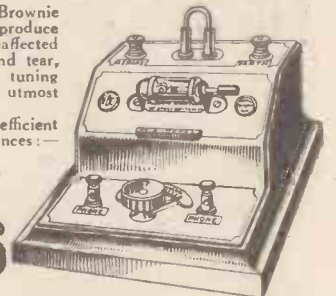

Hundreds of Testimonials

Post Free

entirely unsolicited, have been received in praise of

PERMANITE

The World's Best Crystal.

Originals may be seen at any time. Let us know what your experience is with PERMANITE.

Extract from TESTIMONIAL.

LOUD SPEAKER ON CRYSTAL SET.

Dear Sir,—I am still using the piece of Permanite I purchased 18 months ago, and it has been exposed to dust, etc., the whole of the time and in use every day.

Bertha receiving the local station, 2ZY, I am able to listen to the Liverpool Stn. (Relay), which is 35 miles away; Darenty, 95 miles; and occasionally Birmingham and Bournemouth, on a straight Crystal Set. With the aid of two L.F. Amplifiers I have received Glasgow, Newcastle, Cardiff, and Sheffield (Relay), and with Crystal Set alone a large loud speaker can be heard distinctly 4 yards away.

I have tried many crystals, but none are equal in efficiency to "Permanite." There is a Lancashire word which I think is suitable for expressing its efficiency—a "gradely" Crystal.

Yours faithfully, C. E. B. Manchester, 10th August, 1925.

Complete with Silver Cat's 1/- Extra large piece, 1/6 whisker in Box. Price easily broken, Price 1/6



STAND No. 39

GAMAGES, HOLBORN, LONDON, E.C.1
City Branch:—Benetfinks, Cheapside, E.C.2

Scientific wonders of the world



Patent applied for.

PRICE

£6 - 6 - 0

A NEW invention of the Western Electric Company that will put a new complexion on Loud Speaker reproduction.

The "Kone" Loud Speaker as its name implies has been evolved by the scientific application of two cones with the result that absolutely faithful reproduction is assured of every musical note and complete freedom from the objectionable guttural tones associated with most Loud Speakers of the horn type.

STOCKS AVAILABLE OCTOBER 1st, 1925

ORDER YOURS NOW AND SAVE DISAPPOINTMENT.

Western Electric Company Limited.

Connaught House, Aldwych, London, W.C.2.

WORKS:

North Woolwich.

Bexley Heath.

New Southgate.

Hendon.

Branches: Birmingham, Leeds, Manchester, Newcastle, Glasgow, Cardiff, Southampton, Liverpool, Dublin

A marvel of tonal perfection

TUNGSTALITE'S GREAT TRIUMPH

The Call of the Crystal

The marvellous part which THE CRYSTAL has played in bringing the miracle of radio into the homes of the multitude is now recognised by all. Every amateur starts with THE CRYSTAL, and eventually ends with THE CRYSTAL, after he has tried all the more elaborate and expensive rectifiers, which can never produce that pure, sweet, undistorted, faultless reproduction which only THE CRYSTAL can obtain.

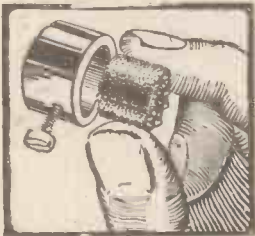

Showing the unique adaptability of the new Tungstalite "Round Type" Crystal.

WONDERFUL TRIBUTE FROM PRESS & PUBLIC

"POPULAR WIRELESS," speaking of the wonderful new ROUND TYPE CRYSTAL, says:—"Great credit is due to MESSRS. TUNGSTALITE in that they have discovered and produced something which is both ORIGINAL AND OF GREAT PRACTICAL VALUE—that is, the ROUND TYPE CRYSTAL, which is uniformly sensitive over the whole of its surface. *This new product represents a distinct advance over other types.*"

"THE BROADCASTER," speaking of the same product, says:—"We have always had a high opinion of TUNGSTALITE CRYSTALS, and, as previously mentioned, TUNGSTALITE, LTD., are the manufacturers of some of the best crystals in the country. This firm has now advanced a step further, and have produced a circular crystal of uniform shape and size, which fits into ordinary crystal cups with a minimum of trouble, and secures better contact and greater stability. The manufacturers have called this the crystal of unexcelled sensitivity, and with this we heartily agree, for we cannot remember HAVING EVER HAD A BETTER CRYSTAL IN OUR HANDS."

MR. BARRETT, writing about BLUE LABEL TUNGSTALITE, reports clear reception from stations of over 100 miles distant.

MR. ULLEFEN, of Utrecht, Holland, using GOLD LABEL TUNGSTALITE, reports direct reception from Chelmsford without valves. The wonderful successes of TUNGSTALITE have won the admiration of experts in all parts of the world. It is *THE ONLY CRYSTAL FOR THOSE WHO MUST HAVE THE BEST.*

SECURE YOUR SPECIMEN TO-DAY



TUNGSTALITE

BLUE
LABEL

1/6

ROUND TYPE

From all dealers or direct from

TUNGSTALITE, LTD.,

47, FARRINGDON ROAD, LONDON, E.C.1,

Phone: Holborn 2557. or 41, CALL LANE, LEEDS.

GOLD

2/-

LABEL

LONDON'S Wireless Exhibition

We publish below the second and concluding instalment of a review of the stalls at the Wireless Exhibition at the Albert Hall.

H. J. GALLIERS (BRIGHTON).
Stand G. 6.

A comprehensive selection of sets and apparatus is to be found on this stand, some very up-to-date "models" being shown. It is, of course, impossible to mention everything, but the 7-valve Super-het. and the short-wave receiver deserve the attention of visitors. This latter should prove very popular among enthusiastic DX listeners during the coming radio season. The Auto broadcast system should also be examined, for this is likely—or some similar arrangement—to be in demand before very long at hotels, etc.



The new Mullard Power Valve—P. M. 4.

HOBDAY BROTHERS, LTD.
Stand G. 25.

In the gallery is staged one of the most varied displays of wireless goods in the whole of the exhibition, for Messrs. Hobday Bros., Ltd., have done their best to emphasise their claim that they hold the largest and most comprehensive stocks of wireless apparatus in Great Britain. Certainly they have made their stand as attractive and complete as possible, and endeavours have been made to display everything likely to be demanded by the radio dealer, some specially interesting lines and, attractive prices being put forward. We understand also that the firm has just opened a new branch at Cleveland Road, Wolverhampton, with a view to stimulating radio interest in the Midlands.

L. McMICHAEL LTD.
Stand No. 6.

This well-known firm is exhibiting on the ground floor, several special lines being on view. A rather novel note has been struck in the method of exhibition of some of the principal components, for these are to be shown in magnified form, fixed condensers, transformers, reactor units, etc., being shown in model about eight times the natural size.

Among the complete sets, the most interesting is a facsimile of the set supplied to H.R.H. the Prince of Wales, and used by him at Johannesburg. By means of this set and seven loud speakers, H.R.H. addresses a gathering of 30,000. The receiver allows for broadcasting to be received and transmitted from the loud speakers, while by the turn of a switch a local microphone can be used, and the set utilised as a public address system.

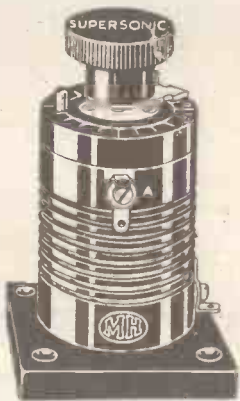

A tuned supersonic filter.

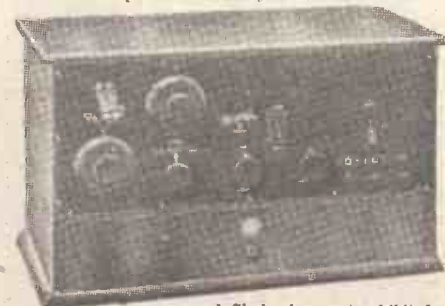

A Chakaphone set exhibited by the Eagle Engineering Co.

The components on view are chiefly characterised by the transformers, a speciality of Messrs. McMichael, Ltd., and these now include in their ranks a new tuned supersonic transformer and filter, specially



A novel variometer exhibited by the Dubilier Condenser Co. It utilises the well-known "D" type of coils.

designed for super-het. circuits. It can be obtained either as a four-pin mounting component in similar form to the ordinary plug-in H.F. transformer, or else on an ebonite base for baseboard mounting.

LONDON & PROVINCIAL RADIO CO., LTD.
Stand No. 69.

The chief feature on this stand is the "Ehancee" (L. & P.) vernier coil holder, which has already gained a great deal of popularity owing to its originality and efficient operation. The action, as will be well known to many readers, is of the worm and pinion type, so arranged with a spring to avoid all traces of backlash. Single-hole mounting can be provided for use where American type sets are used. A valve unit is another interesting item, also of the one-hole, back of panel type. This is a neat little component comprising a valve holder, filament rheostat, and valve window. One side of the filament circuit and rheostat is already connected, so that wiring up this unit into a set is a very simple matter. The sockets are anti-capacity and insulated, so that the filaments cannot be shorted across the H.T. circuit by mistake when the valve is being placed in position.

METRO-VICK SUPPLIES, LTD.
Stand No. 8.

The most striking novelty being shown by Metro-Vick, Ltd., is a new 3-valve set, built on a skeleton panel. The set must be seen to be appreciated.



The new M-L H.T. generator shown at the stand of Messrs. L. Smith & Sons.

for a true idea cannot be obtained by written description, but the design, unconventional as it is, is based upon a "result" point of view, while compactness was also not lost sight of in its conception. A reflex circuit is employed whereby the first valve amplifies at both high and low frequencies. Simplicity is ensured by a minimum of controls, while the coil units cover wave-lengths from 250-500 metres and 1,300-3,000 metres. For loud-speaker reception the ranges claimed under average conditions are 50 miles from a main B.B.C. station and 150 from 5 X X.

A crystal set that can be hung upon the wall like a picture is another novelty that is well worth examination, making as it does a very compact and tidy unit.

The "Cosmos" 5-valve sets, too, have several unique points introduced into their design, the main of which concerns the changing of wave-length ranges. Special units are supplied which will alter all tuned circuits simultaneously and in the most efficient ratios, so that the sets will tune, with the use of three units only, from 30-3,000 metres. As the changes are carried out in one operation by these units, the aerial, H.F., and reaction circuits being altered in correct relationship, the utmost efficiency should be obtained with a minimum of trouble, the sets being to all intents and purposes quite "fool-proof."

Other exhibits include the famous "Cosmos" valves, strip coils, rheostats, condensers, transformers, grid leaks, etc.

STERLING TELEPHONE & ELECTRIC CO., LTD.
Stand: 29-32.

Some of the finest workmanship in wireless apparatus is to be seen here, for an extremely varied selection of sets and components are on view, incorporating many novel features in design. Two different makes of sets will be noticed, those made by the Sterling Telephone Co., and those of Marconiphone manufacture. Among the former several new lines have been introduced, and it is especially gratifying to note that in the newer type receivers provision has



One of the C.A.V. loud speakers on view at the Royal Albert Hall.

been made for an increased range of wave-length—in fact, the range is exceptional, being in the neighbourhood of 40-5,000 metres, covering all that could be wished for by the most ardent listener. Even the 4-valve cabinet long-range receivers have provision made for short-wave reception by the use of a special aerial coupling unit. "Non-pong" valve holders are incorporated in all the sets.

Among the loud speakers we still have the famous "Dinkie" and Sterling "Baby" types, while a new hornless design makes its appearance for the first time under the name of the "Mellovox," which is sold at a very reasonable price.

The second section of the stands is taken up by Marconiphone products, an imposing array of sets of all descriptions being exhibited. Several of the sets are of entirely new design and, as usual, are so constructed as to be as nearly "fool-proof" as possible. For instance, the type No. 21, a 2-valve set (Det. and L.F.) is so arranged that the valves are enclosed so as to avoid leakage, and are mounted on antiphonic holders, interchangeable coils are provided, the range of wave-lengths provided with the set as marketed being 300-3,000 metres. A new three-valver is making its appearance, but the most

(Continued on page 166.)

LONDON'S WIRELESS EXHIBITION.

(Continued from page 165.)

surprising of all the exhibits is, in our opinion, the type 81 receiver. This is an 8-valve set (not superheterodyne) of more or less straight design, and



A large loud speaker at a moderate price, manufactured by Messrs. Radiax, Ltd.

The chief centres of attraction here will probably be the various types of anode converters. These latter consist of different models of a type of machine in which an arrangement of dynamo and motor enable the listener to generate his own H.T. from the L.T. accumulator supply. The design consists of a small, specially designed motor-generator, taking 10 or 12 volts of the accumulator, combined with a smoothing circuit to eliminate any ripple set up by the commutator. Various voltages are available: 6-70, 6-120, 12-300, 12-500, the former figures being the input voltages and the latter in each case being maximum output of H.T. The current consumption of these converters is, we understand, exceedingly low, being rarely in excess of 1.1 or 1.2 amps., so that the drain on the L.T. battery is not really serious.

RADIO INSTRUMENTS, LTD.

Stand No. 46.

In addition to the popular R.I. transformers, loud speakers, and Lyrianette receivers, Messrs. R.I., Ltd., are putting forward a series of new components which are well worth the attention of every radio constructor. Chief of these are the super-het. components, which comprise two forms of specially designed "oscillation couplers," filter units, and inter-valve transformers, the latter being arranged to have maximum efficiency on wave-lengths round about 6,000 metres, the filter unit being tuned to a corresponding frequency.

A very heavy and solid variable condenser is also to be seen, an example of real radio engineering such as might be expected from the works of the firm in question, while another variable condenser of vernier geared design is also being brought out to satisfy the needs of amateurs to whom exceptionally fine control is essential. This instrument has a ratio of 11 to 1, the method of gearing being new and obviating any possibility of backlash occurring. Brass sheet is employed in both these condensers for the construction of the vanes, both moving and fixed being of extremely rigid construction.

THE BRITISH L.M. ERICSSON MANUFACTURING CO., LTD.

Stand No. 9. Box 72.

Though noted chiefly for telephones and loud speakers, the British Ericsson Manufacturing Co. have several new types of receiving sets on view at the Royal Albert Hall. Chief among these are the 3- and 4-valve table cabinet models which incorporate many ingenious improvements on previous receivers. All the valves and coils are enclosed and even the terminals are so arranged as to be concealed. The 4-valve set also incorporates a special wave trap which makes it exceedingly selective. A new 2-valve set also making its appearance for the first time, with a wave-trap which, it is claimed, will effectively cut-out the local station, is designed to be used with almost any set.

Ericsson headphones take a prominent place among the components, many improvements in design and efficiency having been made during the last year. A junior loud speaker to act as "small brother" to the

"Supertone" senior is also a newcomer to the ranks of Ericsson products.

For the home constructor a separate series is on view, including filament rheostats and potentiometers, and transformers which, although they are small, are claimed to give undistorted results. Various condensers, switches, etc., are to be seen, while a new microphone transmitter will interest the more advanced amateur.

THE BRITISH RADIO CORPORATION, LTD.

Stand No. 47.

The exhibits of the B.R.C. should prove of interest to all, as they provide a complete range of apparatus, from a neat 2-Valve Cabinet Set, to their latest B.R.C. 5-Valve Cabinet Neutrodyne, which is of all-British design.

The distinctive feature about these receivers is an ingenious wide-range tuner, which gives a continuous range of wave-lengths from 200 to 2,000 metres, thereby receiving various British and Continental stations without having to change, or buy, any coils or holders.

The latest B.R.C. Astraphone IV Cabinet, with a novel method of changing all circuits with one control, is also being shown. This instrument has



The 4-valve "Tameside" receiver exhibited by Messrs. Hirst Bros.

descriptions have their places on the stand occupied by that concern.

Taking the sets first, we find examples of superheterodynes, the 7 and 8-valve models being shown, and also the 2, 3, and 4-valve "Vox Populi" receivers.

Components vary from complete super-het kits to valve windows and ebonite panels, including between these extremes wave-traps, wave-meters, audibility meters, coil holders, variometers, super-het. transformers, neutrodyne condensers, and H.F. transformers, etc.—in fact, practically everything that could be necessary for the construction of the most up-to-date receiver.

THE BRITISH EBONITE CO., LTD.

Stand No. 15.

As is to be expected, this stand is given up mainly to the display of various types of ebonite, all of the finest grade, but a new feature is also being introduced



A new type of wire rheostat that is rapidly gaining favour among constructors.

in the form of a separate section for low-loss coils. A comprehensive series of specimens of raw and unfinished materials makes an interesting sideline on this stand, and gives the visitor a very clear idea of the large number of processes through which the rubber—shown first in seed form—has to go before it is finally passed out as ebonite. All amateur constructors should make a point of visiting this exhibit, for it is undoubtedly one of the most instructive in the exhibition.

THE MULLARD RADIO VALVE CO., LTD.

Stand No. 18.

Visitors to the Wireless Exhibition can view every type of valve in the comprehensive collection of the products of the Mullard Radio Valve Company, Ltd., displayed at the above stand.

Among the receiving valves, of which over a dozen types are shown, are valves suitable for the single-valve set and for the multi-valve set equipped with the largest loud speaker.

A dull filament power amplifier of special interest is the new P.M.A. This valve has a filament of extremely high emissivity, which takes only 0.1 amps. filament current at 3.5 to 4.0 volts to heat it; The range of transmitting valves is even larger; a 5-watt valve is available for the novice, whilst a 30,000 watt valve, used in large power stations, is seen by its side, and a dozen valves of intermediate powers divide into suitable steps this large range.

A new anode resistance recently developed by the company is also on view. This resistance, being entirely wire-wound, is constant under all conditions of reasonable use. Condensers to work in conjunction with this resistance for detector valves are also made;



One of the complete super-het kits marketed by Messrs. Radiax, Ltd.

a range of from 200 to 3,000 metres, and is designed for long-distance reception.

The Neutrodyne set is in cabinet form, and has five valves, with means of cutting out one valve when required. The selectivity of this instrument enables the local station to be cut out by one or two degrees of the condensers.

THE BOWYER LOWE CO., LTD.

Stand No. 14.

Variety is the keynote of the exhibits of Messrs. Bowyer Lowe & Co., for components and sets of all



This double "Vanicon" condenser is eminently suited for the simultaneous tuning of H.F. circuits

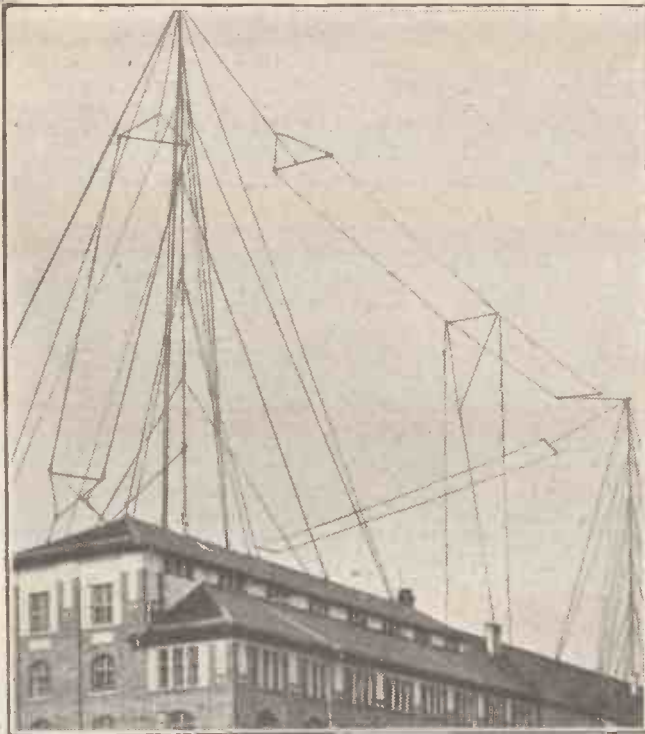

A photograph of the Stuttgart Broadcasting Station showing the aerial system.

NOTES ON BATTERY CONNECTIONS.

By G. V. DOWDING, A.C.G.I., Grad. I.E.E.
(Technical Editor, "Popular Wireless").

Practical Wiring Advice for Constructors.

In the latter it will be seen that H.T. batteries have been omitted, but that, except for the omission of H.T., C and D are exactly similar to A and B. Now, in C the anode of the valve is connected to the negative of the filament battery. Telephone receivers, earth and aerial connections, etc., are shown in all the diagrams so that readers will appreciate the circuits as radio circuits, and not merely as laboratory expositions.

active, thus showing that there is a current passing from plate to filament. In certain circumstances reception from a broadcasting station is possible with a circuit similar to D, but very, very seldom with C. This, of course, is to be expected, as at least something in the nature of an electron stream between filament and plate is essential to the subsequent operation of the telephone receivers.

It can be of very low value, as in the Unidyne circuits, or when operating on the lower bend of the curve in anode rectification circuits. An electron stream resulting in an average plate current of 100 microamps can be enough for quite good signals, although this component is frequently in the order of milliamps (one thousand microamps equal one milliamp).

PROBABLY one of the most puzzling points in connection with wireless circuits, and one that has caused most constructors a certain amount of confusion, is that which concerns the "common" connection of the H.T. and L.T. batteries. The positive of the H.T. battery is always placed nearer to the anode of the valve or valves than the negative in normal receiving circuits, this being quite essential to the functioning of such, so that it is evident that this at least requires no particular consideration in this article.

What is going to happen in C? Very little, because the anode of the valve will be at zero potential or negative in relation

Raising the Anode Potential.

In the short space at my disposal I cannot cover all the exceptions to the rule, and unfortunately there are always many to wireless rules, so I will make the concrete statement that at C there is no plate current, as the anode is negative, and that at D there is some plate current, as the anode is positive in relation to at least the greater part of the filament. No plate current—no signals seems to put the case definitely, if not scientifically, accurately.

The limited efficiency possessed by D which we have agreed is the more practical arrangement between C and D, can be equalled in C by inserting a battery in the anode circuit, as in E, of a similar voltage value to the filament battery, say four volts. This means, though, that we are using eight volts merely to obtain results equal to those given by four when employed as in D, and that were we to place another battery of four volts in the anode circuit of D, would mean eight anode volts results, and not four, as in E. I do hope this constant jumping from circuit to circuit will

(Continued on page 168.)

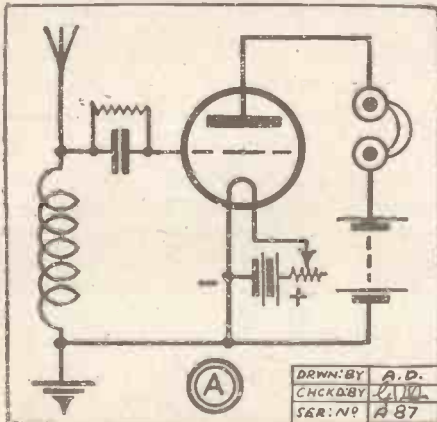

It is a different matter with the negative connection, however, for this can be taken to either the negative or positive of the L.T. or filament battery without seeming to effect results to any great degree, and therefore we have here something right away that requires careful explanation. The two conditions are shown diagrammatically at A and B, and in order to deal with the question so that it can be made quite clear, I will ask readers also to carefully study C and D.

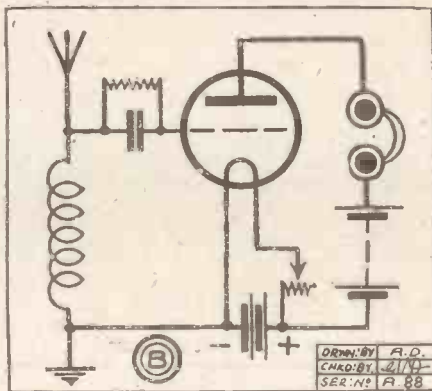

to the filament, and for all practical purposes no electrons will pass from the filament through the grid and reach it. The grid being connected to the negative side of the filament will not help matters either, but this need not enter into our reasoning at this point.

At E, however, the anode is connected to the positive of the L.T., and has a positive value to the extent of the voltage of the L.T. battery in relation to at least one end of the filament. This means that an appreciable electron flow between the filament and the anode should be possible.

That it is can be proved by replacing the telephone receivers for a sensitive galvanometer. In C no deflection results, but in D the needle will become quite

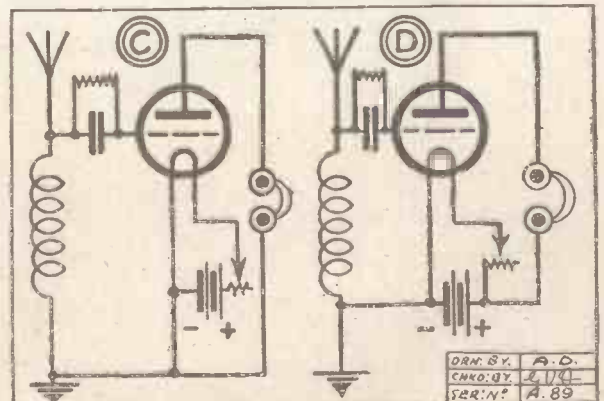

NOTES ON BATTERY CONNECTIONS.

(Continued from page 167.)

not give my readers oscillatory necks, but definite comparisons are absolutely essential for the purpose of this article.

To resume. It is now, I trust, fairly evident that connecting the H.T. negative to the L.T. positive is an economy, and that whatever value of H.T. is used to do so, means, in effect, to add the voltage of the L.T. battery to it for purposes of bringing the anode to the required potential necessary to obtain the correct working conditions.

Standardizing Connections.

Why, then, readers might well ask, do we in POPULAR WIRELESS more often than not connect H.T. negatives to L.T. negatives in various circuits presented to readers? The answer is, for purposes of standardisation. The "economy" of the one method is very slight, and actually hardly worth considering, but on the other hand, making the negatives of the batteries "common" frequently simplifies wiring and makes theoretical diagrams so much easier to follow. Look at Diagram A, and note how

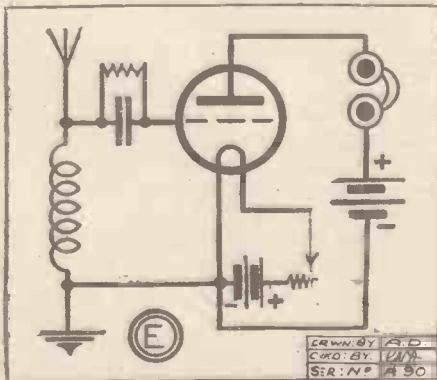

clearly separated are the grid, filament, and anode circuits. Further, when we mention, for instance, 30 volts H.T., we mean 30 volts on the plate, and not 30 plus whatever voltage L.T. is being used, and this might be either 1.1 or 6 volts, and a difference of nearly 5 volts on the plate can make a considerable difference in certain cases when, for example, anode rectification is under consideration.

A clear fact stands out, and that is that fundamentally the negative connection of the H.T. to either L.T. plus or minus need not affect the operation of the circuit in the slightest; adjustment can easily be made to obtain the same practical results whatever method is adopted, but I think I have shown that from the point of view of the general reader of "P.W." it is advisable for us to attempt to standardize the "minus to minus" rule.

Theoretical "Advantages."

An economy of a few volts H.T. would not be of value, and wireless receivers in these days of hard valves are invariably operated at slightly greater plate potentials than is absolutely necessary. It may, then, almost be classified as a theoretical advantage. In this category can also be placed the theory that isolating the filament

battery, which has greater current demands made upon it than the H.T., from the plate circuit, tends to provide more stable reception, owing to the fact that voltage variations in the L.T. battery are not both communicated to the anode directly, as well

as to the filament. But this can at least balance the "economy" theory, so that it will be noted that "minus to minus" holds the balance of advantage against the "minus to plus" method of connecting H.T. and filament batteries.



A concert in the country with a portable set and one of the "Amplion" portable loud speakers.

WHICH WAY DOES A CURRENT FLOW?

By C. E. FIELD, B.Sc., Staff Consultant, "Popular Wireless."

CONSIDERABLE confusion exists in the minds of many of those who are new to wireless work, and who are anxious to understand the elementary theory of the apparatus and circuits they are using, with regard to the direction in which an electric current flows.

This is not surprising, for much of the information they receive will appear to be of a very contradictory nature.

Thus, they will be informed that an electric current flows from the positive to the negative pole, that it consists of a stream of negative electrons, and that an electron stream flows from the filament of a valve, via the plate, to the positive high-tension terminal, and so forth.

The "Contradictions" Explained.

Scientists who first experimented with electricity found that it behaved very much as if it were an invisible fluid, and they therefore regarded it as such, and assumed that this mysterious substance flowed along a wire just as water flows along a pipe, although they could not see it, and had no means of telling in which direction it was moving. It soon became necessary, however, to know the direction of the flow, so it was decided that the positive pole of an electric cell should be regarded as the "high-pressure" terminal, with the result that an electric current was driven from the positive to the negative pole, through the external circuit.

This was purely an assumption, but it is still universally adopted, and is used extensively in electrical calculations, especially those dealing with electro-magnetism.

Early in the present century, however, we learned something of the true nature of

an electric current, which was found to consist of a stream of negative electrons, flowing round the circuit from the negative to the positive pole.

It is thus evident that the convention which is always adopted is incorrect.

We may sum up the situation by saying that, unless it is stated otherwise, an electric current flows round a circuit from positive to negative, but that when an electron stream is being considered, as in a thermionic valve, it must be remembered that

NEXT WEEK

Special Constructional Features:

"How to Make the Cheapest One-Valve Set"

and

"Building a Variometer Crystal Receiver."

the electrons move from negative to positive. When it is a matter of importance to consider direction of current, it is advisable to avoid confusion by referring to a "conventional current," or an "electron current" as the case may be.

Ridiculous though it sounds, the following rule may be borne in mind. An electric current flows round a circuit from the positive to the negative pole, and consists of a stream of negative electrons flowing in the opposite direction.

New Range of Models

FROM THE HOUSE OF

A.J.S.

"Sir Oliver Lodge's Choice after Test"

Considered from every standpoint the new A.J.S. Radio Instruments merit the closest investigation. Every model marks a definite step forward in Radio Evolution, and never before has such perfection been offered. Full details on receipt of postcard.

COMPARE THE SPECIFICATION.

Standard Equipment of all 4-Valve Sets consists of Treble Capacity giant H.T. Battery, A. J. S. Lucas Moulded Accumulator of 6 v. 104 amp. capacity, 3 A. J. S. Mullard specially designed Valves and Power Valve. 1 pair A. J. S. 'Phones. Full Aerial Equipment, Aerial and Earth safety gap. Coil Holder and Daventry Coils. In addition, 12 months' written guarantee and 12 months' Free Insurance with every set. Deferred payments may be arranged.

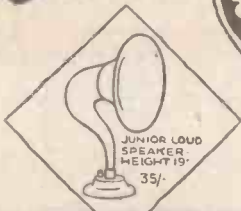

JUNIOR LOUD SPEAKER HEIGHT 19" 35/-



CABINET LOUD SPEAKER £4-15

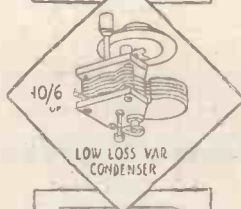

10/6 UP LOW LOSS VAR CONDENSER



2-VALVE SET ACCESSORIES & LOUD SPEAKER £13-18-6

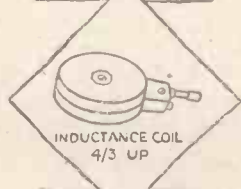

INDUCTANCE COIL 4/3 UP

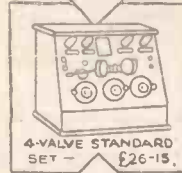

4-VALVE STANDARD SET £26-15.

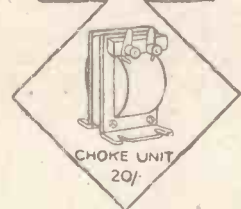

CHOKE UNIT 20/-



WOODEN HORN LOUD SPEAKER £4-15

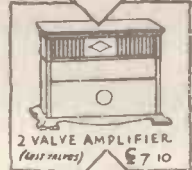

2 VALVE AMPLIFIER (10/11 VALVES) £7-10



PEDESTAL LOUD SPEAKER £22-10.

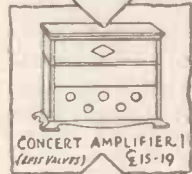

CONCERT AMPLIFIER (10/11 VALVES) £15-19



A.J.S. HEADPHONES 20/-

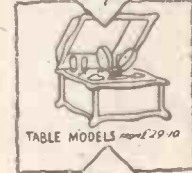
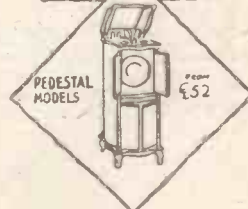
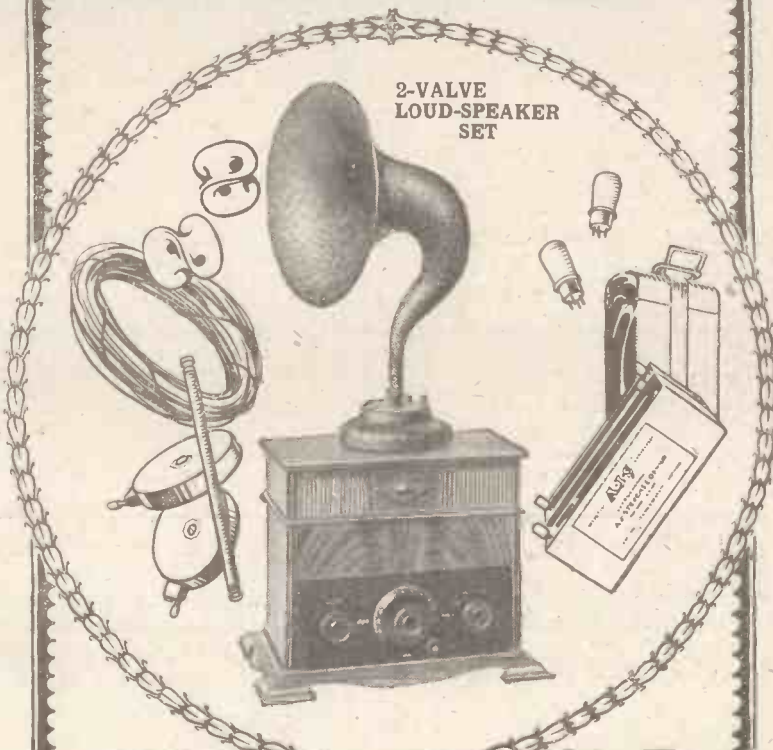

TABLE MODELS approx. 29-10



PEDESTAL MODELS from £52



2-VALVE LOUD-SPEAKER SET

Call and examine these splendid new A.J.S. Models at the ALL-BRITISH WIRELESS EXHIBITION, ROYAL ALBERT HALL, STAND No. E. 37 and BOX No. 46.

In beautiful mahogany Cabinet. Designed to give Loud Speaker results on near-by station and results on actual test are truly amazing. Complete with A.J.S. Junior Loud Speaker, 2 Mullard Dull Emitter Valves, 100 volt H.T. Battery, 2 volt 100 amp. Accumulator, Full Aerial Equipment and Coils (300-550), £13 : 18 : 6 (Royalties extra).

LONDON'S FINEST RADIO SHOWROOMS AND SERVICE DEPOT NOW OPEN AT 122-124, Charing Cross Road, London, W.C.2 'Phone: Regent 5167.

A. J. STEVENS & CO. (1914), LTD., Radio Branch, WOLVERHAMPTON

Telephone: 1748/52.

Radio Call Sign: 5 R.I.

Telegrams: "Reception," Wolverhampton.

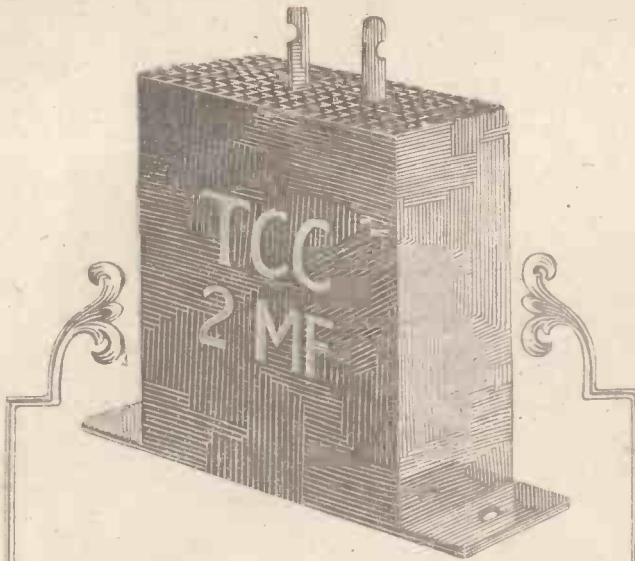

1905—1925

FOR more than twenty years T.C.C. Mansbridge Condensers have been the standard fixed condensers for all electrical requirements. First in telegraphy—afterwards in wireless telegraphy—now in Broadcast reception, their dependability and accuracy have always earned unstinted praise.

Among all your wireless friends you will never have known one who has ever been disappointed with a T.C.C. Mansbridge Condenser. And, after all, this feeling of supreme confidence is a great thing. It means that you can accept a T.C.C. Mansbridge Condenser, place it in the circuit, and know that its capacity is exactly as marked and that it cannot possibly short circuit. The most frequent and rigorous tests that can be devised safeguard both of these points for you.

But not all green condensers are T.C.C., and not all condensers produced to imitate the T.C.C. are of the genuine Mansbridge pattern. In fact, very few of them are. But you are always safe if you see the letters T.C.C. stamped on the side of the case.

T.C.C. Mansbridge Condensers

.0001 to .004 mfd. T.C.C. Mica.
.005 to 2 mfd. T.C.C. Mansbridge.

Telegraph Condenser Co. Ltd.
Mortlake Road, Kew

Six Sixty

The Best Dull Emitter.

GREAT volume is not usually associated with small current consumption.

But every user of the "Six Sixty" knows that in its patented MOLYBDENUM THORIUM COVERED FILAMENT, volume with economy is achieved as in no other valve, either bright or dull emitter.

Make it your next valve purchase.



FILAMENT
VOLTS 1.5-2

FILAMENT
CURRENT
.3 AMPS.

British Made.
B.B.C. Stamped

14/-

If your local dealer cannot supply write direct to us. If possible please give dealer's name and address.

Here's further striking confirmation of "Six Sixty" performance.

Liverpool.

I have now finished testing your two "Six Sixty" Valves under different conditions. The results completely substantiate your claims for them. Volume on local stations and 2ZY (32 miles) is colossal, while distant stations come in at double the strength they do with standard bright Emitters. I must say I am absolutely satisfied with them, and can heartily recommend them to all Wireless fans who want quality with quantity and economy. For clarity they are beyond reproach.

H. J.

How to
increase
accumulator
capacity
10 times



This free folder will interest you. It tells all about the unique filament of the "Six Sixty," and shows how with it great economy of current may be effected whilst actually gaining in range and volume. Send a post-card for it to-day.

ELECTRON

Triumph House,
189, Regent Street,
London, W.1.

Phone: Regent 5336.

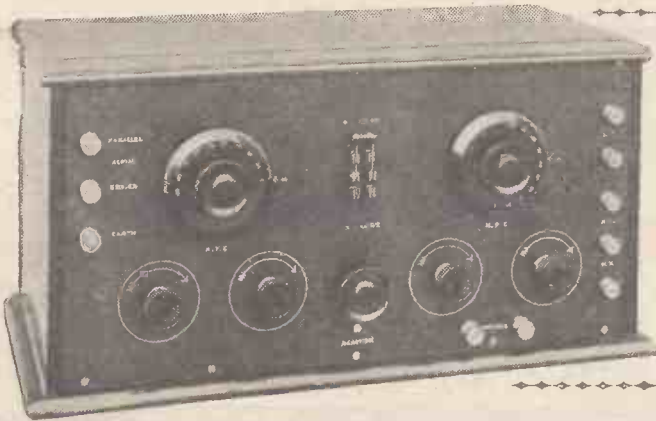

HOW TO MAKE THE "P.W." FOUR-VALVE SET. (H.F., DET., & TWO L.F.)

Designed and Described by
P. R. BIRD
(Asst. Technical Editor, "Popular Wireless.")

The Set Built by
G. V. COLLE
(Technical Staff, "Popular Wireless.")

This Set has been Built and Tested in the "P.W." Laboratory and has been found eminently satisfactory as a general purpose four-valver.

THE set now to be described employs the standard straight-circuit, H.F., Detector, and 2 L.F. It is an excellent all-round receiver, capable of long-distance results combined with good loud-speaker reproduction. Perhaps the best way to describe the functioning of this receiver is to refer to the photograph above and note the use of the various controls shown there. The three terminals on the left are for aerial and earth connections, and it will be noted that by the use of two aerial terminals either "series" or "parallel" tuning may be obtained. In the former case the aerial lead is taken direct to the series terminal, and the parallel terminal is left unconnected. For parallel tuning the aerial lead is taken to the top terminal, and a short bare wire or strip is joined between "series" and earth terminals, to complete the connections. In this way short and long waves are provided for without the necessity for an extra switch.

only. If a power-valve is to be used (and it is recommended, in order to get full results from the set), the full extent of the H.T. battery will probably be needed by

Easy Tuning.

The 4 rheostats are placed in line, with the reaction control in the centre, above which is the switch for 3 or 4 valves.

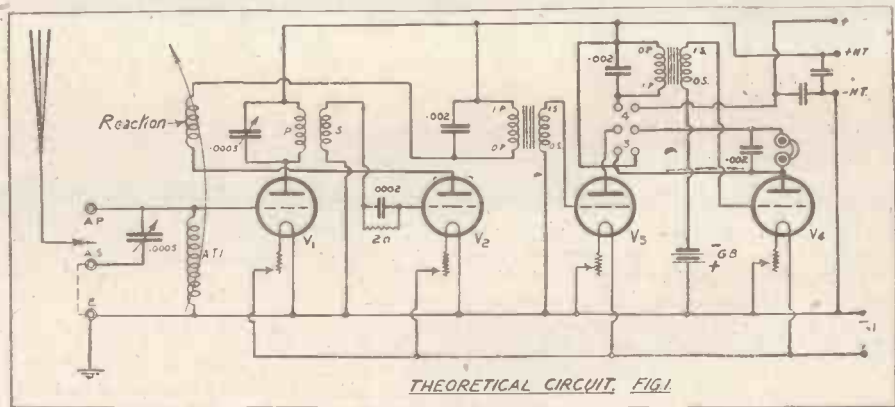

Lay-out of Panel.

The battery terminals on the right of the set are self-explanatory, but it may be as well to point out how the two H.T. + terminals are used. The bottom right-hand terminal supplies the H.T. to the last valve

this plug (100 volts or more.) The upper of the two H.T. + terminals supplies the H.T. to the first three valves, and generally this will be plugged in between 45 and 80 volts, depending upon the valves used.

Tuning of the aerial and H.F. circuits is carried out on the two condensers (A.T.C. and H.F.C.) which are accessibly situated so that they can be operated in unison, by one hand on each dial.

(Continued on page 172.)

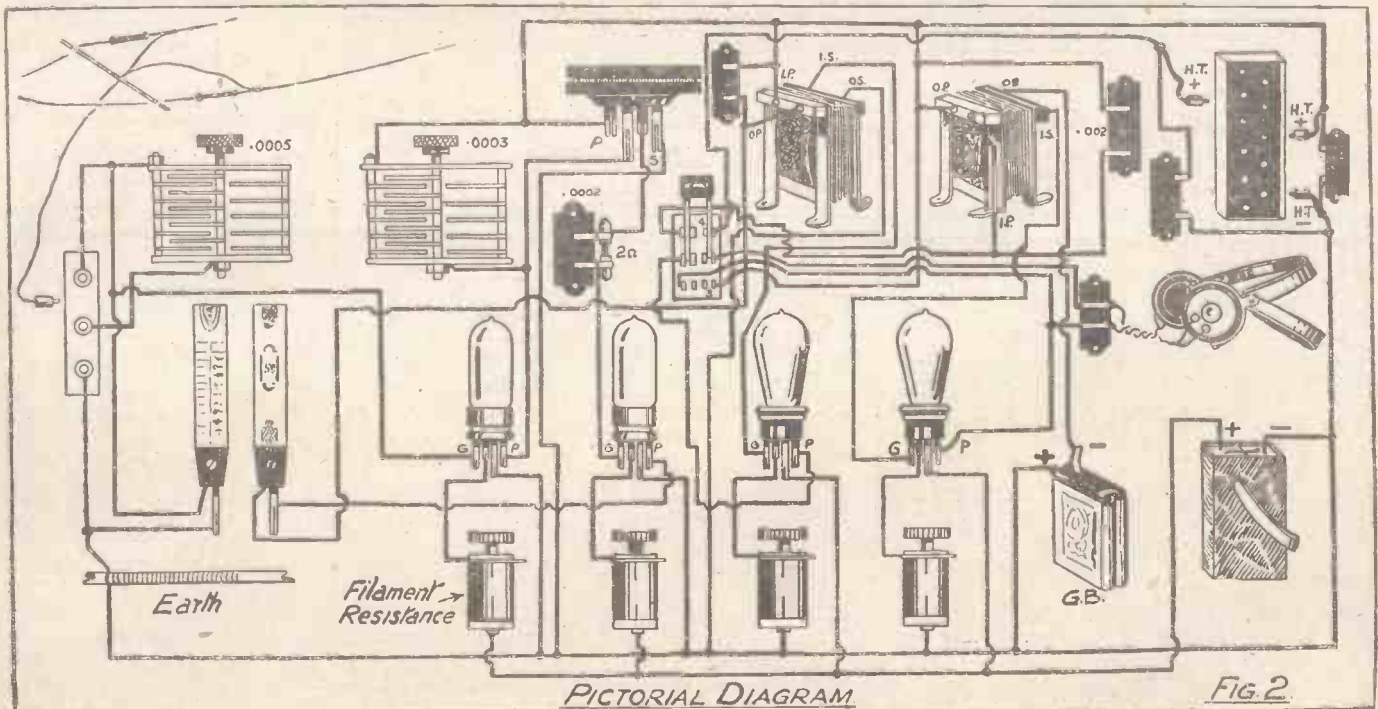

THE "P.W." FOUR-VALVE SET.

(Continued from page 171.)

In order that the set should be as simple to wire as is possible in an efficient multi-valve receiver, the switching has been reduced to a minimum. There is only one switch, which, as stated, places the fourth valve in or out of circuit, as required. The use of this D.P.D.T. switch automatically keeps the same H.T. on the first three valves, whether or no the last valve is in use. The filament current of the fourth valve is *not* cut out automatically, so its rheostat should be turned off when the centre switch is in the 3-valve position.

Apart from these small but useful modifications, the circuit employed is a perfectly "straight" one. The first valve is an H.F. amplifier, coupled to the detector valve by an H.F. transformer. The third and fourth valves are L.F. amplifiers.

The difficulty of making a powerful 4-valve set compact enough to be completely enclosed in a neat cabinet, has, in this instance, been overcome by a careful choice of components. Instead of tuned-anode H.F. amplification, an H.F. transformer couples the first and second valves together, thus avoiding the use of a bulky coil. Another space-saving component is the 2-coil holder, which holds the aerial coil close against the back of the panel, and allows the reaction coil to move away from it towards the back of the case. This coil holder possesses two other noteworthy features. By an ingenious mechanical

movement the reaction coil can be adjusted for "coarse" or "vernier" movement, and, better still, there is no necessity for a reaction reverse switch. The use of this latter bulky component is obviated by means of flexible plug-in connections to the reaction coil.

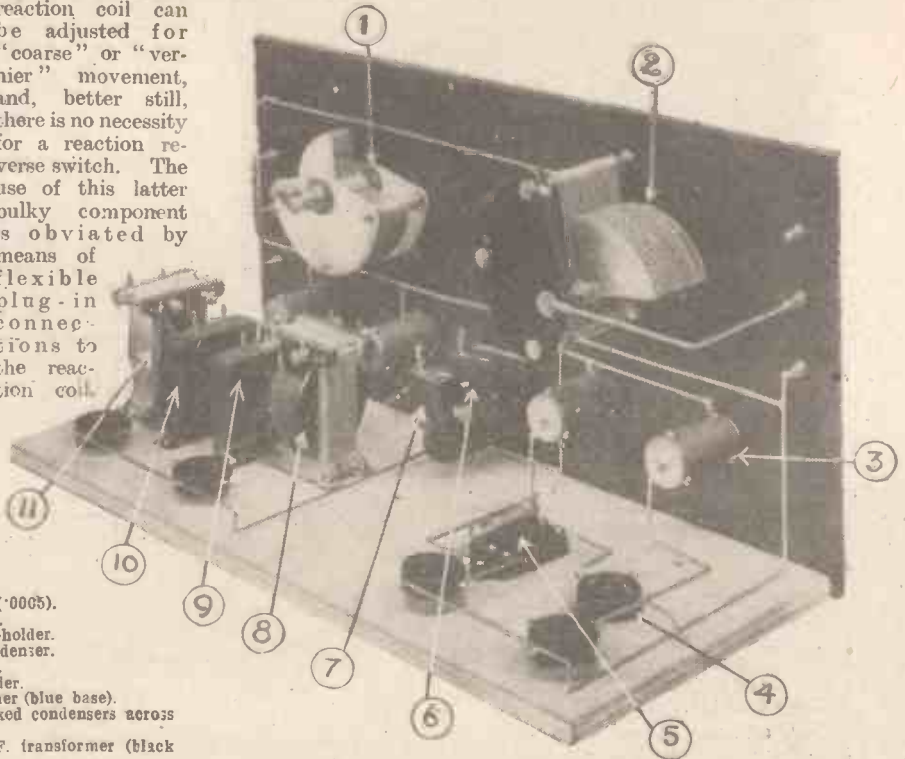

- 1. H.F. tuning condenser ('0003).
- 2. Aerial condenser ('0005).
- 3. Filament rheostat.
- 4. H.F. transformer-holder.
- 5. Grid leak and condenser.
- 6. Aerial coil-holder.
- 7. Reaction coil-holder.
- 8. 1st L.F. transformer (blue base).
- 9 and 10. 5 mfd. fixed condensers across H.T.
- 11. The 2nd stage L.F. transformer (black base).

As constructors know to their cost, after a carefully-made set has been connected up, it is often found necessary to reverse the connections to its reaction coil, because, as wired, the effect of coupling the coils is to oppose instead of to assist, each other. In the particular coil holder chosen for this set provision is made for an easy change-over, which is effected by merely altering the plug-in connections.

Other components which greatly affect the compactness of the "P. W." Constructor's 4-Valve Set, are the L.F. transformers employed. As can be seen from the photographs showing the lay-out of the base-board and the disposition of components, there is quite enough room inside the case to hold the L.F. transformers, H.T. condensers, and grid bias battery on the

(Continued on page 173.)

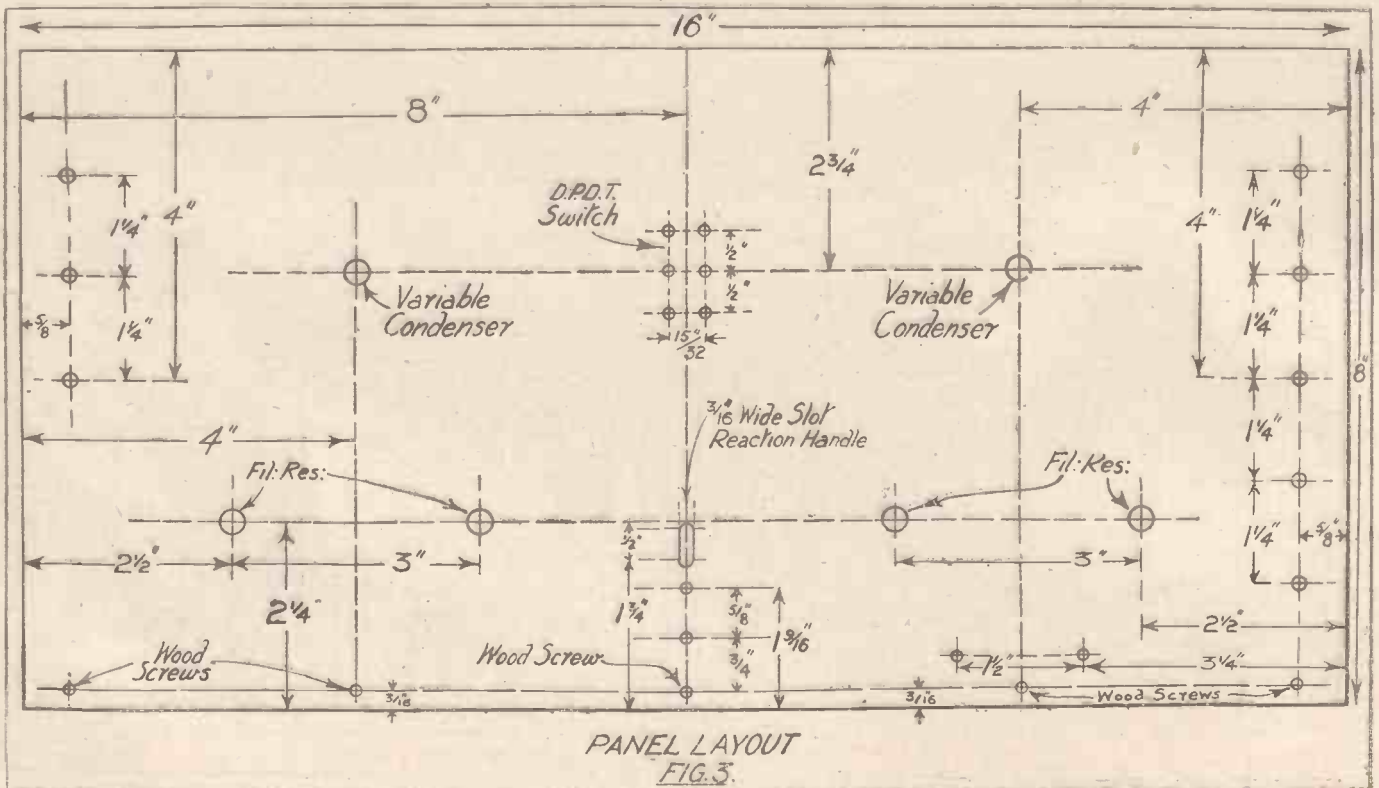

THE "P.W." FOUR-VALVE SET.

(Continued from page 172.)

right-hand half of the baseboard. But all the components were specially chosen, and a complete list of these will be found at the end of this article. It may not be possible to use other components instead of these unless a larger cabinet is used for the containing case.

Mounting the Components.

Actual construction is commenced by an examination of the case and components. The former should fit smoothly round the panel, and any little inequalities on the ebonite may be smoothed away with a file. Similarly the baseboard may require a little smoothing before it slides in and out smoothly, and, when this has been done, the components should be placed upon it in

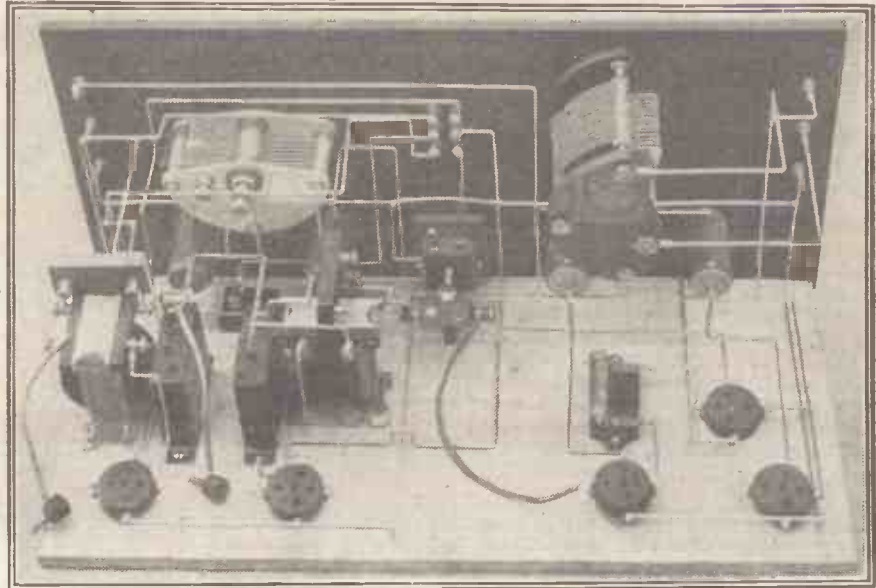

The completed wiring, showing the switch connections and flexible leads.



Ready for wiring.

the positions shown on the plan of baseboard (Fig. 4).

If the identical components named in the list of parts are used, the dimensions may be taken straight from the plan of the baseboard, and the components secured in place accordingly. If any alteration is made, great care must be taken at this stage to see that there is room for the components chosen, bearing in mind the importance of good spacing and wiring.

Similarly, the panel may be marked and drilled from the drilling lay-out, (Fig. 3). It will be seen that for the reaction handle to move sufficiently up and down it is necessary to cut a slot in the centre of the panel, the dimensions of this being as shown. The slot is easily made by drilling three or four holes in a line, and

finishing off the aperture with a sharp knife or small file.

Drilling the panel is quite a simple operation, facilitated as it is by the symmetrical arrangement of the lay-out. In order that the second L.F. transformer might slide in and out of the case, it was found necessary to remove the lower half of the right-hand supporting fillet on the cabinet. This is easily accomplished by a simple saw cut about half-way across the fillet.

The Wiring.

The appearance of the set, when all the components have been mounted, is well shown by the photograph on this page. The grid bias battery is now temporarily removed, and the wiring commenced.

The usual plan of wiring the filament circuit first is a good one, and can well be

(Continued on page 174.)

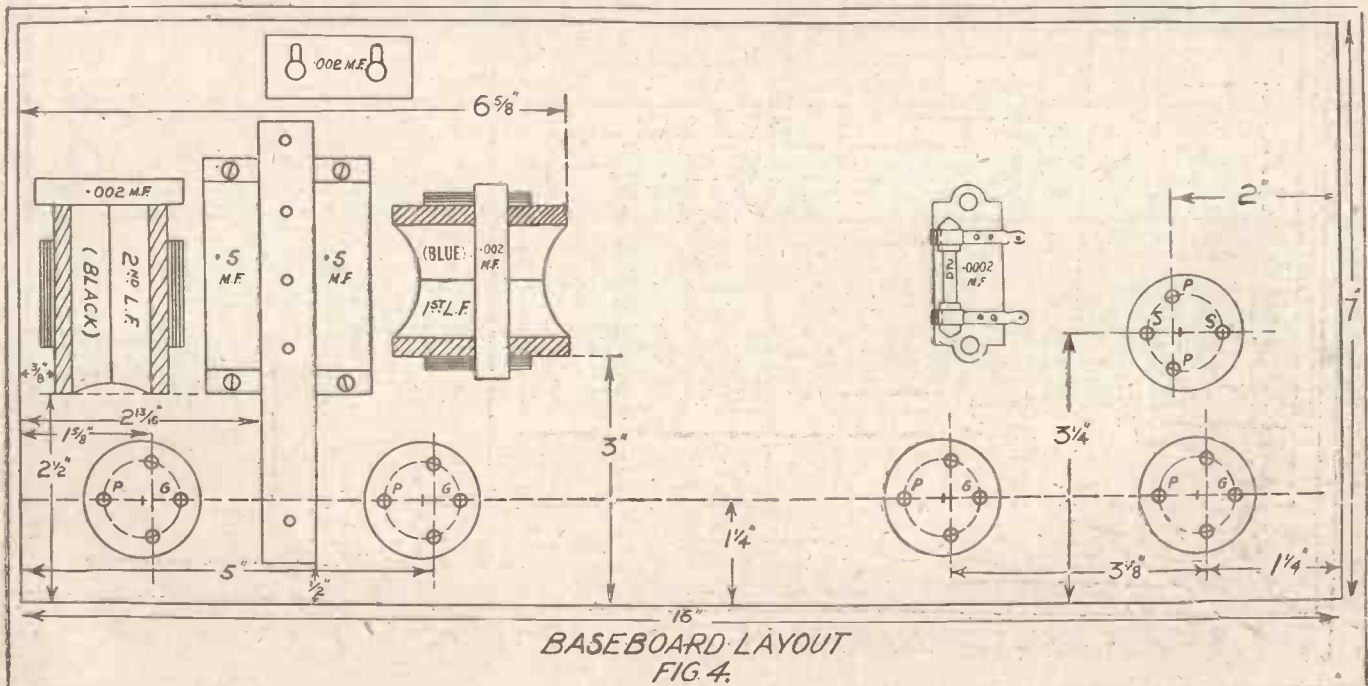

THE "P.W." FOUR-VALVE SET.

(Continued from page 173.)

adopted in this instance. The position for the various wires is clearly shown by the photographs, and by the wiring diagram which is reproduced below.

It is advisable to wire the 'phone terminals before any of the surrounding leads, or otherwise this part of the panel becomes inaccessible. Another little point to watch is in the wiring of the D.P.D.T. switch. The wires to this should lie as flat against the panel as possible, so as to avoid touch-

Another view of the wiring.

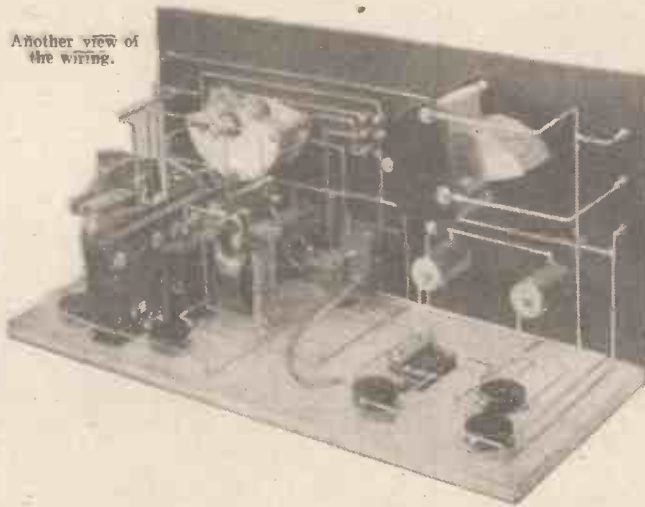

ing the aerial coil. By occasionally inserting the aerial coil in position during the wiring of the switch any trouble of insufficient spacing may be avoided. Similarly the grid bias battery needs to be kept in mind whilst wiring the L.F. end of the panel, and no difficulty will be experienced if this fact is borne in mind from the start of the wiring.

It will be seen that the primary of the H.F. transformer is assumed to correspond with "filament" terminals of the holder.

(Continued on page 205)

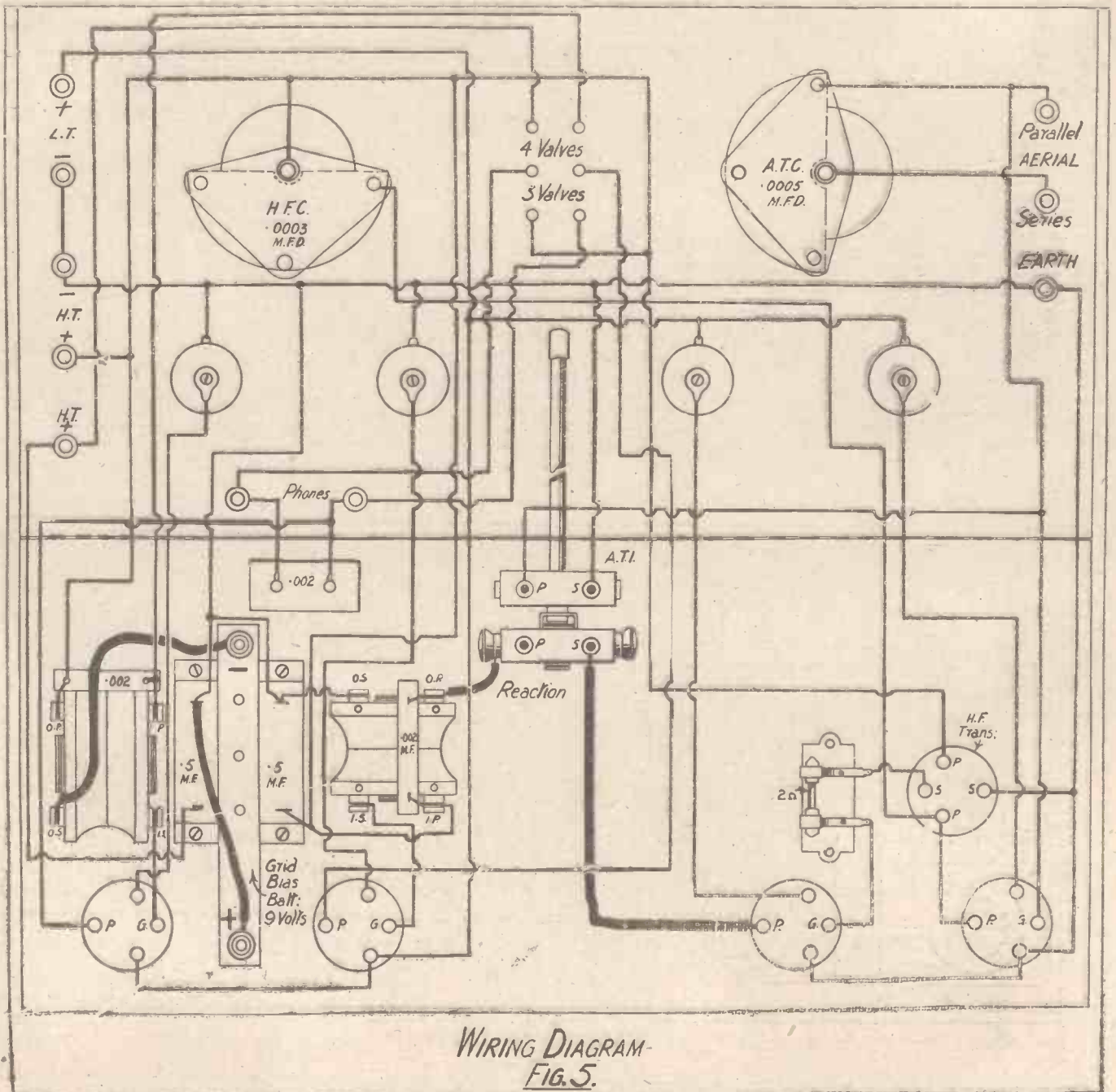

POLARISED WAVES.

Dr. ALEXANDERSON'S IMPORTANT DISCOVERY.

By J. H. T. Roberts, D.Sc., F.Inst.P.
(Staff Consultant "Popular Wireless").

WHEN waves go out from a wireless aerial, are the displacements in a horizontal plane like the up-and-down motions given to a horizontal rope when one end is shaken up and down vertically, or are they in the horizontal plane, or what?

The answer is that all depends upon the aerial and other conditions.

If waves, whether wireless or any other kind of waves, are executed in one plane, the waves are said to be "polarised," and polarised waves have some very remarkable properties, as we shall see presently.

It was known to Hertz and other early wireless experimenters that wireless waves could be polarised, and Artour even took out patents connected with wireless wave polarisation as far back as 1902 and 1903. But since that time the importance of polarised waves in wireless was largely overlooked, until recently, when a curious accident caused attention again to be directed to them. It happened in this way.

Peculiar Phenomena.

Alexanderson, the famous American wireless engineer, was experimenting at Schenectady, transmission being made to Riverhead, on Long Island. The signals were being sent out on a directed short-wave beam system, and on one occasion it was found that, whereas no effect could be noticed in the vicinity of the transmitting aerial, signals were coming in well at Riverhead. Testing instruments were brought up, but still nothing could be found in the intermediate region, whilst the signals were still thumping in at the distant station.



One of the mobile wireless stations used by the Army for the direction of artillery fire.

The region between seemed absolutely dead. In other words, energy was going out, and being received easily at a distance of something like a hundred miles, whilst at less distances it could not be perceived.

A "Twisting" Wave.

On investigation it was found that, due to certain peculiarities in the transmitting circuit, and to certain accidental conditions, the vertical component of the waves was being suppressed, the horizontal component alone being transmitted. That is to say, a "polarised" wave was being emitted.

Now, the curious thing about this wave in the horizontal plane is that it does not remain in the horizontal plane but progressively *twists*, so that at a certain distance it is in the vertical plane, and at a certain distance again it is in the horizontal plane, and so on. Consequently, with certain types of receiver there will obviously be dead

regions, and the positions of these can be varied by varying the height of the transmitting antenna, the wave-length, and other factors.

It is evident that for the purposes of secret wireless, this discovery is of great importance, for not only can a directed beam be used (rendering all receiving stations off the direct line inoperative for the purposes of the signals in question), but also particular regions, even on the direct line of transmission, can be deprived of power to receive signals by the simple expedient of arranging the factors governing the transmission so that those places are at dead spots.

In addition to the evident uses of this discovery in the ways mentioned above, it is also found that by its use the effects of static may be largely minimised. This is not of great importance in this country, as static does not trouble us much for comparatively short transmissions, but in other parts of the world, and in the case of reception from great distances, static plays a most important part. Many high-power stations are forced to shut down for hours at a time owing to static interference, with considerable financial loss.

A Valuable Discovery?

The polarisation of wireless waves has its analogy in the case of light waves. If a beam of ordinary "white" light is passed through a special kind of crystal, known as a "Nicol prism," the emergent light is "polarised" in a certain plane, and if this light is passed into another Nicol prism, the second one being rotated so that it would only allow the transmission of waves at right angles to those which are actually present in the polarised beam, the whole of the light will be cut off by the second prism.

Polarisation with regard to light waves has been known and made use of for many years, but the importance of polarisation in wireless waves is only just beginning to be realised, and many experts consider that the discovery referred to above will prove to be one of the most far-reaching ever made in connection with wireless transmission.



Part of the Hayes receiving station erected by the B.B.C. in connection with the proposed scheme for relaying of foreign transmissions.

BROADCAST NOTES.

By O. H. M.

International Transmissions—The Official Mind and the Broadcasting Authorities—Empire Broadcasting—Improving Showmanship—The Relay Areas—The Concert Industry and the B.B.C.—An Unsound Argument.

IT is gratifying to note the progress of the international side of broadcasting. The B.B.C.'s special receiving station in Kent has already demonstrated its usefulness, particularly in connection with the Geneva experiment. Not only in the wave-length test, but also in the various experiments necessary and preliminary to the relaying of foreign programmes, results have surpassed expectations.

I am now in a position to prophesy with confidence that the scheme for the interchange of programmes internationally, which was disclosed exclusively in this page some months ago, will commence operation early in November.

European Preparations.

The various foreign broadcasting authorities, realising the imminence of international exchange, have been acting together with a view to guaranteeing that at least the early programmes that will come under this scheme will be creditable to national enterprise.

The Germans in particular are leaving nothing undone to guarantee that the programmes taken from that country for re-broadcasting in Europe and America, will be truly representative of the best talent and organisation that can be produced by the combined resources of all the German broadcasting companies.

The French, too, realising the importance of holding their own in the international scheme, are now conducting a general stock-taking, with a view to the better organisation of their broadcasting.

I understand that this is being done primarily at the instance of the French Government, which has been roused to activity because of the recent League of Nations broadcast. It has been known widely that for some time the state of broadcasting in France has not been satisfactory to the Government. The present scheme for more centralised control and better organisation is sponsored by the Government. There is just the possibility of the arbitrary selection of wave-lengths, which may upset the reasonable and workable arrangements which have resulted from the European rehearsals early in September.

Canada to Copy B.B.C.?

Once again it is the problem of conflict between the official mind and the actual broadcasting authorities. It is perhaps inevitable that Government departments of whatever country should attach undue importance to the purely domestic arrangements. This, in the case of broadcasting, is apt to lead to grave difficulties, because the ether pulsations which result in the reproduction of intelligible sounds in headphones or loud speakers have no respect either for geographical or international boundaries.

The recrudescence of activity in international broadcasting calls attention once again to the extreme urgency of devising

a workable scheme for Empire broadcasting.

I understand that the B.B.C. is by no means happy at the prospect of its programmes reaching Canada, Australia, and New Zealand through the United States. Various proposals have been brought forward with a view to encouraging Canada to undertake the provision of a real inter-imperial broadcasting link. Financial embarrassment and the pre-occupation of an imminent general election have made it difficult for the Canadian Government to take prompt action, in the absence of which private enterprise is endeavouring to fill the gap.

There is more in this than imperial sentiment. As the merits of the British system of unified control under government supervision are becoming more widely known in the Dominions, a corresponding movement is gaining ground to establish parallel organisations based primarily and fundamentally on the public service conception. To achieve the object of this movement it will be necessary in most cases to absorb private enterprise, and to modify the

existing system of competitive commercialism.

But the idea is now rapidly gaining ground that the now distinctively British conception of broadcasting should become a characteristic not only of the United Kingdom, but also of the Dominions as well. If the movement goes as far as this, it is probable that its momentum will carry it throughout the English-speaking world, and to other countries as well.

The New Feature.

In the matter of the improved showmanship, to which the B.B.C. is paying particular attention just now, results appear to be satisfactory, on the whole, and judging from the comments of competent critics there is a marked general improvement in the programmes. There is, of course, the usual contradiction in the analysis of opinions.

One of the ideas in the new scheme of showmanship was that before any symphony or classical selection was played there should be a brief introductory description explaining the background, and the motive, with perhaps some biographical reference to the composer. While there is evidence that on the whole this innovation is appreciated, it is curious that a certain proportion of listeners are resenting it on the grounds that they want to hear only the music, the effect of which they believe is spoiled by the preliminary description. It may be, of course, that descriptions are overdone, and this will need to be watched most carefully.

(Continued on page 178.)



Part of the relaying system used at the recent broadcasting of an open-air concert at Barcelona.

See the Latest Valve Developments at Stand No. 26.

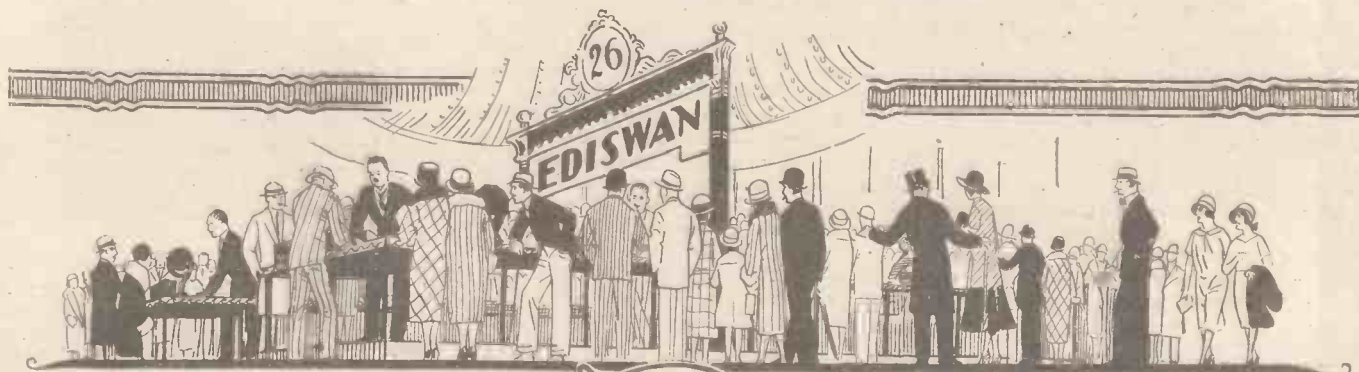

All the recent additions to the famous Ediswan Valves series, embodying new and exclusive features, are on view at Stand 26. These improvements have been adopted only after lengthy experimenting had proved their worth.

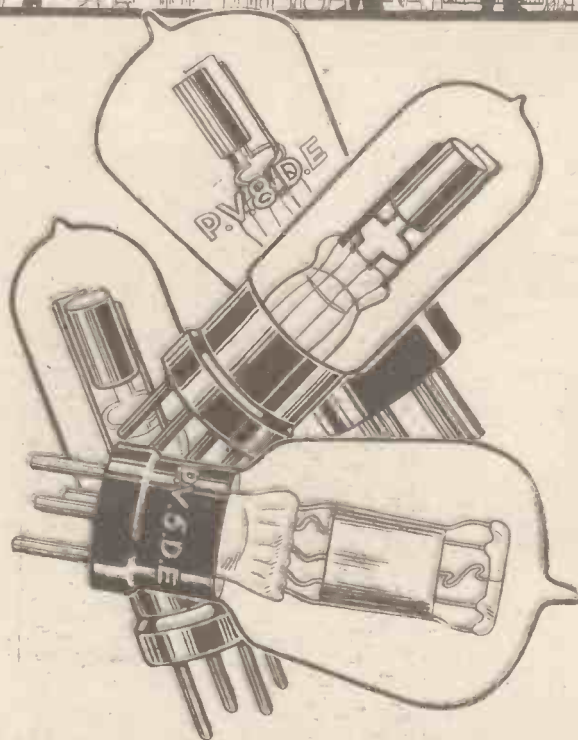

Wireless enthusiasts will undoubtedly find the Ediswan Stand the most interesting at the Exhibition. If there's any problem puzzling you — ask the Ediswan experts. They'll be glad to enlighten you.

EDISWAN VALVES

Will Improve
ANY Set

SEE THE EDISWAN STAND—No. 26.

N.A.R.M.A.T. WIRELESS EXHIBITION, SEPT. 12th to 23rd, 1925,
ROYAL ALBERT HALL.

THE EDISON SWAN ELECTRIC CO., LTD., 123, QUEEN VICTORIA STREET, LONDON, E.C.4.

BROADCAST NOTES.

(Continued from page 176.)

The relay areas of the B.B.C. are becoming restive. The ground of complaint this time is the special local programmes which are to be put on by the relay stations every Friday night. The last time there was trouble in the relay areas, the agitation was directed towards the extension of local programmes. Now just the reverse attitude is adopted. The critics are complaining that on Friday night they are deprived of the London programmes, and they are petitioning the B.B.C. to discontinue the local features.

In view of its approved policy of de-
volution which is designed to develop local
esprit de corps and morale, I do not see how
the B.B.C. can cut out the weekly local
programme of relay stations. I should have
thought a better line of attack would have
been to call for a strengthening and ex-
tension of the local programmes, with a

I understand that the conversations
between the concert authorities and the
B.B.C., to which I referred last week, are
still in progress. No workable scheme has
emerged so far, but an advance has been
made in the direction of a working basis.
There seems little likelihood of a recurrence
of the deadlock of the early summer, and,
were I a betting man, I would suggest that
the odds are "on" that we shall have
some sort of an agreement before the end
of October.

The Licence Trouble.

The ingenious agitation was started with
the object of effecting change over of the
source of income of the broadcasting
services in Great Britain. Ostensibly, the
promoters of this agitation are aiming at a
transfer of the financial burden of the
broadcasting services from listeners to
advertisers and manufacturers.

It is asked why, if industry is prepared to
pay for broadcasting, why then should the
public have to stand the bill? The real
object behind this movement of course is
to introduce paid advertising into British
broadcasting. I imagine that it will receive



A section of a field wireless station carrying out operations at the Army manoeuvres now in progress at Aldershot.

view to the ultimate transformation of
relay stations into main stations.

Districts out of Crystal Range.

Much more serious issues at the moment
are bound up in catering for the sections
of the population which still remain
outside the effective crystal area of
any station. These include parts of the
West country and of Wales, a strip of the
S.E. coast, and a considerable area in
Scotland. In these places although the
population is sparse, crystal reception is
still out of the question. Judging from Press
reports the B.B.C. is fully alive to the
urgency of this set of problems, and is doing
all it can to secure the necessary additional
facilities.

very little support from the Press as a whole.
It is quite obvious that if the large national
advertisers have to devote considerable
sums to broadcasting, they will not increase
their general appropriation, but will greatly
reduce the money they now spend on news-
paper advertising.

Anyway, the argument is fundamentally
unsound. The licence fee of 10s. a year
represents three programmes for one penny,
which does not appear exorbitant. More-
over, it does very definitely give the public
a control over the broadcasting service
which it could not have under a regime paid
for by advertising. However, it will be inter-
esting to see the reaction from the de-
velopment of this movement.

Mullard Double Ring DULL FILAMENT Valves

DOUBLE WHITE RING FOR MASTER DETECTION



Mullard Double
White Ring Valves
have been specially
selected for superior
detection. They are
made in two types:

Type D '3 for 14/-
2-volt accumu-
lators - each.

Type D '96 for 16/6
2 or 3 dry cells
or 4-volt ac-
cumulators - each.

DOUBLE RED RING FOR H.F. AMPLIFICATION



Mullard Double
Red Ring Valves are
designed for real
long distance recep-
tion. They are
made in two types:

Type D '3 for 14/-
2-volt accumu-
lators - each.

Type D '06 for 16/6
2 or 3 dry cells
or 4-volt ac-
cumulators - each.

DOUBLE GREEN RING FOR L.F. AMPLIFICATION

VISIT
STANDS
16,
22 & 23,
(Gallery)
ALBERT
HALL,
SEPT.
12-23,
1925.

Mullard Double
Green Ring Valves
are designed for
real pure tone
reception. They
will operate small
and medium-sized
loudspeakers. Made
in two types:

Type D '3 for 14/-
2-volt accumu-
lators - each.

Type D '06 for 16/6
2 or 3 dry cells
or 4-volt ac-
cumulators - each.

Ask any dealer for Leaflet V.R. 25.

Mullard THE MASTER VALVE

Advt.—The Mullard Wireless Service Co., Ltd.,
Nightingale Lane, Balham, London, S.W.12.

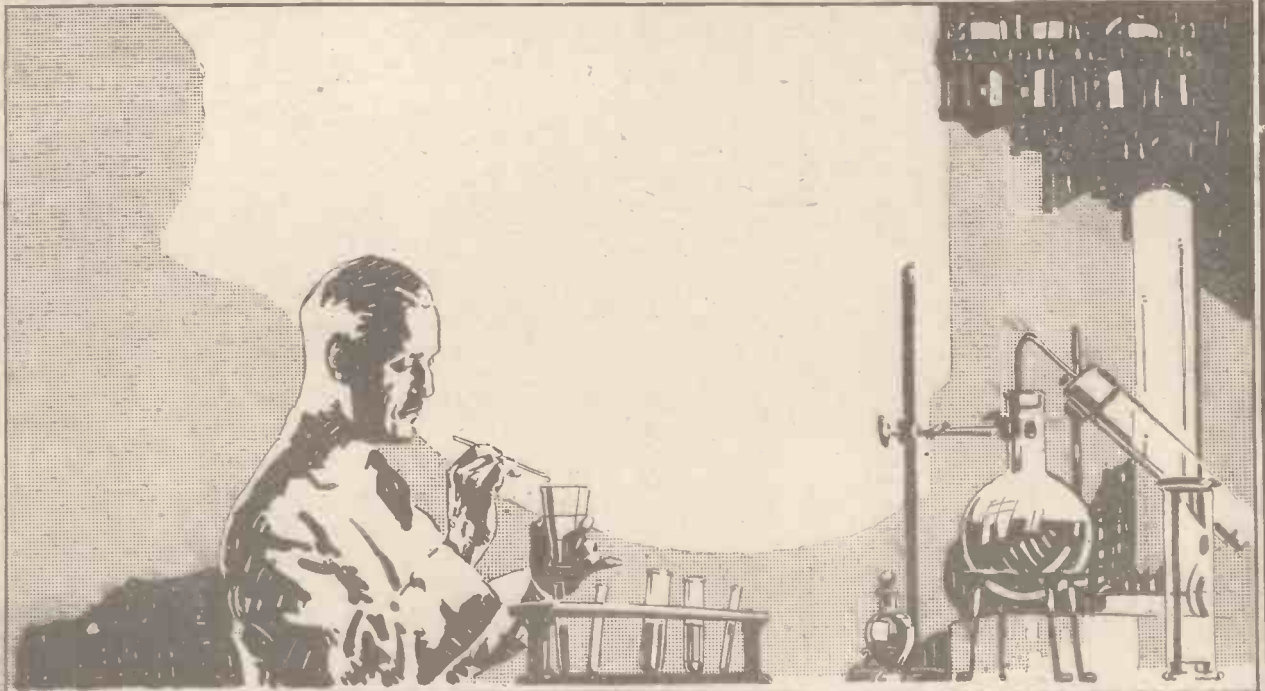

Drops and Globules

*M*ASTER Valves are not entirely the work of the electrical specialist. My beakers and solutions may provoke the mirth of those engineering demi-gods, but they know right well that the purity of their materials and the advantages of certain minerals are the results of my labours.

I am like all chemists—EXACT.

I want perfection in the materials for my valves . . . you want perfect reception Then take the advice of a man who is *decidedly analytical* and ask for



Mullard
THE · MASTER · VALVE



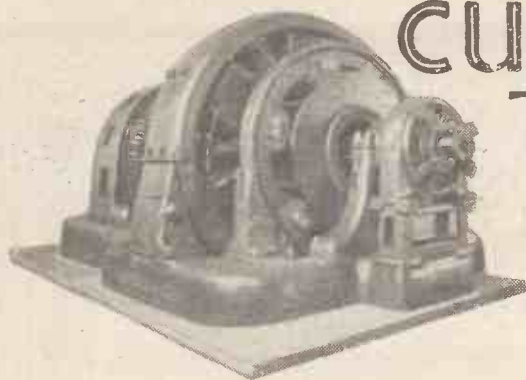

CURRENT TOPICS

BY THE EDITOR

A British Association Suggestion
—Sir Oliver Lodge's New Book—
International Broadcasting—
Peace in the Ether.

AT the recent meeting of the British Association in Southampton a suggestion was made by the representatives of the corresponding societies that the British Broadcasting Company should consult the Association with a view to securing the best talks on scientific subjects. This suggestion arose out of a discussion by Dr. Ascott, of Stoke-on-Trent, who gave it as his opinion that talks on local "flora and fauna," etc., expressed in popular non-scientific terms, would be greatly appreciated; and Dr. Bather, of the Natural History Museum, South Kensington, remarked on the fact that his recent talk on "Dinosaurs" seemed to have been greatly appreciated by listeners, judging by the number of letters he had received.

This suggestion is one worthy of very careful consideration by the B.B.C., and it is pleasing to note that a B.B.C. official has stated that the company has welcomed this gesture on the part of the British Association, and that the B.B.C. would see to it that the project was not dropped.

It has always been the policy of the B.B.C. to consult the highest authorities on any subject with which they wish to deal, and this policy is one which can be heartily commended. The B.B.C. have had ample proof that, in seeking the co-operation of the highest available authorities, they have pleased innumerable listeners by their policy.

"Talks on Wireless."

We have received from Sir Oliver Lodge, our Scientific Consultant, a volume of his latest book, entitled "Talks on Wireless," published by Messrs. Cassell at 5s. net. Many of the chapters in this book have already appeared in serial form in POPULAR WIRELESS, and we have no doubt that many readers will be glad to avail themselves of these "talks," neatly bound and published by Messrs. Cassell at a price within the reach of all.

Sir Oliver, as our readers know, is indefatigable in his study of the progress of wireless, and in this volume he has collected together a mass of information which the practical amateur will find of the utmost value. We cannot refrain from quoting the following passage from Sir Oliver's book, which must strike every reader as being the essence of common sense.

"Civilisation," says Sir Oliver, "ought to have progressed too far by now for the perversions of ingenuity responsible for the construction of diabolical and otherwise useless mechanism, and for the artificial increase of those natural evils among which it is our lot to live and against which it is our business to contend.

"Surely," writes Sir Oliver, with regard to wireless, "it will be a weapon of peace. Isolated groups of men develop insular prejudices, fail to understand other groups; jealousies and misunderstandings arise until they lead to the horrors of inter-ethnic strife and wholesale slaughter."

Successful International Broadcast.

The attempt of the first international simultaneous made on Monday, September 7th, when the B.B.C. broadcast from

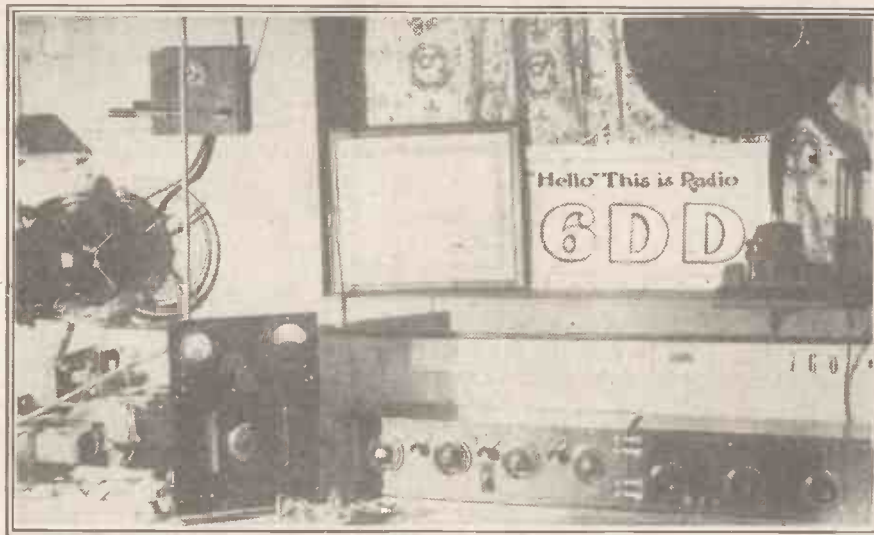

The amateur station owned by Mr. P. Keast, of California, whose signals have often been heard in this country.

5 X X and 2 L O the inaugural speech of M. Painlevé at the opening of the League of Nations Conference at Geneva, was an undoubted success. M. Painlevé, speaking in a hall at Geneva, was heard clearly by thousands of listeners in this country and on the Continent. His speech was transmitted by 200 miles of land-line from Geneva to Paris, then broadcast by the Eiffel Tower radio station, picked up at Hayes, the B.B.C.'s experimental post, relayed by land-line to 2 L O and 5 X X, and re-broadcast to British listeners.

Little Interference.

Despite the complicated path his speech had to travel, it reached British listeners' ears, under the circumstances, in a remarkably clear form, and, save for some slight interference from ships and other stations which interfered with F.L.'s transmission, there was very little of the "mush" and noise we should have expected, in view of the complications in the transmission.

The B.B.C. are to be congratulated, especially the French and British engineers

who were responsible for the technical arrangements.

The Wave-length Tests.

Wave-length tests carried out at the instigation of the Radiophone Bureau at Geneva have certainly done much to create a peace in the ether. The B.B.C. have received a mass of correspondence from listeners commenting on the test transmissions, and, at the time of going to press, we are informed that the staff have not yet been able to draw up a complete schedule of these reports.

But the B.B.C. announce that results, on the whole, are exceedingly satisfactory. Data gained from the test indicated that London, Aberdeen, Cardiff, Glasgow, and Newcastle are being received quite well by listeners in this country, but that Dundee, Manchester, Bournemouth, and Leeds-Bradford were being badly interfered with.

The various alterations still to be made in the wave-lengths will, it is hoped, eventually result in the allotting of a band of wave-lengths to the Continental and British stations which will ensure clear transmission for each station without mutual interference.

The "Daily Telegraph" refers to a German correspondent who wrote to the

B.B.C., and, commenting on the reception of German stations, says: "Hopeless; it was bad enough originally on the old wave-lengths, but even that was better than on this re-distribution." This German gentleman suggests drastic remedies. "Demolish the German relay stations," he says, "or reduce their power to 250 watts, after the example of the English and Swedish stations, and curtail the night range of the small stations. In the present hopeless conditions this is all that remains for Germany to do, and do it she must."

One suggestion has been made that ship stations should employ a different band of wave-lengths. At present ships use 300 and 600 metres, and a good deal of interference with broadcasting is undoubtedly caused through ships with antiquated sets working on these wave-lengths. It is time now that spark sets should be abolished for ever. The problem is an urgent one, and if further chaos is to be avoided, a drastic alteration in the wave-length of ships and in the type of apparatus employed should be made without delay.

The "4 Point" Condenser

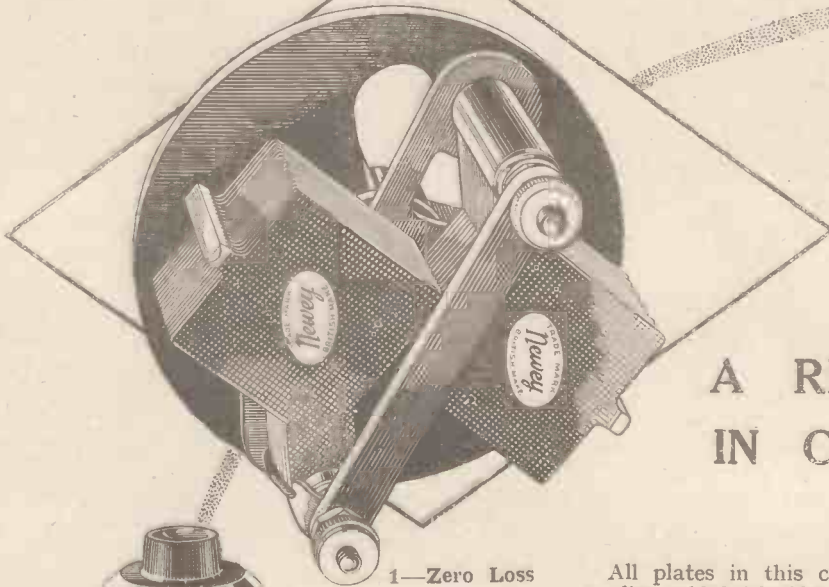

A REVOLUTION IN CONDENSERS

1—Zero Loss

All plates in this condenser are of the finest quality gold-finished brass, and are welded together, thereby eliminating electrical loss experienced with all types of condensers using spacers between plates.

2—Lowest Minimum Capacity

The illustration shows the condenser fully extended, and it will be seen that there is $\frac{5}{8}$ " air space between the two sets of vanes, impossible to obtain in the usual form of condenser.

3—No Hand Capacity

No metal plates are used whatsoever, only the very highest grade Bakelite being employed. The moving shaft connected to dial is entirely insulated from the Condenser by means of Bakelite Sectors.

4—360 Degrees

Vernier is unnecessary, as the condenser is geared and has a calibration range of 360° as against 180° in the usual form of condenser.

Lastly the condenser, which is single-hole fixing is beautifully finished, only the best Bakelite and high grade brass being used and it bears the Newey British Hall Mark of excellence.

PRICES :

.0005 mfd. 17/6
.0003 mfd. 15/-



POINT
CONDENSER

Ask your dealer
for Leaflet.

Newey's

Wholesale Distributors: P. & M. Ltd.,
122-124, Tooley Street,
LONDON, S.E. 1

Telephone: HOP 134.

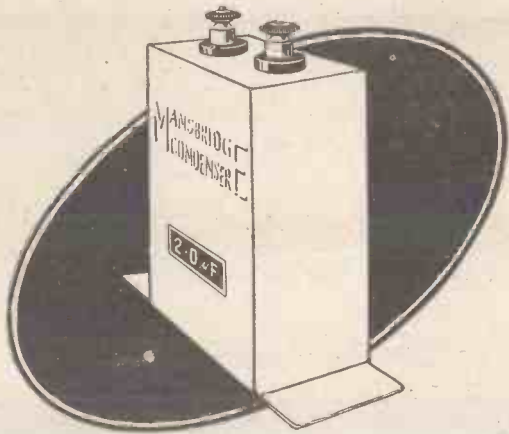

THE MANSBRIDGE CONDENSER

We have pleasure in announcing that the genuine Mansbridge Condenser originated and designed by G. F. Mansbridge, Esq., over 20 years ago, will now be manufactured by the Mansbridge Condenser Co., Ltd., under the aegis of G. F. Mansbridge, Esq., himself, and marketed with the full backing of the Dubilier Condenser Co.

No condenser of the "Mansbridge Type" is a genuine Mansbridge product unless the words "Mansbridge Condenser" are plainly embossed on the metal case. The colour of the case is Maroon.

The capacity is plainly marked and is accurate to within fine limits, and nickel-plated screw terminals are provided for making connections. In your own interests you should see that when you require condensers of this type you

Specify Mansbridge.

PRICES AND CAPACITIES.

Capacity.	Prices.
0.05 mfd.	2s. 6d.
0.10 "	2s. 6d.
0.20 "	2s. 8d.
0.25 "	3s. 0d.
0.30 "	3s. 0d.
0.40 "	3s. 3d.
0.50 "	3s. 6d.
1.00 "	4s. 0d.
2.00 "	5s. 0d.

The Mansbridge Condenser can be seen at the Dubilier Condenser Co.'s Stands, Nos. 28 and 50, at the N.A.R.M.A.T. Exhibition, Royal Albert Hall, September 12th to 23rd.

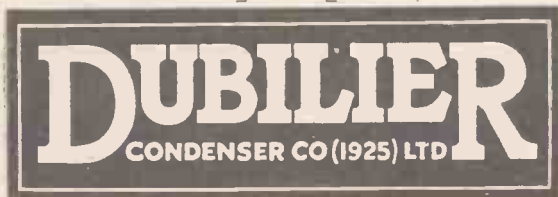

ADVERTISEMENT OF THE DUBILIER CONDENSER CO. (1925) LTD., DUCON WORKS, NORTH ACTON, W.3
Phones: Chiswick 2241-2-3. E.P.S.1.



"Why didn't I use GLAZITE!!"

The more complicated the circuit, the more important it is to use

GLAZITE

REGD. COLOURED CONNECTING WIRE: RED, YELLOW, BLUE, BLACK.

10 ft. Coils 2 ft. lengths, one of each colour,
Per 1/2 Coil

Of all Radio Dealers. Per 1/- Pkt.

BRITISH MADE



THE LONDON ELECTRIC WIRE CO. AND SMITHS LTD.

(Makers of Electric Wire for over forty years.)

Playhouse Yard, Golden Lane, London, E.C.1
Telegrams: Electric, London. Telephone: Clerkenwell 1388 1389. 1390. 1391.

JUDD

REFLEX VERSUS "STRAIGHT" CIRCUITS. AN OLD, OLD ARGUMENT.

By R. H. WATSON.

It has been suggested that Shakespeare had the above problem in mind when he made Hamlet say "To be or not to be." It certainly is an interesting question.

A QUESTION that one is very often asked is: Are reflex circuits better than those of the straightforward type? This is a most difficult query to answer with a plain Yes or No, for there are reflex circuits and reflex circuits, just as

and two L.F.—and a crystal rectifier. The main advantage then of the reflex appears to be that when you build the set it saves you the cost of one valve, one rheostat, and one valve holder. It also requires a panel and a cabinet of rather less size than a three-valve set, and it is slightly less costly to run on account of its smaller requirements from the filament and plate batteries.

Against these advantages we must set several drawbacks. Though I say so with bated breath, as many may not agree with me, I have always found reflexes rather cranky things to

And there are two other rather important points about reflexes in addition. There may be brilliant exceptions, but, on the whole, these circuits are neither so selective nor so free from distortion as well-designed "straights." The incorporation of a crystal in connection with the tuned plate circuit of the first valve introduces an amount of damping which has a serious effect upon selectivity. Purity of reproduction suffers in many circuits from the fact that the grid of the first valve, in order to hold the set down, must be kept either at zero potential or even slightly positive. We cannot obtain perfect amplification at low frequency unless a high plate voltage is used in conjunction with a sufficient amount of negative grid bias to bring the working point of the valve so low down on the characteristic curve that distortion cannot be produced by a flow of grid current.

Reflexes, again, taking them on the whole, are much noisier than straight circuits.

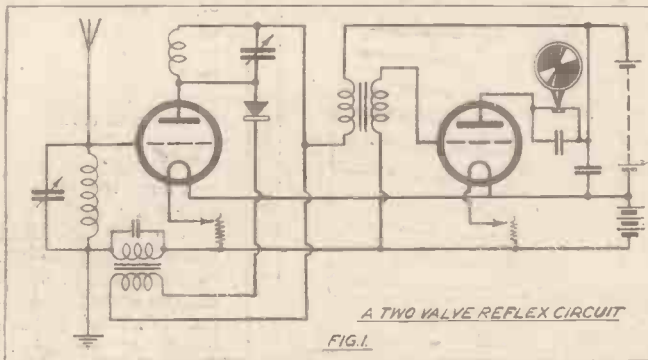

there are straight circuits and straight circuits. On the whole, I give my vote unhesitatingly for the straight kind of circuit, and in this short article I am going to set out the reasons for this preference.

Uncertain in Operation.

Let us see, first of all, what the reflex circuit sets out to do. Most of the types which have achieved popularity contain one or two valves and crystal. A typical circuit of this kind is seen in Fig. 1. The first valve performs a double duty, amplifying at both high and low frequency. Rectification is done by the crystal, and the second valve is a straightforward note magnifier. If you come down to "brass tacks," you will find that what any reflex set does in the end is to "save" one valve. The circuit seen in Fig. 1 gives you one stage (more or less) of high-frequency amplification and two of low. You could obtain exactly the same if not more volume of sound by using three valves—one H.F.

operate in comparison with straight circuits. They have a little way of howling at you for no apparent reason, and they are subject to a whole host of ailments of a brand peculiar to themselves.

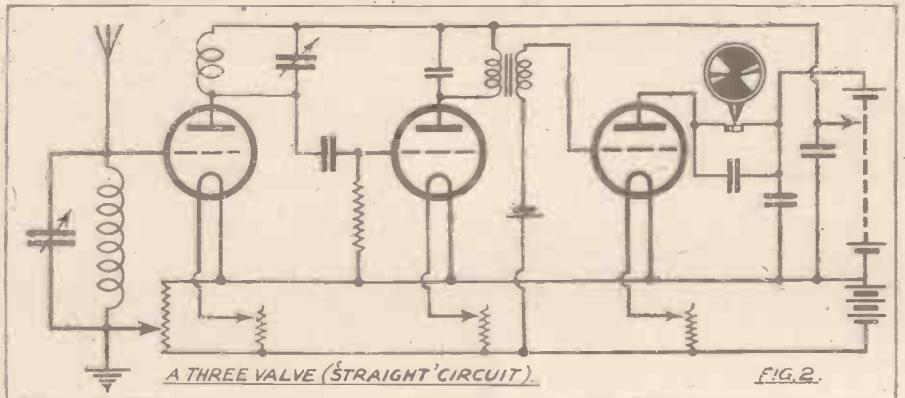

With the latter one can obtain something like the desired background of silence, but with the former this ideal state of affairs is much less nearly approached.

The three-valve straight circuit seen in Fig. 2 will give almost if not quite the signal strength of the two valve dual, whilst its range will be greater, provided it is carefully designed; and it is probable that its selectivity will be of a higher order.

A Good Two Valver.

In such a circuit the last valve should preferably be a small power valve, worked with a plate potential of about 100 volts. In the Fig. 2 circuit we may not obtain quite the signal power of the reflex, because we are really only using two and a bit stages of amplification. The first valve is a H.F. amplifier, and the last a note magnifier. The middle valve rectifies and amplifies at L.F. a little. It cannot give efficient L.F. magnification, since for rectifying we require only a small plate voltage.

(Continued on page 184.)

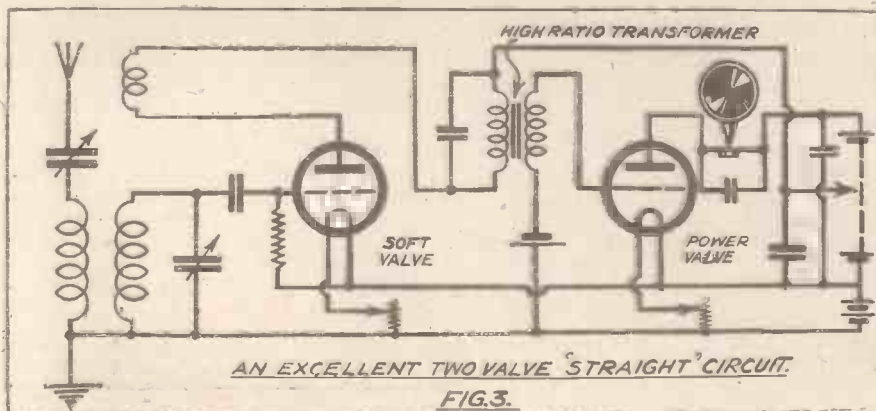

A VERNIER VARIABLE INDUCTANCE.

By C. S. PARSONS, B.Sc.

AN extremely promising vernier variable inductance has recently been invented and satisfactorily tested by Mr. J. C. Ambridge, of Fulham, who has been experimenting in wireless for many years. This instrument enables a very fine adjustment of inductance to be obtained, and thereby avoids the necessity for using condensers for fine tuning. Moreover, owing to the fact that condensers can be dispensed with, the tuning instrument is particularly suitable for low wave-lengths, and remarkable results have been obtained when using the instrument for tuning the aerial circuit of a crystal receiving set, many amateurs being very clearly heard. Apart from the advantages already pointed out, the instrument can be so constructed as to avoid the production of the undesirable dead-end effects which are common in other types of variable inductance.

Bare Wire Coils.

No details of the invention, for which application for a patent has been made, have yet been made public, and readers of POPULAR WIRELESS are, in this article, given the first published details of the tuner.

Although the instrument has not yet been finally developed, its general principle will be apparent from the diagram, in which the inductance is wound on a spirally grooved ebonite cylinder *a*, which is rotatable by a knob *b*. Fixed to one end plate of this cylinder *a* and connected to the metal spindle of same is one end of a bare conductor or wire *c*.

This wire can be wound into the groove of the cylinder *a* by rotating the knob *b* to form an inductance coil on the cylinder of any required number of turns or partial turns. The portion of the inductance wire which is not in use is accommodated on the winding cylinder *d*, which is made of metal and is also spirally grooved in a manner corresponding to the cylinder *a*. The end of the wire is fastened to the end plate of the winding cylinder *d* opposite from the operating knob *e*, and the metal surface of the cylinder *d* is in electrical communication with the spindle. The inductance wire *c* being bare, all the turns of same on the winding cylinder *d* are short-circuited through the surface of the cylinder.

Varying the Inductance.

The grooving on the two cylinders corresponds exactly in pitch, so that the wire feeds smoothly from one cylinder to the other, whilst the two terminals of the instrument are connected to spring fingers effecting rubbing contact with the ends of the two cylinder spindles. Spring washers are provided between the operating knobs and the panel, behind which the cylinders are fixed, to prevent over-run of the cylinders.

It will be readily understood that if it is required to increase the inductance, the knob *b* is rotated to wind a greater number of turns on the cylinder *a*, whilst if it is

desired to decrease the inductance, the knob *e* is rotated to wind more wire on to the cylinder *d*.

It is found in practice that the instrument is best connected into an aerial circuit by connecting the aerial to the terminal of the instrument which is connected to the winding cylinder *d*, and the earth to the terminal of the instrument which is connected to the end of the wire on the cylinder

a. The instrument can, of course, be used either to supplement the action of a main tuning coil in place of the condenser usually used for this purpose, in which case it may be regarded purely as a vernier inductance, or it may be used entirely alone in place of the usual tuning inductance, in which case it acts both as a main and vernier inductance.

The above description and the diagram shows the instrument in the simplest form, but other designs are contemplated in which a single operating knob only is wound, gearing being employed to allow this to be done. The future of the invention should be very promising.

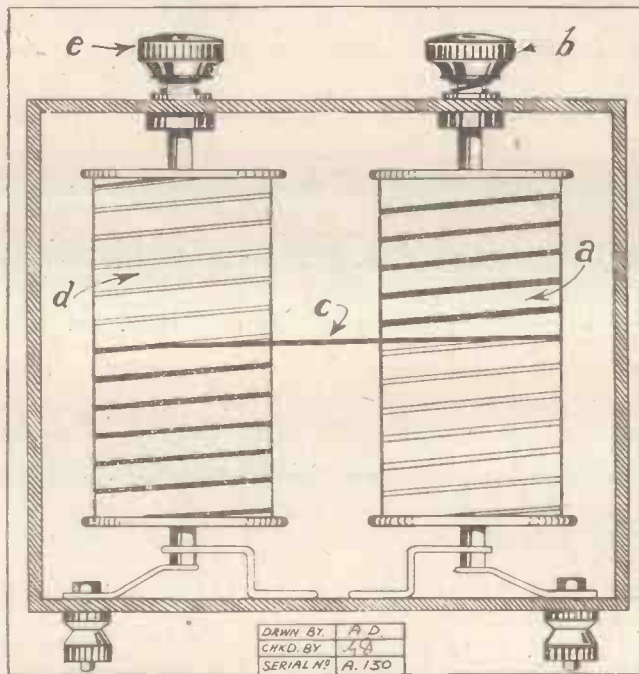

REFLEX VERSUS "STRAIGHT" CIRCUITS.

(Continued from page 183.)

In Fig. 3 is seen a circuit which, though absolutely straightforward in type, gives, to my mind, better results than any reflex. The first valve is so soft that it "blue glows" if a voltage of more than about 40 is applied to its plate. The second is a small power amplifier. The plate voltage of the first valve will be found to be rather critical, and it is best to use an H.T. battery tapped

off in 3-volt steps. As a rule, the best operating voltage for this valve will be between 15 and 24 volts. If the valve is very soft it may be found that a grid leak is unnecessary. The coils should be of the low loss kind, wound with wire of heavy gauge.

Loud Speaker Results.

The possibilities of the soft valve in straight circuits are unknown to many listeners. When I say that with one of these valves alone—that is without any note magnifier—I can get 2 L O at 25 miles regularly on the loud speaker, so that the programme is audible in every part of an average room, and that I have frequently done the same thing with Radio Paris and with the Eiffel Tower, the reader will realise that there is a very great deal in them. They are not nearly so liable to oscillate as hard valves, so that a very large build-up of signal strength may be obtained by means of reaction without the set's bursting into oscillation as it is apt to do with a standard valve. The Fig. 3 circuit will work a loud speaker so as to give excellent signal strength up to at least 20 miles from a broadcasting station; it is extremely selective, and it is so sensitive that there is very little difficulty in picking up even the most distant stations.

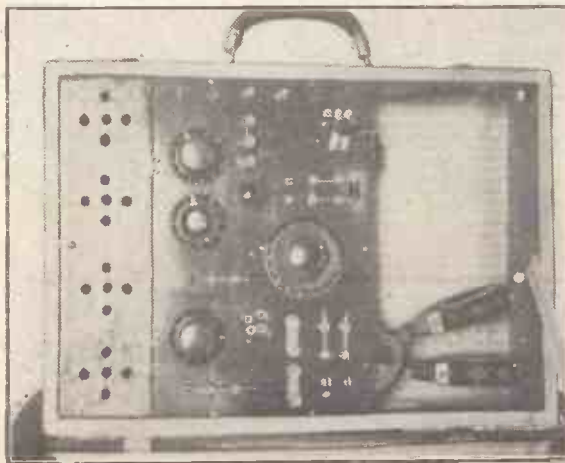

A 4-Valve Unidyne Receiver built in portable form by M. R. Hanssen, Nedre Allé, 22, Trondheim.

See Stand 33

ALBERT HALL

for these New C.A.V. Productions



TUNING COILS.

With winding totally enclosed, these coils are wound with bare wire on a bakelite former. The illustration at sides shows the method of interior construction and indicates clearly the ample air space between windings. All coils have the same external dimensions:—4 in. x 1 in.

Cat. No.	Approx. W/L	Price
5180	250-400	6/9
5181	350-600	6/9
5182	450-900	8/-
5183	1 00-1650	9/6



MULTIPLE FIXED CONDENSER

This has been specially designed to enable a selection of fixed capacities being obtained from one instrument. By connecting up the indicated capacities in parallel as required, any range can be used within the stated limits.

Cat. No.	Price
5190 .001 to .015 M.F.	5/-
5191 .0001 to .0015 M.F.	5/-



GRAMPHONE ATTACHMENT

By utilising the tone-arm of a gramophone for the acoustic amplification of radio reception, a very effective Loud Speaker is provided.

This attachment readily replaces the sound box and produces excellent results. Cat. No. 5210 Price 25/-

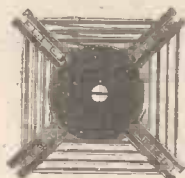

FILAMENT RHEOSTAT

With helical worked arm and interchangeable resistance unit. Very smooth and silent action. By means of a patented construction, the rotation of the contactor causes the resistance unit to revolve with it, thus ensuring smooth and silent action. The resistance unit can be instantly detached when required, to change from bright to dull emitter valves.



Cat. No.	Resistance	Price
5220	7 Ohms resistance	5/-
5221	30 ditto	5/-
5222	Resistance only 7 Ohms	2/3
5223	ditto 30 Ohms	

NEW HORNLESS LOUD SPEAKER.



This harmonises with the furnishing of a room and is encased in a richly polished mahogany cabinet, 15½ in. long, 9½ in. wide, 9 in. high. Although comparatively small it is equal in efficiency to our other types—excellent tonal quality and good volume. Cat. No. 5040 105/-



L.F. TRANSFORMERS.

All-Purpose Model. Specially designed to serve as 1st and 2nd stage. In brown metal case which excludes moisture. Price 15/-

De Luxe Model. Constructed with one primary winding with a secondary winding on either side: therefore minimum of self-capacity with greater amplification, which remains constant over a wide band of frequencies, in black case. Cat. No.

5150 High Ratio (first stage)	Price 27/6
5151 Low Ratio (second stage)	

LOUD SPEAKERS

Standard Ht. 22 ins. 2000 ohms

Cat. No. 5016 Black Satin Enamel

NEW REDUCED PRICE 90/-

120 ohms Cat. No. 5026 Black Satin Enamel

NEW REDUCED PRICE 90/-

4000 ohms Cat. No. 5021 Black Satin Enamel

NEW REDUCED PRICE 100/-

JUNIOR Height 18 ins. 2000 ohms

Cat. No. 5007 Black Satin Enamel ... 55/-

TOM-TIT Height 13½ ins. 2000 ohms

Cat. No. 5001 Black Crystalline

NEW REDUCED PRICE 27/6

ALTERNATIVE TYPE OF HORN.

For those who prefer a non-metallic horn, we can supply the models listed above, with imitation tortoise-shell flare as illustrated. Extra for these as follows:—

STANDARD Cat. No. 5017	15/-	JUNIOR Cat. No. 5008	10/-
TOMTIT Cat. No. 5003	2/6		



MANUFACTURERS OF MOTOR CARELECTRICAL EQUIPMENT



BY APPOINTMENT TO H.M. THE KING

Make **C.A.V.** your Choice and be sure of satisfaction

If unable to visit the Albert Hall, write for a copy of our complete Radio Catalogue. C.A.V. Productions are the **WORLD'S BEST**

C.A. Vandervell & Co., Ltd.
WARPLE WAY, ACTON, LONDON, W.3

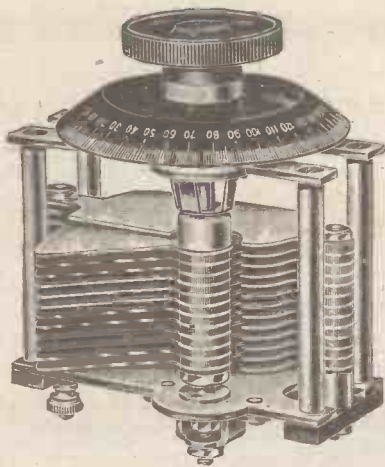

J.B. LOW LOSS	
*001	13/-
*00075	11/9
*0005	10/6
*0003	9/-
*00025	8/9
*0002	8/6
*0001	8/3

J.B. LOW LOSS GEARED VERNIER	
*001	17/6
*00075	16/3
*0005	15/-
*0003	13/6
*00025	13/3
*0002	14/-
*0001	12/0

Post. One 6d.
Two 9d. Three 1/-

Deliveries in strict rotation as and from Sept. 15, 1925

Announcing the New J.B. Condensers

THE name J.B. holds an enviable position in radio. Consistently from the earliest days the J.B. trade mark has been synonymous with better radio condensers. The new model J.B. Condensers here announced embody vital improvements, each of which is the outcome of our own practical experiments. They will perform thoroughly and in every way fulfil the high standard of quality and efficiency for which J.B. stands.

FEATURES:
Losses absolutely negligible (.02 ohms at a million cycles .0005 mfd.)
Plates rigidly supported at two points. Pigtail connection.
Earthed Rotor and Frame (giving perfect freedom from hand capacity).
Minimum solid dielectric.
Ingenuously designed Frame (giving exceptional rigidity).
Metal End plates. Conforming to modern practice. Minimum capacity scarcely affected.
Correct Square Law. Gear Ratio 60:1.

JACKSON BROS.
8 POLAND ST- OXFORD ST
LONDON - W.1. Telephone: GERRARD 7414
(First Floor)

FIT THE "LOTUS" COIL-HOLDER

and

Realise What Perfect Reception Means

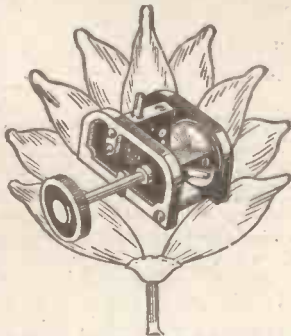

MOVING BLOCK CANNOT FALL

Made from Bake-lite Mouldings with Nickel-Plated Parts

Retail Selling Prices:

Two-Way .. 7/-

Three-Way 10/6

With six-inch handle for inside mounting.

Two-Way .. 1/- extra.

Three-Way .. 2/- extra.

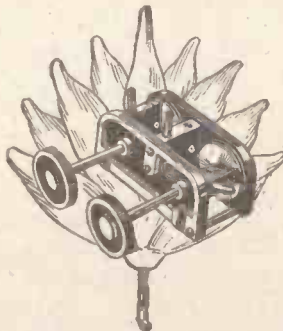

GARNETT, WHITELEY & Co., Ltd.
Lotus Works, Broadgreen Road, LIVERPOOL.

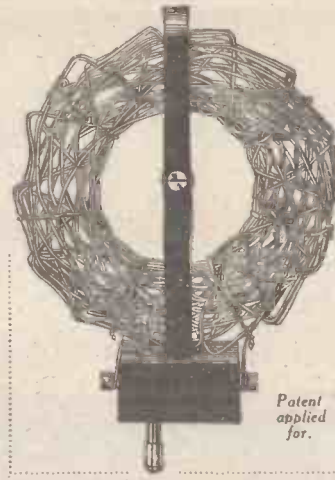

The famous "MARS" Specialities

The New "Mars" Super-low-loss Coil is technically 25% superior; audibly 78% superior than any other. Will command the enthusiasm of expert and amateur.

Patent applied for.

"MARS" COIL WIRE
-the patented multiple-strand wire with the triple-conductor feature. Easy to wind; highly efficient.



THE "MARS" AERIAL—still supreme
The secret in the spiral spin 9/6 100 ft.

Sole Manufacturers and Patentes:

E. & W. G. MAKINSON LTD.,
Wellington Works, Wellfield Road, Preston

Wholesale Distributing Depots:

Houghtons, Ltd., Ensign House, 88-89, High Holborn, LONDON, W.C.1.
70-78, York Street, GLASGOW; 61a, Long Row, NOTTINGHAM; 67b, Bridgegate, LEEDS; Free Trade Hall Buildings, 2nd Floor, Percy St. Hanley, STAFFS.; 20, Orange Street, SWANSEA; 20, St. James Square, Edinburgh.
SCOTLAND: 9, Panmure Street, DUNDEE; 15, Blackfriars Street, Salford MANCHESTER; 6, Fountain Lane, Belfast, IRELAND.
A. Franks (Wholesale), Ltd., 5, South King Street, MANCHESTER.
British Electrical Instruments, Ltd., 3, Hanging Ditch, MANCHESTER.
Pulford Bros., Ltd., 102-110, Whitechapel, LIVERPOOL.
Priestly & Ford, 3, Carr's Lane, BIRMINGHAM.
Tears, Ltd., Bristol Bridge, BRISTOL.
Bristol Wireless Co. (Wholesale), Radio House, Queen's Road, BRISTOL.
Christopher Pratt & Sons, Ltd., North Parade, Bradford, YORKS.
South Wales Wireless Installation Co., 21-22, Edward Terrace, CARDIFF.
Henry Hollingdrake & Sons, Ltd., Princes Street, STOCKPORT.
George C. Lazenby, 29, Old Town Street, Drakes Circus, PLYMOUTH.
Radio Electric Co., 21, St. John Street, WOLVERHAMPTON; and 17, Victoria Street.
Marsdens (Wholesale), Ltd., 115, Church Street, PRESTON.
W. H. Orry, Church Street, BLACKPOOL.
Jones Bros., 1, Birley Street, BLACKPOOL.
Ellis & Mort, 50, Topping Street, BLACKPOOL.
C. E. Needham & Bros., Ltd., Change Alley, SHEFFIELD; also No. 3 Warehouse, Milk Street.
Hobday Bros., Ltd., 21-27, Great Eastern Street, LONDON, E.C.; Cleveland Road, WOLVERHAMPTON.
Manchester Co-operative Wholesale Society, 1, Balloon Street, MANCHESTER.
London Co-operative Wholesale Society, Ltd., Lemon Street, LONDON, E.C.
S. D. Rock, 88, Hesse Road, and 15, Spring Bank, HULL.

CAUTION.—The "Mars" registered trade mark is the property of E. & W. G. Makinson Ltd., Preston, and applies to their "Mars" Aerial Wire Patent No. 230192, and "Mars" Coil Wire Patent No. 229058. It has come to our notice that several firms and persons are illegally using this mark in connection with ordinary multi-strand wire, not of our manufacture. Legal proceedings will be instituted against such offenders.

SAVE MONEY ON VALVES

—GUARANTEED BRITISH MADE.

RADION G.P. A 4-volt bright valve that } 7/-
only consumes '48 amp.

RADION D.E. '06 } 3 volt 'very dull' 10/6

RADION D.E. '06 H.F. } filament valves.

RADION D.E. '24 } 2 volt D.E.'s of 10/6

RADION D.E. '34 H.F. } great efficiency.

RADION PYRAMID VALVES, 22/6

THE POWER VALVES DE LUXE.

No. 1. 6 volt. No. 2. 4 volt. The most powerful on the market. We guarantee the filament.

From untied Dealers or direct, post free.

Radions Ltd., Bollington, nr. Macclesfield, Ches.

Interesting literature concerning Radion Valves and our unique valve repair service gladly sent Free on request.

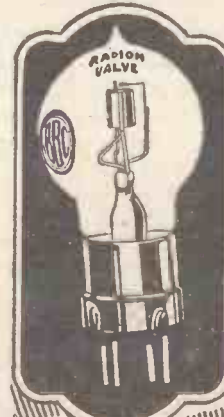

RADION
Reliable Valves

THE IDEAL BROADCASTING PROGRAMME.

SOME SUGGESTIONS.

By Lieut.-Commander the Hon. J. M. KENWORTHY, R.N., M.P.

(Vice-President of the Radio Association).

A SELECT COMMITTEE has been appointed by the Government to advise as to the proper scope of the broadcasting services and as to its management, control and finance. The existing arrangements for broadcasting come to an end on December 31st, 1926.

The committee consists of the following ten members:

The Earl of Crawford and Balcarres (Chairman),
Lord Rayleigh,
Mr. Macpherson, M.P.,
Lord Blanesburgh,
Mr. W. Graham, M.P.,
Sir T. Royden,
Dame Meriel Talbot,
Sir Henry Hadow,
Captain Ian Frazer, M.P., and
Mr. Rudyard Kipling.

It is to be hoped that they will take into full consideration the kind of broadcasting programmes that the public require, and I suggest a few considerations on this subject.

Everyone realises the difficulties in the way of broadcasting programmes to suit all tastes. There is really no sure way of knowing what the majority of the people want, and the audience reached is the greatest mixture possible. All classes, all ages, all types of persons have to be satisfied, and all must be interested.

Need for Variety.

In a theatre or music-hall it is easy to observe nightly what pleases the audience and what bores them. And there is always the infallible test of the Box Office receipts. The lecturer, the public speaker, the politician, can sense the hold or otherwise that he has on his hearers. But those arranging a broadcasting programme have to work, figuratively speaking, in the dark.

I think it would be a good thing if the concerts given could be open to the public, and an audience of 100 or so people invited to go in free, or for a small charge,* so as to be able to tell from their response as to the suitability of the items given.

Another very important matter is to take every means possible to see that a programme once announced is rigidly adhered to. Of course, one knows the difficulties of artistes being ill, etc., but it is very important that listeners-in should never be disappointed if it can possibly be avoided.

The next most important thing is variety. The changes should be rung continually. I think a mistake has been made in presenting too many stereotyped talks. From what I can gather the people are a little tired of them. From my own experience as a public speaker, I think it is a mistake to attempt to talk down to an audience—even of children.

Now, some suggestions I would make for variation are as follows. Some little time ago the Aberdeen Rotary Club invited

two famous raconteurs to a story-telling competition. These were the Marquis of Aberdeen and Sir James Taggart. I believe this would be a splendid idea for a broadcasting evening. Let there be two well-known retailers of anecdotes pitted one against the other in the broadcasting room, and let the listeners-in vote by postcard for the winner. Then I am sure it would be popular if well-known Parliamentarians and public men could be induced to broadcast more frequently.

I know the difficulties about politics, but if famous orators and statesmen could



Commander Kenworthy.

be induced to read a passage from an author who has made the most impression on them, or a portion of one of the historical speeches of bygone days, I am sure it would be a popular feature.

Now with regard to sport. If during the Oxford and Cambridge Boat Race, or the Grand National, or a Football Cup-tie, the final race or the game could be described as it progresses † and, at the same time, the roar of the crowd could be broadcast, I believe it would bring home the atmosphere of the sporting event with great fidelity. In any case, I think there should be more sporting news given, though I know there is difficulty here with the Press; but there are no difficulties that cannot be overcome provided there is goodwill on all sides.

Broadcasting Music.

A suggestion for the children's hour, though it might be extended to the adult programmes, is to broadcast the singing of some of the children's choirs, or some of the north country adult choirs of singers. Immediately afterwards I would broadcast commentaries and criticisms by some famous musician like Sir Edward Elgar.

Again, cathedral music should be broadcast, including High Mass.

With regard to the vexed question of what music should be broadcast, here again we must give people what they want. There must, of course, be dance music for people to dance to, but we must be very careful in broadcasting singers to be sure that they have voices suitable for broadcasting delivery. And certainly arrangements must be made to get over the difficulties of broadcasting grand opera and really good concerts. It is nonsense to say that the British are not a musical people; they certainly are.

Local News Popular.

With regard to the broadcasting of Parliament we will certainly have to wait for some little time before this becomes an accomplished fact, but on the four principal nights a week when Parliament meets during the eight months of the year in which it is in session, I certainly think the proceedings should be broadcast for an hour, care being taken to see that all parties have a fair turn during that hour, and that others besides the most prominent politicians have a fair turn.

I adhere to the present to the hour from 7 to 8 as the most suitable for the broadcasting of Parliamentary proceedings, two nights being given to the Commons and one night to the Lords in a week, until more experience is gained.

Now that relay stations are increasing in numbers and are becoming better organised, I consider a good deal of attention should be given to local news. This is always the most interesting, especially in the provinces, and people want to know what is going on in their own districts.

Also, every endeavour should be made to broadcast local and, especially, new, artistes and musicians. It is not, after all, the great personalities that matter in broadcasting, as the qualities which in the stage phrase "get across the footlights" will not necessarily bring success in wireless. What is most necessary is, in singers, sweetness and clearness of voice; in speakers a good enunciation and delivery; and in musicians freshness and vitality, and the rendering of items that appeal to the widest possible public.

Items Should Appeal to All.

To sum up: First of all in our ideal programme, we need catholicity.

Secondly, we must have variety.

Thirdly, there should be some sort of continuity, the whole making a connected story, and yet the programme should be such that the listener-in who starts part-way through should be able to enjoy the remaining items.

Fourthly, we must have the very highest quality of music, which does not necessarily mean "highbrow" music; and whether it is musical comedy, music-hall songs, grand opera or sacred concerts, the fare provided should be the very best; and the same should apply to the speakers.

And lastly we must avoid all suspicion of attempting to educate or uplift people against their will, whether they be the young people listening-in during the children's hour, or the general public, the invalid in the hospital, or the man seeking relaxation after a hard day's work.

* The B.B.C. have now made arrangements on these lines.

† The B.B.C.'s agreements with the Press will not permit of this procedure.—EDITOR.

HOW TRADE MARKS ARE OBTAINED.

Useful Advice for Radio Experimenters.

By J. F. CORRIGAN, M.Sc., A.I.C.

(Staff Consultant, "Popular Wireless").

THE subject of commercial trade marks and their legal registration is one which will be of interest to many radio experimenters if only on account of the fact that the advertisements of so many well-known radio firms bear distinctive trade marks of their own.

And, of course, there will also be a number of POPULAR WIRELESS readers who have more than a passing interest in the subject of trade marks registration because many of these individuals may be inclined to register a special trade mark of their own in view of some commercial radio accessory which they are engaged in manufacturing.

There are quite a number of successful "one-man" businesses of a wireless nature in this country, and the acquisition of a distinctive legal trade mark by these small manufacturers will go a long way towards increasing the commercial value and status of their productions, besides preventing, to a great extent, any infringements of the patented goods.

We have only to recall such household words and phrases as "His Master's Voice," "Kodak," and "Wild Woodbine" in order to realise the great value which lies in a well-chosen trade mark. A well-chosen trade mark is of the greatest value in the commercial "pushing" of any variety of manufactured goods, and nowhere more than in the wireless trade does this statement hold greater truth.

Any individual or firm can register a trade mark, subject to certain restrictions, provided that the proposed mark is a bona fide one.

Necessary Qualifications

The Trade Marks Acts of 1905 and 1906 lay down that a distinctive mark, to be registerable, must be able to be included in one of the following categories:

1. The name of a company, individual, or industrial concern, presented in a special or characteristic manner.
2. A characteristic signature of any individual connected directly with the firm.
3. A word coined especially for the purpose.
4. A word or a phrase having no direct relation to the type or quality of the goods.
5. Any other distinctive mark which does not fall in the above categories.

Most of the commercial trade marks which are household expressions at the present time will be observed to fall under one of the above categories.

For instance, signature trade marks are very well known, the phrase "none genuine without this signature" being extremely

common. Invented words, such as Kodak, Oxo, Glaxo, and the various registered names under which wireless crystals are marketed, are all included in category 3 of the above list.

Exceptional Cases

Then, again, we have the terms "Barnet" and "Ilford" applied to photographic products. These, however, are really exceptions to the general rule, for geographical names, names of persons, and descriptive words are not, as a rule, registerable, unless it can be proved that the goods have been known under these particular names for long periods of time.

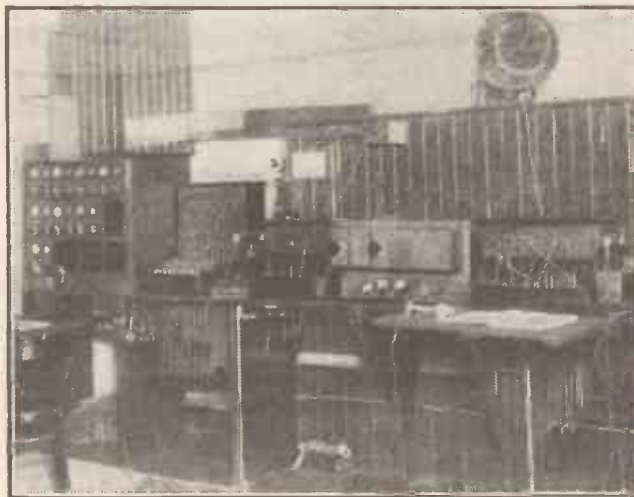

Part of the control room at the Glasgow Station showing the S.B. Board.

Any peculiar device can be registered under the Trade Marks Act, but it is not possible to register the words "Copyright," "Registered Design," or "Entered at Stationers' Hall." Furthermore, it is illegal to attempt to register any national emblem, flag, portrait of a member of the royal family, or any emblematical device belonging to these personages.

Making Application

An individual about to apply for registration of a trade mark should, first of all, send to the Patent Office (Trade Marks Branch), Southampton Buildings, Chancery Lane, London, W.C.2, for a copy of the official publication, "Instructions to Persons wishing to Register Trade Marks." This pamphlet is issued free of charge, and it should be studied by all applicants for a trade mark.

Application for the registration of a trade mark is made on Trade Marks Form No. 2, obtainable at the Patent Office (Trade Marks Branch), and also from many General Post

Offices in the United Kingdom. This form costs 10s., and on it must be clearly illustrated the trade mark or device which it is desired to register.

Further copies of the proposed trade mark must also be forwarded to the Trade Marks Branch of the Patent Office. These are made of the duplicate forms No. 3 which are supplied free with form No. 2.

If registration is granted, a further fee of £1 becomes payable. This payment is made by purchasing the stamped form No. 11.

Before an application for registration of a trade mark is forwarded to the official quarters it should be made reasonably sure that the same or a similar trade mark has not been registered by another person or firm. Advice on this matter can be had for a reasonable fee from a chartered patent agent, or a search may be made at the Patent Office by the individual himself. Permission is readily granted to make this search among the records of already granted trade marks, the fee being 1s. for every quarter of an hour occupied in making the search.

After a trade mark has been granted, the Trade Mark Department of the Patent Office will usually require a line block or "electro," in order to reproduce an illustration of the trade mark in the "Trade Marks Journal."

Renewal of Trade Marks.

The size of the block or electro must not exceed 2 by 2 inches. If this size is exceeded a charge of 2s. for every additional square inch, or part thereof, will be made for the necessary publication of the trade mark in the official Journal.

The registration of a trade mark may be opposed by any interested party, in a similar manner to the "opposition to grant" proceedings of a patent. This opposition must be stated on form No. 7 (costing £1), and within three clear months from the date of illustration of the trade mark in the official Journal.

In all cases of this nature, where opposition to grant proceedings are taken by some other party, recourse should always be made to the expert advice of a patent and trade marks agent.

The registration of a commercial trade mark lasts for a period of fourteen years, after which time it may be again renewed for a further period of fourteen years by a written application on Trade Marks Form No. 12 (£1 stamp).

This application must be made before the date of expiry of the first registration. If it is not the registration will become void. If, however, not more than three months have elapsed from the date of expiry of the first period of registration the trade mark registration will be renewed under the usual conditions, but subject to the payment of an extra 10s.

If, however, the trade mark has been removed from the register during these extra three months, the re-registration will cost an additional fee of £1.

A trade mark may be retained in force for an indefinite period, subject to it being renewed every fourteen years.



The "GOLTONE" (Regd.)
SUPER CRYSTAL
RECEIVING SET

(Licensed under Patent No. 214005/23.)

**Designed to cover ALL British Broadcasting Wave-lengths including
the "DAVENTRY" High Wave Station.**

The Finest Value ever offered in British made Crystal Receivers.
A high-grade Crystal Receiving Set equal in appearance and results to
Crystal Sets sold at much Higher Prices.

SPECIAL FEATURES:

**MOULDED POLISHED INSULATED TOP and BASE.
DUSTPROOF DETECTOR.
FINE ARCHIMEDIAN SELECTIVE TUNING.
REMARKABLE VOLUME.**
Complete with "Goltone" Selected Crystal, PRICE **7/6**
The "WARWICK" British Made DOUBLE HEAD RECEIVERS.
Extreme lightness and comfort. Ensures maximum volume. **15/-**
4,000 ohms. Complete with cords

The "CLARISTAL" AERIAL SET, comprising:—
100 ft. Stranded Copper Aerial Wire, 6 Insulators, 3 yds. Leading-in
Wire and Porcelain Leading-in Tube **3/3**

EXTRACTS FROM PRESS REPORTS!

"POPULAR WIRELESS."
Good value for money, well finished appearance, obtained excellent results.
"AMATEUR WIRELESS."
An efficient set—nicest Crystal Set handled, supplied with splendid crystal.
"BROADCASTER."
Usual standard of excellence of this firm. Tested on standard aerial results gave every satisfaction.

Extract from one of numerous
unsolicited testimonials:—

"Six months ago I bought a
"Goltone" for the youngster,
since then it has developed into
the family set in preference to
another more costly one."



Address all communications to HEAD OFFICE
& WORKS, PENDLETON, MANCHESTER.
Stocks also held at GLASGOW DEPOT,
95, PITT STREET.

RADIO CATALOGUE No. 112.
Large, fully illustrated 36 pp. Catalogue, post free on
request. Enclose Business Card for Trade Terms.

Stocked by the Leading Radio Stores. Write direct if unobtainable.

Why is



THE HALL MARK OF "QUALITY" EBONITE?
Because it is made from finest
rubber and sulphur

IT HAS
PROVED ITSELF

ITS POLISH
SPEAKS FOR ITSELF

All branded panels
are guaranteed
free from surface
leakage.

See
STAND 15
at the N.A.R.M.A.T.
Wireless Exhibition,
Royal Albert Hall,
September 12 to 23.

Write for full particulars and List C.

The BRITISH EBONITE CO., Ltd.,
HANWELL, LONDON, W.7
Rods, Tubes and Mouldings

DON'T BLAME THE SET!



Nine times out of ten
there is a fault in the
circuit which can be
put right in a minute
or two with the aid of
FLUXITE.

Solder all joins with
FLUXITE, and they
cease to be joins, but
become one unbroken
piece of metal. No

chance of leakage there! It's so easy, too. A child could do it.
No wireless enthusiast should dream of making joins any other way.

Ask your Ironmonger or Hardware Dealer to show you the neat little

FLUXITE SOLDERING SET

It is perfectly simple to use, and
will last for years in constant use.
It contains a special "small space"
Soldering Iron with non-heating
metal handle, a Pocket Blow-lamp,
FLUXITE, solder, etc., and full in-
structions. Price 7/6. Write to us
should you be unable to obtain it.

Price 7/6



FLUXITE SIMPLIFIES SOLDERING

All Hardware and Ironmongery Stores sell
FLUXITE in tins, price 8d., 1/4 & 2/8.

Buy a Tin To-day.

ANOTHER USE FOR FLUXITE
Hardening Tools & Case Hardening.
FLUXITE LTD. (Dept. 324), West
Lans Works, Rotherhithe, S.E.16. ASK FOR LEAFLET on improved methods.



Why it is round.

Watmel Fixed Condensers are built this way for a very special reason. We discovered that by making them a circular shape we practically eliminated edge loss—an important consideration in condenser efficiency. They simply bristle with other good features too. Mica sheets securely clamped between the plates render it impossible for the capacity to vary, whilst the bakelite case ensures perfect insulation. Fixing is the easiest matter—one central screw only being necessary. For trouble-free condenser efficiency, always use



FIXED CONDENSERS.
Guaranteed Correct Within 5 per cent.

THE WATMEL WIRELESS CO. LTD.
332a, Goswell Rd., London, E.C.1. Tel: Clerkenwell 7990
Lancashire & Cheshire Representative: Mr. J. B. Levee,
23, Hartley Street, Levenshulme, MANCHESTER.

Standard capacities. Any other size can be supplied at short notice.

GRID CONDENSER.

- '00005
 - '001
 - '002
 - '003
 - '004
 - '0025
 - '005
- 2/6 each.

STANDARD FIXED CONDENSER.

- '002
 - '001
 - '0025
 - '006
- 2/6 each.
3/6 each.

COMBINED GRID LEAK & CONDENSER
3/-

Have you entered for the "SYLVEREX" Radio Crystal Prize Scheme?

Read the side panel for full particulars of a competition in which every competitor receives a prize.

Sylverex is a natural Crystal and is a revelation in sensitiveness. It is subjected to the fullest tests of any crystal on the market, and as a consequence is fully guaranteed.

Ask your Wireless Dealer for Full Details—or send 2/- to Sylverex Ltd. (Dept. B), 25, Victoria Street, London S.W.1.,

when the crystal will be forwarded by return post.

Visit us at the Albert Hall Exhibition Gallery G. 7.



Entrants for the Sylverex Prize Scheme are asked to write down the following list of "turns" in their order of popularity. Put down first which item you consider most popular; then the item you consider second in popularity, and so on. Write only the items listed here. Prizes will be awarded to those entries most nearly in accordance with the total voting of all competitors.

- Covent Garden Opera.
- Symphony Orchestra.
- The Children's Hour
- The Savoy Bands.
- The Wireless Drama.
- "Celebrity" Speeches.
- Sports Talk.
- Humorous Entertainers
- De Groot and Piccadilly Orchestra.
- Concert Parties.
- "Star" Musicians and Vocalists.
- News and Weather Reports.

Your list of items must be written on the plain side (back) of the printed direction slip enclosed with each packet of Sylverex Crystal.

£200

- in Cash Prizes
- 1st Prize - £100 Cash
 - 2nd Prize - £50 Cash
 - 3rd Prize - £25 Cash
 - 50 Prizes of 10/- each

Numerous additional prizes, consisting of Valve Sets, Crystal Sets, Loud Speakers, etc., and thousands of Consolation Prizes of copies of popular published songs.

IS WIRELESS EXPENSIVE?

Why not save money by buying at the CHEAPEST OF ALL PRICES?

POST FREE WITHIN BRITISH ISLES.

7/22 Copper Aerial Wire	2/3
Continental Headphones, very sensitive	8/3
2-Way Coil Holders, ordinary	2/11
"Lotus" 2-Way, geared	7/-
Valve Holders 10d. each. Rheostats, from	1/11
H.T. Batteries 60 volt 6/11 "Peerless" do. for D.E.	2/6
"Radion" (British Made) '06 D.E. Valves	10/6
do. do. Bright Emitters	7/-
Tuning Coils, plug in type, No. 25 or 30	2/4
do. do. 50	3/-
do. do. 75	3/4
do. do. 150	4/8
do. do. 200	5/4
Variable Sq. Law Condensers '0003	4/11
do. do. '0005	5/11
do. do. '0003 with vernier	6/11
do. do. '0005 do.	7/11
ETC. ETC.	

Mail Orders Only **WHARTON'S** Trade Supplied
9, Victoria Street, London, S.W.1.



AT YOUR DEALER

6/-

WANT MORE STATIONS?

Like that elusive distant one you heard last night . . . Well, the cheapest, simplest way to get them is to replace your old dials with

PELICAN UNIVERNIER

Pell, Cahill & Co., Ltd., 61 Newman Street, London, W.1

THE anti-static device to be described in this article is one of many similar devices recently produced by Dr. McCaa, and is known as a repeater circuit. The circuit has not been chosen because it is any better than the other of Dr. McCaa's devices, but because it is the simplest to construct, and because it will give good results on broadcast reception. A similar circuit which was recently tried out on the Parkesburg Radio Laboratory, on signals which were of equal strength to the atmospherics prevailing at the time, gave good loud-speaker signals without any sign of static.

It should not, however, be thought that the device eliminates static, as it does not; it only

ELIMINATING ATMOSPHERICS

FROM A CORRESPONDENT.

A Short Account of a New Static Eliminator.

position to L2, and therefore no currents are induced in L1. It will, of course, be understood that no static either will be received.

If the switch S is closed, and the aerial circuit tuned, both signals and static will be heard, because L3 is short-circuited and cannot therefore neutralise L2.

Tuning Out X's.

From this it will be understood that if the inductance of L4 could be varied synchronously with the received signals, the effect would be that the inductance of L3 would also be varied (the action of the coils being similar to a variometer), and L2 would be able to induce signals into L1 with very little static. The switch S is therefore closed, and the aerial circuit and secondary circuit (L1, C1) tuned to the broadcasting station. The switch is then opened, and the signals are balanced out. The aerial circuit tuning is slightly altered by the

opening of this switch, which leaves that circuit free to oscillate on a slightly higher wave than the signal is on.

The grid circuit of the repeater is now tuned to the broadcast wave-length by altering C3, and this circuit will receive very little static, but will pick up the forced oscillations of the broadcast signal. These oscillations are amplified by the repeater

valve, and made by the plate circuit coil L6 to vary the inductance of L4, which then allows L3 to pass signals to L1 with very little static.

The diagram, Fig. 2, shows how the circuit can actually be arranged. All the coils shown are wound on cardboard tubes of 2 in. diameter, and the dimensions are as follows: L1, 60 turns; L2, L3, and L6, 50 turns; L4, 70 turns; and L7, 10 turns. All should be wound with No. 22 S.C.C. wire, and the coils L6 and L4 and L7 and L5 should be 1 in. apart, while L2, L1, and L3 should be 3/4 in. apart.

The four variable condensers should each have a capacity of approximately '0005. The arrangement of the other components can be seen from the diagram. If after the instrument has been constructed static is not balanced out, several things may be wrong. The first thing to examine is the earth. Unless this is very good the circuit will not operate satisfactorily. A waterpipe earth is often not good enough.

The device will also fail to work if an unsuitable type of valve is used. Many D.E. valves are not suitable; only a few English valves have at the time of writing been tried, so the best cannot be stated. Marconi Osram R5V gave good results.

If unsatisfactory results are still obtained after changing valve and earth, alterations in the coupling between the various coils are probably necessary.

VERNIER POTENTIOMETER CONTROL.

IN circuits which require very fine adjustment of static grid voltage, and in

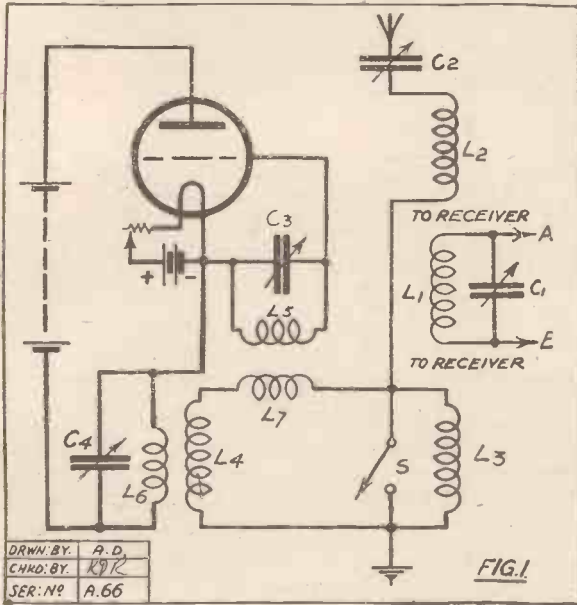

reduces it, but it is always reduced very much more than the signal. Atmospherics are usually reduced to such an extent that to all intents and purposes they are eliminated. The amount they are reduced, however, varies with the different signals.

Operation of the Circuit.

The repeater circuit for use with a broadcast receiver is shown in Fig. 1. The principle upon which the arrangement works is briefly as follows.

The receiver is connected to an oscillatory circuit, consisting of the inductance L1 and capacity C1. This circuit is coupled to the two aerial circuit coils L2 and L3, the aerial circuit being tuned by means of the variable condenser C2. The distance of L1 from L2 is exactly the same as the distance of L1 from L3, and the three coils are also similar, except that L3 is wound in an opposite direction to L2.

Now when the aerial circuit is tuned to the wave-length of the broadcasting station, no signals are heard, because L3 is in op-

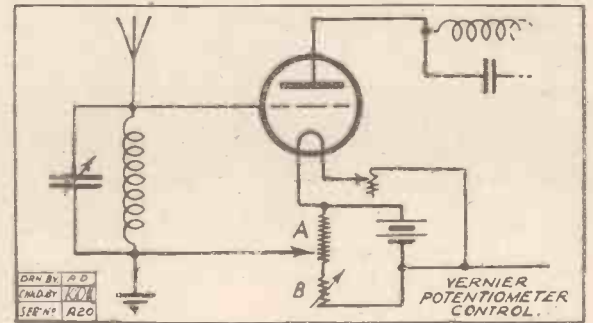

which stability or sensitivity or both depend to any considerable extent upon a correct proportion of such "bias," the following method can be strongly recommended. In series with the potentiometer "A" in the diagram is placed an ordinary filament resistance "B." This latter, if of the wire type, should be of fairly low resistance, 15 ohms being a suitable maximum value. A Lissenstat Major proves excellent for the purpose.

It will be seen that after adjusting the potentiometer "A" to its best position, adjustments of the filament resistance "B" will give a "vernier" control, either way, as it were. According to the diagram the reduction of the resistance of "B" gives the same effect as a very slight adjustment of the potentiometer movement towards negative and to increase it, towards positive, a very fine control becoming available by this means.

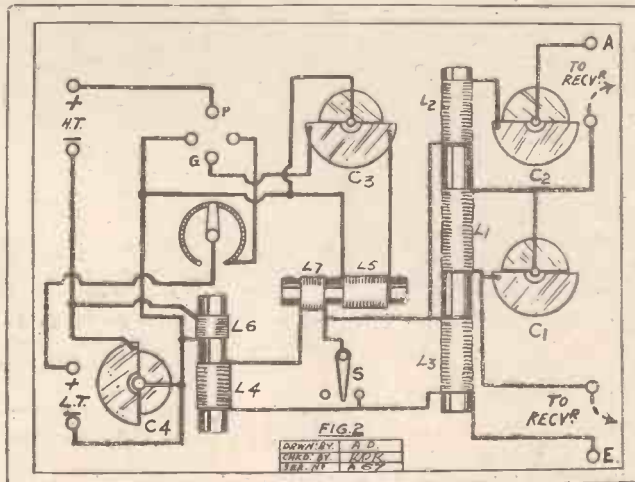

RADIO and the PARIS POLICE

By OUR CORRESPONDENT IN PARIS.

RADIO has joined the Paris police force. It has, in fact, been working out its apprenticeship for some time; but within the last few months it has been admitted to the list of police adjuncts along with the Bertillon system, the fingerprint records, the rogues' gallery, and the riot squad. It has a life contract, and is



Operating the transmitter at the new Police radio station in Paris.

rapidly increasing its forces and scope. Its position seems to be more one of auxiliary work than of direct crime detection or the actual trapping of individual criminals. But that it is an essential auxiliary the entire force now admits, and, in fact, are calling in more radio sets to work with those already enlisted.

With the customary remarkable secrecy of which the Paris police seem to be the masters, experiments with radio in conjunction with police operations have been in progress for two years; yet it was only a short while ago that even the service men themselves realised their new helper had begun work.

Two Motor Radio Vans.

The present radio system comprises only a central transmitting and receiving station and two mobile transmitting-receiving stations, set up in small express or delivery-car type Panhard-Levasser cars. The sets are all made by the Société Française Radioélectrique, being standard tuned radio frequency receivers, of four valves each; the transmitting set having two valves of 50 watts each, and working on either telegraphy or telephony. On the former (C.W.) the transmitting range is about 150 miles; although on telephony this range is reduced to about 35 miles. The aerial at the central station (the famous Prefecture de Police on the Isle de la Cité, in the very heart of Paris) is a single wire horizontal one, approximately 180 feet long, and nearly 250 feet off the ground. The transmitting room is in the police garage, where there is an auxiliary aerial.

The two motors now in service have

demountable single-wire aerials, one mast being set up on top of the car roof, the other (a longer mast) being set up some distance behind the car, and the aerial strung between them. They work on 800 metres wave-length, though they can shift up to 1,200 metres if necessary. In the near future, however, this wave-length is going to be dropped to 400 metres; and four other mobile stations are going to be added to the service, with receiving sets which can work anywhere from 100 to 3,000 metres. These new cars will have the flat type of aerial, which can be raised over the car roof as on the London police radio cars. Thus communication can be effected while the cars are in motion—a very important factor, the

Paris police have discovered. Monsieur Courval, the special commissaire in charge of automobile and radio communication, is in favour of radio as an auxiliary system. That it can even supplant the telephone, or be of value in crime detection, he doubts exceedingly.

"How can radio take the place of our present telephonic system?" he shrugs. "We have in Paris commissariats (sub-stations) for every district, connected to our central station by direct private telephone line. This wired telephone system is automatic. I can either call any individual station by the simple turning of the number dial; or I can, by dialing one code number, call every single sub-station at once, and pass out an alarm that covers the city in as much time as it would take to even tune in on the radio telephone service.

"With this system, suppose that a crime is committed in even an outlying district of Paris. The local station telephones the news to me by the automatic wire, and I have in five minutes more sent the alarm out even to the suburbs to watch out for either some man, or an automobile, or whatever it may be. With radio, I would

have to start out by issuing a general call. The wave-length might vary just slightly, or there might be some other communication on hand from the district, with one of the mobile stations, so that the operator would be listening elsewhere. The general emergency alarm would be blocked, and it might be just in that station's district that the criminals would escape from Paris. With the telephone, I not only dispense with the necessity of an operator on watch all the time; but I also have constant direct communication with my lieutenants. Incidentally, it is more confidential.

Fighting Bandits.

"As for radio-equipped autos to answer emergency calls against bandits—no, I do not believe this will ever occur here. Our problems are slightly different from those in America, for example. In the States, the cities are spread out over large areas, and the number of patrolmen is much less than here. In Paris, a bandit gang would hardly have time to operate. Our men patrol in pairs, and it is a rare thing when one pair is not within actual hailing distance of another pair. A spectacular hold-up or bank robbery such as is an everyday occurrence in America would be a difficult job to 'pull' here. And if we found that bandits were able under present conditions to work thus"—Monsieur Courval's jaw set in a firm line, and his kindly eyes took on a steely glint—"then we can meet them by an even heavier patrol—and we, too, can shoot to kill!"

Another phase of the police work in which radio has proved itself invaluable is the regulation of traffic during the big racing events, or on national fête days. The race-courses are just outside the city, in the Bois de Boulogne, and telephone stations are few and far between. So radio autos hurry out to the tracks and from points of vantage keep the struggling and shouting



One of the radio-vans in operation on the banks of the River Seine.

foot police and mounted men advised of where vacant space may be found, or where the congestion is growing, so that the flow of traffic can be turned away from that point. This method has been found so satisfactory that Longchamps, one of the big courses, has been equipped with a private radio system to supplement the police sets, and the clearing out of the roads jammed by the homeward-bound throngs has been simplified to a remarkable degree.

**THE NEW VALVE WITH THE
IRONCLAD GUARANTEE**



America's foremost
valve made in
Britain's newest
factory.

C.T. 25B. For
resistance capacity
coupled amplifier.
Amplification
Factor 20. Price 15/-

*Perfect Service
or instant replacement*

Positive Performance or a new Valve. That is the Ironclad Guarantee. So long as there is light and life in a Cleartron this Guarantee holds good. No matter where the Valve is bought any Cleartron Dealer will replace it instantly without cost or question.

Make sure of your Valves. Cleartron gives you increased volume, greater distance, purer tone, keener selectivity—and guarantees it up to the hilt

Cleartrons consume less current, oscillate, detect and amplify. In four types—C.T. 08 and C.T. 15 at 12/6. C.T. 25 and C.T. 25B (American types C.T. 199 and

15/=-

C.T. 201A) at 15/-. If your Dealer does not yet carry Cleartrons, order direct from us, with your usual Dealer's name and address.

CLEARTRON RADIO LTD.,
1 CHARING CROSS LONDON, S.W.1
AND BIRMINGHAM.

Phone—Regent 2231/2. Grams—Cleartron, Westrand, London.

CLEARTRON

BRITISH  MADE

**Critical tuning becomes easy
when Burndept Super-Vernier
Dials are fitted**

FOR fine adjustment of condensers, reaction-couplers, or variometers, nothing gives such splendid results as the new Burndept Super-Vernier Dial which looks very much like an ordinary dial. The gear ratio of 7:1 enables such minute adjustments to be made that it is easy to separate stations broadcasting on close wave-lengths. The smooth-working mechanism is noiseless and completely free from backlash and does not cause the loud clicking noises often associated with geared dials. This Burndept Component is one which will help you to manipulate your set to much better advantage.

Model A

No. 905.—As fitted to Burndept Instruments and Condensers. Designed for 1/4 in. spindles where there are no projections above the panel immediately below the Dial. The diameter of the engraved dial is 3 1/4 in. Complete with knob, etc., and full instructions - - - 7/6



Model B

No. 907.—Specially designed for one-hole fixing condensers, etc. Supplied with black moulded distance ring to raise the Dial so that there is room below the mechanism for the one-hole fixing bush and nut. Complete with knob, distance ring, etc. - 8/6



The Simple Mechanism

The reduction of about 7:1 (a ratio selected after careful trial) is obtained by means of a novel friction-driven epicyclic gear. There is nothing to go wrong, and slight wear is self-compensated. Dials have been given half a million revolutions and have then required no adjustment!

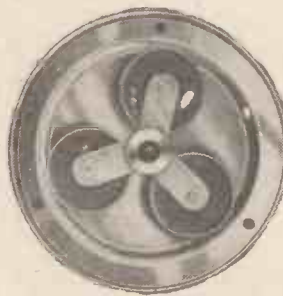

**Visit our Stands 11 and 12 at the N.A.R.M.A.T.
Wireless Exhibition at the Royal Albert Hall,
September 12th—23rd.**

Latest Catalogue sent free on application.

BURNDEPT

WIRELESS LIMITED

**HEAD OFFICE: Aldine House, Bedford Street,
Strand, London, W.C.2.**

BRANCHES at Birmingham, Brighton, Bristol, Cardiff, Exeter, Glasgow, Leeds, Liverpool, Manchester, Newcastle, Northampton and Nottingham.

RADIOTORIAL

All Editorial Communications to be addressed The Editor, POPULAR WIRELESS, The Fleetway House, Farringdon Street, London, E.C.4.

Editor :
NORMAN EDWARDS, M.Inst.R.E., F.R.S.A.,
F.R.G.S.

Technical Editor :
G. V. DOWDING, Grad.I.E.E.

Assistant Technical Editors :
K. D. ROGERS. P. R. BIRD.

Scientific Adviser :
Sir OLIVER LODGE, F.R.S.

Staff Consultants :
Dr. J. H. T. ROBERTS, F.Inst.P.; J. F. CORRIGAN, M.Sc., A.I.C.; O. E. FIELD, B.Sc.

Foreign Correspondents :
F. M. DELANO, Paris; Dr. ALFRED GRADENWITZ, Berlin; L. W. CORBETT, New York; P. F. MARTIN, Italy; W. PEETERS, Holland.

The Editor will be pleased to consider articles and photographs dealing with all subjects appertaining to wireless work. The Editor cannot accept responsibility for manuscripts and photos. Every care will be taken to return MSS. not accepted for publication. A stamped and addressed envelope must be sent with every article. All contributions to be addressed to The Editor, POPULAR WIRELESS AND WIRELESS REVIEW, The Fleetway House, Farringdon Street, London, E.C. 4. All inquiries concerning advertising rates, etc., to be addressed to the Sole Agents, Messrs. John H. Lile, Ltd., 4, Ludgate Circus, London, E.C. 4.

PATENT ADVICE FOR READERS.

The Editor will be very pleased to recommend readers of POPULAR WIRELESS who have any inventions to patent, or who desire advice on patent questions, to our patent agent. Letters dealing with patent questions, if sent to the Editor, will be forwarded to our own patent advisers, where every facility and help will be afforded to readers.

TECHNICAL QUERIES.

Letters should be addressed to :
Technical Query Dept.,
"Popular Wireless,"

The Fleetway House,
Farringdon Street,
London, E.C. 4.

They should be written on one side of the paper only, and MUST be accompanied by a stamped addressed envelope.

Queries should be asked in the form of the numbered questions : (1), (2), (3), etc., but may be accompanied by a short letter giving any necessary additional particulars as briefly as possible.

For every question asked a fee of 6d. should be enclosed. A copy of the numbered questions should be kept, so that the replies may be given under the numbers. (It is not possible to reproduce the question in the answer.)

IMPORTANT.—If a wiring diagram, panel lay-out or point-to-point wiring is required an additional fee of 1/- must be enclosed.

Wiring diagrams of commercial apparatus, such as

sets of any particular manufacture, etc., cannot be supplied. (Such particulars can only be obtained from the makers.)

Readers may submit their own diagrams, etc., for correction or for criticism. The fee is 1/- per diagram, and these should be large, and as clear as possible. No questions can be answered by phone.

Remittances should be in the form of Postal Orders.

THE "P.W." TECHNICAL ASSISTANCE DEPT.

Personal Help for Amateurs in Trouble With Their Sets.

DURING the autumn months, and until further notice, readers of "Popular Wireless" may obtain personal interviews with the Queries Editor or one of his staff on Mondays, Wednesdays and Fridays.

Just as a patient may talk over his troubles with a medical specialist, so it is now possible for readers to make an appointment with a "P.W." radio specialist and, on advance payment of a fee of 2/6, have a ten minutes' interview in order to discuss troubles verbally—a much more satisfactory and expeditious method than asking for assistance by post. Also, in special cases, and on payment of a fee of 10/6, plus all expenses, a member of the "P.W." Queries Staff will visit the home of any reader of "P.W." within a radius of twenty miles of London, and will give advice on wireless sets already installed, or on the installation of receivers, aërials, etc., etc. Hours of visit can be obtained on written application to the Queries Editor.

Readers also desirous of having their sets completely overhauled, tested, and certificated by "P.W." according to merit, may on application, and by forwarding a fee of 10/6, send their receivers to the "P.W." Testing Room. In the latter case sets must be brought by readers and taken away again after test. Sets cannot be received by post.

All queries in connection with this new "P.W." Technical Assistance Dept. should be addressed to the Queries Editor, "Popular Wireless," Fleetway House, Farringdon Street, London, E.C.4. Appointments and testing of readers' sets will be dealt with in strict rotation.

WIRELESS MEN! Make Your Hobby Pay

Let us show you how to commence a new and fascinating business in your own home—by your own fireside.

Without expensive machinery or previous experience you can start at once manufacturing an article in constant and increasing demand by WIRELESS and other users.

Royal Letters Patent protect the article you make and good profits are assured.

We have shown others—we will show YOU—how to turn spare time into money.

Full particulars will be sent to all readers of this paper without obligation. Merely write enclosing 1½d. stamp to cover postage.

THE ENGLAND-RICHARDS CO.
4K, KING'S LYNN, NORFOLK



I am still here

after 25 years of hard work AND SUCCESS. Why? Because I have helped thousands of people to better their positions socially and financially. I am assisted by a large and expert staff, and the advice we give is sound. If we cannot help you we will say so; if we can we will tell you how.

We have booklets setting out the possibilities in connection with each of the subjects shown in the lists; send for the one in which you are interested, or ask for MY PRIVATE ADVICE, which is free. You incur no obligation.

Have You ANY Ambition?

J.H. Bennett

The Bennett College specialises in all Exams. in the following subjects, and guarantees tuition until successful. No extra fees.

Most Moderate Charges. Payable Monthly. All Text Books Free.

WE TEACH BY POST

EXPERT TUTORS FOR EXTRA DEPARTMENT.

COMMERCIAL

- Accountancy
- Advert. Writing
- Salesmanship
- Auditing
- Banking
- Book-keeping
- Commercial Arithmetic
- Commercial Law
- Company Law
- Costing
- Economics
- English and French
- Executorship Law
- Foreign Exchange
- Modern Business Methods
- Secretaryship
- Workshop Organisation

TECHNICAL

- Architectural Drawing
- Building Construction
- Clerk of Works' Duties
- Boiler Engineering
- Boiler Making
- Chemistry
- Civil Engineering
- Concrete and Steel
- Draughtsmanship
- Electricity
- Engineering
- Foundry Work
- Internal Combustion
- Marine Engineering

TECHNICAL (CON.)

- Mathematics
- Matriculation
- Metallurgy
- Mining
- Nine Surveying
- Motor Engineering
- Naval Architecture
- Pattern Making
- Sanitation
- Shipbuilding
- Structural Engineering
- Surveying and Levelling
- Wireless Telegraphy
- Works Managers' Course

ENGINEERING DICTIONARY. Part One Free.

To extend the name of The Bennett College we are publishing an Illustrated Encyclopedic Dictionary of Engineering, Civil, Motor, Elect., Mech., etc. You may have Part 1 FREE. Send for Part 1 today, you are under no obligation.

WRITE FOR FREE BOOKLET to The Bennett College, Dept. 106, Sheffield, naming the subject you are interested in. Parents should seek our advice for their sons. Please state your age. Courses specially combined to meet all requirements. Why stay in the rut?



Sat. Sept. 12th
to Wed. Sept. 23rd

NARMAT WIRELESS EXHIBITION

Latest Radio Developments

10.30 a.m. to 10 p.m.
Daily

What has been described as the most picturesque and interesting of the many Exhibitions held in London every year is the All-British Wireless Exhibition, housed within that historic monument—The Royal Albert Hall.

The Exhibition, which is being held under the auspices of the National Association of Radio Manufacturers and Traders, is representative of the rapid progress and solid excellence of Radio Broadcast Reception in the Home. There Makers and Traders will display the best that Britain

produces in an alluring array calculated to please the eye and tempt the acquisitive faculties, the gallery this year being used in addition to the ground floor. Entertainment with Education for every home, and to suit every pocket, is the keynote of this unique show.

Everyone knows the Royal Albert Hall. You can get there from any Underground Station. Buses pass the door. Be sure to go early, for there you will find the means by which to make delightful our long winter evenings.

ROYAL ALBERT HALL



Special Salons are set apart for Loud Speaker demonstrations. Organ Recitals will be given daily during the morning, and in the afternoons and evenings there will be performances by THE BAND OF H.M. ROYAL AIR FORCE.

Admission 1/6

BUY BRITISH GOODS.



BERTRAM DAY'S

TROLITE

the wonderful new insulating material

TROLITE is superior to all other insulating materials. It can be used for all purposes for which Ebonite is employed with the following advantages.

TROLITE is cheaper and therefore lessens cost.

Easy to work, a joint made with Acetone solution is as strong as the material itself.

TROLITE is not affected by exposure to light, and does not warp or discolour.

TROLITE has no surface leakage, and its beautiful polish enhances the appearance of Radio fittings.

Ask your dealer to show you Standard parts made from TROLITE.

F. A. HUGHES & Co., Limited,
204-6, Gt. Portland Street,
LONDON, W.1



To obtain the best from
YOUR crystal set—fit a

PARAMOUNT PERMANENT CRYSTAL DETECTOR

None other's as good!

It is the only genuine permanent detector on the market. Fit it to your set and forget the troubles of finding and retaining sensitive spots. Made like a valve; plugs in like a valve; always ready; no catswhisker; both crystals rigidly set in dust-proof glass tube.

It is the solution to the Crystal problem. Users are enthusiastic over results.

Get your crystal set to give you the reliability and performance of a valve set. Go to your dealer to-day and see that you get a

PARAMOUNT PRICE: 6/6 PERMANENT CRYSTAL DETECTOR

Complete with
plug & socket
for panel
mounting.

If you have any difficulty
in obtaining locally apply
direct to us, together with
name and address of your
usual dealer please.

THE
PARAMOUNT WIRELESS CO., LTD.,
42, 43, CRANBOURN STREET,
LEICESTER SQUARE, LONDON, W.C.2.

Telephone, Gerrard 6318.



Prod. Pat.
No. 3991/25.
Reg. Nos.
711058 and
711059



Traders and manufacturers are invited to submit wireless sets and component parts to the "P.W." Technical Dept. for test. All tests are carried out with strict impartiality in the "P.W." Test Room under the supervision of the Technical Editor, and the general reader is asked to note that this weekly article is also intended to provide a reliable and unbiased guide as to what to buy and what to avoid.—THE EDITOR.

PATENT terminals and connectors continue to pour from the gates of factories, and the brains of inventors still seem to revolve energetically around the purely mechanical aspect of radio. The "Pinor-spade" plated terminal, samples of which arrived from the Turner Tool Mfg. Co., of Shadwell Street, Birmingham, is, however, an eminently practical device, and should therefore be well received even on a somewhat crowded market.

It is a spring grip terminal ingeniously designed to take pin or spade terminals. A milled jacket pressed downward releases or grips either in a moment. "Pinor-spades" are sold in two sizes at 5d. and 7d. each. The price is a trifle high for this type of article, but it is well made and nicely finished. To use two as telephone

terminals on a receiver even if they are not used throughout, is an arrangement we recommend to constructors. It is certainly annoying to fit ordinary W.O. or pin types and subsequently endeavour to connect to them telephones or a loud speaker provided with awkwardly opposite shapes of connections.

An automatic crystal detector is a luxury, but one that has a strong appeal. The experimenter will not generally employ one because of the difficulty of interchanging "cat's-whiskers" and "crystals," but the "listener" will discover one such as Wates "K" possesses distinct advantages over ordinary types.

Messrs. Wates, of Gt. Queen Street, Kingsway, London, W.C.2, recently submitted

one of their new "K" automatic crystal detectors for test. It is a neat little instrument, and is retailed at 5s. complete with two sockets for panel mounting. The sockets permit the device to be reversed rapidly, and this, of course, is very useful, more especially in valve-crystal circuits.

The unique character of this component is that the two adjusting knobs can be rotated with any speed in either direction without causing trouble. Adjusting such a detector is simplicity itself. The top knob should be slowly rotated in either direction until best signals result, the lower one being given a turn now and then to bring in fresh points on the crystal's surface.

The Wates "K" functioned splendidly on test, and gave signals every bit as loud as the best of ordinary types of detector we have heard. Its sensitivity was such that not the slightest difficulty was experienced in finding an adjustment, practically every turn of the small ebonite knob resulted in a maximum of signal strength.

As a standard detector on a "household" receiver we have no hesitation in recommending the Wates "K" automatic to the attention of our readers.

C.A.C. Radio, Ltd., of 10, Rangoon Street, London, E.C.3, have sent us a pair of their new light-weight telephone receivers for test. They weigh, complete with cords, only 4 oz., and are as comfortable to wear as anything of the nature we have examined. They are beautifully made with a first-class finish and a design that calls for no criticism

(Continued on page 198.)



BONTONE PHONES

An *All-British* Phone
at a popular price

"BONTONE"

Original
Lightweights 13/6 & 14/6

Post free.

Backed by a generous guarantee. Every pair of "BONTONE" Phones are tested by specially designed apparatus to produce the finest possible result. They are sensitive, durable, and comfortable.

Do not let your dealer press you to buy an inferior Phone to your ultimate discomfort and dissatisfaction.

"BONTONE" Phones may be procured from all Radio Dealers or direct from:—

B. D. & Co. (Ed. A. Boynton),
167-173, Goswell Road,
LONDON, E.C.

THE EXHIBITION

After you have seen the Wireless Exhibition at the Albert Hall, there is still much to be seen of the World's finest Wireless Productions, which alone make for perfection in radio reception.

Our Great Display

of the latest American productions can be viewed, entirely without obligation to purchase, at

DAYZITE, LTD.,

18 & 19, Lisle St., Leicester Sq., London, W.C.2

'Phone: Regent 4577. 'Grams: "Titles, Westrand, London."

Write at once for our new
Catalogue, post free by
mentioning this paper.

1/-
NET

1/-
NET

The
AMPLION
MAGAZINE

The Newest and Best
Wireless Journal

Of real interest to all Radio Users.

THE AMPLION Magazine, while catering for those interested in the ethics and the theories of wireless, addresses itself more especially to "the everyday user of the ordinary domestic radio set."

It has a name which is a household word in radio circles, and its association with the House of Graham is a guarantee of excellence.

SPECIAL RADIO EXHIBITION NUMBER

On Sale Sept. 12
at all newsagents,
or by post (1/2),
from the Manager,
Amplion Magazine,
25, Savile Row,
London, W.1.

Some of the Special Features.

Attractive cover offset litho.
Illustrated description of
Albert Hall exhibits.
Amplion Magazine competi-
tion and novel broadcasting
chart.

Articles by

S. R. Mullard, H. M. Bate-
man, J. T. Grein, Major
C. E. Prince, A. R. Burrows,
and other well-known
contributors.

Get Yesly Tuning for
SELECTION

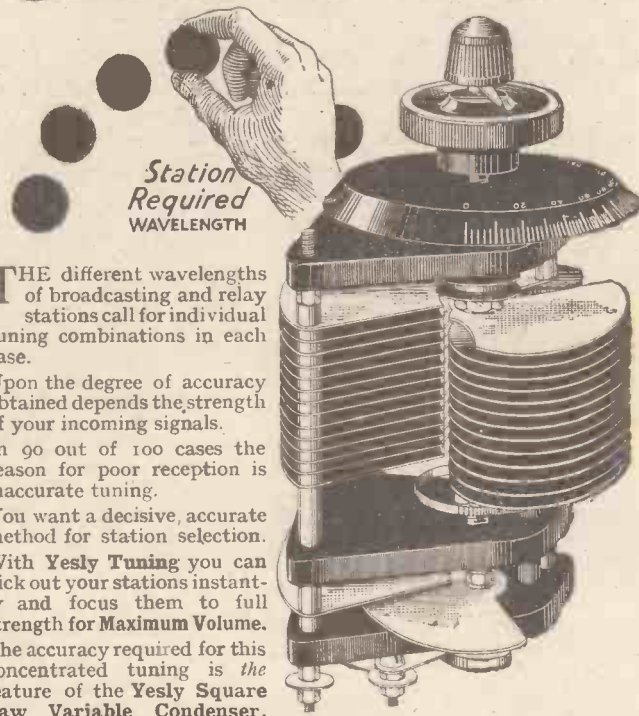

THE different wavelengths of broadcasting and relay stations call for individual tuning combinations in each case.

Upon the degree of accuracy obtained depends the strength of your incoming signals.

In 90 out of 100 cases the reason for poor reception is inaccurate tuning.

You want a decisive, accurate method for station selection.

With **Yesly Tuning** you can pick out your stations instantly and focus them to full strength for Maximum Volume.

The accuracy required for this concentrated tuning is the feature of the Yesly Square Law Variable Condenser.

One of the many letters we receive every day :-

"Having been persuaded by my local wireless dealer to try the 'Yesly' Square Law Condenser I am writing to tell you that the results I have obtained with it are far and away superior to all other makes I have used.

"I have already thanked the dealer who recommended your condenser, and the increased signal strength I obtained with 'Yesly' Tuning makes me want to know what other components you manufacture.

"Please send me your lists. I am so satisfied that you are at liberty to use this letter if you wish."

NOTE

- (1) The first-class GENERAL FINISH.
- (2) The pure EBONITE highly polished plates.
- (3) The coiled SPRING MOVING contacts.
- (4) The ONE-HOLE FIXING with embedded nut to eliminate all backlash and spindle play.
- (5) The special panel pin to prevent bodily rotation.
- (6) The ROBUST CONSTRUCTION.
- (7) The MODERATE PRICES.

Ask for Leaflet C1 giving full information.

	Plain.	Vernier.
·001	11/6	15/-
·0005	10/6	14/-
·0003	10/-	13/-
·00025	9/6	12/6
·0002	9/-	12/-

The highest possible standard in Aerial tuning demands YESLY COMPONENTS.

LOOK FOR THE NAME

REGISTERED



TRADE

MARK

Obtainable from your local dealer. If you have any difficulty write to—
ENGINEERING SUPPLIES Ltd.
235, Blackfriars Road, London, S.E.

APPARATUS TESTED.

(Continued from page 196.)

whatsoever from a mechanical point of view. This represents British instrument craftsmanship at its best.

Notwithstanding the fact that the earpieces are about half the usual size, they are extremely sensitive, and faithfully reproduce weak and strong music and speech alike. Tone, too, is good, and there is an attractive mellowness not quite expected from such light telephone receivers.

They retail at 22s. 6d. a pair, and are sure to prove popular at this more or less standard price. Comfortable to wear, efficient in operation, handsome in appearance, they are sufficiently attractive to attract the attention of both experimenters and listeners.

An excellent little component has been placed on the market by Messrs. H. Clarke & Co., Ltd., of Manchester. It is known as the "Atlas" Aperiodic Coupler. It is a device for applying aperiodic aerial tuning to existing sets employing plug-in coils, and thereby providing sufficient selectivity to cut out the local and other interfering stations. In appearance it is neat and attractive, and consists of a small

ebonite cylinder with closed ends some 2 1/4 in. in length and 1 1/2 in. in diameter. Three terminals are mounted triangularly on one end, and are marked "A," "E" and "E1." The little device is slipped into the centre of the aerial coil and aerial and earth leads removed from



The prizewinners in the "Liverpool Daily Post and Liverpool Echo" Radio Competition.

the set and connected to the "A" and "E" terminals. "E1" is, of course, directly joined to "E" inside the component, and is connected to the earth terminal of the set, where it is desired to earth the "secondary," as the aerial coil becomes when the coupler is in use.

Actually, the instrument consists of a small coil of stout wire, one end of which goes to the "A" terminal and the other to "E" and "E1." As would be expected, it is remarkably efficient, and with it under test we were able to cut out 2 L O in favour of other and distant stations with a receiver employing no stages of high-frequency amplification. Earthing the "secondary" as above was found in most cases to be advisable.

The "Atlas" Aperiodic Coupler fits into "Atlas" coils very comfortably and nicely, and without interfering in the slightest with the movement of reaction or other variably coupled coils, and this is, of course, as it should be. It also fits quite happily into Igranite coils, but the inside diameter of Lissen coils is just too small for the purpose. This, of course, applies to one or two of the other and lesser known makes, and also it must be added, some inside diameters are large, such as in the case of Tangent coils, and then it is a matter of balancing or wedging.

The "Atlas" Aperiodic Coupler couples well with any coil into which it can be inserted, and increases to a very appreciable extent the selectivity of any ordinary type of valve receiver, and although the price is 7s. 6d. there are many listeners to whom it should appeal strongly. It is not particularly suitable for use with crystal circuits, but these, of course, do not so frequently require the local station to be cut out.

Just as Good as Ever

The Standard "Brownie" Wireless Receiver. Although Model No. 2 is now available (price 10/6) the Standard "Brownie" will not be superseded, and will continue to bring the joys of broadcasting into many new homes. Though costing but 7/6 its performance is favourably compared by the Press and satisfied users to receivers costing five or six times its price.

Excellent results are obtained at a distance of 25-30 miles from a B.B.C. station or with loading coil attached (price 2/-) up to 120 miles from 5XX. Complete with solid moulded ebonite cap and base, high grade nickel fittings, glass detector, D.L.5 Crystal and "Palladium" Catwhisker. Price 7/6.

From your dealer—and remember every outfit carries our "money-back-if-dissatisfied" guarantee.

The Standard BROWNIE

The "Brownie" Wireless Co. (of Gt. Britain), Ltd. (Incorporating the J.W.B. Wireless Company), 310a-312a, Euston Road, N.W.1. Facing Warren St. Tube Station. Phone: Museum 3747



RADIO
TANGENT
FITMENTS

Wireless Enthusiasts—

for SHARP SELECTIVE TUNING
CLEAR SPEECH and
MAXIMUM STRENGTH
use

"TANGENT" TUNING COILS

(The coils with the lowest losses)

PRICES:
4/3 to
10/-
according
to wave-
length

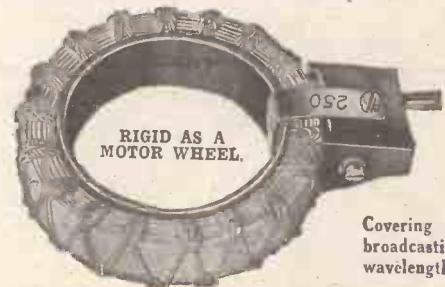

Covering all
broadcasting
wavelengths

See our
Stand No.
7 at the
N.A.R.M.
Exhibition,
Royal
Albert Hall

Above obtainable from all good dealers or direct from—

GENT & CO., LTD. Est. 1872.

"Faraday Works," LEICESTER

London: 25, Victoria St., S.W.1.

Newcastle-on-Tyne: "Tangent House," Blackett St.

Long Life Batteries which Improve Reception

The new

GECOPHONE

Super-Capacity High-Tension RADIO BATTERIES

have made an instantaneous appeal—wireless users have found them to be "just the thing" they have long been wanting.

Their outstanding merits—**LONG LIFE, SILENCE IN USE, LARGE CAPACITY**—are the outcome of much research and experiment, and make for an immense improvement in reception.

These Batteries are the latest development in **BRITISH** Battery manufacture and will undoubtedly become the standard H.T. Batteries for wireless work.

Ask your dealer about them.

Prices from 7/6 to 27/6.

SOLD BY WIRELESS AND ELECTRICAL DEALERS EVERYWHERE.

Manufacturers and Wholesale only:

The General Electric Co., Ltd. Head Office: Magnet House, Kingsway, London.



The Symbol of Perfect Service & Reliability.

The Distortionless Guaranteed British

"RENOWN"

L.F. Intervalve Transformers are made in ONE QUALITY ONLY and in ALL RATIOS

Suited to EVERY Circuit.

Used by Manufacturers and discriminating Constructors of Receiving Sets, the World over.

Price 8/4

40,000 Turn Iron Core Inductance
Choke Couplers, Price 8/4

WRITE FOR DESCRIPTIVE LITERATURE.

We REPAIR ANY MAKE of L.F. Intervalve Transformer, with our efficiency equal to new guarantee, for 5/-

TRANSFORMER REPAIR COMPANY,
HAY STREET, PORTSMOUTH

"It's contact that counts!"

says CLIXIE



"CLIXIE"

At Home, The Albert Hall,
STAND 76.

Retail Prices:

CLIX with Locknut 3d.

CLIX Adapter with
Locknut 2d.

CLIX Insulators (6
colours) 1d. each.

CLIX Bushes (6 colours)
1d. pair.

"A radio circuit is as efficient as its weakest connection" says CLIXIE. "So when you suspect faults in your wiring, look to your connections first.

"'Two-point' contact—and 'touching' contact at that—is perhaps the commonest form of weakness. It's the outstanding attribute of those ingenious silly little wiring gadgets to which the sanest of us occasionally falls victim. And it simply won't do.

"Nothing will do short of full surface contact, constantly maintained. And that's why nothing will do but the plugsocket CLIX.

"The ingenious design of CLIX provides a large area of contact surface with the minimum of capacitive metal in both plug and socket. Hence the CLIX supremacy over every other form of plug, switch or terminal.

Are you well connected? Try CLIX
The Electro-Link with 159 Uses

AUTOVEYORS LTD., 84 Victoria Street, LONDON, S.W.1

WIRELESS IN JAPAN

By B. H. J. KYNASTON.

ALTHOUGH at the time of writing there is not yet any regular broadcasting in Japan, there are a considerable number of radio experimenters, and also a large number of manufacturers and dealers. In Kobe, which was one of the few Japanese towns unaffected by the earthquake, it seems surprising that there should be as many as twelve shops which

sell wireless sets and parts, although there is no broadcasting, and very little telephony was heard (on three valves) during my six days' stay there. Four of these twelve shops deal in nothing else.

The majority of the sets and components I saw were obviously copies of British, American, and French instruments, and out of the many shops and stations which I called at

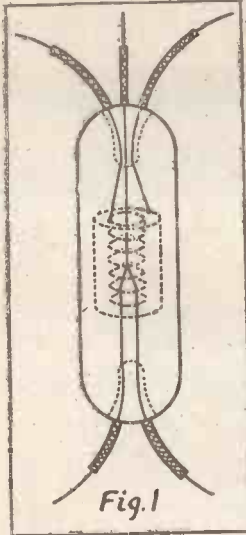

very little out of the ordinary was seen. With the exception of valves and coils, the prices were also about the same. Honeycomb coils from one shilling for the smallest to eight shillings for a coil of 1,500 turns. Valves were cheap, and there were quite a large number of types both for English and American sockets.

Cheap Valves.

A small transmitting valve which was rated at 5 watts cost me 9/6, and gave quite good results when used with 300 volts on the anode. However, 5 watts seemed to overload it slightly, as telephony became distorted when the H.T. was increased to the maker's rating of 500 volts. Two of these tubes in parallel gave excellent results up to 8 watts. These valves were

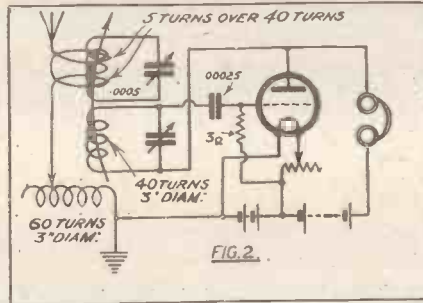

of the R type, made by the Tokyo Radio Company, and are known as the R 4 type. They are rated 6 v 8 amp.

Larger transmitting valves were also cheap. The T V 3, a 20-watt tube made by the same company, could be purchased for

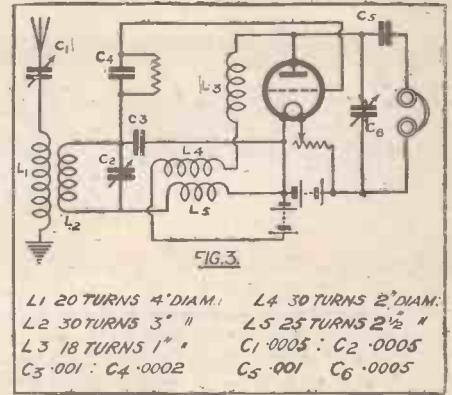

L1 20 TURNS 4" DIAM. L4 30 TURNS 2" DIAM.
L2 30 TURNS 3" " L5 25 TURNS 2 1/2" "
L3 18 TURNS 1" " C1 .0005; C2 .0005
C3 .001; C4 .0002 C5 .001 C6 .0005

£2; while the TS 2, a 50-watt tube, cost only a few shillings more.

The receiving valve type TV1 is shown in Fig. 1, and these were only 9/- each, which is cheap when one considers that each of these tubes has two filaments. The other receiving valves made are of the R type, and have English or American bases. No low temperature valves were obtainable, but the Tokyo Radio Company, I understand, are putting some on the market in a few months' time.

A number of experimental stations were visited in Yokohama and Kobe, and the majority seemed to employ quite straightforward circuits in their receivers and choke control transmitters. A few receiving circuits which were slightly out of the ordinary were noticed, and the arrangements of the most interesting of these are given in Figs. 2 and 3.

A new Service for the Home Constructor

WE feel that many more readers would make up the excellent Sets described in "Popular Wireless" if they were offered greater facilities for obtaining all the components promptly and from one source. Commencing with this issue, we are publishing weekly—a special permission of the Editor—a complete

list of parts for the most popular Set in the current week's issue. Thus, any reader, having decided to build up the Set, knows exactly how much it will cost him, and he will be able to get all the parts from one firm by return of post. All Peto-Scott parts are fully guaranteed, and every reader is offered the services of the Peto-Scott Testing Dept.

This week's "Popular Wireless" Sets

THE "P.W." 4-VALVE SET		THE "P.W." CRYSTAL SET	
1 Peto-Scott Square Law Condenser, .0005 mfd.....	80	1 Peto-Scott Vernier Condenser, .0005 mfd.....	10 6
1 Peto-Scott Square Law Condenser, .0003 mfd.....	6 9	1 Peto-Scott Coil Holder.....	1 2
4 Lissacat Major Rheostat.....	1 10 0	1 Crystal Detector.....	1 6
5 Valve Holders.....	6 3	1 Petocite Crystal.....	1 6
2 Max. Amp. Shrouded Transformers.....	1 19 0	6 3/4" lengths of 1" Ebonite Rod, and 2 Wooden End Pieces.....	2 0
1 Dublier Condenser, .0003.....	2 6	1 lb. Reel No. 20 D.D.C. Wire.....	10
1 Dublier Grid Leak 2 meg.....	2 6	5 Mark III Terminals.....	10
1 Back of Panel Coil Holder.....	15 0	4 2 ft. Lengths Square Wire and necessary Screws, Nuts, etc.....	9
2 T.C.C. Condensers, .5 mfd.....	6 8	Radio Press Transfers.....	6
3 Peto-Scott Fixed Condensers, .002.....	4 6	1 Panel Red Triangle Ebonite, 10 x 5 1/2 x 1.....	3 10
1 D.P.D.T. Miniature Switch.....	2 0	1 Oak Cabinet, with Sliding back.....	8 6
10 Mark III Terminals.....	1 8		
12 2 ft. Lengths square Copper Wire.....	1 0		
1 Hellesen's Grid Bias Battery.....	2 3		
1 Pair of Wander Plugs.....	9		
Necessary Screws, nuts, etc.....	9		
Radio Press Transfers.....	6		
	6 10 1		

PETO-SCOTT CO., LTD.
Head Office and Mail Order
Also at 62, High Holborn, London, W.O.1. WALTHAMSTOW—230,
Wood Street, PLYMOUTH—4, Bank of England Place, LIVERPOOL—4,
4, Manchester Street, (P. 8, 3497)

How to make a Ten way Switch for 2/3

With Bowyer-Lowe Stud Switch Parts for Panel Mounting you can construct any switch from two to ten ways at a cost of 2/3. The Parts are sold complete in box with drilling template, and include Studs, Stops, Nuts, Switch Arm and Ebonite Knob. Full instructions are supplied. All brass parts are thoroughly lacquered.

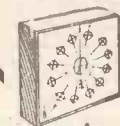

A similar set of parts is also obtainable for making Series Parallel Switches, useful wherever a double-pole change over is required.

TWO TO TEN WAY STUD SWITCH PARTS 2/3 SERIES OR PARALLEL SWITCH PARTS 4/-

Obtainable from Good dealers, or direct from the
BOWYER-LOWE Co. Ltd., Letchworth

Anti-Capacity, Low-Loss, Shock Absorbing

Fit this valve holder into every set in which you want the maximum signal purity with minimum losses. Its valve legs, separated by air, reduce inter-electrode capacity to a negligible amount. Its four Phosphor Bronze Springs prevent all microphonic noises in Dull Emitter Valves and protect all types of valves from accidental jars. The mounting is a Bakelite Ring which will not melt under the soldering iron. Universal Fitting. All screws supplied. **PRICE COMPLETE**

"ANTIPONG" 3/- Valve Holders

Order from your dealer, or direct from the
BOWYER-LOWE Co. Ltd., Letchworth



RADIO SECRETS

WHAT THIS MEANS TO YOU
THE MASTER CONDENSER



WITH 28 VARIATIONS
OF CAPACITIES.

Just one Condenser.
That's all you
require.

YOU CAN FIND
THE CORRECT VALVE TO
MAKE YOUR SET PERFECT.

PRICE 5/6

Experimenters, Owners and Builders of Radio Sets can obtain a "Multicon" through any wireless stores or direct from the patentees and manufacturers. Price 5/6, post paid, with fully illustrated chart, showing how to obtain the 28 variations.

"MULTICON"

TRADE
PRICE
MARK

PRICE'S BATTERY & RADIO CO., LTD.,
Dept. P.W., 11, Hart Street, New Oxford Street, London, W.1.



Adding to
Time!

When you become a user of the famous "ELKA" Batteries you add to the time of your enjoyment of listening-in. Long life, capacity, silent working, and minimum internal resistance. Demand "ELKA" from your dealer.

60 v. H.T. Bty. 8 6
100 v. H.T. Bty. 12 6
9 v. Grid Bias 2/-
4 1/2 v. P.L. Bty. 6d.

L. KREMNER

Trade Prices on Application. 49a, Shudehill, Manchester

W.J.H.

SAXON GUIDE TO WIRELESS

THIS IS THE BEST BOOK OBTAINABLE, AND ENABLES ANYONE WITHOUT PREVIOUS EXPERIENCE TO MAKE WIRELESS SETS WHICH ARE UNEQUALLED IN PRICE, QUALITY, OR EFFICIENCY.

Everything connected with Wireless is clearly and simply explained, and full instructions, WITH CLEAR WIRING DIAGRAMS, are given for making: TWO SUPER EFFICIENT CRYSTAL SETS, ONE AND TWO-VALVE DUAL AMPLIFICATION RECEIVERS, ONE AND TWO-VALVE AMPLIFIERS; ALSO THE VERY LATEST TYPES OF TWO, THREE, FOUR AND FIVE-VALVE TUNED ANODE RECEIVING SETS.

THE CHAPTER ON TESTING WIRELESS COMPONENTS IS ALONE WORTH THE PRICE OF THE BOOK.

NO SOLDERING, NO SPECIAL TOOLS, NO TROUBLE. Simply follow instructions and you will make a better set for one-fourth the price you would pay for an inferior instrument.

Satisfaction guaranteed or money refunded.

SAXON RADIO CO. (Dept. 14), SOUTH SHORE, BLACKPOOL.

176 PAGES

PRICE

1/3 POST FREE

The Improved and Cheaper Coil Plug

SAVE 25%

Get your COIL PLUGS for 5/- per doz. (4/- gross lots). Made of best tested materials throughout, these Plugs offer the advantages of nickel-plated side plate contacts, having patent lip. Send 6d. to cover postage upon sample dozen orders.

CECIL RIDLEY
35 & 37 DUNDAS MEWS
MIDDLESBROUGH

pop

it into your pocket when you take your set on a picnic or visit—it fits snugly, does

THE *Ariane*

POCKET AERIAL

yet its high capacity and perfect insulation ensure splendid results. Can be thrown over tree or car hood, or hung from picture rail or out of the window—anywhere. No tangling—no trouble. Wound up in a minute.

B.E.N. PATENTS LIMITED
100, VICTORIA STREET,
LONDON — S.W.1.

Ask your Dealer or send direct with his name and address

TRADE ENQUIRIES PLEASE.

POST FREE
12/6

SOME REMARKS ON CONDENSERS IN WIRELESS CIRCUITS.

THERE are some parts of a wireless circuit in which condensers are essential, and others in which they are not essential though very desirable. Many beginners in radio observe their more advanced friends putting condensers into their sets here and there, without any apparent regard either for their position or their capacity value, and the newcomer is often at a loss to know just where and when a condenser is going to be of use to him.

The more "optional" places for condensers are across the windings of the L.F. transformers, across the high-tension battery, and as a shunt on the 'phones or loud speaker.

By-pass Condensers.

As a general rule, any piece of apparatus in a wireless circuit which has a high resistance (or "impedance" to be more correct), should have a "by-pass" condenser connected across it in order to provide an easy path for the high-frequency currents.

Of course, the ease of passage of the high-frequency currents through the condenser depends upon the capacity of the latter, and in special cases (as, for instance, in the case of the tuning condenser) the value of the condenser has to be chosen or adjusted very carefully; it is not, in other words, merely a "by-pass" condenser.

The first place for a by-pass condenser is across the primary winding of the first intervalve transformer. The current which is intended to flow through this winding is the rectified current from the detector, but there is a small H.F. current as well. This will not pass through the primary winding of the transformer if a suitable by-pass condenser is provided. A common value for this condenser is 0.001 mfd.

Across the H.T. Battery.

The next position for a by-pass is across the high-tension battery. The resistance of the H.T. battery is a matter for conjecture; in a new battery it is comparatively small, perhaps 50 to 100 ohms, but in a battery which has been in use for some time, the resistance is apt to rise very considerably. The effect of this resistance is much more serious in a multi-valve set and in certain special types of circuit, when the one H.T. battery is common to all the valves. The internal resistance of the battery and its ill-effects can be overcome, however, by the simple expedient of placing a large capacity condenser across its ends.

By "large capacity" in this connection is meant a condenser of anything from 0.1 mfd. to 2.0 mfd.—the larger the better. This condenser is sometimes referred to as a "blocking condenser." It is certainly worth while to include it, even when the battery is new, and you will often be surprised at the improvement in reception.

For these large capacity fixed condensers it is often convenient to use "paper condensers," that is, condensers made up with sheets of tinfoil and insulating sheets of paper. The best type of large-capacity fixed

condenser are the Mansbridge condensers; Mansbridge condensers are made by the T.C.C. amongst others, and are comparatively cheap. In this connection it may be well to mention that many amateurs get the impression that any old condenser will do for a blocking condenser, particularly across the H.T. battery. It is, however, just as important to have a condenser which is perfect in insulation here as elsewhere.

Finally we come to the condenser shunted across the 'phones or loud speaker. At first sight a telephone condenser might seem to have a by-pass action, and to be therefore undesirable. But as a matter of fact, it acts as a storage condenser, and in this way materially improves the reception. Signals can, of course, be heard without a telephone condenser, but it should be remembered that there is always a certain amount of capacity in that part of the circuit, even in the absence of an actual condenser.

Telephone Condensers.

When low-resistance 'phones are used, with a step-down telephone transformer, the condenser should be connected across the primary of the telephone transformer. The value of the telephone condenser, unlike the H.T. battery condenser, should not be too large; 0.001 to 0.005 mfd. is a suitable range.

Owing to the fact that the 'phones and the H.T. battery often occur in proximity in the circuit, some amateurs place a single large capacity condenser right across the two, but this is not the best practice. It is better, as already indicated, to place a large condenser across the battery, and a smaller one across the 'phones.

IGRANIC H.R. Vario-Coupler.

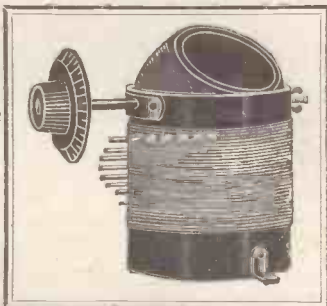

A convenient and selective tuning device

Build a set which will enable you to cut out much of the interference which is so annoying in broadcast reception. The Igranic H.R. Vario-Coupler is a component which you will find gives greater selectivity than can be obtained with an ordinary direct-coupled tuning circuit, and which is very convenient in operation. The stationary winding which is tapped at each turn for the first ten turns and thereafter at every tenth turn, may be used in the aerial circuit, while the ball type rotor carries the secondary winding, which should be tuned by a shunt variable condenser. With this instrument you can obtain very fine tuning to receive all the stations within the broadcast band without the necessity for changing coils, and under conditions which make for high efficiency. Like all other IGRANIC Radio Devices, it is built of the best materials by expert craftsmen. Ask your dealer about it!

IGRANIC RADIO DEVICES include

Honeycomb Duolateral Coils, Variable Condensers, Fixed Condensers, Inter-valve Transformers, Filament Rheostats, Variable Grid-leaks, Variometers, Vario-couplers, Coil-holders, Potentiometers, Vernier Tuning Devices, Switches.

All carry the Igranic guarantee.

Write for List Z711

BIRMINGHAM.
CARDIFF.
GLASGOW.



LEEDS.
MANCHESTER.
NEWCASTLE.

Quee n Victoria St., London. Works: Bedford.

THE PANEL DE LUXE



THE advantage that a Radion Panel confers on a Receiving Set is much more than merely adding a gold case to a watch. Rather, is it comparable to the addition of that delicate compensating balance wheel mechanism which ensures split-second accuracy. If you aim at 100 per cent. efficiency for your Set you'll naturally start with a Radion Panel. With dials to match.

Radion is available in 21 different sizes in black and mahogany. Radion can also be supplied in any special size. Black 1d. per square inch, mahogany 1½d. per square inch.

RADION

American Hard Rubber Company (Britain) Ltd.

Head Office: 13a Fore Street, Depots: 120 Wellington Street, Glasgow.
116 Snow Hill, Birmingham.
London, E.C. 2 Irish Agents: 8 Corporation Street, Belfast

New Turret III Mast

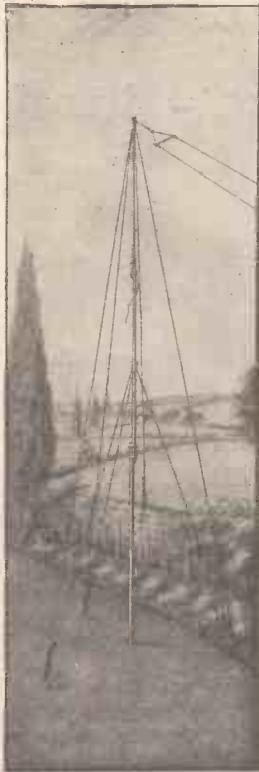

This new 40 ft. telescopic mast has great strength. It is in three sections, each of selected Columbian timber. (Like a ship's mast.)

The first two sections of the mast are erected as one, reaching 30 ft. in height, and when stayed, the third section, already secured to No. 2 section, is hoisted into position and is automatically secured.

30 in. ground-pegs, steel fitted; insulated waterproof stays, and other necessary equipment are provided. **58/9**

27 Turret-II, complete **44/6**
45 ft. telescopic super mast - - - **90/6**

55 ft. doubly telescopic - - - **£6/15/6**

58 ft. super telescopic - - - **£6/19/6**

SIMPSON & BLYTHE, 8-9, Sherwood Street, Piccadilly, LONDON, W.I.
Phone: Gerrard 2650.

A GRID LEAK THAT IS SILENT IN ACTION

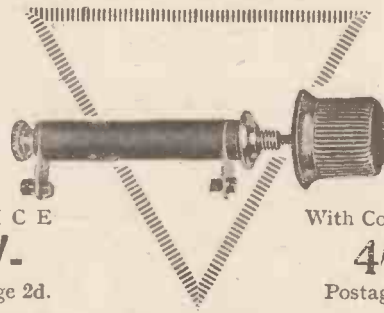

PRICE
3/-
Postage 2d.

With Condenser
4/6
Postage 3d.

Write for details of the **Bretwood Valve Holder—Switch—** and the new **Bretwood Filament Resistance for Bright or Dull Emitter Valves.**

The Bretwood Variable Grid Leak or Anode Resistance is the only instrument of its type that is absolutely constant in action—the homogeneous mastic employed ensures this.

Incorporate the "Bretwood" and be secure from the ever-present tone destroying noises that arise from the usual carbon compression type of grid leak. *As used in Radio Press Sets.*



WIRELESS SPECIALITIES

Obtainable from Most Wireless Dealers.

BRETWOOD LIMITED,
12-18, London Mews, Maple St., London, W.

Barclay's Ad.

Every Pair Guaranteed. **Phone-Joy**



12/6
per pair.

Only truly experienced when listening-in on Bowerman's Phones. There is a charm, comfort and clarity about these instruments that is beyond praise and beyond rival. Get a pair to-day—they will amaze and delight you and reveal undreamt-of powers in your sets. Obtainable from Whiteley's, Barker's, and all leading wireless dealers or direct under guarantee, p.o. 12/6.

Bowerman's
SUPER POWER HEAD PHONES

Bowerman's Phones, 10-12, Ludgate Hill, London, Eng.

The **"Voltone"**

Oscillating Crystal,

of REAL valve power, for the new Crystal Oscillating Sets, is manufactured in our own works. Exhaustive tests have given sensational results in extraordinary sensitivity and amplification.

Puts you on to any B.B.C. station immediately, and has a range of at least 200 miles. Demand "VOLTONE" to-day from your dealer, or, if sold out, write direct to:

M. WILSON
23, King Street, Manchester.
WJH Tel: City 7196.

The Guaranteed Oscillating Crystal.



2/6
Each.

Internal Metal Chuck to grip 14 to 44 gauge wire or flex.
Price: Plug 4d. Socket 2d. Indicating Ring 1d.



PATENTED

BELLING-LEE INDICATING TERMINALS & "MULTY-KONTACT" PLUGS & SOCKETS

(Handles and dome-shaped Indicating Rings in Red or Black) Stocked in the following indications:

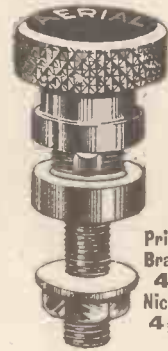

PATENTED

Price: Brass 4d. Nickel 4½d.

DIAL INDICATORS



Solid cast metal, with raised, polished letters showing white on a black background. Single hole fixing, complete with nut. Stocked in Tuner, Filament, Reaction, Aerial, Anode, H. F. Tuner, Secondary, Rejector.

Price - 6d. each.

Aerial, Earth-Phones+, Phones-, L.T. +, L.T. -, H.T. +, H.T. -, Input +, Input -, Output +, Output -, L. S. +, L. S. -, Grid +, Grid -, A. T. I., Reaction, Ap. Aerial, H.T. Medium, and Blanks.

Every high-class dealer stocks them, but in case of difficulty send to **BELLING & LEE, Ltd. Queensway Works. Ponder's End, Midx.**

SUB-CONNECTORS

Eliminate Soldering.



Price 1d. each.

Perfect connection; lowest possible self-capacity; low resistance; connection changed in an instant. Tapped to screw on to 2, 4, 5 and 6 B.A. threads; also T connectors for joining wires.

RAYMOND

HULLO EVERYBODY!

ALL GOODS POST FREE U.K. except where stated. Foreign orders over £10 post free otherwise please send ample for post, etc. Trade orders U.K. less 20% Post extra. Open all day Saturday.

SUNDRIES

- Aerial, 7/22, 100ft. 2/6
- 2-way coil stands 2/9
- 3-way coil stands 4/6
- 2-way nickel 3/11
- 3-way nickel 5/6
- 2-way geared 5/6
- 2-way Slipton cam 6/6
- 3-way Slipton cam 7/6
- 2-way Polar cam 6/1
- 3-way Polar cam 9/1
- vernier 3/6
- 2-way cam vernier 3/6
- Coil plugs, plain..... 1/3
- Shaped wedge 2 for 1/6
- Do. Edison Bell 2 for 2/1
- Do. Nickel sides 1/6
- Do. fitted fibre 2 for 1/6
- Ebonite do. 4/11
- Edison Bell do. 3/0
- Fixed Condensers: Edison Bell, .001 1/3
- .0001 up to .0005 1/3
- .002 up to .006... 2/1
- Grid leak & clips 1/3
- .0003 & grid leak 2/6
- Dubilier 0001 to .0005 each 2/6
- .001 to .006 each 3/1
- 2 or 3 mer Grid 2/6
- Leak on stand 5/6
- (50, 70, 80, 100, 000 ohms)
- 2 mfd., T.O.C. 4/8
- 1 mfd., T.O.C. 3/10
- .25, T.O.C. 3/8
- Spade tags, doz. 6d.
- Bus Bar, 1/16th sq. 12 ft. 1/1
- Solid Rod Valve Holders 1/3
- Bretwood 1/8
- H.T.O. under panel 1/8
- H.T.O. over panel 1/9
- Raymond Rheostat 1/6
- R.I. Detector 6/1
- Twin Flex, 12 yds. 1/9
- Red & Black, yds. 2/1
- 72ln. Phone Cords 1/11
- Loud Speaker Cords 1/11
- Eureka Gravity Detector 6/6
- D.P.D.T. Panel 1/1
- S.P.D.T. 3/6
- LISSEN Minor 3/6
- Lissenstat 7/6
- Universal 10/6
- Switch 2-way 2/6
- Series Parallel 3/8
- Anode Res. 2/6
- Var. Grid Leak 2/6
- Choke 10/6
- Lissen L.F. T.2 3/0
- Lissen L.F. T.3 16/6
- Lissen Coils, 25, 4/10 35, 20, 1/4
- 50, 5/10 50, 5/10
- 75, 5/4 100, 6/6
- 150, 7/1 200, 8/5
- Lissen X Coils, 50 x 5/1, 50 x 6/5
- 75 x 6/5 250 x 9/9
- Colvern Vernier 2/6
- Ditto, Nentrodyns 3/6
- Ormond ditto 2/1
- Phone distribution boards, for 4 prs. 2/6
- "R.I." Choke, 10/6
- Permanent detector "KR" 2/6
- 4 and 6 BA Nuts and Screws, six dozen for 3/1

REFLEX COILS

- Made under licence Burndep. Patent No. 168249
- No. 35 150/200 8d.
- No. 50 200/500 9d.
- No. 75 300/750 1/-
- No. 100 400/1,000 1/2
- No. 150 600/1,500 1/8
- No. 200 800/2,000 2/9
- No. 250 900/2,500 3/3
- Post 2d. each

LOUD SPEAKERS

- O.A.V. Tom-Tit. 30/-
- O.A.V. Junior 35/-
- Sterling Baby 5/3
- Sterling Dinkie 30/-
- Amplion Junior 27/6
- Amplion Dragon 25/-
- Amplion Do. III. 50/-
- Amplion De Luxe 65/-
- Amplion AR.19. 105/-
- Dulcevox 42/-
- True Music Minor 21/-
- Ultra 27/6

TRANSFORMERS L.F.

- Eureka Concert 30/-
- Eureka Second Stage 22/6
- Igranic Shrouded New Model 21/-
- Formo Shrouded 10/6
- General Radio 83 15/6
- Super Success (bracket) 21/-
- 3-1 or 5-1 13/6
- "Croix" 9/6
- Wates Supra 12/6
- Terminals complete. Pillar, doz. 1/-, 1/3
- "Phone" 1/1
- Nickel, 9d. doz. extra. Voltmeter, each 5/6
- Rheostat & Dial. 2/3

ADJUSTABLE

- (4,000 ohms) Dr. Nipper 12/6
- Telefunken 16/11
- Both genuine. 300 6/-

VALVES

- B.T.H., Ediswan, Mullard, Cossor, Marconi, Bright, D.E., '06 and power valves all stocked

IGRANIC COILS

- Coils—25 5/35 5/1, 50 5/2 75 5/8, 100 7/8, 150 7/10, 200 8/8, 250 9/1, 300 9/5, 400 10/3, Rheostat 4/6 30 ohms 7/1

ORMOND

- L.F. Transformer 14/-
- Special Rheostat 2/-

STERLING

- Variable condensers with vernier .0005 25/6
- .00025 22/6
- Non-Pong V.H. 4/3
- Phones 20/- & 22/6
- Primax Loud Speaker 27 15

ERICSSON E.V.

- (Continental) 4,000 ohms 12/-

HEADPHONES

- British, 4,000 ohms. Sterling 22/6
- B.T.H. 20/-
- Brands 20/-
- Brown's P type 20/-
- Ericsson's 22/6
- Michrom vernier 2/6
- Gambrell coils stocked. Paragon panels obtained. Watmel grid leak 2/6
- Watmel anode 3/6
- Watmel 10,000 to 100,000 3/6
- Bretwood leak 3/1
- Ditto anode 3/1
- Colvern Precision Variable .0803 20/- .0005 21/-
- Glaizite 10 ft. 1/2

7 GRAPE STREET SHAFTESBURY AVENUE, W.C.2

New Oxford Street end. 1 minute Tottenham Court Road Tube.
NOTE! Grape Street is between Prince's Theatre and Mudie's Library. 3 minutes Holborn Tube.
OPEN DAILY 9 a.m. to 8 p.m. ALL DAY SATURDAY. 2 minutes Palace Theatre.

RAYMOND Variable Condensers SQUARE LAW LOW-LOSS

- One hole fixing. Ebonite ends. With Vernier Without Vernier
- '001 .. 8/6 '001 .. 7/6
- '0005 .. 7/6 '0005 .. 5/9
- '0003 .. 7/- '0003 .. 5/3
- Including knob and dial. Post 3d. set.

- STANDARD. ORMOND No. 3
- .001 7/6 Ebonite Ends. Sq. law with vernier.
- .0005 5/6 .001 10/6
- .0003 5/6 .0005 9/6
- .0002 5/- Also without vernier, 1/6 each less Knob & dial free. All with knob & dial

- ORMOND "AMERICAN" Square Law Low Loss. Skeleton ends. knob and dial.
- .001 9/-; .0005 8/-; .0003 7/6; .00025 6/6 (with vernier 1/6 each ex.)

- JACKSON BROS. "J.B." Square Law with vernier.
- .001 9/6 .001 13/6
- .0005 8/- .0005 12/6
- .0003 8/9 .0003 11/6
- .00025 6/6 .00025 11/3
- "J.B." 1 .001 5/9 .0005 5/-
- Standard 1 .0005 5/9 .0005 5/-
- ALL with knob and dial. Post free.

- ACCUMULATORS. 2v. 40-amp. 9/6
- 2v. 60-amp. 11/6
- 4v. 40-amp 15/3
- 4v. 60-amp. 19/6
- 4v. 80-amp. 24/6
- 6v. 60-amp. 29/6
- 6v. 80-amp. 35/9
- All new, best makes. Harts also stocked.
- Goswell (quality) Mounted Coils. 25 1/8 35 1/9, 50 2/- 75 2/3, 100 2/9, 150 3/-, 200 3/9, 250 5/3, 300 6/-

- 2-way Panel, 3/-; 3-way, 5/-; 2-way cam vernier, 9/-
- Electric Soldering Set, 5/9
- All parts stocked

- "LOTUS." Geared 8-1. 2-way. 7/-; 5-way, 10/6
- McMichael's Triple Rheostat 22/6
- Dual Rheostat 7/6
- H.F. Transformers each 10/-
- (All wave-lengths) Potentiometer, 7/6
- Fixed Condensers. 1/18, 2/3

BURNDIPT PARTS

- Rheostats, 5/1
- Gen. Purposes, 5/-
- Dual 7/6
- Detector 7/6
- Rheostats 5/7, 4/6
- Amplion V.H. 1/1
- Success choke 10/6
- Athol 1/3
- Athol Coil Plug 1/3
- T.O.B., 6 ohms, 4/-
- T.O.B., 30 ohms, 4/-
- T.O.B. Potentiometer (300) 5/-
- Slipton ditto (600) 4/6
- Slipton 7 ohms, 3/-
- Slipton 50 or 60 ohms 3/-
- Woodhall parts stocked. Dubilier Variables. Dubilier Fixed 510 type.

- IMPOSSIBLE To advertise all lines here. Send name and address (postcard, please) for illustrated order. Special offers not obtainable elsewhere.

VALVES

- To encourage you to use British Valves I am willing to purchase one burnt-out valve for each valve you purchase. Prices given range from 1/3 to 4/- according to value you buy.

YOUR PANEL DRILLED FREE WITH 25/- order (retail)

CALLERS COLUMN ONLY

- All Post Orders from Other Columns
- H.T. BATTERIES (Various makers). 60-v. 5/6, 6/6, 6/11
- 66v. Ever Ready, 12/6
- 108v. 20/11
- 60v., B.B.C. 8/11
- 36v. 5/6
- 16.5v. 2/9
- 9v. (grid bias) 2/-

- Accumulators (well-known makes) 2v. 40a. 7/6, 8/6
- 4v. 40a. 13/11, 15/11
- 4v. 60a. 17/6, 18/3
- 4v. 80a. 22/6, 23/6
- 6v. 60a. 25/11, 27/6
- 6v. 80a. 33/-
- 6v. 100a. 38/6

- Square Law Variable Condensers .0005 5/- .0003 4/6
- Including knob & dial. D.P.D.T. Panel. 1/-
- S.P.D.T. 10/6
- D.P.D.T. china 1/3
- S.P.D.T. 10/6
- Terminals, 1d. 1/-
- Nickel doz. 10d.
- Valve sockets, 4 for 3d.
- Grid valve pins, 1d.
- Washers 12 a/d.
- Nuts 6 a/d.
- Spade tags, 6 a/d.
- Spade terminals, 1d.
- Pin terminals, 2 for 1d.
- Do. Red or Black, 1d.
- Copper foil, foot, 3d.
- Red and black tin, 1/6

- Aerial, 7/22 100ft. 1/11
- Battery Clips, 3 a/d.
- Sleeving, yard, 3d.
- Widener, 100 ft. 1/10
- Contact studs complete, 2 a/d.
- "Phone cords, 6 ft. 1/3
- Knobs and Dials, 10d.
- Empire Tape, 12 yds. 6d.
- Valve Holders, 8d.
- Plug and socket, red 3d.
- 7/22 Aerial, 50 ft. 1/1
- Ins. Hooks, 2 for 1/3
- Loud speaker cords, 1/4, 1/6
- Rheostats, special, 9d.
- Vernier condensers, 1/9
- Tumbler switches, 10 a/d.
- Shorting plug, 3 a/d.
- Egg insulators, 4 for 3d.
- Voltmeter, 250/650 1/6
- Anticap ditto, 10 a/d.
- Solid rod standard 1/1
- Good quality do. 8 d.
- Hank 1/16th sq. Bus Bar 6d.
- Lead-in (10 yds.) 1/-
- Ebonite dials, 8d.
- Unbreakable knobs 3d.
- Adhesive tape, roll, 2/6
- Tape aerial, 100 ft. 1/10
- TWIN Bell Wire, per yard 2d.
- BRUNET 4,000 ohm 'phones 13/11

- Set Parts (one valve) 46/6
- Ditto (two valves) 66/6
- (including valves).

- "MAGNUM." All parts stocked.
- THEORPE K4 (Unidyno 5-pin) VALVES. Genuine, each 14/-
- 5-pin valve holder, 10/6
- Set Parts (one valve) 46/6
- Ditto (two valves) 66/6
- (including valves).

- EBONITE Cut to size. 3/16th sq. inch 1 d. sq. inch.
- "WONDER" AERIAL Phosphor Bronze, 100 ft. 3/3
- Indoor, outdoor or frame, 49 strands.

- "UTILITY." 2 pole c/o knob, 4/-
- 4 pole c/o knob, 6/-
- 2 pole c/o lever, 5/-
- 4 pole c/o lever, 7/-
- Nickel 6d. ea. ex. Variable condensers at list prices.

- SECOND-HAND DEPT. Quantities of nearly new and second-hand goods on sale. CHEAP PRICES. Old parts bought or taken in part exchange.

- IMPOSSIBLE To advertise all lines here. Send name and address (postcard, please) for illustrated order. Special offers not obtainable elsewhere.

- Valves To encourage you to use British Valves I am willing to purchase one burnt-out valve for each valve you purchase. Prices given range from 1/3 to 4/- according to value you buy.

- NO CONNECTION WITH ANY OTHER FIRM WITH A SIMILAR LIST. BE SURE YOU ARE AT RAYMOND'S

HOURS OF BUSINESS Daily 9 a.m. to 8 p.m. OPEN ALL DAY SATURDAY. TWO SHOPS ONE ALWAYS OPEN. Telephone (private line) Gerrard 2831.

FOREIGN NEWS

From Our Own Correspondent.

Koenigswusterhausen.

The Koenigswusterhausen Station will broadcast all its evening programmes on a wave-length of 1,300 metres.

A New "5 X X."

A new high-power station has been opened at Karlsborg, Sweden. It transmits on a wave-length of 1,250 metres and a power of 25 kw.

Powerful German Station.

The work on the new station at Frankfurt is proceeding so well that it is hoped that this station will be opened in November. It is being erected on a hill-top in the vicinity of Frankfurt, and will send out on a wave-length of between 200 and 300 metres, with a power of 10 kw.

Radio Stations in Europe.

According to the latest statistics, there are at the moment 87 radio transmission stations in Europe; 37 more are being constructed and a dozen more projected.

Radio in Rumania.

Both houses of Parliament have passed the new law regulating the use of wireless in Rumania. Radio is made a state monopoly, but the state may give a concession for transmission to a company. It is proposed to open public transmission stations and hearing places for public use, and no fee will be charged to listeners.

Another Austrian Station.

A new station will be opened at Brunn before Christmas. It is being fitted up by the Marconi Co., and will be of 12 kilowatts power.

German Station's Gong Signals.

The Muenster transmission station has inaugurated a new system of signalling the start, etc., of its programmes. One stroke of the gong is given five minutes before the start. Two strokes indicate that the programme is about to begin. Pauses are signalled by as many strokes of the gong as the pause will last minutes.

Denmark's New Radio Rules.

The Danish Government has decreed state control over radio for one year. A state commission composed of 27 members, including Government officials, representatives of the Press, the Academy of Music, and the leading radio companies has been formed with full authority to make up the programmes.

A tax is imposed on all owners of receiving sets, varying according to the power of the set from 10 to 200 kroner. This latter is for sets put up in public places for the amusement of the public, in cafes and restaurants for instance. Defaulters will have their apparatus confiscated in addition to having to pay a heavy fine.

Daily Talks to Congo.

Belgium talks daily to its great African colony, the Congo, by means of the

FOREIGN NEWS.

(Continued from page 204.)

government transmission station at Machelen near Vilvorde. The Congo station is at Stanleyville. Communication in both directions is excellent.

Opera House Loud Speakers.

We learn exclusively that the Government has made preparations for springing a surprise on the Paris public in connection with the loan propaganda.

A powerful receiving set is being installed with all secrecy on the Opera in Paris, and 10 Bardon loud speakers, disposed fan-wise, are to give simultaneous rendering of speeches by Prime Minister Painlevé, Finance Minister Caillaux, and others, recommending all good and thrifty citizens to invest in the new gold coupon loan. If, as is expected, the experiment proves to be a success, it may become a permanent form of Government announcements to the people of Paris.

THE "P.W." 4-VALVE SET

(Continued from page 174.)

This is the case with both the MacMichael H.F. transformer, and that supplied by the Bowyer Lowe Co., either of these components being suitable for use in this set.

No. 16 square section tinned copper wire was used for the connections, and this will be found easy to work, whilst it is of sufficient rigidity to give good spacing.

Either bright or dull-emitter valves may be used, and the fourth valve should preferably be of the "power" type. General-purpose valves can be used for the first three stages, but if the suitable amplifying valves can be used in their respective stages, so much the better.

Results, of course, cannot be foretold, owing to wide variations in local conditions, and to the fact that they chiefly depend upon the skill of the operator in handling the set.

It may be said, however, that with the switch in the 3-valve position it should be possible to receive many British and half-a-dozen or so Continental stations in almost any part of the British Isles. With the fourth valve in use, regular loud-speaker results should be obtainable from several of the British stations, and probably from some of the Continental ones as well.

LIST OF PARTS REQUIRED.

	£	s.	d.
1 panel, 16" x 8" x 1/2" and cabinet to fit, with baseboard (Peto-Scott)	1	15	6
1 '0005 variable condenser		6	6
5 anti-phonic valve holders (Barrie's)		8	9
1 '0003 variable condenser		5	6
1 L.F. transformer, 1st stage (blue base, Peto-Scott)		19	6
1 ditto, 2nd stage (black base, Peto-Scott)		19	6
H.F. transformer (MacMichael or Bowyer-Lowe)	7	0	or 10 0
1 2-way coil-holder for panel mounting, with reversible reaction plugs (Quality, Goswell Engineering Co.)		10	6
3 '002 fixed condensers (Lissen)		7	6
1 grid leak 2 meg.; 1 condenser '0002 (Dubilier)		5	0
4 filament rheostats (Lissenstat Major)	1	10	0
10 terminals, W.O. type		1	3
2 '5 mfd. fixed condensers (T.C.C.)		7	0
1 9-volt grid bias battery (Siemens)		2	6
1 D P D T switch (Westhill)		2	0
Wire screens, transfers, nuts, etc.		3	0



What Others Think.



It would be easy for us to write an advertisement telling you all about the sterling merits of the M.L. Transformer.

We think it is the best transformer that has ever been placed on the British market. Perhaps that is only natural since we are so interested in it. But here is what someone thinks who has no interest in the M.L. transformer, other than that of a satisfied user.

His testimonial is entirely unsolicited. Here is what he says:—

"As you are aware, I have tried out practically every make of L.F. Transformer available to the amateur, and, in my considered opinion your latest production is superior to anything I have previously tested."

The 1:6 ratio is used for amplification after a crystal rectifier. The 1:4 ratio is used for single stage L-F Amplification. The 1:2.6 and 1:4 ratios are used respectively in the first and second stages of two-stage amplification.

S. SMITH & SONS (M.A.) LTD.
 179-185 Great Portland Street, London, W.1
 Telephone: Langham 2323 Telegrams: "Speedomet, Telew, London"
 Also at Birmingham, Manchester, Glasgow and Belfast.

S. SMITH & SONS (M.A.) LTD

Quality RADIO COMPONENTS

Profusely illustrated thirty-page CATALOGUE just out. If your dealer cannot give you one, send us a card with his name and address to receive it direct FREE and POST FREE.

STANDARD COIL-HOLDERS

Reduced Prices

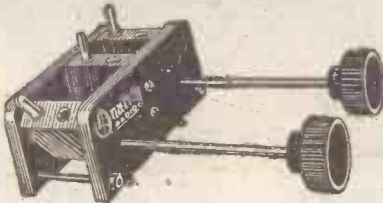

2-way, 3/9, postage 3d.
3-way, 5/6, " 4d.



With Angular Handle,
2-way, 4/-, postage 3d.
3-way, 6/-, " 4d.

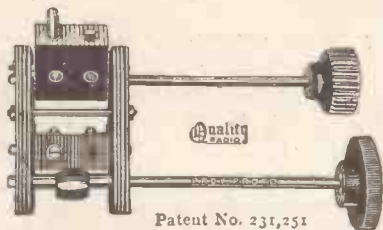

Patent No. 231,251

Quality RADIO CAM-VERNIER COIL HOLDER

Price 9/-, on base 1/- extra. With Reaction Reverse and Shorting Switch incorporated, 12/6. Postage 4d.

GOSWELL ENGINEERING CO., LTD.,

95, 96, 97, & 98, White Lion Street, LONDON, N. 1.

Liberal Trade Terms.

Correspondence

Letters from readers discussing interesting and topical wireless events or recording unusual experiences are always welcomed, but it must be clearly understood that the publication of such does in no way indicate that we associate ourselves with the views expressed by our correspondents, and we cannot accept any responsibility for information given.—Editor.

LOW LOSS COILS.

The Editor, POPULAR WIRELESS.

Dear Sir.—After experimenting for some time with basket coils, I have adopted a method of winding by which it is possible to reduce their capacity to a minimum. This is accomplished by the use of a few feet of insulated wire (such as is used for lead-in purposes).

The wire is first cut up into lengths. As many lengths being required as the former has slots.

The length of each being the same as the diameter of the former to be used.

These lengths are doubled into loops. The loops are placed over the former between every two slots.

The winding of the coil can then be proceeded with in the usual manner; over two, and under two slots; until the required number of turns have been added. After winding, the wire loops can be withdrawn and used again during the construction of other coils of a similar radius.

Trusting the above may be of interest to other readers of POPULAR WIRELESS.

I am,

Yours sincerely,
EDWARD RAMSEY.

1, Waverly Terrace,
Pelton Fell, Newcastle-on-Tyne.

4-ELECTRODE FLEWELLING.

The Editor, POPULAR WIRELESS.

Dear Sir.—Having constructed the "4-Electrode Flewelling" described by Mr. U. L. Patullo in "P.W." of June 27, I should like to say that this circuit is a great improvement on the straight Unidyne circuit. In fact, using 4 volts high tension, the set has worked a small loud speaker. Also several other stations can be very easily got, and the set is well worth the trouble of constructing.

I should like to thank Mr. Patullo through your "Correspondence" columns, and to wish "The Paper" every success.

Yours faithfully,

J. S. DEVENPORT.

19, Lawton Street,
Burslem, Stoke-on-Trent.

DX IN SUMMER.

The Editor, POPULAR WIRELESS.

Dear Sir.—It is easy to boast of long-distance reception during the winter, but it is rather harder to do any DX work when the summer is here. It may interest you to know of the results obtained with my straightforward 3-valve, 1-V-1, during the two months from June 24th till August 24th. I have had the following stations:—Birmingham, Cardiff, Belfast, Nottingham, Radio-Paris, Toulouse, Eiffel Tower, Brussels, Hanover, Hamburg, Leipzig, Hilversum, Vienna, Rome, Barcelona (Radio-Catalana), Munster, and of course 2 L O and 5 X X. Besides this, Croydon Aerodrome, and also two stations, one German, believed to be Berlin, and one Spanish, believed to be Radio-Madrid. Owing to my close proximity to 2 L O, I am only half a mile away. I was unable to get all B.B.C. mains owing to jamming from 2 L O. Hoping that this will be of interest to you, and wishing your paper every success. I remain,

Yours,

M. WILLIAMS.

39, Tottenham Court Road,
London, W.1.

"P.W." ALL-STATIONS TWO-VALVER.

The Editor, POPULAR WIRELESS.

Dear Sir,—I am sending the results obtained on the "P.W." 2-valve all stations set which I have recently completed. On an indoor aerial the first station received was Radio Toulouse at 9.10 p.m., appreciably loud on two pairs of phones, inasmuch after the announcement we distinctly heard the violins "tuning-up." After this item we went discreetly around the B.B.C. stations. I felt reluctant to part with "John Henry"—one of your earlier 1-valve circuits—but excellent though the results were, this set is well worth while. The case is somewhat larger than that illustrated diagrammatically, but this allows for a different coil holder, and gives ample spacing for changing coils. Am looking forward to an interesting winter on this very efficient circuit.

Yours faithfully,

FRANCIS G. LLOYD.

P.S.—Liverpool is easily cut-out, completely.
105, Botanic Road, Edgehill,
Liverpool.

See **STAND 33**
ALBERT HALL
for the new and improved



WIRELESS PRODUCTIONS

or write for a copy of our complete Radio Catalogue

C.A.V. Vandervell & Co., Ltd.
ACTON VALE, LONDON, W. 3.

WHY PAY MORE
when you can get "Selmolite" Crystal, the World's Best for 1/- per box, post free? In sealed boxes with full guarantee. **SIMONS, 100', HOUNDSDITCH, E. 1.**

RIFANCO PHONES & PARTS

4,000-ohm Tested Headphones, 8/6 pair. Cabinets, Pedestals, Sideboards, Accessories for Wireless and Gramophones, Motors, cheaper than anywhere else. Catalogue (64 pages, 180 illus.) telling How to Assemble Gramophones, 3d.

THE REGENT FITTINGS CO.,
P.W., 120, Old Street, London.
E.O.1. Est. 20 years.
Tel. Clerkenwell 2923.

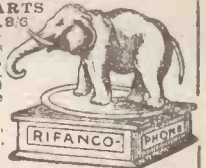

HEADPHONE REPAIRS

Rewound, re-magnetised and readjusted. Lowest prices quoted on receipt of telephones. Delivery three days.—**THE VARLEY MAGNET CO., London, S.E. 18. Phone 888-9 Woolwich. Est. 26 years.**

Wireless Aerial Masts

IN STRONG GALVANISED STEEL TUBE

1/-
Per Foot

Supplied up to 50 feet high, in two and three lengths, with steel erecting base, stakes and guy ropes. Price 1/- per foot inclusive. **SHORT CHIMNEY MASTS** also at 1/- per foot. Masts well galvanised throughout. **STEEL CHIMNEY STRAPS** 4/8 per set complete. Carriage Paid England & Wales.

Makers: **THE DISTRICT IRON & STEEL CO., LIMITED (P.W.) SMETHWICK STAFFS**

2-VALVE AMPLIFIER, 35/-

1-Valve Amplifier, 20/-, both perfect as new; Valves, 4/6 each; smart Headphones, 7/6 pair; new 4-Volt Accumulator, celluloid case, 13/-; new 60-Volt H.T. Battery, guaranteed, 6/-; 2-Valve All-Station Set, £4. Approval willingly.

P. TAYLOR, 57, Studley Road, Stockwell, LONDON.

Picketts Cabinets

Mould-de-Luxe Polished

SENT ON APPROVAL.

Beautifully Polished Mahogany

For 12 x 12 Panel .. 45/-

" 12 x 15 " .. 55/-

" 12 x 18 " .. 65/-

Estimates and Lists free—Send Size 1

Panels and Complete Accessories—Post Free. Picketts Cabinet (P.W.) Works, Bexleyheath, S.E.



IFIX CONNECTORS (Patents Applied for)

The device which gives a direct and complete contact without soldering.

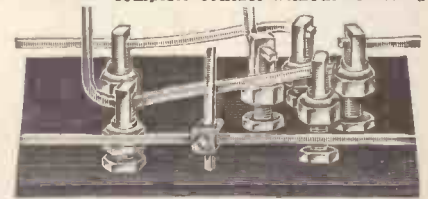

You will be astonished at the rapidity with which you can connect up any circuit.
No. 1 for terminals & screws 4 BA, 5 BA, 6 BA, 2/- per doz.
No. 2 for Butt & Cross joints .. 1/- per doz.
Send P.O. 6d. for set of Samples.
Your Dealer or Patience
W. E. BOTTOM, 34, Denham Rd., SHEFFIELD

A "P.W." CRYSTAL SET.

(Continued from page 151.)

and the aerial lead-in is taken to either one of these, according to whether the condenser is required in a parallel or a series position. This method avoids complication in wiring and losses due to high-frequency leakage between the switch contacts and wiring, etc.

The internal connections of the receiver are as follow :

Point-to-Point Connections.

Aerial parallel terminal to socket side of loading coil holder, to cat's-whisker of crystal detector, and to moving vanes of the variable condenser.

Aerial series terminal to fixed vanes of variable condenser.

Earth terminal to one side of low-loss coil and to one 'phone terminal. Other 'phone terminal to crystal side of crystal detector.

Other side of low-loss coil to plug side of loading coil holder.

For the reception of the local broadcasting station, which we will presume is not 5 X X, the loading coil holder is "shorted" by a metal shorting plug. The aerial is taken to the series terminal, the earth to the earth terminal and the 'phones, of course, to their respective terminals (the parallel terminal is left unconnected). The crystal should now be roughly adjusted, and the variable condenser slowly rotated until signals are heard at their maximum. The reading on the dial of the variable condenser should now be noted, and then it should be rotated until the signals are almost lost.

Next, the crystal should be readjusted without moving the condenser until the signals are as loud as you can get them, whereupon the condenser is still further rotated away from its maximum point until the signals are again nearly lost. Further adjustment of the crystal may result in increasing the signals slightly, but if it does not, then the constructor may rest assured that he has adjusted his crystal to its maximum sensitivity, and, if the variable condenser is now turned to the point which was noted—i.e. the point of maximum signal strength—the fullest results will be obtained from the receiver.

Tuning in High Wavelengths.

In the event of the constructor using an extra large aerial, or living close to one of the broadcasting stations having high wave-lengths, such as Birmingham or Aberdeen, it will be impossible to tune in the receiver properly with the aerial in the series position, and, in this case, the aerial lead-in should be taken from the series terminal and connected to the parallel terminal, the series terminal being connected to earth. Re-tuning should now bring in the local station somewhere near the middle of the condenser.

For the reception of 5 X X the shorting arrangement on the coil holder is opened, and a loading coil of any good manufacture and having about 150 turns should be placed in the socket. The aerial in this case will be in the parallel position, the series terminal being shorted to earth. Tuning is carried out as before, the maximum sensitivity point of the crystal being found as already described.



Baby Grand
No. 1 15/-
(for 1st stage)

Baby Grand
No. 2 15/-
(for 2nd stage)

A real Eureka for 15/-

HERE'S a real Eureka Transformer guaranteed to contain all the essential features of construction of the larger Concert Grand at a price within the reach of all. The same non-laminated core—the same exclusive method of winding—the same hermetical sealing to protect the contents from the action of the atmosphere—the same coppered steel case to prevent interaction—in every respect identical in design with the famous Eureka Concert Grand long ago accepted as the country's standard for volume and even amplification at all frequencies.

The manufacture of Eureka Transformers is a whole-time all-the-year-round job. It is directed by a group of engineers whose experience in the design of low-frequency transformers is absolutely unrivalled. When they say that the new Baby Grand is worthy of the name Eureka, you can rely on their judgment.

Don't judge the Eureka Baby Grand on its price—there is no transformer at anywhere near its price which can approach it for volume or mellowness of tone.

Other Eureka Transformers :
Concert Grand 25/- No. 2 (for 2nd stage) 22/-
Eureka Reflex (for all reflex circuits) - - 15/-

Portable Utilities Co. Ltd.
Eureka House, Fisher St., London, W.C.2

EUREKA

MICROMETER ADJUSTMENT

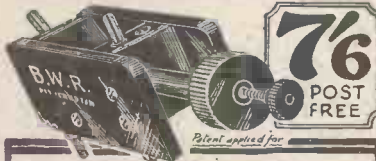

B.W.R. "No 21" COIL HOLDER

This coil holder has distinctive features that fill a real want. The most minute adjustment rapidly or slowly attained without the use of unreliable springs. Absolute rigidity. Mountable in any position (panel or cabinet). Matt or polished. Also in Ebonite (black or mahogany). Post free 7/6 each, direct from manufacturers.

BURGE, WARREN & RIDGLEY, LTD.
91-92, Gt. Saffron Hill, London, E.C.1

Quotations given for all kinds of Ebonite work—large or small—repetition or hand made, lowest prices.

ORDER BY POST

PLEASE be sure to mention **POPULAR WIRELESS** when communicating with **Advertisers** **THANKS!**

READ THIS! An efficient CRYSTAL SET, complete with 1 pair phones, 100 ft. aerial, 2 insulators, and lead-in tube, at the astonishingly low price, post free, of **15/-**.
S. B. WIRELESS CO., 21, Austin Rd., Battersea, London, S.W. 11.



PLUGS & JACKS, 3/- pair.

Dewar Switches, 3-way, 12 pt. ... 2/6
Mansbridge Condenser, 2 m.f. ... 2/-
Modulation Transformers ... 5/-
all Ex-W.D. Post Free.
A. ROBERTS & Co., 42, Bedford Hill, S.W.12

ACCUMULATOR BARGAINS.

C.A.V. & Fullers, solled, but guaranteed 12 months. Sent on approval against cash.
2v-40a ... 9/6 4v-80a ... 27/6 6v-60a ... 32/6
4v-40a ... 17/6 4v-100a ... 32/6 6v-80a ... 40/-
4v-60a ... 21/9 6v-40a ... 25/- 6v-100a ... 46/-
MAUDE RUBBER CO., 58, PRAED ST., W.

THE "DANETREE" LONG RANGE CRYSTAL AND GOLD CONTACT COMBINATION

FOR DISTANCE you require a super-sensitive Crystal and whisker point free from the minutest film of oxide. Most metals quickly acquire this film. Gold does not. The best possible combination is obtained, producing astonishing results. 2/6 post free.

D. HAMILTON,
13, Mauldeth Rd. W., Withington, Manchester.



15/- pair of GORDON-BELL HEADPHONES

THIS is our scheme for securing a gigantic advertisement for our Gordon-Bell Crown Brand Headphones. You can obtain a pair of these Super-sensitive Headphones, 4,000 ohms, and giving beautifully loud and clear reception, at a total cost to yourself of **6d. ONLY!** Immediately you comply with the very simple condition, we **GUARANTEE** to send you a perfect, tested pair of these Headphones, value 15/6, for which you will have paid the paltry sum of **6d.** WRITE NOW for your Coupon which gives full particulars, enclosing 6d. to

GORDON-BELL LIGHT COMPANY (Radio Dept. P.W.)
131, ESSEX ROAD, ISLINGTON, LONDON, N.1

TECHNICAL NOTES

(Continued from page 152.)

makes for great compactness in the condenser; a further advantage is that, as it is entirely enclosed, shielding is effectively carried out by a metal case, and dust is unable to enter. In the models now on the market, a micrometer adjustment is provided. The whole article is well designed and constructed, and appears to be a worth-while innovation. I should mention that this principle was used in variable condensers on the American market some time ago.

A New Filament Coating.

Much interest attaches, from the wireless point of view, to some developments which have lately taken place in the extraction and refinement of Hafnium (the new element which was discovered only a year or two back), and also to the discovery of two further elements, named Masurium and Rhenium.

The important point about Hafnium, so far as wireless is concerned, is that it has been found to have a very high electronic emissivity when heated, and moreover, as it has an exceedingly high melting point, its temperature can be raised to a very high figure without danger. Hitherto this element has not been obtained in the metallic form, but recently Dr. Berglund (one of the collaborators of Dr. Niels Bohr, the famous Danish mathematical physicist) has succeeded in obtaining about two grams of the element in pure metallic form. It appears as a greyish black powder, resembling powdered graphite. Of course, a good deal of further work will need to be done before the pure metal can be produced commercially.

As regards the use of it in wireless valves, however, a considerable enhancement of the electronic emission from a filament may be obtained by coating the filament or otherwise treating it with the Hafnium compounds, without reducing the element to the pure form.

The other two elements mentioned, Masurium and Rhenium are believed to have valuable properties in connection with detectors, but there appears to be little further information available on this point at present.

Radio Fever Dying Out?

"What is to become of the home constructor after he has become tired of building radio sets?" This question is asked by the writer of an article in "Radio Broadcast." He points out that the

constructor, in the States at any rate, occupies himself mainly in building up different receivers from bought components and that, after a time, he not only gets tired of the occupation, but he finds one particular specimen of the results of his labours which satisfies him perfectly well, and feels little or no incentive to proceed further: in other words, he is tired of his hobby and wants a change.

Novel Apparatus.

It should be mentioned that in the States there is a growing tendency to abandon home constructing in favour of the purchase of complete receivers, and several well-known manufacturers in this country are of the opinion that a similar tendency will in time make itself evident on this side.

In order to stimulate the jaded appetite of the super-constructor and to give him, so to speak, fresh worlds to conquer, "Radio Broadcast" is preparing a programme of special apparatus which is believed to have a new interest. The first piece of apparatus—the construction of which is to be described shortly—is a "modulated oscillator," a combination of an H.F. oscillator, a miniature transmitter, and an L.F. oscillator.

The series will then lead the late "home constructor" to become an investigator into the mysteries of coils and, in short, will aim to set his feet on the path of true research, as distinct from mere constructing.

RADIO "CROXSONIA" PANELS

Money back guarantee that each and all Panels are free from surface leakage, Meggar test Infinity. 8" x 5", 1/2; 7" x 6", 1/3; 9" x 6", 1/7; 10" x 8", 2/1; 11" x 8", 2/3; 10" x 9", 2/4; 12" x 8", 2/6; 11" x 9", 2/7; 12" x 9", 2/10; 12" x 10", 3/-; 14" x 10", 3/6; 14" x 12", 4/-; 7" x 5", 1/- thick. Post Free. Callers, cut any size, and quote by Post. Sample, and prices, post free to the Trade.

CROXSONIA CO., 10, South St., MOORGATE, E.C.2

'PHONES REMAGNETIZED FREE

ALL MAKES REWOUND, 4,000 OHMS, 5/-. Phones Rewound & Remagnetized Free. Remagnetizing only 2/-. Loud Speakers from 3/6. Transformers from 5/-. Post extra.
The H.R.P. Co., 48, St. Mary's Road, Leyton, E.10

'PHONES STRENGTHENED!!

NEW SECRET METHOD. of magnetising and adjusting improves new or old 'phones 20 per cent to 200 per cent. 2/- pair. Guaranteed results. New method of layer-wound rewinding renews useless 'phones and makes them better than new. 5/- pair. Every class of repair to 'phones, loudspeakers and transformers. All work guaranteed. Ready same day. Post. 6d. pair. Prospectus P. gratis. **JOHN W. MILLER, 68, Farringdon St., E.C.4. Phone: Central 1950.**

CABINETS—Sloping 8" x 7" panel, 3/6 each. Sloping 12" x 9" panel, 6/- each.
BOXES—Desk pattern, 7" x 5", 13/- per doz.; 1/6 each. Box pattern, 7" x 5", 13/- per doz.; 1/6 each. All Polished. Estimates Free. Carriage Extra.
J. H. TOOMEY, 137, RIVERSDALE ROAD, HIGSBURY, N.5. Satisfaction Guaranteed

ADVERTISEMENTS

FOR THESE COLUMNS ARE ACCEPTED UP TILL 5 P.M. ON WEDNESDAYS FOR THE FOLLOWING WEEK'S ISSUE. RATE 30/- PER INCH; MINIMUM SPACE ACCEPTED, HALF-INCH AT 15/- CASH MUST ACCOMPANY INSTRUCTIONS AND BE SENT TO THE SOLE ADVERTISING AGENTS, **JOHN H. LILE, LTD., 4, LUDGATE CIRCUS, LONDON, E.C.4.**

'PHONE CITY 7261.

WHY THE **RI** CURVE IS RIGHT



TONE and OVERTONE

The pitch of every note must be accurately attained before your piano will be able to give you correct tone.

Pitch, however, is only the value of the fundamental note frequency, whereas

PERFECT MUSIC

calls for the combination of correct pitch and the additional character that lies in the

OVERTONES.

These minute but all-important overtones portray the personality of the artist and vary in frequency from 1,000 to several thousand cycles per second. Their reproduction in radio calls for exacting knowledge. A Transformer that will give perfect amplification of the fundamental note frequencies *only*, results in lifeless reproduction.

In the R.I. Transformer the immediate increase in amplification above 1,000 cycles per second preserves these precious overtones and gives as a result **PERFECT MUSICAL RECEPTION**



25/-

Write for R.I. Catalogue, free on application.

Visit Stand No. 36. All British Wireless Exhibition, Royal Albert Hall, Sept. 12-23



H6 Ord 19

LISSENIUM.

The New LISSEN Wire Wound Anode Resistance

THE outstanding purity of resistance-capacity amplification is fully recognised, but its use has been retarded owing to the difficulty of obtaining a suitable resistance.

To successfully carry the heavy current without partial disintegration and consequent noise, for the best work it is necessary to use a wire-wound resistance.

It is also necessary to have a high resistance—80,000 ohms has proved to be the most suitable and is the one usually recommended.

In the majority of the very few wire resistances on the market, difficulties of manufacture have resulted in a compromise between cost and efficiency, and the results obtainable with the new *Lissen Wire Wound Anode Resistance* are a

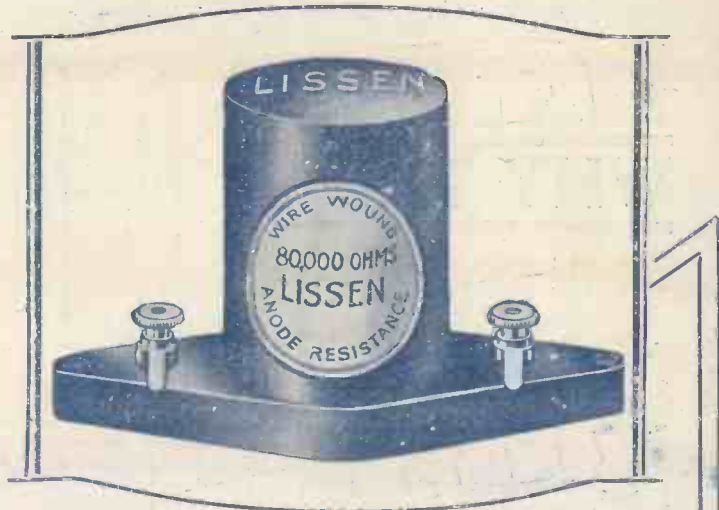

great improvement when compared with what was previously possible.

The *Lissen Wire Wound Anode Resistance* has a full 80,000 ohms resistance, will carry heavy currents, is always perfectly silent under all conditions of service—amplification is strikingly pure. The method of winding results in a very low self-capacity. The coil is wound in sections which inductively neutralise each other. The resistance is hermetically sealed and cannot be affected by atmospheric changes. The *Lissen Wire Wound Anode Resistance* is essentially a "heavy duty" laboratory component at a popular price. In addition to its use for L.F. coupling it will also be found very suitable for H.F. work on the higher wave-lengths.

Price - - - - - 10/-

The LISSEN H.F. CHOKE.

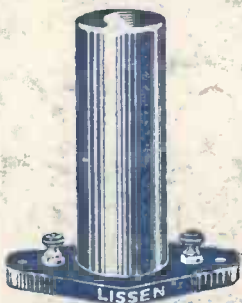

WRITE
for
TEXT BOOK
of
LISSEN PARTS
free to readers of
this magazine.

IN some circuits, such as the popular Reinartz, an air-core choke is necessary. Hitherto the experimenter has had to face the difficulties of winding his own choke or use a large plug-in coil. There is now available the LISSEN H.F. CHOKE which has many advantages over the home-made choke or the plug-in coil used as a choke. For instance, with the LISSEN H.F. CHOKE there is no risk of the H.F. currents being by-passed across it—it is so designed that its influence on stray fields in a receiver is negligible—its induct-

ance value is so high that it is as effective on 4,000 metres as, say, on 300. If a plug-in coil is used as a choke a No. 200 coil is usually recommended, but this size of coil has the disadvantage that the natural wavelength of the coil, although well above the broadcast band, would be below, say, Daventry, and consequently ineffective on that wave-length. This difficulty can be overcome by using an ultra large coil; but such a coil is expensive, and its use would be limited to the higher wave-lengths owing to its comparatively large self-capacity, strength of magnetic field due to its bulk, and so on. The LISSEN H.F. CHOKE therefore fills a very useful need, because it is conveniently formed and also efficiently covers all wave-lengths up to 4,000 metres.

Price - - - - - 10/-

LISSEN LIMITED

LISSENIUM WORKS, 8-16, FRIARS LANE, RICHMOND, SURREY.
'Phone : Richmond 2285 (4 lines). 'Grams : " LISSENIUM, PHONE, LONDON."

LISSEN PARTS—WELL THOUGHT OUT, THEN WELL MADE

Printed and published every Thursday by the Proprietors, The Amalgamated Press (1922), Ltd., The Fleetway House, Farringdon St. London, E.C.4. Advertisement Offices, Messrs. J. H. Lile, Ltd., 4, Ludgate Circus, London, E.C.4. Registered as a newspaper, and for transmission by Canadian Magazine Post. Subscription rates. Inland and Abroad, 19/6 per annum. 9/9 for six months. Sole agents for South Africa: Central News Agency, Ltd. Sole agents for Australia and New Zealand: Messrs. Gordon & Gotch, Ltd.; and for Canada: The Imperial News Co. (Canada), Ltd. Saturday, September, 19th, 1925.

All applications for Advertisement Space in POPULAR WIRELESS AND WIRELESS REVIEW to be made to JOHN H. LILE, LTD. (Sole Agents), 4, Ludgate Circus, London, E.C.4. Phone: City 7261 (2 Lines).

46

MARCUSE & SIMMONDS WRITE ONLY FOR "P.W."

POPULAR WIRELESS

No. 174. Vol. VIII.
September 26th, 1925.

and Wireless Review

PRICE 3d.
EVERY THURSDAY.

Scientific Adviser: SIR OLIVER LODGE, F.R.S., D.Sc.

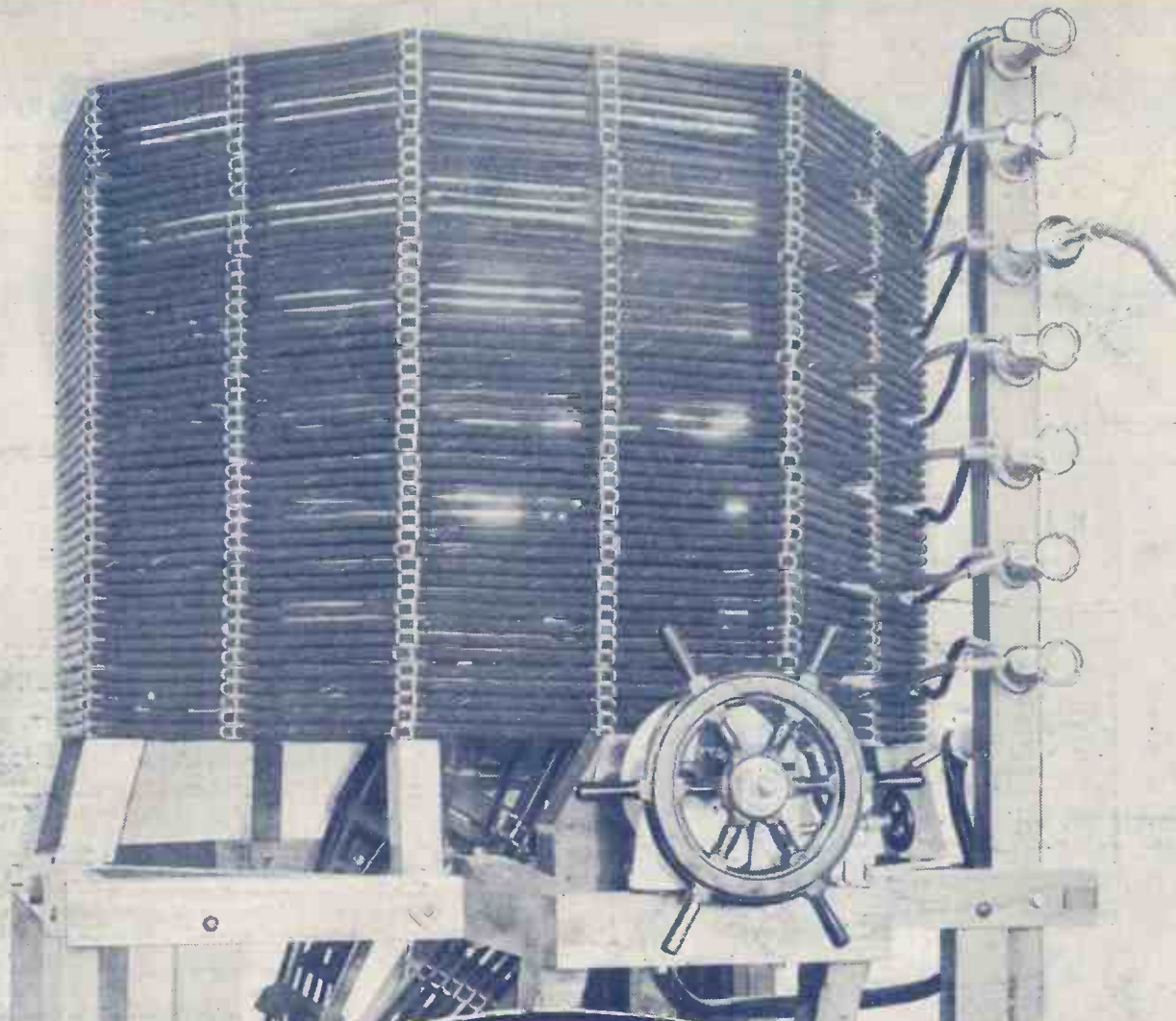

Contents :

How To Make
THE CHEAPEST ONE-VALVE SET,
 and
THE "P.W." VARIOMETER CRYSTAL RECEIVER.

The Super-Sonic Heterodyne Receiver. Bottled Wireless.
 Is Soldering Worth While? Adding an H.F. Valve.
 The Cause of Crystal Rectification.

A special article describing the great German station Koenigs-
 wusterhausen. One of the huge transmitting variometers
 employed at that station is shown in the above
 photograph.

Super Sensitive Tuning

No. 2 of a series of advertisements dealing with the unique features of the GECOPHONE Low-Loss Slow-Motion Variable Condenser.

GECOPHONE

LOW LOSS-SLOW MOTION VARIABLE CONDENSER

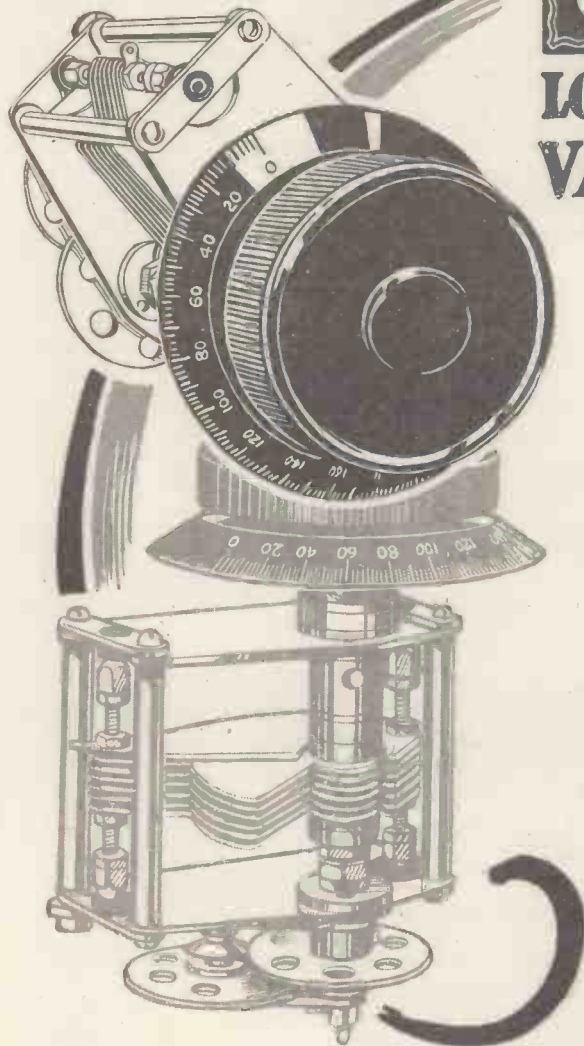

Enormous interest is being shown by wireless users in the new GECOPHONE Low-Loss Slow-Motion Variable Condenser. Never before has any condenser permitted of such a fine degree of selectivity in tuning.

The large control knob, together with the patent micrometer movement, makes this extremely delicate tuning possible. Rotating in the same direction as the dial, the knob allows the setting to be altered to such a minute degree that the dial movement is almost imperceptible—and so in the most crowded wave-length band it is possible to separate stations with remarkable ease.

Ask to see the GECOPHONE Low-Loss Slow-Motion Variable Condenser at your dealer's.

Other Unique Features :

1. The patent reduction mechanism gives micrometer adjustment without backlash, and a dead silent velvety movement in operation.
2. Insulation of fixed plates outside electrostatic field makes dielectric losses the smallest possible.
3. Minimum capacity is lower than in any other type.
4. Hand-capacity is entirely eliminated.
5. The condenser is adapted for one-hole fixing, and can be mounted on a metal panel without insulation.

PRICES :

·0002 mfd. ... 22s. 0d.		·0003 mfd. ... 24s. 0d.
·00025 mfd. ... 23s. 0d.		·0005 mfd. ... 27s. 6d.
·001 mfd. ... 32s. 6d.		

Sold by all GECOPHONE Service Depots, Wireless Dealers and Stores.

For full list of GECOPHONE Components ask for Booklet No. B.C. 3759.

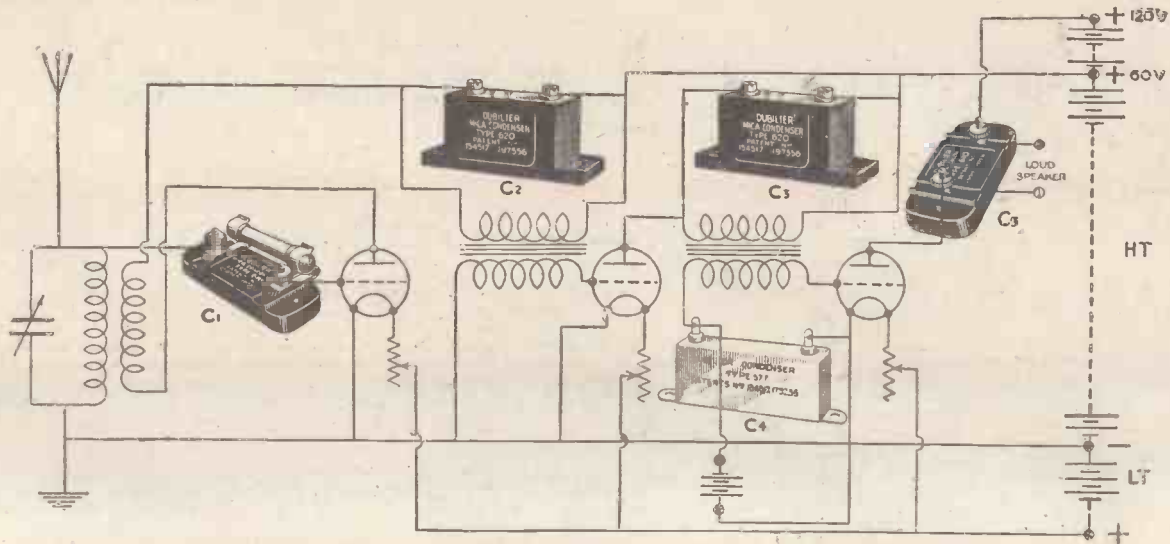

THE RIGHT THING in THE RIGHT PLACE



ALTHOUGH the experience of the average man with wireless matters has been comparatively short, it has certainly been intensive. In the summer of 1922 an aerial outside a house was a rarity. In 1925, on the other hand, it is the house without one that is the exception. Literally millions of people nowadays know quite a lot about the theoretical and practical sides of wireless. Above all they now realise that a successful set must be fitted with good condensers, and in every case the name Dubilier is generally recognised as the hall mark of condensers both fixed and variable, Anode Resistances, and Grid Leaks, and other similar products.

In the illustration above, we show some examples of the right thing in the right place:—

at C1 a Dubilier Type 610 Mica Condenser (from 3/- with Grid Leak (2/6)

at C2 & C3 Dubilier Type 620 Mica Condensers (from 3/-)

at C4 a Dubilier Type 600a Mica Condenser (from 2/6)

at C5 a Dubilier Type 610 Mica Condenser (from 3/-)

Dubilier Condensers are made in a very wide range of capacities, and the Grid Leaks in several values. Every wireless Dealer stocks Dubilier products, and they are used in every good wireless set.

Always remember that quality tells, and make sure you specify—

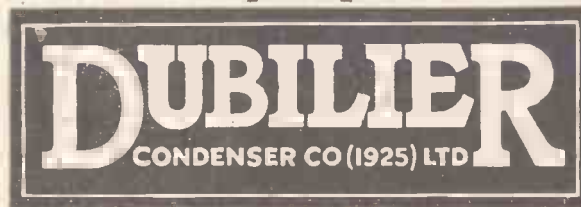

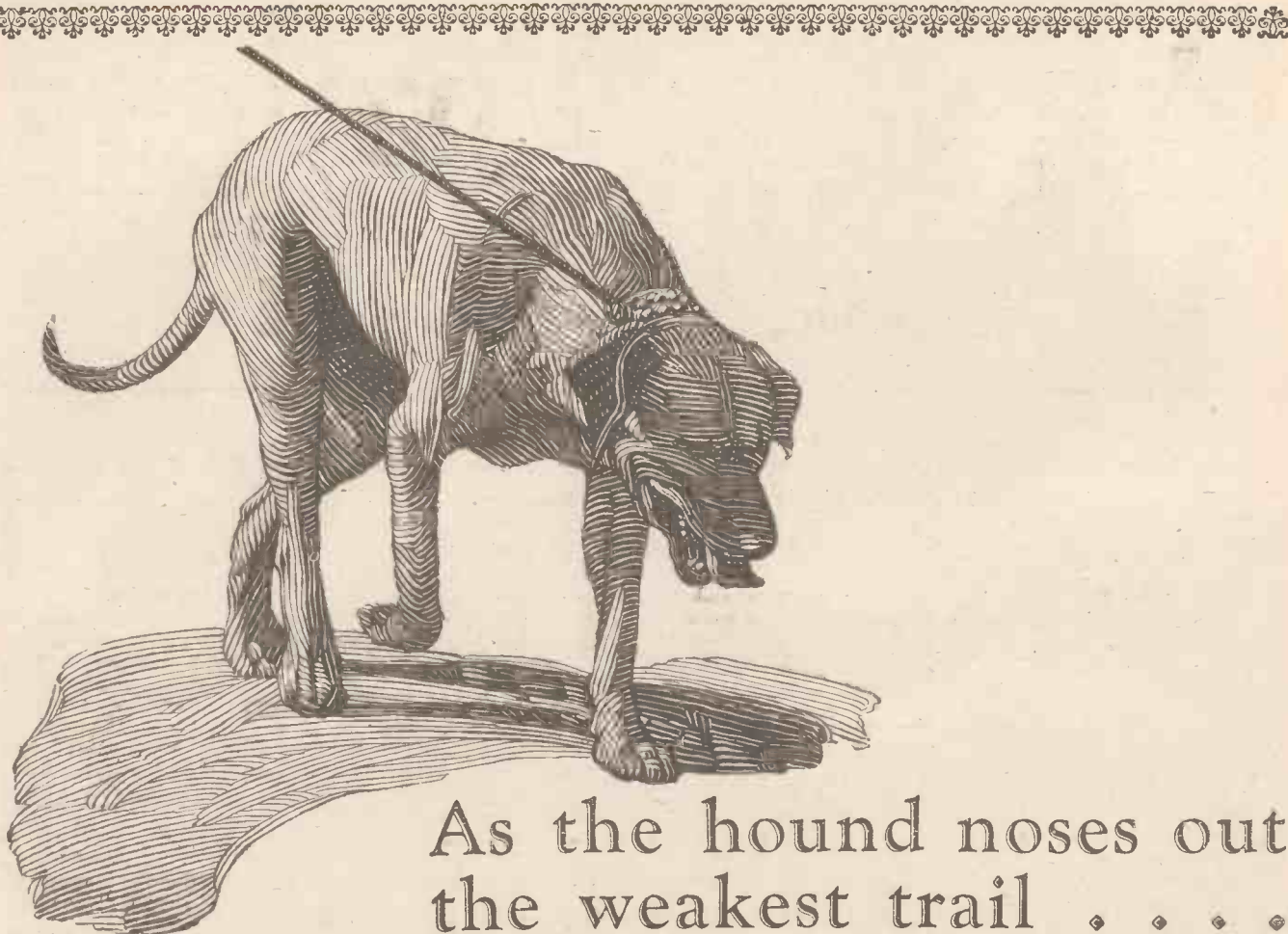

As the hound noses out the weakest trail

AS the hound noses out the weakest trail, so the Cossor Wuncell seeks out the weakest oscillation, amplifies it and converts it into an audible signal. There is no Dull Emitter so sensitive as the Wuncell because no other can utilise the highly efficient Cossor principles—the arched filament and hood-shaped Grid and Anode. Not since the first Cossor Valve—the famous P1—appeared on the market 2½ years ago, has any valve aroused such enthusiasm among amateurs. All early Dull Emitters possessed many defects—they were microphonic, considerably less sensitive, weak in volume and no two were alike. Yet for all these disadvantages they had many adherents.

The coming of the Wuncell has set an

entirely new standard for Dull Emitters. For the first time there is available a low consumption valve of great economy which is a perfect match in every respect for any Cossor bright emitter. Its filament—made under a special process known only to Cossor—is built up layer upon layer until it is actually as stout as that used in a bright emitter. And yet at no time is it required to glow at a higher temperature than the embers of a dying match. Obviously such an abnormally low temperature must mean an exceptionally long life.

Before buying any more bright emitters ask your dealer for interesting literature proving its supreme economy—how it will save its cost within four months and go on saving money for you throughout its long life



The Wuncell Dull Emitter

Voltage 1·8 volts. Consumption 3 amp.
 W 1 for Detector and L.F. 14/-
 W 2 for H.F. amplification 14/-
 W 3 Cossor Loud Speaker Valve
 Voltage 1·8 volts. Consumption 5 amp.
 Price 18/6

Cossor

Popular Wireless

Scientific Adviser :
Sir OLIVER LODGE,
F.R.S.
Consultants :
Dr. J. H. T. ROBERTS,
F.Inst.P.
J. F. CORRIGAN, M.Sc.,
A.I.C.
C. E. FIELD, B.Sc.



Editor : NORMAN EDWARDS, M.Inst.R.E., F.R.S.A., F.R.G.S.

Technical Editor :
G. V. DOWDING,
Grad.I.E.E.
Assistant Technical
Editors :
K. D. ROGERS.
P. R. BIRD.

RADIO NOTES AND NEWS.

The Geneva Tests—A Striking Tribute—A Record Collection—The King's Microphone
—£80 Valves—The Washington Conference.

Plenty of Stations.

LISTENERS are in for a good time this winter, for with the ether properly "policed," and the stations keeping accurately to their allotted wave-lengths, there will be no limit to the number of long-distance stations receivable on a well-handled set. The other evening I was amazed to find how easily Europe could be toured upon a one-valve set. Last year there were plenty of stations if one knew where to hunt for them, but now, if reaction is smoothly controlled, the dial of the tuning condenser seems alive with carrier-waves.

Europe's Star Turns.

THOSE who put away their sets for the summer will find on taking them out again that there are plenty of newcomers to choose from. I think that the star turns among these new performers are Radio-Toulouse and Radio-Catalana, although many readers seem to prefer the German stations. For some reason the latter are not specially well received down my aerial, but I can generally raise Hamburg and Münster without H.F. amplification. And the old friends—Brussels, Paris, Madrid, and the rest of them—seem just as easy to find now, as when they had the ether all to themselves.

The Geneva Tests.

LONG before the last of the European wave-length tests was finished on September 12th it became apparent that the Geneva comb-out was a huge success. Everywhere owners of long-distance sets reported that the various stations were disentangling their wave-lengths from

each other, and the care with which the whole thing was arranged and the exactitude with which it worked is well illustrated by the case of Bournemouth.

Close Work.

TOWARDS the close of the fifth test the Oslo station was being interfered

Radio from the Pole.

NEWS of the MacMillan Polar Expedition continues to filter through at intervals by radio, and some of the messages flashed back to civilisation are of a very thrilling nature. One experimenter in the Midlands picked up a message from the "Peary," which reported that the ship was in a blinding snowstorm, whilst another message disclosed the fact that the ship will probably be back again in Boston before this month is out.

Sir Oliver Lodge.

THE opening of the London Radio Exhibition evoked an inspiring message from Sir Oliver Lodge, who made a striking prophecy regarding the future of wireless. The great scientist re-affirmed his friendly regard for the amateur in the following words, which I feel I must quote, and emphasise by italics:

A Striking Tribute.

SIR OLIVER LODGE said: "The development of wireless signalling in recent years has been so remarkable that it is deserving of scientific recognition. The apparatus employed has reached a stage of what might mistakenly be called perfection, chiefly owing to the labours and contribu-

tions of enthusiastic wireless amateurs and constructors."

This tribute to a host of humble men comes with particular grace and force from one who can claim the highest honours that science can bestow, and the distinction of having been present at the birth of wireless—our greatest British pioneer!

(Continued on page 212.)

MARCUSE AND SIMMONDS. (2NM and 2OD).

Leading British Amateurs to Contribute Exclusive Articles. THE "P.W." POLICY.

WE are pleased to be able to state in this issue of "Popular Wireless" that Mr. E. J. Simmonds, the famous British Amateur, will also contribute exclusive articles to our columns throughout the winter.

IT has already been announced that Mr. Gerald Marcuse will write ONLY for "Popular Wireless," and we feel sure that readers will learn with pleasure that his equally well-known "radio colleague" Mr. Simmonds, has also agreed to write ONLY for this journal.

THUS, the important contributions of the two leading British amateurs—men whose practical experience in short wave, low power, and all aspects of "DX" work is unrivalled—will appear ONLY in this journal.

WE would emphasise the fact that, in making these arrangements with Mr. Marcuse and Mr. Simmonds, we have had in mind the wishes of the great majority of amateurs—their desire to obtain the best and most reliable information about practical radio work.

IN short, Mr. Marcuse and Mr. Simmonds are practical men who have had to solve their own problems and to acquire their knowledge in the hard school of experience. Therefore they are eminently qualified to pass on to readers of this journal some of the knowledge they have gained—knowledge which has undoubtedly helped in no small way to the rapid progress of short wave radio development.

Mr. Simmonds' first article will appear in our issue dated week ending October 10th.

with by Bournemouth's signals, so the latter was instructed to lower his wave-length by one metre. Bournemouth took one step down the wave-length ladder and transmitted again, but this time the transmission was too close to Frankfurt's. So Geneva gave instructions for a rise of half a metre, and when Bournemouth tried this both Oslo and Frankfurt were reported absolutely clear of interference!

NOTES AND NEWS.

(Continued from page 211.)

Listeners on the Lightships.

THE lonely watchers on the lightships round our coasts have applied to Trinity House for permission to tune in to broadcasting. It will be a thousand pities if their request is not granted, for the relief ship only visits them every two or three months, and in the interval they are completely cut off from civilisation.

More Wireless Exploration.

I HEAR that a British Polar explorer, Captain George Wilkins, proposes to try his hand at an Arctic flight next year. The main objective will be an exploration of the coast around Graham's Land, and—following MacMillan's lead—the surveying will be done from an aeroplane. This latter will be based upon the whaler chartered by Captain Wilkins, and will keep in touch with this vessel and with the outside world by means of short-wave wireless.

A Record Collection.

A YEAR or two ago wiseacres were complaining that broadcasting would "electrocute the gramophone industry." It is true that the advent of wireless administered a kind of electric shock to the trade, but this simply made the sales jump, and its effects were entirely beneficial. Now the B.B.C. itself has one of the finest collections of gramophone records in the country. Thousands of the records are filed away already, and every week dozens are added to the stock at headquarters.

The Thousandth Time.

LAST month the B.B.C. celebrated its thousandth night of broadcasting, and some interesting facts and figures came up on that occasion showing the growth of radio in this country. There are now twenty-one stations instead of the original one, and many other amazing developments have been crowded into those thousand days. Not the least spectacular achievement has been that of the listeners, who have joined up at the rate of about 1,400 per day!

Paying the Price.

BETWEEN them—reckoning at the present rate—listeners scrape up £700 from somewhere between every sunrise and sunset, and pay it over to the Postmaster-General for the privilege of listening-in. And on the whole I am inclined to think that the B.B.C.'s feat of preparing and broadcasting those thousand programmes pales into insignificance beside the performance of the British listener, paying £700 per day for them, in these hard times!

The King's Microphone.

ONE of the most interesting exhibits at the Albert Hall show was the King's own microphone, which was on view to the public for the first time. Reserved exclusively for his Majesty's use, it is enclosed in a rich filigree silver case, which bears inscriptions showing the exact dates and occasions on which the King has spoken through it. In design the royal microphone is exactly similar to those in use at the B.B.C. stations.

A Dublin Exhibition.

DUBLIN is arranging a wireless exhibition of its own, to be held about November 11th, in the Round Room of the Dublin Mansion House. Under the auspices of the Wireless Society of Ireland this promises to be quite a big affair, and it is specially interesting as being the first Radio Exhibition to be held in the Irish Free State.

Wireless Cinema Experiments.

MOVING pictures have been transmitted by wireless right across Lake Mondota (a distance of seven miles)—according to a Central News message from America. The inventor—Douglas F. Coffey, aged 18—is a student of Wisconsin University, and the State Department is so impressed by his success that they are giving him every assistance in his experiments. The young inventor has been offered by them the use of two wireless

SHORT WAVES.

"I must go down to the sea again,
To the lonely sea and the sky,
And all I ask is a five-valve set
And a 'phone to hear it by."
(Masefield up to date).—A writer in the "Evening News."

"To my mind wireless existed when the prehistoric man first understood or felt the meaning of a smile of encouragement from the prehistoric girl."—Senator Marconi.

"The harnessing of the electron for the purposes of communication may turn out to be an event in human history equal in importance to the initiation of railway locomotion and the electric telegraph, which dominated the applications of science during the nineteenth century; and it bids fair to make the twentieth century eclipse the nineteenth in importance—with, it is to be hoped, peaceful and friendly international results."—Sir Oliver Lodge.

"Alternative programmes for all must be our slogan for the future."—Capt. Eckersley, writing in the "Radio Times."

"The B.B.C. is not concerned with party politics, but it regards the encouragement of international co-operation as one of the most important potential functions of wireless broadcasting."—An Official Announcement.

stations (Stevens Point and Waupaca), so that he can try out his system over long distances with increased power.

Encouraging Inventors.

OUR own Air Ministry are not indifferent to promising inventions, and I hear that they, too, have made a sporting offer in connection with a new scheme for the safety of aircraft flying in a thick fog. Captain F. T. Courtney, the racing and test pilot, has evolved a scheme based on wireless signalling, which would make possible "blindfold-flying" in any weather. For experimental purposes he has been offered the use of a single-engine machine, but Captain Courtney fears that this is inadequate, as the scheme cannot be tested properly without the use of a couple of three-engined machines.

The Barcelona Station.

THE Barcelona station makes a speciality of operatic programmes, and recently a poll was taken to ascertain the listeners' favourite composers. The result was extremely interesting, and the following names and numbers show the preferences of the Spanish audiences: Verdi, 23;

Wagner, 20; Rossini and Puccini, 14; Mozart, 10; Gounod and Strauss, 6; Beethoven, 2; and Saint Saëns, 1.

"The Figs."

WRITING all the way from Siam to ask me for a diagram, a correspondent says: "Every month I buy POPULAR WIRELESS, and never fail. But every month the figs. is alter. The figs. is never clear to me every month." As "P.W." is sent out to Siam every week, he seems to have mixed the dates as well as the "figs"!

A Big Bargain.

A VERY handsome compliment was paid to the Technical Enquiries Department the other day by Mr. S. Clark, of Lincoln Road, Peterborough, who said, in a letter to the Editor: "I have carried out the alteration to my set as suggested by your Technical Staff, with more than satisfactory results. To have the assistance of the Technical Staff of such a paper as POPULAR WIRELESS for a humble 'bob' is one of the best bargains I know of. I thank them for putting their finger on the weak place first time."

The Loudest Loud Speaker.

WHAT is claimed to be the world's loudest loud speaker is now being installed at the entrance to Cherbourg Harbour. It will be operated by a 30 horse-power motor, and will emit sounds that can be heard up to a distance of 30 miles. The monster is to be used during fog for the purpose of warning shipping.

£80 Valves.

LISTENERS who have proved by experience how easily expensive valves can be burnt out, will sympathise with the wireless engineer. Using about 10,000 volts H.T. he is always liable to burn out transmitting valves, which cost about £80 each! There is a story that some years ago one engineer, by connecting up the wrong way round, burnt out nearly £5,000 worth of valves at one go. If it is true, he was for that moment spending more money per second than all the Allies did in the same period during the war!

The Real Reason.

ACCORDING to the "Yorkshire Herald," out of 4,636 owners of wireless sets in Hull whose licences were due for renewal during August, only 3,503 paid the renewal fee.

All sorts of gloomy theories have been put forward to account for this sad state of affairs, but a Hull correspondent tells me these theories are all wrong. The real reason, he says, is that during August Hull people spent up all their money on buying new mackintoshes and trying to keep warm on holiday!

A Washington Conference

IT is announced from Washington that the proposal to hold an International Radio Conference there has met with great favour. Great Britain has already accepted the invitation, and the conference—which will be held in the spring—will probably be a thoroughly representative one.

ARIEL.

The "P.W." Constructors Series



The Cheapest Valve Set

RECEPTION with a one-valve set is almost as simple as with a crystal, but the valve receiver has a great many advantages not possessed by the

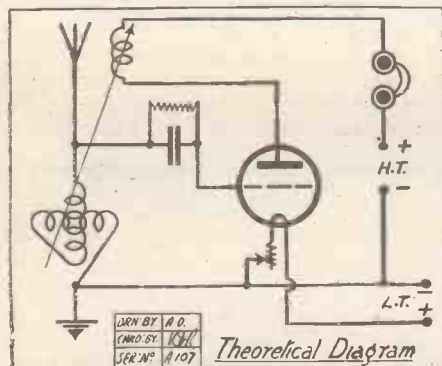

Fig. 1.

crystal, this being mainly due to the fact that what is known as "reaction" can be employed. This results in a greatly increased range. The greatest drawback in the case of a valve set is, of course, its initial cost, and the fact that it needs batteries to keep it going.

In the set described here the initial cost has been cut down to as low a figure as possible, and, though the receiver may not have an exactly professional appearance, there is no doubt but that it is an extremely efficient one. No ebonite is used in its construction, for hard dry wood is employed throughout, and it will be found that this lack of ebonite will not have the slightest effect on the results, providing sufficient care is taken to dry the wood thoroughly before making the set.

The Three Coils.

A piece of wood of about 10 in. by 8 in. by 1 in. will be required, and this should be drilled and the components mounted, as shown in Fig. 2. Very few bought components will be needed; in fact the ten terminals, the four valve legs, 10 ft. of No. 26 Eureka resistance wire, will be all that the constructor cannot make at home.

No variable condenser is used, the tuning being accomplished on the variometer principle by using two basket coils connected together and approaching or receding from each other in "book fashion" (see Fig. 1).

Commencing the construction of the set, a good idea of the appearance of

Here is a set which, although costing only about 2/6 to make, gives results which a far more expensive set might envy. It has been designed, built, and tested by the Technical Staff in the "P.W." Laboratory.

which will be seen from the photographs, the first thing to do is to wind the coils. For ordinary broadcasting wave-lengths three of these will be required, two having 36 turns of wire and the third having 60 turns. As mentioned before, these coils are wound on the basket or spider fashion, and are supported on card formers of approximately 1 in. centre having 11 or 9 slots; 2 are made with 4 in. overall diameters, and one with 4 1/2 in.

No. 26 gauge D.C.C. wire is used for the coils, it being wound round and round the formers in and out of alternate slots until the requisite number of turns has

been put on, the wire being fastened off by passing through holes on the formers, leaving about 12 in. loose at each end.

In making the formers, one section—that is between two slots—should be left longer than the others by about 1 in. to 1 1/2 in.

This will be made quite clear by the diagrams. The mounting of the coils themselves being mounted on skewers fixed into holes drilled in the panel.

Fixing the Tuner.

A wooden block is screwed to the "panel" first, then three holes 1 in. apart are drilled through the block and on to the panel, but not quite through it. These act as sockets for the coil supports.

All that remains now in mounting the coil is to fix one 36-turn coil on to each of two of the skewers by wrapping the extra inch of former that was left when making the coils round the skewers and glueing or binding it firmly to them. These two skewers are then provided with wooden knobs at one end, and are placed in the wooden block so that they rest in the two outside holes. The remaining coil is attached to the third skewer in the same way, and placed in the centre hole.

(Continued on page 214.)

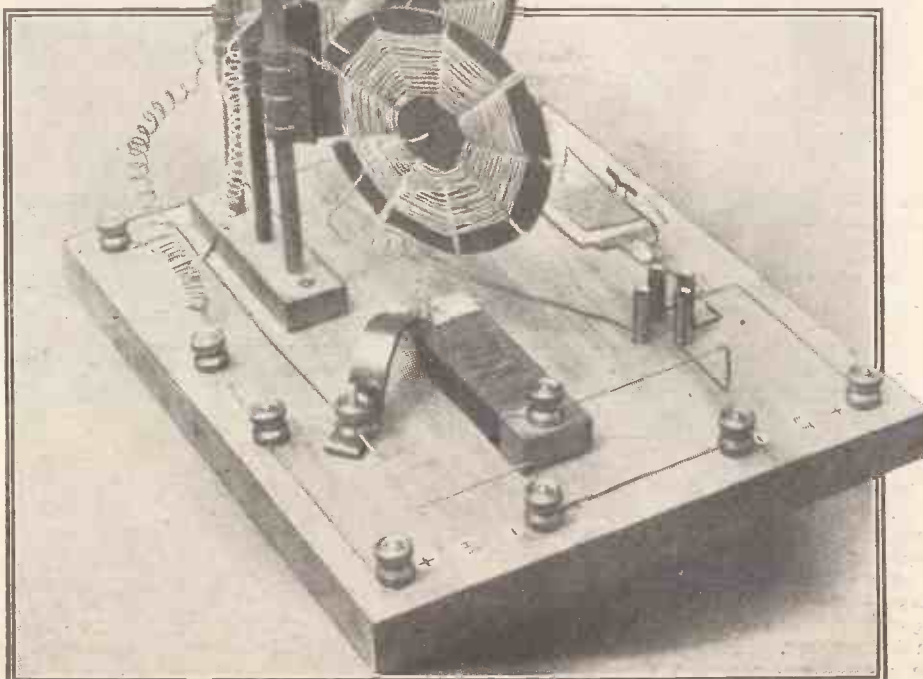

The finished receiver has an unusual appearance, but is exceedingly efficient. The grid leak and condenser can be seen on the right of the coils, while the rheostat is in the left-hand bottom corner.

THE CHEAPEST VALVE SET.

(Continued from page 213.)

We should now have three coils mounted at right angles to the wooden panel, with the two outside coils able to swing outwards from the centre one. The ends of the windings of the three coils have been left loose (just passed through holes in the cardboard former to keep them from unwinding), as these have later to be attached to the various other parts of the set when the wiring up process is carried out.

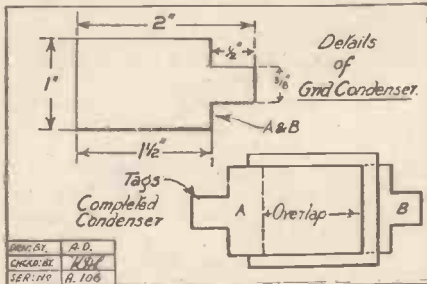

Fig. 3.

The next portion of the receiver to be attended to is the grid condenser and leak. This is a composite component, and can easily be made at home. The condenser should be constructed from a couple of plates of tin (or any other metal to which a

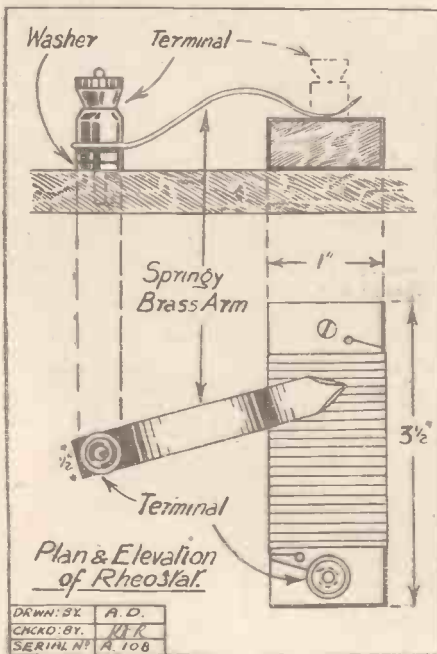

Fig. 5.

wire can be soldered) about 2 in. long by 1 in. wide and cut to shape, as shown in Fig. 3. These will be placed close together so that they overlap by about a square inch and are separated by a sheet of paper, such as an ordinary notepaper, which has been well soaked in boiling wax. This soaking should be carried out carefully, the paper being fried in the wax until all sign of air bubbles disappears. When cold, the paper

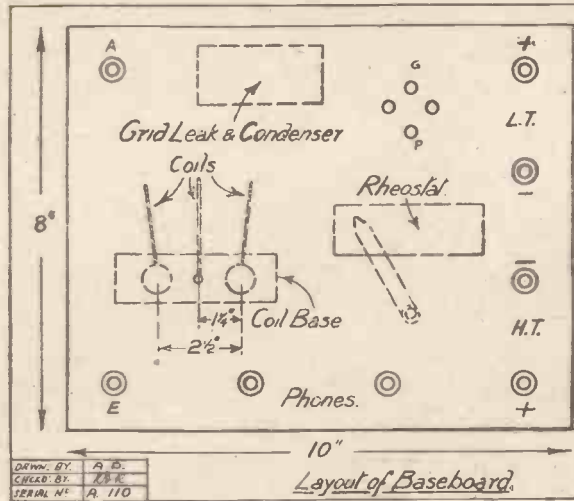

Fig. 2.

is cut to a square with 1 1/2 in. sides and is inserted between the two plates. Two further pieces of waxed paper, 1 1/2 in. by 1 1/2 in., are then attached to the outsides of the grid condenser and the whole gently heated, thus allowing the wax to run and securing the three pieces of waxed paper together.

Making the Grid Leak.

The grid leak is made as follows: A piece of blotting paper is dipped into some indian ink, soaked thoroughly, and when dry cut into a strip 1/4 in. wide and about 3/4 in. long (see Fig. 4).

Some of the 26 gauge copper wire (about 2 in.) is now stripped of its covering of cotton and twisted round one end of the piece of indian inked paper. Another piece, the same length, is now arranged so that it can be slid along the paper. The two extreme ends of the wire are then soldered to each lug of the grid condenser. When the wiring is completed and the set connected

up ready for test, signals should first be received and the indian inked paper adjusted until loudest results are obtained, the wire which was made to slide on the paper then being permanently fixed and left in position. If indian ink is not obtainable a piece of paper 1/8 in. wide, and well graphited by rubbing an HR or B pencil down it on both sides, will answer the purpose excellently. It may be necessary, however, to use more than 3/4 in. of the latter, but this will be a matter of experiment. Alternatively the grid leak may consist of a 2 in. or 3 in. length of slate pencil, the exact length being found by experiment.

The filament rheostat is constructed on simple lines, but provides a very efficient control of the current going through the valve. A piece of wood, 3 1/2 in. long by 1/2 in. wide is required and is wired, etc., as shown in Fig. 5.

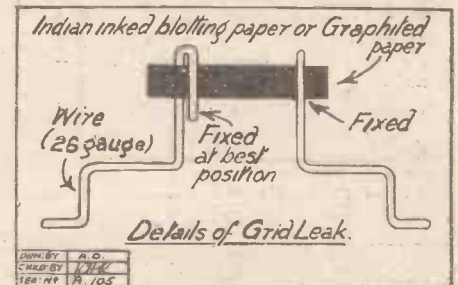
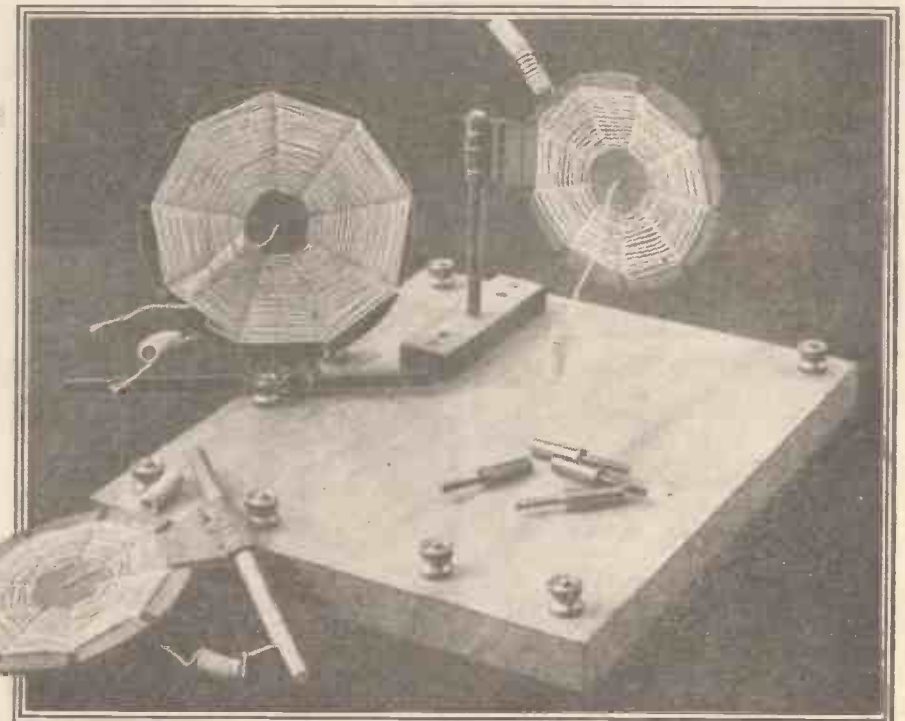

Fig. 4.

To make a resistance of 8 or 9 ohms the centre 2 1/4 in. is then wound with 40 turns (Continued on page 215.)



The "panel" with some of the components ready for mounting. The photograph clearly shows the method of fixing the coils on their supports.

THE CHEAPEST VALVE SET.

(Continued from page 214.)

of No. 26 resistance Eureka wire, the turns being approximately $\frac{1}{8}$ in. apart. Both ends, which should be left about 3 in. long, are passed through holes in the wood. The method of mounting is shown in Fig. 5.

The springy brass arm which rests on the wire is very simple to make and simply consists of 7 in. of $\frac{1}{4}$ in.

wide springy brass strip doubled in two, with a hole drilled through near the point of doubling

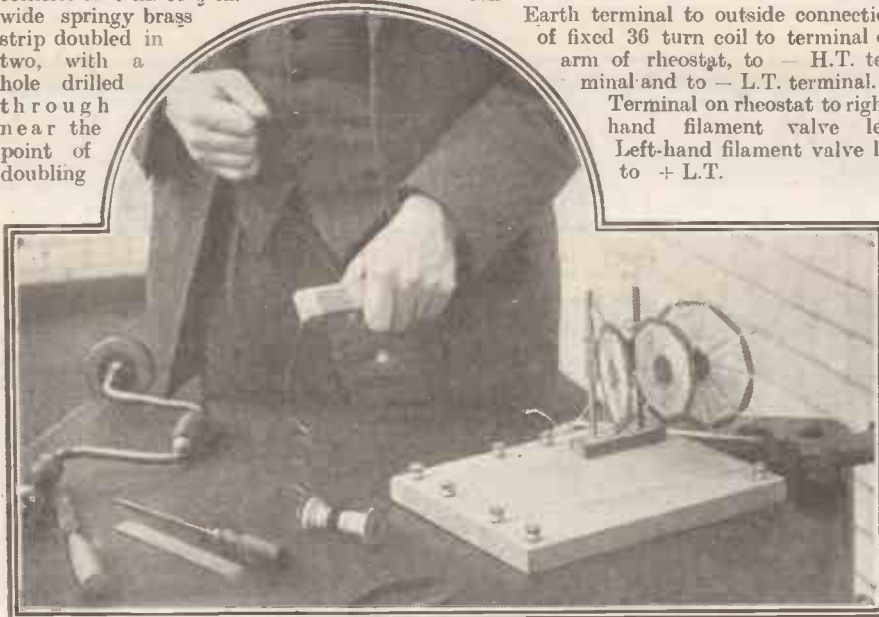

Winding the filament rheostat. A photograph showing the construction of the set in progress.

sufficient to pass an ordinary W.O. terminal. The two ends of the brass strip are twisted over so as to form a V and then bent up. If this is not comprehensive a glance at the sketch of the completed rheostat will make

Plate valve leg to centre connection of 60 turn moving coil. Outside connection of 60 turn moving coil to left-hand 'phone terminal. Other 'phone terminal to + H.T. terminal.

it clear. This completes all construction of components which has to be done, and they can all be mounted on the panel and the set wired up. As is our custom, besides the wiring diagram, a full description of point-to-point connections is given below, the connections being made with rather stout wire, such as 18 gauge tinned copper.

Aerial terminal to one side of grid condenser and leak and to inside connection of moving 36 turn coil.

Other side of grid condenser and leak to grid leg of valve holder.

Outside connection of moving 36 turn coil to inside connection of 36 turn fixed coil.

Earth terminal to outside connection of fixed 36 turn coil to terminal on arm of rheostat, to - H.T. terminal and to - L.T. terminal.

Terminal on rheostat to right-hand filament valve leg. Left-hand filament valve leg to + L.T.

When the set has been wired up it is ready for testing. The choice of the valve is not a very important matter, though it is advisable to buy one of reliable manufacture, and it must be left to the constructor as to what type of valve he will use. He will realise, of course, that there are three main types—the bright emitter, the .06 dull emitter, and the 2 volt dull emitter, and it will depend on the facilities as to which class of valve he will use.

The Necessary Batteries.

Should he decide that, owing to difficulties in getting accumulators charged, he will use a .06 type of valve, we should like to point out that, though this valve will work satisfactorily from dry batteries, it is, as a rule, far more economical to use a 2-volt accumulator of the Exide D.T.G. type, which requires charging only every few months, and in this event another rheostat, similar to the one described, should be connected in series with the first one.

An H.T. battery of about 60 volts will be required and, of course, the usual telephones. When the batteries have been connected up, the valve turned on, the 60 turn coil should be turned away from the centre coil and then brought slowly towards it. When it gets fairly near a loud plop and a rushing sound should be heard on the telephones, denoting that the valve has commenced to oscillate.

If this sound is not heard, the connection to this coil—i.e. the connections to the plate of the valve and to the telephones, should be reversed when no difficulty in obtaining signs of oscillation should be experienced. When this has been accomplished, the coil should be set in a position about 45° away from the centre coil, the other moving coil's position should be varied until signals are heard.

Wave-length Range.

A little practice with this receiver will enable the constructor to pick up several stations besides his local station, if he has a moderately efficient aerial and earth.

On actual test the wave-length of the receiver was found to be 320-390 metres, on an average aerial, so those who wish to receive stations on higher wave-lengths should wind 2 more coils of 40-45 turns each and replace the 36 turn ones by these when stations of 390-500 metres are required.

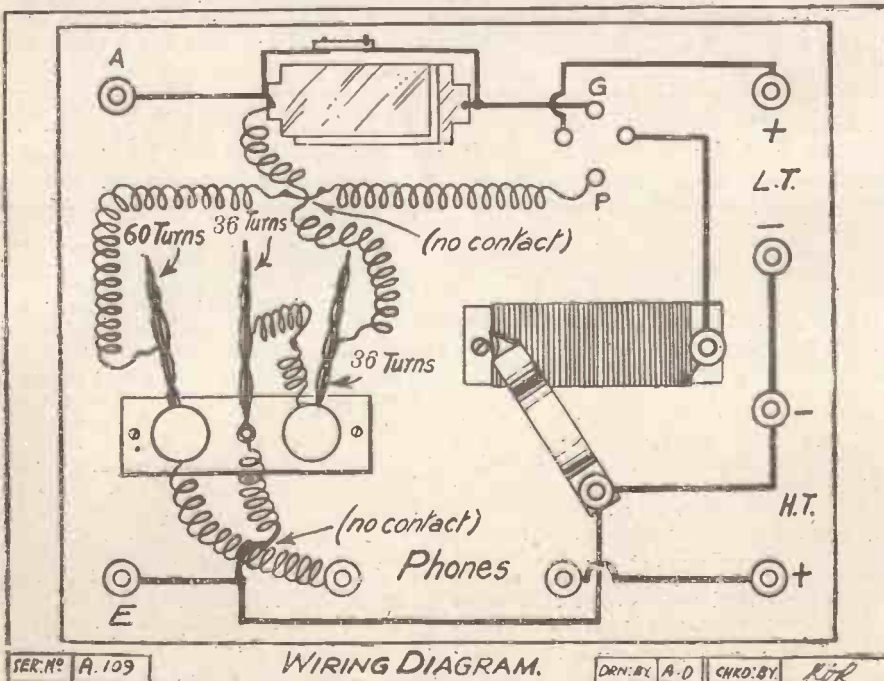

FULL DETAILS OF A Novel Competition

Of Interest to All Amateurs and Listeners

Will appear in next week's "P.W."

Prizes of £200, £150

and over 200 Consolation Prizes will be offered.

This competition is one of the most novel ever devised, and will attract public attention throughout the country.

Make sure of your next week's copy by placing an order for "P.W." NOW.



Technical Notes

Conducted by our Staff Consultant, J. H. T. ROBERTS, D.Sc., F.Inst.P.

The New Quartz Oscillator.

MENTION has already been made of the new quartz oscillator and of the fact that it provides a means of establishing a really constant wave-length standard. This apparatus has been considerably developed and is now available in commercial form.

It is finding such a ready use for the checking of the wave-lengths of broadcast stations that it seems likely that, in the near future, its employment as a standard will be made uniform by international agreement. The desirability of keeping a transmission to its proper wave-length hardly needs to be pointed out. In the first place, variation, or "drift" as it is called, may lead to interference with other transmissions and, secondly, from the point of view of the listener, it is very convenient to be able to tune the set and know that it will remain tuned. Powel Crosley, the "Ford of Wireless," has adopted this method of checking at his own super-power station, W.L.W., and the drift reports will be submitted as part of the observations to be reported to the next Hoover Radio Conference. In the States, wave-lengths are assigned with a minimum separation of 10 kilocycles.

Minute Observations.

The operator at a station equipped with the quartz standard operates the latter in conjunction with a regenerative receiving set of special design. By means of a special condenser adjustment, it is possible to detect a frequency variation in the transmission from the station of less than 1-10th of a kilocycle.

As indicating the thoroughness with which observations on frequency drift are being carried out, the following requirements in the table of informations to be supplied may be of interest: Frequency variation, atmospheric temperature, barometer, humidity, wind strength and direction, weather generally, static, and time of transmission. It will be seen from the foregoing that it is much easier to operate a receiving set than a modern super-power broadcast station.

A "Radio Thief Catcher."

A curious and interesting use of wireless has been devised by a German inventor who has produced what he calls a "radio thief catcher." It is an electrical wired gateway, at the entrance to a factory or a mine, through which workmen pass on their way out. The gatekeeper wears a headset, and by means of an inductance system, he is able to hear a buzz if more than a certain minimum amount of metal passes through the gateway. Thus, if a workman happened to take out metal (for example, precious metals, or tools) concealed in his pockets, the apparatus would prove a tell-tale.

The apparatus is adjusted so that a reasonable amount of metal (represented by pocket knives, watches, coins, etc.) does not produce the warning buzz. A system somewhat similar to this has been used for some years past in surgery, where the presence of a bullet or other metallic foreign body is located readily by the operator.

Calibrated Loud Speaker Adjustment.

Most loud speakers on the market now are provided with some form of adjustment,



Training Army wireless operators on a 120-watt training station at Maresfield.

whereby the loudness (and the quality) may be controlled.

The adjustment usually takes the form of a variation of the clearance between the diaphragm or armature and the pole-pieces of the magnet. It often happens, however, that you may wish to return to a particular adjustment, after trying variations, and here you find that there is no provision made for indicating the position of the control.

In a new loud speaker of Canadian origin, a very neat control is included, fitted with a dial and pointer and also with a micrometer movement. In this way any adjustment may be regained when required. The micrometer adjustment appeals to one also as being very desirable. In some of the present-day loud speakers the adjustment is much too coarse, and in some cases there is so much backlash that the adjustment is hardly any use at all.

A Novel Demonstration Method.

Whilst on the subject of loud speakers, an enterprising firm of wireless manufacturers have placed on the market a very simple and effective arrangement for enabling the retailer to demonstrate loud speakers of different makes in the absence of any broadcast. Complaints were often heard, particularly in the early days of broadcasting, that there was nothing for the retailer to try his sets on during the day, when prospective customers were most plentiful.

So far as loud speakers are concerned, the new arrangement consists essentially of a gramophone in which the record is reproduced electrically, the electrical impulses being then passed to any one of a number of loud speakers in the usual way. A selector switch permits the switching in of any speaker very readily. It is admitted that the method is not perfect, but for the matter of that, neither is the testing of a number of loud speakers all upon the same wireless receiver.

The performance of the loud speaker

depends to no inconsiderable degree upon the characteristics of the valve amplifier which precedes it. But the gramophone method has obvious advantages, and as a test of the loud speakers it is probably as good as a test on an actual set; at any rate, in so far as it demonstrates the relative merits of the instruments.

Mr. William Dubilier, the well-known American manufacturer of radio condensers, has been recently in this country and in Europe on a business visit, and no doubt many readers heard him speak over the microphone a few weeks ago. It is not commonly known that Dubilier was the inventor of the mica condenser, as distinct from the paraffin-paper condenser, which was the first great improvement over the Leyden jar. It is said that just before the War, Dubilier offered his invention to various European governments, including

(Continued on page 263.)

A Special Article by Our
Berlin Correspondent, Dr.
ALFRED GRADENWITZ.

Koenigwusterhausen

A NEW 20 kw. valve transmitter has recently been placed in operation at Koenigswusterhausen, the central wireless transmitting station of the German Telegraph Department, and, though designed both for telegraphy and telephony, has been installed in a hall mainly destined for the telegraph service, while another hall now in course of erection is more especially set apart for telephony. Two other Telefunken transmitters of 20 kw. and 10 kw. respectively are shortly to be added.

The new transmitter has been designed for an antenna capacity of about 10,000 cms., there being available either a whole antenna segment of about 10,600 cms., with a wave-length of 3,300 metres, or a half-segment of about 6,600 cms., and a wave-length of 2,900 metres. The segment is suspended between three 210-metre masts installed at about 430 metres apart. Alludur cables, 18 or 23 mm. in diameter, have been used for this antenna.

The high-tension current generating plant has been designed to supply all three transmitters destined for the same hall of the Koenigswus-

terhausen transmitting station, viz., two 20 kw. and one 10 kw. transmitters, the following machines being provided to operate them: (1) One converter set for each 20 kw. transmitter, (2) one converter set for both 20 kw. transmitters to serve as standby, and (3) two converter sets (one of which

serving as standby) for the 10 kw. transmitter. The main and emergency converters can be connected up at will with the transmitters.

42 kva. converters for 500 cycles have been installed as anode converters for the 20 kw. transmitters, and 10 kva. 500 cycle converters as heating machines. In the case of the 10 kw. transmitters, on the other hand, 20 kva. 500 cycle converters are used as anode converters, and 5 kva. 500 cycle converters as heating machines. Any switches, measuring instruments, etc., required for the five converter sets have been accommodated on a switch-board comprising four panels.

The 20 kw. valve transmitter is an intermediary-circuit transmitter for either telegraph or telephone service, controlled from outside, with an intermediary circuit efficiency of about 90 per cent. With a slightly damped strand coil designed on modern lines for aerial loading, the transmitter will work on five wave-lengths adjusted for at will

(Continued on page 218.)

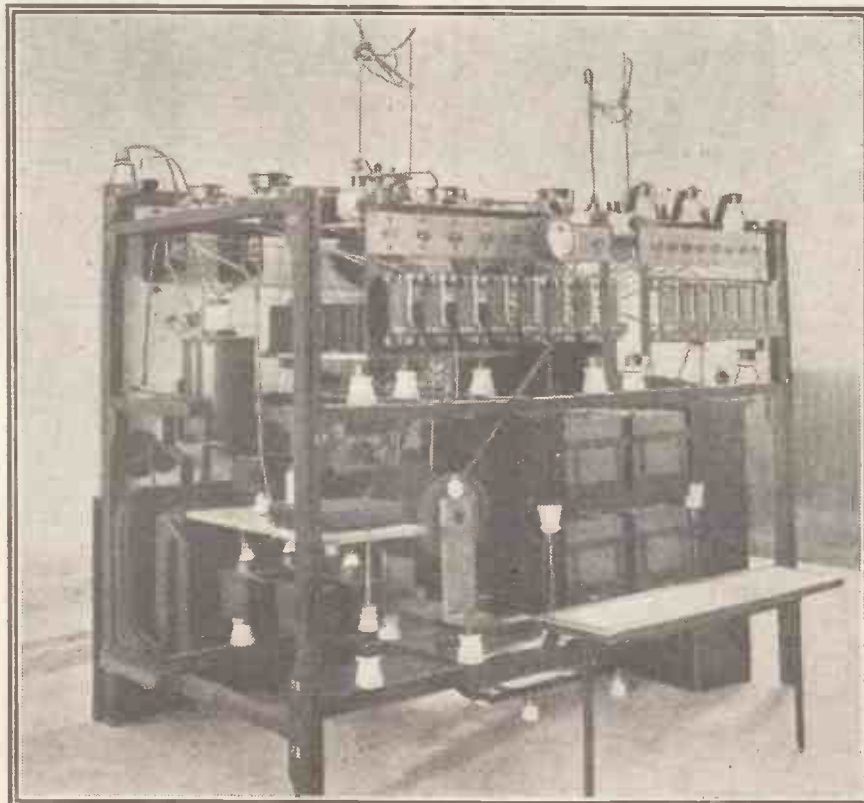

The rectifying and valve panel of the main transmitting installation.

KOENIGWUSTERHAUSEN

(Continued from page 217.)

within a range of, say, 2,500 and 10,000 metres, the antenna output being about 20 kw.

The design of the transmitter from an electrical and constructive point of view complies with most modern requirements.

The transmitter is outwardly arranged like a switchboard, and comprises the following four parts: (1) The rectifier and valve section, (2) the intermediary circuit, (3) the antenna section, and (4) the controlling transmitter with a telephony extension.

Necessary Safety Measure.

The doors fitted into the panelling comprises series-connected safety contacts automatically releasing the main switch as the doors are opened, and thus cutting out the dangerous 10,000-volt direct current.

The anode circuit energy supplied by the 500-volt single phase alternator is about 42 kva., at a pressure of about 220 volts. The transformer fitted into the rectifier section raises this pressure to about 2 x 10,000 volts, this high-tension alternating current being converted by means of 8 valve tubes into pulsating direct current, the

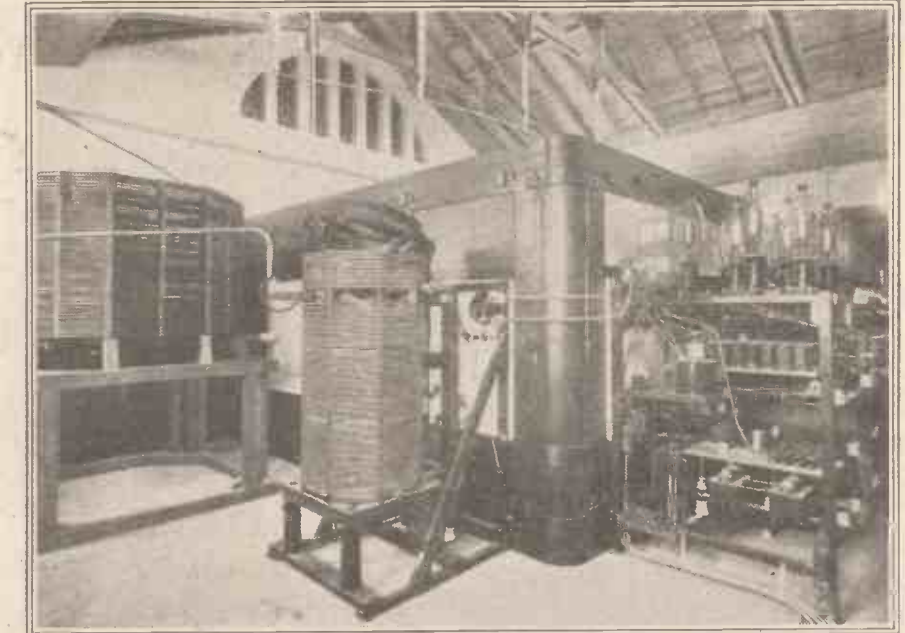

A general view of the new 20-kw. valve transmitter.

pulsations of which are flattened out by condensers. The eight transmitting valves, each of 2.5 kw., which are arranged in parallel, will convert this direct current energy into high-frequency energy.

The continuous current in the grid is interrupted in the case of telegraph service by means of a key-controlled preliminary relay across the main relay, vibrations

(Continued on page 244.)

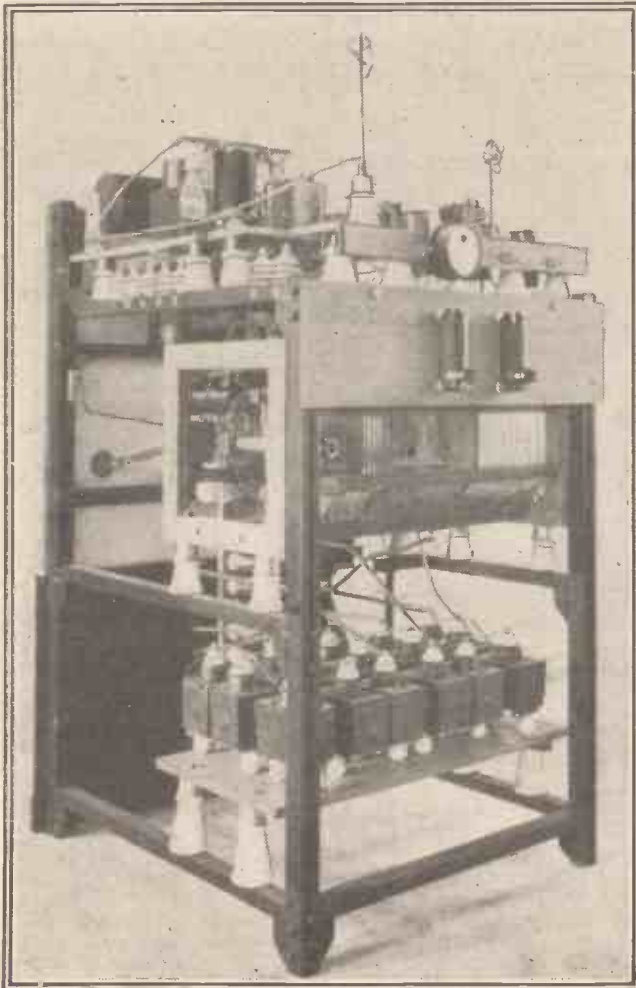

The telephony transmitting panel.

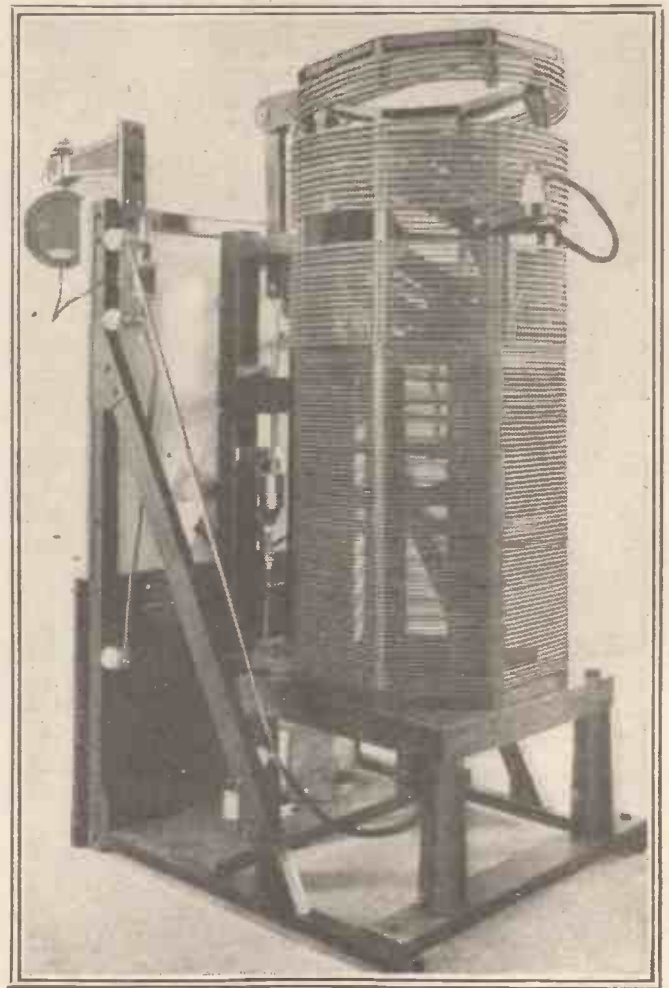

One of the huge intermediate circuit couplers.

Efficiency plus Economy

THE B3 Valve has a very low filament current consumption. Whilst retaining all the excellent qualities of the well-known R Valve, it has in addition, the economies of a dull emitter. It is a really good all-round valve working exceptionally well in all positions, detector, H.F. or L.F. amplification. Undoubtedly it is the most efficient and economical valve on the market at the price. Here are its chief electrical characteristics:—

PRICE
14/-

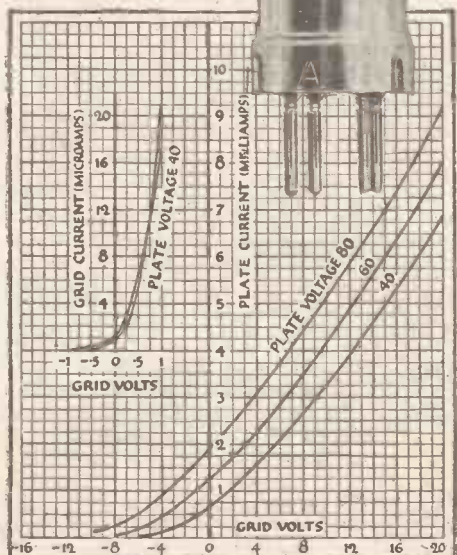
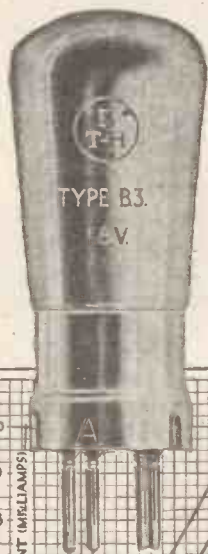

Filament Voltage	-	-	1.8 volts
Filament Current	-	-	0.35 amp.
Anode Voltage	-	-	20 to 80 volts
Anode Resistance	-	-	27,000 ohms

When next you require a valve which will give perfect reproduction combined with good volume, specify B.T.H. and make sure of getting good results.

B.T.H. Radio Valves

General Purpose		Power Amplifying	
R	Filament Voltage 4 Volts. Filament Current 0.7 Amp. Max. Plate Voltage 100 Volts. 8/-	B4	Filament Voltage 6 Volts. Filament Current 0.25 Amp. Max. Plate Voltage 120 Volts. 22/6
B3	Filament Voltage 1.8 Volts. Filament Current 0.35 Amp. Max. Plate Voltage 80 Volts. 14/-	B6	Filament Voltage 2.8 Volts. Filament Current 0.12 Amp. Max. Plate Voltage 120 Volts. 22/6
B5	Filament Voltage 2.8 Volts. Filament Current 0.06 Amp. Max. Plate Voltage 80 Volts. 16/6	B7	Filament Voltage 6 Volts. Filament Current 0.06 Amp. Max. Plate Voltage 120 Volts. 24/6

Insist on B.T.H.—the Best of ALL



The truth about the Mansbridge Condenser

In view of certain misconceptions, it is well that the public should know the facts about the Mansbridge Condenser—its origin and development.

THE Mansbridge Condenser was invented in 1906. Up to this time all condensers were made by assembling alternate sheets of either mica or paper with tinfoil. This process was carried out by hand and was, therefore, relatively slow and expensive. The Mansbridge patent effected several improvements.

Firstly, it enabled the condenser unit to be assembled at a rapid rate because the dielectrics and conductors are fed in continuous strips. Secondly, by reason of the very thin layer of metal which is used in the foiled paper forming the electrode (or conductor), the condenser is not easily short-circuited. This feature forms its well-known self-sealing property.

Undoubtedly the Mansbridge Condenser was a wonderful advance—and even to-day is unexcelled where a compact condenser of large capacity is required.

As a pioneer condenser-making firm, it was only natural that these improvements should attract the attention of the Telegraph Condenser Co. Ltd., and negotiations were early concluded between this Company and the inventor for manufacturing condensers under his patents. Since then T.C.C. Mansbridge Condensers have been supplied in large quantities to the British and Colonial Post Offices, while during the War the

T.C.C. supplied the Army with the majority of Condensers for field telegraphs and many other purposes. In fact, there is hardly a corner of the globe into which these familiar little green condensers have not found their way.

The Mansbridge Patent lapsed in 1919 and, provided that it possesses the requisite scientific resources, the right kind of machinery and a capable staff, any firm can now make Mansbridge Condensers.

But—and special emphasis is necessary here—experience plays a very big part in condenser making. The T.C.C. reputation has been built up over a period of 20 years. Obviously, the mere possession of a plant will not more ensure accurate Mansbridge Condensers than the purchase of a kit of tools will make a man a skilled mechanic. The manufacture of Mansbridge Condensers presents its own difficulties—just as any other product. These difficulties must be faced and overcome. For many years T.C.C. experts have been co-operating in making in the T.C.C. Mansbridge a Condenser which, in all the world, is unequalled for accuracy, dependability and constancy. When you choose a T.C.C. in its familiar green metal case in any value from .004 mfd. to 2 mfd., you obtain a *genuine and fully guaranteed Mansbridge Condenser.*

T.C.C.
genuine
Mansbridge
Condensers

Millions of these T.C.C. Mansbridge Condensers have been made.



Backed
by 20 years'
Condenser
Knowledge

Telegraph Condenser Co. Ltd.
West Park Works, Kew, S.W.



An article of practical value, by E. J. WYBORN, B.Sc., A.C.G.I.

PROBABLY the most popular type of receiver among amateurs at the present time is the valve detector with reaction on to the aerial, frequently followed by one or two stages of low-frequency amplification. The straightforwardness and ease of operation, combined with good sensitivity, are the principal

causes of its popularity, and very considerable success can be achieved with it.

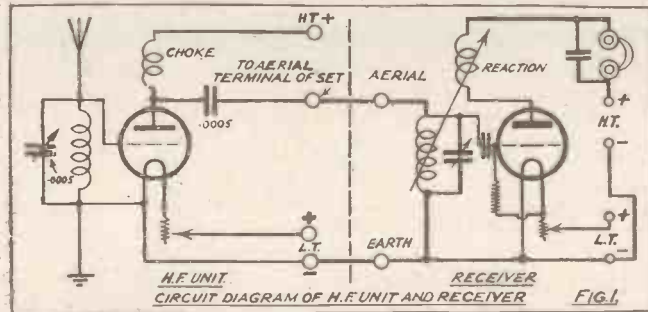

As the price of its simplicity, however, it has definite disadvantages, principal amongst which are the bad distortion which is produced by working on the very edge of oscillation, as is unavoidable when receiving distant stations, and the comparative lack of selectivity which limits its ability to separate stations on near-by wave-lengths.

These faults can be minimised by adding a valve by means of which the minute high-frequency currents set up in the aerial are amplified before rectification. The amplification thus obtained enables the same strength of reception to be obtained on distant stations with less reaction, resulting in very much less distortion, whilst alternatively, by using the utmost reaction, very weak stations may

be received which would otherwise be inaudible. Thus, although high-frequency amplification will add little to the strength of signals from a near-by station (and is in this respect inferior to low-frequency amplification), it is of much greater value than low-frequency amplification when receiving distant stations.

Increased Selectivity.

The presence of a second tuned circuit, which can be made to tune very sharply owing to its low damping, has the effect of very greatly increasing the selectivity of the receiver, so that stations which have hitherto always interfered with each other may now be

separated, thus adding still more broadcasting programmes to the list of those which can be listened to and enjoyed. The increased selectivity which is gained by the use of high-frequency amplification has an even greater significance to the amateur who has the misfortune (from a wireless point of view) to live near one of the broadcasting stations. The big problem, then, is to eliminate the local station when it is desired to receive the programme from a more distant station, and the use of a high-frequency amplifier enables this to be done much more easily at a given distance from the station, or, alternatively, it enables the local station to be cut out at a much shorter distance.

The definite advantages which are obtained by the addition of a high-frequency valve to an existing receiver are thus greatly increased range of reception combined with improved selectivity and ability to cut out the local station. This last consideration alone would justify the addition to any receiver situated within fifteen miles of a main broadcasting station.

A Self-contained Amplifier.

And now for practical details of the method of easily adding the high-frequency amplifier. It is simple enough to add low-frequency amplification to a detector, but it is not quite such a straightforward matter to put high-frequency amplification in front of the detector. However, by

using the system described below, a self-contained high-frequency amplifier can be added without any alteration whatever to the existing receiver.

A glance at the circuit diagram in Fig. 1 will enable the method to be understood. On the right is shown the circuit of the existing single-valve receiver (which may, of course, be followed by one or two low-frequency valves). When the high-frequency stage is added, the aerial circuit of the receiver becomes a tuned anode circuit, and a new aerial tuning circuit is contained in the amplifier unit, shown on the left of Fig. 1. Here we are confronted by a difficulty, for the end of the old aerial tuning coil goes to earth, whereas the end of an anode tuning coil must go to the positive terminal of the H.T. battery.

H.T. Problem Solved.

The trouble is avoided by providing separate paths for the steady anode current and the high-frequency oscillations in the

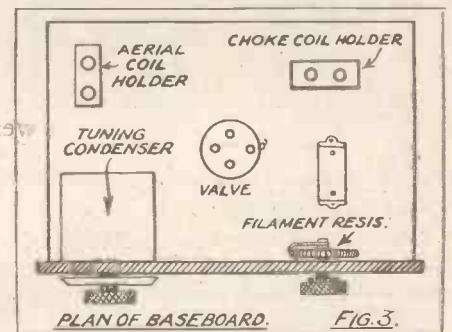
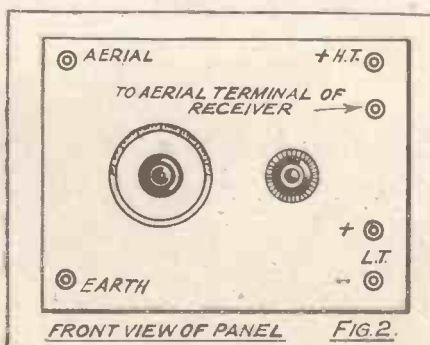

plate circuit of the amplifier valve. An air-core choke, consisting of a coil of high inductance, is connected between the anode of the amplifier valve and the H.T. positive, and the steady current passes through this choke. The high-frequency oscillations, however, cannot pass through the choke, owing to its very high impedance, and so they pass through the fixed condenser, C, to the tuned anode circuit. The fixed condenser, C, prevents the high-tension battery from being short-circuited to earth.

From Fig. 1 it will be seen that the parts comprising our high-frequency amplifier unit are:

- (a) Tuned circuit. (b) Valve. (c) Fixed condenser ('0005 mfd.). (d) Choke coil.

(Continued on page 222.)



ADDING AN H.F. VALVE.

(Continued from page 221.)

Owing to the ease with which the wave-length range may be changed, a variable condenser with plug-in coils is probably the most convenient system of tuning, so that we shall require a variable condenser of .0005 mfd., preferably with vernier, and a fixed coil-holder with suitable coils, e.g. Igranic, Lissen, etc.

A Suitable Choke.

Owing to the fact that no step-up of voltage is obtained, a valve of high magnification factor should be used, as the maximum amplification obtainable is equal to the valve magnification factor. Almost all the valve manufacturers now list special high-magnification valves for high-frequency amplification, and one of these should be used, if possible. The fixed

If the amplifier is only to be used on the lower wave-lengths, a very cheap choke can be made from a number of spider-web coils, connected in series; for example, four spider coils wound on cardboard discs, 4 in. outside diameter and 1 in. inside diameter, wound full with No. 42 double-silk-covered wire and mounted about $\frac{1}{2}$ in. apart on a length of screwed rod, the windings being, of course, in the same direction.

In Figs. 2 and 3 are shown the front and back of panel lay-out of a suitable high-frequency unit. It will be seen that the tuning condenser, filament resistance, terminals, and condensers are mounted on a vertical ebonite panel, whilst the aerial tuning coil, valve holder, choke coil, and two fixed condensers are mounted on a base board to which the panel is screwed. This construction avoids crowding the panel, and the whole can be slid into a suitable cabinet.

It will be noticed that the aerial tuning coil and the choke coil are mounted at right-angles, and as far apart as possible to prevent interaction.

Reaction Control.

The original aerial circuit of the receiver had the capacity of the aerial connected in parallel with it, but this is no longer the case now that it is being used as a tuned anode circuit, and so it will now tune to a much lower wave-length.

If the plug-in coil and condenser system is in use, a remedy is easily effected by substituting a larger coil; but if variometer tuning is in use, a fixed condenser should be connected across the inductance to replace the aerial capacity, .0002 mfd. in the case of a short,

high (low-capacity) aerial, and .0003 mfd. in the case of a long, low (high-capacity) aerial.

If the original receiver is of the "reaction on the aerial" type, as in Fig. 1, the reaction coil will now be coupled to the tuned anode, and in most cases a smaller reaction coil or looser coupling will be required to produce oscillation of the anode circuit. Owing to the capacity between the grid and plate of the amplifier valve, some energy is fed back to the aerial circuit, and when the reaction on to the tuned anode is increased, so this capacity feedback on to the aerial is increased. This is all to the good, of course; but if the aerial has a low resistance and the valve a high capacity, it may happen that the

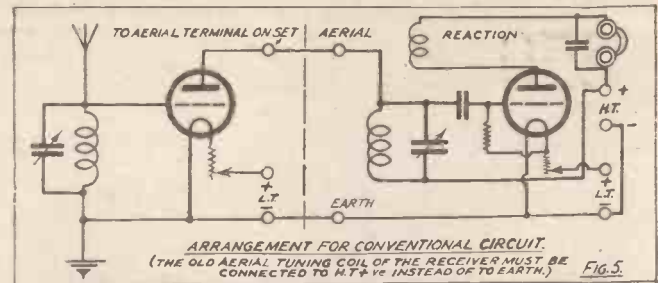

aerial circuit bursts into oscillation before the anode.

Another Method.

This is very undesirable, as it renders the oscillation uncontrollable and will cause very serious interference with other listeners. It may be overcome by connecting a fixed resistance of the grid-leak type across the aerial coil. A value of between 50,000 and 250,000 ohms will usually be effective, the best value being found by trial. But this behaviour is the exception, however, as the anode circuit usually oscillates before the aerial. In cases where only a very bad aerial is available, the valve capacity feedback may be augmented by a very small variable condenser, connected between the grid and plate of the amplifier valve, thus giving a control of the reaction on to the aerial. This introduces an additional complication, however, and as a rule is not recommended.

If it is considered preferable to alter the existing receiver rather than to use the split-feed system described above (there is nothing to choose between the two in efficiency), a high-frequency amplifier as shown in Fig. 5 can be constructed. This is a conventional tuned anode type, and the receiver must be altered by disconnecting the earth terminal from the negative low-tension terminal, thus involving alteration to the internal wiring of the receiver. The old earth terminal will then be connected to the H.T. positive.

The same L.T. accumulator or dry battery must be used for the amplifier and rectifier valves; or, if separate batteries are employed, their negative terminals must be connected together.

If the existing receiver contains a series aerial condenser (variable) for tuning, this should be altered to the parallel position, and if a fixed series condenser is incorporated, it must be short-circuited or removed.

In conclusion, it may be emphasised that the increased power of the receiver, due to the improved selectivity and sensitivity to weak signals, are ample compensation for the trouble involved in constructing the high-frequency amplifier unit.

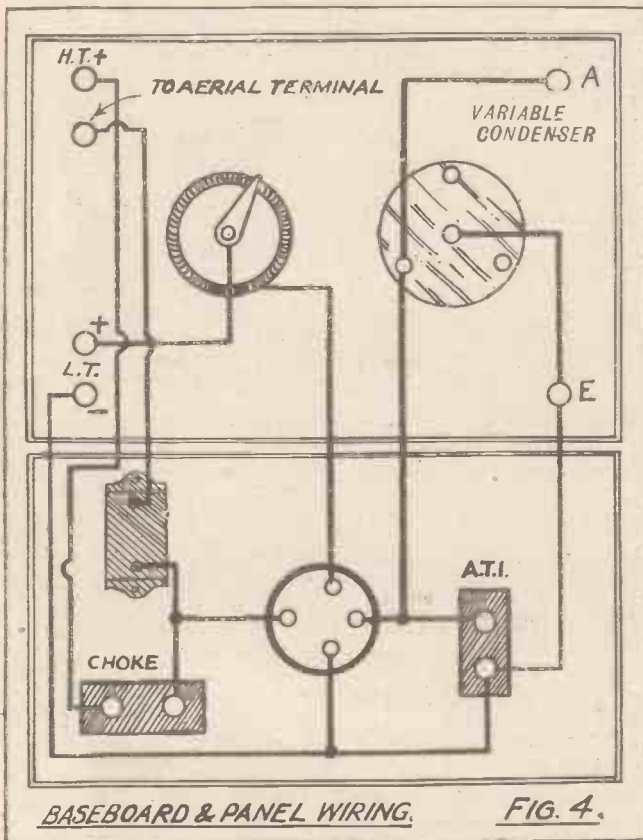

condenser (.0005 mfd.) has to stand the whole high-tension voltage, and should therefore be of reliable manufacture.

The choke coil is the only unusual component, and this may take several forms. A suitable choke can be obtained from the Metropolitan Vickers Electrical Company, or, alternatively, a honeycomb coil such as the Igranic No. 1,000 can be used.

The inductance of the choke coil is not critical, but there is a minimum value for a given wave-length, and, of course, a minimum of self-capacity is desirable. For example, an Igranic coil No. 300 would be quite satisfactory for wave-lengths up to 600 metres, but the No. 1,000 coil will function right up to 2,600 metres.

NEXT WEEK'S
 "How To Make" Articles
 THE "P.W." 1-VALVE REFLEX
 AND
 AN "ULTRA" TWO-VALVER

Don't miss these two fine
 Constructional Articles

250 RADIO QUERIES ANSWERED.

Practical Information For All.

COLLECTED BY THE "P.W." TECHNICAL STAFF.

PART II.

Below we give the second instalment of a collection of 250 Radio Questions and Answers brought up to date and written in concise form by members of the "P.W." Staff. A further instalment will be published next week.

Q.—Having allowed a dull-emitter valve to have too much voltage across the filament, is there any chance of restoring its properties, as they have been destroyed?

A.—This depends upon the type of valve. The D.E.R. '06 amp., and similar types, are not usually curable after this sort of mishap, though the latter can be cured sometimes. In any case, the procedure is to burn the valve at the correct voltage for about half an hour without any H.T. on the plate. This will bring some of the special chemicals to the surface of the filament, and normal electron emission will result. Another way is known as "flashing," but it is decidedly risky. It consists in connecting one

oxide, while other kinds have a composite filament of thorium and tungsten. In any case, the effect is to cause a requisite number of electrons to be thrown off even though the filament is only moderately hot. This obviously means a decrease of cost of upkeep with regard to the L.T. supply.

Q.—What dull emitter valves are best for reflex receivers?

A.—Probably a good '06 valve or D.E. 3 is as good as any, or a '25 amp. valve used as a D.E.R. or A.R.D. E. can be used.

owing to some small shock or sound. The vibrating electrodes cause fluctuations in the plate current, and thus noises in the 'phones, owing to the variations in the respective distances between the grids and plates of the valves.

Q.—What is the difference between a hard and a soft valve?

A.—These are names given to valves having either a high or low degree of vacuum. Soft valves, therefore, have a greater quantity of residual gas in them than have hard ones.

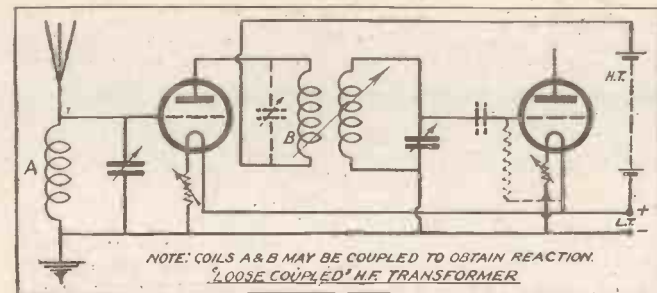

A selective method of coupling an H.F. amplifying valve.

filament leg of the valve to one side of the H.T. battery, and just brushing the other H.T. connection on the other filament leg. This should have the same effect as the above.

Q.—How is reaction employed?

A.—The best methods of employing reaction are to couple a coil inserted in the anode circuit of a valve (usually the detector) to a coil either in the grid circuit of the same valve or the aerial itself. Another method is to connect a variable condenser between plate and grid or aerial, and pass the energy through in a static instead of electro-magnetic form. A variation of this static form is to tune the plate circuit of the reacting valve so that reaction takes place via the capacity between the electrodes of the valve itself. The first-named method is usually the most efficient.

Q.—What is meant by oscillation interference?

A.—This is due to the effect of excessive reaction on to a valve set in such a way as to cause the valve to oscillate and energise the aerial. If reaction on the aerial is used, or if H.F. valves oscillate, a small oscillating current flows up and down the aerial and sends off ether waves of a wave-length approximating to the wave-length to which the oscillating set is tuned. This wave "gets mixed up with" other transmissions (e.g. broadcasting transmissions) and upsets them, producing a beat note as the two waves get in and out of step, for they will not be of exactly the same wave-length. This beat note is heard in other listeners' sets in the form of a high-pitched whistle, which will drown or interrupt anything else being received.

Separate H.T. Control.

Q.—Which type of valve is best for detecting purposes?

A.—A soft valve. But as these take less H.T. than the harder amplifying valves, it should be provided with a separate H.T. control if used with other valves in a set.

Q.—Of what is the filament of a dull emitter made?

A.—This depends on the type of dull emitter. One kind has a tungsten filament covered with a metallic

Choke Amplification.

Q.—Can a burnt-out or damaged transformer be used in any set?

A.—Yes, provided that one winding is quite good, the one winding can be used as a choke in a choke amplifier. This will give only about 75 per cent of the signal strength obtainable with a transformer-coupled amplifier.

Q.—Is there any cure for a valve whose filament touches the grid?

A.—Yes, provided the filament has only sagged and is not stuck to the grid. Invert the valve, so that on heating the filament will tend to sag away from the grid. If the filament is stuck the valve should be lighted, and then with the valve held up so as to tend to free the filament, smartly brought into contact with the palm of the hand. This may sound drastic, but it is a case of kill or cure, for the valve is useless as it is.

Q.—What fuse is best to use for (a) ordinary valves, (b) '06 dull emitters to protect the filaments from H.T. discharges?

A.—A pea-lamp (pocket-lamp bulb) in series with the H.T. positive connection—outside the set—will protect the former, but nothing has yet been devised to act as a fuse for the '06 type of valve. In this case a non-inductive resistance of high value in series with the H.T. plus connection is the best safeguard.

"Hard" and "Soft" Valves.

Q.—What causes the ringing sound in some valves?

A.—This occurs when the valve is microphonic, and is caused by the electrodes of the valve vibrating

Q.—How many valves will be required to receive all the B.B.C. stations on a frame aerial in the 'phones? What combination and circuit should be used?

A.—A good four-valve circuit employing three stages of H.F., would be capable of receiving all the B.B.C. stations in the 'phones.

Q.—What is the range of a single-valve set: (1) with reaction; (2) without reaction?

A.—With reaction a single-valve set has a range of 60 or more miles. Without reaction, the range is not much greater than that obtained with a simple crystal set, and 30 miles would be an average figure.

Q.—How many valves and what combination are required to work a loud speaker at a range of about twenty miles from a broadcasting station?

A.—Three valves employing two stages of L.F. amplification. Reaction should, of course, be used. The above range may, of course, be greatly exceeded under good conditions.

Q.—What is the simplest form of wave-trap I can employ to cut out unwanted stations which interfere during long-range work?

A.—A basket coil and a variable condenser should give quite satisfactory results in this capacity. The connections are as follows: Aerial to one end of coil and earth to the other end. The A. and E.

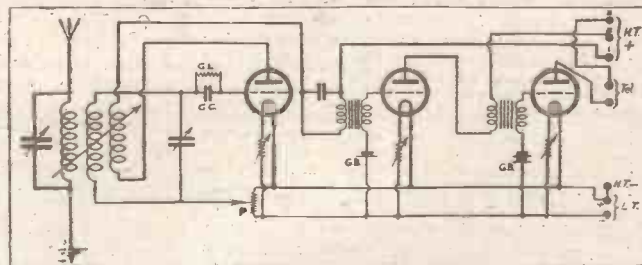

An efficient three-valve circuit employing a potentiometer and double-circuit tuning. It is effective for selective loud-speaker work on medium ranges.

terminals of the complete receiver also go to the same aerial and earth. The variable condenser is placed in parallel with the basket coil. This arrangement will pass all undesired frequencies to earth, but will reject the desired frequency, this latter taking the path through the receiver which is, of course, tuned to the desired frequency.

Q.—What is the minimum number of valves required in a straightforward circuit to obtain all B.B.C. stations on the 'phones?

(Continued on page 224.)

250 RADIO QUERIES ANSWERED.

(Continued from page 223.)

A.—A two-valve set employing one stage of H.F. with interval reaction is capable of receiving all the B.B.C. stations on a good outdoor aerial, if situated more or less centrally.

Eliminating Interference.

Q.—What is the cause of a continual humming noise in my 'phones? How can I prevent it? I am using a three-valve set.

A.—This is probably caused by strong currents from electric mains. If you are employing any L.F. transformers in your receiver, try the effect of earthing the iron cores, or shield them with tin foil and earth

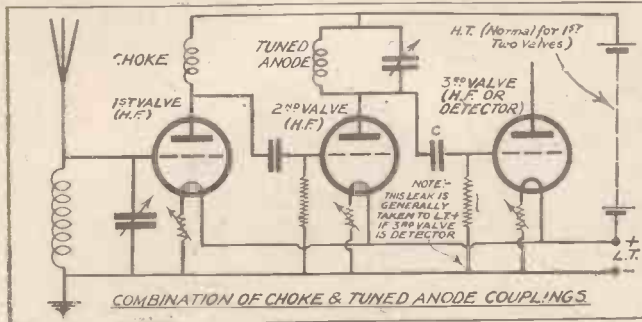

A stable H.F. amplifying circuit.

the foil. A counterpoise earth should also be tried and will probably play an important part in eliminating this unwanted hum.

Q.—What should be the capacity of the grid condenser and the resistance of a grid leak in a valve set?

A.—The grid condenser should have a capacity of .0002 or .0003 mfd., while the resistance of the leak should be about 2 megohms. Some experiments on the value of this latter are often advantageous.

Q.—Is resistance coupling for H.F. valves as satisfactory as the tuned anode or transformer method of coupling?

A.—The resistance method is only used for high wave-lengths, usually above 3,000 metres or so, and will not give satisfactory results on the low wave-lengths.

H.F. and L.F. Amplification.

Q.—How does resistance-coupled low-frequency amplification compare with transformer coupled?

A.—In general practice a transformer coupled low frequency amplifier will be found to give more amplification than a resistance coupled one, although this latter form of coupling is not quite so liable to distortion as is the transformer method. If expense is no object, however, three stages of resistance coupled amplification, which will be found to give about the same volume as two stages with transformers, will give a noticeable improvement over this latter form as regards purity of tone.

Q.—What are the connections for adding an H.F. valve to my existing crystal set? Is it necessary to alter the crystal set in any way?

A.—If the following connections are made, there will be no necessity to alter any of the connections in your existing crystal set, as the inductance included in it can remain to act as a tuned anode coil, as this method of coupling the H.F. to the crystal is to be used. Connect aerial to one end of A.T.I. and other end to earth—or slider to earth if a solenoid coil with slider is to be used. A variable condenser is connected across the A.T.I. if a plug-in coil is utilised. The aerial also goes to grid of valve, while the plate goes to the aerial terminal of crystal set. The earth terminal of crystal receiver should go to H.F. +, and H.T. — be taken to earth, as also are one of the filament and L.T. —. The remaining filament is connected through the rheostat to L.T. +. The 'phones remain in their old position on the crystal set. It may be found necessary to connect a small fixed condenser across A. and E. of crystal set to load up the coil before it will act as an anode coil.

Q.—What are the connections for adding an existing L.F. amplifier to a crystal set?

A.—This is quite simply done. The output terminals of the crystal set are connected to the input terminals of the amplifier—i.e. the 'phono terminals of the crystal set are connected to the two terminals of the amplifier which are connected to the primary of the L.F. transformer. The same connections hold good for adding an L.F. amplifier to a valve set.

Q.—How is a crystal detector connected to an H.F. panel which employs a plug-in H.F. transformer for coupling?

A.—The crystal and 'phones are placed in series with one another, and are then connected across the secondary of the H.F. plug-in transformer.

Action of the Grid

Q.—How can I insert a switch in my two-valve set to cut out the H.F. valve when not required? What type of switch should be employed?

A.—A single pole two-way switch can be utilised for this. The connections are as follows: Break the connection between grid condenser and plate of H.F. valve and connect this side of grid condenser to the arm of the switch. Connect plate of H.F. valve to one stud of switch and aerial to the remaining switch. This switch makes no provision for cutting off the L.T. supply, but most rheostats have an "off position," making this unnecessary. Leads to the reaction coil must be reversed.

Q.—How does the grid control a valve?

A.—The grid controls the number of electrons passing from the filament to the plate, according to how it—the grid—is made positive or negative by the incoming signals. When positive it increases the flow of electrons, and when negative it decreases them.

Q.—What is the purpose of the grid condenser?

A.—To make the valve rectify—in the case of a detector valve. The condenser has the effect—by a process too complicated to be explained here—of keeping the grid slightly negative all the time. Thus the impulses from the aerial merely make the grid more or less negative. This obviously means that positive impulses cannot make the grid positive, for they only result in more electrons collecting on the grid—from the filament—and rectification takes place.

Q.—What is the use of the grid leak?

A.—This device allows electrons that have collected on the grid to leak away back to the filament, and so the grid can never become so negative as to cause the valve to cease functioning.

Q.—Why does a valve set using a valve detector suddenly go dead sometimes, often with a decided click, and only recommence operating when the H.T. or filament have been switched off and on again?

A.—This is usually due to a faulty grid leak. If the leak is not functioning the grid of the valve will gradually become more and more negative, until at last it will cease to function. This is cured by switching off the filament, and the grid becomes normal again. A different value of leak should be tried.

Q.—How does a dual amplification circuit operate?

A.—This is a method whereby one or more valves are made to do double the work they usually perform. Briefly, it means that each valve acting in a dual capacity acts both as a H.F. and L.F. amplifier.

Q.—Why are the signals of a valve-crystal reflex receiver less when the crystal cat's whisker is on the crystal than when it is lifted?

A.—Probably this is due to an unsuitable crystal. Very often a crystal is a perfect rectifier in the usual crystal circuit, but its impedance renders it unsuitable for inclusion in a reflex receiver. Try another crystal.

Q.—In the case of an ordinary straight-forward "dual" receiver, can an H.F. amplifier be added?

A.—Yes, in the usual way, using tuned anode coupling, but using the secondary of the L.F. transformer instead of a grid leak. That is, the grid of the dual valve goes to the one end of the L.F. secondary, the other end going to earth or filament.

Q.—What is the exact action of a single-valve reflex circuit? How is the valve made to do double work?

A.—As is well known, the single-valve reflex receiver makes use of one valve for amplification purposes and a crystal to rectify the incoming oscillations. These are first passed through the valve and are amplified in the usual way; they are then rectified by the crystal and passed back via the transformer to the grid of the valve. The valve then amplifies these again, and they are passed through the 'phones.

Q.—Is reaction on a reflex circuit obtainable?

A.—Yes, by coupling the anode coil either to a preceding anode coil (in the case of a multi-valve set) or the aerial coil. Though not much help for close reception, it is exceedingly useful when tuning-in distant stations.

Q.—What is the neutrodyne system?

A.—A method of stabilising stages of H.F. amplification.

Q.—How is the neutrodyne circuit stabilised.

A.—One of the methods is by connecting very small variable condensers between the grids of the various H.F. valves. These condensers have extremely small capacities, being of about 1 or 2 micro-microfarads. These condensers can consist of two pieces of insulated wire twisted together, or lying side by side in a tube. The lengths of wire overlapping providing the necessary capacity.

Q.—What are the neutroformers of the Hazeltine circuit?

A.—They are the transformers used in the aerial circuit and the H.F. plate and grid circuits. Usually they consist of wire wound round 3" diameter cardboard cylinders so as to give primary and secondary windings. The primaries have about 10 turns, and are untuned even in the aerial circuit, while the secondaries are tuned by means of .0002 mfd. variable condensers. The secondaries of the neutroformers have about 52 turns. 24 S.W.G. wire is used.]

Q.—Which is the most useful type of neutrodyne receiver?

A.—This is hard to say, but probably the four-valve receiver using three H.F. and one detector is best. L.F. amplifiers can be added as usual. The circuit is extremely selective, and considerable practice is required before it can be handled properly.

Q.—Can tapped transformers be used in the neutrodyne receiver?

A.—It is not advisable to do so owing to the variable

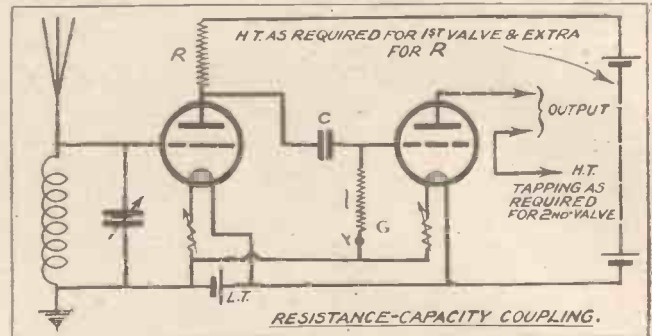

A method of coupling H.F. valves. R = 8,000 ohms, C = .0003 mfd, G = grid leak.

capacity of the leads and tapping switches, etc. In this case the neutralising condensers would have to be rebalanced for each tapping in the transformers.

Q.—Having constructed a two-valve reflex receiver, I find it is not at all selective. Can this be remedied?

(Continued on page 225.)

250 RADIO QUERIES ANSWERED.

(Continued from page 224.)

A.—Reflex circuits are, as a rule, inclined to be non-selective. If you use two-coil tuning in the aerial circuit you will be able to counteract this non-selectivity to a certain extent. Reaction will also assist in cutting out unwanted signals, though reflex receivers are never as selective as the straight types of circuits.

Q.—Can reaction be used in the neutrodyne circuit?

A.—Yes, but not by coupling a coil to the aerial or other transformers. This would result in the unbalancing of the circuit at every movement of the reaction coil. The best way to obtain a reaction effect is by tuning the plate circuit of the detector valve.

Q.—How is the neutrodyne receiver "balanced"?

A.—This is done by turning on all the valves and then turning off the one before the detector. Signals will still be heard, and the neutralising condenser across

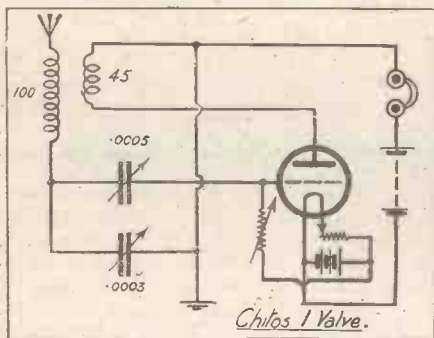

One of "P.W.'s" most popular one-valvers.

the grid of that valve and the grid of the detector is adjusted until no signals are heard. The valve is switched on; and signals should come through again. Next the valve in front of this is switched off, and the same procedure adopted. This process is repeated for all the neutralising condensers until they are all adjusted.

Q.—What is the most efficient and economical loud-speaker receiver for use from the local station at a distance of eight miles or so?

A.—Taking into account economy and efficiency, a two-valve reflex receiver will be the best. This should have a crystal detector, as these give clearer reproduction than is the case with valves. Reaction can be employed when it is desired to use the receiver for other stations, but for local reception it will be unnecessary.

Q.—What is the best crystal to use in a reflex receiver?

A.—Usually Hertzite or a similar mineral and a good sharp gold cat's-whisker incorporated in a detector that is capable of fine pressure adjustment. It should not be forgotten, however, that possibly several specimens of crystal may have to be tried (even of the same type) before satisfactory results are obtained.

Q.—What types of coil are preferable for short and long wave-length reception?

A.—Basket or single-layer cylindrical coils for short wave reception and duolateral (honeycomb, lattice, etc.) for long waves. The latter are preferable in point of compactness more than in respect of actual efficiency in most cases.

Q.—What size basket coils are required in the A.T.I. anode and reaction positions for the reception of broadcasting?

A.—70, 70 and 50 turns respectively, employing a series .0005 mfd. variable condenser for tuning the A.T.I. and a .0002 mfd. variable condenser for tuning the anode coil.

Q.—How are the numbers of turns calculated on a basket or "spider web" coil? Are the turns counted on each side and added together?

A.—No; the turns should be counted as actual turns of wire around the centre irrespective of the

fact that each turn is taken around the one side of each "peg."

Q.—What gauge wire should basket coils be wound with?

A.—24 S.W.G. is a good all-round gauge for such coil winding.

Q.—What covering on the wire is advisable for coil winding in respect of coils required for use in broadcast reception? Can enamelled wire be used?

A.—Enamelled wire can be used, although in winding the enamel is apt to crack off and cause "shorting." Double cotton-covered is quite O.K., although silk-covered wire is preferable in point of appearance—it is, of course, more expensive.

Q.—What value variable condensers are required for tuning primary and secondary coils in a two-coil holder?

A.—.0005 mfd. for the primary, and .001 mfd. across the secondary.

Q.—Why is it necessary to retune when the reaction coil is varied on a two-valve receiver?

A.—The relative positions of the reaction coil and the coil to which it is coupled will vary the inductance of the circuit in which the latter is included so that a tuning readjustment will be necessary every time the reaction coil is moved.

Q.—Is a tuning inductance necessary with a frame aerial?

A.—Not when a limited wave-length range is to be covered. The frame aerial can be wound to within a close value of the total required inductance, and a variable condenser of, say, .0005 mfd. value, placed in parallel for purposes of tuning. When it is required to increase the wave-length range of a frame aerial a loading inductance can be placed in series for the purpose. Sometimes in order to provide facilities for reaction the frame aerial is wound with less turns than are actually required for the loading inductance employed, and to this the reaction coil is coupled.

Q.—What is the most efficient type of variometer?

A.—Undoubtedly the ball-type with an internally wound stator and a very small air space between the stator and rotor. This type is, however, very difficult for the amateur constructor to make, and for most purposes he will find the basket type of variometer quite efficient.

Q.—How can reaction be obtained when a ball-type variometer is employed for tuning?

A.—Merely by placing another variometer in the plate circuit. By so tuning the plate circuit reaction can be obtained by virtue of the capacity coupling existing between the grid and plate circuits through the capacity of the valve itself.

Q.—Can a variable condenser be used, either in series or in parallel, with a variometer to either increase or decrease the wave-length range covered by the variometer?

A.—Yes; but if it is desired to increase the wave-length range it is better to employ loading inductance coils than a variable condenser in parallel.

Q.—Why are honeycomb coils wound in a peculiar wavy fashion? Has this method any very great advantage over ordinary "hank" winding?

A.—The great advantage of such a duolateral winding is the reduction of the self-capacity of the coil. Capacity is a damping factor and should be avoided as much as possible. For this reason increases in tuning should be accomplished by means of an increase in inductance wherever possible.

Q.—In circuits where large duolateral coils are required can basket coils be used instead?

A.—Yes, several basket coils with a total number of turns approximating that of the required duolateral coil can be connected up in series and clamped together with quite good results.

Q.—Are variometers the best tuning devices to employ for the reception of short wave-lengths, such as are used by the B.B.C. stations?

A.—No, a basket or small cylindrical single-layer coil, with a variable condenser in series, is to be preferred for short wave-length reception.

Q.—Is ebonite very greatly to be preferred for coil formers?

A.—Ebonite is excellent material for the purpose, but cardboard well soaked in paraffin wax will prove almost as efficient.

Q.—Is there any definite relation between the sizes of primary, secondary, reaction, and anode coils?

A.—Not that could be expressed in definite figures, it is more or less a question that must be settled by individual experiment, although in the case of one specific range of wave-lengths, such as those covered by the B.B.C. stations, the values have become almost standardised. The secondary coil must always be larger than the primary, because it has not in addition to its own inductance the inductance of the aerial and earth system as has the primary. This applies also to the anode coil, while the reaction can be something approximately the value of the primary coil or the A.T.I. (aerial tuning inductance) as it is called.

(To be continued next week.)



A 42-ft.-long spark. This remarkable flash was obtained by the Westinghouse Co. in America who, in order to produce it, employed a 1,000,000 volt transformer.

VARIOUS systems have already been devised for the purpose of preventing radiated messages from being overheard by the ordinary listener. Many of these are extremely ingenious in theory, but owing to the fact that they involve more or less complicated "accessories" at the transmitting and receiving ends, they have not so far found popular favour.

There are two main objects to be gained from a secret system of wireless. In the first place, secrecy would overcome the present objection to the use of wireless telephony for commercial purposes, where it is difficult to protect private messages from being intercepted outside the particular person or station for whom they are intended. In the second place—and this is a doubtful boon—it would be possible to set up a "secret" service of news or entertainment for the benefit of a selected number of subscribers only, and from which the ordinary public would be shut out.

A Simple Method.

Perhaps the simplest plan of baffling an unauthorised listener is to vary the trans-

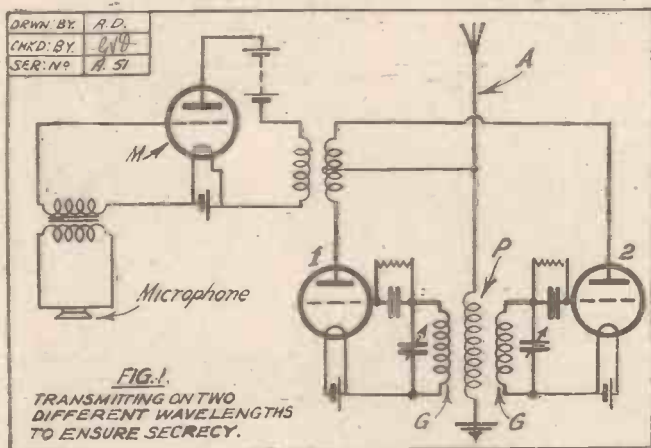

mitted wave-length in an irregular manner, by means of some suitable cam or other device controlling the aerial tuning. Subscribers are then provided with a similar device, driven by clockwork and suitably synchronised, to keep the receiving aerial always in step with the varying wave-length.

At best this is merely an approximation to absolute secrecy. A flatly-tuned aerial within reasonable distance of the transmitting station would probably succeed in picking up the entire message, although the strength would fluctuate. A skilful operator, even at a distance, would likewise be able to overhear most of the message by carefully manipulating his tuning condenser by hand. This would require some practice, but it could be done.

Circumventing Eavesdroppers.

Another plan is to deliberately superpose upon the actual message, at the transmitting end, an obnoxious or confusing tone at one or more definite frequencies. To an ordinary listener, using a simple crystal or valve set, the superposed noise would jam out or render the message unintelligible. By fitting to his receiving set a special filter circuit, designed to block the passage of the interfering tones, an authorised listener will succeed in getting clear reception.

SECRET WIRELESS.

WHY VARIOUS SYSTEMS ARE NOT POPULAR.

By **SEXTON O'CONNOR.**

To prevent an ingenious eavesdropper from discovering the frequency of the confusing tones and building a wave-trap for himself, changes could be rung upon the frequency so used, the subscriber being provided with several corresponding filters to be used in accordance with a code arranged by the transmitting station.

Another method that has been suggested is to transmit upon two different wave-lengths, and to use a doubly-tuned circuit at the receiving end to ensure perfect reception. This is accomplished, as shown in Fig. 1, by coupling differently tuned oscillating valves 1, 2, to an aperiodic aerial A, and causing first one and then the other valve to become operative, according to the varying voltages, from a common modulating valve, M. It will be noticed that the grid circuits, G, of the

valves 1, 2, are back-coupled through the aerial inductance P, which is common to the plate circuit of both valves. Low-pitched voice-frequencies are accordingly radiated on one carrier-wave, and high-pitched frequencies on the other.

An Ingenious System.

At the receiving end two loop circuits, one tuned to each frequency, are inserted in the aerial and are connected by separate amplifying valves to a common detector.

A somewhat similar plan consists in radiating each half-wave on a different wave-length to that used before or after it. Here, as shown in Fig. 2, the transmitting aerial, A, is branched into two differently tuned circuits, B, C. In each branch a two-electrode valve or other rectifying device, K, K1, is arranged so that the upward surge of each oscillation must pass through one branch and the downward surge through the other and differently tuned branch.

Passage of current-surges in both directions in each branch is prevented by the unilateral conductivity of the rectifier in each. The two rectifiers are, of course, opposed, as shown, so that each half-wave has a free path in one or other of the branches only—viz.: upwards in one and downwards in the other. The microphone, M, is connected across the two branches, so

that the H.F. currents introduced at G are suitably modulated in each branch.

At the receiving end the aerial is similarly divided into two separately tuned branches, each containing a blocking rectifier as before. An inductance coil is then coupled to the two branches and picks up both voltages, so that the complete message is received in the 'phones.

An Absolute Safeguard.

The arrangement shown in Fig. 2 appears to provide a highly selective method of transmission rather than a secret system in the strict sense of the term. Probably the most effective system yet devised is one in which the speech frequencies are inverted at the transmitting end, so that high-pitched tones are radiated as low, and vice-versa, the receiving station being provided with means for reversing this process and so restoring the natural speech form.

This is accomplished by modulating a C.W. wave with the microphone current and then selecting by means of a filter circuit the lower side band of the resulting complex of frequencies. This side band contains the signals with their natural frequencies inverted, and is in turn used alone to modulate the aerial or carrier wave, thus giving rise to the peculiar distortion referred to.

At the receiving end the lower side band is first separated out from the carrier wave, and is then heterodyned with a C.W. wave similar to that used at the transmitting station. The lower side band of the resulting complex of frequencies will then correspond to the natural voice frequencies.

This, as will be seen, is a complicated system more suited for commercial use over a limited traffic service than for application to the ordinary amateur's outfit. In practice, however, it would provide an absolute safeguard of secrecy against the casual listener-in.

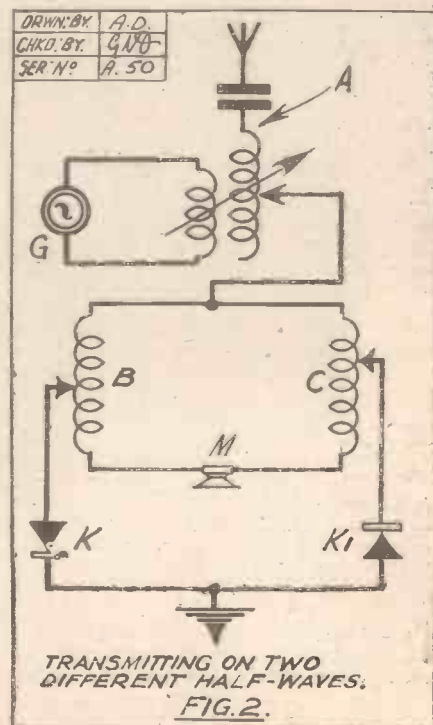

THE FIRST WIRELESS LOUD SPEAKER WAS A Brown



Hear this new Brown —and no other will ever satisfy your critical ear

THE four new Brown Loud Speakers—of which that illustrated on the right is one—represent a big advance in the design of these fine quality British Loud Speakers. Hitherto many wireless enthusiasts have purchased their Loud Speakers on appearance alone—only to find that a handsome and pleasing outline does not necessarily mean purity and mellowness of tone. The Brown, on the other hand, has invariably been bought on *actual performance*. It has achieved a wonderful reputation throughout the world solely for the naturalness of its reproduction.

In the Brown, external shape has always been subservient—in the interests of good music—to the actual design of the reproducer itself. But now the Brown Loud Speaker has been greatly improved in appearance and these four new models possess a dignity and beauty which place them in a class by themselves.

Ally this new beauty of outline to the wonderful sensitiveness of the Brown tuned reed movement and you possess a Loud Speaker which is a positive joy for all time.

S. G. Brown, Ltd., N. Acton, London, W.3

Re'ail Showrooms: 17 Mortimer Street, W.1.
15 Moorfields, Liverpool. 67 High Street, Southampton.
Depo's (Wholesale only): 13 Bushy Park, Bristol.
Cross House, Westgate Road, Newcastle



To the
Trade:

We have instituted a special Dept. to see that your orders are filled promptly. In case of special difficulty write to us at once.

The new HQ

A handsome instrument possessing the same beauty of outline as the famous Brown Q Loud Speaker. Gives a wonderful volume of crystal clear tone. Attractively finished in rich brown colour or a velvet black with polished nickel fittings.
Height 20". 4,000 ohms resistance. Also in 120 and 2300 ohms.

£6

BRITISH

Brown

THROUGHOUT



BESTWAY

WIRELESS GUIDES

FOUR NUMBERS
NOW ON SALE

THE aim of the BEST WAY Wireless Series is to put before the new constructor details for the building of wireless sets and components in such an explicit and minute way that there can be no possible chance for even a beginner to go wrong. All articles, diagrams and photographs are of the highest possible standard, and the books represent the biggest value ever offered in wireless publications.

Ask for "BEST WAY"

CRYSTAL SETS
VALVE SETS
WIRELESS COILS
SPECIAL SETS

6^d each.

BESTWAY The Guide for the Wireless Constructor
HOW TO MAKE
SPECIAL SETS 6^d



THE usual type of self-contained receiver does not, and probably never will, appeal to the average experimenter, for the simple reason that he has no desire to revert to the "fixed circuit" stage, that comparatively disinteresting period before he first began to vary his circuit programme. He is quite out of his

A useful and eminently practical method of devising an experimental system for radio work.

By O. J. RANKIN.

minals, the panels then being clamped in a slotted wooden frame which is supported by four wooden legs. All panels are 6 in. long by $\frac{3}{8}$ in. in thickness, their width varying according to the dimensions of the components to be fitted. The average panel measures 6 in. by 3 in., the largest is 6 in. by $3\frac{3}{4}$ in., and the smallest 6 in. by 1 in. The length of the frame will, of course, depend on the number of panels—amount of apparatus—to be used. The frame shown in Fig. 1 is 2 ft. long, this taking about 7 panels, or sufficient apparatus to experiment with many different types of single-valve circuits; and the double frame shown in Fig. 2 is 2 ft. 3 in. long by 14 in. wide, and takes about 16 panels, or sufficient apparatus to try-out almost any three- or four-valve circuit.

The experienced experimenter will find the larger type of frame more suited to his purpose, and the less advanced amateur, with a limited but growing amount of apparatus and knowledge, might build up the single frame to commence with, and fit extra runners to make a double or triple frame at some later period as desired.

Slotted Runners Fitted.

The frame shown in Fig. 1 consists of two 2 ft. lengths of plain oak picture-frame moulding, which are about 1 in. square in cross section. (See Diagram A, Fig 3.)

These are fitted with fillets to form slotted runners for the ends of the panels, the top flange of each, which is integral with the moulding, then being rounded off, as shown at B. A 2 B.A. tapping hole is drilled into the ends of each runner to a depth of rather

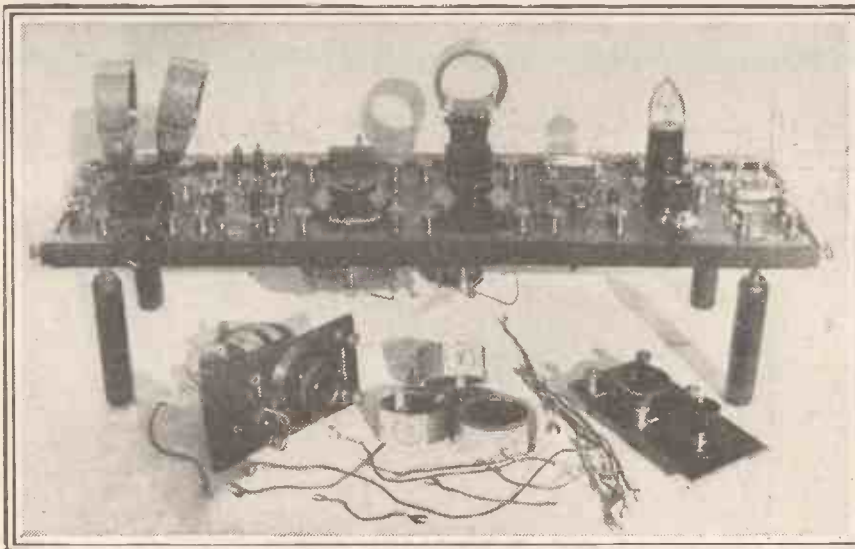

Fig. 1.—A simple single frame outfit.

usual element when handling a "boxed-up" receiving set. He soon realises that his ambitions are more or less stifled, he cannot try-out any little circuit modification which might constitute an improvement, and he cannot conveniently change valve-coupling components, or tinker in the usual manner with any particular part of the system. In fact, he is there merely to provide a little amusement for his friends. In short, he cannot experiment, and as an experienced experimenter he soon becomes disinterested.

With an outfit of suitable apparatus, however, there is no reason why the experimenter should not carry on his work, and always have a set ready for use when required.

Very Adaptable.

He can use sufficient apparatus to receive any desired station at almost any distance. If he is a little too far afield for single-valve work, it does not become necessary for him to rebuild the set, he can simply hook up another valve and so bring in the station he requires.

The photographs appearing on this page should convey an impression of the general arrangement of the experimental system. All components are mounted on small ebonite panels provided with ter-

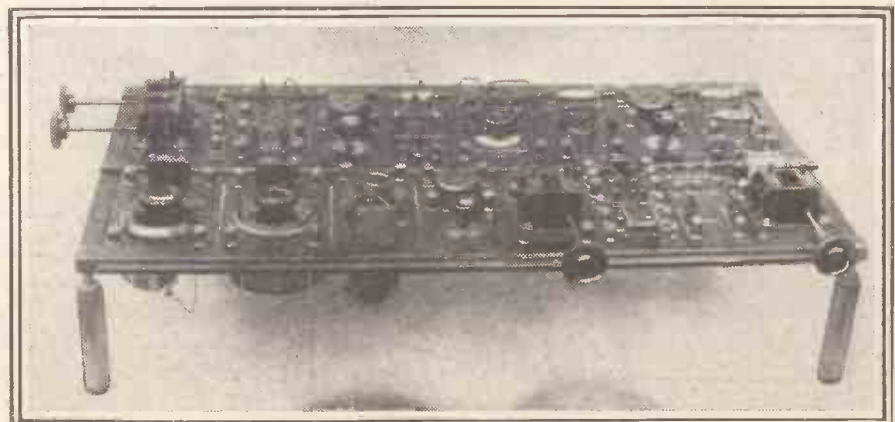

Fig. 2.—The double frame loaded with seventeen panels.

AN EXPERIMENTAL SYSTEM.

(Continued from page 229.)

more than $\frac{1}{2}$ in., and a 1-in. length of 2 B.A. brass studding is carefully screwed into each hole and allowed to project for a distance of $\frac{1}{2}$ in. The studs should be held firmly in the vice in a horizontal position by means

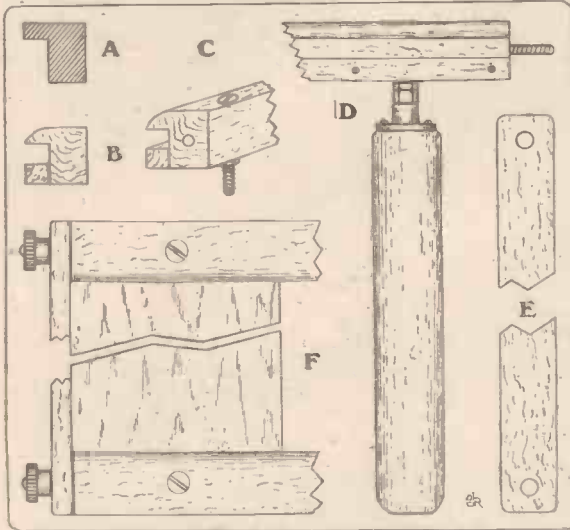

Fig. 3. Details of single frame.

of lock-nuts or a suitable clamp, while the runners are forced on with a screw-up movement. A 2 B.A. clearance hole is then drilled through each runner, about $1\frac{1}{2}$ in. from the ends, these holes being counter-

sunk at the top and fitted with 2 B.A. brass bolts, as shown at C.

The bolts are $1\frac{1}{4}$ in. long, and they should be clamped very firmly to the runners by means of nuts, so that they form the studs for the detachable supporting legs. The legs consist of $4\frac{1}{2}$ in. lengths of 1-in. diameter wooden broom-handle, each one being fitted at the upper end with a 2 B.A. internally threaded brass bush, or with an ordinary clearance bush, with a nut soldered to the sleeve, as shown at D. The two runners with legs attached are held together by two wooden links, E, each link being 7 in. long by 1 in. wide by about $\frac{1}{4}$ in. in thickness, and drilled at each end to engage the end studs. Milled nuts—top portions of 2 B.A. terminals—are used for clamping these in position.

When sliding the panels in the runners, it is, of course, necessary to remove one of the end links. The frame is first rigged up minus one link, fitted with the desired number of panels, and then finally closed by attaching the other link.

The Double Frame.

Diagram F shows an end view of the frame with a panel in position, looking from the top, and from this, and the photograph shown in Fig. 4, the general arrangement of this frame should be clearly understood. It should not be necessary to add that the end links should be cut from good hard-wood, and that care should be taken to see that the tops of the legs are perfectly flat and at true right angles with the sides before fixing the bushes.

The double frame shown in Fig. 2 is built up from "plaster laths"; that is, wooden strips 1 in. wide by about $\frac{1}{4}$ in. in thickness, as used by builders for ceiling work, etc., each strip being planed smooth and screwed one each side to a length of the same material, which is halved lengthwise by means of a fine saw. Thus we obtain a double runner, as indicated in the sectional Diagram G (Fig 5). The strips intended for the tops of the runners are rounded off at both edges as shown.

A portion of the lower strips and centre pieces is cut away, as shown at H, the top projections then being fitted with 2 B.A. countersunk brass bolts, which are clamped firmly in position by means of shallow nuts. These bolts are also $1\frac{1}{4}$ in. long. Three runners are arranged in this manner, these being linked together by two 14-in. lengths of hard-wood, which may be $\frac{3}{4}$ in. wide by $\frac{3}{8}$ in. in thickness, and clamped with milled nuts.

The holes in these links

should be well recessed to take the nuts on the bolts. (See Diagram I.) The arrangement of this type of frame should now be quite clear. Diagrams J and K show top and corner views of the frame, and Diagram L shows how the legs are screwed on over the projecting ends of the bolts, after attaching the end links.

Extending the Scheme.

The only drawback with this type of frame is that it becomes necessary to stand it in a vertical position, with the lower link and legs attached, when sliding in the panels. This difficulty may be partially overcome by temporarily screwing on the legs at the open end, with the frame in a horizontal position, or by providing independent studs for the legs. However, the frame previously described has given best results under varying conditions, and this is the type of frame I would recommend, especially for hard use.

The method of extending this to a double or even a triple frame is, of course, obvious, and if the reader is fortunate enough to be



Fig. 4. End view of single frame showing method of sliding panels.

in touch with a woodworker who can turn out lengths of 1 in. square section hard-wood grooved to take the panels, then so much the better. In this case, one double and two single runners, each about 2 ft. 3 in. long, would make a double frame to take the same number of panels, as shown in Fig. 2.

Not a "Stunt."

The reader may be interested to know that the idea is not merely "a stunt" in order to display a number of sensational-looking photographs exploiting a "lead-you-up-the-garden" feature, the system has been carefully thought out and designed especially to meet the requirements of the modern go-ahead experimenter. It has been simplified to a minimum so that any beginner may confidently undertake its construction by following these instructions, and it has been put to rigid tests and has always given entire satisfaction.

All parts are easily and quickly assembled and connected up by means of insulated leads, provided with brass spade terminals. Large (2 B.A.) terminals are fitted to the valve panels, coil and condenser panels, etc., where it is usually necessary to make several connections to a single terminal, and the valve panels are fitted with 30 ohm filament rheostats for dull emitter valves.

(To be continued next week.)

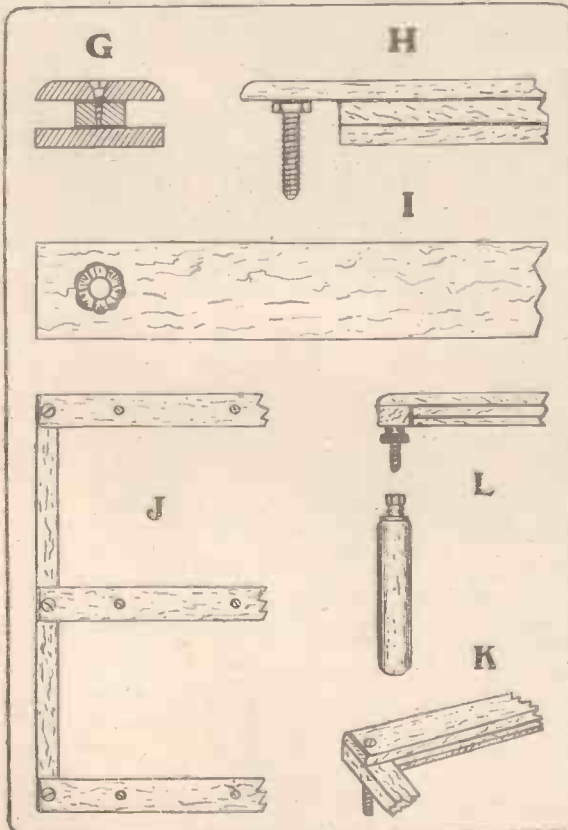

Fig. 5. Details of double frame.

PUT YOUR VALVES ON VELVET.



**THE
MAGAZINE
CATALOGUE**
Ask for a copy
today
FREE
on
Application

Prof. A. M. Low
on: "The Possibility of
Television."

W. B. Medlam, B.Sc.,
A.M.I.E.E.
on "Building a Super-
heterodyne."

Articles on "Building a
Wireless Set," "Upkeep of a
Crystal Set," "Those Micro-
phonic Noises," "Dodging
the Aerial," and many others.

Full details of all the
new **CLIMAX RADIO
COMPONENTS and
SETS.**

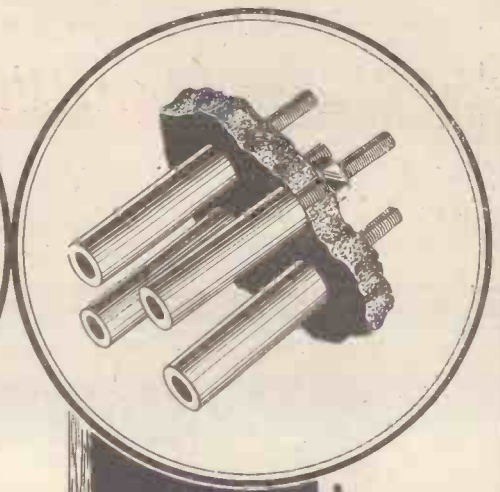
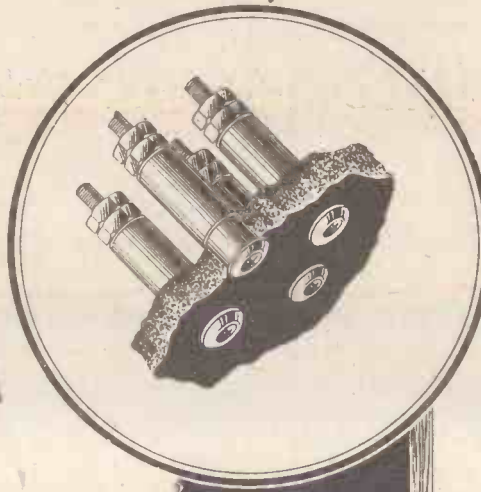

INSULATED HEAD FITS FLUSH ON PANEL
PROTECTS THE VALVE: DECORATES THE PANEL



USE the Climax way of protecting the valve and getting rid of those annoying microphonic noises. Your reception will be immeasurably improved by using **Climax Anti-microphonic Valve Sockets.**

The Climax Anti-microphonic Valve Socket is designed to eliminate mechanical shocks from the valve while avoiding the introduction of additional electrical capacity between the valve stems.

The barrel of the socket is provided with a circular rim which enables the socket to be mounted flush on the panel, the upper surface of this rim being insulated to prevent accidental burning out of the valve.

The Valve Stem is supported on the Climax patent hour-glass spring, the waisted portion of which makes an excellent electrical contact and keeps the stem absolutely clear of all other parts of the mechanism.

PRICE: One set of four Climax Anti-microphonic Valve Sockets, fitted with patent hour-glass contact springs, complete with nuts and washers (hour-glass spring patent applied for). Per box **2/-**

Insist on the name CLIMAX - it pays!

If you have difficulty in obtaining genuine CLIMAX productions, and are asked to accept inferior imitations, kindly send your order direct to us, enclosing P.O. or cheque to the correct amount, when immediate attention will be given to your instructions.

CLIMAX
▲ RADIO ▲

CLIMAX RADIO ELECTRIC, LTD.

Head Office and Works

Telephone: Putney 2599.

Showrooms - 257, HIGH HOLBORN, LONDON, W.C.1.

QUILL WORKS, PUTNEY, LONDON, S.W.15.

All Communications to Head Office.

Telephone: Holborn 2538.

EFESCA

headphones



GOOD HEADPHONES ensure the greatest pleasure from your set. Efesca headphones are light and easy to wear, exceptionally clear and evenly matched in tone, and provide faithful reproduction with full volume of sound.

The magnets are of cobalt steel, ground perfectly true; diaphragms of stalloy, and headbands of polished duralumin. 4,000 ohms, with 6 feet of flexible cord.

18/- PER PAIR

PURAVOX Loud Speakers

For power and purity of reproduction the Efesca Puravox Loud Speaker stands supreme. It is so constructed that the relation of the magnets to the diaphragm is capable of very fine adjustment, allowing the utmost volume of sound to be obtained. The horn is acoustically perfect, and the whole instrument is handsomely finished with a crystalline surface.

PURAVOX STANDARD MODEL, 80/-
 JUNIOR, 48/-
 MINIATURE, 25/-

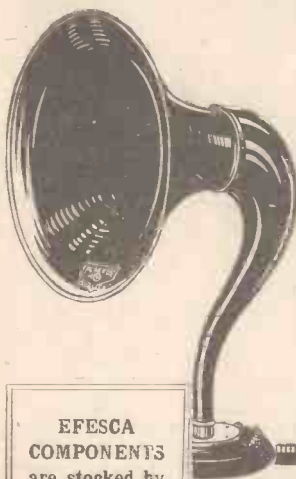

EFESCA COMPONENTS are stocked by all good Wireless Dealers & Electricians.

EFESCA COMPONENTS
 FALK STADELMANN AND CO., LTD.,
 EFESCA ELECTRICAL WORKS,
 83-93, FARRINGTON ROAD, LONDON, E.C.1.
 Also at Glasgow, Manchester and Birmingham.



Bring in the D.X. stations thro' the local!

IF you would separate Radio Paris from 5XX, 2LO from Cardiff and so on up and down the scale . . . if your local station is too "high-brow" this evening or too "low-brow" as the case may be . . . you want an Ericsson WAVE TRAP.



By a careful combination of circuits skilfully arranged you can easily reach out to your heart's content. It simply means 50% extra selectivity for your set. Minimises trouble from electric mains, local disturbances like trams, electric trains, etc. You can easily get distant stations on the loudspeaker you never could try for before . . . all through having an Ericsson WAVE TRAP in your aerial lead.

Price 60/-

Write for further information, also lists describing our receivers, crystal and valve, Super Tone Loudspeaker, telephones, components, etc.

The British L.M. Ericsson Mfg. Co., Ltd., 67/73, Kingsway, LONDON, W.C.2.

Ericsson
 WAVE TRAP



Buy British Goods Only

THE SUPER-SONIC HETERODYNE RECEIVER.

INFORMATION FOR PROSPECTIVE CONSTRUCTORS.

By E. J. POUND, M.I.R.E.

The chief faults to be met with in Super-hets. are clearly explained in this article, which the amateur constructor will find of practical interest and value.



I HAVE been very surprised at the number of super-sonic heterodyne receivers I have seen lately, and which have not been satisfactory. That is to say, instruments which have been built at great expense by the home constructor, use a large number of valves, yet do not give the range that one should expect from such a system.

distorted and should be taken with a little salt, then perhaps divided by 10.

With the super-het. receiver the case is rather different. Here we have a system which is backed up by theory and established facts. It is easily proved that high-frequency amplification is much more efficient on the longer wave-lengths than on the broadcast

aerial receiver to avoid "pick up" from an outside collector. It must be remembered that a frame makes a very good secondary or coupler to an aerial several yards away.

Having taken all due precautions and given the super-heterodyne instrument a fair test, we invariably find that the local station comes in well with plenty of volume, but the "near-distant" stations, say 80 miles, are somewhat weak, and we have a vague feeling that our old straight set on a poor aerial could do almost as well. Distant stations at 150 to 200 miles are a little difficult to find, and we feel perhaps that we need some more experience with the receiver before we can take them well. As for those weak Continental stations and the occasional American broadcast, which we used to hang on to by very careful reaction, they seem very far away, and it appears that range is falling off owing to external conditions.

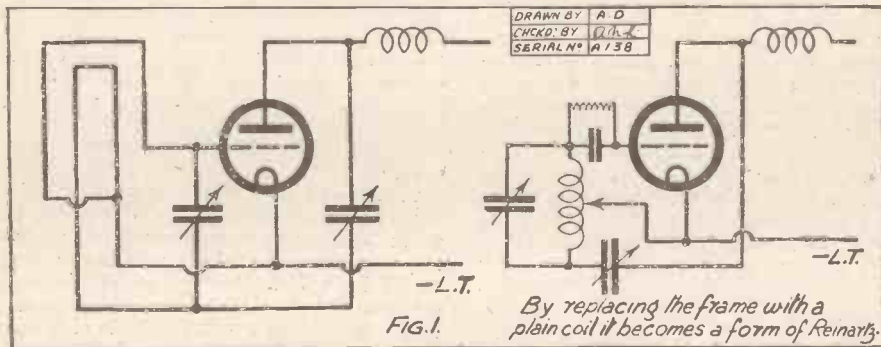

In the course of my travels it is my lot to see a great many home-constructed instruments; good, bad and indifferent; some failures and others very good successes. To get some idea of the percentage of errors and why they occur, I have kept a tabulated list of the faults I see and the type of instrument in which they occur most often.

Large Percentage of Failures.

I do not wish to go into the numerous and varied troubles that worry others, but I think a short discussion on the super-het. receiver and the most prominent faults found in them might be of interest to those readers who contemplate building, or who have found difficulty with their own instruments.

The percentage of semi-failures, even amongst the fairly technical constructors and experimenters, is rather alarming. Great ranges are expected, but when the multi-valve instrument is completed and made to work according to instructions, the builder is inclined to think that "The Americans DO exaggerate a bit." I will not attempt to deny this American trait. I am of the opinion that statements which come over long distances are often somewhat

band. Also that the heterodyne system of frequency changing can be absolutely efficient and free from distortion. Why is it, then, that we hear so often that so-and-so can get better ranges on his one valve with reaction on the aerial, than somebody else can with a seven or eight valve super-het.? And where is this loss?

I know that at this point there will be some readers who would like to dispute me, but let them first prove that their frame aerial is working as a perfect loop and that it is the sole collector of energy. (The easiest test is, is the frame definitely directional.) Remember that I have a little list which tells me that over 40 per cent of the super-hets. I have seen working well were picking up most of their signals from a broadcast aerial terminating in the same room. When the aerial was properly earthed (outside) or the set moved to my test room, the range diminished by about a half. Great care must be taken when using or testing a frame

Distorted Results.

Just one more little complaint, please. When we have brought in our long distance station and by the use of a really trustworthy note-mag. put it through to the loud speaker, the tone is not quite up to our old standard. We may be using power valves with the correct H.T. and grid bias and have taken all usual precautions; but

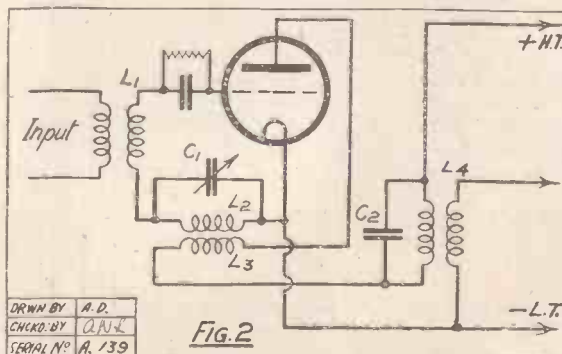

the music is very deep-throated and inclined to be "drummy," the upper register and De Groot's E string is not all there.

(Continued on page 234.)

THE SUPER-SONIC HETERODYNE RECEIVER.

(Continued from page 233.)

The announcer sounds like an American speaking with a plum in his mouth, etc. We tell the wife that So-and-so's transformer is faulty, must be returned to the makers. Then, like good experimenters, we start afresh with the headphones and get very hot and bothered with the intricacies of the super-sonic system.

I detest writing destructive criticism, but now we have clearly stated our faults,

efficiency of a detector is proportional to the square of the input voltage, and our super-heterodyne is no exception to this rule. It is vitally important that we feed some reasonable amount of signal voltage on to our first detector and oscillator. Unless our frame and component circuits are of fairly low loss, the H.F. resistance will damp out almost everything but the strongest signals.

Reaction Essential.

I once read an article on H.F. amplification in which the author stated that "the super-het. was not really H.F. amplification, but only a simple detector followed

copper on a low loss former; that is, providing there is sufficient reaction to overcome the damping.

It is rather surprising that experimenters should be caught on the same point again. It is only a year or so ago that we used to build, or try to build, a receiver employing two or more stages of H.F. in the hope of doing away with reaction. But we found that unless we made provision to reduce the H.F. resistance of at least one of our circuits to almost zero, we could not entice the weak signals in. Reaction has been our greatest friend for years (when properly handled) and yet as soon as we see a chance of obtaining a really efficient amplifier, we turn our old friend down, and try to do without him.

It will be a long time before we are able to find anything more sensitive to an H.F. impulse than a circuit on the pre-oscillation point. And to-day there is no better way of obtaining this delicate point of balance than the use of a valve with the plate circuit coupled back to the grid circuit or input side. There are several ways of doing this, and if we wish to get really good DX results with our super-het. we must devise some means of applying reaction, at signal frequency, to our frame aerial or input circuit.

Good Results on Three Valves.

Space is too small to go into a long technical description of all the arguments for and against this suggestion. I must ask you, once again, to take my word for it. Perhaps doubts will be set at rest if I say that I am prepared to prove, by practical methods, to anyone interested, that it is possible to receive any B.B.C. station and several American stations on a three-foot loop using only one stage of intermediate amplification and this form of lowering the input damping. That is, using only three valves but of course reflexing the first.

There are several ways of providing this reaction, but I think it best to provide a valve for the purpose; it is well worth it. If you are using a separate oscillator you would be well advised to make the first detector do this work, and so save a valve. The first detector is quite capable of doing its own oscillating, providing you use a good circuit. In my experience you cannot do better than to make this detector oscillate at just double the receiving wave-length, i.e. 700 odd metres, and let the first harmonic of this wave-length heterodyne with the incoming signal. This saves a lot of trouble and expense, and also keeps the frequencies well apart. Otherwise the strong oscillations, being only a few metres off tune, would damp out weak signals in the frame and cause trouble with inter-locking frequencies, etc.

Having saved a valve, we cannot do better than use it as an H.F. amplifier at
(Continued on page 235.)

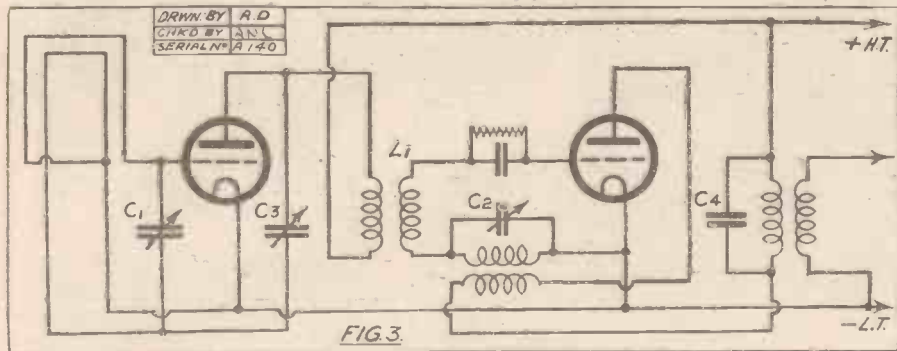

we can proceed together in finding solutions for our troubles.

Although I always place quality first and foremost in broadcast reception, I fear that in this instance I must leave that question till later. Too much technicality is apt to be trying at times.

I must ask you, then, to take my word for it now. "That it is easily possible to get rid of this mysterious distortion and that good quality is more practicable on the super-sonic system than on most long range receivers." I should like to discuss this another time.

Increasing Sensitivity.

We will tackle the question of poor range first. I don't think we need plod through the whole theory of the system here; reference to previous articles will assist with any point I do not describe fully.

The intermediate frequency amplifier when employing several stages may have an amplification of 5,000 fold, and this is often pushed to 10,000 fold with the careful use of regeneration. Then why is it that we do not always get this amplification? A small frame aerial may only pick up one hundredth part of the signal energy obtained by an outside aerial, but with this power of amplification available we should still get good results. Is it that our amplifier is faulty? In my experience it is very rare that the constructor fails to get fairly good amplification at the intermediate frequency, that is, providing he uses good class components and does not attempt to use too low a wave-length. Anything over 2,000 metres is usually easy to handle. Also, this portion, connected with the second detector and note-mags. (if any) is easily tested, there are plenty of long-wave stations working which will prove the efficiency or otherwise of this H.F. amplifier.

The fault usually appears at the first detector or frequency changer. For some reason designers fail to give this enough attention. It is fairly well known that the

by an excess of low frequency amplification." Although this caused a laugh at the time, I have since realised how well he described a great many of the attempts made at this system to-day.

Whichever system of oscillator you use, whether it be separate oscillator type, Tropadyne, or on the first harmonic principle, there is always a fairly heavy damping on the frame circuit, with the result that the weakness of weak signals is out of proportion, altogether, with the strength from the local station. It is almost impossible for the amateur constructor to design and build a frame and oscillator coupling which would have a very low H.F. resistance, so why attempt it? Remember reaction covers a multitude of sins. A coil of 40 S.W.G. wire wound in wax is just as capable of oscillation on short wave as a coil of 16 gauge bare

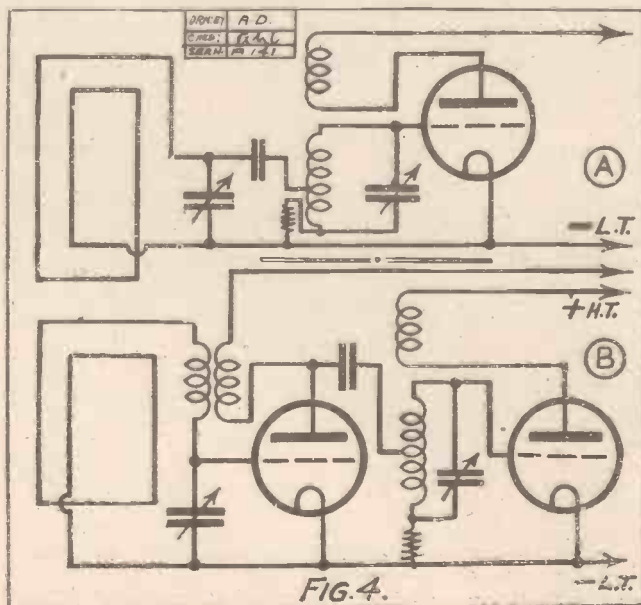

THE SUPER-SONIC HETERODYNE RECEIVER.

(Continued from page 234.)

signal-wave-length, in front of the oscillator and detector. This may sound strange; we were trying to obtain an efficient system of super-sonic amplification to avoid the troubles of short wave H.F., and now I am advising you to revert to the old system and put on a stage of the thing we were trying to avoid. I admit that the amplification at signal frequency would not appear very great, but we shall be able to separate entirely the oscillator from the aerial, and so sharpen tuning considerably, as well as being able to apply reaction to overcome all the losses in our input circuits, and bring our frame to that sensitive point of pre-oscillation. Later on, I may be permitted to tell you how this first H.F. may be reflexed with the intermediate frequency; it is quite an easy matter, and well worth the small trouble involved.

Use of an Auxiliary Valve.

An aperiodic H.F. transformer is by far the best form of coupling to use between first H.F. and oscillator. In any event, the tuning here would be exceedingly flat, owing to the strong H.F. at 700 odd metres flowing in the secondary winding. By leaving it untuned we should save one control, which might interfere with the oscillator calibration.

Several methods have been tried for introducing reaction on frame, but I have not found anything better than capacity reaction. To do this we have only to provide a centre point tap on the frame for filament connection, and place a small vernier condenser between plate of first valve and lower end of frame. (Fig. 1.)

For those readers who do not wish to alter the present wiring of their frame,

but would like to try the effect of reaction at signal wave-length, they can fit an auxiliary valve to do this work. It consists of a simple one-valve set tapped on the input by grid and filament connection with some form of reaction between the plate and input side. It is impossible to give a circuit which would suit all existing sets, but I will describe a few methods later. (Figs. 4, 5 and 6.)

The diagram of a first harmonic oscillator would look like Fig. 2, L1 being the aperiodic coupling for input. L2 the grid coil of oscillator. L3 the plate coil coupled sufficiently tight to L2 to sustain oscillations. L4 is the filter or transformer as used for coupling to the intermediate amplifiers.

C1 is a variable condenser of about .0005 mfd. used for tuning the oscillator. C2 being the usual filter condenser.

The completed arrangement would look like Fig. 3. All the values are standard, the condensers C1 and C2 being about .0005 mfd. C3 should be a verrier of small capacity; a Colvern would do well. C4 is invariably supplied by the makers of the intermediate transformers. L1 is the aperiodic transformer for 300 to 500 metres; this can be easily home-made by winding about 125 turns of 42 S.W.G. Eureka D.S.C. for both primary and secondary, in two slots cut about $\frac{1}{8}$ in. apart and $\frac{1}{8}$ in. deep in a piece of broom-handle or round wood (dry).

The action of the receiver now is to tune in a station as before, then, by careful adjustment of the reaction condenser C3, bring the strength of signals up to the desired degree. That is to say, for weak signals the frame should be brought up almost to the point of oscillation, in the same way in which you would bring in a weak station on a straight set.

It will be found that on the local stations little difference will be noticed when the reaction condenser is varied; this is due to saturation of one or more of the amplifying valves, but when taking a distant station the reaction effect will be most marked. Carefully handled reaction should be found to about equal the amplification of two intermediate frequency stages, which can now be cut out, if desired.

Should you inadvertently apply too much reaction and make the frame oscillate, it

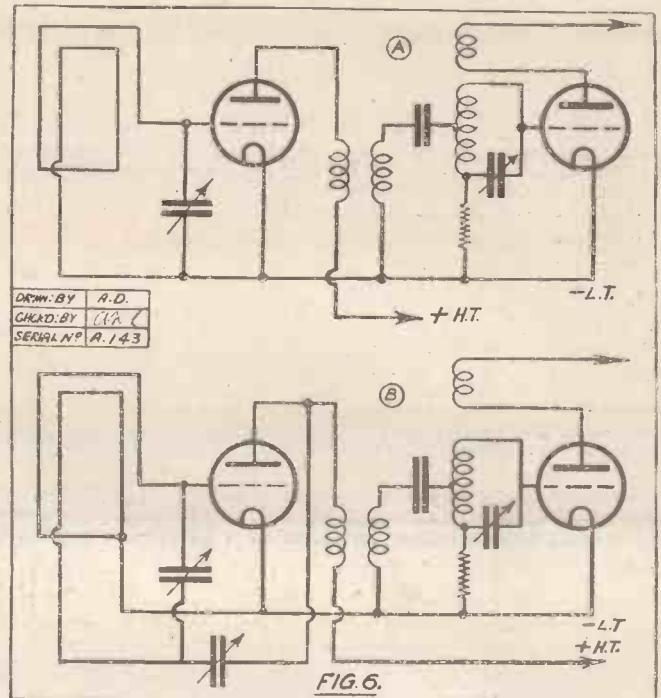

would heterodyne the station you were tuning in and give a note in the 'phones, in exactly the same way as an ordinary straight set. In fact, this note can often be used to find a weak station, but should not be used generally, because radiation may cause interference.

A Few Useful Circuits.

As mentioned previously, I append three diagrams illustrating methods of attaching auxiliary valve for supplying regeneration to frame. Fig. 4a is an ordinary Tropadyne circuit, and Fig. 4b is the method I should advise for attaching auxiliary valve.

Fig. 5a is a fairly common type of separate oscillator system. For this I should tap off the top of frame to grid, and couple plate coil to the existing coil used for oscillator coupling, as in Fig. 5b.

Fig. 6a is rather more rare, but I have met cases of this type. Here we have an H.F. valve, transformer coupled, preceding the oscillator, which is usually Tropadyne type. It is a simple matter to move filament tap to somewhere near centre point of frame, taking the aerial condenser across the whole of frame or inductance and attaching a small vernier condenser from plate to lower end, for reaction, as in Fig. 6b.

There are numerous other methods of applying reaction to the very numerous different types of super-het. systems and circuits. But no doubt experimenters will devise a means for themselves, or, if in doubt, write to me giving a diagram of their present arrangement.

The "P.W." Crystal Experimenters' Handbook

A Thirty-Six Page Book

FREE

With Next Week's "P.W."

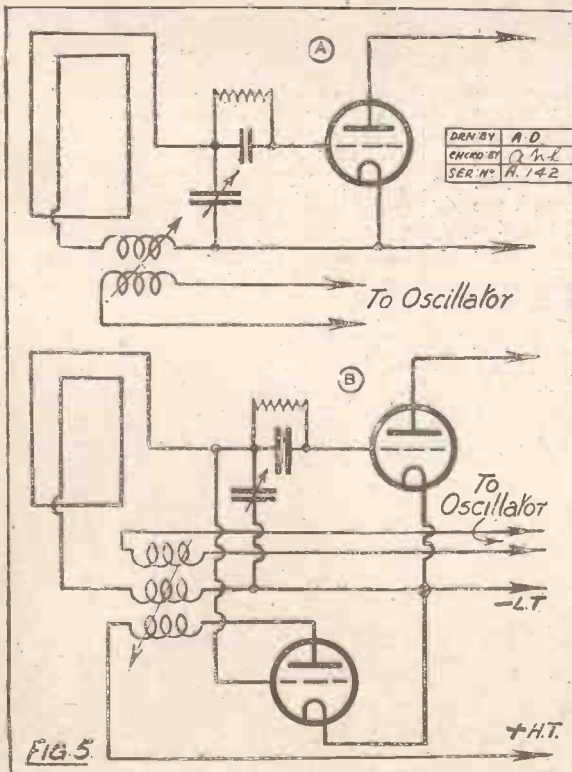

"BOTTLED" WIRELESS.

A Telegraphone Idea.

By J. H. CARDEN.

IT is said that the B.B.C. are seriously considering the possibility of making permanent records of selected items from their programmes in order to give repeat performances for the benefit of those unable to listen to the original transmission. Quite apart from the desirability, on general principles, of keeping a record of speeches of historic importance, such as that made by His Majesty at the opening of the Wembley Exhibition, there is much to be said in favour of sending out each morning a selection of the more interesting items from the previous night's programme.

Gramophone Records.

Such an innovation would be welcomed by many who are unable for one reason or other to listen-in during the evening. At the same time it would enable the B.B.C. to fill in a large proportion of the vacant hours during the day-time at very little extra cost.

At first sight it would appear to be a simple matter to make a gramophone record directly from the performer's voice as he speaks or sings into the microphone. This, however, is not the case. It is difficult in the first place to distribute the sounds between both the microphone and the gramophone reproducer in such a way as to do full justice to both. In the second place the noises from the disc machine are likely to be reproduced in the neighbouring microphone, and thereby affect the quality of the broadcast signals.

Two methods at least have been suggested for overcoming this difficulty. In both cases the currents for creating the permanent record are branched off in parallel from the actual microphone circuit.

The Magnetic "Image."

The first is the so-called telegraphone or electro-magnetic recorder. This device, invented by Vladimir Poulsen of Poulsen-arc fame, is based upon the retentive powers of steel under the influence of a magnetic force. Perhaps the simplest illustration of this property is to be seen in the well-known experiment of writing a

name on the steel blade of an ordinary saw, using one pole of a small horseshoe magnet instead of a pen or pencil. If iron filings are now scattered over the blade they will be "held" along the track traced out by the magnet, and the invisible signature thus shown up in bold relief.

Again, if a steel ribbon is brought within close range of the pole-piece of an electro-magnet, the magnetic flux from which is

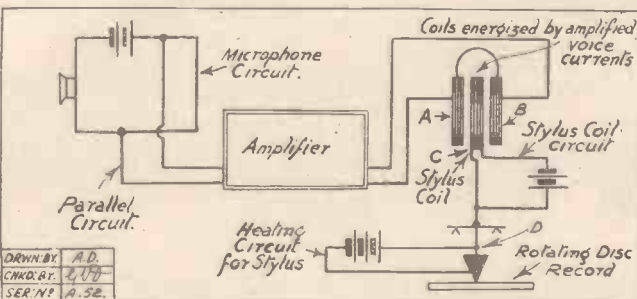

varying in accordance with speech-frequency currents flowing in the magnet windings, it is possible to impose a "magnetic image" of the speech upon the ribbon in much the same way as the signature tracing previously referred to.

Reversing the Process.

Both effects are due to the property possessed by the steel of reacting in a sensitive manner to magnetic influence. The duration of the magnetic image is temporary or lasting according to the quality of the steel or other alloy used in the ribbon, and to the strength of the impressed magnetic field.

As used for recording broadcast a part of the microphone current is branched off through a parallel circuit and is amplified by a series of valves. The output current from the last valve is passed through the windings of an electro-magnet, and the corresponding magnetic fluctuations from the pole-piece are impressed upon a moving metal ribbon.

In order to reproduce from such a record the magnetised ribbon is unwound past the pole-piece of a second electro-magnet. The lines of force from the "image" on the ribbon induce voltages in the magnet windings. These are passed through a series of valve amplifiers and are finally used to modulate the output from a transmitting valve in the usual way.

A Third Method.

An arrangement for making a permanent gramophone disc record is illustrated diagrammatically in the figure. A part of the original microphone current is passed, as before, through a series of valve amplifiers, the output from the last valve being utilised to directly control the up-and-down vibrations of a heated stylus kept in contact with a rotating disc having a specially prepared recording surface.

The plate circuit of the last valve comprises a pair of flat spiral coils, A, B, spaced apart sufficiently to allow a third similar coil, C, carrying the stylus, D, to move vertically between them. The varying currents flowing in the first two coils react upon the steady current flowing in the stylus coil and so cause the latter to vibrate up and down in much the same way as the diaphragm of the Magnavox, or other electrodynamic type of loud speaker, is vibrated by the received signal currents. This up-and-down vibration is communicated to the stylus, which is kept at a high temperature by means of a separate heating current, and causes it to cut out the usual sound record upon the surface of the rotating disc.

NEXT WEEK!

The "P.W." Crystal Experimenters' Handbook.

Presented Free with every copy of "Popular Wireless."

Don't miss this magnificent gift number.

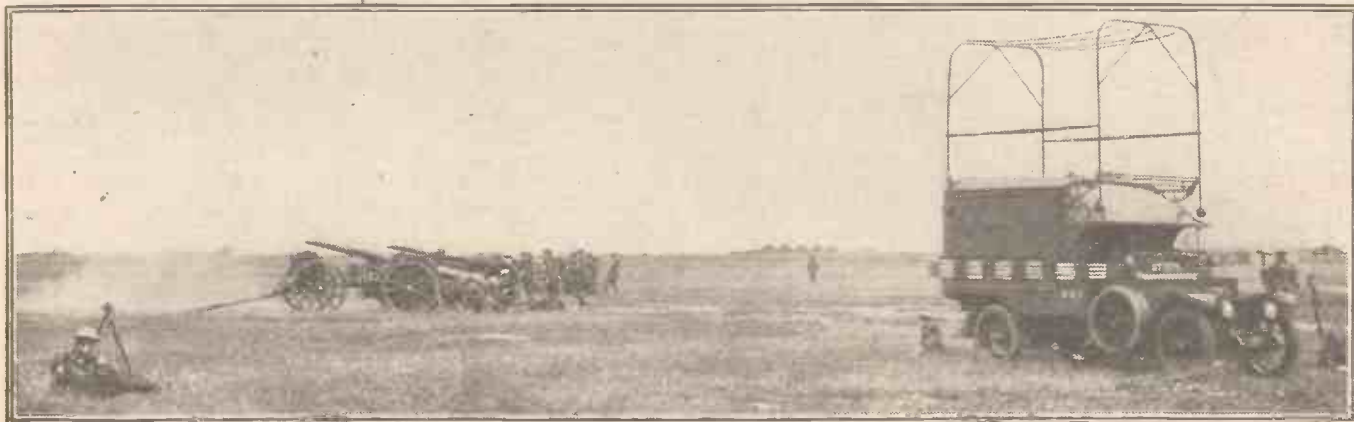

A mobile field wireless station in operation on Salisbury Plain during the Army manoeuvres.

Although extremely easy to construct, this little crystal set gives extraordinarily efficient results. It was made and tested by the "P.W." Technical Staff.



The "P.W." VARIOMETER CRYSTAL SET

NOW that the evenings are longer, thousands of people are asking themselves, "Can I make a wireless set?" The programmes are "on the air" every night, and for most of us only a simple crystal set is needed in order to bring the music, speeches, news

The former may be of any type, but in order to make the set absolutely simple to operate the actual set shown in the photographs embodies a "fixed" detector, which very seldom needs re-adjustment.

of having a single tuning unit is compactness, and the neat appearance of the complete instrument is well shown by the photographs.

Starting Construction.

Having obtained the components, the first step in construction is to mark the panel. This is very easily done from the diagram (Fig. 2), which shows the exact dimensions, providing the components named in the list are used. If not, allowance will have to be made accordingly, but it may be stated in passing that the panel and case specified are of ample size to take an ordinary crystal detector of the cat's-whisker type, if for any reason this is preferred.

(Continued on page 238.)

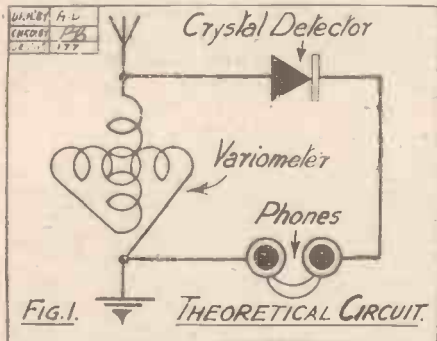

The Tuning.

Tuning is carried out by means of the variometer over the whole range of wave-lengths between 230 and 1,630 metres.

When it is realised that one turn of the dial automatically tunes the receiver between these wide limits, the cost of the variometer—which at first glance appears high—will be found to compare very favourably indeed with the price of any other tuning method. Another advantage

and songs into the home. The aerial and earth connection are easily arranged, but can the set be made easily?

The answer to this question will be found in the following article, which describes a simply-made but efficient crystal set which can be used for the reception of the high-power or local B.B.C. stations.

LIST OF PARTS REQUIRED.

	s.	d.
1 Ebonite Panel 6x6x1/4" ..	4	6
1 Case for above, 4 1/2" deep ..	0	6
4 Terminals ..	0	6
1 Marconiphone Variometer ..	16	0
1 P.M. Crystal Detector (R.I.) ..	7	6

The list of components given above shows that, apart from terminals, there are really only two components necessary—the crystal detector and the variometer.



Tuning the Set

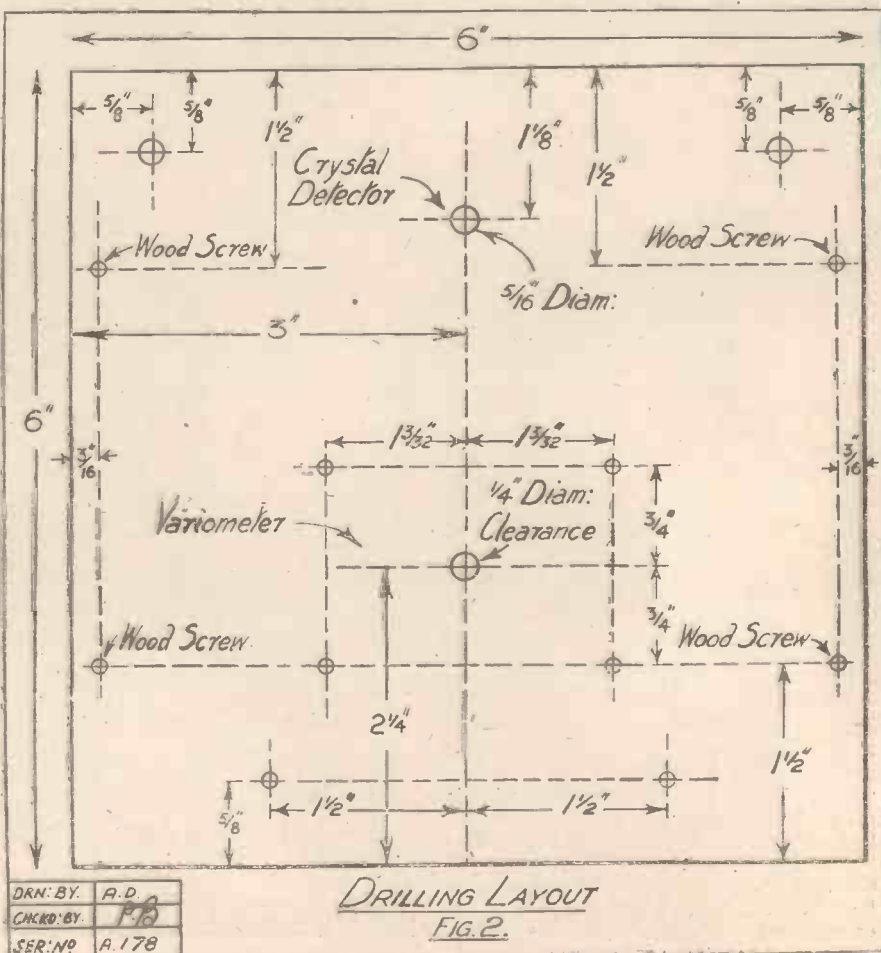

DRN. BY.	A. D.
CHKD. BY.	P. B.
SER. NO.	A. 178

THE "P.W." VARIOMETER CRYSTAL SET.

(Continued from page 237.)

Drilling can be done with one of the little hand-drills now easily obtainable from any wireless dealer, or the ordinary household brace can be pressed into service. The four holes for the wood-screws at the side of the panel are enlarged (on the upper surface of the panel) by a larger drill, to permit the screw-heads to sink flush with the panel. Then the terminals and variometer are mounted and fixed firmly in place, and finally, the crystal detector also.

There are only four wires used in connecting-up, but for maximum results these should be soldered to the terminals.

Where this is impracticable, good, strong, screwed-down connections can be made, but the former method is much to be preferred.

Referring to the

Then the two opposite terminals are joined together and connected to the other side of the variometer, thus completing the wiring.

The fixing of the knob of the variometer can be left over until the wiring is completed, and is carried out as follows. First move the variometer round to the "all-in" position, where the rotor is completely contained inside the stator (below, at the right, the variometer is shown *nearly*

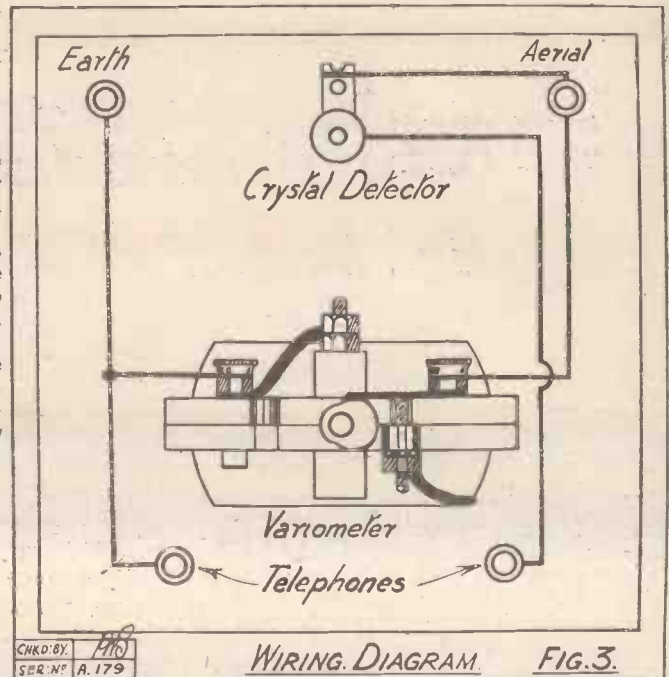

A view of the back of panel, which should be used in conjunction with the wiring diagram.

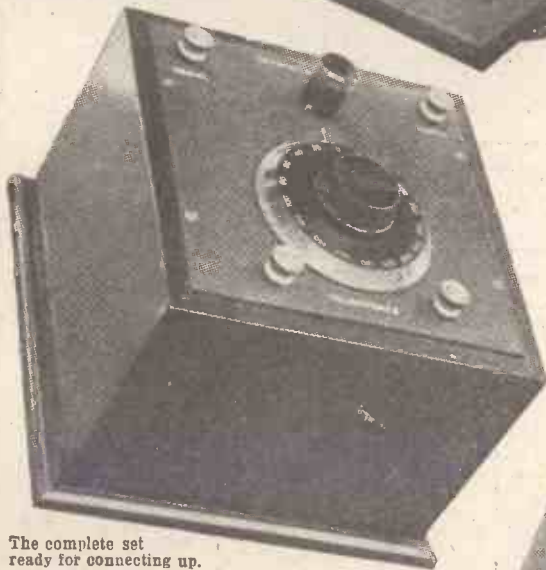

The complete set ready for connecting up.

wiring diagram above, the first wire is that which runs from the crystal detector to the right-hand 'phone terminal. The shape of this wire is clearly shown by the accompanying photograph, and when it has been fixed in place the other side of the crystal detector is joined to the aerial terminal and to one side of the variometer.

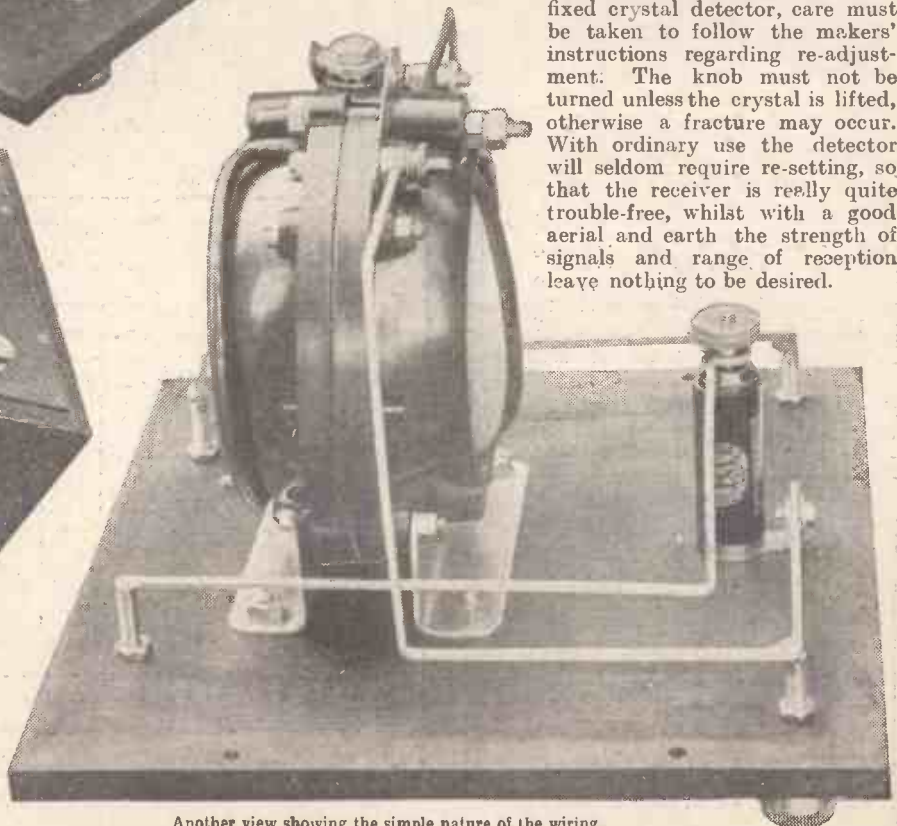

Another view showing the simple nature of the wiring.

"all-in."). Then adjust the dial so that it is exactly opposite

to the crystal detector, and tighten the fixing screw which clamps the knob to the spindle.

Finishing Touches.

The set is completed by fixing the transfers and cleaning the back of panel thoroughly. This last operation is important, but, providing that ordinary care has been taken in the making, there is nothing that can give trouble which is not easily removable by "touching-up" with a clean duster.

The operation of the set is simplicity itself, but if the best is to be got from the fixed crystal detector, care must be taken to follow the makers' instructions regarding re-adjustment. The knob must not be turned unless the crystal is lifted, otherwise a fracture may occur. With ordinary use the detector will seldom require re-setting, so that the receiver is really quite trouble-free, whilst with a good aerial and earth the strength of signals and range of reception leave nothing to be desired.

FREE HANDBOOKS

FOR "P.W." READERS.

THE
"P.W." 6^d
CRYSTAL
Experimenters's
Handbook

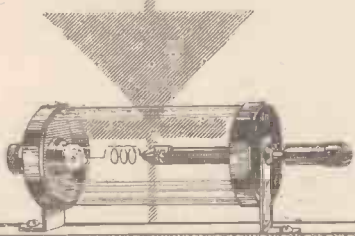

A special "Vade Mecum" for the crystal owner, including contributions by J. F. CORRIGAN, M.Sc., A.I.C., and SEXTON O'CONNOR. Full details for building two crystal sets are also given in this book.

NEXT WEEK.

"P.W.'s" Gift to Readers.

← This 36-page book, price 6d., will be presented free with every issue of "P.W." on sale next Thursday. It has been specially written by Mr. J. F. Corrigan, M.Sc., A.I.C., Staff Consultant to "P.W.," and contributions have also been made to it by other well-known "P.W." writers.

The contents include chapters on The Evolution of the Crystal—The Crystal Classified—Interesting Characteristics of Crystals—How to Make and Test Crystals—The Oscillating Crystal—List of Radio Sensitive Crystals, Minerals, and other substances for general and experimental use—How to Make a Variometer Crystal Set—Duo-Reception Crystal Circuits—Making a Plug-in Crystal Set—and a mass of other information about crystals and crystal sets of interest and value to all amateur experimenters.

A phenomenally heavy demand is anticipated for next week's "P.W.," judging by the larger orders from newsagents, bookstalls, etc., and readers are strongly advised to order next week's "P.W." at once in order to avoid the disappointing answer of the bookstall clerk—"Sold out."

ANOTHER FREE BOOK

With Every Copy of "P.W."

On Sale October 8th.

The "P.W." Valve Experimenter's Handbook is the title of the second gift book to readers who buy "P.W." on sale Thursday, October 8th. Like the Crystal Experimenter's Handbook it consists of 36 large pages—6 x 9 ins.—and is lavishly illustrated with diagrams and photographs.

This book has also been specially written by a well-known radio authority—Mr. E. J. Wyborn, B.Sc., A.C.G.I.—and is full of practical information on valves and valve circuits, etc., which the amateur experimenter cannot afford to miss.

The contents include chapters on How The Valve Works—The Valve as an H.F. Amplifier—The Valve as an L.F. Amplifier—Modern Developments—Reaction—Aperiodic Coupling—Action of the Grid—The Valve as a Detector—The Super-Heterodyne—The Ultra Audion—Super Regeneration—Special Circuit Arrangements—Reflex Receivers—etc., etc., and a special "P.W." Valve Guide, giving prices, details, etc., about every type of British valve.

Again readers are urged to place early orders for "P.W." on sale October 8th, and so avoid the disappointment of missing this valuable gift.

The "PW" 6
VALVE
Experimenter's
Handbook



This handbook has been specially written by E. J. Wyborn, B.Sc., A.C.G.I. The amateur will find the information given on valves and valve circuits written in concise and straightforward language, the text being amply illustrated by diagrams and photographs.

BROADCAST NOTES.

By "O.H.M."

"Narmat and Non-Narmat"—Behind the Scenes—Competitive Broadcasting—American Announcers—Concert Stars and the B.B.C.—Operatic Music—The Agitation Against Relay Stations—London's Talent.

JUDGING from the formal utterances in connection with the opening of the "Narmat" Exhibition, one would have been justified in concluding that so far as Wireless Manufacturers are concerned, the present organisation of British Broadcasting was imminently satisfactory.

I have discovered, however, that there is a good deal going on behind the scenes. The wireless trade in general is tending to divide itself into "Narmat" and "Non-Narmat" camps. Non-Narmat forces are by no means inconsiderable. They have gained ground recently by defections from the other camp. The Non-Narmat group are seriously considering an attack on the unified control of broadcasting. Hitherto the enemies of unified control have been outside the industry. This unexpected adhesion to their cause comes most opportunely and tends to revive the atmosphere of uncertainty in which the report of the Government Committee on broadcasting will be evolved.

American Announcers for Britain.

The new protagonists of competitive broadcasting advocate legislation which would restrict the operations of any one broadcasting company to one station, and this particular group has in mind the establishment of one super power station capable of crystal reception throughout the whole of the United Kingdom. They propose staffing the station mainly with Americans, taking the best talent that can be bought in the United States.

The idea is to maintain this service out of the profits to be derived from the sale of certain proprietary lines of receiving apparatus, the merits of which will be broadcast persistently. I hear that several prominent American announcers have already been approached; but I cannot help thinking that, to say the least of it, such an action is absurdly premature. Before unified control is abolished, the Broadcasting Committee must report against it emphatically; Parliament must introduce the necessary legislation; there must then be re-adjustments of wave-lengths—all of which represents a process that will take at least eighteen months before even a start can be made with the new stations.

I should think that the odds were just about 200 to 1 against the success of this scheme, and I hope, therefore, that those of our American Radio colleagues who have been approached with tempting offers will not entertain high hopes that these will ever materialise.

Concert Negotiations Successful.

I gather that, although there is still no general agreement between the B.B.C. and the concert industry, enough progress is being made to make it possible for the B.B.C. to include in their programmes this winter a fair proportion of the big stars

they have been after. To mention names at this juncture would be to imperil the conclusion of the negotiations. It is interesting to note, however, that the intervention of the gramophone industry to assist the progress of agreement has been both opportune and effective.

Reorganisation at Savoy Hill.

The process of re-organisation at B.B.C. headquarters, which I described some time ago, is now nearing completion. It is, of course, quite impossible to stabilise any enterprise which is still in its experimental stages, and which is developing so rapidly

will follow will not only damage the B.B.C. but also the cause of good music itself.

S.B. Preferred.

The agitation against relay stations putting on any programmes of their own is now assuming more serious proportions. The movement is spreading to the areas of the provincial main stations, in some of which it is being seriously advocated that all local programmes should be eliminated and that the whole country should get 2 L O and 5 X X only.

The sponsors of this idea regard the London programmes as being continuously

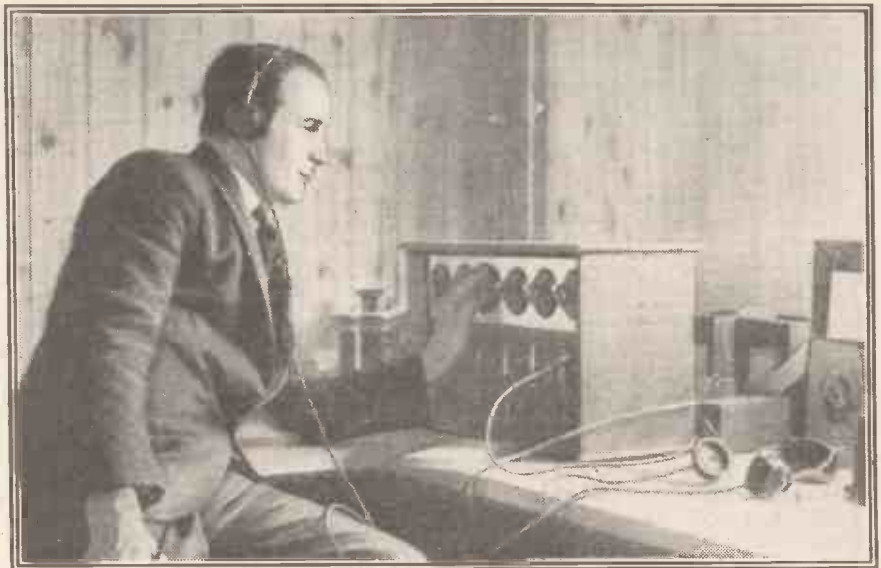

Tuning-in one of the receivers at the experimental B.B.C. station at Hayes.

that frequently the whole position is transformed within a fortnight. But already the improved showmanship of the programmes and the easier transition between items are an adequate justification of the changes that are being made.

Better Music for the Winter.

The indications are that listeners will be provided generously with operatic music during the coming season.

In October and November the B.B.C. will send out B.N.O.C. opera, and several times a week. There will be more broadcasting of concerts this year than last. The symphonic and operatic societies of the Midlands are also to be broadcast fairly fully. I hope the Savoy Hill people realise that there are limits to the public appetite for this high-class music. It is all for the good that the programmes should be improved, and that on the average programme material should be a little above what might be described as fulfilling the requirements of the moment. But, if the margin is made unreasonably big the reaction that

superior to those of other stations. They point out that if all other stations become simply relays, then a considerable sum of money would be released to increase still further the variety and efficiency of the London programmes. The old objection to long land-line transmission no longer holds in view of the establishment of sub-relay stations, such as the one at Leeds.

While, of course, there are points in this argument, I do not think they are strong enough to outweigh the desirability of identifying at least main stations with local aspirations and characteristics. At present the best items in the London programmes are simultaneously broadcast through other stations. Provincial listeners may have gained the impression that all the items in the London programmes are as good as those which are broadcast simultaneously.

This is by no means the case. While naturally London is in a position to get a wider range of talent, some of the provincial main station programmes are even more varied and better all round than those from the metropolis.

Now, Perfect Reception costs you still less

**EDISWAN
DULCIVOX
LOUD SPEAKER**

Reduced in Price from 2 Guineas to

37/6

(BLACK FINISH)

This latest reduction in the price is yet another stage in Ediswan Policy of making Perfect Reception available at the smallest cost.

The Ediswan Dulcivox is well known to give clear and natural reproduction, unmarred by any "tinniness" or "gramophone effects."

Suitable for rooms 12 to 14 feet square. 18½ inches overall height. Flare diameter 9¾ inches. Resistance of windings 2,000 ohms.

Hear the Ediswan Dulcivox at your Wireless Dealer's.

**THE EDISON SWAN ELECTRIC Co. Ltd.,
123-125, Queen Victoria Street, London. E.C.4.**





Try a Sparta in your home. That fine full tone is a secret shared by no other loud speaker. You can make your own interpretation . . . there is a tone modulator in the base.

SPARTA
Fuller
ALL BRITISH

LOUD SPEAKER.
FULLER'S UNITED
ELECTRIC WORKS LTD.,
Chadwell Heath - - Essex.
Telephone: - - - Ilford 1200.
Telegrams: "Fuller, Chadwell Heath."
London Depot:
176, Tottenham Court Road, W.1.
Telephone: - - - Museum 9008.

The Type B Sparta is supplied with diaphragm adjustment and tone controller for six positions. 120 ohms, £5 15s.; 2,000 and 4,000 ohms, £6. The Type A model without tone controller is supplied for 120, 2,000 or 4,000 ohms, £4 15s. The Little Sparta is supplied in the same three ohmages for 55s.

*The Secret
is in the
Base*

174-50

They're "nothing to look at,"
cost more money but

**compare
the
results**



Patent
applied
for.

**THE NEW
"MARS"
COIL**

The "Mars" is the plain Jane of the super low-loss coil family without a single pretty, pretty ornament. The "Mars" cost a few pence more than most super low-loss coils. Why, then, is it so popular? Only because it gives appreciably better results. The moment you "plug in" the difference is apparent—louder, clearer, more musical signals.

There are reasons. The wire used is ten times more efficient than ordinary wire—it is multi-strand wire with the exclusive spiral spin and triple conductor features. ("Mars" patent No. 229,058.) The coil is wound in a novel way, the method being based on the principles of harmonics. Each wire crosses the next, so that there are no parallels.

Already, hundreds of listeners have endorsed the merits of this new coil. Get yours to-day.

PRICES:

For Broadcast Wavelengths.		
No.	Price	'0005 Condenser
35	4/9	280 to 440 metres
50	5/0	390 ,, 680 ,,
75	5/3	600 ,, 1,000 ,,

For Daventry, etc.		
150	7/1	1,100 ,, 2,050 ,,
200	8/0	1,450 ,, 2,300 ,,
250	8/9	1,800 ,, 2,700 ,,

If you're just
starting—start
right—get the

"MARS" AERIAL

Nearly 50,000 were sold last season. Nothing to compare with it has been introduced since. Consisting of 84 strands of SPIRALLY WOUND hard drawn phosphor bronze wire, its ohmic resistance is TEN times less than ordinary aerial wire (7/22's). The "Mars" Aerial gives valve set volume to the simplest crystal set; enables valve set users to get distant elusive stations more clearly and with greater certainty. Costs 9/6 per 100 ft. Beware of "Ma's" and "Pa's" Aerials—they're imitations—NOT spirally wound, often less efficient than ordinary 7/22's wire. "Mars" Specialities are stocked by all progressive wireless dealers. Thirty leading Wholesalers distribute them. In case of difficulty in obtaining, send P.O. to the Sole Manufacturers and patentees:



E. & W. G. MAKINSON, LTD.,
Wellington Works, Wellfield Road,
PRESTON.

100 ft.
9/6

The Right Resistance

There is always just one value of the grid leak best suited to the characteristics of your detector valve. Tone quality, signal strength, good reception, all depend in no small measure upon this correct resistance being obtained—and maintained. Don't handicap your receiver—use a Watmel and make sure of obtaining the exact value. Send for descriptive folder.

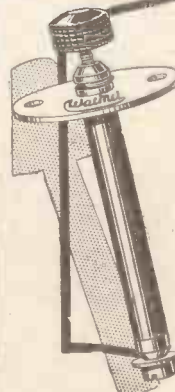

GRID LEAK (Black knob) 5 to 5 megohms
ANODE Resistance (Red knob) 50 000 to 100,000 ohms
2/6 3/6
10 000 to 50,000 ohms (Green knob) 3/6

The Watmel Wireless Co., Ltd.
332a, Goswell Road,
London, E.C.1.

TEL.: Clerkenwell 7990.
LANCASHIRE & CHESHIRE REPRESENTATIVE:
Mr. J. B. Levee, 23, Hartley Street,
Levenshulme, MANCHESTER.

IS SOLDERING WORTH WHILE?

An Alternative Method for Constructors.

By O. J. RANKIN.

THE common practice of soldering connecting wires direct to terminal shanks is, in the writer's opinion, a mistake, not only on account of the general difficulties encountered in heating the mounted terminals—and incidentally the surrounding ebonite—to a temperature at least equal to that of the melting-point of the solder, but also because the majority of enthusiasts cannot make efficient joints in this way without making a general mess of things.

Danger of "Dry Joints."

Clamp the terminals as tightly as possible to the ebonite panel, solder the connecting wires to the shanks *efficiently*, turn the panel over for the test, and you will soon realise that you have yet something to learn about the expanding and contracting properties of metals and other materials, such as ebonite, when you find the terminals turning bodily on the panel and shearing off the wires underneath.

Of course, there are both efficient and inefficient connections; the latter are easily made by simply touching the end of the soldering-iron and making a sort of "dew-drop" joint which apparently holds the end of the connecting wire in position. All may seem well until of course something goes wrong, and then one wonders why and how such things as "dry joints" develop. To make a really efficient joint to a terminal shank the whole shank should be tinned—and what a job when the terminal is fitted to the panel!—and a small "blob" of solder should be run over the end and well into the first three or four threads. In doing this it is necessary to *heat* the shank, and not merely warm it with the point of the iron. The consequence is that the ebonite heats up to almost sizzling point, and since heated ebonite requires at least a week to harden again, I very much doubt if there is a more troublesome method of making so-called efficient connections.

When Terminals Loosen.

A very common complaint amongst non-technical enthusiasts is that, although they have purchased—invariably from a local amateur—a "fool-proof" receiver, something or other has gone wrong almost immediately, and in nearly every instance the trouble can be easily traced to—soldered joints.

The amateur constructor, having a strong desire to make a "job" of the outfit, has followed the best (?) advice and soldered all connecting wires to the terminal shanks. In his haste to get things going, he has overlooked the matter of overhauling all terminal nuts after making the soldered joints, and the result is that when the owner connects up a new battery, or an extra pair of 'phones, he finds a loose terminal, and in

trying to tighten the terminal by a natural screwing-up movement on the face of the panel, he turns the whole terminal round in the ebonite and shears off any joints on the end of the shank.

Alternative Methods.

Another disadvantage is that when a terminal shank is covered with solder, that terminal is doomed to remain for ever in the same place on the panel, since it is almost impossible to melt away the solder and make the thread sufficiently clean to pass the nut without binding.

Let us now consider a few alternative methods of making under-panel connections.

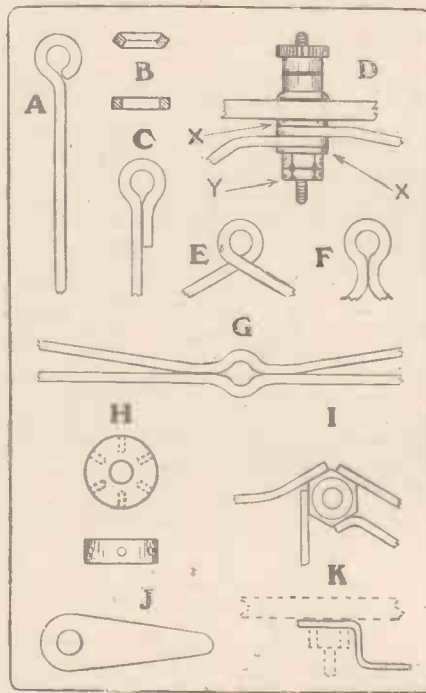

In Diagram A the ends of the square section bus' bar leads are neatly looped by means of a pair of round-nosed pliers, and arranged to slide over the terminal shanks. The loops should not be formed in a haphazard manner.

Care should be taken to avoid an uneven or true edgewise surface, as indicated in the upper sectional diagram at B; the correct method of making the loops is shown in the lower diagram (B), where it will be seen that both sides of the loop are perfectly flat. If fairly stout bus bar is used, it will not be necessary to seal the loops with solder, but with finer wire it is always best to do so, since the thrust of the terminal nut often opens out the loop.

Diagram C represents about the best form of soldered loop, and although the

tinning on the bus bar is usually sufficient for making the joint, it is as well to add a slight trace of solder. It is most important that the sides of the loops are perfectly flat, and if necessary they should be trimmed up with a smooth file before being fitted to the terminals. Diagram D shows how the loops are clamped tightly between two washers (X) to the terminal shanks, a small lock nut (Y) being used to prevent the terminal nut from slackening, if so desired. The washers should be quite flat and thoroughly cleaned with emery cloth. In this way one has a good sound joint which can be dismantled at any time without the least trouble.

No matter how many connections are to be made to a terminal shank, it is always best to provide a separate looped lead for each; but where this is impractical, a single length of wire may be looped, *not* in the manner shown in Diagram E, but as indicated at F, where the loop is arranged as shown and firmly soldered.

The Use of "Tags."

A single loop may be made to serve as a junction for three or four leads in the manner shown in Diagram C, but if one is not capable of making good strong sweated joints, this method is best counted out.

Diagram H shows how an ordinary brass bush is drilled to accommodate the leads which are soldered into the holes before the bush is fitted to the terminal shank, and Diagram I suggests another very simple method where the leads are soldered to the sides of a small brass nut, the threads of which are previously filed out so that the hole is large enough to slide over the terminal shank.

One of the very best arrangements is shown in Diagrams J and K, where a simple sheet-brass tag is cut out and drilled as shown to fit over the terminal shank, and bent to the shape indicated at K. Several tags may be firmly clamped under a terminal nut, and since they are made from thin material and well spaced from the ebonite panel, the leads may be soldered to same with the greatest ease and without the least risk of heating up the terminal or the ebonite.

Emulating the Engineer.

In conclusion, I would say by all means solder your connections, but do not expect good results by cutting off corners, so to speak, and soldering wires direct to terminal shanks. An engineer does not make pipe joints in a haphazard manner; each joint receives special attention, collars or flanges being brazed to the ends of the pipes beforehand, machined, and provided with union nuts, or bolts, before being passed on to the fitter.

The wireless constructor should follow this example; he should first make a joint and then fit it, and not commence the job at the fitting stage. A little extra care at the outset is all that is necessary; let the receiver be "engineer made" throughout, and there will be no "after-worries."

READERS' QUERIES.

"Popular Wireless" offers its readers the best Technical Queries Service in the country. Turn to the Radiatorial page for full details, and don't fail to take advantage of the advice of experts if you are in trouble with your receiver.

FOREIGN RADIO NEWS.

Military Bombshell in Radio Camp.

Proceedings before the "military police-court" in Landau have thrown a veritable bombshell in the camp of radio amateurs in Germany.

A school teacher, Herr Julius Henn, living in Edigheim, was prosecuted before the court on the demand of the Allied occupation authorities for having installed at his home a radio receiving set. The official prosecutor advanced the amazing theory that this constituted "a grave danger to the safety of the occupation authorities." The unfortunate amateur was condemned to pay a fine of 300 gold marks and to have his apparatus confiscated.

Wireless users in the Rhineland are hastily dismantling their sets, but the alarm has extended beyond the occupation region. It is known that the German military authorities are by no means enamoured of "civilians" having radio sets, and the fear is expressed in many quarters that, on the now not far-distant day when Allied control is removed, the German military men, whose powers and arrogance are swiftly increasing to something approaching pre-war conditions, may seek to make trouble for amateurs.

Schoolwork Neglected.

The Japanese Minister of Public Instruction has sent round a circular to all schools under his control stating that it has come to his notice that "schoolboys are inclined to pay so much attention to radio that they are neglecting their schoolwork. Teachers are instructed to draw the attention of boys and of their parents to the fact that listening-in to radio programmes, however useful and agreeable it may be, is not a proper substitute for performing home lessons."

Hospital Wireless Sets.

Two more Paris hospitals have installed radio for the benefit of the patients
(Continued on page 260.)

KOENIGSWUSTERHAUSEN

(Continued from page 218)

being stopped during intervals between Morse signals, when the grid through the main relay is connected up to a negative preliminary tension of about 100 volts, thus avoiding any automatic vibrations of the transmitter. In order to keep the rise in anode tension within low limits during intervals resonance condensers have been inserted in the generating circuit.

(1) *Rectifier and Valve Section.* The 500-cycle alternating-current output feeding the valve anodes is led across a double-pole main switch, two fuses, and a double-pole self-acting switch actuated by a push button, and automatically released by contacts in the transmitter doors. Two signalling lamps are provided at the front of the valve section switch panel, the red lamp being lighted when the transmitter is "on" and the green lamp with the transmitter switched off, though with the auxiliary D.C. supply

switched on. The switching relay and signalling lamps are fed from the existing 220-volt D.C. system.

Wave-length Control.

(2) *Intermediate Circuit.* This mainly comprises the intermediate circuit coil and variometer, the intermediate-circuit condenser and the intermediate-circuit ammeter. One stationary and one rotary aerial coupling coils have moreover been fitted into the intermediate-circuit section. The intermediate-circuit coil is so designed as to reduce losses to a minimum. Its upper windings are designed for variable coupling, and are used as variometers for wave correction. Switching over from one wave to another is done by acting on the self-induction by means of a 5-stage switch, the capacity of the intermediate circuit remaining constant throughout the whole range of wavelengths.

Intermediary-circuit currents can be read from the intermediary-circuit ammeter. The aerial coupling is constituted by the stationary and rotary coupling fitted into the intermediate-circuit coil. The coupling coil by varying the impedance of the intermediate circuit enables the intermediate-circuit current to be acted upon within wide limits, thus adjusting accurately the anode tension derived from the intermediary-circuit condenser. The proper adjustment of this is shown by the plate current of the valves, i.e. by the incandescence of the anodes.

(3) *The Antenna Circuit* is made up of the antenna extension coil, variometer, ammeter and reduction condenser. The aerial extension coil comprises a single layer of windings, a strand coil of very low damping being coupled up in accordance with the wave-length required. The antenna variometer, which is made from the same material, serves to bridge the various stages in the extension coil, so that each working wave desired can be adjusted continually throughout the whole wave-length range. The aerial ammeter is used for reading the current intensity passing through the antenna circuit. A reduction condenser is used to shorten the antenna, a short-circuit switch short-circuiting this condenser whenever the aerial is to be left its full length.

The Modulating System.

(4) *The Controlling Transmitter* comprises an intermediate-circuit transmitter of about 1 kw., with a generating valve of about 10,000 volts, being like the main generator designed for five predetermined wave-lengths. This controlling transmitter can, in the same way as the main transmitter, be adjusted for five predetermined wave-lengths.

The modulating system constitutes part of the controlling transmitter, and comprises two modulating valves, by means of which the continuous current in the grid of the main transmitter is controlled in accordance with the speech frequencies. The apparatus for a direct speech input (transformer and microphone) have been included in the controlling transmitter frame. A switch mounted on the transmitter enables it to be switched over at will to "telephony" or "telegraphy." Special preliminary amplifier arrangements have to be fitted close to the transmitter whenever this is to be used for telephony.



The PM4 Valve

The Finest Loudspeaker Valve ever produced

The P.M.4 Master Loudspeaker Valve stands triumphantly alone above the accepted standard in valves for loud-speaker reception.

It is the NEW "N" FILAMENT VALVE!

This "N" filament is prepared by an entirely new process, whereby the special coating is obtained in an extremely adherent condition, making it capable of giving considerable electron emission at very low temperatures.

There are four supports to this unique "N" filament. It is absolutely non-microphonic. The low current consumption of only 100 milli-amperes means vastly increased valve life and longer battery service without recharging.

Only a 4-volt accumulator or three dry cells are required for the P.M.4 Master Valve.

Try one in your set to-night and note the wonderful purity of tone and volume you will obtain from your loudspeaker.

PRICE 22/6 EACH

Ask for Leaflet V.R.28.



Mullard

THE MASTER VALVE

Advt.—The Mullard Wireless Service Co., Ltd.,
Bulwer, London, S.W. 12.



"I am responsible!"

The real test of master valves is a question of perfect radio reception. It is very easy for me to design a valve with the strong flow of electrons that you hear so much about, but all the electrons in the world will not give you the perfect valve unless that flow is in absolutely correct proportion to the entire design of grid and anode.

It has been a great joy to me to see the tremendous successes of the valves my department has designed and tested. Mullard transmitters speak and the world hears through Mullard receiving valves.

I have found greater and greater scope in making valves to please you all, and have pleasure in recommending to you for perfect purity of radio reception

Mullard

THE MASTER VALVE

Ask your dealer for leaflet V.R. 26 for Complete Range of Mullard Master Receiving Valves.

P.W. 2.

Advt. The Mullard Wireless Service Co., Ltd. (P.M.), Nightingale Lane, Balham, London, S.W. 12



Give a good set its best chance

It's unfair to choke it with poorly designed coils. H.F. Currents demand area; ATLAS LOW-LOSS COILS are wound with twin-wire and offer a double-surface path. Everything that is known of low-loss coil design is incorporated, and whether it's a question of distance, selectivity, volume, or all combined, there's no serious rival to Clarke's ATLAS LOW-LOSS COILS. Price 4/3 to 17/6. Clarke's ATLAS Special Daventry Coil No. 175. Price 7/9 each.

Patent No. 215053.

Sole Manufacturers—
H. CLARKE & CO. (MCH.) LTD., Radio Engineers, ATLAS WORKS, OLD TRAFFORD, MANCHESTER.

CLARKE'S "ATLAS" LOW LOSS COILS



The Symbol of Perfect Service & Reliability.

The Distortionless Guaranteed British
"RENOWN"
 L.F. Intervalve Transformers are made in ONE QUALITY ONLY and in ALL RATIOS Suited to EVERY Circuit. Used by Manufacturers and discriminating Constructors of Receiving Sets, the World over.
 Price 8/4

40,000 Turn Iron Core Inductance
 Choke Couplers, Price 8/4

WRITE FOR DESCRIPTIVE LITERATURE.
 We REPAIR ANY MAKE of L.F. Intervalve Transformer, with our efficiency equal to new guarantee, for 5/-

TRANSFORMER REPAIR COMPANY,
 HAY STREET, PORTSMOUTH



Too near the Band to be pleasant—

is often the effect obtained by volume from a receiving set. Invariably, however, the fault lies with the Intervalve Transformer—not the microphone. The secret of perfect amplification is demonstrated by the

SUPRA L.F. TRANSFORMER

Distortion is unknown on sets which include a Supra Maximum amplification and stability are guaranteed, yet the price to you is only **12/6**

WYATES BROS. LIMITED
 Head Office: 12-14, Gt. Queen Street, Kingsway, W.C.2.
 'Phone: Gerrard 575-576. 'Grams: "Zywateseng, Westcent."
 Works: LONDON, BIRMINGHAM, and WESTCLIFF.

This is the first of three special articles which have been written in response to numerous requests from readers anxious to know more about crystals. The past and present theories regarding the action of the crystal will be dealt with in a way understandable by every reader.

THE CAUSE of CRYSTAL RECTIFICATION

PART 1
of a new series
of
THREE ARTICLES
by
J. F. CORRIGAN,
M.Sc., A.I.C.
(Staff Consultant).

IT is rather an interesting and a significant fact that most of the theories of crystal rectification which are now included in the text-books of radio science had their origin long before the crystal set, as a receiver of broadcast transmissions, was ever thought of.

Such a fact is an interesting and a significant one, because it illustrates the manner in which the attention of scientists and other investigators has been applied to the elucidation of valve problems, and to other spheres of radio interest, rather than to the working out of the exact nature of crystal rectification.

The phenomenon of crystal rectification has been known, and practically applied to the reception of wireless signals, for a period which is now something like eighteen years. But despite this fact, the present-day crystal investigator is nearly quite as much in the dark, when he comes to consider the precise manner in which the crystal exerts its rectifying action, as was his confrère of eighteen years ago.

Remarkable Characteristics.

The conditions under which various crystal contacts and combinations of different crystals will rectify have been investigated, and, in many cases, fully worked out, but, up to the present day, it is safe to say that the basic and underlying reason of the crystal's rectifying action is as imperfectly understood as ever it was.

Furthermore, since the introduction of the crystal as a radio rectifier, it has been found to possess other remarkable characteristics which are in every sense quite as mysterious in their nature as its rectifying properties. Besides being able to rectify H.F. currents, there are a number of crystals which are now known to be able to generate oscillations when they are connected in suitable circuits, and, in addition, several varieties of crystalline minerals have recently been shown to possess the extraordinary property of converting light rays into electrical impulses.

Other strange and unusual characteristics which are possessed by some varieties of crystals show themselves in the effects of "pyro" and "piezo" electricity. That is to say, crystals possessing these properties are able to generate electrical currents in their interiors when they are either heated or subjected to varying amounts of pressure. But here again, practically nothing is known about the causes of these effects. One can only surmise certain probable actions which might account for the effects. However, it is with the now everyday phenomenon of crystal rectification that we propose to deal in these articles, and therefore, for the time

being, at any rate, the other equally interesting, though not at the present so practically important, characteristics of the crystal must be placed in the background.

The main theories which have been advanced in order to explain the nature of crystal rectification may be divided into

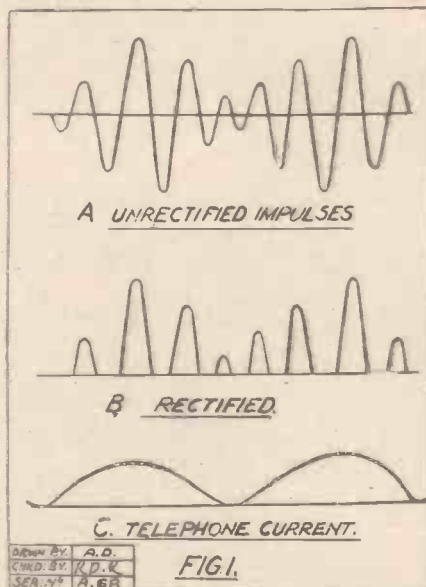

four distinct categories, and, although each of these classes may be submitted to a process of further division, it is sufficient for our present purpose if we consider them as they are without introducing any more complexities than are necessary.

Theories of crystal rectification may, therefore be divided into four distinct classes as follows:

1. Theories assigning the cause of crystal rectification to abnormalities in the electrical conductivities of the materials.
2. Electro-chemical theories.
3. Thermal theories.
4. Molecular theories.

The Most Popular Theories.

With the exception of the last division, all the rectification theories which are indicated in the above classes have been formulated for quite a number of years, and, therefore, they cannot be regarded as the latest word on the matter. Nevertheless, as they are introduced into all the text books on the subject, it is necessary for us to consider them in some detail at the present juncture.

Probably the most popular and well-known of the crystal rectification theories

at the present time are those which can be included in the first division of the above classification, viz. those theories which ascribe the crystal's action to some peculiarity of its electrical conductivity.

It was Professor Pierce who, in 1907, first suggested that the rectifying action of a carborundum crystal with a small potential locally applied across it might be due to the oscillatory current flowing through the crystal more easily in the one direction than it does in the other. In other words, the crystal acted very closely to the ideal of a unilateral conductor of alternating currents.

Early Experiments.

Pierce found that a crystal rectifier, such as the one mentioned above, appeared to disobey Ohm's law entirely. For instance, with a local potential of two volts applied to it, the crystal passed approximately 35-40 times as much current in the one direction as it did in the other; and, furthermore, it was subsequently discovered that, as the locally applied potential was increased, the unilateral conductivity of the crystal also increased quite out of all proportion. Thus, with a local potential of 30 volts, the carborundum crystal passed 3,000 times as much current in the one direction as it did in the other.

The very first discovery of this remarkable fact of unilateral conductivity appears to have been made by a certain Professor F. Braun who, in the year 1874, noticed that when certain pairs of mineral and metallic substances were placed in imperfect contact with one another, a current passed through them had to overcome much more resistance when it flowed in one direction than when it was made to flow the opposite way.

To revert to more modern times, however. About the period of Pierce's investigations into the matter, L. W. Austin pointed out that a steel-silicon combination passed more current from the steel to the silicon than it did from the silicon to the steel. Other investigators made similar discoveries, and hence arose the theory of crystal unilateral conductivity as a cause of crystal rectification.

We all know what unilateral conductivity means, of course. Applied to crystal science, the expression serves to indicate the fact that the crystal passes current only in one direction, or nearly so. The diagram given at Fig. 1 on this page is, no doubt, a very hackneyed one, but it has to be repeated in order that we may become quite clear as to the effects which the crystal is supposed to give rise to.

(Continued on page 248.)

THE GRID LEAK.

A NEW PRINCIPLE IN CONSTRUCTION.

From A CORRESPONDENT.

THE grid leak, which is in reality nothing more than a very high resistance, is made in a great variety of forms and upon a variety of different principles. The great aim with a grid leak, apart from securing the necessary amount of resistance in a small space, is to secure constancy of resistance and immunity from the effect of weather, damp, temperature and current-load. It is easier to make a fixed resistance to conform to these conditions than a variable one.

Unsatisfactory Methods.

The different principles used in different types of grid leak are probably familiar to the reader. One of the commonest is some form of carbon, either in powder form, or in the form of carbonised discs, which are pressed together by means of an adjusting screw. Another form is the graphite or indian ink trace upon a piece of glass or ebonite, whilst a third form is the tube of high-resistance liquid, sometimes consisting of a mixture of gum and water.

All these methods of providing a high resistance of very small current-carrying capacity are effective in their way: some are more reliable than others. The

carbon disc method, generally speaking, is apt to be unreliable, whilst the carbon trace suffers from the important practical drawback that it is difficult to make proper contact with the ends of the resistance element.

Recently an entirely new principle has been introduced in connection with the making of grid leaks and, as a result, a leak has been produced which is found to have extreme constancy of resistance value. The leak consists essentially of a short piece of glass rod, about one inch in length and about one-eighth of an inch in diameter, enclosed in a small glass tube capsule, with metal clips upon the ends of the glass rod. The glass rod is the resistance element, or rather, it carries the resistance element, the latter consisting of an exceedingly thin metal film deposited upon the glass rod.

Metallised Glass Rods.

The method by which this film is deposited is interesting. It is probably well-known to many readers that in a vacuum discharge tube, such as an X-ray tube, in course of time the metal of the electrodes, particularly of the cathode, evaporates or "sputters" (the exact mechanism by which it is thrown off is imperfectly understood) and may be deposited as a thin metal film upon surrounding objects. The metallised glass

rods for the grid leaks mentioned above are made by placing the pieces of rod in a vacuum tube and sputtering the electrodes. After a certain amount of trial it is possible to know fairly accurately what is going to be the resistance of the film of metal deposited upon the glass rods, this depending upon the nature of the electrodes in the discharge tube, the degree of vacuum, and the discharge current, as well as certain other minor factors.

Tests on these new leaks have shown that, even when too hot to be touched by hand, their resistance value is very little changed, and that it goes back to normal on cooling.

So far this leak is only manufactured as a fixed leak, but a variable model is promised very soon.

There is still room for improvement in grid leaks, especially variable grid leaks,

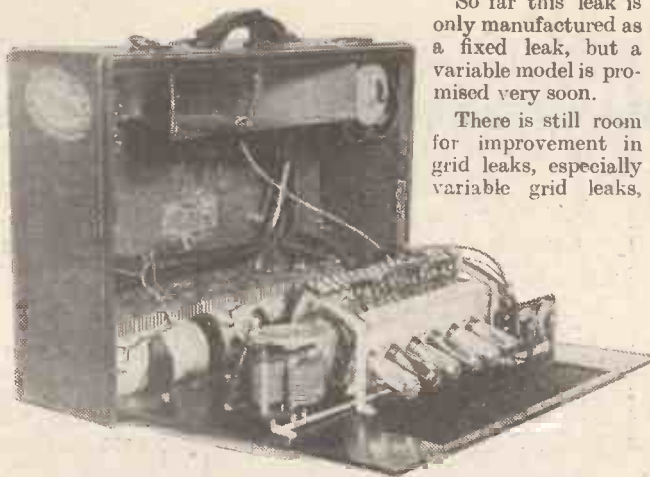

A six-valve portable super-heterodyne receiver owned by Mr. Bernays Johnson, the well-known American wireless engineer.

and although the above-mentioned principle seems to indicate an important step forward, the wireless experimenter should always have an eye for any principle or phenomenon which might be made the basis of a better, simpler, more reliable, or cheaper grid leak.

EDISON ON STATIC.

IT is not often that a famous scientist expresses himself so definitely, in the negative direction, as did Thomas Edison, the great inventor, recently upon the question of the elimination of static. It is to be remembered that static is a very great bugbear to wireless broadcasting in the United States, very much more than it is in England, and in consequence a great deal of research work has been devoted there to its reduction or elimination.

Edison is reported as saying "Static can never be eliminated." This sounds at first rather pessimistic. But Lord Kelvin gave it as his opinion, in the very early days of flying experiments, that an heavier-than-air machine would never become a practical

achievement. So perhaps it may be hoped that in this case, at any rate, the famous savant may be wrong.

At any rate, many other experts believe otherwise. Dr. Alfred Goldsmith, Chief Engineer of the Radio Corporation of America, says that the problem of static is now fully understood, and that by increasing the power of the broadcasting stations, the transmissions may come through the warmest static-infested night just as well as through a cold, dry night of winter.

Frame Aerial Effects.

Dr. Alexanderson, of the General Electric Co., says that static will be overcome by the use of polarised wireless waves. He cites the fact that static is received very much more loudly on a loop aerial in a vertical plane than upon one rotated to the horizontal plane, and suggests that if the loop be used in this latter position—thus practically eliminating static—and the broadcast waves be polarised in such a way that they are received by such a loop, the signals may be received and the static left behind.

A good deal of practical experiment on these polarised waves has actually been carried out by David Grimes, with very promising results.

THE CAUSE OF CRYSTAL RECTIFICATION.

(Continued from page 247.)

A in the diagram represents the unrectified currents from the aerial circuit of the receiver. *B* is the current after it has passed through the detector, and *C* is the resultant "Beat current" which enters the phones. The first current impulses, *A*, are oscillatory in nature. However, when they emerge from the crystal rectifier they are uni-directional. The crystal has selected the impulses which flow in one direction only, and it has suppressed almost entirely the component of the aerial current flowing in the opposite direction. The beat telephone current is, of course, the smoothed-out and uni-directional current from the detector.

"Filter Theories."

The one great objection to the statement that a crystal effects its rectifying action by being a uni-directional conductor is that such a statement does not go far enough. *Why* does the crystal act thus? What circumstances increase its efficiency in this direction? What influences work in the other direction, and cause crystal insensitivity?

All the above theory does is to assume that either the bulk of the crystal itself, or the surface area of the crystal contact, acts as an H.F. oscillation filter, and that whilst it almost completely suppresses one half of the wave cycle of current, it allows the other half to freely pass through it. Theories of this nature very seldom fail to completely dissatisfy the keen crystal enthusiast and to convince him of their want of stability. But, nevertheless, such "filter theories," if they may be so called, are no doubt very popular at the present time. They are simple to explain in popular language, and they prove acceptable to the beginner in radio science. But, at the best, they provide very inadequate interpretations of the crystal's action, and, so far as practical deductions and improvements are concerned, they lead—practically nowhere.

New Range of Models

FROM THE HOUSE OF

A.J.S.

(Sir Oliver Lodge's Choice after Test)

Considered from every standpoint the new A.J.S. Radio Instruments merit the closest investigation. Every model marks a definite step forward in Radio Evolution, and never before has such perfection been offered. Full details on receipt of postcard.

COMPARE THE SPECIFICATION.

Standard Equipment of all 4-Valve Sets consists of Treble Capacity giant H.T. Battery, A.J.S. Lucas Moulded Accumulator of 6 v. 104 amp. capacity, 3 A.J.S. Mullard specially designed Valves and Power Valve. 1 pair A.J.S. Phones. Full Aerial Equipment, Aerial and Earth safety gap. Coil Holder and Daventry Coils. In addition, 12 months' written guarantee and 12 months' Free Insurance with every set. Deferred payments may be arranged.

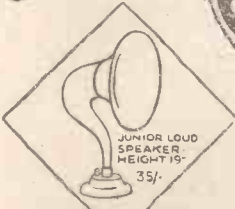

JUNIOR LOUD SPEAKER HEIGHT 19" 35/-



CABINET LOUD SPEAKER £4-15

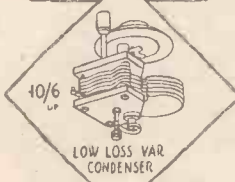

LOW LOSS VAR CONDENSER 10/6



2-VALVE SET ACCESSORIES & LOUD SPEAKER £13-18-6

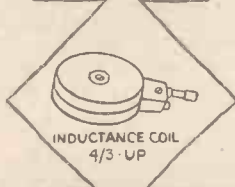

INDUCTANCE COIL 4/3-UP

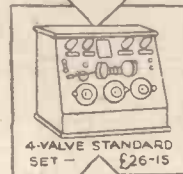

4-VALVE STANDARD SET £26-15



CHOKE UNIT 20/-

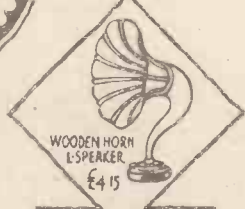

WOODEN HORN LOUD SPEAKER £4-15

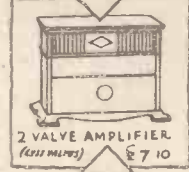

2-VALVE AMPLIFIER (LIT VALVES) £7-10



PEDESTAL LOUD SPEAKER £22-10

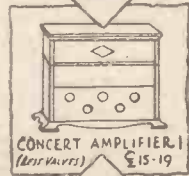

CONCERT AMPLIFIER (LIT VALVES) £15-19

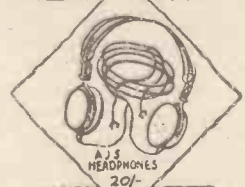

A.J.S. HEADPHONES 20/-

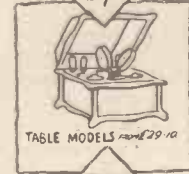
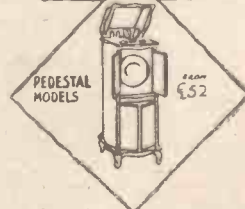
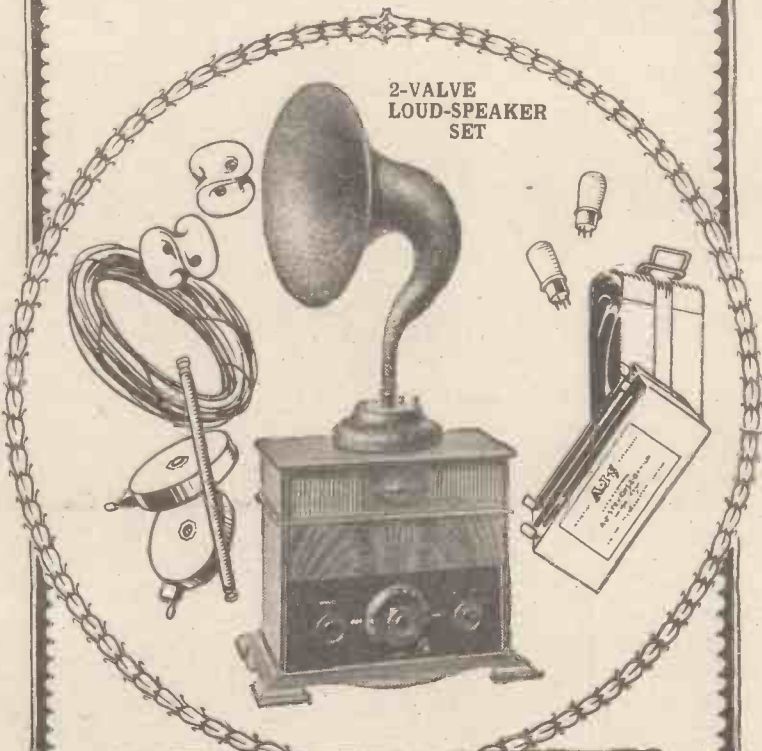

TABLE MODELS FROM 29-10



PEDESTAL MODELS FROM £52



2-VALVE LOUD-SPEAKER SET

Call and examine these splendid new A.J.S. Models at LONDON'S FINEST RADIO SHOWROOMS AND SERVICE DEPOT NOW OPEN at 122-124, Charing Cross Road, London, W.C.1. Phone: Regent 5167.

In beautiful mahogany Cabinet. Designed to give Loud Speaker results on near-by station and results on actual test are truly amazing. Complete with A.J.S. Junior Loud Speaker, 2 Mullard Dull Emitter Valves, 100 volt H.T. Battery, 2 volt 100 amp. Accumulator, Full Aerial Equipment and Coils (300-550), £13 : 18 : 6 Including Royalty.

Call and examine these splendid new A.J.S. Models at LONDON'S FINEST RADIO SHOWROOMS AND SERVICE DEPOT NOW OPEN AT 122-124, Charing Cross Road, London, W.C.2. Phone: Regent 5167.

A. J. STEVENS & CO. (1914), LTD., Radio Branch, WOLVERHAMPTON

Telephone: 1748/52.

Radio Call Sign: 5 R.I.

Telegrams: "Reception, Wolverhampton."

CURRENT TOPICS.

BY THE EDITOR.

The Wireless Exhibition—The Growth of Broadcasting—Mr. Marcuse and Mr. Simmonds—Next Week's Free Book—Dr. Alexanderson's Discovery.

THE opening of the Wireless Exhibition at the Albert Hall was prefaced by a luncheon at the Savoy Hotel, at which Mr. Marconi, Mr. J. C. W. Reith, and others made some interesting speeches. The occasion was a happy one, inasmuch as it closely coincided with the 30th anniversary of Mr. Marconi's first successful experiments in wireless.

Although the exhibition at the Albert Hall is only the fourth of its kind to be held by the National Association of Radio Manufacturers and Traders, it is indicative of the extraordinary growth of the wireless industry. As Mr. W. W. Burnham, Chairman of the Association, pointed out in his speech at the inaugural luncheon, the exhibition had been organised for the purpose of placing before the public in the most convenient and convincing form the record of a year's achievement of the design and production of efficient and moderately priced wireless apparatus, all of which is entirely produced in Great Britain by British labour from British materials. We can only add that the exhibition did infinite credit to the British wireless industry.

The Growth of Broadcasting.

Viscount Wolmer, M.P., Assistant Postmaster-General, who formerly opened the exhibition, stated that it was calculated that there were already ten million listeners, and Viscount Wolmer did not exaggerate when he said that the wonderful work achieved in three years by the British Broadcasting Company was such that foreigners look on the broadcast service in this country with admiration. Not less than three years ago—although readers might find it difficult to believe—a new wireless industry has sprung up to cater for B.B.C. listeners, and it is stated that something like £10,000,000 a year is spent on wireless apparatus, and that employment is given to over 35,000 people.

Readers can judge from the following table the growth of the popularity of broadcasting.

	1924	No. of Listeners.
January	636,159
February	692,556
March	720,793
April	770,793
May	804,936
June	821,413
July	872,548
August	914,738
September	998,607
November	1,082,270
December	1,140,119
	1925	
January	1,191,625
February	1,311,653
March	1,348,840
April	1,355,778
May	1,371,581
June	1,387,500

Readers will have noticed that on page 211 of this issue we take pleasure in announcing that Mr. E. J. Simmonds, a famous colleague of Mr. Marcuse, will write an exclusive series of articles for POPULAR WIRELESS. Thus we shall be able to place before our readers throughout the forthcoming months a number of articles by two of the most famous British amateurs.

Mr. Marcuse and Mr. Simmonds will not contribute articles to any other wireless journal for some time to come. We are well aware that they have been asked to do so by other journals, but Mr. Marcuse and Mr. Simmonds preferred to contribute to POPULAR WIRELESS only.

2 N M and 2 O D.

Everyone who reads the daily newspapers is well aware of the achievements of both these amateurs. By conscientious experiment and devotion to the cause of radio experimental work they have demonstrated, time after time, the infinite possibilities of short-wave radio work of low power. They are essentially practical men. They have gained their knowledge in the hard school of experience, and there are no two other amateurs in the world whose records in experimental radio work can compare with the results obtained by Mr. Marcuse and Mr. Simmonds.

We have arranged to publish their articles alternatively, that is, one article a fortnight by Mr. Marcuse and one article a fortnight by Mr. Simmonds—so that in every issue of POPULAR WIRELESS for some months to come readers will find an article either by Mr. Marcuse or Mr. Simmonds.



One of the earth plates at station 5 X X.

Their articles will deal exclusively with the transmitting side of amateur radio work; the fruits of their experiments in short-wave reception will also be fully dealt with. Detailed descriptions of the receiving systems employed by Mr. Marcuse and Mr. Simmonds will likewise be published exclusively in this journal, and results of any further tests and experiments that may be carried out will be included in their articles for the benefit of readers.

Next Week's Gift.

In next week's issue we are presenting readers with a 36-page book—for which we should normally charge sixpence—entitled "The 'P. W.' Crystal Experimenter's Handbook," and for the following week we are presenting another book of the same size and price, free to readers, entitled "The 'P. W.' Valve Experimenter's Handbook." We shall also announce in next week's POPULAR WIRELESS details of two great schemes which will arouse interest throughout the country.

More we cannot say at the moment, but we would urge once more that readers place an early order for their next week's issue. Intensive advertising in the daily Press will acquaint readers of some of the details concerning next week's issue.

We were able to make early publication in our last issue of news concerning Dr. Alexanderson's important discovery which may eliminate one of the greatest drawbacks in modern radio work—fading.

The polarised wave, Dr. Alexanderson hopes, will enable him to devise methods for considerably reducing, if not entirely eliminating, atmospheric interference. The secret of an anti-static device has not yet been found, but Dr. Alexanderson believes his discovery in connection with polarised radio waves will possibly guide him to a successful solution of the problem.

Corkscrew Waves.

Preliminary tests in connection with the polarised wave method has shown that, as these waves travel further and further from the source of transmission they change their plane, like a corkscrew. This makes it only possible to receive them at specific distances, the distances being dependent on quantities which, says Dr. Alexanderson, are not yet thoroughly understood.

Experiments at the G. E. C.'s works in America showed, however, that the distance for the first corkscrew turn, or motion, was approximately fifteen miles.

More explicit details concerning Dr. Alexanderson's experiments have not yet reached this country as we go to press, but our New York correspondent will be forwarding in due course his report on the discovery, which we shall publish without delay.

HATS OFF TO N.A.R.M.A.T AT THE ALBERT HALL

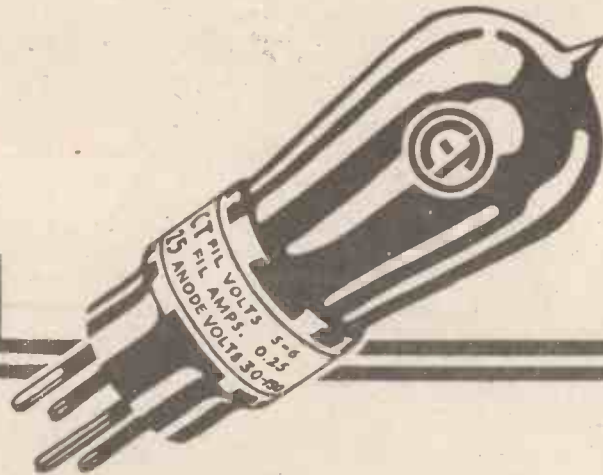

America's foremost
valve made in
Britain's newest
factory.

C.T. 25. An every
purpose volume
valve. Amp. Factor
9. Retail 15/-

Hats off to the N.A.R.M.A.T. for their notable Exhibition

This Exhibition has further demonstrated the supremacy of British wireless—just the reason why CLEARTRON crossed the water, with the result that America's foremost valve is now made in Britain's newest factory.

CLEARTRON Radio is British owned and CLEARTRON Valves are British made and sold under an Ironclad Guarantee of POSITIVE PERFORMANCE or INSTANT REPLACEMENT.

If your Dealer does not carry Cleartron, order from us, with your Dealer's name and address.

CLEARTRON RADIO LTD.,
1, Charing Cross, London, S.W.1
and Birmingham.

Phone: Regent 2351, 22

Grams: Cleartron, Westrand, London.

12/6

CLEARTRON guaranteed valves oscillate; detect and amplify. Types C.T. 08 and C.T. 15, 12/6 retail.

15/-

Types C.T. 25 and C.T. 25B (American Types C.T. 199 and C.T. 201a) 15/- retail, performance guaranteed.

CLEARTRON

BRITISH



MADE

GEARY'S HISTORY OF WIRELESS.

By HIGHAM BURLAC.

Another account of the adventures of that inimitable radio fan, A. Geary, Esq.

WHEN one's family is at the seaside and one's friends ill in bed is the time when the wireless set is at its best and breaks records. When one is trying to repeat the performance before a few incredulous and bat-eared enthusiasts, or is about to demonstrate at a public lecture, the apparatus is struck dumb, the valves open like lily-buds, and the batteries deliver ohms instead of amperes. Yes, wireless gear is as unreliable as a pup in a sausage shop, or a darling child who recites—or Geary.

Not long ago, having to compile a handbook in a hurry—"Wireless Whizzes While you Wait"—I asked Geary if he would knock together a few historical notes; not such an unreasonable thing to ask of the author of "Ten Centuries of Wire-drawing." This is what he sent to me. All rights—and wrongs—reserved.

Historical Researches into the Science, Art, and Practice of Wireless.
BY ALOYSIUS GEARY.

Adam was the first Home Constructor. He made the first loud speaker. She was constructed of bone. He called it Eve, because it was what he had to go home to in the evening after his day's work in the figgery. He had no blue-prints so wore fig leaves instead.

The first vessel to be fitted with wireless was the s.s. "Ark." It was completely wireless, wire not being invented, and the wire-haired terrier not being aboard, having lost the boat owing to an argument with next-door's dog over one of Noah's bed socks.

Oscillation a Punishable Offence.

Marcus Aurelius Geariolanus, an ancestor of mine, invented the wireless tight-rope. He fitted one on the Tarpeian Rock and those who used it went all to bits, such was the state of radio knowledge at the time.

Henry the First lost his son in the White Ship and never smiled again. Gifts of a cat's-whisker and a tickler coil from the Pope failed to work. German made, I expect.

Henry the Eighth invented wireless wives. Having no wire they had no "pull" and failed to hang on. Being king he had several models, though he probably got them at trade price, knowing men in the trade.

W. Shakespeare records that Puck (Query: Prof. Puckle of Warwickshire Technical College) alleged his ability to put a girdle round the earth in forty minutes. Puck was, however, probably alluding to the cable service. It is not inappropriate to refer at this stage to a report by Jules Verne, a Frenchman, who describes a remarkable piece of work by an amateur, Phineas Fogg, who succeeded in relaying round the world in eighty days.

Count Izkeshi mentions in his charming "History of Bohemia under Vladimir the Bandy" that wireless cheese-cutters were employed in 1634 in the village of Snijz.

He explains that they used an axe, and adds in a footnote that cheese was unknown in Bohemia until 1650.

I find in the State Papers of 1701 that one, Thos. Serooby, was fined a groat and put in the stocks for using reaction, "to ye grate bane of ye publick and ye especial undoing of divers neighbours." This must be one of those remarkable anticipations occasionally met with in State Papers.

"Invention" of the Electron.

The first recorded instance of the use of a valve is found in the "Newcastle Courier" for June 6th, 1836, in an article describing the "Rocket." Stephenson fitted it with a

per annum per extra electrode per valve.

In 1924, "Popular Wireless" took the H.T. out of valve circuits. In the preceding year Steinmetz took the ether out of the atmosphere, it being replaced by Sir O. Lodge on the death of the former. As you were.

No less than seven persons claim to have put reaction direct on to the aerial. But there is only one British Post Office. If there were two—well, I suppose we should have two Leaflet arcs, and twice the number of P.O. Wireless Inspectors.

The B.B.C. was invented in 1922. The date of the composition of "In a Monastery Garden" will be communicated later.

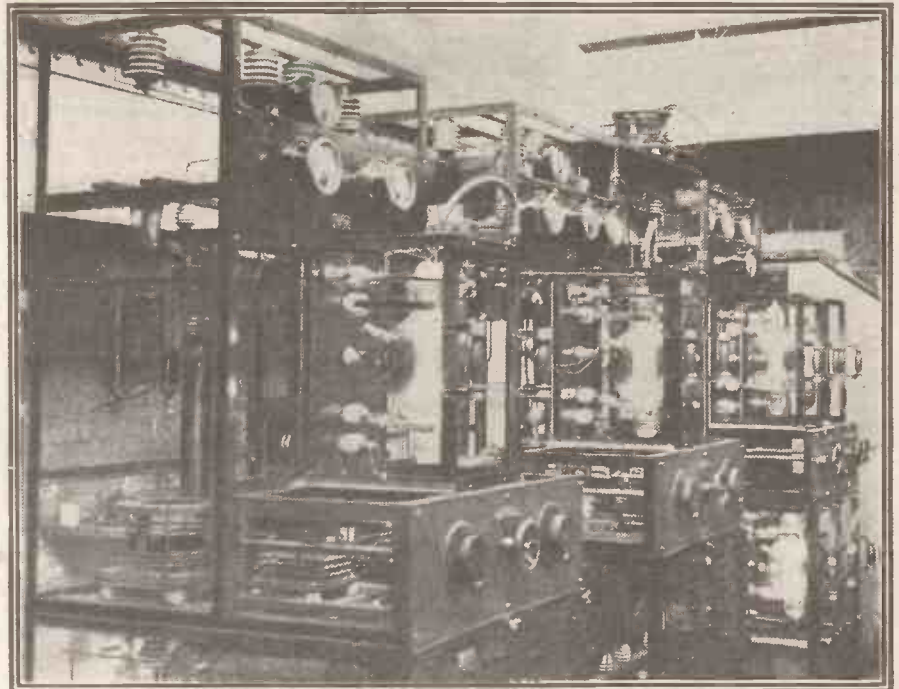

The three valve panels in use at the Glasgow Broadcasting Station.

valve, and it oscillated so much that the engine-driver resigned in favour of a sailor who had been round Cape Horn twelve times without losing a meal.

An unknown Greek invented the electron, Francis Bacon gave it a miss, Mike Faraday sneaked the idea, but took the wrong turning and wasted his time in inventing farads, thus increasing the cost of receivers.

Recent Developments.

Dr. J. A. Fleming invented the two-electrode valve. Lee de Forest thought two electrodes good enough for a Britisher, but nothing less than three suitable for the U.S.A. Later, another electrode, the fourth, crept in and was allowed to stay. The Post Office then prohibited amateurs from using more than four per valve unless they could show just cause, etc., and pay 10s.

I don't know how the former would manage without the latter work. The latter is a great work, with a chorus of Uncles and interludes by dickybirds, generally interrupted by the 10 o'clock time signal.

A. Geary. Born April 23rd, 1874.

G. Marconi. Born April 25th, 1874.

The inference is plain, but in case of doubt I will explain that I was born in Clapham Rise, and invented the Geary All-Weather, four-speed, self-energising, super, de luxe, sonic, universal T.S. 99, pea-fed, non-corrosive, low-loss receiver. I invented also the Geary non-directive oscillating aerial for beginners, guaranteed P.O., free and completely Eckersley-less.

That is how Geary helps one at a crisis. But let him wait. He will soon borrow my ammeter. It will be set to read 50 per cent of true value. R-revenge.

The valve with the tape filament

Stocked by all reliable dealers

Western Electric

VALVES AND HEADPHONES

DO not be content with your results until you have tried Western Electric Improved Head Receivers and Wecoalves. You may be getting good reception at the moment, but the progress of science allied to the Wireless art must call for continual progression, unless you wish to be hopelessly left behind.



HEADPHONES per pair **20/-**

Patent Nos.
17580 (1915) and
180090 (6641-1921).

WECOVALVES each **16/6**

Write for our new Catalogue No. W546 which gives fullest details of our Valves, Headphones, and new apparatus for the Season. It is free upon request.

Western Electric Company Limited **Connaught House**
ALDWYCH LONDON WC.



Traders and manufacturers are invited to submit wireless sets and component parts to the "P.W." Technical Dept. for test. All tests are carried out with strict impartiality in the "P.W." Test Room under the supervision of the Technical Editor, and the general reader is asked to note that this weekly article is also intended to provide a reliable and unbiased guide as to what to buy and what to avoid.—THE EDITOR.

A PLUG and socket of ingenious design has been produced by Messrs. Partidges, Ltd., of Northwood Street, Birmingham. The plug is in the form of a nickel helical spiral, and the effect is to make it elastic and springy. When the end of the plug is compressed the sections above tend to open, and thus a very efficient contact results when it is inserted into its socket. These plugs and sockets are to be retailed at 3d. each, and indicating washers will be available at 1d. each. The patent helical plug will probably be supplied for coil holders, valves, etc.

It is certainly a very efficient device, neat, well made, and a considerable improvement over the "split pin" type, at least over those that are split upwards and not downwards in the more logical manner adopted by some makers.

Of outstanding interest in respect of component design is the new Gecophone Low-Loss Slow-Motion variable condenser. The G.E.C. people claim that "this condenser can be described as something entirely new rather than an advancement on present day design." Whether they are justified or not there is no doubt that it is a most excellently designed piece of apparatus, bears evidence of close research and attention to detail, and in fact represents an achievement well worthy of its famous manufacturers.

Primarily a variable condenser must be criticised from a mechanical point of view. A variable condenser can be Low Loss, Low Power Factored, of High Insulation Resistance, Square Law, Non-Inductive, Non Pong, or anything else that sounds attractive electrically, but if its plates begin to

scrape or "sieze" after a little use, such become purely negative qualities. Therefore, we first of all examined the Gecophone product as a piece of mechanism and we found it to be robustly constructed and capable of standing up to hard work without developing mechanical faults. The plates are of hard brass and no spring washers are employed.

The movement is excellent and is absolutely positive, no backlash being present. An outstanding feature is the large "Vernier" dial which operates a uniquely smooth micrometer gearing of patent design, having a ratio of about 12 to 1. It is "square law" and the moving plates are connected to a rigid metal frame. The insulation of the fixed plates is not in the electrostatic field. One-hole fixing is arranged for. A National Physical Laboratory report concerning this Gecophone component is highly favourable.

We have only one small criticism to make, and that is that there is no positive stop on the vernier adjustment at either end of the scale, although, perhaps, it is a moot point whether such is really required, the number of amateurs who adjust their sets without reference to dial readings being problematical. The .0005 mfd. Gecophone Low-Loss Slow-Motion sells at 27/6, the .001 at 32/6, .0002's, .00025's and .0003's being available at 22/-, 23/- and 24/- respectively.

With reference to the "Lowdist" crystal combination, upon which we recently reported, it appears that the two crystals supplied are not intended for use as a "perikon" combination. A cat's-

(Continued on page 256)

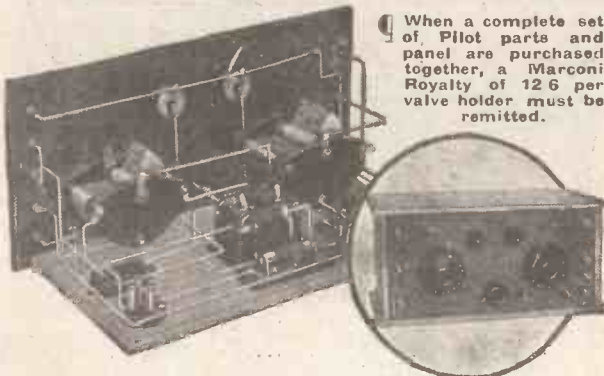

When a complete set of Pilot parts and panel are purchased together, a Marconi Royalty of 12 6 per valve holder must be remitted.

Build the "Popular Wireless" 3-Valve Reflex for £7-4-0

For splendid all-round value there is nothing to beat the "Popular Wireless" 3-valve Reflex. And it is as cheap to build as it is efficient to use. Buy your parts from Peto-Scott's for £7-4-0 (Cabinet 30/- extra) and you can be sure that the Set will work well when you have made it up. If it does not, our Service Dep. will put it right for you. See last week's issue for prices of the "P.W." 4-valve Set and the "P.W." Crystal Set. Catalogue (48 pages) of Radio components 3d. (post free). Pilot Chart of Sets for Home Constructors 3d. (post free).

PETO-SCOTT CO., Ltd.,
77, CITY ROAD, LONDON, E.C.1.

Also at 62, High Holborn, London, W.O.1 WALTHAMSTOW-320, Wood St., PLYMOUTH-4, Bank of England Place, LIVERPOOL-4, Manchester St.

P.S. 3900

Parts for "P.W." 2-Valve Continental shown above

- 1 Peto-Scott Square Law Condenser, '0005 . . . 8 0
- 1 Peto-Scott Square Law Condenser, '0003 . . . 6 9
- 2 Microstats . . . 5 6
- 1 Two-Coil Holder, Board Mounting . . . 5 6
- 2 Anti-capacity Valve Holders . . . 2 6
- 1 Board Mounting Coil Holder . . . 1 6
- 1 2-Meg. Leak and Fixed Condenser (Peto-Scott) . . . 3 6
- 1 '002 Fixed Condenser (Peto-Scott) . . . 1 6
- 10 Mark III. Terminals . . . 1 8
- 6 2 ft. Lengths 1/16 Bus Bar, Nuts, Screws, etc. . . 1 1
- 1 Packet Panel Transfers Plain Panel "Red Triangle", 13" x 6" x 4" . . . 5 0
- Panel drilled, extra . . . 2 0
- Panel engraved, extra . . . 2 0
- CABINET**, 13" x 6 1/2" x 3 1/2", with Baseboard, Mahogany . . . 1 1 0
- £3 8 0**

SWCSWCSWCSWCSWC

INDUCTANCE COILS
Robust, highly efficient and well finished. Minimum self-capacity. Ebonite Mounting and fitted with special strong supporting band.

PRICES:

o. 25	3/9 each	No. 10)	5/- each
.. 35	3/9 150	5/9 ..
.. 50	4/- 200	6/3 ..
.. 65	4/8 250	6/9 ..
.. 75	4/6 300	7/3 ..

SWC
BRUSSELS OFFICE:
72, RUE DE LA HOUCHE.

SWC
JACK TERMINALS
Box of 6 complete sets, 2/3 (12 for 4/6), with soldering tags.

Special non-soldering tags, 2s. each. Complete set of 12 with these tags, 6/-

SWC
ANTI-CAPACITY VALVE HOLDER
Maximum efficiency with low cost.

Weight of metal is only 1/27th of an ounce. In envelope containers with 4 legs and ebonite disc, 2 1/2d. each. Baseboard type 10 1/2d. each.

MANUFACTURERS
S. WILDING COLE LTD
116 SNOW HILL, BIRMINGHAM
PHONE CENTRAL 3131

SWCSWCSWCSWCSWC



No. 4780. 60 Volts.
 PRICE 22/6 NET.
COLUMBIA HIGH CAPACITY

HIGH TENSION BATTERIES are by far the most satisfactory plate batteries you can use. The extra large sized cells employed in the construction of these batteries supply sufficient power for the finest reception. These batteries are fitted with spring clip terminals ensuring *quick and secure* connections.

Columbia

RADIO BATTERIES

THE Radio Battery is the vital part of your receiving set. COLUMBIA Batteries—especially manufactured for Radio—serve better, last longer and improve reception.

COLUMBIA RADIO "A" DRY CELLS

Especially designed for use with all types of dull emitter valves, the Radio "A" is the most reliable filament heating unit manufactured.

PRICE 2/6



SEND FOR THIS NEW FREE BOOKLET

"H"—35 pages of valuable information pertaining to the care and operation of your radio batteries.

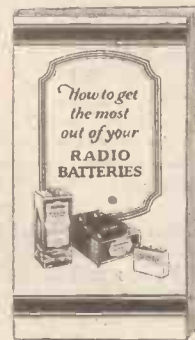

ADVERTISEMENT OF J. R. MORRIS, 15, KINGSWAY, LONDON, W.C.2.



Unshrouded Efficiency



All good dealers stock them—any difficulty write us.

Scientific Users

will tell you they always employ

THE "TANGENT"

The Self-Capacity of this Unshrouded Coil is extraordinary low (see figures below)—result—closest selectivity.

Coil No.	25	35	50	75	100	150	200	250
Self-Capacity in Micro-Microfarads	8	9	25	31	22	16	22	22
Price, each	4/3	4/3	4/3	4/6	5/-	6/-	7/-	7/6

COMPLETE SETS—

4 Concert Coils (W/L 250 to 1,180) 16/- the set
 11 " " (W/L 250 to 9,500) 67/- " "

GENT & Co., Ltd. Est. 1872.

"Faraday Works," LEICESTER.

LONDON : 25, Victoria St., S.W.1.
 NEWCASTLE-ON-TYNE : Tangent House, Blackett St.

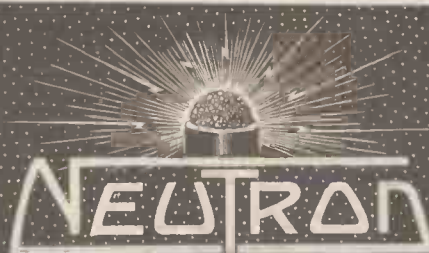

The World's Greatest Radio Crystal

Acclaimed by every Radio user as the premier Crystal of to-day.

Sole Distributors :—
NEUTRON DISTRIBUTORS,
 SENTINEL HOUSE,
 SOUTHAMPTON ROW,
 LONDON, W.C.1

"The Crystal with Valve Power"



APPARATUS TESTED.

(Continued from page 254.)

whisker should be used and the two crystals mounted one above the other in a crystal cup. The smaller crystal is placed underneath and it is claimed that this imparts a magnifying action. This is certainly a novel method of employing two crystals, and we must apologise to the patentee for not reading his instructions more carefully in the first place. Anyway, we subsequently tested the two crystals sent us in the above manner and they gave very good results. We discovered that an increase of signal strength could be obtained by using the two crystals together with a cat's-whisker, but the relative positions of the former appeared to be important.

From Messrs. Harding, Holland and Fry, Ltd., of 52, Queen Victoria Street, E.C.4, we have received a sample of the "Harko" basket coil holder. The original feature of this is that it embodies a novel vernier attachment. It takes but a few seconds to mount a basket or spider-web coil on this holder, and it can then be plugged into any standard type of two- or three-way coil-holder. If this latter already has a vernier control the additional fine adjustment is an added advantage in that it is a lateral movement and enables an unusually close coupling to be obtained. The "Harko" is provided with two small terminals so that coils can be changed

without the necessity of employing a screw-driver. It is quite well made, and at the price of 2/- asked for it should prove a popular component.

Messrs. C. A. Vandervell & Co., Ltd., whose new High Tension Accumulators have proved so popular, have been informed by the Oxford Telephony Co., that in con-



The Model H.T. 3 C.A.V. accumulator. Rating—80 volt—1 amp. Dimensions—7 in. 8 1/2 in. x 7 1/2 in. Weight charged 12 1/2 lbs.

nection with the London Hospitals' installations, which they are engaged upon, they are using the C.A.V. in every case. Messrs. C.A.V. have, by the way, recently placed on the market the H.T. accumulator illustrated on this page.

This reliable H.T. Accumulator, offered at the low price of 1/- per volt, is already popular with wireless amateurs. Troubles peculiar to dry batteries such as inconsistent discharges, temperature effects, crackling noises with reception, and constant regulation to correct voltage variations are not known to the H.T. accumulator user.

Quite recently Messrs. A. J. Stevens & Co. (1914), Ltd., of Wolverhampton, opened large London offices, and this, an event of considerable importance, is one that doubtless will prove of interest to all radio enthusiasts. At a luncheon given on the above occasion, a letter from Sir Oliver Lodge was read, and in this our scientific adviser commented very favourably upon an A.J.S. valve set he possesses. That their London venture is a necessity and not merely pretentious development will be apparent to all who have watched the rapid progress made by this firm in obtaining a leading position in the radio market. We wish Messrs. "A.J.S." every success in the future.

The A.J.S. two-valve set advertised last week was quoted as costing £13 18s. 6d. Royalties extra. This we are asked to inform readers was a slip, the above figures include all royalties.

In a constructional article which appeared recently in "P.W." the price of the "Atlas" filament resistance, a well-known component manufactured by Messrs. H. Clarke & Co., of Manchester, was stated to be 5/6. This, however, was an error, the actual figure being 6/6.

7/-
EACH

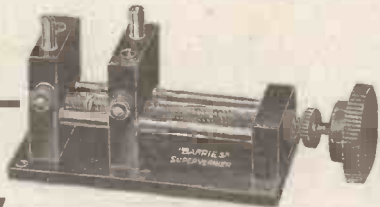

7/-
EACH

"BARRIES" SUPER VERNIER TWO-WAY COIL HOLDER.

No Backlash. No Gears. No Springs. UNIVERSAL FIXING.

EMC
FILAMENT DIMMER & VALVE HOLDER
ONE-HOLE FIXING.

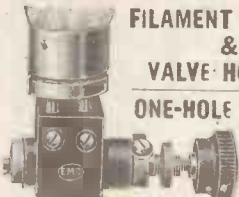

REGISTERED DESIGN NO. 714,009.

OHMS.	PRICE COMPLETE
0-5	5/9
0-10	6/-
0-20	6/3
0-30	6/6

ENTERPRISE MANUFACTURING Co. Ltd.
(WIRELESS DEPT.)
GRAPE STREET, SHAFTESBURY AVENUE,
LONDON, W.C.2.
ESTABLISHED 1909.

The "KENMAC" BOOK Crystal Receiving Set

(Pat. Pending.)



The Latest Novelty in Crystal Sets. Efficient, Compact. Guaranteed to give Every Satisfaction. Provision made for 5 X X Loading Coil.

PRICE :
Imt. Tortoise-shell (Non. Inflam.)
£2-2-0

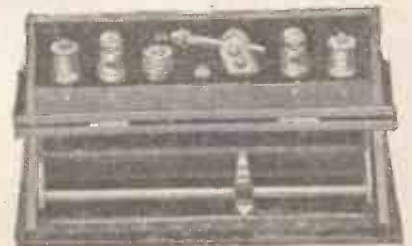

Leather Covered (Red, Green, Blue).
£1-1-0

Actual size 4 1/4" x 3 1/2" x 1".

THE KENMAC RADIO LTD.,
(DEPT. P.)
Dalling Road, Hammersmith, London, W.6

Why the REFLEX COIL?

(Manufactured under Licence, Burdett Patent No. 168,249)



STAND No. 4
Wireless Exhibition,
Horticultural Hall.

REFLEX COIL PLUG.
This plug has been specially designed for use with Reflex Coils, a combination of the two producing the most satisfactory results. Made from the finest grade lapped ebonite and packed in separate cartons. Price 1/-. Entirely British Made.

BECAUSE it is one of the outstanding achievements in successful reception. It is the only reliable self-supporting coil on the market. Once you use Reflex Coils you can never go back to the old-fashioned kind.

PRICES :

Wave-length with .0005 in parallel (approx.)	
No. 25	100-250 8d.
No. 50	150-300 8d.
No. 75	200-500 9d.
No. 100	300-750 1/-
No. 125	400-1,000 1/2
No. 150	500-1,250 1/6
No. 175	600-1,500 1/8
No. 200	740-1,750 2/3
No. 250	800-2,000 2/9
No. 300	900-2,500 3/3
No. 400	1,200-3,000 4/3
No. 500	1,500-4,000 5/-
No. 600	2,000-5,000 5/6
No. 750	2,500-6,000 6/-
No. 1,000	3,000-8,000 7/-
No. 1,250	4,000-10,500 8/-
No. 1,500	5,000-15,000 9/-
	6,000-18,000 10/-

5 XX Loading for Crystal Sets, 1/6.
Reflex Coils can be obtained from all good wireless retailers. Ask to see them to-day.
Trade Enquiries Invited.

New Address—

The REFLEX RADIO Co. Ltd.
198, Lower Clapton Road, E.5.
Telephone: Clissold 4852.

"So we left the middle out," says CLIXIE



"CLIXIE"

"Has it ever occurred to you," asks CLIXIE, "that the ordinary wire lead absorbs no end of the energy it's supposed to conduct?"

"Realising this, my people have produced a conductor that sticks to it's job and really does conduct. Radio Condit is a tiny copper tube, burnished inside and out. Since the middle of wire is the dead-end absorbent, Radio Condit is wire with the middle left out. Accordingly its H.F. resistance is cut down to the minimum.

"With the minimum capacitative metal, it provides two highly polished conducting surfaces, outside and inside. Lateral surges are completely eliminated. Much of the confined internal air column is ionised.

"Radio Condit is the H.F. conductor you've been looking for for ages."

Are you well connected?
Try CLIX

RADIO CONDIT

The H.F. Conductor

Tinned in 24 inch lengths (equivalent to 16 S.W.G.) in packets of 6 lengths 2/- per pkt.

Obtainable from all Wireless Dealers or direct from the Patentees:

AUTOVEYORS LTD., 84 Victoria Street, LONDON, S.W.1

"FAMA," "FRELAT," "FAIRY" VALVES, CHEAPEST & BEST

AMPLIFIERS 4/6
4 Volt 30-100.
DETECTORS 4/6
4 Volt 20-60. Post Free.

POWER FOR POWER 4/6
AMPLIFICATION 4/6
4 Volt 100-200. Post Free.

DULL EMITTER 0'08 9/6
Fil. 1'8 to 3'0
Anode 20 to 180.
Amps. 0'06. Post Free.

POWER (Double Grid) 8/6
Fil. 4 to 6.
Anode 100 to 250.
Amps. 0'3. Post Free.

EXTRA LIBERAL TRADE DISCOUNTS

Illustrated Radio Trade Price List on Application

BISHOPSGATE ELECTRIC SUPPLY (1924) CO.,
Phone: Dept. FIRST 180, BISHOPSGATE, LONDON, E.C.2
Central 7361 P.W. FLOOR

Sling

it over a tree—out of the window—anywhere, whether indoors or out. Although taken down in a moment.

THE Ariane

POCKET AERIAL

is the most efficient and handy Portable Aerial invented. Needs no extra fittings or insulators. Ideal for flats or picnics. Strongly recommended by "POPULAR WIRELESS."

B.E.N PATENTS LIMITED Ask your Dealer or send direct with his name and address.
100, VICTORIA STREET, LONDON S.W.1. TRADE ENQUIRIES PLEASE.

POST FREE 12/6

TROLITE

the wonderful new insulating material

TROLITE commends itself to all amateurs because of its cheapness and the beautiful finish it gives to Wireless Sets by its lasting Polish. TROLITE has no surface leakage, is unaffected by exposure and does not warp or discolour. Ask your Dealer to show you standard parts from TROLITE or write for full particulars to **F. A. HUGHES & CO., LIMITED, 201-6, Gt. Portland Street, LONDON, W.1**

Why is BECOL

THE HALL MARK OF "QUALITY" EBONITE?
Because it is made from finest rubber and sulphur
IT HAS ITS POLISH
PROVED ITSELF SPEAKS FOR ITSELF
All branded panels are guaranteed free from surface leakage—

Write for full particulars and List C.
THE BRITISH EBONITE CO., LTD.,
HANWELL, LONDON, W.7.
Rods, Tubes and Mouldings.

RADIO TUTORIAL

All Editorial Communications to be addressed The Editor, POPULAR WIRELESS, The Fleetway House, Farringdon Street, London, E.C.4.

Editor :
NORMAN EDWARDS, M.Inst.R.E., F.R.S.A.,
F.R.G.S.

Technical Editor :
G. V. DOWDING, Grad.I.E.E.

Assistant Technical Editors :
K. D. ROGERS. P. R. BIRD.

Scientific Adviser :
Sir OLIVER LODGE, F.R.S.

Staff Consultants :
Dr. J. H. T. ROBERTS, F.Inst.P.; J. F. CORRIGAN, M.Sc., A.I.C.; C. E. FIELD, B.Sc.

Foreign Correspondents :
F. M. DELANO, Paris; Dr. ALFRED GRADENWITZ, Berlin; L. W. CORBETT, New York; P. F. MARTIN, Italy; W. PEETERS, Holland.

The Editor will be pleased to consider articles and photographs dealing with all subjects appertaining to wireless work. The Editor cannot accept responsibility for manuscripts and photos. Every care will be taken to return MSS. not accepted for publication. A stamped and addressed envelope must be sent with every article. All contributions to be addressed to The Editor, POPULAR WIRELESS AND WIRELESS REVIEW, The Fleetway House, Farringdon Street, London, E.C.4. All inquiries concerning advertising rates, etc., to be addressed to the Sole Agents, Messrs. John H. Lile, Ltd., 4, Ludgate Circus, London, E.C.4.

PATENT ADVICE FOR READERS.

The Editor will be very pleased to recommend readers of POPULAR WIRELESS who have any inventions to patent, or who desire advice on patent questions, to our patent agent. Letters dealing with patent questions, if sent to the Editor, will be forwarded to our own patent advisers, where every facility and help will be afforded to readers.

TECHNICAL QUERIES.

Letters should be addressed to :
Technical Query Dept.,
"Popular Wireless,"

The Fleetway House,
Farringdon Street,
London, E.C.4.

They should be written on one side of the paper only, and MUST be accompanied by a stamped addressed envelope.

Queries should be asked in the form of the numbered questions : (1), (2), (3), etc., but may be accompanied by a short letter giving any necessary additional particulars as briefly as possible.

For every question asked a fee of 6d. should be enclosed. A copy of the numbered questions should be kept, so that the replies may be given under the numbers. (It is not possible to reproduce the question in the answer.)

IMPORTANT.—If a wiring diagram, panel lay-out or point-to-point wiring is required an additional fee of 1/- must be enclosed.

Wiring diagrams of commercial apparatus, such as

sets of any particular manufacture, etc., cannot be supplied. (Such particulars can only be obtained from the makers.)

Readers may submit their own diagrams, etc., for correction or for criticism. The fee is 1/- per diagram, and these should be large, and as clear as possible.

No questions can be answered by phone. Remittances should be in the form of Postal Orders.

THE "P.W." TECHNICAL ASSISTANCE DEPT.

Personal Help for Amateurs in Trouble With Their Sets.

DURING the autumn months, and until further notice, readers of "Popular Wireless" may obtain personal interviews with the Queries Editor or one of his staff on Mondays, Wednesdays and Fridays.

Just as a patient may talk over his troubles with a medical specialist, so it is now possible for readers to make an appointment with a "P.W." radio specialist and, on advance payment of a fee of 2/6, have a ten minutes' interview in order to discuss troubles verbally—a much more satisfactory and expeditious method than asking for assistance by post. Also, in special cases, and on payment of a fee of 10/6, plus all expenses, a member of the "P.W." Queries Staff will visit the home of any reader of "P.W." within a radius of twenty miles of London, and will give advice on wireless sets already installed, or on the installation of receivers, aerials, etc., etc. Hours of visit can be obtained on written application to the Queries Editor.

Readers also desirous of having their sets completely overhauled, tested, and certificated by "P.W." according to merit, may on application, and by forwarding a fee of 10/6, send their receivers to the "P.W." Testing Room.

In the latter case sets must be brought by readers and taken away again after test. Sets cannot be received by post.

All queries in connection with this new "P.W." Technical Assistance Dept. should be addressed to the Queries Editor, "Popular Wireless," Fleetway House, Farringdon Street, London, E.C.4. Appointments and testing of readers' sets will be dealt with in strict rotation.



AS USED IN
The "P.W."
3-Valve Reflex
Issue of September 12th, 1925.
"FOR UTMOST EFFICIENCY."
"C.E. PRECISION" RHEOSTATS are invaluable for perfect control of valves, they are compact, strongly made, and equal in every way to those selling at much higher prices; wire-wound on solid fibre, the resistance remains constant under varying conditions, thus relieving the valve from strains which would otherwise shorten its life. The smoothness of their control is remarkable.

C.E. PRECISION 7 ohms Rheostats, Price 2/9 each. C.E. PRECISION 15 ohms Rheostats, Price 2/9. C.E. PRECISION 30 ohms Rheostats, Price 3/-. C.E. PRECISION POTENTIOMETERS, essential for H.F. control and for applying suitable potentials to the grids of L.F. valves. Price 3/9. C.E. PRECISION PRODUCTS obtainable through all reputable dealers. We can supply carriage paid, but your dealer's name must be enclosed with order.

C. EDE & Co., High Road, Byfleet, SURREY.

"GUDWRUN"
RADIO SOLDERING SET.
BRITISH MADE.
MAKES THE CLEANEST JOINT.



1/9

"GUDWRUN" FLUX MAKES CLEANEST JOINT
IN 4D. AND 3D. TINS.
THE SANITARY & WATER FITTINGS MFG. CO.,
(H. A. PINCHBECK, PROPRIETOR),
35, FRIDAY STREET, LONDON, E.C.4. TELE. : CENTRAL 3689.

SAXON GUIDE TO WIRELESS

THIS IS THE BEST BOOK OBTAINABLE, AND ENABLES ANYONE WITHOUT PREVIOUS EXPERIENCE TO MAKE WIRELESS SETS WHICH ARE UNEQUALLED IN PRICE, QUALITY, OR EFFICIENCY.

Everything connected with Wireless is clearly and simply explained, and full instructions, WITH CLEAR WIRING DIAGRAMS, are given for making:
TWO SUPER EFFICIENT CRYSTAL SETS, ONE AND TWO-VALVE DUAL AMPLIFICATION RECEIVERS, ONE AND TWO-VALVE AMPLIFIERS; ALSO THE VERY LATEST TYPES OF TWO, THREE, FOUR AND FIVE-VALVE TUNED ANODE RECEIVING SETS.

THE CHAPTER ON TESTING WIRELESS COMPONENTS IS ALONE WORTH THE PRICE OF THE BOOK.

NO SOLDERING, NO SPECIAL TOOLS, NO TROUBLE. Simply follow instructions and you will make a better set for one-fourth the price you would pay for an inferior instrument.

Satisfaction guaranteed or money refunded.

176 PAGES
PRICE
1/3 POST FREE

SAXON RADIO CO. (Dept. 14), SOUTH SHORE, BLACKPOOL.

Coil Winding Made a Pleasure

The "Worthmore" Coil Winder is the best value ever offered. Makes Coils any width from 1/8" to 1" and practically any weave. Coils supported without wax or tape.

The **WORTHMORE**
Coil Winder



pays for itself in the first few coils you wind. Supplied complete with Reel Carrier, and fixed in a minute.

CECIL RIDLEY
(Manufacturer)
35/37, DUNDAS MEWS,
MIDDLESBROUGH.
Telephone No. 1366 Middlesbrough

PRICE
5/- EACH
include 6" cover POSTAGE

PROV. PAT.

Something Entirely New in Radio Detector Crystals



Each sealed Kathoxyd carton contains one Detector Element and two Contacts, as follows:—

1 The "Crystal"—a Metal Plate.

This consists of a brass Holder, in which is mounted the specially treated Kathoxyd metal plate, of perfectly smooth surface, sensitive all over, giving clear and loud results, together with splendid long-distance reception.

2 The "General-Purpose" Contact.

A zinc ball-ended rod, held in a spiral spring, suitable for short-distance reception, is merely dropped at any point on the Kathoxyd Plate.

3 The "Long-Distance" Contact.

Consists of a special pointed rod, held in spring, for use in place of ordinary cat's-whisker. This is specially suitable for long-distance work.

Abolish your Crystal and cat's-whisker and adopt this trouble-free method of detection. Not a permanent detector, but a readily adjustable one, with a zinc ball making contact with a smooth plate coated with mineral compounds.

Kathoxyd consists of a station use; the other smooth metal plate in a fine graphite point brass mount, which fits for long-distance your Crystal cup. It work. Each contact is supplied with two readily fixed in place contacts—one a ball of your ordinary cat's-zinc iron, for local-whisker.

METAL PLATE

Kathoxyd

DETECTOR CRYSTAL

The Kathoxyd Element and two Contacts are supplied in attractive cellophane-windowed carton at

RETAIL PRICE

1/6

All enquiries welcomed by:—
KATHOXYD, Ltd., 41, High Holborn, London, W.C.1. Phone, Chancery 8542.
If unobtainable locally, send 1/6 and Dealer's Name and Address, when the Crystal will be sent by return post.

Internal Metal Chuck to grip 14 to 44 gauge wire or flex.

Price: Plug 4d. Socket 2d. Indicating Ring 1d.

PATENTED

"BELLING-LEE" INDICATING TERMINALS & "MULTY-KONTACT" PLUGS & SOCKETS

(Handles and dome-shaped Indicating Rings in Red or Black) Stocked in the following indications:

PATENTED

Aerial, Earth, Phones +, Phones -, L.T. +, L.T. -, H.T. +, H.T. -, Input +, Input -, Output +, Output -, L.S. +, L.S. -, Grid +, Grid -, A. T. I., Reaction, Ap. Aeria, H. T. Medium, and Blanks.

Price: Brass 4d. Nickel 4 1/2d.

DIAL INDICATORS

H.F. TUNER

Solid cast metal, with raised, polished letters showing white on a black background. Single hole fixing, complete with nut. Stocked in Tuner, Filament, Reaction, Aerial, Anode, H. F. Tuner, Secondary, Rejector.

Price - 6d. each.

SUB-CONNECTORS

Eliminate Soldering.

Perfect connection; lowest possible self-capacity; low resistance; connection changed in an instant. Tapped to screw on to 2, 4, 5 and 6 B. A. threads; also T connectors for joining wires.

Every high-class dealer stocks them, but in case of difficulty send to

BELLING & LEE, LTD.,
Queensway Works, Ponder's End, Midx.

VALVE VALUE—

Secure Philips' Valves while they are obtainable.

Philips' '06 Gen. Purpose	12/8	PLIOTRON '06, 3 volt	11/-
Philips' "E" Bright Emitter for last L.F. positions	7/6	A.P. DUTCH 'R' 4v. 5a.	4/-
Philips' D ₂ Gen. Pur. B.E.	6/-	THORPE K4 Valve	14/-
Philips' 4-Electrode Bright Emitter for Unidyne	11/-	5-Pin Holder	13
Special Vernier Coil Holder for Unidyne, one-hole fixing	5/-	Wates' Microstat	2/9
TRIOTRON '2 amp. 2 volt	7/6	Bretwood Leak	3/-
		Selected Set of Parts for 1-Valve Unidyne Set including Valve	46/6

VALVE POWER WITHOUT VALVES

The "Aneloy" Mineral Oscillator was used in the first English experiments. Each mineral is actually tested for oscillatory properties by Mr. L. L. Barnes, the inventor of the circuit. Two minerals, special carbon steel hair spring and signed Laboratory Test sheet, 5/- post free.

All goods 48 hours' approval, post and packing free. Full responsibility for damage in transit accepted.

ANELOY PRODUCTS, Camomile Chambers, Camomile Street, LONDON, E.C. (Near Liverpool Street Station.)

SAVE MONEY ON VALVES

—GUARANTEED BRITISH MADE.

RADION G.P. A 4-volt bright valve for general purpose use	7/-
RADION D.E. '06 } 3 volt 'very dull' filament valves	10/6
RADION D.E. '06 H.F. }	
RADION D.E. '34 } 2 volt D.E.'s of great efficiency.	10/6
RADION D.E. '34 H.F. }	

RADION PYRAMID VALVES, 22/6

THE POWER VALVES DE LUXE.

No. 1. 6 volt. No. 2. 4 volt. The most powerful on the market. We guarantee the filament.

From untied Dealers or direct, post free.

Radions Ltd., Bollington, nr. Macclesfield, Ches.

Interesting literature concerning Radion Valves and our unique valve repair service gladly sent Free on request.

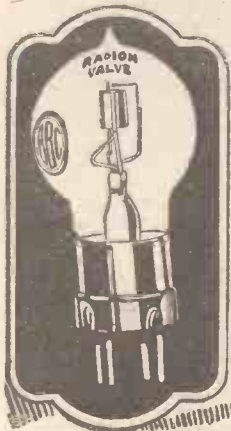

RADION
Reliable Valves

All Post Free At Callers Prices

Orders 5/6 value carriage paid.

Under 5/6, 2d. per 1/- for packing.

<p>Ebonite Panels</p> <p>Matt 1 3/16</p> <p>8" x 6" 2/2 1/10</p> <p>12" x 9" 4/6 3/9</p> <p>12" x 12" 5/9 5/-</p> <p>15" x 9" 5/6 4/9</p> <p>15" x 12" 7/6 5/8</p> <p>4" x 4" 8d. 6d.</p> <p>7" x 5" 1/6 1/2</p> <p>6" x 6" x 1/8 10d.</p> <p>Any Size Cut.</p> <p>Sq. In. 1 1/2d. 1/4 1d.</p>	<p>MARK OF RELIABILITY</p>	<p>Square Law Var. Condensers (with knob & dial).</p> <p>0005 type 6/8</p> <p>0005 " 5/1</p> <p>0005 " 4/6</p> <p>Vernier Blade ex. 1/4</p> <p>J. B. Ormond, & Utility, usual prices.</p> <p>Vernier no dial 2/6</p> <p>Polar types 10/6</p>
---	--------------------------------	---

SEND FOR NEW FREE Comprehensive Price List.

TRADE ENQUIRIES INVITED Generous Terms - Prompt Service

<p>Terminals</p> <p>MIL-Pol. Brass 2d.</p> <p>Lacquered 2d.</p> <p>Multiphone 4w. 9d.</p> <p>6-way 1/-</p> <p>Aerial Wire 7/22</p> <p>Enamelled, Bright.</p> <p>100' 3/3 2/3</p> <p>do. Electron 1/2</p> <p>do. Mars..... 9/6</p> <p>Lead-in 4d.</p> <p>Insulators</p> <p>Shell, 2" x 2" 3d.</p> <p>Crystal type 9d.</p> <p>Lead-in 4d.</p> <p>4" & 6" do. 2d.</p> <p>9" do. 12 & 15 1/3</p> <p>Valve Holders</p> <p>Type A 7d. Polar 1/3</p> <p>Screwed 8 nuts 8d.</p> <p>Ebonite 10d.</p> <p>Do. Open Type 6d.</p> <p>"Security" Valve Holder 1/-</p> <p>1,000-Ohm Ex Govt. Choke Coils..... 9d.</p> <p>Coil Plugs</p> <p>Ebonite..... 10d.</p> <p>Superior..... 1/3</p> <p>Narrow..... 5d.</p> <p>"Athol" Ebonite 1/3</p> <p>Do. Porcelain 1/-</p> <p>Horned Coil Plugs 3d.</p> <p>Basket..... 11d.</p> <p>Basket Coil Sets. 6-1/9, 4-1/-</p>	<p>Headphones</p> <p>4,000ohms Brown's 'F', B.T.H., Siemens, Brandes, General Radio 20/-</p> <p>Ericsson, Claritone & Sterling..... 22/6</p> <p>Handphone..... 5/-</p> <p>Airweight..... 9/-</p> <p>H.T. Batteries</p> <p>With Wander Plugs</p> <p>50v. 2 1/2 36v. 4/10</p> <p>30v. 4/- 15v. 2/-</p> <p>4 1/2v. F.L. Btry 5d.</p> <p>66v. Ever-Ray 13/6</p> <p>36v. 8/- 15v. 3/6</p> <p>Siemens same price</p> <p>British Wires</p> <p>swg. dcc. sec. dcc.</p> <p>18 1/2 21 3/5</p> <p>20 2/2 3/4 4/2</p> <p>22 2/6 3/9 4/7</p> <p>24 2/11 3/10 5/-</p> <p>26 3/4 4/2 5/9</p> <p>28 3/9 4/9 6/6</p> <p>30 4/10 5/4 7/6</p> <p>32 5/6 6/- 8/9</p> <p>36 8/- 8/6 12/-</p> <p>40 17/- 14/8 20/-</p> <p>Ebonite Dials</p> <p>Engraved 5" 7d.</p> <p>Knobbed type 1/-</p> <p>2 1/2" Fil. Type 5d.</p>	<p>Transformers</p> <p>L.F.A. Silvertown 21/-</p> <p>Radio Inst (new) 25/-</p> <p>Igranite 21/- 20/-</p> <p>Burndept (new) 24/-</p> <p>"Croix"..... 9/-</p> <p>Ferranti..... 17/6</p> <p>Tangent 12/6 14/6</p> <p>Royal..... 20/-</p> <p>Eur. 3a No. 2. 21/-</p> <p>Concert Grand 25/-</p> <p>Baby..... 15/-</p> <p>H.F. Tangent 5/6</p> <p>McMichael's... 10/-</p> <p>Ooljah 300..... 5/6</p> <p>4" 300 m. 4/6</p> <p>Formers only 1/6</p> <p>Fil. Resistances</p> <p>Good quality..... 1/6</p> <p>Igranite..... 3/6</p> <p>Vernier type..... 5/6</p> <p>Ormond..... 2/6</p> <p>"R.I." Dual..... 7/6</p> <p>Burndept..... 5/-</p> <p>T.O.B. 4/- & 5/-</p> <p>Microstat..... 2/9</p> <p>Peerless Inr..... 2/6</p> <p>Condensers</p> <p>Mallard, Edison Bell, Duffiler, usual prices</p> <p>New Mansbridge 2 mfd. 3/6, 1 mfd. 2/6; 5 mfd. 1/9; 25 mfd. 1/6.</p>	<p>A Reader Writes</p> <p>"Many thanks for your Catalogue. This is an admirable booklet, concise and well arranged, and will be exceedingly useful."</p> <p>Have you got one? IT'S FREE.</p> <p>New Jacks & Contact</p> <p>1-Hole Fixing 1/9</p> <p>Standard Plugs 1/3</p> <p>Potentiometer, 300 ohms, ex-Govt. 5/-</p> <p>Hydrometers... 3/-</p> <p>Microphones... 2/-</p> <p>Tapping Keys 2/-</p> <p>All 'Igranite', 'Lissen', 'Burndept', 'Edison-Bell', 'Atlatas', & 'Sterling' goods supplied.</p> <p>Coil Holders</p> <p>Igranite 3 Set 8/6</p> <p>Ebonite 3 Coil 3/-</p> <p>Vernier 2 Coil 3/9</p> <p>Anode holder 9d.</p> <p>Variable Leaks</p> <p>Filteron 0.7 meg 3/6</p> <p>Watmel 0.5 2/6</p> <p>"Bretwood" 2/6</p> <p>"Lissen" 2/6</p> <p>"Resistances" 2/6</p>
---	--	---	--

J. H. TAYLOR & Co.
4 RADIO HOUSE, MACAULAY ST., HUDDERSFIELD
Tel 341 Grams; THOROUGH HUDDERSFIELD

FOREIGN RADIO NEWS.

(Continued from page 244.)

RAYMOND

HULLO EVERYBODY!

ALL GOODS POST FREE U.K. except where stated. Foreign orders over £10 post free otherwise please send ample for post, etc. Trade orders U.K. less 20%.

SUNDRIES

- Aerial, 7/22, 100ft. 2/6
2-way coil stands 2/8
5-way coil stands 4/8
2-way nickel 3/6
3-way nickel 4/11
2-way geared 5/6
2-way Shipton cam 6/3
3-way Shipton cam 7/6
2-way Polar cam 6/1
3-way Polar cam 7/1
vernier 9/1
2-way cam vernier 3/6
Coil plugs, plain 2 for 1/3
Shaped wedge 2 for 1/6
Do. Edison Bell 2 for 2/1
Do. Nickel sides 2 for 1/6
Do. fitted fibre 2 for 1/6
Ebonite do. 4/11
Edison Bell do. 10/1
Fixed Condensers: Edison Bell, .001 1/3
-.001 up to .0005 1/3
-.002 up to .002 2/1
Grid leak & clips 1/3
-.0003 & grid leak 2/6
Dubilier .0005 each 2/6
-.001 to .006 each 2/6
2 or 3 meg Grid 2/6
Leak 2/6
Anode res. on stand 3/6
(50, 70, 80, 100,000 ohms.)
2 mfd., T.O.C. 4/8
1 mfd., T.O.C. 3/10
25, T.O.C. 3/8
Spade tags, doz. 6d.
Bus Bar, 1/16th 1/2
Solid Rod Valve 1/3
Holders 1/3
Bretwood do. 1/9
H.T.C. over panel 1/9
H.T.C. over panel 1/9
Raymond Rheostat 6/6
R.I. Detector 6/6
Twin Flex, 12 yds. 1/9
Red & Black, 12 yds. 2/1
7-Phn. Phone Cords 1/11
Loud Speaker Cords 1/11
Eureka Gravity Detector 6/6
D.P.D.T. Panel, 1/3
S.P.D.T. 1/3

REFLEX COILS

- Made under licence
Burneppet Patent No. 168249
No. 35 150/200 8d.
No. 50 200/500 9d.
No. 75 300/750 1/1
No. 100 400/1,000 1/2
No. 150 600/1,500 1/8
No. 200 800/2,000 1/8
No. 250 900/2,500 3/3
Post 2d. each.

LOUD SPEAKERS

- O.A.V. Tom-Tit 30/1
C.A.V. Junior 55/1
Sterling Baby 55/1
Sterling Dinkle 30/1
Amplion Junior 27/6
Amplion Dragon 25/1
Amplion Do. III 50/1
Amplion De Luxe 65/1
Amplion AB18 105/1
Dulcevox 42/1
True Music Minor 21/1
Ultra 27/6

TRANSFORMERS L.F.

- Eureka Concert Grand 30/1
Eureka Second Stage 22/6
Igranic Shrouded New Model 21/1
Formo Shrouded 10/6
General Radio 83 15/1
Super Success (black) 21/1
Brunet shrouded 3/1 or 5/1 13/6
"Grey" 3/6
Wates Supra 12/6
Terminals complete. Pillar, doz. 1/1, 1/3
W.C.O. 2/3
Phone 2/1
Nickel, 9d. doz. extra
Voltmeter, each 5/6
Rheostat & Dial, 2/3
Red & Black, 12 yds. 2/1
7-Phn. Phone Cords 1/11
Loud Speaker Cords 1/11
Eureka Gravity Detector 6/6
D.P.D.T. Panel, 1/3
S.P.D.T. 1/3

ADJUSTABLE

- (4,000 ohms)
Dr. Nesper 12/6
Telefunken 16/11
Both genuine.
VALVES
B.T.H., Ediswan, Mullard, Gossard, Marconi
Bright, D.E., '06 and power valves all stocked.

IGRANIC COILS

- Coils—25 5/1, 35 5/1, 50 5/2, 75 5/6, 100 7/1, 150 7/10, 200 9/5, 250 9/10, 300 9/5, 400 10/3, Rheostat 4/6 30 ohms 7/1.

ORMOND

- L.F. Transformer 14/1
Special Rheostat 2/1
Variable condensers, with vernier.
-.0005 25/6
-.00025 20/1
Non-Pong V.H. 4/3
'Phones 20/1 & 22/6
Primax Loud Speaker £7 15

STERLING

- Variable condensers, with vernier.
-.0005 25/6
-.00025 20/1
Non-Pong V.H. 4/3
'Phones 20/1 & 22/6
Primax Loud Speaker £7 15

ERLSON E.V.

- (Continental) 4,000 ohms, 12/1
HEADPHONES
British, 4,000 ohms, 22/6
Sterling 20/1
B.T.H. 20/1
Brands 20/1
Brown's P type 20/1
Erison's 22/6
Michrom vernier 2/6
Gambrell coils stocked.
Paragon panels obtained
Walmel grid leak 2/6
Walmel anode 3/6
100,000 to 1,000,000 3/6
Bretwood leak 3/1
Ditto anode 3/1
Colvern Precision Variable 2/6
-.0003 20/1 - .0005 21/6
Glazite 10 ft. 1/2

POLAR

- R.O.C. Unit 15/1
Micrometer 5/6
-.0005 or .0003 10/6
EVER-READY
108 volts H.T. 20/1
66 volts H.T. 12/6

RAYMOND

Variable Condensers

SQUARE LAW LOW-LOSS

- One hole fixing. Ebonite ends. With Vernier Without Vernier
'.001 .. 8/6 '.001 .. 7/6
'.0005 .. 7/6 '.0005 .. 5/9
'.0003 .. 7/1 '.0003 .. 5/3
Including knob and dial. Post 3d. set.

STANDARD

- ORMOND "No. 3" Ebonite ends. Sq. law with vernier.
-.001 7/6
-.0005 5/6
-.0003 5/6
-.0002 5/1
Take up tiny space. Also without vernier 1/6 each less. Knob & dial free. All with knob & dial.

ORMOND "AMERICAN"

- Square Law Low Loss. Skeleton ends, knob and dial.
-.001 9/1 - .0005 8/1 - .0003 7/6 - .00025 6/6 (with vernier 1/6 each ex.)

JACKSON BROS. "J.B."

- Square Law with vernier.
-.001 9/6
-.0005 8/1
-.0003 6/1
-.00025 6/6
"J.B." { .001 8/6 .0005 7/1
Standard { .0003 5/9 .00025 5/3
ALL with knob and dial. Post free.

ACCUMULATORS

- 2-v. 40-amp. 9/6
3-v. 60-amp. 11/6
4-v. 40-amp 15/11
4-v. 60-amp. 19/6
4-v. 80-amp. 24/6
6-v. 60-amp. 29/6
6-v. 80-amp. 35/9
All new, best makes. Harts also stocked.

Goswell (quality) Mounted Coils.

- 25-1/6, 35-1/9, 50-2/1, 75-2/9, 100-2/9, 150-3/3, 200-3/9, 250-5/3, 300-6/1.

2-way Panel, 3/1

- 3-way, 5/1; 2-way cam vernier, 9/1. Electric Soldering Set, 5/6. All parts stocked.

"LOTUS"

- Geared 8 1/2 way, 7/1; 3-way, 10/6
McMichael's Triple Rheostat, 22/6
Dual Rheostat 7/6
H.F. Transformers each 10/1
All wave-length potentiometer, 7/6
Fixed Condensers, 1/9, 2/3

BURNEPPT PARTS

- Rheostats: Gen. Purposes, 5/1
Dual, 7/6
Detector, 4/1
Rheostats 5/1, 7/6
Antiphenic H.5/1
Success choke 10/6
Acho V.H. 1/3
Acho Coil Plug 1/3
T.C.B. 6 ohms 4/1
T.C.B. 30 ohms 4/1
T.C.B. Potentiometer (300), 5/1
Shipton ditto (600), 4/6
Shipton 7 ohms 3/1
Shipton 30 or 60 ohms, 3/1
Woodhall parts stocked. Dubilier Variables, Dubilier Fixed 610 type.

USE BRITISH VALVES

- For each one you buy I am willing to purchase one burnt-out valve. Prices given range from 1/3 to 4/1 according to valve you buy.

YOUR PANEL DRILLED FREE WITH 25/- order (retail)

CALLERS COLUMN ONLY

All Post Orders from Other Columns.

H.T. BATTERIES

- (Various makers).
60-v. 5/6, 6/6, 6/11
66v. Ever Ready, 12/6
108v. " " 20/1
60-v. B.B.C. 8/11
36v. " " 5/6
16-5 " " 2/9
9v. (grid bias) 2/1

Accumulators

- (well-known makes)
2v. 40a. 7/6, 8/6
4v. 40a. 13/11, 15/11
4v. 60a. 17/6, 18/3
4v. 80a. 22/6, 23/6
6v. 60a. 25/11, 27/6
6v. 80a. 33/11, 35/11
6v. 100a. 38/6

Square Law Variable Condensers.

- .0005 5/1 - .0003 4/6
Including knob & dial.
D.P.D.T. Panel, 1/3
S.P.D.T. 10/6
S.P.D.T. 10/6
Terminals, 1d.
Nickel, doz. 10d.
Valve sockets, 4 for 3d.
Stop or valve pins, 1d.
Washers, 12 a 1d.
Nuts, 6 a 1d.
Spade tags, 6 a 1d.
Spade terminals, 2 for 1d.
Pinterinals, 2 for 1d.
Do. Red or Black, 1d.
Copper foil, foot, 3d.
Red and black flex, 12 yards, 1/6
Aerial, 722 100ft. 1/11
Battery clips, 3 a 1d.
Sleeving, yard, 3d.
Wander plugs, pr. 2d.
Contact studs complete, 2 a 1d.
'Phones, 20/1 & 22/6
Knobs and Dials, 1/3
Empire Tape, 12 yds. 6d.
Valve Holders, 6d.
Plug and socket, red or black, 3d.
722 Aerial, 50 ft. 1/1
Ins. Hooks, 2 for 1d.
Loud speaker cords, 1/4, 1/6
Rheostats, special, 9d.
Vernier condensers, 1/9
Turnbuckle switches 10d.
Shorting plug, 3d.
Egg insulators, 4 for 3d.
Vacuumator 250/650 1/6
Sohd rod standard 1/1
Good quality do. 8/1d.
Hank 1/16th sq. Bus Bar 6d.
Lead-in (10 yds.), 1/1
Ebonite dials, 8d.
Unbracketable knobs 2d.
Adhesive tape, roll, 2d.
Tape aerial, 100 ft. 1/10
TWIN Bell Wire, per lb. 1/1
BRUNET 4,000 ohm 'phones 13/11

Ebonite Coil Plugs

- Fitted Fibre, 7d.
Plain, 4d.
Shaped, 6d. & 7d.
Edison Bell, 11d.

Loud speakers

- 4,000 ohm 'phones, 6/6
3-way coil stands, 3/6
Special rheostats, 1/1
Crystals, best, 6d.
Enclosed detectors, 8d.
Extra large do. 1/1
2v. 40 accumulator, 7/6

SECOND-HAND DEPT.

- Quantities of nearly new and second-hand goods on sale.

CHEAP PRICES.

- Old parts bought or taken in part exchange.

IMPOSSIBLE

- to advertise all lines here. Send name and address (postcard, please) for illustrated folder. Special offers not obtainable elsewhere.

USE BRITISH VALVES

- For each one you buy I am willing to purchase one burnt-out valve. Prices given range from 1/3 to 4/1 according to valve you buy.

NO CONNECTION WITH ANY OTHER FIRM WITH A SIMILAR LIST.

- BE SURE YOU ARE AT RAYMOND'S

HOURS OF BUSINESS

- Daily 9 a.m. to 8 p.m.
OPEN ALL DAY SATURDAY.
TWO SHOPS ONE ALWAYS OPEN.
Telephone (private line) Gerrard 2921.

Lariboisiere and Saint Antoine. Lariboisiere hospital is the one where all street casualties from the Paris area are sent. A French wireless firm has presented both hospitals with apparatus and has installed it free of charge.

German Government's Charitable Action. The Government has bought, for the sum of 43,500 marks, 2,000 receiving sets, which are to be distributed among all the institutions for the blind throughout Germany.

Extraordinary Alpine Aerial. A German correspondent who is holidaying in the Bernese Oberland informs us that two members of the Swiss Radio Club have set up an extraordinary receiving station. One of the masts is in the valley at Grindelwald, and the other on the very summit of the Wetterhorn, one of the giant peaks of the Alps. The mean height of the aerial is therefore about 5,000 feet. The two amateurs purpose shortly submitting the result of their experiments to the Swiss Radio Club.

New Amateur Station in Germany. It is announced that a new amateur transmitting station has come into operation at Netzschkau, and is worked by the local radio club. The power used is 500 watts and the call sign is J2.

Earthquake Warnings Automatically Broadcast. The Tokio correspondent of a French news agency states that Professor Shida, who is lecturer in seismology at the University of Kyoto, has perfected a device which will enable automatic warning of earthquakes to be broadcast by the seismic recording instruments.

The vibrations that are recorded by these delicate instruments are, by this apparatus, translated into sounds, which are amplified and connected up with the Government wireless stations. The transmission of the sound-vibrations will then in each case be followed by an announcement of the general direction and distance of the shock as judged by the seismic experts in charge of the recording instruments.

The great use of this in countries that are subject to frequent earth tremors, such as Japan, is that violent earthquakes are usually preceded by very slight shocks, so slight that the inhabitants do not feel them. But they are recorded at the registration stations, and serve as a warning and premonition of the serious shocks to come. In many cases, had it been possible to convey this warning quickly to the population, precautionary measures might have been taken that would have greatly diminished the loss of life.

Radio Gondolas in Venice. Radio amateurs in Venice have hit on a particularly bright idea—many of them, fortunate possessors of private gondolas, have fitted them up with receiving sets, and, with small loud speakers, go floating about the canals of a moonlit night. The effect is surprisingly romantic, when turning a corner on a silently gliding gondola, to hear from the next canal, wafted on the night air, some dreamy love melody from a Vienna or Italian station.

7 GRAPE STREET SHAFTESBURY AVENUE, W.C.2
New Oxford Street end.
NOTE: Grape Street is between Prince's Theatre and Radio's Library.
1 minute Tottenham Court Road Tube.
3 minutes Holborn Tube.
2 minutes Palace Theatre.
OPEN DAILY 9 a.m. to 8 p.m. ALL DAY SATURDAY.

Correspondence

Letters from readers discussing interesting and topical wireless events or recording unusual experiences are always welcomed, but it must be clearly understood that the publication of such does in no way indicate that we associate ourselves with the views expressed by our correspondents, and we cannot accept any responsibility for information given.—Editor.

EFFECTS OF MINERAL DEPOSITS.

The Editor, POPULAR WIRELESS.

Sir,—I have read with interest your article on conditions of reception in Devon and Cornwall ("P.W." No. 160).

I reside in a country which is "all tin," where the metal can be recovered from one's own garden, so your article holds little hope for any serious DX reception here. Receiving sets in Malaya have only been permitted within the last few months, and as yet no one has taken up wireless seriously.

The general opinion is that Malaya, consisting as it does of a large tin field, is not suitable for wireless reception.

I have not had an opportunity of proving or disproving the above opinion, as considerable time is taken in getting out components from England, and it will probably be September before I receive them.

However, I hope to experiment later, and find to what extent metal deposits have an injurious effect upon reception.

Yours faithfully,

F. J. BARNETT.

168 Pumpun,

Ipoh, Perak, F.M.S.

GOOD UNIDYNE RESULTS.

The Editor, POPULAR WIRELESS.

Dear Sir,—I thought it might interest you to know the excellent results which I have obtained with a one-valve Unidyne set.

I have deviated slightly from the original circuit as published in POPULAR WIRELESS by using a grid condenser of twenty times the usual capacity, viz. .006 mfd. This alteration requires a blocking condenser of approximately .002 mfd. to be shunted across the phones. Ledron diamond weave coils, despite the fact that they are double-wound, have given the greatest satisfaction, No. 5 of the set of five covering all B.B.C. main stations while No. 4 gives ample reaction. A three-plate vernier condenser, with an extension handle, is in parallel with the A.T.C. (.0005 mfd. "J.B." square law), and is essential for distant reception. The grid leak is a Bretwood, filament resistance microstat, and valve Thorpe K4.

Using these components, I have obtained on the Unidyne results which, as all admit when they have heard them, are but seldom equalled on a similar set with H.T.

Daventry (78 miles) can be heard several feet from the phones, while 5 W A (28 miles), and 6 B M (60 miles), are comfortable strength on three pairs. 5 I T (78 miles), 5 X X (60 miles), and Radio-Paris (270 miles) are somewhat weaker.

The following stations can all be heard after dark: 2 Z Y (91 miles), 2 L O (103 miles), 5 N O (250 miles), 2 B E (261 miles), L'Ecote Supérieure and Le Petit Parisien (270 miles), 5 S C (314 miles), 2 B D (400 miles), Radio-Toulouse (560 miles), and Madrid (760 miles).

Some half a dozen amateurs, including 2 M P, Bath (11 miles), and 6 R S and 5 T H, Newport (20 miles), are regularly received.

The purity and selectivity of the set are outstanding, and the results on the whole are the best which I have yet heard on a one-valve straight circuit.

With many thanks.

I beg to remain, yours truly.

C. H. GRIFFITHS.

5, Brentry Road,
Fishponds, Bristol.

A SUPER CRYSTAL SET.

The Editor, POPULAR WIRELESS.

Dear Sir,—I made up a Super crystal set as described in one of your recent issues and the results are amazing.

Having made up dozens of crystal sets, I consider the Super is the best of anything I have come across.

True, I am fairly close to 2 L O, but on an indoor aerial I have to tune the signals down.

There is a "body" in the tone which is delightful.

Yours sincerely,

VINCENT NEAL.

28, Mackeson Road,
Hampstead, N.W. 3.

WHAT MAKES THE CRYSTAL INSENSITIVE?

The Editor, POPULAR WIRELESS.

Dear Sir,—I read with great interest the excellent article on this subject in a recent issue. In this connection it may be of some interest to record two simple experiments I carried out a few months ago.

Two crystals, one old and insensitive, the other new and easy to adjust, are fitted in the same circuit. When fitted in parallel to each other the reception is invariably bad, the good crystal being unable to work

(Continued on page 262.)

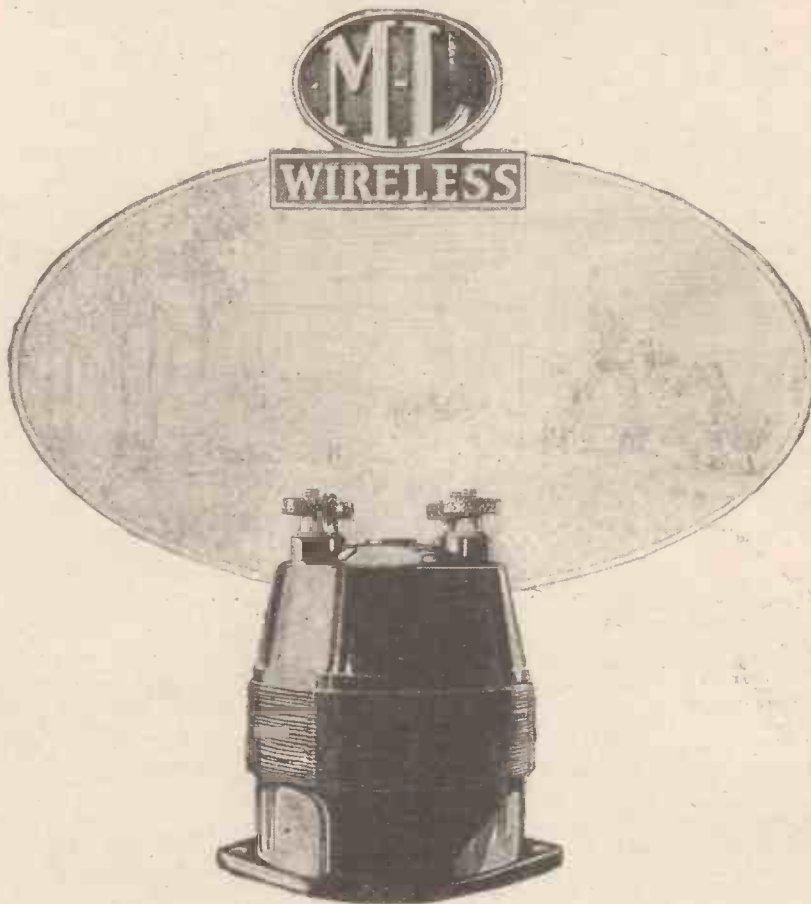

What Others Think.



It would be easy for us to write an advertisement telling you all about the sterling merits of the M.L. Transformer.

We think it is the best transformer that has ever been placed on the British market. Perhaps that is only natural since we are so interested in it. But here is what someone thinks who has no interest in the M.L. transformer, other than that of a satisfied user.

His testimonial is entirely unsolicited. Here is what he says:—

"As you are aware, I have tried out practically every make of L.F. Transformer available to the amateur, and, in my considered opinion your latest production is superior to anything I have previously tested."

The 1:6 ratio is used for amplification after a crystal rectifier. The 1:4 ratio is used for single stage L-F Amplification. The 1:2-6 and 1:4 ratios are used respectively in the first and second stages of two-stage amplification.

S. SMITH & SONS (M.A) LTD.
179-185 Great Portland Street, London, W.1
Telephone: Langham 2323 Telegrams: "Speedomet, Telew, London"
Also at Birmingham, Manchester, Glasgow and Belfast.

S. SMITH & SONS (M.A) LTD

CORRESPONDENCE.

(Continued from page 261.)

effectively. On the other hand, when fitted in series the reception was generally good, the poor crystal having no effect on the rectification. I think the only inference to be made from these results is that insensitivity is due to short circuiting of the contact points along the surface of the crystal. By ringing the crystal between the points of contact with a layer of insulating varnish or oil I have found the insensitivity to be diminished.

Yours faithfully,
N. W. BARNITT.

29, Park Road East,
Birkenhead, Cheshire.

NEW ZEALAND READER'S RESULTS.

The Editor, POPULAR WIRELESS.
Dear Sir,—I have experimented with the majority of one and two-valve circuits of merit that have appeared in your magazine for the last two years.

Re Mr. Allan Cash's 2-valve circuit that appeared in April 4th issue. I constructed this set and results are remarkable. K G O, San Francisco, over 6,500 miles away, being easily received every night on detector only, on adding 2 stages L.F. it works a "Claritone" loud speaker with pleasing volume. There is very little interference here (except static, which is very loud at times), as my nearest radio neighbour is 12 miles away and electric lines over 20.

I am no judge of a selective receiver, as the nearest station is 130 miles away, but I can tune in 3 stations on vernier only. Last night I bagged 9 Americans in half an hour, the farthest being WEB H, Chicago, this was on 2 valves.

I have twice heard a carrier wave on about 1,600 metres, and I hope some day to "get" 5 X X out of it.

Could you possibly give the constructional details of the heterodyne wave meter mentioned in Mr. Cash's article?

Thanking you for your valuable space and wishing every success to both your paper and all amateurs at "home."

Yours sincerely,
R. A. HOSKIN.

Matata, Tauranga, New Zealand.

P.S.—I will write again if I receive 5 X X.—R.A.H. (5 X X is now, of course, at Daventry—Ed.)

CRYSTAL SET FOR 5 X X.

The Editor, POPULAR WIRELESS.
Dear Sir,—You will, no doubt, be pleased to hear of the success of your crystal set for 5 X X (published in POPULAR WIRELESS on June 20th, 1925) here in Lancashire. I might say I have made dozens of crystal sets (I make nothing else in wireless sets but crystals) since taking up wireless, but this one is absolutely the best circuit I have made. Again thanking you for that admirable set, and hoping you will give us northerners a bit more attention.

I am,
Yours truly,
GEO. H. SALTER.

Milton House,
Blackrod, near Chorley.

MORE UNIDYNE RESULTS.

The Editor, POPULAR WIRELESS.
Dear Sir.—I thought it might interest "Unidyne" enthusiasts with my experiences with a single-valve Unidyne made from a description in "P.W.," May 2nd 1925. During a recent morning, when new wave-lengths were being tried, I picked up the following stations: 2 L O, 5 I T, 6 B M, 2 Z Y, 5 W A, 5 N O, and two French stations, Petit Parisien and Toulouse; at approximately 3.45 a.m. I picked up W G Y on 379 metres, broadcasting a concert. There was very little interference, the aerial used being 100 ft. of Electron wire run backwards and forwards on the beams in the roof, the earth also Electron wire, about 18 ft. long. Wishing you every success. I am,

Yours faithfully,
P. J. INGRAM.

The Terrace,
New Northcourt,
Abingdon, Berks.

THE "P.W." LONG-RANGE L.S. SET.

The Editor, POPULAR WIRELESS.
Dear Sir,—I am writing to inform you that the "Long-Range Loud Speaker" receiver published in your journal last March was made up by me, and has been thoroughly tested since then. I have made a good many receivers, but should like to say that for maximum results with ease of operation your circuit is hard to beat. I will not bore you with results obtained, except that several weeks ago I picked up the new station Radlo Catalana, situated at Barcelona, and received a confirmation of my report. This set is used regularly by me, and I wish for none better. Congratulating you on your excellent journal.—I remain,

Yours truly,
H. A. LODGE.

Church Cottages,
Fobbing, Essex



Worm Action

combined with a compensating spring that positively eliminates backlash! That's the secret of the unsurpassable smoothness of action of the L. & P. This coil-holder gets stations that others just miss. It tunes to a hair, and you can mount it anywhere. It's the best at any price and the cheapest real high-grade component on the market.

From all Good Dealers or Write at once for list. Sent free on request.

LONDON & PROVINCIAL
RADIO COMPANY, LTD.,
35, Colne Lane, Colne, Lancs.



L. & P. Coil-holder now reduced to
8/6
Post Free

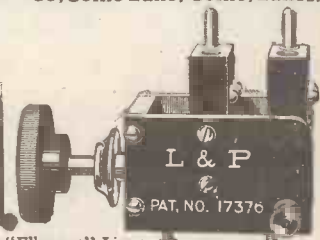

Other leading "Ellanges" Lines.
L. & P. Valve Windows enhance the appearance of any set. Small size 2/6 each. Large size 3/6 each. L. & P. Miniature Switches, D.P.D.T., 1/6 each. L. & P. Pull and Push Switch—positive action, positive satisfaction—only 1/6 each.

'PHONES REMAGNETIZED FREE

Phones Rewound are Remagnetised Free. RE-ALL MAKES REWOUND, 4,000 ohms, 5/- magnetizing only 2/-. Loud Speakers from 3/6. Transformers from 5/-. Post extra.
The H.R.P. Co., 46, St. Mary's Road, Leyton, E.10

ZIG-ZAG
ELECTRODES OR EARTH PLATES

MAKE A PERFECT EARTH.

Electrical & General Sundries Ltd
14 Victoria Street, S.W.1.

ACCUMULATOR BARGAINS.

C.A.V. & Fullers, solled, but guaranteed 12 months. Sent on approval against cash.
2v-40a ... 9/6 4v-80a ... 27/6 6v-60a ... 32/6
4v-40a ... 17/6 4v-100a ... 32/6 6v-80a ... 40/6
4v-60a ... 21/6 6v-40a ... 25/6 6v-100a ... 46/6
MAUDE RUBBER CO., 58, PRAED ST., W.

2-VALVE AMPLIFIER, 35/-

1-Valve Amplifier, 20/-, both perfect as new; Valves, 4/6 each; smart Headphones, 7/6 pair; new 4-Volt Accumulator, celluloid case, 13/-; new 60-Volt H.T. Battery, guaranteed, 6/-; 2-Valve All-Station Set, £4. Approval willingly.
P. TAYLOR, 57, Studley Road, Stockwell, LONDON.

REPAIRS

Headphones re-wound and re-magnetised, 5/- per pair.
Any kind L.F. Transformer re-wound and repaired, 5/-.
Loud Speakers re-wound, 5/-.
All work guaranteed and tested on our aerial.
Phone: 1795 Clerk.
MASON & CO., 44, East Road, City Road, E.C.

3 to 10-fold AMPLIFICATION WITHOUT VALVES

from any Crystal or Valve Set at small cost, by the NEW MAGNETIC MICROPHONE BAR.

(Prov. Patent No. 557425)

It clings to the Magnets of any Wireless Receiver and amplifies direct from them. No Microphone Button. No Diaphragms whatsoever. No distortion. A three-volt Dry Battery only required. Full particulars 1/6 stamp.



New Wilson Electrical Manufacturing Co., Ltd.
18, Fitzroy St., Euston Rd., London, W.1.
Phone: Museum 2705.

Stop that continued vibration of the filament!

USE the Clearer Tone Valve Holder and float your valves—secure from the ever-present, tone - destroying vibrations caused by street traffic, indoor footsteps and the hundred and one other microphonic disturbances. So thoroughly does this new holder cushion the valve that foreign noises are completely dissipated. The springs, though delicately adjusted, are immensely strong and the tightest valve can be inserted without fear of damaging them. Each spring has one turn only. Bakelite construction of the body of the holder ensures high insulation, low capacity and sturdiness.

each 2/9

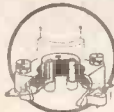

There are terminal connections for the experimenter and soldering tags for the permanent set.

2/9 each.

The springs themselves form the valve pin sockets. No soldered joints—all one solid metal piece from tag to valve leg. No flexible wire connections. The spring supports are not affected by stiff bus-bar wiring. For good reception with Dull Emitter Valves, Benjamin Clearer Tone Anti-Microphonic Valve Holders are essential.



Patents Pending.



BRITISH BENJAMIN MADE
CLEARER TONE VALVE HOLDER
(ANTI-MICROPHONIC)

From your Dealer or Direct from
THE BENJAMIN ELECTRIC LTD.,
Brantwood Works, Tariff Road,
Tottenham, N.17.

The Benjamin Battery Switch gives perfect current control, 2/- each.

TECHNICAL NOTES

(Continued from page 216.)

those of Germany and Russia, and also to the United States; but it was declined, as so many other valuable inventions have been declined before their true value was realised.

It remained for the British Government to appreciate the value of the mica condenser in telephone and wireless work, and from that time Dubilier's name has been prominently linked with mica condensers. The British Dubilier Company is similarly associated with mica condensers on this side of the Atlantic, and as an example of their supremacy in this direction, they have lately manufactured and installed the huge bank of mica condensers at the Rugby station, the largest bank of condensers in the world. Mica condensers are nowadays so perfect, and also so familiar, that it is difficult to realise what a large amount of experimental work, covering some years of manufacture, was necessary before the mica condenser was brought to its present form. In this work W. H. Goodman, of the British Dubilier Co.—whom I have the pleasure of knowing very well—has been most prominently concerned.

The Finest Broadcasting System.

Mr. Dubilier has some interesting and important observations to make upon British broadcasting. He was questioned as to how the British system compared with those of America and various parts of Europe.

It is well known that the British broadcasting is immeasurably superior to that of Europe generally, and as regards America, it is Dubilier's opinion that American broadcasting has been largely spoilt by the demands of the listeners themselves. They wanted a large number of stations, with a correspondingly large variety of programme. This they got, but owing to the multiplicity of stations, jamming is frequent, and it is not easy to tune out stations and avoid interference. He particularly expressed the hope that such a state of affairs would not be allowed to arise in this country, and congratulated Great Britain on having the finest broadcasting system in the world.

A Common Trouble.

One of the commonest troubles of a receiving set, especially where the owner has not had a great deal of experience in the management of the same, is the accompaniment of crackling, scraping and sizzling noises which frequently arise and which are often difficult to diagnose. The high-tension battery is the first component to fall under suspicion, and in eight cases out of ten this is the offender.

When the battery is getting "old"—and the time required to reach this stage depends upon the make of the battery and upon a variety of conditions, besides age in weeks or months—faulty cells and high-resistance effects produce all manner of troubles. When a crackle develops in the set, therefore, borrow an H.T. battery from a friend and try it before bothering to investigate any other part of the set. If it should prove that the H.T. battery is not at fault, suspicion next falls on the grid

(Continued on page 264.)

To announce GREAT £500 PROFIT-SHARING PRIZE SCHEME

Open to all Amateur Radio Users
(Crystal or Valve Sets).

In making this important announcement, it is our purpose to broadcast the inauguration of the latest milestone in British Wireless History—the formation of the

British Radio Users Association.

Constituted in the exclusive interests of all users of wireless, and for the general betterment of purchasing conditions and facilities for all amateurs.

SPECIAL HONORARY MEMBERSHIP
to the first 100,000 applicants.

Numerous Benefits and Privileges in addition to
Unique £500 Prize Scheme

—BIG CASH PRIZES—

Free Crystal and Valve Sets, Loud Speakers,
Valves, Coils, H.T. Batteries, etc., etc.

—OPEN TO ALL—

(including those who intend to become Radio Users)

Don't wait! Seize this unique opportunity *now* of securing Honorary Membership in an Institution which marks an important milestone in British Wireless Advancement.

IT COSTS YOU NOTHING

Full particulars, explanatory brochure and special form of application on receipt of a postcard to—

The Secretary, B.R.U.A.,
CUMBERLAND AVENUE, PARK ROYAL,
WILLESDEN, N.W.10.

APPLY AT ONCE

VISIT US AT STAND 23, ROYAL HORTICULTURAL HALL,
WIRELESS EXHIBITION, OCTOBER 10th—16th INCLUSIVE.

Quality RADIO COMPONENTS

Profusely illustrated thirty page CATALOGUE just out. If your dealer cannot give you one send us a card with his name and address to receive it direct FREE and POST FREE.

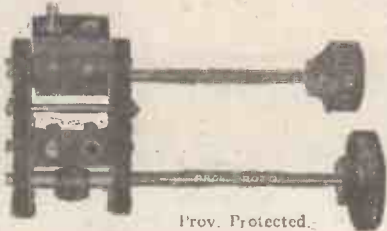

Prov. Protected.

CAM-VERNIER COIL HOLDER

Price 9/-; on base 1/- extra.

With Reaction Reverse and Shorting Switch incorporated, 12/6; postage 4d.

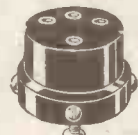

LEGLESS VALVE HOLDERS

1/6 post 2d.



Acts as own drilling jig.

BASKET COIL HOLDER.

1/3 postage 2d.



PANEL COIL HOLDER

(no base)

Back connections eliminating flex. 2-way 3/-, 3-way 5/-, N.P. 2-way 6d., 3-way 1/- extra. Post 3d.



Drilling template with all.

If your dealer has not got them we send post free if you mention his name and address.

GOSWELL ENGINEERING CO., LTD.
95/8, WHITE LION ST., LONDON, N.1.

TECHNICAL NOTES.

(Continued from page 263.)

leak, especially if this be of the variable variety. If the fault lies here, it should cease on disconnecting the aerial, although, of course, the cessation of the crackle on disconnecting the aerial does not necessarily mean that it is in the grid leak or grid condenser.

The intervalve transformers may be the cause of the trouble, but suspicion should fall upon them only after other possible clues have failed. If the transformer is faulty, you will probably find the crackle continue even when the aerial is disconnected. Try tapping the frame of the transformer with a piece of wood, as this will sometimes cause the crackle to come and go, due to a partial contact making and breaking. If the trouble should eventually be traced to the transformer, there is nothing to do but to take it out, put another in and have the first one repaired.

An Elusive Fault:

There is one very frequent source of trouble which often escapes attention until the end of a long and trying search, and that is bad contacts of the valves in their sockets. It must be remembered that there are four pins to make contact simultaneously, and it is surprising how seldom the whole four really make good contact.

Before inserting the valve in its socket, each of the four pins should be very carefully opened out with a penknife blade, until it makes a tight fit in the socket. I had a case not long ago of a trouble of this kind, which was very difficult to locate, until eventually it was found to be due to the fact that the leading-out wires from the valve were not properly soldered to the valve-legs, and when the valve was pushed home in the holder the contact became very uncertain. On going over the soldering on the four legs the trouble completely disappeared.

Changing Valves Round:

Another hint in this connection is to change the valves about in the different holders—assuming they are of the same type—not, for example, power-valves, or dull and bright emitters, or hard and soft. It is sometimes surprising how much better the set will function when the valves are shuffled round.

Dull Emitters Repaired
Concert Tested 7/6. '06 Valves 9/6. Bright, 4 9.
Crick Delivery. Send Valve and remittance to
W. G. FAMES, 15, Red Lion St., London W.C.1.
Phone Chancery 7750.

CABINETS for Wireless CONSTRUCTORS

PICKETT'S HIGHLY POLISHED CABINETS
from 1/6 each
They're good Value
Send for constructors list free
PICKETT'S CABINET WORKS
BEXLEY HEATH S.E.

ESTIMATES & LISTS (P.W.) SEND SIZES.

The Home for Your Wireless Set!

MORRIS SOLID OAK STANDARD CABINET with Locks,
to lock up any set and batteries with panel up to 36" x 18".
Sent on approval. Trade supplied.
Price carriage paid and packing free: £4 15
22" wide inside. £5 0
25" " " " £5 15
25" model de Luxe £5 15
36" " " " £3 0

MAKERIMPORT CO. (Dept. 5)
50a, Lord Street, LIVERPOOL.

PATENTS, TRADE MARKS, INVENTIONS
ADVICE, HANDBOOK & CONSULTATIONS FREE
E. T. KING, C.I.M.E., Regd. Patent Agent (G.B., U.S. & Canada), 146a, Queen Victoria Street, London, E.C.4. 39 years' experience.

RADIO "CROXSONIA" PANELS
Money back guarantee that each and all Panels are free from surface leakage, Meggar test Infinity. 8" x 5", 1/2; 7" x 6", 1/3; 9" x 6", 1/7; 10" x 8", 2/1; 11" x 8", 2/3; 10" x 9", 2/4; 12" x 8", 2/6; 11" x 9", 2/7; 12" x 9", 2/10; 12" x 10", 3/-; 14" x 10", 3/5; 14" x 12", 4/-; 7" x 5", 1/- thick. Post Free. Callers, cut any size, and quote by Post. Sample, and prices, post free to the Trade.
CROXSONIA CO., 10, South St., MOORGATE, E.C.2

VARIABLE CONDENSER PARTS.
.001, 6/-; .0005, 3/9; .0003, 3/-; .00025, 2/9; .0002, 2/6; .0001, 2/3; .00005, 2/- Post 6d.; on 4 free. Full ebonite end-plates, 1/- per pair extra. Knobs and dials 1/- extra. Packed in attractive box. If you are requiring anything Wireless, write to us. Trade enquiries invited.—CHARLES DAVIS, WATER LAKE, LEEDS.

ACCUMULATOR MATS
Prevent Damage by Spilled Acid. 12in. x 8in. 2/9
GUARANTEED ACID PROOF. 10in. x 8in. 2/6
ADDIS & CO., 15, Paradise St., Liverpool.

HEADPHONE REPAIRS
Rewound, re-magnetised and readjusted. Lowest prices quoted on receipt of telephones. Delivery three days.—THE VARLEY MAGNET CO., London, S.E.18. Phone 888-9 Woolwich. Est. 26 years.

Accumulators Charged
in your own home with a
TUNGAR BATTERY CHARGER
Simple, Safe and Economical. No moving parts. Requires no attention. No Garage, Owner-driver or Wireless Enthusiast should be without one. Will charge from one to ten 6-12-volt batteries at a time. Deliveries from stock. Descriptive booklet free on application. The Tungar Battery Charger is suitable for use on Alternating Current supply only. Obtainable from your Garage or Electrician.
THE BRITISH THOMSON-HOUSTON CO. LTD.
MAZDA HOUSE, NEWMAN STREET, OXFORD STREET, W.1.

SELECTIVITY
with the simplest sets. Tune your Aerial Circuit with my **SERIES-PARALLEL CONDENSER** (Pats. Pdg.). Variable capacity in SERIES, PARALLEL, or S. & P. SIMULTANEOUSLY. No switches. No tuning gap. Price 10/6.
LOWE, 158, LEWISHAM ROAD, S.E.13

'PHONES STRENGTHENED!!
NEW SECRET METHOD.
of magnetising and adjusting improves new or old 'phones 20 per cent to 200 per cent. 2/- pair. Guaranteed results. New method of layer-wound rewinding—renews useless 'phones and makes them better than new. 5/- pair. Every class of repair to 'phones, loudspeakers and transformers. All work guaranteed. Ready same day. Post. 6d. pair. Prospectus P. gratis. **JOHN W. MILLER, 68, Farrington Street, E.C.4. Phone: Central 1950.**

The MICROHM VERNIER CONDENSER
for sharp and accurate tuning
2/6
GET ONE TO-DAY
Postage 3d.
MICROHM ENGINEERING CO., Tel: Varsity Works, College St., London, E.9. Clissold 2887
R/R

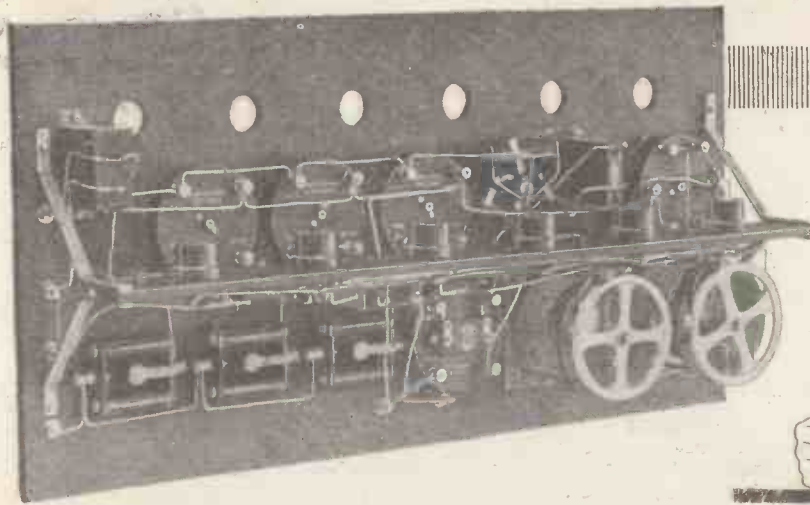

THE SUPER-HETERODYNE PARTS YOU WANT

In placing the R.I. Super-heterodyne parts on the market many thousands of enthusiasts will receive the benefit that they have already enjoyed from the designers of the first high frequency intervalve components placed on the British market.

The R.I. Super-heterodyne Transformers will become famous for their maximum stability and minimum stray field losses. It is essential in super-heterodyne circuits that the energy from the primary circuit of intervalve transformers be transferred as fully and quickly as possible to the grid of the succeeding valves.

In the R.I. units there is a greater freedom from self-oscillation with a maximum amplification per stage. The R.I. winding eliminates sharp amplification peaks, and enables easier tuning.

PRICE PER SET OF 3 TRANSFORMERS

£3 0 0

THE R.I. OSCILLATION COUPLER

Consists of a specially wound anode and grid circuit. The efficiency of the Coupler is such that practically no attention need be paid to filament and anode voltage, due to the adjustments necessary not being critical. In addition to this, there is a smaller winding which can be connected in the earth lead of the aerial or frame coil circuit.

It is intended that a variable air condenser should be connected across the anode coil, the capacity of this condenser being '0005.

PRICE 25/-

THE R.I. COMBINED OSCILLATING UNIT

Comprises a low-loss efficient variable air condenser of '00025 mfd. capacity connected to the most efficient grid anode and coupling circuit. The windings are all of 9/38 double silk stranded and enamelled wire; and the dimensions being absolutely correct, the efficiency of this coupling is as high as possible.

Panel mounting is by one-hole fixing.

PRICE 35/-

THE R.I. FILTER

PRICE 25/-

We feel confident that there are no units on the British market giving the same quality and results as the R.I. Super-heterodyne units.

With each set of components a full diagram of connections is given, which enables one to get the best out of the Super-heterodyne circuit.

Full Particulars Free on Application.

This unit, which has externally the same dimensions as the Super-heterodyne Transformer, consists of two inductances tuned by means of a fixed condenser to approximately 6,000 metres.

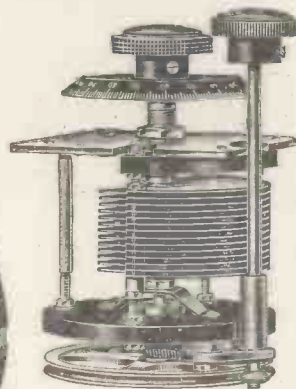

PRICES

	£	s.	d.
·001 mfd.	1	12	6
·0005 mfd.	1	8	6
·00025 mfd.	1	6	0

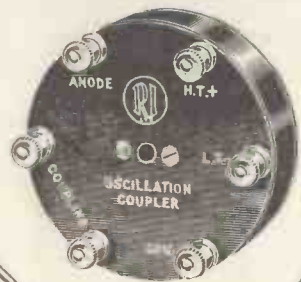
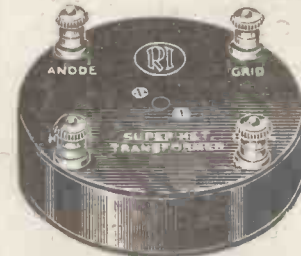

R.I. new slow-motion geared condenser giving continuous vernier control throughout its travel with remarkably fine tuning.



12 HYDE ST. NEW OXFORD ST. LONDON W.C.1

Contractors to the Admiralty and all Government Departments.

LISSENIUM.

Cutting out local interference.

THE most simple means of increasing the selectivity of a receiver is to use a LISSENIUM X COIL in place of the usual aerial coil.

Sometimes, however, local interference is so powerful that selective tuning is not sufficient in itself, particularly when the detector valve is not preceded by tuned H.F. stages. In such cases a wave-trap circuit is of great advantage provided it will eliminate the local interference without reducing the efficiency of the receiver.

A particularly effective circuit can be connected up in a few minutes, using a LISSENIUM X COIL and a standard LISSENIUM COIL.

The LISSENIUM X COIL should be inserted in the aerial coil holder, which should be wired so that the socket of the coil is connected to earth. The aerial should be connected to one of the terminals on the side of the coil mount instead of to the usual terminal on the receiver; parallel tuning should be used.

The circuit so obtained results in a considerable increase in selectivity, but if it is not sufficient, owing to very powerful local transmissions, the wave-trap

can be added. One side of a standard LISSENIUM COIL should be connected to earth and the other side to one terminal of a variable condenser, the remaining terminal of which is connected to aerial.

WITH SUCH A CIRCUIT, POWERFUL LOCAL TRANSMISSIONS CAN BE TUNED OUT, PERMITTING OF DISTANT RECEPTION WITHOUT INTERFERENCE.

For broadcast wave-lengths, use a LISSENIUM X COIL No. 50, 60, or 75, and a standard LISSENIUM COIL No. 75. In order to obtain extremely critical tuning, LISSENIUM Mk. 2 MICA VARIABLE CONDENSERS are recommended for tuning.

LISSENIUM X COIL No. 60 covers the broadcast wave-lengths, but in order to obtain the best coil combination for all conditions of reception, experimenters usually purchase also LISSENIUM X COILS Nos. 50 and 75 for the lower and higher broadcast wave-lengths respectively. LISSENIUM X COIL No. 250 covers the Daventry and Radio-Paris wave-lengths.

LISSENIUM X COILS are particularly suitable for aperiodic aerial tuning, auto-coupled tuned-anode, "neutral-grid," and Reinartz circuits. **THEY POSSESS ALL THE CHARACTERISTICS WHICH HAVE MADE STANDARD LISSENIUM COILS FAMOUS AND HAVE THE ADDITIONAL CONVENIENCE OF THE TWO TAPPING POINTS.**

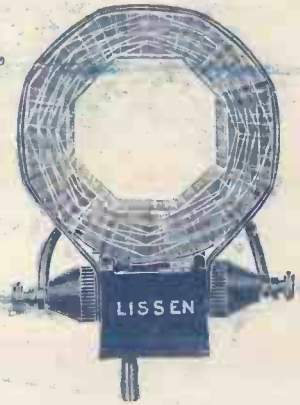

LISSENIUM X COILS

No. 50	6/-
„ 60	6/4
„ 75	6/4
„ 250	9/9

Send for interesting leaflet describing the uses of Lissen X Coils and for Text Book of Lissen Parts — free to readers of this magazine.



LISSENIUM COILS.

No. 25	...	4/10
„ 30	...	4/10
„ 35	...	4/10
„ 40	...	4/10
„ 50	...	5/-
„ 60	...	5/4
„ 75	...	5/4
„ 100	...	6/9
„ 150	...	7/7
„ 200	...	8/5
„ 250	...	8/9
„ 300	...	9/2

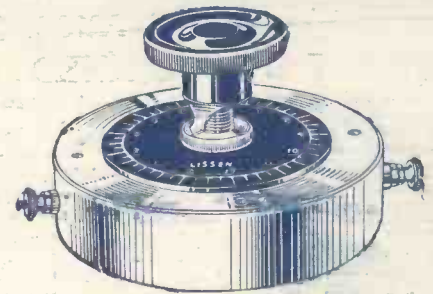

LISSEN MK. 2 MICA VARIABLE CONDENSER.

Tunes through 710 degrees of the scale—makes a separate vernier unnecessary.

Table or panel mounting—Lissen One-Hole Fixing,

17/6

LISSEN LIMITED

LISSENIUM WORKS, 8-16, FRIARS LANE, RICHMOND, SURREY.

'Phone : Richmond 2285 (4 lines).

'Grams : "LISSENIUM, PHONE, LONDON."

BUILD with ALL LISSEN PARTS and your receiver will give results which would never be possible with mixed parts.

Printed and published every Thursday by the Proprietors, The Amalgamated Press (1922), Ltd., The Fleetway House, Farringdon St., London, E.C.4. Advertisement Offices, Messrs. J. H. Lile, Ltd., 4, Ludgate Circus, London, E.C.4. Registered as a newspaper, and for transmission by Canadian Magazine Post. Subscription rates. Inland and Abroad, 19/6 per annum. 9/9 for six months. Sole agents for South Africa: Central News Agency, Ltd. Sole agents for Australia and New Zealand: Messrs. Gordon & Gotch, Ltd.; and for Canada: The Imperial News Co. (Canada), Ltd. Saturday, September 26th, 1925.

R/R