

# Radio News of Canada

3587-1-27  
Leverette J. ...



Vol. 5—No. 6

TORONTO

January, 1927



GRETA NISSEN IN "BLONDE OR BRUNETTE"  
This Norse beauty who has a prominent part in Malcolm St. Clair's, "The Popular Sin," is now playing the part of a blonde in Adolphe Menjou's Paramount starring picture, "Blonde or Brunette."

# PERFEX AERIAL

**Non-Directional**

**Super Aerial Efficiency—Anywhere.**  
**Increases Selectivity, Range, Volume and Purity of Reception**  
**Reduces Interferences, Noises and Fading, Overcomes Blind Spots.**  
**You can get more Stations on your set and**  
**hear Broadcasting Louder and Clearer.**

## Reception From All Directions

The patent "PERFEX" Aerial is the outcome of considerable scientific investigation, resulting in it being the most efficient collector of wireless energy yet devised, and the compact form, obviating the necessity for space, permits of installation at any address in a manner to secure maximum aerial efficiency.

As will be seen from the illustration, it embodies new advanced principles, the advantages of which are as follows:

1. The wire being carried on rectangular spreaders broadcasting can be received equally well from all directions.
2. The spreaders act as conductors for the energy collected, enabling it to flow to the download over the shortest path and thus reduce resistance, avoiding loss from this cause.
3. The aerial wire being in a vertical plane, advantage is taken of the proved fact that a vertical wire collects a greater amount of wireless energy than a horizontal one, and also avoids capacity losses.
4. The special "PERFEX" Aerial Wire is the most efficient yet invented, taking the form of an open woven tube with the whole surface of each strand exposed to the oncoming waves. It is made of 22 strands of tinned copper wire.

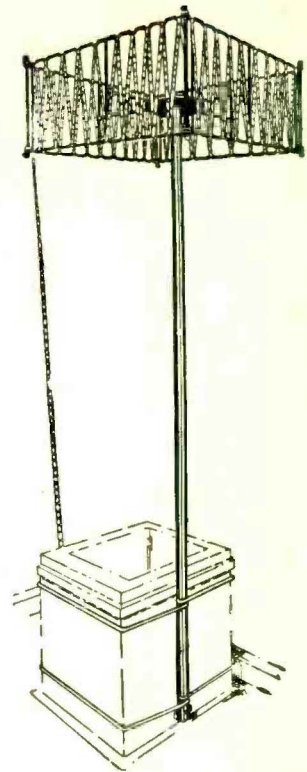

Patented in Canada and  
Other Countries

**\$15.00**

(WITHOUT MAST)

**ASK YOUR  
NEAREST DEALER**

**\$5.75**

Complete  
with Insulators

**"PERFEX" AERIAL WIRE**

IN COILS OF  
150 FEET

### SOME OF THE JOBBERS ALREADY HANDLING "PERFEX"

#### WESTERN DISTRIBUTORS OR JOBBERS

|  |          |
|--|----------|
| Marshall Wells Company, Limited        | Winnipeg |
| J. H. Ashdown Company, Limited         | Winnipeg |
| Consolidated Distributors, Limited     | Winnipeg |
| Miller Morse Hardware Company, Limited | Winnipeg |
| Canada Cycle & Motor Co., Limited      | Winnipeg |
| Radio Corporation of Winnipeg, Limited | Winnipeg |

#### EASTERN DISTRIBUTORS OR JOBBERS

|                                 |         |
|---------------------------------|---------|
| Toronto Radio Company, Limited  | Toronto |
| Aikenhead Hardware Co., Limited | Toronto |

|                                   |           |
|-----------------------------------|-----------|
| Vimy Supply Company, Limited      | Toronto   |
| R. S. Williams Music Co., Limited | Toronto   |
| Cutten & Foster Company, Limited  | Toronto   |
| A. Carey & Sons, Limited          | Hamilton  |
| W. M. McPhillips Company          | London    |
| Wesley Electric Company, Limited  | Windsor   |
| Service Supply Company, Limited   | Ottawa    |
| Radio Limited                     | Montreal  |
| Ellis & Howard, Limited           | Kitchener |
| Wentworth Radio Supply Co. Ltd.   | Hamilton  |

Manufactured in Canada by:

THE  
**FEDERAL RADIO COMPANY LTD.**

445 KING STREET WEST

TORONTO 2, CANADA

CANADIAN DISTRIBUTORS:

**Carter Radio Co. Ltd.**  
TORONTO, CANADA.

Trade Mark Registered

Tell Them You Saw It In "Radio News of Canada"

---

---

# A Real Opportunity To Get First Class Radio Equipment at the Right Price

---

*We Can Send You Any Part or  
Set on Short Notice*

---

WE STOCK ALL THE LEADING SETS, BATTERIES AND COMPONENTS, INCLUDING FADA,  
BREMER TULLY, ALL-AMERICAN, ETC.

SEND FOR PRICE LIST, AND TIME PAYMENT PLAN

---

FADA SIX  
TWO CONTROL  
DRUM TYPE

---

UNLIMITED  
RANGE

---

WONDERFUL  
TONE

---

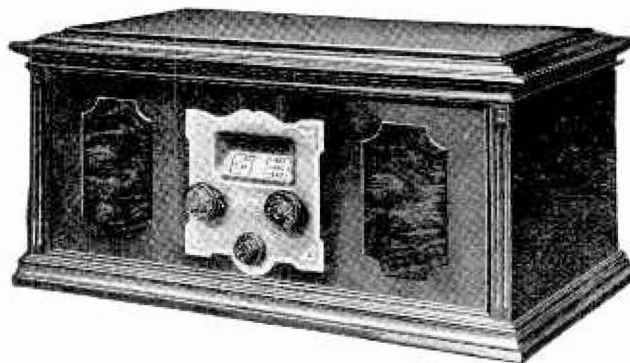

---

A fully shielded Six Tube  
Receiver. Three stages of  
R. F. Amplification, De-  
tector and two stages A.F.  
Amplification.

---

PRICE INCLUDING  
LOOP, \$215.00

---

FOR USE WITH LOOP OR OUTSIDE ANTENNA.  
POWER TUBE ALWAYS IN CIRCUIT.

## Dominion Radio and Motor Supplies

1176 BLOOR WEST, TORONTO, ONT.

---

---

# ATWATER KENT RADIO



MODEL 35, illustrated, 6-tube One Dial Receiver, less tubes and batteries, but with battery cable attached, \$98. Other One Dial Receivers, \$120 and \$195.

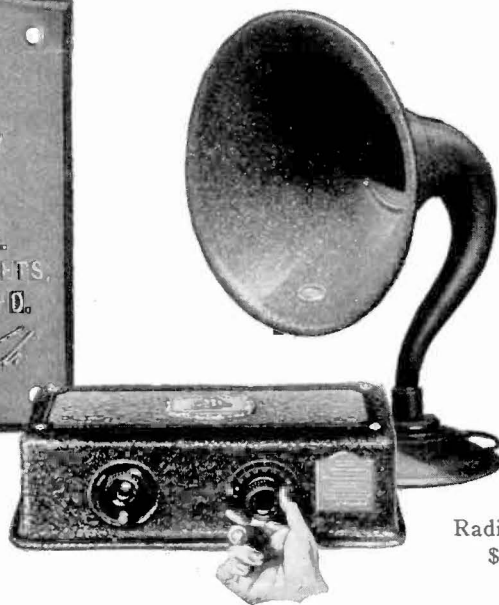

Radio Speakers  
\$22 to \$32

The first receiving set sold by the Atwater Kent Manufacturing Co. was shipped from the factory November, 1922.

Figures for the intervening years, showing the increasing demand for Atwater Kent Sets, are:

|                             |                             |
|-----------------------------|-----------------------------|
| 1922-1923 . . . . . 6,628   | 1925-1926 . . . . . 311,208 |
| 1923-1924 . . . . . 58,927  | PRODUCTION OF SETS FOR:     |
| 1924-1925 . . . . . 175,461 | 1926-1927 . . . . . 600,000 |

EVERY SUNDAY EVENING:  
The Atwater Kent Radio Hour brings you the stars of opera and concert, in Radio's finest program. Hear it at 9:15 Eastern Time, 8:15 Central Time, through:

- WEAF . . . . . New York
- WEEI . . . . . Boston
- WRC . . . . . Washington
- WSAI . . . . . Cincinnati
- WTAM . . . . . Cleveland
- WGN . . . . . Chicago
- WFI . . . . . Philadelphia
- WCAE . . . . . Pittsburgh
- WGR . . . . . Buffalo
- WOC . . . . . Davenport
- KSD . . . . . St. Louis
- WWJ . . . . . Detroit
- WCCO . . . . . Minneapolis-St. Paul
- WGY . . . . . Schenectady
- WSB . . . . . Atlanta
- WSN . . . . . Nashville
- WMC . . . . . Memphis
- WHAF . . . . . Louisville

ATWATER KENT MANUFACTURING COMPANY

A. Atwater Kent, President

# Radio News

Eastern United States Representatives:

**HEVEY & DURKEE,**  
15 West 44th Street, New York City  
Phone Murray Hill 8488

Western U. S. Representatives:

**MACINTYRE & SIMPSON,**  
14 W. Washington St., Chicago, Ill.

## OF CANADA

*Applicant for Membership in Audit Bureau of Circulation*

**H. LEWIS,**  
Man. Editor

**B. HETHEY,**  
Business Manager.

Phone Elgin 3859

**Canadian Periodicals Limited, Publishers, 33-43 Adelaide Street West, Toronto 2, Canada**

"Radio News of Canada" is not responsible for any statements made, other than those which appear on its editorial page

Vol. 5

TORONTO, JANUARY, 1927

No. 6

## An All-Star Programme Ushers in the Year 1927

On New Year's night one of the greatest achievements in the Radio world, as far as Canada is concerned, was demonstrated, when stations CHIC (Northern Electric Co.) and CKNC (Canadian National Carbon Co.) in co-operation with the Victor Talking Machine Co., hooked up with the WEAFF chain of stations, and put the Victor artists on the air.

To those of us who have been forced to listen to a repetition of mediocre Radio programmes, this concert gave us a real treat and was undoubtedly one of the best ever presented.

When it is considered that Metropolitan stars like John McCormack, Rosa Ponsella, Mischa Elman and Alfred Cortot gave a two hour concert that did not cost the listener-in a cent, we must acknowledge the indebtedness we owe to the promoters and stations who co-operated, and we trust that this will not be the last time the Canadian stations will hook in with the WEAFF chain.

This concert gave an opportunity of hearing these wonderful artists to millions of people who would never have been able to hear them, or have the opportunity to listen to John McCormack's wonderful voice in any other way. There was doubtless a large number of farmers, working men and their families who were thus able, for the first time, to hear artists of this calibre.

The value of Radio as a means of spreading culture and high class entertainment will be greatly appreciated by those whose pleasures are confined to a limited purse.

CHIC, CKNC and the Victor Talking Machine Co. are to be heartily congratulated on their enterprise and initiative in supplying the Canadian public with such a wonderful programme. Needless to say this is the finest radio concert that has ever been heard in Canada. It was truly an ideal New Year's gift and undoubtedly added much to the general festivities in the many homes throughout Ontario.

Quebec also profited through Montreal station CKAC, La Presse, who tied up with WEAFF, thus completing the chain and enabling the whole of Eastern Canada to listen in on the Victor programme. This has never been achieved before and marks another stepping stone in the continued progress of Radio.

By a courtesy arrangement with the other broadcasting stations in Toronto, the "Star" (CFCA) has in the past been given the opportunity of broadcasting election results, and since on Jan. 1st the Municipal elections in Toronto took place, they desired the air on that night as usual. They were asked, in view of the importance of the Victor concert, to allow the other stations to go on the air from 9 to 11 p.m., which, however, they refused to do. Mr. Combs, of CKNC, then made special arrangements with Ottawa to use a five hundred meter wave length for the concert, and to this the "Star" reluctantly agreed.

In an article of Jan. 3rd the Star stated that crystal set owners reported interference while both stations were on the air, and in consequence CFCA had to

curtail its announcements of election reports every quarter of an hour. They further state that in future they do not intend to agree to a repetition of such a situation.

It is no doubt true that a limited number of crystal-set owners within a small radius of CFCA's broadcasting station may have had interference, but in our opinion the whole subject must be looked at from a broader point of view.

The Victor programme was heard and appreciated by hundreds of thousands of people throughout Ontario, whereas the Toronto Municipal elections results are purely a local affair and would not interest outside listeners-in.

It is hardly fair, therefore, to spoil the enjoyment of hundreds of thousands on account of a few hundred crystal-set owners in the immediate vicinity of CFCA.

With all due regard to the Star's pioneer work in the Radio field in this district, and admitting that they have in the past broadcast many interesting events and concerts, we feel that the time has now come when they must be prepared to give some thought to the fact that listeners-in want to hear entertainment other than local talent. We doubt very much, that if a census had been taken in Toronto on New Year's night, whether 10 per cent. of the people would have been listening to the election reports between 9 and 11 o'clock, which was the time this concert was taking place.

We appreciate the fact that in broadcasting election reports the "Star" is

(Continued on page 4)

giving a great public service. However, when all is said and done, it is rather a monotonous business listening to a repetition of figures, and more figures, for hours on end.

We believe that if CFCA had closed down entirely between 9 and 11 o'clock, and then furnished a complete list of the reports, they would have earned the gratitude and good will of hundreds of thousands of listeners-in within a radius of 200 miles of the city of Toronto.



**R. H. COMBS**  
Popular Director of CKNC, Toronto

We fail to understand the "Star's" reluctance to dual broadcasting at this time. Some four years ago we, too, opposed dual broadcasting in the city of Toronto, for the reason that the big majority of sets at that time were so broad in tuning that they could not separate local stations, even if they were as much as one hundred meters apart. But the modern set is capable of separating local stations within a few degrees, and it must be recognized that these sets are now in the majority. We must appreciate the fact, that Toronto listeners, as well as the listeners within the zone of the Toronto stations, are entitled to the best there is in Radio. This can only be done when our local stations are given some freedom to operate and the opportunity to link up with the big chain of stations in the States which are putting on such super-programmes.

With all diffidence to the position the "Star" takes with regard to dual broadcasting, we feel that now is the time when this must be done in the city of Toronto. The Toronto stations should be separated as far as the wave lengths we have in Canada will allow; and, the stations outside the city, which will be in operation soon, should be treated in the same way.

Other big cities have had to do likewise. Take Chicago as an example with its 23 Radio stations. Crystal-set users there undoubtedly get interference, but

they are in such a minority that they hardly count at all; in fact, it creates a demand, not only for better sets, but also for better equipped broadcasting stations, which can hold strictly to their wave length, to the advantage of everybody.

Radio is still in its infancy and steady progress is constantly being made to improve Radio reception, for the benefit of the masses. A city, the size and importance of Toronto, should therefore also be up-to-date, and give its listeners-in the best there is.

We again wish to congratulate the Victor Talking Machine Co., the Canadian National Carbon Co., and the Northern Electric Co. on their wonderful achievement on New Year's night. We earnestly hope that they will not allow the selfish viewpoint of other stations to stand in the way of a repetition, whenever they desire to put on similar concerts of this nature.



**RUTH AMOS**  
Leading Lady at the Vaughan Glaser Victoria Theatre, Toronto, who recently spoke over the Radio from CKCL

#### ANSWERS TO ANXIOUS

If a radio fan's wife is getting plump, what can he do about it? Ans.: Condenser.

If she is a brunette and he prefers a blond? Ans.: Transformer.

If she is inclined to be wild? Ans.: Rectifier.

If she elopes with the repair man? Ans.: Arrestor.

If she gets grouchy? Ans.: Tickler.

If she wants to meet him for lunch? Ans.: Meter.

If she insists upon his going to bed? Ans.: Resistor.

If she still insists? Ans.: Eliminator.

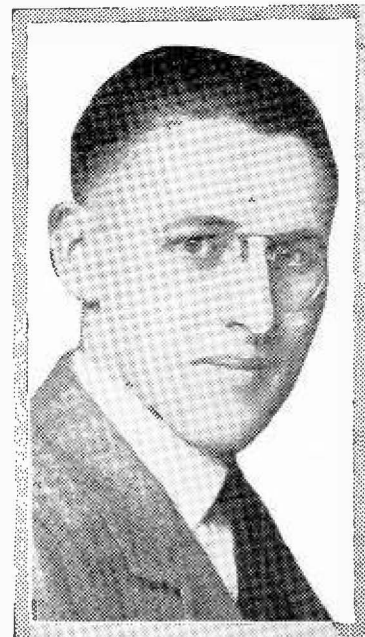

**EDGAR H. TWAMLEY**  
Studio Director of WOC, Davenport, Iowa

Edgar T. Twamley, recently appointed Studio Director of WOC, the radio station operated by The Palmer School of Chiropractic, at Davenport, Iowa. He is a former newspaper man, world traveler, and has lived for several years in China, Japan, England and other countries. He is also a graduate of the institution operating Station WOC.

#### JACK LITTLE BREAKS ALL RECORDS AT WOC

Little Jack Little broke all his previous endurance records in broadcasting uninterruptedly for exactly five hours from Station WOC, Davenport, during the early morning hours of January 1. Jack went on the air at 12.17 Central Standard Time (after playing the music incidental to a radio wedding which commenced at midnight) and concluded his programme at 5.17 a.m. During the time he was on the air, he acknowledged by radio 893 telegrams from appreciative listeners. Last March, also at WOC, Little Jack Little broke all his previous long programme records, by playing and singing continuously for 3 hours and 17 minutes. WOC officials believe his latest stunt broke all records for one artist, both in the number of messages received and acknowledged, and also the length of programme. During his entire programme Little Jack Little used no music, but played and sang entirely from memory.

# Manufacturers of Receivers Encourage the Set Builders

**They Are Able to Determine the Tendency of Radio Design by Observing Closely the Activities of 500,000 People Who Annually Build Home Sets**

By HUGO GERNSBACK

When radio was young in this country you could not go out in the open market and buy a complete radio set. I refer to the time when radio first came into vogue; that is, after the appearance of the modern vacuum tube, in 1912. At that time such a thing as a radio cabinet was unknown. We used to mount our instruments of various descriptions on our table; and the more room they took up, and the bigger the table was, the better pleased we were.

This state of affairs lasted for a number of years, and possibly culminated about 1923 in the first vacuum-tube sets of the multiple type which then made their appearance. It is true that, beginning with 1918, we had possessed a few self-contained sets of the cabinet variety, which, of course, had been used not for broadcast purposes, but for listening to code.

When broadcasting finally made its appearance the factory-made set took the country by storm, and while previously the home-built set had been in vogue the factory set took the ascendancy immediately. Today, at least in this country, the factory-made radio set for broadcast purposes has far outstripped the home-made set in popular demand. By this I do not mean to imply that the genus of radio constructor who builds his own set has died out. Quite the contrary. There are more sets being built this minute than ever before.

## 500,000 Build Sets

From the best available sources at hand it seems that there are at the present time between 400,000 and 500,000 people who annually build sets, and this figure seems to be on the increase. Large as this figure may seem, it is small compared to the figure of factory-made sets annually turned out in this country (over 2,300,000 at the last census of manufacturers), and it may be said that the manufacturers of ready-made sets today do not worry about the home-built set, but rather encourage it. This at first thought would seem paradoxical, but it is true nevertheless, for the following simple reasons:

\*The above is a talk which was given from station WRNY by Hugo Gernsback.

Radio is an art which changes rapidly, as is well known. While no revolutionary improvements have been made in the past ten years, or are likely to be made soon, changing styles, as well as improvements, keep the trade on the jump. New condensers come out, new dials are devised, new coils are produced. At the present time the shielding idea has attained great favor, almost overnight. Naturally, for this reason, set manufacturers are always anxious to incorporate the latest devices in their receivers.

But once the manufacturer is "tooled up" to turn out the season's supply, it is not always possible or desirable for him to make a change. In the meanwhile, the art and progress of radio goes on, and the manufacturer naturally wants to know, in plenty of time, what the tendency will be for the next year. By encouraging the set builders he gets a very good idea in what direction the tendency is heading; and he is able, at no cost to himself, to get this information, by simply watching the radio press and studying this tendency. When the new season comes along, the manufacturer is, therefore, apt to have a pretty good idea of what will happen, or what may be expected to happen next season. This is not to say that the manufacturer gets all of his ideas from the radio constructors. No such meaning is implied; but he gets valuable information; and for that reason most set manufacturers today openly encourage set building, because, first, they know that it cannot hurt their business and, secondly, because they derive from it valuable information which they would not have if there were no set building going on.

## The Set Builders "Job"

The set builders themselves, in the meanwhile, are having a mighty fine time, building to their heart's content, in which they are encouraged by the parts manufacturers, who are themselves always ahead of the set manufacturers in bringing out new devices. These new devices are tried out by the set builders, and within six months it

becomes known whether a certain device will "take," in the long run, or not.

This has been the case with the straight line frequency condensers, as it has also been with the new vernier dials. It is true of shielding the various parts and many other features, none of which would perhaps have become incorporated in ready-made sets as soon as they were, if the set builders themselves had not paved the way for such parts.

On the other hand, by encouraging the set builders the parts manufacturers get themselves very valuable experience which they would not obtain otherwise, and once the majority of set builders have adopted a certain article the set manufacturers in turn will adopt it as a rule. Such was the case, for instance, with the straight line frequency condenser, which was used by the set builders for some six to eight months before the set manufacturers adopted this type of condensers.

It may be said, therefore, that the set builders are always ahead of the game; they are forever pioneering. If you wish to see the latest circuit, or if you wish to see the latest radio wrinkle applied, you will always find it in the best home-made sets. All of this does not mean that the set builder does not use the ready-made set; in most cases he does. There is hardly a radio constructor today worth his salt who does not own two or three sets that are in constant use.

## Design Changes Frequently

For instance, I myself have two factory-made sets in my home, whereas the set which stands on my study table is one constructed by myself. This particular set probably does not stay there for more than a month at a time, because next month I shall be using a later model; but in the meanwhile the factory-made sets are doing their duty and are being used constantly by the household.

This condition is found all over the country, for it is duplicated in the home of practically every set constructor.

# The Bremer Tully Counterphase Power Six

By ARTHUR KURTS, of the Staff of CKCL

The tendency of a TRF circuit to oscillate is very evident to the average radio fan. When the tuned stages of radio frequency are tuned to the same frequency in other words are in resonance the circuit will oscillate freely unless some method is used to check such action.

The introduction of fixed neutralization has the effect of stopping the oscillating condition but at the expense of enormous loss of energy. This loss while improving the action of a receiver on the lower wave lengths is not conducive to proper performance on the higher waves because the condition of the circuit which has fixed neutralization is similar to a receiver employing regeneration and having a feedback coil (Tickler) which could not be varied. This of course would not be feasible as the receiver would not come up to the proper point of sensitivity necessary to proper reception. Other methods have been resorted to each with a view to control the oscillating circuit. The manufacture of low loss coils and conden-

The Bremer Tully Counterphase is a distinct step forward in the most popular of all circuits the TRF. Its method of oscillation control is distinctly unique. In addition to the usual primary and secondary of the radio frequency transformers a third circuit is employed to set up an opposite potential called the Counterphase. This coil is in the input and output of the circuit and feeds through an adjustable condenser which is in common with a 500,000 ohm resistance. This resistance varies the effective capacity of the neutralizing condenser thus keeping the circuit at the most sensitive point (just below the oscillating point). This when compared with the fixed method is a much superior and does not induce losses as the neutralizers are in a subsidiary circuit which is inductively coupled to the grid and plate coils. This is employed in the three stages of TRF and the neutralizing condensers are in common with a 500,000 ohm variable resistance which varies the capacity as required.

As a TRF receiver tends to oscillate

From the above it will be seen that a receiver employing three stages of TRF will necessary be more selective and more sensitive than a set using the customary two. Also it must be understood that in order to properly control three stages, the utmost care and precision must be taken in construction and adjusting the set. It also must be remembered that no loss is entailed in the neutralizing method employed and that the third stage is not put in to make up for losses previously introduced.

On tests taken with a BT Power Six the following was found. In one of the most powerful and active of the local broadcasters a BT set was installed for operation. It was found that in the same room as the oscillating unit of the transmitter the receiver was able within five dial divisions to tune out the said transmitter and bring other stations in with clear and pleasing volume. The loud speaker was pointed in the direction of the mouthpiece of an ordinary telephone and the announcer was distinctly heard at the other end of the line,

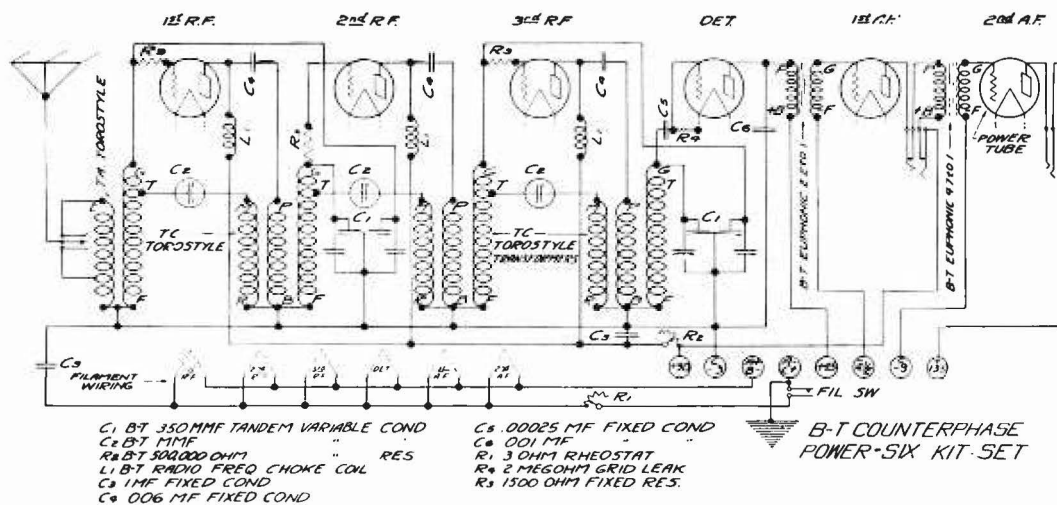

**BREMER  
TULLY  
COUNTERPHASE  
POWER SIX  
CIRCUIT**

sers have made the control of oscillation still more imperative.

Receivers that use low loss parts are infinitely more sensitive to radio frequency signals than are receivers that use the ordinary high loss coil and condenser. Considering the care that has been exercised in the manufacture of these parts it is a fallacy on the face of it that to introduce losses in a low loss receiver to control oscillation discounts the care and skill of the engineer and manufacturer.

more readily on the lower wave lengths (higher frequency) there is placed in the grid circuit of each tube a fixed resistor 1,500 ohms. This is necessary to keep the circuit equally sensitive over the entire broadcast range.

The secondaries of the coils are tuned with four 00035 mfd. variable condensers. These are made up in banks of two so that it is possible to use two tuning controls, in other words two stages are tuned with one control, the other two also requiring a control.

all this while the local station was in full swing.

So much for selectivity. The sensitivity of the receiver was such that the customary station whistle or carrier of the broadcaster, the operator happened to tune in was not very much in evidence excepting in the case of very distant stations. It was like turning from one station to another without having to tune to the lower range of the whistle and having to twiddle and turn to obtain satisfactory results. The set was sensi-



tive practically from full in to full out on the tuning condensers.

The audio is very pleasing and the transformers show a satisfactory curve the low frequencies coming through with good and undistorted volume. The set is primarily designed for 201A's and a power tube in the last stage. An output transformer is not necessary if a good make of speaker is used.

**Parts Required**

- 1 panel bored and engraved, 7 x 24 x 3/16.
- 1 rheostat, 2 ohm.
- 1 variable resistor (Carter) 500,000 ohm, three (3) fixed resistors, 1,500 ohm.
- 1 grid leak and holder, 200,000 ohm (2 meg.)
- 1 torostyle transformer, type "A".
- 3 torostyle transformers, type "C."
- 6 universal sockets (BT).
- 1 spdt jack switch (Carter).
- 1 open circuit jack (Carter).
- 1 closed circuit jack (Carter).
- 2 00035 mfd. variable tandem condensers (BT.)
- 1 00025 mfd. fixed condensers.
- 3 006 mfd. fixed condensers.
- 1 001 mfd. fixed condenser.
- 3 choke coils (BT.)
- 3 mikro mikes (BT.)
- 1 battery switch (Carter).
- 2 vernier dials (BT.)
- 2 imfd. fixed condensers.
- 2 audio transformers (BT Euphonic) Ratio 4 to 1 and "2.7 to 1.

**RADIO STATIONS NOT GOSSIP-MONGERS**

Call your enemy any names that you think appropriate and finish up by telling him that you have a drag with some radio station, and the story of his misdeeds will find its way out on the ether for the rest of the world to gloat over. This is the sum and substance of a little affair with which WOC at Davenport has just had to deal, after receiving a letter and several telephone calls regarding an alleged misdemeanor in a small mid-west town. The investigation which WOC officials immediately conducted disclosed that one party had a dispute with a neighbor, and in the height of verbal battle told his opponent that an account of the affair had been broadcast, and was now common gossip from Coast to Coast. Needless to say considerable paper, ink, postage, and temper used in stinging rebukes addressed to WOC would have been saved if he had even a crystal set. In the strictest confidence may it be added that radio stations have other things to concern them besides petty neighborhood disputes.



**MARCONI STATION CFCF, MONTREAL**

Station CFCF Broadcasts regularly from the Mount Royal Hotel, the largest hotel in the British Empire. Rex Battle's Concert Orchestra provide the Classical Music, while Joseph C. Smith and his Mount Royal Hotel Dance Orchestra is very popular with both dancers and Radio fans.

**NEW YORK SYMPHONY BROADCASTS VARIED PROGRAM, JANUARY 22**

Walter Damrosch, for more than four decades the conductor of the world famous New York Symphony, again brings his orchestra to the radio audience during Balkite Hour, Saturday evening, January 22nd, 9 p.m. Eastern (8 p.m. Central) time over WEAf, WEEI, WGR, WFI, WCAE, WSAI, WTAM, WWJ, WGN, WCCO, KSD, WDAF, WOC, WCAP.

Recently Mr. Damrosch announced his resignation at the end of this season as conductor of the New York Symphony Orchestra with which he has spent practically his whole life. With vast skill, knowledge and culture he has brought the orchestra to the exalted position it now holds. Throughout America and Europe it is accepted as an organization without a peer. All the players have been selected because of individual proficiency and many are virtuosos of the first rank.

With long experience in concert, opera and oratorio, under the sure and steady guidance of Walter Damrosch for forty seasons, the New York Symphony outranks any other similar organization as an accompanying body and has been associated with the world's greatest soloists. It assisted at the first Paderewski American appearances in

1891 and again in 1922-23 when he re-entered so triumphantly the concert field.

Mr. Damrosch has chosen for this Balkite concert music from four countries and three centuries. The program is as follows:

1. Overture, "Fingal's Cave" .....Mendelssohn
2. Dance of the Old Ladies .....Casella
3. Andante from Symphony No. 5 .....Tschaikowsky
4. Air on G String .....Bach  
Gavotte .....Bach
5. Dances from "Henry VIII" .....Saint-Saëns

It was Mr. Damrosch himself who had the honor of first performing Tschaikowsky's Fifth Symphony in this country.

**WILL ROGERS ON THE AIR AGAIN**

Will Rogers has signed a return engagement for an Eveready Hour to be broadcast in January.

About two years ago the cowboy-humorist who lately as "minister aplenty" has set the world laughing good naturedly over American political problems, was a guest of the Eveready Hour. This year he will be supported by the De Reszke Singers, who have been appearing with him in his stage engagements throughout the country.

### CANADIAN ANNOUNCER BEST ON PACIFIC



"It is quite true, I really had 'stage fright,'" said genial George Wright, explaining that when at the close of the radio show in Vancouver he was offered the cup which signalized the fact that he had been elected the most popular broadcasting announcer on the Pacific Coast, he was unable to do more than fairly gasp a half-audible "Thanks." "I found there is a vast difference between talking over the air through a microphone and speaking to a crowd of people present and visible."

Mr. Wright is chief announcer at CNRV, the Canadian National Rail-

ways broadcasting station at Vancouver, British Columbia, and the vote which placed him at the head of the list was in progress for some months. From all States of the Union along the Pacific and adjoining territory there was a big poll in favor of Mr. Wright, while scarcely a dissenting vote was cast in so far as British Columbia, Alberta and Saskatchewan were concerned.

CNRV is an outstanding station on the Pacific Coast and its message from Canada is consistently heard from Alaska to Mexico and flows well across the great ocean.

### WET LEAD-IN STRIP DECREASES VOLUME

With certain radio receivers it is found that the volume of received voice and music is reduced noticeably during a rain storm. This is sometimes due to poor insulators on the

aerial, but it can more often be traced to a defective or wet lead-in insulator. Some of the "window-strip" lead-ins are an abomination in this respect. Consisting merely of strips of thin copper with flexible non-waterproof casings, they are easily short-circuited

### "ROLA" PEDESTAL RE-CREATOR

This instrument represents the latest development of the engineering staff of the Rola Company, of Oakland, California. The Rola Cone unit, which comprises the reproducing system of these instruments, is of the free-floating cone type.

The conical tympanum is of a special material and is not affected by moisture or climatic conditions. All of the reproducing elements, including the cone, are completely enclosed in a perforated steel housing, protected against dust and damage. The cone is vibrated by a laminated and balanced armature mechanism, with the electrical and mechanical impedences closely matched for unhampered transfer of sound energy. The effective frequency range is approximately 45-9,000 cycles per second, the wood disc acting as an acoustic baffle and causing effective sound radiation at the lower frequencies.

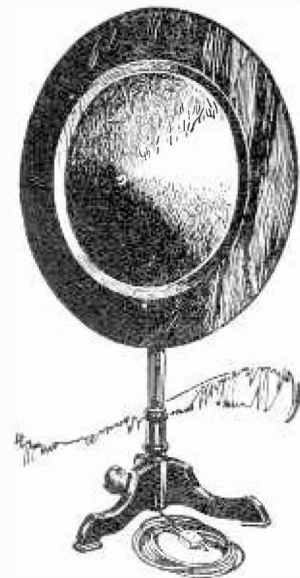

It is mounted on a stand thirty-six inches from the floor, with the upper part tilted in the manner of a tilt-top table.

A sample has been tested by Radio News of Canada Laboratories with satisfactory results, the tone being exceptionally pure and with ample volume. It lives up to all the makers claim for it and in our opinion is equal to any other first-class cone speaker on the Canadian market. Awarded Radio News of Canada Certificate of Merit No. 223.

against the window frame, and cause the loss of much of the energy flowing down the aerial wire. If, because your wall cannot be drilled, you must use one of these window strips, be sure you get one that is covered with waterproof insulation.

# You Can Travel Safely With a Life Belt and a Radio

The Seven Seas offer little danger to the modern voyager, because radio is ever warning, informing and saving in its greater mission daily on the Five Oceans

By EMMETT DOUGHERTY

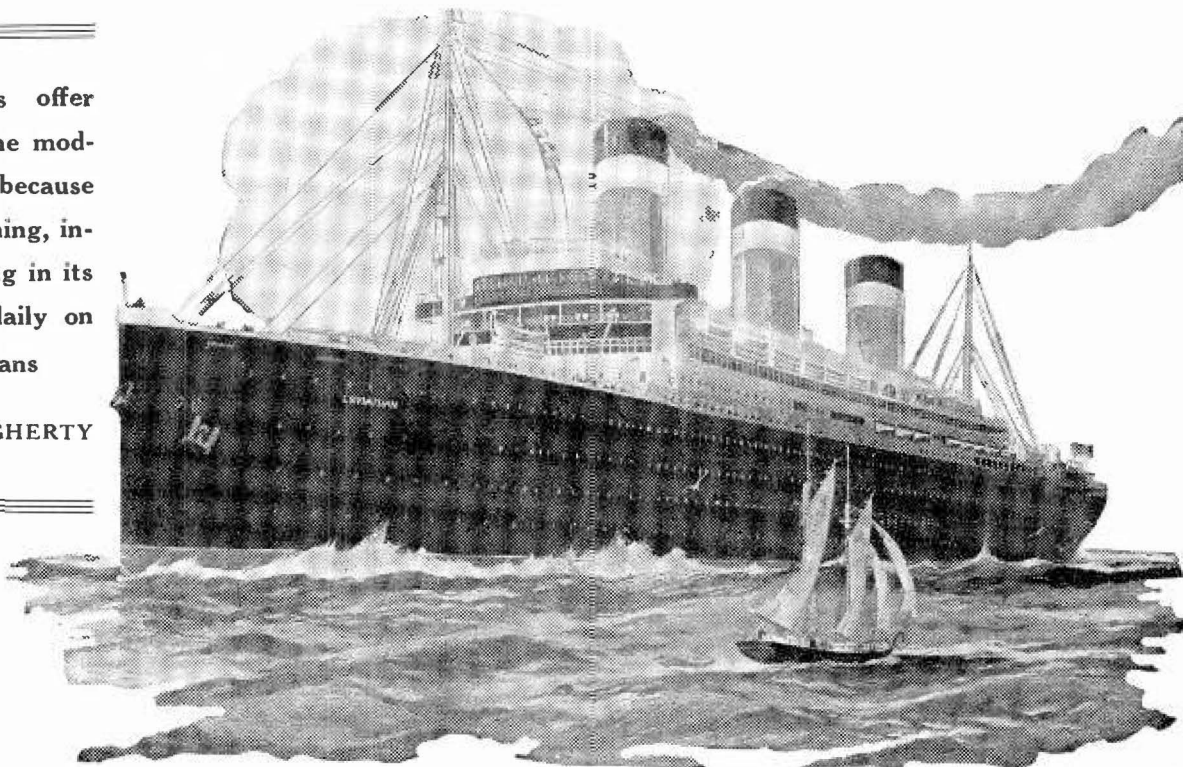

Reaching all corners of the seven seas through powerful naval radio broadcasting and receiving stations, the United States Navy Department has solved the question of safety of life at sea and has made possible the economical navigation of ships the world over.

Along the approaches of American coasts naval radio compass stations offer safe guides into port for the fog-bound or storm-swept mariner. This service of maritime security is carried on throughout each day and night of the year and, keeping pace with the development of aviation, has been extended to navigator of sea airways.

The problem of keeping the ocean travel lanes safe, simplified of late years by the widespread use of radio, is a joint one in which ships, both merchant and naval, contribute a large share. The radio sea net gathers in for the Hydrographic Office messages of derelicts, of icebergs, of lighthouses rendered temporarily un-serviceable by hurricanes, of buoys dragged by ice or storm from their charted anchorage, of navigational landmarks demolished. These messages are rebroadcast immediately by the Hydrographic Office in warnings to that part of the ocean highway concerned. In addition, storm warnings and weather observations for mariners and sea aviators are sent out in co-operation with the Weather

Bureau at Washington, and a daily time signal from the Naval Observatory is transmitted to navigators, so dependent on exact time in order to determine accurately their position at sea.

#### Distance no Bar

Merchant vessels and men of war almost half-way round the world from the sending stations are receiving these safety-at-sea directions. A merchant vessel, for instance, southeast of Cape of Good Hope, Africa, reported hearing hydrographic messages sent out from Washington. The American warship Scorpion at Constantinople reports receipt of navigational warnings and time signals from Washington.

Out on the broad ocean mariners are constantly kept informed of floating obstructions dangerous to the safety of their ships. A storm sweeps the main and wreckage occurs. Wreckage or derelicts floating in transoceanic lanes of travel, either in a partly submerged or awash condition, are the constant dread of mariners, especially at night. Once reported to the Hydrographic Office the location of these menacing obstructions is made known by radio. In addition, until drifting derelicts are removed, they are plotted on monthly pilot charts issued to mariners by the Hydrographic Office, so that future drifts of such menaces may be predicted by mariners themselves.

An unusual menace to mariners was let loose upon the Atlantic, July 12 of this year. Thirty-seven steel cylindrical pontoons, measuring about twenty feet in length and five feet in diameter, were lost from a barge which broke adrift from the tug Susan A. Moran off Frying Pan Shoals, North Carolina, in the path of coastwise shipping. The news was relayed to the Hydrographic Office by radio from the tug to the branch hydrographic office at Norfolk, Va., and was immediately broadcast from Washington to Atlantic mariners.

A sheaf of messages over an inch and a half in depth (and these messages written on onionskin paper) concerning the pontoons are on file in the Hydrographic Office. These include reports received from merchant masters stating the location of one or more of these pontoons and subsequent broadcasts of the Hydrographic Office. The Coast Guard, closely following these broadcasts, has been able to track down and destroy by gunfire fourteen of these rolling, drifting pontoons. That they are particularly hard to remove from the path of shipping is revealed by the fact that the Coast Guard cutter Majave was compelled to expend eleven rounds of six-pounder ammunition before its pontoon target sank. Invariably, as the sheaf of messages grows, the

(Continued on page 11)

The long arm of radio reaches out to all parts of the world, so that every ship route, every distant ocean is covered. This map shows extent of the United States Naval Radio Service.

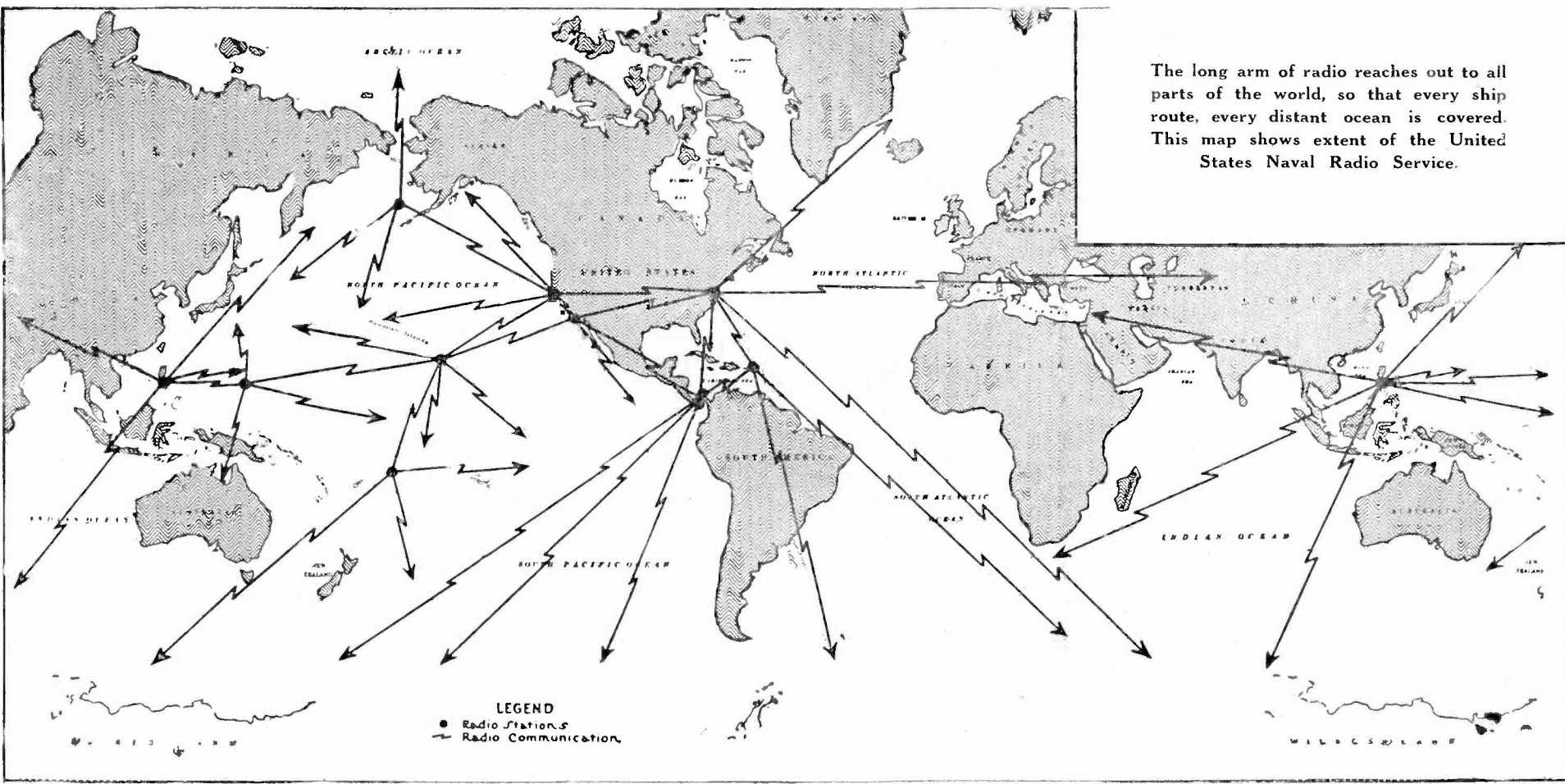

## YOU CAN TRAVEL SAFELY WITH A LIFE-BELT AND A RADIO

(Continued from page 9)

reports state that the "large, cylindrical objects" are becoming coated with rust and marine growth. Gradually the remaining pontoons have scattered to the north and east under the influence of the Gulf Stream. The pontoon sunk by the Mojave on August 25 was 500 miles north and east of the spot where it had gone adrift.

### Locating a Target Raft

A ten-day search by United States naval ships for a bulky dangerous target raft which had to be temporarily abandoned off Eleuthera Island, the Bahamas, during the hurricane of September 18, was ended by a report from a merchant ship of the raft's position. This raft, measuring about 150 feet in length and 15 feet in width, with a deep draft, showed but intermittently above the surface of the waters and was a matter of concern to the Navy Department as well as to mariners traveling the much used route to the eastward of the Bahamas.

The mine-sweeper Rail, which had been towing the raft to Guantanamo Bay for use in target practice by the scouting fleet, reported the raft's position as she put into San Salvador to accomplish emergency repairs from damage wrought by the hurricane. Six days later the raft was first sighted by a merchant ship, the steamship Oradell, and the commander of the scouting fleet at Guantanamo Bay sent a light cruiser and a division of destroyers to search in the area reported. After two days' search in this area the raft was not located. On the following day, however, a complete description of the submerged raft, its location and its probable direction of drift was radioed to the Hydrographic Office by the Canadian Forester and rebroadcast from Washington. As a result the Rail located the position, took the cumbersome tow in charge and ended the ten-day period of worry by sending the simple message: "Rail at Eleuthera Island for Guantanamo with target raft in tow." The shipping world in the north Atlantic was notified and went on its way relieved.

Many derelicts have drifted across the Atlantic Ocean, others have drifted aimlessly at the beck of the wind and current. The longest duration of derelict drift on record in the Hydrographic Office is that of the American schooner Fannie E. Wolston, abandoned off the coast of Virginia in October, 1891. Carried by the Gulf Stream and westerly winds, the abandoned ship drifted eastward to the 40th meridian, then was set southward and again eastward for months, finally was swept up again by the Gulf Stream and was last seen in October, 1894, a few hundred miles to the northeastward of the

position where she had been abandoned three years before. The track of this derelict in her aimless wanderings, as recorded in the Hydrographic Office, totaled some 8,995 miles.

The most notable drift in recent years was that of the British four-masted lumber-laden schooner Governor Parr, which was abandoned practically dismasted on October 2, 1923, to the southward of Newfoundland and drifted eastward in the path of trans-Atlantic shipping. On January 2, 1924, the Coast Guard cutter Tampa picked her up to the eastward of the Grand Banks and attempted to tow her to port, but after a day or two of heavy weather was obliged to abandon her. After this the derelict schooner drifted eastward again, and in October, 1924, appeared between the Canary Islands and the African coast, having drifted in that time almost half-way around the Atlantic Ocean and having been sighted a number of times and once boarded and set on fire.

### The Ice Patrol Reports

In the wide lanes of steamer travel between Europe and America, the radio reports from the ice patrol during the months of March, April, May and June have greatly increased surety of transoceanic navigational safety. These reports, sent each day on a carefully guarded wire length, are broadcast faithfully by ice patrol ships maintained by international agreement and stationed during the dangerous spring and summer months in areas where they can best note the southern movements of icebergs from the Arctic region. In addition, the ice patrol reports are rebroadcast twice daily by the Hydrographic Office.

On May 13 of this year the ice patrol ships had a busy day reporting the exact position of five bergs and two "growlers," the limiting areas for fourteen bergs and six growlers and the limiting area of a large field of bergs and "growlers." "Growlers" are detached piece of bergs, showing above water only a "whaleback" part of their submerged size. The date of withdrawal of the ice patrol this year, June 30, is broadcast to the trans-Atlantic world, and is accomplished only after a certainty that the steamship lanes will be free of ice.

In addition to the protection afforded by the ice patrol ships, the Hydrographic Office, after careful study over a period of years of the day-to-day southern limits of ice fields, has, in agreement with twenty-four transoceanic steamship companies, laid out safe tracks for steamships to travel both eastbound and westbound across the Atlantic. By plotting the ice patrol reports daily the Hydrographic Office recommends which tracks should be used in order to provide lanes free of ice. The north Atlantic track agreement,

brought about by the Titanic disaster, has been effectively in operation during the last fourteen years.

### Free Ship Bearings by Radio

As the open sea navigator approaches the American coast he may feel uncertain as to his exact position because of fog, hazy weather, strong currents or similar conditions encountered. At this point, upon his request by radio, naval radio compass stations will supply him free of charge with bearings which will fix his position. These radio compass stations, maintained by the navy for the purpose primarily of enemy tracking in war, are used as aids to navigation in peace time and are operated by naval personnel in order that this personnel, through constant practice, will be efficient and ready in an emergency for their real job in time of war. Mariners of all nations recognize the accuracy of these operators, as is testified by the 206,000 bearings furnished vessels during the year ending June 30, 1926, by United States radio compass stations.

Not only have the radio compass stations been able to serve ships with bearings to fix their position, but they have also actually guided ships into port, and, unsolicited, have warned others of their dangerous position.

The steamship Canada, conveyor ship for the Argentine world flight, while en route to Cross Sound, Alaska, reported herself in distress in a fog, July 8, 1925, at an unknown distance off Cape Spencer.

The ship's commander notified the naval radio compass station at Soapstone Point, situated on Yakobi Island, seven miles across the entrance to Cross Sound from Cape Spencer, that his standard compass had been smashed by heavy seas, and that his ship's log, by which he measured distance traveled, had been washed away. He had power, but no directing apparatus. The personnel at the radio compass station commenced sending bearing at 8:48 a.m. Placing his faith in the station personnel, Captain Tine of the Canada, accepted thirteen directional bearings furnished him, and at 5:10 p.m., passed Cape Spencer and entered Cross Sound. At 5:18 p.m. he sent his appreciation by radio: "I thank you very kindly for your good work in guiding us inside. My compass was broken, so I depended entirely on your guidance and you have done a fine job."

### Averting a Marine Disaster

The radio compass operator on watch from midnight to 4 a.m. at Tatoosh Island, on the southern entrance to the Straits of Juan de Fuca, Puget Sound, discovered at 3.16 a.m. from his plotted bearings on a foreign steamer that the ship was in grave danger of grounding. He sent a radio warning: "Why don't

(Continued on page 33)

## Broadcast Engineers Must Solve Interference--the Blank Wall of Radio

**"Do you think the broadcast interference can best be solved through technical means, the enacting of suitable laws, or by a combination of the two?" we asked several of the leading radio engineers of the country. Their opinions, at a time when the situation is getting worse, and Congress is considering radio legislation, is quite interesting.**

Broadcasting was the invention of radio engineers, men well versed in the art of sending and receiving voice and music over long distance through the ether and without wires. These men have been laboring ever since to improve that which they have created.

No group of experts that could be assembled could better tell how to end the broadcast interference problem than these pioneer inventors.

Quietly, they have been working out in their laboratories new devices and theories which would clear the air of all disturbances. They have been doing this while a storm was raging outside, to pass legislation that would attempt to lead wayward radio into a straight, though narrow path.

There may be a technical solution to the interference situation. Only the engineer can tell what it is.

What are the U.S. Department of Commerce and the government engineers doing about finding a solution? The answer is given in this statement from Commissioner D. B. Carson:

"The bureau is giving little thought to the method that may be adopted to regulate or straighten out the present situation, nor can it do so until such time as legislation is enacted, for it is at present not known whether the control will be given to the Secretary of Commerce, or be placed in the hands of an independent commission, nor is it known what form of legislation will be enacted therefor, until such time as Congress acts no plans can be formulated."

Dr. J. H. Dellinger, who is chief of the radio laboratory of the Bureau of Standards in the States, believes that a new system, in which one of the side bands is suppressed, may yet revolutionize transmission and open up many channels now occupied by the necessarily wide frequencies under the present system of broadcasting.

There are many advantages to the new system, such as greater distance and better signals, due to the diverting of energy to the side band used, which was originally distributed over the second side band

and the carrier wave; a narrower frequency, since the side band will take half as much "space" as the original wave; and the fact that more stations can fit in closer; due to the narrower individual side bands, with less interference. "Although there are a number of problems that must be solved before the new transmission system can be put into everyday use," says Dr. Dellinger, "I have no doubt that we are surely coming to it."

Another technical solution is outlined below by Dr. Lee DeForest, the inventor of the Audion, the three-element tube which made possible the present-day method of broadcasting and receiving.

"While the only immediate solution from the present chaotic condition in radio broadcasting lies in Federal legislation, and while there seems to be little doubt that effective legislation will be forthcoming early in the Congressional session," states Dr. De Forest, "it is appropriate at this time to consider what aid technical development has to offer in this ever present and growing problem of minimizing radio interference.

"It is reasonable to expect that radio traffic, like automobile traffic, will continue to increase, and it is obvious if this is the case that legislation alone cannot afford a complete solution of the problem.

"I have pointed out on several previous occasions that, in my opinion, radio service of the future would be based on modulated carrier waves, whereby a single broadcasting station could utilize a half dozen or more channels of communication on the same carrier wave frequency, modulating the latter in different super-audio frequencies, these, in turn, to be modulated telephonically.

"This idea is by no means new—dating back to the early part of this century. I think Professor Reginald Fessenden may have made the first disclosures or suggestions along this line. At that time the art was limited to spark transmission. Obviously the multiple channel transmission by this method, other than for telegraph service, must be very crude and imperfect. With the perfection of the

three-electrode oscillating audion the situation takes on an entirely different aspect. Particularly is this the case where we are working into higher and higher frequencies. The use of high frequencies (under 150 meters), permits in itself a great increase in the number of carrier wave channels which can be used without interference. On the other hand, fading on these short wave lengths becomes more bothersome, so that it may prove necessary shortly to utilize two or three fairly well separated frequencies simultaneously from the same transmitting station, with receivers tuned to all of these, so as to take care of transient fading.

"But the super position of several modulated frequencies well above the audible limit upon a high frequency carrier wave, or waves, offers a method of transmission very largely multiplying our channels for broadcasting.

"Obviously a great deal of research work remains to be done in this field. Multiple receivers which this method requires must be developed, made as simple in manipulation as the present ones, and standardized for public use. I see no insuperable difficulties along these lines, however I feel positive that the radio art will see very interesting developments in this direction during the ensuing four or five years."

A man who has had considerable to do with broadcasting is Frank Conrad, assistant chief engineer of the Westinghouse Electric and Manufacturing Company, who designed and built the first broadcasting station in the country, KDKA. He seems to think that the solution is one for the legislators to handle:

"The best solution of the problem of present day interference would be to restrict the number of stations," said Frank Conrad.

"Technically there is no real solution available at the present time. It remains a matter for legislative regulation," continued Mr. Conrad, who then drew a parallel between the radio situation and congested traffic on the highways.

"When there are more cars on the roads than they will carry, what can be done

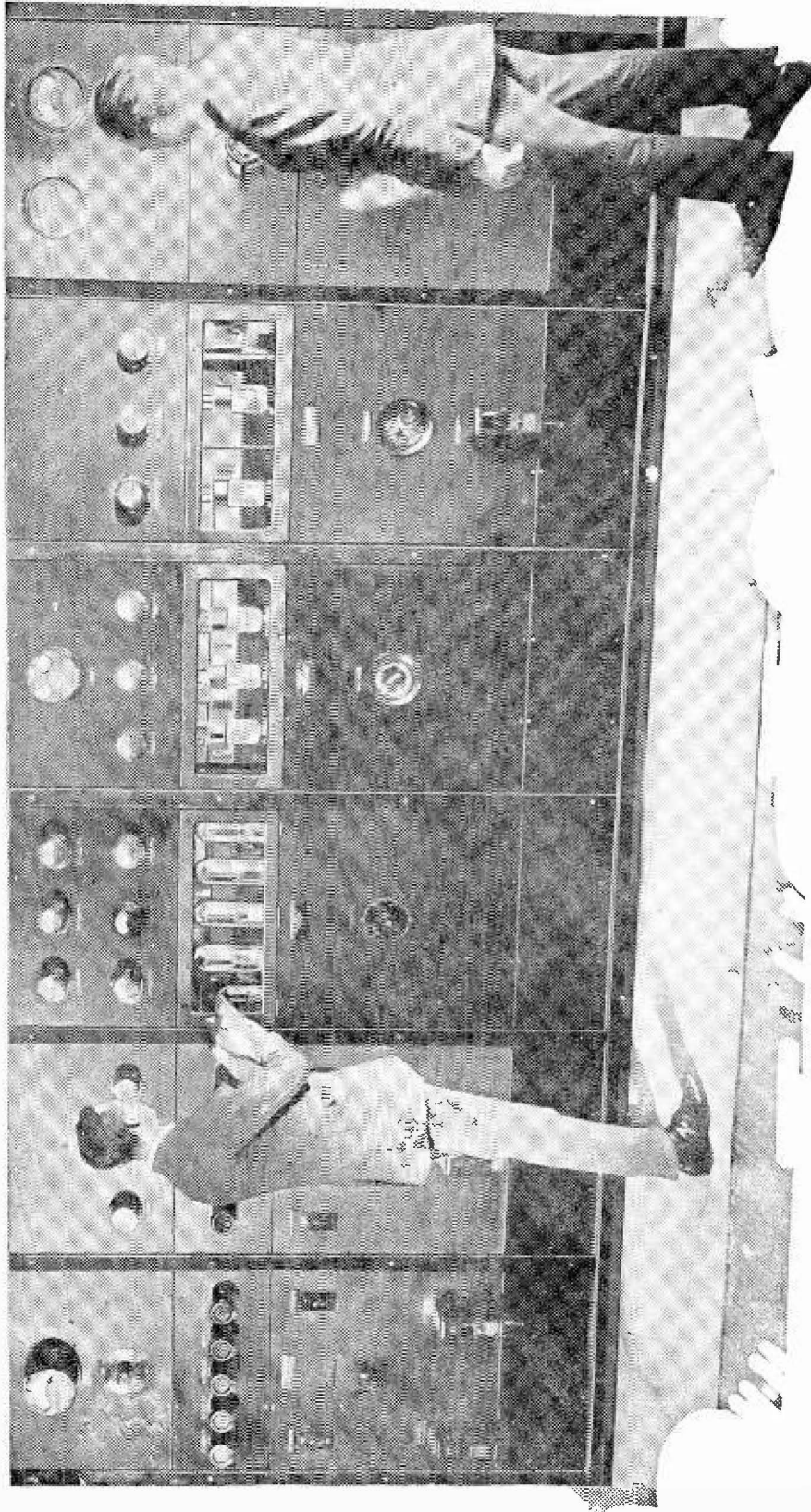

Broadcast Engineers Must Solve

about it? Certainly changing the design of the cars won't help much. If more or wider roads can't be built, there is just one remedy—take off some of the cars.

"You will observe that practically all schemes for the relief of radio interference mean that some stations, preferably those with little merit, must sacrifice themselves. And not one seems willing to shut down.

"Technical development so far has actually increased the frequency band required by stations. Originally regulations allowed ten kilocycles to the station. That is not enough for the modern station. If the station is to transmit good quality, twenty kilocycles would be nearer right."

Another radio engineer of note, Dr. Alfred N. Goldsmith, secretary of the Institute of Radio Engineers, prefers to seek a solution in the co-operation between stations with a possible consolidation of stations. His opinion follows:

"There are two possible avenue along which the solution of the radio broadcasting interference situation could be solved. One is in the direction of improvements in the principles of operation underlying the broadcasting transmitters and the receiving sets. And the other looks to increased co-operation on the part of those who are operating radio broadcasting stations.

"It might be an interesting experiment to determine whether the reaction to broadcasting would not be entirely beneficial if a well thought out plan of consolidation of stations and their programmes were undertaken. There is reason to suppose that the future developments of an electrical character will aid in the elimination of such interference as is troublesome today or that may become troublesome. But it seems likely that the situation will call for increasingly careful co-operation between those who are actively engaged in broadcasting."

#### SUNSHINE GIRL AT WSB

Catherine Boswell, "The Sunshine Girl," who has often been heard on WSB programmes during the last few years, is now back in Atlanta, and will again entertain WSB audiences with her catchy and tuneful melodies. Her tour, terminating at the Broadway Theatre, in Fayetteville, N.C., covered many theatres in Georgia, Florida and North Carolina where she received tremendous ovations in many places as "WSB's Sunshine Girl."

#### HE'D BEEN THERE BEFORE

"What are you taking your radio to the football game for?"

"Well, if I get the same seat I had last time, I'll need it to follow the game."



A. P. HOWELLS

"Good morning Mr. Howells! We have a very important speech we would like to have you handle from a town 138 miles from here on Tuesday night, do you think you can make arrangements for us?" "If we can get telephone lines, we can certainly arrange it for you," we answer, "please ring off and we will call you later."

This 'phone message reached my home on Sunday night. We suddenly remember that Monday is a holiday, however, little things like that must not disturb a Broadcasting Manager, and in order to avoid small troubles, we have the brilliant idea of calling the Vice-President of the Telephone Company, in fear and trembling of getting our heads

MARJORY GRANT, L.R.A.M.  
Pianist at CKCL

## A Remote Control Adventure

By A. P. Howells

Broadcasting Manager CKCL

Toronto

chopped off. On the contrary, however, we are met with the greatest kindness and courtesy, and with the assurance that everything humanly possible will be done to assist us.

Our next move is to get in touch with the men with whom we have been doing our business previously. We find from them that the machinery has been set in motion. Tuesday morning arrives and we 'phone the Telephone Company, inquiring if there is any news as regards the line being completed, and are met with the answer "not yet." We can't wait, but collect our Remote Control apparatus and engineer, and away we go, trusting that all will be O.K. Halfway on our journey, we stop for lunch and incidentally, call and put through a long-distance telephone message to the telephone office, asking for news. This time we are told "Everything O.K." Heaving a sigh of relief we start on our way again. Sailing along merrily in our high-powered Chandler Station Car, with, as we think, plenty of time to spare, suddenly looming ahead of us, we spy what looks to us like an army of workmen and the sign "DETOUR." Glancing up the hill we find a string of cars stalled with a tractor engine at the top with rear-end wheels in the ditch, and the remainder across the top, which means an hour to wait until we can get through. Thus, the spare hour we had allowed ourselves, is eaten up. However, we get started once more and reach our destination at about 6.30, one hour and a half before scheduled time for the Big Meeting. The first thing to do is to call the Telephone office, then a wash and

to supper. We ring and ring, but the only result is local station only can be raised. This continues until 7.15, when the broad smile of satisfaction on my engineer's face tells me that he is talking to the head engineer at our station, and everything is all right. At two minutes of eight, I am told to stand by the Announce Microphone, and have the pleasure of hearing the last number at our Toronto studio, and Mr. Fricker's voice coming to me saying, "Mr. Howells will announce our next programme from . . . . . ." I then start to announce and the Big Meeting is being heard by our listeners in all parts of the North and South American continent.

After the Meeting, we return to our hotel, a tired but satisfied trio, chauffeur, engineer and Broadcasting Manager, ready to leave next morning at eight o'clock.

This Remote Control is only one of the many activities taking place at Reliable and Maxinite Battery Station CKCL, Toronto.

It would be of great interest, I am sure, to readers of your magazine, if they would call and visit our studios, where a hearty welcome awaits them, and either myself or members of my staff will gladly explain any little details that they may wish to learn, rehearsing of artists, bands, orchestras, etc. This station, since its opening, May 5th, 1926, has sent out to its listeners, over 1,350 programmes, mornings, afternoons, and evenings.

In conclusion, I wonder how many of us, who sit by our fireside enjoying its warmth and comfort on cold winter nights, grumbling should our reverie be disturbed by a sudden explosion from

ROY LOCKSLEY  
Entertainer at CKCL





**ENGINEER'S OFFICE AND TRANSMITTING ROOM OF "RELIABLE" BATTERY STATION "CKCL", TORONTO**

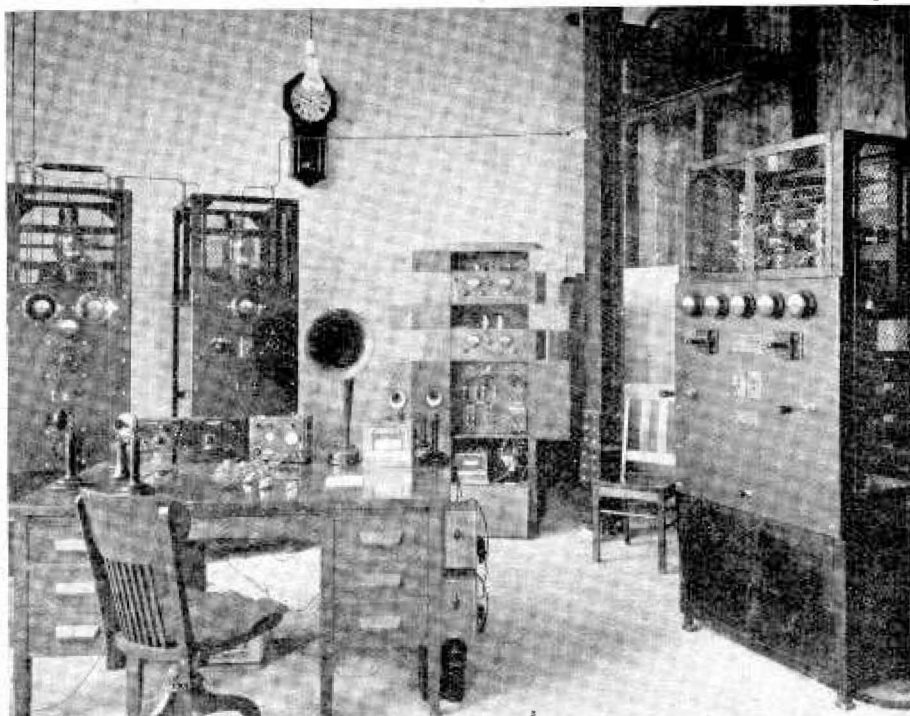

our fireplace, and complaining at having had to pay \$15.00 a ton for rubies, think of the poor man who lies on his back, chopping away with his pick, 1,400 feet below the earth's surface.

that the Broadcasting Manager and his staff are catering, not to two, but to two hundred thousand.

**A NIGHT CALL**

Neither Dorothy nor I felt inclined to listen any more that night. We were both absolutely fagged out. Dorothy's young nephew, however, wanted to stay up and hear some more of the programme but I didn't care very much for the idea of leaving my fine new ten-guinea set to his tender mercies, so we packed him off to bed, and then we prepared to receive Slumberland.

I had just got tuned-in on the Dreamland wavelength, when Dorothy's elbow made a short-circuit, and jabbed me in the ribs.

"Hark! What's that?" she whispered.

"Thomasina Felines giving a Moonlight Sonata," I murmured, drowsily, and punched the pillow again.

"D-don't be absurd," muttered Dorothy, now thoroughly awake and startled. "It's burglars. I can hear someone downstairs. Listen!"

I listened. There certainly seemed a dull sort of murmuring, but—

"There you are," whispered Dorothy, "there is someone. You'd better go and investigate." I do hate the way some women will risk valuable lives for the sake of morbid curiosity.

However, I had to do something, so I groped for some slippers and a coat, grasped a poker and an electric torch.

Then I quietly opened the bedroom door and stood on the landing.

There really was someone downstairs. I could hear muttered voices plainly. My teeth began unaccountably to chatter. What if the burglars had a revolver? And a knife? Visions of all the most horrible burglaries I had ever read about rose to my mind. I pictured myself prone on the floor, and poor Dorothy in black—which doesn't suit her a bit—a widow. I shivered again. I couldn't bear the thought of Dorothy alone in the world.

Gingerly I trod down the stairs. Only the scorn of Dorothy kept me going; I couldn't go back and say I was afraid. The voices still floated up to me; deep, guttural voices. My hand clasped tighter round the poker. I felt afraid even to breathe as I trod the last few stairs.

I hesitated at the door, trying to formulate some plan. The telephone was in the room where the voices were coming from. Should I try to get in unobserved, and telephone for help, or—?

A gruff voice came filtering through the door, and I distinctly heard the words, "What are you going to do with the body, Jeff?"

Heavens! A body! A murder in my house! The poker fell from my nerveless hand to the hall mat. Came another voice—"Aw! leave it right here, bo', i'll—"

Then came a strange, unaccountable silence, and presently I heard a thin

(Continued on page 38)



**MME. LUGRIN FAHEY**  
The Famous Canadian Soprano whose Songs and Lectures are a special feature of CKCL

The same may be applied to radio fans. Very few, I am sure, realize the detail work the Studio staff has to go through, in order that these concerts and entertainments may be sent to your homes. How quick we are to find fault, but how slow to praise, forgetting often

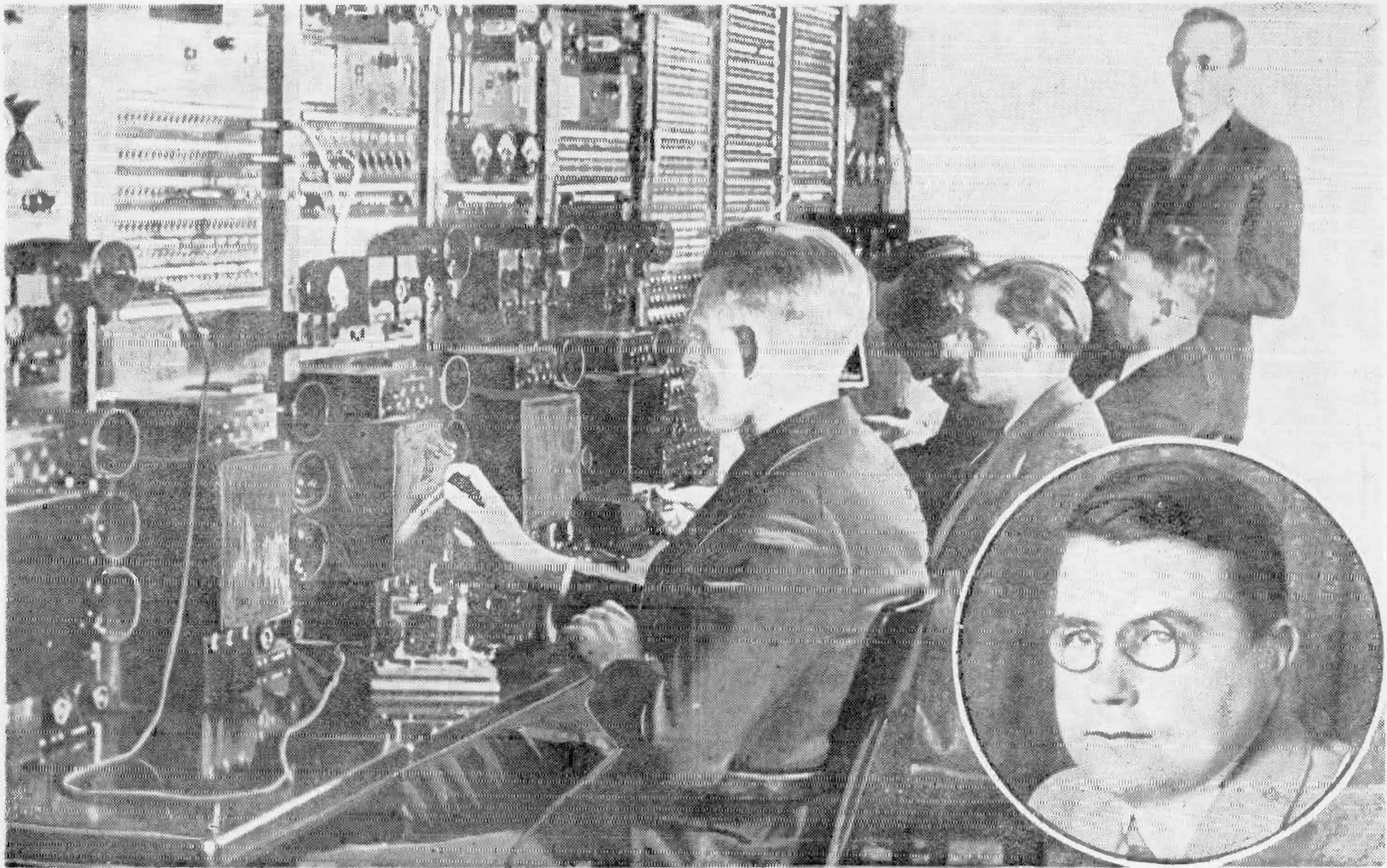

"Hello" board controlling the WEAf chain out of New York. G. F. McClelland, in insert, is credited with the idea of chain broadcasting by wire

# Big Business Now Chaining Radio

**A new movement has been consolidating the management and operation of stations—the “chain” idea. A number of groups are successfully broadcasting in this way. Experiments show that the world will be eventually tied up in a huge network of broadcast thread, which will open up a new field of home broadcast entertainment to the radio fans.**

Another operating broadcast company has just been announced. It will take its place among the growing lists under the name of “Atlantic Broadcasting Corporation” and will own and operate six separate stations.

Definitely, the trend of broadcast exploitation is now toward the group, chain, or net systems. And it would appear that the small independent station will be more and more forced in the background in the face of organized and extensive competition.

It isn't a month ago since the Radio Magazine announced the formation of National Broadcasting Corporation, which purchased station WEAJ and the rights to the “chain” of twenty-two odd stations situated throughout the country. The Atlantic Broadcasting Corporation has just purchased the Grebe station, including a new five kilowatt plant just installed in Richmond Hill, L.I.

Broadcasting, which started out as an experiment, and which for a long time was purely a novelty, is now to bring in returns to the clever business men and organizations who can capitalize on it as a business proposition.

One of the earliest “chains” was probably the Westinghouse group which consisted of KDKA, Pittsburgh; KDPM, Cleveland; WBZ, Springfield, Mass., and KYW, in Chicago. These stations were among the original broadcasters in the country, KDKA being the first. Nothing very definite was done with this system, and KDPM has since discontinued.

The best known and most extensive chain is, of course, that operated by station WEAJ in New York. Some twenty-two stations are ordinarily hooked up to WEAJ, this number varying widely and being as high as thirty-four at one time. The connections are made by special telephone wires between the station in New York and the “subscriber” stations.

Thousands of miles of telephone lines are included in these links, which have stretched on occasions clear to the Pacific Coast and down to Cuba. While this linking up is expensive, it has the merit of being fairly reliable, and every flexible.

With WEAJ's special facilities to secure and hold telephone lines to any and all points, because of the close affiliation of that station with the telephone companies, it became the sole and undisputed leader in the “chain” system in this country.

Westinghouse engineers, wishing evidently to be independent of the wire situation for the linking up of their stations, devised an entirely new tie-up method. Instead of using wires they used radio. Some of the first long distance relaying ever done was by means of short wave broadcasts from KDKA to KFKX in Hastings, Neb., rebroadcast from there on the regular waves for the Middle Western and West Coast fans. In fact, so successful were these tests that a station located on the Pacific Coast picked up the KFKX transmissions and put them on the air once more for the Pacific fans. Thus radio had helped to bridge the 3,000 mile span between coasts in only two jumps, and the fans in the Western states enjoyed just as fresh programmes as though they were only a hundred miles away from KDKA.

The first American programmes that European listeners-in ever picked up on their simple little crystal sets of ten-mile range were these same KDKA broadcasters heard in England and rebroadcast from 2LO, London, and its own chain.

Radio has proved its value as a long-distance link, and will no doubt be the medium used for world-wide broadcasting from one country to another, of which KDKA's English experiments are a sample. The wire tie-up is more satisfactory for short distances.

This may be the reason why WJZ, New York, tied up with WGY, Schenectady, N.Y.; WBZ, Springfield, and, occasionally, KDKA, too, by wire in its own individual chain arrangement. Probably in imitation of these successful chains some of the other Eastern stations have tried experiments that have been more or less successful. There has been a small group formed which ties up with WMAF. They are, alternately, WOR and WRNY.

Besides the Round Hills Radio Corporation, which was interested in the above tie-ups, there was the Commercial Broadcasting Corporation, in which WLWL, this city, was connected with one of the Boston stations. This link with WLWL has been discontinued lately.

The Gimbel Stores have established a system which includes WGB, New York, and WIP, Philadelphia. Occasionally, there have been tie-ups with WGN, Chicago, and more frequently with WPG, Atlantic City. There are possibilities that WCAE, recently acquired by the

Gimbel interests, may soon extend the chain to Pittsburgh, Pa.

Another small chain, known as the People's Broadcasting Corporation, started out with stations WFBH, and WRW. This group may continue with WPCH, a new installation opening tomorrow evening in New York.

The Grebe group's activities have not been well defined, even at this time. There are six stations operated in this net, among them several mobile stations, which have given interesting and unique performance in news and sports reporting. But it is possible that the Atlantic Broadcasting Corporation will find some very definite way to use these stations in its own service.

There are hundreds of independent stations throughout the United States that have no affiliations of any type. They are doing their best to compete with the “chains,” and the competition is all the keener in that the chain stations, by “subscribing” to the main station, can give their listeners the benefit of costly talent at very small cost to themselves.

What will become of these low-powered, small broadcasters now that the novelty of broadcasting is worn off and its money-making possibilities are becoming more and more apparent every day?

Perhaps the chain broadcast movement will be one of the developments of radio which will help stabilize the entire field. It may starve the small fellow out and bring up such fierce competition between rival chains as to give the listeners the very best of artistic talent obtainable.

What the possibilities of the chain system are even engineers cannot guess. Only a short time ago station WGY was furnishing programmes by radio to Lima, Peru, and to Cape Town, South Africa. The WGY broadcasts to those points were received and rebroadcast for the benefit of local fans. What WGY has done on such an humble scale perhaps the stations of the world can carry on in an international way.

The fan of the next few years will be entertained by the best that music, literature, science and other arts have to offer regardless of where those most illustrious and famous performers may be. Nor will he have to tune outside of his present set range, for chain stations will bring to him the broadcasting of the world.

# Loud Speaker Volume With One Tube

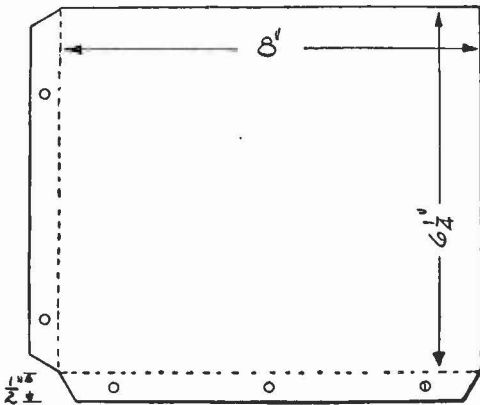

Sketch of the Shield used in this One-Tube Set (Shown as "S")

The drawings show full constructional details of what is probably the loudest and most sensitive one-tube broadcast receiver ever designed. It has a maximum receiving range in excess of 2,000 miles and operates a loud speaker on stations within approximately 200 miles. The construction is simple and the parts are inexpensive.

The Carborundum Stabilizing Unit plays a very important part in the success of this receiver, as the electrically

controlled detector permits operation at the peak of regeneration throughout the entire wavelength range.

A single shield, connected to the A battery circuit, allows greater amplification without undue self-oscillation. The shield is No. 20 gauge aluminum, but brass, copper, tin, zinc and other sheet metals may be used.

Transformers T1 and T2 can easily be made at home. The primaries of these transformers are semi-tuned through use of small inductance switches. This feature results in much greater efficiency than would otherwise be possible. The secondaries and antenna coil are of No. 24 double cotton-covered wire. The plate circuit coil is No. 30 double cotton-covered wire. The primaries are tapped after winding by scraping off a quarter-inch section of the insulation on the turn to be tapped and soldering the tap lead (No. 24 wire run in "spaghetti") to the exposed wire. Bus bar or No. 18 rubber insulated stranded wire may be used in connecting the parts. The four leads that pass through the shield should be carefully insulated in order not to touch the metal.

The circuit as shown, with a good 4:1 ratio audio frequency transformer, will not oscillate at audio frequencies; but should this occur (as evidence by "howling" that is not affected by turning the condensers), it may be stopped by connecting a variable high resistance across the secondary terminals (G and F) of the audio frequency transformer (T3). This resistance should have a minimum value of about 50,000 ohms and a maximum value of about 500,000.

Either a UX 201A or a UX 199 (or corresponding tubes) may be used. The '201A filament requires a 6-volt storage battery or four large dry cells connected in series. The '199 tube requires three large dry cells connected in series for the A battery. The B battery in either case should be from 90 to 135 volts. The C battery should be adjustable from 3 to 9 volts; it may be made up from six regular dry cells connected in series. A single No. 14 enamel-insulated solid copper wire is recommended for the aerial. It should be from 100 ft. to 150 ft. in length. The ground connection should be made to the water-pipe system.

The variable condensers are the wave-

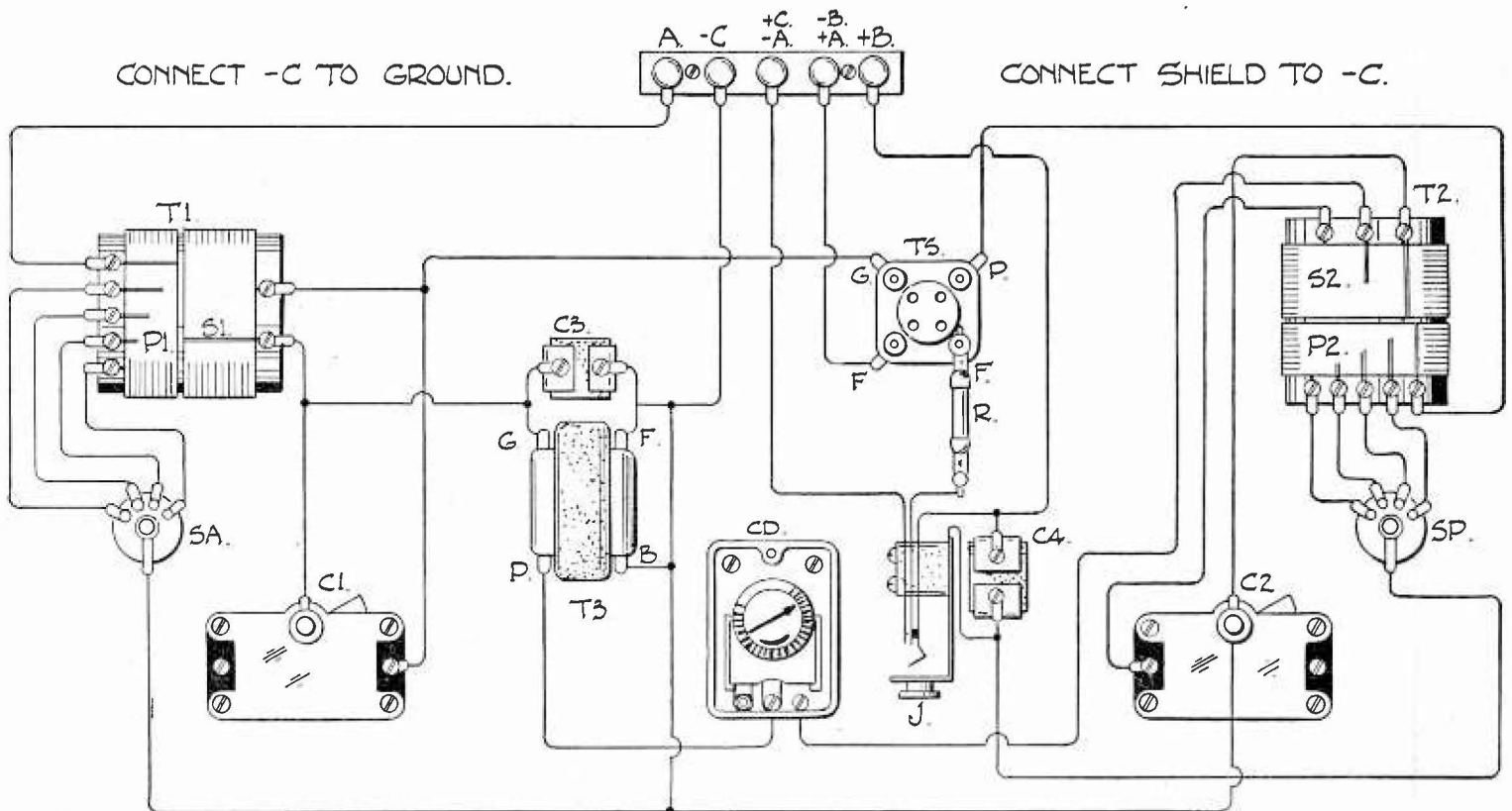

Picture Diagram of the One-Tube Reflex

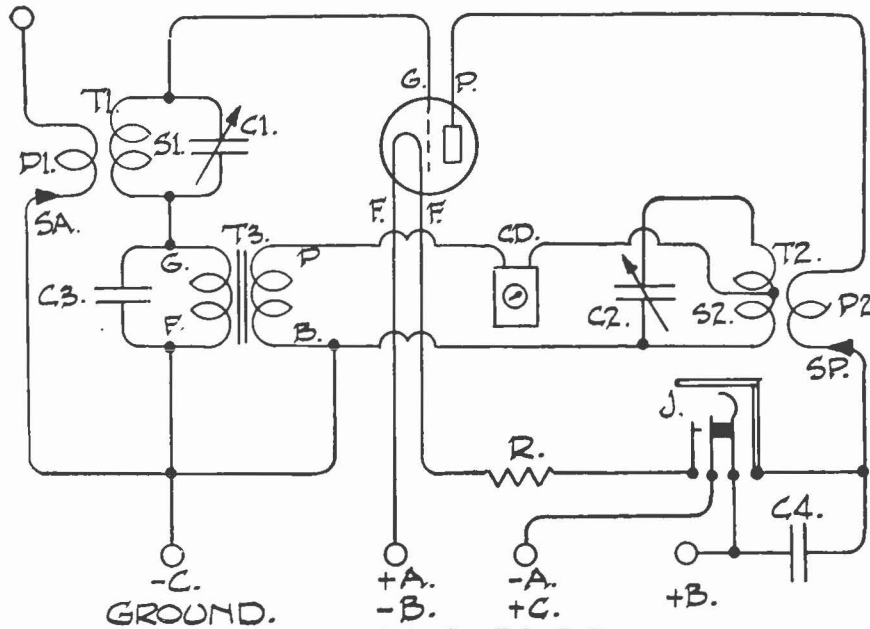

Diagram of the One-Tube Reflex

Note that the primaries of both radio frequency transformers are tapped, thus providing unusual sensitivity.

length controls. The inductance switches regulate the volume and are not critical. The Detector Unit should be adjusted for strongest and clearest signals.

The audio amplifier is used in conjunction with this one-tube set. The input ter-

minals of the amplifier should be connected with flexible leads to a plug which is inserted in the jack (J). The phones or speaker is then plugged in one of the jacks on the amplifier. The same batteries may be used for both the receiver and amplifier.

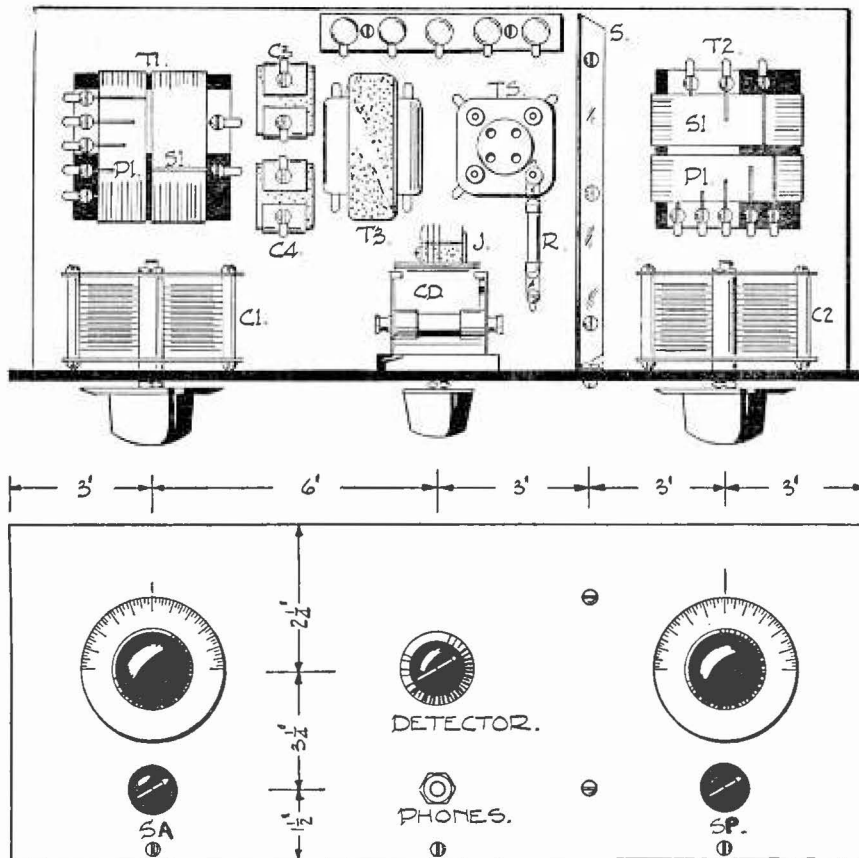

- C1, C2—.0005 mfd. grounded Rotor Variable Condensers.
- C3—.0001 mfd. Fixed Condenser.
- C4—.0005 mfd. Fixed Condenser.
- CD—Carborundum Stabilizing Detector Unit.
- TS—Non-Microphonic Tube Socket.
- R—Ballast Resistor for tube being used.

- T3—Audio Frequency Transformer.
- S—Metal Shield, Aluminum or Copper.
- J—Single Circuit Automatic Filament Control Jack.

T1—Radio Frequency Transformer wound on bakelite form 3" diameter and 3 1/2" long with No. 24 Double Cotton-Covered Wire. Primary, P1, 32 turns tapped at the 8th, 16th, 24th and last turn. Secondary, S1, 45 turns. 1/8" space between primary and secondary.

T2—Radio Frequency Transformer similar to T1 but with primary, P1, of 48 turns, No. 30 Double Cotton-Covered tapped at 12th, 24th, 36th and last turn. Secondary 45 turns No. 24 Double Cotton-Covered tapped at centre.

SA, SP—Back of Panel, 4-point, Inductance Switches.

Panel, 18" x 7". Wood Base, 17" x 8" x 5/8".

### THE "PHASATROL" A NEW ELECTRAD PRODUCT

Electrad, Inc., announce the perfection and marketing of a new accessory for radio frequency amplifiers which is to be known as "Phasatrol."

Essentially, Phasatrols are balancing devices for use in stabilizing any radio frequency amplifying circuit, whether tuned or untuned. They are attractively mounted in genuine bakelite cases and are "fool-proof" in every respect. When correctly installed and properly adjusted, they need no further attention and are guaranteed to stop the squealing and eliminate distortion in any radio frequency circuit, no matter how persistently it tries to oscillate.

The mounting is simplicity itself, requiring only one hole in the panel or sub-panel, while adjustment is made with a screw driver on a small set screw in the center. The device takes very little panel-room and can be introduced into any radio frequency set by opening the plate leads of the radio frequency am-

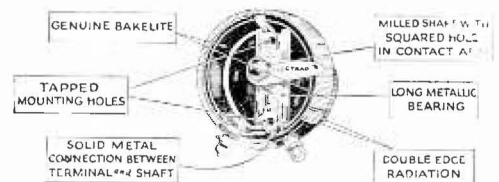

plifier tubes and soldering three connections as shown on the instruction sheet which accompanies it.

In actual operation, the Phasatrol appears to clear up reception considerably, giving the tubes an opportunity to function to better advantage and eliminating the distinction which so often accompanies amplification when the tubes are on the verge of oscillation. It makes no change in the tuning of the set but has one great advantage in these days of radio congestion in that it absolutely prevents any radiation interference to neighboring sets.

# WUXTREE!

## ADVANTAGES OF BEING BLONDE OR BRUNETTE

Fast and furious rages the "Blonde and Brunette" controversy in Hollywood, home of the most beautiful representatives of both shades.

The debate has been intensified by the statement of Richard Rosson, Paramount director, now making "Blonde or Brunette," with Adolpe Menjou in the starring role, and Greta Nissen and Arlette Marchal as the blonde and the brunette respectively, that the agitation has resulted in a "twenty-five per cent increase in the number of blondes" and that

"many brunettes are sacrificing their beauty" by bleaching their hair.

Greta Nissen, Norwegian beauty, a natural blonde and the last work in the allegedly preferred style of pigmentation, has come forward with a statement that she "doesn't blame the brunettes for wanting to be blondes" and Arlette Marchal has countered with a defence of her darker sisters.

Both have outlined their reasons for being satisfied with the tinting Providence dispensed them in the following summarized statements:

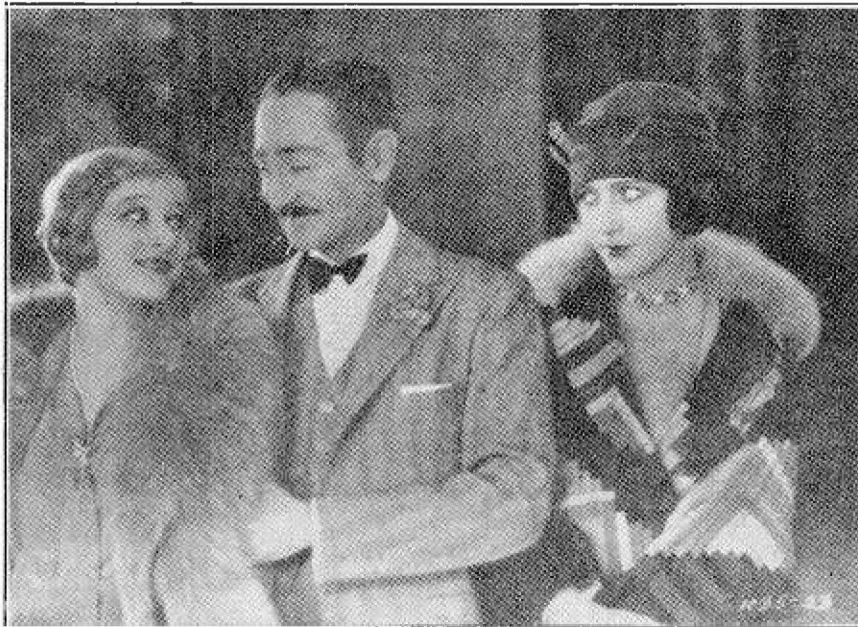

"BLONDE OR BRUNETTE"

Looks like Adolphe Menjou cannot make up his mind. "Blonde or Brunette" is the title of his next Paramount starring picture now being made on the coast. Greta Nissen portrays the kind of a girl that gentlemen prefer while Arlette Marchal is the other beauty in the case.

### THE ADVANTAGES OF BEING A BLONDE

By Greta Nissen

1. Blondes can be seen farther away.
2. Blondes don't have to worry about grey hair.
3. Blondes look younger.
4. A blonde "vamp" can work without being suspected. Everybody thinks vamps are always dark.
5. Blondes look best in fluffy clothes that men like.
6. Gentlemen prefer blondes.

### THE ADVANTAGE OF BEING A BRUNETTE

By Arlette Marchal

1. The nearer you see a brunette the more you like her.
2. Brunettes don't worry about anything.
3. Brunettes generally are younger.
4. Brunettes have a reputation for constancy. They're never expected to be fickle, so they're never found out.
5. Brunettes can wear comfortable tailored clothes that blondes can't.
6. Gentlemen marry brunettes. They just step out with blondes

The blonde and brunette controversy has become so heated that it is thought possible that a photoplay showing a blonde winning a man against a brunette, or vice versa, may cause rioting and rock-throwings at the screen in the larger peroxide and henna centres. In the case of "Blonde or Brunette" it has been decided to keep the winning tint a secret. The hero marries them both and things are straightened out from there.

## THE FARTHEST NORTH TRANSMITTING STATION

Within the Arctic Circle Constable Timbury, of the Royal Canadian Mounted Police stationed in Baffinland, operates the world's farthest north transmitting station.

Equipping this outpost with radio may be the beginning of a radio net connecting stations with Baffinland as headquarters.

The Canadian Government ship Boetchic, which recently made its annual trip into the far northland supplying remote outposts, carried with it short wave equipment for Constable Timbury stationed at Pond Inlet at Baffinland.

He is separated from civilization by a bleak and barren wilderness of about 2,000 miles. In this lonely outpost he is the only emissary of law and leads a life quite opposite from that of which we think on seeing their picturesque attire.

Robert Foster, a Canadian amateur, built the transmitter which is similar to the Burgess Baby Transmitter and is operating entirely from dry cells.

These portable sets serve unusually well for transmission on short waves over distances of several thousand miles. The receiver is also built for the low wave bands and is used to receive amateur and broadcast messages.

Only recently the annual supply ship of the Hudson Bay Trading Company was caught and crushed in the ice pack of the Hudson Straits. Messages broadcast from the Company's station were picked up at Chesterfield Inlet and supplies rushed by dog team over the frozen wilderness to save these people who faced certain death.

This far flung transmitting station has been given the amateur call letters 5AC. Important messages will be easily sent and accepted and the amateur will be thrilled on hearing this far distant station.

We little realize the enjoyment of Constable Timbury listening to our broadcast programmes, for there the winter is long and severe, with constant

(Continued on page 31)

## EVENTS OF THE MONTH

By JAMES MONTAGNES, of c-3CK

A new Canadian low power transmission record was established on December 20th when George F. Stiff, c-3EL, seventeen year old amateur of Toronto connected with a-2RX of Adelaide, Australia. The transmission took place between eight and eight-forty-five a.m. At the Toronto station a five watter of 1923 vintage was used, with a total input of twenty watts.

The signals were easily and clearly received in Australia, an R4 rating being given by a-2RX. c-3EL received them somewhat weaker on a one tube receiver with the regular amateur short wave circuit. The Australian was on 32.5 meters while Stiff used 37. This transmission no doubt came as his best Christmas present, although it is known that Santa Claus also brought him a 250 watter! Both he and his dad spend a great deal of their spare time at the set, one of the few using fivers in Toronto.

This work, coming just as it does before the end of the year, is in all probability the outstanding low power record for 1926, although a number of other notable low power transmissions over shorter distances have been made by amateurs in Montreal and Toronto during the past few months.

Plans are at present under way between the various provinces of Canada, England, Australia, South Africa and India to relay official messages over an ALL-RED route via amateur radio early in 1927. To do this successfully requires scheduled transmission, with all the Canadian amateurs joining in on the 52.5 meter "prayer-meetings" on Wednesday nights. It is possible to communicate with the various units of the Empire to-day, but we have all looked forward to the day when a message starting in England would be able to pass through all the Dominions back to its starting point.

If the relay is successful the problem of using such a series of stations in case of emergency will be solved. But it will require the aid of every good "ham" and brass pounder in the country to carry our share of it through in first class manner. Everybody who reads this and owns the good old transmitter better step on it and get her in shape, because this thing may come anytime and we want everybody to be in on it.

Fifty-two point five is coming into its own. If you're not sure, listen in on Wednesday nights or better still get the transmitter dusted and working again. The ones, twos, three and fours are all on the air regularly, and the fives and eights (Newfoundland) have also been heard. So get to work, OM.

c-9CC, of Ottawa, went to Vancouver a short while ago, and being a good amateur he took a receiver with him to pick up the 52.5 signals. One night in Vancouver he heard the following:—1EI, 3AFP, 3HP, 9AL, 9BJ, 4CB and 4DW stations in St. Johns, N.B., Ottawa, Kingston and Toronto, Morse, Saskatchewan and Winnipeg. This was corroborated by Keith Russell, c-9AL of Toronto, who heard the same stations that night. This shows that the gang is awakening.

Then Ernie Thompson, c-3FC, a few nights ago, on a "prayer-meeting" night to be sure, sat down and worked from his station in Toronto, both c-5GO and c-5CT of Vancouver. The latter he held for over an hour, exchanging traffic and chewing the rag.

52.51 is certainly a good wave when we all get on.

Facts of a revolutionary nature in regard to electrolytic rectifiers used in low powered transmitters have been unearthed by James Hill at Toronto University. A number of experiments have shown this young scientist, whose career is being followed with interest by radio men throughout the Dominion, that the common practice of allowing 40 volts to each unit of the rectifier can be raised to 100 or even 150. Where heretofore fairly large size jars were required with

large elements in them, using smaller containers and smaller elements with a greater voltage concentration on each unit will give better results. These rectifiers are used in a great many amateur stations where motor generator sets are too expensive for the owner of the station.

Mr. Hill, c-4AJ, whose name has appeared throughout Canada, and eastern United States, recently in connection with low powered transmission records using a UV2OA as transmitter, is a third year student in Electrical Engineering at Toronto. His home is Regina, where he has an amateur station known to all as c-4AJ. While in Toronto he operates at various amateur stations and carries on a great number of experiments to improve transmitting conditions on the short wave lengths. Many of the improvements have been put to practical use at stations throughout Ontario with subsequent record results for their owners.

Early in December some notable 20 meter noon-day work was carried out by two of the best known Canadian amateurs, E. C. Thompson, c-3FC, Assistant Communication Manager in the American Radio Relay League for Ontario, and A. H. Keith Russell, c-9AL, Canadian General Manager of the A.R.R.L.

Thompson was the first to do the trick and connected with a Frenchman in broad daylight. This was followed by contact with g-5HS of England. Scheduled transmission was had with this station for the greater part of the month by c-3FC, and Keith Russell also worked him several times at noon. Furthermore Thompson worked ACD of Italy for many nights running, doing it at about one a.m. E.S.T. Neither station used more than 100 watts to do this good transmission, although c-3FC and c-9AL both use 250 watters.



DOROTHY BANGER  
Popular Artist at CKCL, Toronto



LATEST FOR MILADY

Natalie Kingston, featured player in Paramount's "Kid Boots" which is being directed by Frank Tuttle, is "knee deep in fringe." In a frock of maize colored crepe with close fitting bodice, deep fringe falls from the hip line to the knee—fringe that separates, closes, sways—as a grass skirt while she dances. If she happens to be dancing in the open cafe overlooking the swimming pool, she may swathe her neck in a scarf whose length of rippling fringe nearly trails upon the floor.

### A FEW WOULD-BE WISE-CRACKS FROM "DON EDDY"

Hello Folks:—

Well, folks, here we are again for no reason whatsoever.

My boy, Harry Langdon, is pretty near through with this "Long Pants" opery, so I thought it might be a good idea to sit down and write a few pieces and see if maybe somebody would print them or something. Anyhow, here they be. I hope you'll read the first one anyhow. And that's that.

It's cold and miserable this morning, and I have a slight touch of the housemaid's knee, so I will go ahead and tell you all I know; it will only take a minute. I feel like the guy that said he

was in the business of buying up old oil wells. When he got a whole pile of them he cut them and up sold them for post holes.

Had a letter yesterday from Leah Dufand, bless her heart! Leah writes little ones and big ones for the Des Moines Register. She wants to deny that they only raise corn and hogs in Iowa. She knows a couple there in Des Moines that have raised twelve children, and they still dance and play bridge every night. Their grandfather is a nice old guy, too. He takes little walks of a hundred miles or so at a clip. The last time he was gone longer than usual, and when they asked him what the trouble was he said, "Well, I was going good until I came to that town of Adel where they had a sign up, 'Slow down to

20 miles an hour,' so I lost time right there."

Then there's another nutty one here from A. Arcand, who gets paid by La Presse, in Montreal, for going to the movies. They probably want to keep him out of the office, especially if he makes a practice of pulling ones like this: Patient—"Doctor, I snore so hard at night I woke myself up! What can I do?" Doctor—"That's easy; just ask the clerk to change your room."

Well, I was going to write you some more, but I just sealed the envelope.

Yours for nothing,

DON EDDY.

P.S.—Come on and kick through with them story.

DON.

### A WORD ABOUT HARRY LANGDON, POPULAR SCREEN COMEDIAN

For the first time in the history of motion pictures, technicolor is being used in a comedy.

Harry Langdon, whose first two big features sent him rocketing to a place among the screen's great artists, revealed today that technicolor is being prominently used in filming "Long Pants," his new feature now being completed for First National.

One complete sequence of the picture, Langdon said, has been filmed in color. It is a romantic episode in which Langdon plays at love with the exotic Alma Bennett, one of the five Hollywood beauties who appear with him in the new production.

With the introduction of technicolor, "Long Pants" will doubtless take its place beside "The Black Pirate," and the very few big pictures which have pioneered in color photography.

Upon the reception the public accords his innovation, Langdon intimated, will depend his decision to make a future feature comedy entirely in color.

Weeks were spent in erecting a massive set representing a medieval castle and its courtyard. With actual construction complete another ten days were spent in color-scheme experiments. Dozens of shades of paints were tried before one was found which was suitable for the environment, and yet which should not glare when transmitted to the sensitive technicolor film.

Incidental arrangements included the improvising of an orchard of peach trees in full bloom and the transplanting of half a city block of grass sod.

Technicolor photography is taken with special cameras, much larger and more



complicated than the ordinary motion picture camera, and by special cameramen.

Although extremely expensive, the result has more than justified the end. Mr. Langdon is enthusiastic over the prospects of technicolor in feature comedy, and doubtless will continue with his plans to make an all-color picture if the public welcomes his experiment.

**SOMETHING NEW FROM THE WEST**

Rather a novel idea has been introduced by Broadcasting Station CJRM, at Moose Jaw, Saskatchewan, which station is owned by James Richardson & Sons, Ltd., grain merchants.

The "Maple," Canada's national tree, has been selected as their emblem, and it is called the "CJRM Radio Tree." Its leaves are all numbered, and each leaf represents a "Radiophan," whose number corresponds with the number of his or her leaf on the tree.

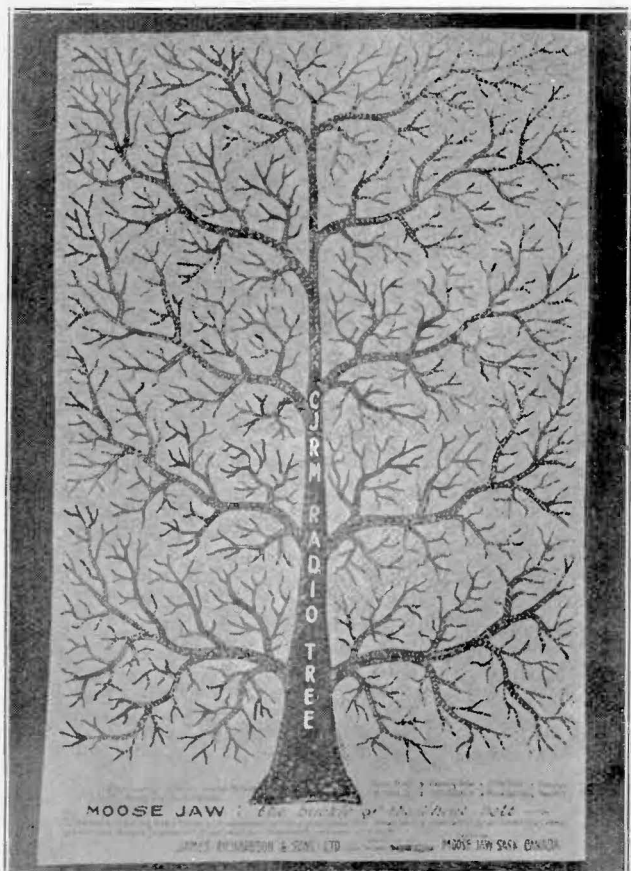

The only entry requirements necessary to belong to this "Big Radio Family," as it is termed, is to write to the station telling them how their programmes have been received and how much they have been enjoyed.

CJRM have issued a pamphlet on which the names of the fans are printed opposite their number and these have been sent around to all the members as a souvenir.



**MADELEINE HURLOCK**  
One of the Mack Sennett Beauties

# This is the Average Set of 1927

Over two hundred 1927 radio set models, ranging in price from a few dollars to several hundreds of dollars, of various weights and varying dimensions, were analyzed and "averaged." The Average Radio Set of 1927, shown above, is the average of all the facts and figures used.

BY LLOYD JACQUET

Radio sets designed and built for the 1927 radio season weigh more and are larger than those offered for sale to the public during the 1926 season. The price is greater than last year's model, and the number of tubes is on the increase. All of this information was gathered from an analysis made from more than two hundred representative and diversified sets, which have just been exhibited at the many radio shows by leading manufacturers throughout the country.

By taking all of the average of dimensions, weight, prices, number of controls, number of radio and audio tubes and other facts about these sets it was possible to "build" the average radio set for 1927.

## 1927 Set Larger and Heavier

Actually, the average set measures 28 inches in length, 17 inches in height and 20 inches in width. It is much larger than the 1926 model, which was, according to figures gathered and made public by "Radio Retailing" last season, only 11 by 10 by 24. Thus the modern radio set is growing.

There has been a gain, or rather considerable increase, in weight. Whereas the 1926 average set weighed but 23 pounds, the new 1927 model reaches 61 pounds. This is easily explained, since a great deal more metal in transformers, chassis, panels, shields and elsewhere has been introduced in the construction of the modern radio receiver.

As to the analysis of the number of tubes, the indications are that a greater number are included in the 1927 type of set. Last year the number was five. This year the figures give an average of a little more than five and a half tubes a

set. Of course, the "half" tube is largely an indication that there are more six, seven and eight tube outfits and fewer one, two and three tube sets than previously. Inasmuch as the fraction is over the half, it would probably be correct to assume that the average number of tubes per 1927 set is six.

## Increase in R.F. and A.F. Tubes

These tubes are divided into radio frequency and audio frequency tubes, each set needing besides a detector tube. The findings are rather interesting in that they show a tendency to increase both the radio and audio stages of amplification, but in uneven proportions.

Radio-frequency stages seem to be one of illuminated dials, calibrated scales, decorated "windows," hand-carved cabinets, carefully balanced radio circuits, and specially designed giant audio transformers.

## Number Controls Varies With Prices

The number of controls seemed to decrease with the increase in prices. They numbered at least three in the \$30 to \$80 group, and were reduced to two in the \$100 to \$400 group, and average between the increase, as the average tube value a set of radio-amplifier tubes is nearly 10 per cent larger than the increase in audio tubes. Curiously enough, the survey does not show the tendency of quite a few manufacturers to include the extra "power" stage in the audio-frequency end of the receivers now being sold.

This compares as follows with the 1926 set: Radio-frequency amplification, two tubes; single detector tube; audio frequency, two tubes; total, five tubes.

Practically the only thing which remains unchanged in the 1926 and 1927

average set is the matter of controls, or knobs and dials. Our 1927 average set shows two main dials for tuning and two or three smaller knobs for rheostats and switches. There has been somewhat of a change, however, in the design of these controls. While many sets still make use of the dials, the tendency is decidedly towards the flush type of "window" control by means of a small knob only.

More of the 1927 sets have calibrated dials, with illuminated scales, and wave lengths are indicated, instead of numbers, in a number of cases. These are small refinements which merely show how the appearance of the sets has changed over a period of a year.

## A Surprise in Price

It is in the matter of the price that the greatest surprise comes, however. Last year's survey showed that a set would cost, on the average, about \$80. Very evidently, the radio public has had a great deal more money to spend on radio, or has become completely "sold" on it, as today there are sets that sell for as much as \$5,000.

Our Average 1927 Set has a sale price of \$184. This is practically one hundred dollars more than the 1926 model.

Unquestionably, the radio buyer is getting more for his money than he did last year. In this great advance in price, it must be considered that a great number of sets have fine cabinets, with elaborate woodwork, which naturally add a considerable amount to the price of the instrument.

While the Average 1927 Set is still in the "table type" class, it is competing fiercely with the console model. It is, in fact, the console which has brought up its average price to such a high level, because there are sets listed on the 1927 list which reach down to \$9.75, a price never before attained in tube sets, and consoles costing \$500 or more.

It must be remembered too that a great deal of workmanship is necessary in the new chassis type of construction, which has been adopted by quite a few of the 1927 set manufacturers. Shielding has added to the cost, as has the introduction one and two in the high price sets. The higher priced sets had a large number of

## THE AVERAGE RADIO SET OF 1927

Here are the main facts and figures about the average radio set of 1927. These figures have been compiled from over two hundred standard radio sets, which are the 1927 models of representative American manufacturers, shown at the recent radio shows, this year:

Average size, 17 by 20 by 28 inches.

Average weight, 63 pounds.

Average number of tubes, 5.50.

Average number of controls, two.

Average price, \$184.

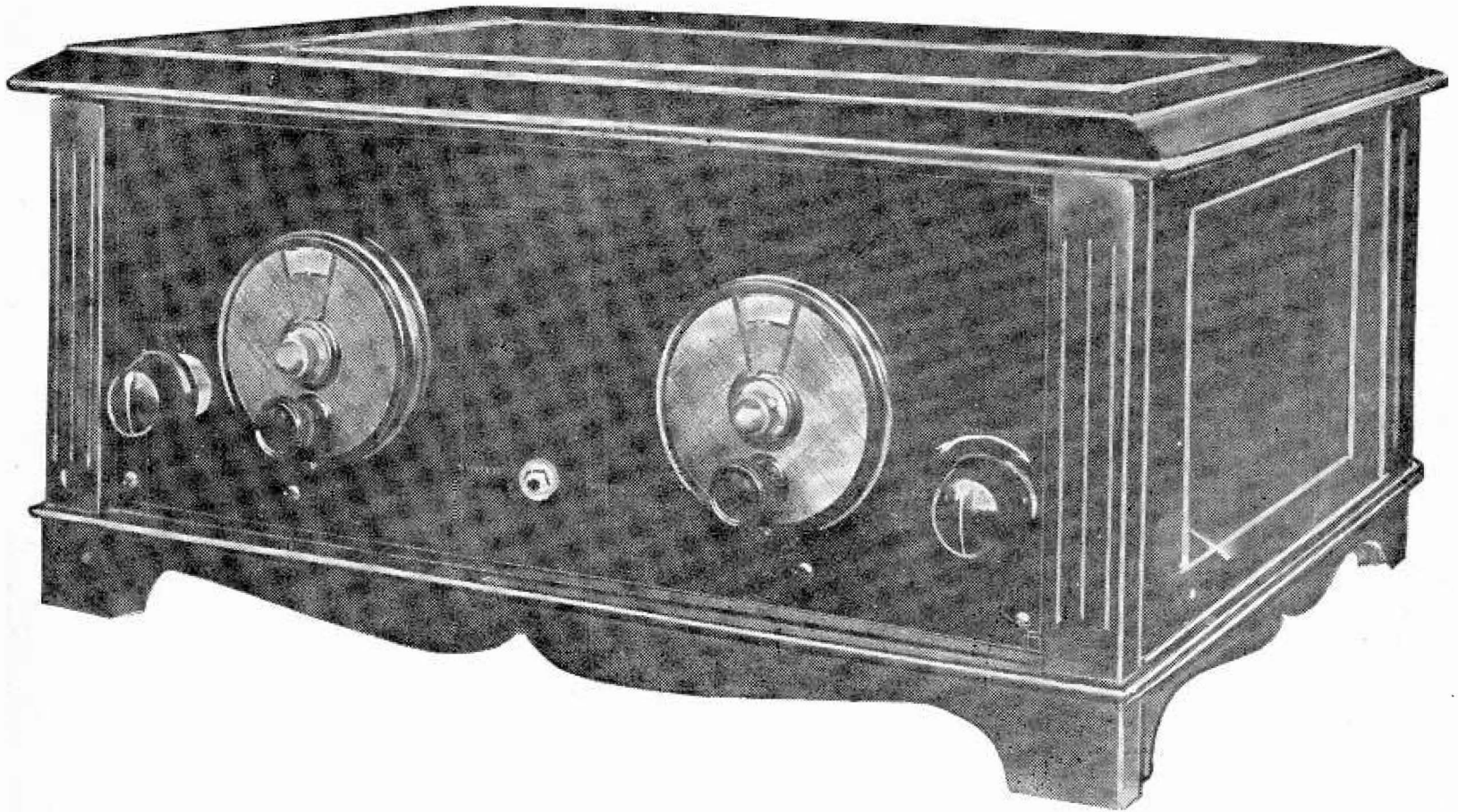

loop equipments and were naturally housed in beautiful cabinets, which added considerably to the average price, as finally calculated for the Average Set.

#### Improvements Add to Cost

Greater care, too, has been exercised in the design and finish of each individual part entering into the assembly of the final set. There are innovations in variable condensers, radial tuning dials with "gang" combinations, and single control possibilities, which require exquisite workmanship for smooth operation.

Almost every set is equipped with a vernier type of tuning control. Sensing no doubt the necessity for a large degree of selectivity in the radio sets of this year, anticipating the chaotic condition of the air, the Average Set is quite selective. Tuned radio frequency circuits are still the most popular, with the use of power stages in the audio end growing into favor.

Practically every 1927 set will work on an aerial and ground, but there are quite a few—enough to mention them—which operate from a loop, and aerial and ground.

With very few exceptions, the tube sockets were designed to receive the standard five-volt tubes. A few sets have been designed for both the five and three volt tubes.

Not many have a built-in loud speaker.

The speakers are more common as an integral part of the set when the entire installation is housed in a console.

The single control set, which seemed to be so popular among the manufacturers a year or so ago, has practically been abandoned. Today, the sets have arrangements which can be made into single control, but which allow of dual tuning, if necessary.

Altogether, the Average Set of 1927 is a superior set. It is more selective, has better quality, and is easier to tune and to take care of than any of its predecessors. It represents a stabler value, and shows very definitely that radio manufacturers have learned how to make a good, substantial, permanent product, which will not have to be radically changed from year to year, as has been the custom since broadcasting began.

### ICELAND NEXT GOAL OF KDKA BROADCASTS

#### Encouraged by Greenland Reception, Pioneer Station Attempts Greater Reach

Pittsburgh, Pa., Dec. 11.—When KDKA, the Westinghouse broadcast station here, attempts to get its programme across to Iceland, on the night of Christmas, it will have the enspiriting help of having gotten already as far as Greenland. On its first "far north" broadcast

of the winter on November 20, KDKA, world's pioneer in programme broadcasting, reached Godhaven, Greenland. Acknowledgment of that reception was received a few days later.

On Christmas night, it is planned to transmit greetings in Icelandic to officials of the Kingdom of Iceland, whose capital is Reykjavik. There is a broadcast station on Iceland, but no American station has yet succeeded in getting more than the merest fragment of a programme to the remote island in the North Atlantic.

Reykjavik has been officially informed that KDKA intends to transmit voice and music programmes to it on Christmas night. The confirmation of the Greenland reception included acknowledgment that a message had been forwarded to Iceland telling of KDKA's Christmas programme.

The far north broadcasts from the Westinghouse stations—KDKA, Pittsburgh; WBZ, Springfield, Mass.; KYW, Chicago, and KFKX, Hastings, Neb.—were inaugurated three years ago. They were intended primarily for remote trappers and trading post residents within the Arctic circle; people in settlements which are not visited the whole winter long, and where for four months the sun does not shine. These programmes have been amplified from year to year, until

(Continued on page 33)

# Victim of the Fog

BY KENNETH JUDD

On a cold fall night two hundred and fifty miles off the coast of Nova Scotia, the United States liner *President*, bound from Cherbourg to New York, ran its mighty steel prow into the wall of a fog bank. Rogers, the second officer, in command on the bridge, rang the engineer's bell sharply. The dull monotonous hum of the gigantic turbines which day in and day out, through storm and wind, had ground on ceaselessly, stopped, and the mighty *President* slid noiselessly over the water which far below was blotted out by the fog. Everything was blotted out, muffled. The fog, damp, clinging, thick, swallowed up sound and sight alike.

Captain Dickman appeared on the bridge. Quickly Rogers made his report. The fog had come on without warning. It had seemed to rise up out of the sea ahead, a great impenetrable blanket into which the *President* had plunged. What was to be done? Half-speed ahead? The usual precautions? Or what? For battered by adverse gales the liner was already a half-day late, and below in the saloons and cabins were men to whom time meant money and to whom delay was inexcusable. Hastily Captain Dickman made his decision, and for that decision he cannot be blamed too strongly. A gallant officer, he made a mistake. He bears its mark today.

The engineer's bell rang again. Full speed ahead. The mournful fog horn sent a muffled warning out into the night and fog. And straight down the transatlantic lane, driven at full speed ahead, the mighty liner plunged through the blanket of fog.

Below, the passengers who had come out on deck as the familiar hum of the turbines stopped, returned to their interrupted games. In the cabins those who had already gone to bed turned over and went back to sleep. The radio program of a New York concert went on. Half a dozen bridge games were resumed. Laughter and talk began again. Dancers in the main saloon stepped back on the smooth floor. Eight hundred souls rested secure on the greatest ship afloat. And the *President* plunged down the transatlantic lane through a blinding fog.

In the radio operator's cabin, Stephen Phillips worked like mad transmitting a hundred messages of welcome. For this was the last night at sea. To-morrow they would all be home again. And it

seemed that every passenger was sending a radiogram.

By twelve o'clock the last message had been transmitted. Phillips rested for a moment by his table, then rose and locked the cabin door. Twelve o'clock. The weariness left his body. His mind raced across hundreds of miles to a little room in a house on the Jersey coast. It was twelve o'clock there too. Midnight. And beside a radio receiving set he knew that his wife and his mother were waiting for the message he sent them each night at midnight. Slowly his mind thought out the message. His fingers gripped the key. And through the night, across hundreds of miles of blackness, the invisible waves carried these two words, "Arline. Mother." His wife and mother. Through the fog.

He paused for a moment, his fingers on the key. They seemed suddenly very close to him, as though he too had crossed all those miles of darkness and were with them in the little room with the windows looking out on the sea. A fire would be burning brightly on the hearth. His chair was by the fire, empty, waiting. The room was waiting, for him. And Arline. And his mother.

There was a crash which jarred the great liner to its vitals. A ripping, grinding crash. Phillips was thrown from his chair and landed in a corner. There was a moment of absolute si-

lence. The *President* poised, seemed to shake itself, then listed sharply to port. Far off somewhere behind the cabin walls a woman screamed. The pandemonium broke loose. Shrieks, calls, breaking crockery, rushing feet. The security of the greatest liner afloat was smashed. And a gaping wound had opened in its side, splitting it from bow to stern.

Out of the fog a great black shape had suddenly loomed. To Rogers and Captain Dickman on the bridge it had seemed that the crash came at the exact moment that the shape loomed up on them. No time for an order. No time for anything. It was on them. The steel mast of a Danish freighter travelling at half speed was struck on the port side and ripped the steel sheets from the *President* like paper.

It is impossible to describe in detail the horror of the scene that followed, the individual deeds of heroism, the utter terrible confusion. Men, women, and children sprawled madly out on the starboard decks, fought their way across the slippery boards, clutched the damp wet rails. Men went mad in those few moments. Men became cowards. Men became heroes. And everywhere, covering everything, lay the terrible muffling fog.

The few available lifeboats were lowered and manned. In the darkness and the fog and the terrible clutching fear of death, order was impossible, yet the

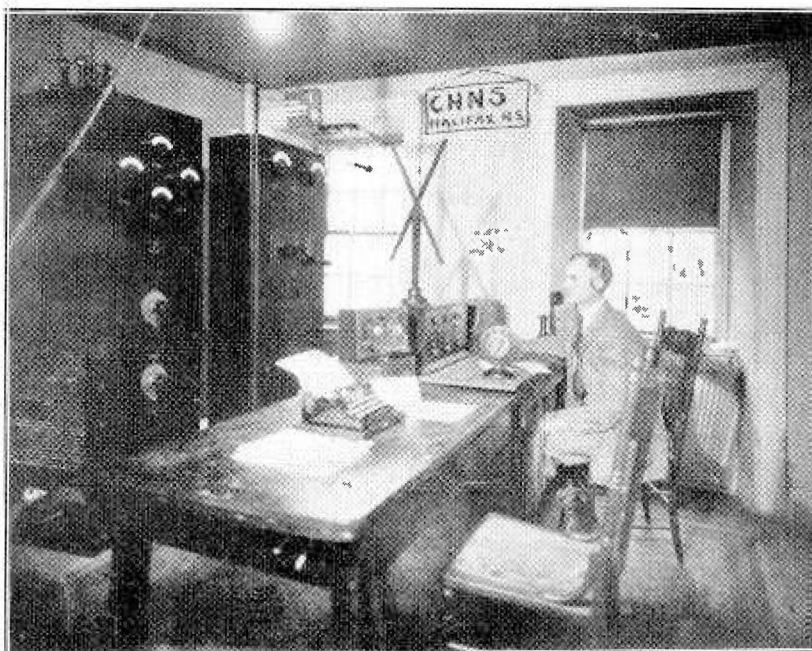

The Operating Room at Northern Electric Radio Station, C.H.N.S. Carleton Hotel, Halifax, Nova Scotia. Mr. C. A. Landry, Chief Operator.

order of heroism was born out of the confusion. And the pitifully few life-boats were filled to overflowing and lowered. They disappeared into the darkness. Women shrieked to the husbands they were leaving behind. Out of the fog the shrieks and the cries came like cutting knives. Then they too were swallowed up in the night. Of the eight hundred and thirty souls on board the President three hundred had escaped. Five hundred and thirty faced almost certain death. And perhaps the knowledge of that death combined with the muffling fog to produce a tremendous calm on the crowded decks. A calm so great that the occasional shrieks and groans only served to make it more intense. For ten minutes pandemonium had held sway, complete horror. Now the calm had come. And the great ship was slowly settling.

Phillips had picked himself up from the floor of his cabin and ran to the door. After a great effort he unlocked it. In falling he had struck the side of his head on a chair. A jagged wound ran across his forehead. Blood, warm and sticky obscured his eyes. A frightened steward passing in the corridor outside the door told him what had happened. It was enough. Half blinded by his wound Phillips groped his way back to the radio table. His fingers splitting the night and fog, went the cry of distress, the thrilling awful signal of disaster, "S.O.S., S.O.S., S.O.S." Over and over again.

Far across the night sea the radio carried its message. A hundred and fifty miles away the freighter R. B. Whalen, out of Boston, picked it up. One hundred and fifty miles away. Eight hours. Too long. Another freighter, four hundred miles south. Another ninety miles due east. Another one hundred and ten. All headed for the slowly settling President. All too far away.

And then suddenly a sharp clear message in the phones. The English liner Mercedes sixty miles due west was on the way under full power. And the race between the sea and man had begun.

And across those miles of darkness the message had been carried to other waiting ears. Arline, and Phillips' mother. Waiting for the uncomplete midnight message. Heard those awful words. "The President is settling fast. Afraid it can't hold up. Hurry."

On the decks the huddled men and women drew near together. On the bridge the officers waited, talking in undertones, receiving reports from below. In the great hull of the ship the pumps worked on in impotent fury against the rising water. In the radio

(Continued on page 34)

## Station "C.H.N.S."

Halifax, Nova Scotia

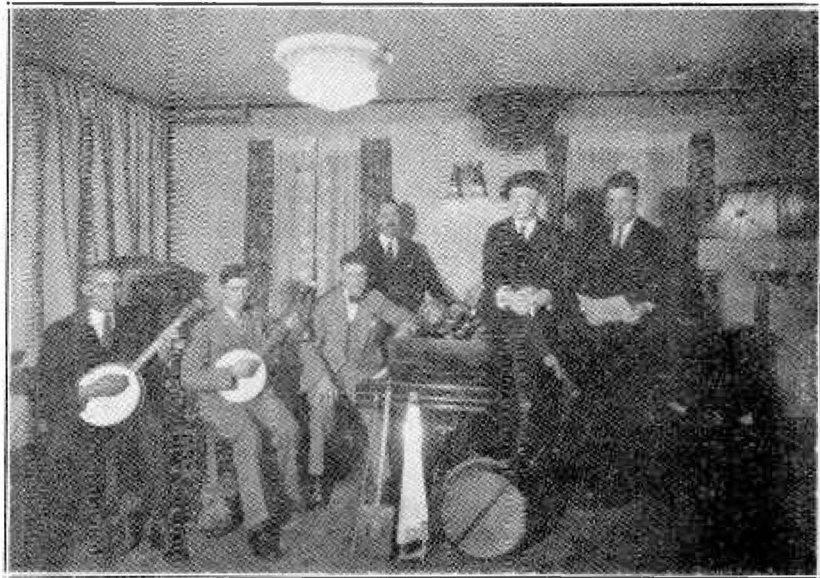

### THE C. H. N. S. LIFE BOYS

Art Kane, Eric Merchant, Gerald Mahar, Bill Borrett, (announcer), Sammy Shields, Carl Edwards.

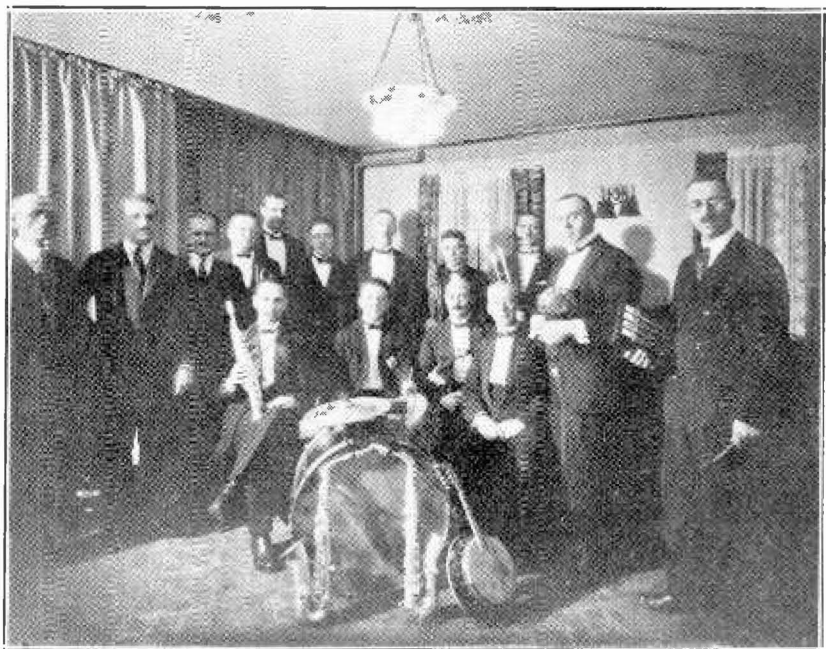

Studio group at C.H.N.S. Halifax, N.S., F. W. Johnson, Manager, Halifax Branch, Northern Electric Co., and former Broadcast Manager of C.H.Y.C., Montreal, is holding the microphone.

Major Wm. Coates Barrett, Station Director C.H.N.S. is standing next to him, on extreme right of photograph. The first three on extreme left of photograph (reader's left) are Dr. S. G. Ritchie of the programme committee. Mr. Paul Demers, Northern Electric Company, transmission engineer of Montreal, and Mr. Cecil A. Landry, operator in charge at C.H.N.S. The remainder are members of Sandy Smith's Dance Orchestra.



**ETHEL REDMOND**  
WPAP Artist, Palisade Amusement Park, Palisade, N.J.

### CANDIDATES SUCCESSFUL IN EXAMINATIONS FOR RADIO CERTIFICATE

The Radio Branch of the Department of Marine and Fisheries announce that twenty-three (23) candidates were examined during the month of November, 1926, of which the following were successful and obtained Certificate of Proficiency in Radiotelegraphy:—

#### COMMERCIAL

##### 1st Class

**Newfoundland**—Myrick, J. B., Cape Race, Nfld.; Myrick, M. A. (Miss), Cape Race, Nfld.; Stewart, W. M., Cape Race, Nfld.

The following has been further examined and has had his existing certificate endorsed for additional equipment

**Nova Scotia**—McKay, Wm., Dartmouth, N.S.

#### AMATEUR

**Alberta**—Beaumont, W. J., Lethbridge, Alta.; MacLeod, J. H., Calgary, Alta.

**British Columbia**—Mawbey, A. R., Black Lake, B.C.; Spilsbury, A. J. W., Savary Island, B.C.; Spence, J. W., Vancouver, B.C.

**Manitoba**—Burch, S., Winnipeg, Man.

**New Brunswick**—Upton, L. F., Fredericton, N.B.

**Nova Scotia**—Rose, J., Halifax, N.S.

**Ontario**—Bulteel, J. A. C., Camp Borden, Ont.; Fowler, J. H., Goderich, Ont.; Jaffrey, W. R., Hamilton, Ont.; Brodhacker, G. A., Hanover, Ont.; Graff, H. R., Hanover, Ont.; Punched, J. C. R., Toronto, Ont.; Snelgrove, C. R., Toronto, Ont.; Wild, A. T., Toronto, Ont.

**Prince Edward Island**—MacQuarrie, R. B., Summerside, P.E.I.

**Quebec**—Boyd, D., Lachine, P.Q.; Moodie, R. L., Montreal, P.Q.

### RADIO'S DESTINY

By Eric H. Palmer\*

Mankind's progress towards the Golden Age of Peace and Prosperity is predicted on the kindred "c's" of civilization, conscience, courage, consistency, charity, on a background of conviction. All these are founded on knowledge and understanding, men to men, and we are at the beginning of an era where science, more than ever before, is contributing to the realization of the dreams that every normal human being has had in the hope of lasting peace and goodwill among the nations of the earth.

Ease of communication, rapid interchange of information—these are the primary factors in making us all acquainted. As we grow to know each other, national and racial prejudices and jealousies will recede, never to die out perhaps, but always to be subdued by the challenge of mutual admiration.

The vision of permanent world peace may never come true, but it is certain that with all the agencies for good that are now coping with the forces of evil, the tendency to discord, the desire to rush to arms, is present no longer.

Public opinion everywhere is against war. It will be strengthened in that antagonism by latter-day developments in all the fields of human activity.

In the very foreground, as a factor in unifying the world, we find the miracle of wireless transmissions. The radio assumes a large aspect as the means of advancing man to his destined state of brotherly responsibility.

By radio, human contacts are instantaneous with a most romantic appeal. The wireless waves know no national boundaries, no single tongue. Through its use, all sides of every international problem may be heard by all who listen in. Music is the universal language, and it preaches, over a range of hundreds and soon thousands of miles, a lesson of unity and concord.

For one general staff which is analyzing the potentialities of radio for war, a hundred million human hearts are beating in hope of its effectiveness in promoting peace.

Basically, radio can render a public service, the full extent of which can hardly be realized so early in its development. But already, we have noticed its achievements in education, as a result of which there is no question but that the next generation—and succeeding generations—will be more mentally alert than the present generation. Even more than that, the average man will possess a vision which extends beyond his own doorstep, and on all matters he will take a larger and broader view.

The microphone, therefore, is the symbol of a high civilization.

\*Freed-Eisemann Radio Corporation.



# The Tower Cone

## PRODUCTION!

**O**NLY mass production, scientifically conceived and executed, could make possible the Tower Cone with its exclusive features and high quality performance at such a phenomenally low price. Only genuine merit could continue its world-wide sale in record breaking volume.

[ More Tower Cones have been sold since March 21 than any other make. Such preference is your guarantee of value and lasting satisfaction. ]

Consolidated Distributors, Ltd.  
Winnipeg, Manitoba

Emerson & Fisher, Ltd.  
St. John, N.B.

Distributed by

Imperial Radio Co.  
Sault Ste. Marie, Ontario

John Millen & Sons, Ltd.  
Montreal, Quebec

Radio Specialists, Ltd.  
Vancouver, B.C.

Fullers Electric Co., Ltd.  
Toronto, Ont.

Western Radio Distributors, Ltd., Edmonton, Alberta

Tell Them You Saw It In "Radio News of Canada"

# Tone Quality -- What It Is and How To Get It

BY CHARLES GOLENPAUL  
American Mechanical Laboratories

Tone quality, the main consideration in present-day broadcast reception, depends upon a variety of factors, any one of which may be the cause of distortion and therefore unsatisfactory tone quality. Specifically, the requirements of good tone quality are: (1) a clean signal; (2) pure radio frequency amplification; (3) good detector action; (4) audio frequency amplification capable of handling the necessary wide range of frequencies, evenly and sufficiently; (5) tubes of ample power, especially in the last audio stage; (6) a loud-speaker capable of translating the electrical ripples of the audio amplifier into corresponding sound waves; (7) a speaker filter, to keep the direct current out of the loud-speaker, but to pass only the useful alternating current or modulated component; (8) the satisfactory placement of the loud-speaker so as to ensure the proper distribution of the sound waves and the desired acoustic background.

As for the first consideration, a clean signal, much might be said of present conditions when more and still more broadcasters are endeavoring to cram into some 88 available broadcast channels. It is almost unavoidable that there should be some overlapping of carrier waves and that clean signals should be a rarity rather than the rule at least during the evening hours. However, a sharply tuned receiver, especially with shielding for the radio-frequency components, will do much to reduce such interference to a minimum, and to produce reasonably clean signals for the detector and audio stages.

In the matter of pure radio-frequency amplification, the problem is to guard against undesirable oscillation without sacrificing sensitivity and volume. An oscillating condition makes itself known by a fuzziness and even violent distortion of the rendition. However, oscillation is controlled in tuned radio-frequency circuits either by adjustment of the grid bias; neutralizing the internal capacity of the tubes; feeding back counter-electromotive force; by the proper application of choke coils; or by placing a Clarostat in series with the plate lead of the r.f. tubes, thus regulating the B-battery voltage. The last-mentioned method is by far the simplest and most efficient, and is therefore employed in most of the leading receivers as the "Volume Control." In this manner the oscillation at all frequencies can be controlled at the most efficient point, giving the ideal form of radio-frequency amplification. Because of the stepless and positive variation, the Clarostat type of variable high resistance permits of the nearest approach to the saturation point, without danger of spilling over into oscillation to cause tonal distortion. In regenerative receivers, a Clarostat can be shunted across the tickler or feed-back coil, which is set for maximum regeneration. This arrangement permits of hair-splitting adjustments, not possible with any other means.

Good detector action depends upon a good detector tube, used with the proper grid leak and grid condenser, and the proper plate and filament current. The grid leak and grid condenser are always specified for any given tube, hence this point is readily taken care of. In the matter of filament current, the rheostat or amperite, as the case may be, takes care of that requirement, which is seldom critical. The plate voltage, however, is apt to be critical if maximum sensitivity with good tone quality is desired. A Clarostat in the plus detector plate lead will provide the precise voltage. This is especially important if a B-battery or B-eliminator without intermediate voltage taps, is to be used.

Audio-frequency amplification has received so much attention during the past year or two that distortionless amplification is closely approximated in the better kind of receivers. Whether transformer, impedance or resistance coupling is employed, good results may be obtained if proper units are properly employed. In any of these three main forms of amplification, the use of variable high resistance is essential for best results. Thus in the case of transformer coupling, a Clarostat placed across the secondary of the last transformer permits of introducing the precise resistance necessary so that all voice and musical frequencies will be amplified to the same degree, resulting in excellent rendition. Even the poorer grade of transformers can be used for quality rendition by employing this simple stunt. In impedance and resistance coupling, the Clarostat serves as a grid leak which may be adjusted for just the proper degree of leakage for any given plate voltage, thus ensuring maximum volume without choking or blurring. In the last stage especially, such an adjustable grid leak, with its silent operation, will be found surprisingly efficient.

Because of the tremendous amplification, together with the powerful signals to be handled, in present-day reception, the last audio tube and even other tubes are apt to overload unless they are of ample capacity to handle peak values. This overloading makes itself known by serious distortion and choking in the rendition. The solution is found in the present power tubes. There is ample variety for a proper power tube for dry-battery, storage-battery or socket-power operation. Sometimes a power tube is also required for other functions, such as the second detector in a super-heterodyne, and for the first audio stage of a powerful receiver. It goes without saying, too, that the correct "C" battery is essential with power tubes, if good tonal rendition is to be obtained.

As for a satisfactory loud-speaker, little need be said. Any good make of cone speaker will give good rendition. Horn speakers are also capable of satisfactory tone quality, provided they are of sufficient size. But don't forget that it takes a horn seven feet or longer to give the depth of tone of the usual cone speaker!

A speaker filter should be employed for quality rendition and easy volume control. The simplest and cheapest arrangement is to place a Clarostat across the output of the amplifier, with one side going direct to the loud-speaker, and the other passing through a 4 mf. condenser. This arrangement permits only the modulated or working energy to reach the loud-speaker, while keeping out the harmful direct current which only serves to render the loud-speaker sluggish and incapable of the necessary rapid response. The variable resistance must be capable of handling considerable current, without noise.

The last remaining feature is the placement of the loud-speaker, which only too often receives scant attention. The loud-speaker should be shifted about the room and even the entire home, until the most pleasing results are obtained. Furthermore, the volume should be regulated according to the size and the nature of the room. A large room can take more volume than a small room, while a sparsely furnished room will take less than a well-furnished and heavily draped room. It is well to remember that the loud-speaker is not necessarily chained alongside the receiver! Move it about with an extension cord or wiring, so as to have your radio programmes anywhere.



**CONDITIONS IN WESTERN CANADA**

Arthur O. Secord, of Windsor and Detroit, has returned from his trip to Western Canada, where he has been in the interests of several companies, whose Canadian sales are being taken care of by him.

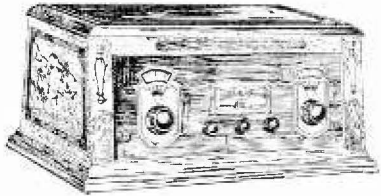

"Erla" Standard Model

He informs us that conditions in the trade are very satisfactory over the whole of Canada. In the Prairie Provinces, the season is late in starting owing to the wet fall and delayed harvesting operations.

Among the companies represented are the Mohawk Corporation of Illinois, the Electrical Research Laboratories of Chicago, the C. E. Manufacturing Company, Providence, R.I., Arthur J. Lynch, Inc. of New York, King Electric Mfg. Co. of Buffalo, Trimm Radio Mfg. of Chicago, S. & B. Specialty Mfg. Co. of Detroit, and others.

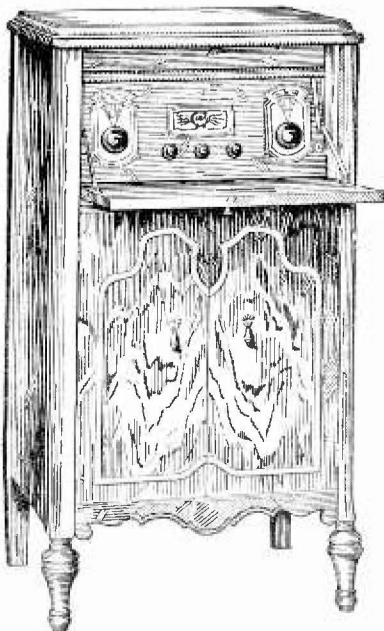

"Erla" Gainsborough Model

Mr. Secord is occupied at the present moment in the reorganization of distribution of "Erla" Receivers in Ontario and Quebec, and he will be glad to hear from responsible jobbers to whom this might appeal. As the "Erla" Receiver now embodies the famous R.F.L. Cir-

**PATENTED**

# SUBANTENNA!

**THE AMAZING, NEW UNDERGROUND ANTENNA SYSTEM**

## Eliminates All Interference

**INCREASES DISTANCE—KILLS STATIC**

**SCIENCE**  
Now offers a Positive Means to Enjoyable Long Distance Reception

How often, when for days you have anticipated listening to a certain program from some distant station your set has failed you—because of the condition of the air. And how often "man-made" static, such as leaky power lines, or some other nuisance has spoiled your radio evening. Indeed, there has been a dire need for some means of overcoming these obstacles. SUBANTENNA is the answer, for it not only cleans up the reception before it reaches the set, but it actually gives greater distance, bigger volume to weak signals and finer selectivity. Send coupon for particulars and Trial offer.

**Cloverleaf Mfg. Co.**

**LOCAL**  
No longer need static, air noises, arc lamps, leaky power lines, street car trolleys and other disturbances spoil your radio enjoyment. For SUBANTENNA—The new underground pickup system gets nothing but the pure radio waves.

**USE FILTERED GROUND WAVES NOT NOISY AIR WAVES**  
Being buried in the ground and shielded, SUBANTENNA is sensitive only to the continuous broadcast wave. Intermittent impulses such as static, etc. are filtered out before they reach SUBANTENNA. Hence, you get greater distance because the radio signal is not held back by the interfering noise level.

**2716-G South Canal St., CHICAGO**

**NOTHING ELSE LIKE IT**  
SUBANTENNA is not just a wire. It is a patented device consisting of a specially treated wire, sheathed in a lead jacket, and containing three specially constructed pick-up or building-up coils. Nothing else will do what SUBANTENNA does.

**MAKE THIS TEST**  
Connect your set to your regular aerial. Then connect it to SUBANTENNA. If you do not get the results we promise, we agree to promptly refund your money.

**Send Coupon for TRIAL OFFER**  
Right now—decide to tear down your aerial; that unsightly, inefficient combination of sticks and wires that is obsolete. Just send the coupon and we'll mail you full particulars of SUBANTENNA—the first and only really practical system of radio reception. Mail the coupon NOW—for special TRIAL offer. Clip at once!

**CLIP AND MAIL NOW**

Cloverleaf Manufacturing Co.,  
 2716-G South Canal Street, Chicago.  
 At once—send me full particulars of SUBANTENNA, also tell me about your special introductory TRIAL OFFER.  
 Name .....  
 Address .....

cuit, which is also employed by Bosch and Kellogg, he feels that a good proposition is open to those interested.

**THE FARTHEST NORTH TRANSMITTING STATION**

(Continued from page 20)

The hazards of arctic patrols have existed ever since these outposts were darkness except for a few minutes at high noon. Through the co-operation of Station KDKA and KFKS broadcast news and official messages will be sent.

established. Often it is necessary for these men to make patrols of 1,000 to 3,000 miles to adjoining stations across treacherous ice fields in the teeth of arctic blizzards with death close at hand.

This station 5AC may become the headquarters for communication between the various outposts scattered over the arctic region. A closer linkage of the Canadian Mounted Police would result in simpler and more efficient action of the law, greatly reducing the present hazards.

# CC

## The Tube of Longer Life

There's a Type for Every Radio Need

Makes a Good Receiver BETTER

Write for Complete Data Sheet

**C.E. MFG. CO. Inc. Providence, R.I.**

The Largest Plant in the World Making Radio Tubes Exclusively

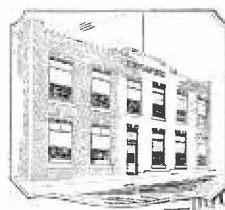

The New CC Plant Located at Providence, Rhode Island  
The Largest in the World Devoted Entirely to Radio Tube Manufacture

Tell Them You Saw It In "Radio News of Canada"

## Canada's Largest Radio Dealers



Westinghouse 57  
Console  
Receiving Set  
\$147.00

SEND FOR NEW CATALOGUE

A FEW REASONS WHY IT IS MORE ECONOMICAL  
TO BUY FROM US:

1. We can supply you with Receiving Sets at the lowest possible prices.
2. At the same time and in the same shipment, you can procure radio equipment of mostly any reliable radio manufacturer. This will save overhead, time and transportation charges.
3. Toronto Radio Service is prompt—goods usually shipped the same day as order is received.
4. With large buying power and connections with practically all radio interests, you are assured of the best discounts and most up-to-date apparatus on the market.

HAVE BEEN APPOINTED DISTRIBUTORS FOR THE  
FOLLOWING MANUFACTURERS:

|                       |                     |                       |
|-----------------------|---------------------|-----------------------|
| Can. Westinghouse Co. | Towers Loud Speaker | Amplion Loud Speakers |
| Canadian Brandes Co.  | Brach               | Amsco                 |
| Reliable Batteries    | General Radio Co.   | Brown Loud Speakers   |
| Burgess Battery Co.   | National Company    | Celeron Panels        |
| Carter Radio Co.      | Baldwin Company     | N.E. Peanut Tubes     |
|                       |                     | Patent                |

# Toronto Radio Company, Limited

241 Yonge Street - Toronto

### NATIONAL BROADCASTING COMPANY ANNOUNCES BOARD OF DIRECTORS H. P. DAVIS ELECTED CHAIRMAN

H. P. Davis, Vice-President of the Westinghouse Electric and Manufacturing Company, under whose encouragement and direction the first regular broadcasting service in the United States was established, has been elected Chairman of the Board of Directors of the National Broadcasting Company, according to an announcement made public to-day by the company which now owns and operates station WEAJ, and manages stations WJZ in New York and WRC in Washington. It was under Mr. Davis' regime that station KDKA at Pittsburgh first "took the air" with election returns, and finally with musical programme broadcast regularly every night.

Mr. Davis, long known as one of the pioneers in the radio broadcasting field, took a leading part in the organization of the National Broadcasting Company. He had always been strong in the belief that broadcasting would become a permanent institution in the United States and that a service could be developed which would rest upon a secure and economic foundation.

"His election as Chairman of the Board of Directors of the National Broadcasting Company," it is declared in the statement issued by Merlin Hall Aylesworth, President of the Company, "is perhaps the best earnest symbol of the fact that no effort will be spared to develop a broadcasting service which will permanently establish the primacy of the United States in the broadcasting art as pronounced as its leadership in the radio industry and international wireless communications."

The list of Directors now published includes the leading figures in the electrical and radio industries of the United States.

CHAIRMAN: H. P. Davis, Vice-President Westinghouse Electric and Manufacturing Company;

M. H. Aylesworth, President National Broadcasting Company;

Owen D. Young, Chairman of the Board General Electric Company;

Gen. Guy E. Tripp, Chairman of the Board Westinghouse Electric and Manufacturing Company;

Gerard Swope, President General Electric Company;

E. M. Herr, President Westinghouse Electric and Manufacturing Company;

Gen. J. G. Harbord, President Radio Corporation of America.

David Sarnoff, Vice-President and General Manager Radio Corporation of America;

William Brown, Vice-President and General Attorney Radio Corporation of America;

E. W. Harden, James Colgate and Company;

Dwight W. Morrow, J. P. Morgan Company.

One of the first official acts of the new Board of Directors was to establish a Board of Consulting Engineers to assist the National Broadcasting Company in problems of transmission and mechanical development. This Board consists of Dr. Alfred N. Goldsmith, Chief Broadcast Engineer, Radio Corporation of America; Chairman E. F. W. Alexanderson, Chief Consulting Engineer General Electric Company, and Frank Conrad, Chief Consulting Engineer, Westinghouse Electric and Manufacturing Company.

## PATENTS - - -

Procured in all Countries

TRADE MARKS AND DESIGNS

Special Attention given to Patent Litigation

Pamphlets sent free on application

**RIDOUT & MAYBEE**

156 Yonge Street

Toronto, Ont.

Tell Them You Saw It In "Radio News of Canada"

**YOU CAN TRAVEL SAFELY WITH A LIFE-BELT AND A RADIO**

(Continued from page 11)

you back off shore. Chart here shows you dangerously close to north side of strait." Five minutes later, the steamer sent to Tatoosh: "We just stopped our engines." Two minutes thereafter the ship sent an SOS saying she was grounded. An hour elapsed, then the ship advised Tatoosh that she was afloat and no damage done. Undoubtedly, the warning sent by Tatoosh had averted a marine disaster.

The navigator along the coast is further protected by radio. After the great hurricane of September, which did so much damage to the Florida coast, the Great Isaac Light was found to be extinguished. The lighthouse ordinarily flashes its warning from the western shore of the Bahamas to shipmasters making the "hole-in-the-wall" passage through the Florida Straits. Upon receipt of the news that this light would not be available until repaired, the Hydrographic Office sent out a broadcast warning, so that mariners proceeding along the inside route would be advised that they would not have this navigational aid to assist them.

During the latter part of the summer of 1926 a gas and whistle buoy at Matanilla Shoal, which lighted and sounded its warning at the northern tip of the Bahamas, was blown away from its position with its heavy anchor and chain attached. This news was broadcasted by the Hydrographic Office. The buoy was carried into deeper water and about the middle of September was recovered 300 miles southeast of its original position by the lighthouse tender Cypress, with a saving to the government of \$7,500.

**ICELAND NEXT GOAL OF KDKA BROADCASTS**

(Continued from page 25)

this year the most pretentious of any has been scheduled.

Since there is no contact with the outside world except during a two or three-month navigation period each summer, it was found necessary to prepare the programmes a year in advance, and to get copies of it to the isolated dwellers of the Arctic by mail and supply boats operated by the Hudson's Bay Company and the Dominion of Canada. These boats enter the Arctic each spring after the thaw, to take food and supplies to the far-flung outposts for another winter.

**Short Wave Used**

In the Greenland transmissions, special messages for Greenland were read in Danish from KDKA. (Greenland is a protectorate of Denmark). Simultaneous with the broadcast on KDKA's regular wavelength of 309 meters, the programme was impressed on a 63-metre wave used

**History**

Wherever ships sail history has been made by wireless. Lives often depend on the reliability of a headset. Reception of a message means nothing unless reproduction is perfect. Because Baldwins give this, they are the favorites for professional use.

In your home a Baldwin can reproduce perfectly, any program—without any adjustment. The Baldwin patented principal eliminates the necessity of adjustment. There is no adjustment.

Ask to hear a Baldwin in horn, cone or cabinet type. Many of the leading manufacturers of the finest cabinet radio sets are installing Baldwin units as standard equipment. When buying such a set make sure it is equipped with Baldwin built-in unit.

All Baldwin products adapt themselves perfectly to the new Power Tubes.

*Before you decide—hear the Baldwin*  
**Baldwin International Radio of Canada, Ltd.**  
 Toronto, Ontario

**Nathaniel BALDWIN**  
 LOUD SPEAKERS

for experimenting. In addition to these two wave transmissions, many of the messages were repeated afterward on 63-metre telegraph.

A number of receiving sets are scattered throughout the Arctic. Some of them are located in trading posts, others at outposts of the Royal Canadian Mounted Police, and still others are privately owned. Then Mounted Police also have a few shortwave telegraph transmitting sets in strategic points.

After England, Iceland is the largest island in Europe. It has an area of 55,000 square miles, and a population of about 90,000. Its climate represents two extremes—the cold of mountain peaks and the warmth of bubbling wells of marked medical properties. Of its area, about one-seventh is covered with glaciers, or

plateaus covered perpetually with ice. Its coastline is indented with thousands of bays, fiords and inlets, many of which form natural harbors. Its mountain shapes are perhaps the most varied of any country in the world. Nearly all them are of glacial or volcanic origin. The volcanoes still alive in Iceland do not number many, and their eruptions are few and of little consequence.

**Eruption 1875**

Not since 1875, when the Askja volcano burst forth, covering the whole of eastern Iceland in dense darkness and carpeting it in a stifling bed of pumice, has Iceland been seriously menaced by volcanoes.

Eiderdown, Icelandic moss and feldspar are peculiar products of the island. The down is taken from the nests of eider

(Continued on page 38)

Noiseless,  
permanent

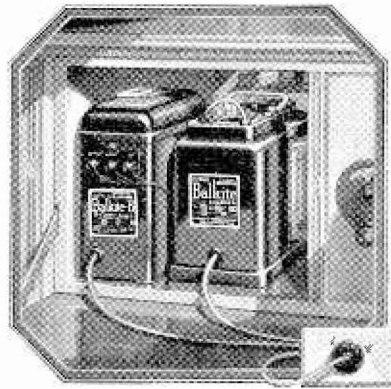

## light socket Radio Power

with Balkite "B" and the  
new Balkite Trickle and High-Rate Charger

For noiseless, permanent radio power from the light socket add Balkite "B" and the Balkite Charger.

Balkite "B"—the standard "B" power supply—eliminates "B" batteries entirely and supplies "B" current from the light socket. The new Balkite "B"-W at \$39 serves any set of 5 tubes or less where 67 to 90 volts are required. Balkite "B"-X at \$59.50 serves sets of up to 135 volts and 8 tubes. Balkite "B"-Y at \$96 serves any standard set.

The new Balkite Charger at \$27.50, with both high and low charging rates, gives you the ad-

vantages of both trickle and high-rate charging. At the low rate, on trickle charge, it automatically keeps your "A" battery at full power, in effect converting it into a light socket "A" power supply. The high rate provides a reserve of power ample for the largest sets.

Both Balkite "B" and the Balkite Charger are noiseless, permanent pieces of equipment, with nothing to wear out or replace.

Add these two Balkite Units to your receiver now and own a radio set always ready to operate at peak power. Ask your dealer.

All Balkite Units operate from 50-60 cycle current. The Balkite Charger is also made in a special model for 25-40 cycles

Distributed by

**BURNDPT OF CANADA, Ltd.**

130 Richmond St. W., Toronto 307 St. James St., Montreal

SPARLING SALES, Ltd., 214 Graham Ave., Winnipeg

RADIO SPECIALTIES, Ltd., 179 Pender St. W., Vancouver, B. C.

# Balkite *Radio* Power Units

### VICTIM OF THE FOG

(Continued from page 27)

cabin Phillips stayed by his key, for until the end he must keep in constant touch with the Mercedes rushing through the night to the rescue. And under him the President was slowly sinking, slowly and inevitably, minute by minute. And now it seemed that it might last another two hours and now an hour and a half. And now only an hour, and the Mercedes still twenty miles away.

And hundreds of miles south in a tiny house on the Jersey coast a mother and a wife waited as the sinking ship was waiting and called out for help for their boy at his post of duty in the fog.

There was a dull explosion below the decks. The President righted itself for a moment then settled more sharply to port. The end was near. In the frenzy of despair Phillips sent out again his call. Back it came. The Mercedes was very close. Ten minutes. Could the President hold together that long? And back through the night the radio crashed out its message of hope and despair and information.

On the promenade deck the ships band had assembled. With their feet on a sinking ship they pinned their faith in a Higher Power and over the heads of the huddled passengers the strains of music floated out with a message of hope.

(Continued on page 36)

### AN "EVEREADY HOUR" GUEST ARTIST

The wise-cracking patter and snappy songs of Broadway and the plaintive melancholy songs of the Southern mountain districts will weave their contrasting colors into the "Eveready Hour" to be broadcast on Tuesday evening, from station WEAJ and its associate stations.

Belle Baker, of vaudeville fame, will supply the sparkling, flashing color from the "Great White Way." Vernon Dalhart, who is widely known for his renditions of "The Prisoner's Song," will pour out the heart-throbs of the mountain folk.

The regular "Eveready Hour" singers and orchestra will provide the musical miscellany which will be the setting for these two contrasting artists.



Belle Baker, of vaudeville fame, who will be the guest artist during the Eveready Hour broadcast.

For a number of years Belle Baker has been one of the most popular American vaudeville stars. Just now she is preparing for an important part in a new Ziegfeld show which will make its appearance in New York in December.

Almost everyone knows Vernon Dalhart for his phonograph records of mountaineer songs. Comparatively few, however, know that years before he gained such popularity as a singer of country sob songs, he sang in grand opera roles. Some of his earliest appearances were with a grand opera company on the Pacific coast some years before the World War.

Tell Them You Saw It In "Radio News of Canada"

**WE ARE DISTRIBUTORS FOR  
SUPERTRON TUBES**  
"The Tube with the Sensible Guarantee"  
**IMPERIAL RADIO CO.**  
SAULT STE. MARIE - - - ONTARIO

**LIST OF PATENTS RELATING TO RADIO  
ISSUED DURING NOVEMBER, 1926**

**COMPILED BY RIDOUT & MAYBEE, TORONTO**

- 265,421 Audio Regenerator—Walter Englof—November 2, 1926.
- 265,427 Wireless Reception Apparatus—Edward Alfred Grahm—November 2, 1926.
- 265,517 Thermionic Tube—The Canadian Westinghouse Company, Limited—Hubert M. Freeman and Wallace G. Wade—November 2, 1926.
- 265,541 Electricity Condenser—The Marconi Wireless Telegraph Company of Canada, Limited—Edward Herbert Trump—November 2, 1926.
- 265,611 Radio Circuit—Alphonse Christen—November 9, 1926.
- 265,629 Radio Apparatus—Raymond Adam Klock—November 9, 1926.
- 265,632 Condenser—George John Mahieu—November 9, 1926.
- 265,684 Oscillation Mechanism—The Carborundum Company—Miner Louis Hartmann and Morrow Culver Miller—November 9, 1926.
- 265,745 The Western Electric Company Incorporated—The International Western Electric Company—Sidney E. Anderson—November 9, 1926. Improvement in Electric Wave Translating Systems.
- 265,746 Amplifying System—The Western Electric Company Incorporated—The International Western Electric Company—Charles W. Green—November 9, 1926.
- 265,747 Electron Discharge Device—The Western Electric Company Incorporated—The International Western Electric Company—James M. Eglin—November 9, 1926.
- 265,794 Wireless Transmission Reception—William G. H. Finch—November 16, 1926.
- 265,867 Electrolytic Rectifier—The Canadian National Carbon Company, Ltd.—Glen D. Bagley and Fred. T. Bowditch—November 16, 1926.
- 265,868 Electrolytic Apparatus—The Canadian National Carbon Company, Ltd.—Raymond C. Benner—November 16, 1926.
- 265,883 Electric Transformer—Ferranti Limited—Sebastian Ziani de Ferranti—November 16, 1926.
- 265,900 Electric Discharge Tube—N. V. Philips' Gloeilampenfabrieken—Gustav Zecher—November 16, 1926.
- 265,901 Electric Discharge Tube—N. V. Philips' Gloeilampenfabrieken—Popko Reinder—November 16, 1926.
- 265,902 Electric Discharge Tube—The N. V. Philips' Gloeilampenfabrieken—Albert Bouwers—November 16, 1926.
- 265,903 Electric Discharge Tube—The N. V. Philips' Gloeilampenfabrieken—Willen de Groot—November 16, 1926.
- 265,933 Method of and Apparatus for the Observation and Determination of Bodies—La Societe Leroy. Lajoux et Compagnie—Robert Pierre Ernest Leroy—November 16, 1926.
- 265,936 Method of Controlling or Preventing Oscillations in Vacuum Tube Circuits—The R. E. Thompson Manufacturing Company. Jersey City—Boyd Phelps—November 16, 1926.
- 266,068 Talk Machine Support—The Brandes Laboratories, Inc. The Canadian Brandes, Limited—David H. Moss—November 23, 1926.
- 266,078 Thermionic Relay—The Canadian Westinghouse Company, Limited—Roy J. Wensley—November 23, 1926.

(Continued on page 44)

THE TUBE WITH THE SENSIBLE GUARANTEE



## A Broadcasting Studio In Your Home



Isolantite is a dielectric composition that is rated highest by the Bureau of Standards—a manufacturer who employs Isolantite indicates his preference to Quality rather than cost.

Supertron tubes are internally re-enforced by a rigid construction that combines all the elements into one unit "Isolantited."

Reception coming through Supertrons will make you feel like the Broadcasting Station is right in your home -- Try them.

### Your Money Will Be Refunded If They Are Not Better

ALL TYPES AT PUBLIC DEMAND PRICES

|                       |        |
|-----------------------|--------|
| SX 201 A.....         | \$2.75 |
| SX 199 .....          | 3.10   |
| SV 199 Small .....    | 3.10   |
| SV 199 Large.....     | 3.19   |
| SX 112 Power.....     | 6.90   |
| SX 120 Power.....     | 3.45   |
| SX 171 Detector ..... | 6.90   |
| SX 200 Detector ..... | 6.90   |
| SX HiMu .....         | 4.15   |
| SUPERTRON Half .....  | 5.50   |
| SUPERTRON Full .....  | 6.90   |

SUPERTRON MFG. CO., Inc.  
HOBOKEN, NEW JERSEY, U.S.A.

Chicago Office: 30 N. Dearborn Street  
Export Department: 220 Broadway, New York City

PERSONALLY  
ENGINEERED  
*H. Bolker*  
ASK THE MAN  
WHO KNOWS

## SUPERTRON

A SERIAL NUMBER GUARANTEE

The Foremost Independent Tube In America

# YAXLEY

APPROVED RADIO PRODUCTS

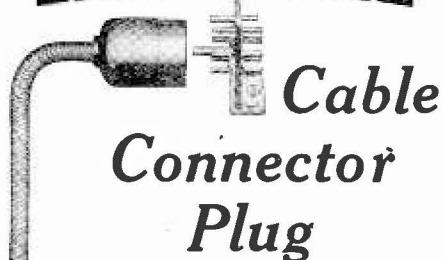

## Cable Connector Plug

The very appearance and sure positive action as you put it together will sell you on the new Yaxley Cable Connector Plug.

The Bakelite construction, the phosphor bronze double contact springs, the convenient mounting plate with the permanently attached color guide for wiring tell you the unusual merits of this practical plug for quickly and conveniently connecting battery leads to your set. The No. 660 is the plug illustrated, \$4.20.

The No. 670 is the plug for the set with binding posts—no soldering. Just hookup the terminals to your set and batteries and the job is done, \$4.80.

### JUNIOR JACKS

For the set builder who wants a thoroughly dependable jack in the junior size. Absolutely the same in every exclusive feature of design and construction as Yaxley standard jacks. Pure silver, self-cleaning contact rivets. All spring combinations from one to seven.

### MIDGET BATTERY SWITCH

A neat, efficient filament control switch. Never gets out of order. One nut mounting. Hard rolled phosphor bronze springs. Pure silver contacts. Quick make and break. Furnished complete with "Off" and "On" plate, as illustrated, at 60c.

At your dealer's. If he cannot supply you send his name with your order to

### STERLING SPECIALTIES

301 Travellers' Building,  
Winnipeg, Man.  
412 Duncan Bldg.,  
Vancouver, B.C.

A. C. SIMMONDS  
311 King St. East, Toronto 2

## NEWS FROM RUSSIA

The Society of Radio Friends in Russia—The Society of Radio Friends was formed in 1924 out of a union of a number of radio-amateur circles, scattered all over the Soviet Union. At the Congress in March, 1924, in Moscow, were already present 281 delegates from 43 Republican, district and provincial sections of the society. The Congress has adopted

the statutes, whereby the work is done on an all-Union scale.

200,000 radio amateurs are united at present by the society. The members' fee is from 36 to 60 copecks per year for peasants, workers and employees.

The society is educating in its circles many thousands of youth already acquainted with the foundation of radio-technics and the Morse alphabet. In provincial and district towns special courses of radio-technics are conducted, where knowledge obtained by radio-amateurs in their circles is supplemented by self education. Self-education on radio questions is attained not only by way of reading special literature at home, but in systematic hearing of technical lectures given by the society over radio from Moscow, conversations in the consulting sections of the local branches of the society, etc.

By the way, the Morse alphabet and Esperanto language are also transmitted by radio.

Among the members of the society are inventors, making useful improvements, which are popularized by the society in its fortnightly journal "Radio to All." The Society of Radio Friends is furthermore publishing another magazine, "The Radio Friend," in Leningrad. The Council of Labor Unions is publishing the magazine "Radiolub tel" (Radio-Amateur), and the "Radioperedacha" Co., Ltd., a weekly—"Radio News."

The main merit of the society is the creation of hundreds and thousands of volunteer workers propagating radio in the most out of the way corners of the country, and organizing radio-circles there. A new figure of "peripatetic radio-ist" has appeared. In the majority of cases it is a young peasant, who learned to read and write in the army, and mastered a certain minimum of technical knowledge at the circles of the Society of Radio Friends. He comes to some village of his volost, gathers the peasants, and demonstrates the work of the loud-speaker, in the majority of cases, a concert, or a lecture on agricultural questions—from Moscow. Among the many hundreds of listeners, gathering from the neighboring villages, quite often a group is organized on the spot, which later forms a circle of the Society of Radio Friends, and begins to collect means for the purchase of their own loud-speaker. It happened sometimes that the peasants carried a resolution of tilling a special plot of land, income wherefrom should be used for the construction of a radio station, training of local mechanic for serving same, establishment of library of the circle of Society of Radio Friends, etc.



The Christmas Tree at "KMOX"  
The Voice of St. Louis

### VICTIM OF THE FOG

(Continued from page 34)

But what was that through the fog and darkness to starboard? A dull moan. A ship's horn. Back went the sound of the President's fog horn. Again came the sound out of the night. And very close now, again. And then lights and the sound of muffled voices. The Mercedes had come. But the President was sinking fast now. And the work of rescue must not be delayed.

Until the end Phillips stayed by his key. Until they came and told him to hurry, that all were taken off, and that the ship had but a few moments more. And then still he waited, and they called him a fool, and left him. He waited to send his last message into the night, the two words, "Arline, Mother."

But had he waited too long? There was a second rending explosion below deck. Another, louder. He fought his way out of the cabin. He climbed up the sharply leaning deck to the rail. The President was turning over. Below him in the darkness he could see some dark green water. He jumped. The water took him.

\* \* \*

In the morning when the fog lifted a heap of litter on which the sun shone and which the green swells of the sea heaved up and down was all that was left of the greatest ship afloat. The gulls had already joined those of the Mercedes which was slowly steaming south carrying safe and sound every man woman and child of the liner President. Everyone. Including a radio operator named Stephen Phillips who nursed an ugly wound on his forehead and thought about a small room in a tiny house on the Jersey coast.

Tell Them You Saw It In "Radio News of Canada"

# Natural, Rich, Pure Tone

*Its name is its guarantee of perfection.  
Brandes means advanced acoustical  
standards.*

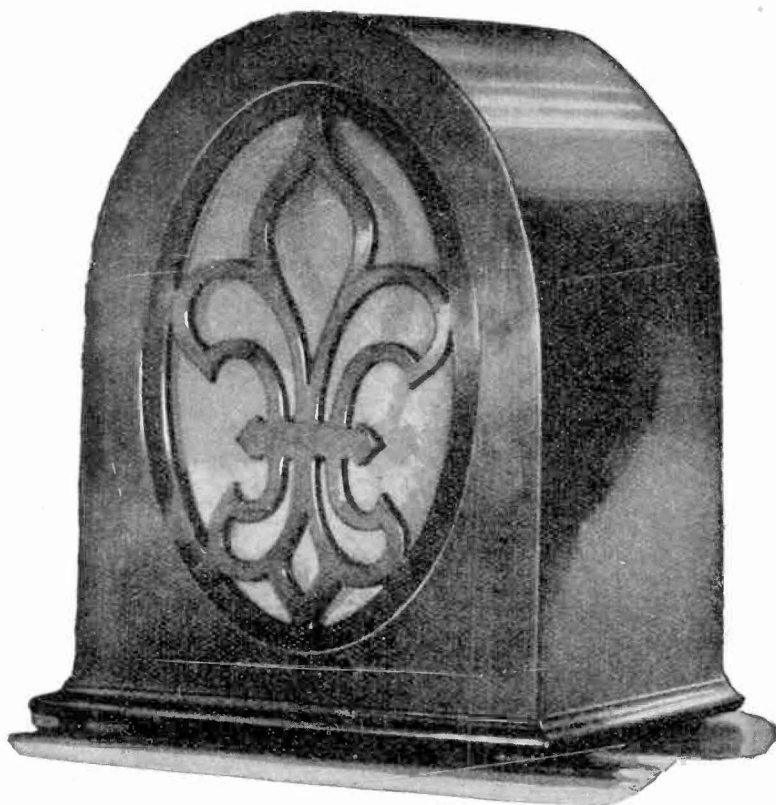

The Brandes Cabinet Cone is beautifully finished in Adam Brown duotone mahogany---a decorative touch in any home. Unusually large volume delivered --- extremely sensitive to weak signals. Adjustable for maximum sensitivity. Retailing at \$32. (West of Fort William, \$33.)

**Canadian Brandes  
Limited**

Factory and Office: 243 Church St., Toronto

|   |                  |
|---|------------------|
| Brandes Cabinet Cones   | \$32.00          |
| (West of Fort William, \$33.00)   |                  |
| The Brandes Adjustable Table<br>Talker                                      | \$11.00          |
| (West of Fort William, \$11.50)   |                  |
| Brandes Table Cone  | \$16.00          |
| (West of Fort William, \$17.00)   |                  |
| Brandes Type H Speaker  | \$22.00          |
| (West of Fort William, \$23.00)   |                  |
| Brandes Phonograph Attachment   | \$13.00          |
| Brandes Superior Headset  | \$ 6.50          |
| Brandes Dublier Micadon Con-<br>densers. From .0001 to .02<br>Mfd. capacity | \$0.50 to \$2.20 |
| Brandes Dublier Micadon Con-<br>sers. From .1 to 2. Mfd.<br>capacity        | \$0.90 to \$2.50 |
| Brandes Durham Metalized Re-<br>sisters. From .25 to 5. Me-<br>gohms        | \$ 0.50          |



**SIMPLICITY!  
EFFICIENCY!  
BEAUTY! This is the NEW  
UNITUNE**

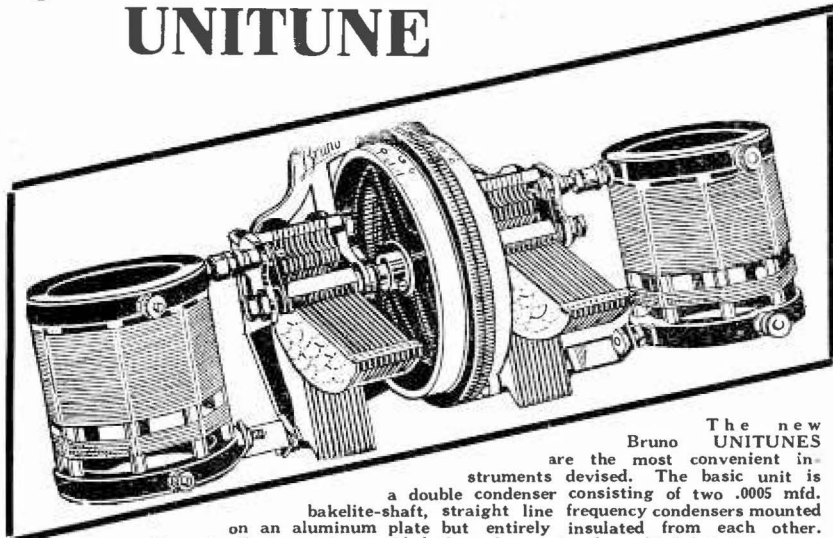

The new Bruno UNITUNES are the most convenient instruments devised. The basic unit is a double condenser consisting of two .0005 mfd. bakelite-shaft, straight line frequency condensers mounted on an aluminum plate but entirely insulated from each other. Manual adjustment is provided through a pair of moulded bakelite drums which can be operated individually. No supplementary "vernier" or "micrometer" condensers are necessary. The other UNITUNES are combinations of Bruno quartzite inductances with the basic condenser unit. All models mount to the back of the panel by means of only two screws, which also hold handsome bronze indicating plates. Special bronze mounting screws are supplied.

**The "2C" UNITUNE**  
consists of two condensers on one frame, with drum control, bronze panel plate, and special bronze mounting screws. Price, \$15.00.

**The "TK" UNITUNE**  
consists of "2C" unit with one fixed R. F. Coupler and a three circuit (tickler) tuner mounted on condenser posts. Price, \$28.00.

**The "CF" UNITUNE**  
consists of "2C" unit with one fixed R. F. coupler and special three winding coil, with fixed primary and tickler, for use in capacity feed-back regenerative circuits. Price, \$27.00.

**The "BD" UNITUNE**  
consists of "2C" unit with two special Bruno inductances for the Browning-Drake receiver. Price, \$29.00.

**The "CC" UNITUNE**  
consists of one .0005 mfd. bakelite-shaft, straight line frequency condenser and a three circuit tuner on one frame, with regular Bruno drum control. Price, \$16.50.

**The "RF" UNITUNE**  
The model "RF" UNITUNE consists of two .0005 mfd. (illustrated) condensers with two matched radio frequency transformers adaptable to a wide variety of circuits; no subcondensers necessary. Price, including bronze panel plate, \$25.00.

**DRUM CONTROL (Bronze Plate and Screws—2 Drums and Scales—Mounting Frame)**

A convenient addition to a good line!  
**THE BRUNO ADJUSTABLE BRACKET**

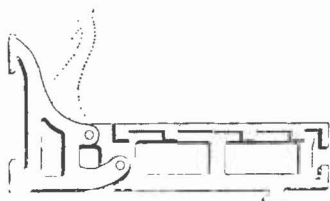

Now that the tendency is toward sloping cabinets, you will find these Brackets very useful as they adjust themselves to any angle.

Price, \$..... Price, \$1.75

**Radio Besttone Co., 23 Richmond St., Toronto**

**G. C. Payette & Co.**

**190 St. Catherine St., Montreal**

**INVENTORS GRANTED PATENTS FOR MANY UNUSUAL DEVICES**

Inventors have been granted patents for many odd and unusual ideas, covering a range from mechanical cow-milking devices to refrigerated hats, says Stuart Walker in Science and Invention Magazine.

One enterprising gentleman from Buffalo has a beautiful scheme for solving the transportation problem, he writes. The inventor proposes an aerial railway which consists of cars suspended from a cable extending between balloons stationed at pre-determined distances, an inclination of the cable between balloons furnishing the motive power for this means of transportation. A pleasant word picture of the delightful pleasures experienced in riding through the air in this fashion is painted in the patent.

Another curious patent covers what is called a "useful hat." This hat has two supports, one resting on each shoulder of the wearer, which hold the hat above the head. The inventor contends that this unique chapeau "will permit the free circulation of air around and over the head of the wearer, preventing headaches from the weight of the hat and allowing free movement of the head independently of the hat."

The man surely must have been farm-raised who produced a combination churn and rocking chair, remarks Mr. Walker. The device consists of a rocking chair having the churn in a small barrel attached beneath the seat. All that is necessary for milady to do is to sit in the chair, read or knit and rock, and the distasteful task of churning is taken care of.

A high sense of civic pride is apparent in the invention covering India rubber sidewalks. The pleasure of stopping or bouncing along a resilient sidewalk is obvious, but there is also an economic slant to be considered. The inventor points out that such sidewalks might be stretched to any desired length.

Although the subject matter is very serious, there is something amusing in the patent which covers a coffin equipped with a rope extending to the surface of the ground and attached to a loud bell. This humane invention anticipates the recovery of a person in a highly disagreeable and dangerous position below the ground; all the poor fellow need do to summon help is to tug on the rope.

A cautious gentleman from beyond the Mississippi secured a patent on anchors for houses. He provides homes with anchors in the form of blocks to be buried at each corner of the house plot, the purpose of the hooks being to prevent the buildings from blowing all over the landscape during a cyclone.

**A NIGHT CALL**

(Continued from page 15)

treble voice muttering to itself, "What's wrong now, I wonder?"

I picked up the poker again, my lips compressed. I flung open the door. Perched in front of my ten-guinea-set was Dorothy's young nephew, swathed in a warm and woolly dressing-gown, and trying to "get" the crook play broadcast from London!—Leslie T. Barnard.

**ICELAND**

(Continued from page 33)

ducks bred particularly for this purpose. It is used to stuff pillows and coverlets. The moss is made into pastilles for coughs, and is used for medicinal purposes throughout the world. Feldspar is used in optics because of its power of double refraction. It is mined from the world's sole quarry, in the southeast of Iceland, under government ownership.

Tell Them You Saw It In "Radio News of Canada"



# DURABILITY

The Long-Range 4 in 1 aerial is exceptionally durable, for it is constructed of heavy steel and stranded copper wire, scientifically treated with a special enamel which makes it immune to corrosion.

A Long-Range will give highly satisfactory service for many years.



has four separate sections each insulated from the other but combined with one down lead. The enamel on the frame and stranded wire also acts as a perfect insulator, preventing cross leaks and assuring perfect reception.

The Long-Range is easily erected on a single steel mast and any number may be used on the same roof without the least interference.

You should know more about this wonderful aerial—Send for illustrated folder.

General Sales Representatives:

**Colonial Traders, Limited** - CHATHAM, ONTARIO

Manufactured by

**L. A. Young Industries of Canada, Ltd.**

WINDSOR - ONTARIO

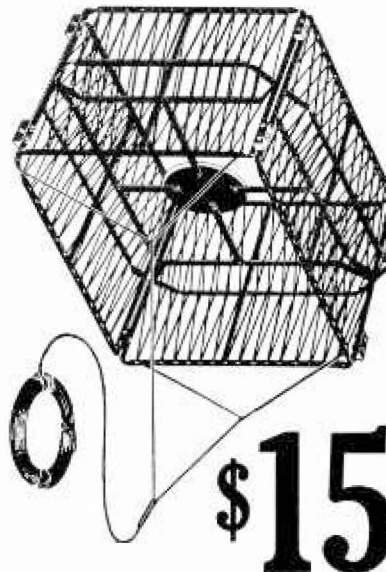



STATION WOC  
DAVENPORT

HERE'S WORK THAT IS  
ALMOST ROMANCE!

**Now Owns a Radio Store**

"The Radio business is rushing just now. Building many Super Heterodynes, also doing installation and repairing. To your course I owe all my success in the Radio profession." A. J. Ommodt, Bowman, N. Dak.



**Controls First Car by Radio**

"I operate the portable broadcasting station in rear car, driving front car by Radio control. Will operate this car from New York to Frisco—13 months trip. Then we take the car around the world—a three years' tour. I owe it all to you." Leo Paul, New York City.



# You Can Do What These Men Did!

## I Will Train You at Home to Fill a Big-Pay Radio Job

Get into the great new Big-pay Industry—Radio. If you're earning a penny less than \$50 a week, clip coupon now. Send for AMAZING FREE BOOK, "Rich Rewards in Radio." Why go along at \$25 or \$35 or \$45 a week, when you could earn \$50 to \$250 in the same six days, as a Radio Expert? Hundreds of N. R. I. trained men are doing it—why can't you? I'll train you just as I trained them—just as I trained the men whose letters you see on this page. I'll teach you quickly at home in your spare time to be a Radio Expert, and draw down big money for the easiest and most fascinating work in the world.



**These Instruments Given FREE of Extra Cost**

All instruments shown here and others sent to all my students free of extra cost under short time special offer. Clip coupon now—find out all about this big unequalled offer while you still have time to take advantage of it. This training is intensely practical—these instruments help you do the practical work.

**My Radio Training is the "Famous Course That Pays for Itself"**

Make more money quick when you take up this practical course.



**\$70 in one Day for T. M. Wilcox**

"I am in business for myself and recently made \$70 in one day. I was an electrician of rich experience and was occupying a splendid position as telephone superintendent when I enrolled with your course believing it would open up greater opportunities—have not been disappointed. Estimate that Radio will be worth tens of thousands of dollars to me in the next few years." T. M. Wilcox, Belle Island, Newfoundland.

I show you how to increase your earnings almost from the start of your course through practical pointers I give you.

**Howard B. Luce of Friedens, Pa.,** made \$320 in 7 weeks during his spare time. **D. H. Suitt of Newport, Ark.,** writes "While taking the course I earned in spare time work approximately \$900." **Earl Wright of Omaha** reports making \$400 in a short time while taking his course—working at Radio in his spare time only! **Sylvester Senso, 207 Elm St., Kaukana, Wis.,** made \$500. These records not unusual—these men are a few of hundreds.

And when you graduate, my big Free Employment Department helps you get the job. You get just the same preparation and assistance toward success we gave C. C. Gielow, Chief Operator of the Great Lakes Radio Telegraph Co., E. W. Novy, Chief Operator of Station WRNY, Eric Chambers, Radio Engineer for Stewart-Warner, J. E. Fetzer, Chief Engineer of Station WEMC. The National Radio Institute, established 1914, today offers you the same opportunity these men had under a bond that guarantees you full satisfaction or money refunded. It's your big chance to get into the great Radio field—mail coupon TODAY for my big Free Book and proof!

### \$50 to \$250 a Week as a RADIO EXPERT

It's the trained man, the Radio Expert, who gets the big jobs of this profession—paying \$75, \$100, \$200 a week and up. Free book gives all the facts. Every day N.R.I. trained men are taking good places in the Radio field—men like you—men like those whose stories I show you here. You can prepare just as they did by new practical methods, learn right at home in your spare time. Lack of experience no drawback—common schooling all you need. Our tested clear methods make it easy for you. We guarantee to train you successfully. Big Free Book contains all the proof.

**Clip Coupon Now for FREE BOOK**

Most amazing book on Radio ever written—full of facts and pictures—tells all about the great Radio field, how we prepare you and help you start. You can do what others have done—GET THIS BOOK. Send coupon today—no obligation.

**J. E. Smith, Pres. NATIONAL RADIO INSTITUTE Dept. AC-1 Washington, D. C.**

Read the true stories printed in this border-of men who got out of the rut



**Chief Engineer Station WEMC**

"Please communicate with my two junior operators here who want to increase their knowledge of Radio. Being a graduate of your course I know they could do nothing better for themselves than study it for it is the way to success in this profession." John E. Fetzer, Chief Engineer, Station WEMC, Berrien Springs, Michigan.



"Photo shows Graduate E. F. Spadoni in his own Radio store at Chicago, Ill. 'Your course gets the credit,' says Spadoni.

**RADIO NEEDS TRAINED MEN!**



**MAIL THIS NOW!**

**J. E. Smith, President NATIONAL RADIO INSTITUTE Dept. A.C.-1, Washington, D.C.**

Dear Mr. Smith: Without obligating me in anyway, send me your free book "Rich Rewards in Radio" and all information about your practical, home-study Radio course.

**Originators of Radio Home-Study Training**



**Kimball With WMAQ Chicago**

"Accepted a position with the Chicago Daily News Station WMAQ. My Income practically doubled, thanks to your fine course. I handle all consultation also do operating." Keith Kimball, Station WMAQ, Chicago, Ill.



**Promoted to Big Job**

"Just been made Sales Manager of this Radio firm—received a very good increase in pay. Up to present have been getting salary which in 3 months enabled me to purchase a new car." R. Jones Bay City Mich.

SEND THIS COUPON

Name ..... Age .....  
Street Address .....  
Town ..... State .....

Tell Them You Saw It In "Radio News of Canada"

## STRIKING DEVELOPMENTS IN RADIO FIELD

**Radiotelephone Service Between United States and Great Britain Predicted. Increased Use of Radiocompass on Merchant Ships.**

Radiotelephone commercial service between the United States and Great Britain in the near future is a reasonable probability, according to D. B. Carson, United States Commissioner of Navigation, in his annual report.

Tests which have been conducted show encouraging results, but it is pointed out the difference in time in connection with office hours of banks, stock exchange and brokerage houses may present some difficulty.

Commercial pictoradiogram services, the report reveals, are now in operation between New York and London and San Francisco and Hawaii. By means of this development, photographs, pictures, advertisements, legal documents, bank cheques, cartoons, fingerprints, and similar pictorial or printed matter are quickly transmitted and reproduced. This new field, the Commissioner states, may develop into an important branch of radio communication.

## ANNUAL REPORT ON THE RADIO SITUATION IN THE STATES

**528 Broadcasting and 14,902 Amateur Stations**

Broadcasting stations in the States on June 30, 1926, decreased slightly during the past fiscal year, totalling 528 licensed stations as compared with 571 last year and 535 in 1924. There has been a material increase in power used. The average power per station in watts is 715.8 as compared with 312.4 last year and 190.5 the year previous. During the past fiscal year, 117 new stations were licensed and 160 discontinued. The previous year 281 new stations were licensed and 245 discontinued.

On June 30, there were 14,902 active amateur radio stations in the United States, according to the report. There was a considerable decrease in the number of these stations licensed during the fiscal year as compared with 1925, the figures being, respectively, 8,037 and 10,074. During the year under review 3,209 amateur stations were discontinued. Amateurs in this country are taking advantage of all improvements made in the art and are inclined to more readily adopt new ideas than is possible with the larger stations where much experimenting must be done before changes are made which involve large expenditure of time and money. Practically all amateurs are now using continuous-wave transmitters, many of them having crystal control. With the amateurs, the spark set is considered obsolete as is the crystal receiving set.

At the close of the year under review, there were 1954 vessels equipped with radio as compared with 1,901 during the year previous. Considerable progress was made during the year in converting spark transmitters on ships to the more modern type tube transmitters, which increase the range of the station and produce much less interference. It is not unusual for ships equipped with continuous-wave apparatus, tube or arc, to maintain daily communication with land on a trans-Atlantic voyage.

Radio compasses were in use in 230 American merchant vessels at the close of the fiscal year compared with 83 during 1925, the report discloses. The value of this equipment as an aid to navigation and for the purpose of locating vessels in distress is now generally recognized by steamship companies.

Continued growth in the use of radio is predicted by Commissioner Carson, together with improved service to the public. However, he states that in the absence of adequate radio laws, it is difficult to forecast just what the actual conditions may be during the coming winter.

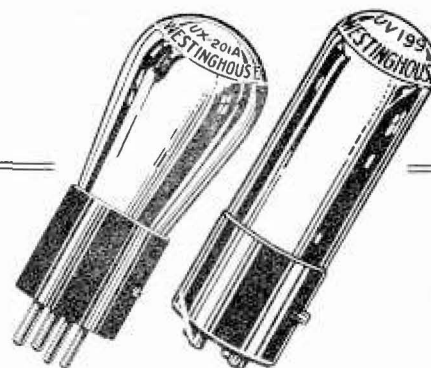

**Distance--  
Clarity--  
Volume**

### *Distance*

With Westinghouse Radiotrons distant stations are readily brought in. They give power to a Radio Set.

### *Clarity*

With Westinghouse Radiotrons there is a clearness of tone—speech, song or instrument all given a life-like reproduction.

### *Volume*

Westinghouse Radiotrons give maximum volume.

By selling Westinghouse Radiotrons you can build up a permanent list of satisfied users.

**CANADIAN WESTINGHOUSE CO. LTD.**

HAMILTON - ONTARIO

Sales Offices in Principal Canadian Cities



# Westinghouse

Tell Them You Saw It In "Radio News of Canada"

**TONE  
is the  
Big  
Thing**

PRICE

**\$35.00**

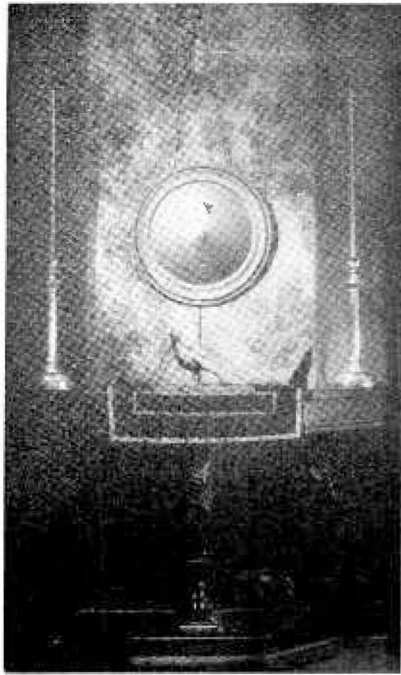

**Silk Cord  
Permits  
Use as  
Wall  
Decoration**

SUPPLIED WITH BASE FOR TABLE USE

**Ten reasons why the SPLITDORF Tone-Cone will please you**

- 1 The Splitdorf Tone-Cone is different from any cone speaker on the market and its design is protected by patents.
- 2 Capable of handling a wide range of musical notes, delightfully modulated, giving emphasis to the bass clef and assuring musical satisfaction.
- 3 The continuously curved surface of the diaphragm makes it resilient, sensitive and highly responsive to sound vibrations.
- 4 The guttered edge prevents the damping of vibrations and assures the brilliancy of rich tones.
- 5 The diaphragm is made in one piece so that there are no laps, seams or joints to come apart or to introduce distortion. And being of a specially-treated fabric, it has no natural "crackle" like paper and, consequently, introduces no tones of its own.
- 6 It is weather-proof and not subject to tone changes under changing atmospheric conditions.
- 7 If the cone is damaged it is readily replaced by removing one thumb screw.
- 8 In appearance it is beautiful and adds to the attractiveness of any drawing or music room.
- 9 It is modern and up-to-date, for it hangs on the wall, if desired, out of danger's way; or the handsome mahogany base permits of its use as a table ornament.
- 10 Many, many tests, in competition with higher-priced cone speakers have led music critics to concur that in richness of tone, in naturalness of key, and in pleasing resonance—it is pre-eminent among sound reproducing instruments.

**SPLITDORF ELECTRICAL COMPANY  
LIMITED**

493 Yonge Street, TORONTO 5

**A MODEST FAN**

A gentleman of long purse and short humor recently bought a receiving set with all accessories and installed it with great gusto in his hillside home in Hollywood, and started the very first night to fish for DX.

Just before closing down for the night, KFI received a call from the new fan.

"Say," he grumbled, "you ought to know things about radio that the ordinary person wouldn't. I've been trying for four hours to get Japan or England, with no success. What I want to know—does DX stand for D—d Exasperating?"

**PRINCE IS ONE OF "TWO GUITARS"**

A Russian prince, whose identity must remain unknown, has arrived in America from Constantinople with his lifelong friend, Serge Krotkoff. The two, known as "The Two Guitars," have played successful engagements at the famous Maxim's Cafe in Constantinople. They will offer an hour of Russian, Spanish, Turkish and gypsy music from WGBS Sunday night, commencing at 9 30 o'clock. The Russian prince plays under the pseudonym of "Sokoloffsky."

**THE JAYNXON TONE-BRIDGE**

The Jaynxon Tone-Bridge is a radio accessory designed by the engineers of the Jaynxon Laboratory to overcome many of the imperfections of tone and volume control incident to radio reception in the modern receiver.

By affording a perfect means of volume control, it enables the listener to take full advantage of his radio receiver. This is accomplished not by changing the constant of the circuit thereby distorting tone and lowering sensitivity, but by controlling only the output and allowing the listener a control of volume over the full range of tone designed into the receiver he employs.

The second application is that of protecting the loud speaker against harmful direct current which soon demagnetizes it and allows distortion to creep in. The electrical output of a radio receiver contains two components—a direct or B battery current and a pulsating current. The direct current is not needed in the coils of the loud speaker and aids in no way the reproduction of sound. The Jaynxon Tone-Bridge diverts this direct current, allowing only the pulsating current to enter the coils of the loud speaker. Thus the life of the speaker as a quality instrument is prolonged indefinitely.

The third application is that of a coupling unit between the receiver and the modern cone or disc speaker, enabling the listener to get from this type of speaker that tone and quality which that speaker should give.

The fourth application of the Tone-Bridge is that of eliminating to a great degree the incidental noises which mar radio programmes and are directly traceable to nearby power leaks, various medical machines, and atmospheric disturbances (static). This is accomplished by so adjusting the Tone-Bridge to slightly less volume so that the music or other entertainment overrides the disturbing noises which are dampened and although present, are not heard with the violence usually associated with them.

The installation requires no labor or altering of the set. It may be used on any set that is capable of actuating a loud speaker and may be used on any speaker, both horn and disc type.

**PERSONAL SERVICE**

Little Jimmy's mother took her "daily dozen" with the aid of the physical director of WJX. One morning she turned on the radio set a few minutes before the time and went on about her household duties. Suddenly the music started and the director began his exercises. Jimmy rushed to the loud speaker and called into it, "Wait a minute! Mama isn't here yet."

Tell Them You Saw It In "Radio News of Canada"

**IMPORTED THRILLS FOR  
BROADCAST LISTENERS**

Europe promises thrills for American broadcast listeners was the good news brought from Arthur C. Burrows, Director General of the Union Internationale de Radiophonie, representing all the broadcasters of Europe.

His communique from the headquarters at Geneva conveyed to Canadian radio fans the information that improvements in the European broadcast stations brought about by their use of higher power and revised wavelengths should result in their being frequently heard in America, especially as some will send very often at hours suitable for reception here.

Mr. Burrows gives these outstanding recent developments in European radio:—"The outstanding feature of European broadcasting is the general realization that stations are interdependent in transmission affairs, and that it is most advisable to collaborate in the development of all branches of radio technique.

"The first fruits of the many conferences toward co-operation that have been held will be noticed the middle of October when the voluntarily prepared repartition program of European wavelengths with the object of elimination of interference will be applied.

"This new plan should increase the chances of European stations being heard over here. Many existing stations are increasing their power and also, new higher power long wave stations are under construction, notably, a Swedish station which is to use 40,000 watts on 1350 metres, and a station in Holland which is to use 20,000 watts aerial power. There is a marked growth in experimental short wave stations.

"Systematic education by broadcasting is making considerable headway. There is also definite provision for the radiation of symphonic concerts on a grand scale.

"In receiving apparatus the tendency is towards simplified controls but multi-tube neutrodynes are finding favor among seekers for purity of reproduction."

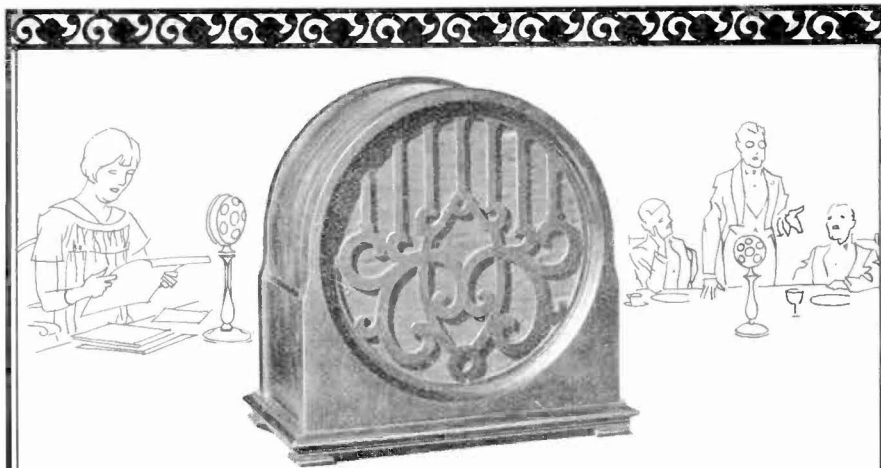

Model A.C., \$35

**The AMPLION CONE  
ably stands the severest  
test you can give**

*-- clear reproduction of speech*

You will enjoy the many speeches and talks that will be broadcast this winter much more if you attach an Amplion Cone to your radio set.

The secret of its fine performance lies in the matchless Amplion unit which is assembled with the Cone in a handsome mahogany cabinet, 14"x14"x9". Model AC12, \$35.

In Amplion models - Cone - Air Column - Dragon (horn type) and phonograph Units --the Amplion Unit is an integral part.

**Other AMPLION reproducers from  
\$11 to \$50**

**In Western Canada \$12 to \$53**

*Ask your dealer for demonstration or write for booklet  
illustrating and describing all Amplion models*



**THE AMPLION CORPORATION OF CANADA**

Suite Y, 130 Richmond St. W., Toronto

**THE AMPLION CORPORATION OF AMERICA**  
New York City

**NEW YEAR - NEW IDEA**  
**PATENT YOUR IDEAS**  
Call or send me a sketch of  
**your invention.** Phone Hanover 3662  
**FREE** Inventors Recording Blank  
Confidential Advice  
U. S. and Foreign Patents secured by  
**Z.H. POLACHEK** Reg. Patent Attorney  
Consult. Engineer  
70 WALL ST., NEW YORK

**No Trick---"no magic," An unusually efficient crystal receiver in attractive book that stimulates sales**



**The Talking Book**  
A Complete Radio Set

Pair of standard Ear Phones. Aerial and Ground Leads, Indoor Antenna, self contained in attractive book.

**Price \$7.00 Complete**  
IN CANADA

With new **CELERUNDUM RECTIFYING UNIT**—No batteries required.

We have an interesting sales proposition for live dealers and jobbers

This Talking Book will make an attractive window display and increase your sales.

**THE LISTEN-IN CO., 115 Federal St., Boston, Mass.**

**BROWN, WYLIE AND PURCELL**  
BARRISTERS AND SOLICITORS

Stuart H. Brown Ian M. Wylie Gerald M. Purcell  
Tel. Elgin 5274 Cable Address, "Brolie" A.B.C. Code

**320 BAY ST., TORONTO, CANADA**

**Specializing in Company and Patent Law**

**RADIO PATENTS ISSUED IN NOVEMBER**

(Continued from page 35)

- 266,079 Electric Relay—The Canadian Westinghouse Company, Limited—Walter J. Brown, Edward J. E. Hubbard, E. Y. Robinson and C. R. Burch—November 23, 1926.

**RADIO USED IN TEST FOR REAR AXLE NOISE AT AUTO FACTORY**

**Loud Speaker With Three Stages of Amplification Used to Detect Defects; Amateur Devices Hook-up**

Cooped up in a double-walled, sound proof box, a man listens to the whir of softly engaging gears broadcast from a radio transmitting station and stepped up through three stages of power amplification while his eyes watch the vibrating finger of a gigantic dial that measures the delicate pulse of the current consumed in reproducing the sound. This is how rear axles are tested in the dynamometer room of the Franklin automobile factory.

Three points on the dial are the limits between which he is permitted to pass the gears. Three one-thousandths of an ampere whisper through the loud speaker in a hoarse static like murmur revealing by pitch and intensity the most minute roughness on the polished surface of the gears as they glide over each other.

Two massive wheels of steel whirl at each end of the axle, which represents the weight of a sedan bowling along under a thirty-horsepower load. When a speed of 40 miles an hour is reached the power is turned off. Within four and a half seconds the wheels are stopped

and the radio operator presses his microphone like a doctor's stethoscope to various portions of the gear case. It is claimed that such a test will reveal any microscopic rough spot on the teeth of the gears under test.

The radio test is the result of study by Percival Harrison and Professor R. A. Porter, of Syracuse University. The hook-up was worked out by Clarence Jones, a radio amateur.

**DISCOVERED—REAL "ELECTRIC ATMOSPHERE"**

—'Tis Not Fiction!—

Pittsburg, Pa.—The atmosphere was electric! Was it emotion or electricity?

It might be lightning; it might be love or hate. But in this case it was neither; it was heavy, induced static electricity.

In the transmitting room of KDKA, Westinghouse station at Pittsburg, an operator pulled a screw-driver out of his pocket and holding it close to a metal plate on a door frame, drew forth a heavy blue spark. We examined the door frame; it wasn't wired; there was no connection whatever between that metal plate and anything which might act as an electrical conductor.

"How come the arc?" we asked.

"Short-wave," was the brief reply.

**Engineers Testing**

Now, in addition to its 309-metre

- 266,129 Variable Condenser—The Radio Corporation of America—George H. Clark—November 23, 1926.  
266,158 Space Discharge System—The Western Electric Company—The International Western Electric Company—Olindo O. Ceccarini—November 23, 1926.  
266,226 Telephonic Receiver—Edward Alfred Graham—November 30, 1926.  
266,227 Storage Battery—Daniel Grill—November 30, 1926.  
266,296 Telegraphic Transformer—The Canadian Marconi Company—Newsome Henry Clough—November 30, 1926.  
266,322 Variable Inductance—The Marconi Wireless Telegraph Company of Canada Limited—Newsome Henry Clough—November 30, 1926.  
266,337 Vacuum Tube—The Radio Patents Corporation—Alexander Nyman—November 30, 1926.

**THE "DAILY DOZEN" IN A NEW FORM**

R. M. sends us the story of a young bride who asked her husband to copy off a radio recipe she wanted. He did his best but got two stations at once, one of which was broadcasting the morning exercises and the other the recipe. This is what he took down:

"Hands on hips, place one cup of flour on the shoulders, raise knees and depress toes and mix thoroughly in one half cup of milk. Repeat six times. Inhale quickly one-half teaspoonful of baking powder, lower the legs and mash two hard-boiled eggs in a sieve. Exhale, breathe naturally, and sift into a bowl.

"Attention! Lie flat on the floor and roll the white of an egg backward and forward until it comes to a boil. In ten minutes remove from the fire and rub smartly with a rough towel. Breathe naturally, dress in warm flannels, and serve with soup."

broadcast transmitter, KDKA has a short-wave transmitter with which it has successfully transmitted programs to Australia, South Africa and South America. We looked in the direction of the short-wave panel-board. Yes, the power tubes were glowing, we could almost feel the heat ten feet away. A telegraph relay hooked in with the set was clicking away merrily. The engineers were testing something.

Again I asked how come the arc. This time the operator was more kindly.

**High Frequency**

"Well, you see, in order to get short waves which will carry a long distance, we have to make the current change direction hundreds of thousands of times a second. The greater the rate of pulsation, or the frequency, the shorter are the waves and the more there are of them.

"Takes up an awful lot of power, that set; that's the reason you can get a spark from most any piece of metal in the room. We have to ground all the water pipes, the metal frames; everything has to be grounded, or you wouldn't be able to get around in here. As it is, most of the atmospheric electricity is neutralized, carried off to the ground. But there's still lots of it left to play with, you see . . ."

It was a sure-enough electric atmosphere.

**THE NEW "PHASATROL"**

Below we give a picture of the new balancing device for stabilizing radio frequency amplifying circuits, known as the "PHASATROL" and manufactured by Electrad, Inc.

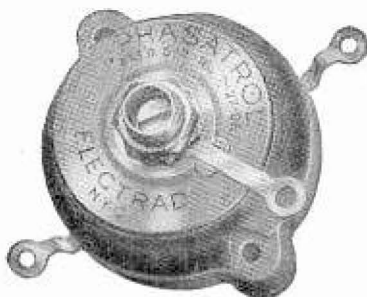

This device is more fully described on page 19, but owing to a printer's error the wrong cut was inserted in the article on that page, the above being the correct one that should have been used.

**THE NEW WJR STUDIO IS A UNIQUE ONE**

Station WJR's new "Good Will" studio in the Richards-Oakland show rooms on the ground floor of the General Motors Building, Detroit, is in a class by itself at least in one respect. So far as can be learned, the Richards-Oakland station is the only station in the world which operates a studio on the ground floor, in which the entertainers are clearly visible to passersby on the streets.

Huge electric letters "WJR" in front of the General Motors Building are continually attracting visitors from the streets to watch the performers at the microphone. Three sides of the studio are glass, and so there is no difficulty at all in watching every movement of the radio artists.

The studio necessarily is artistically decorated, of course, since it is exposed to the view of so many people every day and every night. It employs rich folds of red velvet draperies and a heavy red plush carpet, with appropriate chandeliers and electric candle torchiers to present a parlor effect. From the outside, the studio appears as a Japanese pagoda, with a movable roof which makes it possible to change the studio to suit the different surroundings of the show room.

Nightly programmes by the Good Will Ensemble, the Good Will Trio and soloists of the WJR Musical Comedy Troupe attract a large crowd of onlookers who watch the artists sing and play, and hear them through the monitor horns installed outside.

# ELECTRAD

**Just Plug In--- That's All**

**No Trouble With This Antenna**



Listed by Underwriters Laboratories. All Genuine Bakelite.

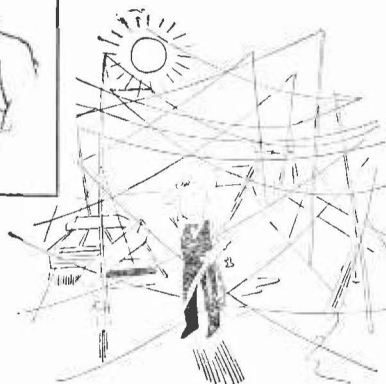

No trouble putting up an aerial. Just plug in on any electric light socket. No inconvenience or interference from neighbors' sets and aerials. Also smothers static and helps get distance. Uses no current. Perfectly safe to use. Tested and certified electrically. The simplest, neatest and most efficient on the market.

At all good radio stores, or they can easily get it for you. Price, \$1.10.

## ELECTRAD Royalty

Variable High Resistances

Endorsed by Radio Engineers because of their superior quality. Wire wound and absolutely non-inductive. Resistance always the same at the same point and frequent adjustments do not impair the resistance element. Unaffected by atmospheric conditions. One turn of knob covers entire range of resistance. A range for every purpose—11 in all. Prices, \$2.10 to \$3.00.

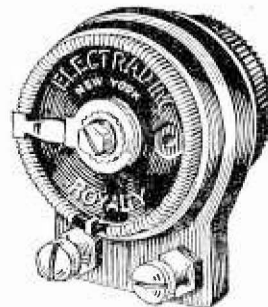

Licensed by Technidyne Corporation under Canadian Patent No. 253834, issued Sept. 22, 1925

Little, But Oh, My!

## ELECTRAD Fused Metallic Grid Leak

Little things are important in radio—as in life. Electrad Metallic Grid Leaks are little, but try them in your set and hear the improvement in reception. New and totally different. Resistance element fused to inside of glass. Unvarying with weather or working conditions. Greater current capacity without overheating. Price, 85c.



(4 MEGOHMS)

For perfect control of tone and volume use the Electrad 500,000 ohm compensator. For free hook-up write 428 Bway, N.Y. City.

Canadian Representative: G. S. Whitaker, Limited, 8 Colborne St., Toronto



# ELECTRAD Inc

Tell Them You Saw It In "Radio News of Canada"

### NEW RADIO ACCESSORY ADDS VOLUME AND QUALITY TO RECEIVER

A new accessory has been placed upon the radio market, which will improve reception with any receiver, giving better reproduction of the low notes, and increased volume without distortion, as well as protect the loud speaker. The device, called an "ORTHOPHONE" (meaning correct sounds) may be attached, between the loud speaker and any receiver, in less than thirty seconds.

The ORTHOPHONE consists of carefully designed reactances, which eliminate the direct loud speaker current, passing to the speaker only the alternating or sound producing fluctuations. This division of current has several desirable effects.

#### Improves Quality

This new accessory maintains a desirable impedance balance between the tube and its load. To do full justice to the low notes, the load impedance should always be higher than the tube imped-

ance, which is seldom the case when the speaker is included in the D.C. plate circuit. Indeed, the impedance of the speaker is often considerably below that of the tube with a resulting loss in frequencies below three hundred cycles. The impedance of the ORTHOPHONE, however, is well above that of even low power tubes, and its use improves the quality of all receivers, bringing out the full roundness of the tones.

#### Increased Volume

The elimination of the direct plate current increases the volume which the speaker can develop without distortion. A direct plate current pulls the armature closer to one of the pole-pieces, causing it to hit, with resultant rattling, on loud signals. The use of the device also makes it impossible to demagnetize a polarized speaker by connecting incorrectly.

#### The Speaker Protected

As mentioned, the direct plate current no longer passes through the speaker. The intense direct plate current is sufficient in many cases, to injure the wind-

ings. The speaker is similarly protected against sudden fluctuation in this direct current which might induce a sufficiently high e.m.f. to break down the coils. It is in consideration of this fact that manufacturers of power tubes, which draw relatively high plate currents, recommend the use of an output device such as the ORTHOPHONE.

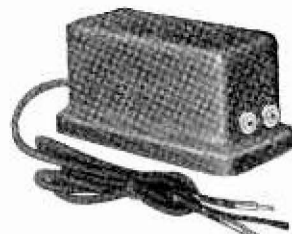

The Orthophone

While the possibility of increased volume and loud speaker protection are particularly emphasized with the larger tubes, and the improved tonal quality on the O1-A type, these various improvements are to be noted to an appreciable degree on all tubes.

The parts of the ORTHOPHONE are mounted in a small, brown, crystalline container, a general idea of which can be obtained in the accompanying illustration. It is arranged for instant mounting either within the receiver itself, or alongside of it on the table. This device is manufactured by Amsco Products, Inc.

## The BASS NOTE CORNER

DEVOTED TO BETTER RADIO RECEPTION

By AUSTIN C. LESCARBOURA

FORMERLY MANAGING EDITOR, SCIENTIFIC AMERICAN

### FROM STUDIO MICROPHONE TO HOME LOUD-SPEAKER

RADIO broadcasting is a long series of translations. Sound waves travel from the prima dona's lips to the microphone. The latter, correctly placed, picks up and translates the sound waves into corresponding variations of an electric current which goes to the

values, goes to the antenna system for propagation in all directions. There is virtually no distortion in the modern broadcasting studio and transmitting station. The radio signal is picked up by the distant listener. The intercepted energy, in its high-frequency state,

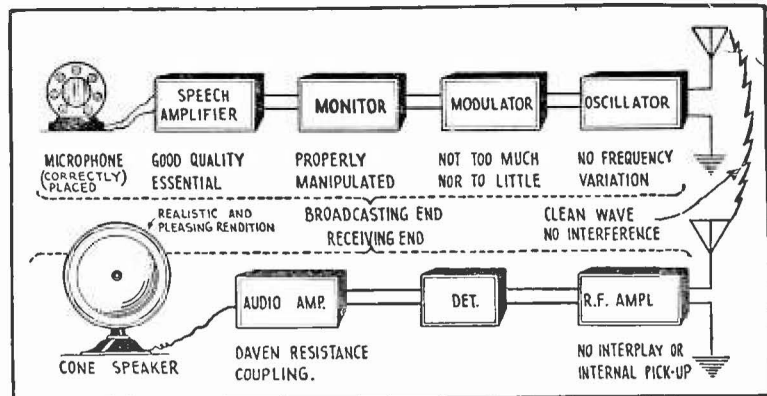

speech amplifier, where the variations are stepped up or amplified many times, and then on to the monitoring circuit. Here the fluctuating strength of the electrical variations, must be built up one moment and reduced the next so as to provide a certain level of outgoing signal strength. Amplified once more, the so-called carrier frequency, with its incorporated sound

is amplified and passed to the detector, which sorts out the latent sound values which are turned over to the audio-frequency amplifier. Here is the veritable bottle-neck of the entire broadcasting scheme. The Daven Super Amplifier is conceded by experts to be the most perfect amplifier and transmits the music from the studio without distortion.

### FILLING THE BATTERY

If you have misplaced the funnel, an easy way to fill a storage battery with water is to place a screwdriver directly in line with the cell opening and to pour the water slowly down the shank. The liquid is thus guided into the battery without spilling. Do not on any account attempt this same trick with acid, as the latter will attack the tool and contaminate the battery solution.

## ACME CELATSITE WIRE

—a tinned, copper bus bar wire with non-inflammable "spaghetti" covering, for hook-ups. 5 colors; 30-inch lengths.

**Flexible Celatsite**  
Flexible, stranded wire for point-to-point and sub-panel wiring. Non-inflammable "spaghetti" covering. In black, yellow, green, red and brown; a color for each circuit. Put up in 25-ft. coils.

Send for Complete Acme Wire Products Folder  
ACME WIRE CO., DEPT. N, NEW HAVEN, CONN.

# ACME WIRE

MAKES BETTER RADIO





**PRESTON GRAVES**  
Director, WMBB, Chicago

**"THOROLA" CONE SPEAKER**

This Speaker, manufactured by the Reichmann Company, of Chicago, presents several novel principles in radio cone manufacture. The low notes resonate clearly from the flat surface of the diaphragm; the centre cone reproduces the highest middle tones with purity and distinction. This is a dual principle that reproduces every sound wave. In appearance it is ornamental and pleasing to the eye.

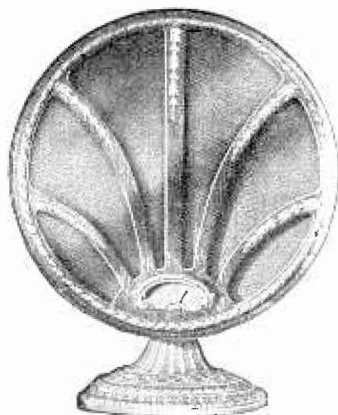

Cone Model No. 9, was tested by Radio News of Canada Laboratory and was found to give excellent volume with clear and resonant tonal quality. It compares favorably with any similar type of Cone Speaker on the local market.

Awarded Radio News of Canada's Certificate of Merit, No. 222.

**TROUBLE NOTE**

The cause of the squealing set is usually found in the nut that turns the dial.



**Howl Arresters**

**STOP THAT INHERENT HOWL**

**with McDONALD HOWL ARRESTERS**

They are a real Anti-Microphonic Tube Shield and recommended by leading Radio Engineers, and used by the pioneer radio manufacturers.

Standard equipment on Westinghouse Model 57

**EXCLUSIVE DISTRIBUTORS:**

QUEBEC—W. T. Hawes Ltd., Montreal; Canadian Fairbanks-Morse Co. Ltd., Montreal; John Millen & Son Ltd., Montreal; McKee Sales and Service Co., Sherbrooke.

MARITIME PROVINCES—Can. Fairbanks-Morse Co., Ltd., St. John; Maritime Accessories Limited, Halifax.

SASKATCHEWAN—Wood Vallance Limited, Regina.

BRITISH COLUMBIA—Marshall Wells B.C. Co. Limited, Vancouver.

ONTARIO—Purser Bull Co., Toronto; A. Carey & Sons, 274 King St. East, Hamilton; Benson Wilcox Electric Co., London.

MANITOBA—Marshall Wells Co., Limited, Winnipeg.

ALBERTA—Marshall Wells Alberta Co., Ltd., Edmonton; Wood Vallance Ltd., Calgary.

PATENTED

Licensed and Manufactured by

**Scientific Products Canada Ltd.**

50 Notre Dame St. West, Montreal

**J. M. GREENE ELECTED ALDERMAN AT PETERBOROUGH, ONT.**

The many friends of Mr. J. M. Greene, of the J. M. Greene Music Company, Ltd., will be pleased to hear that he has again been elected Alderman to the Peterborough City Council for two years. He stood third in the contest out of eleven in the running and when this two year term is complete, it will mean that he will have spent eleven years in the municipal interests of Peterborough. We wish him every success during his term of office.

**NEW CARTER "HI-OHM"**  
(500,000 Ohms)



A non-inductive variable wire wound high resistance which regulates the volume gradually and evenly from full power to a whisper, without distortion, by merely turning the knob.

Price, each \$2.00

**EBY DIAL**

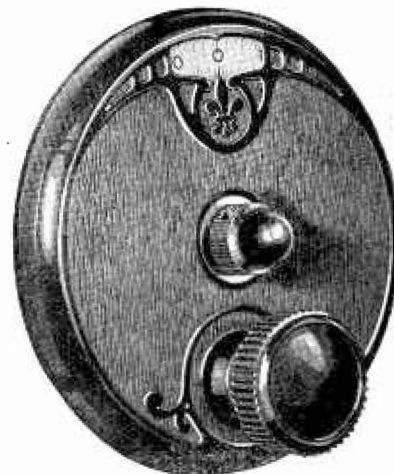

A new dial is offered to Canadian radio fans by the H. H. Eby Co. This dial represents the most advanced workmanship and the newest design, being completely shielded and having both clockwise and counter-clockwise movement. It will operate on any type of condenser and has a superior friction drive of brass on brass, ensuring long life and great accuracy. Like all other Eby products, it is, of course, guaranteed.

Price, \$2.50

**CARTER ADAPTER**

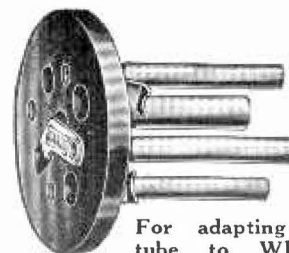

Price 50c.

For adapting UX type tube to WD-11 type socket.

TRADE MARK REG.



WESTERN OFFICE:  
290 McDermot Ave.  
Winnipeg - Man.

*Specify*



# BAKELITE

TRADE MARK REGISTERED

MADE IN CANADA

**BAKELITE CORPORATION**  
OF CANADA LIMITED

163 Dufferin Street  
TORONTO 2

Panels  
Sheets  
Tubing  
Rods

Moulded  
Products  
to  
Specification

**VEST POCKET  
ADDING MACHINE**  
Just what you need for Accuracy and Speed. Counts to 1 Billion  
Clears Instantly  
A Real Adding Machine in your Vest Pocket  
**SEND NO MONEY \$3.95**  
Just Your Name and Address. We Deliver C.O.D. Postage Paid  
AGENTS: Write for new offer  
**HENRY E. FAIRCLOUGH & CO.**  
32 CHURCH STREET (DEPT. C) TORONTO, CAN.

LACAULT'S Genuine L-2 Ultradyne Superhetrodyne Kits, list price \$30.00, price \$12.95 postpaid. Build this famous circuit at ridiculously low cost. Bargains in New and Second-hand Sets. Acme Trading Company, Box 284, Saint Louis, Mo., U.S.A. 1-C

**MISSED SOMETHING**  
Irate Apartment Dweller—"Say, your radio kept me awake until 1 o'clock this morning."  
His Neighbor—"You should have stayed awake about half an hour longer. I got some great stuff from Chicago then."—Life.

**22½v. \$2.65**

**U N A C I D** **E V E R L A S T I N G**

**"HAWLEY" NEW TYPE**

45 volts \$5.25, 90 volts \$10.00, 112½ volts \$12.50, 135 volts \$14.75, 157½ volts \$16.80, 180 volts \$19.20. Includes chemical. Nothing to purchase extra. Special sizes to order. Easily recharged upon any current including 32 volt systems. Any special detector voltage easily had. Operates any 1 to 10 tube set. Tested and approved by leading authorities, such as Popular Radio Laboratories, etc. Over 4 years sold on a non-red tape 30 day trial offer with complete refund if not thoroughly satisfied. Further guaranteed 2 years. Knock-down kits at still greater savings. Complete "Hawley" "B" Battery charger, \$2.75. Order direct—same day shipments, shipped C.O.D.—simply pay expressman cost on delivery or write for my free literature, testimonials, etc.

**B. HAWLEY SMITH**  
320 Washington Avenue  
Danbury, Conn.

**RADIO DEALERS  
SET BUILDERS!**  
Get the New 1926-27 Van-Ashe Catalogue Van-Ashe has what you want—the new parts, circuits, and kits. All the hard-to-get items that set builders demand are shown—B-Eliminator kits; power-audio equipment; Sargent Infradyne intermediates; short-wave supplies. 12 hour-shipment; extra-good discounts.  
Write today

**Van-Ashe Radio Co.**  
222 North 10th St. ST. LOUIS, MO.

**WORLD'S FINEST  
LOUD SPEAKER**  
A three-foot cone speaker—unit developed by the inventor of the Tropadyne. Easily assembled, saving 80% of the cost. Complete Kit with blue prints sold on rigid money-back guarantee — shipped prepaid, \$10.00.

**ENGINEERS' SERVICE COMPANY**  
25 Church St. New York, N.Y.

**The Jaynxon Tone Bridge**  
The Ultimate in Tone Quality—  
Brings the entertainer into the room—  
Saves Loud Speaker from burnout—  
From the maximum to the minimum volume with not a change in tone-quality.  
DESIGNED BY RADIO ENGINEERS  
ENDORSED BY RADIO ENGINEERS  
\$11.50 Postpaid  
**JAYNXON LABORATORIES**  
57 Dey Street - New York, N.Y.

**CONE UNIT**  
For use on cones of any size up to 4 feet. Most powerful and efficient made. Sold on rigid money back guarantee.  
Prepaid, \$7.50  
**TUNBAR RADIO CO.**  
Suite 203  
15 Park Row, New York 12-C

**\$10.98 Complete  
GUARANTEED**

Operates from 110-120 volt A. C. Socket (any cycle) for less than 50c per year. Delivers a constant flow of unflinching, clear, noiseless B power that will operate an eight tube set using power tubes with ease. No more recharging. No troublesome creepy acid cells. No more dead dry cells. Built in handsome metal case.  
LASTS INDEFINITELY giving maximum power at all times. Taps at 22½, 45 (90-100). Higher voltage can be obtained by connecting regular "B" battery in series with eliminator. Guaranteed to be equal or superior to any eliminator regardless of price. Use it for ten days to convince yourself, and if not found as claimed, return it and your money will be refunded. Trickle charger for. A battery \$6.50.

6 Volt "A" Eliminator \$17.50  
150 Volt "B" Eliminator \$17.98

Order Direct or from Your Dealer  
**UNION SERVICE COMPANY**  
Morris Heights P. O. Box 23  
NEW YORK, NEW YORK

# “Radio News of Canada”

WISHES

ALL ITS FRIENDS AND READERS

A Very Happy and Prosperous  
New Year

YOUR RADIO LICENSE FOR 1926-27 AND  
RADIO NEWS OF CANADA FOR 12 MONTHS

BOTH  
FOR .. \$2.00

A radio license costs \$1.00, and the regular subscription price of “Radio News of Canada” is \$2.00 per year. If your present subscription has not expired, you can take advantage of this offer by mailing coupon and \$2.00, and we will mail

your license at once, and have your subscription start at expiration of your present one. Agents who are soliciting subscriptions to “Radio News” have no authority to give you the above offer.

SEND YOUR \$2.00 DIRECT TO THIS OFFICE

You must have a license to operate a receiving set—the penalty for the non-observance of this law is \$50.00, plus confiscation of your set. Here is our offer:

**You Get Your License  
Absolutely Free!**

### Features of Radio News

Latest information on all radio matters. Editorial Articles that are up to the minute. 75% of all articles are copyrighted in the Dominion.

“Radio News of Canada,”  
33-43 Adelaide St., Toronto.

Gentlemen:

Please enter my subscription to “Radio News of Canada” for 12 months, same to include Radio License for 1926-1927, for which I enclose herewith the sum of Two Dollars.

Name .....

Address .....



# Start the New Year Right

## Instal' Reliable Batteries in Your Set



1430V—\$6.25  
U. S. Bureau No. V-30-F  
For 4 or More Tubes  
8 1/4" x 4 1/2" x 7 7/8"  
Weight, 13 3/4 lbs.  
Voltages 22 1/2, 45  
3,000 Hours at 3 Milliamperes

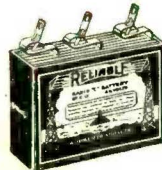

13C—60c  
U. S. Bureau  
No. H-3-D  
4" x 1 1/2" x 3 3/8"  
Weight, 3/4 lb.  
Voltages 1 1/2, 3,  
4 1/2



215C—\$1.95  
U. S. Bureau No. H-15-C  
For "C" Battery purposes  
only  
5 1/2" x 3 3/4" x 3 1/4"  
Weight, 2 1/2 lbs.  
Voltages 4 1/2, 9, 16 1/2, 22 1/2  
450 hours at 3 Milliamperes



130V—\$5.10  
U. S. Bureau No. V-30-D  
For 1, 2 and 3 Tubes  
8 3/16" x 3 1/4" x 7 7/8"  
Weight 9 lbs.  
Voltages 22 1/2, 45  
1,200 Hours at 3 Milliamperes



230V—\$3.90  
U. S. Bureau  
No. V-30-C  
Portable Sets Only  
5 1/4" x 2 5/16" x 7 1/4"  
Weight, 5 lbs.  
Voltages 22 1/2, 45  
450 Hours at 3 Milli-  
amperes.

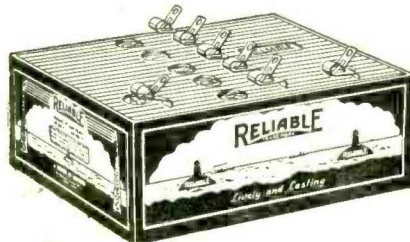

130T—\$5.10  
U. S. Bureau No. H-30-D  
For 1, 2 and 3 Tubes  
8 1/4" x 7" x 3 9/16"  
Weight, 8 1/4 lbs.  
Voltages 22 1/2, 45  
1,200 Hours at 3 Milliamperes

TUNE IN  
RELIABLE BATTERY STATION

357  
Metres

# C-K-C-L

840  
Kilocycles

Also Broadcasting from CKY, CFQC, CFCF, CFCN,  
CFDC and WKBB

ALWAYS A GOOD PROGRAMME

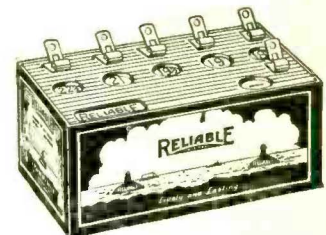

115T—\$2.50  
U. S. Bureau No. H-15-D  
For 1, 2 and 3 Tubes  
7" x 4 1/4" x 3 9/16"  
Weight, 4 1/4 lbs.  
Voltages 16 1/2, 18, 19 1/2, 21, 22 1/2  
1,200 Hours at 3 Milliamperes

# THE DOMINION BATTERY CO. LIMITED

TORONTO 2

MONTREAL

WINNIPEG

CALGARY

VANCOUVER

Tell Them You Saw It In "Radio News of Canada"