

ELECTRONIC INDUSTRIES

THE STATE-OF-THE-ART MAGAZINE

B54
21
B-0
83

F. W. Preziosi Grp Hd
2921 Scutter Ave SE
Cedar Rapids Iowa
126500 Collins Radio

MEMORY DEVICES FOR COMPUTERS
Trends in Computer Design
Failure Physics of Integrated Circuits

DECEMBER 1965  Chilton Company



RELIABILITY

**TOTAL CAPABILITY
IN PRECISION RESISTANCE**

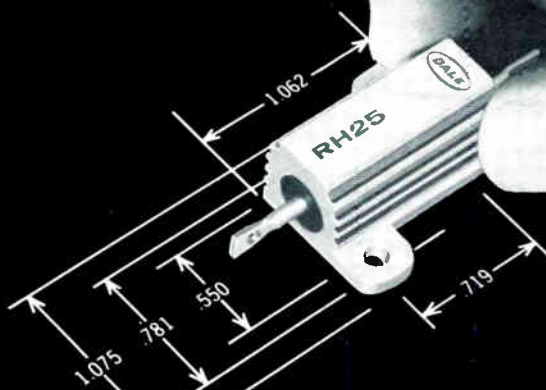

25 watt POWER in
15 watt Mil Size equals
10 watt DALE BONUS!

All new Dale RH Housed Wirewound design dissipates 25 watts from 15 watt Mil Size

This superior heat dissipation is typical of Dale's all-new RH line. It means extra design flexibility plus unprecedented stability when operated at MIL-R-18546C levels. It stems from: (1) New, specially conductive extruded aluminum housings; (2) A new Dale-developed molding compound which binds resistance unit and housing together in a homogeneous void-free mass with exceptional heat transfer ability.

COMPLETE HOUSED RESISTOR CAPABILITY

In addition to RH resistors, Dale produces PH Housed wirewounds for through-chassis mounting in 10, 25 and 100 watt sizes. Both RH and PH lines are available in non-inductive styles and with special mounting methods, terminals and other variations to suit your application.

RH RESISTOR SPECIFICATIONS					
DALE TYPE	EQUIV. MIL. TYPE	DALE RATING	MIL. RATING	RESISTANCE RANGE (OHMS)	STANDARD HEAT SINK
RH-5	-	7.5	-	.1 - 24K	4x6x2x.040 AL CHASSIS
RH-1G	RE-65	12.5	10	.1 - 47K	5x7x2x.040 AL CHASSIS
RH-25	RE-70	25	15	.1 - 95K	12x12x.125 AL PANEL
RH-50	RE-75	40	20	.1 - 273K	
RH-100	-	100	-	.1 - 50K	
RH-250	RE-80	250	120	.1 - 75K	

ELECTRICAL & ENVIRONMENTAL SPECIFICATIONS

Tolerance: 3%, 1%, .5%, .25%, .10%, .05%

Load Life: 1% max. ΔR (RH-5 - 50) 3% max. ΔR (RH-100 - 250) in 1000-hour load life

Operating Temp: -55 C to +275 C

Overload: ± .5% max. ΔR per MIL-R-18546C

* Power Rating based on 275 C max. internal hotspot temperature with resistor mounted on proper heat sink as specified by Mil. Spec.

WRITE FOR RESISTOR CATALOG A



DALE ELECTRONICS, INC.

1304 28th Avenue, Columbus, Nebraska

Also Sold by Dale Electronics Canada, Ltd., Toronto, Ontario, Canada

Circle 98 on Inquiry Card



ELECTRONIC INDUSTRIES

The State-of-the-Art Magazine

Review and Forecast for the Electronic Industries

Dear Reader :

For the past several months our Editorial and Marketing Departments have been gathering data from industry and government sources. These will be published in the Annual Review and Forecast for the Electronic Industries in next month's issue.

The report will cover the 5-year period from 1963 through 1967 in graphic and tabular form. The Electronic Industries sales will be shown with detailed breakdowns on government, industrial and consumer markets.

Statistics will define the rapidly expanding areas of computing and data processing equipment and integrated circuits. Sales of selected electronic components, exports and imports, research and development expenditures, world electronic output and pertinent data taken from ELECTRONIC INDUSTRIES Census of Electronic Manufacturers will be included.

Special reprints of the Review and Forecast article will be prepared. We shall be glad to provide copies to readers who request them. In addition, further information on any of the statistical data in the Review and Forecast can be obtained from ELECTRONIC INDUSTRIES' Marketing Department.

In the past, our forecasts have been widely accepted and distributed both within and outside the industry. January's report, now being readied for press, is as comprehensive as those previously issued and has been expanded in many ways. It will be a valuable addition to your reference files. This report is part of our continuing program of service to the electronic industries.

*Sincerely,
The Editors*

1965-1966 EDITORIAL FEATURES

- JANUARY**
- 1966 Review & Forecast for the Electronic Industries
 - Potentiometers, Part 3, Specification Chart—Trimmers
-

- FEBRUARY**
- Switches, Part 2—Push-button
 - The Expanding Role of SCR's
-

- MARCH**
- 1966 IEEE Show Coverage
 - Potentiometers—General purpose
-

- APRIL**
- Special Purpose Tubes, Part I
 - Switches—Rotary & Stepping
-

- MAY**
- Switches—Slide & Snap Action
 - Special Purpose Tubes, Part II
-

- JUNE**
- Reference Issue
 - Switches—Limit & Mercury
-

- JULY**
- Switches—Time Delay, Inertia, Vacuum
-

Let's Not Repeat Past Mistakes!

WE ARE DISTURBED TO LEARN that improved defense business has caused some electronic companies to curtail plans for diversification into industrial, commercial, or consumer markets. Others seem to have reverted entirely to bidding on government contracts.

A searching report, just released, by Battelle Memorial Institute* states: . . . "that arms control and disarmament is a stated U. S. policy and goal and has some chance of occurring, and that the Federal Government has no intention of preserving any individual company. If arms control or disarmament becomes a reality, many defense-oriented electronic firms will be completely unprepared for survival. Their erroneous judgments will cause the failure of many firms—including some large ones."

When defense business slackens, the Battelle report suggests that electronic companies would react in one of these three ways:

1. Do nothing, risking serious sales and profit loss, business failure, major layoffs, and abandonment of facilities.
2. Try for a larger share of the smaller defense market, hoping to do considerably better than competitors.
3. Diversify to non-defense markets where there are opportunities for continued growth.

Battelle's conclusion is that defense oriented electronic companies should now "diversify to non-defense markets to reduce the impact of losses of defense sales."

*"A Study of Implications of Reduced Defense Demand for the Electronic Industry" by Battelle Memorial Institute (Columbus Laboratories). Prepared for the U. S. Arms Control and Disarmament Agency (USACDA). We are happy to report that the Electronic Industries' Census of Electronic Manufacturers was used as one of the basic sources of data for the Battelle report. The report will be available soon from the U. S. Government Printing Office, Washington, D. C.

We see the industrial-commercial-consumer electronic revolution gaining momentum at an ever increasing rate. Examples of this growing market were abundantly evident at the recent Business Equipment Manufacturers' Association exposition. IBM showed its computer display which translated mathematical data into such practical applications as garment patterns, bridges, or simulated Gemini flight. New peripheral machines provided data to be processed by computers, in plant or linked by remote microwave communications. Seven new desktop electronic calculators were shown. Various other electronic devices ranged from Elliott Business Machines' transistorized control for addressing machines, to Pitney Bowes' electronic scanner to count paper currency.

Today more and more companies are seeking new electronic devices to help cut their operating costs and improve their efficiency and profits. Similarly, American consumers look forward to new electronic products to improve their standard of living.

To the electronic manufacturer we say again: Accept government business, but do not let up on non-defense, non-government development work. Maintain a more balanced mixture of government and other business.

Bendix Corp. has just announced a 3-year program to bring its commercial volume into 50-50 balance with its Government business. Giannini Controls is moving its corporate headquarters from the West Coast to New York City to be near the center of its industrial electronic markets. This reflects a policy of wide diversification from a 90% defense posture a decade ago.

Thus it is apparent that prudent electronic companies are striving for a reasonable mix of government and commercial business. They don't intend to be caught unprepared for changes in government spending.

Bernard F. Osburn

New from Sprague!



FOUR LEAD
TO-72 CASE

LOW COST DUET[★] 3N123

DUAL-EMITTER CHOPPER TRANSISTORS



CHECK THESE FEATURES!

$$BV_{EEO} > 25 \text{ VOLTS}$$

$$|V_o| < 250 \mu\text{V}$$

$$|\Delta V_o / T_A| < 2.3 \mu\text{V per } ^\circ\text{C}$$

$$f_T > 6 \text{ mc}$$

HIGH VOLTAGE! RELIABLE PLANAR CONSTRUCTION!

Sprague offers more dual-emitter transistor types than any other source!

TYPE No.	BV _{EEO} (volts)	V _o (μV)	TYPE No.	BV _{EEO} (volts)	V _o (μV)	TYPE No.	BV _{EEO} (volts)	V _o (μV)	TYPE No.	BV _{EEO} (volts)	V _o (μV)	TYPE No.	BV _{EEO} (volts)	V _o (μV)
3N90	30	50	3N95	50	200	3N104	20	50	3N109	50	150	3N116	12	200
3N91	30	100	3N100	10	50	3N105	15	250	3N110	30	30	3N117	20	50
3N92	30	200	3N101	30	50	3N106	30	250	3N111	30	150	3N118	20	100
3N93	50	50	3N102	40	50	3N107	50	250	3N114	12	50	3N119	20	200
3N94	50	100	3N103	50	50	3N108	50	30	3N115	12	100	3N123	25	250

★Trademark

For complete information, write to Technical Literature Service,
Sprague Electric Co., 233 Marshall St., North Adams, Mass. 01248

SPRAGUE COMPONENTS

TRANSISTORS
CAPACITORS
RESISTORS
INTEGRATED CIRCUITS
THIN-FILM MICROCIRCUITS
459-9153R1

PULSE TRANSFORMERS
INTERFERENCE FILTERS
PULSE-FORMING NETWORKS
TOROIDAL INDUCTORS
ELECTRIC WAVE FILTERS

CERAMIC-BASE PRINTED NETWORKS
PACKAGED COMPONENT ASSEMBLIES
BOBBIN and TAPE WOUND MAGNETIC CORES
SILICON RECTIFIER GATE CONTROLS
FUNCTIONAL DIGITAL CIRCUITS

SPRAGUE[®]

THE MARK OF RELIABILITY

Sprague and ® are registered trademarks of the Sprague Electric Co.

Editorial: Let's Not Repeat Past Mistakes! 1

STATE-OF-THE-ART FEATURES

More Computing Power Per Dollar	J. B. Totaro	58
A Survey of Optical Character Recognition	D. Stevens	62
OCR Equipment Manufacturers Listing	E. I. Staff	68
Memory Devices for Modern Computer Memories	A. Knowles	70
Basic Considerations in Time-Sharing	K. O. Fisketjohn	82

DESIGN/DEVELOPMENT

Looking at Integrated Circuit Costs and Failures	R. A. Bernay	76
1966 Survey of Switches, Part 1: Toggle, Rocker, Slide and Lever Types		88

MEASUREMENT/TEST

Notes on the Measurement of SNR	I. Dlugatch	100
---------------------------------------	-------------	-----

PROFESSIONAL GUIDELINES

Legal Protection for Computer Software	E. C. Gonda	110
--	-------------	-----

WHAT'S NEW

Automated Plant and Advanced Circuitry	37	Tester Handles all IC's	41
Frequency Multiplication with Power Gain	41	Quality Control on Wheels	43
		Low Cost Time-Sharing Computer	54
		Control Returned to System Designer ..	54

DEPARTMENTS

Highlights	4	Circuit Wise	66
Radarscope	8	New Tech Data	96
Coming Events	14	Microelectronic Developments	108
Washington Trends	16	Professional Guidelines	109
Electronic Snapshots	22	Editor's Notebook	116
Marketing: Fact & Figure Roundup	26	International News	117
Letters	31	Books	118
New Products (in Color)	44	New Products	123

COVER: Data storage devices of the IBM memory system that will be used in NASA's Orbiting Astronomical Observatory (OAO). The two-hole geometry provides a non-destruct read-out feature.

*STATE-OF-THE-ART: up-to-the-moment capability in each area of electronic technology



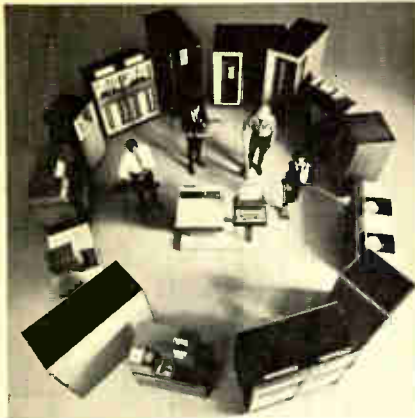

More Computer Power



Optical Character Recognition



Computer Time-Sharing

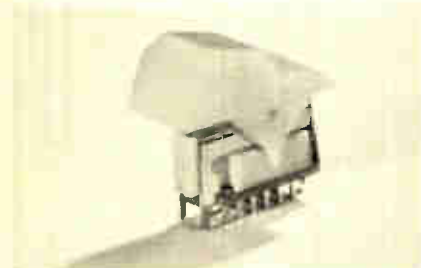

Switch Survey

IC Costs and Failures

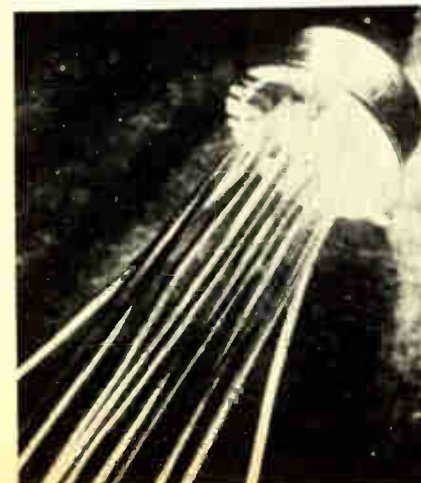
**MORE COMPUTING POWER PER DOLLAR****58**

As a group, the "third-generation" computer systems offer much more computing power per dollar than their predecessors. Equally important in reducing costs and expanding computer usage are the trends toward multi-programming, time-sharing, IC's, thin-film memories, etc. These trends are discussed here.

A SURVEY OF OPTICAL CHARACTER RECOGNITION**62**

Optical Character Recognition has been a commercial practicality for almost 10 years, but widespread use has yet to be realized. Recent developments may constitute the basis for broader use of the technique than has been seen to date. These developments are outlined here and an attempt is made to gauge their significance in this respect.

MEMORY DEVICES FOR MODERN COMPUTER MEMORIES**70**

Status of the ferrite core memory device is reviewed and an attempt is made to anticipate how cores will be used in the next two years. The ferrite core device is also compared with the newer "integrated" approaches and some predictions are made as to their relative expected usage in the next two years.

LOOKING AT INTEGRATED CIRCUIT COSTS AND FAILURES**76**

The increased silicon integrated circuit complexity per package is reducing costs and improving reliability. This statement appears to be a farce. But it is not, as you will learn here. Included are descriptions of the main causes of IC failures.

BASIC CONSIDERATIONS IN TIME-SHARING**82**

What is computer time-sharing? How does it benefit the user? Why was it not available sooner? What is its future? These and other pertinent questions are answered and some current approaches to software and hardware are discussed.

1966 SURVEY OF SWITCHES**88**

Switches, Part I, Specification Chart includes data on toggle, lever, slide, and rocker types. The manufacturer and his products are listed alphabetically to allow rapid review of the switches available.

NOTES ON THE MEASUREMENT OF SNR**100**

Some warning signals to the engineer, when making measurements of signal-to-noise ratio, are given which should help avoid possible sources of errors.

LEGAL PROTECTION FOR COMPUTER SOFTWARE**110**

Investment in software has passed the billion dollar mark. What can be done to protect this investment without stifling the industry? How can this be done and still provide professional recognition for workers in this field? These and other pertinent questions are answered.

• A REPRINT of ANY ARTICLE in this issue is available from ELECTRONIC INDUSTRIES Reader Service Department, 56th & Chestnut Streets, Philadelphia, Pa. 19139

New Bridge Design For Safe, Accurate, Easy Measurement of 'Lytic Capacitors



The Sprague Model 1W2A Capacitance Bridge introduces new, improved technical refinements as well as restyling for added attractiveness and ease of operation. Built by capacitor engineers for capacitor users, it incorporates the best features of bridges used for many years in Sprague laboratories and production facilities.

Precision Measurements over Entire Range from 0 to 120,000 μF

The internal generator of the 1W2A Bridge is a line-driven frequency converter, and detection is obtained from an internal tuned transistor amplifier-null detector, whose sensitivity increases as the balance point is approached. It has provision for 2-terminal, 3-terminal, and 4-terminal capacitance measurements, which are essential for accurate measurement... $\pm 1\%$ of reading $+ 10\mu\text{F}$... of medium, low, and high capacitance values, respectively.

No Damage to Capacitors

The model 1W2A Capacitance Bridge will not cause degradation or failure in electrolytic or low-voltage ceramic capacitors during test, as is the case in many conventional bridges and test circuits. The 120 cycle A-C voltage, applied to capacitors under test from a built-in source, never exceeds 0.5 volt! It is usually unnecessary to apply d-c polarizing voltage to electrolytic capacitors because of this safe, low voltage.

Complete Specifications Available

For complete technical data on this precision instrument, write for Engineering Bulletin 90,010A to Technical Literature Service, Sprague Electric Company, Marshall Street, North Adams, Massachusetts.

45SP-12B-63

Circle 2 on Inquiry Card
ELECTRONIC INDUSTRIES • December 1965

The First of its Kind!

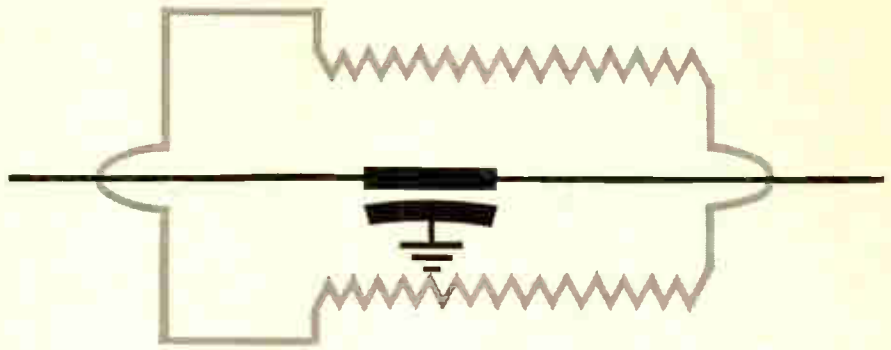

A Solid Tantalum 5-Ampere Feed-thru Capacitor for RFI Suppression

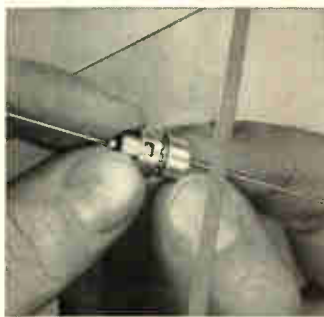

Sprague Type 180D Tantalex Capacitor on transparent panel to illustrate feed-thru mounting.

- Sprague's Type 180D Tantalex[®] Capacitor is another result of extensive pioneer work in the field of solid-electrolyte tantalum capacitors.
- Three-terminal unit—line current is carried through tantalum section from lead to lead, case is ground terminal.
- Negligible self-inductance, minimum length of internal path for RFI—large values of capacitance in small physical size account for unusually effective elimination of spurious and unwanted signals.
- Completely new case design assures firm metallic contact with mounting surface over a closed path, completely encircling the feed-thru conductor.
- Threaded body and spanner nut of same outside diameter as collar of the case permit close mounting and maximum stacking capacity.
- Corrosion-resistant metal case, hermetically-sealed with glass-to-metal solder seal terminals for maximum protection against severe environmental conditions.
- All units carry 5 amperes thru-current. Capacitance ratings range from 60 μF at 6 volts to 3.9 μF at 75 volts d-c.

For complete technical data, write for Engineering Bulletin 3525A to Technical Literature Section. Sprague Electric Company, 233 Marshall St., North Adams, Mass.

45-439 B2



*Sprague and [®] are registered trademarks of the Sprague Electric Co.

Circle 3 on Inquiry Card

high-voltage workhorse **VICTOREEN DIODES**

Regulator
Pulse Coupler
High-Impedance
Voltage Divider
High-Voltage
Reference



Victoreen GV1A Corotron diode actual size; other types available.

You probably think of Victoreen Corotron diodes as high-performance thoroughbreds for exotic uses. And they are. But this is only part of the Corotron pedigree. They're also real workhorse diodes for everyday uses. As regulators and H-V references . . . H-V pulse couplers . . . high-impedance voltage dividers. And still we haven't run out of Corotron applications. So put your imagination to work. Savings in cost, complexity and weight can put you on velvet. Right away, write away for latest dope on Corotron diodes — high-voltage workhorse. Address Applications Engineering Department.

Write for free copy of illustrated 40-page catalog of Victoreen diodes.

THE VICTOREEN INSTRUMENT COMPANY
10101 WOODLAND AVENUE • CLEVELAND, OHIO 44104
EUROPEAN SALES OFFICE GROVE HOUSE, LONDON RD., ISLEWORTH, MIDDLESEX, ENGLAND



**ELECTRONIC
INDUSTRIES**



SHELBY A. McMILLION,
Publisher
BERNARD F. OSBAHR,
Editor

CREIGHTON M. MARCOTT
Executive Editor

JOHN E. HICKEY, Jr.
Managing Editor

SMEDLEY B. RUTH
SIDNEY FELDMAN
Associate Editors

JOHN J. HUNTER
ROBERT J. BRAMLETT
Assistant Editors

DR. ALBERT F. MURRAY
Consulting Editor

ELMER KETTERER, Art Director
ANNE AXE, Editorial Assistant
ANN LAVENDER, Research Assistant
MAE MOYER, Reader Service
IDA GOOD, Editorial Secy.

EDITORS-AT-LARGE

Eastern Region

ELMER T. EBERSOL,
100 East 42nd St.
New York 17, N. Y.
(Area Code 212) OXford 7-3400

Western Region

I. PHILIP GEDES,
1543 W. Olympic Blvd.
Los Angeles, Calif.
(Area Code 213) DUUnkirk 7-1271

Defense/Space

CHARLES R. WILHIDE,
4400 Brookside Drive
Alexandria, Va.

WASHINGTON NEWS BUREAU

1093 National Press Bldg.
(Area Code 202) 393-3474
TWX—202 965—0675

GEORGE BAKER, Mgr.
NEIL R. REGEIMBAL

BUSINESS DEPARTMENT

ELMER DALTON
Advertising Promotion
& Circulation Manager

EDWARD G. SHAUD, Jr.
Marketing Manager

ARA H. ELOIAN
Production Manager

See Advertisers Index on page 137 for
Regional Sales Managers.

Chilton Company—G. C. BUZBY, Chairman of the Board; R. E. McKENNA, President. Executive Vice President: G. T. Hook. Vice Presidents: P. M. Fahrendorf, L. V. Rowlands, M. E. Cox, E. B. Terhune, Jr., R. W. Case, Jr., J. H. Kofron. Treasurer: Stanley Appleby. Secretary: J. A. Montgomery. Other Directors: C. A. S. Heinle, T. C. Campbell, H. W. Barclay, W. A. Phair, L. F. King, C. W. Hevner. Assistant Treasurer: J. Miades; Assistant Secretary: I. C. Holloway.

JOHN H. KOFRON
Chilton Research Director

ELECTRONIC INDUSTRIES, December, 1965. Vol. 24, No. 12. A monthly publication of Chilton Company. Executive, Editorial & Advertising offices at Chestnut & 56th Sts., Phila., Pa. 19139. (Area Code 215) Sherwood 8-2000. Controlled circulation postage paid at Philadelphia, Pa. \$1 a copy; Reference issue (June), \$5.00 a copy. Subscription rates U. S. and U. S. Possessions: 1 yr. \$10.00; 2 yrs. \$18.00. Canada 1 year \$12.00; 2 yrs. \$20.00. All other countries 1 yr. \$18.00; 2 yrs. \$30.00. Copyright 1965 by Chilton Company. Title Reg. U. S. Pat. Off. Reproduction or reprinting prohibited except by written authorization.



One way to check for power loss

Visual inspection may sometimes reveal the source of a power loss. Most transmitters, however, require more sophisticated test equipment. Fortunately, the cost of wide-range power meters like Sierra's new Series 401A r-f termination wattmeters need not sound a sour note in your budget.

At prices you can appreciate (see below), Series 401A wattmeters make precise measurements of power on four selectable ranges up to 1,000 watts, with frequency coverage of 2 to 1000 Mc. Single-knob switching lets you read down to two watts on the 1,000-watt model. Sierra's "Twist-Off" connectors permit quick field changes of eight connector types. Permanent sealing eliminates coolant leakage.

You can bring on a full range of data concerning Sierra Series 401A r-f wattmeters with a note to Sierra/Philco, 3885 Bohannon Drive, Menlo Park, California 94025.

Sierra 401A R-F Termination Wattmeters

401A (120 w)	\$195.00	401A (500 w)	\$275.00
401A (250 w)	\$225.00	401A (1,000 w)	\$365.00

Circle 5 on Inquiry Card

World Radio History

A better way from Sierra

SIERRA ELECTRONIC DIV.
OF
PHILCO
A SUBSIDIARY OF *Ford Motor Company*

Developments and trends affecting the State-of-the-Art of technologies throughout the electronic industries

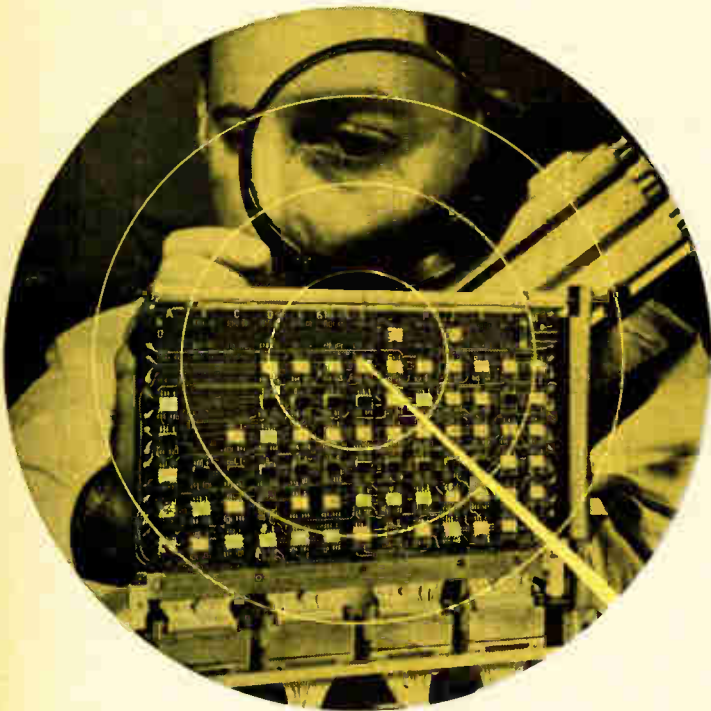

MINIATURIZED COMPUTER

Engineer from Sylvania Electric Products Inc., tests components for a miniaturized computer which weighs less than 200 pounds and occupies only four cubic feet of space. Using about 3,500 integrated circuit packages, the computer will perform the large-scale, high-speed computations of conventional data processing equipment.

MICROWAVE SILICON PLANAR diode oscillators have operated at 1 GHz to 8 GHz CW, with pulsed output to 28 GHz. This was announced last year by Sperry Rand Corp. Current work is toward operation in the mm wave region. These work directly from a dc input. The device is a tiny silicon planar epitaxial diode reversed-biased beyond breakdown. It is mounted in a small, tunable cavity. These are expected to replace klystrons in low power uses.

12-INCH BLACK & WHITE TV tube, 90°, has been made by Sylvania for use in battery-powered sets. Tube is a 12.6v rapid warmup with a neck diameter of 0.788 in., and a straight gun.

AVALANCHE PN JUNCTION photodiode combines both a light detector and a microwave amplifier. It is made from germanium. The device operates at room temperature and responds to light ranging from 6000 to 15,000 Å. At 6 GHz it has a signal power gain of 20 db. The device can be used to measure low intensity light or to detect microwave modulated light. It was developed by Bell Telephone Laboratories.

LASER EFFICIENCY has been increased 50% in neodymium (Nd) glass lasers by Westinghouse scientists. The increase is through a process called "sensitization." A second impurity ion, manganese (Mn), is added to Nd. The Mn ions will not "lase" by themselves. Instead they act as an energy transfer agent. They are pumped by wasted light to higher energy. This energy is then transferred to the Nd ions. The effect is increased efficiency.

EXPERIMENTAL PCM (Pulse Code Modulation) system that transmits 224 million bits/sec. over coaxial cable has been developed at Bell Telephone Laboratories. TV, voice and data signals are converted by the system into a stream of digital pulses. These pulses can be transmitted over transcontinental distances. A new method of synchronization, called "pulse stuffing," makes it possible to take signals from the digital stream and add new signals as desired along the route.

COCONUT JUICE has been used to produce electricity. TRW engineers used bacteria to break down the juice into a simpler form. The biochemical fuel cell can produce 150-watt hours per pound if operated for a thousand hours or more. This could be used for emergency power systems. More information is available in the report, "AD 619 665N Biochemical Fuel Cells" from Clearinghouse, U. S. Dept. of Commerce.

22-INCH COLOR CRT is to go into quantity production in mid-1966. This tube will be made by Rauland, a subsidiary of Zenith. The glass bulbs will be made by Corning. The tube is rectangular.

ELECTROCARDIAGRAMS are being read by computers. This method was tested successfully by Lockheed Missiles & Space Co. The computer can analyze the heart signals in 15 seconds with good accuracy.

COMPUTERS installed in Europe have risen 17% in the first six months of the year. The Diebold Group also reports that the number of computers on order has grown almost 50% during this same period. Germany still leads in both categories. Over 50% of the installed computers are IBM models.

SOLID STATE high frequency exponential tweeter is being used by Motorola. The horn tweeter uses a slim ceramic cylinder made by Clevite. The piezoelectric element powers a small driver piston which "kicks" pulses of air through the horn. One end of the ceramic has a flower-shaped driver piston glued to it. The other end has two wires connected, one on the outside and one on the side surface. The unit is claimed to have smoother h-f response and is cheaper to make than normal tweeters.

STATE-OF-THE-ART data, methods, and procedures related to reliability physics have been compiled in one volume at the Columbus Laboratories of Battelle Memorial Institute. Said to be the first compilation of its kind, the "Reliability Physics Notebook" was prepared for the Rome Air Development Center, Griffiss Air Force Base, N. Y. Containing 254 pages, the notebook is available from Clearinghouse, U. S. Dept. of Commerce, Washington, D. C. 20230.

FLUIDIC-TO-ELECTRIC switch for users of fluid amplifiers is being made by Corning Glass. It converts fluid pressure to electrical output at a factory set level of $\frac{1}{4}$ lb psig. A diaphragm moves a normally open SPST switch.

LASER COMMUNICATION under water appears to be feasible according to Ohio State University Antenna Lab. engineers. They have been studying this for two years with results.

UNDERWATER COMMUNICATION system has been made by Raytheon. It consists of a mike assembly that fits into an ordinary diving mask, and a speaker case that fits on the weight belt. Made for skin divers, it has a voice range of 50 ft. and a built-in beeper alarm with triple the range for recall. The transistorized unit weighs 25 oz. Boat-to-driver range is 100 ft or more when using a special transducer unit.

SPACE ANTENNA

Technician unfurls fiberglass frame of mesh net space antenna built by Electro-Optical Systems, Inc. Unit can collapse to briefcase size and then expand to a diameter of more than 60 feet. The antenna's highly reflective surface is comprised of an EM spectrum reflecting mesh woven into a hair net pattern and then attached to the frame.

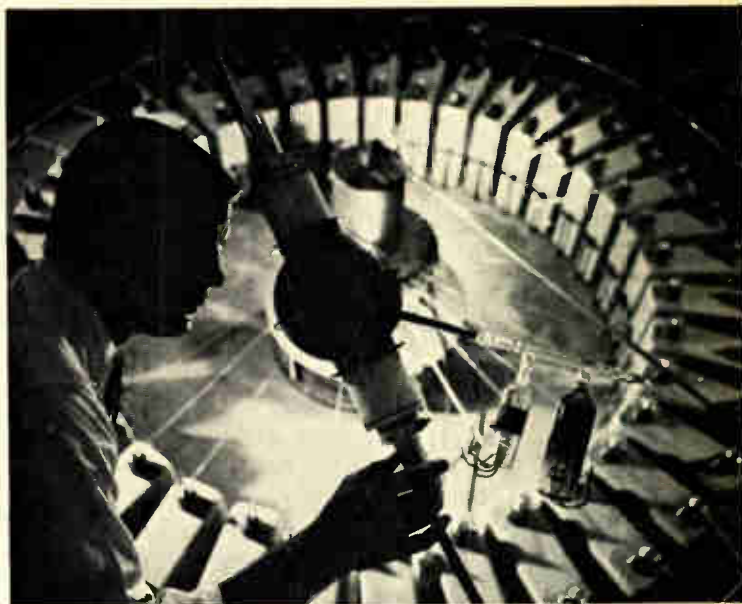

TRIGGERED VACUUM GAP

Developmental model of a triggered vacuum gap developed at the General Electric R&D Center in Schenectady, is readied for an experiment. New device can protect utility power lines and electronic equipment from sudden surges of electricity. Equipment in the background supplies high currents necessary for laboratory experiments.

MICROELECTRONIC CIRCUITS are being made at twice the normal capacity by IBM. A new "barrel" reactor has been designed for depositing epitaxial layers on silicon wafers. Two reactors are run in tandem to best make use of time, space and the r-f generator. One is loaded while the other is being used. 60 wafers can be done at one time. Cycle time on the drum shaped unit is a little longer than other types, but the capacity greatly overcomes this.

GaAs OSCILLATORS, using the "Gunn effect" are reportedly able to work in pulsed operation at hundreds to probably thousands of watts. Devices were operated at over 200 watts pulsed power at 1540MHz by Varian Associates. This result was the best of many attempts. The method should be useful in the future to 10KW at 1MHz. Efficiency was about 5%, with 9% noted. This will increase as more work is done in this area.

ORGANIC SEMICONDUCTORS are the subject of a free report from Clearinghouse, U. S. Dept. of Commerce. Report "OTR-126 Organic Semiconductors" describes the rapid progress being made. As defined by researchers, organic semiconductors are those containing an appreciable number of carbon-carbon bonds. These are divided into molecular crystals, charge transfer complexes, and polymers.

A NEW PHOTOMULTIPLIER, made by RCA can detect and measure radiations present on the moon and other planets. It is made of ceramic and metal so that it is extremely rugged. The 10-stage tube has a venetian blind head-on type photomultiplier with a 2 in. diameter aluminum-oxide window.

We're into electronics

**that's why Bausch & Lomb V.O.M.
ASSURE YOU**

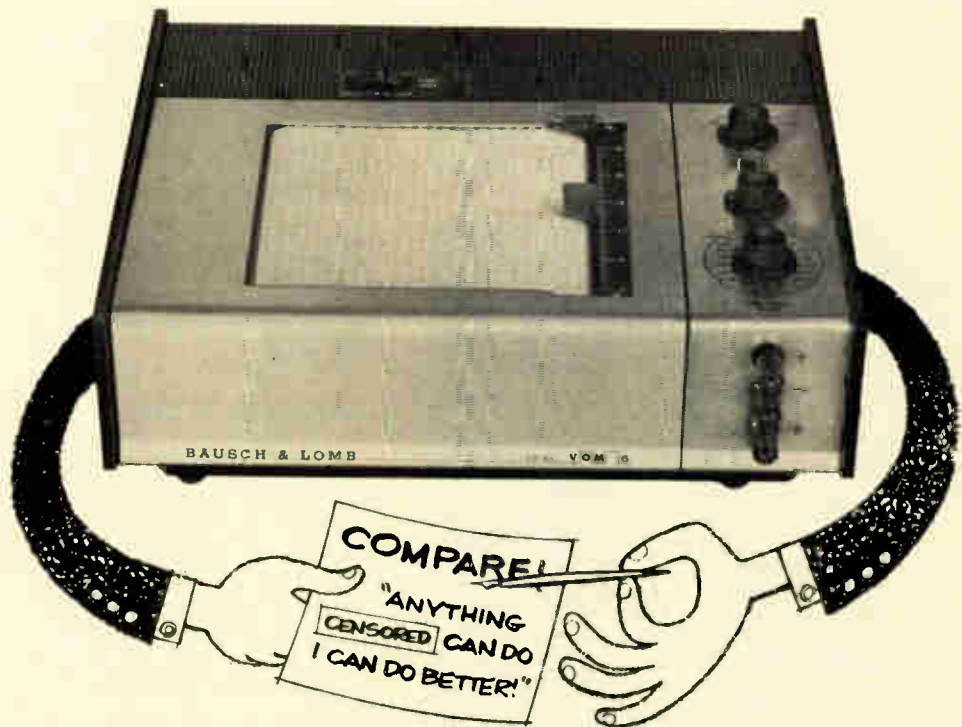

up to our ears...

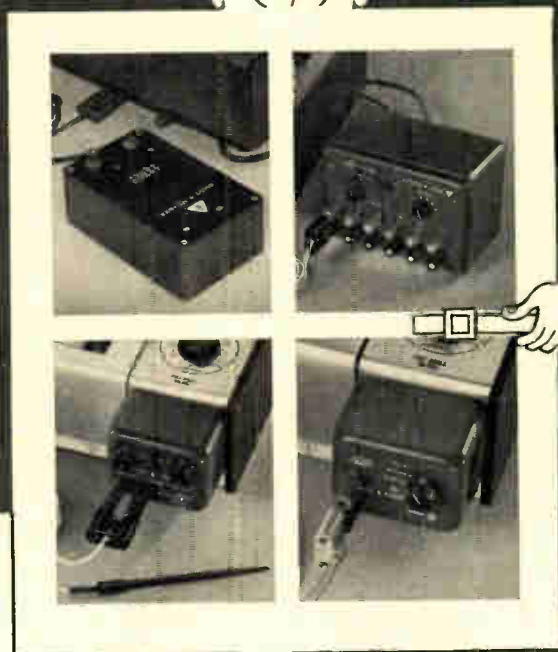

Recorders outstanding performance!

V.O.M. Recorders are backed by years of experience in engineering the most sophisticated electronic circuitry for a wide variety of precision scientific instruments. An entire division is devoted exclusively to the development and production of electronic products. Result? Outstanding performance and reliability... with exclusive important advantages for you at surprisingly low cost. Like recording multiple inputs... volts, ohms, milliamps... directly, without extra converters. Or the 5 chart speeds, and many more. People who buy them, like them and buy more. The V.O.M. Recorder in use is its own best salesman!

	V.O.M.-5	V.O.M.-6	V.O.M.-7	V.O.M.-8
Voltage range:	10 mv—500 v DC	2.5 mv—125 v DC	0.5 mv—10 v DC	Absorbance / Transmittance Measurement (voltage, current, resistance ranges same as V.O.M.-5)
Current range:	10 μ a—100 ma	2.5 μ a—25 ma	1 μ a—10 ma	
Resistance range:	1 ohm—100 K ohms	0.25 ohms—25 K ohms	1 ohm—100 K ohms	
Prices: (suggested list)	\$595 COMPLETE	\$700 COMPLETE	\$885 COMPLETE	

We also have the capability of designing special recorders... modified to handle whatever applications you wish. For complete information on our standard recorders and the many time-saving accessories available for them, write for Catalog 37-2068. Let us know if you are interested in modification for special needs. Bausch & Lomb, 91724 Bausch Street, Rochester, New York 14602.

BAUSCH & LOMB 

ELECTRONICS DIVISION

Series 53M Potentiometer for quieter performance, long life, zero backlash!

100% CARBON-TO-CARBON wiper-element contact construction completely eliminates metal-carried carbon wiper and results in an extremely long, noise and backlash free, life. One piece molded construction is the Clarostat secret . . . and for even greater reliability and stability, each unit is completely sealed against moisture, dust and other environmental hazards.



BRIEF SPECIFICATIONS

■ Power Rating — 2 Watts ■ Working Voltage—500VDC ■ Resistance Range — 50 ohms to 10 megohms linear, 250 ohms to 5 megohms tapered ■ Available with shaft seals, mounting seals, switches, high torque, ganging, non-metallic shafts, L & T Pads, concentric shafts, high-voltage standoffs, backlash assemblies, and locking bushings. ■ Meets specifications per MIL-R-94 — Style RV-4.

WRITE FOR COMPLETE SPECIFICATIONS

CLAROSTAT

CLAROSTAT MFG. CO., INC. DOVER, NEW HAMPSHIRE

We're blowing our horn because...

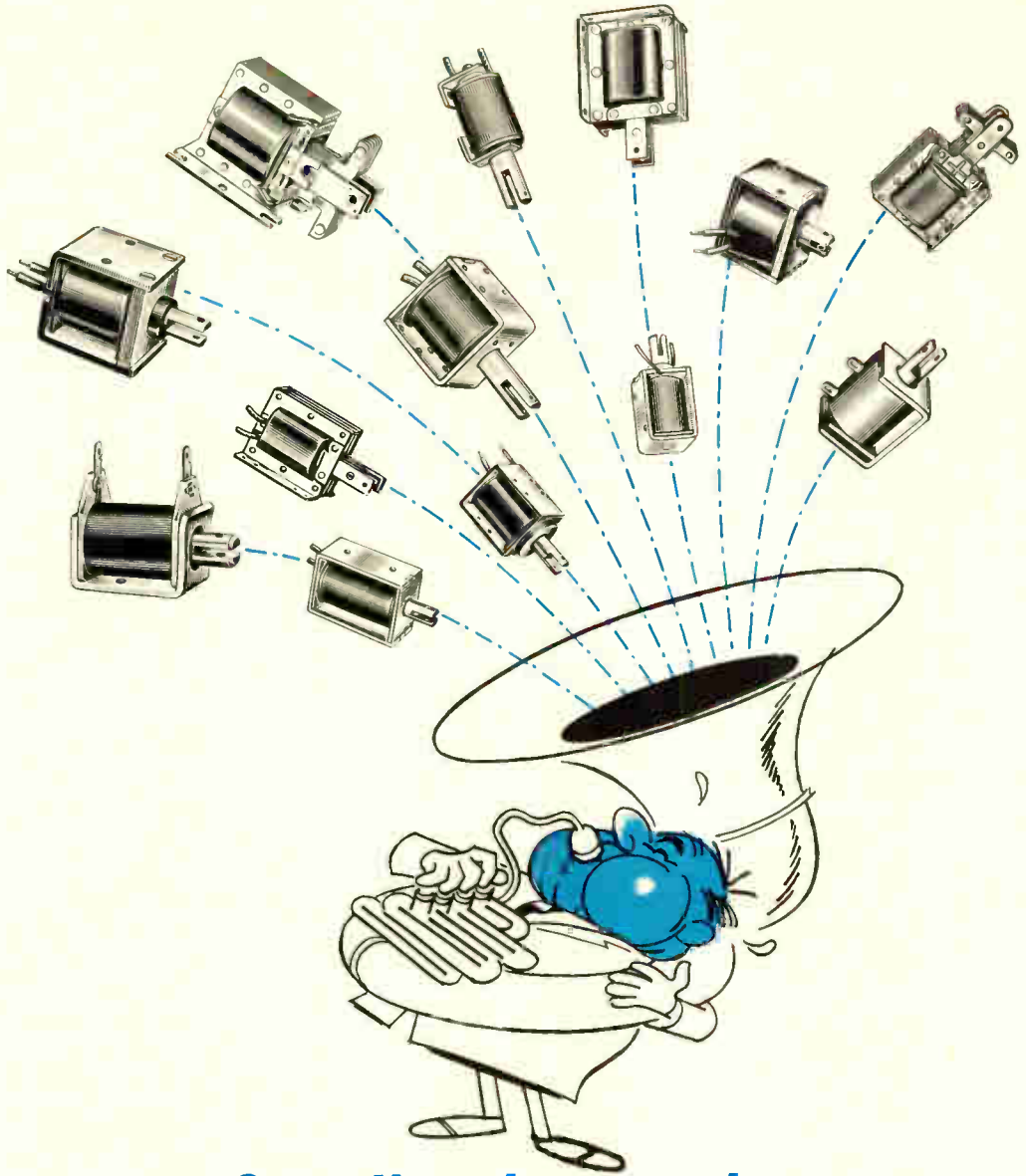

***Guardian does produce
the most complete line of solenoids in the world***

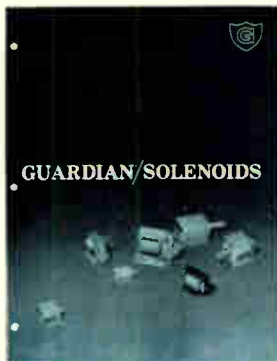

◀ **THIS FREE TECHNICAL MANUAL BELONGS IN YOUR FILE**

More than just a catalog—this Guardian technical manual enables you to find exactly the *right* solenoid for each application and do it quickly. It contains a full 28-pages of information and solenoid details, plus dimensional drawings, complete specifications and “hot” and “cold” pull charts. You’ll find data on all of the general purpose and power-type solenoids in the Guardian line as well as details on custom-engineered solenoids.

This working manual will assure greater accuracy and speed in your solenoid selection. It *belongs* in your file. It is free and sent without obligation. *Write today* to Guardian Electric Mfg. Co., Dept. E1512, 1550 W. Carroll Ave., Chicago, Ill. 60607.

GUARDIAN  **ELECTRIC**

COMING EVENTS

January 1966

- Jan. 25-27: 12th Annual Symp. on Reliability, IEEE, ASQC, et al; Sheraton Palace Hotel, San Francisco, Calif.
 Jan. 30-Feb. 4: IEEE Winter Power Mtg., IEEE; Statler-Hilton Hotel, New York, N. Y.
 Jan. 31-Feb. 2: Int'l Symp. on Information Theory, IEEE; UCLA, Los Angeles, Calif.

February

- Feb. 2: Integrated Circuits Seminar, IEEE; Stevens Inst. of Tech., Hoboken, N. J.
 Feb. 2-4: 7th Western Conv. on Aerospace & Electronic Syst., IEEE; Los Angeles, Calif.
 Feb. 9-11: Int'l Solid-State Conf., U of Penna., IEEE; Univ. of Penna., Sheraton Hotel, Phila., Penna.

'66 Highlights

- IEEE Int'l Conv., Mar. 21-24; Coliseum, New York Hilton, New York, N. Y.
 WESCON, Western Electronics Show & Conv., Aug. 23-26, WEMA, IEEE; Sports Arena, Los Angeles, Calif.
 Nat'l Electronics Conf., Oct. 3-5, IEEE; McCormick Place, Chicago, Ill.

March

- Mar. 2-4: Scintillation & Semiconductor Counter Symp., IEEE; Shoreham Hotel, Washington, D. C.
 Mar. 21-24: IEEE Int'l Conv., IEEE; Coliseum & New York Hilton Hotel, New York, N. Y.

April

- Apr. 4-5: Rubber & Plastics Industries Tech. Conf., IEEE; Sheraton-Mayflower Hotel, Akron, Ohio.
 Apr. 12-14: Int'l Symposium on Generalized Networks, IEEE, OSA, Brooklyn Polytech, et al; Hotel Commodore, New York, N. Y.
 Apr. 12-15: 4th Quantum Elect. Conf., IEEE; Towne House, Phoenix, Ariz.
 Apr. 18-21: Spring URSI-IEEE Meeting, URSI, IEEE; Nat'l Academy of Sciences, Washington, D.C.
 Apr. 20-22: Southwestern Conference & Exhibition, IEEE; Memorial Auditorium, Dallas, Tex.
 Apr. 26-27: 14th Annual Nat'l Relay Conf., Oklahoma State U., Nat'l Assn. Relay Mfrs.; Student Union Bldg., Stillwater, Okla.
 Apr. 26-28: Spring Joint Computer Conf., IEEE, AFIPS, ACM; Boston Civic Center, Boston, Mass.
 Apr. 26-28: Future Engineering for Earth and Space Conf., IEEE; Pioneer Int'l Hotel, Tucson, Ariz.

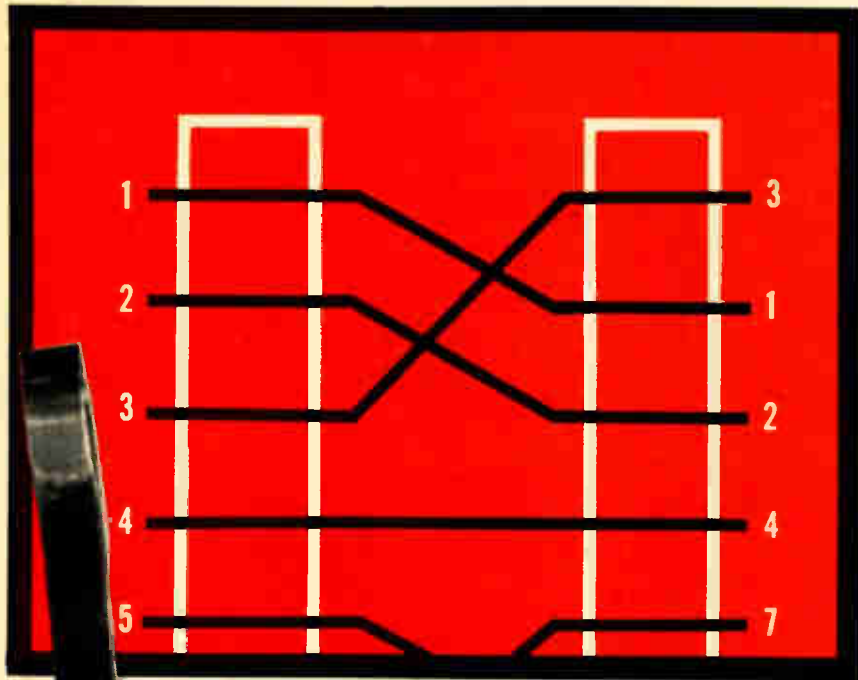

TRANSLATION*

The everyday job of aci application engineers is translating your diagrams, schematics and working drawings into complete interconnection "systems" incorporating advanced techniques in the art of flat conductor cabling developed by aci.

Try the aci "systems concept." It provides the fastest, most fool-proof and least expensive way to make reliable circuit interconnections.

... new connective dimensions



DIVISION OF KENT CORPORATION
 206 Industrial Center, Princeton, N. J. 08540

Send for Bulletin E-5

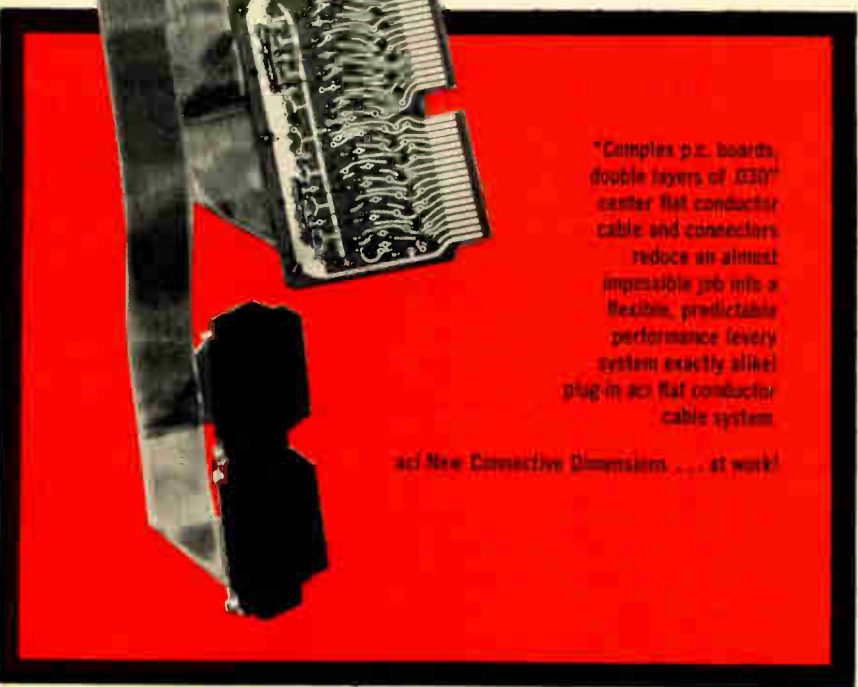

*Complex p.c. boards, double layers of E30¹ center flat conductor cable and connectors reduce an almost impossible job into a flexible, predictable performance lever system exactly alike plug-in aci flat conductor cable system

aci New Connective Dimensions ... at work!

Four low-cost compacts for 6 circuit functions

These little rotary stepping switches from Automatic Electric are as versatile as they are economical. Capabilities for counting, controlling, monitoring, selecting, indicating or timing are built into each switch.

They're remarkably reliable, too. When the armature steps the wiper assembly to the next position, it also *locks* the rotor. Overthrow is impossible, thanks to this *positive positioning*—a unique AE design feature. There are no armature pawl stops to wear out, or get out of adjustment. Also... improved shock-resistant spring assemblies; excellent low-maintenance record.

You can get these AE compact stepping switches in numerous variations—many available directly from stock. If you need a "custom" variant, we can tailor it to your specifications, quickly and economically.

For helpful application information, get the 160-page book, "How to Use Rotary Stepping Switches." Just ask your AE representative, or write Director, Relay Control

Equipment Sales, Automatic Electric, Northlake, Ill. 60164.

(A) TYPE 40 No bigger than a pack of king-size cigarettes. A decimal switch with up to five bank levels—but only 10 points per level. Eliminates extra steps when counting decimally.

(B) TYPE 80 A decimal switch with a larger capacity than the Type 40. From six to twelve 10-point levels.

(C) TYPE 44 Available with up to eight 10-point levels—or 11 points on all levels where specified.

(D) TYPE 88 A larger-capacity version of the Type 44, with up to twelve 11-point levels where specified.

AUTOMATIC ELECTRIC
SUBSIDIARY OF
GENERAL TELEPHONE & ELECTRONICS **GTE**

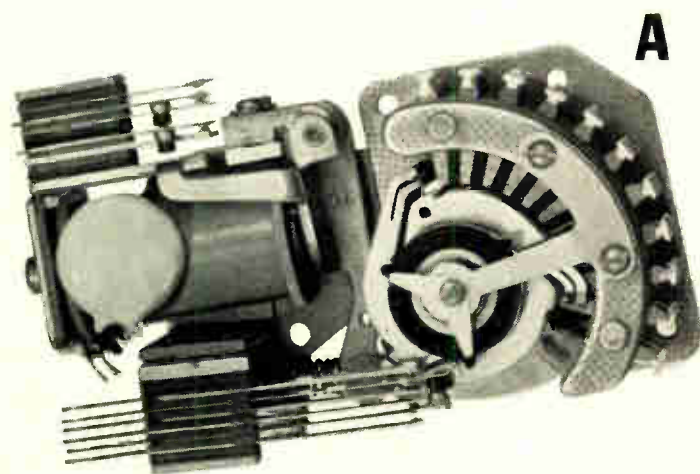

A

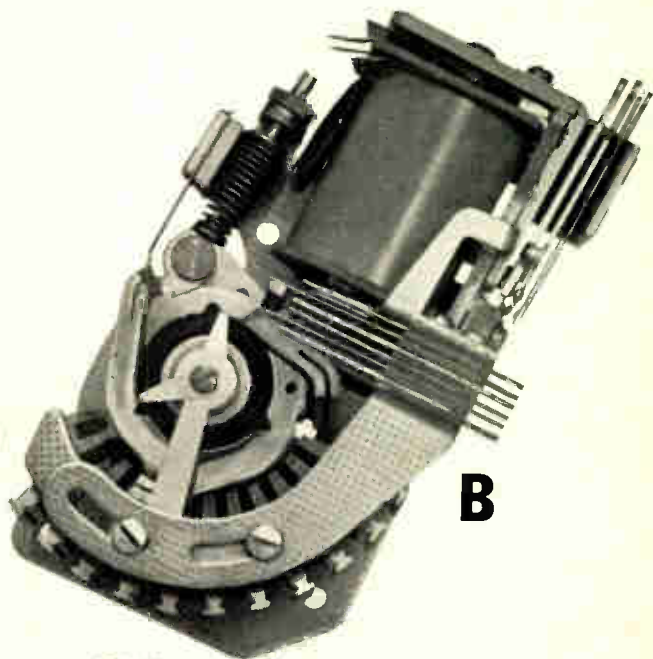

B

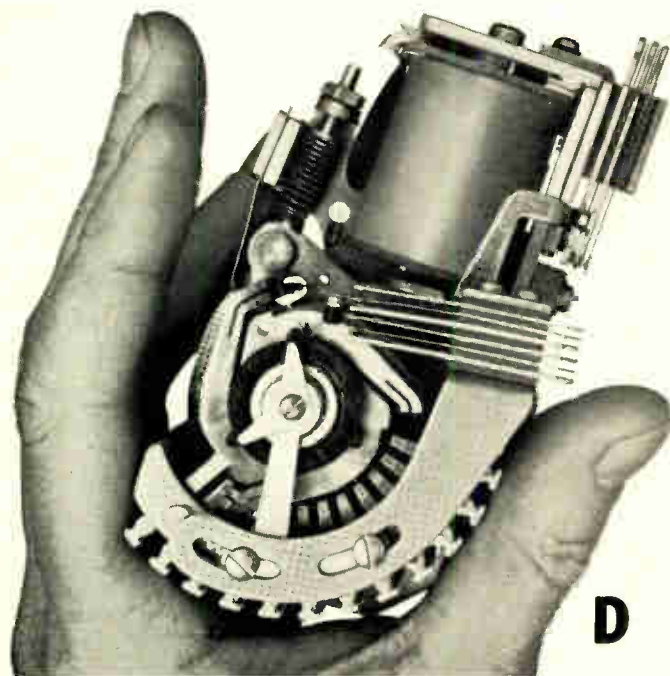

D

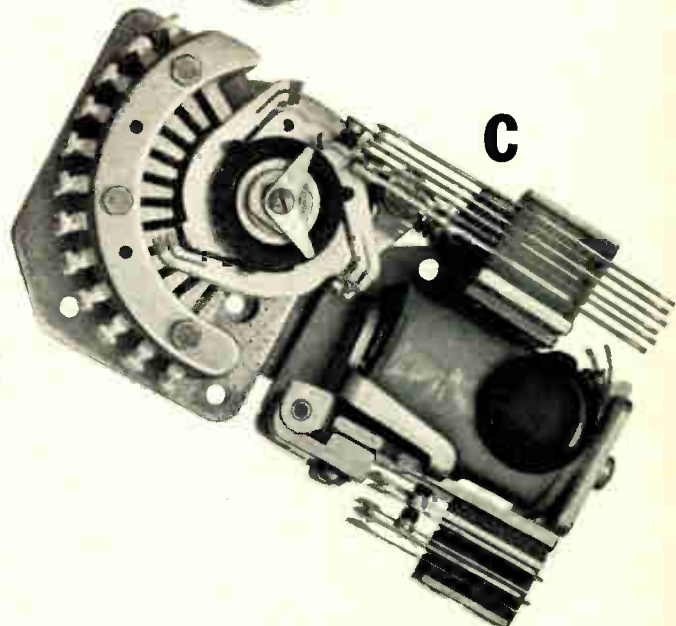

C

ENGINEER SHORTAGE TO CONTINUE—

Shortage of engineers and other technicians evidently is going to continue for several more years, government figures indicate. This year, the outlook for engineers was the brightest since early 1963. U. S. Labor Dept. offers a broad hint: Employers are continuing to maintain rigid hiring specifications, despite tightening job markets. The government doesn't come right out and say the specs could be lowered; it simply invites industry to ponder the possibility.

KEEPING A HAND IN—The Johnson Administration is letting it be known to space officials that the White House is going to keep a "policy" hand on subcontracts for big projects. The word is that the Administration will reserve the right to choose some of the subcontractors for the massive Supersonic Transport project (SST). Subcontractors for electronics, propulsion, and other fields may be picked in about 15 months—two months ahead of the announcement of the prime contractor.

COMSAT PUSHES APOLLO SYSTEM—Communications Satellite Corp. (COMSAT) is pressing for necessary FCC approvals to buy four communication satellites for the Apollo program as well as commercial uses (\$11.7 million contract — Hughes Aircraft). COMSAT plans to launch two of the satellites in synchronous orbits (over the Atlantic and Pacific) at 22,300 miles next summer. In addition to handling Apollo, the satellites would provide some 100 voice grade commercial circuits. The system of which the satellites will be a part includes 46 countries. Nine ground stations will be operated for Apollo.

C OF C, EIA AIR VIET WAR

Conferring on impact of Viet war on procurement and defense budget, and legislation on ownership of government-financed inventions at U. S. Chamber of Commerce meeting are (left to right) Assistant Defense Secretary Paul R. Ignatius; Paul H. White, Chamber's National Defense Committee; William H. Moore, Gov't Products, EIA.

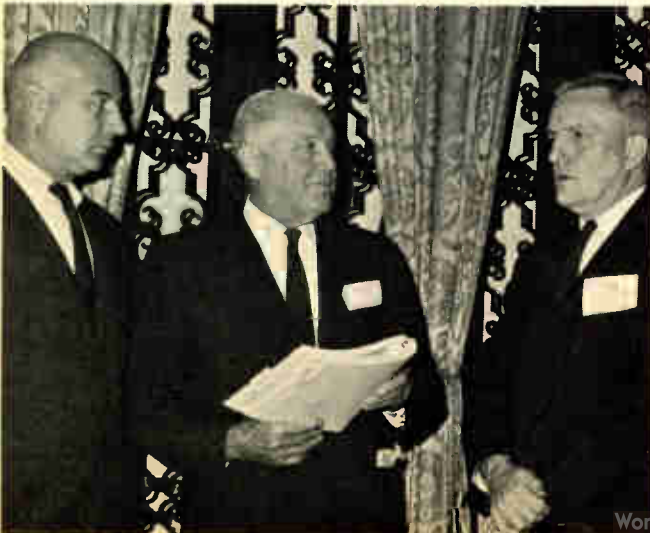

COMSAT STATION OK'D—FCC has OK'D construction of a communications satellite earth station (one of two) complex at Brewster Flat, Wash., for a cost of about \$6 million. The other will be located near Honolulu. An Early Bird-Type communications satellite, served by both new stations, will link Western U. S. with Hawaii, Japan, and the Western Pacific.

NEW RULES FOR CATV—New FCC rules govern use of non-common carrier microwave facilities serving community antenna (CATV) systems. The commission established a new class of service known as community antenna relay service (CAR). FCC also proposes rules to determine whether CAR licensees and TV stations can interconnect relay facilities, and whether they can share programs obtained via microwaves.

BAN ON DUAL DISTRIBUTION—A fresh attempt will be made next year to obtain a ban on so-called dual distribution (in which a manufacturer-owned outlet competes with an independent seller). Sen. Russell B. Long (D-La.) claims it is a necessary step in the shielding of small business from large competitors. Manufacturer-owned outlets often charge less than independents for goods of equal grade and quality, Sen. Long observes.

URGE ASSEMBLY PROCUREMENT—Electronics and aerospace experts have suggested that the Pentagon can save money and cut delays—and smooth orders to suppliers—by stocking "vendor repairable items (RI) as complete assemblies rather than sub-components. A joint report by the spare parts committees of EIA and AIA said savings could run as high as 30% if whole assemblies were stocked as complete assemblies, rather than buying just the parts for the assemblies.

SHOULD IMPORTS BE MARKED?—Should imported radios, TVs, phonos, and tape recorders be labeled as to country of manufacture? The Federal Trade Commission raises the question, and is investigating such imports. A public hearing in Washington is currently airing views from importers, U. S. Industry, and the public. FTC wants facts and figures on: (1) Extent and penetration of the U. S. market by imports, including components and parts; (2) Volume of imports, volume of U. S. production, effect of imports on U. S. production and employment in electronic industries; (3) Whether the public prefers domestic sets; (4) Whether imports should be marked as to country of origin; (5) Whether failure to disclose foreign origin constitutes an illegal "deception."

Inside story of the new look in series regulators

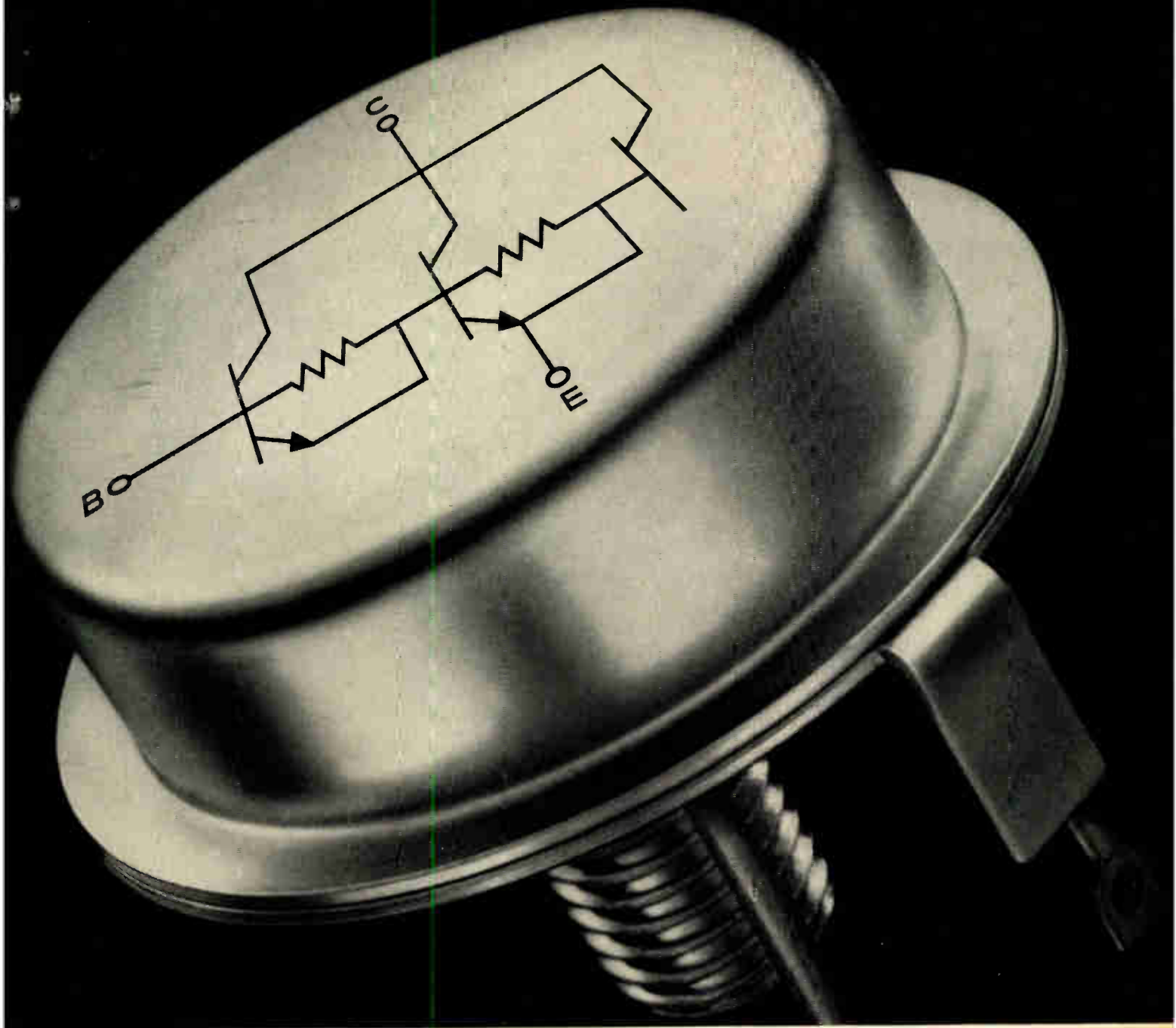

Westinghouse power integrated amplifiers eliminate a complete driver stage.

Save space, improve reliability, cut costs with Westinghouse power integrated amplifiers. Types 2N2233 and 2N3477 provide exceptionally high gain at high power levels— $h_{FE} = 400$ at 10 amps I_c , $V_{CE} = 200$ volts and $P_D = 150$ watts. Single and double ended packages provide complete design flexibility. Check these exclusive features:

- Hard soldered junctions eliminate thermal fatigue.
- Large emitter-base area puts an end to secondary breakdown.
- True monolithic construction stops runaway leakage.

SINGLE ENDED	DOUBLE ENDED	V_{CE}	h_{FE}
2N2226	2N3470	50	100
2N2227	2N3471	100	@
2N2228	2N3472	150	10A
2N2229	2N3473	200	
2N2230	2N3474	50	400
2N2231	2N3475	100	@
2N2232	2N3476	150	10A
2N2233	2N3477	200	

You can be sure if it's Westinghouse



Circle 11 on Inquiry Card

And, of course, reliability is assured by the exclusive Westinghouse Lifetime Semiconductor Guarantee.* For full information call your Westinghouse salesman or distributor, or write to the Westinghouse Semiconductor Division, Youngwood, Pennsylvania.

*Westinghouse warrants to the original purchaser that it will correct any defect or defects in workmanship, by repair or replacement f.o.b. factory, for any JEDEC-type silicon power semiconductor during the life of the equipment in which it is originally installed, provided said device is used within manufacturer's published ratings and applied in accordance with good engineering practice. This warranty is applicable to devices of the stated types shipped after March 9, 1964, until further notice. This warranty shall constitute a fulfillment of all Westinghouse liabilities in respect to said products. This warranty is in lieu of all other warranties expressed or implied. Westinghouse shall not be liable for any consequential damages. SC-2050

DEEP SPACE AT "GROUND ZERO"

When NASA's astronauts board their Gemini spacecraft it will be with the feeling of old hands at familiar jobs. Even ground crews will operate with the facility of seasoned experts. This is the way it must be, even though it will be a first for both men and machines—each person, each system functioning in unison.

McDonnell engineers designed and built the trainers and simulators for Gemini's orbital rendezvous missions as well as launch, orbital flight and reentry.

The Gemini Mission Simulator is one example of how the skills and facilities of McDonnell Electronics Division are applied to mirror desired situations through true simulation.

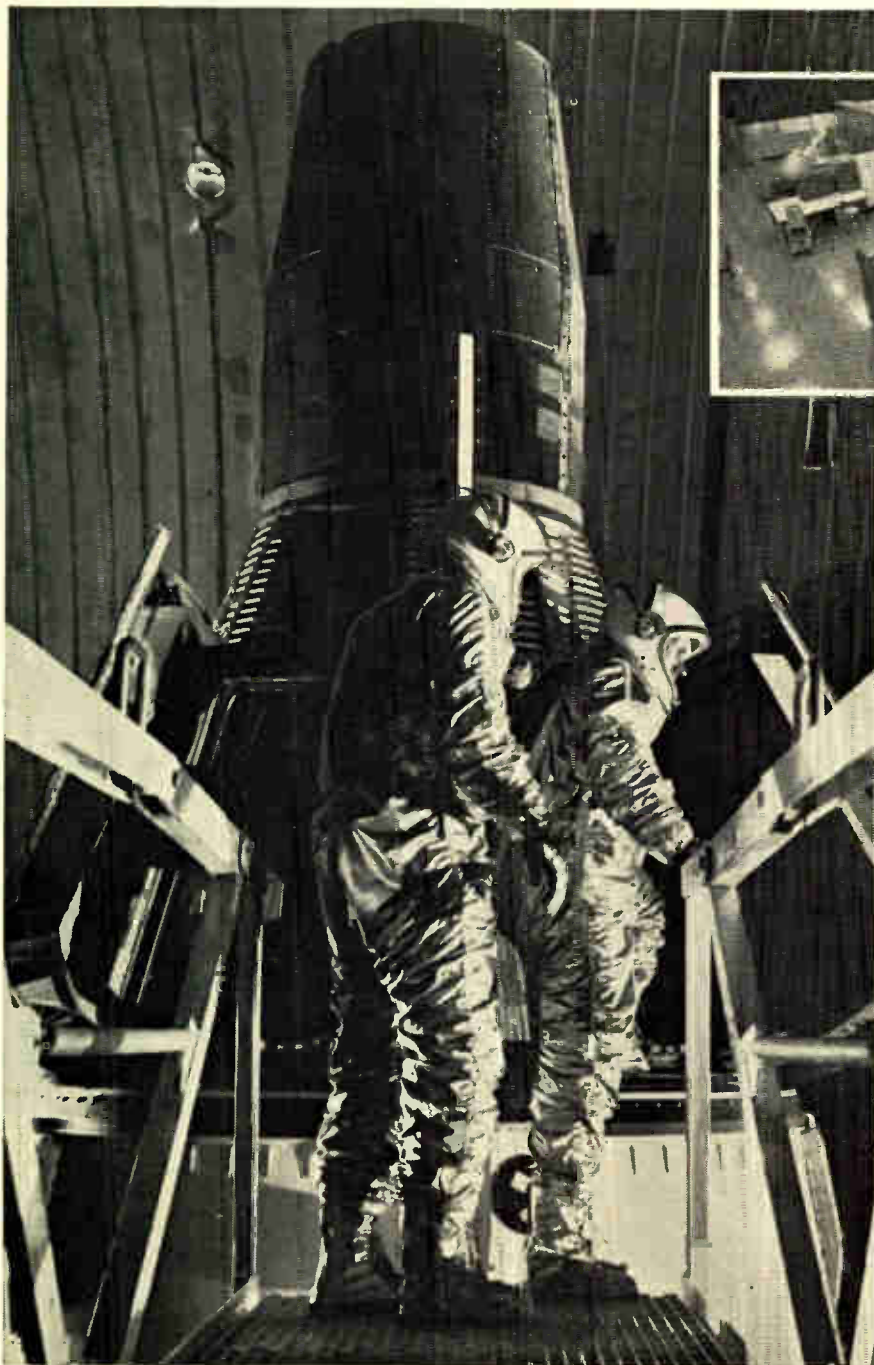

GEMINI MISSION SIMULATOR

Our brochure, "Skill in Electronics" will show you why McDonnell is a leader in end-mission related electronics such as Trainers and Simulators.

Write to:

MCDONNELL ELECTRONICS DIVISION

DEPT. 946 • BOX 516 • ST. LOUIS, MISSOURI 63166

APPLYING ELECTRONICS AS AN INTERDISCIPLINARY SCIENCE

For Capacitors with **GREATER RELIABILITY . . .**

Choose
EL-Menco

*The Capacitors You
Find Wherever
There's Electronics!*

EL-MENCO DUR-MICA CAPACITORS

Only 1 Failure Per 43,000,000 Unit-Hours!

- It has been computed that "debugged" DM30, 10,000 MMF units, when subjected to 257,000 hours of life at 85°C with 100% of the rated DC voltage applied, will yield only 1 FAILURE PER 43,000,000 UNIT-HOURS!
- DM15, DM16, DM19, DM20 . . . perfect for miniaturization and for new designs using printed wiring circuits. Also available in DM30, DM42 and DM43.
- New "hairpin" parallel leads insure easy application. Exceed all electrical requirements of military specification MIL-C-5A.



EL-MENCO TRIMMERS & PADDERS

Design Versatility!

- Available in 350 VDC and 500 VDC as well as other test voltages.
- All bases are of low-loss steatite.
- Special lugs are obtainable for printed circuitry.
- Miniature units are available.
- Solder Lugs can be bent in any position without affecting the capacity setting due to the rigid construction.
- Various types of mounting brackets are available for all trimmers.
- Units can be constructed for special applications.

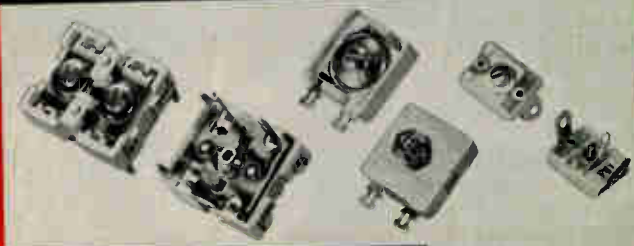

EL-MENCO *MYLAR-PAPER DIPPED CAPACITORS

Only 1 Failure in 14,336,000 Unit-Hours!

- Life tests at 105°C with rated voltage applied have yielded only 1 FAILURE PER 1,433,600 UNIT-HOURS for 1 MFD. Since the number of unit-hours for these capacitors is inversely proportional to the capacitance, 0.1 MFD Mylar-Paper Dipped capacitors will yield only 1 FAILURE PER 14,336,000 UNIT-HOURS!
- Working volts DC: 200, 400, 600, 1000 and 1600.
- Durez phenolic resin impregnated.
- Tolerances: $\pm 10\%$ and $\pm 20\%$ (closer tolerances available).
- Dielectric strength: 2 or 2½ times rated voltage, depending upon working voltage.
- Exceed all electrical requirements of E.I.A. specification RS-164 and military specifications MIL-C-91A and MIL-C-25A.

*Registered Trademark of DuPont Co.

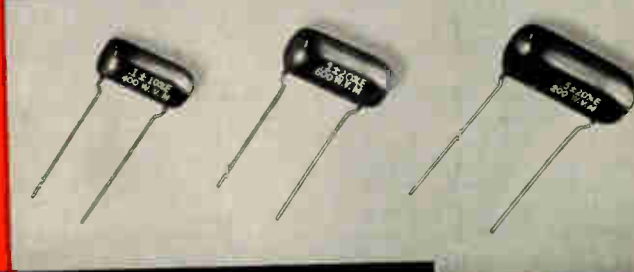

EL-MENCO MOLDED MICA CAPACITORS

Superior Performance!

- Unmatched for excellent stability, dielectric strength, high insulation resistance, extremely high "Q" and correspondingly low power factor.
- Units can be subjected to a short "debugging" life test at elevated voltage and temperature for removal of early life failures and for improved reliability.

*Write for Free Samples and Booklets
on Any of The Above Capacitors*

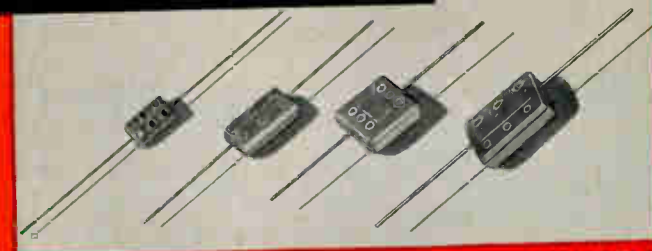

EL-MENCO OFFERS A COMPLETE LINE OF CAPACITORS . . . STANDS READY TO SERVE ALL YOUR CAPACITOR NEEDS.

THE ELECTRO MOTIVE MFG. CO., INC.

WILLIMANTIC, CONNECTICUT

*Dipped Mica • Molded Mica • Silvered Mica Films • Mica Trimmers & Padders
Mylar-Paper Dipped • Paper Dipped • Mylar Dipped • Tubular Paper*

MANUFACTURERS OF

EL-Menco
Capacitors

ARCO ELECTRONICS, INC., Community Drive,
East Rock, L. I., New York
Exclusive Distributors in the U.S. and Canada

West Coast Manufacturer Contact:
CULLING & HYDE CO., 1224 Corporation Way,
P.O. Box 426, California
1220 Wootton Boulevard, Los Angeles, California

FROM TRANSISTORS TO TRIGGERS...

NEW MOTOROLA TYPES TO FIT YOUR TOUGHEST DESIGN JOBS

all new... all oriented to your needs!
 In this handy "applications
 brochure... yours for the



all described
 unlimited"
 asking!

SILICON BILATERAL TRIGGER...MT-32 (32V ± 4V)

... For an economical, highly reliable device for use in Thyristor and other triggering circuits

- Symmetrical V-I characteristics
- High pulse-current — 2 Amps
- Packaged in miniature DO-7 "glass" hermetic encapsulation — $P_D = 150 \text{ mW}$

VOLT/AMP. CHARACTERISTICS

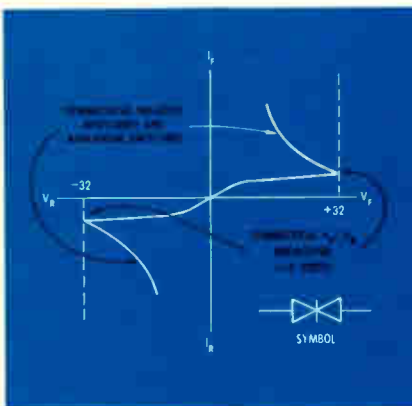

LOW-VOLTAGE, FAST SWITCHING, EPITAXIAL 4-LAYER DIODES

Series M4L3052, 53, 54

- Low breakover voltages: 8-12 volts
- Low junction capacitance: typically 35 pf @ 8-12 V_F
- Fast switching speeds: typically $t_{ON} = 50 \text{ nsec}$, $t_{OFF} = 100 \text{ nsec}$
- Packaged in DO-7 "glass" case ($P_D = 150 \text{ mW}$)

All this at new low prices!

TYPICAL CHARACTERISTICS

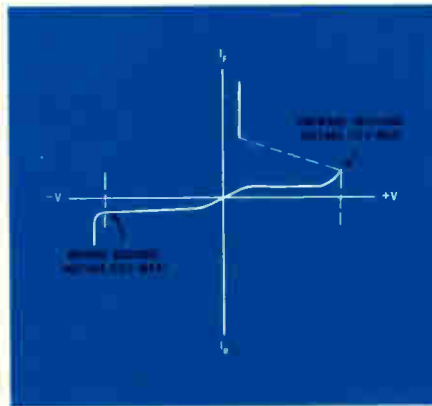

"NO COMPROMISE" LOW-COST PLASTIC SILICON TRANSISTORS

... with UNIBLOC* Performance and Reliability Features!

- NPN/PNP for complementary circuit design
- Complete "h" parameters specified
- Gain specified from 100 μA to 100 mA
- High voltage — 40 volts (min)

*Trademark of Motorola Inc.

PNP — 2N3905-6

NPN — 2N3903-4



CHOOSE FROM 3 NEW RTL INTEGRATED CIRCUIT LOGIC COMPLEMENT LINES

... to best fit your particular performance/cost requirements!

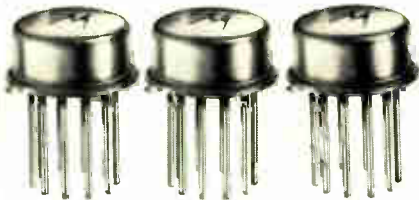

- Fan-out capability up to 5
- 12 nsec — typical propagation delay
- 15 mW/NODE Dissipation
- MC900G series — designed for MILITARY extreme environmental applications. Operating Temp. Range: -55°C to $+125^{\circ}\text{C}$
- MC800G series — for reliable operation in INDUSTRIAL logic applications. Operating Temp. Range: 0 to $+100^{\circ}\text{C}$
- MC700G series — value priced for broad INDUSTRIAL/COMMERCIAL applications. Operating Temp. Range: $+15^{\circ}\text{C}$ to $+55^{\circ}\text{C}$ — choice of 19 circuit functions.

✓ (New, comprehensive technical brochures are available describing the complete MC900G, MC800G, and MC700G series ... check coupon below for your copies.)

... for saturated switching OPTIMIZED "FOUR-H" GEOMETRY — FOR MEMORY DRIVER DESIGNS TO 1½ AMPS!



Optimized "Four-H" Geometry

PNP 2N3762 Series

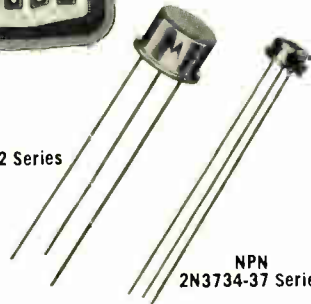

NPN
2N3734-37 Series

Featuring:

- High speeds — $t_r = 330$ mc (NPN), 220 mc (PNP)
- High current — to 1.5 A
- $C_{ob} = 7$ pf (NPN), 12 pf (PNP)
- h_{FE} — specified from 10 mA to 1.5 A
- Low $V_{CE(sat)} = 0.7$ V @ 1.0 A

... for non-saturated switching

1800 MC CURRENT-MODE SWITCHES NPN-2N3959 & 2N3960

CURRENT-GAIN — BANDWIDTH PRODUCT

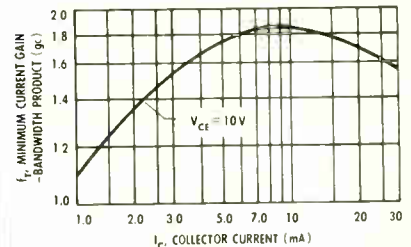

TYPICAL PERFORMANCE FOR THE 2N3960

Featuring:

- 1800 mc — frequency response
- Specified 12 volt (min) BV_{CEO}
- Low $C_{ob} = 2.5$ pf (max)
- Low $r'_b C_c = 20$ psec (typ) TO-18 Pkg.

12-AMP SILICON RECTIFIERS (50-1000V) MR1120-MR1130

... filling your needs for high-performance, medium-current rectification at an economical price!

- 12 amps @ 150°C
- High surge-current @ elevated temperatures — 300 amps @ 150°C
- Low forward voltage drop — 0.55 V (average)
- Available in standard or reverse polarity

CURRENT VS. TEMPERATURE DERATING CURVE

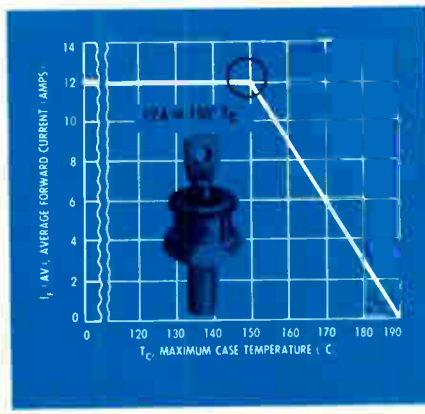

To receive your copy of APPLICATIONS UNLIMITED and the following design aids, just fill out coupon below and drop it in the mail to us.



MOTOROLA
Semiconductor
Products Inc.

5005 EAST McDOWELL ROAD PHOENIX ARIZONA 85008

Please print

NAME _____ TITLE _____

JOB FUNCTION _____

COMPANY _____ DEPT. NO. _____

HOME ADDRESS WORK _____ PHONE _____

CITY _____ STATE _____ ZIP _____

Send to:

MOTOROLA SEMICONDUCTOR PRODUCTS, INC.
BOX 955, PHOENIX, ARIZONA 85001

- RTL Integrated Circuit Brochures Zener Selection Guide Silicon Rectifier Selection Guide Silicon Annular Transistor Selection Guide
 Germanium Power Transistor Selection Guide

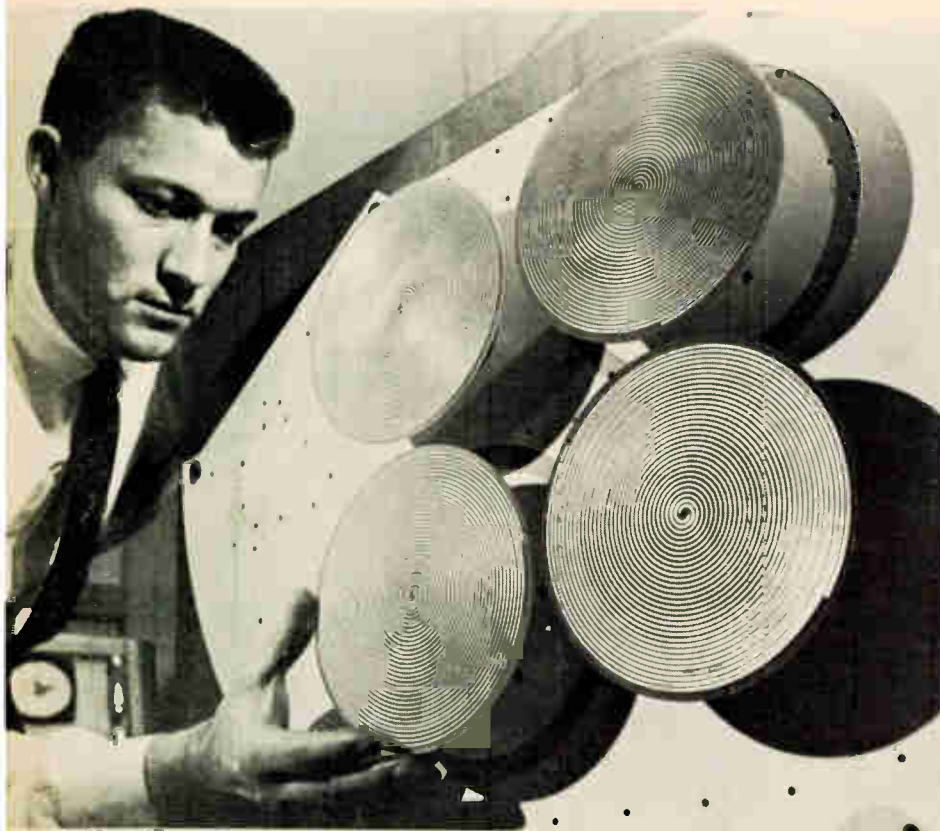

The Changing
STATE-OF-THE-ART
in the
electronic
industries

ELECTRONIC

▲ RADAR ANTENNA FOR GEMINI TRANSMISSION

Separate spiral antenna, part of special radar equipment made by Westinghouse for the Gemini program, is used for transmission to avoid use of a transmit-receive duplexer.

▼ MONOLITHIC MEMORY CHIPS

Two IBM chips being mounted for testing on ceramic substrates with printed circuit paths. The substrates are electrically combined on logic cards, and cards are plugged into boards of memory assembly. The 70 x 70 mil chips each contain a 4 x 4 array of 16 storage cells.



▲ CONTOUR MEASURE

Parabolic mirror, is measured for contour preciseness by non-contact electro-optical instrument developed by The Boeing Company. A two-unit device, one unit projects light pinpoint, reflected from mirror into second, sensor unit. Sensor records surface variations and sends data to readout computer system.

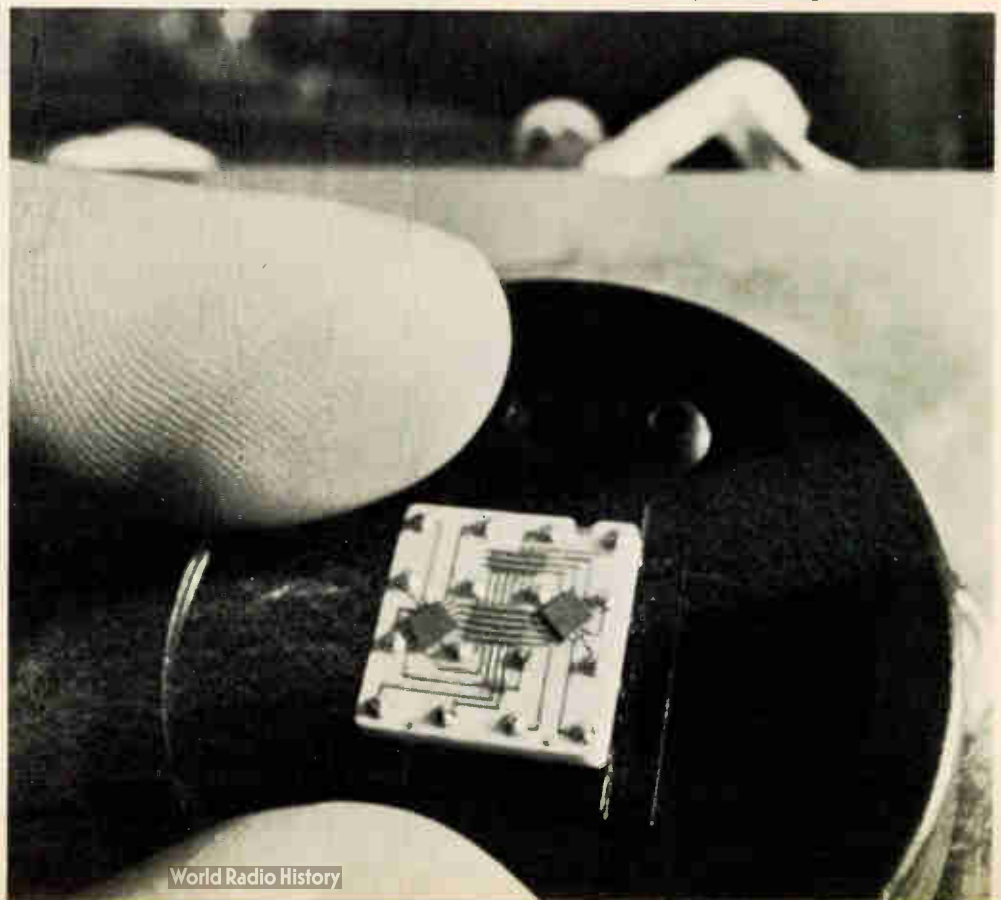

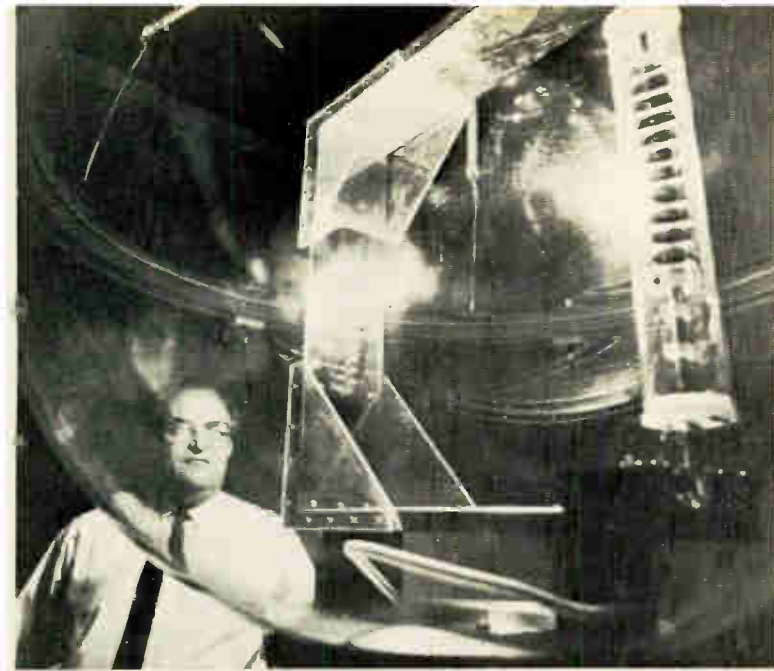

◀ SUPERSONIC ANTENNA TEST

Advanced antenna, being developed for Lockheed 2000 supersonic transport, undergoing high-altitude tests in transparent vacuum chamber at firm's Rye Canyon Lab. Temp. range: -65 subsonic to $+550^{\circ}\text{F}$ cruise speed.



▲ A TWT THAT 'YELLS'

Unsung space-age hero is the traveling wave tube (inside bell jar) that amplifies outer space signals from a whisper to a shout. Here Hughes Aircraft Co. technician pours potting agent to seal the tube.

SNAPSHOTS

▼ LASER LIGHT DETECTOR

H-f laser beam detector tested by Herbert Ogawa, RCA Laboratories. In vertical cylinder behind glass porthole in liquid N, detector can sense intensities of IR up to 100 million/sec. Such h-f variations would permit the laser to carry 25 TV programs simultaneously.

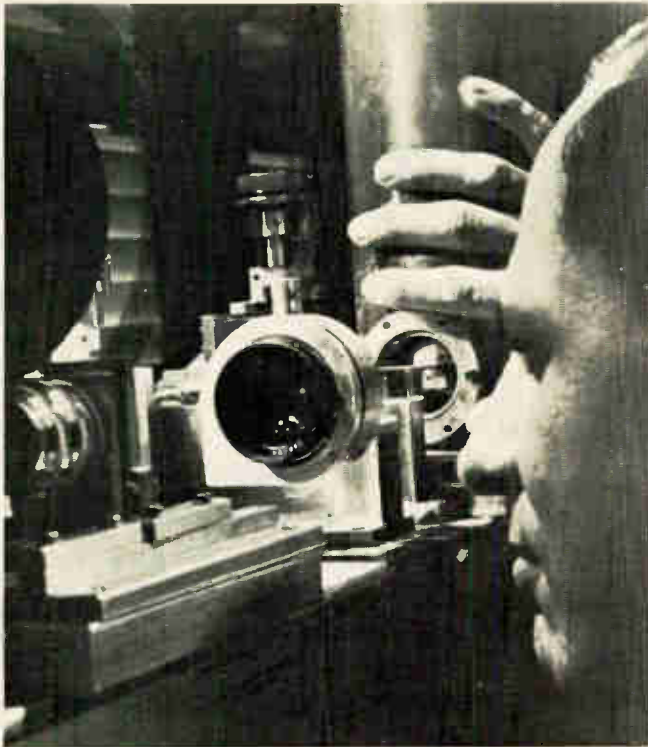

SAUCER AT SEA ▶

Earth station antenna made by ITT Corp. ready on U.S.S. Wasp to relay live TV of astronaut recovery from Gemini. Signals will be sent via Early Bird to Andover, Me., station and then to networks.



Two new 40 mw and 20 mw high-speed, billion-operation CLARE Relays

■ These CLARE Type HGSL and HGSM Mercury-Wetted Contact Relays meet the requirements of modern electronic systems.

■ Their complete freedom from contact bounce, isolation between coil and contacts and high speed qualify them as excellent input buffers to solid state circuitry. As output buffers they can be driven by low power logic circuitry with an input to output power gain of up to 5000. Contacts can handle up to 100 va, ac or dc, over billions of operations without derating.

■ As scanner contacts in checkout systems they can stand off a hi-pot voltage of 1000 vac and, at the same time, offer a contact resistance variation of less than 2 milliohms over life for critical resistance measuring circuits. Their lack of contact bounce, high speed and low noise generation commend them for tape transport read-write head switching. In their compact, space-saving packages these relays meet a wide range of design requirements for both printed circuit boards and wired assemblies.

type HGSM

Module
for printed
circuit boards



Relays shown actual size

type HGSL

Plug-in
for wired
Assemblies



Sensitive

40 mw Single-Side
Stable
20 mw Bi-Stable

High Speed

Nominal operate
time: 1.0 ms

Long Life

Billion operations
minimum at rated
load

Contact Advantages

Low and consistent
contact resistance
over complete life.

No bounce.

Both form C and form
D contacts available.

OPERATE AND RELEASE TIMES

20 MW BI-STABLE DOUBLE WOUND COIL

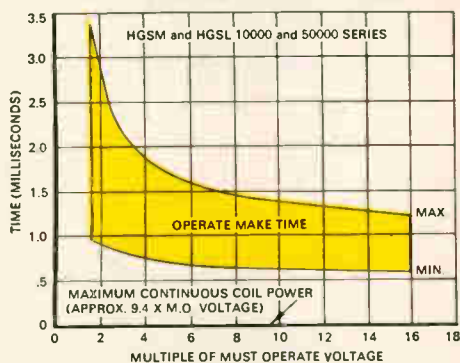

40 MW SINGLE-SIDE STABLE SINGLE WOUND COIL

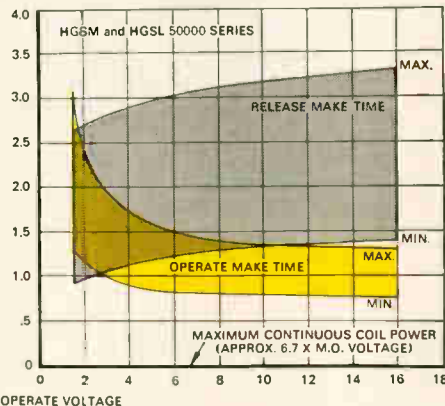
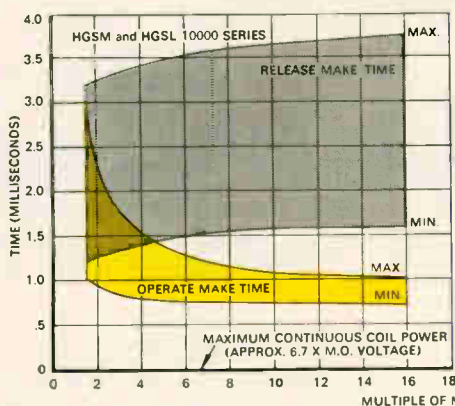

ELECTRICAL CHARACTERISTICS	FOR WIRED ASSEMBLIES		FOR PRINTED CIRCUIT BOARDS	
	HGSL		HGSM	
	Series 10000	Series 50000	Series 10000	Series 50000
Contact Arrangement	1 Form D	1 Form C	1 Form D	1 Form C
Sensitivity	40 mw. Single-Side Stable 20 mw. Bi-Stable			
Contact Rating Low Level	0-100 Microamperes 0-300 Millivolts			
Power (with Contact Protection)	2 amperes max. 500 volts max. 100 volt amperes max.			
Contact Circuit Resistance	35 milliohms max.		20 milliohms max.	
Nominal Operating Voltage	Up to 90 vdc			
Nominal Operate Time at Maximum Coil Power	1.0 ms			

Send for Data Sheet 852 giving complete information on these new miniature, high-speed, sensitive relays. Address C. P. Clare & Co., Group 12D8, 3101 Pratt Boulevard, Chicago, Illinois 60645.

For complete information contact your nearest CLARE Sales Engineer

CALL— NEEDHAM (Mass.): (617) 444-4200 • GREAT NECK, L.I. (N.Y.) (516) 466-2100 • SYRACUSE: (315) 422-0347 • PHILADELPHIA: (215) 386-3385 • BALTIMORE: (202) 393-1337 • ORLANDO: (305) 424-9508 • CHICAGO: (312) 262-7700 • MINNEAPOLIS: (612) 920-3125 • CLEVELAND: (216) 221-9030 • XENIA (Ohio): (513) 426-5485 • CINCINNATI: (513) 891-3827 • MISSION (Kansas): (913) 722-2441 • DALLAS: (214) 741-4411 • HOUSTON: (713) 528-3811 • SEATTLE: (206) 725-9700 • SAN FRANCISCO: (415) 982-7932 • VAN NUYS (Calif.): (213) 787-2510 • TORONTO, CANADA: C. P. Clare Canada Ltd. • TOKYO, JAPAN: Westrex Co., Orient IN EUROPE: C. P. Clare International N. V., TONGEREN, BELGIUM



relays and related control components

COMPUTERIZED, MONEYLESS ECONOMY/CREDIT FORECAST

The need for using money may be removed entirely by 1986, based upon anticipated breakthroughs in electronic data processing. That new world would function on computerized credit, says J. Lewis Nungesser, Vice President, Philadelphia National Bank.

In this system credit would be recorded and debited automatically for everyone and every business through a complex computer system. This new system might be called IBIFS; International Banking Information and Fiduciary System.

Such computerized banking would permit: automatic deposit and withdrawal, instant reading and deciphering of credit data, pre-authorization of periodic payments, automatic loans, shopping by UNI-card.

These developments would be achieved by two simple proposed devices: an individual UNI-card, or Universal Numeric Identifier, which would be provided at birth, and PV: Phono-Vision, a combination of telephone, television, and data processing terminal.

In this data processing revolution, Mr. Nungesser foresees optical scanning and MICR: Magnetic Ink Character Recognition, both replaced by greater electronic advances for which the groundwork now is being laid.

CERAMIC MAGNET MARKET MAY RISE 20% IN 5 YEARS

A 20% increase in the 10-million-dollar ceramic permanent magnet market over the next five years is predicted by Westinghouse Materials Div., Blairsville, Pa.

To meet this growing demand, the Division has completed a threefold expansion of its ceramic magnet production capability. During 1966, the division intends to increase output to eight times original level.

ZENITH TOPS 2-MILLION TV SET GOAL FOR 1965

Zenith officials report that the firm set new all-time TV industry record with orders for more than 2 million TV receivers for delivery in the first eleven months of 1965.

L. C. Truesdell, president of Zenith Sales Corp. said, "Since these are firm orders covering our planned production and delivery of TV sets of all types as of and through November, our total shipments in 1965 will far exceed two million total TV sets, a figure that to date has never been reached by anyone in a 12-month period."

AIRBORNE DATA PROCESSING DEMONSTRATION



Flying computer demonstration—IBM Computour—is now on a two-month tour of 30 cities in 20 European and Middle East nations, sponsored by IBM World Trade Corp. Recently announced IBM 1130 system, the 360, and commercial Model 20 are demonstrated during the tour.

ELECTRONIC OFFICE SYSTEMS RISING IN ANNUAL SALES

More than half of the annual estimated \$6 billion office equipment industry represents electronic equipments and systems.

Electronic data processing systems, including peripheral equipments, now represent about \$3 billion. Office machines, including electronic adding machines, dictation machines, quasi-electronic photocopiers, and various electronic telephone attachments, now account for about a \$2 billion annually. Furniture and fixtures make up the balance.

These are among statistics cited by Walter W. Finke, chairman of the Business Equipment Manufacturers Association and president of Electronic Data Processing Div., Honeywell, Inc. Mr. Finke cited other statistics.

Cumulative value of installed computing equipment by the end of 1965

U. S. ELECTRONIC FIRMS WILL SHOW WARES AT FRANKFURT

A U. S. Trade Center exhibit in Frankfurt, West Germany, in January will provide American manufacturers of production equipment for the electronic industries an opportunity to show and sell their products in a fast growing German electronic market, reports the Department of Commerce.

The Trade Center exhibit, to be staged Jan. 12-19 by the Department's Bureau of International Commerce (BIC), will feature production and packaging equipment for the electronic industries.

Market surveys conducted for the BIC indicate that U. S. manufacturers of machinery, tools, materials, and components for electronic packaging and production will find Germany a receptive market for their products.

will approximate \$7.5 billion. This represents a net increase of \$1.5 billion in the cumulative base. Actual gross shipments for 1965 are estimated at \$1.75 billion.

The \$250 million-gap between gross shipments and net cumulative increase indicates computer dynamics—the fast growth rate of solid-state systems.

By the end of 1965, about 27,000 computers will be in operation. Of these, about 20,000 will be full-size systems, and 7,000 will be desk size.

These computer sales figures should be compared with 16,000 full-size computer systems and 5,000 desk-size systems in use during 1964. Two dozen computers are being installed daily in the U. S.

The computer industry's biggest year is expected in 1966. More than 8,000 units of all types will be shipped. This is about 1,000 units more than were shipped in the record year of 1964. The average rate for all of 1966 will approach three dozen systems installed daily.

AUTOMATIC CONTROL MARKET SEEN RISING 10-15% YEARLY

Domestic automatic controls industry should maintain a 10-15% annual growth rate over the next five years, James H. Manecke, executive vice president of Ranco Inc., predicted.

Overseas, Mr. Manecke predicted, the industry should grow even faster expanding 25-50% per year in many underdeveloped countries during the 1965-70 period.

Consumer controls will grow fastest in such "low saturation" appliances as room air conditioners, dishwashers, clothes dryers and color television sets, Mr. Manecke predicted.

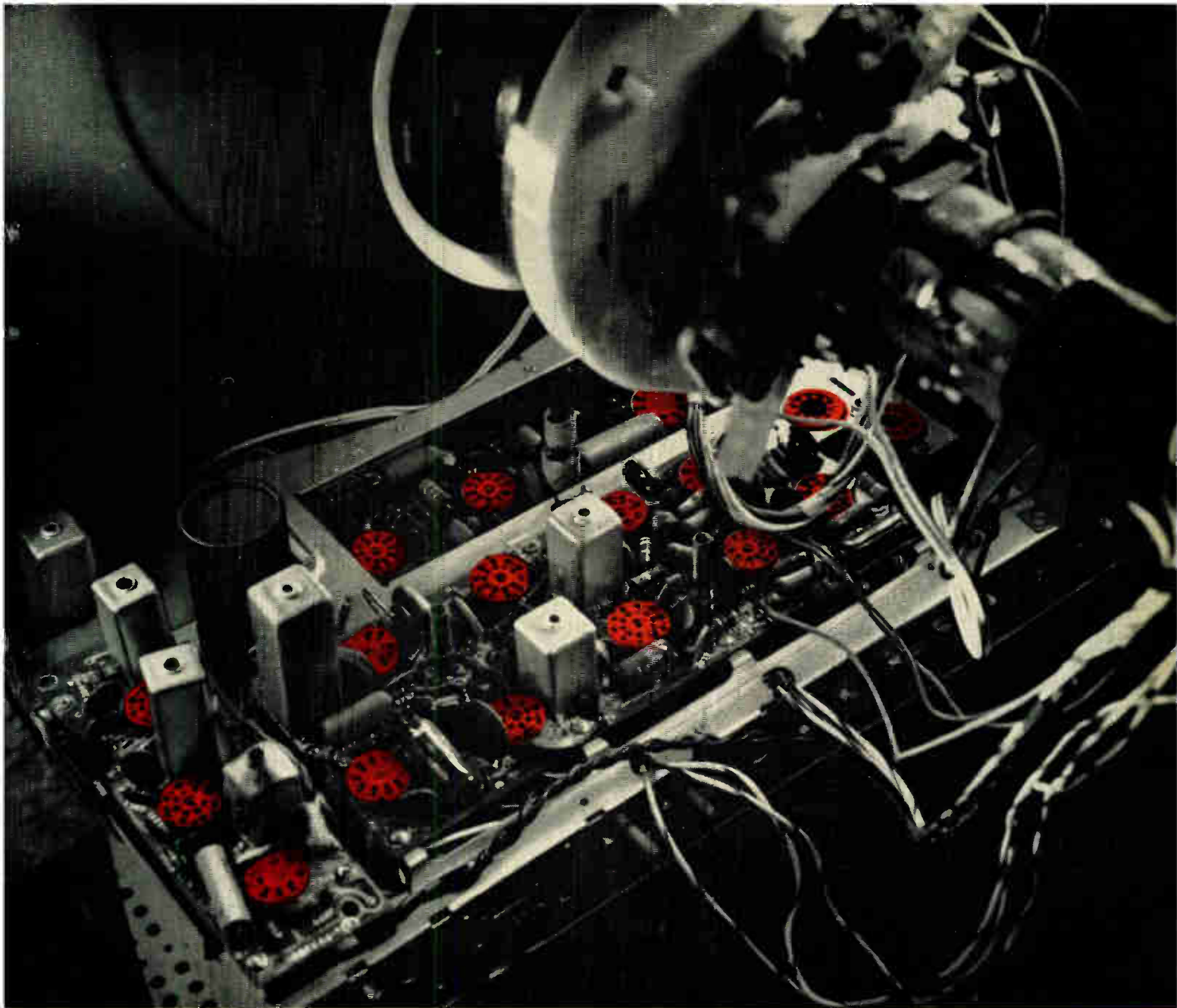

For the best possible color-TV picture

THESE SOCKETS NEED COLOR-TV RECEIVING TUBES BY RCA

In today's growing and highly-competitive color-TV market, your company's reputation rides on the performance of the color sets you manufacture.

That's why it's so important that you specify dependable RCA COLOR-TV RECEIVING TUBES for every socket.

What's so special about RCA COLOR-TV RECEIVING TUBES?

As pioneer of today's compatible color TV, RCA has accumulated knowledge of color-TV circuitry that is unmatched in the industry. This knowledge has enabled us to select and develop the group of receiving tubes that best meet the exacting requirements of today's high-fidelity color TV.

The tubes have been field-proven in thousands of color-TV sets across the nation.

Samples of each week's production of RCA COLOR-TV RECEIVING TUBES are given exhaustive tests, under actual field conditions, in our Tube Reliability Laboratory. The performance of these sample tubes must meet rigid quality standards before their respective production lots are released to the warehouses.

This group of RCA tubes offers color-TV manufacturers the best combination of price, performance and reliability on the market today.

RCA ELECTRONIC COMPONENTS AND DEVICES, HARRISON, N. J.

RCA DISTRICT OFFICES—OEM SALES: EAST, 32 Green St., Newark, N.J. 07102, (201) 485-3900 • MID-ATLANTIC, 605 Marlton Pike, Haddonfield, N.J. 08034, (609) 428-4802 • MID-CENTRAL, 2511 East 46th St., Bldg. Q2, Atkinson Square, Indianapolis, Ind. 46205, (317) 546-4001 • CENTRAL, 446 East Howard Ave., Des Plaines, Ill. 60018, (312) 827-0033 • WEST, 6363 Sunset Blvd., Hollywood, Calif. 90028, (213) 461-9171 • INTERNATIONAL OPERATIONS, RCA International Division: Central and Terminal Aves., Clark, N.J. 07066, (201) 382-1000 • 118 Rue du Rhone, Geneva, Switzerland, 357500.



The Most Trusted Name in Electronics

World Radio History



You can get a rise out of a Fairchild scope faster than anybody's

In 3.5 ns, to be precise. That's the risetime of Fairchild's Series 765H scopes fitted with the Type 79-02A plug-in. And if $t_r = 3.5 \text{ ns}$, $f = 100 \text{ mc}$. Thus, whether you look at it in terms of speed or bandwidth, the 765H Series is the highest performance, real-time general purpose scope available.

But compare some other features too: dual trace capability with the 79-02A plug-in . . . 10 mv/cm sensitivity (or cascade the preamplifiers by flipping a switch and get a 50 mc single trace at 1 mv/cm) . . . trigger selection from composite signal or Channel 2 only . . . built-in 230 ns delay line.



Also consider the advantages in reliability and compactness of Fairchild's all solid-state circuitry . . . of advance design that incorporates all amplifier circuitry in the plug-in. These and other features of the Series 765H with its family of plug-ins give you the precision and versatility demanded in so many applications today.

Price of the dual trace 79-02A plug-in is \$1,200, and the entire 100 mc scope with $5 \mu\text{s/cm}$ sweep is only \$2,265. Call your Fairchild Field Engineer today for a demonstration at your convenience, or for complete specifications write Fairchild Instrumentation, 750 Bloomfield Ave., Clifton, N.J.

FAIRCHILD
INSTRUMENTATION
A DIVISION OF FAIRCHILD CAMERA
AND INSTRUMENT CORPORATION

*Technological Obsolescence

Circle 37 on Inquiry Card

World Radio History



EXECUTIONER OF OBSOLESCENCE

2N1792-2N1800 110 AMPERE SCR'S

Silicon Transistor Corporation. No toleration for obsolescence there. Look at Silicon's broad array of 110 ampere Silicon Controlled Rectifiers for power switching applications. All diffused junctions and rugged post and clip construction mean better performance and reliability.

Other applications include voltage regulators, power converters and inverters, dynamic braking, ignition firing, frequency converters, constant current supplies, pulse width modulators, overload protection, welding controls, and many others.

Replacements for thyratons, ignitrons, magnetic amplifiers, power transistors, relays, switches, contactors, and circuit breakers.

2N1792-2N1800. Peak Reverse Blocking Voltages from 60 to 720 volts.

Can you tolerate obsolescence? Contact . . .

EAST GATE BLVD., GARDEN CITY, NEW YORK 11532, 516 Pioneer 2-4100. TWX 510-222-8258

REGIONAL OFFICES:

CHICAGO, ILL. 60625, 5555 NORTH LINCOLN AVE., 312-271-0366-7, TWX 910-221-1304

LOS ALTOS, CALIF. 94022, 1 FIRST ST., 415-941-2642.



**SILICON
TRANSISTOR
CORPORATION**

HERE'S AN OPPORTUNITY

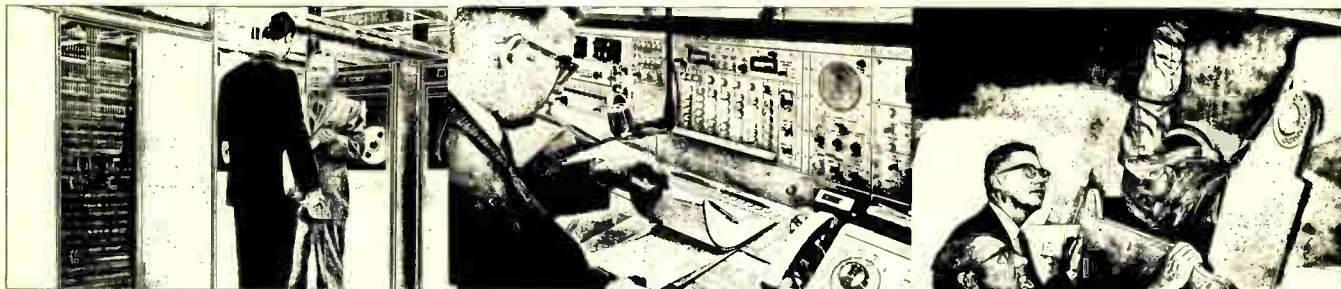

TO IMPROVE YOUR FUTURE

... Both professionally and personally. Every project at Collins is the most demanding in its area of industry, and we need professionals to continue the growth this level of qual-

ity has created. Living and working conditions—and compensation—are commensurate with these standards. These listings are current.

SEND RESUME FOR PROMPT INFORMATION

MICROWAVE SYSTEMS ENGINEERS—Electrical engineers with experience in microwave communication systems, design, or wire line carrier design. B.S.E.E. preferred. Must be willing to travel. (Dallas)

INDUSTRIAL ENGINEERING—These men will have a wide range of industrial engineering experience. They will be involved in standard data application, cost estimating, utilization studies, layout facilities planning, work measurement and cost reduction. (Cedar Rapids and Newport Beach)

INDUSTRIAL ENGINEERING, MECHANICAL ENGINEERING OR INDUSTRIAL MANAGEMENT GRADUATES—Experience in any of the following areas: manufacturing planning and methods, facilities planning, work measurement, cost reduction and control systems and procedures, tool and equipment design, computerized manufacturing techniques, quality engineering. (Dallas and Newport Beach)

FIELD SUPPORT ENGINEERS—Openings for field engineers with installation and

check-out experience in one or more of the following: high density microwave systems, toll terminal equipments, cable and open wire multiplex monopulse tracking techniques, phase locked loop receivers, parametric amplifiers, Cassegrain feeds, tropospheric scatter systems, solid state data systems. Most openings are single status with minimum of one year at location. (Dallas)

MECHANICAL ENGINEERS—B.S.M.E. for equipment and systems design. Duties will include machine design, hydraulic circuit design, stress and dynamic analysis, hydraulic and pneumatic design, electronic packaging and production processes. (Dallas and Newport Beach)

CRYSTAL FILTER ENGINEERS—To work in the challenging field of crystal filter development and/or crystal development. Minimum requirement B.S. degree but prefer M.S. or Ph.D. Two to four years minimum experience. (Newport Beach)

PRODUCTION ENGINEERS—These men

should have a background in flight director systems, gyroscopic devices or general electronics manufacturing. This area involves final development, tooling up and development of processes required for manufacture of newly designed avionics products. (Cedar Rapids and Newport Beach)

ELECTRICAL ENGINEER (Test Equipment)—This supervisory position involves the application of advanced techniques in product testing. Background should include utilization of programmed tape control and real time computer control technology and automatic test stations. (Cedar Rapids and Newport Beach)

RF SYSTEMS ENGINEERS—B.S.E.E. with experience in RF Systems including receivers, transmitters, and antennas in the VHF-UHF frequency range. Of specific interest is experience in phase locked loop receivers, high power transmitters, tracking (monopulse) antenna systems, and tracking system analysis. (Dallas)

COMMUNICATION / COMPUTATION / CONTROL



COLLINS RADIO COMPANY

An equal opportunity employer

LETTERS

to the Editor

An Invitation . . .

Editor, ELECTRONIC INDUSTRIES:

I read with great interest the tabulations of your survey of electronics industry which appeared in your August issue.

I noted particularly that 49% of electronics engineers are under 35; that 66% are aiming for supervisory or management positions; and that 65% are active in civic, fraternal or service organizations. Such figures help explain dynamism of the industry.

We in the Jaycees proudly boast of having a large number of electronics engineers serving their communities in our 5,700 local chapters.

We need more and know that more young men could benefit from the Jaycees. We offer personal development and leadership training to all our members. We ask in return, service for the community.

We have bulging files of testimonials to the value of Jaycee membership in helping young men advance in their careers. They come from professional men, engineers, laborers, white collar workers, salesmen and men who own their own business. They prove our theory that leadership training through community service is of benefit to all.

I encourage all engineers 21-35 to contact their local Jaycee chapter (it may be listed as the Junior Chamber of Commerce) and learn the Jaycee way. All, regardless of race or creed, are invited.

James A. Skidmore, Jr.
President

U. S. Jr. Chamber of Commerce
National Headquarters
Boulder Park, Box 7
Tulsa 2, Okla.

Good Work!

Editor, ELECTRONIC INDUSTRIES:

My congratulations on your excellent coverage of current semiconductor progress in the September issue. The articles were uniformly well-written and informative.

Again may I thank you for your commendable performance in consistently presenting "State-of-the-Art" technology.

R. W. Kinne
Reliability Engineering Lab.

IBM
Systems Development Div.
P. O. Box 6
Endicott, N. Y. 13764

Excellent Article . . .

Editor, ELECTRONIC INDUSTRIES:

Please send us eighteen copies of "Making Meaningful Measurements" as published in the February and March 1965 issues of ELECTRONIC INDUSTRIES magazine. I feel this excellent article is a classic in the field and would like to use it as required reading in a course in Precision Measurements I am teaching at San Jose City College. This is a one semester long college level course for electronic engineers and technicians, taught in the extended day department.

DeWayne B. Sharp
Sr. Assoc. Engineer

Measurement Standards Lab.
Dept. 311-001
IBM Corporation
Monterey and Cottle Rds.
San Jose, Calif. 95114

Very Useful

Editor, ELECTRONIC INDUSTRIES:

Would you please send me reprints of the three articles appearing in the July, August and September issues of your magazine entitled "1965 Survey of Commercial Semiconductor Photo-sensitive Devices."

I had started to prepare a similar list until your first article appeared. Needless to say, these articles have saved me an enormous amount of work, and I have used them quite often.

Robert E. Willey
Principal Engineer

The Bendix Corp.
Radio Div.
Baltimore 4, Md.

"Get Acquainted" Offer

If you'll tell us more about yourself through the confidential resume below, we'll know where to send you this booklet telling more about ourselves.



Send resume to Manager,
Professional Employment,
Collins Radio Company

Cedar Rapids, Iowa
Dallas, Texas
Newport Beach, California

CHECK LISTINGS

Name _____ Home Address _____ Phone _____

City & State _____

Present Position, Company _____

Primary Experience Area _____ No. of years _____

Education: EE _____ ME _____ Math _____ Physics _____ Chemistry _____

Bus. Adm. _____ Other _____ MS _____ PhD _____

Degree: BS _____ school, date _____ MS _____ school, date _____

Please attach any pertinent information

4

These P&B relays are immediately available at factory prices from your electronic parts distributor



CD-38
SOLID STATE TIME DELAY—You get excellent timing characteristics in these knob-adjustable solid state relays. Timing range: 0.6 to 60 seconds. AC or DC models. Internal DPDT relay rated at 10 amperes, 115V AC resistive. For continuous duty over temperature range of -40°C to $+55^{\circ}\text{C}$.

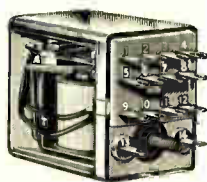

KHP
COMPACT FOUR-POLE RELAY—Small, rugged 4PDT relay designed to meet exacting requirements of data processing, computer and process control applications. Rated at 3 amperes at 30V DC or 115V AC resistive. Solder terminals. Special sockets have printed circuit or solder lug terminals. Also available hermetically sealed.

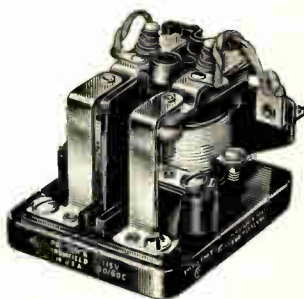

PR
POPULAR 25 AMPERE POWER RELAY—Compact, heavy-duty power relay listed by U/L and CSA. Screw terminals and rugged construction suitable for industrial application requiring reliability and long life. AC or DC models.

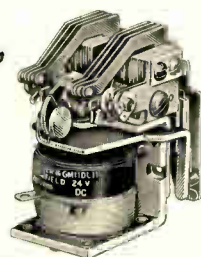

GM
VERSATILE IMPULSE/SEQUENCING RELAY—Unusual single-coil relay can be used to latch, step, count and switch in sequence. Switching occurs during drop-out for greater reliability. AC or DC models. Contacts rated for 3 amperes. Can also be furnished with uni-directional printed circuit boards having 10 or 12 switch positions.

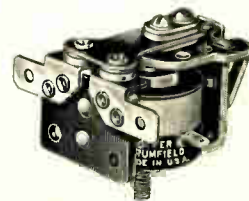

KR3-H
SMALL RELAY SWITCHES 20 AMPERES—Three KR3-H relays will fit in space required for most other 20-ampere relays. Mechanical life exceeds one million operations and twin contacts are rated at 20 amperes at 115V AC, 60 cycles resistive or 28V DC, 1 HP 115/230V 60 cycles. Contact terminals will accept $\frac{1}{4}$ " quick-connects or solder connections. Contact arrangement: SPST-NO-DB.

...and there are 60 other types to choose from!

Chances are, you'll save both time and money when you order standard P&B relays from an authorized distributor. You'll get speedy service at factory prices. Your P&B distributor has available more than

60 basic relay types totalling 627 coil voltages and contact arrangements. All are shown in our new Stock Catalog 100 . . . free from your electronic parts distributor. Ask for a personal copy today.



POTTER & BRUMFIELD

Division of American Machine & Foundry Company, Princeton, Indiana
 Export: AMF International, 261 Madison Avenue, New York, N.Y.

COAXIAL CABLE AND SHIELDED WIRE PRODUCTS

COAXICON* CONNECTORS 390

A complete line of multiple and single-in-line connectors for coaxial cable covering RG/U cable sizes .075" to .250". Terminations are made with AMP's exclusive one-stroke crimping action—one stroke of the matching A-MP* crimping tool terminates inner conductor, outer braid and cable support—simultaneously! Contact plating—AMP standard gold over nickel—assures maximum conductivity and long time reliability.

TERMASHIELD* SPLICES AND FERRULES 391



Selection includes pre-and-post insulated types for both single and multiple conductors. Choice of nylon and TEFLON† insulation. Included are special heat-resistant ferrules and specially designed pre-insulated ferrule for use with printed circuit boards. Crimping process assures connections of maximum conductivity, high resistance to adverse environmental factors and a tensile strength approaching that of the wire itself.



MINIATURE—(Type IV contact) 7, 14, 20 positions plus 25-position "T" connectors.



STANDARD—10, 18, 26, 34 positions plus 10-position "T" and "Y" connectors.



BNC—bayonet coaxial connector for quick connect/disconnect—meets requirements of MIL-C-3608

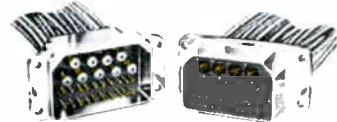

Coaxial and Pin and Socket mix



Threaded Nut Connector—standard and miniature sizes—special hardware adaptation for through panel installation

PRINTED CIRCUIT CONNECTORS

AMP-INCERT Printed Circuit Connectors are available in one and two piece types featuring crimp, snap-in contacts. Connectors are not pre-loaded—only those contacts necessary to meet circuit requirements need be used! Special contact

design assures controlled pressures . . . reduces wear on circuit paths. Matching A-MP tooling for crimping contacts available in choice of hand, semi-automatic and fully automatic types. Contacts feature gold over nickel plating.

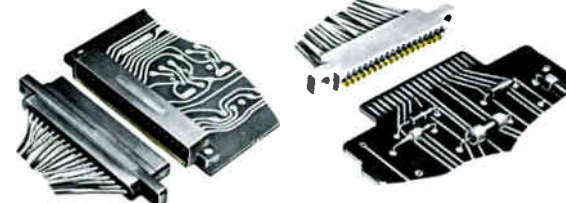

RIGHT ANGLE CONNECTOR—Pin and Socket contacts . . . 19 positions. Sealed and/or unsealed.

AMP-LEAF* CONNECTORS—8, 15, 18, 22 and 30 positions. Conforms to MIL-C-21097A.

394



AMP-BLADE* CONNECTORS—17, 23, 29, 35, 41 and 47 positions. Conforms to MIL-C-21097A.



DUO-TYNE* FLAG CONNECTORS—One-piece right angle connector. 3 to 22 positions.

REUSABLE COMPONENT TEST RECEPTACLE (left)—provides easier, faster . . . least expensive method of mounting components for "burn-in" and other test procedures. Component leads are hand-inserted into drawn brass cup and held in place by integral spring receptacle. Solderless method extends board life . . . saves valuable components from damage. One size receptacle accepts leads of varying diameters and can be used up to 100 times.

CIRCUITIP* TERMINALS (right)—component tip for improved solder dip attachments. Can be applied at rates up to 7,200 tips per hour with A-MP Component Tipping Machine.

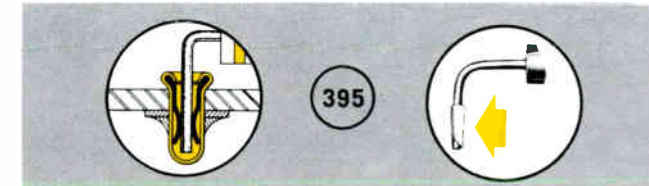

395

PIN AND SOCKET MULTIPLE CONNECTORS

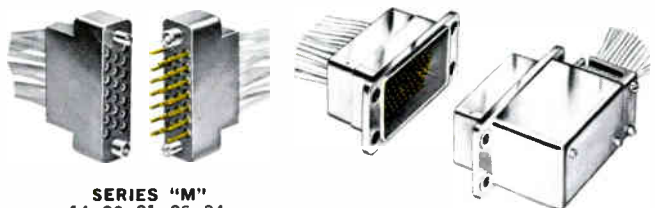

SERIES "M"
14, 20, 21, 26, 34, 41, 50, 75 and 104 position

SERIES "D"—45 and 78 positions.

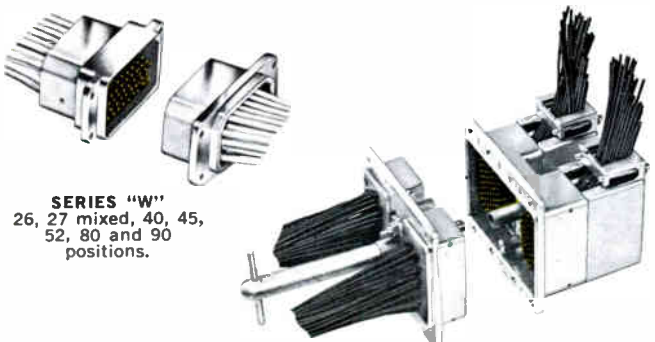

SERIES "W"
26, 27 mixed, 40, 45, 52, 80 and 90 positions.

SERIES "DD"—90 and 156 positions.

AMP-INCERT* Pin and Socket Connectors in a full range of sizes and configurations. Connectors feature crimp, snap-in type contacts. Standard hardware available for all connectors. Line satisfies and exceeds applicable Military and commercial requirements. Choice of screw-machine or formed contacts in single-piece or strip form for application with A-MP hand, semi-automatic or fully automatic matching crimping tools. Plating—gold over nickel—standard with AMP!

392



SERIES "A"—Meets electrical and environmental requirements of MIL-C-26518. Metallic shell—sealed or unsealed—50 and 100 positions. Rack and panel or bulkhead mounting. Screw-machine contacts exclusively. Center to center spacing of .150".



SUBMINIATURE—High density, 50 position connector. Center contact spacing of .060". Wire range 25-32. Insulation support.

TAPER TECHNIQUE

Miniaturized terminals for high density applications. Both pre-and-post insulated, formed and solid type taper pins to mate with a variety of one or two piece stackable nylon taper blocks. Pins are self-cleaning and self-locking—compression crimped to the conductor for insured uniformity of connections. Newest addition to the line, TAYP-AIR* Pins, feature elongated pins which provide extreme vibration resistance.



TAYP-AIR ASSEMBLY 396

STANDARD ASSEMBLY



INSULATED and NDN-INSULATED

STACKED TAPER BLOCKS

DUALATCH* CONNECTORS

Hermaphroditic connector line in standard and miniature sizes—modular miniature, 40, 60, 132 and 396 position miniature and 200 position standard. Self-cleaning contacts are crimp, snap-in type and gold over nickel plated to AMP standards to resist oxide-insulation build-up. Same contact fits both connector halves.



397

200 CONTACT CABLE CONNECTOR—can be electrically disengaged without mechanical uncoupling. Cable outlet positioned at either 45° or 90°.



PROGRAMMING DEVICES

PATCHCORD—Boards in both universal and shielded construction. Standard rack mounted types and new "space-saver" model which mounts into rather than onto panel. Crimped contact design offers double wiping action for assured reliability. Double detent retention feature of patchcord prevents accidental dislodgement.



393

TOOLING

The AMP concept of matching tool and terminal has resulted in a precision crimp which assures maximum tensile strength and electrical conductivity. From hand tools for limited production, to high speed automatic crimping machines capable of 12,000 terminations per hour, the AMP crimping method is identical and precise.



*Trademark of AMP INCORPORATED.

†Trademark of E. I. duPONT.

A-MP® U.S.A. and Foreign. A-MP® products covered by U.S. and foreign patents and/or patents pending.

TERMINALS AND SPLICES

In these categories, we offer industry's broadest lines of products designed for basic connection problems in the electrical/electronic fields. Available in every shape and size, and covering the entire spread of industry used wire size ranges, our terminals not only meet but in many cases actually exceed the most stringent commercial and military specifications. They are available in un-insulated and pre-insulated types, in various base materials and in a complete selection of platings ranging from the most common to precious metals. All of them offer the advantages that go with our matched tool and terminal crimping technique — high resistance to corrosion, shock and vibration and superior conductive ability.

All of the above features can also be ascribed to our line of

splices. Again, these are available in both un-insulated and pre-insulated types for the entire range of most commonly used wire sizes. The line also includes specially designed splices which are highly resistant to adverse environmental factors such as moisture or extremes of heat and cold.

From computers to power-stations, in ground control installations and in super-sonic aircraft, in the whole range of consumer oriented products, wherever a wire must be terminated to complete a circuit or in any manner effect the workings of an electrical or electronic function, you'll find A-MP Terminals and Splices. Industry proved, over the years, they offer superior performance and long-lasting reliability at the lowest possible installed cost.

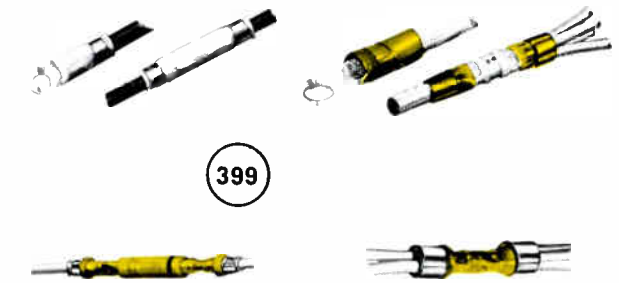

RESEARCH AND TESTING

Our research and testing facilities have always played a very important part in the improvement of existing products and the creation and development of new products. From the very beginnings, our concern with reliability and quality has manifested itself in considerable expenditure and effort and facilities second to none in the industry. Continuing programs in research have been responsible for the development of new platings and plating techniques designed for today's refined and complex equipments. Out of this activity has come an X-ray technique for measuring metal thicknesses which helps control platings to one-millionth of an inch. In our research and testing activities, continuing study is being given to the effects of radiation on electrical connections.

In our Testing Laboratory, the very latest equipment is employed to subject all products, existing and in the making, to thorough and rigorous testing under all conditions with the result that in many instances the findings have been adopted as standards by both commercial and military segments served by the industry.

In keeping with the reliability demands of our Space Age technology, this facility includes four "white rooms" for the ultra-refined testing of electrical/electronic connections and components.



AMP

THE PRODUCT

Over 15,000 different products backed by more than 3,300 U.S. and foreign patents issued or pending. A solution to almost every conceivable connection problem in the electrical/electronic industries. Dependable product performance and long-lasting reliability assured by quality control checks all along the line of manufacture from receipt of raw materials on through to the finished product. Research and Testing facilities second to none in the industry with constant and continuing efforts to improve existing products and developments of new products for Space Age needs.

THE TECHNIQUE

A controlled compression crimping technique for terminating the widest range of wire sizes of every type—solid, stranded and irregularly shaped—singly or in any combination. Reliability assured through matching tool to terminal so that every connection of a given size and type is perfectly identical in appearance and performance by the tens or the tens of thousands. Color coding of terminal and matching tool to maintain operator errors at an absolute minimum and further add to the quality control measures utilized in creating the basic product. An end result of unqualified superior performance, maximum reliability and conformance to the most stringent commercial and military requirements.

THE COMPANY

A worldwide network of manufacturing and distributing facilities with complete duplication of products and services strategically located to fulfill customer needs promptly and efficiently. A knowledgeable sales force backed by Field Service Engineers, Creative Analysis Teams, Employee Instruction Personnel, New Product Seminars, the AMP Mobilab, modern Research and Testing facilities and a Speed Order Service for fastest possible delivery of the product.

For a brief description of the products listed below, see the following pages:

- Coaxial cable and shielded wire products
- Pin and socket multiple connectors
- Programming devices
- Printed circuit connectors
- Taper technique
- Hermaphroditic connectors
- Application tooling
- Terminals & Splices

FOR FURTHER INFORMATION ON ANY OF THE PRODUCTS LISTED, CIRCLE THE READER SERVICE CARD NUMBER INDICATED NEXT TO THE PRODUCT.

AMP . . . PIONEER AND WORLD LEADER IN THE DEVELOPMENT AND MANUFACTURE OF SOLDERLESS TERMINAL AND CONNECTOR PRODUCTS FOR SPACE AGE ELECTRICAL/ELECTRONICS CIRCUITRY.

For specific information on all A-MP products, write to:

AMP
INCORPORATED
Harrisburg, Pennsylvania

INDUSTRIAL
SALES
DIVISION

A-MP products and engineering assistance available through subsidiary companies in: Australia • Canada • England • France • Holland • Italy • Japan • Mexico • Spain • West Germany

Automated Plant and Advanced Circuitry Shown

DURING A RECENT TOUR of the IBM Corp. facilities at East Fishkill and Endicott, N. Y., the press was introduced to a new microelectronic circuit family and to one of the world's most highly automated production lines.

The microelectronic circuits used in the IBM System/360 computer are made at the plant in East Fishkill. These Solid Logic Technology (SLT) circuits are printed on ceramic substrates $\frac{1}{2}$ in. sq., affixed with active components and covered with a protective covering. Each complete circuit (module) contains transistor and diode chips measuring only 0.028 in. sq. which are soldered to the circuit. These circuit modules are shipped to the Endicott plant for mounting in PC cards which are then inserted into the System/360.

The interesting feature of this operation is that computers are used in almost every step of the manufacturing process—from assisting engineers in preliminary circuit design—to testing finished circuit assemblies. They are used to convert engineering drawings to production data; simulate circuitry performance; maintain on-line control of manufacturing and testing machines; move production parts from one manufacturing operation to the next; perform in-process and final testing of every component assembly; and, monitor and analyze individual machine tool performance and automatically schedule machine maintenance. The computers have also been programmed to exchange information with other computers at IBM's new circuitry production facilities in Sindelfingen, West Germany; Corbeil-Es-

sonnes, France; Burlington, Vt.; and Owego, N. Y. These systems also handle more mundane tasks such as payrolls, purchase accounting, etc.

Use of the computers allows the company to meet their high-volume needs for complex System/360 components. And, this can be done without sacrificing reliability, economy or flexibility.

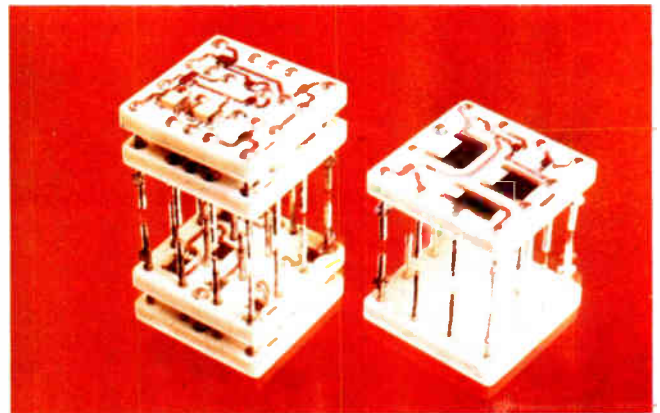

New IBM Corp. Advanced Solid Logic Technology (ASLT) circuit (left) and SLT circuit used in System/360 are placed on a mirror to show their top and bottom surfaces. "Piggyback" approach used in the ASLT version helps increase circuit speed.

In addition to the impressive automated manufacturing operation, members of the press were shown IBM's new high-speed microelectronic circuits. These ASLT (Advanced Solid Logic Technology) circuits are more than three times faster than the fastest logic circuits now being mass-produced by the company. Developed for use in the company's computers, the circuits have a basic time delay of less than 1.5 nsec. This increase in speed results from a new module packaging approach. In this approach, one layer of circuitry is mounted atop another in "piggyback" fashion (see photo), and components are placed on both sides of the substrate. Thus, pulses take less time to travel through the circuit due to the shortened electrical paths.

Speed of the new circuits is further increased by a circuit design method known as current steering, and by use of double and triple transistor chips.

In current steering logic, electronic impulses are directed by high-speed transistors over one of two possible circuit paths. These two paths provide the equivalent of the "on" and "off" circuit operation found in normal diode-transistor logic. But, the new circuits are always in the "on" condition, meaning that current flows continuously through the circuit paths.

MORE COLOR What's New on page 41.

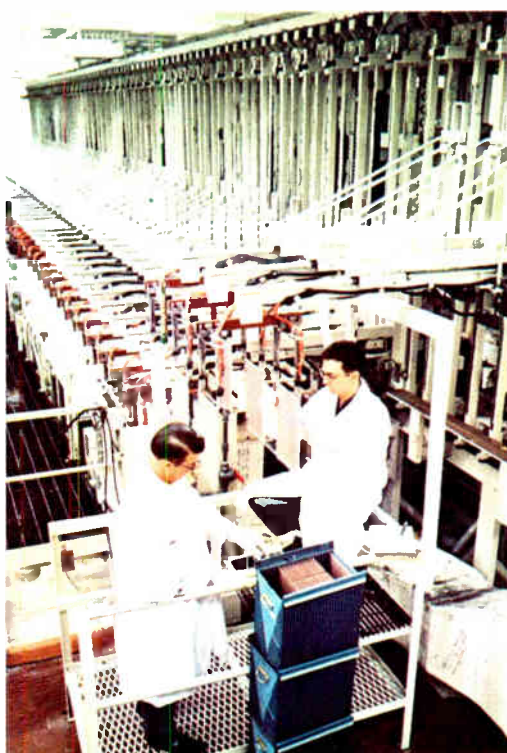

Laminated panels which form the PC cards of System/360 emerge from 86-ft. long machine after being coated with precisely controlled films of electroplated and electroless copper. The machine, at IBM's Endicott, N. Y. facility, is monitored by a 1710 control system.

SIGNALITE

COMPLETE LINE OF GAS DISCHARGE DEVICES



Spark Gaps — Two Electrode

Used for protection of electronic components . . . transfer of high energy. Use them singly or in various combinations. Select from a standard line of spark gaps that fit 400 volt to 50,000 volt applications.

Signalite recently purchased the entire Gas Discharge Tube Product Line of the Bendix Red Bank Division and now offers *Complete Engineering Capabilities* in the production, design, and application of gas discharge devices for your requirements. Feel free to contact us for any special design work. Our engineering staff will be pleased to serve you.

Signalite's high production capabilities insure that every standard gas discharge item in the catalog will be in stock — in quantity. Further, many specially fabricated assemblies can be supplied to you on short notice.



Triggered Spark Gaps

Switch high levels of energy faster and easier with low-energy-controlled triggered spark gaps. Hundreds of types are available covering the applied voltage range of 1,000 to 40,000 volts.



Miniature Gas Discharge Microwave Noise Generators

Reliable, inexpensive references for establishment of system receiver sensitivity levels. These small size and light weight units are ideal for system applications where space and power are limited. A full range of microwave noise generators is available. Specials can be supplied to individual requirements.

Gas Discharge Microwave Noise Source Tubes



Used in waveguide from L-band to Ka-band and with coaxial noise generators. Standard tubes are available for use in frequencies from 200 Mc to 40 Gc. Specials in the 40 Gc to 90 Gc range can be supplied.

Experimental He-Ne Laser

Output is 6328Å at approximately 1mW. All components are visible and unit is portable. Its use in basic physical optics experiments insures easier measurements and superior end results.



If there is a Gas Discharge Device or Glow Lamp to meet your needs, We'll have it.

For an introduction to Signalite's Gas Discharge Products Line . . .

Circle 21 on Inquiry Card

Your Single Source for Gas Discharge Tubes and Glow Lamps

VOLTAGE REGULATING TUBES WITH ± 1 VOLT TOLERANCE

These specifications cover only 2 of the 19 different voltage regulator tubes presently available. Reference voltages of 82, 91, 100, 103, 105, 115, 139, and 143 are in stock. All of them have that significant ± 1 volt tolerance. For more detailed specifications, write for Signalite Application Newsletter Supplement #1 or contact us and describe your particular applications.

Typical Characteristics		
	Z82R10	Z100R12
BREAKDOWN VOLTAGE (in Dark or Light) MAX	115	150
REFERENCE VOLTAGE (measured at)	82 ± 1 (2.0 MA)	100 ± 1 (3.0 MA)
VOLTAGE REGULATION (variation in reference voltage exhibited by individual tube) LESS THAN 1 VOLT CHANGE FROM	0.3 to 10.0 MA	0.6 to 12.0 MA
TEMPERATURE COEFFICIENT (TYPICAL)	-2mv / C	-9mv / C
LIFE EXPECTANCY (hours)	30,000 hours	30,000 hours

Tentative specifications subject to change without notice.

Some Proven Applications

- Reference Voltage Sources
- Regulated Power Supplies
- Oscilloscope Calibrators
- Photo Multipliers
- Zener Diode Voltage Sources
- Digital Voltmeters
- Timing Circuits
- Overvoltage Protection
- Suppressed 0 Voltmeters
- Frequency Dividers
- Indicating Voltmeters

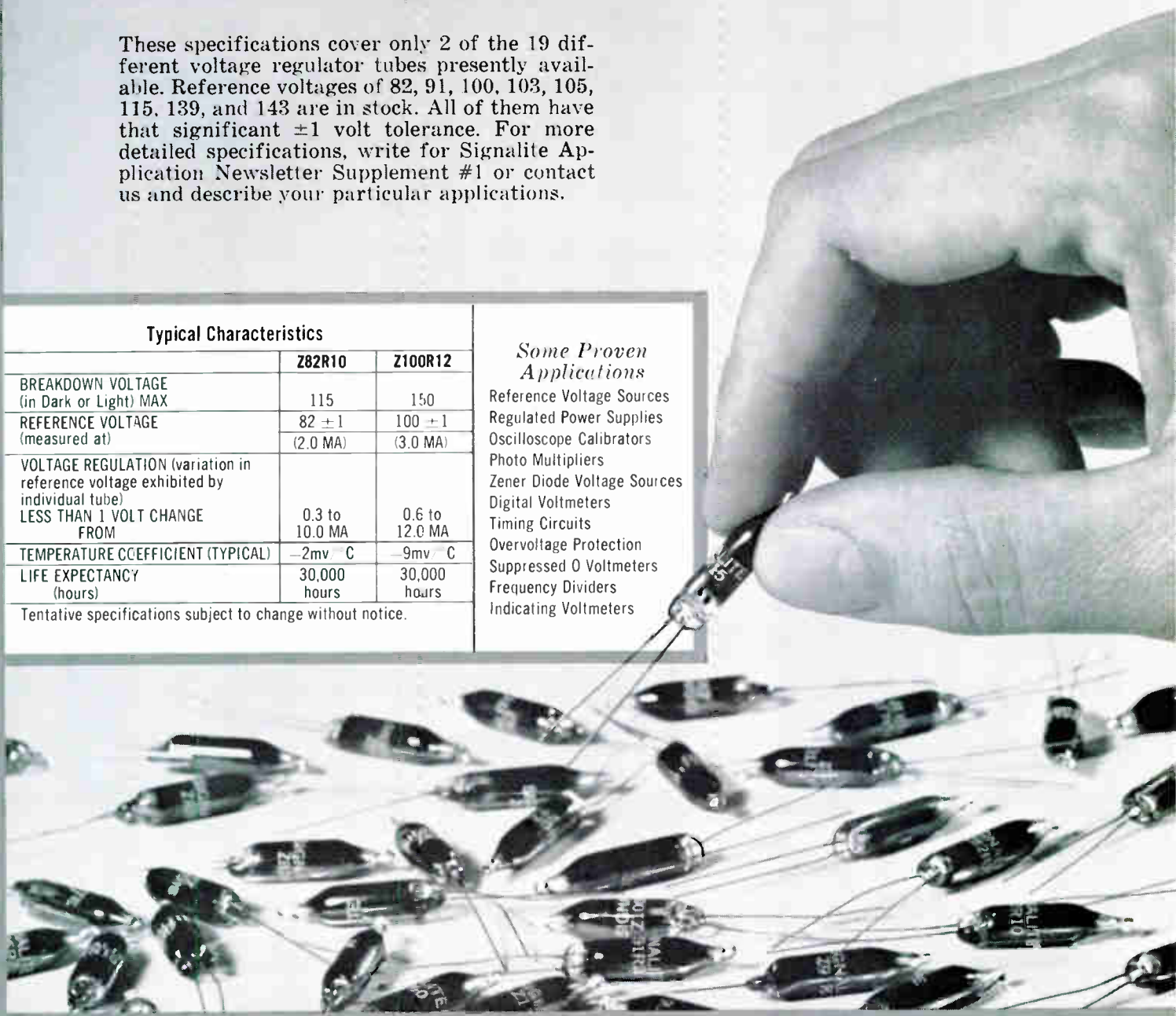

If there isn't, We'll Design it!



For your copy of the Signalite Application Newsletter, Supplement #1 . . .

Signalite

INCORPORATED

NEPTUNE, NEW JERSEY — 201-775-2490 — TWX 201-775-2255
Circle 87 on Inquiry Card

World Radio History

17...

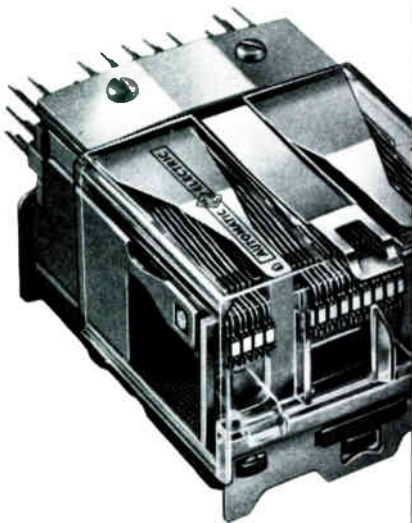

34...

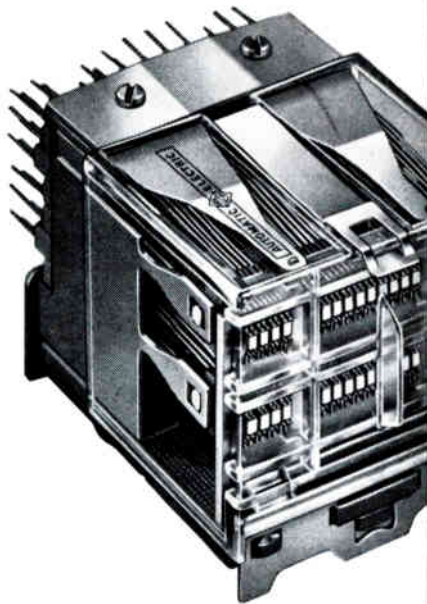

51...shift
or latch!

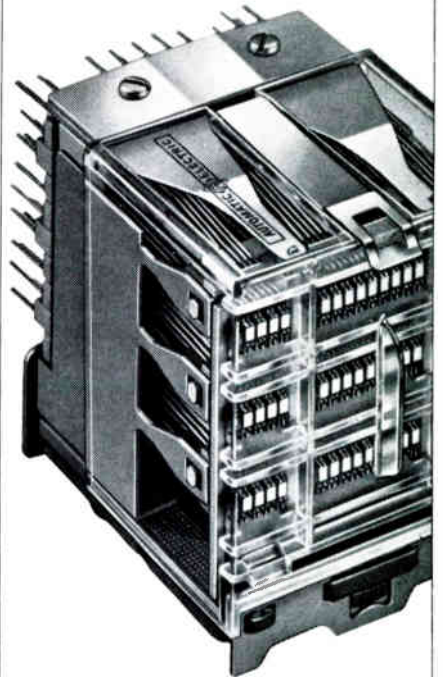

Assuring the simultaneous transfer of circuits in a multiple-relay group is one of the trickier problems faced by electrical and electronic engineers. AE's happy solution is the WQA Relay—the first industrial-control component specifically designed for uniform transfer of up to 51 circuits.

The modular construction of the WQA permits one, two or three rows of contact forms, each with a capacity for 17 circuit transfers. Unique, compact design saves valuable mounting space, replacing 4 or more "general-purpose" relays. Remarkably sensitive, even the largest pile-up requires less than 6 watts input. Continuing tests show a life expectancy of over 800 million operations without readjustment.

If you use latching relays, investigate the new WRM. It has

all WQA features plus a special one of its own. When pulsed on one winding, remanent magnetism keeps the WRM relay latched without power consumption until it is restored by a second pulse to its release winding.

For full information, ask for Circular 1957. Write the Director, Control Equipment Sales, Automatic Electric, Northlake, Illinois 60164.

AUTOMATIC ELECTRIC
SUBSIDIARY OF
GENERAL TELEPHONE & ELECTRONICS **GTE**

WHAT'S NEW

FREQUENCY MULTIPLICATION WITH POWER GAIN

AN "OVERLAY" TRANSISTOR which offers watts of power in the microwave frequency region has been developed by RCA Electronic Components and Devices, Harrison, N. J. The device, RCA 2N4012, extends transistor performance into the 1gc region with 2.5w. output and 4db conversion gain (min.) when operated as a tripler. One 2N4012 can replace both the transistor power-amplifier and varactor-diode stages previously required to achieve this performance.

The 2N4012 is ideally suited as the first stage of telemetry transmitters operating in 2.2gc band. This epitaxial silicon n-p-n planar transistor with an overlay emitter electrode structure provides high power as a freq. multiplier into the UHF, or L-band, freq. range for military and industrial communications equipment. It can be operated as a doubler, tripler, and even as a quadrupler with watts of microwave freq. power output.

Frequency multiplication—with power amplification—is possible with the overlay structure because the variable

The overlay structure used offers greater power output, gain, efficiency, and frequency capability.

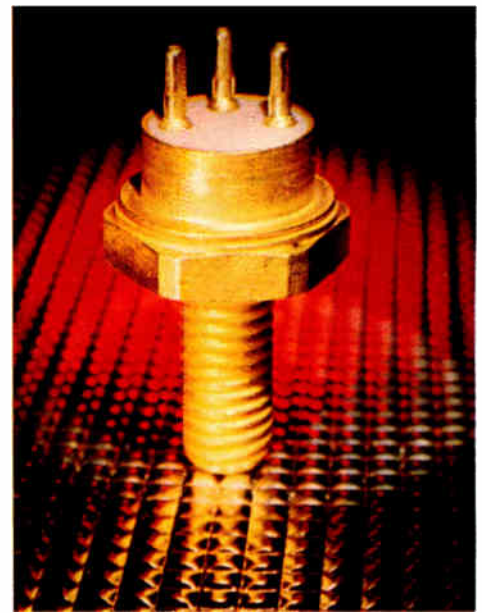

collector-to-base capacitance becomes the non-linear element of a harmonic generator. The collector-to-base capacitance acts like a variable-capacitance diode, or varactor, in parallel with the amplifier section of the transistor. In the overlay structure there are a number of individual emitter sites which are all connected in parallel and used in conjunction with a single base and collector region. This arrangement provides a substantial increase in emitter periphery for higher current or power, and a corresponding decrease in emitter and collector areas for lower input and output capacitances.

TESTER HANDLES ALL IC

EVERY INTEGRATED CIRCUIT CURRENTLY AVAILABLE can be tested by the Model 850A, according to its manufacturer, Signetics Corp., Sunnyvale, Calif.

Chief feature of the system is an internal magnetic

drum memory of 1.2 Megabit program capacity and an access time of about 16msec. This provides a normal internal storage capability of 166 different programs of 25 tests each. One or more test stations may be used in conjunction with the memory, so that devices of different types may be tested simultaneously and at locations some distance from the main frame.

Expansion of the system throughput capacity, therefore, does not require duplication of the entire system. This substantially reduces cost when doubling the system's test capability.

The tester can test devices with up to 16 terminals. Provision is made for optional expansion of this capability in increments of 16 terminals. Five programmable power supplies (four constant voltage and one constant current) are furnished as standard equipment, and three additional supplies can be added. The expandable interface connector system for devices under test, and the range of power supplies available allow the system to also test printed-circuit or modular assemblies and power supplies.

The 850A may be programmed manually from a keyboard. The system accepts input interfacing directly with a computer, or with prepared magnetic tape, perforated tape or card-punch programs, and includes a program verification display panel. The standard system provides a GO/NO-GO readout and all facilities necessary for the optional addition of DVM readout and data logging equipment.

(More What's New on page 43)

Tests every integrated circuit including 16-terminal devices.



Designing Circuits with CERMET* Passive Elements

Designers attracted by 10 to 300,000 ohms per square sheet resistance range and proven reliability record.

Economies realized from CTS mass production techniques and low tooling costs.

CTS CERMET resistance elements are produced by screening formulations of conductive, resistive, and insulating materials onto ceramic substrates. After firing above 650°C, a semiconducting matrix is formed which is permanently bonded onto the dielectric substrate.

Since the middle '50's, the CERMET resistance element has been designed successfully into many types of resistor-capacitor modules and microcircuits. Apollo, Tiros, Minute Man, Talos and numerous other high performance military and industrial applications use CERMET resistors.

Wide resistance range simplifies design, improves performance, saves space and provides design flexibility.

The designer is offered an unusually wide range of sheet resistance from 10 to 300,000 ohms per square. Short straight resistance paths, in a range from 10 ohms to 10 megohms, simplify design, reduce size and improve frequency capabilities. For example, at 100 ohms, resistance is constant to at least 250 mc. Other resistance values have limited predictable change through several hundred megacycles.

192,400,000 hours of unmatched reliability

See Table I for the story of unmatched reliability of the CERMET resistance element.

Tests are run continuously on sample quantities from current production.

Typical CERMET resistor module test data

CERMET resistors from 50 ohms to 100K ohms were applied to both sides of a .310" x .310" x .010" ceramic dielectric substrate.

1) Temperature Cycling—168 resistors tested: Substrates were subjected to 5 cycles from -65°C to +125°C. Each temperature noted was held for 30 minutes.

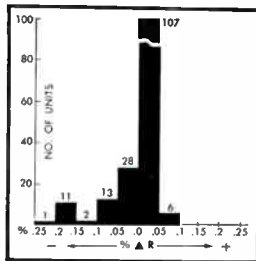

2) Short Time Overload—2876 resistors tested: Resistors were subjected to 6¼ times rated wattage for 5 seconds per MIL-R-10509B.

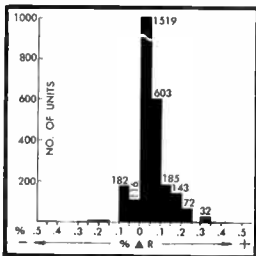

3) Moisture Resistance—168 resistors tested: Substrates were tested per Method 106A, MIL-STD-202B, ½ watt per resistor, 93% to 95% RH, 10 cycles.

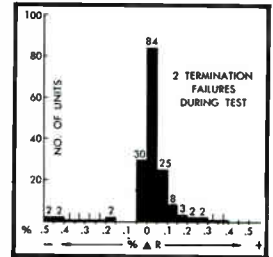

Economy

Low tooling and start-up costs effect significant economies for CERMET circuitry over integrated circuits. Cost savings are also substantial over discrete components, including elimination of interconnections, much smaller physical size, and the elimination of costs incurred in purchasing, stocking, handling and inserting various components. Additional economy is effected by efficient CTS proprietary mass production techniques.

Other design parameters

In addition to wide sheet resistance, unequalled reliability and economy, CERMET resistors and capacitors offer the designer these additional characteristics:

- 1) Stability at end of life: ±2% for resistors, ±3% for capacitors.
- 2) Low temperature coefficient over a wide temperature range: For resistors; ±200 PPM/°C (T.C. on individual substrates can be matched to ±25 PPM/°C.) For capacitors: -300 to -700 PPM/°C.
- 3) Low current noise: -30db at 100 ohms per square.
-10 db at 10K ohms per square.
+20db at 300K ohms per square.
- 4) Initial tolerances as low as ±0.10% for resistors, ±2% for capacitors.
- 5) Moisture resistance: less than ±1% change under ordinary humidities. For extreme humidity conditions, encapsulation or cover coat is recommended to maintain ±1% max.
- 6) Vibration, shock and abrasion resistant because all CERMET passive circuit elements and conductors are fused to the substrate and to each other.
- 7) High overload capacity due to superior heat sink capability.
- 8) Relatively low capacitance losses—dissipation factor less than .002 ("Q" greater than 500) @ 1 Meg C—before and after processing and throughout life.
- 9) Very low (0.5pf max.) parasitic capacitance introduced by CERMET crossover and parallel conductors.

Unaffected by severe environments

The CERMET resistance element is virtually indestructible. It remains unaffected by the most severe environmental conditions

*Trademark of CTS Corporation

TABLE 1 RELIABILITY DATA	RELIABILITY	FAILURE RATE	RESISTANCE	POWER DENSITY	
	95% Confidence Level ±3% Failure Criterion	95% Confidence Level ±3% Failure Criterion	RANGE	Watts/sq. inch of resistor area	Watts/sq. inch of substrate area
A. 12.4 million resistor hours documental 10,000 hours with ½ watt per substrate; 97° C ambient resulting in a 125° C hot spot temp.; encapsulated, 1236 resistors; ½ watt applied to each resistor; 1½ hours ON, ½ hour OFF.	99.962% per 1,000 hours	0.038% per 1,000 hours	47 ohms to 100K ohms	9 to 55	5
B. 94 million resistor hours documented 10,000 hours with 1.2 watts per substrate; 25° C ambient resulting in a 116° C hot spot temp.; unprotected resistors; 9420 resistors; 0.1 watt applied to each resistor.	99.990% per 1,000 hours	0.010% per 1,000 hours	50,000 ohms	11.4	3.2
C. 86 million resistor hours documented 10,000 hours with 1 watt per substrate; 25° C ambient resulting in a 99° C hot spot temp.; unprotected resistors; 12,000 resistors; 0.1 watt applied to each resistor.	99.9946% per 1,000 hours	0.0054% per 1,000 hours	1K to 55K ohms	8.6	2.6

WHAT'S NEW

QUALITY CONTROL ON WHEELS

A MOBILE QUALITY CONTROL LABORATORY, which delivers precision testing capabilities, will be available to industry as of Jan. 1, 1966. The new Mobile Quality Services (MQS) will feature fully self-contained quality control laboratories in a specially equipped van that will visit manufacturing plants on a scheduled basis to perform instrument calibration and other quality services.

The vehicles, called Mobile-Q-Labs, will function as secondary standards laboratories, with all measurements traceable to the National Bureau of Standards. Mechanical measurements will be accurate to 0.000001 in., electrical measurements to 0.03% (individual instruments to 0.001%), freq. and time measurements to 1 count/10⁶, and temp. measurements to 0.001°F. With MQS, manufacturers can upgrade their precision and hold tighter quality controls without additional investment in precision measurement equipment and inspection personnel.

Among the services offered by the MQS program are: establishment of quality-control procedures; quality-control personnel training; assistance in bidding for contracts with high quality-control requirements; precision mechanical, electrical and electronic inspection; calibration of mechanical, electrical and electronic inspection equipment; and certification of production tools, jigs and fixtures.

The MQS program will particularly benefit companies seeking defense contracts who have either not had experience or acquired the test and measurement facilities required for this type of work. The mobile laboratories will be operated by Wheaton Engineering Div., Hurlington Ind., Wheaton, Ill.

Mobile quality control lab. delivers precision testing capability to small businesses and supplements the facilities of larger industries. Its personnel will aid those bidding for contracts which require high quality control procedures, and train personnel in test procedures.



and oxidizing atmospheres up to 500°C. Designers are using CTS CERMET resistance elements successfully under such adverse conditions as nuclear radiation, solvents and cesium atmospheres.

Packaging techniques

An infinite array of package designs to fit every designer's need is possible with CERMET circuitry. TO-5 headers, flatpacks, or various sizes and shapes of molded housings can be used. Round or flat leads can be attached in any configuration parallel or perpendicular to the substrate. Leads can be bonded to pads, swaged into the substrate or anchored through holes in the substrate.

Three classes of CERMET elements available to designers

- 1) Element groupings: Resistor modules, capacitor modules, and resistor/capacitor modules. All are available with or without assembled active devices such as dice, flip chips, and pico, micro or conventional leaded types.
- 2) Interconnections: In addition to the fired conductive network, pads can be provided for soldering, welding, alloying, die bonding, thermocompression, ultrasonic and wedge bonding, beam lead bonding, and flip chip bonding.
- 3) Auxiliary elements: Edge-around conductor, plated-through-hole conductor, lead crossover, insulative cover, and reconnect conductor.

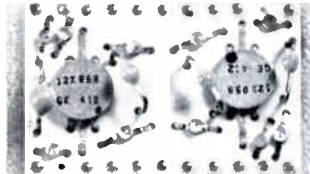

Top view of CTS hybrid integrated circuit showing attached discrete components and terminal pins soldered through holes in substrate.



TO5 header showing cermet resistors and transistor dice.



Enlarged view of flip chip assembly to ceramic substrate with platinum gold conductors.

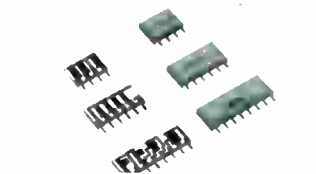

750 series resistor network package. Modules on left show circuitry before coating.

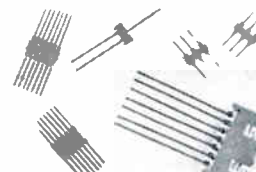

Typical cermet passive circuit modules with leads attached.

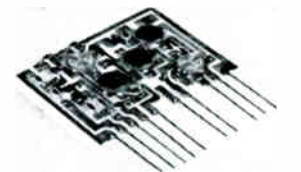

CTS hybrid integrated circuit showing attached discrete components soldered to terminating pads.

Delivery

4-5 weeks for prototypes, 5-6 weeks in production quantities. Several hundred thousand CERMET microcircuits are being shipped by CTS weekly.

Latest data available to designers

Many of the nation's leading designers have already been attracted by the unique properties and design flexibility of CTS CERMET elements. Great strides have been made every year by CTS engineers in the art of microcircuitry. Send for the latest technical data or forward your circuit. CTS engineers will analyze your requirements and recommend a CERMET microcircuit design to your exact specification. Just contact your nearest CTS office or rep.

Sales offices and representatives conveniently located throughout the world.

founded 1896



CTS CORPORATION
Elkhart, Indiana

Circle 23 on Inquiry Card

MICROVOLT STANDARD

Has 0.01% accuracy. Voltage includes 1 μ v. to 11vdc.

This highly portable voltage standard/source, Model MV-100N, weighs 8 lbs. It is completely short circuit and overload proof with no zeroing or calibrating. Short term stability is 0.001%. A protected, built-in nullmeter provides for potentiometric measurements. Price is \$745.00. Electronic Development Corp., 423 W. Broadway, Boston, Mass. 02127.

Circle 125 on Inquiry Card



REED-TYPE SWITCHES

Miniature switches can be operated by both cam and pushbutton.

The GRI series are hermetically sealed pushbutton switches of the dry-reed type. They are available in sizes as small as 0.625 x 0.375 in. dia. (including panel). A new dry-reed design uses permanent magnetic lines of force to open and close switch contacts. This results in fast closure time, low bounce and positive contact holding pressure which is completely independent of actuating pressure. Switches are available with contact ratings up to 3a. Standard dielectric strength is 500vac and insulation resistance is 100 megohms. Both actuating pressure and travel required for actuation can be adjusted to customer spec. George Risk Industries, Inc., Columbus, Nebr.

Circle 126 on Inquiry Card

FREQUENCY MULTIPLIER

Varactor freq. multiplier provides mw of output power at 60cc.

Model MT 1113 provides state-of-the-art efficiency in tripling 20GC input signals to 60GC output signals. Principal uses are in radiometry and in extending K-band equipment into the millimeter range. Input power is 300mw max.; conversion efficiency is -15db typical. American Electronic Laboratories, Inc., P. O. Box 552, Lansdale, Pa.

Circle 127 on Inquiry Card

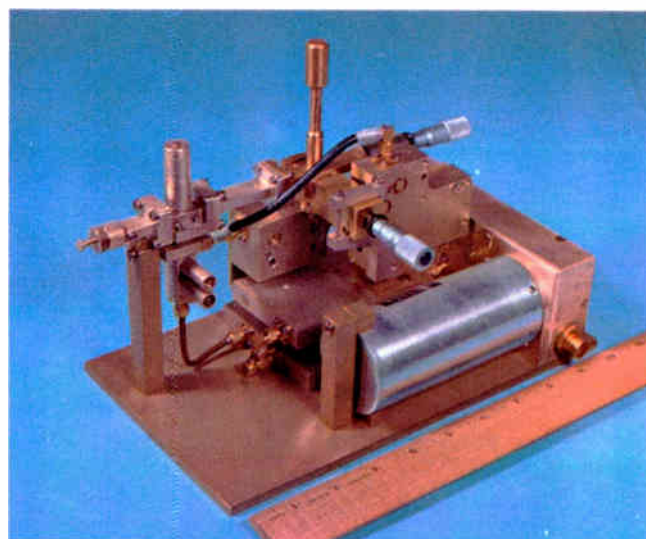

TRUE HERMETIC SEAL

Allows standard capacitors to operate at 125°C in 10⁻³ Torr.

With this hermetic seal, it is possible to buy standard capacitors that have the reliability of higher cost units. These tantalum-foil capacitors, designated CL-20 through CL-27 and CL-30 through CL-37, cost slightly more than units without this seal. All capacitors in this series meet MIL-C-3965, and life tests have exceeded 28,000 hours without failure. General Electric, Electronic Components Div., Irmo, S. C.

Circle 128 on Inquiry Card

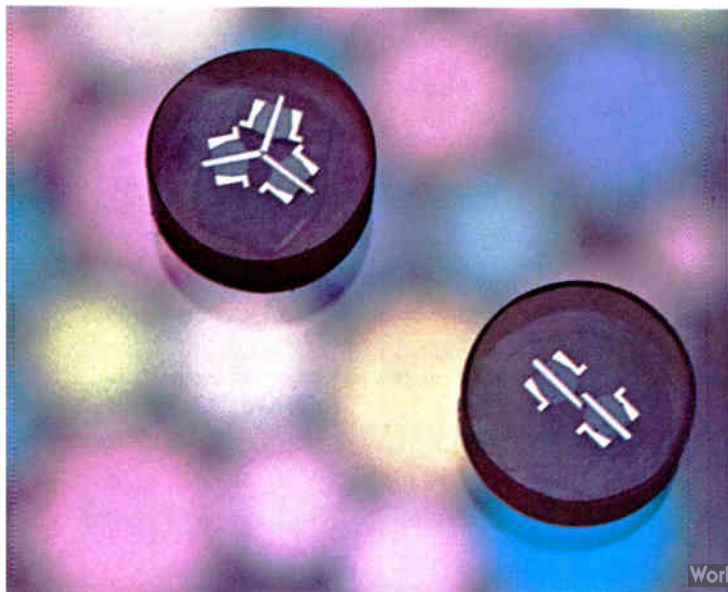

DATA ACQUISITION SYSTEM

Formats jet engine data for direct entry into digital computer.

Model 5013 allows the user complete freedom in selecting desired system functions to satisfy his requirement. Basic system accepts 16 single-ended analog signals $\pm 5.120v$. full scale (2.5mv/bit) for full 12-bit resolution. Sequential address data for multiplexer sampling is generated by the system programmer. The programmer receives its clock from the A/D converter for 50,000 samples/sec. operation, or from external sources for lower sampling speeds. Radiation Products, Melbourne, Fla. 32902.

Circle 129 on Inquiry Card

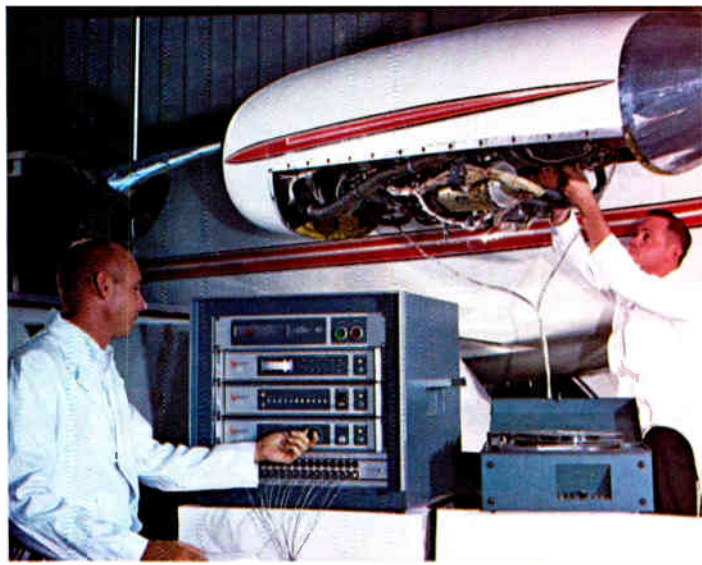

REDUCE SIGNAL LEAKAGE

Cooling system does not generate RFI. Uses advanced shielding.

This unique motor does not generate RFI/Mil-I-16910 and uses advanced shielding and packaging techniques. The combined techniques solve the problem of uncontrolled signal leakage either inward or outward in the cooling airstream. The package is ready for quick, easy installation in shielded electronic cabinets. They exceed the requirement of Mil-I-6181D and provide 100db attenuation through the range 15KC to 10GC. All have low audible noise level and are without r-f noise generation or transmission. Airflow ratings are 150, 300, 350, 500, 800 and 1000 CFM. McLean Engineering Laboratories, P. O. Box 228, Princeton, N. J. Circle 130 on Inquiry Card



HIGH-MEG RESISTORS

The HR600 series have resistances from $10^8\Omega$ to $10^{14}\Omega$. This miniature hermetically glass-sealed resistor operates at voltages up to 1kv and temps. up to $150^\circ C$. Tolerances are 2, 5, and 10%. The HR600 measures 0.526×0.110 in. dia. Pyrofilm Resistor Co., Inc., 3 Saddle Rd., Cedar Knolls, N. J.

Circle 131 on Inquiry Card

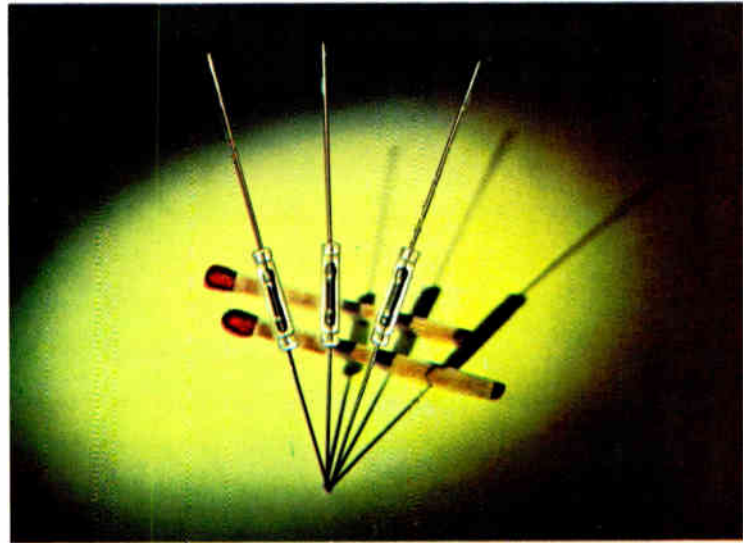

SPUTTERING SYSTEM

Used for depositing thin-film circuits or encapsulating them.

This unit is an accessory to Consolidated Vacuum's Plasma-Vac triode sputtering system. It deposits the dielectric in thin-film capacitors, encapsulate thin-film and integrated circuits, and carries on surface passivation of semiconductors. The major parts of the r-f accessory are multi-freq. driver and power amplifiers, an impedance-matching network, an r-f coaxial feedthrough, and a target assembly. The unit operates on standard freqs. Its multi-freq. capability permits the operator to select the 1 freq. best suited to his special target configuration and process requirements. Consolidated Vacuum Corp., 1775 Mt. Read Blvd., Rochester, N. Y.

Circle 132 on Inquiry Card

MORE ►

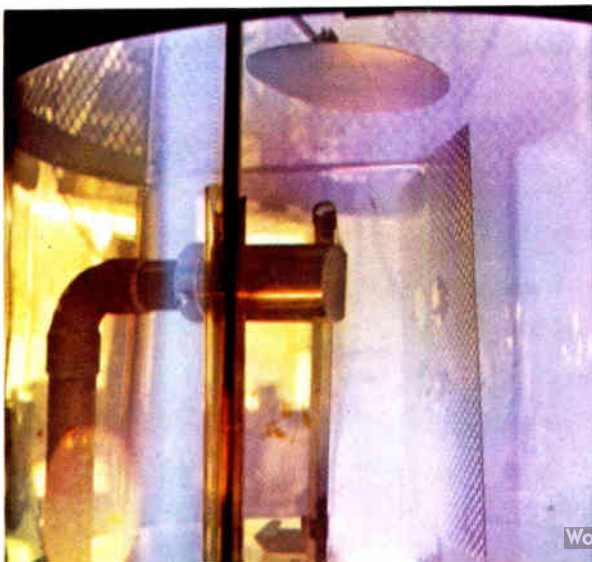



COMMUNICATION / COMPUTATION / CONTROL • COLLINS RADIO COMPANY / WORLD HEADQUARTERS / DALLAS, TEXAS

Look Into Collins Narrow-Band Crystal Filters!

They Give You

Computer-Assisted Designs
Newly Reduced Production Prices
Fastest Prototype Delivery (3-week)
— Plus Collins Quality

Over 5 kc — 60 mc Range

For any of the following designs:

Butterworth	TBT	Elliptic Function
Chebyshev	Predistorted	Band Reject
Linear Phase	Comb Set	Prescribed Transfer Function

For prompt response, contact Collins Components Sales, 19700 Jamboree Road, Newport Beach, California

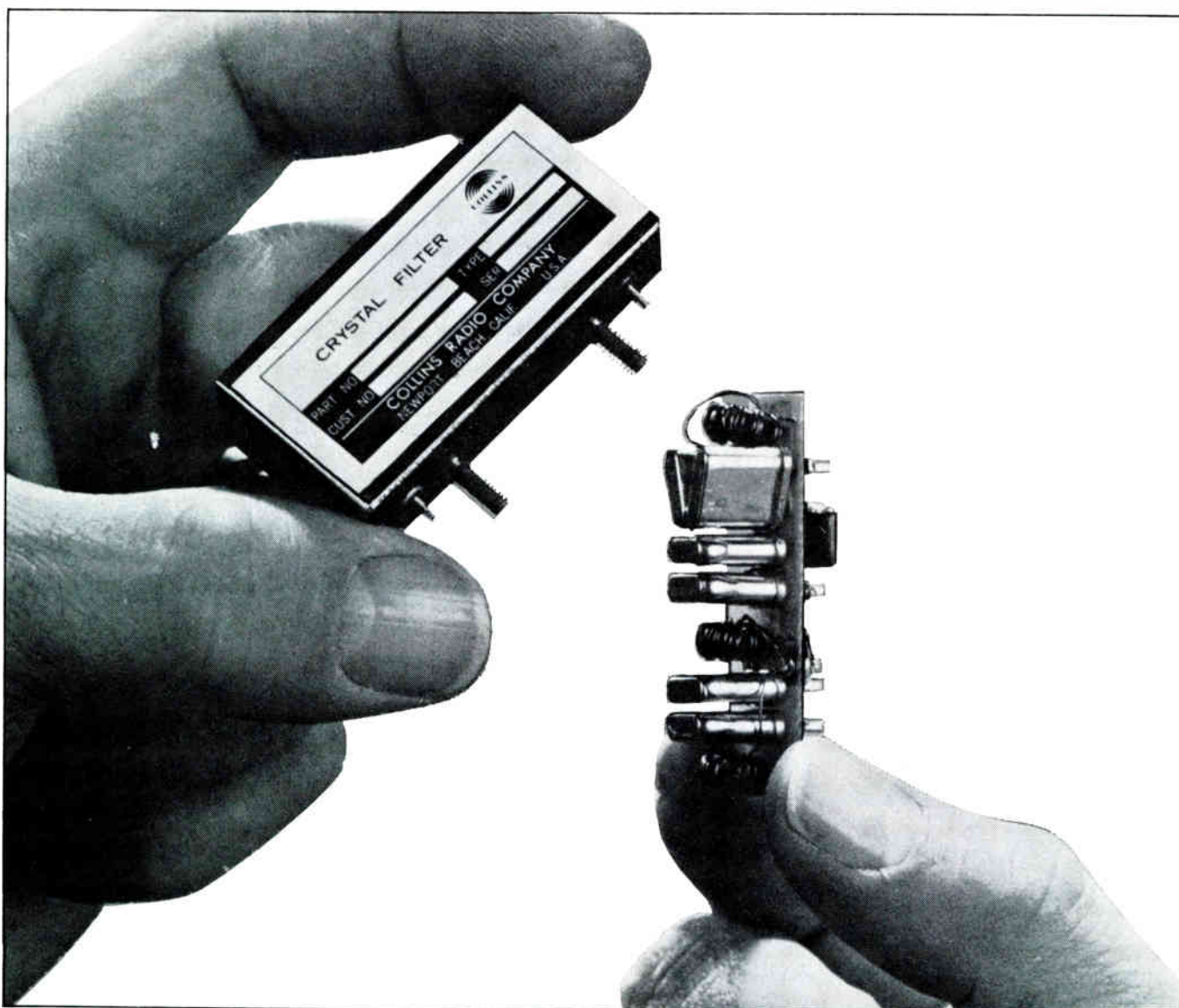

QUALITY, VARIETY SERVICE

...that's the story of "Ohmitran" v. t.[®] variable transformers

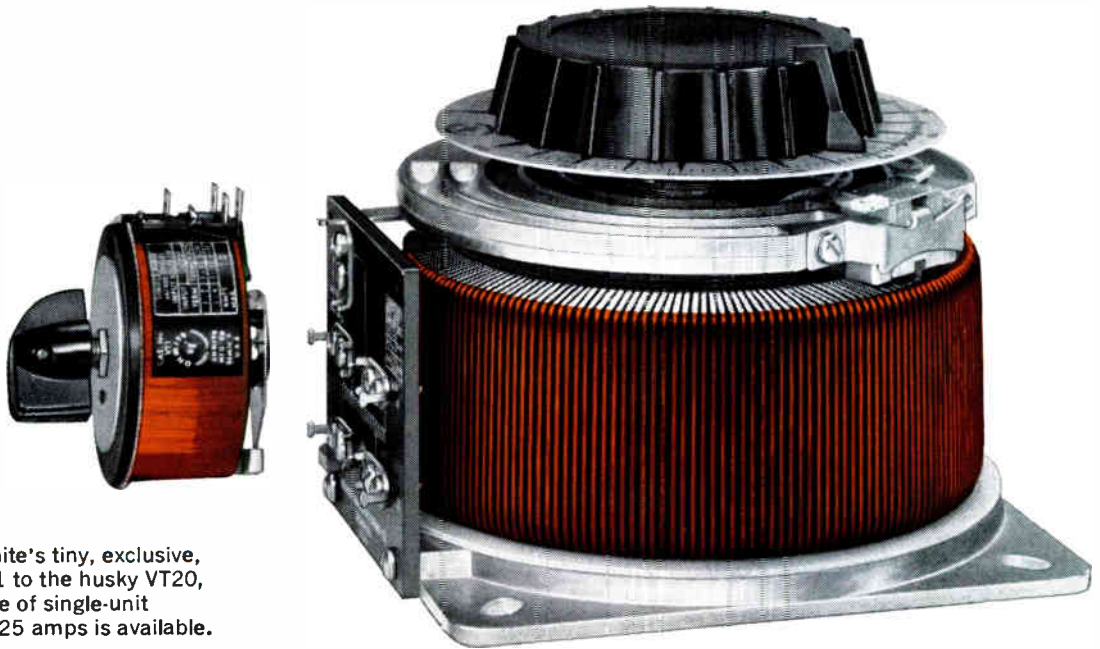

From Ohmite's tiny, exclusive, 1-amp VT1 to the husky VT20, a full range of single-unit ratings to 25 amps is available.



SATISFY yourself . . . eliminate irritating variable transformer difficulties with Ohmite's famed reliability and long service life. In any piece of equipment, an Ohmite component indicates that there has been no compromise with quality.

MEET virtually all your requirements from Ohmite's big selection. Single units start with a tiny (and exclusive) 1-amp model, extend through heavy-output models of 25 amps. For single and/or ganged models,

voltage inputs begin below 40 volts, run to 480 volts. There are assemblies for 3-phase applications, too, plus models in stationary or portable cases—with meters if you like. Most are stocked for fast delivery.

EASE engineering headaches by taking advantage of Ohmite's ready-to-ship stock of standard units, or willing advice and service on units for special applications. Bone up on the broad aspects of Ohmite's complete variable transformer service by requesting *Catalog 500*.

**RHEOSTATS • POWER RESISTORS • PRECISION RESISTORS • VARIABLE TRANSFORMERS • RELAYS
TAP SWITCHES • TANTALUM CAPACITORS • SEMICONDUCTOR DIODES • R.F. CHOKES**

OHMITE

MANUFACTURING COMPANY
3662 Howard Street • Skokie, Illinois 60076
Phone: (312) ORchard 5-2600



New products

REUSABLE CONNECTOR

Installed quickly and easily and are ready for immediate use.

The Timatch connectors are re-usable. Repeated assembly and disassembly operations do not impair either the r-f or physical characteristics of the connector or cable. Its 1-piece construction incorporates all components into the connector body. With all components matched and pre-positioned during manufacturing process, uniform mechanical and electrical characteristics, fast installation and long-term reliability are achieved. The connectors are available in all popular sizes and fit all metal tube sheathed coaxial cables. Times Wire & Cable, Wallingford, Conn.

Circle 133 on Inquiry Card



DATA PROCESSOR

Memory cycle, 1.75μsec. Computation, 285,000 additions/sec.

Programmed Data Processor-7 is a general-purpose, single-address binary computer. It has a fixed 18-bit word length, and uses 1's and 2's complement arithmetic to facilitate multiprecision arithmetic. Software includes a FORTRAN compiler, a symbolic assembler, and floating-point arithmetic. The use of integrated circuits greatly increases reliability. Digital Equipment Corp., Maynard, Mass.

Circle 134 on Inquiry Card

RADIOMETER

Precision unit measures temp. without contact.

Mark 1X measures temp. even where rapid variations as short as 1msec. occur. Spatial resolution is 0.03 in. at 1 ft. Uses include flame temp., weld flaw inspection, re-entry studies, temp. measurement of fragile surfaces, explosions, and spectral measurements with two 8-position filter wheels. A built-in reference provides accuracy under changing conditions. An emissivity control compensates for radiating efficiency of different materials. Focusing range is from 1 ft. to infinity and non-parallax sighting is included. Huggins Laboratories, Inc., 999 E. Arques Ave., Sunnyvale, Calif.

Circle 135 on Inquiry Card

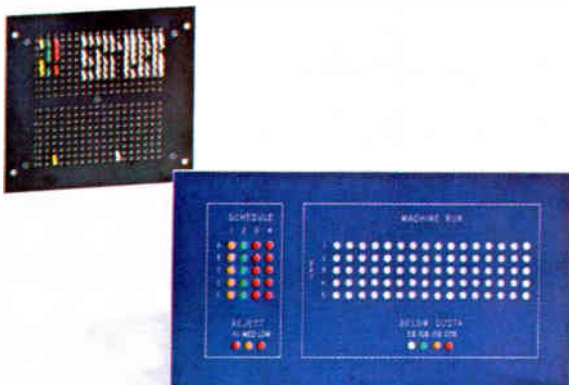

VISUAL DISPLAY READOUTS

Data display panels work with cordless matrix programmer.

These visual information display panels are activated by a matrix board. Inserting a single program pin into the cordless matrix programmer causes an indicator lamp to light. The product is suitable for indicating circuit errors, or it may be used to provide visual data displays in an area remote from the programming operation. In this way changing statistics, status, or emergency situations can be simultaneously displayed in several locations while activated by an operator using a single program board. Seaelectro Corp., 225 Hoyt St., Mamaroneck, N. Y. 10544.

Circle 136 on Inquiry Card

MORE ►

sampling made simple



with your existing
Type 530, 540, 550,

or 580 Series Oscilloscopes

Here's a new dc-1 GHz sampling unit with operation practically as simple as conventional plug-ins—as you can see by the front panel of the sampling plug-in. You need no pretriggers or external delay lines—the 1S1 unit has internal triggering with a built-in delay line.

Many other features add to the capabilities and operating ease of the Type 1S1, such as:
A tunnel-diode trigger circuit that insures stable triggering through 1 GHz • A single control to select the sweep rate and magnify the display up to X100 when desired • Direct readout of the sweep rate even when magnified • A dc-offset control that permits observation of millivolt signals in the presence of up to ± 1 volt input levels • Less than 1 mV noise in the display, with a smoothing control for further reduction • Output signals available at the front panel for driving chart recorders—and for powering an auxiliary time domain reflectometer pulser unit.

BASIC CHARACTERISTICS

RISETIME ≤ 0.35 ns. SENSITIVITY from 2 mV/cm through 200 mV/cm, in 7 steps. DYNAMIC RANGE ± 2 V. Safe overload is ± 5 V. DC OFFSET range is greater than ± 1 V. SWEEP RATES from 100 ps/cm to 50 μ s/cm, with $\pm 3\%$ accuracy normal or magnified. SAMPLES/CM continuously variable. TRIGGERING ac-coupled, \pm internal, \pm external, and free run. DISPLAY MODES are repetitive, single display, manual scan, or external scan. VERTICAL OUTPUT is 200 mV per displayed cm through 10 k. HORIZONTAL OUTPUT is 1 V per displayed cm through 10 k.

Type 1S1 Sampling Plug-In Unit \$1100
Type 281 TDR Pulser Unit \$95

U.S. Sales Prices, f.o.b. Beaverton, Oregon

*used with Type 81 Plug-In Adapter.

For a demonstration,
call your Tektronix field engineer.

Tektronix, Inc.

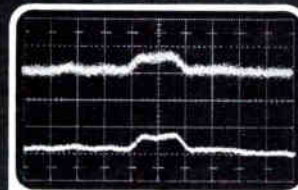

Tangential Noise
Display of a 1 mV, 2 ns wide pulse, externally triggered. Upper waveform is unsmoothed, the lower is smoothed.
2 mV/cm—1 ns/cm

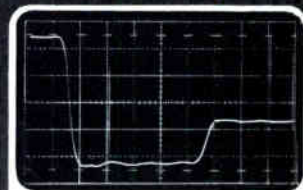

Time Domain Reflectometry (TDR)
Display (with 281 Pulser) of 50 Ω system, with transition to a 25 Ω system. Any portion of the display can be expanded vertically and horizontally for more detailed analysis.
100 mV/cm—5 ns/cm

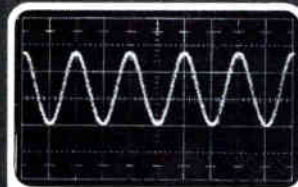

Triggering At 1 GHz
Display of a 1 GHz sine wave internally triggered
100 mV/cm—0.5 ns/cm

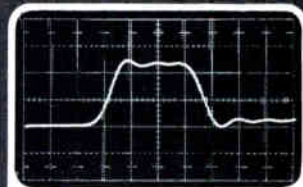

Pulse Triggering
Display of a 50 mV, 2 ns wide pulse, internally triggered.
20 mV/cm—0.5 ns/cm

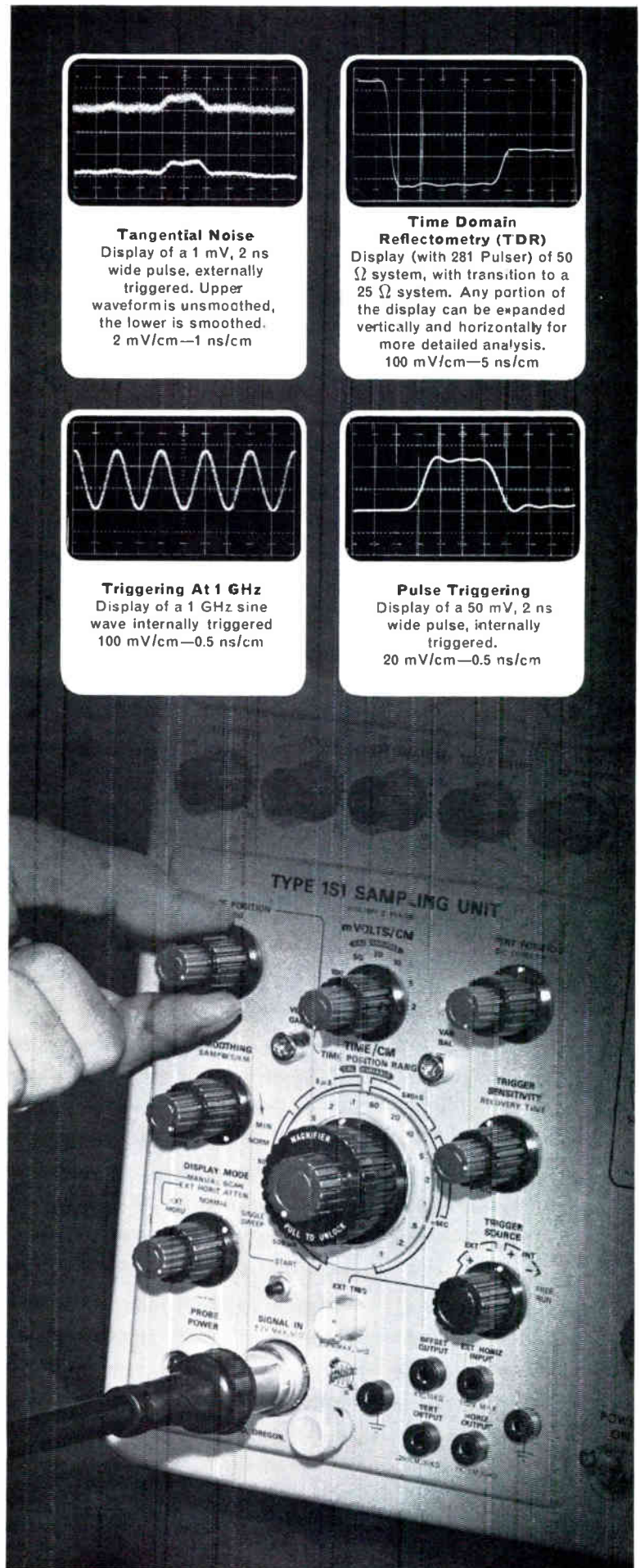



new 260[®]SERIES 5 VOM

We're at it again... making the 260[®] a better buy than ever. This latest improvement is built-in meter protection... standard on regular* 260 volt-ohm milliammeters—Series 5 and 5M.

It prevents mechanical damage to the moving element in the movement from instantaneous overloads up to 1,000,000%, or steady state overloads up to 500,000%. It also stops overheating or burnout of the armature coil, damage to hair springs, and calibration change due to high overloads. Otherwise the famous 260 remains unchanged.

If you now have a Series 1, 2, 3, or 4, 260 VOM, you can install your own meter protection. Ask your electronics distributor for a Simpson meter "safe/guard[®]." It takes only minutes to install.

260-5 with new meter protection..... \$4995

260-5M (mirror scale) with meter protection..... \$5195

*260-5P has both meter and circuit protection except on the 1000V and 5000V DC and AC ranges, and the 10-amp DC range. Price \$78.95

RANGES (20,000 o/v DC; 5000 o/v AC)

DC VOLTS: 0-0.25; 0-2.5; 0-10; 0-50; 0-250; 0-1000; 0-5000

AC VOLTS: 0-2.5; 0-10; 0-50; 0-250; 0-1000; 0-5000

DC MICROAMPERES: 0-50 (250 MV Drop)

DC MILLIAMPERES: 0-1; 0-10; 0-100; 0-500

DC AMPERES: 0-10 (250 MV Drop)

RESISTANCE RANGES: RX1 0-2000 ohms (12 ohms center) RX100 0-200K ohms (1200 ohms center) RX10K 0-20 megohms (120K ohms center)

ACCURACY: DC, ±2% F.S.; AC, ±3% F.S.

Write for Bulletin 2070 showing the entire line of Simpson VOM's



SIMPSON ELECTRIC COMPANY
 5213 W. Kinzie Street, Chicago, Ill. 60644 • Phone: (312) ESTbrook 9-1121
 Representatives in Principal Cities... See Telephone Yellow Pages
 Export Dept: 400 W. Madison St., Chicago, Ill. 60606 Cable, Amergaco
 In Canada: Bach-Simpson Ltd., London, Ontario
 In India: Ruttonsha-Simpson Private Ltd., Vikhroli, Bombay

WORLD'S LARGEST MANUFACTURER OF ELECTRONIC TEST EQUIPMENT



Belden has it...

Every electronic and electrical wire you need—from the finest drawn magnet wire to the most complex multi-conductor cables.

There is a Belden wire or cable in every insulation and shielding to meet your application and design needs. Here is just part of this complete line. Available from stock. Ask your Belden electronics distributor for complete line information or write for catalog. Request also a copy of A Buyers' Guide to Specifying Electrical Wire and Cable.



















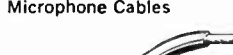









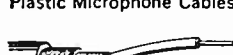











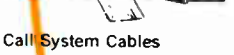

3 REASONS WHY Belden is the most specified line

1. **Basic Manufacturer**—Belden draws its own wire—compounds its own insulations for complete quality control.
2. **Research and Testing**—All Belden wire and cable are laboratory tested to guarantee insulation and conductor efficiency. Lab test data available.
3. **Design and Engineering Service**—Belden has a completely staffed design and engineering department to help customers meet unusual wire application or design requirements.

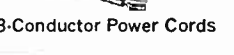
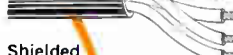
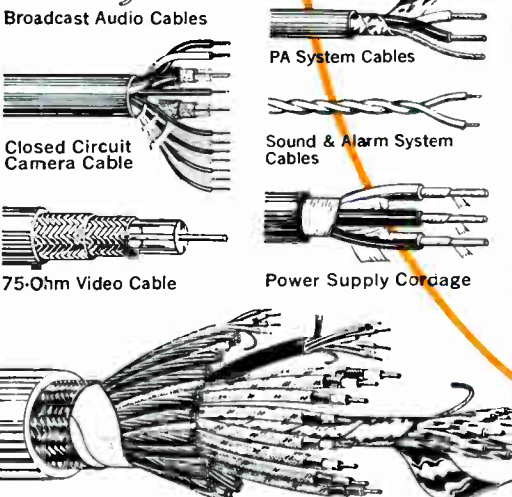
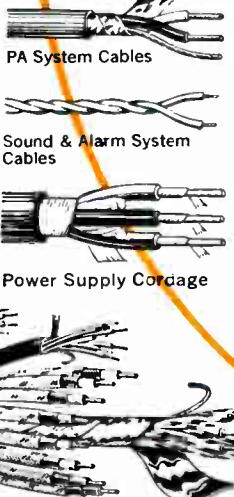
Better Built... Better Buy...

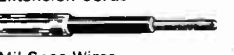

BELDEN MANUFACTURING COMPANY • P.O. Box 5070-A • Chicago, Illinois 60680

 Cathode Ray Tube Lead	 Miniaturized Cables	 Magnet Wire	 Automation Cable	 Miniature Microphone Cables
 Shielded Power Supply Cables—Rubber or Vinyl	 Grid Wires	 60 KV D.C. High Voltage Cable	 Language Lab Cables	 Control Cables
 Plastic Microphone Cables	 Multi-Conductor Cables	 TV Distribution Cables	 Miniature Coaxial Cables	 Unshielded Audio Cables
 Shielded Interconnecting Cables	 Low Impedance Lines	 Multiple Pair Individually Shielded RF Cables	 RG/U Transmission Line Cables	 Shielded Control Cables
 Strain Gauge Cables	 Call System Cables	 Test Prod Wires	 3-Conductor Power Cords	 Rubber Microphone Cables
 Broadcast Audio Cables	 PA System Cables	 2 & 3 Conductor Extension Cords	 Hook-Up Wires	 Coiled Test Prod Wire
 Closed Circuit Camera Cable	 Sound & Alarm System Cables	 Mil-Spec Wires	 Duplex Wires	 RG/U Cables
 75-Ohm Video Cable	 Power Supply Cordage	 Lamp Cordage	 Teflon* Hook-Up Wires	 Shielded Cables
 Color, Studio, Camera Cables	 Industrial Audio & Sound Wires	 Coiled Cords	 Multiple Pair Cables	 Miniature Audio Cables
		 Multiple Pair Individually Shielded Audio and Data Cables	 Shielding & Bonding Cable	 Special Sound Cables

*DuPont Trademark

8-1-4

New products

DIGITAL READ-OUT

The incandescent lamps of DT1511 provide clear, white characters with a minimum brilliance of 500 ft.-lamberts at 4.0v. Characters lose none of their legibility even when viewed at an angle of 150°. Viewing surface is a single, integrated block with characters precisely aligned in the same plane. Seven-segmented characters have high contrast between "on" and "off" segments, resulting in unequalled clarity. Tung-Sol Electric Inc., Newark, N. J. 07104.

Circle 137 on Inquiry Card

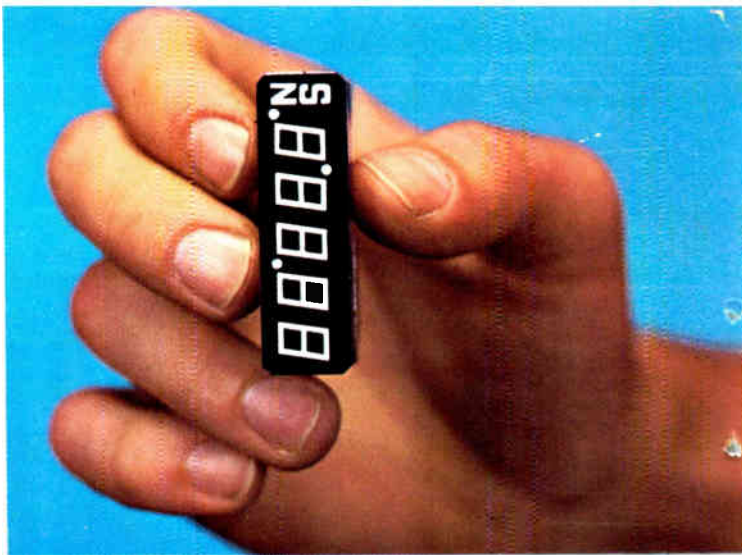

LOW COST VOLTMETER

High noise rejection at low freqs. without encoding degradation.

Model 620 Digital Measuring Instrument is a guarded differential solid-state logic digital voltmeter/ratiometer. It features a noise-cancelling principle called Autojet. This, combined with the integration technique of voltage measurement, provides a minimum of 60db of superimposed noise rejection from 30 CPS up. An encoding speed of 100msec. is constantly maintained. The sample durations of 1 to 3 sec. previously needed to obtain high noise rejection at low freqs. have been eliminated. Electro Instruments, Inc., 8611 Balboa Ave., San Diego 12, Calif.

Circle 138 on Inquiry Card

AVIONIC TESTER

Speeds diagnosing of airborne electronics failures.

The VAST (Versatile Avionic Shop Tester) performs hundreds of high-speed electronic tests on missile fire-control equipment, communications gear and navigation systems in military aircraft. Its objectives are to speed the diagnosing of avionic (airborne electronics) system failures in aircraft, and to ease the space-squeeze aboard aircraft carriers. By using a computer to store test programs and procedures, VAST tests about 85% of carrier-based avionic systems. Currently being developed for the Navy, it should save millions of dollars each time a new type of aircraft is introduced to the fleet by eliminating the need for Special Support (Test) Equipment (SSE). PRD Electronics, Inc., 1200 Prospect Ave., Westbury, L. I., N. Y. 11590

Circle 139 on Inquiry Card



HI-POWER CALORIMETER

Calorimetric assemblies for measurement of r-f power to 500mc.

The r-f Termaline® calorimeter device is placed in series with the coolant flow of 15, 25, or 50kw loads. The input-to-input temperature differential at a constant flow rate yields accurate power data. Depending on the power level, probable error is as small as 2%. These calorimetric assemblies are self-checking at dc or 60 CPS and are not affected by amb. conditions. The coaxial load resistors are designed for a VSWR below 1.1 from dc to 500MC, with 3/8 in. flanged or unflanged line connectors. Continuous power rating of 15kw, 25kw, or 50kw is available with matching thermometers and flow indicator. Bird Electronic Corp., 30303 Aurora Rd., Cleveland (Solon), Ohio 44139.

Circle 140 on Inquiry Card

THE HEART OF THE EQUIPMENT

ELCO VARICON* PRINTED CIRCUIT CONNECTORS

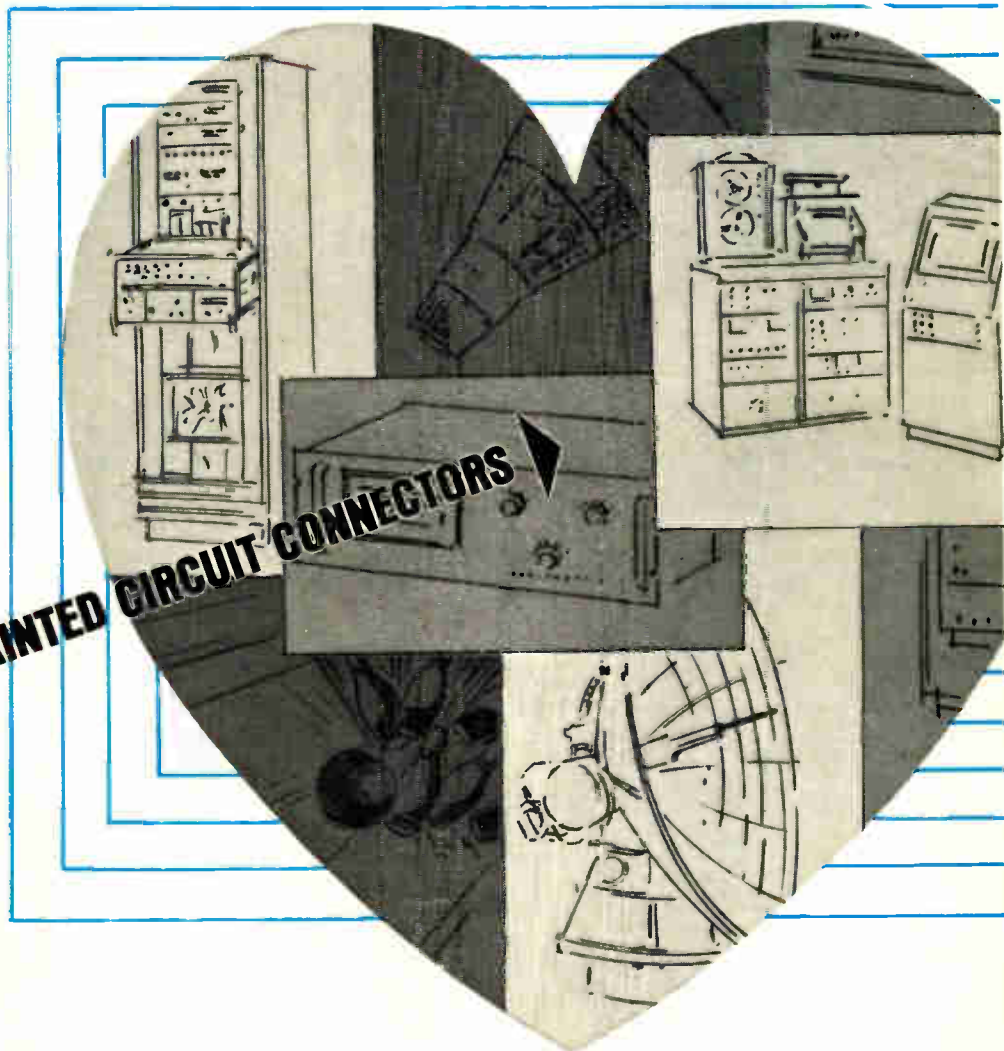

Despite the great strides in microelectronics (including our own giant steps) most semi-complex to super-sophisticated equipment still employs printed circuitry. With an overwhelming preference for ELCO VARICON* connectors. Why? More sizes. More varieties. More wiring options. And world-proven reliability. From automatic bowling pinspotters . . . through medical electronics, computers, test instruments, data processing, numerical controls, communications. Up to telemetry, missiles, the lunar lab, etc., etc., etc. Our Tech Data may answer your own etcetera. Right? Write!

if it's new...if it's news...it's from...



ELCO Corporation: Main Plant and Offices, Willow Grove, Pa. 19090; 215-659-7000; TWX 510-665-5573.
ELCO Pacific: W. Los Angeles, Cal. 90064. ELCO Midwest: Chicago, Ill. 60645. Representatives, Subsidiaries,
Licensees Throughout the World. ®TRADE-MARK

WHAT'S NEW

CONTROL RETURNED TO SYSTEM DESIGNER

A NEW CONCEPT IN LOGIC DESIGN returns to the system designer a measure of control over the performance of individual integrated circuits. The new concept, Variable Threshold Logic, is available in the Series 650 integrated circuits from Motorola Semiconductor Products Inc., P.O. Box 955, Phoenix, Ariz.

The VTL circuits permit the system designer to adjust the performance over a broad range by varying the power-supply voltages. This is done without sacrificing the inherent economies of high-production monolithic integrated circuits. In addition, the VTL circuits provide high noise immunity and high logic swing. This high noise immunity allows ICs to be used in industrial computers and other high-noise environments.

VTL is actually a modified form of diode-transistor logic designed to offer the advantages of greater noise

Variable Threshold Logic family allows system designer to select the best combination of noise immunity, power dissipation and speed.

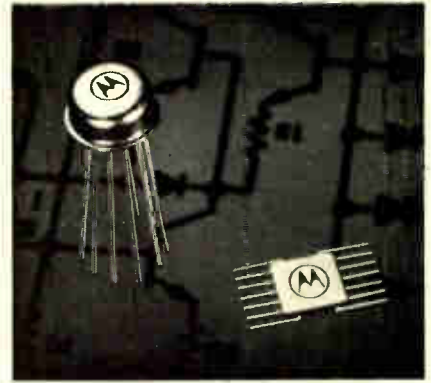

immunity, selectable characteristics, and circuit-threshold relatively unaffected by temperature variations.

Taken together, these characteristics mean that the computer designer can select the best combination of noise immunity, power dissipation and speed for his particular application.

Currently there are three VTL circuits available: The MC650 a dual 3-input NAND gate; the MC651 input NAND gate; and the MC652, an R-S flip-flop. The logic swing for the circuits is adjustable from +4v. to +10v., and the noise immunity is from 2 to 5v.

LOW-COST, TIME-SHARING COMPUTER

WHEN TIME-SHARING COMPUTERS WERE INTRODUCED a few years ago, they offered something unique to the industry: they could be multi-programmed; had real time processing; on-line remote data processing; and allowed simultaneous access by several users to the central processor. The only drawback was the high initial cost of the system. Now the high cost has been eliminated by the SDS 940, a product of Scientific Data Systems, Santa Monica, Calif.

The SDS 940 time-sharing system provides up to 32 users with simultaneous access. A response time of 2 to 3 sec. facilitates rapid communication between the user and the computer.

The computer offers the user a broad range of programming languages. Those included with the system are FORTRAN 11; CAL, a conversational algebraic language; SNOBOL, for string manipulation;

Up to 32 users can have simultaneous access to the 940 system.

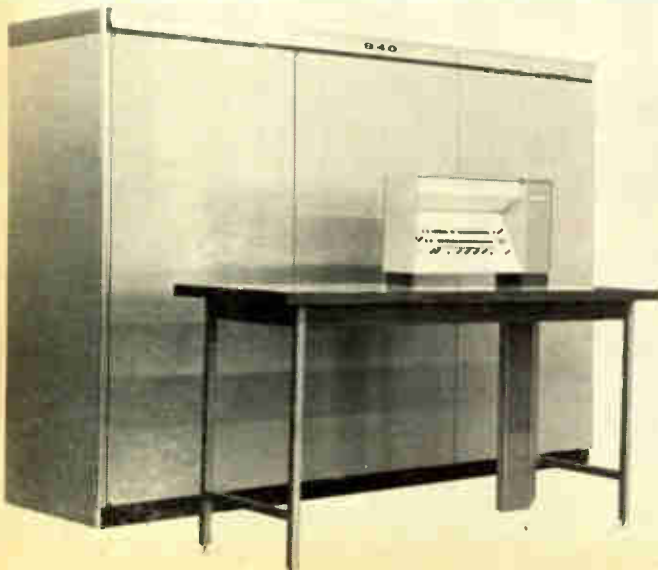

QED, a conversational text editor; a macro-assembler that permits programs to be written in machine language; LISP, a list processing language, and a machine-language debugging system.

With the SDS 940, users may be individuals, machines, or a combination of the two. Each can obtain access to the computer without affecting the others. Memory protection is provided to prevent one user from accidentally destroying or gaining access to the programs or data of another user.

Another important feature of the computer is its ability to continuously load programs in any available portion of core memory. Thus users do not have to wait for a specific memory location. In effect, the 940 provides each user with his own central processor containing up to 16,384 words of core memory, selected as random blocks from an available core memory pool which may contain as many as 65,536 words.

Memory cycle time is 1.75 μ sec. with memory expandable to 65,536 words. The computer features a 24-bit word size and 48-bit capability for floating-point arithmetic. Other features include built-in multiply and divide logic circuitry, automatic checking of memory transfers and input/output logic circuitry, automatic checking of memory transfers and input/output operation, multiple-level indirect addressing with indexing at any level, and up to 1024 levels of priority interrupt, each with a unique priority and address in memory.

A typical 940 system includes a minimum of 24,576 words of core memory; two random access discs, each providing 2 million characters of auxiliary storage; 2 magnetic tape transports; teletype multiplexer; card reader and 8 on-line user stations. Price of this configuration is \$430,050.

Why Eclipse-Pioneer precision-cleans Saturn rocket assemblies with **GENESOLV-D**

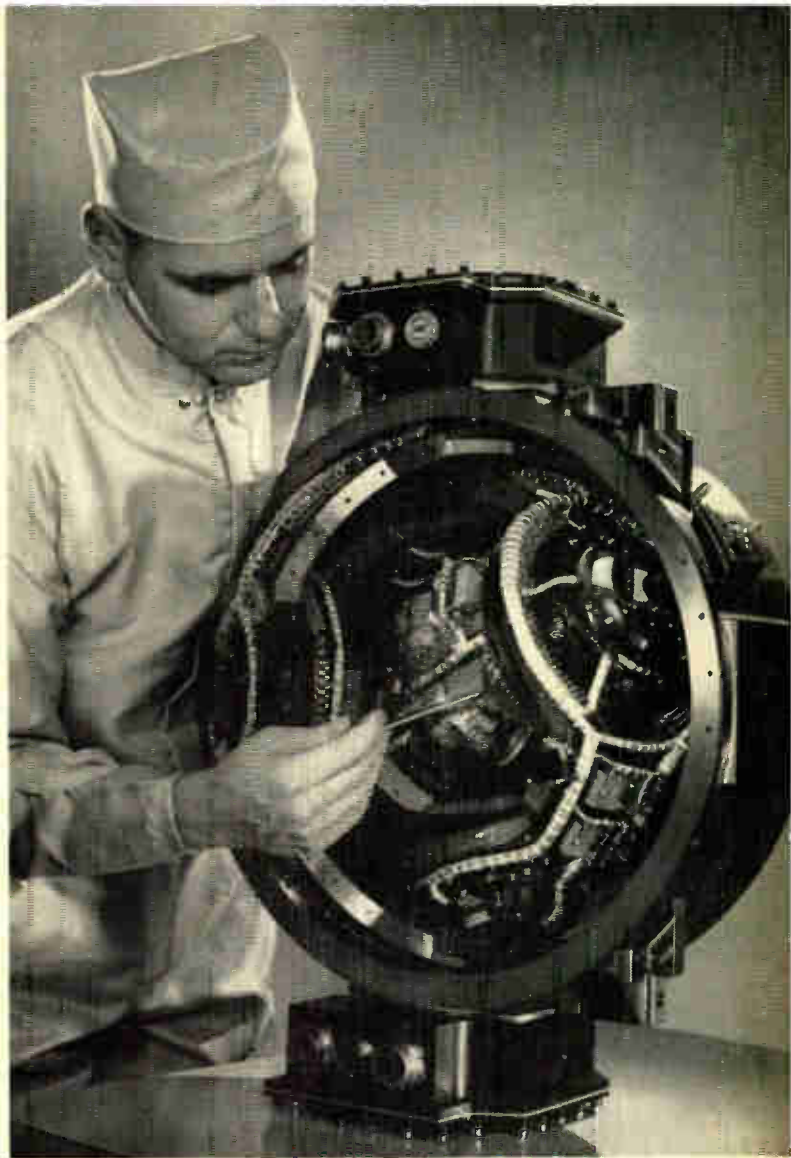

Technician at The Bendix Corporation's Eclipse-Pioneer Division points to inner gimbal of Saturn rocket stabilized platform, which includes components cleaned by Genesolv-D.

The reliability of critical aerospace assemblies depends on scrupulous cleanliness as well as on precision tolerances and finishes. That's why Eclipse-Pioneer uses Allied Chemical's Genesolv-D Electronic Grade Solvent for this critical cleaning assignment.

All parts in six components of each stabilized platform are cleaned in Genesolv-D during assembly.

Eclipse-Pioneer, a division of The Bendix Corporation, uses Genesolv-D for these important reasons:

1. It's 99.99% pure (less than 1 ppm residues).
2. Has low surface tension/high density; penetrates

smallest spaces for fast, easy cleaning.

3. It's nonflammable, nonexplosive, relatively non-toxic.

4. Selectively cleans metals, plastics, elastomer and paint or varnish surfaces, with little or no solvent action on base materials.

5. Excellent electrical properties – resistivity over $200,000 \times 10^6$ (megohm cm). Low dielectric constant.

6. Stability and economy – Genesolv-D won't decompose at temperatures up to 300°F; can be distilled and reused since it contains no additives.

Genesolv-D is processed and packed under class 100 clean-room conditions to assure you a contaminant-free solvent; shipped in non-returnable drums with special moisture-proof covers, and in tank truck quantities. Each shipment bears inspector's analysis of purity. Write for full details.

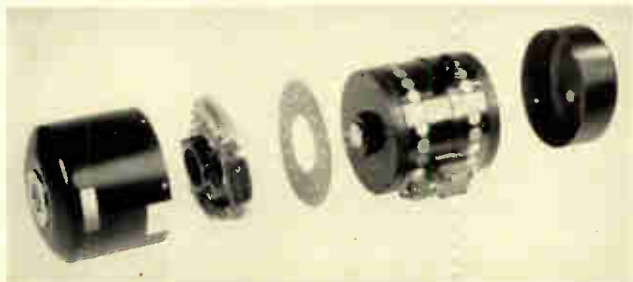

These gyros are used in each stabilized platform, which includes components cleaned by Genesolv-D.



GENERAL CHEMICAL DIVISION
P.O. Box 353, Morristown, N.J.

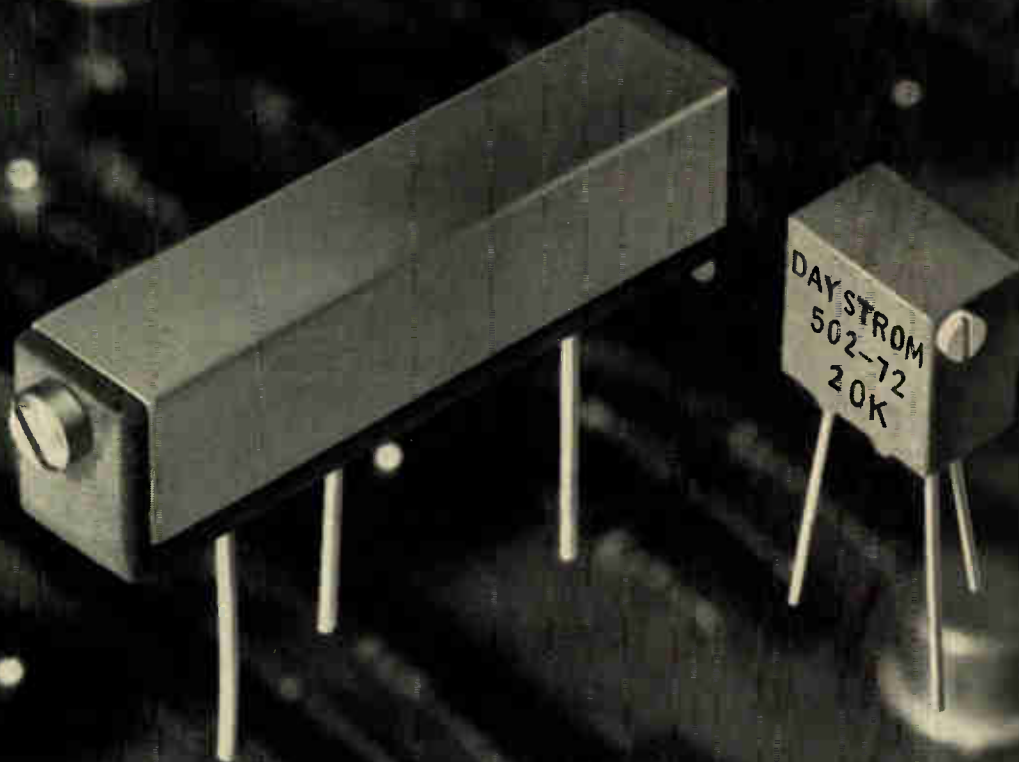

And the small one does a better job

New 5/16" Daystrom Models 501 & 502 Squaretrim[®] Potentiometers Take About 1/6 Space At No Extra Cost

Notice how much space you save: 0.0185 inch cubic volume releases five-sixths of the space formerly required by conventional rectilinears—and you save that space at no increase in price. Nor do you pay extra for:

Soldered Terminations—for better protection against vibration, shock and humidity—no pressure taps.

Better Tolerance— $\pm 5\%$ (100% better than many rectilinears).

Superior Resolution—0.125% or less.

Adjustability—15 mechanical turns.

Slip Clutch—eliminates wiper damage, cuts production delays.

Convenience—3 different configurations to choose from: with adjusting screw on top, side or end.

Wide Range—10 to 20K ohms.

High Power—0.6 watt in still air at 70 C.

Wide Temperature Range— -55 C to $+150$ C.

Low Temperature Coefficient— ± 70 ppm max.

Low Noise—100 ohms max. ENR.

Add it up and you can see why so many large users already have turned to the New Weston-Daystrom Models 501 & 502 Squaretrim[®] Potentiometers. Get the facts and you will too.

Weston Instruments, Inc. • Archbald Division • Archbald, Pa. 18403

WESTON[®] *prime source for precision . . . since 1888*

**A date for you to remember
from February 3 to 8, 1966
in Paris (at Porte de Versailles)**

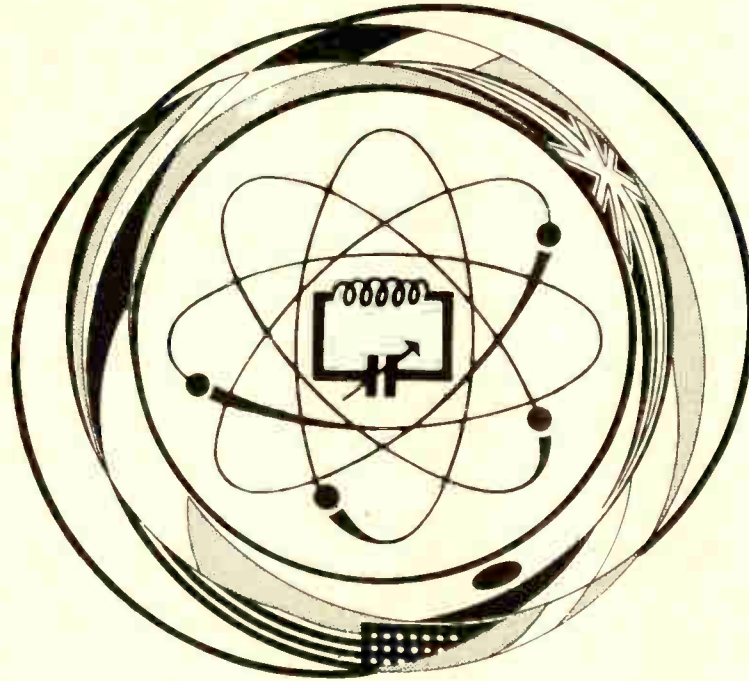

International Exhibition of

ELECTRONIC COMPONENTS



the latest discoveries in the field of
electronics:

all components, tubes and semi-conduc-
tors, measuring and control appliances,
audio equipment . . .

For information and literature write to:
S.D.S.A. 16 RUE DE PRESLES, PARIS 15e., FRANCE

**Official carrier: Air France,
Overseas Trade Show Department,
683 Fifth Avenue, New York, N. Y. 10022**

PUBLIC SERVICE
PARIS



Please fill in this application for admission
card, cut it out (as per top and bottom dotted
lines) and mail it to:

S.D.S.A. Relations Exterieures
16 Rue de Presles - Paris 15e.

NAME:

FIRM:

ADDRESS:

INTERNATIONAL EXHIBITION OF ELECTRONIC COMPONENTS

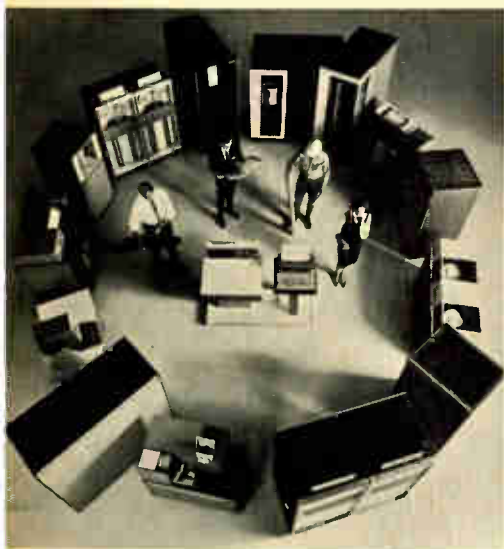

Fig. 1: Some of the many data processing units which comprise IBM's System/360 are shown here.

As a group, the "third-generation" computer systems offer much more computing power per dollar than their predecessors. Equally important in reducing costs and expanding computer usage are the trends toward multi-programming, time-sharing, IC's, and thin-film memories. These trends are discussed here.

By J. BURT TOTARO,

Assistant Editor, Auerbach Standard EOP Reports,
Auerbach Corp., 1634 Arch St., Phila., Pa. 19103

More Computing Power

**ELECTRONIC
INDUSTRIES**
STATE-OF-THE-ART
FEATURE

AFTER THREE GENERATIONS OF MACHINES and 10 years of fast and furious competition, there is strong evidence that the computer industry has finally come of age. Computer systems are no longer isolated machines with rigid functional and operational features that vary from one maker to another. Computers can now be used as powerful, flexible tools, working together with other computers, sharing job responsibility, and using a great variety of peripheral equipment.

Competition is largely responsible for this improvement. It has also ensured that the advances in technology should be accomplished without any extravagant price increases. Manufacturers have learned to produce computer components at a fraction of the cost of the less powerful versions of a few years ago. This maturing process within the industry has resulted in a favorable by-product for the computer user: increasing dividends for relatively modest investments.

Improved Central Processor Design

"Third generation" computer systems (which in this discussion, include all systems initially delivered after Jan. 1, 1964) exemplify the trend toward giving the user more computing power per dollar. Improvements in both hardware design and software develop-

ment have contributed to the overall gain. For example, the use of miniaturized circuits has become common.

"Hybrid-integrated" circuits are being used by IBM in its System/360. These circuits combine the use of discrete but miniaturized transistors and diodes with an integrated silicon substrate on which resistors and capacitors are deposited. True monolithic integrated circuitry, such as is being used in several models of RCA's Spectra 70 line, has not become the defacto standard to date, but a trend in that direction is evident.

Thin-film memories have also begun to appear in recent computers, either as replacements for, or as high-speed supplements to, magnetic core storage. Core memories have reached a high level of design refinement. An example is the Extended Core Storage for Control Data's 6000 Series computers, which can provide data transfer rates up to 40 million char./sec. and storage capacities up to 21 million characters.

Increased use of microminiaturized circuitry and thin-film memories has contributed to computing speeds

generation computers. Some of these units have not yet been delivered.

Storage Flexibility

In addition to the use of core and thin-film memories within the central processors, today's user can select auxiliary storage devices to satisfy specific needs within his total system. IBM, for example, is offering seven different types of auxiliary storage devices—from cores to drums, discs, and magnetic strips—for use with its System/360 computers. With this kind of choice, the user no longer needs to pay exorbitantly high prices per unit of stored data; nor must he restrict the scope of his system because of constricting prices or storage capacities. Today's user can select high-speed auxiliary core and drum devices for storage of data that must be accessed quickly. He can also select lower-speed disc and strip devices (at lower costs) for mass storage of less often accessed data. With the flexibility that this choice provides, efficient systems design has become feasible for each user and for each of his diverse uses.

Remote Access

Flexibility in the use of third generation computer systems is also provided by the many data communications and display devices offered. This is true even with smaller third generation computers. These devices also aid in the integration of the data processor into the real world of events and transactions. Artificial and time-consuming data preparation and transcription operations can now be largely masked or eliminated. Thus, the computer system can function as a flexible and accessible partner in the solution of data processing tasks. Efficient use of this equipment is not easy, but at least the user has the equipment available to him if he has the resources to use it properly.

Data communication devices can be obtained either from the computer builder himself, from competitive manufacturers, or from utility companies. The remote terminal units offered with each computer system usually can handle a variety of these devices. This is due to highly developed interfacing capabilities. Thus no office is too distant nor too small to have fairly inexpensive direct communications with a powerful data processing center.

Visual display devices, such as the IBM 2250 and the RCA Video Data Terminals, contribute in a similar way to the flexibility and integration of today's computer system. CRT display units and their "light pens" permit man-machine conversations with little, if any, communications time lag. Digital plotters and photographic film units can also be used to assimilate the computer into the real world. IBM's 7770 and 7772 Audio Response Units can provide computer-initiated

Per Dollar

measured in nsecs and to a high degree of equipment reliability. It has also helped reduce cost and physical size of the associated components. Present-day technology has developed computing power that is many times greater per dollar than that of comparable first and second generation versions.

Evidence for this claim is presented in Fig. 3 where representative second and third generation computers are compared. This comparison is in terms of their rental costs and the times they need for straightforward inversion of a non-symmetric, non-singular 20-by-20 matrix. Elements of the matrix are assumed to be in floating point form with a precision of at least 8 decimal digits. The number of matrix inversions that can be performed per hour is divided by the computer's prime-shift monthly rental to generate a "Scientific Performance Index" (SPI) for each computer. The white bars in Fig. 3 represent the SPI's of second generation, solid-state systems, delivered before Jan. 1, 1964. The color bars, placed beside a comparable second generation unit from the same manufacturer, represent the superior SPI's of comparably-priced third



Fig. 2: Main control console and some of the operating equipment of RCA's Spectra 70 family are shown in this photo.

COMPUTING POWER (Continued)

vocal responses to telephone inquiries. These units, again, represent the trend toward the total integration of the computer into the information processing needs of modern business. As computers assist more people within each company, the user pays progressively less money per job solution.

Hardware/Software Simultaneity

It seems evident that the third generation central processors, memory units, and communications devices are much better than their predecessors. But, many of the more conventional I/O equipment, such as card readers and punches, magnetic tape units, and line printers, offer little, if any, performance improvements over some earlier versions. Yet many third generation systems will outperform comparably-equipped and comparably-priced systems of five years ago by more than two to one in overall throughput. In many uses this improvement clearly cannot be ascribed to the faster computing speeds of today's processors, since a certain class of jobs will always be limited by their input-output demands.

Fig. 4 shows the overall performance improvements, in a typical business use, of representative third generation systems over comparable versions of second generation solid-state computers from the same manufacturers. A bar graph has been constructed to show the "Commercial Performance Index" (CPI) of comparable computers solving a typical file updating problem. All systems are configured with about the same core storage and I/O equipment in order to develop realistic comparisons. Each white bar represents the CPI (the number of master-file records processed per hour divided by the prime-shift monthly rental) of

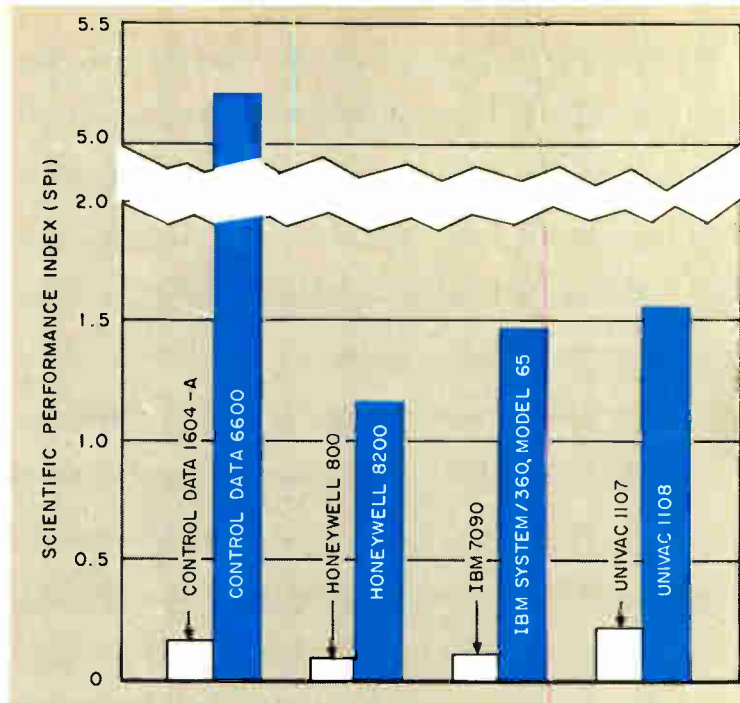

Fig. 3: Relative scientific processing power of second generation (white bars) and third generation (color bars) computer systems.

a second generation system. Comparable third generation systems from the same manufacturers are represented by the color bars. They are placed beside their related predecessors to facilitate comparison.

Key to the success of the post-1964 computer systems in outperforming their predecessors lies in the area of simultaneity—the ability to perform more than one operation at a time. Today it is a standard feature to be able to control many I/O data transfer operations simultaneously with internal processing. The Honeywell 200, for example, can simultaneously perform three I/O operations and internal computations. Advances in the design of I/O channels are mainly responsible for this capability to perform many concurrent I/O operations. Efficiency in the use of the total system is thus offered. Jobs can be processed in half the time, and the user's throughput per hour of rental can be doubled.

Simultaneity of operations is an important and almost standard feature in third generation hardware. But equally important in today's systems and highly contributory to their throughput improvements is the hardware-software feature called "multiprogramming." This is the ability to perform multiple programs concurrently within a single computer. When one program must wait for some event—e.g., completion of an I/O operation—before it can continue, control is automatically transferred to another program. This other program is one which currently has available to it the I/O equipment and storage space needed to perform its programmed operations. Transfer of control between programs is made easy by hardware interrupt systems. These systems recognize a variety of conditions that warrant temporarily passing control to other programs.

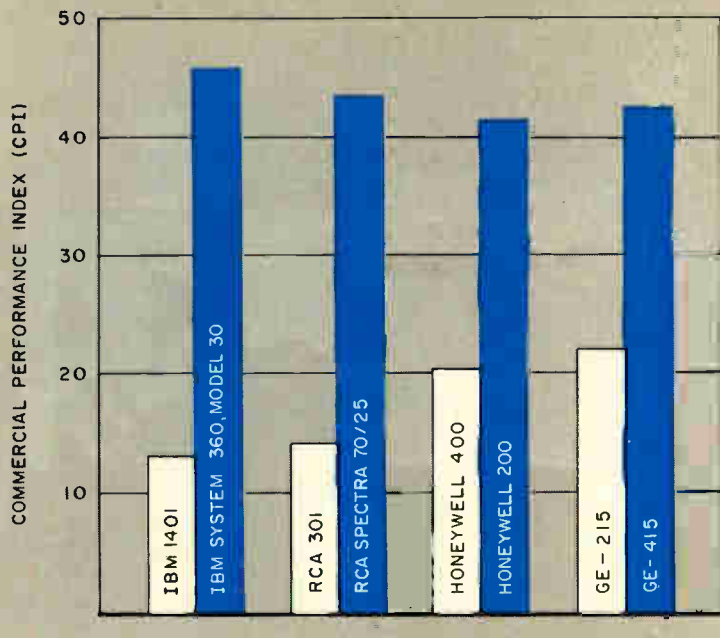

Fig. 4: Relative commercial processing power of second generation (white bars) and third generation (color bars) computer systems.

A complex software routine, usually called an "executive system," is needed to work with the interrupt system. This routine regulates the flow of computer control and governs the selection of programs that can actually operate concurrently at any given moment. The executive system that coordinates the multiprogramming computer system usually has one main objective: to keep in continuous use as many components of the system as possible, from main storage to I/O devices. Here again, the objective is to use the computer system to the fullest possible extent throughout a given working period. More productive work per period should result from this mode of operation. Multiprogramming is not an exclusively third generation development; but it has only recently become the accepted normal mode of operation for the larger models in nearly every manufacturer's computer line.

Success of the executive systems that control multiprogramming has been varied. This illustrates the fact that developments in software have not always kept pace with the rapid advances in hardware design. But, the computer manufacturers are committed to developing efficient operating systems to control multiprogramming, so improvements in this area will probably be forthcoming.

Time-Sharing

Third generation computers are not only accessible to many programs simultaneously, but also to many different users—all of whom can share the operational costs. This is made possible by a process called "time-sharing." Here the goal is to give each user the impression that all facilities of a large computing system are at his disposal, and to keep him unaware that he is actually competing with others for their use.

Time-sharing operations are made possible by special hardware logic circuits and core storage arrangements, and are controlled by complex software operating systems. Most of these systems are still in their early development stages, but rapid progress is being made. Users competing for time on the central computer are connected to it through remote terminal units. At that point the user can enter his program through a data communications device. He can also merely request that his program be loaded from a library of stored programs at the processing center. The operating system stores the program requests on a work queue and allots a certain "time-slice" to each program currently in storage. As each program's slice of time is exhausted, control is transferred to the next program in the queue and the cycle continues.

Programs and segments of programs can be continuously called into core storage as they are due for processing. By means of time-sharing, many users can receive the services of a single, powerful computer system with little loss of time between requests for service and job solution.

Program Compatibility

Many of today's third generation systems provide not only increased processing and throughput capabilities, but also—almost as a bonus—program compatibility. User pressures and sales quotas have forced several manufacturers to provide compatibility between their second and third generation offerings. This reduces the user's cost of conversion to the new systems. Program compatibility is also provided in some cases between the systems of various manufacturers. Thus, with conversion aids being offered from all quarters, the user is no longer forced to remain with one manufacturer. He is now relatively free to choose whatever system will give him the most productivity for the least cost. Today's compatibility features can ease his conversions and provide abundant system back-up.

Summary

There appears to be a continuing trend among manufacturers toward producing more reliable, productive, and flexible systems and selling them for less than their predecessors. This phenomenon has resulted from a maturing process that has been speeded by competition. The computer itself has been put to use as a powerful tool in the design of still better computers and in the analysis of methods to build them more reliably and at less expense. Today's user is the beneficiary—he really does get more computing power per dollar.

• A REPRINT of ANY ARTICLE in this issue is available from ELECTRONIC INDUSTRIES Reader Service Department.

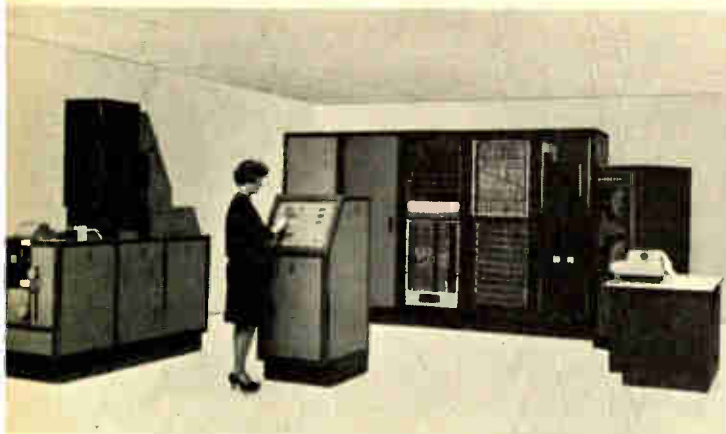

Philco General Purpose Print Reader reads common typewriter and business machine fonts intermixed on any form up to 14-in. long at 2000 char./sec.

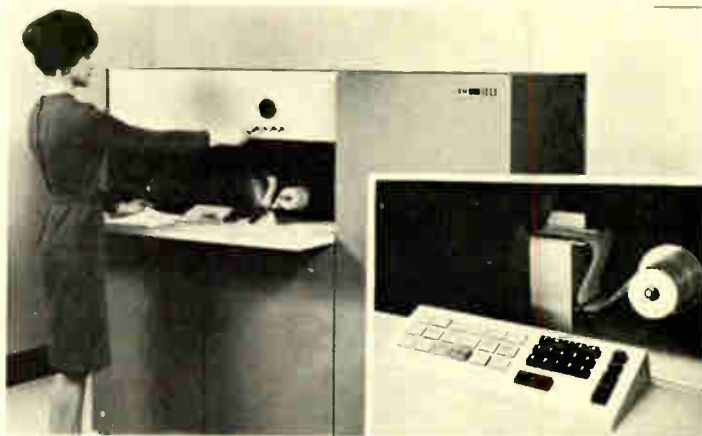

The IBM 1285 Optical Reader can read all entries on a 200-foot tape roll in 3½ minutes at speeds up to 3,000 lines a minute.

A Survey of Optical Character

Optical Character Recognition has been a commercial practicality for almost 10 years, Recent developments may constitute the basis for broader use of These developments are outlined here and an attempt is made

OPTICAL CHARACTER RECOGNITION (OCR) is on the verge of a major growth in applications and use. It provides the most versatile means of supplying computers and communication equipment with the vast volume of data that they can process. The growth of OCR has followed that of electronic data processing.

Multiple-Font Recognition

Since the early 1950's work has progressed on stylized single-font optical character readers. But, there are many organizations that cannot impose the controls on input needed for a limited font system. The U. S. Post Office, for example, does not control the type faces used on letter mail. Further, the federal government processes reports from too many regional and local offices to immediately replace all typewriters and printing equipment involved. Data processing service bureaus desiring to use optical scanning prefer to recognize a variety of common type faces in the inputs from their users. Otherwise the data would have to be re-typed into a stylized font. Often too, important file data already exists in non-stylized and intermixed fonts on abstract cards, address plates, or other documents.

Thus, a need for multi-font recogni-

tion exists. Hence, work has been directed toward making operational OCR equipment, capable of recognizing, intermixed on the same form, many different typewriter and EDP printed fonts.

Current Scanning Systems

All optical character recognition systems comprise five major elements:

A document handler, to move the form to be read to the light source and light pickup.

A light source to illuminate the areas on the form to be read.

A light pickup to collect the light reflected from these areas.

A recognition unit, to determine the identity of the characters being scanned.

A control section, to control the overall system and in some instances provide editing and validity checks.

Document Handlers

Paper handling is closely related to the recognition method. It is discussed separately here for convenience, but the separation is somewhat artificial.

There are two modes of document handling—the document is either moving or stationary during the scanning process.

**ELECTRONIC
INDUSTRIES**

**STATE-OF-THE-ART
FEATURE**



RCA Spectra 70/251 Videoscan Document Reader reads up to 1,800 documents/min. continuously and up to 1,300 documents/min. on demand.



The Control Data Corp. 915 Page Reader is shown with the 8092 Teleprogrammer (center) and the 603 Tape Transport (at left).

Recognition

but widespread use has yet to be realized. the technique than has been seen to date. to gauge their significance in this respect.



By DON STEVENS,

Director,
Commercial Electronic Operation,
Philco Corp.,
3900 Welsh Rd.,
Willow Grove, Pa.

In systems where the paper is moved during reading, document travel provides one of the scanning dimensions. This method has the potential for low equipment cost, but also has low throughput and limited rescanning capability. Character rescanning cannot be accomplished instantaneously because an entire line must be rescanned and sometimes repositioned as well. Rescanning ability is very important when the type is degraded, or, when the need for accuracy is especially critical.

Reading continuously moving documents "on the fly" with a CRT flying spot could yield high speeds, but the field of view would be limited. Also, the circuits would be complex. "On-the-fly" reading can also be accomplished by using a strobe light and storage tube methods to hold the image stationary. Although this method can lead to low cost equipment, system capability is restricted because of limited resolution and read area.

A stationary document may be read with a flying spot (CRT) either in a synchronous or asynchronous mode. With the synchronous mode the paper is held in place for a fixed time, and thus rescanning ability is limited. It is appropriate when the amount of information to be taken from each document is predictable. In the asynchronous mode, the paper is held under the scanner only until the reading is complete. Much higher throughput can be attained in this mode when variable-length documents are to be encountered.

Light Sources

Light sources are being used in three basic modes. The light may be mechanically moved, electronically moved, or stationary. Systems that use light that is moved mechanically (e.g., by mirrors) generally require that the document be precisely indexed, one line at a time, by the document handler. This method generally limits throughput.

Methods used in this class of device can usually be embodied in relatively inexpensive hardware. But, as always, there is a cost/capability tradeoff. The document indexing can be time consuming if scanning is to be selective. Instantaneous rescanning cannot be done, and it is difficult to correct for misregistration and skew.

Systems using electronically moved light (CRT systems) are more versatile. The document may be stationary or it may be moving during the scan process. The light can be directed to any portion of the document. Also, instantaneous rescanning can be made because the electron beam is inertialess. This rescanning capability is a dominating factor when high system throughput is needed. The high resolution and speed which can be achieved with a CRT facilitates reading many fonts.

A stationary light source (e.g., the strobe light with storage tube pickup) can immobilize the image of a moving document. This method lends itself very nicely to the case where there is a high volume of documents

OPTICAL CHARACTER RECOGNITION (Continued)

with a small amount of information on each. A Vidicon, for example, has less than a half million resolution elements in contrast to more than two million useable elements for a CRT.

Light Collection Devices

There are four types of photo pickups used in OCR systems: photocathode emitters, photoinjection, photoconductive, and storage devices.

Photoconductive components are slow, but can be used in mosaics. Cadmium sulfide cells and vidicon mosaics are in this category. This implementation, because of its slowness and narrow bandwidth, has good signal-to-noise (S/N) ratio. Slowness can be overcome by using a number of them in a field mosaic.

Photoinjection pickups are fast, but low in signal level. Thus they are limited to use to line or field mosaics in cases where much light is available.

Vacuum photocathodes are lower in quantum efficiency than the other two types. But they lend themselves readily to efficient light collection through use of a large cathode area. Also, they may be followed by a low-noise secondary emission amplifier, i.e., a photomultiplier. Total cathode current determines S/N ratio since one photon can produce no more than one electron; and, since thermal noise is the discrete nature of electronics, it is desirable to have many to produce a smooth flow of current, i.e., signal sans noise. The intensity of photons (light) must be great or the collection area must be large.

Recognition Unit

Once the data have been captured by the system, they must be reduced to a simple form, such as the 6- or 8-

bit code per character acceptable to a digital computer. Basic approaches to character recognition are statistical analysis, mask matching, and combinations of these which may be implemented by either software or hardware. The software method in a general purpose computer operates serially, whereas the hardware recognition systems may be operated in parallel.

In recognition by software research, the raw data, collected during the scanning, is fed to a digital computer. There it is statistically analyzed to determine the character identity. This approach shows promise of providing great versatility in recognition capability. But, the breadboards demonstrated to date have been slow and costly because of the large amount of digital processing involved.

In the hardware approach, a mask can be applied for either template matching or feature analysis. Full template matching, i.e., mask per character, can accommodate only slight variations in character size or shape. Thus, it requires a nearly perfect character. Feature analysis is more versatile, since recognition is obtained by detecting the presence of significant character parts, and combining these logically. It can be implemented at a much lower cost than statistical analysis needing digital computation. It is thus the most practical current approach to multi-font recognition. The inherent capability of complete parallel processing in the hardware implementation renders it, by its nature, faster than any of the software (serial decision) methods.

System Control

An optical character reader can be controlled by "wired" or plugboard programs, general purpose com-

The earliest of Farrington Manufacturing Company's reading systems (Model 8CD-1 below) is quite different from the new Series III Farrington Multi-Font Document Reader shown in the photo at the right. This new document reader has the capability of reading intermixed multi-font styles at high speeds.

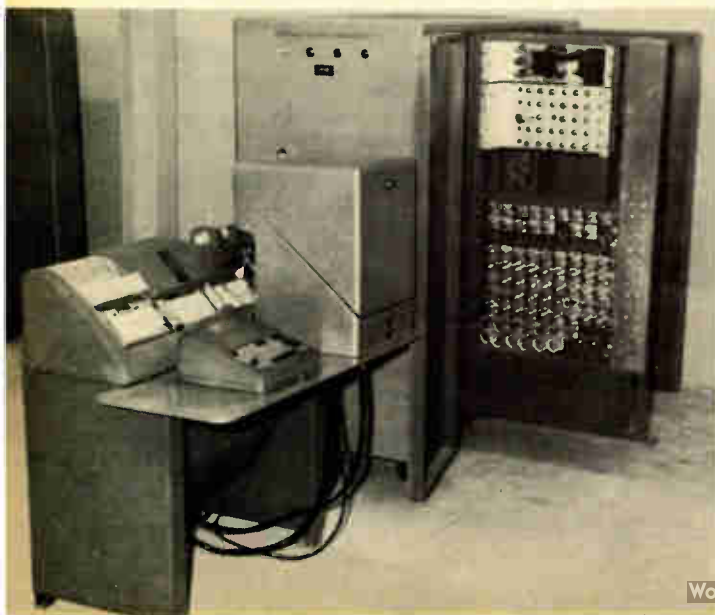

puters, or special purpose controllers. Table 1 summarizes advantages and disadvantages of each method.

Current Problem Areas

Major problem areas now being investigated in the labs of OCR manufacturers in the U. S. are: reading degraded print, reducing paper 'noise,' achieving higher throughput, improving error correction procedure, dispensing with the need for predictable formats, and recognizing a greater variety of type faces.

Degraded Print—Efforts to expand the capability for reading degraded print are being directed toward better recognition methods, and toward systems which can accommodate more background noise.

A character is degraded if it has voids, is filled in, is surrounded by extraneous ink, contains variations in stroke density, or is surrounded by "hairlines." Most of the methods being studied involve operating upon the character information during the preliminary data reduction process, viz, before the information is presented to the recognition unit. As an example, at some point in pre-processing, small isolated clusters of additive noise¹ could be erased and small voids caused by subtractive noise could be filled. Also, thin strokes detected could be assigned a predetermined thickness.

Paper "Noise"—Paper is considered "noisy" when it contains resolvable flaws, whether they be introduced during paper manufacture (shives, dirt, or surface roughness), forms manufacture (misapplied ink) or in use (carbon smudges or creases).

Recognition in the presence of noise can be improved by segregation of character into groups by salient features. Interference can then be reduced by area inhibiting methods or by modifying the recognition criteria.

Recent improvements in light pick-up have allowed thermal (photon) noise, inherent in the system, to be reduced to the point where the decision threshold can be set near zero. This helps detect faint character strokes. But, it is the ratio of background to character strokes which determines signal. Care must be taken to eliminate or disregard paper flaws that have a density comparable to that of a character part. The human eye overcomes this difficulty by detecting density changes rather than absolute value. Thus, OCR systems which respond to character edges rather than to density have a higher capability for reading degraded print.

Improved Correction Procedures—There are few system correction procedures designed specifically for use with OCR. But, the following methods are being evaluated by the industry. A real-time visual display (e.g., a CRT unit) can be included with the OCR system, showing the operator the group of words containing an unrecognizable character. The operator could determine the correct character by context and key it

¹Additive noise is that attributable to extraneous resolvable information around the character, such as hairlines, fill-ins.

Table 1
CURRENT SYSTEM CONTROL METHODS

Technique	Potential Advantages	Potential Disadvantages
WIRE PROGRAM OR PLUGBOARD	<ol style="list-style-type: none"> 1. Lower machine cost 2. Fast internal data transfer 	<ol style="list-style-type: none"> 1. Higher operating cost because of plugboard changes 2. Limits document variation 3. Limits growth potential 4. Limits system flexibility 5. Very limited data editing
GENERAL PURPOSE COMPUTER	<ol style="list-style-type: none"> 1. Greater document format variation 2. Better system growth potential 3. Better integration into existing data processing systems 4. Greater system flexibility 	<ol style="list-style-type: none"> 1. Complex programming 2. Most of computer capability unused 3. Higher system cost
SPECIAL PURPOSE CONTROLLER	<ol style="list-style-type: none"> 1. Variable accept/reject criteria by program 2. Simple programming 3. High speed internal data transfer 4. Variation in document format permitted 	<ol style="list-style-type: none"> 1. High initial development costs

into the record via a control console. But, this procedure cuts system throughput considerably. This is because it takes the operator longer to key in a single letter than it takes the system to process three or four error-free forms.

Another approach is to pass on, for further processing, all error-free data and to examine separately the data in question. This can be done in several ways. The form in question could be marked by the OCR equipment for retyping and re-entry into the system; or, examination by a computer could be made on the words containing unrecognizable characters. For example, a spelling correction unit can perform a table look-up on the words in question. It can then insert in the output record the corrected version of the word originally designated as having a confused character.

Context recognition methods can also be powerful. In the future, linguistic analysis of the data scanned should aid immeasurably in identifying letters within words, and words within contexts.

Higher Throughput—Instantaneous scan rates of about 2000 char./sec. are now being achieved, but document handling speeds are curtailing system throughput considerably.

In the near future, scanners capable of reading moving paper, will have the potential for increasing OCR throughput in particular uses. (Continued)

OPTICAL CHARACTER RECOGNITION (Concluded)

Many current systems are limited in throughput as much by paper handling methods as by low reading rates. Effort will be concentrated on developing high-speed paper handlers.

Format Recognition—Basic format recognition is available in mail reading equipment which finds the address by a search-scan pattern before reading the characters. The system then reads the city, state, and zip-code information, and from that determines the letter's destination.

The U. S. government is sponsoring investigations into the feasibility of recognizing the formats of intermixed inputs from several technical journals. This research is directed toward producing a system which can recognize the format and then read and assemble the information for later computer processing.

Format recognition can be done either by analog or digital methods though, at present, analog schemes appear less promising. Digital methods are being investigated, but have not yet been demonstrated in a complete system. Digital analysis requires the manipulation of vast quantities of data, and this in turn requires much costly time on a large-scale computer.

It will probably require a judicious combination of analog and digital methods to create a full scale format and data recognition system.

Reading a Greater Variety of Input Data Modes—The word font or type face is variously interpreted by individuals in the field. There is no consistent definition (in engineering terms) or identification inherent in the name of a particular type style. The U. S. Government Printing Office has a book of typefaces which is nearly an inch thick. And, very few of these faces are business-machine prints. Also, fonts of the same name can vary—depending on whether the machine was U.S. or foreign made.

Finally, there are growing needs for readers to accommodate hand print (constrained and non-constrained), languages that use alphabets different than our own, and eventually handwriting (script).

Print and document quality have been the subject of a two-prong attack which is gaining impetus. One prong represents the R&D that OCR manufacturers are devoting to systems which one day will adapt to "the world" (that is the more common type faces, hand print, etc.). The other prong represents the efforts of business supply manufacturers toward upgrading typewriters, ribbons, and paper characteristics. Much of the work has been done on an individual project basis between companies. The most prominent, and promising, of the activities are the attempts at industry-wide cooperation. BEMA (Business Equipment Manufacturers Association) through the X3.1 committee, is attempting to create a stylized font, character set, and print quality definitions which are acceptable to all participating OCR manufacturers. *TAPPI (Technical Association of the Paper and Pulp Industry) has created an OCR com-

mittee set up to recommend practical paper testing methods which will meet OCR needs and also be compatible with the highly automated fast-pace-production environment of a modern paper mill. It would be ideal if one set of tests could be designed to fulfill the needs of all OCR systems. As it stands, the term "OCR bond" means different things to different people.

Future of OCR

OCR equipment has already reached a state of development in which its error rate and throughput are comparable to those of alternate means of data acquisition. But, other data entry methods have reached a plateau in reducing error rates and increasing throughput while OCR has the potential for major improvements. The future is bright, but the state of development is still young, and the many problem areas noted stand as a challenge to the engineer.

*Proposed American Standard, Communication of the ACM, Vol. 8, No. 1, Jan. 1965 and addenda.

VOLTAGE CONTROLLED OSCILLATOR

A VOLTAGE OSCILLATOR (VCO) that can be easily adjusted for optimum performance was needed. A conventional VCO, using crystal control and mutual inductance feedback coupling, required much trial and error to select the best crystal and circuit parameters for stable operation and minimum phase noise.

A VCO that can be represented by a simple equivalent r-f circuit for determining nominal values of r-f circuit parameters, and in which the crystal drive level can be easily adjusted for minimum phase noise was a solution.

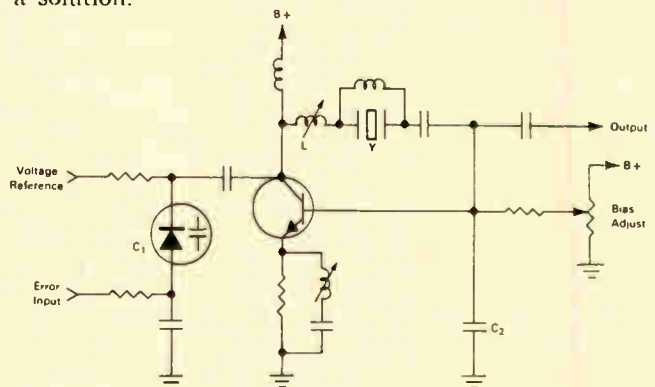

The only components in the VCO which are part of the r-f circuitry are the control crystal Y, the series inductor I, which is used to tune the external circuit to the crystal resonance, the voltage variable capacitor C₁, the base load capacitor C₂, and the transistor. These can be represented by an equivalent r-f circuit and their nominal values can be chosen to make the oscillator loop gain greater than unity. The oscillator can be adjusted for best performance by varying the circuit parameters. The "bias adjust" control may be used to determine the gain of the transistor, thus varying the crystal drive level and signal-to-noise ratio at the transistor input to obtain minimum phase noise.

For further information contact Technology Utilization Officer, Jet Propulsion La., 4800 Oak Grove Dr., Pasadena, Calif. 91103. Ref.: B65-10-223.

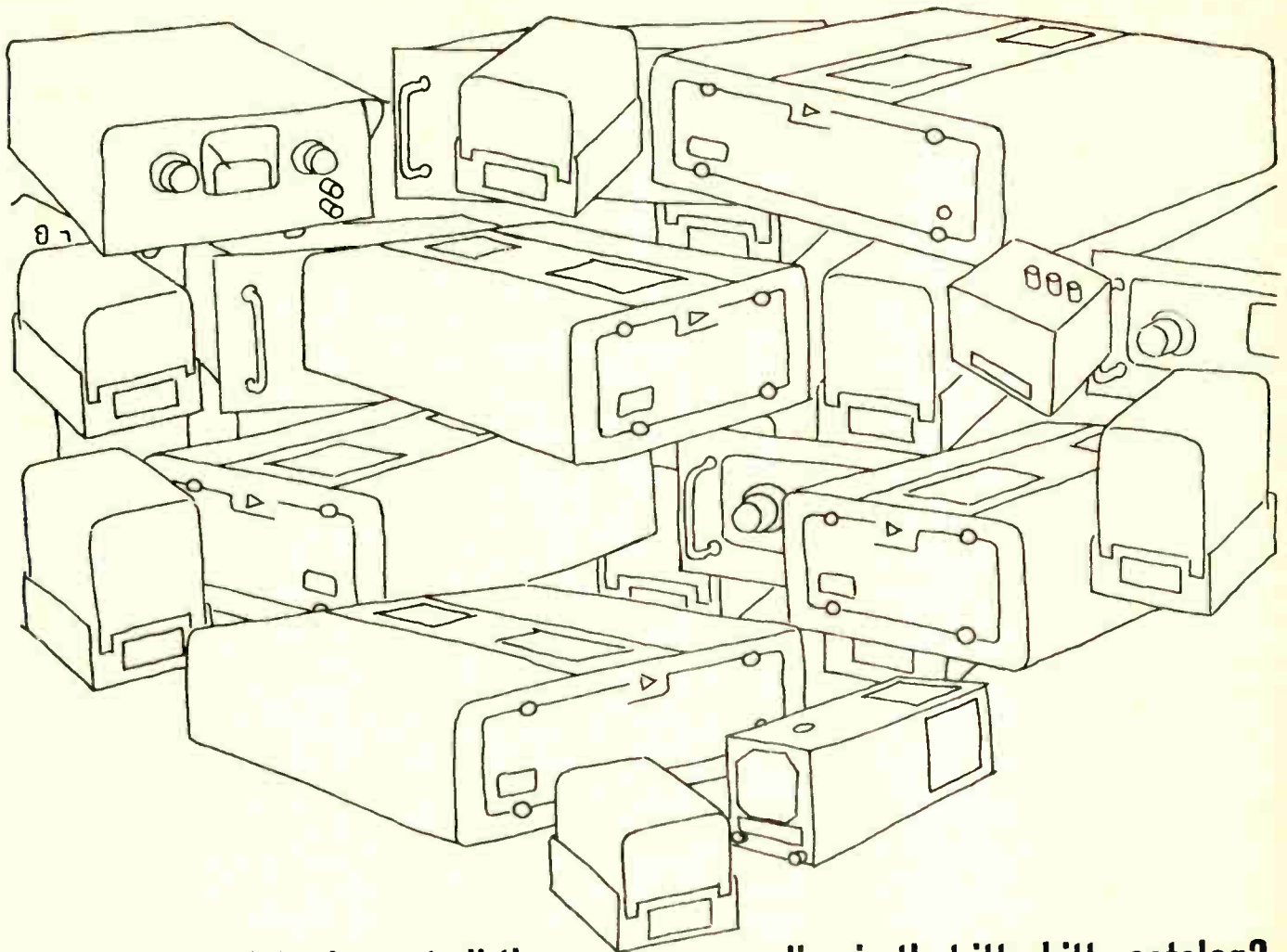

How did Con Avionics get all those power supplies in that itty-bitty catalog?



We have an itty-bitty Short Form catalog because most engineers find it easier to work with. Especially when it's supplemented by our comprehensive data sheets.

And we have a lot of power supplies because Con Avionics makes the widest variety of ac-dc modules for systems. Once you've got our handy little catalog, in fact, you really don't need any others.

Take our HS series for example. Until we made these units, most engineers thought you had to buy expensive wide-range lab supplies for high current systems applications.

That's changed now. Because an HS power

supply will do anything a lab supply will do in a system, but cost about \$100 less per unit. They come in rack or half-rack size, are self-cooled (you won't need systems space for heat dissipation) and operate in ambients up to 75°C. The new modules are unconditionally guaranteed for five years, are built completely with silicon transistors and have an amazing M.T.B.F. of 35,000 hours.

How we packed all this quality into the supplies and still can make them available for \$100 less than lab supplies is described in the data sheet we can send you.

But not in the catalog. It wouldn't fit.

PARTIAL SPECIFICATIONS

Input: 105-125 VAC, 47-63 cps
 Regulation: (Line and load combined) $\pm 0.05\%$
 Ripple: 1 mv RMS max.
 Response time: 25 microseconds
 Temperature Coefficient: 0.015%/°C or 18 mv/°C., whichever is higher
 Temperature: 75°C max.
 The entire voltage range between 5.5 vdc and 51.0 vdc is covered in twenty-six models. Currents range from 8.0 amps to 46.0 amps. Wattages from 104.5 to 816.

CONSOLIDATED AVIONICS

800 Shames Drive, Westbury, Long Island, New York/(516) ED 4-8400

A DIVISION OF



CORPORATION

MANUFACTURERS OF OPTICAL CHARACTER RECOGNITION EQUIPMENT

(Compiled by the editors of Electronic Industries Magazine)

Company Name	Model Number	Data Transfer Rate	Document Size	Type Style	Type of Scanning	Means of Recognition	Price Range	Date of First Availability	Remarks
Farrington Electronics, Inc. Shirley Industrial Area Springfield, Va.	Page Reader 1P	400 chor./sec.	Width: 4½ in. - 8½ in. Length: 5½ in. - 13½ in.	ASA Selfchek® 12H, 12L Alphanumeric	Electromechanical	Stroke-Analysis	From \$114,000	6 Months	-
	Document Reader 1D	330 chor./sec.	Width: 2-5/8 in. - 8½ in. Length: 2¾ in. - 6 in.	Selfchek® 12F, 12H, 12L, 7B Alphanumeric ASA 1428 407	Electromechanical	Stroke-Analysis	From \$93,600	6 Months	-
	Reader-Punch 253 C	600 chor./sec.	Tabulating Card	Selfchek® 12F, 7B 1428	Electromechanical	Stroke-Analysis	From \$130,000	6 Months	-
	Journal Tape Reader 2J3M	1000 chor./sec.	Width: 1-5/16 in. - 4-9/16 in. Length: To 350 ft.	Selfchek® 12F, 7B, 9B ASA 1428 NCR	Flying Spot	Stroke and Contour Analysis	From \$109,000	6 Months	-
Honeywell Electronic Data Processing 60 Walnut St. Wellesley Hills, Mass. 02181	Type 289-8*	50 chor./sec.	Width: 3½ in. Length: 5 in. to 8 in.	5 Level Bar-Code 2 Level Mach-Scan	Photocell Sensing; Docu- ment is transported past a Photocell Block and Lenses	Self-clocking System; Recognizes Black-to- White changes within the channels of the Code Band	\$250 M.R. \$11,250 Pur.	1st Qtr. 1966	* Connects to Data-Station (a Remote Communications Terminal Control)
IBM Corp. 112 East Post Rd. White Plains, N.Y. 10601	1231/32	Up to 2000 Doc./ Hr. (1000 Mark Positions/Doc.)	8½ x 11	Mark Read	Photocell	Positional	\$350-430	Already Avail.	-
	1418/28	Approx. 400 chor./sec.	2¾ x 5-7/8 to 3-2/3 x 8¾	407 407E (numeric only) 1428 (alphanumeric) Mark Read	Image Dissection	Feature	\$2700 3400	Already Avail.	-
	1285	2000 L.P.M.	Journal Roll up to 4 in. wide	NOF (NCR) 1428	Flying Spot	Feature	\$2000	Already Avail.	-
	1282	200 C.P.M.	51 or 80 Col. Card	Farrington 7B IBM 1428, 1428E Mark Read	Image Dissection	Feature	\$1500- 1700	Already Avail.	-
The National Cash Register Co. Main & "K" Sts. Dayton, Ohio 45409	NCR 420-1	To NCR 315 Computer Sys. - 10 µsecs./chor.	Journal Tape 3¼ in. x 1200 in.	NCR NOF Font	Journal Reader	Direct Character with Binary Coding	\$60,000	1962	Can be operated off-line or interfaced for direct input to any computer sys. - Reader Speed: 520 chor./sec. (to 315 computer)
	NCR 420-2	10 µsec./chor.	2 in. or 3 in. width by up to 1,560 in.	NCR NOF Font	Journal Reader	Direct Character with Binary Coding	\$80,000	1st Qtr. 1966	Can be operated off-line or interfaced for direct input to any computer sys. - Reader Speed: 1,664 chor./sec.
Philco Corp. 3900 Welsh Rd. Willow Grove, Pa.	Philco 6000 OCR Sys.	2000 chor./sec.	Width: 5 in. - 8½ in. Length: 3 in. - 14 in.	Reads intermixed type- writer styles plus busi- ness machine fonts, hi-speed printer forms and plate impressions	CRT Flying Spot	Feature Masks - 680 Elements	\$300,000 to \$500,000	Apr. 65	9 Mon. Delivery on orders
	Mail Reader	5 to 10 pieces of mail/sec.	Various Sized Envelopes	Typewriters, Hi-speed Printers, Addressing Machines	CRT Flying Spot	Feature Masks - 680 Elements	\$150,000 to \$400,000	Delivered May 65	-
Rabinow Electronics Inc., Sub. of Control Data Corp. 1425 Research Blvd. Rockville, Md.	915 Page Reader	Read 370 chor./sec.	Width: 4 in. to 12 in. Length: 2½ in. to 14 in. May also accommodate continuous fanfold	Proposed ASA Standard Font	Photocell Scan	Map Matching	\$80,000	10/1/65	-
RCA, EDP Div. Cherry Hill Camden 8, N.J.	5820 (used with RCA 301 Systems)	1500 chor./sec.	2½ in. - 4 in. - V. 2½ in. - 8½ in. - H.	RCAN-2 Numeric	Vidicon-Electronic Scan	Stroke & Feature	\$3450/Mon. \$3560/Mon.	Oct. 63	Mark Reading optionally available
	70/251	1500 chor./sec. 600 cards/min. option	2½ in. - 4 in. - V. 2½ in. - 8½ in. - H.	RCAN-2 Numeric	Vidicon-Electronic Scan	Stroke & Feature	\$2700/Mon. \$3000/Mon.	Aug. 66	Mark Read and Card Read optionally available
Recognition Equip- ment, Inc. 4703 Ross at Prairie Ave. Dallas 4, Tex.	Electronic Retina Computing Reader*			Up to 360 characters. Standard fonts. Upper and lower case alphanumeric plus special symbols	Electronic Retina (TM)	Matching Mask and Statistical Analysis	\$500,000 to \$700,000	1964 6 to 9 Mon. Delivery	* Is modular and can include one or more paper handling devices according to user's needs
	(Document Carrier)	Up to 1800 doc./min.	Width: 2 in. to 8¾ in. Height: 2 in. to 5 in.						
	(Rapid Index Page Carrier)	Up to 2400 chor./sec.	Width: 4-7/8 in. to 14 in. Height: 3¼ in. to 14 in.						
	(Journal Tape Carrier) & (Microfilm Carrier)								
The Western Union Telegraph Co. 60 Hudson St., N.Y.	220	17 chor./sec.	8½ in. x 5½ in.	Farrington	Retina	Statistical Analysis	\$30,000 to \$50,000	Spring 1966	-

...NOW IN A NEW MINIATURIZED SIZE

Hermetically Sealed ERIE BUTTON® MICA capacitors designed for -55° to +200°C at 2000 Mc.



Featuring 508 MECHANICAL VARIATIONS TO SUIT ANY HIGH TEMPERATURE—HIGH FREQUENCY CAPACITOR APPLICATION

With the addition of these new miniatures, Erie further broadens the most complete selection of Button Mica Capacitors in the industry. These new miniaturized micas provide 33% reduction in mounting area.

Erie Button Mica Capacitors are designed for use in radio frequency circuits for tuning, bypassing and coupling. The outstanding properties of metallized mica dielectric combined with the radial current pattern, make Erie Button Capacitors ideal for low inductance, high frequency applications.

These high quality capacitors are designed for microwave and filter applications, for use in carrier equipment, parametric and RF amplifiers, oscilloscopes... any application where high temperature and high frequency are factors.

The welded hermetic seal of these excellent broad frequency Gold Seal® capacitors for military and commercial use is 100% tested under pressure steam/salt water during production to guarantee a positive moisture seal.

Consider the advantages of Erie Button Mica Capacitors in the equipment you are designing. Write for Gold Seal Bulletin 500-2 or Resin Seal Bulletin 318-3.

GENERAL SPECIFICATIONS

Capacitance: 5 pf. thru 2500 pf.
Tolerance: 1% or .25 pf thru ±20%
Working Voltage: 500 WVDC for 1/2" dia. units
250 WVDC for 3/8" dia. units

Frequency Range: to 2Gc and beyond
Operating Temp.: -55°C to +200°C
-55°C to +150°C
-55°C to +85°C

Q: per MIL-C - 10950

TYPES AVAILABLE

HERMETICALLY SEALED (GOLD SEAL®)	RESIN SEALED
.410" O. D. or .505" O. D.	.375", .447" or .657" O. D.



MINIATURE BYPASS CAPACITOR SYSTEMS FOR TRANSMITTING TUBES...



Designed for the 10 to 3,000 megacycles range—and beyond

Erie now provides effective capacitive bypassing and coupling or filtering of all RFI signals in the range of 10 to 3,000 megacycles. Variety of systems to meet your requirements.

Write for Bulletin 525-R

Formerly
Erie Resistor
Corporation

Another Series of Components in Erie's Project "ACTIVE"
Advanced Components Through Increased Volumetric Efficiency

ERIE
TECHNOLOGICAL
PRODUCTS, INC.



644 West 12th Street
Erie, Pennsylvania

Memory Devices for Modern Computer Memories

Status of the ferrite core memory device is reviewed and an attempt is made to anticipate how cores will be used in the next two years. The ferrite core device is also compared with the newer "integrated" approaches and some predictions are made as to their relative expected usage in the next two years.

By **ANDREW C. KNOWLES**, Radio Corporation of America, Electronic Components and Devices, Needham Heights, Mass.

SINCE THE LATE '50's the basic storage element dominating the high-speed computer-memory-device market has been the individually strung ferrite core. During this period storage capacities and switching speeds of these magnetic memories have increased rapidly. At the same time costs have steadily decreased.

Ferrite cores are ceramic-like toroids that are individually made and tested. When assembled in memories they are positioned and supported by 2, 3, 4 or more wires which are hand and/or automatically threaded through the core apertures. These wires also serve as conducting paths for reading, writing, and sensing bits stored in the memories. The hand-stringing and the single-core manufacturing operation have led many manufacturers into pursuing various "integrated" memory-device approaches. Objectives of "integrated" device approaches are (1) Reduction of the basic device cost through batch- or mass-fabrication methods and, (2) Improvement in memory system performance/cost ratio by using inherently faster (than individual ferrite cores) devices that are more compatible with integrated circuits (IC's). Some earlier approaches included thin films of permalloy^{1, 2}, and ferrite apertured plates³. The newer memory-device approaches involve monolithic ferrites⁴, MOS transistors^{5, 6}, flip-flop semiconductors, thin-film transistors^{7, 8}, and superconductive thin films⁹⁻¹². To date none of these (or any other) approaches has threatened, in dollar or unit volume, the

strong position of the individually wired ferrite-core memory. While it is my opinion that this dominance will continue into the next few years, limited "integrated" device penetration is expected in 1966. And, further increases are expected in 1967 and 1968.

Coincident-Current Devices

Table 1 is a chronological listing of coincident-current ferrite core memory devices (sometimes referred to as "3D"). It lists devices used in high speed, random access, commercial computer main memories from their initial stages to the present.

An important factor in the reduction of cycle time has been the reduction in the ID/OD ratio of the cores. These reductions are shown in Table 1. Fig. 1 shows core switching time minus drive rise time ($t_s - t_r$) as a function of drive factor (full-select current is proportional to drive factor). The dotted lines outline the present core limits attainable with existing conventional materials. Three mixtures of manganese, magnesium, and zinc oxide show the effect of core material on cycle times. Each mixture contains a different amount of zinc oxide. To show how decreased switching times were obtained, the following example is given (see Table 1 and Fig. 1).

A 0.018-in. ID core is to be selected which has the best temperature and square-loop hysteresis properties available. The switching time (t_s) must be equal to or

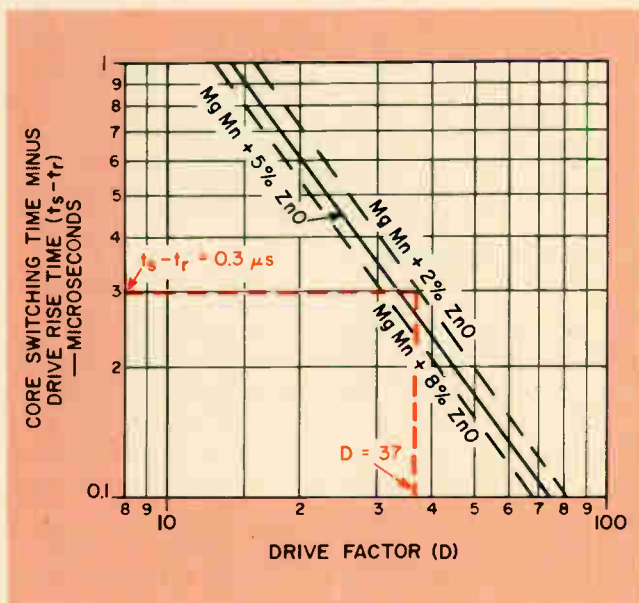

Fig. 1: Core selector chart. The dotted lines outline the present core limits available with existing conventional materials.

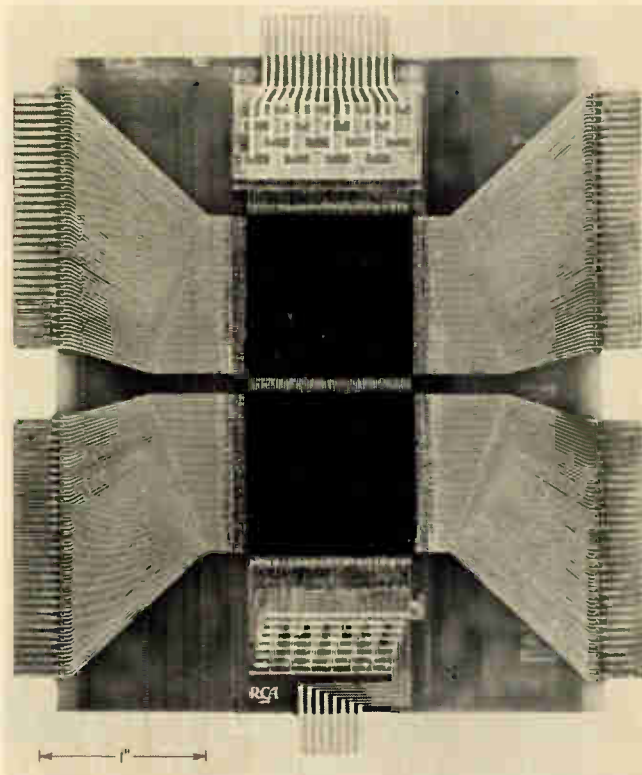

Fig. 2: The RCA MF2100 memory contains the basic module 4½ in. by 1.2 in., complete with integrated diode matrix and 2 wafers.

less than 0.4 μ sec. and the pulse-rise time (t_r) must be 0.1 μ sec.

Step 1. MgMn with 2% ZnO is the mixture chosen for two reasons. (1) As the ZnO content is increased, the core properties become more sensitive to ambient temperature variations. This is because of a lowering in the core Curie temperature (i.e., the one output voltage and the threshold current have a steeper slope). (2) The core hysteresis loop becomes less square as the ZnO content increases.

Step 2. $t_s - t_r = 0.4 - 0.1 = 0.3 \mu\text{sec.}$

Step 3. From the chart, $D = 37$. Thus, Full Select Current = Drive Factor \times Core ID = (37) (18) \cong 680 ma. This value of current results in the "disturb ratio" (I threshold/ I full-select) of 0.61 which is needed for satisfactory coincident-current memory operation.

Word-Address Devices

In addition to a reduction of core ID's from 0.050 to 0.030 to 0.018 in., operating modes other than the "3D" coincident-current mode were investigated with a three-fold purpose in mind. (1) Reduce the core switching time. (2) Reduce, or at least maintain the

same magnitude of the driving currents. (3) Reduce the number of wires from the minimum of 4 needed for the "3D" coincident-current mode. This investigation resulted in the use of 0.030-in. OD, 0.018-in. ID cores in the linear-select (commonly referred to as word-address or "2D") mode. This selection of core diameters allowed the number of wires through the core aperture to be reduced from a minimum of 4 to a minimum of 2, but increased the cost of the selection circuits. A reduction in core switching time, hence memory cycle time, was attained through the use of impulse switching of the core. Table 2 shows the evolution of the "2D" linear-selected memory device up to the present.

This table shows that a reduction in core size results in a slight increase in memory capacity. This is made possible because of reduced drive current and increased packaging density. As mentioned before, an increase in circuit cost results, primarily caused by the increase in the number of selection diodes needed. For capacities of greater than a few million bits, this increase in selection circuit costs is appreciable. To increase capacity to beyond 10^6 bits, the use of two memory-system modules is cheaper than one larger unit.

"2½D" Devices

Another approach to cheaper ferrite core memory devices has been the mode, referred to as "2½D", in

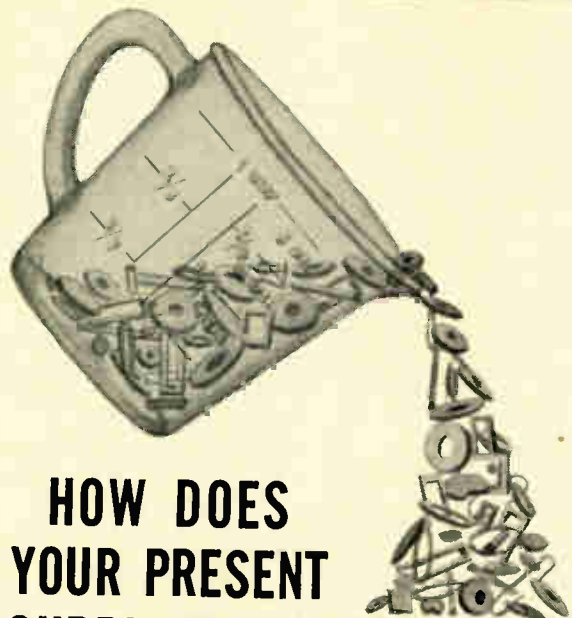

HOW DOES YOUR PRESENT SUPPLIER OF MATERIALS FOR SEMICONDUCTOR DEVICES MEASURE UP?

CAPABILITY

Can he supply a whole range of miniature and micro-miniature parts in Aluminum, Gold, Indium, Lead, Tin and other exotic and coated metals as ALPHA can, or does he limit you in your selection?

Does he have a technical staff available to help you with the research, design and application of these parts as ALPHA does?

QUALITY

Are his employees 100% quality conscious as ALPHA's are?

Does he have up to the minute measuring devices and analytical facilities with which to check your parts before shipping as ALPHA does?

CAPACITY

Can he handle the really tough jobs (micro-miniature discs, spheres, and washers; special high purity materials; intricate base tabs; close dimensional tolerances; etc.) as ALPHA can, or is he only interested in the parts that are easy to make?

When devices proceed from prototype to production, can he produce the prototype parts in production quantities as ALPHA can?

DEPENDABILITY

Can he be depended upon to deliver your material when you need it as ALPHA can?

What happens in the tight situation when a little extra effort is required — do you get what you need as ALPHA's customers do?

Unless you can answer yes to every question listed above, you are not receiving the technical assistance and service you need and deserve. Before placing your next order contact your ALPHA representative.

J-5672

For further information write or call for Alpha's General Products Bulletin.



alpha

ALPHA METALS, INC.
56 WATER ST., JERSEY CITY, N. J. 07304 201-434-6778
Los Angeles, Calif. • Alphasoy Corp. (Div.), Chicago, Ill.
Alpha Metals, Inc. (U.K.) Ltd., London, England

COMPUTER MEMORIES (Continued)

which the address-selection-circuit cost has been greatly reduced.

The number of wires strung through each core aperture is dependent on the speed and/or capacity ultimately desired. Table 3 lists the expected "2½D" evolution through 1967. In a "2½D" device the core itself is selected using normal coincident-current, half-select-current pulses. The previous "core selector" chart will thus apply to "2½D"-memory-device-core selection.

Peripheral Memories

Although all of the preceding has been limited to the so-called main memory of a computer, ferrite core memories also are used in high-speed "scratchpad" and other peripheral memories. In these memories "2D" and "3D" modes of operation are commonly used. With the exception of buffer memories, most applications are in certain small 2 core/bit, "2D" "scratchpads." In these scratchpads core diameters are 0.030 in. (OD) and 0.010 in. (ID), "full-read" drive currents are 400 ma, capacities range from 200 to 20000 bits, and read-regenerate cycle times are as small as 0.2 μsec.

Integrated Memories

The older "integrated" memory-device elements, such as thin films of permalloy and ferrite apertured plates, have not replaced ferrite core memory elements because of one basic reason—high cost. This high cost results from difficulty of making these devices with any reasonable degree of reproducibility. Experimental work continues mainly on the thin-film permalloy devices.

Newer "integrated" memory devices will not be used in volume until reproducibility has been established at the manufacturing level. Until this reproducibility has been established, actual and projected costs are questionable. Thus, computer manufacturers will wait until these devices and their associated circuits can be shown to be competitive with existing ferrite-core memory devices and their associated circuits. Of the devices mentioned in the introduction, monolithic ferrite and integrated flip-flop semiconductor memories are closest to fulfilling the price/performance needs. In Table 4 the status and characteristics of the most promising of the newer integrated memory devices are reviewed.

It is interesting to note that as the main memory switching speed increases the "scratchpad" switching speed must also increase, otherwise the "scratchpad" loses its function and utility. Whereas "scratchpads" with 0.2 to 0.3 μsec. cycle times are adequate for use with main memories operating in the 1 to 2 μsec. cycle time region, their usefulness becomes limited when the main memory cycle time approaches 0.500-0.750 μsec. It is expected that a push towards one of the faster "integrated" memories for at least scratchpad use will occur in 1966-1967. Because semiconductor "flip-flop" memories are now available, and are able to operate at cycle

(Continued on Page 75)

NEW!



CEC announces the first low cost, three-in-one portable direct-writing recorder

CEC's new solid-state DG 5511 introduces engineering and performance advantages never before offered by any recorder in its price range.

This portable, 2-channel, thermal writing recorder is so versatile it provides the capability formerly achieved only through multiple instruments. The DG 5511 features *two* plug-in signal conditioners for a wide range of voltage inputs. *No* preamp is needed for high level signals. Due to its all-modular design, users may convert from high level signal inputs to low level inputs by a simple change of plug-in attenuator/amplifier units.



In addition, the DG 5511 is remarkably easy to use with its unique snap-in, front chart-loading and convenient push-button selectable chart speeds.

Frequency response is equally outstanding—d-c to 70 cps; flat to 125 cps at reduced amplitude. And its wide signal range (25 millivolts to 500 volts full scale) makes the DG 5511 readily adaptable to telemetry and computer readout. And of particular importance to industry is the fact that the DG 5511, being a true portable, may be used virtually anywhere there is a power source and wherever there are unknown forces such as vibration, pressure or temperature to be measured. Consequently, the DG 5511 is certain to be a "must" instrument for every conceivable application from foods and pharmaceuticals to chemicals, construction and heavy equipment.

Features:

- ☐ Portable
- ☐ Rugged and compact

- ☐ Lightweight
- ☐ Low cost
- ☐ Versatile (3 in 1)
- ☐ High performance
- ☐ Snap-in chart-loading
- ☐ Excellent frequency response
- ☐ Push-button chart speeds
- ☐ All solid state

A wide range of accessories and operating supplies is available.

What about service? CEC backs its instruments with the largest, best equipped sales/service organization in the field today.

For a desk top demonstration of the DG 5511, contact your nearest CEC Field Office, or write for CEC Bulletin 5511-X12.

CEC

Data Recorders Division

CONSOLIDATED ELECTRODYNAMICS

A SUBSIDIARY OF BELL & HOWELL/PASADENA, CALIF. 91109
INTERNATIONAL SUBSIDIARIES: WOKING, SURREY, ENGLAND
AND FRIEDBERG (HESSEN), W. GERMANY

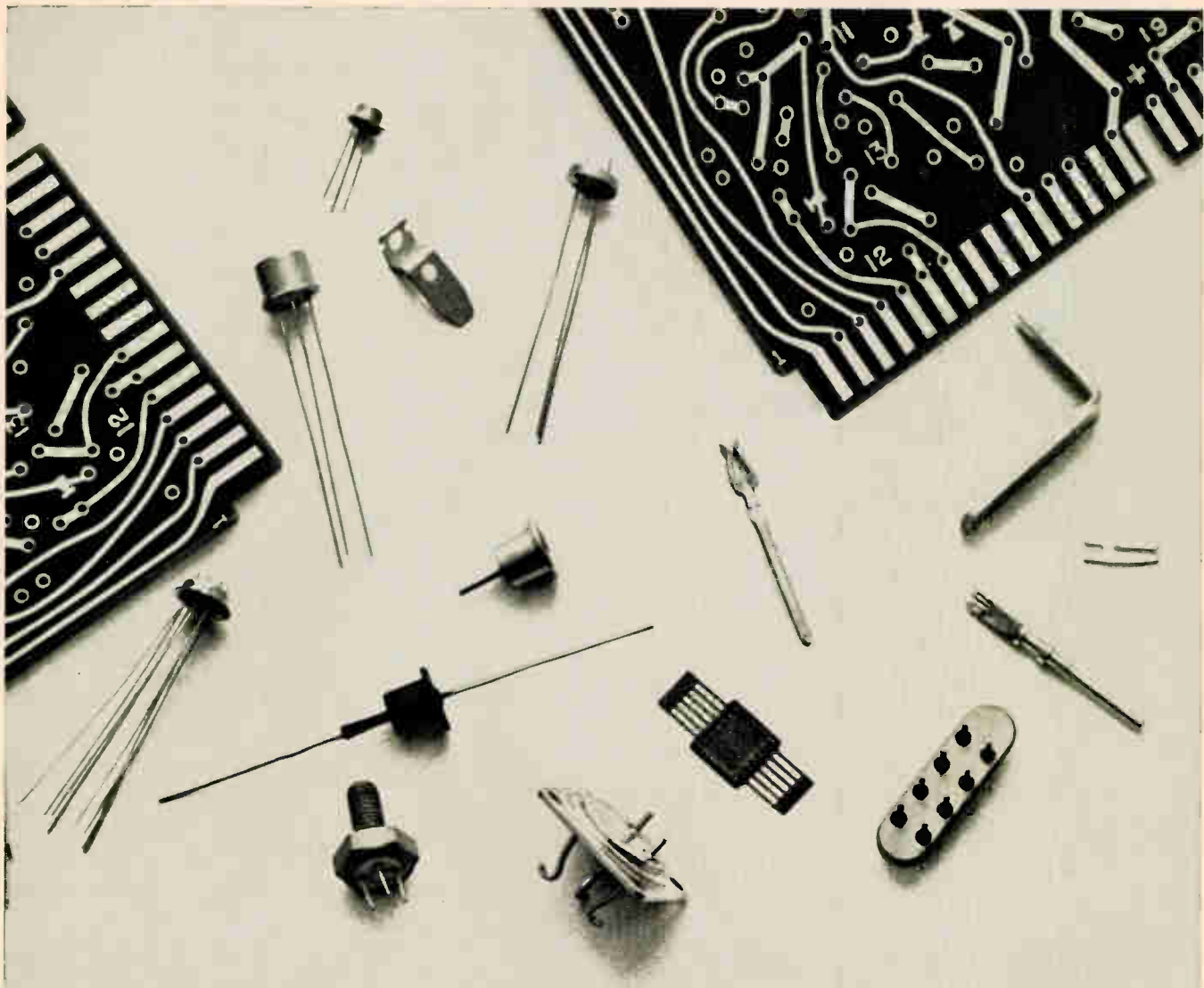

Gold-plated components
conduct better,
solder easier,
reflect heat,
and resist wear,
corrosion,
oxidation,
galling.

Now let us give you the details.

The details are in our comprehensive reference guide—a voluminous encyclopedia of precious metal electroplating processes. Here you'll find charts, graphs, technical papers, magazine articles. A compendium of today's most advanced knowledge of gold-plating—the facts that have put gold into computers, communications equipment, jet aircraft, missiles, space probes. Write for your copy of "Gold Electroplating Processes."



Sel-Rex Corporation, Dept. Q-12, 75 River Road, Nutley, N. J. 07110.

COMPUTER MEMORIES (Concluded)

times of less than 0.1 μ sec., these devices will be used predominantly in scratchpad memories. Price becomes a secondary consideration at these high switching speeds.

Conclusions

New computer memory designs started in 1966-1967 are summarized in Table 5.

A strong possibility for consideration in the high-speed main memory area is the monolithic ferrite device. The choice of device in this high-speed memory will be determined by the usual performance/price tradeoffs.

The year 1966 appears to be an important one in memory devices. On one hand, ferrite-core manufacturers will continue to seek lower-cost methods of stringing 2, 3, and 4 wires through a small ferrite core aperture. On the other hand, "integrated"-memory-device manufacturers will attempt to demonstrate reproducibility and achieve the lower costs inherent in a batch-fabricated device. The computer manufacturer will, of course, benefit from the progress made in both areas.

References

- (1) Pohn, A. V., and Mitchell, E. N., "Magnetic Film Memories—A Survey," *IRE Trans. Electron. Computers*, EC-9, 1960, pp. 308-314.
- (2) Chong, C., and Feede, G., "Magnetic Films: Revolution in Computer Memories," *Proceedings Fall Joint Computer Conference*, 1962.
- (3) Rajchman, J. A., "Ferrite Apertured Plate for Random Access Memory," *Proc. IRE*, 45, 1957, pp. 325-334.
- (4) Shahbender, R., Wentworth, C. P., Li, K., Hotchkiss, S. E., and Rajchman, J. A., "Laminated Ferrite Memory," *Proceedings Fall Joint Computer Conference*, 1963.
- (5) Schmidt, J. D., "Integrated MOS Transistor Random Access Memory," *Solid State Design*, Vol. 6, No. 1, Jan. 1965, pp. 21-25.
- (6) Burnes, J. R., "Switching Response of Complementary Symmetry MOS Logic Circuits," *RCA Review*, Vol. 25, No. 4, Dec. 1964, pp. 627-664.
- (7) Borkan, H., and Weimer, P. K., "An Analysis of the Characteristics of Insulated-Gate Thin-Film Transistors," *RCA Review*, Vol. 24, No. 2, June 1963, pp. 153-165.
- (8) Weimer, P. K., Shallcross, F. V., and Brokan, H., "Coplanar-Electrode Insulated-Gate Thin-Film Transistors," *RCA Review*, Vol. 24, No. 4, Dec. 1963, pp. 661-675.
- (9) Burns, Jr., L. L., Alphonse, G. A., and Leck, G. W., "Coincident Current Superconductive Memory," *Trans. IRE PGEC*, Sept. 1961.
- (10) Burns, Jr., L. L., Christiansen, D. A., and Gange, R. A., "A Large Capacity Cryoelectric Memory with Cavity Sensing," *Proceedings Fall Joint Computer Conference*, 1963.
- (11) Burns, Jr., L. L., "Cryoelectric Memories," *IEEE Proceedings, Special Issues on Cryogenic Electronics*, Vol. 52, No. 10, Oct. 1964, pp. 1164-1176.
- (12) Barnard, J. D., Blumberg, R. H., and Caswell, H. O., *IEEE Proceedings, Special Issue on Cryogenic Electronics*, Vol. 52, No. 10, Oct. 1964, pp. 1177-1190.

Table 1
Chronological Listing of "3D" Devices

Core Size		Drive Current Full-Select Milliamps	Capacity Bits	Cycle Time (Read/Regenerate) μ secs
OD (in.)	ID (in.)			
0.080	0.050	500-800	10^5 - 10^6	≥ 10
0.050	0.030	400-800	10^5 - 10^6	≥ 5
0.030	0.018	500-800	10^5 - 10^6	≥ 1.5
0.025-0.020	0.015-0.012	600-1000	10^5 - 10^6	≥ 0.75

Table 2
Evolution of the "2D" Linear-Selected Memory

Core Size		Drive Current Full-Read-Select Milliamps	Capacity Bits	Cycle Time (Read/Regenerate) μ secs
OD (in.)	ID (in.)			
0.050	0.030	600	$5+ \times 10^5$	≥ 1.0
0.030	0.018	400	10^6	≥ 1.0

Table 3
Expected "2½D" Evolution Through 1967

Core Size		Drive Current Full-Select Milliamps	Capacity Bits		Cycle Time (Read/Regenerate) μ secs	
OD (in.)	ID (in.)		2 wire	3 wire	2 wire	3 wire
0.030	0.018	400-800	10^7 - 10^8	$1+ \times 10^6$	≥ 2.0	≥ 1.0
0.020	0.012	700-1000	10^7 - 10^8	$1+ \times 10^6$	1.0-2.0	≥ 0.5
0.014-0.015	0.008-0.009	900-1200	10^7 - 10^8	$1+ \times 10^6$	0.75-1.5	≥ 0.25

Table 4
Integrated Memory Devices

Memory Device	Capacity Bits	Cycle Time (Read/Regenerate) μ secs	Status
Monolithic Ferrite Scratchpad	2×10^3 - 50×10^3	0.1	Small scale production
Monolithic Ferrite Main Memory	10^5 - 10^6	0.5	Small scale production
Semiconductor Flip-Flop	0.25×10^3 0.25×10^4	0.05	Small scale production
Superconductive Thin Films	10^7 - $1+ \times 10^8$	1-2	Laboratory
Thin-film-transistor	?	?	Laboratory

Table 5
New Memory Designs Begun in 1966-67

Device	Scratchpad		High Speed Main Memory			Slow Speed Mass Memory		
	Speed	Bit Capacity	Device	Speed	Bit Capacity	Device	Speed	Bit Capacity
Semiconductor	0.05 μ s	0.25×10^3 to	Ferrite Cores	0.25-0.75 μ s	$1+ \times 10^6$	Ferrite Cores	1-2 μ s	10^7 - 10^8
Flip-flop		0.25×10^4	"2½D" 3 wires			"2½D" 2 wires		

Fig. 1:
Here are the normal steps
found in making individual
integrated dice.
First photo shows
a typical silicon slice
containing hundreds of
circuits prior to separation.
Second photo is a closeup
of the silicon slice.

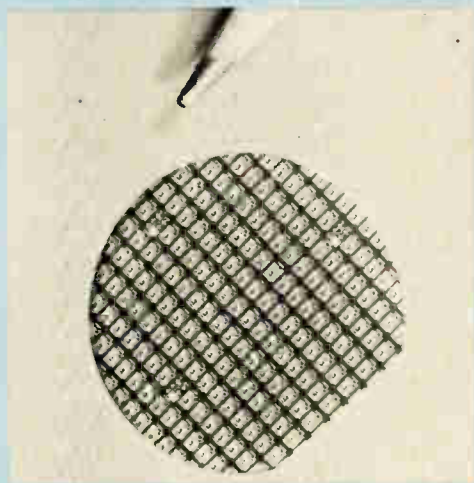

Looking at Integrated Circuit



By **ROBERT A. BERNAY***

Project Engineer, TRW Systems, Washington Operations,
1735 I Street, N.W., Washington, D. C. 20006

MONOLITHIC ICs of the silicon planar variety have been in use over 4 years. Producers have made refinements which improve yields, costs, and reliability. We will discuss these here.

Cost Factors

The process for planar ICs has been described many times.¹ Let us start, then, with a slice of silicon which has gone through the oxidation, masking, diffusion, metallizing, etc., steps. (See Fig. 1). It now contains a large number of ICs, (between 300 and 1000 is common). The slice represents perhaps \$10 to \$100 in labor added to a, roughly, \$1.00 slice of raw silicon. Since this is a batch process using photographic methods, it matters very little whether the circuits are simple or complex. The number of diffusions, maskings, handling operations, etc., are the same for either. Thus, a

*This article was originally written while Mr. Bernay was Consultant Project Engineer with Melpar, Inc., Falls Church, Va.

slice of complex circuits costs almost no more to make than a slice of simple ones.

So far, we have a cost per circuit (but as yet un-separated) of between 1.1¢ and 30¢. But, not all of the circuits on the slice are good. They now have to be tested and the bad ones sorted out. It used to be the practice to mount all of the dice on headers, complete the connections, and then test them. This was very wasteful. Methods have been perfected for testing each circuit while it is still on the slice. Practice now is to use a multi-point probe attached to an automatic test set, to check each circuit, and to put an ink spot on the bad ones. These can be thrown away when the dice are cut apart. The waste of assembly labor has been eliminated and costs reduced. The temptation to accept marginal units is also reduced, thus improving reliability.

Now that the bad circuits have been sorted out at the die stage, a good circuit costs, say \$0.10 to \$1.00,

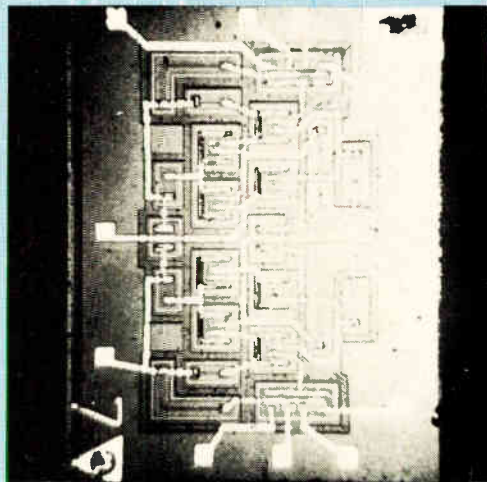
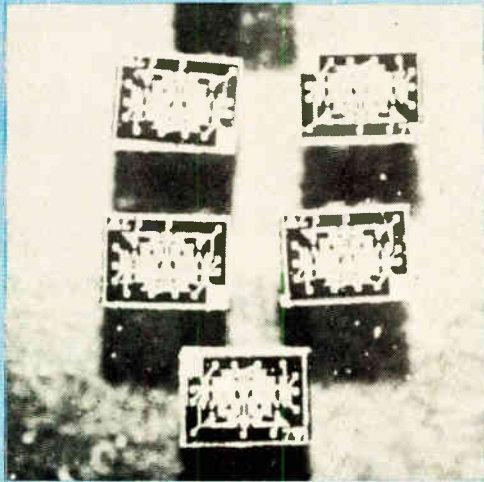

The left photo shows individual dice after separation and testing. Right photo is a closeup of one complete circuit, ready for packaging.

Costs and Failures

The increased silicon integrated circuit complexity per package is reducing costs and improving reliability.

This statement appears to be a farce.

But it is not, as you will learn here.

Included are descriptions of the main causes of IC failures.

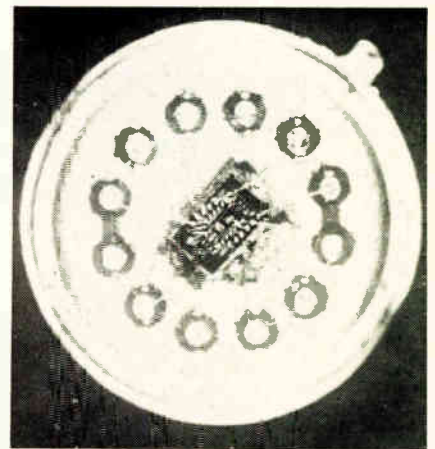

Fig. 2: Typical integrated circuit mounted in a TO-5 package, without the top.

depending on yield. It is still true, of course, that complex circuits have a higher probability of being defective. But, controls over the diffusion and masking, absence of pinholes due to particle contamination, etc., have been improved to increase yields. It is becoming nearly true that a good circuit die costs \$X.XX, regardless of its complexity. In any event, it does not much matter, as we will see.

The remaining assembly steps consist of attaching the die to a package, bonding leads to it, and testing the complete unit. (See Fig. 2). This is not a batch operation, nor is it yet automated to any great degree. Instead, persons still handle a die under microscopes, attach 0.5- to 1.0-mil gold or aluminum wires to each pin, and so on. This represents much labor, and thus is expensive. In fact, it can cost 10 to 50 times as much as the dice. The cost of making the silicon circuits themselves often becomes almost negligible.

The point of importance is that these assembly opera-

tions, and the number of them in making one finished IC package are about the same, no matter whether the circuit is simple or complex. Pricing levels are beginning to reflect this. For example, if you compare prices for a 3-input gate in a single package to those for a triple 3-input gate in one package, the latter costs much less than three times the price. Thus, *the higher the complexity, the greater the value.*

There is still another factor speeding this trend: the advent of the flat pack. Since this is now made with 14 leads (more are possible—Fig. 4), whereas 10 leads is the practical maximum for the TO-5, greater complexity can be built into a unit. The shape of the flat pack also lends itself much better to automated assembly and handling methods. This will result in lower labor costs. In fact, some procedures have already made much progress in this. Thus, the capability of the flat packs leads to greater value.

It is clear, therefore, that the fewer packages one can

● quick reference guide to RCA memory cores

**Whatever your ferrite memory requirements,
RCA has the right cores...conventional,
wide-temperature-range or special-purpose types**

Two new cores, RCA types 1100M5 and 1101M5, are specially designed and characterized for the new "2½D" and "3D" schemes for memory system operation. Check the table below for the basic characteristics of these new cores which also feature extra-square hysteresis loops.

RCA WIDE-TEMPERATURE-RANGE CORES
Operate over any 100° C range between the limits of -55° C and +125° C without temperature compensation, air conditioning, or special cooling.

CORES FOR SPECIAL APPLICATIONS
For custom-formulated cores designed to meet your special or unusual requirements, ask for a quotation.

FOR MORE INFORMATION and extra copies of our Quick Reference Guide, write, wire or phone your local RCA Sales Office, or: RCA Electronic Components and Devices, Memory Products Operation, 64 "A" Street, Needham Heights, Mass. Telephone: (617) 444-7200.

YOUR SYSTEM CYCLE-TIME	RECOMMENDED RCA CORE TYPE		RECOMMENDED COINCIDENT-CURRENT DRIVE CONDITIONS PULSE CHARACTERISTICS @ 25 C				TYPICAL OUTPUT CHARACTERISTICS @ 25° C				CORE SIZE OD/ID (in mils)
	(Coincident-Current)	Conventional	Wide-Temp Range	I _m in Ma	I _{pw} in Ma	t _r in μsec	t _d in μsec	dV _i in mv	dV _z in mv	t _p in μsec	
< 1 μsec	NEW! 1100M5	0181M5	875	437.5	0.05	0.2	35	5	0.10	0.18	20/12
			875	437.5	0.05	0.2	40	5	0.10	0.18	23/15
1 to 2 μsec	0183M5 0172M5 0175M5	270M1 0187M5 NEW! 1101M5	550	275	0.1	0.5	55	7	0.21	0.41	30/18
			700	350	0.1	0.4	60	5	0.18	0.36	30/18
			700	350	0.05	0.3	40	5	0.13	0.25	23/15
			800	400	0.1	0.5	65	6	0.21	0.41	30/18
			820	410	0.05	0.25	35	5	0.11	0.22	20/12
2 to 4 μsec	0173M5	0167M5	450	225	0.2	0.8	50*	4	0.36	0.60	30/18
			625	312.5	0.2	0.8	50	4	0.36	0.58	30/18
4 to 6 μsec	232M1	264M1	480	240	0.2	1.5	80*	10	0.45	0.95	50/30
			630	315	0.2	1.5	80*	12	0.45	0.90	50/30
6 to 8 μsec	226M1	269M1	400	200	0.5	1.5	80*	7	0.70	1.25	50/30
			480	240	0.5	1.75	55	7	0.80	1.50	50/30
over 8 μsec	225M1 222M2	269M1	250	125	0.5	3.0	35*	3	1.15	2.40	50/30
			400	200	0.5	3.0	75*	10	1.15	2.30	80/50
			480	240	0.5	1.75	55	7	0.80	1.50	50/30

RCA ELECTRONIC COMPONENTS AND DEVICES

* μV_i



The Most Trusted Name in Electronics

Circle 38 on Inquiry Card

World Radio History

See RCA Monolithic Ferrites in operation at FJCC, Booths 202-203

IC COSTS & FAILURES (Continued)

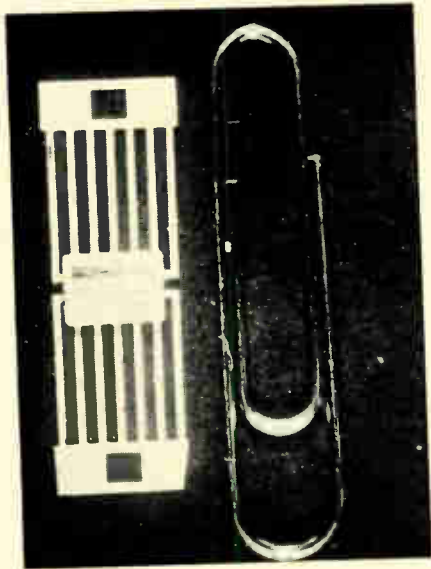

Fig. 3(a): Here is a typical integrated circuit in a 14-lead flat package.

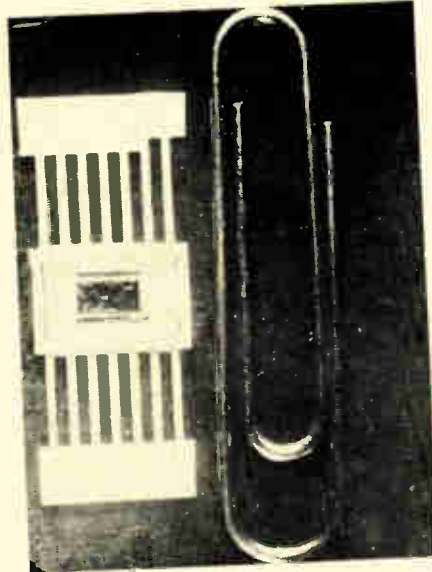

Fig. 3(b): The integrated circuit chip is shown, without the top, in a flat pack.

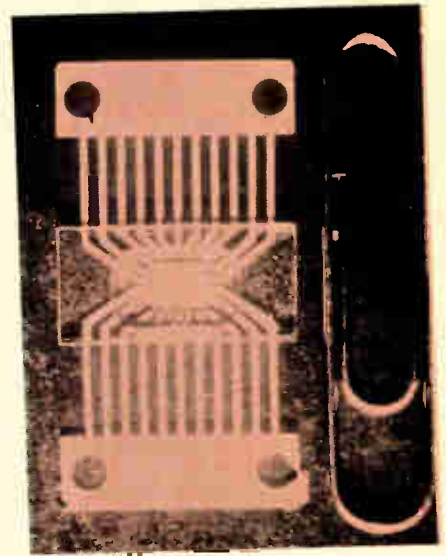

Fig. 4: A 22-lead flat package is shown that is now in pilot production.

use to do a given function, by putting as many functions as possible in one package, the lower the cost. One recent quotation received for a medium-size digital system makes this clear. About 5500 flat packs were needed at a normalized cost of 25 to do the same function with TO-5 units required 9600 packages at a normalized cost of 42. If design and assembly costs are added to this, the difference becomes even larger.

Failure Mechanisms

So far, we have only mentioned costs. Let us look at the failure mechanisms of ICs. It will become apparent that low cost per function (high value) and high reliability go hand-in-hand.

The greatest single cause of failures up to now has been the internal lead bonds: i.e., the gold wires which connect the aluminum interconnection pattern on the die to the external leads on the package. One reason for failure of this bond has been the "purple-plague." The intermetallic aluminum-gold compound which forms at a temperature-dependent rate, has high resistance, and is very brittle. Thus, open circuits often result. Sometimes a bond is made with too much or too little pressure, with too much or not enough heat. The result is again an intermittent or open contact.

One way to avoid the purple-plague problem is to use aluminum wires. These are generally attached by ultrasonic bonding. Much work is being done in this area, but the process is not yet widely used. Even with aluminum bonds, though, it is still possible to use too much or too little pressure, or to have something else go wrong and have poor connections. Thus, this is not a complete answer.

The obvious way to reduce the problem of poor bonds is to have as few of them as possible. In a 14-lead

package, there are 14 such bonds, regardless of what internal complexities the circuits on the die contain. Thus, the greater the complexity of the die (i.e., the more functions per package), the fewer total number of bonds one winds up with in the system. We conclude, then, that *the reliability per function increases with increasing internal package complexity.*

Exactly the same kind of argument can be made for the external solder or welded connections which tie the package into a system.

But, is this really true? We have only examined one failure mechanism—poor connections. Even though this is the most important one, what about others?

The next most frequent failure mode is open aluminum interconnects. It is estimated that this causes about one-tenth as many failures as open bonds. These interconnects are aluminum metal deposited on the silicon oxide surface of the die. They connect the resistors, diodes, and transistors together within the circuit. Naturally, in a complex circuit there will be more of these than in a simple one. Is it not true, then, that the more complex interconnects will fail more often than the simple ones?

To a degree, perhaps, but not really. Let us find why these aluminum patterns fail. The most frequent cause is a slip of the hand by the person who picks up a die with a pair of tweezers (under a microscope) to sort it, mount it on a header, or whatever. Considering the size of the die, 40 to 70 mils square, and the size of the tweezers, 3½ to 4 inches, this is not at all unlikely. When this happens, the aluminum is scratched, and the circuit is ruined. The circuits that the user worries about, of course, are the ones which are only partly scratched through, still pass electrical test, but fail later

IC COSTS & FAILURES (Concluded)

due to overheating and sublimation, or perhaps corrosion, of the remaining aluminum. But in any event, this problem hardly depends on the complexity of the circuits, only on their number.

Other causes of interconnect failure are poor deposition and adherence of the aluminum, ragged edges due to poor masking methods, too thin a layer of metal, or "shadowing" which is too thin a layer at a stepdown in the silicon dioxide. Some of these problems are such that, if they occur in one part of the circuit, all parts of it will be bad; but others do increase with complexity because of thinner lines, and these are more crowded. Still another failure mechanism is poor alloying of the aluminum where it is supposed to make contact with the silicon, through the SiO_2 windows. Again, this is a batch-type problem.

A third failure mode is leaky packages (hermetic seal failures). When these happen, moisture and other contaminants are admitted to the interior surfaces, and even though the "planar" silicon dioxide protects the junctions, this protection is not perfect. Eventually, leakage currents increase, gains decrease, and, if this goes far enough, circuit failure results.

Contamination is sometimes sealed with the package, due to unclean environments, or to faulty washing and drying. These affect the circuit in much the same way as seal leaks. But whether the failure cause be a leak or sealed-in contamination, it is most likely that all junctions within the package are affected, not just one or two. Thus, putting more junctions in one package does not affect the reliability of the "unit" IC very much.

The fewer sealed packages one has, the less often these problems are likely to happen. Again, therefore, greater complexity leads to better reliability.

One should ask another question, though: Is not the incidence of hermetic seal leaks in 14-lead flat-packs

very much higher than for the older, proven 8- or 10-lead TO-5 package? If so, this would set a "10-lead limit."

It is true that a year ago, or even as late as 6 months ago, it was a tough problem to buy flat packs which were hermetic, and would remain good after handling and environmental sequences. We believe that they have now been largely solved. There is not yet enough statistically meaningful test data to prove this. This will take at least another year. Meanwhile, most manufacturers have done much work to improve the mechanical design of the package, as well as their handling and sealing methods. Stress-to-failure test results and other torture tests recently done by Fairchild² are impressive. Others are doing similar work. We contend, therefore, that if you are careful to choose a vendor who has a good package, the TO-5 and the flat pack have equal reliability per package, and the greater complexity of the flat pack gives it an advantage on a system basis.

Chipping and cracking of the silicon die, or of the protective oxide, is another failure cause, though infrequent. Such things are caused by mishandling of the die in manufacture. And once more, it is obvious that the fewer dice/circuits, the less the problem.

There are still other failure mechanisms in ICs, mostly related to bulk defects in the crystal, to diffusion spikes, secondary breakdown, and uncontrolled PNP switching. These are so very much rarer than the other mechanisms discussed, that it is not worth treating them as a user's reliability problem now.

References

1. Booklets *Fairchild Epitaxial Micrologic*, Fairchild Semiconductor Div., Sept. 1963, or *Advanced Fabrication Techniques for Motorola Integrated Circuits*, Motorola Semiconductor Div., Dec. 1962.
2. *Fairchild Flat Package*, Reliability Report dated August 1963; also private communications.
3. *Electronics*, "Go-it-alone Circuits Advocated for Apollo Spaceship's Computer," December 1964. This also contains discussion of failure mechanisms.

VARIABLE LOAD TESTS SUPPLIES

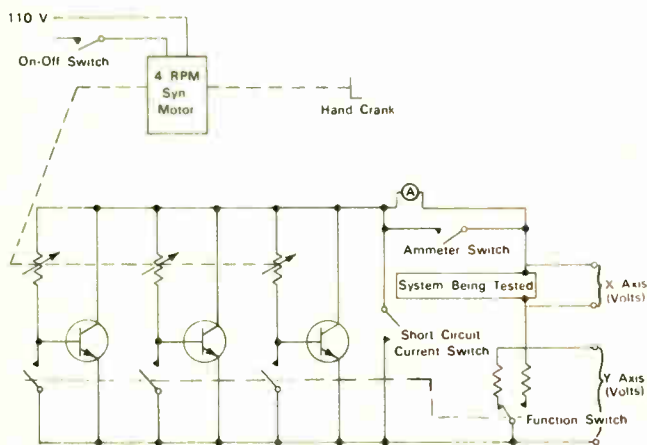

For further information contact: Technology Utilization Officer, Goddard Space Flight Ctr., Greenbelt, Md., 20771. Ref. B65-10105.

THERE WAS A NEED for a method of measuring the current and voltage, and plotting the power characteristics of low-voltage, high-current, dc supplies over an extended current range. A continuously variable automatic load with capabilities up to 10a and 300w was used.

The circuit uses 3 ganged logarithmic resistance potentiometers driven by a self-reversing synchronous motor. When the function switch is closed, the emitter circuits of the 3 transistors are shorted, and the load consists of the parallel resistances of the variable potentiometers. The upper limit of the load, with the function switch closed is 1a and 5w. When the function switch is open, the transistors are biased on by the potentiometers, and the upper limit of the load is then 10a and 300w. The large current and power handling is provided by the transistors. The pots enable a smoother transition from an open to short circuit, and provides a high "off" resistance for a given current.

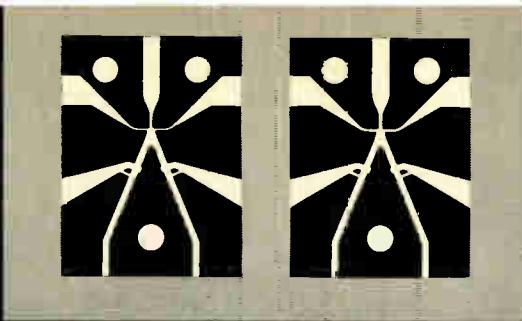

Fluid computer elements

**Whether
you move air
to control
or compute...**

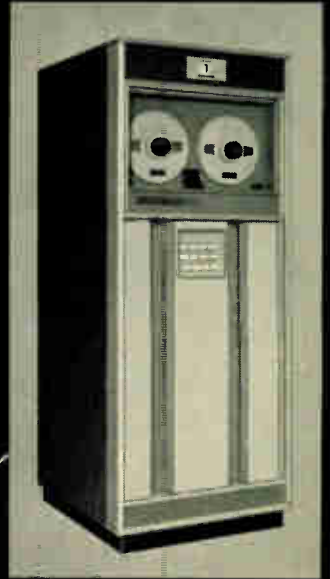

Vacuum tape loop control



Diehl's new Series 915[†] vortex-type single stage blower offers these 8 advantages never before available in 1 unit

Now one blower—the new Diehl series 915—can do all these things for you: (1) generate high air pressures or vacuums (2) with longest possible life (3) with utmost simplicity and minimum of moving parts (4) for minimum maintenance (5) at lightest weight (6) with low rotational speeds (7) at low noise levels (8) at the lowest possible price!

New Series 915 vortex-type single-

stage blowers provide 60 cfm free air delivery, a static head of 24 inches of water at 20 cfm (.872 psig) (3400 rpm), with LOW NOISE—in the under-60 db range at most frequencies.

A unique design achieves this excellent noise suppression without the usual sacrifice in performance. Inlet and outlet are directly from the multi-blade impeller—no right angle turns to lower efficiency. Instead, resonant

sound absorbers—perforated tubes wrapped with polyurethane foam surrounded by a cavity and carefully tuned to the exact frequencies generated by the impeller blades—are located at both inlet and outlet.

Optional feature: a control which permits adjustment of pressure or suction at any flow rate.

Send the coupon today for a four-page bulletin on the 915 blower.

[†] Patent applied for



THE SINGER COMPANY

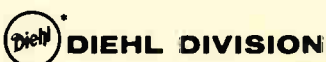

Finderne Plant, Somerville, N. J., Tel. Randolph 5-2200
Greenville Service Office, 207 Eisenhower Drive, Greenville, S. C., Tel. 803-235-0382

*A Trademark of The Singer Company

Yes, I'd like to see a bulletin on the high performing but quiet new Diehl Series 915 vortex-type blower.

NAME _____

TITLE _____

COMPANY _____

ADDRESS _____

CITY _____ STATE _____ ZIP _____



Fig. 1: Data communications secretary operates Datanet-760 keyboard display terminal. Datanet-30 data communications processor in background automatically schedules communications flow and monitors messages in and out of the computer center.

Basic Considerations in Time-Sharing

What is computer time-sharing?

How does it benefit the user?

Why was it not available sooner?

What is its future?

These and other pertinent questions are answered and some current approaches to software and hardware are discussed.



By **KENNETH O. FISKETJOHN,**

Mgr., Communications Programming,
Computer Department,
General Electric Co., Phoenix, Ariz.

IN THE PAST SEVERAL YEARS, DATA PROCESSING technology has advanced significantly. Software has improved with better and easier-to-use language processors, and more comprehensive use-oriented packages. Hardware is faster, more flexible and cheaper. These improvements have extended the use of computers in many directions.

But, few advancements have as much potential as the real-time or time-shared use of computers. Time-Sharing has created a new philosophy of computer usage, in the spirit of "bring the computer to the man, not the man to the computer." Through use of a relatively new form of hardware and software, many people may now have simultaneous access to a computer from a remote device with no apparent interference from any other user. Resultant benefits to the user in time, expense, and convenience are apparent. Potential application of these methods promises to be explosive.

Many types of time-sharing are in use today. We will identify some of these systems and explore basic characteristics common to them.

On-Line Data Collection

The on-line data collection and inquiry system is one of the most important to users who have neither engineering nor scientific needs. This system is exemplified by the airline reservation system and by the production recording system in manufacturing.

The airline system has a large and complex inventory control problem. A finite number of seats are available for sale on routes requiring connections with other flights and many other airlines. The reservations clerk must fill as many seats as possible without overselling space. Using a time-sharing facility, many clerks have simultaneous access to the files which contain the inventory information. By submitting a variety of formatted requests, the clerk can establish seat availability, reserve or cancel space, acquire schedule information and other such functions.

The production recording system has a large variety of fixed inputs. Production activity is recorded on-line as each job is completed. These inputs are used in the control of inventories, both finished and in-process. They are also used in order entry, labor and material distribution and—in some cases—for direct control of machinery. In addition to the production control service which the system provides, many accounting functions are also performed.

In both of these cases, the business needs are similar, but the systems characteristics vary. The terminals used in the airline system require typed input; the production system needs hard copy plus limited variable input. Typed output is needed for the airline; but, little if any output is needed at the remote station in production recording.

Major advantage of both systems is that all files are centralized and reflect current status. This provides the basis for closer control of service or product. It also increases the speed with which data can be retrieved for use in making general business decisions.

Time-Sharing for Problem Solution

A second type of time-sharing, oriented toward general problem solution, is particularly suitable for engineering and scientific calculations. This system is based on conversational language processing and selective program execution. It is being used to perform many other functions in addition to engineering and scientific problem solution.

An example of its use is in the field of education, where time-sharing is being used with great success to make computer time available to many students. This allows a student to become familiar with the use of a computer and extends his capability to learn a specific subject. As the use of computers in business increases, the need for this training becomes more acute.

The field of accounting is another area which can benefit from time-sharing. Many desk calculator functions can be performed more quickly and accurately by the computer. There are advantages here in reducing many laborious tasks.

Program Languages

Many time-sharing users are unfamiliar with computers and programming. For this reason several new languages have been created for use in time-sharing. All have been developed with a few simple features in mind.

Each must be easy to learn: Although Fortran, Algol and other standard languages are in use in this mode, many people are not familiar with their use. The new languages are designed to be learned in a few hours rather than days.

The language must be easy to use: Programs can be submitted with few format restrictions and no complicated coding needs.

The program must compile and execute quickly: Rapid response is the greatest advantage of this system; thus, compile-and-run time must be held to a minimum.

Permanently stored programs or programs in un-debugged form must be changeable with little effort. Many of the programs in this system will be used only once; they will be modified if used again. Thus, the operation must be simple.

The language must operate in a conversational mode—to keep the operating features simple, the computer must ask for and check the various inputs. Each pro-

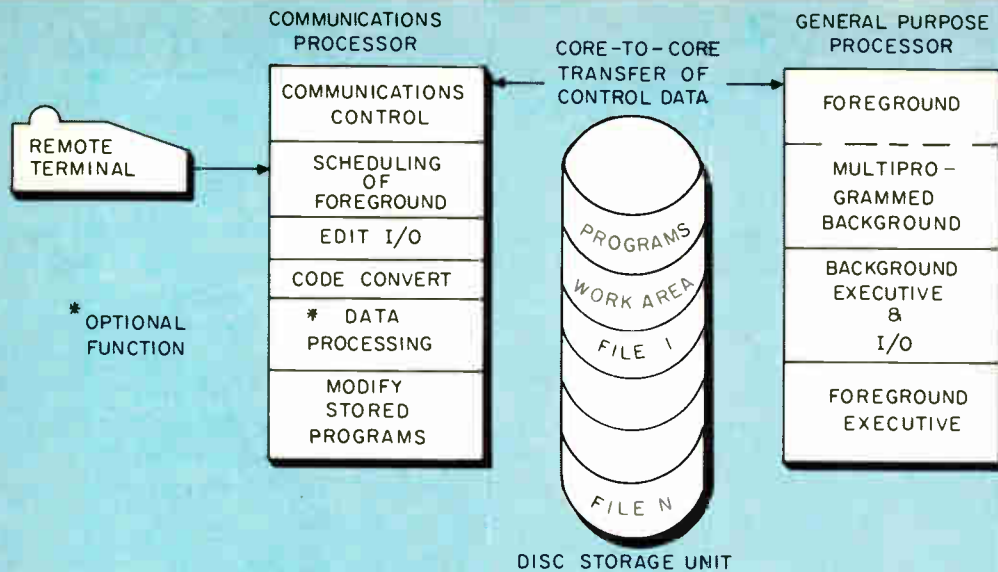

Fig. 2: Arrangement of basic time-sharing system. Communications may be performed by a free-standing device, such as Datanet-30, or, by the general-purpose processor. Remote terminal may consist of a teletype unit, a keyboard display, a remote computer with communications capabilities, or by a desk-top communications device. Main functions of the disc storage unit are the transfer of bulk data between the processors and the furnishing of general file data to both.

COMPUTER TIME-SHARING (Continued)

gram statement is checked for format validity to permit immediate correction.

Lastly, the system must accommodate the use of simple, inexpensive remote devices.

Hardware

There are several major hardware requirements in a time-sharing system. The most important single hardware element other than the computer itself is a communications facility.

The communications can be handled by a separate computer or through the use of a line controller on a general-purpose machine. Each approach has its advantages; but, the most important requirement is that the device used be capable of handling the required number of lines and a variety of line speeds. Where a line controller is part of a general-purpose machine, it must not dilute the systems performance by consuming too much time or space.

In general, it is best to use a separate communications computer with a small-to-medium scale machine.

Another needed hardware component is the random access storage device. All intermediate bulk storage and all permanently recorded programs must be available to the system as rapidly as possible. Inadequate disc or drum storage will dilute performance to the point where systems response is too slow.

Several other hardware features are available which make time-sharing more practical. *Memory protect* places hardware boundaries around specific program segments. The program cannot function outside of these boundaries. Thus, system destruction caused by program bugs is avoided. *Two-level interrupt* permits a secondary interrupt while the hardware is operating in a primary interrupt mode. When the machine is in interrupt mode servicing a peripheral, another interrupt may be superimposed on the first to perform a real-

time function. An *interval timer* is an internal, programmable clock which permits the system to suspend a function after a certain amount of time has elapsed. When various functions share the system, it is important that no single program retain control too long. When the allocated time for a given program has elapsed, a hardware interrupt occurs and the executive regains control.

If two computers are used—a general-purpose and a communications computer—they must be able to communicate on a core-to-core basis. It is also highly desirable that they both have access to the random access storage device. This will permit them to function independently when desired, and thus increase throughput.

Software Considerations

Most existing systems have a limited capacity to perform background operations concurrent with the real-time function. Let's consider the software problem involved in the concurrent "foreground-background" environment using two processors.

Functions of the communications processor are many and varied. It must perform all line service and control functions needed by the remote terminal. All format editing and request verification is performed here so that timely replies may be issued to the remote user. Statement sorting, insertions and deletion of program elements, and program listing requests can most easily be handled here. It is also best to perform all code conversion at this point in the system.

Because the communications processor decides all of the control requests from the remote station, it is also desirable for this processor to schedule all of the real-time functions in the other processor. It will contain the scheduling algorithm which allocates time, based on a pre-established priority scheme, to the various real-time functions. (Continued on page 87)

Watch those "HIDDEN" COSTS in an economy line of resistors



■ The "saving" is not pure "money in the bank" when you buy low cost, inferior grade resistors. Actually, the few pennies that you believe yourself to be "ahead" through purchasing resistors of uncertain performance can cost dollars in test line rejections, or worse, in customer disappointments with the product—a situation that is beyond repair.

How can you protect yourself against such accidents? Easy—standardize on Allen-Bradley resistors!

Allen-Bradley makes *only* one quality of resistors—a premium quality. The many manufacturers who have standardized on Allen-Bradley resistors find these resistors function also as an endorsement of the quality of the instrument in which they are used. Being produced by a unique hot molding process on highly specialized automatic equipment—designed and used only by Allen-Bradley—the resultant uniformity of characteristics from resistor to resistor—from one billion to the next—is not even approached by other resistor manufacturers. In fact, long term resistor performance is accurately predictable. And no user of Allen-Bradley resistors has ever encountered a catastrophic failure in service.

You'll be more fair with your customers when you permit your resistor dollar to buy for you the ultimate in dependability, performance, and uniformity of Allen-Bradley hot molded resistors. Allen-Bradley Co., 222 W. Greenfield Ave., Milwaukee, Wisconsin 53204. Export Office: 630 Third Ave., New York, N.Y., U.S.A. 10017.



HOT MOLDED FIXED RESISTORS are available in all standard EIA and MIL-R-11 resistance values and tolerances, plus values above and below standard limits. Shown actual size.



ALLEN - BRADLEY

QUALITY ELECTRONIC COMPONENTS

This label of "quality"



*covers everything
made by
Allen-Bradley*

EXCLUSIVE HOT MOLDED RESISTORS

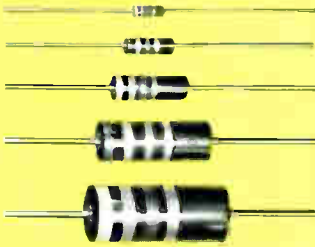

World renowned for their conservative ratings and stable characteristics. Due to uniformity of production, long term performance can be accurately predicted. With billions of these resistors in service, there is no known instance of catastrophic failure. Rated 1/8, 1/4, 1/2, 1, and 2 watts at 70°C. Available in all standard EIA and MIL-R-11 resistance values and tolerances, plus values above and below standard limits.

SUBMINIATURE LOW PASS FILTERS

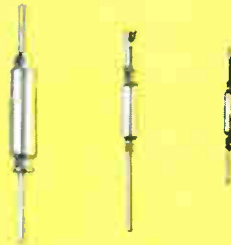

Especially designed for use in cable connectors, FO type filters provide a maximum reduction of RFI in a minimum of space—attenuation is greater than 50 DB over the frequency range from 100 MHz to 10 GHz. With these filters mounted through a ground plane in the connector, there's complete shielding to prevent rf coupling between input and output. Individual filter replacement is possible.

**ADJUSTABLE FIXED RESISTORS
Type R**



Type R built to withstand environmental extremes. Resistance element and terminals hot molded into integral unit with insulated mounting base. Has stepless adjustment and is noninductive. Watertight, can be encapsulated. Rated 1/4 watt at 70°C. Values from 100 ohms to 2.5 megohms. Tol. ±10 and 20%. Type N similar in construction but for less critical environments. Rated 1/3 watt at 50°C.

**HOT MOLDED POTENTIOMETERS
Type J and Type K**

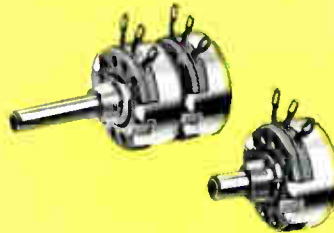

Type J potentiometers have solid, hot molded resistance element. Smooth, quiet control. Available in single, dual, and triple units, also with vernier adjustment. Rated 2.25 watts at 70°C. Values to 5 megohms. Type K have similar construction rated 1 watt at 125°C, 2 watts at 100°C, and 3 watts at 70°C.

**HOT MOLDED POTENTIOMETERS
Type G and Type L**



Type G potentiometers are miniature controls with solid molded resistance element. Only 1/2" in diameter. Quiet, stepless operation. Rated 1/2 watt at 70°C. Values to 5 megohms. Type L are similar to Type G but rated 1/2 watt at 100°C. Can be used at 150°C with "no load."

**HOT MOLDED POTENTIOMETERS
Type H 5 Watt**



Provides higher voltage and wattage ratings for industrial and commercial electronic equipment. Quiet, stepless control. Life exceeds 100,000 complete cycles of operation on accelerated tests with less than 10% resistance change. Rated 5 watts at 40°C and 3 watts at 70°C, with a maximum of 750 volts.

FEED-THRU AND STAND-OFF CAPACITORS



Discoidal design eliminates all parallel resonance effects at 1000 Mcps and less. Insulation resistance exceeds 100,000 megohms. Standard values: 470 mmf ±20% and 1000 mmf GMV. Special values from 6.8 mmf to 1500 mmf. Rated to 500 v DC maximum.

FERRITES AND CERAMIC MAGNETS



Ferrite cores are available in a wide range of sizes and shapes, such as flared yokes; U, E, and cup cores, and toroids.

Ceramic permanent magnets are available in nonoriented and oriented materials. Also types especially suited for use in the design of high efficiency d.c. motors.

Please send for Publication 6024:
Allen-Bradley Co., 222 West Greenfield Ave.,
Milwaukee, Wisconsin 53204.
Export Office: 630 Third Ave., New York,
N.Y., U.S.A. 10017.



ALLEN-BRADLEY

QUALITY ELECTRONIC COMPONENTS

COMPUTER TIME-SHARING (Concluded)

With control of scheduling in this system, it is possible, as background demands change, for the control station in the computer center to make adjustments in the allocation of time. Thus, emphasis may be placed on the function which is most critical at that moment. This is a capability which is of paramount importance in a background-foreground system.

The software needs of the general-purpose system are more difficult to satisfy.

The first problem to consider is the method of allocating memory. To be prepared to satisfy requests for real-time functions, a block of core must be available upon request. This implies that core be dedicated for this function at least during the period when most of the time-sharing requests are made. If enough memory is available, it is important that it be allocated to the background system on a multiprogrammed basis. This will permit one or more programs to use the background memory concurrently with the foreground function. It will also allow full use of memory during periods when time-sharing is made inoperable.

An *executive* is needed to control the background functions in the system. The program, which is in core at all times, will allocate time, space and peripherals to the various programs in the job stock. This program will also contain all of the generalized peripheral routines.

Since random access storage input/output is an essential part of the real-time function, special emphasis should be placed here. It must be designed to permit interruption by foreground. It is also desirable to permit multiple requests of the storage I/O, which are satisfied on a priority basis as time permits. This will provide greater use of the storage—extent of use can be the limiting factor in the whole system.

The executive must quiet the background system when foreground requests are received. This requires that all affected peripherals be brought to an orderly halt and work registers be in a *save* mode before control can be transferred to background.

It is necessary that an executive function, responsible for all communication with the communications computer, be developed to control the time-sharing section of the system. It will control the foreground section in the same fashion as the background executive. This particular executive will not include any peripheral functions, however, since only one such routine can be permitted in a system for each peripheral.

Benefits of Time-Sharing

Time-sharing improves efficiency and productivity. When using this system, there is no longer a need to struggle with the complex problem of computer scheduling. The turn-around time needed to get results from the computer no longer requires a stipulated period of hours.

A problem can be coded with a minimum of effort. It is then submitted to the system through a remote

console. The format is checked as it is entered. At this point the program is compiled and checked. If errors are found they are reported immediately to the remote user. If no errors are found, the program is executed and the results are returned to the user. If the results are incorrect, adjustments can be made in the program and new output acquired without leaving the terminal.

There are no major delays during which the engineer or scientist must find something else to occupy himself. He can stay with a problem until he has carried it to a conclusion. The need for hand calculators and long manual operations disappears. These operations can be done more accurately and in less time when using the computer. Many things that in the past were done by programmers may now be done by the problem originator at his desk.

Why Hasn't it Been Available Sooner?

Why was time-sharing not available sooner? For one thing, hardware which will accommodate this system has not been in general use very long. The data communications and random-access storage equipment needed has only in recent years been perfected to a satisfactory measure of speed and dependability. Were its performance any less, time-sharing would be impractical. In fact, without the equipment designs used today, time-sharing might well be impossible.

But, probably more significant than hardware is the advancement in software technology. Manufacturers and users alike have developed a degree of software competence that did not exist a few years ago.

With the accelerated growth of computer application to work-a-day problems and chores, an overwhelming need for improved interfaces between people and the machine has developed. Time-sharing today is simply a gesture in the advance of communication between man and the computer.

Future

Much can be done to improve the man-machine interface. Better, more flexible remote equipment which is more natural and convenient to use, will be produced. Small computers will be developed for use in communicating the more complicated problems to a large time-sharing system. The small system will have high-speed card and printing equipment to accommodate the jobs having high volume I/O needs.

Software will certainly be improved. Languages will be developed to satisfy the many different needs, from the simple to the most complex. Extensions will be made to eliminate almost all the size and timing restrictions of some current systems.

Perhaps the most important improvements, however, will be in the area of systems integration. The various types of time-sharing and the batch-oriented systems will tend to come closer together. There is, and will continue to be, a trend toward the creation of a single data base from which to work.

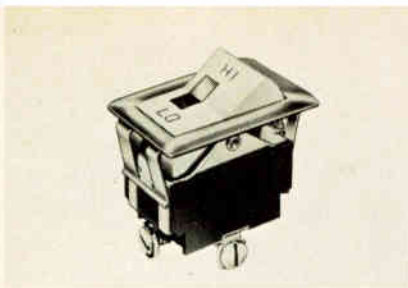

Series SL1 Rocker Switch (Sorenson)

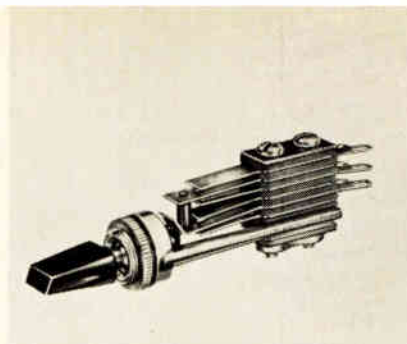

Series 29000 Key Switch (Switchcraft)

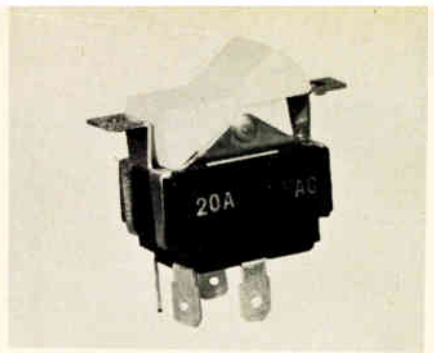

Type 8155K1 Rocker Switch (Cutler-Hammer)

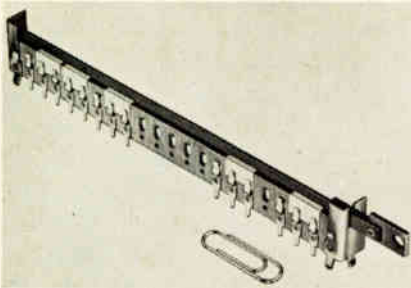

Type 005 20-contact Slide Switch (Centralab)

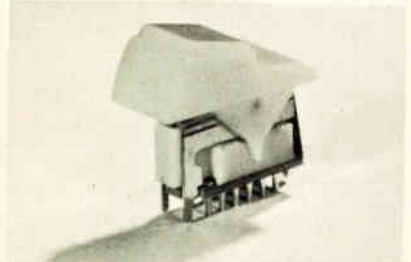

Type 203-026 Slide Switch (Chicago Switch)

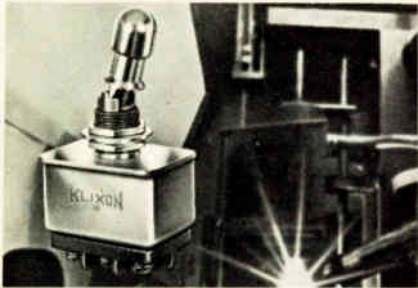

Type 2LS Toggle Switch (Texas Instruments)

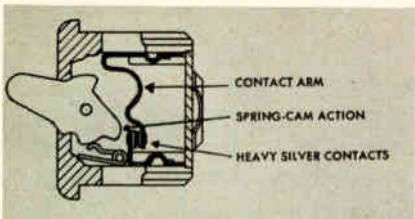

Series 164 Snap-In Toggle Switch (Hart)
Bi-Directional Rocker-Actuated Switch (Oak)

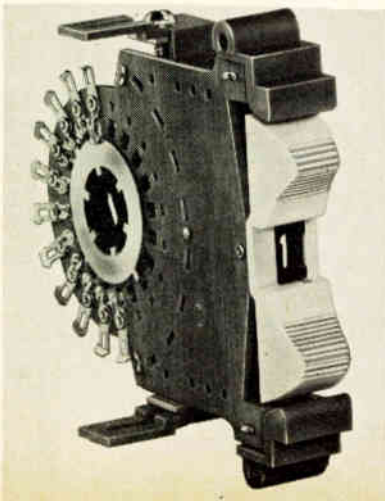

Series L Toggle Switch (Carling)

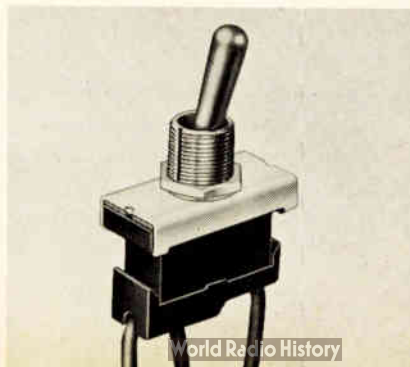

Type MS 18151 Toggle Switch (Controls Co. of America)



1966 Survey of Switch Specifications

Part 1: Toggle Switches

First in a series of special EI reports surveying hard contact, non-magnetic switching devices for the electronic industry

PART 1 OF THIS SURVEY spotlights the hand-operated toggle, slide, crossbar, rocker and key or lever type switches. The charts identify the appropriate types of switches offered by each manufacturer and give typical applications and basic electrical and mechanical design specifications. AC and DC current ratings are nominal values for resistive loads at the voltages indicated.

Future issues of EI will present other switch types including rotary, pushbutton, snap action, limit and many special purpose types except solid state or ferrite devices and magnetically operated switches. Stacks will also be covered. There are spring-leaf and snap-action switch assemblies offered by several manufacturers, including Cherry

Electrical Products, Guardian, Controls Company of America, Switchcraft, Maxson (Unimax), Honeywell and others, that form basic switching elements common to many types of switches including toggle, slide, pushbutton, lever, roller, feather touch and cam-operated switches.

SWITCH SURVEY

Watch for Parts 2, 3, 4, 5 and 6 in future EI issues:

Part 2: Pushbutton Switches

Part 3: Rotary Switches (including manual RF, stepper and thumbwheel types)

Part 4: Snap Action Switches, stack assemblies, reeds

Part 5: Limit, Mercury Switches

Part 6: Special Purpose Switches

Part 7: R-F Switches

EXPAND IT! RETRACT IT!

THESE EXTENSIBLE CABLES ALWAYS RETURN TO THEIR ORIGINAL POSITION. THE UNIQUE PLYCON* HARNESS IS THE ONE WITH THE BRAIN.



Combines flexible printed wiring conductors with male and female connectors for unlimited versatility in connecting drawer or rack mounted electronic equipment.

Standard retractable harnesses expand from 12" to 48"—spring right back to 12" or hold anywhere in between. Available with up to 72 contacts per end.

Straight jumpers available in standard lengths of 6", 12" and 18" with up to 72 contacts per end.

"Specials" are also available. You can even get a straight jumper with an unbroken length up to 100 feet.

Write us today for brochure and price list or engineering information and assistance.

*Pat. Pend. Registered Trademark of Methode Electronics, Inc.

Methode Electronics, Inc.
7447 W. Wilson Ave. • Chicago 31, Ill.

UNderhill 7-9600

1966 SURVEY OF SWITCHES (Part One)

SWITCHES: Toggle, Slide, Rocker and Lever Types	Type No. or Series	Toggle (T); Lever (L)	Slide (S); Rocker (R)	Illuminated (I); Colors (C)	Detent (D); Spring Return (S)	Appliances (A); Equip./Controls (C)	Machinery (M); Power/Lighting (P)	No. of Positions	No. of Poles	Contact Form/No. of Throws	Nom. DC Amps	Nom. AC Amps	@ Nom. Volts	Bush-Mtg.(B); Screw(SC); PTD CKT(PC)	Lug Terms.(T); Screws(SC); Leads (L)	Body Depth Behind Panel (In.)	Body Length (In.)
Alcoswitch Lawrence, Mass.	105/115	T		C	D	C		2	1	2				B	T	.5	.5
	205/215	T		C	D	C		2	2	2	5		115	B	T	.5	.5
	305/315	T		C	D	C		2	3	2	3		115	B	T	.5	.4
	405/415	T		C	D	C		2	4	2	3		115	B	T	.6	.4
	205PA	T		C	D	C		3	2	2	3		115	B	T	.6	.5
Ark-Les Switch Corp. 51 Water St. Watertown, Mass.	1751/2*		R	C	D	C		3	2	1,2	20		120	SC	T	1	1.2
	1761	T		C	D	C		2	1	1	6		125	SC		.8	1
	1740	T		C	D	C	M	3	1	1,2	20		125	B	T	.7	1
	1750	T		C	D	A	M	3	2	1,2	20		125	B	X		1
	7007	T		C	D	A	M	2	1	1	10		125	B	X	.8	.9
	2000	T		C	D	A	M	3	1	1,2	10		125	B	X		.9
	2050	T		C	D	A	M	3	2	1,2	15	10 15	120	B	X		.9
	2020	T		C	D	A	M	3	1	1,2	15		120	B	T		.8
* Double Rocker																	
Automatic Switch Co. Florham Park, N. J.	—	T			S		P	3	1	2			277	SC	(with plate for box mtg.)		
Cable Electric Prods. Providence 7, R. I.	111	T		C	D		P	2	1	1	5		250				
	133	T		C	D		P	2	1	2	5		250				
	151	T		C	D		P	2	1	1	15		277				
	153	T		C	D		P	2	1	2	15		277				
Carling Electric, Inc. 505 New Park Ave. West Hartford 10, Conn.	110/111	T			D/S	C	M	2	1	1	3	3	250	B	X	.5	1.3
	112	T			D/S	C	M	2	1	2	1	1	250	B	T/L	.6	1.5
	216	T			D/S	C	M	2	2	1	1	1	250	B	T/L	.6	1.5
	316	T			D/S	C	M	2	2	2	1	1	250	B	T/L	.6	1.5
	516	T			D/S	C	M	2	2	2-CKT	1	1	250	B	T/L	.6	1.5
	2BB	T			D	C	M	2	1	2	3	3	250	B	T/L	.6	1.5
	160	T			D	C	M	2	1	1	5	5	250	B	X	.5	1.3
	DA	T			D	C	M	2	1	1	6	6	250	B	SC	.75	1.9
	DK	T			D	C	M	2	2	1	6	6	250	B	SC		
	EA	T			D	C	M	2	1	1	10	10	250	B	SC	.9	2
	EK	T			D	C	M	2	2	1	10	10	250	B	SC	.9	2
	2F/6F	T			D/S	C	M	2	2	2-CKT	10	10	250	B	T/SC	1	1.1
	2GK/2GL	T			D/S	C	M	3	3	2-CKT	3	3	250	B	X	1	1.3
	HK	T			D/S	C	M	3	2	3-CKT	10	10	250	B	T	1.1	1.3
	IK	T			D/S	C	M	4	1,2	1,2	10	10	250	B	X		
	L	T			D/S	C	M	1	2	2	10	10	250	B	X	1.1	1.2
	S60	S	C		D		M	2	1	1,2	4	125	SC	T		.4	1.3
	GK/GL	S	C		D/S		M	2	2	1,2	3	250	SC	SC		1.3	1.3
	S110/111	S	C		D		M	2	1	1	3	250	SC	X		.7	1.6
	S112	S	C		D		M	2	1	2	1	1	250	SC	T/L		
S216/316	S	C		D		M	2	2	1,2	1	1	250	SC	T/L	1.3		
S516	S	C		D		M	2	2	2-CKT	1	1	250	SC	T/L		1.5	

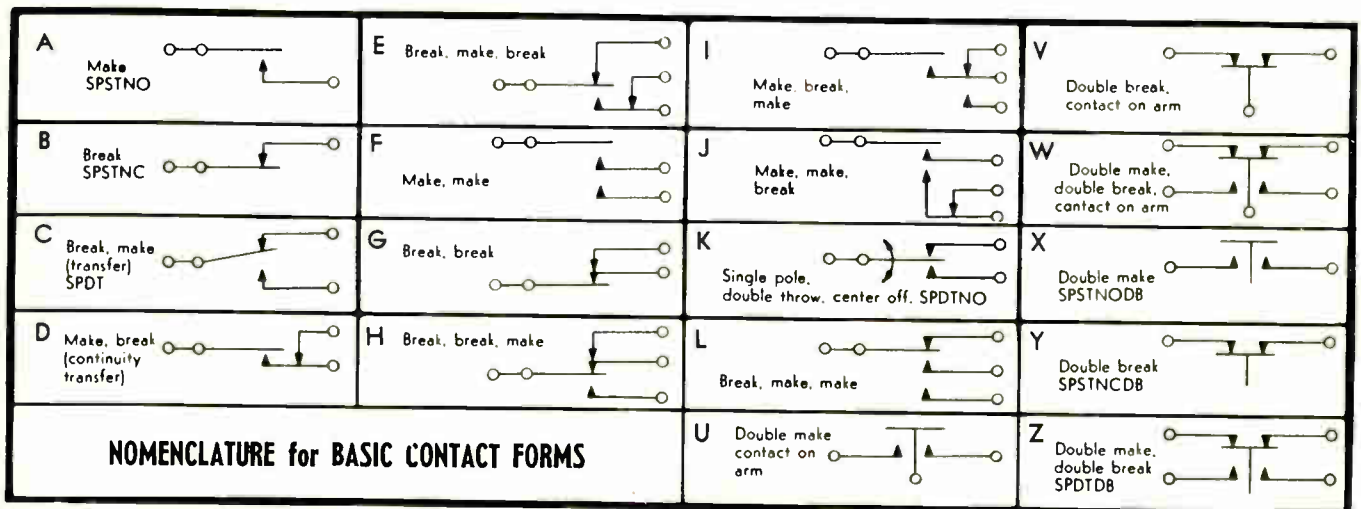

SWITCHES: Toggle, Slide, Rocker and Lever Types	Type No. or Series	Toggle (T); Lever (L)	Slide (S); Rocker (R)	Illuminated (I); Colors (C)	Detent (D); Spring Return (S)	Appliances (A); Equip./Controls (C)	Machinery (M); Power/Lighting (P)	No. of Positions	No. of Poles	Contact Form/No. of Throws	Nom. DC Amps	Nom. AC Amps	Nom. Volts	Bush. Mtg. (B); Screw (SC); PTD CKT (PC)	Lug Terms. (T); Screws (SC); Leads (L)	Body Depth Behind Panel (In.)	Body Length (In.)
Centralab P. O. Box 591 Milwaukee, Wisc. 53201	001/002	S			D			4		1	.7	115	SC				
	003	S			D/S			2		1	.5	115	PC				
	005	S			D/S			1,2	to 10	1	.45	115	PC				
	125	S			D/S			2		1	.4	115					
	222	L			D/S			2	4	1	.4	115					
	700	L			D/S			2	4	1	.4	115					
Cherry Electrical Prods. Corp. P. O. Box 438 Highland Park, Ill.	C10-19A					C		200 ²	10 ¹	A	1	125		(basic type)			
	C10-20A					C		200 ²	10 ¹	A	1	125		(miniature-4"x4"x2")			
	C10-19A					C		200 ²	10 ¹	A	1	125		(patchboard type)			
		1. No. of sliders	2. No. of crosspoints														
Chicago Switch Div. F & F Enterprises 1733 Milwaukee Ave. Chicago, Ill. 60647	203-004	S			S	C		2	4	2	3	120	PC	T		1.2	
	203-006	S			S	C		2	6	2	3	120	PC	T		1.6	
	203-010	S			D/S	C		2	4	2	3	120	PC	T		1.2	
	203-011	S			D/S	C		2	6	2	3	120	PC	T		1.6	
	203-024	R			S	C		4	4	2							
	203-025	R			S	C		6	6	C							
	203-026	R			D	C		4	4	C							
203-027	R			D	C		6	6	C								
Clark Controller Co. 1146 E. 52nd St. Cleveland, O. 44110	8301	T			D		P			3-wire	30	240					

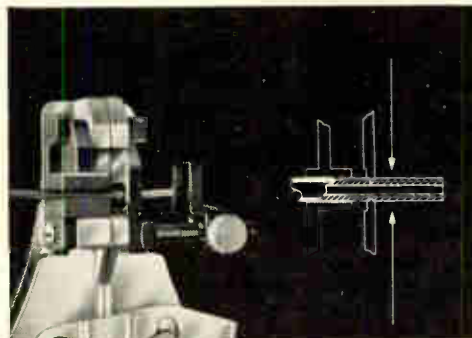

Collet clamping action compensates for off-center conductor, irregular insulation.

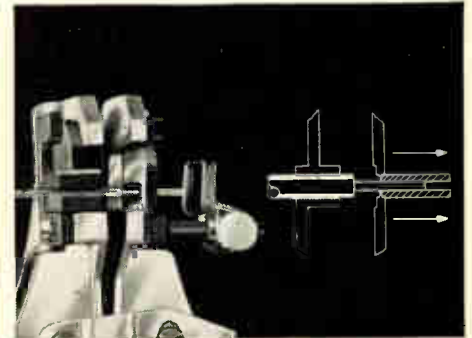

Die severs insulation and strips slug. Never touches conductor, can't nick or scrape.

NO-NICK, NO-SCRAPE WIRE STRIPPING

With Ideal's Custom Stripmaster® you can production strip both stranded and solid conductor wires to aerospace precision specifications. Even under 40-power magnification wires show no nicks, scrapes, or scratches. That's because insulation is removed with dies rather than knife blades. These dies sever insulation with a colleting action that automatically compensates for off-center conductors and insulation irregularities. Special grippers hold the wire without crushing or marking insulation as dies strip the slug without touching the conductor. Each pair of matched dies is individually machined on watchmaker's equipment to precision tolerances.

There are standard Custom Stripmaster models for Type E Teflon, Type EE Teflon, and for general-purpose insulation in wire sizes 10 to 14, 16 to 26, and 26 to 30. Custom Stripmasters with special dies are available for unusual stripping problems.

If you are precision stripping any kind of wire on a production basis, you ought to know about the Ideal Custom Stripmaster. Write today for details.



IDEAL INDUSTRIES, INC.

5127-L Becker Place, Sycamore, Illinois
IN CANADA: IDI Electric (Canada) Ltd., Ajax, Ontario

Master Specialties Company Series 90E Miniature Tellite Switch....

Versatility!

1 IN ELECTRICAL FUNCTION
AND INSTALLATION EASE



2 IN INFORMATION DISPLAY,
PANEL LAYOUT AND STYLE

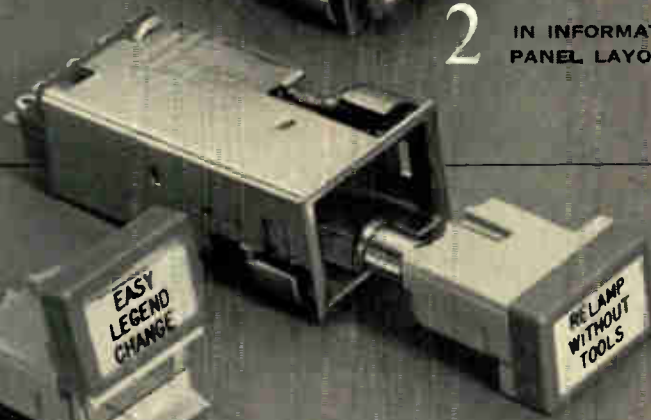

3 IN OPERATIONAL MAINTENANCE
AND QUICK MODIFICATION

GET MAXIMUM CONTROL IN MINIMUM SPACE WITH THE SERIES 90E ILLUMINATED PUSHBUTTON SWITCH

1 Wide Choice of Electrical Characteristics—easy to install and wire.

Specify 2PDT or 4PDT snap-action switches in momentary or alternate action, or in momentary action with holding coil. Lamp circuits include 6, 12, or 28 volt, or special neon lamp 115 volt. Mount from the panel front using integrated mounting sleeves. No brackets or hardware to show from the panel front. All terminals at rear for easy wiring, and they are non-corrosive gold plated. Each terminal will accept two #20 wires.



2 Smart, functional styling with maximum information display legend area.

Choose from black or grey, standard lens holders or optional full-view lens, both offering maximum legend area. Legends can be included with your order . . . and they are reverse engraved to withstand long wear without effacing. For design esthetics in panel layout, mount units in rows, stacks or matrices. Smooth, unobstructed sides permit close grouping for maximum control in minimum space. Two lamp illumination provides for horizontal or vertical split display or two color full display. Get extra-margin reliability in one color full display from two-lamp operation.



3 No Tools Required for Relamping, Filter or Legend Change—from the Panel Front!

Replace lamps or change color filters or legends at any time simply by removing the light capsule with your fingers. No tools needed. Removable, colored slab filters permit quick modification of color-coded indication. If needed, legends can be quickly changed at any time.



Complete Design Data is included in
CATALOG 2008



MASTER SPECIALTIES COMPANY

15020 South Figueroa Street, Gardena,
California Telephone: 213-321-8450

Regional Offices and Telephone

Sunnyvale, California 408-245-9292
Chicago, Illinois 312-282-7112
Dallas, Texas 214-357-9459
Syracuse, New York 315-479-9191
Valley Stream, L.I., New York 516-561-2334
Huntsville, Alabama 205-536-7415

Circle 41 on Inquiry Card



Don't be fooled!

"There is no other integrating 4-digit DVM as accurate or as stable at a lower price."

There are other integrating 4-digit DVM's. There may be other 4-digit DVM's as accurate; or there may be other 4-digit DVM's as stable. But there are **no** other 4-digit DVM's which combine all 3 capabilities selling as low as **\$2395!** The Hughes Model 4000 is an outstanding buy. Just check these specs.

Accuracy is ± 1 digit on all ranges. 100 microvolts sensitivity on lowest range. Complete bipolar noise rejection. Constant high 1000-plus megohms



of unattenuated input impedance. Fast readings—9.9 per second. Automatic ranging and polarity. All electronic, solid state components. The price—only \$2395!

To obtain additional information and complete specifications on the new

Hughes Model 4000 Digital Voltmeter, or to make arrangements for an in-plant demonstration, just **teletype**, write or call: HUGHES INSTRUMENTS, 2020 Oceanside Boulevard, Oceanside, California 92057 — or 1284 North Broad Street, Hillside, New Jersey. For export information, write: HUGHES INTERNATIONAL, Culver City, California



“... STATE-OF-THE-ART information on Components and Equipment.”

Capacitor Handbook

A handbook to help circuit designers select capacitors has been published. The 33-page handbook entitled “Which Capacitor?” discusses factors considered in evaluating capacitor types. Major sections include: How is a Capacitor Measured?; Capacitor Characteristics—How do they Behave?; The Metallized Dielectric, Environmental Effects on Capacitors, and Reliability. Marshall Industries, Capacitor Div., 1960 Walker Ave., Monrovia, Calif.

Circle 141 on Inquiry Card

Resistor Catalog

This 14-page catalog contains photos and operating specs. for a line of wire-wound and precision resistors. In addition to the resistors available from stock, custom facilities are described. Precision Inc., 4748 France Ave. No., Minneapolis, Minn.

Circle 142 on Inquiry Card

Capacitor Elements

Bulletin A-2 describes Mucon multi-layer ceramic capacitor elements for use in hybrid circuits. For a wide choice of properties, these elements are supplied in NPO, Stable-K and Super-K ceramic bodies. They are available in 4 sizes with capacitance values from 33pf through 1500pf, although values to 330kpf can be supplied. Republic Electronics Corp., Dept. 12, 176 E. 7th St., Paterson, N. J.

Circle 143 on Inquiry Card

Film Capacitor Catalog

Complete physical and electrical characteristics and prices of instrument grade plastic film capacitors are contained in an 82-page catalog. Included are physical and electrical characteristics, graphs showing dissipation factor change with freq. and temp., capacitance change with temp., and insulation resistance with temp. on each capacitor series. Included is a complete price section. Midwec Corp., 585 S. Jacon St., Denver, Colo. 80223.

Circle 144 on Inquiry Card

Axial-Lead Zeners

Data on silicon zener diodes covering a 2w., 7.5 to 200v. range and contained in an hermetically-sealed axial-lead insulated package is now available. Termed Series 2R, the new diodes have a max. dc zener current of 165ma for the 9.1v. unit to 7.5ma for the 200v. diode. The zeners may be used at full rating up to 50°C, then they derate linearly to zero at 175°C. Standard tolerances are 20%, 10%, or 5% with tighter tolerances available to special order. All units meet environmental requirements of Mil Standard 202. Solitron Devices, Inc., 256 Oak Tree Rd., Tappan, N. Y. 10983.

Circle 145 on Inquiry Card

Terminology Glossary

“IRC Expanded Glossary of Electronics Terminology,” 28 pages, contains definitions of nearly 800 terms, many of which are illustrated as a further aid to clarity. The glossary defines many terms that are currently being misused. International Resistance Co., 401 N. Broad St., Philadelphia, Pa. 19108.

Circle 146 on Inquiry Card

Analyzers Handbook

This 16-page booklet covers spectrum analysis theory, measurement techniques, applications, performance capabilities and design features of Panoramic Spectrum Analyzers for 18mc to 75Gc applications. Contents include an introduction to spectrum analyzers, discussions of resolution, incidental FM and minimum usable dispersion, sensitivity, etc. Send request on company letterhead to The Singer Co., Metrics Div., 915 Pembroke St., Bridgeport, Conn. 06608.

IC Logic Cards

Integrated circuit logic cards that not only provide standard arrangements but also can quickly and economically be supplied to customer needs are described in a new catalog. Basic logic and logic function cards are defined. Engineered Electronics Co., 1441 E. Chestnut Ave., Santa Ana, Calif.

Circle 147 on Inquiry Card

Rectifier Guide

A selection guide listing 200 silicon rectifiers which “replace more than 1000 existing types” is available. Easy-to-read, the 17 x 11 in. guide permits design and procurement personnel to reduce number of devices to be considered. Selection guide comprises rectifiers in current ratings to 1000a and in voltages 50 to 1000v. Current/temp. de-rating curves are included. Motorola Semiconductor Products, Inc., Dept. TIC, Phoenix, Ariz. 85001.

Circle 148 on Inquiry Card

Piezoelectricity Data Book

A piezoelectric data book has been published for electronic device, circuit and system designers. The 45-page book, “Piezoelectric Technology—Data for Designers,” progresses from general characteristics and principal applications to constants and specific properties of ceramics. There is discussion of equivalent circuits and application. The book contains 7 tables, and 8 pages of conversion charts (U. S./metric units) for angular, linear, area and volume measure; force, torque, pressure and density, compliance and mechanical impedance. Clevite Corp., Piezoelectric Div., 232 Forbes Rd., Bedford, Ohio.

Circle 149 on Inquiry Card

Microwave Measurements

A 42-page HP Application Note (#65) on microwave swept-frequency measurements develops their history, describes capability reached, and explains techniques. Sections explain how techniques may be used anywhere to display or to record broadband measurements of attenuation, impedance, power, and frequency. Details are offered on application of new logarithmic oscilloscope readouts attaining 30db dynamic range. Available from Hewlett-Packard, 1501 Page Mill Rd., Palo Alto, Calif. 94304.

Circle 150 on Inquiry Card

Integrated Circuits

A short form catalog contains data on double-diffused integrated circuits, including DTL, TTL, and RTL circuits; epoxy transistors, and a line of Picologic-MOS subsystem functions. Brochure describes the MOS state-of-the-art technology in progress at GME. Included are diagrams, schematics, and data tables. General Micro-electronics, Inc., 2920 San Ysidro Way, Santa Clara, Calif.

Circle 151 on Inquiry Card

Laser Brochure

Lasers & Laser Optics, a 24-page brochure, gives full specs. and prices on a line of continuous wave gas lasers, optical coatings and filters, and wide variety of laser optics. Electronic Products Div., Perkin-Elmer Corp., Main Ave., Norwalk, Conn.

Circle 152 on Inquiry Card

FM, TV Circuits

Two new technical papers have been released outlining development work in the field of FM tuners and color TV receivers. An all solid-state circuit for a chromatron color tube has been developed and demonstrated. MOS-FET devices and integrated circuits seem destined for the consumer electronics field. Both papers give schematic diagrams, performance data and some general design discussions. Single copies from Fairchild Semiconductor, 313 Fairchild Dr., Mountain View, Calif.

Circle 153 on Inquiry Card

Silicon Planar Devices

Bulletins 31702, 31703, 32033 and 32205 describe ten new members added to a growing family of silicon planar chopper, amplifier, and switching transistors. Type 2N2840 features an c-to-b voltage of 50v and a minimum Beta of 50 at $I_c=1ma$. Types 2N2944, 2N2945, and 2N2946 have e-to-b ratings of 15, 25, and 40v and minimum Betas of 80, 40, and 30, respectively. Duet Types 3N114 through 3N119 are dual-emitter PNP silicon planar choppers. Sprague Electric Co., Marshall St., North Adams, Mass.

Circle 154 on Inquiry Card

Get Trouble-Free Fuse Protection in Wet Locations with a . . .

Another
outstanding
development
by the makers
of BUSS Fuses

PICTURE
APPROXIMATELY
ACTUAL
SIZE

TRON

In-the-Line WATERPROOF FUSEHOLDER

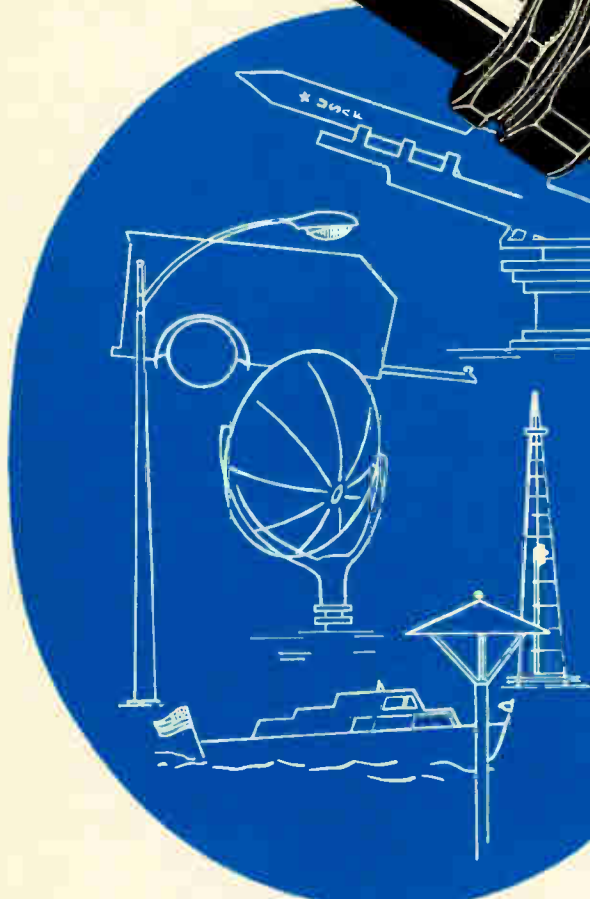

FOR USE ON:

- Mobile Power Supply Units
- Military Field Applications
- Electronic Components at Missile Sites
- Surveillance Equipment
- Fire and Police Call Systems
- Marine Equipment
- Communications Equipment
- Street or Highway Lighting Standards
- Sub-surface Junction Boxes Supplying Lighting or Equipment Circuits
- Oil Field Equipment
- Yard Lights
- Portable Outdoor or Construction Equipment
- Mine Equipment or
- Any circuit operating in exposed locations.

Watertight construction; resistance to damage by weather, water, salt spray or corrosive fumes permit use of TRON fuseholders in exposed locations where safety and long life are of vital importance.

For Protection of Circuits of 600 Volts or Less

TRON Waterproof Fuseholders fill the need for a watertight holder that is easy to install to give fuse protection to circuits in exposed locations.

Crimp-Type Tubular Terminals Available in Many Sizes

The crimp-type tubular terminals on TRON fuseholders are available in sizes to take many sizes of solid or stranded wire.

If desired, Load-side terminals can take one size wire, while Line-side terminals take another size wire.

A crimpable insulating sleeve covers each terminal. This provides a good surface for taping after crimping. When properly taped the crimped terminal is completely insulated and waterproof.



CAN BE USED AS TAP-OFF CONNECTOR

TRON Waterproof Fuseholders can also be used as Tap-Off connectors by having the Line-side terminal large enough to permit the two ends of the Line-wire to be crimped into it. This eliminates costly line connections and labor.

Two Models Available
Both rated at 30 amps. at 600 volts or less
The TRON HEB Fuseholder takes fuses 13/32 inch diameter by 1½ inches long.
The TRON HEH Fuseholder takes fuses 13/32 inch by 1¾ inches long.

Write for BUSS Bulletin SFH-11

INSIST ON

BUSS QUALITY

BUSSMANN MFG. DIVISION, McGraw-Edison Co.
St. Louis, Mo. 63107

NEW TECH DATA

DC Power Supplies

Catalog No. 143 describes a recently expanded line of extra-high current silicon modular dc supplies. These supplies have current ratings of 40a., 25a., and 15a., in voltage ratings from 1 through 31vdc, and are packaged as to provide minimum size and weight characteristics. The catalog provides technical data, physical and electrical spec., model listings and pricing data. Electronic Research Assoc., Inc., 67 Sand Park Rd., Cedar Grove, N. J.

Circle 155 on Inquiry Card

Tube Catalog

Catalog SF-1800, contains descriptions and specs. for 6 standard traveling wave tubes and for 3 others in late stages of development. Included are graphic illustrations of traveling wave tube facilities. The traveling wave tubes range from UHF through C-band with CW outputs from watts to kilowatts. Microwave Associates, Burlington, Mass.

Circle 156 on Inquiry Card

Handbooks

These handbooks include an 86-page Servo Motor Handbook; a 58-page Synchro Handbook; and a 50-page Motor Tach Generator Handbook. Available on letterhead request from Sunbeam Electronics, Industrial Airpark, Ft. Lauderdale, Fla. 33307.

Chopper Stabilized Amplifiers

Short-form catalog describes 3 way operational amplifier series, including Models 201/202 high-performance chopper-stabilized types. Catalog covers 17 different analog devices plus guidelines for amplifier selection. Three series described are: economy grade differential, high performance differential, and state-of-the-art chopper-stabilized. Literature gives response curves, configurations, and applications. Analog Devices, 221 Fifth St., Cambridge, Mass. 02142.

Circle 157 on Inquiry Card

Logic Modules

Data is available on a complete family of 100kc digital logic modules. They meet the requirement for a reliable and flexible low-speed logic system which operates over an amb. temp. range of -55°C to +70°C. Electronic Modules Corp., 1949 Greenspring Dr., Timonium, Md.

Circle 158 on Inquiry Card

High-Voltage Catalog

Silicon high-voltage assemblies, both custom and stock, are described in a new, 16-page catalog. The brochure has data on general circuit use, construction and reliability, and contains performance specs. on a variety of different high-voltage assemblies. Standard items include single-phase bridges, high-voltage stacks, modular rectifier assemblies and a new bonded-plate series that offer significant advantages in heat dissipation. Unitrode Corp., 580 Pleasant St., Watertown, Mass.

Circle 159 on Inquiry Card

Digital Tape Systems

This brochure provides a generous description of digital magnetic tape data systems including Dartex 100 Tape Transport and 101 incremental recorder. Data include physical descriptions, transport characteristics, incremental read/write operation, and general specs. Dartex, Inc., 1222 E. Pomona St., Santa Ana, Calif. 92707.

Circle 160 on Inquiry Card

Rotary Switch Catalog

Descriptions, specifications, applications and other pertinent product data are detailed in a 20-page catalog entitled, "High Accuracy Rotary Commutating Switches and Analog-Digital Converters." This fully illustrated catalog is available from Airflyte Electronics Company, 535 Avenue A, Bayonne, N. J.

Circle 161 on Inquiry Card

Micro-miniature Modules

Catalog 665 features specs. of Transmagnetics microminiature modules in expanded lines of sine wave modulators, analog multipliers and dividers, magnetic amplifiers, demodulators, freq. to dc converters, current sensors and conditioners, solid-state sensitive relays, failure monitors, comparators and null monitors. Transmagnetics, Inc., 134-08 36th Rd., Flushing 54, N. Y.

Circle 162 on Inquiry Card

Toroidal Cores

New data sheets describing a wide variety of iron powder toroidal cores, primarily for h-f applications is offered. Included are tables and graphs, information on Q vs. freq. for typical inductances, and dimensions. MicroMetals, 72 E. Montecito Ave., Sierra Madre, Calif.

Circle 163 on Inquiry Card

Microwave Materials

A fold-out brochure suitable for notebook or wall mounting describes the Eccosorb line of microwave absorbers—both for free space and for waveguide uses. A thumbnail description of each product is presented together with performance data, so that selection can be made rapidly. Reference to the appropriate technical bulletin for more detail is also given. Photographs illustrate the use of many of the products. Emerson & Cuming, Inc., Canton, Mass.

Circle 164 on Inquiry Card

Digital Strip Printers

Brochure describes Type M-1000 Digital Printers which are specially designed strip recorders for use in military and aerospace systems. Brochure, aside from brief specs and other data, also mentions a 24-page guide to digital printing applications including operating principles, logic diagrams, timing charts and waveform diagrams. Franklin Electronics Inc., E. Fourth St., Bridgeport, Pa.

Circle 165 on Inquiry Card

DELCO RADIO SEMICONDUCTORS AVAILABLE AT THESE DISTRIBUTORS

EAST

BINGHAMTON, N. Y.—Federal Electronics, Inc.
P. O. Box 1208/PI 8-8211
PHILADELPHIA 23, PENN.
Almo Industrial Electronics, Inc.
412 North 6th Street/WA 2-5918
PITTSBURGH 6, PENN.—Radio Parts Company, Inc.
6401 Penn Ave./361-4600
NEWTON 58, MASS.—Greene-Shaw Company
341 Watertown Street/WO 9-8900
CLIFTON, N. J.—Eastern Radio Corporation
312 Clifton Avenue/471-6600
WOODBURY, L. I., N. Y. 11797
Harvey Radio Company, Inc.
60 Crossways Park West, Phone (516)-921-8700
BALTIMORE 1, MD.—Radio Electric Service Company
5 North Howard Street/LE 9-3835

SOUTH

BIRMINGHAM 5, ALA.
Forbes Distributing Company, Inc.
2610 Third Avenue, South/AL 1-4104
WEST PALM BEACH, FLA.—Goddard, Inc.
1309 North Dixie/TE 3-5701
RICHMOND 20, VA.—Meridian Electronics, Inc.
1001 West Broad Street/353-6648

MIDWEST

KALAMAZOO, MICH.—Electronic Supply Corporation
P. O. Box 831/381-4623
INDIANAPOLIS 25, IND.
Graham Electronics Supply, Inc.
122 South Senate Avenue/ME 4-8486
CLEVELAND 1, OHIO—The W. M. Pattison Supply Co.
Industrial Electronics Division
777 Rockwell Avenue/621-7320
CHICAGO 30, ILL.—Merquip Electronics, Inc.
4939 North Elston Avenue/AV 2-5400
CINCINNATI 10, OHIO—United Radio, Inc.
7713 Reinhold Drive/241-6530
KANSAS CITY 11, MO.—Walters Radio Supply, Inc.
3635 Main Street/JE 1-7015
ST. LOUIS 17, MO.
Electronic Components for Industry Co.
2605 South Hanley Road/MI 7-5505
TULSA, OKLAHOMA 74119—Radio, Inc.
1000 South Main Street/(918)-587-9124
MINNEAPOLIS, MINNESOTA 55413
Northwest Electronics Corporation
336 Hoover St., N. E./612-331-6350

WEST

DALLAS 1, TEXAS—Adleta Company
1907 McKinney Ave./RI 2-8257
HOUSTON 1, TEXAS—Harrison Equipment Company, Inc.
1422 San Jacinto Street/CA 4-9131
SAN DIEGO 1, CAL.
Milo of California, Inc.
2060 India Street, Box 2710/232-8951
LOS ANGELES 15, CAL.—Radio Products Sales, Inc.
1501 South Hill Street/RI 8-1271
LOS ANGELES, CAL. 90022—Kierulff Electronics
2585 Commerce Way/OV 5-5511
MOUNTAIN VIEW, CAL.—Kierulff Electronics
2484 Middlefield Road/968-6292
DENVER, COLO.—L. B. Walker Radio Company
300 Bryant Street/WE 5-2401
SEATTLE 1, WASH.—C & G Electronics Company
2600 2nd Ave./Main 4-4354
PHOENIX, ARIZ.—Midland Specialty Co., Inc.
1930 North 22nd Ave./258-4531
ALBUQUERQUE, N.M.—Midland Specialty Co., Inc.
1712 Lomas Blvd., N.E./247-2486
TUCSON, ARIZ.—Midland Specialty Co., Inc.
951 South Park Ave./MA 4-2315

Ask for a complete catalog

DELCO RADIO

DIVISION OF GENERAL MOTORS • KOKOMO, INDIANA



HOW TO CRAM BIG POWER INTO A LITTLE SPACE

Consider this family of miniature Nu-Base† transistors. Delco Radio's 2N3212, 13, 14 and 15 in the TO-37 case. They'll help you pack high current, high voltage, and fast switching in a small circuit package. And our SPAC‡ process gives them excellent parameter stability over a wide range of environmental conditions.

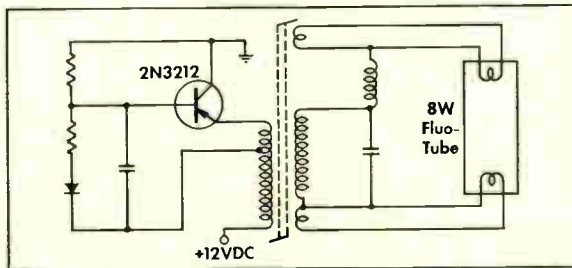

Battery-operated fluorescent light supply: A basic transistorized blocking oscillator forms the heart of this 8-watt portable fluorescent light.

Each of these Delco devices is rated 5 amperes, maximum continuous collector current. Their VCEO ratings, shown on the chart, make them especially useful where high voltages and high currents are encountered. In switching applications, they combine relatively low satu-

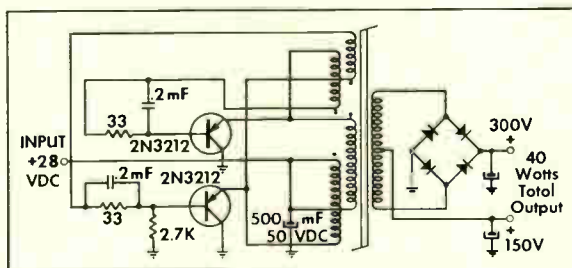

40-watt DC to DC converter gets an efficiency of 90 percent from the low saturation resistance of the miniature Delco 2N3212.

ration resistance and high speed for excellent efficiency and reliability.

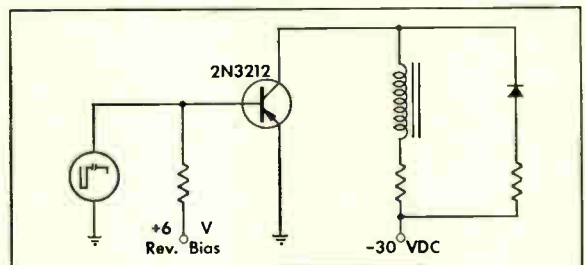

Print-out hammer driver: The high gain of this miniature TO-37 Nu-Base transistor enables it to switch 7 amperes of collector current at short duty cycles (10-15%).

In Delco Nu-Base construction, the husky element has built-in protection from current "hot spots" to assure freedom from secondary breakdown over the operating range.

These units will dissipate over 5 watts at 71°C case temperature, and operate over a range of -65° to 110°C. They lend themselves easily to automatic insertion.

Get in touch with one of our sales offices or your Delco semiconductor distributor. More data, prices and application information on this big little transistor will soon be on its way.

TYPE	2N3212	2N3213	2N3214	2N3215
Vcbo	-100	-80	-60	-40
Vceo @ Ic=20ma	-80	-60	-40	-30
hFE @ 3A	30-90	30-90	30-90	25-100
Vce (sat.) @ Ic=5A	-0.5v	-0.5v	-0.5v	-0.5v
Vce (sus.) @ Ic=3A	-80	-60	-40	-30

Conditions for Vce (sus.) { Pulse Width = 1.4ms
Duty Cycle = 4%
Inductance = 6mh

Operating temperatures = 110°C max., -65°C min.; max. storage temperature = 125°C.

†Delco's name for drift field non-uniform diffused base construction.

‡Surface Passivation and Ambient Control.

FIELD SALES OFFICES
 UNION, NEW JERSEY*
 Box 1018 Chestnut Station
 (201) 687-3770
 SYRACUSE, NEW YORK
 1054 James Street
 (315) 472-2668

DETROIT, MICHIGAN
 57 Harper Avenue
 (313) 873-6560
CHICAGO, ILLINOIS*
 5151 N. Harlem Avenue
 (312) 775-5411

SANTA MONICA, CALIFORNIA*
 726 Santa Monica Blvd.
 (213) 870-8807
 General Sales Office:
 700 E. Firmin, Kokomo, Ind.
 (317) 457-8461—Ext. 2175

*Office includes field lab and resident engineer for applications assistance.

DELCO RADIO
 Division of General Motors
 Kokomo, Indiana

Warnings to the engineer, when making measurements of signal-to-noise ratio, are

NOTES on the Measurement of SNR

AN IMPORTANT CHARACTERISTIC of any communication system is its threshold. This is defined as the signal-to-noise ratio (SNR) at which a specified output is obtained from the receiving system. The theoretical threshold for most demodulation methods has been the subject of a great many studies so there is reasonable confidence in theoretical values. The design which winds up in hardware requires verification of the threshold through direct measurement of the SNR at points in the system.

Mainly the concern is with the ratio of the available SNR at the input of a system to the available SNR at its output. This is a definition of the noise factor. More rigidly, the noise factor is the ratio of the total noise power at the output to the total noise output power due to the external noise sources, and the symbol, F . The noise figure of a network is in db and is found from:

$$NF = 10 \log F.$$

The noise factor is normally found by comparison between the input and output SNRs. Thus,

$$F = \frac{N_o S_i}{N_i S_o},$$

where N_o = output noise power; N_i = input noise power; S_i = input signal power; S_o = output signal power.

When a signal generator is used to measure F , the signal power required to double the output power with noise alone is found. The equation becomes

(since $S_o = N_o$),

$$F = \frac{S_i}{N_i} = \frac{S_i}{kTB},$$

where k = Boltzmann's constant; T = Temperature °K; B = Equivalent noise bandwidth.

When a wide-band noise source is used in the measurement, there is a close relationship to the definition of F given above. The equation for F will differ from the one for the signal generator method. If F_s is the ratio of the noise source power output per cps of bandwidth

to kT , and S_i is, in this case, the excess input noise we have

$$S_i = F_s kTB - kTB.$$

N_1 = output noise power (noise source replaced by an equivalent impedance).

N_2 = output noise power (with the noise source present).

$$S_o = N_2 - N_1.$$

$$F = \frac{N_o S_i}{N_i S_o} = \frac{N_1 kTB (F_s - 1)}{kTB (N_2 - N_1)} = \frac{F_s - 1}{\frac{N_2}{N_1} - 1}.$$

The noise factor found by this method may differ by 3 db from the signal generator method when non-linear networks, such as mixers and parametric amplifiers, are involved where no image rejection exists. Such a system receives both the input signal and its image, thus accepting noise from the wide-band source over a range of $2B$. An image filter will make the two measurements agree, or a 3 db correction can be made. If the filter is added, the filter insertion loss and impedance mismatch must not be neglected.

Meter Selection

In measuring either noise or signal power, it is important that the true relationship between signal and noise be demonstrated by the choice of RMS or peak values. The true RMS meter is best for getting the amplitude of a noise signal. Quite often, an ac voltmeter is used. The ac voltmeter is an averaging device with a scale which reads RMS values for sine wave inputs. When using such a meter, the true magnitude of a white noise signal is found by dividing the meter reading

$$\text{by } \sqrt{\frac{\pi}{2}}.$$

The significance of the noise and signal crest factors is shown in Fig. 1. In this sketch, the signal power spectrum has a bandwidth much narrower than the noise power bandwidth. It is seen that for this example,



given which should help avoid possible sources of errors

By I. DLUGATCH, Engineer, Aerospace Group, Hughes Aircraft Co., Culver City, Calif.

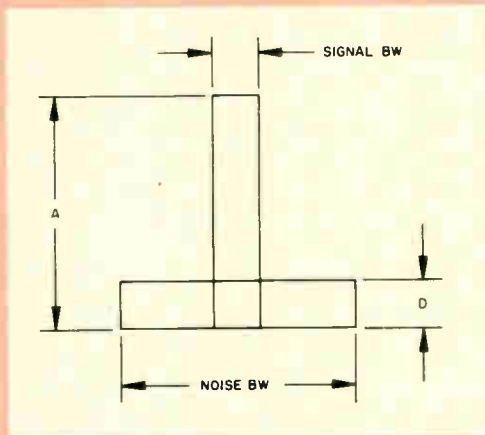

Fig. 1: Sketch illustrates the relationship between the noise and the signal.

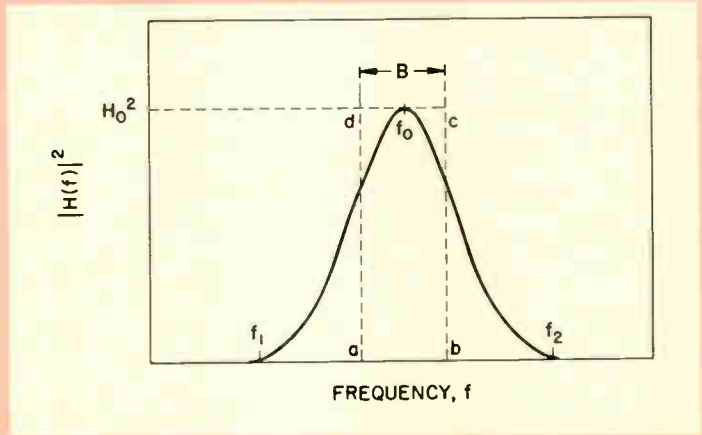

Fig. 2: Pictorial definition of bandwidth. See text for definition of letters.

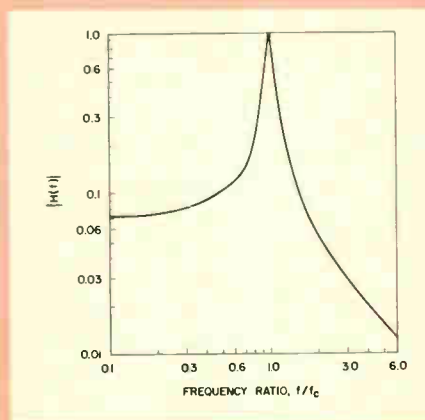

Fig. 3: Frequency response curve for single tuned band-pass filter. The half-power bandwidth is 0.1 times the center frequency.

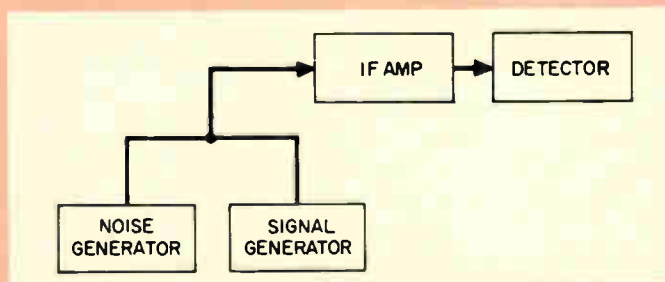
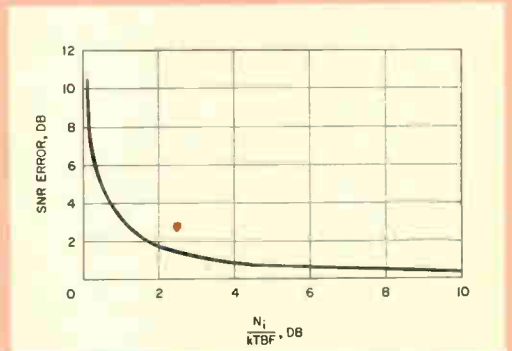

Fig. 4 (above): A popular method of measuring the threshold SNR of a receiver.

Fig. 5 (below): SNR measurement error as a function of the input noise to the thermal noise power ratio is shown.



SNR MEASUREMENTS (Continued)

Noise Bandwidth $\times D = P_N =$ Noise Power.

Signal Bandwidth $\times A = P_S =$ Signal Power.

We will assume that:

$$P_S = P_N \text{ or } \frac{S}{N} = 0 \text{ db.}$$

A conventional power meter would so indicate. But, the ratio of the power spectral densities is about 7 db. It is this ratio which may be of greatest importance in the operation of many signal detection devices. A spectrum analyzer is suggested as a possible solution to obtaining meaningful SNR values, but the measurements can be made with a filter which reduces the noise bandwidth to that of the modulation. In a specific example, the SNR in the feedback loop of a phase-lock demodulator is more indicative of the system operation than the SNR in the i-f amplifier. Both computed and measured SNR using i-f noise bandwidths give misleading low values.

Error Factors

It is in the definition of the noise bandwidth that a large source of error is found. The bandwidth term is usually taken to mean the half-power bandwidth of the network being tested. It must be stressed that the *noise* bandwidth is intended to be used and is referred to as the "noise equivalent bandwidth." It is defined as the rectangular frequency spectrum which is equal to the actual system frequency spectrum. To be more precise, "the width of an ideal bandpass filter transmittance which has an absolute value of transmittance in its passband equal to the maximum absolute value of the transmittance function and which delivers the same mean-square total output voltage or current from a white-noise source as the given transmittance function."¹ This is stated as:

$$B = \frac{1}{H_0^2} \int_0^{\infty} |H(f)|^2 df; \quad (1)$$

Table 1
Relationship Between Noise and Network Bandwidths

Number of Tuned Couplings	Number of Stages	Noise Bandwidth	3 db Network Bandwidth	Ratio (db)
1	1	3.14	2.0	1.95
1	2	1.57	1.286	0.85
1	3	1.18	1.02	0.64
1	4	0.985	0.868	0.55
2	1	2.22	2.0	0.46
2	2	1.67	1.6	0.2
3	1	2.096	2.0	0.2
4	1	2.038	2.0	0.08
5	1	2.02	2.0	0.04

where, B = noise bandwidth; H_0 = maximum absolute value of $H(f)$ = maximum gain; and $H(f)$ = transmittance function.

Fig. 2 shows the definition, with B as the width of the rectangle "abcd" having the same area as the amplifier response. Where more than one peak exists, or none occurs in the spectrum of interest, more than one B may need to be computed. For example, where both signal and image frequencies are being accepted, Fig. 2 would show two responses and, therefore, two noise rectangles.

Solution of the integral to obtain the noise bandwidth may be hard, even for relatively simple lumped constant circuits with known transfer functions. This is because it is rare in practice to have an explicit equation for the response of the network under analysis and, when available, the transfer function is often a complex expression.

A rough check of a network's noise bandwidth can be done (with low accuracy) by measuring the mean square output of the network when the input is a band limited white noise having a known power spectral density. If the input white noise has a uniform power spectral density of $S(f)$ and the output has a mean square value of \bar{y}^2 , the noise bandwidth is given by

$$B = \frac{\bar{y}^2}{H_0^2 S(f)}$$

Inaccuracies in this method are aided by the difficulty in establishing the noise generator's power spectral density at a given output setting, and the need to measure \bar{y}^2 over long averaging times.² Also, completely erroneous results are obtained if the input noise bandwidth is narrower than that of the network.

Measurement for Linear Devices

An empirical, but reliable method for linear devices is as follows: The gain factor $|H(f)|$ for a linear filter at any frequency f is equivalent to the voltage gain of the filter for a sine wave input at that frequency.

$$\frac{Y}{X} = |H(f)|;$$

where, Y = voltage output at frequency f ; and X = voltage input at frequency f .

The square of the output-input ratio measured at any frequency gives the value of $|H(f)|^2$ for that frequency. If this is done at enough frequencies, a smooth plot of $|H(f)|^2$ against f can be obtained. The area under this plot, divided by the maximum value of the plot, H_0^2 , is equal to the noise bandwidth (B) for the filter. Fig. 2 is a typical squared-frequency response curve. Its area is the sum of an infinite number of rectangles whose height is $|H(f)|^2$ and width is df . An approximation

(Continued on page 104)



New flexible lighting you can twist, coil, weave...

it's protected
by ACLAR®

Panelescent® Tape-Lite—developed by Sylvania—makes lighting available in a continuous flexible ribbon only $\frac{1}{32}$ " thick. The electroluminescent light source consists of a thin strip of aluminum foil, a layer of phosphors and a transparent conductive coating—all sealed between protective layers of Allied Chemical Aclar fluorohalo-carbon film.

Why did Sylvania choose Aclar? Because it protects better than any other transparent film! Aclar absorbs no

water at all and transmits virtually no moisture vapor. It has excellent dielectric strength... withstands severe shock and pressure... resists tearing and pinholing, and is chemically inert to harshest chemicals. The film is fully transparent—all the brightness of Tape-Lite comes through!

Shielded by Aclar, Tape-Lite flexible lighting has many display and safety applications, as in decorative wall lighting, highway marking, and instrument panel illumination. What

clear, strong, moisture-proof Aclar has done for lighting... it may be able to do for *your* product. To explore the possibilities, write to:



GENERAL CHEMICAL DIVISION
P.O. Box 353, Morristown, N.J.

Circle 45 on Inquiry Card
World Radio History

SNR MEASUREMENTS (Concluded)

can be obtained by dividing the area into n parts whose width is $(f_2 - f_1)/n$ with n as large as possible.

Treat each element as a rectangle whose height is the value of $|H(f)|^2$ at the midpoint of the increment of frequency. Adding together the areas of the rectangles and dividing the sum by H_0^2 gives an estimate of the equivalent noise bandwidth. This was done for Fig. 2, and the method gave $B = 15.7$.

Units were deleted by normalization in Fig. 2 and, therefore, none appear for the value of B . The half-power width of the curve was 16.0 indicating that, at least for this case, the 3 db width is a reasonable estimate of the equivalent noise bandwidth. One cannot assume that this will be true for all frequency responses as is shown in Table 1.³ The error that is tolerable will depend on the needs of the system.

The bandwidths in Table 1 are the absolute differences between the frequencies at each end of the band. Thus, the response of the network is down 3 db at f_1 at the low end and at f_2 at the high end. The bandwidth is then $f_2 - f_1$. The units are omitted, since this information is not essential to the analysis.

The largest variation for B from the 3 db bandwidth is seen to occur in the very first line of the table. This is evident from Fig. 3, which is the response for a single-tuned bandpass filter. Here, the half-power bandwidth is 0.1 times the center frequency, and the relationship between the noise bandwidth (B) and the network's 3 db bandwidth (BW) is found with the help of eq. (1). The ratio of the two is $B/BW = \pi/2$ which is seen to be equal to 1.95 db. It is common practice to substitute BW for B whenever a multi-stage system is being analyzed.

Table 1 is used to support the contention that the error accrued from this assumption will be small. Unfortunately, the data in the table is based on optimally designed, stagger-tuned i-f amplifiers, and, therefore, should not be considered as typical for all networks.

A popular method for measuring threshold SNR is shown in Fig. 4. The output of the noise generator is measured and the signal level is referenced to the noise generator's output. The receiver's thermal noise is ignored because it is lower in amplitude than the external noise. The reasoning behind this scheme is that, in measuring a receiver's output noise, one cannot determine whether the source of the noise is internal or external. Therefore, the ratio of the input signal to the power from the external noise source is the system's

SNR provided one neglects the receiver's noise. Under certain conditions, this can lead to large error.

Consider only the thermal noise at the network's input, which is specified as $kTBF$. Assume:

N_i = external noise source power;

S_i = external signal power;

N_T = total noise input;

Then, $N_T = N_i + kTBF$, and

$$\text{Resultant } \frac{S}{N} = \frac{S_i}{N_T} = \frac{S_i}{N_i + kTBF}$$

Since the SNR is designated in this method as S_i/N_i , the size of N_i relative to $kTBF$ is a measure of the

error in the result. The error, $\frac{N_i + kTBF}{N_i}$, is plotted against the ratio $N_i/kTBF$ in Fig. 5.

N_i needs to be very much larger than the thermal noise power if the error is to be kept small. This in turn may imply a need for a noise amplifier to obtain enough output. The amplifier must be a stable, linear unit over a very wide frequency spectrum if the output is to be truly white noise. Peaks and droops in the frequency response add errors in keeping with their magnitudes. The noise spectrum must be referenced to some frequency, f_c , at which the network under test is most likely peaked, particularly at r-f.

The use of an amplifier for the noise input to the system is likely to present problems in impedance matching at the connectors, with resultant distortion of the frequency response of both the noise amplifier and the unit being tested. Mismatches to the test equipment add additional frequency response distortions. Mismatch errors can approach 3 db in magnitude, a sizeable discrepancy where low SNRs are involved.

A final note is a caution on the SNR measurements where phase sensitive systems are being analyzed. The randomness of noise means that only half of it is properly phased at any instant. Thus, only half the noise is amplified by the system. At low SNR values, unreliable measurements are obtained after detection in such systems, and the preferred method is to measure both the signal and noise before detection.

The notes presented here were intended to provide warnings to the engineer engaged in SNR measurements on possible sources of errors. The solutions, where offered, were general in nature and not necessarily best for the reader's specific use. A wealth of papers has been published on exact methods for noise measurement which are certain to minimize the errors described, and these papers should be consulted.

References

1. Bennett, W. R., "Electrical Noise," McGraw-Hill Book Co., New York, 1960, pp. 15-17.
2. Bendat, J. S. and Piersol, A. G., "Analog Power Spectral Density Analyzers," Honeywell, Denver, Colorado, 1964, pp. 4-10 to 4-14.
3. Lawson, J. L. and Uhlenbeck, G. E., "Threshold Signals," Boston Tech. Publishers, 1964, pp. 176-177.

• A REPRINT of ANY ARTICLE in this issue is available from ELECTRONIC INDUSTRIES Reader Service Department.

Solid State Newlyweds

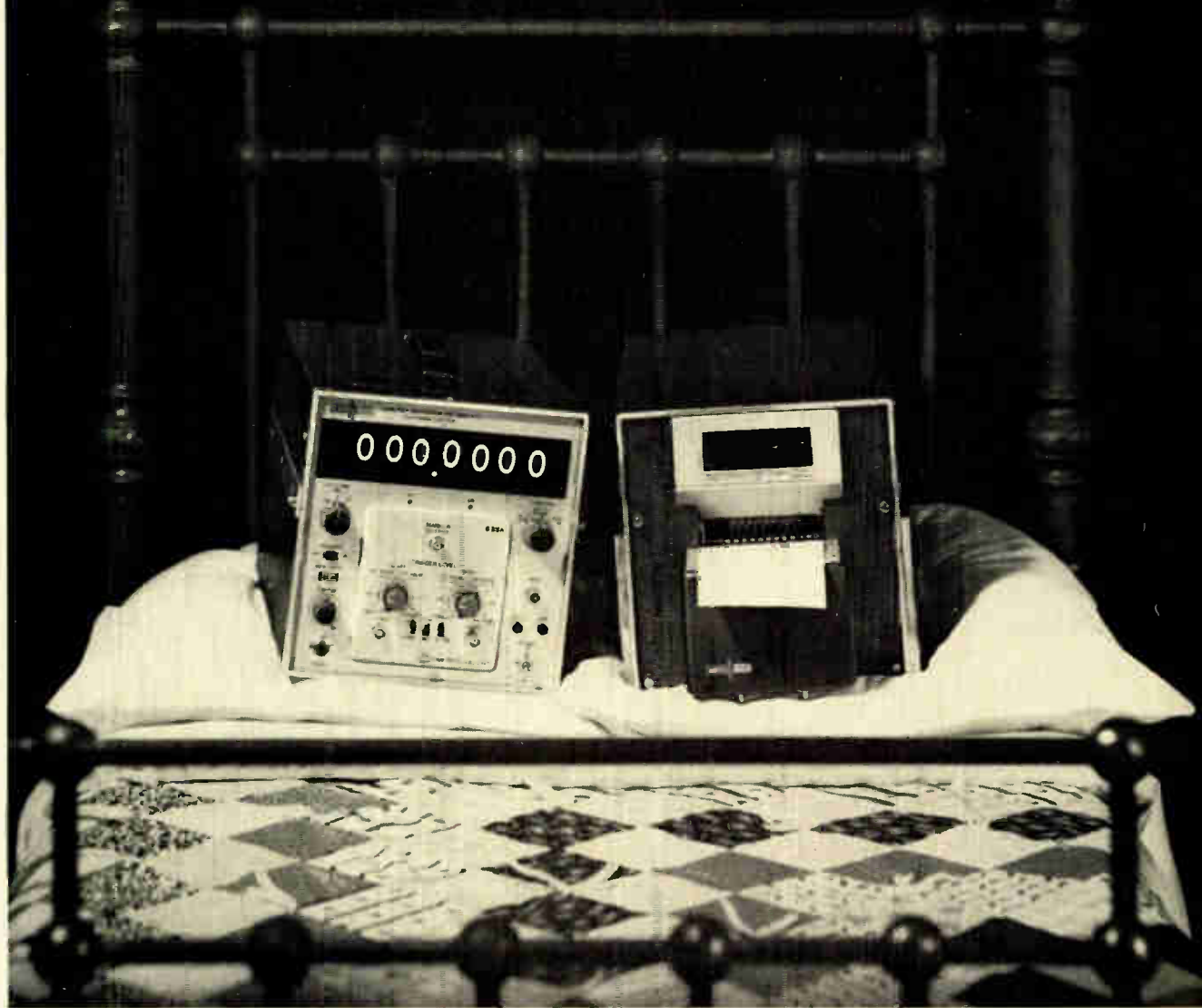

It's the ideal marriage! The CMC 616A frequency meter with the CMC 410A digital printer. Each being half-rack size and rugged all-silicon design, these two perfect rack-mates cozily fit just about anywhere you want to put them.

By blissfully joining these two instruments, we offer you an unbeatable combination for measuring and recording. The 616A measures up to 225 mc without plug-ins by means of a unique built-in pre-scale. With some clever plug-ins we added, you can even measure time interval, and frequency up to 1,000 mc, 3000 mc and (get this) 12 gigacycles!

Keeping up with this whizzing counter

is no problem for the 410 printer. It fires out up to 12-digit columns using electronic logic conversion and 35-millisecond data-gathering.

It's a first off-the-shelf "systems" thinking from CMC. Being first to offer you all-silicon instruments just wasn't enough. We have to make sure we are going to stay ahead of high-powered Hewlett-Packard and big, bad Beckman.

Systems have been a part of our capability for a long time. So don't

be surprised to see a lot more revolutionary combinations from us in the future. And, isn't it about time you started thinking systems too? Be daring... break that old habit of thinking one instrument at a time.

Ask us for the specs on both these half-rack-size-go-togethers. And don't forget, we're still challenging all engineers to compare our specs to those of the other two "leaders."

We'll send you the specs, so you can earn one of our glorious Crusading Engineers' medals for thinking double. If you don't want to wear it... have it framed or stuffed! It'll be great for your ego.



12976 Bradley • San Fernando, California • Phone (213) 367-2161 • TWX 213-764-5993

COMPUTER MEASUREMENTS COMPANY IS A LEADING DESIGNER AND MANUFACTURER OF ELECTRONIC INSTRUMENTATION TO COUNT, MEASURE, AND CONTROL

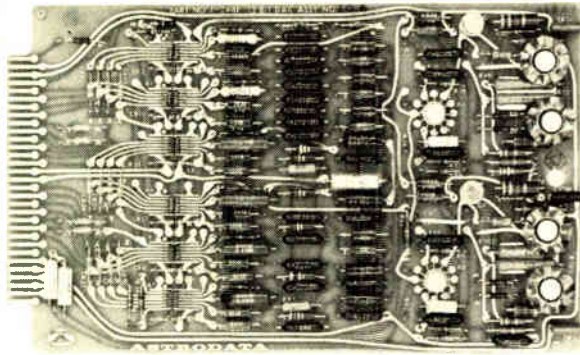

NEW DIGITAL TO ANALOG CONVERTERS WITH FLAT-PACK INTEGRATED CIRCUITRY

Now you can obtain highly reliable 8-bit and 12-bit D-to-A conversion in multi-channel applications with vastly reduced space and interfacing. As many as 60 8-bit DAC channels (including all internal reference regulators) accommodated in a single 19-inch rack frame, taking just a few inches in height. Built-in buffer storage which can be updated without affecting previous value in output amplifier utilizes data lines and load line common to all channels, separate enable line for each channel. Compatibility with loading/recording devices, expansion capability and performance options all designed into the flat-pack circuitry of the series 3500.

SPECIFICATIONS

	Model 3508	Model 3512
Number of channels	2 to 60	1 to 36
Input	7 bits and sign	11 bits and sign, or 3 BCD digits
Updating rate	0 to 100 KC	0 to 100 KC
Output	± 10 volts at 100 ma	± 10 volts at 100 ma
Accuracy	$\pm 0.2\%$ F.S.	$\pm 0.04\%$ F.S.
Linearity	$\pm 1/2$ LSD	± 1 LSD
30-day stability	$\pm 0.2\%$ F.S.	$\pm 0.04\%$ F.S.
Size	7" high by 16" deep by 19" wide for rack mounting	
Power Supplies	Self-contained, operates from 115VAC	



ASTRODATA

P. O. Box 3003 ■ 240 E. Palais Road, Anaheim, California ■ 92803

Circle 48 on Inquiry Card

NEW TECH DATA

Integrated Circuits Guide

A quick reference guide (91-000) that presents schematic diagrams, design features, and complete model designations of 64 digital and linear integrated circuits is available. Accompanying the booklet is price list. Westinghouse Molecular Electronics Div., Box 7377, Elkridge, Md. 21227.

Circle 166 on Inquiry Card

Connectors

A 16-page catalog (CM-76) on "Omega" series of military, miniature, round connectors describes Mil-C-26500 one-piece monoblock connectors with a resilient dielectric insert and Mil-C-38300 connectors with closed entry, hard dielectric socket inserts. Eight shell sizes are illustrated, including units having from 5 to 61 contacts. Dimensional drawings are included. Cinch Mfg. Co., 1026 Homan Ave., Chicago, Ill. 60624.

Circle 167 on Inquiry Card

Photoelectric Catalog

Catalog C, 20 pages, completely describes an entire line of transistorized photoelectric controls. Included are plug-in logic modules, photoelectric counters, multiple controls, solid-state switching, scanner assemblies, explosion-proof and retro-reflective scanners, self-contained photoelectric controls, and conveyer controls. A general selector guide features the most common applications and the recommended components. Farmer Electric Products Co., Inc., Tech Circle, Natick, Mass. 01762.

Circle 168 on Inquiry Card

IC Packaging

Bulletin 1001 explains microminiature packaging and assembly of integrated circuits using all welded interconnections. Described are the use of point-to-point and gridmatrix resistance welding techniques to assemble integrated circuits (TO-5 case) via the welded multi-layer interconnect scheme. The bulletin also describes the connector arrangement, as well as the reparability or servicing of the electronic system using integrated circuits. High Reliability Circuit Systems, 1853 N. Raymond Ave., Anaheim, Calif.

Circle 169 on Inquiry Card

Operational Amplifiers

A catalog is available which gives specifications for a standard line of operational amplifiers. A custom capability is also described. Single-ended units include chopper stabilization with 100 volt swings and very low drift. The differential amplifiers range from FET inputs for high impedance and low drift without choppers to chopper stabilized high voltage units with extremely low offset current. Dimensioned case drawings and some typical applications are also included. Zeltex Inc., 2350 Willow Pass Road, Concord, Calif.

Circle 170 on Inquiry Card

Frequency Converters

A technical bulletin on Series 4300 and 4700 freq. converters, which convert a variable freq. input into precisely proportional dc voltage or current, is available. Designed to accept freq. inputs from turbine flowmeters and other devices, these instruments offer a wide choice of output signals. Brooks Instrument Div., Emerson Electric Co., Hatfield, Pa.

Circle 171 on Inquiry Card

Attenuation Graph

A 4-page design aid for reducing vswr with coaxial r-f attenuator pads is available. The pamphlet includes some background data on the proper choice of impedance of coaxial transmission lines and describes how the curves were calculated. Bird Electronic Corp., 30303 Aurora Rd., Cleveland (Solon), Ohio 44139.

Circle 172 on Inquiry Card

Analog Instruments

A 24-page catalog on analog instruments and solid-state counters is now offered. Catalog contains specs. of freq.-to-dc converters, freq. detecting switches, freq. meters, freq. deviation meters, and multiple freq. standards. Specs. are also included on solid-state counters, including counter timers, bi-directional counters, variable time base counters, and preset counters. Anadex Instruments Inc., 7833 Haskell Ave., Van Nuys, Calif.

Circle 173 on Inquiry Card

Capacitor Chips

A new line of discrete capacitor chips for use in hybrid microcircuits is described in bulletin H25. Introduced in 3 new series designated UL-10, UC-10 and UC-06, the microminiature components are available in capacitance values from 10pf to 0.1mf in tolerances of $\pm 10\%$ and $\pm 20\%$. They are rated at 50vdc over the temp. range -55°C to $+150^{\circ}\text{C}$. All 3 series exceed the requirements of Mil-C-11015B. Gulton Industries, 212 Durham Ave., Metuchen, N. J.

Circle 174 on Inquiry Card

Microwave Pin Diodes

A new line of low capacitance microwave pin diodes that provide power dissipation up to 1.25w and voltage breakdown ranging up to 900v is described in this bulletin. Primary applications are in high power microwave switching, limiting, and electronically controlled attenuation. Capacitance values range from 0.3 to 0.9pf; resistance ranges from 0.8 to 2Ω . American Electronic Laboratories, Inc., P. O. Box 552, Lansdale, Penna.

Circle 175 on Inquiry Card

Design Kit

An engineering design kit for custom building and breadboarding prototype circuits is described in a new folder. The kit contains an assortment of reed switches, magnets and coils. Instructions for designing 10 devices are included. Specifications, actuating power sources, test circuits, and ordering information are contained in a series of tables, graphs, summaries and drawings. New Product Engineering, Inc., Wabash, Ind.

Circle 176 on Inquiry Card

DISTRIBUTOR-AVAILABLE

AEROVOX MICROMINIATURE
DIPPED METALLIZED
PAPER CAPACITORS
TYPE P95ZN

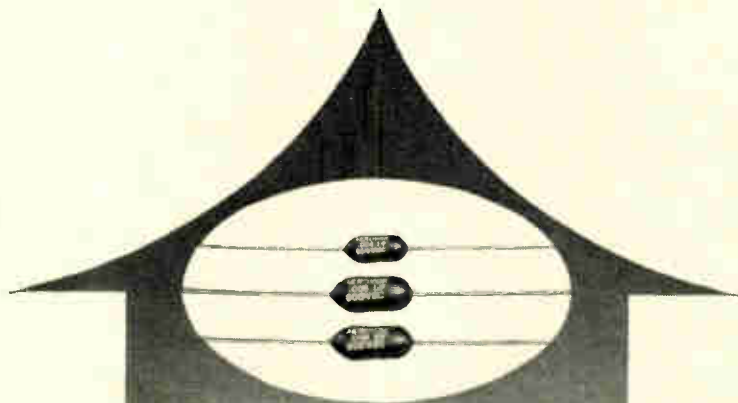

Add ONE MORE to the most complete line of distributor-available metallized paper capacitors to be found — the new P95ZN. These amazingly small units feature mechanically pre-determined capacitance control, sturdy lead connections, and operation from -55°C to $+125^{\circ}\text{C}$. They offer low price, high quality replacement for low capacity requirements. Voltages from 200 to 600 volts; capacity ratings from .00005 to .05 mfd.

The AeroVox Type P95ZN is immediately available from your local AeroVox distributor in a complete range of sizes and ratings. Go there for the complete line of DISTRIBUTOR-AVAILABLE High Temperature Metallized Paper Capacitors including:

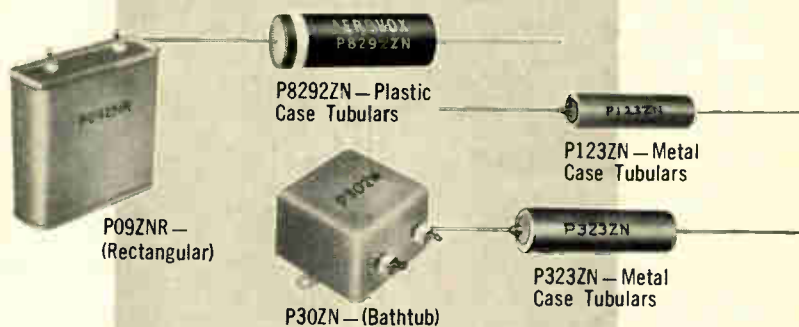

AeroVox Metallized paper capacitors are designed and manufactured to meet the highest possible reliability standards. Request latest technical data from your local authorized AeroVox distributor, or send for technical bulletins.



AEROVOX CORPORATION
DISTRIBUTOR DIVISION NEW BEDFORD, MASS.

Technical Leadership — Manufacturing Excellence

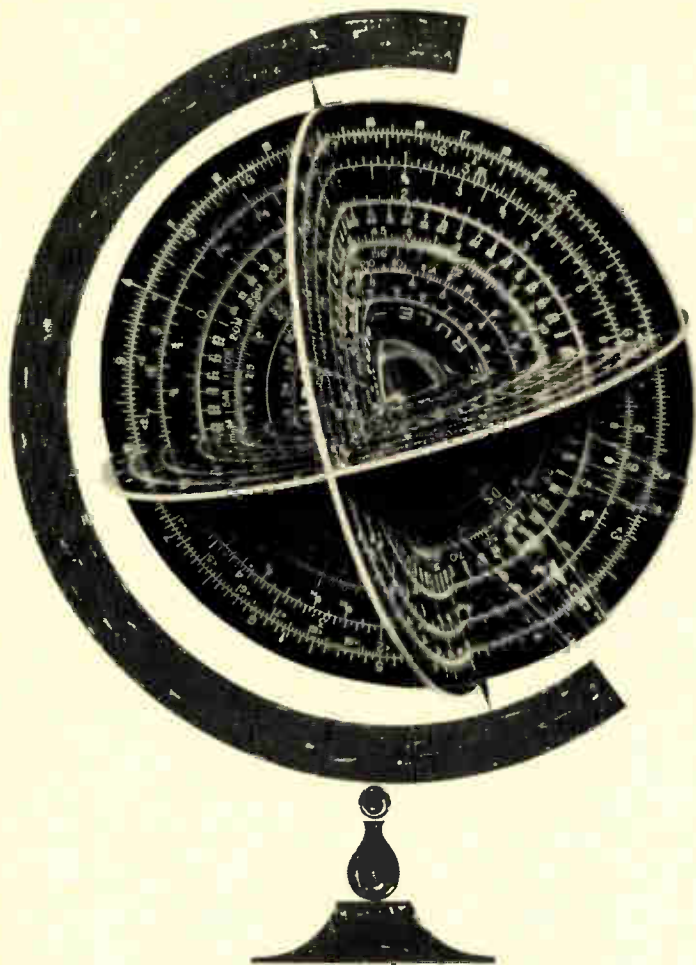

INTERSTATE ELECTRONICS ... where longitudinal experience and latitudinal capability form a world all by themselves.

That's right, Interstate Electronics is long on experience and wide in capability. It took both to develop the sophisticated and highly successful test instrumentation equipment for the FBM weapon system of the Polaris submarine program. As prime contractor for this important equipment, Systems Development Division of IEC relies heavily on its staff of top experts, and excellent facilities. The same applies to the Data Products Division which specializes in the development of real-time permanent paper or film video recorders, phase lock devices, timing systems, data handling systems and analog-to-digital conversion equipment. Lots of savvy. Lots of ability.

And although the seas have been here since time began, Man is only now beginning to read, understand, and use the waters of the world. OceanicS Division, formerly National Marine Consultants Division, for over a decade has used scientific principles to develop unique products and methods for studying everything from piers to pollution, from sand to salinity. It's all done with people... the best in the business.

You see, it's really elementary. People with ability are what make the world go round at IEC.

INTERSTATE ELECTRONICS CORPORATION

707 E. VERMONT AVE., ANAHEIM, CALIFORNIA 92803

Regional Offices: Atlanta, Georgia • Washington, D. C.

Subsidiary of

INTERSTATE ENGINEERING CORPORATION



MICROELECTRONIC DEVELOPMENTS . . .

Integrated circuits produced by Stewart-Warner Microcircuits Inc. are now being 100% tested on a new ultra high speed fully-automated testing device, to an accuracy of better than one millivolt. This exceeds industry practice by a factor of ten, Stewart-Warner production officials report.

General Instrument Corp. has introduced a new "family" of standard off-the-shelf MOS integrated circuits, "for low cost computers, calculators, data processing, and other systems." The company also announced two special "custom lines" of microcircuits: 1) ultra-complex MOS monolithic circuits, containing up to 1,000 "components" on a single chip of silicon, and 2) new types of hybrids, or multi-chip, circuits combining both MOS and conventional devices in a single unit.

Fabrication of small contacts and connectors from tough, resilient beryllium copper alloy has aided IBM Corp. in micro-miniaturization with high reliability in the design of its System/360. Certain micro-miniaturized components, such as contact springs and connectors, could not be made of materials generally used for larger contact springs and connectors. The material chosen for the 360 was Beryllco 165, a beryllium copper alloy from The Beryllium Corp., Reading, Pa.

Sperry Rand Corp.'s UNIVAC Division is using laser radiation in a new way to adjust microcircuit resistors to extreme tolerance. Sperry engineers say that subtle adjustments can be made in even the smallest resistors. "Unlike other laser trimming methods where material is burned away, the new process alters film resistivity." This is done by heating the thermally alterable film above a threshold temperature. Below this temperature the films are stable.

A differential voltage comparator which offers a resolution of 2mv and a response time of 40nsec is in production at Fairchild semiconductor. The μ A710 and μ A710C, monolithic Planar epitaxial integrated microcircuits, are useful as variable threshold Schmitt triggers, pulse height discriminators, voltage comparators in high-speed A-D converters, memory sense amplifiers or as high-noise immunity digital line receivers.

Reporting late developments affecting the employment picture in the Electronic Industries

ENGINEER DEMAND REACHES SECOND HIGHEST LEVEL

The boom in demand for engineers and scientists, especially in the electronic field, led to a September demand higher than any previously recorded by its Engineer/Scientist Demand Index, reports Deutsch & Shea.

From a brief dip in July, demand rose 21.9 points in August and September to 150.6. That figure is 72.4 above the previous September and is the second highest level reached in the five-year history of the Index.

The heavy recruiting that has continued through the summer vacation season—usually a slack period—indicates that intense competition for technical talent can be expected to continue at least through the first three months of 1966.

ENGINEER-EXECUTIVE DEMAND ROSE 27% IN 3RD QUARTER

Nationwide visible demand for engineering executives rose in the quarter ended September 1965, according to EXECUTREND, survey of management openings by Heidrick and Struggles, national executive search firm.

The seasonally adjusted figures for defense engineering and Science rose 23% and for general engineering, 4%.

Total national demand, as measured by seasonally adjusted figures, rose 9% from the three months ended June, and a whopping 60% over the third quarter of a year ago.

DRAVO CORP. ENCOURAGES ENGINEER REGISTRATION

Dravo Corp. of Pittsburgh, Pa., on recommendation of its executive committee, has adopted a personnel policy to encourage registration of its engineers.

Recognizing that registration helps the firm "effectively perform its many engineering functions, as well as being a significant personal accomplishment for its engineers to achieve professional status," the Dravo policy states that "registration of engineers is deemed to be of first importance."

ELECTRONIC LEARNING LABORATORY SYSTEM

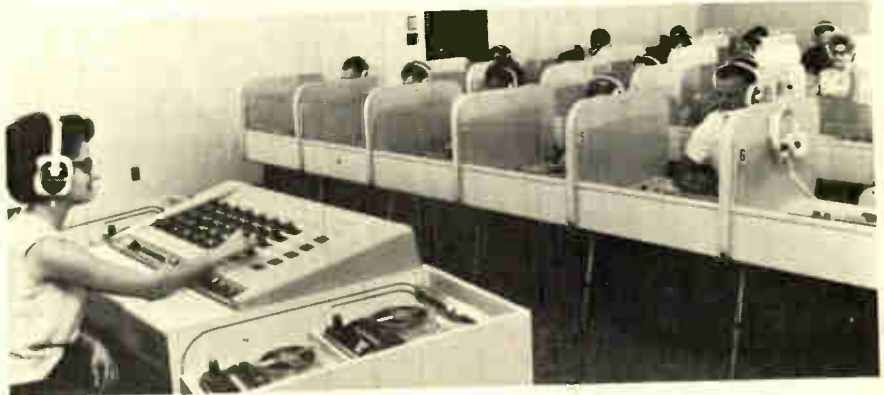

New type RCA Learning Laboratory at Shippensburg (Pa.) State College as teaching adjunct for language courses. Mrs. Chita C. Townsend, at console, communicates with a single student, a group or entire class. Each booth has a tape recorder so the student can record and replay.

SEEK HELP IN DESIGNING, URGES PSYCHOLOGIST

Design engineers could probably come up with more effective systems if they used more fully the findings of psychologists who have studied how man uses machines, according to University of Michigan psychologist Richard W. Pew.

While the typical systems designer today is aware of psychologists' interest in understanding performance capacities, the engineer often overlooks this work because either it "isn't understandable" or "isn't applicable."

But, so much has been done in the past 15 years, Mr. Pew said, that the engineer would be limiting himself if he were to "retreat to his armchair and intuitive design techniques."

Mr. Pew urged engineers to "make a conscientious effort to talk to psychologists about particular design problems and to seek out applicable literature."

He said, "There is an increasing number of psychologists who are hard at work developing a growing body of data which have relevance to engineering design problems."

The U-M psychologist also noted

FOR MORE INFORMATION . . .
on opportunities described in this section fill out the convenient resume form, page 113.

that there are "more and more individuals with interdisciplinary training in engineering and psychology" who can help the design engineer. These are known as "human factors engineers" or "engineering psychologists."

UNION AND DOUGLAS UNITE IN TECH. TRAINING PROGRAM

An apprenticeship program to develop experienced electronics technicians with a broad base of knowledge and skills in their specialty was announced jointly by Douglas Aircraft Co. and International Association of Machinists and Aerospace Workers.

Goals are to provide technicians trained in theoretical and practical aspects, and to upgrade skills of employees so they can adapt to automation and other technological changes in industry.

ENGINEER WEEK TO CITE FIELD AS VITAL SOURCE

"Engineering . . . Creative Resource for Progress" will be the theme of the 16th National Engineers' Week under the aegis of the National Society of Professional Engineers. The 1966 observance will be held February 20-26.

The theme was chosen to call attention to engineering as vital for technological and scientific progress.

Legal Protection for Computer Software

The importance of computer software is constantly increasing.

dollar mark. What can be done to protect this investment without

and still provide professional recognition for workers in this field?

THERE ARE FOUR BASIC LEGAL APPROACHES to protecting software, namely patents, copyrights, trade secrets and contracts. Each of these legal concepts will be discussed. No single one of these is a panacea. Each should be reviewed with legal counsel so that the protection best suited for the proprietor is pursued. Each concept has different attributes and more than one concept may be pursued. For example, a program may be treated as a trade secret while a patent is pending or before publication for purposes of statutory copyright.

PATENTS

A Letters Patent is a grant of an exclusive right to an inventor to make, use and sell his invention for a period of 17 years. To be patentable, a software program must be an invention. Only certain subject matter is patentable. Subject matter of a patent* must be a machine, article of manufacture, composition of matter or process which is novel, useful and unobvious to a man skilled in the art to which the invention pertains, namely to the art of programming computers. This statement of the categories of patentable subject matter excludes such subjects as methods of doing business, laws of nature, mathematics, printed matter, mental steps, etc.

Are Software Programs Patentable?

There is no lucid answer to this question at the present. Unofficially, the Patent Office has indicated that software programs are not patentable subject matter since they do not fall into any one of the categories for which a patent may be obtained. That is, software programs are not a machine, an article of manufacture, a composition of matter, or a process. There are no reported decisions by the courts or the Patent Office to that effect.

Most software programs are not and probably never will be of patentable significance. Many programs can be protected *indirectly* by claiming the structural interrelationship in the hardware or the process per-

formed thereby which are responsive to the program. See *Ex parte Egan et al.*, 129 USPQ 23, 26 (Board Appeals, 1960), *Ex parte Cunningham et al.*, 102 USPQ 174, (Board Appeals, 1940).

In securing such indirect protection for a program, the claims of the invention are not directed to the program per se, but to the structure which responds to the program. Inherent in this type of patent protection is the criterion that the claims must recite subject matter which is new and unobvious to a man skilled in this art. It is believed that the Patent Office will have difficulty in evaluating what is obvious or unobvious. This is because the Patent Office is unaware of the contents of most programs which have been devised over the years.

The few programs which involve new concepts which would not be obvious to a skilled programmer present problems to a patent attorney in terms of formulating the disclosure and claims. The inventor will have to spell out in detail to the attorney the obvious way in which the program could be formulated so that the unobvious solution will be crystal clear. The inventor should keep dated records of the different levels of the program. Each record should be dated and signed by an associate who can swear that he understood the subject matter at the time. This applies to the flow charts, operating instructions, input data format, output data format, sample messages, memory print at end of job, and program listing.

It should be noted that a patent application must be filed within one year of the first public or commercial use of the program.

Attributes of Patents

Patents provide the ideal protection for computer programs. Patents are at present difficult to obtain on software. There are no enforceable rights until a patent issues. A patent may be pending in the Patent Office for two or three years from the time it is filed. Patent protection will prevent others from making, using or selling the claimed subject matter. Hence, if one were

*Design and plant patents are ignored for the purposes of this article.

Compilation of a computer program often involves much study and expenditure of time. Thus, it is important that the program be protected.

By **EDWARD C. GONDA** Seidel and Gonda, Patent Attorneys, Land Title Bldg., Phila., Pa. 19110

Investment in software has passed the billion

stifling the industry? How can this be done

These and other pertinent questions are answered.



to conceive a merge or sort for the first time, and obtained a patent on the broad method concept of making a merge or sort, all programs using the merge or sort would be infringements.

COPYRIGHTS

Copyright is protection afforded to authors and proprietors concerning their writings. From the moment the program is produced, there is a common law copyright for that portion which is the work product of the author so long as there is no public disclosure. This article will deal with statutory copyright which requires disclosure.

As of April 1964, software programs are being registered by the Copyright Office. The Copyright Office has advised that it will grant a registration certificate even though it has doubts as to whether programs are "writings" of an author and are forms capable of being "copies." There are no court decisions on the validity of a copyright on a software program.

Registration Requirements

Requirements for registration as set forth by the Copyright Office are:

(1) Compilation of the program must be enough to constitute original authorship. That is, it must involve elements of selecting, arranging, editing and literary expression. This is a nebulous standard. It is believed that a typical program which is an original work product will meet this standard while a mere re-editing of an old program to accommodate a minor change would not qualify.

(2) The program must be published with the statutory notice. Copies bearing the notice must have been publicly disclosed, distributed, sold or made available to the public. Each card of the object deck should have the notice printed thereon. The notice should appear physically on the object tape and on the tape as a part of the program. Thus, the notice will appear twice on an object tape.

The notice for a program published for the first time

in 1965 by an imaginary programmer John Doe is as follows:

"© 1965 by John Doe."

This notice should appear on all copies of the program. The levels of the program, other than the decks or tapes, may be clipped together in the form of a book having a title page. The notice should appear on the reverse side of the title page.

All the programmer has to do is to apply the proper notice on the program. At this point, no application papers have been filed anywhere and no certificates have been applied for. When the program having the proper notice is published, copyright protection has been obtained. The programmer is now ready for the next step, securing of a registration certificate.

(3) Two copies of the program as published must be deposited, with the required fee and an application, with the Copyright Office. If the first publication was in a form that cannot be perceived or read by humans, something more such as a complete print-out of the entire program must be deposited. To date, the Copyright Office has granted registration certificates for programs in the form of magnetic tapes, perforated tapes, object decks, and even a complete print-out as published in a periodical.

Copyright protects certain aspects of the writing but not the idea itself. Hence, it should be noted that the protection one receives is similar to that of a copyright on a book. Thus, others are prevented from making copies, distributing copies, translating, and transcribing the program but are not prevented from using the ideas which are an integral part of the program.

Proposed Revisions of the Copyright Statute

Section 1 of the Sept. 1964 draft of the Copyright Act states in part:

"(a) Copyright protection under this title shall be available for an original work of authorship fixed in any tangible medium of expression, now known or later developed, from which it can be visually or aurally per-

ELECTRONIC INDUSTRIES

Please type or print

Professional Profile

The ELECTRONIC INDUSTRIES Job Resume Form for Electronic Engineers

Name _____ Tel. No. _____

Street Address _____ Zone _____

City _____ State _____

Single Married Citizen Non-Citizen Date of Birth _____

Will Relocate Yes No. If Yes Another City Another State

Salary Desired to Change Jobs in present area _____

Salary Desired to Change Jobs and relocate in another area _____

Professional Memberships _____

College or University	Major	Degree	Dates

RECENT WORK EXPERIENCE

Company	Div. or Dept.	Title	Dates

SIGNIFICANT EXPERIENCE AND OBJECTIVES

STATE ANY FACTS ABOUT YOURSELF THAT WILL HELP A PROSPECTIVE EMPLOYER EVALUATE YOUR EXPERIENCE AND JOB INTERESTS. INCLUDE SIGNIFICANT ACHIEVEMENTS, PUBLISHED PAPERS, AND CAREER GOALS.

Mail to: ELECTRONIC INDUSTRIES—Professional Profile—56th & Chestnut Sts.—Philadelphia, Pa. 19139. This resume is confidential. A copy will be sent only to those Companies advertising for engineering personnel in this issue, whose number you circle below.

800 801 802 803 804 805 806 807 808 809 810

SOFTWARE PROTECTION (Concluded)

ceived, reproduced, performed, or represented, either directly or with the aid of a machine or device. The subject matter of copyright shall include the following categories of work:

"(1) Nondramatic literary works, including works expressed in words, numbers, or symbols representing them."

If adopted, this Section will provide statutory recognition for software programs and resolve any doubt as to validity. At present, there is no statutory recognition that software programs are "writings."

Attributes of Copyright

Attributes of copyright include low cost, easy and quick to obtain, and presumption of validity. Copyright exists for 28 years with the right of renewal for another 28 years. Copyright statutes provide procedural advantages for enforcement of the same. We will compare these and other attributes with the other forms of protection available for software.

Trade Secret—A trade secret is any formula, pattern, list, device or compilation of information used in one's business and which gives him opportunity to obtain advantages over competitors who do not know or use it, and which has not been published or otherwise made known to the industry.

A software program can meet the above definition and can be the subject matter of a trade secret. The choice as to whether a program should be treated as a trade secret depends on the nature and purpose of the program. For example, assume that a service bureau after much study and expenditure of time and money compiles an information retrieval program containing the name and address of every corporation in all 50 states.

The service bureau is now in a position to offer a service to new corporations or old ones seeking to change their name. Before incorporating, the incorporators contact the service bureau. For a fee they can ascertain whether or not the name they choose for their corporation is available for adoption and use in every state. Such a service would be faster and less costly than the approach wherein the incorporators contact the Secretary of State of every state and then compile their answers.

The object deck of this imaginary service bureau is an example of a program which is best protected by keeping the contents of the program as a trade secret. To establish and maintain the program as a trade secret:

(1) No details of the program's contents should be published.

(2) The program should be clearly marked "Secret" and all employees made aware of that fact.

(3) Access to the programs should be limited to those persons, preferably few in number, who require access to make use of the program.

(4) A record should be kept as to date and name

of persons who have access and the purpose for needing such access.

(5) All levels of the program should be kept under lock and key when not in use, and jurisdiction of the program should be assigned to one person who will be responsible for the protection and maintenance of the trade secret.

(6) All persons who have access to the program should sign an acknowledgement that they recognize the program as being a trade secret.

Adherence to the above will assist counsel in convincing a court that the program qualifies as a trade secret and is entitled to be protected from unfair competition by a competitor. A competitor will be enjoined from making or using a similar program which was obtained without consent and after having access to the program of our imaginary service bureau. Of course, there is nothing which can be done if the competitor compiles his own program without having had access to the program of the service bureau described above.

Many programs have been and are now being treated as trade secrets. It should be noted that the general nature or existence of the program is not a trade secret, but rather the contents of the program. More than one complete copy of the program can exist and the program still be considered a trade secret. If nothing is to be gained by publication of a program, it is perhaps best protected by maintaining it as a trade secret. For ease of reference it should be identified by a number or name.

Contracts—Contracts offer a means to control use of a program. The users of a program may be limited by contract. Purposes for which a program may be used can be limited by contract. The manner in which the proprietor is to be paid for use of the program can be limited by contract.

Contracts are the most versatile of the legal approaches available and can be used to supplement other forms of protection. For example, a user of a copyrighted program can be required to acknowledge the validity of the copyright and agree not to infringe the copyright. Also, any user of a program which is considered to be a trade secret can be obligated to treat it as a trade secret.

COMPARISON OF ATTRIBUTES

Time to Secure the Right

Until a patent issues, there are no enforceable rights. *Patents* require two to four years to issue after filing. A statutory *copyright* exists as soon as there is publication with proper notice. A copyright registration certificate is required before suit can be brought for infringement. This certificate can be obtained within about two months of filing. *Trade secrets* are established and exist as soon as a program is in existence and steps are taken to assure that its secrecy will be maintained. Contractual rights are obtained as soon as an enforceable contract, oral or written, comes into existence.

(Continued on page 114)

MADE ANY GOOD CONTACTS LATELY?

You don't have to any more...you can get your contacts from a specialist and save yourself a lot of time, money and aggravation. Most electrical manufacturers know this, of course, but you'd be surprised how many still try to make their own contacts or sub-assemblies.

What many people don't know is this: besides know-how, it takes a wealth of specialized equipment and specialized people to economically turn out contacts as good as Deringer's. It takes years of study and cumulative experience in successfully solving countless contact problems and the development of special equipment and processes to produce such a wide variety of electrical contact types and sizes.

To deliver the right contact for a given application...to deliver promptly and at the right price...these things take what Deringer has: specialized capability plus the newest, most modern contact manufacturing facilities and plant.

Contact Deringer the next time you have contact problems. It's your best bet for quick, economical solutions.



METALLURGICAL CORPORATION

1250 Town Line Road - Mundelein, Illinois 60635

Circle 51 on Inquiry Card

Duration of the Right

Patent rights expire 17 years after the date of the patent and cannot be renewed or extended. Copyright protection extends for 28 years from the date of first publication and can be renewed for another 28 years. Trade secrets endure indefinitely so long as the contents of the program are kept secret. Contract protection terminates according to the contract terms.

Cost

Patents are by far the most costly of the forms of legal protection which may be secured. The cost of applying a copyright notice is generally negligible and the cost of obtaining a registration certificate is far less than that associated with obtaining a patent. Cost of obtaining trade secret protection depends upon the cost of the controls installed to maintain the secrecy of the program. Likewise, the cost of contract protection depends on the counsel fees connected with the preparation of the same. Thus, it varies according to the length and complexity of the contract.

Validity

Patents and copyrights are presumed to be valid. Validity of patents is subject to attack on the basis of a variety of grounds. Copyright validity is subject to attack but is generally more invulnerable than patents. Thus, the validity of a patent can be attacked on the ground that there is no invention involved or that the subject matter claimed is not novel. Subject matter of a copyright need not be novel and validity is generally upheld if there is original authorship. Trade secrets and contracts are generally not contested on the ground of invalidity.

Enforceability

Enforceability of patents involves proof of infringement. Preliminary injunction is seldom granted in patent infringement cases unless validity is not contested or has been established and infringement is apparent. Hence, relief for patent infringement generally requires several years depending on the court calendar. Copyright infringement offers the procedural advantage of preliminary injunction after proof of access and similarity. Copyright infringement has the procedural advantage of providing for a writ of seizure simultaneously with the bringing of suit whereby infringing programs will be seized by a U.S. Marshal and retained in a bonded warehouse during the pendency of the litigation.

Trade secrets can be enforced by a preliminary injunction and/or by the granting of damages. Depending on the circumstances, contracts may be enforced by injunction proceedings if irreparable injury will occur.

Willful infringement of a copyright for profit is a crime. This is rarely enforced. Willful infringement of a patent is not a crime. Recently several states have passed specific statutes making it a crime to appropriate a physical manifestation of a trade secret for his own use or the use of unauthorized persons.

Two Unique Reasons Why Hughes Can Offer You A Truly Rewarding Career In Systems Analysis

1 Continuing responsibility throughout product development. The shaping of basic concepts is only the beginning of your contribution as a Hughes systems analysis engineer. It also includes systems and subsystems optimization, and responsibility for technical integrity of the system through prototype design and development, production design and testing, and operational phases. You monitor each stage of the program, evaluating all pertinent technical information and suggestions for refinement or possible modification. Your strong involvement from start to finish, and the responsibility you have for a successful outcome, provide the kind of incentives that inspire a man's best efforts.

2 "Accent on enlightenment" among technical managers. From immediate supervision to the policy forming level, Hughes managers

are young, vigorous and technically oriented. A high percentage hold advanced degrees in science and engineering — an achievement encouraged and respected at Hughes. Many present technical managers began their careers just a few years ago as Fellows in the Howard Hughes Masters and Doctoral Fellowship programs. The resulting climate of rationality assures that your work and professional growth will be recognized and rewarded.

These policies have contributed measurably to the Hughes position of leadership in the systems industry. The company has grown from 2,000 employees in 1950 to over 8,000 in the Aerospace Engineering Division alone.

Hughes systems analysis is not limited to current programs. Much is directed toward the conception and development of advanced systems requiring such techniques as synthetic array radar, infrared sensors, LASERS and

MASERS, ion engines, television sensors, millimeter wave devices, inertial devices, digital computers, displays and controls.

If you are a graduate of an accredited engineering university, are a U.S. citizen, and have acquired some applicable technical experience, we would like to acquaint you with some of our hundreds of openings.

For immediate consideration, please airmail your resume to:

MR. ROBERT A. MARTIN
Head of Employment
Hughes Aerospace Divisions
11940 W. Jefferson Blvd.
Culver City 10, California



WE PROMISE YOU A REPLY WITHIN ONE WEEK

An equal opportunity employer.

Creating a new world with electronics

HUGHES

HUGHES AIRCRAFT COMPANY
AEROSPACE DIVISIONS

EDITOR'S NOTEBOOK

ALUMINUM HOT-BOX placed along tracks can now spot trouble in moving railroad cars, reports General Railway Signal Co. Called GRS Wheel Thermo-Scanner Unit, the system contains a wheel detector unit, lightning arrestor box, infra-red radiometers, amplifier, gate unit, power supply, and an analog recorder. GRS system scans each railroad car wheel that passes over the detector unit. An alarm system alerts the operator if the tempera-

ture of any wheel exceeds a pre-determined value.

COMPUTERIZED DELIVERY is being used by United Press International to disseminate its news report to newspapers. The system using RCA 301's is a dual system of on-line computers. Operator punches news dispatches on a teletypesetter machine, without justifying lines.

A CONTROLLED ARC DISCHARGE through a gaseous mixture of sodium mercury and xenon achieves a light output 50% higher than conventional light sources. GE engineers are incorporating the principle in their new Lucalox line of lighting bulbs. (The Lucalox tub comes from translucent-aluminum-oxide, the material developed by GE from which the gas mixture container is made.) In announcing the new development, GE spokesmen pointed out that the unusual spectral output of the lamp very closely approaches that of natural sunlight.



Here is a Complete PW Eyelet Prototype "Lab"

Before production, use prototypes to select the right eyelets for optimum PW Board performance. Eliminates costly post-production changes — and the economical USM S-5 Hand Eyeleter and the USM Electronic Eyelet Selection Kit handle virtually all your prototype eyeleting work.

The USM S-5 Hand Eyeleter provides ample throat depth, 5/16" and, with its four setting tools, sets all standard and sub-miniature eyelet sizes. The selection kit includes more than 15,000 brass and OFHC copper eyelets in standard sizes capable of meeting most PW Board eyeleting needs. For complete information, write, wire or phone: (TWX 710 451-3734 — Phone (203) 735-3391.)

USM Eyelets



FASTENER DIVISION

United Shoe Machinery Corporation

2253 River Road, Shelton, Connecticut 06485

Branches: Atlanta, Ga. • Boston, Mass. • Chicago, Ill. • Cincinnati, Ohio
Dallas, Texas • Sun Valley (Los Angeles), Calif. • Lynchburg, Va.
Milwaukee, Wisc. • Nashville, Tenn. • East Orange, N.J. (New York) • St. Louis, Mo.

MISSION CONTROL REPLICA is being made for Frank Capra Productions, Inc., Hollywood. Philco Corp. is recreating a manned spaceflight Mission Control Center based on NASA's Mission Control Center, which directed the Gemini 5 flight. The replica will be used in a space exploration motion picture titled "Marooned." Philco Houston Operations was prime contractor for the Mission Control Center (MCC).

WINK TECHNIQUE will help NASA people see a lost object from a greater distance. Object is coated with fluorescent paint, NASA Tech Brief explains. General location is scanned alternately through a transmitting filter and an obscuring filter, causing object to appear as a blinking point of light against a steady background. Dimmer objects can be detected this way in bright sunlight.

PACEMAKERS free from interference is good news for more than 10,000 U. S. heart patients fitted with the implantable electronic devices. Public Health Service's National Heart Institute reports that the pacemakers made in the U. S. have been repeatedly tested and found completely free of susceptibility to outside rf interference. Once the device is implanted, its design and natural shielding by body tissues ward off RFI.

ENERGY LEVEL MONITOR, smaller than a kitchen toaster, can detect dangerous electrical energy levels in almost any electro-explosive device, reports developer United Technology Center, Sunnyvale, Calif. The unit, a Stray Energy Detector, is "fall-out" from Titan III-C booster work being done by UTC. Extremely low energy levels are detected by a thin film thermocouple next to but insulated from an electro-explosive device bridgewire. Critical level is predetermined. Unit can interrupt firing circuit.

INTERNATIONAL NEWS

Manchester—To "maintain first-class sales facilities and provide better service for increasing customers in Northern England, EMI Electronics Ltd. has opened a branch in Manchester.

Putney—Orders for more than 450 of Marconi's new closed circuit TV cameras, demonstrated at National Audio Visual Exhibition, Whitelands College, Putney, have been received from the U.S., Australia and Canada.

Bonn—West German Government has awarded ITT Gilfillan Inc., a subsidiary of ITT Corp., a contract for several million dollars for Quadrarad ground control approach radar systems (GCA) and associated electronics.

Paris — Societe Internationale des Tele-Communications Aeronautiques (SITA) has ordered and will soon receive two UNIVAC 418 Real-Time data processing systems to route nearly a million airlines messages a month.

Madrid — Telefunken Radiotecnica Iberica S.A. recently celebrated its twenty-fifth anniversary. The company makes radio and TV sets for the Spanish market and for export.

Hong Kong—Globe-Union, Inc. has purchased majority interest in Unicon Electronics Company Ltd., manufacturer of polystyrene and ceramic capacitors. Unicon sells capacitors in the Far East and United States; plans include marketing in Europe.

Tokyo—Toshiba (Tokyo Shibaura Electric Co.) succeeded in applying a computer system to automatically run all operations of an atomic reactor, it was announced.

Hong Kong—National Cash Register Co. has opened the "very first data center in Hong Kong." More than 20 organizations have already signed up for data processing services, reports NCR.

Tokyo — First Japanese-produced Honeywell 200 data processing system has been installed in the Toyko Business Center of Sumitomo Bank. The system was made by Nippon Electric Co. by license agreement.

Bulova forks solve low frequency problems

Let the experience behind 300,000 forks per year help you!

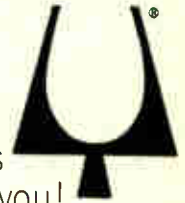

American Time Products forks are now available up to 25 kc, thanks to years of experience plus new design techniques developed by Bulova. (Including the tiny forks for Accutron® electronic timepieces, Bulova made 300,000 last year alone!)

Result: ATP units provide lower cost, smaller size, lighter weight and greater long term stability in such applications as Computers, Navigation Systems, Doppler Radar, Motor Drives, Encoders and Timers. Accuracies of up to 0.001% are available.

Bulova fork oscillators offer the added advantage of simplicity of design and circuitry. Fewer components mean greater reliability. Finally, Bulova fork products are uniquely capable of withstanding severe shock and vibration environments.

No wonder Bulova sold 300,000 last year!

FS-11 FORK FREQUENCY STANDARD

Standard Frequencies: Up to 10,000 cps

Accuracy: Up to ±.001%

Input: 28V DC (others on request)

Output: 5 volts p-to-p min. into 10K ohms

Temperature Range: As low as -55°C to as high as +85°C

Size: 1 1/2 in. sq. x 3/8"



SUB-MINIATURE TF-500

TUNING FORK

Standard Frequencies: Up to 2400 cps

Accuracy: Up to ±.001%

at 25°C

Input: 28V DC (others on request)

Output: Up to 5V rms into 20K ohms

Temperature Range: As low as -55°C to as high as +85°C

Size: 3/8" x 3/4" x 1 1/2" max.

Write or call for specifications on Bulova's complete line of tuning fork products.

Address: Dept. EI-16

BULOVA

AMERICAN TIME PRODUCTS

ELECTRONICS DIVISION OF BULOVA WATCH COMPANY, INC.

61-20 WOODSIDE AVENUE WOODSIDE, N.Y. 11377, (212) DE 5-6000

Circle 54 on Inquiry Card

Switch to the Best

- 6000 volt peak flashover at 60 cps
- 20 ampere current carrying capacity
- Current carrying members heavily silver plated
- Low loss silicone impregnated steatite stators and rotors

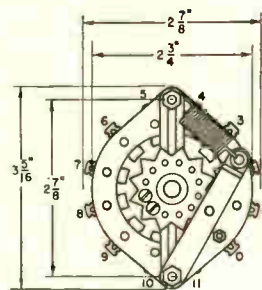
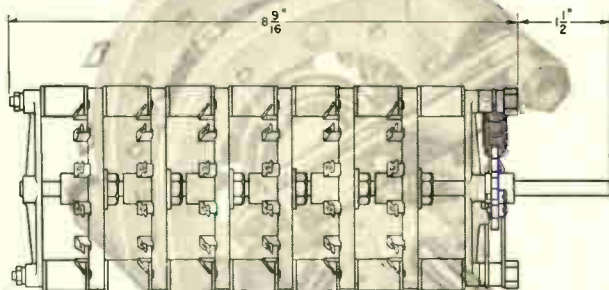

MODEL 86 SHORTING SWITCH

- Coin silver contact shoes
- White glazed steatite spacers
- Nylon detent wheel
- Black anodized aluminum die cast support brackets
- Stainless steel detent arm



RADIO SWITCH CORPORATION

MARLBORO, NEW JERSEY
Telephone: HOpkins 2-6100

Circle 67 on Inquiry Card

1st of a series



brings you
"THE *Cadillacs*"
OF
FILTERS

HERE'S PROOF!
(TWO TYPICALS:)

1 state-of-the-art



TUNABLE BAND-REJECT FILTERS

- 40 to 2000 mc
- Peak rejections: Typically 105 db
- 3 db bandwidth: 10% max.
- Insertion loss: Typically 1.5 db
- Send for application notes.

2 off-the-shelf



GENERAL PURPOSE HIGH-PASS FILTERS

- 50 to 700 mc
- Rejection: 40 db min. from DC to 0.8fc
- Insertion loss: 1 db max. to 2.0fc
- Passband ripple: Less than ± 0.25 db

See the full line in AEL's new 78-page catalog — write for it.



American Electronic Laboratories, Inc.
P. O. BOX 552, LANSDALE, PENNA. 19446
(215) 822-2929

Circle 55 on Inquiry Card

BOOKS

Electromagnetic Field Theory

By Robert D. Stuart. Published 1965 by Addison-Wesley Publishing Co., Inc., Reading, Mass. Price \$8.95. 214 pages.

This book is concerned with developing from first principles the properties of electric and magnetic fields and the interaction of these fields with charged particles. Thus, it provides the basic theory needed to deal with such devices as waveguides, antennas, CRT's, high energy particle accelerators, and ferrites and microwave tubes. Field theory is approached via circuit theory. Organization is such that the mathematical methods required become progressively more difficult.

German-English and English-German Electronics Dictionary

By Charles J. Hyman. Published 1965 by Consultants Bureau Enterprises, Inc., 227 W. 17th St., New York, N. Y. 10011. Price \$14.00. 182 pages.

This vocabulary contains over 6000 entries in each language. It includes both specialized terms found in such commercial electronic industries as computers, radar, radio, telephone and TV, and appropriate terminology from such related fields as optics, mathematics and nuclear physics. Wherever necessary, the translation equivalent is supplemented by explanation.

Information, Computers, and System Design

By I. G. Wilson and M. E. Wilson. Published 1965 by John Wiley & Sons, Inc., 605 Third Ave., New York, N.Y. 10016. Price \$12.50. 341 pages.

Book examines system concepts in the light of information theory. It reflects the industrial and practical approach to system engineering. Emphasis is on the energy and structural aspects of systems, particularly on the roles human beings and information play in system design and operation.

Books Received

Data Transmission and Data Processing Dictionary

By James F. Holmes. Published 1965 by John F. Rider Publisher, Inc., 116 W. 14th St., New York, N. Y. 10011. Price \$2.50. 103 pages, paperback.

Application Guide for RCA Memory Products (MP-315)

Published 1965 by Electronic Components and Devices, Radio Corp. of America, Harrison, N.J. Price \$0.50. 24 pages, paperback.

British Miniature Electronic Components Data, 1965-66

Edited by G.W.A. Dummer and J. M. Robertson. Published 1965 by Pergamon Press Inc., 122 E. 55th St., New York 22, N.Y. Price \$28.00. 984 pages.

Digital Logic Laboratory Workbook

By Barbara W. Stephenson. Published 1965 by Digital Equipment Corp., 146 Main St., Maynard, Mass. Price \$5.00. 137 pages, paperback.

WE'LL DESIGN YOUR MAGNETIC SHIELDS



About 80% of all magnetic shield designs now in use originated here.

Maybe it's because our designs work. Maybe our designs work because we've had the most experience. All are good reasons to contact us.

Netic and Co-Netic magnetic shields are the recognized standard all over the world for military, laboratory, industrial and commercial applications. They are insensitive to ordinary shock, do not require periodic annealing, and have minimal retentivity. A few typical applications are illustrated. Our design department is yours.



Magnetically Shielded Room



Scan Converter Shield



Nesting Cans



CRT Shield Complex



Sectionalized P.M. Shield

MAGNETIC SHIELD DIVISION

Perfection Mica Company

1322 N. ELSTON AVENUE, CHICAGO, ILLINOIS 60622

ORIGINATORS OF PERMANENTLY EFFECTIVE NETIC CO-NETIC MAGNETIC SHIELDING

Circle 56 on Inquiry Card

NEW PRODUCTS

TUBE SOCKETS

Provides a safe, highly economical method of wiring assembly.

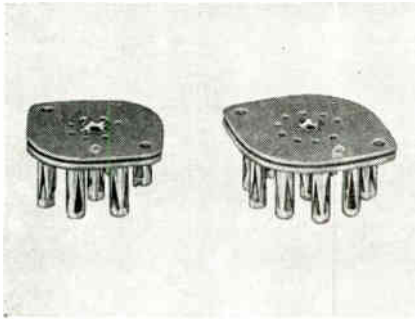

With these sockets no time lost due to replacement of wires before soldering, since the wires cannot work loose once they are inserted. These low-cost units are supplied with laminated insulating plates of XP or XXP phenolic or X2B hard rubber. Contacts are available as cadmium plated or electroless-tinned brass. Integral ground tabs can be provided. Both 7-pin miniature and 9-pin noval types are available. Cinch Mfg. Co., 1026 So. Homan Ave., Chicago, Ill.

Circle 177 on Inquiry Card

NANOSECOND DIODE

Can operate at freqs. of 100kc sq. wave, or 350kc sine wave.

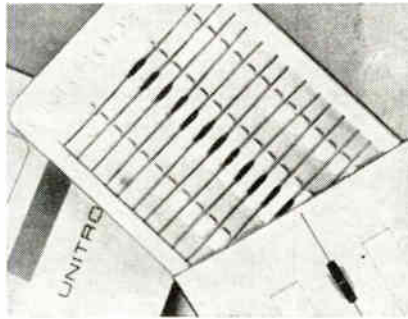

These 2a. rated devices have typical recovery times of 50 to 60nsec. They can withstand surges up to 40a. and have leakages under 1μ @ 25°C. Size is less than $\frac{1}{4}$ in. long with a max. dia. of 0.085 in. Refractory metal pins are metallurgically bonded across full face to a silicon dice of identical dia. The resultant structure is then fused in hard glass which forms a void-free hermetic seal around the junction. Unitrode Corp., 580 Pleasant St., Watertown, Mass.

Circle 178 on Inquiry Card

AC VOLTAGE STANDARD

True absolute standard with continuously variable freq. to 11KHz.



Model 146-AV10 has an internal, continuously variable oscillator. It provides a precision voltage in 6 fully switched decades from 0 to 511.110v. RMS, and continuous freq. selection from 38 to 11,100 Hz. True absolute accuracy is 0.025% including the algebraic sum of all calibration uncertainties. It has a 0.01% total harmonic distortion, 0 to full load. Stability is 1 yr. Weston-Rotek, Weston Instruments, Inc., 11 Galen St., Watertown, Mass.

Circle 179 on Inquiry Card



Induction Heating's Most Trusted and Creative Craftsmen Since 1926

High Frequency INDUCTION HEATING UNITS

for

- BRAZING
- MELTING
- SOLDERING
- ZONE REFINING
- HEAT TREATING
- CRYSTAL GROWING
- BOMBARDING
- PLASMA TORCH

ELECTRONIC TUBE GENERATORS

Kilocycle Frequency Units
Megacycle Frequency Units
Dual Frequency Units

- SPARK GAP CONVERTERS
- ACCESSORY EQUIPMENT

FREE APPLICATION ENGINEERING SERVICE—Our engineers will process your work samples and submit recommendations.

WRITE FOR NEW LEPEL CATALOG
Lepel HIGH FREQUENCY LABORATORIES, INC.

55th St. & 37th Ave., Woodside 77, N.Y.C.
Chicago Office for Sales & Service: 6246 W. NORTH AVE.

Circle 57 on Inquiry Card

Just off the Press

SEND FOR YOUR COPY TODAY

Your guide to Guaranteed Blower life and performance



Here in one handy folder are specifications, dimensions and capacities of the one line of motor blowers powered by the history-making, patented Howard Unit Bearing Motor — a motor with a history of nearly five million successful installations, guaranteed for five years to require no maintenance or re-lubrication. Your request for Bulletin 8-01 will bring a copy to your desk.



HOWARD INDUSTRIES

DIVISION MSL INDUSTRIES, INC.
1760 STATE ST. • RACINE, WIS.
MOTORS, GEARS, FANS, BLOWERS, LAMINATIONS
AND COMPONENT PARTS

Circle 58 on Inquiry Card



the
BEST
all-purpose
**MICROVOLT-
AMMETER...
KEITHLEY**
model 153

- 5 μ v to 1000 v f. s. voltage range
- 5×10^{-12} to 0.1 ampere f. s. current range
- 40 db ac line rejection assures less than 0.5% error
- less than 0.06 μ v rms noise
- 2 microvolts drift per day
- only \$550, including input leads

Use versatile zero-center and zero-left voltage ranges on the 153 Microvolt-Ammeter for measuring 0.2 μ v to 1000 volts. Switch selectable input resistances from 200 megohms down to 2 megohms. Read measurements directly with 1% accuracy on most ranges. Pinpoint resolution with less than 0.06 μ v rms noise. Measure long term with under 2 μ v per day zero drift and recorder output adjustable between 0 and ± 1 volt. And . . . forget about extraneous signals with the 153's 40 db ac rejection.

As a direct-reading ammeter, the 153 provides 42 f.s. ranges measuring 5×10^{-12} to 10^{-1} ampere. 2% accuracy and less than 2 second rise time, 10%-90%, are featured for most ranges.

Any way you use it, this photo-modulator type microvoltmeter fills the bill for low noise, high input resistance microvolt measurements. Try this laboratory giant . . . an in-plant demonstration is yours for the asking. Be sure to ask for four-page Model 153 technical engineering note, too.



**KEITHLEY
INSTRUMENTS**

12415 Euclid Ave. • Cleveland, Ohio 44106

electrometers | differential voltmeters | picoammeters | calibration devices

NEW PRODUCTS

DIGITAL GAUSSMETER

Hall probes with linear flux response, high thermal stability.

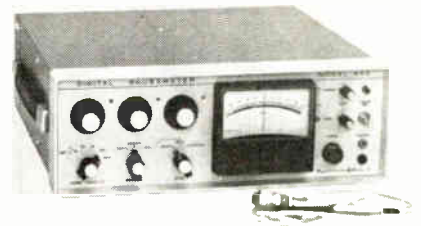

Model 660 offers both digital and analog readout capability. Decade scale ranging is used to provide a choice of full-scale ranges from 1 gauss (analog) or 100 gauss (digital) to 100kc. Accuracies approaching $\frac{1}{4}\%$ are attainable in the digital read mode between 0 and ± 10 kc. Resolution of 1 part in 1000 of reading is attained in this same mode. F. W. Bell, Inc., 1356 Norton Ave., Columbus, Ohio 43212.

Circle 203 on Inquiry Card

TAPE TRANSPORT

Provides a full range of compatibility with third generation computers.

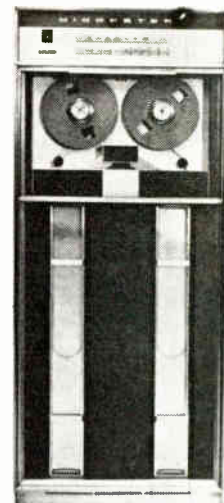

The Model M4000 digital tape transports handle either 7 or 9 track recording format on $\frac{1}{2}$ in. magnetic tape. Available for single or multiple speed operation covering the range from 25 to 150 ips, and with recording densities up to 800 bits/in., it provides data transfer rates to 120K characters/sec. Options provide a full selection of system interface features including multiple transport control toggles for read/write, density set, tape indicate and other specialized functions. Digital Tape Equipment, Midwestern Instruments, Inc., 41st & Sheridan Rd., P. O. Box 1526, Tulsa, Okla. 74101.

Circle 204 on Inquiry Card

NEW PRODUCTS

SOLDERLESS TERMINAL

For instant push-in use in round 1/16 or 0.093 in. holes.

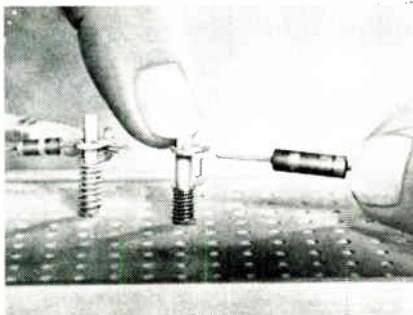

Model T32 is a solderless "U" clip terminal for testing or breadboarding solid-state and tube circuits, components, or for cable connections. Spring tension clamps up to 6 leads together in low resistance (under 0.002Ω) contact in the terminal. A side entry slot for component wires is uncovered by finger pressure on a plunger, permitting multiple leads to be laid in rather than threaded through the terminal. Vector Electronic Co., Inc., 1100 Flower St., Glendale, Calif. 91201.

Circle 180 on Inquiry Card

THERMAL WRITING RECORDER

Records 2 channels of analog data on 50mm-wide channels from dc to 125 cps.



DG 5511 2-channel thermal writing recorder has a 3-in-1 signal conditioning capability that can be duplicated only by using multiple instruments. It can be used with attenuator plug-ins for high-level signals, with pre-amplifier plug-ins for low-level signals, or without plug-ins for high-level signals. It is usable in laboratories for research and development, in production areas for monitoring and inspection testing, and in the field for service and maintenance. It has a heated stylus. Freq. response is dc to 70 cps ($\pm 1.5\text{db}$) at full amplitude and dc to 125 cps ($\pm 2.0\text{db}$) at 10 mm amplitude. Consolidated Electrodynamics Corp., 360 Sierra Madre Villa, Pasadena, Calif.

Circle 181 on Inquiry Card

Slash YOUR production costs! with **KÄHLE** AUTOMATIC EQUIPMENT

— FOR PRODUCTION, ASSEMBLY,
CONTROL, INSPECTION, TESTING

Typical KAHLE cost-saver designed and built for a leading miniature lamp manufacturer. Automatically assembles stem and bulb, then seal-molds, exhausts and tips-off the lamp...

CAPACITY
OVER 2,000
UNITS
PER
HOUR!

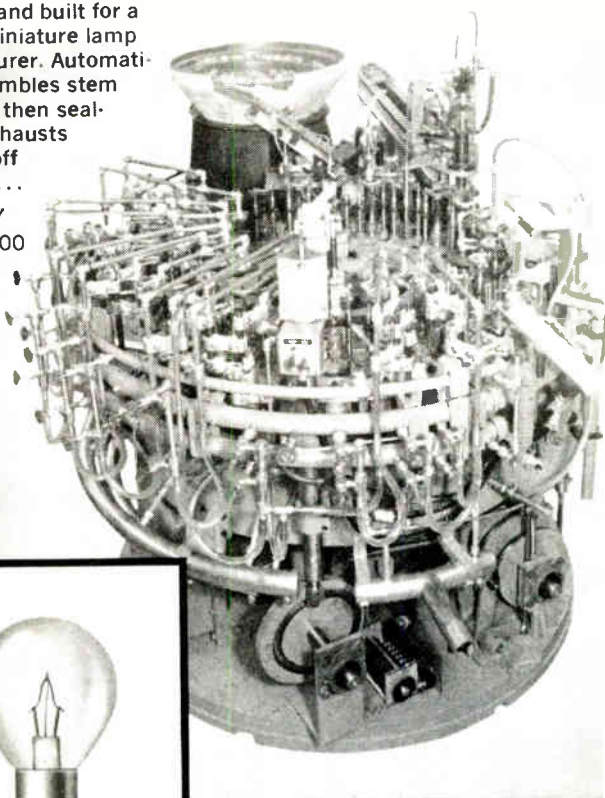

— KAHLE did it here!

KAHLE Servos and Feedbacks detect rejects prior to completion of assembly

Instrumentation feedbacks and servos can be supplied that will reject faulty parts prior to assembly and product finishing... saving materials and time in production.

KAHLE Machines are Customer-approved under actual operating conditions

Your equipment is run in our factory, using your materials in the presence of your engineers; the machine is not shipped to you unless you approve it!

CONSULT KAHLE—Save time and money by letting professionals build your specialty production equipment for automation!



Kahle Engineering Company

3320 HUDSON AVE., UNION CITY, N. J.
Telephone: UNion 7-6500 (Area Code 201)

NEW PRODUCTS

HIGH-POWER SWITCH

Solid-state switch that combines high power capability and broadband operation.

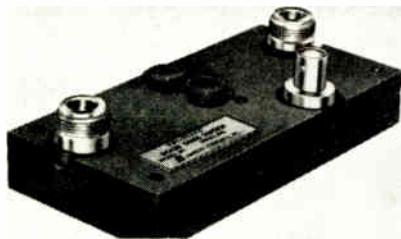

Model DS-650 is a SPST switch capable of handling up to 100w. CW power—average peak—and operates from 100 to 600mc. Isolation at 100mc is typically greater than 42db and at 500mc it is greater than 31db. It switches (10% to 90% points) at speeds as high as 200nsec. when used with a suitable driver. Insertion loss across the entire bandwidth is less than 0.5db; ON vsvr is typically below 1.7; impedance is 50Ω nominal. Electronic Product Dept., Sander Associates, Inc., 95 Canal St., Nashua, N. H.

Circle 182 on Inquiry Card

THERMAL TIMING RELAYS

Delay intervals from 2 sec. to 3 min. are available and are factory set.

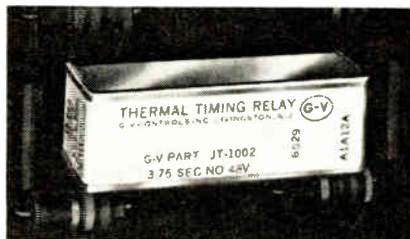

The JT series relays mount on PC boards. Four pins on the base serve as terminals and allow attachment to the PC board. They are fully compensated for amb. temp. variation and operate in any plane. Timing tolerance is $\pm 15\%$. Heater voltages of 6.3, 28, 115, and 230v. are standard and relays operate interchangeably on ac and dc. Contacts are SPST, either normally open or normally closed. Contact rating for resistive loads: 5a. to 125vac; 3a. to 250vac; 1a. to 32vdc. G-V Controls Inc., Livingston, N. J.

Circle 183 on Inquiry Card

ANTENNA MULTICOUPLER

Can drive up to 24 receivers, yet maintains low noise and distortion.

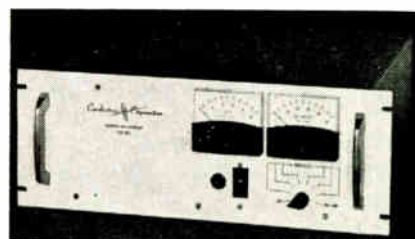

The C-325-24 antenna multicoupler satisfies the demand for energy distribution from a single antenna into multiple outputs functioning as an integrated distribution amplifier system. Fed directly from any antenna, it can drive up to 24 receivers yet maintain low noise and low intermodulation distortion characteristics. It has a built-in fault isolation (less than 30 min. to repair); high MTBF—20,000 hrs.; and modular construction. Conduction Corp., 343 S. Main St., Ann Arbor, Mich. 48107.

Circle 184 on Inquiry Card

RESINITE Mylar* Tubing

FOR HIGH DIELECTRIC STRENGTH, CORROSION AND HEAT RESISTANCE

Resinite Mylar Tubing provides 2500 v/mil min. ave. dielectric strength, continuous heat resistance of 300° F. and is impervious to corrosion and fungus. I.D.'s range from .040" to 8", wall thicknesses .001" to .050". Tubing can be supplied in any length for coils, flyback transformers, capacitor jackets, wire insulation, shafts . . . also furnished slotted for iron core coils, etc.

Send or phone specs, for quote. Request bulletin and arbor list.

PRECISION PAPER TUBE CO.
RESINITE DIVISION
1049R S. Noel Ave., Wheeling, Ill. 60090 (Chicago Suburb)
TELEPHONE 312... 537-4250 TWX 312... 537-5202

Circle 60 on Inquiry Card

CR* batteries

*** CHARGE RETAINING**
Dependable Power
for a Year
Without Recharging
or Maintenance



- Typical applications are instruments, buoys, deep sea devices and systems requiring uniform voltage characteristics over prolonged, unattended operating periods.
- Permit continuous or intermittent discharge at high or low rates. 85% of capacity available after one-year idle stand at 80° F — more at lower temperatures.
- May be charged and discharged repeatedly with little change in characteristics. Voltage practically linear between 2.12 and 1.95 per cell.
- All the proven dependability and cost advantages of the lead-acid battery plus charge retention. Five sizes available: 26 to 600 ampere hours.

FOR COMPLETE INFORMATION WRITE:

WISCO The Electric Storage Battery Co. **ESB**
DIVISION 1222 — 18th Street, Racine, Wis. 53403

Circle 61 on Inquiry Card

NEW PRODUCTS

RELAY ADJUSTING TOOLS

Adjusts all foreign or domestic type relay springs.

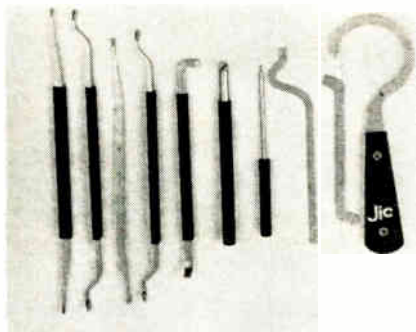

This group of precision adjusting tools for relay springs, armatures, rotary switches and telecommunication equipment should be useful in production of relays and components, and greatly ease maintenance of related equipment. Adjuster tips have various shapes and slot openings to accommodate the wide range of relays. Jonard Industries Corp., Precision Tools Div., 3733 Riverdale Ave., Bronx, N. Y. 10463.

Circle 185 on Inquiry Card

HIGH CURRENT RECTIFIER

PIV ratings of 5000, 7500, 10,000, 12,500, 15,000, 20,000 and 25,000v.

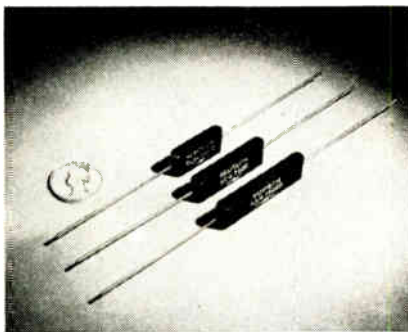

The Slimpac series are 1/2a. (1a. in oil) high-voltage coaxial, lead mounted, rectifiers. It is corona free and features low forward drop, low leakage @ PIV, operating and storage temp. -55°C to +175°C. The package is 0.25 in. deep by 0.53 in. wide. Length varies with the PIV rating from 1.125 in. to 4.250 in. max. Units have 0.051 dia. axial wire leads. Semtech Corp., 652 Mitchell Rd., Newbury Park, Calif. 91320.

Circle 186 on Inquiry Card

telephone quality components

There is no higher standard for switching components. Specify famous Stromberg-Carlson . . . known to telephony since 1894.

RELAYS: Types A, B, BB, C and E. All standard spring combinations are available. Send for Bulletin T-5000R3.

KEYS: Broad selection of push-button, cam and twist types. Send for Bulletin T-5002R2.

HANDSETS: High-efficiency instruments; standard or with switch assemblies. Send for Bulletin T-5017R.

Full-line data on request.



STROMBERG-CARLSON CORPORATION

115 Carlson Road • Rochester, N. Y. 14603



Circle 62 on Inquiry Card

ELECTRONIC INDUSTRIES • December 1965

BARNSTEAD

Disposable Cartridge Type DEMINERALIZERS

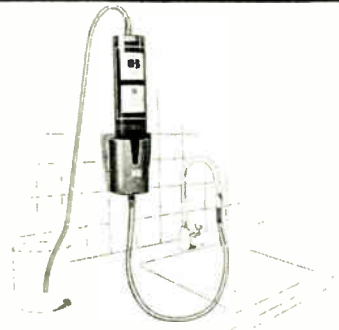

HOSE NIPPLE TYPE FOR LOWEST COST OPERATION

Ideal where need for demineralized water is small or too infrequent to justify capital investment. Connects to faucet and collection vessel with lab tubing. No meter nor electrical connection needed. Resin changes color when exhausted. Flow rate up to 20 gallons per hour. A complete demineralizer for only \$10.85. U.S.A.

Bantam® BD-1 WITH DIRECT READING PURITY METER

Meter shows water purity at a glance. Wall or bench mounted for convenient placement. Larger Barnstead Cartridge Demineralizers are available with flow rates up to 1500 gallons per hour.



Bantam BD-2 OPERATES UNDER PRESSURE UP TO 100 PSIG.

Excellent at final polishing station for rinsing transistors, diodes, microcircuits, rectifiers, printed circuit boards etc. Puralite (purity indicator) shows when to change cartridge. Flow rates up to 25 gallons per hour.



Write for Bulletin # 154

Barnstead STILL AND STERILIZER CO.

22 Lanesville Terrace, Boston 31, Mass.

New York, Philadelphia, Washington, Atlanta, Cleveland, Detroit, Chicago, St. Louis San Francisco, Los Angeles

Circle 63 on Inquiry Card

NEW PRODUCTS

R-F EQUIPMENT

Combines solid-state design with economic advantages of transmitting klystron.

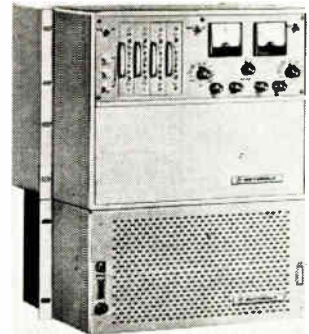

The MR-30 operational fixed-band microwave r-f equipment operates at 60c. It provides a transmission medium capable of toll quality performance using companion SSB or FM carrier equipment. It handles voice, telemetering, facsimile, and data communications at low channel cost, low maintenance cost and low total communications cost. Flexibility features permit custom installations at off-the-shelf prices. Motorola Inc., Military Electronics Div., Chicago Center, 1450 N. Cicero Ave., Chicago, Ill. 60651.

Circle 199 on Inquiry Card

DIFFERENTIAL COMPARATOR

Differential voltage comparator offers 2mV resolution and a response time of 40nsec.

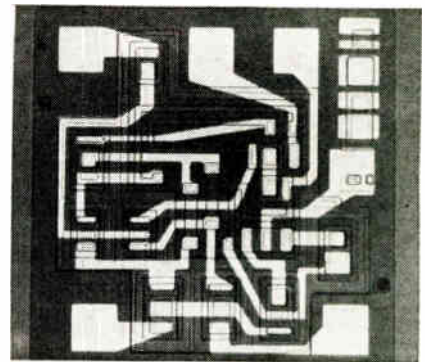

The $\mu A710$ and $\mu A710C$ monolithic planar-epitaxial integrated microcircuit is useful as a variable threshold Schmitt trigger, a pulse height discriminator, a voltage comparator in high speed A-D converters, a memory sense amplifier or a high-noise immunity digital line receiver. The $\mu A710$ is for military applications, and the $\mu A710C$ is intended for commercial systems. Compatible with practically all integrated logic forms, the units offer an input voltage range of 5v. Fairchild Semiconductor, div. of Fairchild Camera & Instrument Corp., 313 Fairchild Dr., Mountain View, Calif.

Circle 200 on Inquiry Card

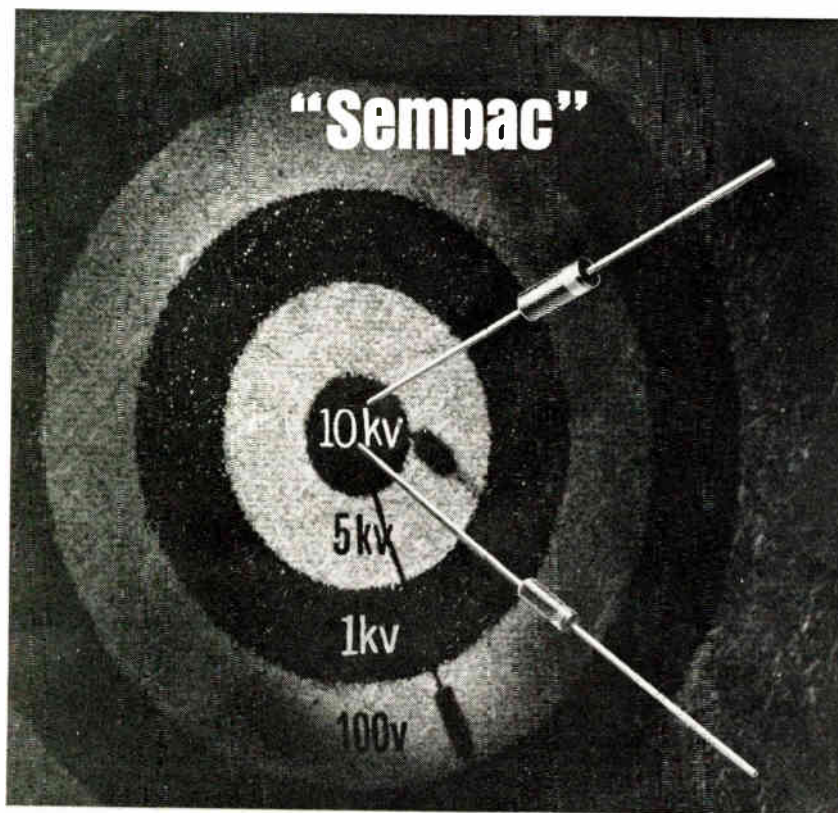

miniature high voltage silicon rectifiers

Semtech Corporation offers "Sempac" the first Miniature Multipurpose Silicon Power Rectifier series with peak inverse voltages ranging from 100 to 10,000 volts.

Sempac is cylindrical in design, with insulated case and axial leads, similar to a computer diode. Better electrical characteristics are obtained by excellent thermal conductivity provided by Sempac's solid internal construction and pure silver leads. Hermetically sealed, Sempac is designed to meet stringent temperature-cycling and humidity requirements. Electrical and mechanical specifications:

100 to 1000 volts, 1 amp @ 55°C (no heat sink), 3 amps per MIL-STD-750
1500 to 3000 volts, .25 amp @ 55°C (no heat sink)

Package dimensions: Length .235 \pm .005", Dia. .125 \pm .003

2500 to 5000 volts, .150 amp @ 55°C (no heat sink)

4000 to 10,000 volts, .10 amp @ 55°C (no heat sink)

Package dimensions: Length .410 \pm .005", Dia. .140 \pm .005"

Storage and operating temperatures range from -55°C to +175°C.

Sempac is designed to meet the most critical military, industrial and consumer (product) applications. The entire series is MASS PRODUCED and available for immediate delivery.

Send for Technical Bulletins R51 and R52.

SEMTECH  **CORPORATION**

Western Office: 652 Mitchell Road, Newbury Park, California

(805) 498-2111, from L.A., (213) 628-5392 / TWX 805-499-7137

Eastern Regional Office: 71 West 23rd St., New York, N.Y., (212) 989-7550



55 AMP 110 AMP
SCR's

**ALL-DIFFUSED
 SHORTED EMITTER**

- ⊕ PRV up to 1300 volts.
- ⊕ dv/dt 200 volts per microsecond.
- ⊕ Assembled with hard solder for high reliability.
- ⊕ Designed for minimum thermal fatigue.
- ⊕ No peak forward voltage limitation.

request bulletin

NATIONAL
 ELECTRONICS, INC.
 A SUBSIDIARY OF VARIAN ASSOCIATES
 PHONE (312) 232-4300 • GENEVA, ILLINOIS, U.S.A.

Circle 65 on Inquiry Card

NEW PRODUCTS

DIGITAL OHMMETER

Measures from 1 milliohm to 10 megohms. Accuracy $\pm 0.01\%$ of reading.



Model 2050 can be used in conductor and semiconductor materials research, quality control and production, systems check-out, measuring integrated circuit parameters, transformer coil resistances, and resistivity of semiconductor materials. It has 6 automatically selected ranges. Non-Linear Systems, Inc., P. O. Box 728, Del Mar, Calif.

Circle 187 on Inquiry Card

PULSE GENERATOR

For a variety of applications which require fast-rise and fast-fall pulses.

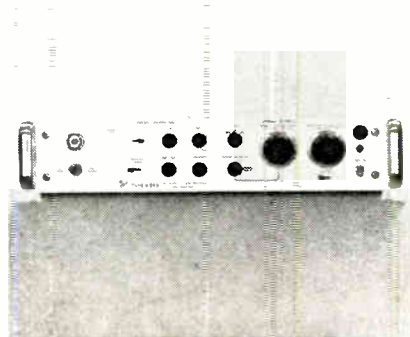

Type R293 is a programmable pulse generator and power supply. Its remote program capabilities make it useful in production line and systems applications. It can be used for testing time and charge parameters of semiconductor devices and to measure switching and propagation times of micro-logic circuits. Programmable parameters include pulse amplitude, pulse width, pulse repetition rate, and both regulated voltage and current. Any single or combination of programmable parameters can be externally programmed, with the remaining parameters controlled from the front panel. Programming is accomplished by analog resistances and conductances connected between appropriate program leads. Tektronix, Inc., P. O. Box 500, Beaverton, Ore. 97005

Circle 188 on Inquiry Card

MANDEX

Wire Grip
Circuitry Components

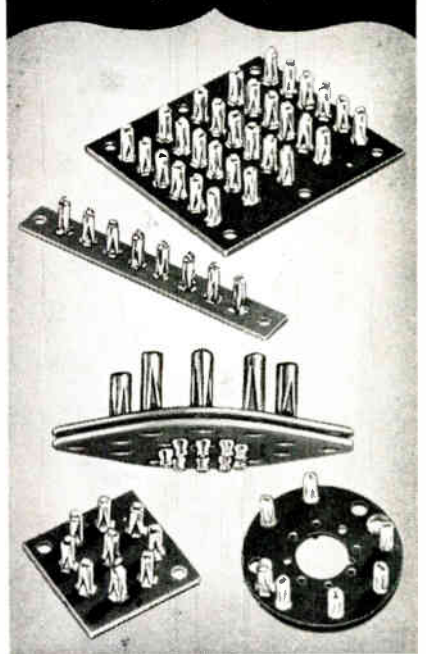

Reduce Production Costs—Connections can be made quickly and easily without experienced wrappers or solders. Training costs and losses due to rejected parts are greatly reduced.

Increase Reliability—Gripping fingers soak up solder for highest quality, long-lasting connections. Pre-cutting of leads eliminates "stray wire" short circuits. Predetermined lead lengths reduce circuit impedance.

Provide Easy Servicing—Advanced technical knowledge is not required. Component replacement is accomplished by simply heating connection to remove old lead and reheating to insert new lead.

Call or write for facts concerning your application. Request Bulletin WG-644 for detailed general information.



MANDEX MANUFACTURING COMPANY, INC.
Specialists In Electronic Parts

2618 West 48th Street
 Chicago, Illinois 60632, Phone: 312...254-4200

Circle 66 on Inquiry Card

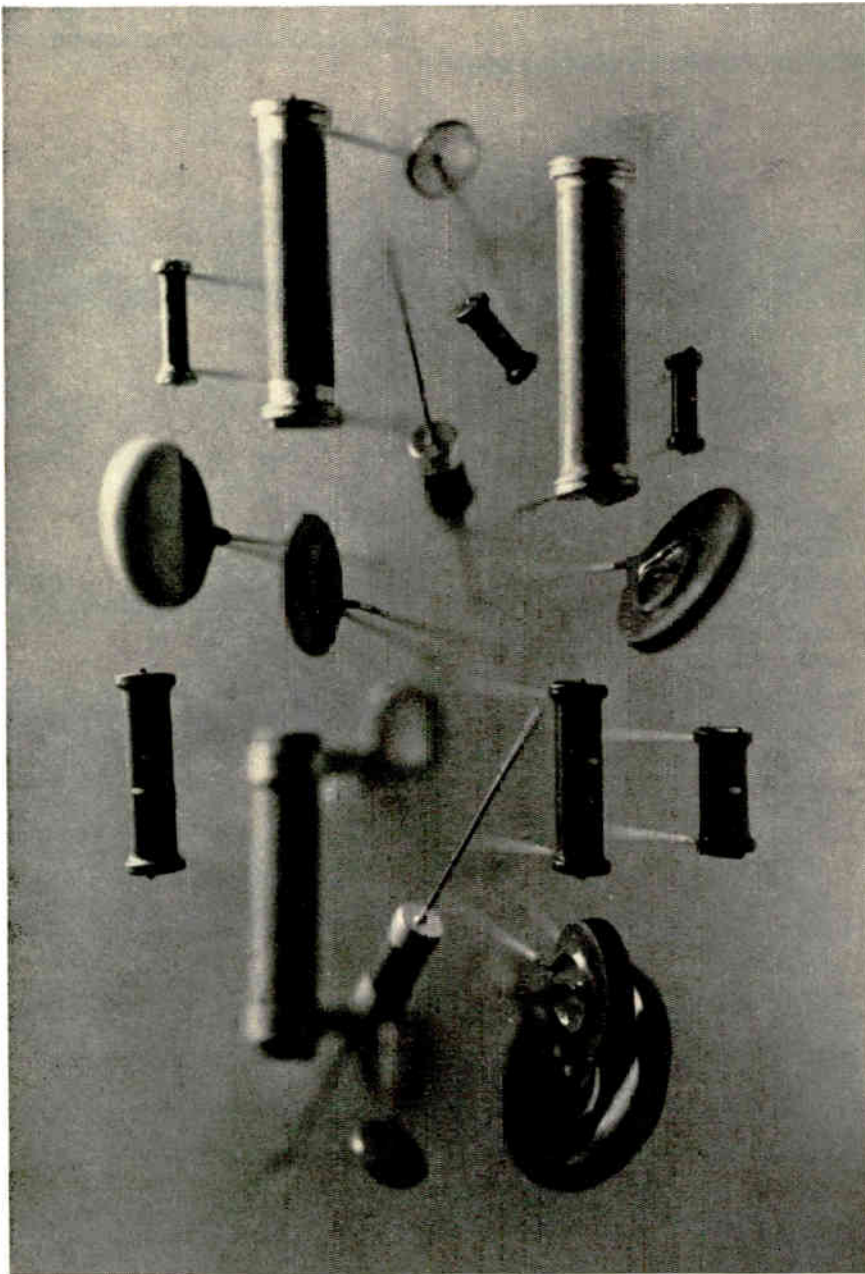

Varistors come get 'em

We make 99 standard silicon carbide varistors and stock them for immediate off-the-shelf delivery. Values range from 0.25 through 3.00 watts; sizes from 0.500" x 0.090" through 1.50" x 0.155" in discs. You'll find a full range of sizes in rod varistors just as available. Prices from \$0.08 to \$1.00. Send for complete technical data and see how economically, how quickly we can help you solve arc-suppression, voltage-regulation and -control problems with CARBORUNDUM® varistors. Varistors Dept. E N-04, Electronics Division, The Carborundum Company, Niagara Falls, N. Y.

CARBORUNDUM

Circle 85 on Inquiry Card

NEW PRODUCTS

MICROWAVE SEAL

Withstands unusual and critical environments of advanced design concepts.

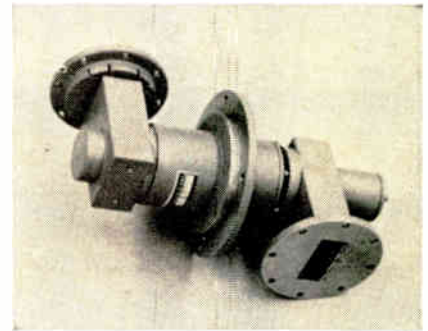

A high-speed long-life pressure seal has been developed which withstands critical environments without degrading r-f performance. This rotary joint has been operated well over 1000 hrs. continuously at 1000 RPM and 30 psig without loss in pressure or mechanical change. The rotary coupler operates at 5400-5900MC with a 1.25 max. vswr and insertion loss of 0.15db. Diamond Antenna & Microwave Corp., Winchester, Mass. 01890.

Circle 197 on Inquiry Card

GENERAL-PURPOSE RELAY

Miniature lamp glows in coil circuit to indicate relay condition.

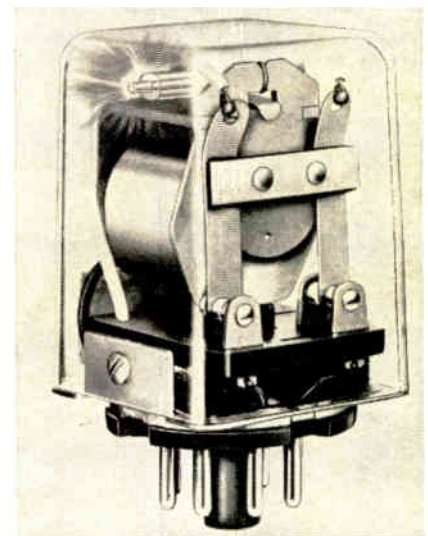

Model 22AL has a subminiature neon lamp connected across the coil terminals. When coil is energized, the lamp glows. Lack of this glow indicates a circuit failure and speeds servicing in relay banks and multiple or isolated relay installations. A close-fitting dust cover makes it useful for difficult operating environments. A variety of contact arrangements are available. Eagle Signal Div., E. W. Bliss Co., Davenport, Ia.

Circle 198 on Inquiry Card

NEW PRODUCTS

FLAT PACKAGE

A hermetically sealed, 22-lead flat package for selected HLTTL integrated circuits.

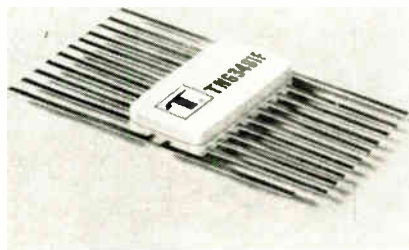

This 22-lead package uses ceramic-glass to insure a highly reliable hermetic seal. Nominal dimensions are 0.250 x 0.450 in. The 11 leads on each side are 4 mils thick and 14 mils wide, and are located on 50 mil centers. The package has a gold-plated kovar bottom plate, allowing for high power dissipation. Circuits currently available in the new package are: Quad 4 input Nand/Nor gates (TNG-3481F through TNG3484F), and dual master-slave JK flip-flops (TFF3181F through TFF3184F). Transatron Electronic Corp., Wakefield, Mass.

Circle 189 on Inquiry Card

MASKING CAMERA

Produces 2 x 2 in. exposure masks from 400X or 200X art in less than an hour.

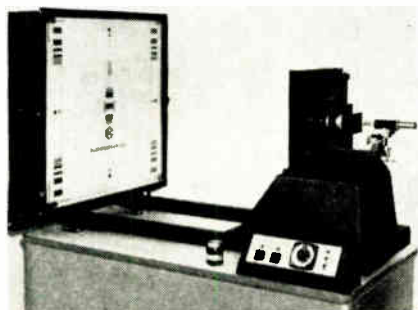

The self-contained Model 200X2 is 2 cameras in 1: a multiple aperture intermediate reduction camera and ultra-precise 2 x 2 in. working-mask camera. It produces 0.0005 in. lines to an accuracy of 0.0001 in. The system fits into a 3 x 5 ft. darkroom space and provides a high-intensity monochromatic light source, 2 precision cameras mounted on a vibration-free frame, and exposure control console. The aperture camera has 2 standard multi-aperture plates to produce final die sizes from 0.020 to 0.150 in.; the ultra-precise 2 x 2 in. camera has 2 reduction lenses and 200X microscope. Electroglas Inc., 150 Constitution Dr., Menlo Park, Calif.

Circle 190 on Inquiry Card

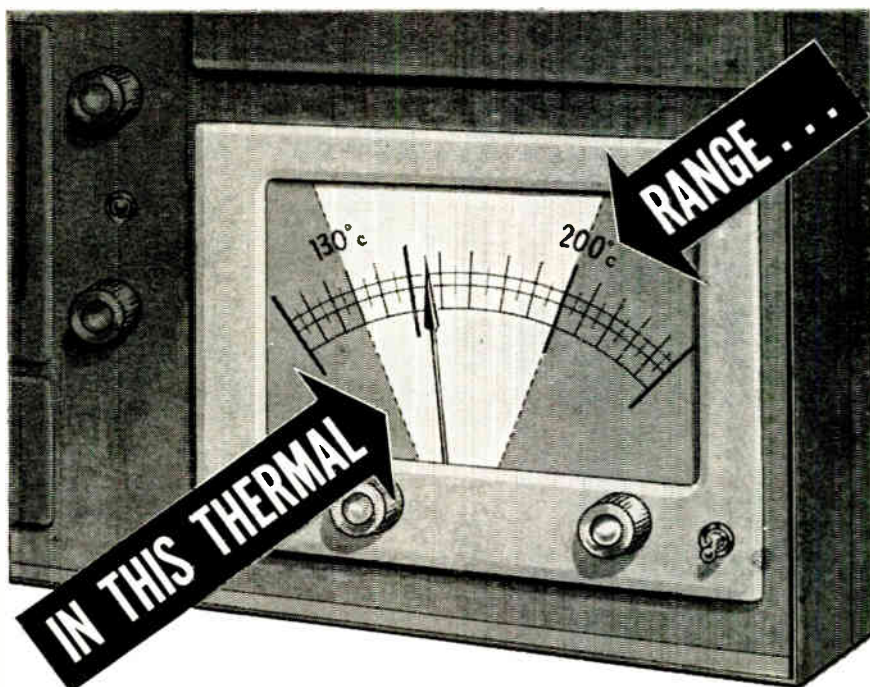

RELY ON

Varglas CLASS F Flexible Sleeving

For such "middle-of-the-range" applications any less than Class F courts failure — any more is wasteful. Get exactly the protection you need without paying for more than you need, with this Varglas flexible polyurethane sleeving.

Fiberglass braid is impregnated with heat- and abrasion-resistant polyurethane resin that can be worked and flexed without loss of rated dielectric value (up to 7000 volts). Absence of vinyl in the resin precludes chloride contamination.

Like other Varglas sleeveings, Class F is resistant to attack by acids, alkalis, organic solvents, oils, and water; fully compatible with polyester, acrylic, epoxy, phenolic, and formvar wire enamels. Expose it continuously at 155°C., and there is no softening, flowing or blistering — surpasses NEMA standards. Most sizes in coils, spools or pre-cut lengths available off-the-shelf for quick delivery — special production within one week.

VARFLEX CORPORATION, 308 N. Jay Street, Rome, N. Y.

SEND FOR FREE FOLDER OF ACTUAL TEST SAMPLES

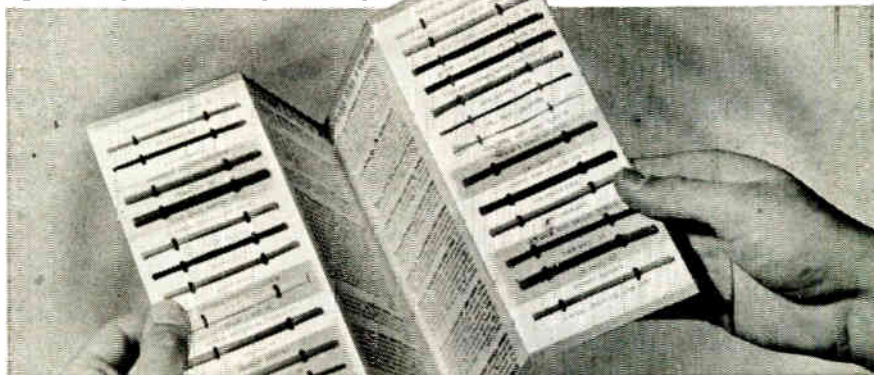

another BURR-BROWN innovation



a small operational amplifier with FET chopper

Model 1538 is a new solid-state operational amplifier that uses a Field Effect chopper for maximum stability. But, the big news is its size... a module 0.6" x 1.8" x 2.4". It's really a slimmed-down version of our popular 1608A rack-mount unit, designed especially for engineers faced with space problems. Don't let the size fool you though, it's still a tiger when it comes to performance. And, the 1538 is immediately available at a single unit price of \$165.00.

MODEL 1538

Voltage Output	±10 volts
Current Output	±20 ma
Voltage Gain	160 db
Voltage Drift	±0.5 μV/°C
Current Drift	±2.5 pA/°C
Temperature Range	
Operating	-40 to +85°C
Storage	-55 to +100°C

FOR COMPLETE TECHNICAL INFORMATION, or prompt assistance with your operational amplifier applications, wire, write or phone Burr-Brown, today.

BURR-BROWN

RESEARCH CORPORATION
INTERNATIONAL AIRPORT INDUSTRIAL PARK
BOX 11400, TUCSON, ARIZONA 85706

Circle 70 on Inquiry Card

NEW PRODUCTS

LOW-COST OVENS

Provides precisely controlled environment without RFI problems.

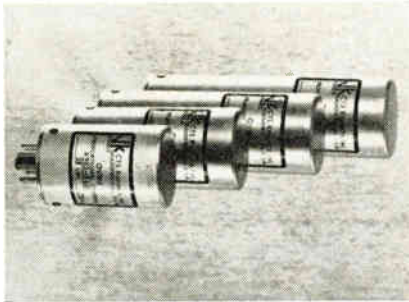

Four low-cost proportional-control ovens are available for use with crystals, oscillators and other components. Series 952-5 provides a precisely controlled temp. environment without the RFI problems associated with thermostat-controlled ovens. Oven temp. variation with change in amb. is 0.15°C max. from -40° to within 10°C of operating temp. and is held ±0.025°C at constant amb. temp. Standard operating temps. are 65°C, 75°C and 85°C (±5°C). Other temps. and closer tolerances are available on special order. Standard input voltage is 28vdc. CTS Knights, Inc., Sandwich, Ill.

Circle 201 on Inquiry Card

MULTI-METERS

Available in the standard waveguide sizes covering 12.4 to 110 GHz.

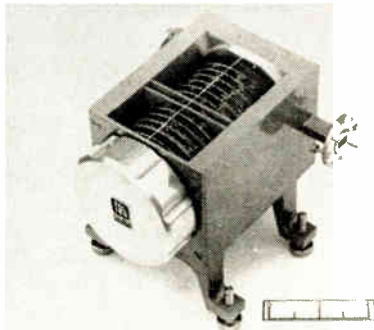

The Series 551 Direct-Reading Millimeter-Band Frequency Meters are available in 7 models. This compact unit consists of a precision, highly polished tellurium copper cavity which operates in the TE_{1n} mode. A small hole in the waveguide wall couples energy to the cavity and results in a resonance dip in transmitted power of 0.5 to 1.0db over the waveguide band. Cavity tuning is accomplished by a precision drive screw and non-contacting short circuit. Direct read-out of freq. is provided by a 74 in. long helical scale with 10mc marking increments. TRG Inc., subs. of Control Data Corp., 400 Border St., E. Boston, Mass.

Circle 202 on Inquiry Card

Solid Status Report 12/65

What can solid-state photomixers do for you that nothing else can?

As detectors and mixers for emitter and laser radiation, semiconductor photomixers offer you some extraordinary opportunities. Look what our L4500 series of diodes can do:

They can extend your spectral coverage into the far infrared—to 5.7 microns, as compared with the photomultiplier and TWT limit of 1 micron.

They can extend your transit-time frequencies to 18 Gc, with RC cutoff frequencies beyond 40 Gc—exceeding that of the best photomultipliers.

They can eliminate bulky power-supply requirements—power consumption within the device is negligible.

They can improve operating reliability—offering the same basic advantages of stability that have prompted the use of semiconductor devices in many other areas.

They can save you a substantial amount of money. Just ask for prices and compare!



Any disadvantages? About the only one we can think of is the absence of gain within devices presently available. Easily remediable with a low-noise preamp. It should be noted in this connection that the L4500 series offers an excellent signal-to-noise ratio. And that quantum efficiency is higher than that of tubes. Coherent *minimal* detectable powers are approximately 10⁻¹⁶ watts.

The full spectral range of 0.4 to 5.7 microns is covered by a series of silicon, indium arsenide and indium antimonide diodes.

Our photomixer/detector diodes are available in a variety of package configurations for mating to BNC-type plugs, and in miniature Dewars for optimum performance in the far infrared region.

For full information and prompt technical help, call, write or wire John Roschen. Or circle the Reader Service card. (Phone: 215-855-4681.)

SOLID-STATE PRODUCTS OPERATION

PHILCO

A SUBSIDIARY OF Ford Motor Company,
LANSDALE DIVISION • LANSDALE, PA.
In Canada, Don Mills Road, Don Mills, Ontario, Canada

Circle 71 on Inquiry Card

ELECTRONIC INDUSTRIES • December 1965

NEW PRODUCTS

FLIP-FLOP MODULES

General-purpose modules useful in experimental or breadboard work.

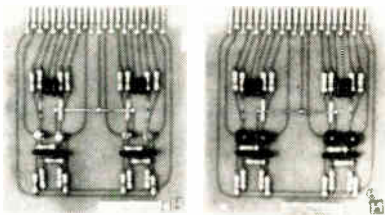

Modules 2FB-M and 2FB-H are spray etched and wave soldered to provide consistently uniform fabrication and eliminate irregular etching and poor solder joints. Designed for implementing counters, shift registers, and general control, the modules provide 2 independent JK, RS type flip-flops with separate dc (RS), ac (JK), and steering inputs. Logic levels are $-10(\pm 2v.)$ at logical "1," and $-0.25(\pm 0.25v.)$ at logical "0." Module operating temp. is $0^{\circ}C$ to $+50^{\circ}C$. Wyle Laboratories, Products Div., 133 Center St., El Segundo, Calif.

Circle 191 on Inquiry Card

PUSH-PUSH SWITCH

Uses internal bonding and grounding to eliminate mechanical discontinuities.



The Type J334P6 uses internal bonding and grounding to eliminate mechanical discontinuities that could serve as points of RFI emission. All switches meet radiation requirements for use in airborne electronic equipment designed to Mil-I-26600 specs. A low-impedance ground path for spurious RFI is provided by connecting moving metal parts within the switch to the switch case. Thus RFI radiation in the critical 0.15 to 1000mc range is suppressed. The push-push switch is rated for 1a. resistive at 28vdc or 120vac. Min. life expectancy is 25,000 cycles. Controls Co. of America, Control Switch Div., 1420 Delmar Dr., Folcroft, Pa.

Circle 192 on Inquiry Card

Communications
& Broadcasting
Activities

Delta News

Defense
Activities

Phone (703) 836-3133

December, 1965

VOL. IV No. 3

COMMUNICATIONS ENGINEERING FIRSTS

Alexandria, Virginia—A group of high power, quality transmission equipment for H.F. featuring new concepts in communications engineering has been introduced by Delta Electronics, Inc.

The communications equipment offer unmatched performance, complete reliability, compactness and economy.

Employing a new design principle, the Model SLS-1 is 50 ohm crossbar switch matrix—with manual or remote control—that permits an extremely compact system with excellent power handling capability, impedance and cross talk characteristics. It connects any one of a number of 50 ohm transmitter outputs—having power outputs up to 50 kw average—to anyone of a number of 50 ohm antennas at a heretofore unequaled low cost.

Note: the SLS-1 has no residual stubs on any circuits and uses no vacuum switches.

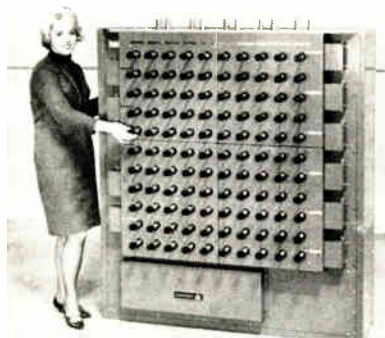

SLS-1

Also entirely new in design concept is the OIB-2 Operating Impedance Bridge. It permits measurement of impedance under power with a minimum of insertion effects on the circuit. This unit can be installed di-

rectly in the circuit of each element. Covering 2 to 30 mc, the OIB-2 has a power rating of 1 kw.



OIB-2

For high frequency antenna use, Delta presents the HFAS-3—a tuned horizontal dipole antenna system for 3 to 30 mc. with a power capacity of 10 kw PEP. The system includes a motor driven coupler and a remote control unit. A servo system permits remote control and preset tuning for four frequencies. An accessory unit provides 10 additional preset frequencies.



HFAS-3

For more information, Write Dept. 11-65 for individual sales bulletins.

DELTA ELECTRONICS, INC.
4206 Wheeler Avenue
Alexandria, Virginia 22304
(703) 836-3133

A leader in design, development and production of antennas and associated ancillary equipment for communications, broadcasting and defense activities.

NEW HIGH DENSITY RELAYS DELIVER 200 OPNS. PER SECOND

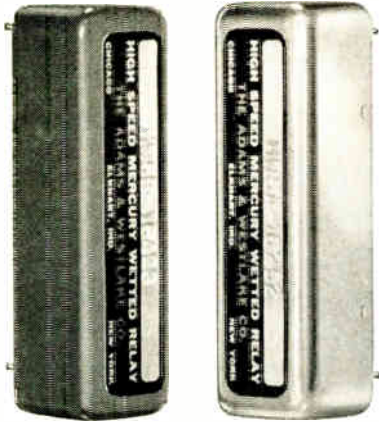

These contact form C relays follow signals up to 200 operations per second without variation in timing. Are available in single-side-stable, bi-stable and chopper forms. Adlake MWSA 16000 relays like the one on the left are the only ones you'll find anywhere molded in epoxy. Though less expensive, they stay cooler. Contain no wax to overheat and run. Parts are rigidly secured—no movement to cause circuit noise. Epoxy is proof against all caustics and solvents except acetic acid. The metal encased version on the right can be grounded to assure magnetic shielding. Use it where magnetic interference is a special problem. For more information, call Adlake. And remember, *Adlake makes more kinds of mercury relays than anybody.*

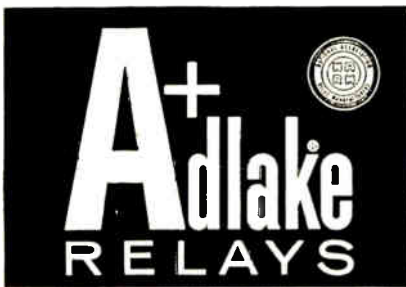

The Adams & Westlake Company
Dept. R-8812, Elkhart, Indiana
Phone Area 219, COngress 4-1141
Circle 73 on Inquiry Card

NEW PRODUCTS

ATTENUATOR

Inserts accurate and fixed amount of loss in circuits operating from dc to 1gc.



With the Model 90-0, attenuation is controlled by miniature h-f toggle switches. The resistors are 1% tolerance carbon-film types. The maximum total error is low, and incidental insertion loss is negligible. Input and output impedance: 50Ω; insertion loss: 0db at low freqs.; approx. 0.1db at 250mc; approx. 0.2 at 500mc; approx. 0.6db at 1gc. vswr: 1.2:1 max. up to 250mc, 1.5:1 max. from 250 to 1000mc (50Ω units). Kay Electric Co., Pine Brook, Morris County, N. J.

Circle 193 on Inquiry Card

CONVERTER PREAMP

Useful with sinusoidal inputs of 50 cps to 100kc with RMS values from 3mv to 500v.



Model 8807A produces a dc voltage proportional to the average value of full-wave rectified ac voltages. The instrument features a true floating, guarded input which is transformer-coupled and isolated from system ground. The calibrated zero suppression and variable scale expansion permits detailed observation of small changes in large input voltages. The unit can drive a 1KΩ load to ±3v. or 0 to ±5v. When used in a recording system, it has transient response time of 10msec. Plug-in filters within the unit permit selection of response time. Sanborn Div., Hewlett-Packard Co., 175 Wyman St., Waltham, Mass. 02154.

Circle 194 on Inquiry Card

maintenance

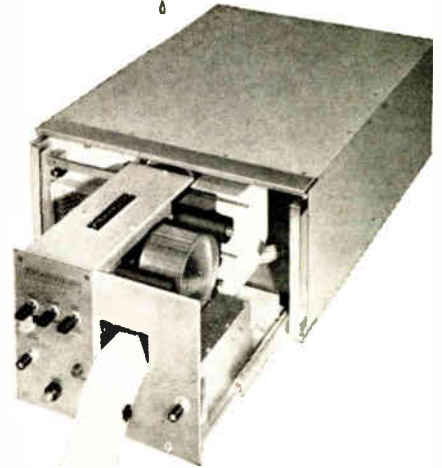

World's Fastest, Low-Cost Digital Printer

Apply several drops of oil to the drive-motor shaft-ends each year (or every fifty-million lines). Brush out any accumulated dust or lint. Clean the air filter periodically.

That's the extent of maintenance for a Franklin Model 1000 . . . the only digital printer that offers a printing rate of 40 lines per second (or less) at low, low, OEM prices.

REQUEST BULLETIN 2301

FRANKLIN
electronics, inc.

East Fourth St. • Bridgeport, Pa. 19405
A Division of the Anelex Corporation

Circle 64 on Inquiry Card

NEW PRODUCTS

OPERATIONAL AMPLIFIERS

Has 6 Meg input Z, below 5 μ v/ $^{\circ}$ C drift, 30v./ μ sec. slew rate, 10mc bandwidth.

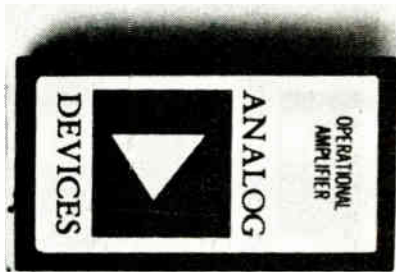

Series 102 features 2 Meg open-loop gain and bandwidth of 10mc. It can be operated differentially or non-inverting over its full freq. range with slewing rate of 30v./ μ sec. Current drift is 0.2na/ $^{\circ}$ C over the temp. range from -25 to +75 $^{\circ}$ C. Long term drift at constant temp. is held below a 10 μ v/day by highly stable metal-film resistors used in place of conventional drift-prone carbon resistors. Analog Devices, Inc., 221 5th St., Cambridge, Mass. 02142.

Circle 195 on Inquiry Card

HOT-AIR TORCH

For all soft soldering uses, heat shrinking of thermal-fit tubing, etc.

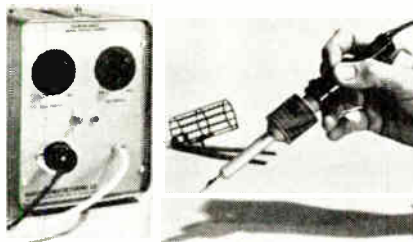

A 1000 $^{\circ}$ F temp. capability, combined with precise controls for air flow and temp., are features of a new 4 oz. pencil-type hot air torch. Designated Model FT-200, it features changeable tips ranging in dia. from 0.037 to 0.093 in. This allows the user to match the size of the superheated air stream to the application requirement. Temps. and air flow at the torch tip can be set precisely for predictable and repeatable levels. Henes Mfg. Co., 4301 E. Madison St., Phoenix, Ariz.

Circle 196 on Inquiry Card



rated 625,000 operations between failures by independent customer tests

MIL SPEC

DREXAMATIC PUNCHED CARD PROGRAMMERS



Model 2545



Model 754-A

are now used in
**MINUTEMAN,
SATURN & APOLLO**

- for
- Test programming
 - Status indication
 - Access limitation
 - Communication switching
 - Operator identification and Parameter programming

These militarized card readers are offered in both IBM and Rem Rand format . . . with up to 960 switch contacts. For assistance in applying punched card readers to your specific installation . . . just give us details . . . and we will send our recommendations plus application data on how to use card readers. Write to:

DREXEL
DYNAMICS
CORPORATION

400 MAPLE AVE., HORSHAM, PA.
SUBURBAN PHILADELPHIA

Circle 74 on Inquiry Card

**Ever need plug-in power supplies in a hurry?
Send for our 1965 catalog.
It lists 62,000 different types.
The one you need will be shipped in 3 days.**

(We've never failed to make good on this promise)

Acopian
TRANSISTORIZED REGULATED PLUG-IN POWER SUPPLIES

Acopian
TRANSISTORIZED REGULATED PLUG-IN POWER SUPPLIES

Acopian

Acopian Corporation, Easton, Pennsylvania, (215) 258-6149

Circle 68 on Inquiry Card

Ω

VI

+9

8

GO

7 NEW FROM **IEE** **μ**

+

A

4

1 VOLT

3

WORLD'S SMALLEST REAR-PROJECTION READOUT GIVES YOU CHARACTERS THIS BIG



Shown actual size

The new Series 340 is the smallest rear-projection readout in the world! It's just 3/4" x 1/2" x 2"—yet its 3/8" characters are clear, sharp, and easily read.

Only IEE's patented rear-projection readouts give you your choice of any type face, symbol, color. Anything you can put on film! Use the single-plane Series 340 anywhere you need maximum clarity in minimum space.

Send for complete technical information.

IEE

INDUSTRIAL ELECTRONIC ENGINEERS, INC.
 7720 Lemona Avenue • Van Nuys, California
 Phone: (213) 787-0311 • TWX (213) 781-8115

Representatives in Principal Cities

Circle 76 on Inquiry Card

Something NEW!

Simplify Component Replacement

USE THESE NEW CERAMIC TERMINAL STRIPS

ALCO CATALOG

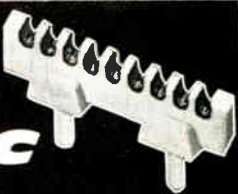

SNAP MOUNTING

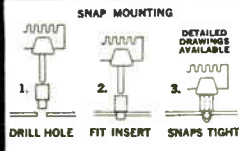

DETAILED DRAWINGS AVAILABLE

The uniform manufacturing of the miniature terminal strips gives the row after row assembly a neater appearance; adds a quality look overall. Tinned copperplate on silvered ceramic facilitates soldering of components and leads. Withstand excess heat. Available with 3-5-7-9-13-16-20 terminals.

WRITE FOR FREE CATALOG

MANUFACTURED UNDER A LICENSE GRANTED BY TEKTRONIX INC.

ALCOSTRIP

By ALCO ELECTRONIC PRODUCTS, INC. LAWRENCE, MASS.

MINIATURE

3-POSITION ON-ON-ON

TOGGLE SWITCH

FOR UNIQUE APPLICATIONS

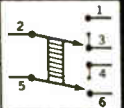
WITH HANDLE TO THE KEY WAY	CENTER	WITH HANDLE OPPOSITE SIDE OF KEY WAY	
ON	ON	ON	
1 2 4 5	2 3 4 5	2 3 5 6	

First of its kind! Ultra-miniature 1/2" size. 5 amps @ 115VAC. In stock. Write for details.

ALCOSWITCH

Lawrence, Mass. Dept. X-57

SEND FOR FREE CATALOG

Circle 82 on Inquiry Card

PRECISION

Printed Circuit Tapes ±.002" Tolerance



Brady's All-New printed circuit tapes and shapes assure uniform, accurate layouts — sharp, clean outlines. Made of Brady's new B-225 see-thru red tape. Card-mounted for fast application. Matching connector strips in rolls with .002" tolerance. Write for bulletin and FREE samples.

W. H. **BRADY** CO. • 751 W. Glendale Ave. • Milwaukee 9, Wis.
 Manufacturers of Quality Pressure-Sensitive Industrial Tape Products • Est. 1914

Circle 77 on Inquiry Card

DISCOVER

THIS FASTER, MORE ACCURATE, DISTORTION-FREE "PRESS and PEEL" METHOD for making printed circuit master drawings



BY-BUK

"TAPE-LIFT"

PRINTED CIRCUIT DRAFTING AIDS in flat 8" strips packaged in handy slip-pack boxes. Featuring our NEW Black Matte Finish, Clear Adhesive Centerless Donuts, Teardrops and Oval Pads in many new stock sizes, also Tees, Elbows, Fillets, Adapters, Register Marks, Drafting Film and Grids, Conductor line tapes in Matte or Creped finish in widths from 1/64" up.

Write for our NEW CROSS-REFERENCE DRAFTING AIDS GUIDE & PRICE LIST NO. P-41 — FREE SAMPLES.

BY-BUK COMPANY
 4326 W. Pico Blvd., Los Angeles, Calif. 90019 • (213) 937-3511

Circle 78 on Inquiry Card



Advertisers—December 1965

This index is published as a convenience.
No liability is assumed for errors or omissions.

A	
Acopian Corporation	135
The Adams & Westlake Co.	134
Aerovox Corporation	107
Alco Electronic Products, Inc.	136
Allen-Bradley	Insert Fol. p. 84
Allied Chemical	
General Chemical Division	55, 103
Alpha Metals, Inc.	72
American Electronic Laboratories, Inc.	118
American Machine & Foundry	
Potter & Brumfield Division	32
Ammon Instruments, Inc.	138
AMP Incorporated	Insert Fol. p. 32
Astrodata	106
Automatic Electric	15, 40
B	
Barnstead Still & Sterilizer Co.	127
Bausch & Lomb	10, 11
Belden Manufacturing Company	51
W. H. Brady Co.	136
Brush Instruments Division	
Clevite Corporation	Inside Back Cover
Bulova Watch Company	
Electronics Division	117
Burr-Brown Research Corp.	132
Bussman Mfg. Division	
McGraw-Edison Co.	97
By-Buk Company	136
C	
Carborundum Co., The	130
Christie Electric Corp.	138
C. P. Clare & Co.	24, 25
Clarostat Mfg. Co., Inc.	12
Collins Radio Company	30, 31, 46
CMC-Computer Measurements Company	105
Consolidated Avionics	67
Consolidated Electrodynamics	73
CTS Corporation	42, 43
D	
Dale Electronics	Inside Front Cover
Delco Radio	
Division of General Motors	98, 99
Delta Electronics, Inc.	133
Deringer Metallurgical Corp.	114
Drexel Dynamics Corp.	135
E	
Eisler Engineering Co.	138
Elco Corporation	53
The Electric Storage Battery Co.	
Wisco Division	126
The Electro Motive Mfg. Co., Inc.	19
Erie Technological Products, Inc.	69
F	
Fairchild Instrumentation	
A Div. of Fairchild Camera & Instrument Corp.	28
Franklin Electronics, Inc.	134
G	
Guardian Electric Mfg. Co.	13

H	
Howard Industries	123
Hughes Aircraft Company	
Aerospace Division	115
Instrument Division	94
I	
Ideal Industries, Inc.	91
Industrial Electronic Engineers, Inc.	136
International Exhibition	57
Interstate Electronics Corp.	108
K	
Kahle Engineering Company	125
Keithley Instruments	124
Kent Corporation	14
L	
Lepel High Frequency Laboratories, Inc.	123
M	
Mandex Manufacturing Company, Inc.	129
Master Specialties Company	93
McDonnell Electronics Division	18
Method Electronics, Inc.	89
Motorola Semiconductor Products, Inc.	20, 21
N	
National Electronics, Inc.	129
O	
Ohmite Manufacturing Company	47
P	
Perfection Mica Company	118
Philco	
Lansdale Division	132
Sierra Electronic Div.	7
Pioneer Electric & Research Corp., The	138
Potter & Brumfield	
Div. of American Machine & Foundry Co.	32
Precision Paper Tube Co.	126
R	
Radio Corporation of America	
Electronic Components and Devices	27, 78
Semiconductor Division	Back Cover
Radio Switch Corporation	117
S	
Sel-Rex Corporation	74
Semtech Corporation	128
Signalite Inc.	38, 39
Silicon Transistor Corporation	29
Simpson Electric Company	50
The Singer Company	
Diehl Division	81
Sprague Electric Company	2, 5
Stromberg-Carlson Corporation	127
T	
Tektronix, Inc.	49

U	
United Shoe Machinery Corporation	116
V	
Varflex Corporation	131
Victoreen Instrument Company, The	6
W	
Westinghouse Corporation	
Semiconductor Division	17
Weston Instruments Division	
Daystrom, Inc.	56



REGIONAL SALES MANAGERS

Philadelphia 19139—56th & Chestnut Sts.
(Area Code 215) SHERWOOD 8-2000
JOSEPH DRUCKER

New York 10017—100 East 42nd St.
(Area Code 212) OXFORD 7-3400
GERRY PELISSIER

Boston, Mass. 02110—10 High St.
(Area Code 617) LIBERTY 2-4460
ROBERT G. SMITH

Chicago 60621—540 N. Michigan Ave.
(Area Code 312) 467-9660
JOHN W. BERNHARDT
PHILIP T. CLARK

Cleveland 44114—601 Rockwell Ave.
(Area Code 216) SUPERIOR 1-2860
GREG JOHNSON

Hollywood, Fla. 33021
4831 Tyler St., Hollywood Hills
FRANK A. SMITH

Los Angeles 90057—
1543 W. Olympic Blvd.
(Area Code 213) DUNKIRK 7-1271
GEORGE F. KELLEY
BURT UNDERWOOD

San Francisco 94103—1355 Market St.
(Area Code 415) 861-7107
DON MAY

Atlanta 30309—1776 Peachtree St. N.W.
(Area Code 404) 875-1255
JOHN W. SANGSTON

Dallas 75206—Meadows Bldg.
Expressway at Milton
(Area Code 214) EMERSON 3-6426
HAROLD E. MOTT

EUROPEAN SALES OFFICES

London, S. W. (1)—67/68 Jermyn St.
St. James
MAX F. HOLSINGER

United International Industrial Press
Eitelstrasse 32
4 Dusseldorf—Rath, Germany
MAX F. HOLSINGER

FAR EAST SALES OFFICE

Tokio Marunouchi, Japan
C. P. O. Box #1572, Room 814
Tel.: 211—3506-3509
Togin Bldg.
CLARENCE T. SAKAGUCHI

rugged



CDS-5 (To-5)

reliable



CDS-7

top performance



CDS-9

POWERMASTER PHOTOCELLS

Outstanding construction and design of Pioneer Photocells assure long-life and top performance. New heavy base (.080) allows compression glass to metal seal on leads, eliminates danger of air leakage and cell deterioration.

Available in one inch, half inch and To-5 sizes over a wide sensitivity range.

Consult us on special applications of photo sensitive layers.

Photocells pictured are actual size.

The Pioneer Electric & Research Corp.

Subsidiary of **PENN** Controls, Inc.
743 Circle Avenue • Forest Park, Ill.

Circle 84 on Inquiry Card

NEW WAVEGUIDE TRIPLER REPLACES KLYSTRONS

Development of an X band to Ka bandharmonic waveguide tripler that replaces Ka klystrons in test equipment has been announced by Sylvania Electric Products, Inc.

"The high-frequency waveguide tripler provides economical Ka band power with X band reliability," according to Marvin E. Groll, Product Marketing Manager—Microwave Semiconductor Products.

The new tripler provides a simple, low cost method of converting X band power to Ka band frequencies. It is ideal for commercial communications equipment, military radar systems and test equipment bench applications, according to Mr. Groll.

TI AND GE AGREEMENT

Mark Shepherd, Jr., Executive Vice President of Texas Instruments Incorporated, and L. C. Maier, Jr., General Manager of the Semiconductor Products Dept. of General Electric, announced that TI and GE agreed on exchange of patent licenses in semiconductors, which includes integrated circuits.

CHRISTIE D-C POWER

**SCR
VOLTAGE-
CURRENT
REGULATED**

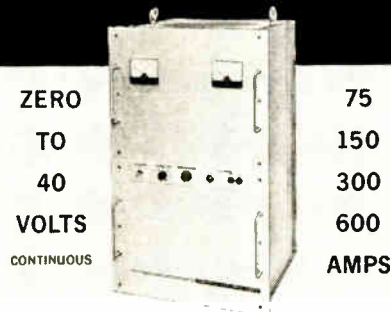

ZERO	75
TO	150
40	300
VOLTS	600
CONTINUOUS	AMPS

- 30 mv. Ripple
- 0.1% Regulation
- Fits Relay Rack
- MIL & RFI Specs

CHRISTIE ELECTRIC CORP.

Since 1929

3408 W. 67th St., Los Angeles, Calif. 90043

Circle 81 on Inquiry Card



a name to remember
in machinery
for electronics



At left:
Largest assortment
of wet and dry type
Glass Cutters.

Below:
An Eisler
precision
vertical
Spot Welder
designed
exclusively
for welding
electronic
components.
Sizes from
1/2 to 7 1/2 KVA



Write us today for full particulars!

EISLER ENGINEERING COMPANY

Dr. Charles Eisler, M.E. President
770 South 13th Street, Newark, N. J., U.S.A. 07103

Circle 79 on Inquiry Card

High torque, Self-shielded

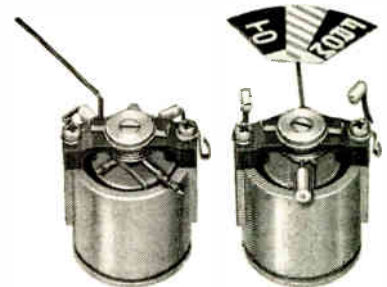

A1-2 (actual size)

moving coil mechanism

Versatile mechanisms for critical indicating and control systems have "On-off", "+, -". "Go-no go", null, left-right, or scale indicators. High torque, self-shielded core magnet design permits grouping of functions in small panel space. Moving coil weighs 100 mg less and provides at least 10% more torque than best previously available mechanism of this type. Wide choice of sensitivities; synchro or stand-ard mounting.

AMMON

AMMON INSTRUMENTS, INC.
345 Kelley Street, Manchester, N. H. 03105

Circle 80 on Inquiry Card

Another Brush Innovation in Recording:

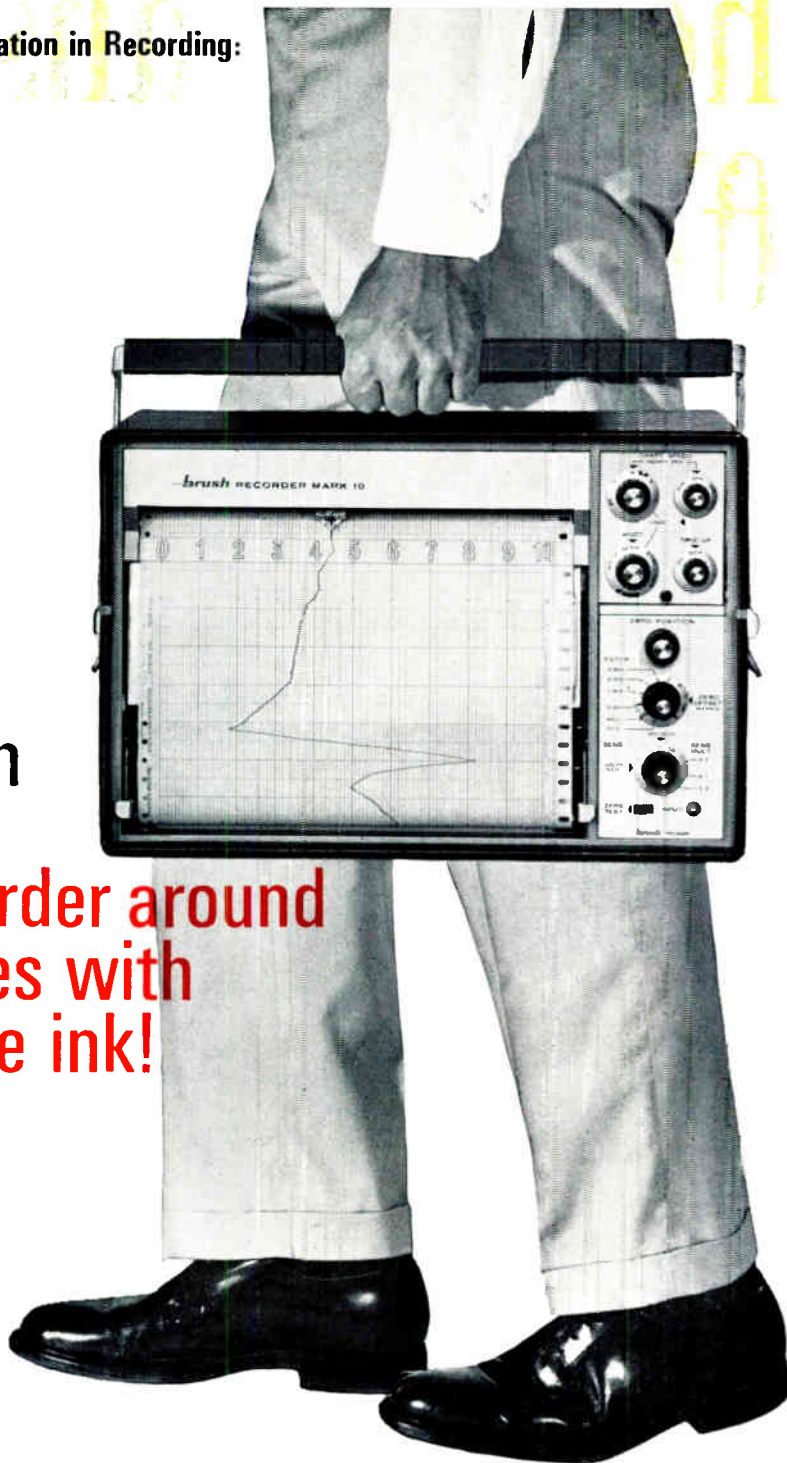

The Brush Mark 10.

Only recorder around that writes with solid state ink!

That's right.

We said "solid state ink". Comes in a little stick. Turn the Mark 10 on, the wax-base ink melts . . . flows freely, evenly from the pen regardless of temperature changes. Dries the instant it hits the paper. Won't smear, won't blot, won't clot. Won't weaken the paper if you re-trace all night. Now, turn the Mark 10 "off". Ink goes solid state again. Nothing

to spill. Nothing brittle to break. Beautiful!

And there's much more: Basic accuracy of $\pm 0.2\%$. Five step input filtering to eliminate high frequency signal noise. Input range of 5mv to 200 volts in 15 steps. Accepts common mode voltages to 500 v. Ten chart speeds. Full 10" chart width plus "zero offset" . . . lets you take any 1" of chart width and "magnify"

it ten times.

Impressed? You'll be even more impressed by a demonstration. Contact your local Brush Sales Engineer.

Ever see "solid state" ink? We'll be happy to send you a free sample. Write: Brush Instruments Division, Clevite Corporation, 37th & Perkins, Cleveland, Ohio 44114.

brush **CLEVITE** INSTRUMENTS DIVISION

Circle 99 on Inquiry Card

No other RF transistor can offer this performance

- ✓ 5 dB NF typ. at 450 Mc/s
- ✓ 11.5 dB gain min. at 200 Mc/s
- ✓ High temperature capability and low-leakage silicon construction

at this price... **\$1²⁵** 2N3932 in quantities of 1,000 and up.

RCA's new 2N3932 and 2N3933 low-noise, low-capacitance devices let you simplify VHF receiver circuitry and get more gain, less noise at the same time.



ACTUAL SIZE

RCA 2N3932 and 2N3933 low-noise silicon transistors are hermetically sealed in a 4-lead metal case. Grounding the metal case with the 4th lead:

- reduces internal capacitances, to provide higher usable gain;
- reduces spurious signal pickup and device radiation;
- permits the devices to be operated at full gain because of the internal shielding, even at high frequencies.

These top-value transistors are made possible by RCA's skills in silicon technology and mass-production economy techniques.

For full price and delivery information, phone your RCA Field Representative. Or write: RCA Commercial Engineering, Section EJ12, Harrison, N. J.

AVAILABLE THROUGH YOUR RCA DISTRIBUTOR

RCA ELECTRONIC COMPONENTS AND DEVICES



The Most Trusted Name in Electronics

SUGGESTED APPLICATIONS: Commercial, industrial and military communications equipment, such as: Mobile and aircraft radio. Expendable military equipment, Ham Gear, Citizens' Band radio. Wide-band amplifiers in industrial, military and nuclear applications.

Check the specifications and see how these RCA devices can help you build better VHF/UHF circuits:

- High Gain-Bandwidth Product (f_T): 750 Mc/s min., both types
- Low System Noise Figure†

	2N3932	2N3933	
NF @ 450 Mc/s	5.0 dB typ.	5.0 dB typ.	†As measured in noise-test circuit shown in Technical Bulletin for RCA 2N3932 and 2N3933.
NF @ 60 Mc/s	2.5 dB typ.	3.0 dB max.	
NF @ 200 Mc/s	4.5 dB max.	4.0 dB max.	
- Low Collector-to-Base Time Constant ($r_b C_c$):
2N3932—8 ps max. 2N3933—6 ps max.
- High Unneutralized Power Gain (G_{un}):
2N3932—11.5 dB min., at 200 Mc/s 2N3933—14 dB min., at 200 Mc/s
- Low Output Capacitance (C_{ob}):
2N3932—0.55 pF max. 2N3933—0.55 pF max.
- Hermetically Sealed, Isolated Collector with one lead connected to case.

Maximum Ratings, Absolute-Maximum Values

	2N3932	2N3933
V_{CBO} , COLLECTOR-TO-BASE VOLTAGE	30	40 max. volts
V_{CEO} , COLLECTOR-TO-EMITTER VOLTAGE	20	30 max. volts
V_{EBO} , EMITTER-TO-BASE VOLTAGE	2.5	2.5 max. volts
I_C , COLLECTOR CURRENT	limited by dissipation	
P_T , TRANSISTOR DISSIPATION at free-air (up to 25°C)	175	175 max. mW
TEMPERATURE RANGE: Storage and Operation (Junction)	-65 to +175°C	