

ELECTRONIC INDUSTRIES

A CHILTON PUBLICATION

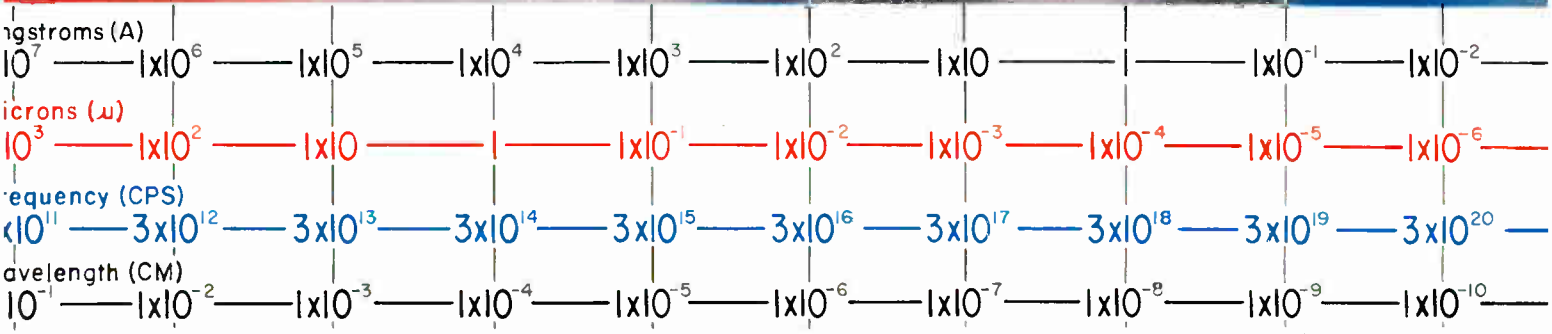
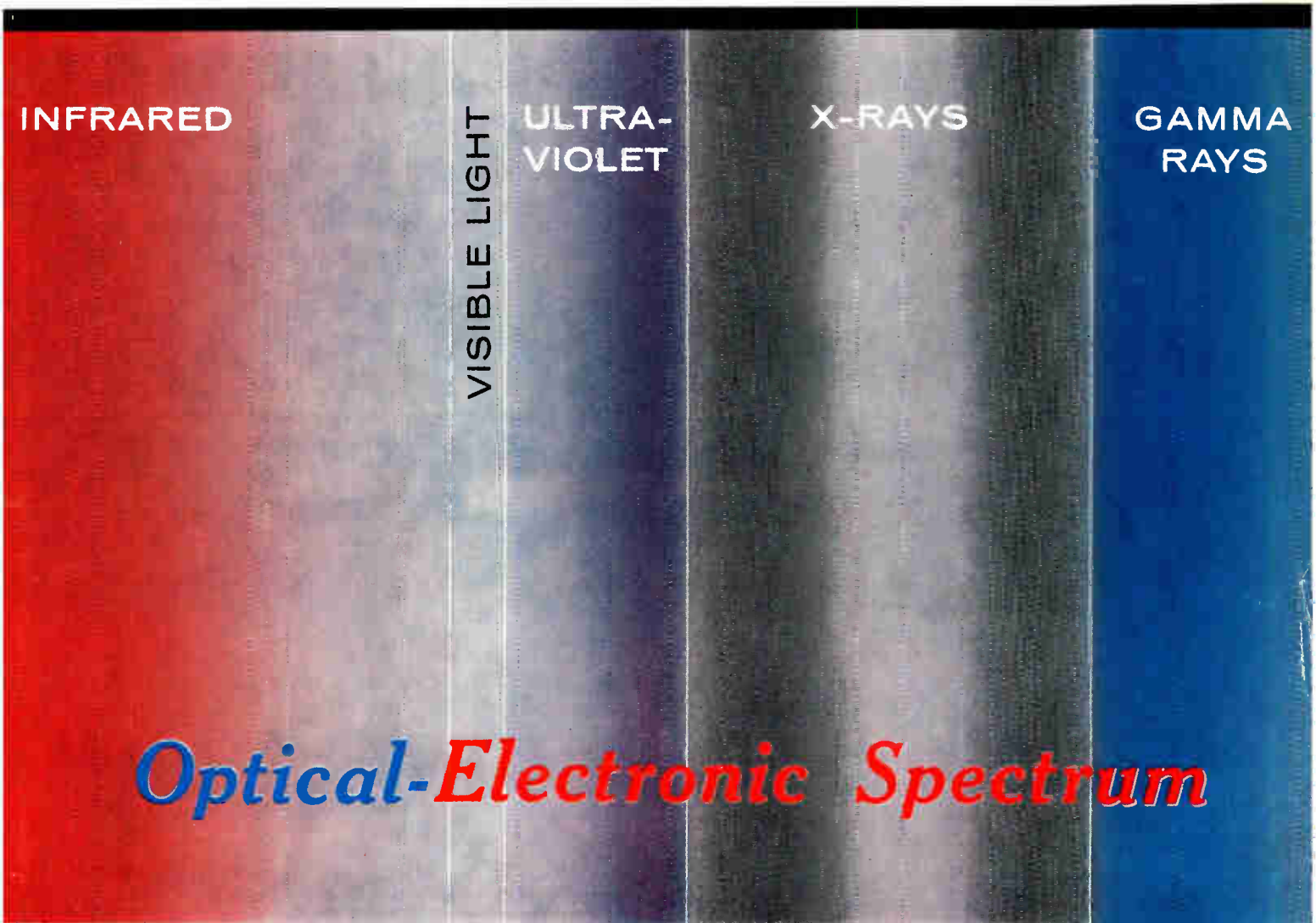

- Also in this issue . . .
- Automatic Launching of Space Vehicles
 - Calculating Tunnel Diode Gain
 - Power Transfer in Microwave Systems

(Cover Story on page 112)

April
1962

Purchasing knows **DALE**
 builds *the most*
Comprehensive Line of Resistors

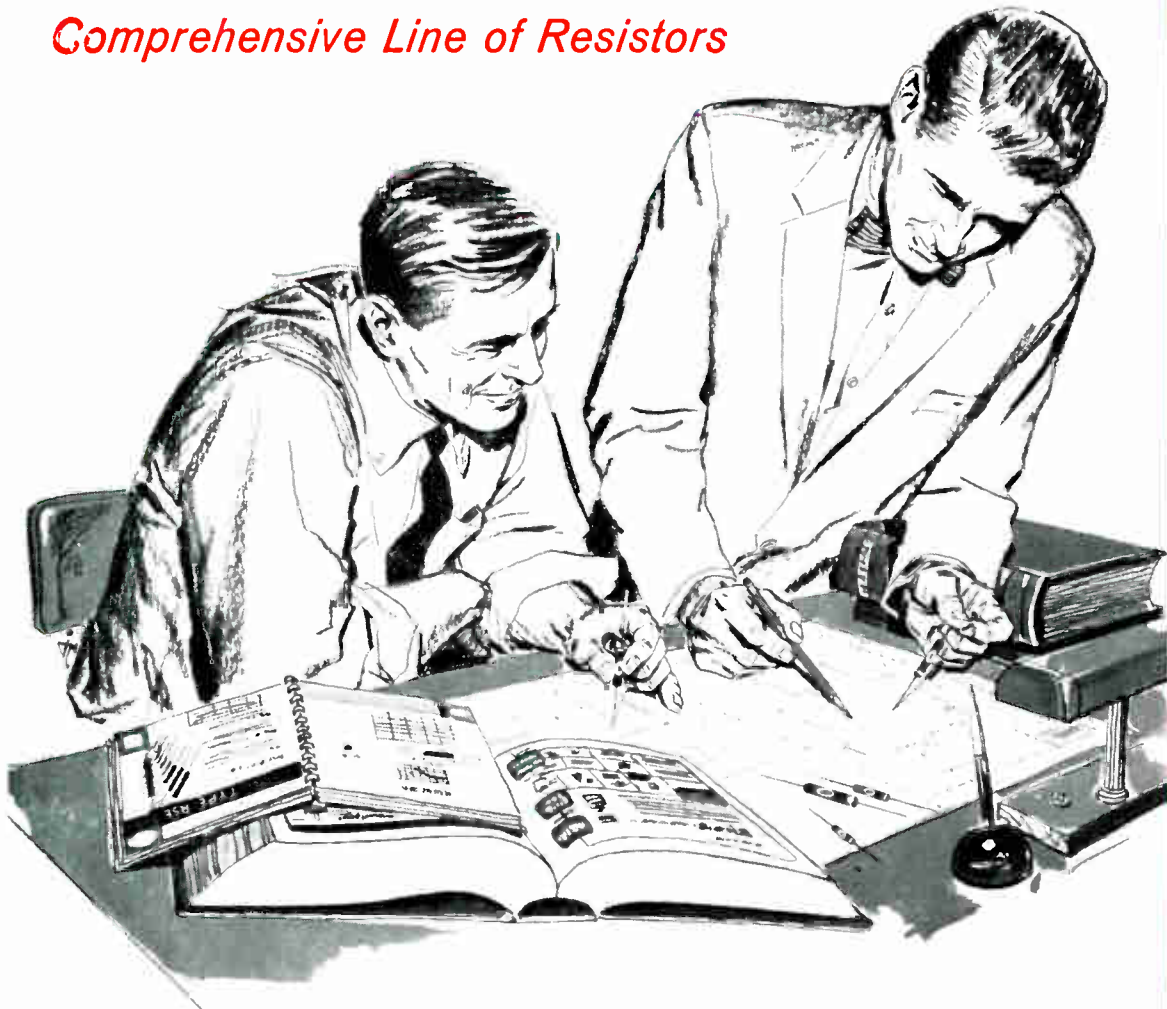

No questions asked by purchasing when engineering calls out Dale resistors. Every department has learned that you can count on Dale resistors to meet every need and for performance as specified.

Dale reliability is the result of advanced design and stringently controlled methods of manufacture—methods which have reached new levels of achievement as part of Dale's super-high reliability development program.

SPECIAL PROBLEMS? Let us help you with your requirements for special resistance products. We make modifications of standard products, resistor networks, matched pairs, etc. Send us your specs.

PROMPT DELIVERY: Whether your need is for a short "test run" or a large production release, Dale offers prompt service, direct from the factory and through a widespread network of distributors.

Write for Dale Resistor Catalog A

DALE ELECTRONICS, INC.



1304 28th Ave., Columbus, Nebraska

A subsidiary of THE LIONEL CORP.

DALE TYPE RSE RESISTORS

WIRE WOUND • FOR CLIP MOUNTING

Designed to meet the most severe environmental conditions. Precision resistance unit is suspended in special shock absorbing material and inserted in metal tube. Complete protection is afforded against moisture, salt spray, vibration and mechanical shock.

- RATED at 2, 3, 5, 7 and 10 watts
- RESISTANCE RANGE from .5 ohm to 175K ohms, depending on type
- TOLERANCE 0.05%, 0.1%, 0.25%, 0.5%, 1%, 3%
- DIELECTRIC STRENGTH 1000 VAC
- TEMPERATURE COEFFICIENT within 0.00002/degree C.
- MAXIMUM continuous operating temperature 275° C.
- SMALLEST in size; lead or clip mounted



Circle 98 on Inquiry Card

ELECTRONIC INDUSTRIES

SHELBY A. McMILLION, Publisher • BERNARD F. OSBAHR, Editor

SOUTHWARD, HO?

DURING these last few cold weeks of winter, one of the more beguiling thoughts is to pack our bags, pile the kids and the better-half into the wagon, and take off for the land of sunshine and warm breezes.

Ten years ago, when these moments came upon us, our thoughts wandered West to California. But lately, Florida seems, somehow, more appropriate.

Against this backdrop, then, it seemed particularly timely when the civic leaders of Miami (Fla.) a few weeks ago asked us to come down to visit with them. Their object was patently simple—to sell the idea that, in addition to being one of the country's finest vacation resorts, Miami is also a good place for businessmen to locate their new plants.

As recently as 10 years ago, this idea would have gotten little attention, but it bears some listening to, now.

Times have changed. The old emphasis on production capability is rapidly giving way to a new emphasis on technical know-how. If the trend continues, the majority of electronic firms will eventually come to be rated on the number of engineers they employ, and the quality of their engineering.

Why, asks the Miami-Dade County Development Commission, should not these engineers and technicians want to live in the most attractive climate? And what climate is better than Miami's? Even when we eliminate the obvious prejudice, it still makes a very provocative question.

Metropolitan Dade County, of which Miami is the center, already has 2,600 manufacturing plants, 35 of them electronic. Last year it led the nation in the number of new plants, with 275. These firms have an average of 23 employees.

The population of Miami just went over the 1,000,000 mark—and, hardly by accident, the new resident tagged as "1,000,000th Resident" is a young electronic engineer, Minas E. (Nick) Nicolaidis, who transferred from California.

Salary-wise, engineers are getting a distinct break. Where most other people moving South have to take salary cuts up to 20%, engineers command exactly the same salary as in the other parts of the country. And since the cost of living is about 10% lower, they are that much better off.

At the Univ. of Miami, the engineering school is adding many graduate courses, most of them in the already substantial evening school. Instruction through the Ph.D. level will be available within the near future.

In the suburbs, 3-bedroom homes, complete with pool and patio cost less than two-thirds the price of the same house in the North.

We found ourselves mightily impressed with the industrial progress that has been made in Miami, and even more so with the preparations that have been made to welcome new business.

Particularly outstanding is the exceptionally fine system of high speed highways, just being completed, which will whisk people from downtown Miami to the far suburbs at speeds up to 55 mph.

From the businessman's point of view, there are also advantages in lower labor rates, generally lower building costs, and the promise of lessened "absenteeism."

Part of Florida's industrial growth is assured. There are only a few locations in the U. S. where missiles can be launched—at least at the present state-of-the-art. The Cape Canaveral area seems to be most highly regarded by Washington, and indications are that it will be the site of the U. S.'s major space shots during the coming decade.

As this becomes more clear, it seems likely that the major missile manufacturers will be setting up more construction and assembly facilities in Florida. They will have to, as the size and number of space vehicles increases.

Once a substantial industrial complex has been established, pressures will probably develop within the individual firms to diversify their efforts. Proprietary items will appear, some of them for the industrial and consumer field.

But the missile industry, alone, cannot support the booming population of Florida. Diversified industry is needed, primarily light manufacturing. Of all the possible industries, Florida is looking most covetously at electronic industries.

The key to attracting the electronic industries is the appeal to engineers. At the moment, engineers fare very well, indeed.

Does this add up to an industrial boom in Florida?—The next few years will tell.

—C. M. M.

SHELBY A. McMILLION, Publisher
 BERNARD F. OSBAHR, Editor

CREIGHTON M. MARCOTT
 Executive Editor
 RICHARD G. STRANIX
 Features Editor
 SMEDLEY B. RUTH
 LOUIS S. GOMOLAK
 Assistant Editors
 DR. ALBERT F. MURRAY
 Contributing Editor
 ROLAND C. DAVIES
 Washington News

JOHN E. HICKEY, Jr.
 Managing Editor

ELMER KETTERER
 Art Director
 IDA M. GOOD
 Editorial Secretary
 ANNE N. AXE
 Editorial Asst.
 MAE E. MOYER
 Readers' Service

EDITORIAL CORRESPONDENTS

Washington—1093 National Press Bldg.
 GEORGE BAKER
 NEIL R. REGEIMBAL
 DAVID R. HEINLY

BUSINESS DEPARTMENT

ELMER DALTON
 Advertising Promotion
 & Circulation Manager
 DONALD J. MORAN
 Marketing Manager
 GORDON HERNDON
 Production Manager

REGIONAL SALES MANAGERS

Philadelphia (39)—56th & Chestnut Sts.
 (Area Code 215) SHerwood 8-2000

JOSEPH DRUCKER
 HERMANN W. BOZARTH
 (Classified Advertising)

New York (17)—100 East 42nd St.
 (Area Code 212) OXford 7-3400

GERRY PELISSIER

New England—62 LaSalle Rd., W.
 Hartford, Conn.
 (Area Code 203) ADams 6-4237

AL KAISER

10 High St., Boston 10, Mass.
 (Area Code 617) Liberty 2-4460

JOHN PICKERING, Jr.

Chicago (1)—360 N. Michigan Ave.
 (Area Code 312) RAndolph 6-2166

GEORGE H. FELT

Cleveland (15)—930 Keith Bldg.
 (Area Code 216) SUperior 1-2860

ROBERT COBURN

Los Angeles (57)—198 S. Alvarado St.
 (Area Code 213) DUncirk 7-4337

MENARD DOSWELL III

BURT UNDERWOOD

San Francisco (3)—1355 Market St.
 (Area Code 415) UNderhill 1-7107

DON MAY

Atlanta (9)—1776 Peachtree St., N.W.
 (Area Code 404) 875-1255

JOHN W. SANGSTON

Dallas (6)—Meadows Bldg., Express-
 way at Milton
 (Area Code 214) EMerson 3-6426

HAROLD E. MOTT

EUROPEAN SALES OFFICES

London, S.W. (1)—67/68 Jermyn St.
 St. James'

MAX F. HOLSINGER

Dusseldorf—Hüttenstrasse 17
 Am Ernst-Reuter-Platz

MAX F. HOLSINGER

JOHN H. KOFRON
 Chilton Research Director

G. C. BUZBY, President

Executive Vice Presidents: R. E. Mc-
 Kenna, G. T. Hook. Vice Presidents:
 P. M. Fahrendorf, L. V. Rowlands, M.
 E. Cox, E. B. Terhune, Jr., R. W. Case,
 Jr., J. H. Kofron. Treasurer: Stanley
 Aoooley. Secretary: J. A. Montgomery.
 Other Directors: W. H. Vallar, F. P.
 Tighe, C. A. S. Heinle, G. E.
 Cameron, T. C. Campbell. Assistant
 Secretary: I. C. Holloway.

Cable Address—"CHILTON PHILADELPHIA"

ELECTRONIC INDUSTRIES

Vol. 21, No. 4

April, 1962

FRONT COVER: Interest in the Optical-Electronic Spectrum has risen with the use of infra-red detection and the advent of the maser and laser, plus many other new uses for this region. There seems to be no strict agreement on the limits of the bands in this region. What we have depicted here are general band limits arrived at through a consensus of the industry experts we talked to. See page 112 for more details.

MONTHLY NEWS ROUND-UP

Radarscope: What's ahead for the Electronic Industries	4
As We Go To Press	7
Electronic Shorts	9
Coming Events	11
TOTALS: Late Marketing Statistics	23
Electronic Industries News Briefs	25
Snapshots . . . of the Electronic Industries	28
International News	34
Next Month in Electronic Industries	89
Washington News Letter	191

Editorial: Southward Ho?	1
Automation for Future Space System Launchings L. S. Klivans	90
Engineer's Notebook #62 Nomograph for Parallel Resistors, Series Capacitors and Parallel Inductors Dr. L. B. Hedge	94
Tunnel Diode Amplifier Gain S. Derman	95
Field Intensity Meter Characteristics M. Engelson	97
Analyzing Power Transfer in Microwave Systems . . Dr. E. Jacobs	101
What's New	106
Design and Packaging for Nuclear Exposure Dr. G. L. Keister	108
The Optical-Electronic Spectrum	112
Adjusting Micro-Element Resistors Dr. R. C. Langford	114
Microwave Tube Interchangeability Chart, Part 2	118
Electronic Operations	187
Designing a Low-Cost Power Supply for Electroluminescent Lamps T. M. Corry	188
International Electronic Sources	194
Professional Opportunities	203
Indexes: Tools of the Engineer R. J. Tritschler	205

NEW PRODUCTS & TECH DATA

New Products	122
New Tech Data for Engineers	126

DEPARTMENTS

Tele-Tips	38	Systems-Wise	187
Letters	52	Cues for Broadcasters	192
Personals	64	Systems & Circuits	201
Books	71	Industry News	213
		News of Mfrs. Representatives	218



ELECTRONIC INDUSTRIES, April, 1962, Vol. 21, No. 4. A monthly publication of Chilton Company. Executive, Editorial & Advertising offices at Chestnut & 56th Sts., Phila. 39, Pa. Controlled circulation postage paid at Philadelphia, Pa. \$1 a copy; Directory issue (June), \$5.00 a copy. Subscription rates U. S. and U. S. Possessions: 1 yr. \$10.00; 2 yrs. \$18.00. Canada 1 year, \$12.00; 2 yrs. \$20.00. All other countries 1 yr. \$18.00; 2 yrs. \$30.00. Copyright 1962 by Chilton Company. Title Reg. U. S. Pat. Off. Reproduction or reprinting prohibited except by written authorization.

Highlights

of this issue

Automation for Future Space System Launchings page 90

A fresh approach is needed to accomplish checkout and launching activities for the projected space systems of the 1965-1975 era. Some of the requirements and possible solutions are discussed here.

How to Derive . . . Tunnel Diode Amplifier Gain page 95

It is common knowledge that a tunnel diode exhibits a negative resistance over part of its volt-ampere characteristic curve. Because of this strange trait, it can be used for signal amplification. Here's how—mathematically!

Field Intensity Meter Characteristics page 97

A wide variety of RFI meters are available for RFI investigations. But they differ widely in their performance characteristics. To select the proper meter, the purchaser must be able to evaluate the equipment for his needs. This article points the way.

Analyzing Power Transfer in Microwave Systems page 101

In any microwave system, distributed parameter transmission line is normally used. It has become usual to specify power transfer between components in terms of the lowest feasible VSWR. But, while this is a convenient measurement, it does not tell the whole story. Here are the results of a comprehensive study which deals with other aspects of maximum power transfer.

Design and Packaging for Nuclear Exposure page 108

Nuclear blast effects on electronic equipment outside of the heat and blast zones can be overcome. Methods such as shielding, component replacement, circuit design, and advanced circuit concepts can be used to make the equipment radiation resistant. The problem can be attacked in the same manner as for thermal or vibrational environments.

Adjusting Micro-Element Resistors page 114

Spiralling cylindrical, deposited resistors to range has long been practiced. But the flat Micro-Module resistors demanded a new system; and so, a wide search for new cutting methods ensued. This article presents the results of that search—and comments on each new method.

Designing a Low Cost Power Supply page 188

This unusual design produces significant economies. Not only are the base bias capacitors and separate feedback transformer eliminated, but, in one version, even the expensive output transformer. The circuit can energize large ceilings as well as small demonstration lamps.

Indexes: Tools of the Engineer page 205

Indexes belong in the same category as slide rules, voltmeters, and strain gages as engineering aids. As with any of these, efficiency increases with practice; but their purpose and potential must be understood.

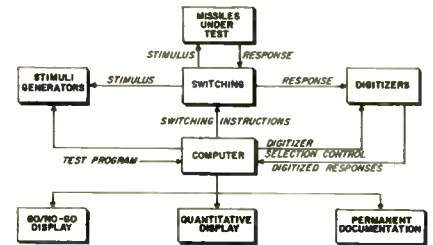

Automation for Space Launchings

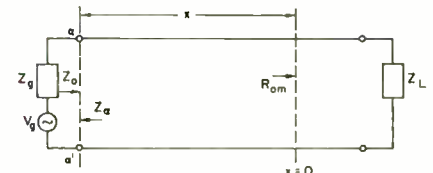

Microwave Power Transfer

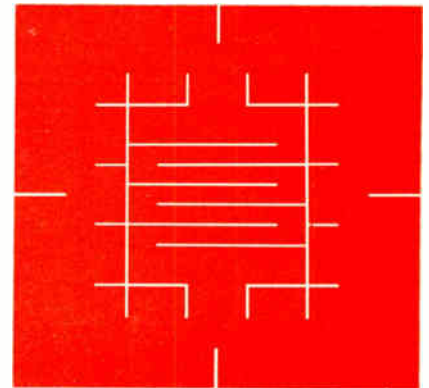

Micro-Element Resistors

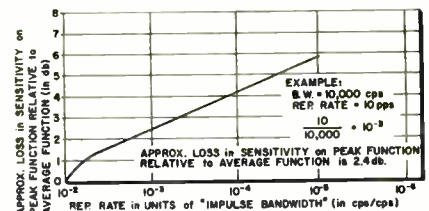

Field Intensity Meter

Nuclear Exposure

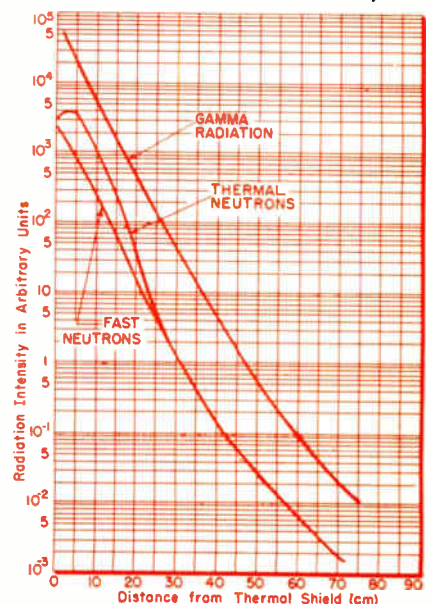

RADARSCOPE

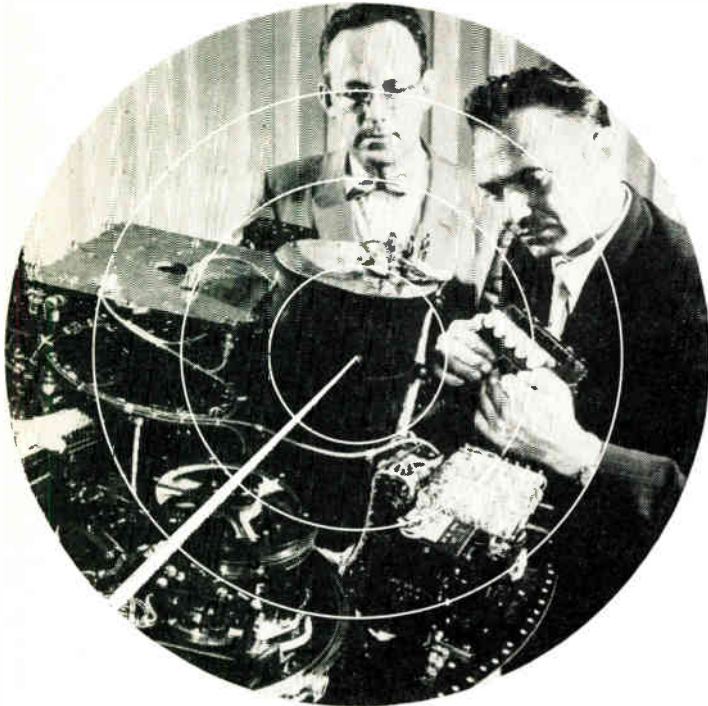

I-R CHECKOUT

Dr. Rudolf Stampfl, NASA scientist in charge of IR system development for the TIROS weather satellite program, checks replacement of the equipment in the TIROS II payload. Looking on is A. Schnapf, Asst. Proj. Mgr. for RCA's Astro-Electronics Div., prime contractor. Infra-red system was developed for NASA by Barnes Engineering Co.

NASA EXPENDITURES in the eastern portion of the United States have risen from 5.7% of their total in 1959 to 17.7% in 1962. In dollars, reflecting the overall increase in NASA's spending, the expenditures have gone up from \$8.3 million to \$229.8 million. For the fiscal year of 1963 it is expected that NASA's expenditures in the east will rise above \$450 million, to approximately 19.1% of the total NASA budget.

IF FREQUENCY SPACE can be found, the Office of Navy Research would like to see hundreds of remote buoys scattered across the earth's oceans and equipped with transponder systems. Equipped with suitable recording and memory systems, the buoy could transmit weather information and could be interrogated at any time in a given 24-hour period.

NEW SMALL BUSINESS production, research and development team has been organized in Chicago to handle government contracts. The pool, Manufacturers Assoc. for National Defense (MANDCO) has a total of 244 employees and is expected to bid on contracts dealing with manufacturers and R&D of parts for airplanes, rockets, missiles, ships, tanks and weapons.

SPACE TECHNOLOGY COURSE will be established at Texas A & M College to be used by the National Aeronautics & Space Administration in training engineer recruits. The course will emphasize space satellites, their components and subsystems. The course will include instruction on satellite design, packaging, component fabrication, system integration and engineering coordination and test. Working with Texas A & M on the project will be the Aero Geo Astro Corp. of Alexandria, Va.

NEW HIGH TEMPERATURE CAPACITOR that is capable of operating at nuclear power aircraft temperatures up to 500°C, is described in a research report on the development of special processes for spraying dielectric material and capacitor construction. The processes involve spraying by use of an oxyacetylene flame and by means of plasma jet. The full report can be obtained from OTS, U. S. Dept. of Commerce, Washington 25, D. C.—Order No. AD 261960, for price \$1.50.

THE MOTOR AND GENERATOR INDUSTRY is about to be saddled with a new minimum wage requirement under the Walsh-Healey Contract Acts. The rates, which will apply to all employees working on Government supply contract in excess of \$10,000, would be set at \$1.48 for employees engaged in the manufacture of fractional horse-power motors and generators, and \$1.73 an hour for employees engaged in the manufacture of all other products within the scope of the motors and generators industry.

CIRCUITRY CHECK

IBM engineer tests the solid-state memory circuitry of the 7750 programmed transmission control. Unit links a large network of communications lines and terminals to a single computer. Engineer is looking at panel that is built into unit to permit checking of memory circuits, input-output channels and communications lines.

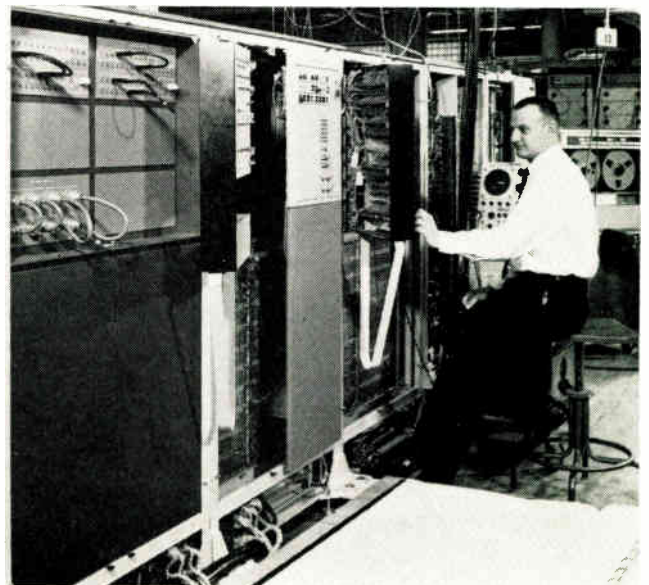

Analyzing current developments and trends throughout the electronic industries that will shape tomorrow's research, manufacturing and operation

EMPLOYMENT IS SHIFTING from manned aircraft to missile production. To quote the U. S. Dept. of Labor, "Missile employment expanded 9.2% during the year ending August 1961 to reach a total of 565,400." The West has strengthened its position as the dominant regional missile center, accounting for 51.5% of the national job total. Despite the increase in the missile end, the aircraft industry as a whole experienced a slight decline in employment between August 1960 and August 1961.

A LONG LIFE SILVER CADMIUM BATTERY for aerospace vehicles is being investigated by the Air Force. The silver cadmium program is being pushed because the silver system "can potentially yield about twice the watt hours per pound of the nickel cadmium system." The silver system can also be made non-magnetic if necessary, which may be important for scientific satellites containing instruments for the measurement of magnetic fields.

FIRST SYSTEMATIC STUDY of operating ruby lasers with a high speed framing camera have been made by physicists at the U. S. Naval Ordnance Laboratory, White Oak, Maryland. The study has revealed the character of the optical processes which actually occur within ruby crystals when they emit a narrow beam of coherent visible light as a result of being flashed with a short duration light of high intensity.

THE EIA has challenged supporters of all-channel TV to show that the slow growth of the UHF telecasting has been due to lack of cooperation from the TV receiver manufacturers. The EIA is opposing Bill S.2109 which would require the manufacture of only all-channel receivers. The mandatory legislation, they say, would not accomplish its objective and would penalize both consumers and manufacturers by limiting production to all channel receivers. Many TV set owners would be required to buy UHF tuning facilities which they might never need, and the price of all TV sets would be boosted an average of 14% or \$30.00.

PRINTED CIRCUIT BUSINESS reached approximately \$80 million in 1961, according to the Institute of Printed Circuits. About 11% of the industry volume is used in application for consumer products. Approximately 29% went into industrial products, and 60% of the dollar value went into military applications. Independent producers of printed circuit boards are operating, on an average, at 65% of capacity. The present facilities of private manufacturers could produce an estimated \$70 million in printed circuit boards. This problem has kept competition at a high level with profits under 5% before taxing.

BLUE PRINT for an orderly transition of TV broadcasting from the VHF to the UHF band has been drawn up by Rep. Emanuel Celler (D., N. Y.), Chairman of the House Committee on the Judiciary and of its Anti-Trust Subcommittee. Mr. Celler's recommendations are that the FCC immediately cease from granting any further VHF channel assignments. The Commission then would promptly assign a UHF frequency channel to each present VHF TV station, and these licensees would immediately be authorized to broadcast simultaneously over both bands. Finally, at the expiration of six years all VHF broadcasting would cease.

NBS SCIENTISTS have made the first successful studies of single crystal potassium (whiskers) by field emission microscopy, providing a new view of crystal growth processes. In their study, the NBS scientists used vapor grown single crystal potassium whiskers, which are extremely strong because they lack the imperfections found in large crystals and polycrystalline masses of the metal. The whiskers are less than 2 millionths of an inch in diameter and 8 ten thousandths of an inch in length. In field emission microscopy, a strong electrostatic field is applied to the crystals. Under the influence of the electrostatic field, electrons are drawn from the tips of the crystals and sprayed on a fluorescent screen forming an image of these tips. Interestingly, it's been found that light has a significant effect on crystal growth.

TACTICS FLIGHT SIMULATOR

Control console of the Goodyear Aircraft Corp. tactics flight simulator is given final check in Akron, O., prior to delivery to the Naval Air Station at Miramar, Calif., for training fighter pilots assigned to the Navy F8U-2N all-weather interceptor airplane.

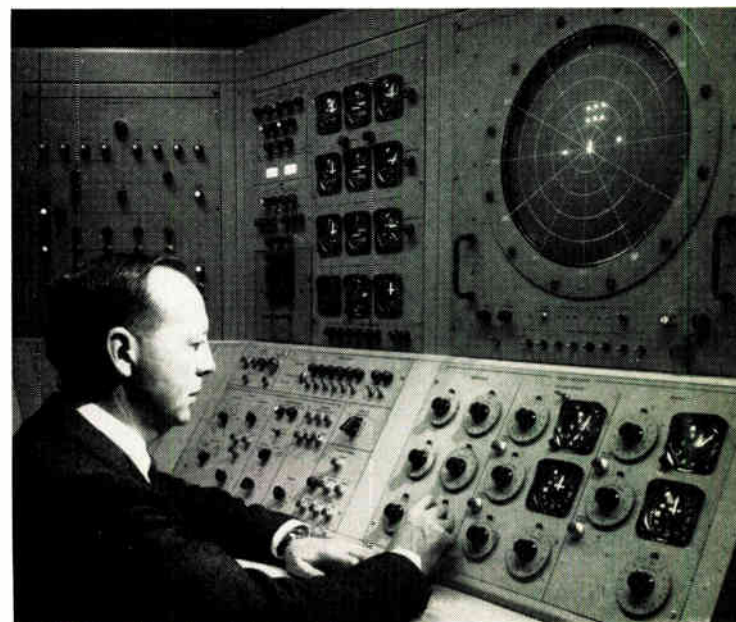

New from Sprague!

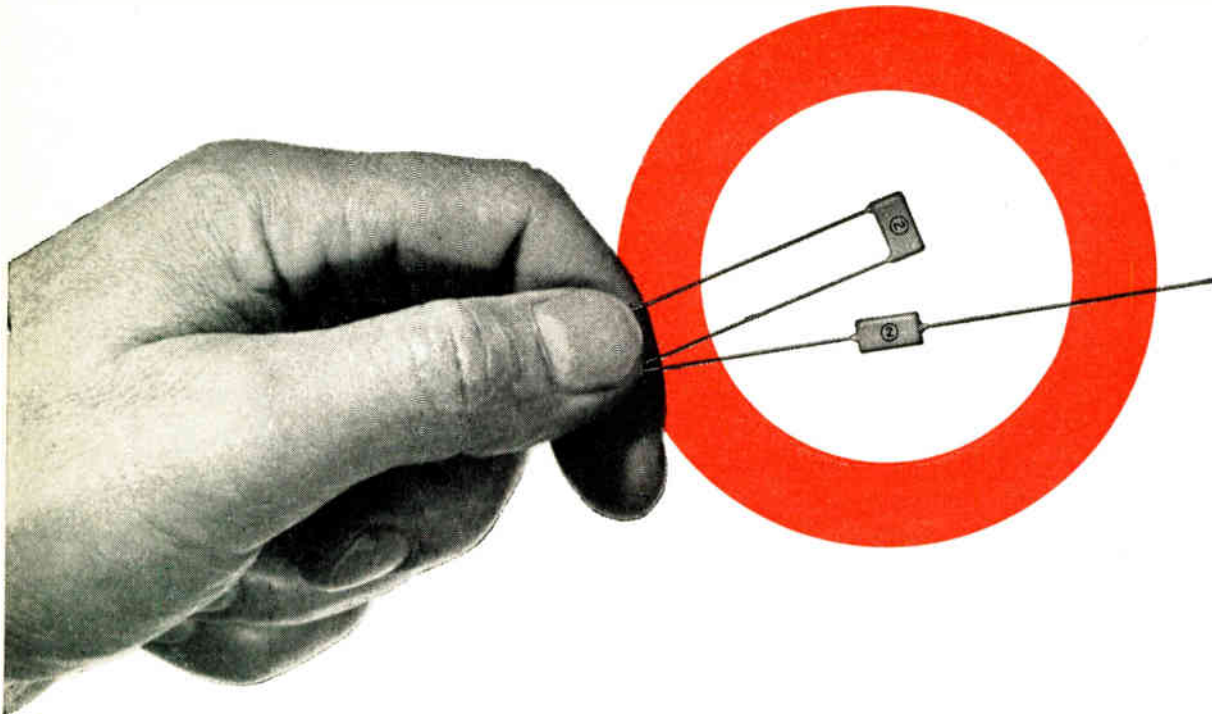

N030 MONOLYTHIC[®] Ceramic Capacitors **offer unparalleled size and circuit stability**

Here is a new kind of capacitor . . . with a combination of stability, weight, and size advantages never before achieved in a "compact" capacitor!

Layer-built by a unique automated process, MONOLYTHIC Ceramic Capacitors exhibit extremely low capacitance change with temperature (about one-fourth that of comparable capacitors using other dielectrics). Their special construction also permits a new order of compactness—MONOLYTHICS pack more capacitance per unit volume, resulting in substantial reductions in size and weight.

In addition to single-section capacitors, MONOLYTHICS can also be obtained as multiple-section units, allowing circuit designers to replace several conventional capacitors with a single compact device. The availability of these tiny yet highly stable units with either axial or radial leads offers further flexibility to the circuit design engineer.

Cumulative test data prove the low failure rate of these epoxy or phenolic coated capacitors in service—established by thousands of life, moisture resistance, shock, and vibration tests.

For application engineering assistance without obligation, write to Commercial Engineering Section. For complete technical data, write for Engineering Bulletins to Technical Literature Section. Sprague Electric Company, 233 Marshall Street, North Adams, Mass.

SPRAGUE COMPONENTS

CAPACITORS
RESISTORS
MAGNETIC COMPONENTS
TRANSISTORS

INTERFERENCE FILTERS
PULSE TRANSFORMERS
PIEZOELECTRIC CERAMICS
PULSE-FORMING NETWORKS

HIGH TEMPERATURE MAGNET WIRE
CERAMIC-BASE PRINTED NETWORKS
PACKAGED COMPONENT ASSEMBLIES
FUNCTIONAL DIGITAL CIRCUITS

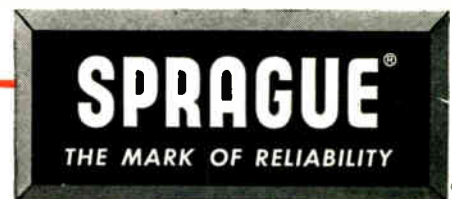

*Sprague' and 'Q' are registered trademarks of the Sprague Electric Co.

As We Go To Press...

Martin Unveils "Suitcase" Laser

A new optical radar set which employs a ruby laser has been unveiled by Martin Marietta's Orlando (Fla.) Aerospace Div. The prototype consists of a complete transmitting and receiving system packaged in a suitcase occupying only 1.6 cu. ft.

The "suitcase" laser, which transmits and receives a concentrated beam of light, much like a radar, is believed to have considerable value in military applications. It can be used to zero in on targets such as tanks and artillery.

Commercial uses include surveying, where distances can be accurately measured without triangulation. Operator simply aims the laser beam on a target and reads the range to the target from an indicator.

Program to Improve Emergency Communication

First nationwide program designed exclusively to provide more efficient two-way radio communications under local emergency conditions has been launched in Chicago.

Called REACT (Radio Emergency Associated Citizens Teams), the movement is a federation of volunteer Citizens Band radio operators. This group has grown from 28,000 to 250,000 in the past four years. REACT is sponsored by the Hallcrafters Co.

A primary objective of the organization will be to provide a round-the-clock radio communications system supplementing police, fire, ambulance, hospital and Civil Defense efforts.

MIDARM Equipment Bought by Air Force

A contract for a 360° Razdow Micro-Dynamic Angle and Rate Monitoring System (MIDARM), plus associated equipment to measure the accuracy of precise guidance system equipment, has been awarded to Razdow Labs, Inc., Newark, N. J., by Dayton AF Depot, Dayton, Ohio. System will be used for acceptance testing of rate tables and inertial quality gyros. MIDARM is a wide-angle, electro-optical, automatic, high resolution, auto-collimating device that measures angular motions precisely.

RADAR "GUN"

Sp. 5 H. W. Korteling operates Army's new experimental hand-held radar at U. S. Army Signal R&D Lab, Fort Monmouth, N. J. The 10 lb set can detect enemy movements more than a mile away. It produces an audible signal when an object passes through its beam. It ignores stationary terrain, and picks out only moving objects.



Output to Hit Record \$7.2 Billion in 1962

Record highs will be achieved again in 1962 by the electronics industry in output and employment, the Business & Defense Services Administration, U. S. Department of Commerce, said in an outlook report for the industry.

"Because of increasing defense procurement, accelerating space exploration programs, and greater industrial demand, total output of systems and equipment is expected to exceed \$7.2 billion in 1962, about 7% more than in 1961," BDSA stated. "Total output of components

should exceed \$3.7 billion. These projections do not include the value of electronics research, development, evaluation, and test expenditures or distribution, service, installation, and operating revenues."

The latter activities are expected to continue to increase rapidly and may exceed \$2.8 billion this year.

Electronics output in 1961 generally followed expectations, the report pointed out. The factory value of electronics production reached an all-time high of \$6.7 billion—about 5% above the 1960 level.

EAL COMPUTER CENTER



V. Baudier of Remington Rand UNIVAC mounts a reel of magnetic tape on Uniservo tape units of the UNIVAC 490 Real-Time System installed at the new Eastern Air Lines' Electronic Computer Center in Charlotte, N. C. Looking on is D. Pusey, manager of the center. The system will handle all seat reservations for the airline. Computers handle 30,000 transactions per hour.

Thermoelectric Air Conditioner Tested

A new air conditioner employing thermoelectric principles rather than conventional refrigerant gases is being tested by U. S. Army Engineers at Fort Belvoir, Va.

Designed for use in missile control vans, the thermoelectric air conditioner requires no compressor, evaporator, or condenser. In eliminating refrigerant gases, it also eliminates leakage problems associated with them.

The prototype air conditioner features a "heart" of matched pairs of bismuth telluride plugs. Direct current is passed through them to generate heat and cold which is dispensed by the circulation of air through fins attached to each element. Eight fans circulate air across the hot and cold sides of the conditioner within a panel less than four inches thick.



spin 'em, soak 'em

We dug into the bin for some Hoffman 1N935 series temperature compensated zener reference diodes and gave them a rough, 10-minute ride on the prop of a big, 75-horse outboard. They survived to perform to specs.

No wonder. We build these zeners to meet the requirements of MIL-S-19500B. They've been tested to 20,000-g angular acceleration (twice the MIL) and meet all environmental requirements of the MIL spec. Delivering voltage/temperature coefficients of $\pm .01$ to $.0005$, they evolve from the same technology that produced our workhorse 1N821 series. They're rugged and reliable, like all Hoffman semiconductors.

We specialize in devices for control, regulation and power. You can buy them with confidence that they'll work and keep on working. Confidence that they'll be available when and where needed. That's why so many of the most successful electronics designers keep coming back to Hoffman—again and again and again. Chances are you'll do the same. Try us. Call your nearest Hoffman distributor or sales office today.

Hoffman / **ELECTRONICS CORPORATION**
Semiconductor Division

1001 N. Arden Dr., El Monte, Calif. • CUMberland 3-7191 • TWX: El Monte 9735

Circle 3 on Inquiry Card

IBM to Equip DOD Communications Centers

Four advanced information handling systems will help the Dept. of Defense keep vital military messages moving through its global Defense Communications.

The systems will be installed at Defense Dept. Area Communications Control Centers in Europe, Alaska, Hawaii and Colorado.

An IBM 1410 Data Processing System at each center will receive status reports from DCS operating stations in its geographical area. From these reports, the 1410 will plot the area status on electronic wall displays in each center and at the Defense National Communications Control Center near Washington, D. C.

Systems supervisors at each center thus will have access to a detailed picture or printout of the area's status, allowing them to make quick decisions to keep the network operating at its maximum capability.

NERVA Engine Contract Awarded

A follow-on five-year contract for the development of the NERVA (Nuclear Engine for Rocket Vehicle Application) engine has been awarded to the Aerojet-General Corp. by NASA and the AEC. Westinghouse Electric Corp. will continue to be responsible for the nuclear portions of the work under a subcontract with Aerojet-General.

The new contract will run through Sept. 1966. Work to be performed under this contract between now and Sept. 30, 1962, is expected to cost approximately \$26.6 million.

OPTICAL RADAR



"Laser" is discharged at a rate of 10 bursts a sec. by J. P. Chernoch of G.E.'s engineering lab. It is believed the first time that a Laser beam has been pulsed rapidly and at high power. It's for an optical radar system.

Electronic SHORTS

▶ First production contract to manufacture radar chronograph sets to measure the velocity of projectiles has been received by Admiral Corp., Chicago. New equipment will measure the velocity of field artillery and anti-aircraft shells at a pre-selected delay interval up to 1/2 sec. after firing the weapon. It will display the speed in fps on a direct read-out counter. Chronograph operates at a X-band frequency of 10,500 MC. It will be used to determine speed of missiles ranging from 40 mm to 280 mm in diameter.

▶ An order of more than \$4,000,000 for advanced search radar systems and data processing units has been received by United Aircraft Corp.'s Norden division, Norwalk, Conn. Equipment is to be used on the A2F-1 Intruder, the Navy's all-weather attack aircraft. Intruder is a carrier-based, low level, subsonic attack bomber which can accurately deliver nuclear or conventional weapons on targets completely obscured by weather or darkness.

▶ Martin Marietta Corp. will conduct a feasibility study on the new anti-tank guided missile system for the U. S. Army. Development work on the missile, designated TOW, will be performed by the Orlando, Fla. division. Similar contracts were also awarded to the Hughes Aircraft Co. and McDonnell Aircraft Co. Preliminary designs for the missile will be completed by the three companies.

▶ U. S. Army's Nike Zeus anti-missile recently intercepted a simulated target traveling at the speed of an ICBM. The test was the fifth consecutive success scored by Nike Zeus missiles fired from Pt. Mugu, Calif., one of the two major test sites on the Pacific Missile Range. Simulated target was programmed into the Zeus system's Target Intercept Computer, designed and developed by Univac, St. Paul, Minn.

▶ One of the first in a series of new free fall Navy weapons will be developed by Ryan Aeronautical Co., San Diego, Calif. Designated ROCK-EYE, the weapon would be air-launched from carrier-based attack planes to provide close support for troops. First of the prototypes has been delivered to the Naval Ordnance Test Station (NOTS), China Lake, Calif. for testing.

▶ NASA has awarded Dynatronics, Inc., Orlando, Fla., a contract for an advanced data handling system for the Marshall Space Flight Center. The system—a pulse code telemetry playback station—will be used in testing the Saturn space booster. It will collect and convert digital telemetry data from Saturn flight tests and display this data in various forms to aid in the evaluation of test performance.

▶ A high reliability, two-channel satellite tape recorder/reproducer for the Discoverer program will be designed, developed and manufactured by Leach Corp., Azusa, Calif. Work will be done under a contract from the Lockheed Missile and Space Co. The recorder will be capable of registering pertinent space data for three hours at a time during Discoverer orbits and playing it back to earth interrogation stations in approximately 6 min.

▶ Receipt of an approximately \$28 million contract for continued development of an advanced radar design for possible incorporation into the U. S. Army's NIKE-Zeus anti-missile system has been announced by General Telephone & Electronics Corp. Radar-called ZMAR (ZEUS multi-function array radar)—will be designed to search nearly simultaneously large areas of space in order to detect, track, and identify enemy missile warheads.

▶ A voice interruption priority system called VIPS—a 20 channel, electronically controlled, tape message unit using a woman's voice—is being produced by the Nortronics Div. of Northrop Corp. for SAC's B-58 Hustler Bomber. A woman's voice is used in recording the messages to differentiate promptly between warnings and the voices of crew members. VIPS was designed to solve the acute aviation problem of quickly warning pilots in supersonic aircraft of impending hazards.

YOU DID IT *again!*

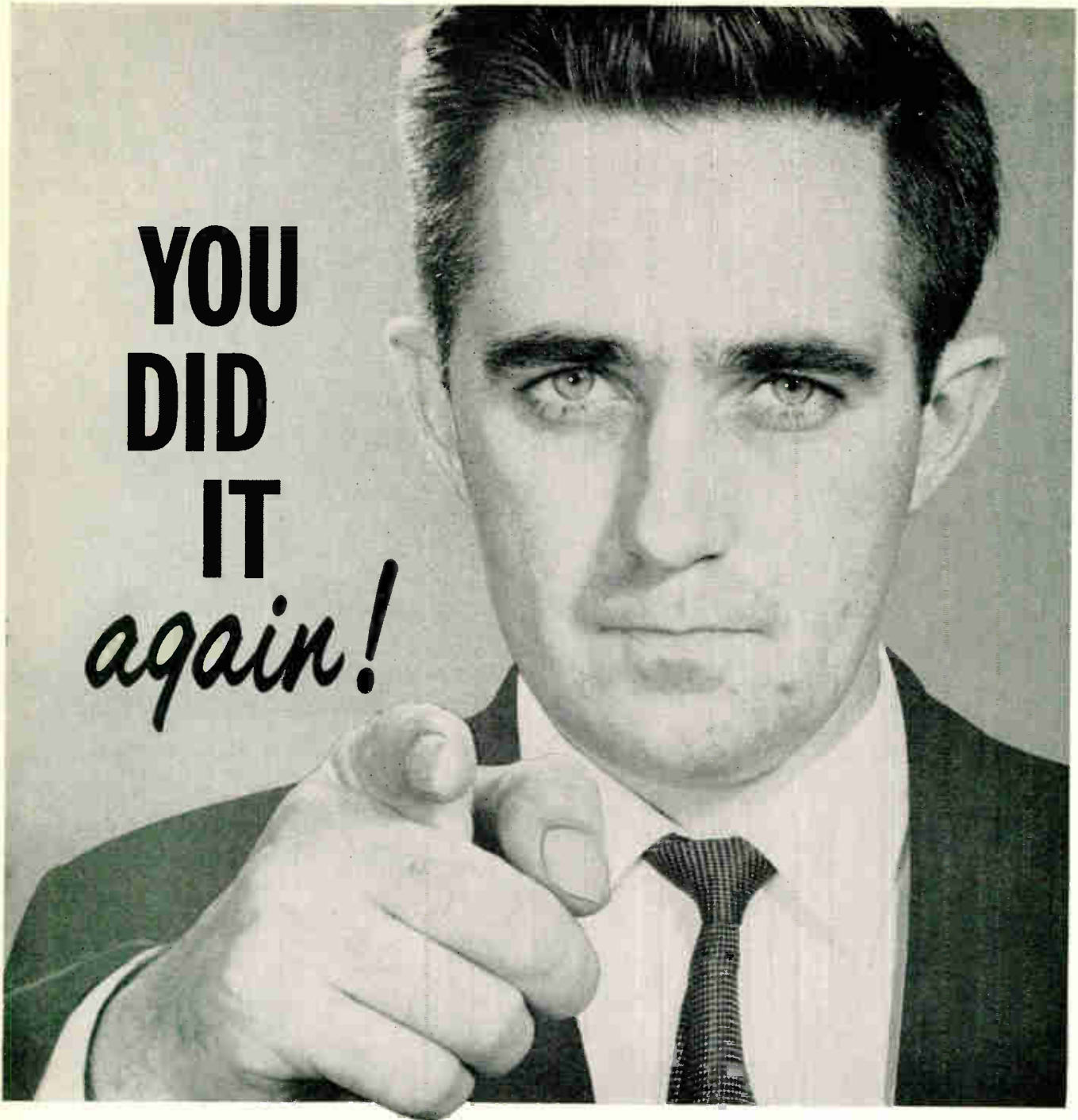

In answer to your requests, we now offer our latest development—high quality, low-cost, 10-Mc digital circuits on epoxy cards. These are the first elements of our new G-Series family of extended-service digital modules. Additional frequencies are being made available to make the G-Series our most extensive and complete family of digital circuit modules ■ These are entirely new circuits, designed for either synchronous or nonsynchronous applications.

- They feature:
- Compatible standardized logic levels.
 - Consistently conservative specifications.
 - Repairable etched circuit card construction.
 - Individual circuit keying for error-free insertion.
 - Standardized input impedances to simplify load considerations.

Write, wire, or phone today for detailed information on the new EECo G-Series 10-Mc digital modules or on any of our other families of digital circuits.

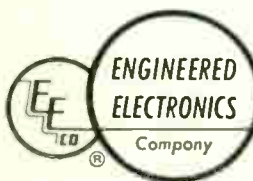

ENGINEERED ELECTRONICS Company

1441 EAST CHESTNUT AVENUE • SANTA ANA, CALIFORNIA
KIMBERLY 7-5651 CABLE ADDRESS: ENGELEX

Typical G-Series Specifications

Logic Levels: —6VDC = True; 0VDC = False.
Operating Temperature Range: —55°C to +71°C.
Storage Temperature: —65°C to +100°C.
Power Requirements: —12V ± 3%
— 6V ± 3%
+ 6V ± 3%.

Short-Circuit Protection: Internal circuitry provides protection to minimize and localize damage resulting from power supply shorting. Power supplies may be shorted together indefinitely without catastrophic damage to a system (a common danger when high-frequency clamped output circuits are used). Individual transistors at the point of probing can be destroyed by faulty troubleshooting techniques, but power supply shorting will not destroy other circuits in a system.

Construction: Glass-epoxy etched circuit card, measuring 4½" wide by 5" high by ¼" thick, with eyeletted holes.

Standard Contacts: Two-sided rhodium-plated, with beveled edges for insertion into standard 22-pin etched circuit board connectors.

Coming

Events

in the electronic industry

- Apr. 16-18: Aerospace Systems Reliability, IAS; Salt Lake City, Utah.
- Apr. 17: Polypropylene's Expanding Position, SPE; Sheraton Hotel, Phila., Pa.
- Apr. 17-19: Rural Electrification Conf., AIEE; Ft. Shelby Hotel, Detroit, Mich.
- Apr. 17-19: ASM Reg. Conf. and Exhib.; Shamrock Hilton Hotel, Houston, Tex.
- Apr. 17-20: Conf. on Sector-Focused Cyclotrons, Univ. of Cal.; Los Angeles, Calif.
- Apr. 18-20: Great Lakes District Mtg., AIEE; Hotel Van Ormon, Ft. Wayne, Ind.
- Apr. 21-Oct. 21: 1962 World's Fair; Seattle, Wash.
- Apr. 23-25: 1962 Powder Metallurgy Show & 18th Annual Powder Metallurgy Tech. Conf., MPIF; Sheraton Hotel, Phila., Pa.
- Apr. 23-26: Spring APS Mtg.; Washington, D. C.
- Apr. 24: Joint Mtg. AEP&EM with distributors and representatives; Chicago, Ill.
- Apr. 24-26: Production Eng'g. Conf., ASME; Van Curler Hotel, Schenectady, N. Y.
- Apr. 24-26: 10th Nat'l. Conf. on Electromagnetic Relays, NARM; Oklahoma State Univ., Stillwater, Okla.
- Apr. 25-26: Symp. on the Mathematical Theory of Automata, IRE, AIEE, U. S. Defense Res. Agencies; Auditorium of United Eng'g. Ctr., New York, N. Y.
- Apr. 25-29: Western Space Age Industries & Eng'g. Expos./Conf.; Cow Palace, San Francisco, Calif.
- Apr. 26-27: Conf. on the Nucleonics Heat Transfer Committee of ASME; Argonne, Ill.
- Apr. 26-27: 3rd Nat'l. Pulp & Paper Instrumentation Symp., ISA; Jacksonville, Fla.
- Apr. 29-May 4: 91st Conv. of SMPTE; Ambassador Hotel, Los Angeles, Calif.
- Apr. 30-May 2: Mid-America Distr. Mtg., AIEE; Hotel Chase, St. Louis, Mo.
- Apr. 30-May 2: 8th Nat'l. Symp. on Instrumentation Methods of Analysis, ISA; Daniel Boone Hotel, Charleston, W. Va.
- Apr. 30-May 2: Manned Space Flight, IAS; St. Louis, Mo.
- Apr. 30-May 3: Design Eng'g. Conf. & Show, ASME; McCormick Place, Chicago, Ill.

MAY

- May 1-3: Spring Joint Computer Conf.,

- IRE (PGEC) AIEE, ACM; Fairmont Hotel, San Francisco, Calif.
- May 1-3: 9th Annual Cleveland Electronics Conf.; Cleveland Eng'g. Scientific Ctr., Cleveland, Ohio.
- May 3-4: Int'l. Congress on Human Factors in Electronics, IRE (PGHFE); Lafayette Hotel, Long Beach, Calif.

Highlights '62

- WESCON, Aug. 21-24, IRE, WEMA; Los Angeles, Calif.
- Nat'l. Electronics Conf., Oct. 9-11, IRE, AIEE, EIA, SMPTE; Chicago, Ill.
- NEREM (Northeast Res. & Eng. Mtg.) Nov. 13-15, IRE; Boston, Mass.
- May 4-5: Bay Area Symp. on Reliability & Quality Control; U.S. Naval Post Graduate School, Monterey, Calif.
- May 6-9: 5th Nat'l. Power Instrumentation Symp., ISA; Hotel Texas, Ft. Worth, Tex.
- May 6-10: 1962 Spring Mtg. of The Electrochemical Soc.; Statler-Hilton Hotel, Los Angeles, Calif.
- May 7-8: 1962 AIEE Packaging Industry Technical Conf., AIEE, PMMI, PI; Shelburne Hotel, Atlantic City, N. J.

Highlights '63

- IRE Int'l. Conv., Mar. 24-28, 1963 (tent.); Coliseum & Waldorf-Astoria Hotel, New York, N. Y.
- Western Electronics Show & Conf. (WESCON), Aug. 20-23, 1963; Cow Palace, San Francisco, Calif.
- Nat'l. Electronics Conf. (NEC), Oct. 8-10, 1963; Exposition Hall, Chicago, Ill.
- Northeast Research & Eng'g. Mtg. (NEREM), Nov. 12-14, 1963; Boston, Mass.
- May 7-8: Process Planning & Reliability, ASTME; Sheraton Cleveland Hotel, Cleveland, Ohio.
- May 7-9: Middle Eastern Distr. Mtg., AIEE; Hotel DuPont, Wilmington, Del.
- May 8-10: 1962 Electronic Components Conf., AIEE, EIA, IRE,

- ASQC, SNT; Marriott Twin Bridges Motor Hotel, Washington, D. C.
- May 9-11: North Eastern Distr. Mtg., AIEE; Hotel Statler, Boston, Mass.
- May 10-11: Plastics in Electrical Insulation Workshop, SPE; Military Park Hotel, Newark, N. J.
- May 14-16: Joint Distr. Mtg., AIEE; Erie, Pa.
- May 14-16: Nat'l. Aerospace Electronics Conf. (NAECON), IRE, PGNE; Dayton Biltmore Hotel & Memorial Hall, Dayton, Ohio.
- May 14-16: Joint Tech. Soc.—Dept. of Defense Symp. on Thermionic Power Conversion; Antlers Hotel, Colorado Springs, Colo.
- May 15-16: 4th Annual Mtg. Council on Medical TV; Clinical Center, Nat'l. Institutes of Health, Bethesda, Md.
- May 16-17: Plastics Injection Molding Workshop, Central Ohio Sec., SPE; Ohio State Univ., Columbus, Ohio.
- May 19-20: ARRL Roanoke Div. Conv.; Hotel Roanoke, Roanoke, Va.
- May 20-23: Nat'l. Mtg. of American Inst. of Chemical Engrs.; Baltimore, Md.
- May 20-23: Annual Mtg. of Radiation Res. Soc.; Colorado Springs, Colo.
- May 20-24: 43rd Int'l. Conf. & Annual Expos. of the Nat'l. Office Management Assoc.; San Francisco, Calif.
- May 21-23: Hydraulic Conf., ASME; Bancroft Hotel, Worcester, Mass.
- May 21-23: 8th Nat'l. Aerospace Instrumentation Symp.; Marriott Motor Hotel, Twin Bridges, Washington, D. C.
- May 21-24: 1962 Electronic Parts Distributors Show; Conrad Hilton Hotel, Chicago, Ill.
- May 22-23: Appliance Tech. Conf., AIEE; Deshler-Hilton Hotel, Columbus, Ohio.
- May 22-24: Nat'l. Microwave Theory & Techniques Symp., NBS, IRE (PGMTT), Boulder, Colo.
- May 22-24: Conf. on Self-Organizing Systems, ONR (ISB), ARF; Museum of Science & Industry, Chicago, Ill.
- May 23-25: EIA 38th Annual Conv.; Pick-Congress Hotel, Chicago, Ill.
- May 23-25: 11th Nat'l. Telemetry Conf., ISA, ARS, IAS, AIEE, IRE; Sheraton-Park Hotel, Washington, D. C.
- May 24-26: IRE 7th Region Conf.; Seattle, Wash.
- May 24-27: 1st Biennial Southwest Air, Space & Electronic Expos.; Market Hall, Dallas, Tex.

(Continued on page 13)

*This is
NOT
A NEW PRODUCT
... it just behaves
like one*



Here is a standard Clevite PNP germanium power transistor. It looks like thousands of other high quality units we've made in the recent past . . . on the *outside*.

But inside, this transistor is significantly better, because it's an example of the constant product improvement efforts that are a part of the Clevite-Shockley engineering integration program.

At Clevite Transistor, engineering resources are concentrated on the improvement of existing products by redesign and advances in production techniques. In Palo Alto, our Shockley Transistor Unit under the guidance of Dr. William E. Shockley engages in the development of new products and fundamental solid state research to improve our understanding of semiconductors and permit more effective process control.

In this case it's a "standard" product . . . but it behaves like a *new* one! The specs are the same . . . but the performance is superior. And you pay no more for it . . .

For one thing, we've achieved a thermal resistance of only .8°C per watt junction to heat sink. Real cool. Ratings are based on a 100°C junction temperature. All transistors are stabilized for 100 hours at 125°C . . . which means plenty of reserve safety margin and stable life characteristics. The original ratings were based upon 1.0°C/w thermal resistance, so at the new registered power dissipation the transistors will run much cooler and provide a substantial safety factor to increase reliability significantly. Special types can be rated for even more stringent service.

For another thing, this transistor has the closest emitter to base spacing in the industry resulting in low base resist-

ance and input impedance without sacrifice in breakdown voltage. Overall . . . another Clevite contribution to reliability.

The table below gives some of the essential data. Send for a set of data sheets for full details.

Symbol	Measurement Conditions	2N1146 and 2N1147		2N1146A and 2N1147A		2N1146B and 2N1147B		2N1146C and 2N1147C		Units
		Min	Max	Min	Max	Min	Max	Min	Max	
h_{FE}	$I_C = 5A$ $V_{CE} = -2.0V$	60	150	60	150	60	150	60	150	
V_{EB}	$I_C = 15A$ $V_{CE} = -2.0V$		2.0		2.0		2.0		2.0	Vdc
$V_{CE(SAT)}$	$I_C = 15A$ $I_B = 1.0A$		1.0		1.0		1.0		1.0	Vdc
R_T			0.8		0.8		0.8		0.8	°C/W
BV_{CBO}	$I_{CBO} = 15mA$	40		60		80		100		Vdc
BV_{CES}	$I_C = 500mA$ Swept to 750mA $V_{EB} = 0$	30		40		60		75		V
BV_{CEO}	$I_C = 1500mA$ $I_B = 0$	20		30		40		50		V
I_{CBO}	85° C		35		35		35		35	mA dc
			40 Vdc							
			60 Vdc							
			80 Vdc							
			100 Vdc							



CLEVITE TRANSISTOR
Reliability in volume
Waltham, Massachusetts

Shockley Transistor • Stanford Industrial Pk. • Palo Alto, Cal.

Coming Events

(Continued from page 11)

Engineering Education

Short courses of interest at leading institutions.

Industrial Engineering

Cornell University is holding its Industrial Engineering Seminars from June 12 through the 15th, 1962. Eleven groups are offered: Industrial Management; Engineering Administration; Capital Investment Planning—Theory and Practice; Operations Management of the Smaller Company; Work Measurement; Applied Operations Research; Systems Simulation Using Digital Computers; Techniques of Mathematical Programming; Queuing and Inventory Theory; Statistical Decision Making; and Statistical Reliability Analysis. Contact: J. W. Gavett, Seminars Coordinator, Upson Hall, Cornell Univ., Ithaca, N. Y.

Summer Seminars

Pennsylvania State University is offering 8 short courses from June 10 through the 29th, 1962. They are: High-Speed Flexible Couplings; Mechanical Properties and Design of Materials; Dislocations and Mechanical Properties of Materials; R&D Management Development; Advanced R&D Management Development; Theoretical and Experimental Continuum Mechanics; Underwater Missile Engineering; and Underwater Acoustics. Contact: Engineering Seminars, Conference Center, Penn. State Univ., University Park, Pa.

"CALL FOR PAPERS"

9th Nat'l. Symp. on Reliability and Quality Control, Jan. 22-24, 1963. Forward title of paper and abstract, not more than 800-words, with brief biographical sketch of author/authors, (10 copies), deadline: May 15, 1962, to: Leslie W. Ball, The Boeing Co., P.O. Box 3707, Seattle 24, Wash.

2nd Cong. of IFAC on Automatic Control, Basle, Switz., Sept. 1963. Papers to cover Theory, Applications, and Components. An abstract of not more than 200 words should be sent by June 1, 1962, to: American Automatic Control Council, c/o Dr. G. Weiss, Electrical Engineering Dept., Brooklyn Polytechnic Institute, 333 Jay St., Brooklyn 1, N. Y.

1962 Northeast Electronics Research and Eng'g. Mtg. (NEREM), Nov. 5-7, 1962. Papers to deal with Radar Astronomy, Quantum Electronics, Information Technology, Plasmas, Solid-State Devices, Engineering Management, and Communication and Control. Forward either complete papers or 400-500 word abstracts (triplicate), and 50-word summaries, deadline: June 11, 1962, to: I. Goldstein, Raytheon Co., Box 555, Hartwell Rd., Bedford, Mass.

Circle 6 on Inquiry Card →

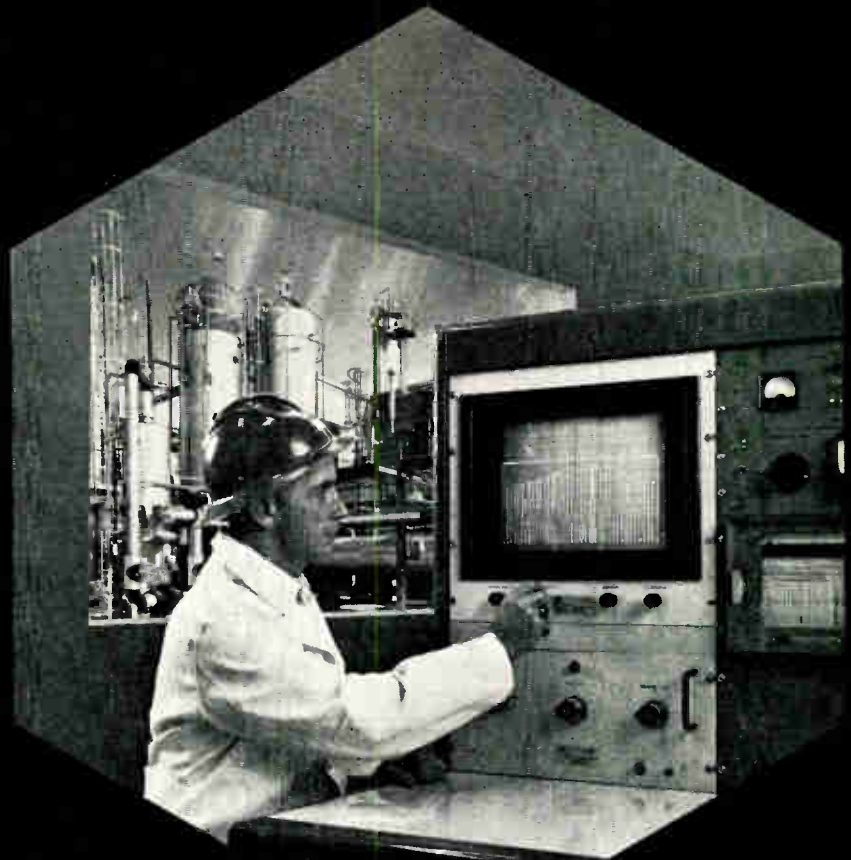

PROFILE ON "TV SET" KEEPS PROCESS ON STREAM

The "TV set"—a name given to the ATL Profile Monitor by technicians using it in a ticklish processing application—gets rapt attention from its audience. At a glance, an operator gets the full story of temperature gradients throughout all critical points. As many as 48 different readings are displayed simultaneously to form a characteristic profile for the process. The moment any abnormality occurs, it changes the profile on the screen, trips an alarm, and enables the operator to take instant corrective action.

This "TV set" is even more popular than the one at home. It does away with the need for checking dozens of separate instruments and insures that no transients are missed. For the processor, it assures safer operation and process continuity. In this and a growing number of other applications, the ATL Profile Monitor has paid for itself many times over.

Would you like to find out how it can pay you to put your process profile on "TV"? Write today for details.

ADVANCED TECHNOLOGY LABORATORIES
369 Whisman Road • Mountain View 23 • California



AMERICAN-Standard

American-Standard and Standard®
are trademarks of American Radiator
& Standard Sanitary Corporation

NOW
AVAILABLE
WITH WELDABLE
LEADS

**RUGGED END-CAP
CONSTRUCTION FOR
LONG TERM STABILITY**

**EXCEPTIONAL RESISTANCE
TO MOISTURE
AND MECHANICAL
DAMAGE**

**SURPASS MIL-R-10509
PERFORMANCE
REQUIREMENTS**

AVAILABLE IN
REEL PACKING
FOR AUTOMATED
PWB INSERTION

FILMISTOR[®] METAL FILM RESISTORS

**OFFER 5 DISTINCT
TEMPERATURE
COEFFICIENTS TO
MEET ALL CIRCUIT
REQUIREMENTS**

Providing close accuracy, reliability and stability with low controlled temperature coefficients, these molded case metal-film resistors outperform precision wirewound and carbon film resistors. Prime characteristics include minimum inherent noise level, negligible voltage coefficient of resistance and excellent long-time stability under rated load as well as under severe conditions of humidity.

Close tracking of resistance values of 2 or more resistors over a wide temperature range is another key performance characteristic of molded-case Filmistor Metal Film Resistors. This is especially important where they are used to make highly accurate ratio dividers.

Filmistor Metal Film Resistors, in 1/8, 1/4, 1/2 and 1 watt ratings, surpass stringest performance requirements of MIL-R-10509D, Characteristics C and E. Write for Engineering Bulletin No. 7025 to: Technical Literature Section, Sprague Electric Co., 233 Marshall Street, North Adams, Mass.

*For application engineering assistance write:
Resistor Division, Sprague Electric Co., Nashua, New Hampshire.*

SPRAGUE COMPONENTS

RESISTORS
CAPACITORS
MAGNETIC COMPONENTS
TRANSISTORS

INTERFERENCE FILTERS
PULSE TRANSFORMERS
PIEZOELECTRIC CERAMICS
PULSE-FORMING NETWORKS

HIGH TEMPERATURE MAGNET WIRE
CERAMIC-BASE PRINTED NETWORKS
PACKAGED COMPONENT ASSEMBLIES
FUNCTIONAL DIGITAL CIRCUITS

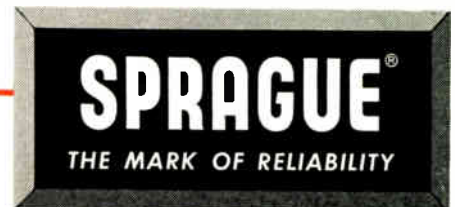

'Sprague' and '®' are registered trademarks of the Sprague Electric Co.

PARAMETRIC AMPLIFIER



K. M. Eisele adjusts Bell Labs' new parametric amplifier. It will be sealed in a metal cavity and immersed in liquid nitrogen. Arrangement provides even cooling of the amplifier and improves stability. Non-degenerate amplifier has an over-all system noise temperature of 60°K at 6 CC, or a noise figure of about 0.9 db.

Air Defense System Dedicated at St. Louis

An electronic air defense system developed by the Orlando (Fla.) Aerospace Div. of Martin Marietta Corp., recently went into action coordinating the fire of NIKE missile batteries protecting the Greater St. Louis area.

St. Louis is one of 19 sites around the nation using the BIRDIE (Battery, Integration and Radar Display Equipment) system to automatically provide target information to missile units. BIRDIE is a transistorized version of MISSILE MASTER.

New Radar Aids High-speed Aircraft

A new "Terrain Avoidance" Radar System that increases "blind-letdown" capabilities for high-speed aircraft is being flight tested by General Dynamics/Electronics, San Diego, Calif.

System assists the pilot during landings—even on unequipped fields—in adverse weather. It also permits high-performance aircraft to accomplish their missions at low levels over unfamiliar country when vision is obscured.

It automatically guides the aircraft over all obstacles during "ground-hugging" flight.

Designed primarily for military aircraft, the system is based on a non-scanning radar antenna, and can be adapted for commercial use. Civilian planes could use the new system in adverse weather.

As We Go To Press . . .

Device Helps Keep Communications Secret

A new frequency shifting device to help keep communications secret, improve radio direction finding and aid air navigation has been developed by the Univ. of Michigan Cooley Electronics Lab.

With the device both receiver and transmitter jump quickly from frequency to frequency, always in unison but in an apparently random manner. An eavesdropper would find it almost impossible to catch continuously the right frequency at the right time.

For direction finding, the system would help eliminate the need for operators at stations some distance from the central control. Receivers at these stations could be tuned automatically through telephone cables.

In "omnirange" navigation systems, use of this pre-programmed, automatic station-switching device would eliminate the pilot's having to re-tune his radio every few minutes.

NASA Awards Kollsman Star-Tracker Contract

Kollsman Instrument Corp., has been awarded a prime contract of \$1 million from the Goddard Space Flight Center of the National Aeronautics and Space Administration for intricate instruments to analyze stars from an observatory orbiting in space.

Instruments will gather data on the radiation content of outer space, especially in the ultraviolet range. Earth bound scientists have been unable to study the ultraviolet rays emitted by celestial bodies because the rays are absorbed by the atmosphere.

RADIO TELESCOPE

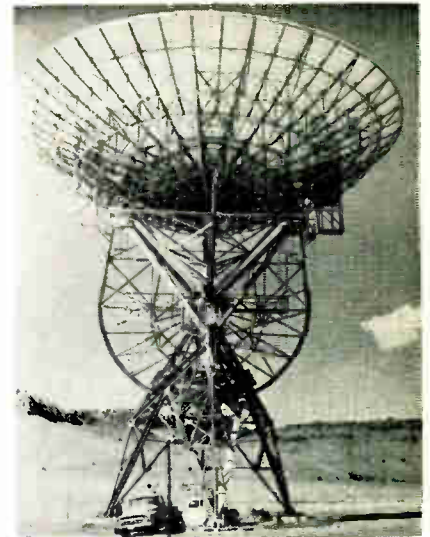

HA-Dec (hour angle-declination) radio telescope for Harvard Univ., will be used to study solar and galactic radio emission. The 85-ft. diameter antenna, being built by Blaw-Knox, is located at Harvard's radio astronomy field station in Fort Davis, Tex.

Army Engineers Test Electrostatic Printer

A printing machine that uses an electrostatic process, rather than conventional paper, ink, or printing plates, is being tested by Army Engineers at Fort Belvoir, Va. It may be used in the Army's new automated system of map reproduction, distribution, storage and display.

The test model is designed to reproduce topographic maps almost instantly from 70 mm microfilm, eliminating preprinting and storage of maps and the storage of drawings and printing plates. It can print in black-and-white or in color and can reproduce type, line-drawings or photographs.

FACSIMILE TRANSMITTER

New lightweight facsimile transmitter allows forward troops to flash charts, maps and drawings to combat headquarters. Device was developed by U.S. Army Signal RGD Lab in cooperation with the U.S. Marine Corps. First units were built by the Westrex Co., N.Y.C.



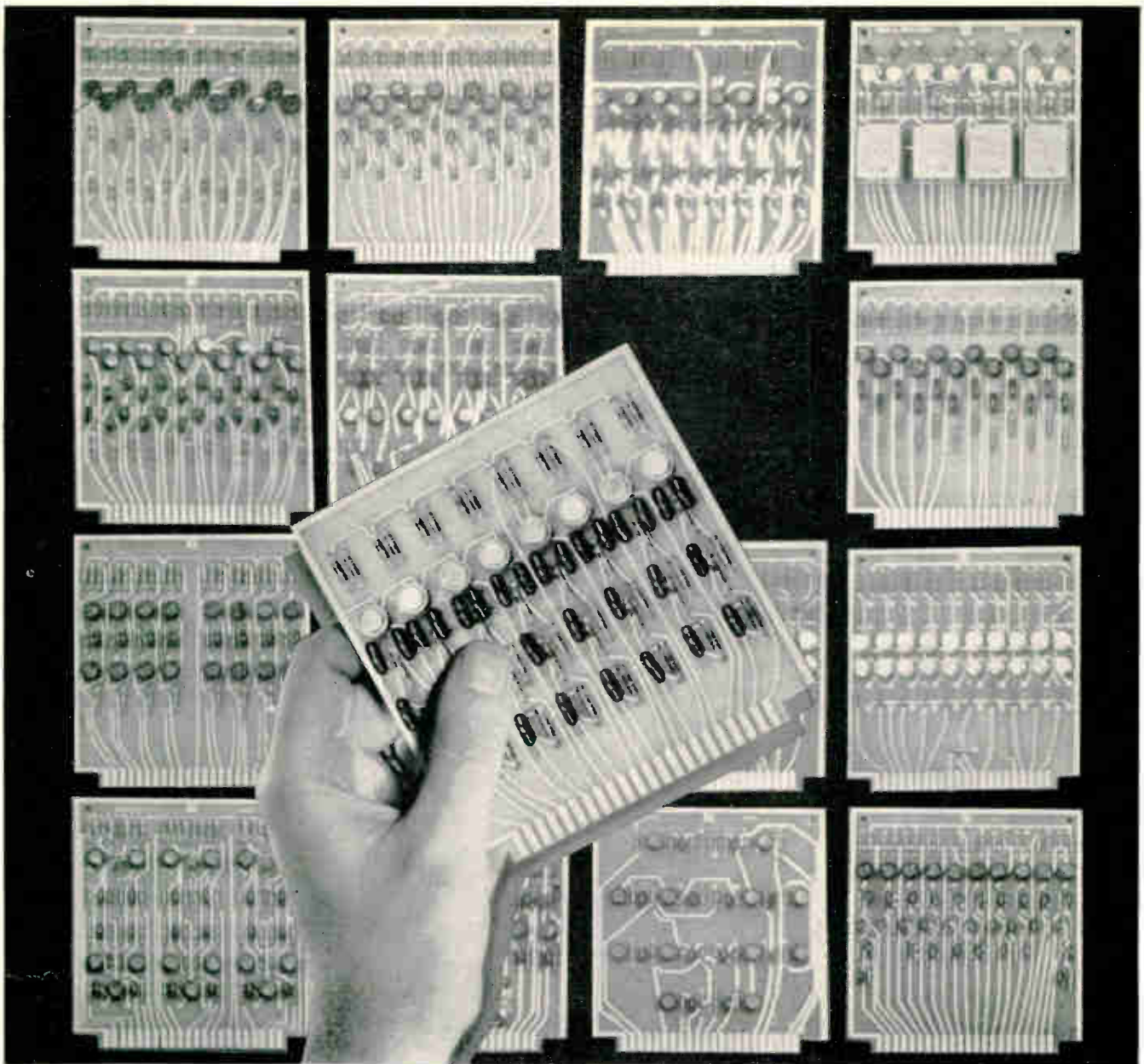

Take this 1 mc Solid State Printed Circuit, for example...

Intermountain Branch of Curtiss-Wright Electronics Division designed and manufactured it to meet exacting standards of quality, reliability and performance in a wide variety of digital logic systems. These precision built 1 mc units are available in a broad selection of standard "off-the-shelf" circuits, or Intermountain will custom design and manufacture solid state printed circuits and systems to your specifications.

- Double sided, gold, plated through holes
- Lower cost multi-circuit packaging
- Meet all specifications in accordance with Mil. Std. 275A

Write for information and prices on standard units, or a quotation on your specific requirements.

NEW—MAXPAK® Digital Modules are welded, high density modules, encapsulated in HEATCON® high conductive plastic. Offer substantial savings in space and weight, flexibility and reliability at modest cost. Standard units available, or your circuits can be packaged to specification. For complete information, write: Advanced Miniaturized Electronics, Inc., 55 Kearney Rd., Needham Heights, Mass.



Electronics Division Intermountain Branch

Curtiss  **Wright**

CORPORATION

P.O. Box 10044 Albuquerque, New Mexico

Phone: 345-1661 TWX: AQ-69

NEW... Weston Series 1900 Meters Give You *Integrated Design!*

- 7 1/2"
- 5 1/2"
- 4 1/2"
- 3 1/2"
- 2 1/2"

Function Movement	D-C		A-C	Thermo	A-C Rect.	VU
	1%	2%				
Cormag®	✓	✓			✓	
Ext. Magnet	✓	✓				
Iron Vane						
Cormag®	✓	✓			✓	✓
Ext. Magnet	✓			✓		
Iron Vane			✓			
Cormag®	✓	✓			✓	✓
Ext. Magnet	✓			✓		
Iron Vane			✓			
Cormag®		✓			✓	✓
Ext. Magnet		✓		✓		
Iron Vane			✓			

Weston offers the widest choice of instrument types and styles available in a single matching line. All instruments listed above are available with conventional pivot and jewel movements. The new Weston Taut Band Suspension offers highest accuracy and sensitivity, is available in 3 1/2" and larger sizes.

Weston's new concept of design (illustrated below) makes possible a fully integrated family of instruments for your every need. Layout problems are simplified since all meters of the same size are *directly interchangeable* . . . regardless of the mechanism you choose. All meters meet ASA elec-

trical requirements in Specification Number C-39.1 for indicating instruments with 2600 V A-C dielectric test, and are available with
 ■ Bakelite or clear plastic faces
 ■ Color inserts for coding or styling
 ■ 100° scale arcs for both A-C and D-C instruments.

In addition, only Series 1900 Meters offer . . .

THREE TYPES OF MOUNTING

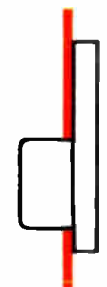
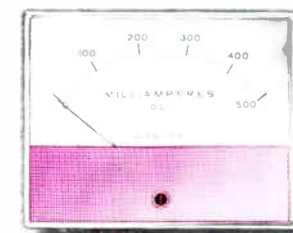

1. SURFACE

Use same dimensions, whether you choose a meter with taut band or pivot and jewel movement.

2. FLUSH

Full bezel permits mounting flush with panel through rectangular cutout.

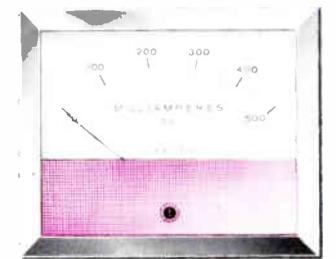

3. RECESS

Only the scale is visible since meter is mounted behind the panel . . . half bezel fits into window. Available with internal illumination.

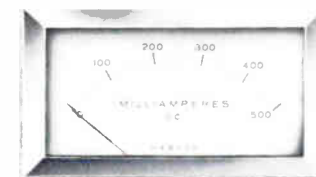
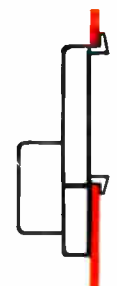

Series 1900 Meters

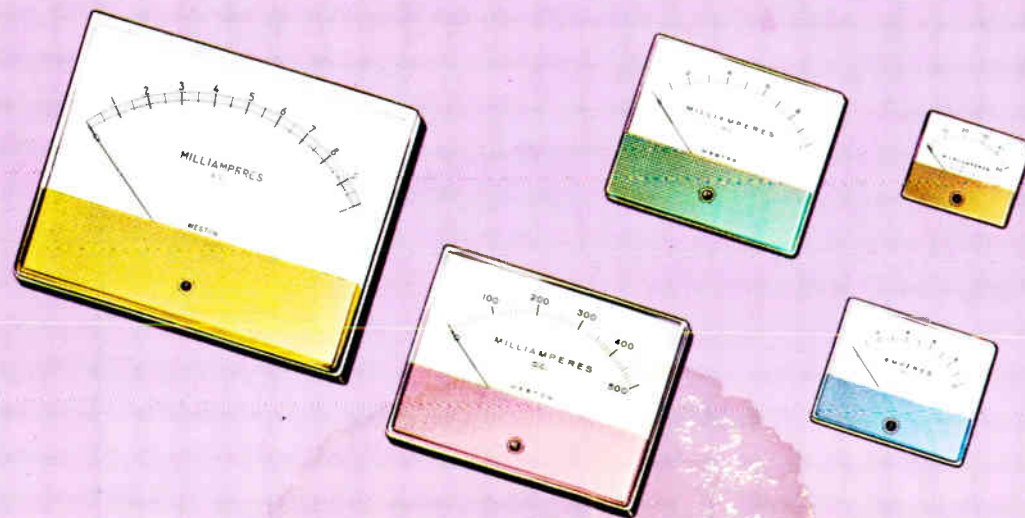

World Radio History

New Concept of Design... Series 1900 PANEL METERS

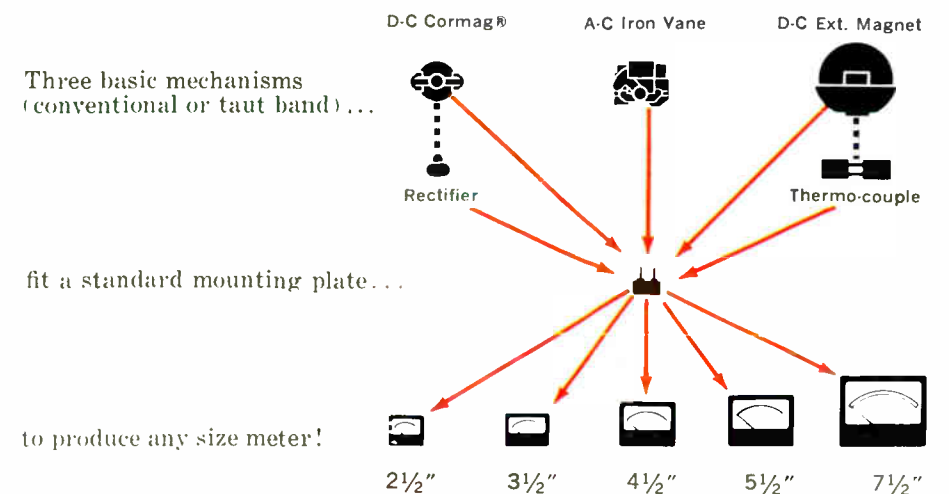

WESTON TAUT BAND Gives You These Outstanding Benefits!

■ *Modern in every way*

■ *Series 1900 Panel Meters are*

now available in...

any

size

from 2½" to 7½"
(Taut Band from 3½" to 7½")

any

function

DC, AC, VU, Thermo, Rectifier,
or Log-scale

any

range

from 2 µa, full scale, to highest
needed

any

accuracy

1% and 2%, standard ...
higher accuracy on request

any

style

traditional Bakelite or modern
static-free plastic

any

mounting

surface, flush or recess

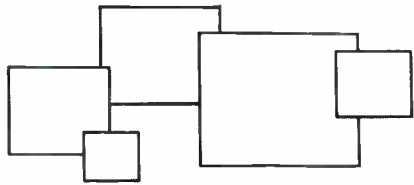

a-c thermo
log-scale **rectifier** **d-c**

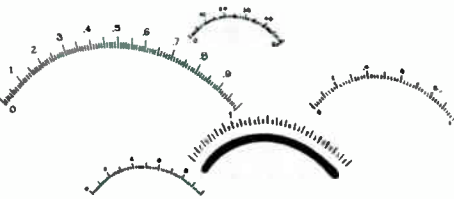

1% **2%**

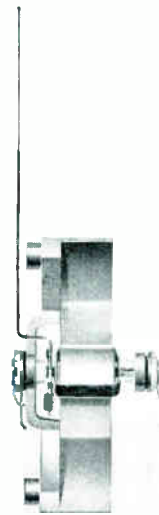
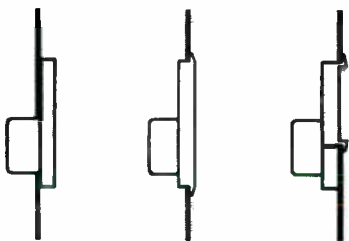
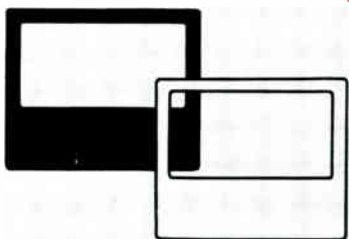

Because taut band instruments have no pivots and jewels ...

- pivot friction is eliminated,
- error due to pivot fall-over is eliminated.

Because there are no movement springs ...

- spring-set or hysteresis is eliminated.

Taut band instruments ...

- require less driving energy,
- may be operated in any position without degrading performance,
- are 4 times more sensitive than conventional meters.

Here's what Weston's exclusive design means to you

Weston Co-planar™ termination is the only method of construction which assures complete control of taut band ribbon length and tension. This type of suspension also: assures precise centering of the moving coil for highest accuracy; guarantees uniform torque of the flat movement ribbon throughout the scale; and eliminates soldering within ribbon's active length. Important features of Weston's Co-planar™ design are illustrated in the drawing:

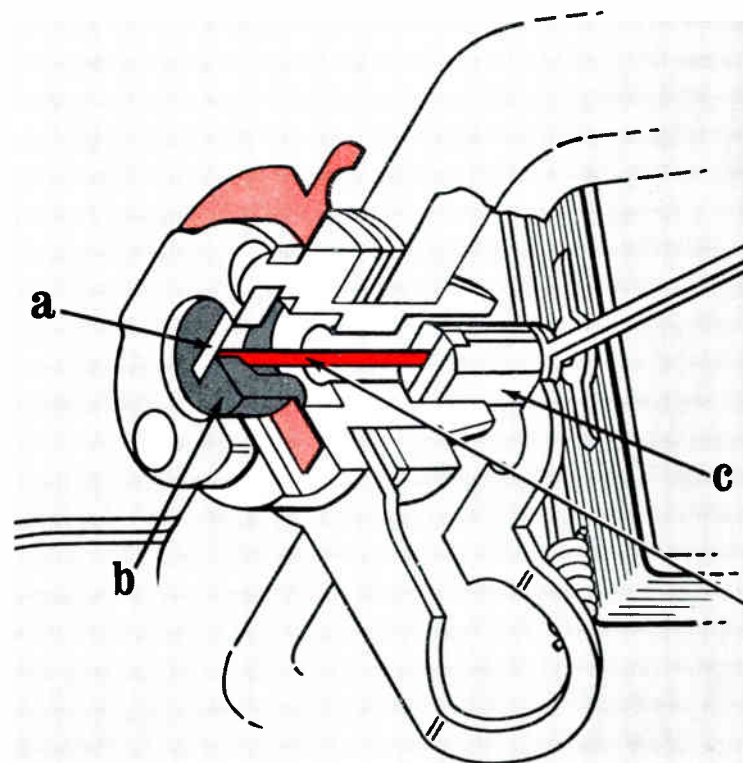

- 1 **Small hub** has wedge "a" which securely locks the taut band ribbon in place. The ribbon is then soldered at point "b". No soldering within active length of ribbon to disturb the ribbon's stress characteristics. Other end of ribbon is attached in like manner to the threaded anchor nut "c", into which the moving coil is attached.
- 2 **Tension spring** maintains firm pressure on band, absorbs shock, increases ruggedness of instruments.
- 3 **Nylon bushing** prevents excessive axial and lateral motion—further contributing to ruggedness.
- 4 **Special taut band ribbon** is produced by Weston's own metallurgical facilities. In-plant quality control assures precise characteristics in finished suspension ribbon.
- 5 **Weston mechanism** requires an active ribbon length of only 0.18" on each side of moving coil. That means Weston Taut Band Instruments are less bulky, and are completely interchangeable with pivot and jewel meters in Series 1900.

FACTS ABOUT WESTON TAUT BAND RIBBON

- Average size is only 0.0003" thick, 0.003" wide, and 0.18" long.
- Thickness is controlled within 1% — or ± 0.000003".
- Ribbon is supporting a weight equivalent to 50-tons per square inch in the instrument.
- No degradation resulting from high shock or vibration.
- Short ribbon length of 0.18" permits higher sensitivity than with longer ribbons.
- A one-pound ingot of Weston Taut Band Alloy provides enough ribbon for 750,000 meters.
- The cross-sectional area of a bundle of 18 ribbons is equal to that of a human hair.

Complete technical information from: **WESTON INSTRUMENTS**
Division of Daystrom, Incorporated
614 Frelinghuysen Avenue
Newark 14, New Jersey

LOW LEAKAGE
TANTALUM

Good-All

TYPE 901

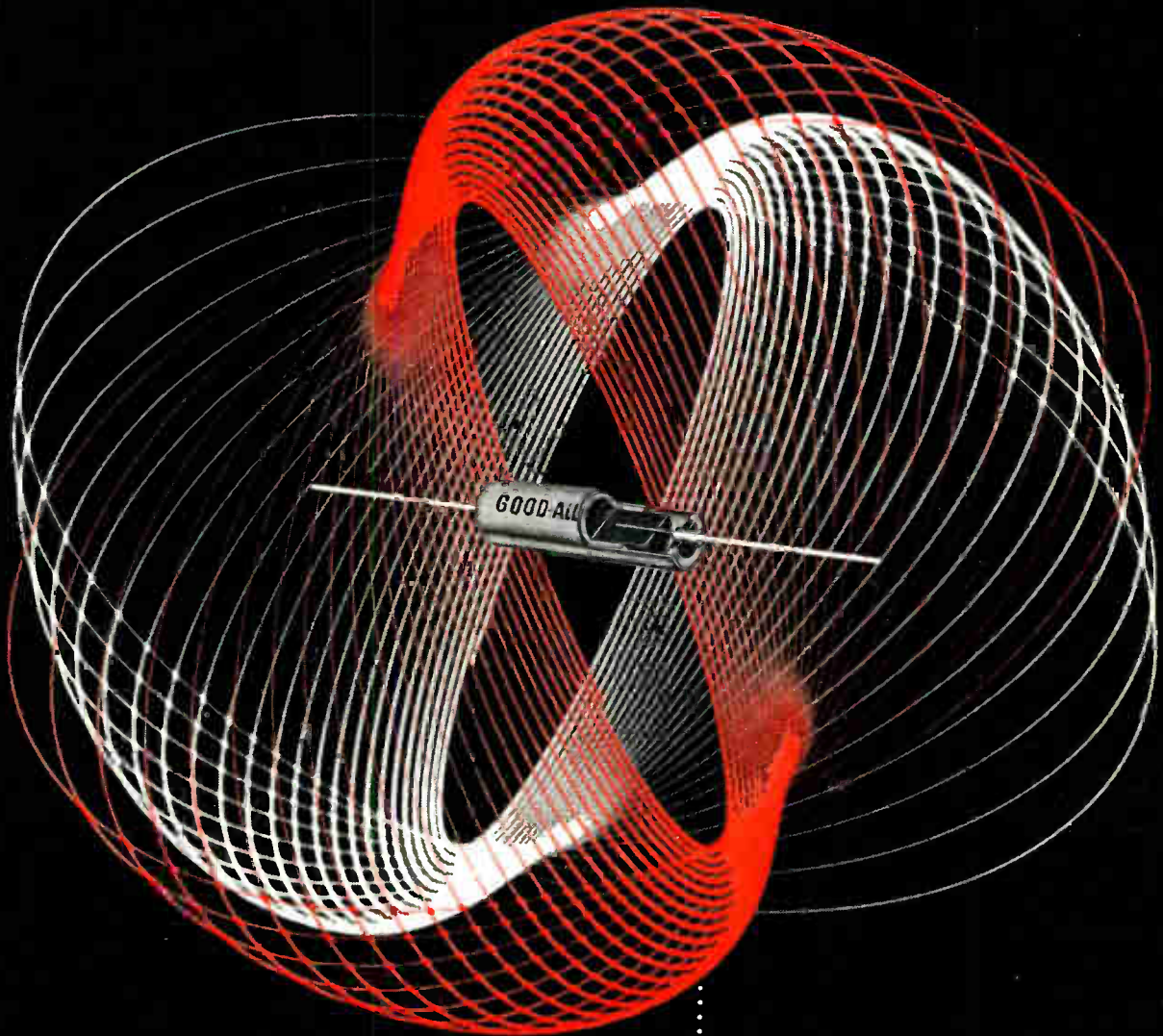

SOLID TANTALUM CAPACITORS

MR. ENGINEER:

LOW LEAKAGE, the trademark of a truly SUPERIOR TANTALUM, is an outstanding characteristic of the Good-All 901. Our man in your area has detailed test data and would like very much to show it to you. You will be interested in the LOW LEAKAGE CIRCUIT ADVANTAGES and outstanding PERFORMANCE of this new 901 series Tantalum.

Standard MIL-SPEC Values through 35 Volts

Type 901 Tantalums are available from stock
at AUTHORIZED INDUSTRIAL DISTRIBUTORS

See you at IRE — BOOTHS 1119-1120



GOOD-ALL ELECTRIC MFG. CO. • OGALLALA, NEBRASKA
A SUBSIDIARY OF THOMPSON RAMO WOOLDRIDGE INC.

■ New Circuitry Made Possible By Philco Transistors

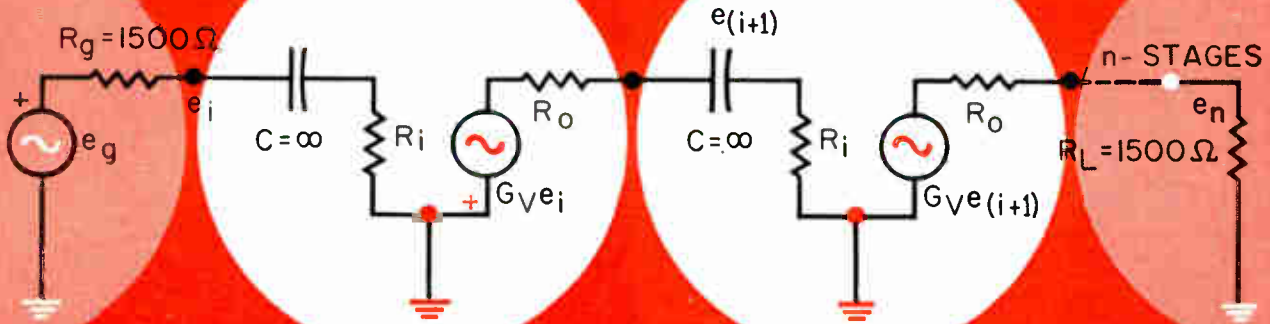

GAIN CHAIN

A compact direct-coupled utility amplifier, with identical input and output impedances, can be duplicated and cascaded in an iterative chain for extremely high gain. And the "links" (amplifiers) in this chain are adaptable to many applications. The amplifier's 3 direct-coupled Philco 2N858 Silicon Precision Alloy Transistors deliver high gain, over a wide temperature range. ■ The 2N858 transistor, as a result of Philco's fully-automatic SPAT* process, features low cost and process-controlled uniformity, in addition to the device's superior temperature stability. ■ Send for Application Lab Report 746, and data on Philco SPAT type 2N858. Write Dept. EI462.

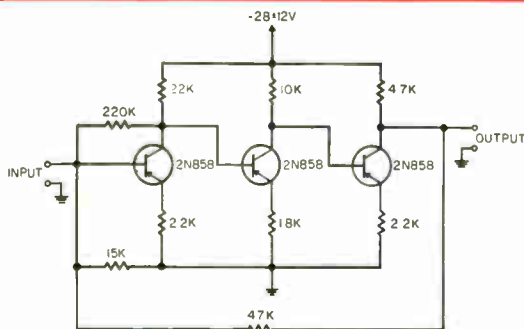

DIRECT-COUPLED UTILITY AMPLIFIER

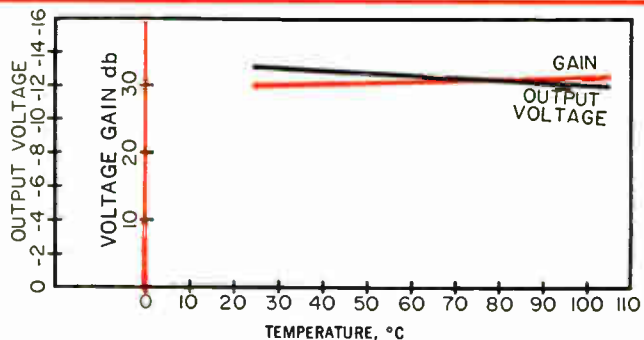

DC OUTPUT VOLTAGE AND VOLTAGE GAIN VS. AMBIENT TEMPERATURE

Philco SPAT
Types 2N858—2N865
are immediately available
from your Philco Industrial
Semiconductor Distributor.

*Trademark Philco Corp.

PHILCO

A SUBSIDIARY OF *Ford Motor Company*

LANSDALE DIVISION, LANSDALE, PA.



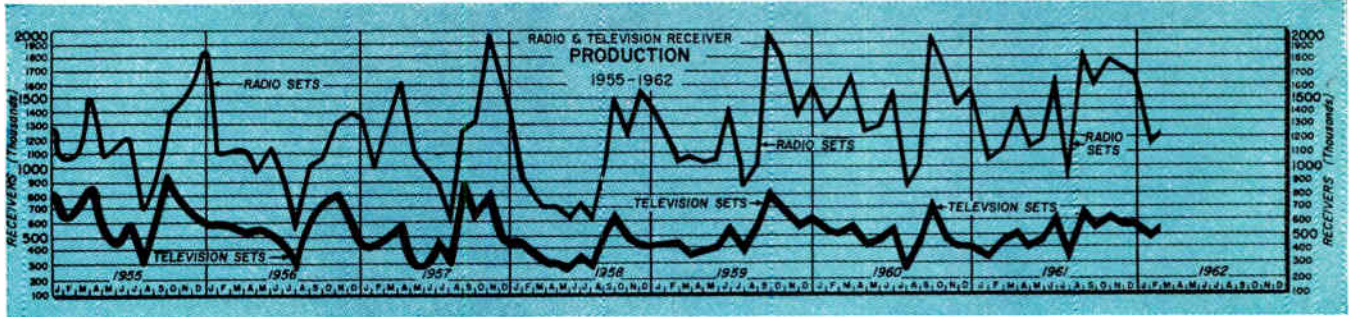

GOVERNMENT ELECTRONIC CONTRACT AWARDS

This list classifies and gives the value of electronic equipment selected from contracts awarded by government agencies in February, 1962.

Actuators	37,191
Amplifiers	1,884,387
Analyzing systems	69,191
Antennas	788,631
Batteries	533,298
Blowers	64,122
Cable assy	207,581
Cable, telephone	28,510
Communications equipment	55,134
Computers	7,677,120
Connectors	35,754
Control systems	339,583
Converters	277,291
Counters, portable	98,524
Couplers & assys	608,251
Data communications set	6,500,000
Decoders	40,778
Demodulation equipment	83,984
Detector, radioflo, leak	29,165
Digital magnetic tape system	58,947
Discriminator	50,840
Display system, remote	355,600
Duplexer	64,343
Encoder system	99,443
Filters	27,709
Gyroscopes	7,016,878
Handsets	550,390
Hydrophones	35,123
Indicators	439,517
Loudspeakers	140,532
Magnetic tape dataplotter system	52,500
Magnetron assy, stabilized	27,423
Meters	244,549
Navigation equipment	1,784,521
Oscillators	451,000
Oscilloscopes	107,010
Power supplies	99,845
Radar	2,552,039

Radiacmeters	203,645
Radio direction finder	1,312,000
Radio set	508,228
Radio terminal set	990,000
Radomes	414,622
Receivers	408,166
Receiving system	1,247,658
Recorder, tape	1,003,456
Recorder, video	306,405
Relay armatures	71,828
Relays & assys	374,503
Resistors	100,568
Semiconductor devices	65,455
Servos	268,618
Shelter, electrical equipment	381,630
Signal generators	36,637
Simulators	810,280
Sonobuoys	7,651,613
Standards, audio voltage	164,900

Switchboard	70,982
Switches	138,264
Tape, recording	228,406
Telemetry equipment	283,774
Telephone equipment	34,924
Teletypewriter equipment	2,550,228
Terminals, telegraph	65,424
Test sets	553,091
Transceivers	510,863
Transducers	227,550
Transmission assys	231,797
Transmitters	45,211
Transponders	759,985
Tubes, electron	2,794,867
Tubes, klystron	815,064
Tubes, magnetron	2,255,640
Vibration exciter system	27,927
Viewing set, infrared	375,166
X-Ray equipment	43,240

1961 Receiving Tube Sales

December	29,052,000	\$25,084,000
November	32,636,000	26,561,000
October	32,480,000	26,155,000
September	37,611,000	30,472,000
August	36,907,000	31,347,000
July	27,566,000	20,979,000
June	31,463,000	25,989,000
May	29,823,000	25,308,000
April	28,687,000	24,392,000
March	36,635,000	30,719,000
February	25,803,000	21,865,000
January	26,343,000	22,227,000

Year-to-date, '61	375,006,000	311,098,000
Year-to-date, '60	393,055,000	331,742,000

Source: E.I.A.

1961 TV Picture Tube Sales

	Units	Dollars
December	709,556	\$14,099,555
November	835,929	16,896,809
October	912,281	18,000,957
September	946,405	18,981,210
August	870,578	17,239,228
July	457,181	9,364,364
June	806,852	15,887,776
May	673,315	13,238,774
April	722,110	14,293,375
March	936,098	18,725,011
February	728,989	14,395,981
January	707,833	14,430,602

Year-to-date, '61	9,306,927	185,553,642
Year-to-date, '60	9,013,671	180,832,131

1961 Factory Sales

	Monaural	Stereo
December	132,822	314,086
November	141,083	358,285
October	151,580	350,254
September	124,142	328,045
August	106,157	242,164
July	70,681	171,331
June	61,533	197,170
May	53,887	142,450
April	53,074	152,974
March	62,396	227,469
February	50,710	204,638
January	80,366	211,383
Year-to-date, '61	1,088,431	2,900,249
Year-to-date, '60	1,183,608	3,339,777

Source: Electronic Industries Assoc.

1961 TV and Radio Production

	Total TV	TV with UHF Tuner	Total Radio	Auto Radio	FM Radio
December	580,262	38,772	1,845,206	658,687	110,822
November	582,952	42,743	1,730,761	588,343	125,184
October	620,815	43,198	1,796,391	576,529	95,318
September	694,580	41,253	2,048,698	591,493	110,174
August	514,674	33,946	1,385,101	451,374	69,090
July	383,378	23,233	1,030,399	320,128	48,114
June	615,118	34,641	1,626,263	518,010	88,808
May	470,399	22,782	1,196,949	408,875	49,705
April	405,808	19,085	1,124,924	375,570	51,260
March	497,458	21,540	1,384,052	384,227	75,044
February	444,418	24,514	1,115,029	307,973	41,357
January	367,935	25,270	1,090,073	387,136	50,421
Year-to-date, '61	6,177,797	370,977	17,373,846	5,568,345	915,297
Year-to-date, '60	5,708,346	428,527	17,126,518	6,432,212	904,766

THERMOFIT

PVC

radiation crosslinked heat-shrinkable polyvinylchloride tubing

STANDARD DIMENSIONS

Size	As Supplied		Recovered Dimensions After Heating		Standard Package Feet
	Minimum I.D. Inches	Maximum I.D. Inches	Wall Thickness (nominal) Inches		
3/64"	.046	.023	.020		500
1/16"	.062	.031	.020		500
3/32"	.093	.046	.020		200
1/8"	.125	.062	.020		200
3/16"	.187	.093	.025		200
1/4"	.250	.125	.025		200
3/8"	.375	.187	.030		200
1/2"	.500	.250	.030		100
3/4"	.750	.375	.035		100
1"	1.000	.500	.040		100
1 1/2"	1.500	.750	.045		100
2"	2.000	1.000	.050		50
3"	3.000	1.500	.055		50
4"	4.000	2.000	.060		50

NOTES:

Wall thickness will be less if tubing is restricted during recovery.
Standard color — black.
Supplied on reels.
Standard package: as indicated; no more than three lengths per package.

BUS BAR INSULATION

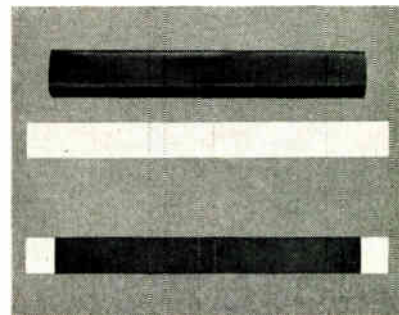

HARNESS JACKET

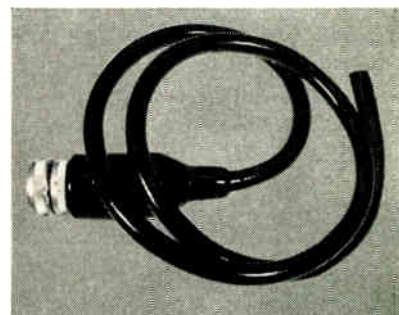

ELASTIC MEMORY

Thermofit PVC is a modified polyvinyl chloride whose molecules have been cross-linked by high-energy electron beam radiation, producing a compound which will not melt or flow at any temperature, and which possesses a unique elastic memory.

When Thermofit PVC is exposed for a few seconds to a temperature in excess of 350°F, the radiation-induced elastic memory causes an instantaneous shrinkage to the recovered diameter. Lengthwise shrinkage is held to less than 10%.



RAYCLAD TUBES
INCORPORATED

A SUBSIDIARY OF
RAYCHEM
CORPORATION

OAKSIDE AT NORTHSIDE • REDWOOD CITY, CALIF.—AREA CODE 415 • 369-7171 TWX RW 149

News Briefs

Capsule summaries of important happenings in affairs of equipment and component manufacturers

EAST

CLEVITE ELECTRONIC COMPONENTS, DIV. OF CLEVITE CORP., Cleveland, Ohio, has moved its Eastern Region Sales Offices from Maplewood, N. J., to 1 Rockefeller Plaza, New York 20, N. Y.

RCA'S AEROSPACE COMMUNICATIONS AND CONTROLS DIV., DEFENSE ELECTRONIC PRODUCTS, Burlington, Mass. has received a joint NASA-USAF \$400,000 contract. The contract calls for a nine-month conceptual study of an Operation Flight Control Scheme for SATURN class space vehicles.

LAVOIE LABORATORIES, INC., Morganville, N. J., has increased its production facilities by 5,000 sq. ft., with the construction of a new building to house its Test Dept.

SYSTEMS INC., Orlando, Fla., has consolidated its production of precision quartz crystals and the manufacture of crystal filters into one plant, located at 31 N. Coburn St., Orlando, Fla.

MELPAR INC., SUBS. OF WESTINGHOUSE AIR BRAKE CORP., Falls Church, Va., has announced plans to situate a subsidiary plant in Fairmont, W. Va. The new organization will be known as MELPAR-FAIRMONT, INC.

ATLANTIC RESEARCH CORP., Alexandria, Va., has acquired the **GENERAL COMMUNICATION CO.** of Boston, Mass. The acquisition was accomplished through an exchange of stock. Atlantic Research's electronic interests now include its Jansky & Bailey Div., Electromechanical Div., and another subsidiary, Northeastern Engineering, Inc., Manchester, N. H.

The directors of **AMERICAN ELECTRONIC LABORATORIES, INC.**, Lansdale, Pa., at a special meeting of the Board, proposed a 2-for-1 split in both classes of common stock. AEL currently has 116,960 shares of common stock outstanding.

MICROWAVE ASSOCIATES, INC., Burlington, Mass., has announced the receipt of R&D contracts totalling \$236,000. Two contracts of over \$112,000 cover low-noise microwave diode development and the application of microwave semiconductor devices in high power switching systems and is USAF sponsored. Two additional contracts in excess of \$123,000, cover tunnel diode R&D and development work on high power gaseous switching devices and is sponsored by the U. S. Army.

AMERICAN MACHINE & FOUNDRY CO., New York, N. Y., is to be the major tenant of the new Madison Square Garden Center to be built at ground level above the Pennsylvania and Long Island Railroad Stations in New York City. AMF plans to lease 12 floors totalling 229,000 sq. ft. as its new executive world headquarters in the 30-story office building. The building will be known as the AMF Tower.

GENERAL DYNAMICS CORP., New York, N. Y., has been awarded a \$7.6 million contract by the USAF Ballistic Systems Div. for communication systems at three additional Titan, ICBM bases and a training facility. The system will be installed at Davis-Monthan, McConnell, Little Rock and Vandenberg AF Bases. Previous systems have been installed at Lowry, Ellsworth, Beals, Larson and Mt. Home AFBs.

WESTINGHOUSE ELECTRIC CORP., Baltimore, Md., announces the formation of a new department to coordinate and manage the company's efforts and those of its major subcontractors on large defense systems. The **SYSTEMS DEPT.** is the fifth major organization to be added to the Westinghouse Defense Center.

FAIRCHILD CAMERA AND INSTRUMENT CORP., Syosset, L. I., N. Y., is acquiring all property, business and assets of **COSMIC CORP.**, El Cajon, Calif. Cosmic Corp. produces rocket engine and cryogenic sub-systems for missiles, spacecraft and nuclear uses. The agreement calls for an undisclosed number of shares of the authorized and unissued common stock of Fairchild Camera.

XEROX CORP., Rochester, N. Y. has announced plans to acquire **UNIVERSITY MICROFILMS, INC.** Ann Arbor, Mich. University will operate as a wholly-owned subsidiary of Xerox, under its present management. Xerox will pay a little more than 1% of its current outstanding common stock for University under terms of the agreement.

RAYTHEON CO., has awarded a \$300,000 contract to **ADVANCED ELECTRONICS CORP.**, Hicksville, N. Y. for telemetry equipment for the Hawk missile. Advanced also supplies equipment for the Pershing, and Terrier-Tartar missiles.

GENERAL TELEPHONE & ELECTRONICS CORP., New York, N. Y. has announced plans to merge its **LEICH SALES CORP.** into its **AUTOMATIC ELECTRIC SALES CORP.** Headquarters for the marketing subsidiary of **AUTOMATIC ELECTRIC CO.** will continue to be at Northlake, Ill.

SPERRY GYROSCOPE CO., DIV. OF SPERRY RAND CORP., Great Neck, N. Y., has announced receipt of \$15 million from the U. S. Navy for design, production and installation of navigation equipment aboard 10 new, Lafayette class, Polaris submarines. The Lafayette class ships are scheduled to be in service with the fleet by the end of 1964 and will carry 2,500-mile nuclear-tipped Polaris missiles.

THE LIONEL CORP., has announced receipt of contracts totaling over \$6 million from the Army, Navy, Air Force, and AEC. Partial breakdown includes: **LIONEL ELECTRONICS LABS.**, Brooklyn, N. Y., \$200,000 for radiation rate meter scalars for the AEC and \$315,000 for connectors for the Hawk, Nike Zeus, Sparrow, Polaris, Advanced Polaris and U.S.A.F. Sidewinder. **INTERCONTINENTAL MANUFACTURING CO.**, Garland, Texas, \$1,490,000 for motor cases, nose cones and nozzles for the Scout, Nike Hercules and Honest John missiles, and air frames and assemblies for the Navy's F8U-2 Crusader.

MIDDLE WEST

RADIO CORP. OF AMERICA has awarded the J-V-M DIV. of **FIDELITONE MICROWAVE, INC.**, Brookfield, Ill., initial production contracts approaching \$1 million. J-V-M will furnish the r-f assemblies for the RCA DME and commercial transponder.

THE BENDIX CORP., Detroit, Mich., has entered into a contract to acquire the business and assets of **GREENBRIER INSTRUMENTS, INC.**, Roncerverte, W. Va. Greenbrier will continue operations in Roncerverte under its present management as a wholly owned subsidiary of Bendix.

OAK MANUFACTURING CO., Crystal Lake, Ill., has acquired **DELTA-F, INC.**, Geneva, Ill., manufacturer of freq. control systems. The purchase was made for an undisclosed amount of cash. Delta-f will be operated under its present management as a subsidiary of McCoy Electronic Co., acquired by Oak in 1961.

VITRO CHEMICAL CO., Chattanooga, Tenn. has received a contract from the A.E.C. (Atomic Energy Commission) to supply 20 tons of Thorium metal ingots to the AEC's facilities at Savannah River. Value of the contract is estimated to exceed \$600,000.

WEST

ULTRASONICS SYSTEMS, INC., Los Angeles, Calif., has consolidated with **DURABOND BEARING CO.**, Palo Alto, Calif. Under terms of the acquisition, Ultrasonics will operate as a wholly-owned subsidiary of Dura-Bond.

The management group of **THE KEARFOTT MICROWAVE DIV.**, Van Nuys, Calif., have formed a corporation and purchased the assets of that facility from the parent corporation, **KEARFOTT DIV., GENERAL PRECISION, INC.**, Little Falls, N. J. The new corporation will be known as **MICRO-RADIONICS, INC.**, and will continue its manufacturing and engineering operations at its present location, 14844 Oxnard St., Van Nuys, Calif.

BRUSH INSTRUMENTS, DIV. OF CLEVITE CORP., Cleveland, Ohio, has established a new district office at 300 Speer Blvd., Denver, Colo.

SYLVANIA ELECTRIC PRODUCTS, INC., has announced plans for a 77,000 sq. ft. addition to its **RECONNAISSANCE SYSTEMS LABORATORY** in Mountain View, Calif. The new 2-story addition is expected to be ready for occupancy this summer. It will bring Sylvania's total operating floor space at Mountain View to more than 375,000 sq. ft.

MILITARY PRODUCTS DIV., HOFFMAN ELECTRONICS CORP., Los Angeles, Calif., has received an initial letter contract to produce \$648,178 worth of specialized **TACAN AN/ARN-66(V)** radio navigation sets for the Aeronautical Systems Div., Wright-Patterson AFB, Ohio.

HUGHES AIRCRAFT CO., Culver City, Calif., has been awarded a follow-on contract in excess of \$750,000 for continued development of an advanced guidance unit for the Mauler tactical air defense system missile. The award was made by the **POMONA DIV., GENERAL DYNAMICS CORP.**, prime contractor on the Mauler to the U. S. Army.

UNITED TRANSFORMER CORP., New York, N. Y., has announced the opening of its expanded Pacific Div. in newer and larger facilities at 3630 Eastham Dr., Culver City, Calif.

PERMALUSTER, INC. has relocated in larger facilities at 2801 W. Olive Ave., Burbank, Calif. This move has increased manufacturing space to 6,000 sq. ft.

TEXAS INSTRUMENTS INCORPORATED, Dallas, Tex., has been awarded a \$370,000 contract by the Electronics Systems Div., USAF Systems Command, for design, development and manufacture of a full duplex digital vocoder system.

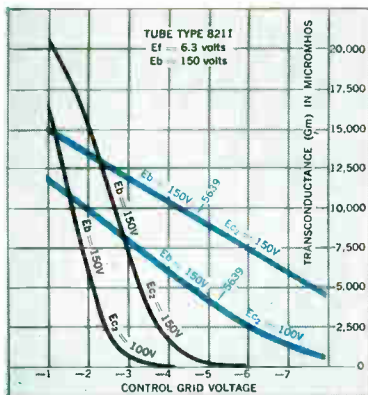

NEW!

Sylvania High Gm Pentode

Unusually sharp cutoff characteristics for video amplifier applications, servo-drive or series pass circuits

Curves, shown above, comparing cutoff characteristics of SYLVANIA 8211 with its prototype, provide striking evidence of the improvements gained through the use of a strap frame control grid. Strap frame grid also contributes substantially to the high transconductance of 13,500 μ mhos which, shown in a ratio to plate current of 10mA, provides an excellent figure for Gm to Ib. A further outstanding feature of 8211, high power sensitivity, makes it well suited for use as a high-efficiency servo driver or series pass tube.



NEW!

Sylvania Sharp Cutoff Pentode

for RF, IF amplifier service to 400 Mc offers 50% greater G x BW

SYLVANIA 8210 combines strap frame control grid with these unusual design advantages over prototype—improved heater requires less power (Ef = 6.3V, If = 125 mA), offers cooler operation and extended life; grid #1 lead is brought out the top of the envelope, thereby reducing plate to grid capacitance. Too, 8210 offers a higher Gm of 8500 μ mhos contributing to a 40% improvement in maxim stable gain $\left(\sqrt{\frac{GM}{2\pi f_{cg} p}}\right)$ of $\frac{326}{\sqrt{f_{mc}}}$ and a better gain bandwidth product of 92 Mc.

Now there are 9 strap frame

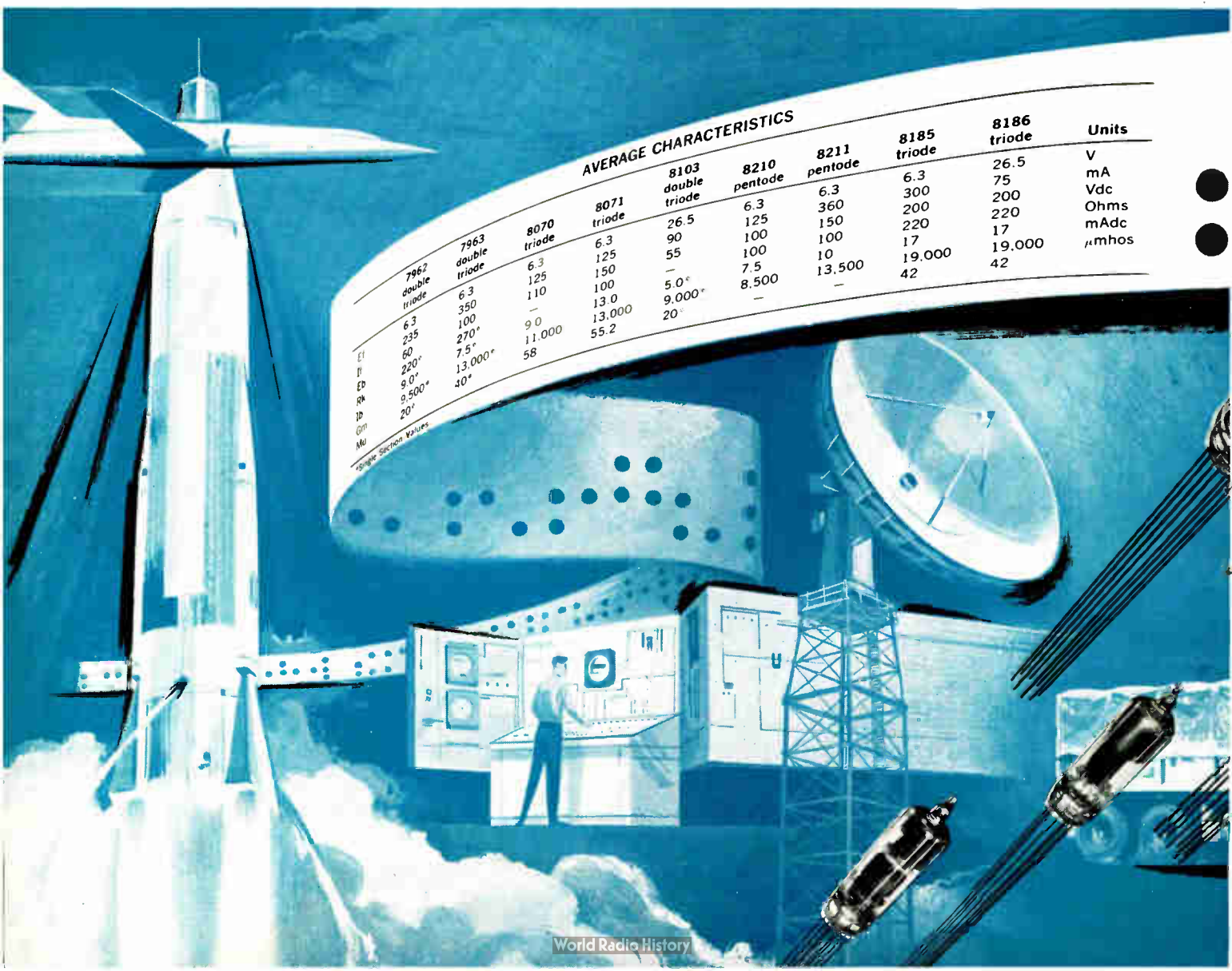

AVERAGE CHARACTERISTICS							8185 triode	8186 triode	Units	
	7962 double triode	7963 double triode	8070 triode	8071 triode	8103 double triode	8210 pentode	8211 pentode	8185 triode	8186 triode	
Ef	6.3	6.3	6.3	6.3	26.5	6.3	6.3	6.3	26.5	V
If	235	350	125	125	90	125	360	300	75	mA
Eb	60	100	150	150	55	100	200	200	200	Vdc
Rk	9.0°	270°	110	100	5.0°	100	150	220	220	Ohms
Ib	9.500*	13.000*	9.0	13.0	9.000*	7.5	100	17	17	mAdc
Gm	20°	40°	11.000	13.000	20°	8.500	13.500	19.000	19.000	μ mhos
Mu			58	55.2				42	42	

*Single Section Values

Grounded Grid RF Amplifier—235Mc

Plate Voltage	200 Vdc
Cathode Resistor	200 Ohms
Plate Current	36 mAdc
Grid Current	7 mAdc
RF Driving Power (Approx.)	0.5 Watts
Power Output	3.9 Watts
Plate Efficiency	55%

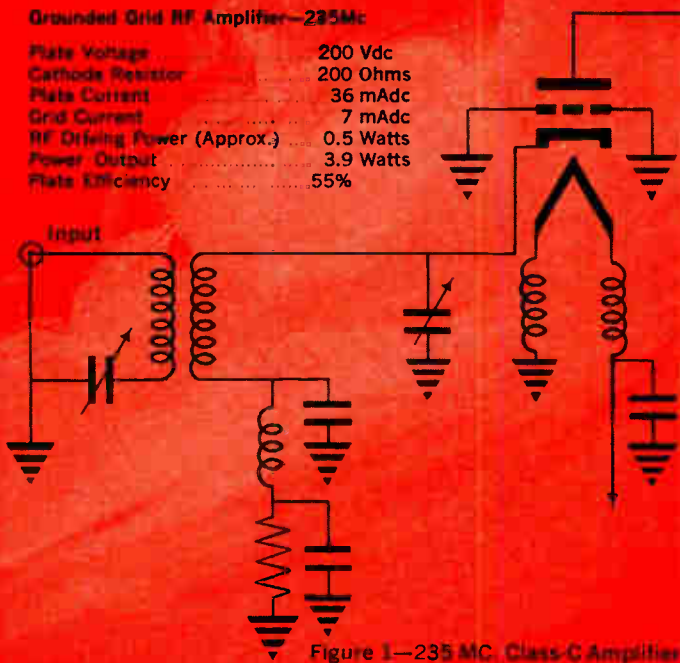
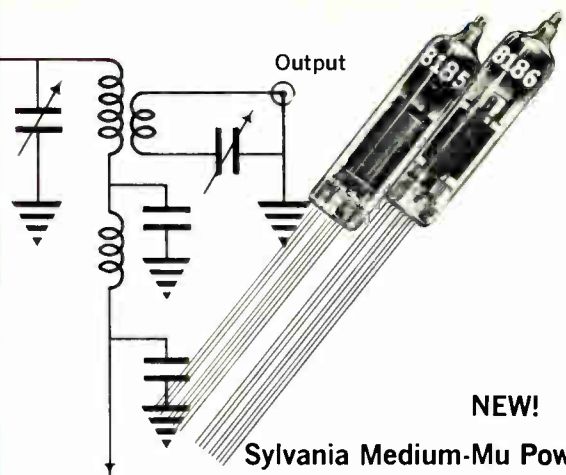

Figure 1—235 MC. Class-C Amplifier



NEW!

Sylvania Medium-Mu Power Triodes offer Gm of 19,000 μ hos

SYLVANIA-8185 is designed for use as a grounded grid RF power amplifier in the VHF, UHF regions in critical applications of communications, telemetering and guidance equipment.

SYLVANIA-8186 is identical to 8185 except for heater characteristics. 8186 has a 26.5V heater; 8185 has a 6.3V heater.

grid subminiature tubes...

offering high performance and high reliability

"Forced" to compromise high performance for high reliability? No longer! Not with Sylvania strap frame grid subminiature tubes in your design. Specify from 9 Gold Brand premium types, including 2 new pentodes, 2 new triodes. Compare a few of their advantages:

- High gain • Low noise • Excellent gain bandwidth product • Exceptional Gm to Ib ratio • Unusual electrical stability • Inherent resiliency to voltage surges • High uniformity, interchangeability • Improved cutoff characteristics • Radiation tolerance of 10^{12} nv dose rate and 10^{16} nvt total dosage • Resistance to shock of 500g, temperature of 180°C • Extraordinary storage life • Specified base failure rates (percent per 1000 hours)

Your Sylvania Sales Engineer can detail the many advantages strap frame grid subminiature tubes offer for your design. Ask him. For data on specific types write Electronic Tubes Division, Sylvania Electric Products Inc., 1100 Main Street, Buffalo 9, New York.



SYLVANIA

SUBSIDIARY OF

GENERAL TELEPHONE & ELECTRONICS



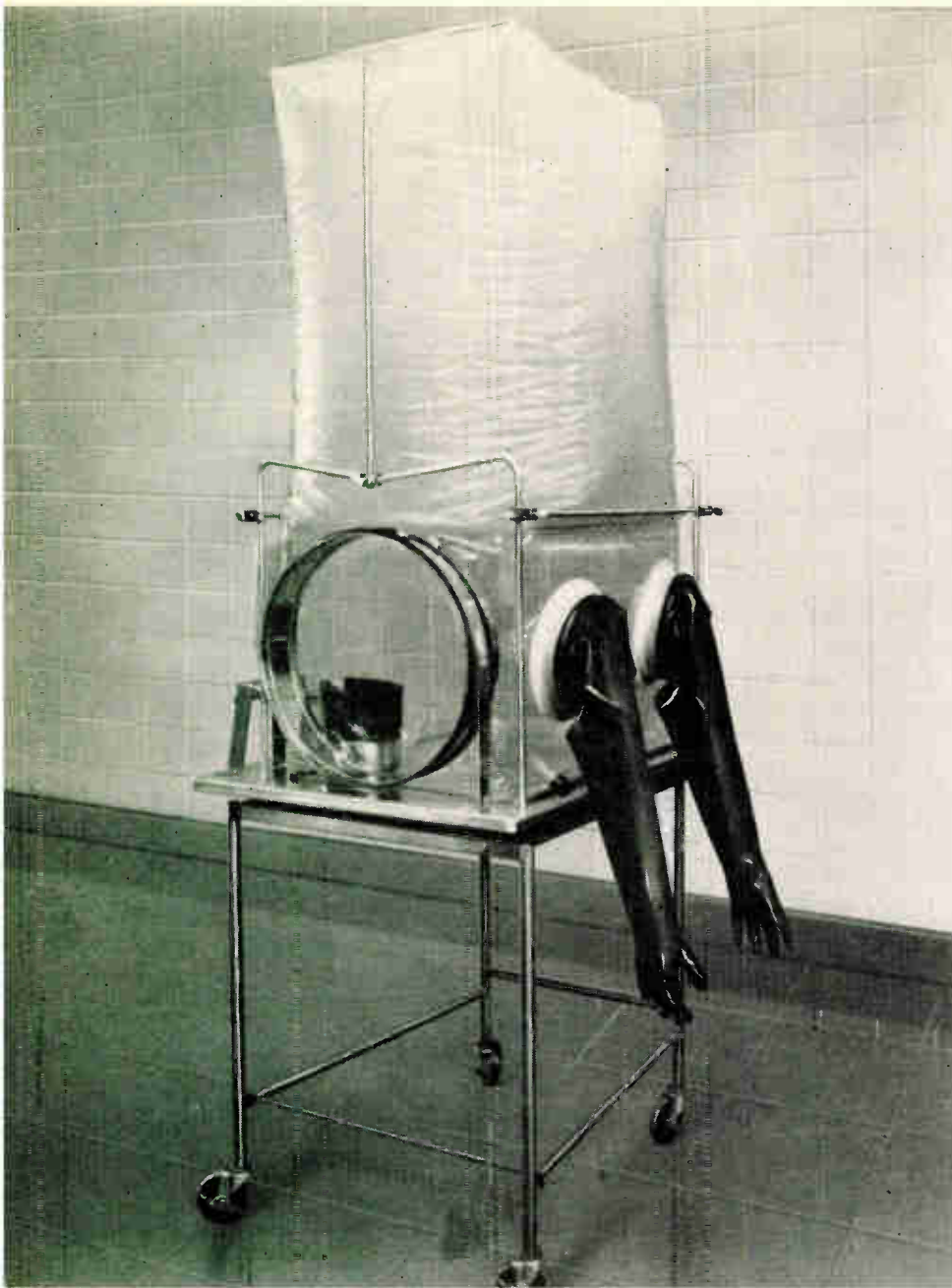

ONE PIECE REFLECTOR

Largest precision parabolic reflector ever successfully fabricated in one piece, has been delivered by Electronic Specialty Co., Los Angeles, Calif., to the Lincoln Laboratory of the Massachusetts Institute of Technology. Reflector is 28 ft. in diameter.

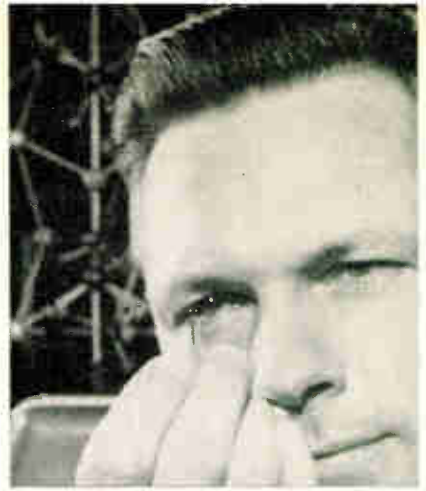

YIG RESONATOR

Spherical resonator of yttrium iron garnet (YIG) used in making measurements of the acoustic loss of the material is examined by C. LeCraw. Bell Telephone Labs measurements have shown that, over a wide frequency range, YIG has a lower acoustic loss than quartz, the best previously known material.

"SO TIRED"

Apparatus designed for sterilizing components used in space craft is made by American Sterilizer Co., Erie, Pa. It is intended for exposure of the components to ethylene oxide gas. It permits later studies to determine whether exposure to the sterilant gas alters any function of the components sterilized. The studies also determine whether sterility has been obtained.

Snapshots . . . of the Electronic Industries

NEW OPTICAL MASER

New Minneapolis-Honeywell optical maser is demonstrated by scientist J. Killpatrick. He observes pink glow caused by exciting helium and neon gas in a glass tube in the process of producing a continuous wave maser (laser) action. This maser is believed to be only the fourth such operating device.

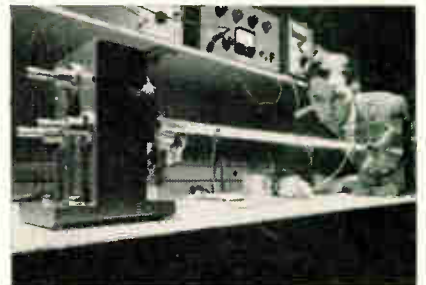



CARBON BOIL

In a demonstration of carbon boil, sparks shoot from the vaporizing remains of a razor blade (high-quality steel with a melting point of 3000° F.) as it is heated well beyond that point. Developed by Baird-Atomic, Inc., Cambridge, Mass., the furnace produces a temperature of 5000° F in 3 secs. Graphite cloth heating elements are supplied by National Carbon Company.

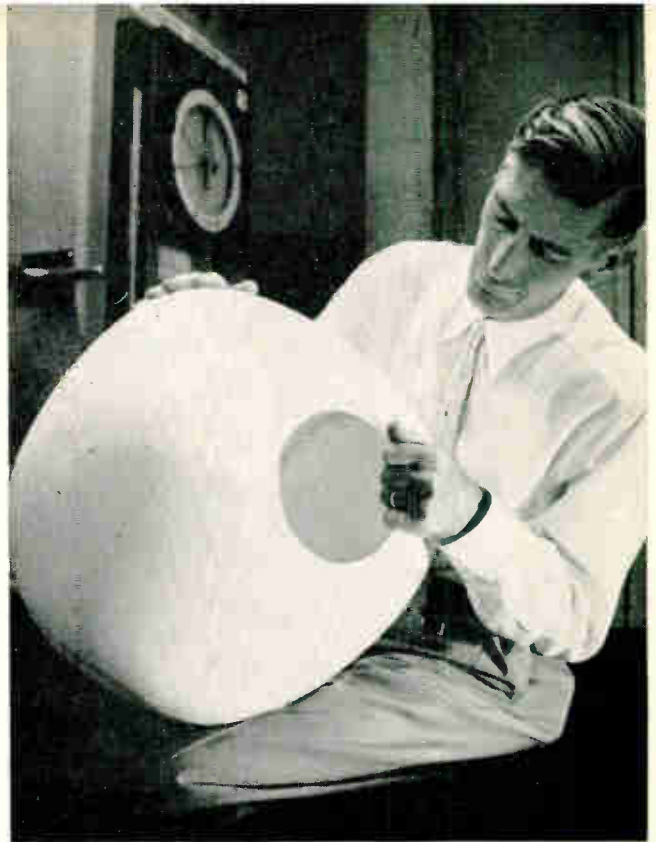

SPACE MATERIALS

Sphere made of special "rigidizing" materials is shown after surface has hardened. It is hoped that these materials, being developed by Westinghouse, can be tightly packaged as a missile payload, and then inflate and become structurally strong once put into orbit.

COIL WINDER

Lesona Corp. Coil Winding Machine has from six to twelve winder heads. It will wind from 400 to 1000 coils per hr. in AWC 16 to 50 and finer. Individually-powered heads will wind all sizes of coils up to 3" in diameter by 2³/₈" in length, and will wind two or more coils at the same time.



GIANT-SIZED LAMP

This 50 kw lamp which can operate on ordinary 100 volt household current, is the largest electric bulb in the world. Built by Tokyo Shibaura Electric Company (Toshiba), the lamp develops enough light to read a newspaper by at 1,968 ft. The lamp has a diameter of 20.5 in. and is 35.9 in. long. It weighs 50.8 lbs. Equipped with a reflector it is 47,300 times brighter than an ordinary bulb.



FINGERTIP CONTROL

William F. Alexander, Hughes Aircraft Co. engineer, displays new "ball tracker" which instantly centers the tracking "pip" on a radar screen, saving valuable time in detecting targets. Tracker is U.S. Armed Forces' device for tracking aircraft or missiles.

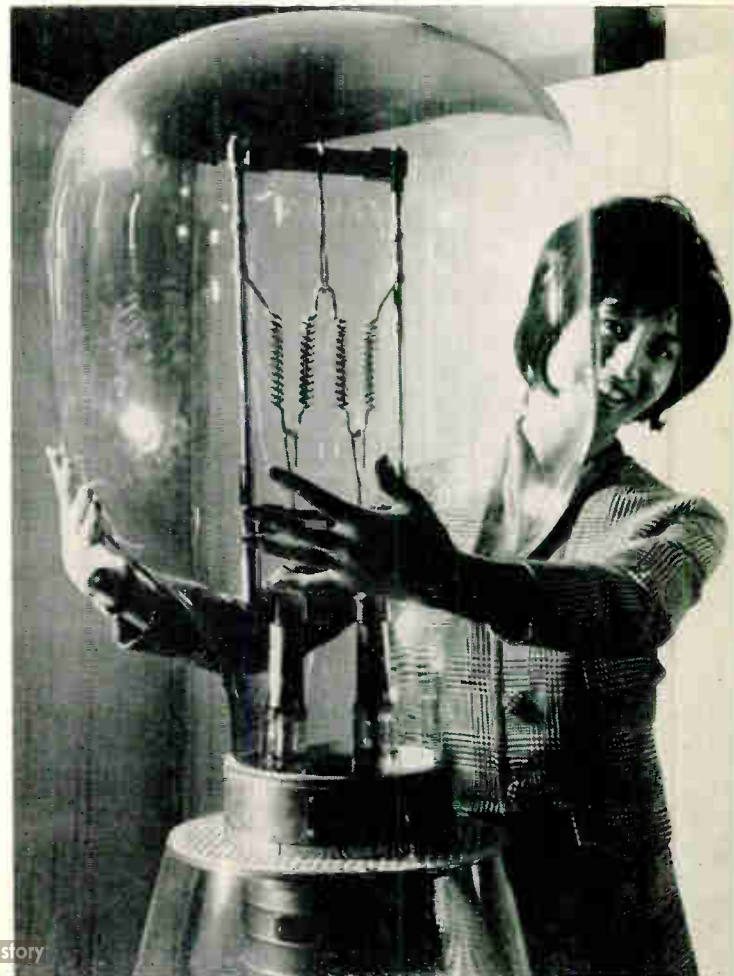

G-E TETRODES AND TRIODES OFFER . . .

HIGHEST AVAILABLE POWER AND DUTY RATINGS TO MEET NEW IFF REQUIREMENTS

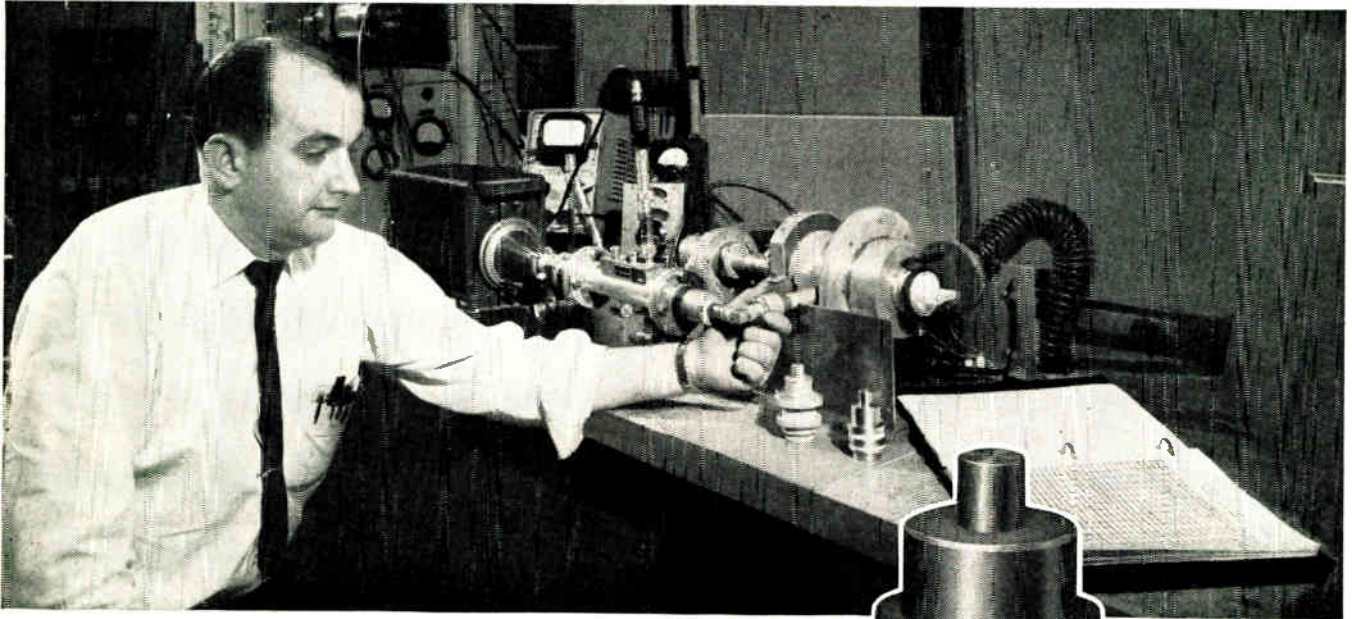

GL-7399 long life is proved in IFF cavity designed by Power Tube Department.

New General Electric metal-ceramic, negative-grid transmitting tubes permit operation at peak power levels up to 10 kw and duty cycles up to .02.

Their outstanding electrical performance and compact mechanical construction simplify military and commercial IFF equipment design, with greater reliability for airborne and ground applications.

For instance, Type ZP-1018 has gain capability up to twice that of any tube type in its class. High power gain in grid-pulsed amplifier service eliminates need for a modulator, offering space- and weight-saving opportunities in circuit design. Heat-sink conduction cooling also reduces component requirements, minimizes package size. Longer life and more reliable performance are achieved by use of a cathode area seven times that of tubes commonly employed in this service.

Type ZP-1025 features internal feedback—an industry first for a tube of its size—which simplifies cavity design for oscillator service in transponders.

TO ORDER, or obtain more information, call your Power Tube Sales Office. 265-18

POWER TUBE DEPARTMENT

GENERAL  ELECTRIC

TELEPHONE TODAY:

SyracuseOL 2-5102	ChicagoSP 7-1600
New YorkWI 7-4065	DaytonBA 3-7151
Clifton, N. J.GR 3-6387	Orlando, Fla.GA 4-6280
Washington, D.C.EX 3-3600	Los AngelesGR 9-7765

ZP-1025 (shown 2 3/8" actual size) reflects design trend in G-E IFF tubes.

TYPICAL OPERATION FOR TUBES NOW IN FAMILY

Tube	IFF Application	Service	Frequency mc	Peak Power KW	Duty
GL-7399	Ground-based Interrogator	Grid-Pulsed Amplifier	1030	10	.01
ZP-1015	Airborne Interrogator	Grid-Pulsed Amplifier	1030	10	.01
ZP-1018	Airborne Transponder	Grid-Pulsed Amplifier	1090	2	.02
ZP-1025	Airborne Transponder	Oscillator	1090	2	.02



GROWTH

has
many

dimensions

... it can be measured by pure statistics:

Employment up 40% in 1 year
Plant space up 900% in 3 years
Sales up 100% in 2 years

... it can be measured by product development:

3 capacitor designs — 1955
12 capacitor designs — 1958
20 capacitor designs — 1961

... it can be measured by the utilization of human resources:

Sales management increased 30% in 1 year
Engineering management increased 50% in 1 year
Production management increased 60% in 1 year

If interested in knowing more about product lines circle number below on reader service card.

If interested in knowing more about a growth company send resume to: Personnel Department, Vitramon, Inc. Box 544, Bridgeport 1, Connecticut. Inquiries receive immediate attention in strict confidence.

Pioneering in Solid State Materials

Vitramon[®]
INCORPORATED

Box 544 • Bridgeport 1, Connecticut

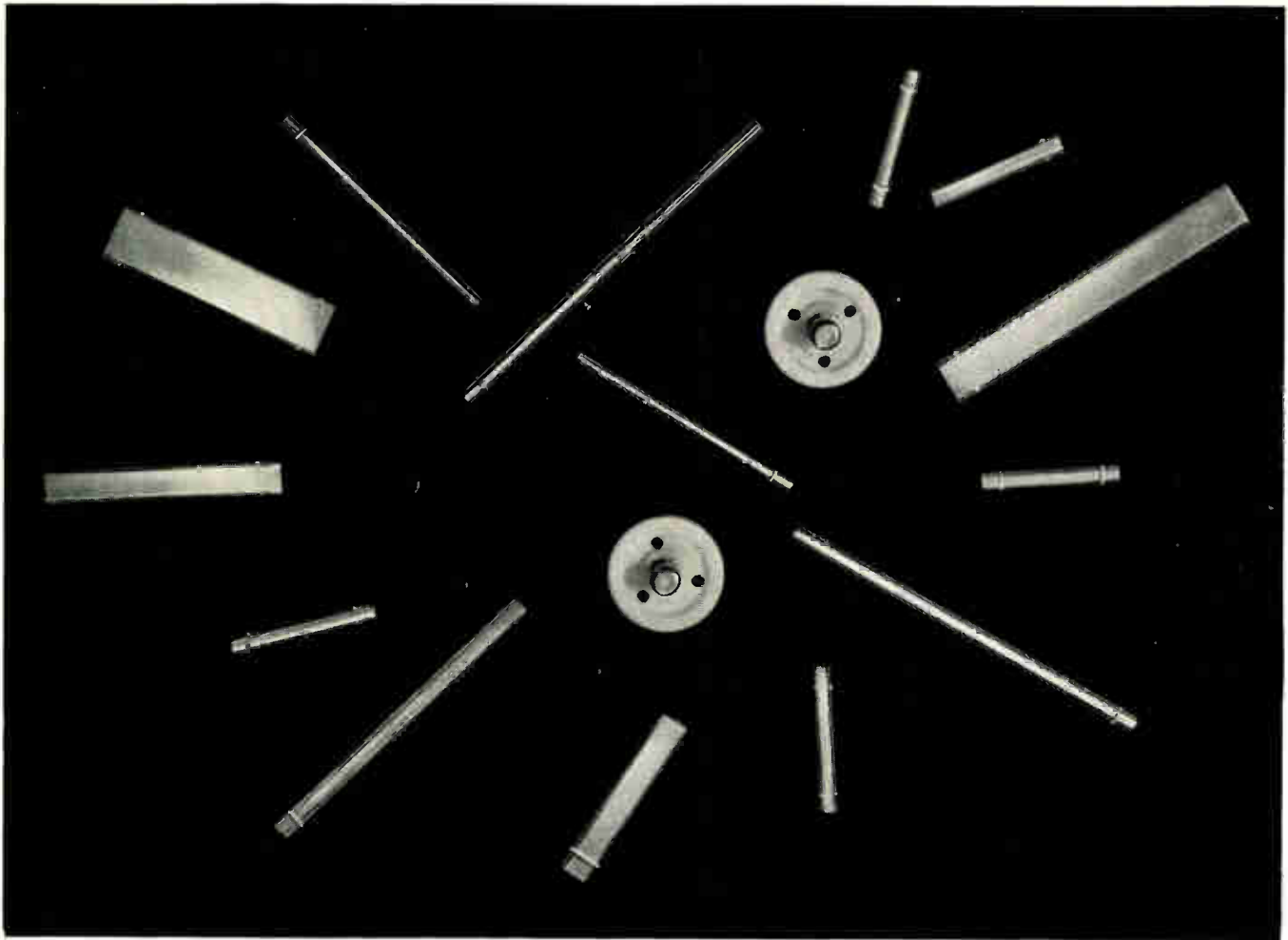

Superior Tube leads the way in cathode progress—offers you a complete line covering all needs.

THIS ADVERTISEMENT IS PRIVATE— FOR ELECTRON TUBE DESIGNERS ONLY

Which of these cathode developments means most to you?
Which do you need right now? Which will you need tomorrow?

1. Low-power disc cathodes. Superior's miniature disc cathodes give a satisfactory electron beam with only $\frac{1}{2}$ to $\frac{3}{4}$ the heater power required by standard sizes. New triangular hole ceramics reduce heater requirements still further, in addition to improving "warm-up" characteristics. Contact area is 60% less than with round hole ceramics.

2. Controlled E-dimension. In the manufacture of disc cathodes, Superior Tube controls E-dimension to within .0005 in. of specification. This permits interchangeability in tube assembly. Likewise it insures a uniformity of cut-off characteristic of tubes and permits use of a less costly fixed resistor in the grid circuit.

3. No seams. Superior's Weldrawn® process makes available no-seam cathodes in many materials not available in regular seamless form. Weldrawn cathodes are made by welding flat strip and cold drawing to desired dimensions.

4. All purpose cathode alloy. New Superior Tube Alloy X-3012 combines both the high emission capacity of active alloys and the long life normally associated with passive alloys. In addition, sublimation and interface impedance are reduced practically to zero. This alloy has twice the hot strength of ordinary nickel alloys and can take high current and overvoltage abuse. X-3012 is available in both sleeve and disc types.

5. Special alloys. The Cathaloy® series of cathode alloys was developed by Superior to provide a few alloys of broad application capable of meeting any cathode requirements, plus offering certain properties not available in other cathode alloys. These alloys greatly simplify cathode alloy selection. Their composition is carefully controlled, and electron tube tests of individual heats are made in Superior's Electronic Laboratory.

Do you have a copy of Superior's catalog No. 51 covering its complete line of cathodes and other electronic tubing products? Write Superior Tube Company, 2502 Germantown Ave., Norristown, Pa.

Superior Tube 

The big name in small tubing
NORRISTOWN, PA.

Johnson & Hoffman Mfg. Corp., Mineola, N.Y.
—an affiliated company making precision metal stampings and deep-drawn parts

Here's a new "twist" for the specialized application:

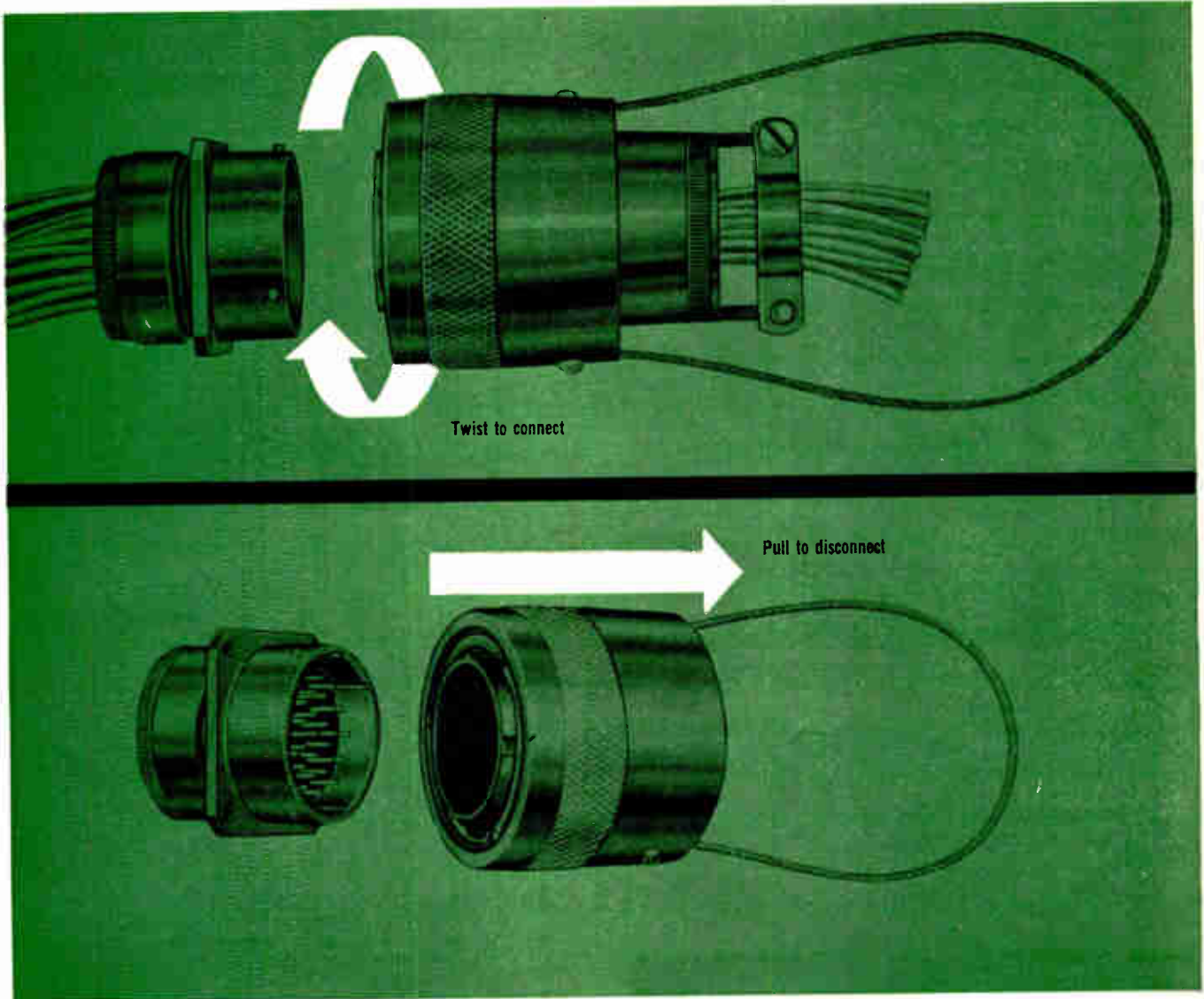

Bendix "TWIST / PULL" Pygmy Electrical Connector

This new Bendix® Pygmy® Electrical Connector uniquely combines positive coupling and pull-to-disconnect features. It is connected by a twist; disconnected either by hand or, remotely, by lanyard.

Complete intermateability with PT receptacles is achieved through use of standard Pygmy PT plug shells, five-key polarization, and three-point bayonet lock coupling. The "twist/pull" design assures inter-facial sealing and meets the performance requirements of MIL-C-26482.

Resilient inserts assure extreme vibration resistance and provide support for size 20 or 16 gold-plated Pygmy contacts of either the solder or removable crimp type. Plating options for the aluminum shell components are: cadmium with an olive drab chromate after treatment, or alumilite hard anodic coating.

Write us at Sidney, New York, for your copy of our informative technical bulletin SL-102, giving complete information on shell sizes and arrangements, as well as helpful design and dimensional data.

Scintilla Division



Canadian Affiliate: Aviation Electric, Ltd., 200 Laurentien Blvd., Montreal 9, Quebec. Export Sales & Service: Bendix International, 205 E. 42nd St., New York 17, N. Y.

ENGLAND**Royal Navy Orders
EMIDEC Computer**

Stock records of naval stores for H. M. ships, held at the Royal Naval Stores Depot at Copenacre, Wiltshire, will soon be maintained by a EMIDEC 1100 computer. EMI Electronics Ltd. recently delivered the computer to the Depot.

The computer, which will include several magnetic tape units, will also maintain lists of components for different types of electronic equipment. EMIDEC will work out complete lists of components needed, look up the stock record and confirm availability, debit the stock record and prepare printed invoices for the items to be dispatched to the ships. Computer will also perform the calculation of future requirements of stores to be ordered from manufacturers, and the recording of subsequent contracts placed and deliveries received.

Companies Pool Resources

General Electric Co. Ltd. and Mullard Ltd., have agreed to pool their resources in the field of semiconductors. This step has been taken in view of the prospect of growing foreign competition and wider opportunities overseas, particularly if Britain enters the European Common Market. It will facilitate further increase in the exports of each company in this field. Large-scale manufacturing resources thus made available can support the growing R&D facilities needed to meet present and future demands.

**NATO Building High-power
Radio-Telegraph Station**

NATO is building a high-power VLF radio-telegraph station on the coast of Cumberland.

Prime essential for this station is reliability. Accordingly, high power and a 19 KC frequency will be used to ensure that transmissions will be as immune as possible to the effects of ionospheric disturbances. To avoid interruptions, the transmitter will be built of duplicate sections which can be worked individually or in parallel. Site is located at the end of a peninsula in a region of fairly flat land of low resistivity.

Transmitter will be comprised of a 50 mw drive stage, followed by five stages of amplification. It will be capable of delivering a peak power of 500 kw into the antenna at its working frequency.

Continental Electronics Systems, Inc. of Dallas, Texas, whose British associates are Redifon Ltd., London, have been awarded a contract for the design and provision of this station. Masts and antennas will be supplied and erected by British Insulated Callender's Construction Co. Ltd. under subcontracts.

IRELAND**New Plant for STC**

Standard Telephones and Cables Ltd., British associate of International Telephone and Telegraph Corp. will establish a plant in northern Ireland to build telephones and telephone exchange equipment. The plant will be at Monkstown, about eight miles from Belfast, on the northwest shore of Belfast Lough.

X-RAY TEST

Technician uses new industrial gauge to measure thickness of plating layers without harming the finish on an automobile bumper. Gauge was developed at the Ontario Research Foundation, Toronto, Canada. An electron beam does the probing, and X-rays sent back from the surface of the base material tell when the film has been penetrated.

JAPAN**New Electronics
Company Formed**

Raytheon Co., Lexington, Mass. and Japan Radio Co., Ltd. Tokyo, have completed plans to form and operate a new electronics company in Japan. It is expected to be in operation soon.

To be known as the New Japan Radio Co., the firm will engineer and produce a complete line of microwave tubes. Administrative headquarters will be in Tokyo. Engineering, manufacturing and warehousing will be in Mitaka, a Tokyo suburb. New company's products will be marketed in Japan and the Far East by the Japan Radio Co.

**Transpacific Cable
To Be Laid in 1964**

AT&T Co., Hawaiian Telephone Co. and Kokusai Den shin Denwa Co., Ltd. of Japan, have signed an agreement for a transpacific telephone cable to be laid in 1964.

The \$84 million project will be one of the most extensive ocean cable systems ever undertaken. Cable will stretch some 6,300 mi. between Hawaii and Japan, routed via the islands of Midway, Wake and Guam. It will have a capacity of 128 simultaneous conversations.

AT&T's Long Lines Dept., will build and operate the Hawaii-Japan system in conjunction with the Hawaiian Co. and K. D. D., the Japanese overseas telecommunications company.

(Continued on page 36)

**OLYMPIC
SCORER**

Dr. F. Wolfgang, sec. gen. of the Organizing Com. for the IX Olympic Winter Games, B. Neumann, press mgr. and W. A. Boesenberg, gen. sales mgr. of IBM, Germany (l to r) watch operation of 600-line/min. printer in IBM computing system of the same type that will be used to score the 1964 Winter Games at Innsbruck, Austria.

MINUTEMAN RELIABILITY AVAILABLE FROM FAIRCHILD

Under the auspices of Autonetics, a division of North American Aviation, Inc., Fairchild has completed the most comprehensive reliability program in the semiconductor industry. The results of this program demonstrate that Fairchild reliability is not a claim — it's a fact. MINUTEMAN parts — with proven reliability — are now available in quantity through your nearest Fairchild Sales Office.

MINUTEMAN FAIRCHILD RELIABILITY EVALUATION RESULTS

FAIRCHILD 2N1613 MINUTEMAN PART NO. 853M

Environmental Conditions	No. of Units	Millions of Transistor Hours	Observed Failure Rate	Upper 60% Confidence Limit
25°C, 10V, 150mW	13,815	45.6	.002	.004
All Units Within Ratings	14,607	46.4	.002	.004

FAIRCHILD 2N1132 MINUTEMAN PART NO. 501M

Environmental Conditions	No. of Units	Millions of Transistor Hours	Observed Failure Rate	Upper 60% Confidence Limit
25°C, 10V, 150mW	21,163	84.6	.004	.005
All Units Within Ratings	21,924	85.5	.004	.005

Note — Failure Rates expressed in %/1000 hours based on assumption of exponential distribution without any acceleration factors.

FAIRCHILD
SEMICONDUCTOR

545 WHISMAN ROAD, MOUNTAIN VIEW, CALIF. • YORKSHIRE 8-8161 • TWX: MN VW CAL 853
A DIVISION OF FAIRCHILD CAMERA AND INSTRUMENT CORPORATION

International News

(Continued from page 34)

SCOTLAND

LFE to Market Scotch Firm's Instruments in U.S.

The Instrument Div. of LFE Electronics expanded its product line when an exclusive agreement was signed with James Scott (Electronic Engineering) Ltd., Glasgow, Scotland, to market the Scottish firm's complete line of Allscott test instruments in the U. S. LFE Electronics is a major operating group of Laboratory For Electronics, Inc.

Under terms of the agreement, the Instrument Div. will handle domestic marketing of Scott's line of Allscott microwave noise measuring equipment, spectrum analyzers, antenna radiation pattern recorders, power units and noise generators. Scott has been United Kingdom representative for the Instrument Div.'s ultra-stable microwave oscillators, stability testers, radar test sets and microwave components since early in 1961.

SWEDEN

LFE Acquires Swedish Firm

Laboratory For Electronics, Inc., has acquired 100% of the Elenik Engineering Co., Stockholm, Sweden. Elenik is a specialist in design, development and production of electronic systems for industrial material handling. These systems integrate instruments for measurement of forces, weight, length, pressure and motion with electronic control equipment such as servoregulators and programming units in order to provide precise control of proportioning and batching operations.

Broadcasting Systems Ordered By Swedish Board

Royal Board of Swedish Telecommunications has placed an order for TV and sound broadcasting transmitters with Marconi's Wireless Telegraph Co. Ltd.

Contract calls for the supply of 21 vision transmitters, 21 sound transmitters, 40 frequency-modulated sound transmitters and a considerable quantity of program input, paralleling, feeder and ancillary equipment.

The transmitters will augment Sweden's TV and VHF frequency-modulated sound broadcasting systems by providing first-class reception in the northern area and in what are at the moment fringe areas throughout the country. Deliveries, at the request of the Royal Board of Swedish Telecommunications, are to be spread over the next four years.

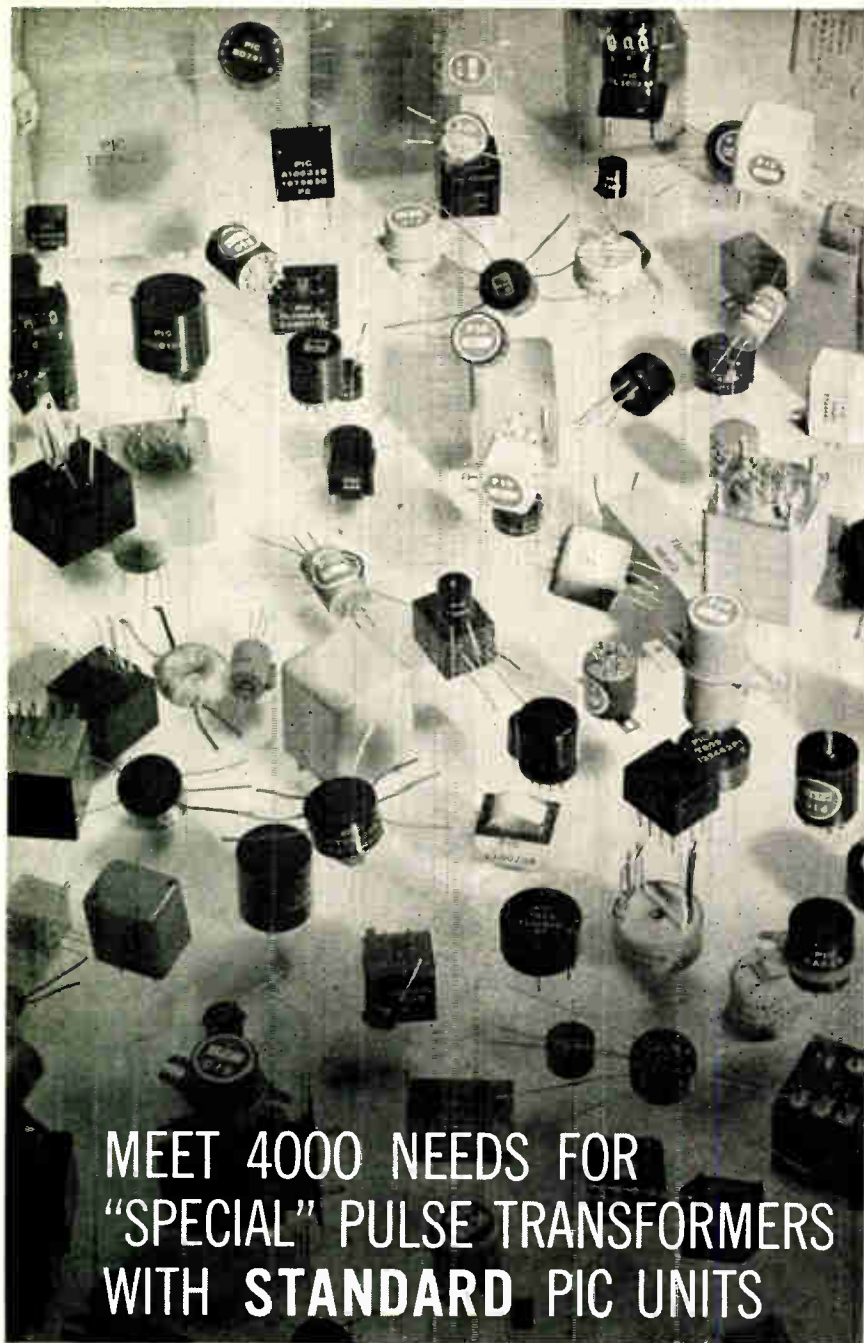

MEET 4000 NEEDS FOR "SPECIAL" PULSE TRANSFORMERS WITH STANDARD PIC UNITS

you can do it by taking these two steps:

1. Check the PIC Selection Guide for Pulse Transformers. It catalogs 68 case style options and 106 electrical types. Then, if this doesn't answer your special requirements . . .
2. Ask PIC to run your pulse transformer specifications through its file of over 4000 production drawings. This file has been increasing at the rate of two new transformer designs per day for more than 14 years. In 8 out of 10 cases a transformer duplicating the spec's you submit can be produced directly from existing production drawings.

Send today for your copy of PIC's Selection Guide for Pulse Transformers. For complete information, write us on your company letterhead.

PIC

POLYPHASE INSTRUMENT COMPANY

Bridgeport, Penna.

TRANSFORMERS • FILTERS • MAGNETIC AMPLIFIERS • DELAY LINES

THE WORLD'S FASTEST COLD CATHODE TRIGGER TUBE

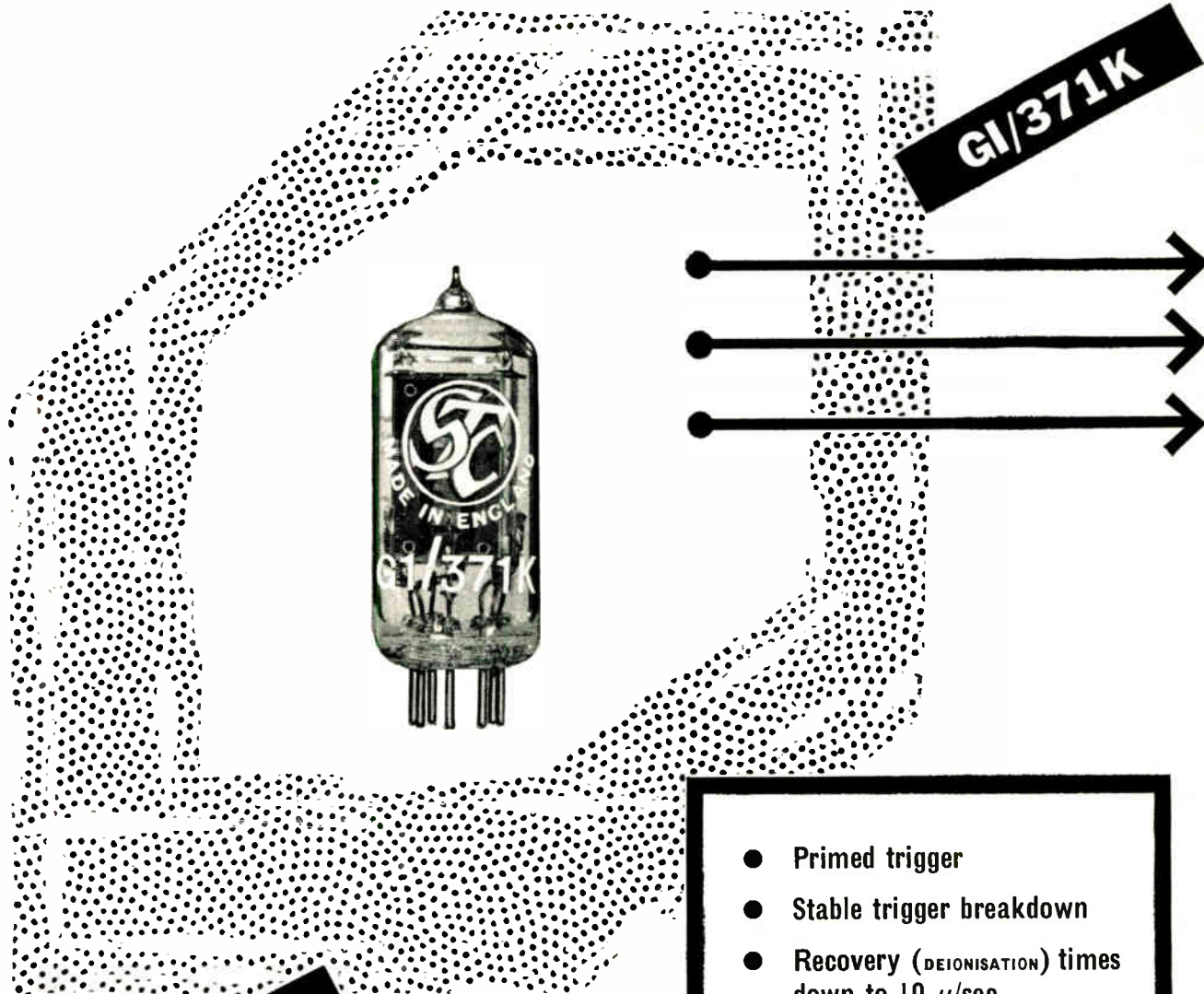

CV2224

Write for new
application
report
MS/118

- Primed trigger
- Stable trigger breakdown
- Recovery (DEIONISATION) times down to 10 μ /sec
- Ring counter operation up to 100 kc/s
- Suitable for use on rectified 200/250V. mains supply.

ITT



62/16MS

Standard Telephones and Cables Limited

VALVE DIVISION : BRIXHAM ROAD · PAIGNTON · DEVON · ENGLAND

USA enquiries for price and delivery to ITT Components Division, P. O. Box 412, Clifton, N.J.

INSTRUMENTS ELECTRONICS AUTOMATION

INTERNATIONAL EXHIBITION

More than 500 British and foreign manufacturers of electronic equipment, scientific instruments and industrial controls will be showing their newest products at the 1962 I.E.A. — the largest exhibition of its kind ever held in the world. If you are in this field, or planning automation in your plant and office, you should be there for the 1962 I.E.A. exhibition will show not only the latest developments in instrumentation and electronic equipment, but also prototypes vital to the world in the years ahead.



LONDON ENGLAND
28 MAY - 2 JUNE 1962

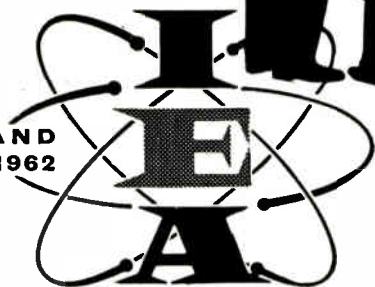

PLAN YOUR VISIT TO LONDON and the I.E.A. NOW

For your Official Invitation Card and further details contact:

INDUSTRIAL EXHIBITIONS LIMITED, 9 ARGYLL STREET, LONDON W.1, ENGLAND

AN **I.E.A.** EXHIBITION

W.H.

Tele-Tips

"HAM" OPERATOR William G. Welsh, an engineering writer at Librascope Inc., Glendale, Calif., is this year's "Ham of the Year," recipient of General Electric's 1961 Edison Radio Amateur Award for public service. Welsh earned the distinction for his efforts at instructing others in code practice, working at it 20 to 30 hours a week.

FACED WITH THE PROBLEM of making a periscope that could be pointed directly into the firing chamber of a rocket engine, engineers at Aerojet-General took a cue from the human eye, used a film of cooling water inside the lens to make it "weep." They also used the "light refraction" qualities of the water for their optic needs.

FUEL CELLS as eventual power sources for automobiles are getting increased attention. At a recent meeting of the AIEE, one paper itemized the probable fuel cell applications chronologically: first, in military equipment, then portable tools and garden equipment, eventually in fork lift trucks and tractors, and finally in automobiles.

AIR TRAFFIC CONTROL operations are making severe physical and emotional demands on airport controllers. The casualty list from the New York Center makes grim reading: three coronary cases, one case of intestinal surgery, one hernia and three ulcer operations.

AT NBS high-speed data processing and display equipment has been programmed to simulate traffic flow over a 9-block length of a principal traffic artery in downtown Washington, D. C. After information on volume of traffic and traffic controls has been fed into the system, the simulated traffic flow is tabulated on printouts and is also shown in a motion picture of simulated cars moving, changing lanes, and stopping for lights, as in a helicopter view of the actual streets.

(Continued on page 42)

Now—A High-Performance Potentiometer For As Little As \$3

NUMBER 15—NEW PRODUCT SERIES

Never before could you find a low price tag on this kind of potentiometer performance. Now—for as little as \$3 a unit in quantity orders—you can buy a single-turn 1/2" wirewound rotary that meets the highest standards for computer and industrial control applications. A Resiston® carbon version, Model 3368, is available at slight extra cost.

Weighing in at a scant .05 ounce, these new 1/2" dia. potentiometers hold residual end-setting resistance from 0 to 1.0% and operate in 105°C heat. Model 3367 (wirewound) dissipates 0.5 watt; Model 3368 (carbon) 0.25 watt. They meet requirements for steady-state humidity and Mil Specs for sand, dust, salt spray and fungus. Designed for convenience, too, they have index points that let you check your setting at a glance.

Model 3367 is available immediately from factory and distributor stocks with resistances of 100Ω to 20K; Model 3368, 20K to 1 Meg. Your choice of printed circuit pins (spaced for interchangeability with more expensive devices) or solder lugs with bushing mount. Units are subjected to 100% and statistical sample inspection, and are included in the rigorous Bourns Reliability Assurance program. Write for complete data and list of stocking distributors.



ACTUAL SIZE

AVAILABLE IMMEDIATELY FROM COAST TO COAST FROM ALMOST 100 STOCKING DISTRIBUTORS.

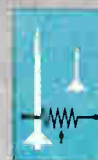
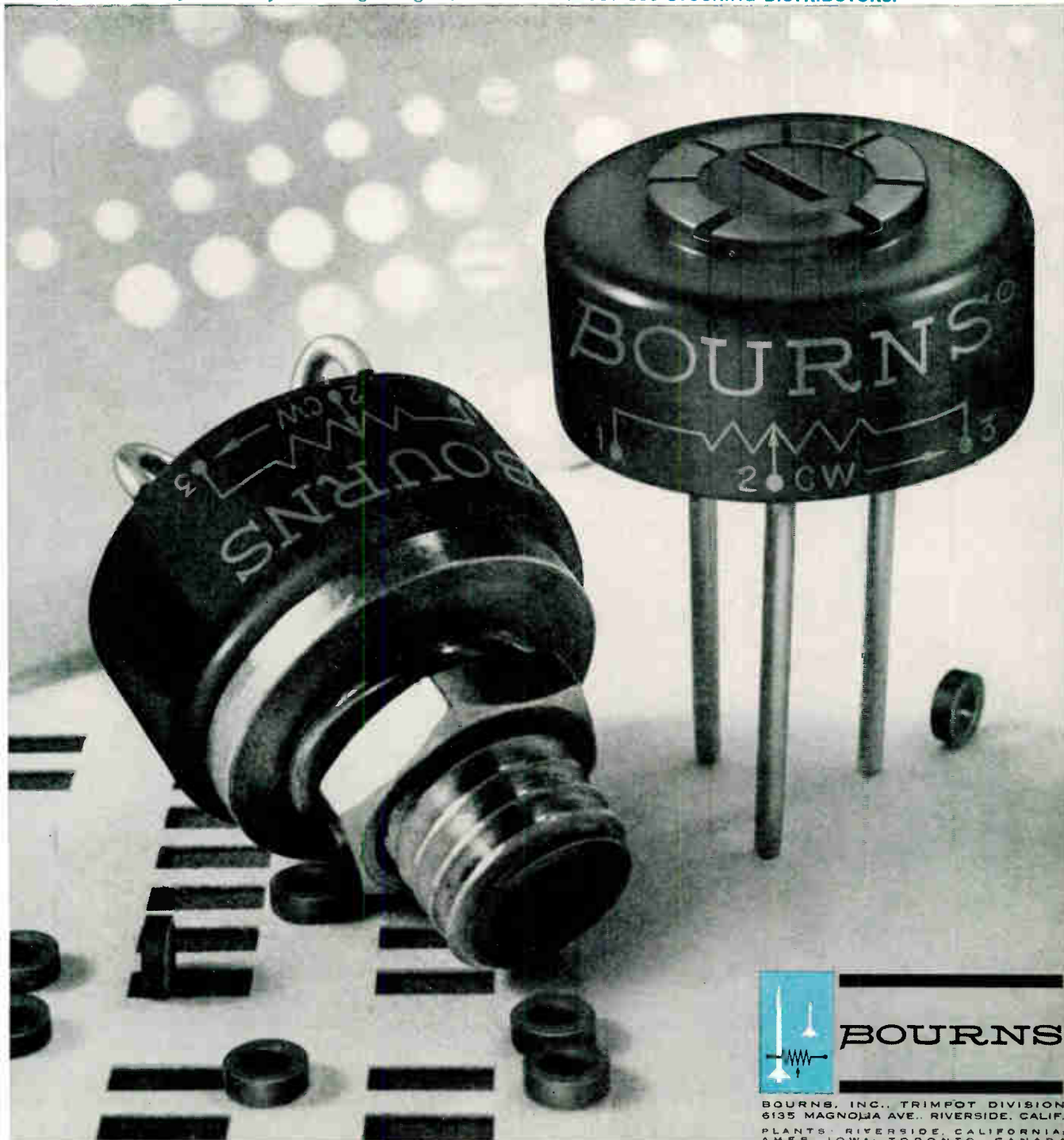

BOURNNS

BOURNNS, INC., TRIMPOT DIVISION
6135 MAGNOLIA AVE., RIVERSIDE, CALIF.
PLANTS: RIVERSIDE, CALIFORNIA;
AMES, IOWA; TORONTO, CANADA

Exclusive designers and manufacturers of Trimpot® potentiometers. Pioneers in transducers for position, pressure and acceleration.

Wanted:

25 POUNDS LUNAR DUST

For environmental testing of switches
and indicator lights we manufacture for space vehicles
and interplanetary industrial equipment.

For detailed product data write:

CONTROLS COMPANY OF AMERICA
CONTROL SWITCH DIVISION
1420 Delmar Drive, Folcroft, Pennsylvania

Manufacturers of the Electrosnap and Hetherington full line of switches, controls and indicators for all military and commercial applications. All standard units stocked for immediate delivery by leading parts Distributors.

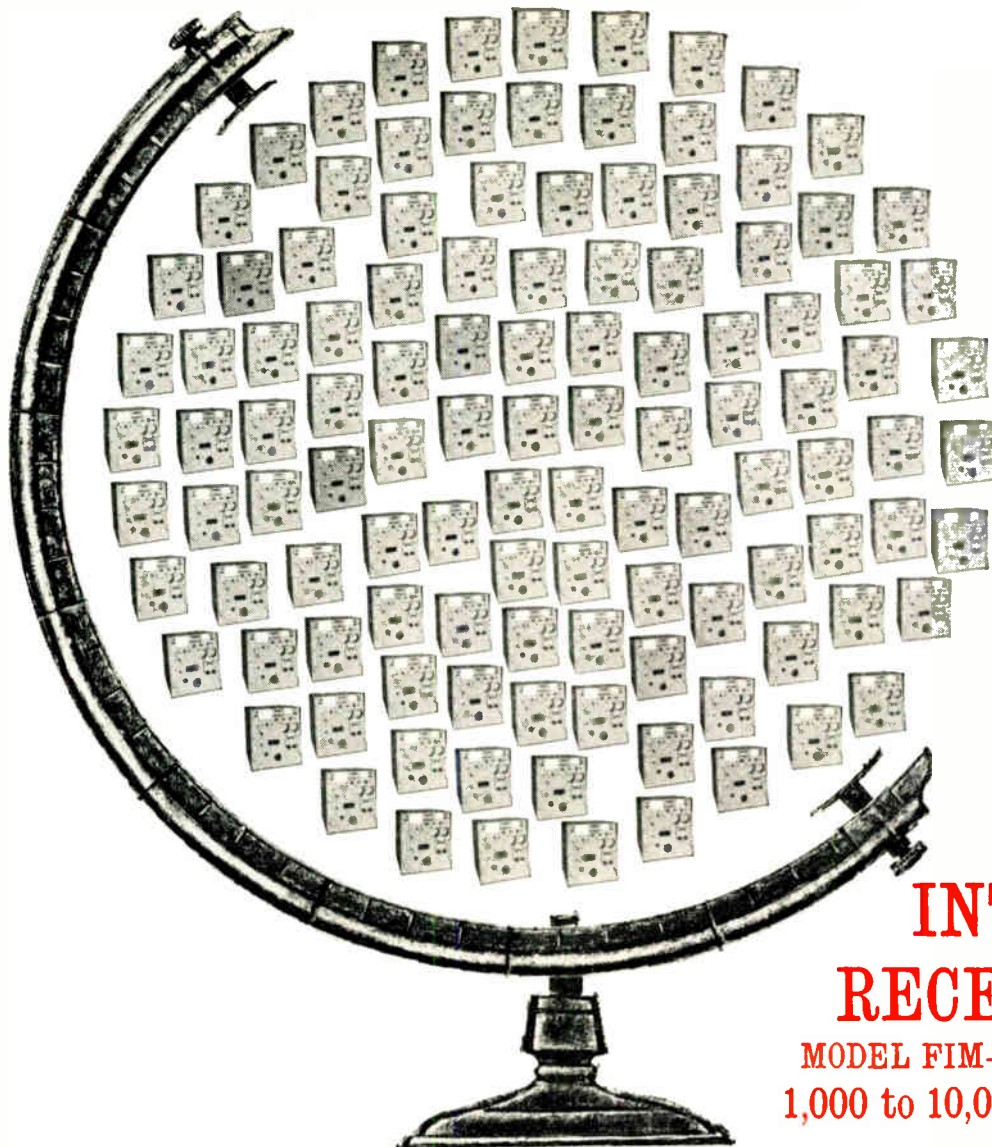

A WORLD WIDE STANDARD POLARAD FIELD INTENSITY RECEIVERS

MODEL FIM-2
1,000 to 10,000 mc.

Hundreds of Polarad Calibrated Field Intensity Receivers are in use today throughout the world. Why?

...because the FIM series, in production since 1956, offers ± 1 db accuracy because of its self-contained signal generator.

...because the Model FIM-2 is the only single unit microwave system capable of measuring rf interference and susceptibility. It has been designed for measurements in accordance with all military RFI specifications.

...because the FIM-2 is an integration of two instruments in one, it is always available in your laboratory as either a sensitive microwave receiver or an accurate signal generator.

...because UNIDIAL® tunes both the receiver and signal generator simultaneously; and, the front-panel meter indicates average, peak, slide-back peak or quasi-peak value of rf signals, the Polarad of FIM-2 is the most convenient instrument in use today.

MODEL FIM-2 FEATURES

MAIL THIS COUPON

- FREQUENCY RANGE: 1 gc to 10 gc in 4 tuning units; 2 more tuning units under development will extend frequency to 20 gc.
- FREQUENCY DIAL ACCURACY: $\pm 1\%$
- SENSITIVITY: 20 microvolts
- MAXIMUM RF INPUT: 3 volts
- IMPULSE BANDWIDTH: 5 mc
- IMAGE AND SPURIOUS RESPONSE REJECTION: 60 db
- OUTPUTS: Video, audio, recorder
- SIGNAL GENERATOR OUTPUT POWER: 0.223 volts to 5 microvolts (for susceptibility measurements)
- SIGNAL ATTENUATION: 0 to 80 db in 1 db steps

POLARAD ®PEC
ELECTRONICS CORPORATION
43-20 34th Street, Long Island City 1, N. Y.

Representatives in Principal Cities (See your yellow pages)

POLARAD ELECTRONICS CORPORATION:
43-20 34th St., Long Island City 1, N. Y.

Please send me information and specifications on:

- Model FIM-2 Calibrated Microwave Field Intensity Receiver
- Notes on Microwave Measurements



My application is _____

Name _____

Title _____ Mail Station _____ Dept. _____

Company _____

Address _____

City _____ Zone _____ State _____

Waveguide Switches

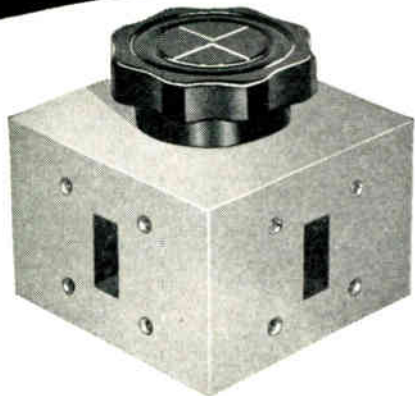

Waveline precision Waveguide Switches are available in seven waveguide sizes to cover the frequency range of 3.95 to 40.0 KMC. These manually operated devices have been designed for applications in the laboratory or for microwave systems to make alternate connections between two waveguide inputs and two waveguide outputs.

Excellent electrical characteristics are achieved by unique precision and assembly techniques which Waveline has developed to provide the highest quality of microwave instruments. Full waveguide range operation is obtained with a VSWR of 1.10 maximum and an isolation greater than 60 db.

The switches are normally supplied with rotation in the narrow wall plane (circular bend of the rotor in the "E" plane) and are manually operated by means of a knob. Also available are "H" plane versions which are designated by suffix letter H.

Waveline Model No.	Frequency Range, KMC	Waveguide Type
378-E	3.95 to 5.85	RG-95/U
478-E	5.85 to 8.20	RG-106/U
578-E	7.05 to 10.00	RG-68/U
678-E	8.20 to 12.40	RG-67/U
778-E	12.40 to 18.00	RG-107/U (AL)
878-E	18.00 to 26.50	RG-66/U (AL)
1078-E	26.50 to 40.00	RG-96/U (AL)

WAVELINE INC.

CALDWELL, NEW JERSEY

Phone: CApital 6-9100

TWX Caldwell, N. J. 703

Tele-Tips

(Continued from page 38)

AIRLINE OPERATING costs average \$15 per minute for jet aircraft and \$10 per minute for reciprocating four engine air liners. This is as good an argument as we can think of for improved air traffic control.

DEVICES that will concentrate the sun's rays can lead to making electricity from sunlight at reduced cost compared with photovoltaic systems not having similar light gathering ability. An Air-Force sponsored study indicates possible savings of up to 30% using present-day techniques.

CUT-RATE MESSAGES to Congressmen and Senators are being offered by Western Union. Up to 15 words, including signature, can be sent for 75¢. This reduced rate compares with a normal charge of \$1.10 for 15 words, plus tax.

CITIZENS BAND RADIOS are being offered as optional equipment in Ford automobiles. The Raytheon-built five channel transceivers operate on 12-volt battery power as mobile, and from 115-volt AC as a base unit. Ford's suggested list price for each "Ray-Tel" unit will be \$189.95, with a press-to-talk microphone and a set of matched crystals.

NEW VARIATION on the old dead-man pedal on locomotives has been developed by a Swiss firm. Called a "Vigilance Supervision," it sounds a warning horn when the driver fails to respond to certain duties within a given distance. If no controls are operated over a distance of one mile, power is cut and the brakes are applied automatically.

SURVEY of personnel recruiters from thirty of the nation's largest defense contractors finds that 20% are reluctant to hire women engineers and scientists. According to the Careers Inc. survey, the main objections were (1) "Upsetting to the office environment, (2) "Difficulty in advancing women to management level, and (3) "Early pregnancy."

(Continued on page 46)

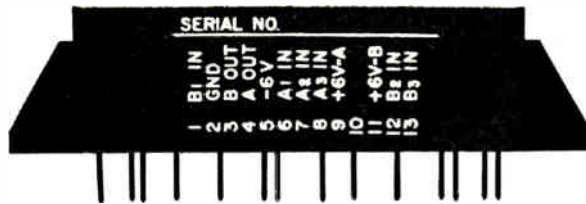

In less time than it takes light to cross this room, a new product, **DELCO'S NEW** high speed **10 MC** silicon modules, could: (1) correct the course of a missile in flight; (2) make it possible for sonar pickups to track and compute the position of targets with microsecond accuracy; and (3) handle any number of other airborne guidance and control functions that previous modules—due to low speed or environmental or performance limitations—could not handle. Delco Radio's 10mc modules, with a maximum gate-switch speed of 40 nanoseconds, convert data 100 times faster—even under the most extreme environmental conditions.

These **SILICON** modules come epoxy encapsulated, and operate over a temperature range of -55°C to $+100^{\circ}\text{C}$. And these same reliable **DIGITAL** circuits are available packaged on plug-in circuit cards. These Delco **MODULES** are environmentally proved to: **SHOCK**, 1,000G's in all planes. **VIBRATION**, 15G's at 10 to 2,000 cps. **HUMIDITY**, 95% at max. temp. **STORAGE AND STERILIZATION TEMP.** -65°C to $+125^{\circ}\text{C}$. **ACCELERATION**, 20G's. Designed for systems using from one module to 100,000, and the module's rated performance considers the problems of interconnection. Data sheets are available. Just write or call our Military Sales Department.

Physicists and electronics engineers: Join Delco Radio's search for new and better products through Solid State Physics.

PIONEERING ELECTRONIC PRODUCTS THROUGH SOLID STATE PHYSICS

Division of General Motors • Kokomo, Indiana



Instant Information for the Man in Command:



STANDARD EQUIPMENT: HUGHES TONOTRON STORAGE TUBES

Shipboard naval strategists, using Hughes TONOTRON* storage tubes in the Navy's new Naval Tactical Data System, can now predict enemy moves with uncanny precision. They can watch every move of his aircraft, ships and submarines in a combat area and follow the tactical situation second-by-second as it unfolds.

Key component in the NTDS is the Hughes TONOTRON storage tube. This direct-view tube accurately displays up-to-the-instant information even under difficult ambient light conditions. Its controllable persistence permits high-resolution, halftone displays to be stored for detailed study—or erased instantaneously!

Today's rugged and reliable TONOTRON tubes are the result of more than 10 years'

*Trade-mark of Hughes Aircraft Company

experience in the research, design, development and production of over 50,000 Hughes direct-view storage tubes.

For full information on how Hughes direct-view storage tubes can help solve your display problems, wire, write or telephone today: **HUGHES STORAGE TUBES, VACUUM TUBE PRODUCTS DIVISION**, 2020 Short Street, Oceanside, California. For export information, write: Hughes International, Culver City, California.



NTDS displays in Combat Information Center provide instant information for evaluating enemy threats and determining task force countermeasures.



Hughes Model H-1010 TONOTRON direct-view storage tube provides bright, accurate, high resolution display of information as it is received from sensors.

Creating a new world with Electronics

HUGHES

HUGHES AIRCRAFT COMPANY
VACUUM TUBE PRODUCTS DIVISION

Circle 24 on Inquiry Card

World Radio History

NOW
ANYONE CAN
STRIP WIRE
ALL DAY
WITHOUT
NICKING!

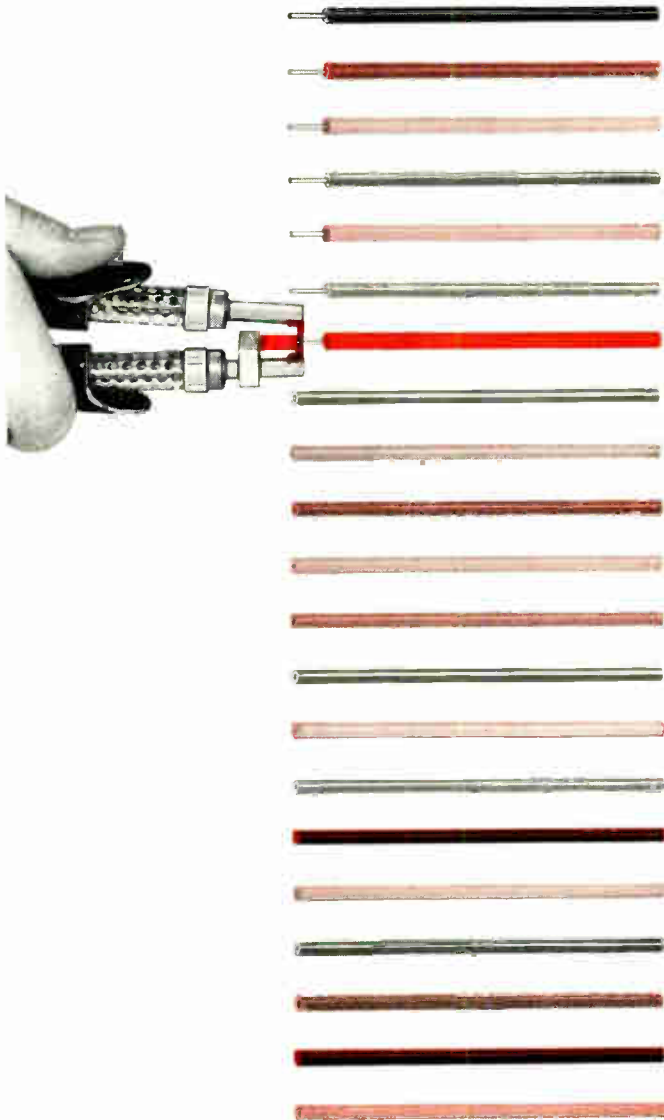

New **IDEAL**

THERMO-STRIP™
 WIRE STRIPPER
 FOR PLASTIC INSULATION

*The Precision Stripper
 That Can't Harm Wire*

Make precision stripping routine — for missile components, aircraft, computers, instruments — any equipment where wire damage can't be tolerated. New Ideal Thermo-Strip melts through insulation — no cutting, no tearing — prevents all nicking and breaking. Won't disturb strands of even finest wire. Works on all thermo-plastic insulation, including Teflon. Infinitely variable heat control prolongs element life, cuts fumes, lets you pick the exact temperature for the job. Can operate continuously — with no warm-up wait. Safe, fast, easy to use — Thermo-Strip is a precision wire stripper, not a converted soldering gun.

JUST PLUG IT IN . . .

Comes complete with 50-watt transformer and your choice of tools:



Pincer — for high-speed production stripping. Just grip wire, and pull off insulation slug with heating elements.

Single Element — for probing into miniature or crowded assemblies. Just put wire end in electrode V-notch.

Selection of elements.

Sold Through America's Leading Distributors. IN CANADA: IRVING SMITH, Ltd., Montreal

■ **TRY IT IN YOUR SHOP!**

IDEAL INDUSTRIES, Inc.
 5127-D Park Avenue, Sycamore, Illinois

- Please arrange a trial for me
 Send data only

Name _____
 Company _____
 Address _____
 City _____ Zone _____ State _____



**EXCLUSIVE
HIGH
DC POWER**

Choose From A Wide Line of Regulated Transistorized Models • Automatic Programming Features • Constant Voltage and Constant Current Outputs • Regulation 0.03% • Ripple Less Than 1 MV RMS

Trygon's Century Series of transistorized power supplies give regulated high DC power in a compact package. Complete range remote programming is provided. Electronic circuitry automatically limits maximum output current at pre-set values in case of short or overload. Overvoltage protection circuitry prevents output voltage from rising above operating voltage setting at any time. Turn-on, turn-off transients are also eliminated. Constant current output is accomplished through automatic crossover from constant voltage to constant current operation.

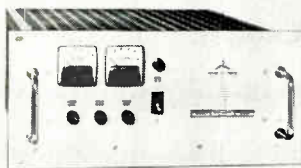

Model	OUTPUT		Rack Mount Dimensions			Weight
	Volts	Amps	W	H	D	
C15-50	0-15	0-50	19"	8¾"	16"	100 lb.
C15-80	0-15	0-80	19"	8¾"	16"	120 lb.
C36-30	0-36	0-30	19"	8¾"	16"	100 lb.
C36-50	0-36	0-50	19"	8¾"	16"	120 lb.
C60-15	0-60	0-15	19"	8¾"	16"	100 lb.
C60-25	0-60	0-25	19"	8¾"	16"	120 lb.
C160-8	0-160	0-8	19"	8¾"	16"	100 lb.
C160-16	0-160	0-16	19"	10½"	16"	120 lb.



TRYGON ELECTRONICS INC.
111 Pleasant Avenue, Roosevelt, L.I., N.Y.
FR eeport 8-2800

Circle 26 on Inquiry Card

Tele-Tips

(Continued from page 42)

ELECTRON BEAM FABRICATOR is being offered commercially by Hitachi, Ltd., of Japan. It performs operations of spot welding, cutting, sealing, and drilling by aiming electron beams at metal surfaces in the micron range. Large sales are expected in the semiconductor and other component fields.

ULTRASONIC OPTOMETRY is being studied by Univ. of California scientists. The technique of producing "echograms" of the human eye uses a transducer suspended in a container of water that is fitted to the subject's face. The echoes, in the 15 mc range, are plotted on a scope and photographed. This method is expected to locate eye faults such as cataracts or blood clots that elude other methods of detection.

COLOR PHOTO PRINTER has been developed for consumer use that will print colored photographs automatically in 3½ minutes. It does not require a darkroom and will print from 120, 127 and 35mm negatives. The device uses two cadmium-sulphide photocells that feed a bridge circuit against a calibrated resistor to determine the right color ratio for automatic exposure. The Pavelle Corp. expects to have the unit in production by this fall.

SEMI-ANNUAL COMPUTER Census released by John Diebold & Associates, Inc., shows that the computer population of the U. S. has increased by over 2,000 since mid-1961. Manufacturers are now filling the orders that were placed soon after the announcement of transistorized equipment. The census indicates there are now 3,735 transistorized general purpose digital computers installed in the U. S. Manufacturers hold orders for future delivery of over 7,700 of the new systems.

There was a net decline of about 200 in older type computer systems employing vacuum tube circuitry, the only classification to show a decrease.

FROM STC...

FIRST SILICON POWER TRANSISTORS WITH ISOLATED COLLECTOR

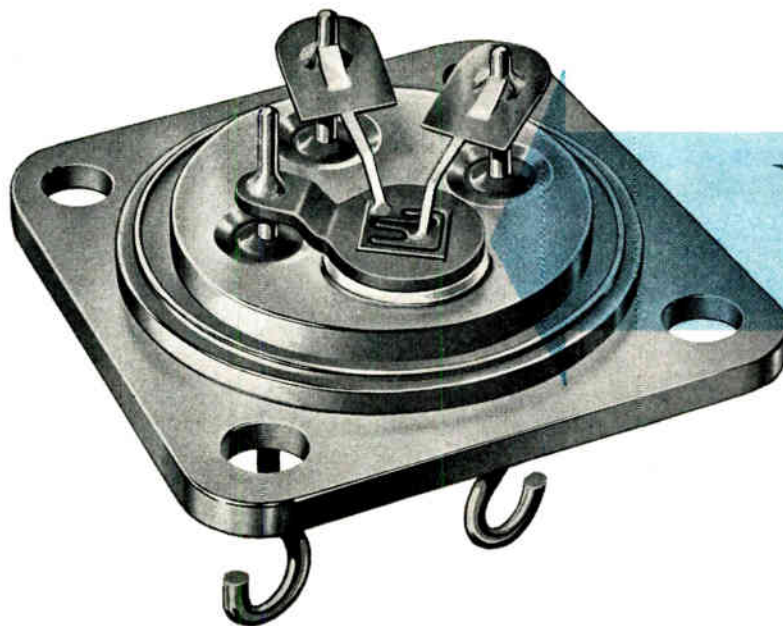

85 watts 2N2383

2N389/I 2N424A/I 2N1250/I
2N389A/I 2N1210/I 2N1620/I
2N424/I 2N1211/I 2N1722/I



85 watts 2N2384

2N1208/I 2N1616A/I 2N1618/I
2N1212/I 2N1617/I 2N1618A/I
2N1616/I 2N1617A/I 2N1724/I

Unprecedented transistor series... developed by Silicon Transistor Corporation. For higher reliability—minimum thermal resistance. Silicon power transistors with isolated collector—*Eliminate* these common transistor problems: 1. Cracked Mica Insulators. 2. Scratched Anodized Surfaces. 3. Arcing Around Insulating Hardware.

4. High Case-To-Heat Sink Thermal Resistance. 5. Assembly Mounting Problems.
2N2383 and 2N2384—two new types with $h_{FE}:20$ to $60 @ 1.5$ Amps, $I_{CEX} \leq 1.0$ mA @ 80 volts, saturation resistance $\leq 0.67 \Omega @ 1.5$ Amps.

For specifications and additional information on the entire STC line of silicon power transistors, write:



SILICON TRANSISTOR CORPORATION

CARLE PLACE,
LONG ISLAND,
NEW YORK
Pioneer 2-4100



Bendix Craftsmanship at work for you



TYPICAL SPECIFICATIONS

	Phase Shifter	Y-Circulator	Attenuator
Frequency Range	5200 to 5800 mc	4700 to 5700 mc	4900 to 5800 mc
Insertion Loss	1 db max.	0.4 db max.	1 db max.
Impedance	50 ohms	50 ohms	50 ohms
VSWR	1.30 max.	1.20 max.	1.25 max.
Power Handling Capacity			
Average	5 watts	10 watts	5 watts
Peak	5 kilowatts	10 kilowatts	5 kilowatts
Temperature Range	-55°C. to +85°C.	-55°C. to +85°C.	-55°C. to +85°C.
Diameter	1.12"	2.375"	1.12"
Weight	6 oz.	11 oz.	6 oz.

NEW BENDIX® MICROWAVE FERRITE DEVICES* **1** The Electrically Variable Phase Shifter, TFP-1, can produce phase shifts in excess of 90° over a minimum bandwidth of 10%. Chief uses are as phase modulator, fast shift, and in a wide variety of r-f direction finding devices. **2** The Y-Circulator, TFC-1, offers at least 20 db isolation with less than 0.4 db insertion over bandwidth exceeding 20%. Ideal for use with masers, and parametric amplifiers. **3** The Electrically Variable Attenuator, TFA-1, has a range exceeding 25 db over a minimum bandwidth of 15%. Useful in fast AGC circuits and remote level control applications. Write today: Electron Tube Products, The Bendix Corporation, Eatontown, New Jersey.

*PAT. PENDING

Red Bank Division



BEST FOR YOU—
IT'S MOST VERSATILE

TRIPLET

MODEL 850 ELECTRONIC VOLT-OHMMETER

USES UNLIMITED:

Field Engineers • Application Engineers • Electrical, Radio, TV and Appliance Servicemen • Electrical Contractors • Factory Maintenance Men • Industrial Electronic Maintenance Technicians • Home Owners, Hobbyists

MODEL 850 \$79.50

FACTS MAKE FEATURES:

- 1** Long 7" easy-to-read scale.
- 2** .5 D,C, volt range for transistor circuits.
- 3** HIGH STABILITY. Meter connected in cathode circuit of 12 AU7.

High Input Impedance (11 MEGOHMS) and wide Frequency Ranges give this extremely versatile Electronic Volt-Ohmmeter considerable advantage in the measurement of DC voltages, AC RMS and Peak-to-Peak voltages. It measures directly the Peak-to-Peak values of high-frequency complex wave forms and RMS values of sine waves on separate scales. Exclusive Triplett BAR-RING instrument is fully self-shielded; high flux magnet and spring-backed jewels for ruggedness. Wired circuit.

ADDED PROTECTION. Meter is shorted out in OFF position for greater damping, meter safety during transit, electrically protected against accidental overload. ZERO CENTER mark for FM discriminator alignment, plus other galvanometer measurements.

New pencil thin test probe used for all functions: DC, AC, and ohms. No need to change cables. Beautifully styled case for professional appearance and functional utility, 7 $\frac{1}{8}$ " x 6 $\frac{1}{16}$ " x 3 $\frac{3}{4}$ ".

Carrying handle can be used as a tester stand to place the tester at 25° angle for ease in reading.

Frequencies to 250 MC may be measured with auxiliary Diode Probe, \$7.50 extra. DC voltages to 50 KV may be measured with auxiliary High Voltage Probe. \$20.50 extra.

TRIPLET ELECTRICAL INSTRUMENT COMPANY, BLUFFTON, OHIO

CARRYING CASE

Case 859—OP—Black leather
Padded Carrying Case. \$19.50 Net



RANGES

8 DC VOLTS RANGES	0-.5-1.5-5-15-50-150-500-1500
7 AC RMS VOLTS RANGES	0-1.5-5-15-50-150-500-1500
7 PEAK-TO-PEAK VOLTS RANGES	0-4-14-40-140-400-1400-4000
7 RESISTANCE RANGES	0-1000-10,000-100,000 OHMS; 1-10-100-1000 MEGOHMS.

FREQUENCY RANGE 15 CPS to 3MC; (Up to 250 MC with accessory diode probe available extra.)

INPUT IMPEDANCE DC Volts 11 Megohms;
AC Volts minimum of .83 Megohms.

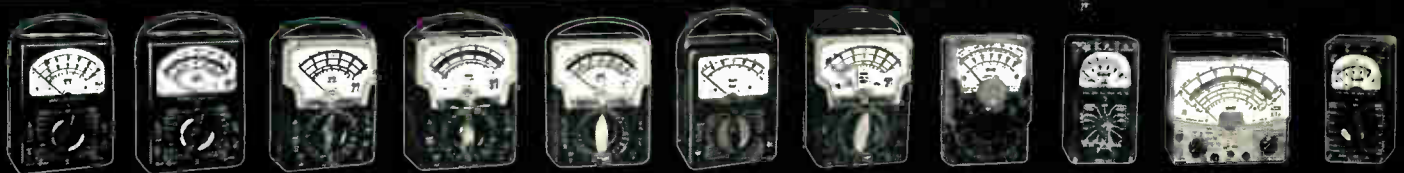

630

630-A

630-PL

630-APL

630-NA

630-T

631

310

666-HH

800

666-R

THE WORLD'S MOST COMPLETE LINE OF V-O-Ms. AVAILABLE FROM YOUR TRIPLET DISTRIBUTOR'S STOCK

Westinghouse now offers silicon rectifiers in ratings to 1000 volts...

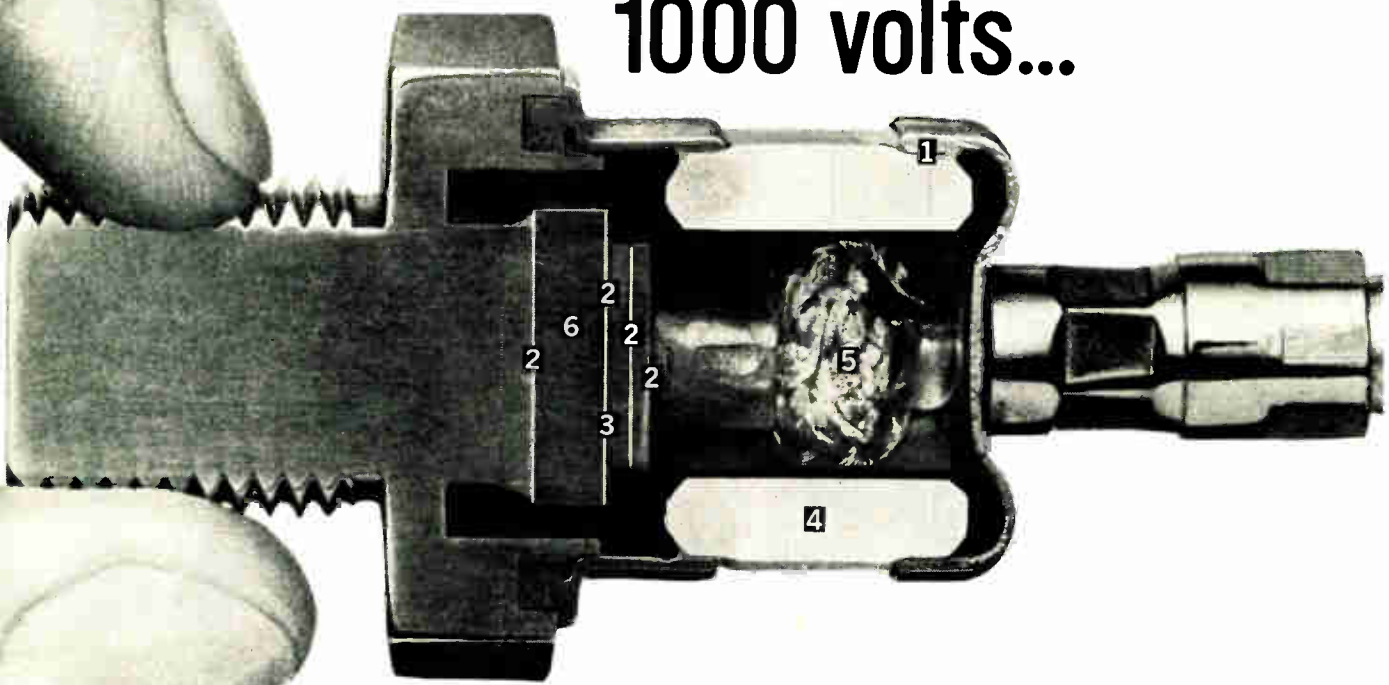

Westinghouse high power silicon rectifiers—proved in use since 1958—are now available in the highest ratings ever offered. **Design and construction superiorities:**

1. Ceramic-to-metal bond and welded case—provide lifetime hermetic seal.
2. Hard-soldered joints—eliminate thermal fatigue.
3. Alloy junction—prevents internal corona.
4. "Rock-Top" ceramic case—provides maximum creepage distance.
5. Flexible internal lead—absorbs mechanical stress.
6. Exclusive silver tungsten base—provides matched expansion coefficient and high thermal conductivity.

Depend on extra reliability, extra ruggedness, and extra long life from this series (1N 3270-71-72-73) on all kinds of high-power applications including: Plating/ Crane/ D-C motors/ Utilities/ Battery chargers/ General-purpose D-C.

For complete information, call your nearest Westinghouse representative or semiconductor distributor. Or write: Westinghouse Electric Corp., Semiconductor Division, Youngwood, Penna. SC-1064

You can be sure... if it's Westinghouse.

160-amp current!



For immediate "off-the-shelf" delivery, order from these Westinghouse Distributors:

EASTERN

ACK SEMICONDUCTOR, INC.
Birmingham 5, Ala./FA 2-0588
CAMERADIO
Pittsburgh, Pa./EX 1-4000
CRAMER ELECTRONICS, INC.
Newton, Mass./WO 9-7700
EASTERN SEMICONDUCTOR SALES, INC.
Syracuse, N. Y./GR 8-0903
ELECTRONICS WHOLESALERS, INC.
Melbourne, Florida/PA 3-1441
GENERAL RADIO SUPPLY CO., INC.
Camden, New Jersey/WO 4-8560
GENESEE RADIO PARTS CO.
Buffalo, New York/TR 3-9661
KANN-ELLERT ELECTRONICS, INC.
Baltimore, Maryland/TU 9-4242
MILGRAY ELECTRONICS
New York, New York/YU 9-1600
RADIO & ELECTRONIC PARTS CORP.
Cleveland, Ohio/UT 1-6060
SCHWEBER ELECTRONICS
Long Island, New York/PI 6-6520
Silver Spring, Maryland/JU 5-7023

MIDWESTERN

E.C.I. SEMICONDUCTORS, INC.
Kansas City, Mo./WE 1-0829
ELECTRONIC COMPONENTS FOR INDUSTRY CO.
St. Louis, Mo./WO 2-9916
HALL-MARK ELECTRONICS CORP.
Dallas, Texas/TA 4-1648

INTER-STATE RADIO & SUPPLY CO.

Denver 4, Colo./TA 5-8257
LENERT CO.
Houston, Texas/CA 4-2663
MIDLAND SPECIALTY CO.
El Paso, Texas/KE 3-9555
Phoenix, Ariz./AL 8-8254
Albuquerque, N. M./CH 7-0236
RADIO DISTRIBUTING CO.
Indianapolis, Ind./ME 7-5571
SEMICONDUCTOR SPECIALISTS, INC.
Chicago, Illinois/NA 2-8860
UNITED RADIO, INC.
Cincinnati, Ohio/MA 1-6530

WESTERN

ALMAC ELECTRONICS CORP.
Seattle, Wash./PA 3-7310
ELMAR ELECTRONICS
Oakland, Calif./TE 4-3311
HAMILTON ELECTRO SALES
Los Angeles, Calif./BR 2-9154
Palo Alto, Calif./DA 1-7541
Phoenix, Ariz./272-2601
NEWARK ELECTRONICS CO.
Inglewood, Calif./DR 4-8440
DENNY-HAMILTON ELECTRONICS
San Diego, Calif./AC 4-3451

CANADA

CANADIAN WESTINGHOUSE CO., LTD.
Hamilton, Ontario/JA 8-8811



Westinghouse

Interested in
TEMPERATURE MEASUREMENT?
TEMPERATURE COMPENSATION?
TIME DELAY?
LIQUID LEVEL SENSING?

THIS USEFUL KIT IS FOR YOU!

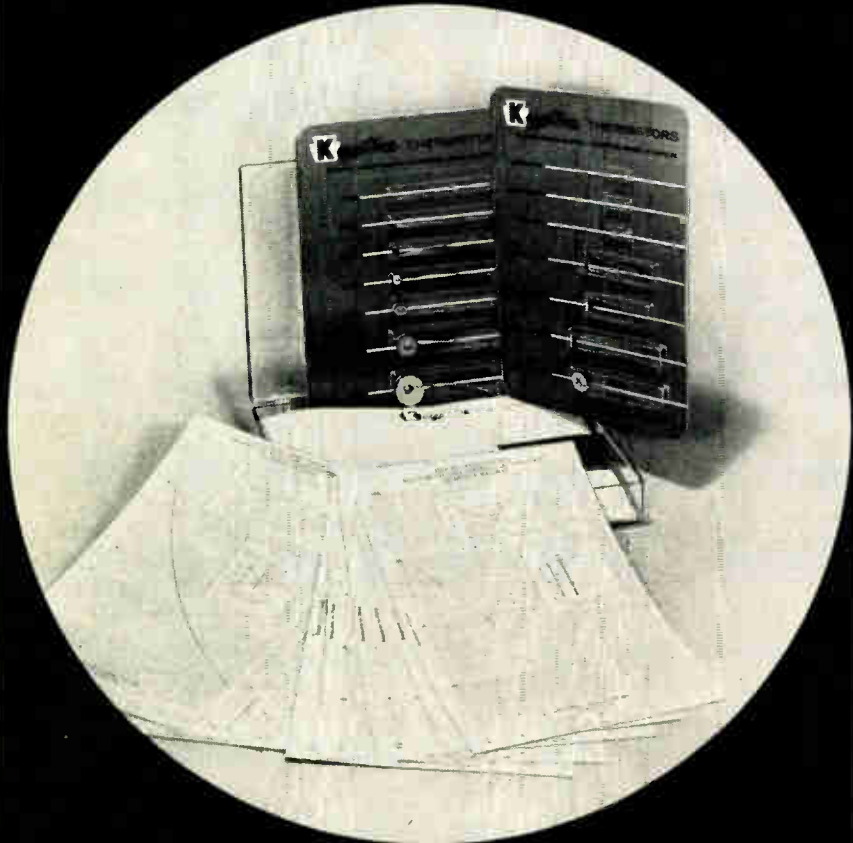

KEYSTONE THERMISTOR ENGINEERING KIT NO. 1

Discs • Beads • Rods

For precise development work on actual prototypes, and for general background in investigating thermal projects. Kit provides A-1 quality units in each type covering complete range of temperature coefficients from 3.3% to 5.2% per deg. C. Full design information on each type includes curves. Standard list describes 680 Keystone units. Kit complete, \$15.00 postpaid.

Keystone
CARBON COMPANY
ST. MARYS, PA.

THERMISTOR DIVISION

Letters

to the
Editor

"You Missed Us—"

Editor, ELECTRONIC INDUSTRIES:

The fact that ELECTRONIC INDUSTRIES is a well read publication was brought forcibly to my attention immediately after the November Microwave Issue was published. I was informed by numerous people in our company, starting with the President, that our name, "AMERICAN ELECTRONIC LABORATORIES, INC.," was not included in the listing of microwave equipment manufacturers, starting on page 119.

I believe this was an inadvertent omission, since most of the growth of our company has been based on developments in the microwave field. I might also add, that we featured one of our microwave products in a full page advertisement on page 16 of this issue.

Considering the number of comments I have received, regarding this matter, I felt it desirable to bring it to your attention.

R. D. Freedman

Commercial Sales Mgr.

American Electronic Laboratories,
Inc.

Richardson Road, Colmar, Penna.

Ed: Mr. Freedman is correct—the omission was inadvertent, and we are certainly sorry it happened.

"Nuclear Blasts and Unreliability"

Editor, ELECTRONIC INDUSTRIES:

I have just completed reading your article "Nuclear Blasts and Unreliability" published in the December 1961 issue, and would appreciate your sending me a reprint of this article.

In addition, if it is possible, I would like to receive reprints of the follow-on articles in this series, as your outline very definitely indicates they will serve a very useful purpose in my present position of attempting to create more interest along the lines of radiation resistant designs for our products.

John G. Diehl

Senior Engineer

The Bendix Corporation
Mishawaka, Indiana

Editor, ELECTRONIC INDUSTRIES:

Would you please send me a reprint of the following article from the December 1961 issue of your magazine: "Nuclear Blasts and Unreliability" by John E. Hickey, Jr.

I enjoyed the article very much, and look forward to subsequent articles on this subject.

W. A. Headley, Jr.

Advanced Technology Staff

The Martin Company
Orlando, Florida

(Continued on page 56)

Get this new 24 page Heathkit® Industrial Catalog

save money on test-research instruments



Professional Equipment Representing the Combined Electronic Skills of the Vast Daystrom Industrial Complex Costs Less By Far . . . Meets Top Performance Standards

YOU SAVE 3 WAYS WITH HEATHKITS . . . (1) You buy from the factory; (2) Kit form saves the costs of factory assembly; (3) Any plant personnel can assemble a HEATHKIT.®

YOU GET PROVED HEATHKIT QUALITY . . . HEATHKITS are performing regularly in hundreds of industrial test, research and communications installations. They meet professional performance requirements. (Case histories on request.)

250 HEATHKITS TO CHOOSE FROM . . . HEATHKIT Industrial Equipment includes oscilloscopes, meters, transistor checkers, computers, signal generators, 2-way radio for vehicle or plant communications. The most complete line of electronic equipment for industry. Plus audio, marine and amateur gear.

NOTE THESE LOW, LOW HEATHKIT PRICES!



EXTRA-DUTY WIDE BAND 5" OSCILLOSCOPE Kit 10-30.....\$69.95



IGNITION ANALYZER Kit 10-20.....\$89.95



TRANSISTOR CHECKER Kit 1M-30.....\$54.88



DELUXE 9-TRANSISTOR "WALKIE-TALKIE" Kit GW-21-2 (pair).....\$84.95

HEATH COMPANY
BENTON HARBOR, MICHIGAN
a subsidiary of
DAYSTROM, INCORPORATED

FREE CATALOG SHOWS TYPICAL INDUSTRIAL USES. GIVES ALL PERFORMANCE DATA, FEATURES AND SPECIFICATIONS. ORDER YOUR COPY NOW!

HEATH COMPANY • BENTON HARBOR 29, MICHIGAN

Yes, send me my free 1962 HEATHKIT Industrial Catalog No. 95/01

Your Name _____

Title _____

Company _____

Address _____

City _____ Zone _____ State _____

When ordering from this ad, please attach this coupon to your company purchase order.

ITEM	MODEL NO.	PRICE

Rx for GEPHYROPHOBIA*

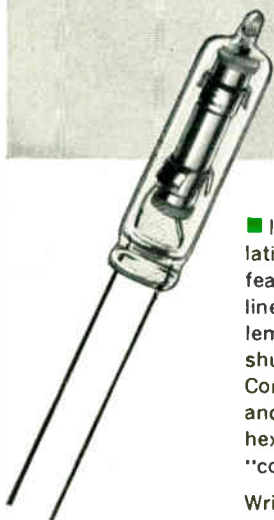
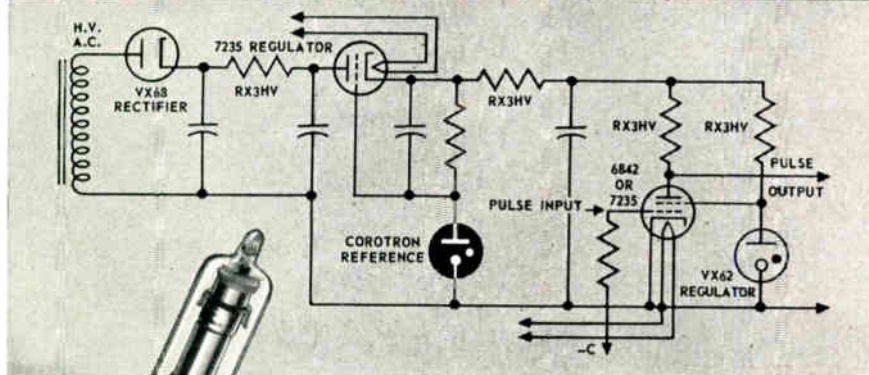

■ If you're considering upgrading your high voltage regulation circuits in the area of 400 to 27,000 volts — yet you fear to go over to new, uncertain components—Victoreen's line of *proven* Corotrons can solve your high voltage dilemma. Corotrons are often neat enough as a simple shunt regulator. For more stringent requirements, use a Corotron as a high voltage reference to a series pass tube and get performance that's positively exotic. So put the hex on your power supply problems by arranging for a "consultation" with our Applications Engineering Dept. Write today for your technical information capsule.

*Fear of crossing bridges.

A-5763A

5806 HOUGH AVENUE • CLEVELAND 3, OHIO
EXPORT: 3 WEST 61st STREET • NEW YORK 23, NEW YORK

Letters to the Editor

(Continued from page 52)

"Vacuum Tube Voltmeters—"

Editor, ELECTRONIC INDUSTRIES:

Congratulations on your January issue, the best of any issue I have yet received—and that is good. I wonder if it would be possible to obtain reprints of the following articles: "Using Magnetostrictive Delay Lines," "Nodes and Tables Lighten Trouble Shooting," "Basic Effects of Nuclear Radiation," "Shielding An Enclosure," "Survey of Vacuum Tube Voltmeters," "Inexpensive Remote Pick Up Receivers," "Human Factors and Electronic Computers."

Regarding your excellent tabulation of vacuum tube voltmeters, I prepared a similar compilation, but much reduced in scope for a course which I have taught on electronic instruments and this course is being taught every spring to our freshman electronic engineering students.

If it were possible to do so, I would like to have 4 more, or a total of 5 copies of this summary which could be posted on the bulletin board in the freshman lab and placed on reserve for the course. This magazine's material I find highly useful for the courses which I teach on packaging of electronic equipment and on electronic instruments and in a course which I teach that deals a lot with transducers.

Jerry Dillion, Associate Professor
Electronics Department
California State Polytechnic College
San Luis Obispo, Calif.

Fiber Optics

Editor, ELECTRONIC INDUSTRIES:

I would like a reprint of the article, "Handling Light With Fiber Optics," appearing in the December 1961 issue of ELECTRONIC INDUSTRIES.

I found this article very informative.

William M. Cleary
Design Engineer
American Machine & Foundry Co.
Alexandria, Va.

What Price Reliability?

Editor, ELECTRONIC INDUSTRIES:

In reviewing a copy of your article "What Price Reliability," by John E. Hickey, Jr., I found that the contents were of tremendous interest and extremely well presented.

I would like to order (25) copies of the reprints of this article for our management and staff.

James B. Rivera, Manager
Product Assurance Services
Radiation Incorporated
Melbourne, Florida

(Continued on page 60)

VL/3 POTENTIOMETER
Actual Size



JP/2 POTENTIOMETER
Actual Size



APD 1/2 DIALPOT®
Actual Size



WATERS

REFLECTS REFLECTS REFLECTS

INGENUITY

by designing the ordinary into the extraordinary.
Example: These three pots.

The JP/2 POTENTIOMETER: A wire-wound precision panel mount potentiometer, the JP/2 is smaller in overall volume than standard 1/2" miniature pots and considerably lower in cost than competitive miniature pots. It is interchangeable with most 1/2" pots. Available in 10 Ω to 20 KΩ, it will operate over a temperature range from -55° C to +150° C. Waters' complete new design and standardization gives the benefit of lower cost and guarantees fast delivery.

The VL/3 POTENTIOMETER: A sub-miniature pot, the VL/3 has numbered positions on the case to allow fast and accurate reading of the wiper position over a rotational span of 320° controlled by mechanical stop. The VL/3 was designed primarily for printed circuits and for applications where space limitations require convenient mounting arrangements (as in high parts-density modules). The metallic case and wire leads color-coded at the base permit simple connections into standard printed circuits or modules. Resistance range: 10 Ω to 15 KΩ. Will operate over a temperature range from -55° C to +150° C.

The APD 1/2 DIALPOT®: A compactly designed 1/2 inch sub-miniature pot with a calibrated dial for fast and easy reading of slider position. Rugged anodized aluminum case with plug-in type terminals. Ideally suited for printed circuits. Resistance range: 10 Ω to 20 KΩ.

All pots are designed to meet the environmental and electrical requirements of MIL-R-19A, MIL-E-5272A, and others as applicable.

For further information write to Dept. R3



WATERS MANUFACTURING, INC.
WAYLAND MASSACHUSETTS

Send
for
Your
Copy

Full of Facts
and
Free!

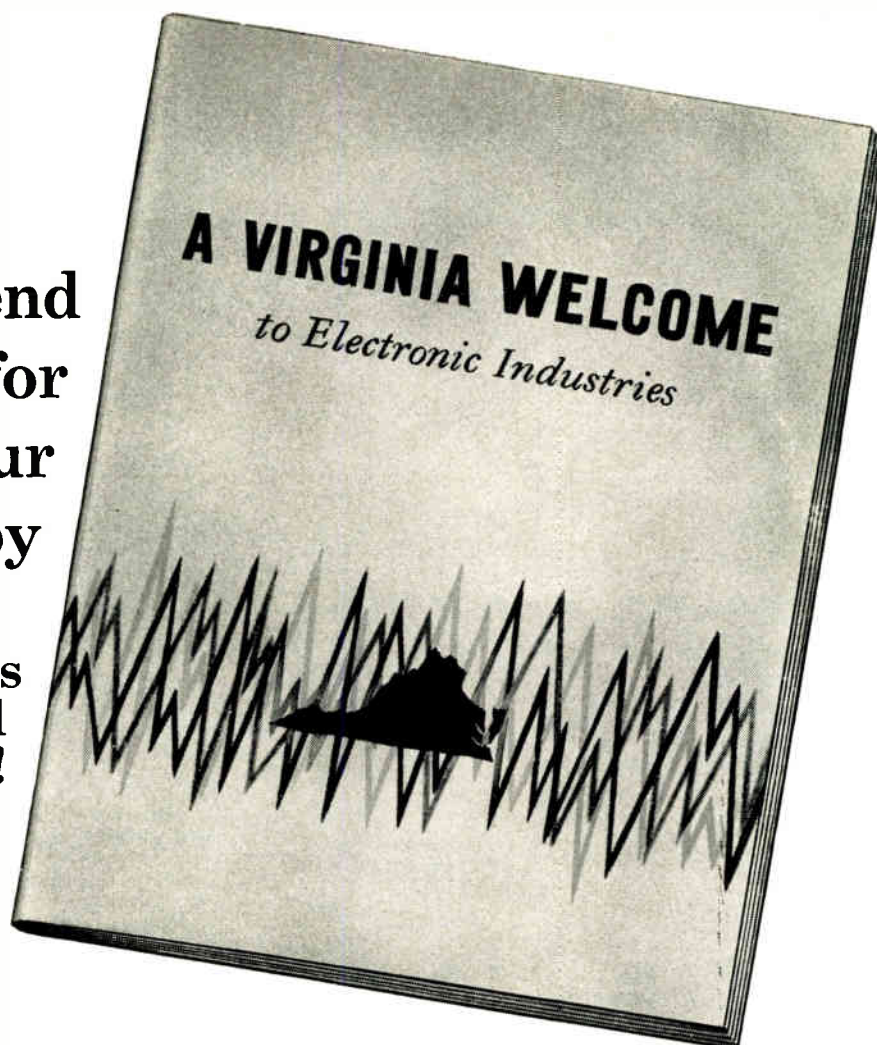

52 electronic companies have located in Virginia during the past 10 years. This new 30-page report gives facts about the experience of many of these companies, and presents maps, charts, statistical tables and short text on topics such as the following:

A directory of the electronic companies in Virginia.

The population and geographic characteristics of Virginia that provide such a wide range of site choices for electronic companies.

The federal military, space and other technical operations in the Washington, D. C. area, the Hampton Roads region and other areas that are in the forefront of the government's electronic programs.

The delivery time by truck from Virginia localities to major electronic markets, the air facilities available at Virginia communities, other transportation data.

Estimates of the number of persons available for new jobs annually and wage rates prevailing in the electronic industries.

Virginia's program of trade and technical courses in electronics.

Engineering graduates of Virginia colleges and universities, present college courses available for company personnel, faculty and equipment at these institutions for company research.

Record of labor-management harmony — salient features of Virginia's favorable government climate.

Recreational facilities in the State.

Whether or not you are immediately planning a new plant, you should have this book in your files. For your copy, write on company letterhead.

C. M. Nicholson, Jr., Commissioner
Division of Industrial Development and Planning
**VIRGINIA DEPT. OF CONSERVATION
AND ECONOMIC DEVELOPMENT**
Room 803-EI, State Office Bldg., Richmond 19, Va.
Phone: MILton 4-4111, Ext. 2255

Specifically engineered for each application

CLARE TYPE J RELAYS

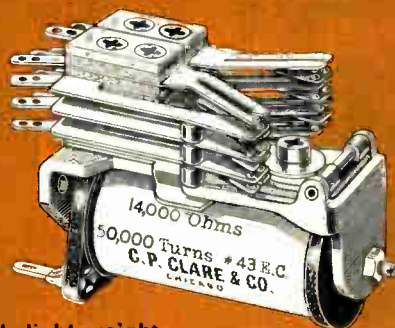

Clare originated the compact, light weight telephone-type relay... and has supplied over 10,000,000 for exacting users.

customized for optimum reliability !

FAST OPERATE FAST RELEASE LONG LIFE

Standard coils provide fast operate and fast release:

Operate: 5 to 60 ms
Release: 5 to 125 ms

Power Type J Relays—Heavy-duty contacts riveted to springs. $\frac{3}{16}$ " diameter (silver). Rated current-carrying capacity: 7 amperes, 28 vdc. or 110 vac.

Type J Video relays for switching video and other high-frequency currents.

You get exactly the telephone-type relays you need—precisely adjusted, and 100% tested for adjustment, dielectric strength and operating characteristics...when you specify the *original* compact industrial telephone-type relay.

For applications which require a conventional telephone-type relay, the CLARE Type J offers a versatility of performance and flexibility of installation that meet the requirements of the widest variety of industrial designs.

Contact failure is precluded by the use of independent twin contacts. Stable operation and adjustment are maintained by the largest possible armature bearing surface. Fine adjustment is also aided by an extremely rigid heel-piece. Tests (discontinued after 70,000,000 operations) showed no contact failure whatsoever.

For more complete information write or call C. P. Clare & Co., 3101 Pratt Blvd., Chicago 45, Illinois. Cable Address: CLARELAY. In Canada: C. P. Clare Canada Ltd., 840 Caledonia Road, Toronto 19, Ontario. In Europe: Europelec, Les Clayes-sous-Bols (S. et O.) France.

C. P. CLARE & CO.

Relays and related control components

HIGH
RELIABILITY...

Fully Interchangeable

Midget 482 CONNECTOR



Proof of Methode product reliability and versatility. The new Midget 482 Connector not only solves the "space problem" but is fully interchangeable with existing MS type miniature connectors with Bayonet Lock. It meets the environmental requirements of MIL-C-26482 and meets or exceeds the requirements of MIL-C-0026482 where applicable.

PLUS THESE FEATURES, TOO:

- Crimp style removable contacts using standard MIL-T-22520 tool modified locator
- Shells of high strength impact extruded aluminum
- Cadmium plated with olive drab irridite finish
- Bayonet coupling with positive lock for easy mating
- Closed entry sockets meeting or exceeding MIL-C-26636 requirements where applicable
- Resilient inserts permanently bonded to shell designed for moisture resistance and protection against vibration failure and five (5) key polarization.

And, as always with Methode, you'll find the product performance and service "extras" you always get. Write for informative literature.



Methode Electronics, Inc.
7447 W. Wilson Ave. • Chicago 31, Ill.
Telephone: UNderhill 7-9600

Letters

to the
Editor

(Continued from page 56)

Nuclear Radiation

Editor, ELECTRONIC INDUSTRIES:

I would appreciate very much receiving fifteen copies of the following article which appeared in ELECTRONIC INDUSTRIES, January, 1962.

"Basic Effects of Nuclear Radiation," by J. R. Crittenden.

I would like these to distribute to a Naval Officers Class in Atomic and Biological Warfare.

Burton Bartzoff, C.E.C.
Branch Manager

Snelling & Snelling
Boston 11, Massachusetts

Editor, ELECTRONIC INDUSTRIES:

Please send us 10 reprints of the article "Basic Effects of Nuclear Radiation" by J. R. Crittenden which appeared in the January 1962 issue of Electronic Industries.

Your survey article "Basic Effects of Nuclear Radiation," by J. R. Crittenden serves a most useful purpose. It happens that we manufacture a high dose rate x-ray machine with output of 10^8 rads/sec. We note that no mention was made of high dose rate type of testing or measurements in the article by Crittenden. Although this is a specialized field it is growing exceedingly rapidly. Perhaps your editorial staff would desire to look into this oversight.

There are a large number of experts in the field including Dr. J. W. Easley, Sandia Corporation, New Mexico, Dr. Paul Caldwell, Diamond Ordnance Fuse Laboratory, Washington, D. C., and M. M. Weiss, Bell Telephone Laboratories, Whippany, New Jersey.

S. D. Bennett
General Mgr.

Field Emission Corp.
McMinnville, Ore.

Vacuum Tube Heaters

Editor, ELECTRONIC INDUSTRIES:

In accordance with your instructions, please send a reprint of "Vacuum Tube Heaters" which appeared on pages 118-122 of the December issue. This is fine background material for our newer engineers in the vacuum tube industry.

May I also add that I am looking forward to your proposed series on nuclear radiation. As you have mentioned in earlier issues, the vacuum tube industry is already engaged in studies of this nature.

Henry B. Hagman
Manager, Applications Engrg.
Industrial Components Div.
Raytheon Company
Newton 58, Massachusetts

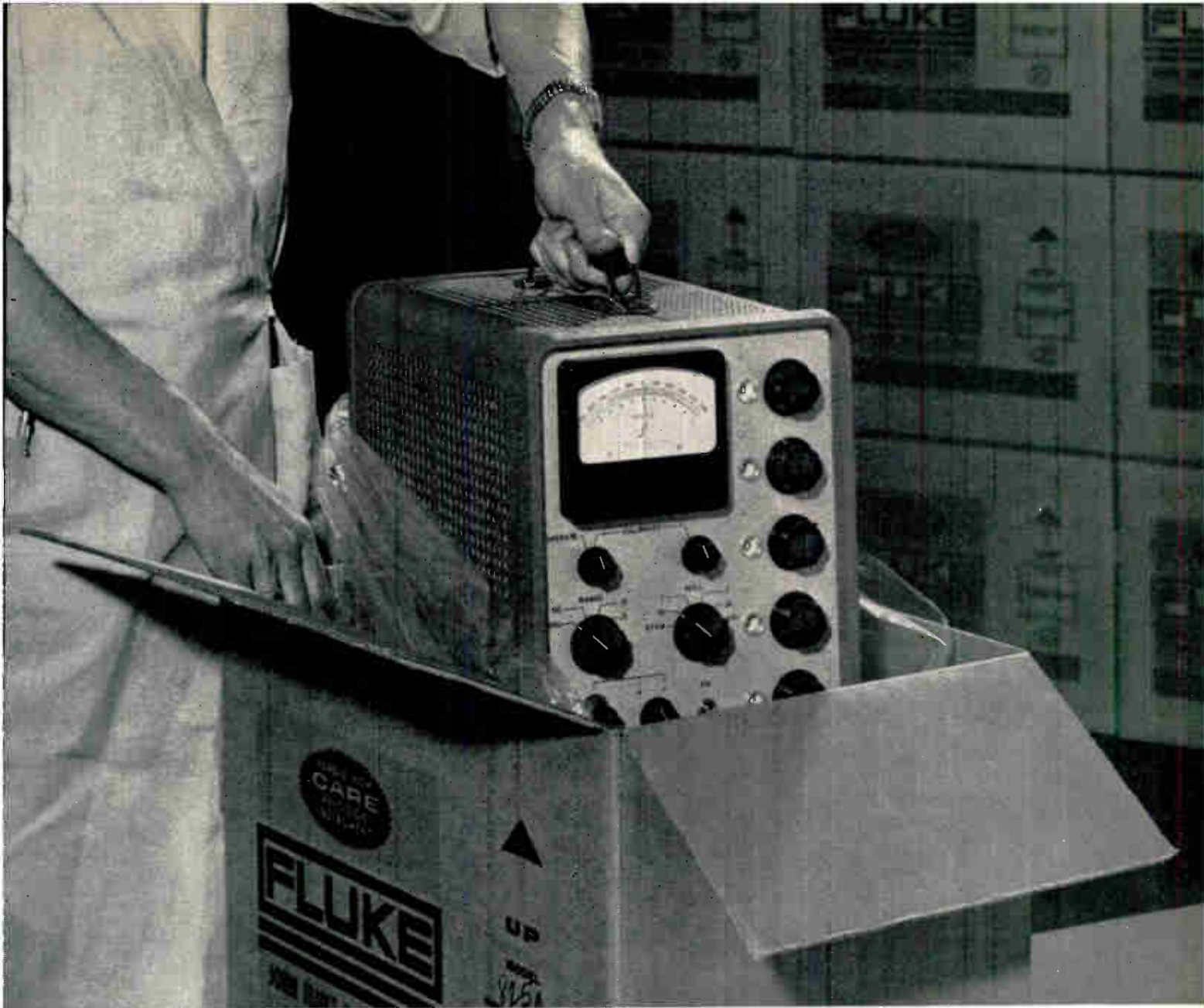

THIS NEW VOLTMETER WAS DESIGNED BY 15,000 CUSTOMERS

You had a hand in the engineering of the **FLUKE MODEL 825A DC DIFFERENTIAL VOLTMETER**. Customer suggestions spanning seven years and 15,000 differential voltmeters have helped create the most versatile and reliable instrument of this type ever offered.

Beginning with an overall accuracy of $\pm 0.025\%$, this advanced model features these significant advantages: recorder output—no zero controls—taut band meter suspension—flow soldered glass epoxy printed circuit boards.

To fully utilize the inherent advantages of high accuracy differential voltage measurements, Fluke Model 825A provides two major features not found in other instruments:

1. Infinite input impedance at null from 0 to plus or minus 500 VDC; this feature is extremely important since all voltages to be measured have significant source resistance. With the Model 825A operated at null, there will be no measurement errors due to circuit loading. The majority of other voltmeters provide a maximum of 10 megohms input impedance. Should the unknown voltage have a source resistance in the order of 5000 ohms, the measurement error due to source loading only will be at least 0.05% and does not include the basic error specification of the voltmeter itself.

2. Polarity reversing switch: A feature that enables you to measure either positive or negative voltages with equal ease. This is not merely a polarity reversal of front panel binding posts—but rather the internal 500 V reference supply is made either positive or negative with the front panel switch. This effectively provides you with two voltmeters for the price of one.

PARTIAL 825A SPECIFICATIONS

OVERALL ACCURACY: $\pm 0.025\%$
 MAXIMUM FULL SCALE NULL METER SENSITIVITY: 1 MV
 MAXIMUM NULL METER RESOLUTION: 5 uv
 STABILITY OF REFERENCE SUPPLY: $\pm 0.005\%$ per hour after warmup or $\pm 0.005\%$ for $\pm 10\%$ line voltage change.
 REFERENCE ELEMENT: . Standard cell (zener diode optional)
 INPUT VOLTAGE: . . . 117/234 VAC $\pm 10\%$ from 50 to 400 cps

Write, wire or phone for short form catalog F-162

John Fluke Mfg.
 Company, Inc.
 Seattle 33, Wash.
 Box 7428

FLUKE

INSTRUMENTS

PR. 6-1171 TWX—Halls Lake TLX—852

ANOTHER **UNIQUE** TEST SYSTEM FROM **ROHDE & SCHWARZ**



"REFLECTOMAT"

AUTOMATIC PLOTting of Reflection Coefficients

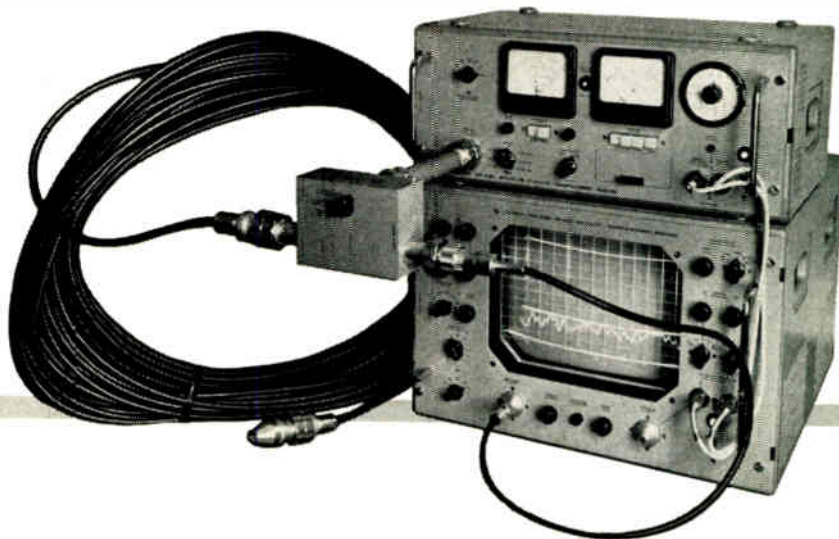

DELIVERY FROM STOCK

Unique Features

1. Large screen display — 14" CRT.
2. No parallax error — Calibration by substitution method.
3. Wide range — Reflection coefficients as low as 0.1% can be measured.
4. High accuracy — Because of features (1) and (2).
5. New convertible precision Dezifix connectors establish a well-defined reference point for the test object.

30 to 400 mc

A new test assembly system that simplifies electronic measurements of cables, terminations, connectors, antennas . . .

DYNAMIC RANGE OF 60 (80) db
REFLECTION COEFFICIENT RANGE OF 0.1% to 100%

Description of Equipment

As shown in the illustration, the test assembly consists of three units: the Polyskop (swept frequency system) Type SWOB, the Selektomat Type USWV as the tracking preamplifier, and the Reflectometer Type ZUP.

The swept output voltage of the Polyskop is applied to the input of the Reflectometer, while the item under test (a cable in this case) is connected to the opposite end. The incident and reflected signals from the test object are sampled by two directive couplers and are applied alternately by means of a switch to the input of the Selektomat Type USWV, which is an automatically-tracking preamplifier with a dynamic range of 80 db. From there the signal is fed into one channel of the display section of the Polyskop, while the other channel carries a calibrating dc signal which plots a reference line. The level of this calibrating signal can be read directly in db from the scale of a potentiometer located in the Selektomat.

Thus, reflections as low as -60 db or 0.1% can be read directly from the 14-inch screen and without parallax. (20 db of the 80 db are lost in the Reflectometer.) Use of the convertible precision Dezifix connectors reduces measuring errors because of the low VSWR of these connectors, and establishes a well-defined reference plane for the test object. Connection to other systems is made simple by means of conversion parts or adaptors.

These individual instruments may be used separately, also. Data sheets are available detailing the characteristics and applications of each.

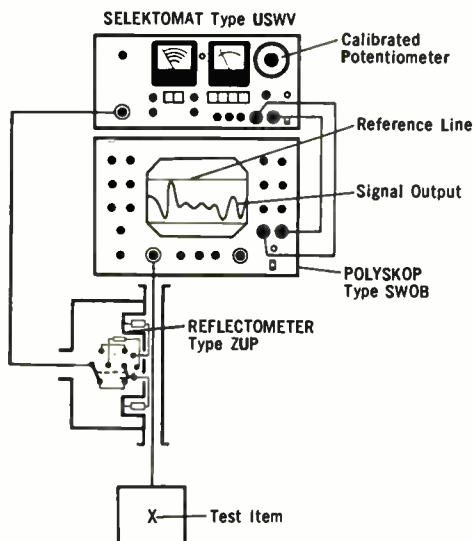

Test system for reflection-coefficient measurements, showing assembly of the Rohde & Schwarz SELEKTOMAT Type USWV, POLYSKOP Type SWOB and REFLECTOMETER Type ZUP.

Write for Additional Information



ROHDE & SCHWARZ

111 Lexington Ave., Passaic, N. J. • PRescott 3-8010

ELECTRONIC MEASURING EQUIPMENT FOR THE UNCOMPROMISING

Regulator Diodes—useful devices in electronic circuits

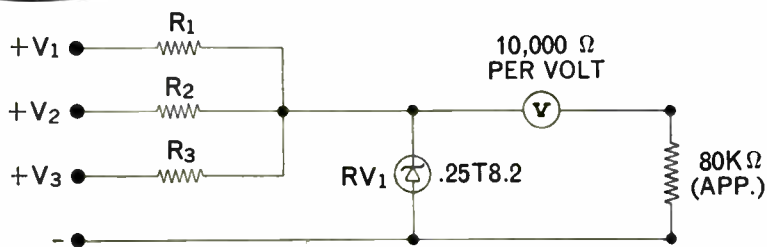

PROTECTION OF DC METER MOVEMENTS

R₁, R₂, and R₃-Meter Multipliers.
RV₁-Sarkes Tarzian Type .25T8.2 Regulator.
V = 100 Microampere Meter Movement.

PROTECTION OF AC METER MOVEMENTS

R₁, R₂, and R₃-Meter Multipliers.
RV₁-Sarkes Tarzian Type .25T6.2 Regulators.
V = 1 Milliampere Meter Movement.

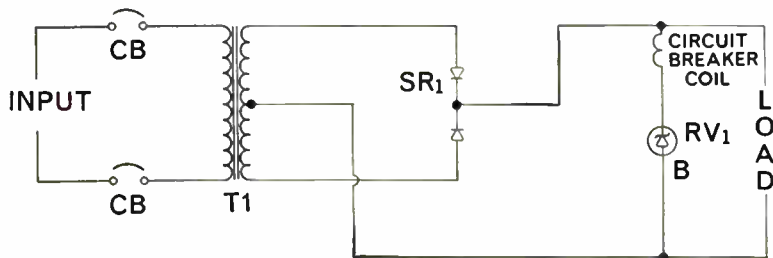
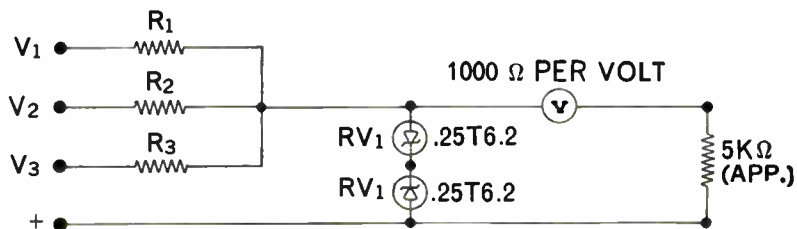

OVERVOLTAGE PROTECTION FOR SENSITIVE LOADS

RV₁-Selected to Avalanche at Critical Voltage and Cause Circuit Breaker to Open.

Not too long ago, the regulator diode (Zener) was considered a "luxurious" component, to be used only in the most sophisticated circuit. Progress in processing techniques and predictable voltage yields has made almost any application economically practical. The small size, inherent ruggedness, and physical simplicity of these devices—and their clipping, limiting, and protecting functions—can now be put to work widely.

The four applications shown here, while typical, can only suggest the usefulness of the silicon voltage regulator. We hope they will also suggest some useful answers to your problems, or new ways to improve reliability and performance. Our new catalog, 61-VR-11, contains data on five Tarzian series of silicon voltage regulators, plus design and test information. We will include prices. (You may be pleasantly surprised!) Prompt engineering service is also available.

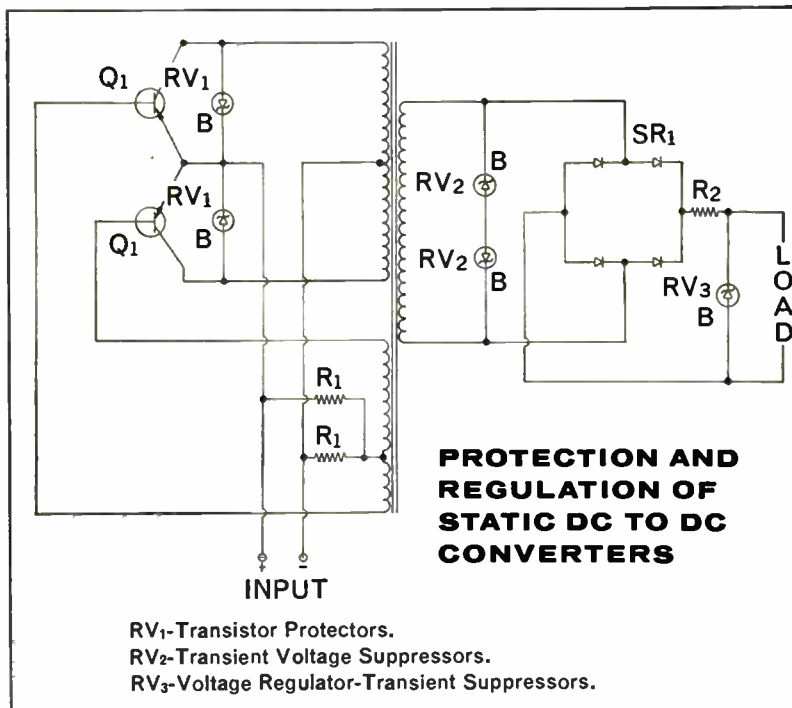

PROTECTION AND REGULATION OF STATIC DC TO DC CONVERTERS

RV₁-Transistor Protectors.
RV₂-Transient Voltage Suppressors.
RV₃-Voltage Regulator-Transient Suppressors.



SARKES TARZIAN, Inc.

World's Leading Manufacturers of TV and FM Tuners • Closed Circuit TV Systems • Broadcast Equipment • Air Trimmers • FM Radios • Magnetic Recording Tape • Semiconductor Devices

SEMICONDUCTOR DIVISION • BLOOMINGTON, INDIANA
In Canada: 700 Weston Rd., Toronto 9 • Export: Ad Auriema, Inc., New York



NEW from



The only **IN-CIRCUIT** **TRANSISTOR TESTER***

**not requiring
identification
of transistor leads**

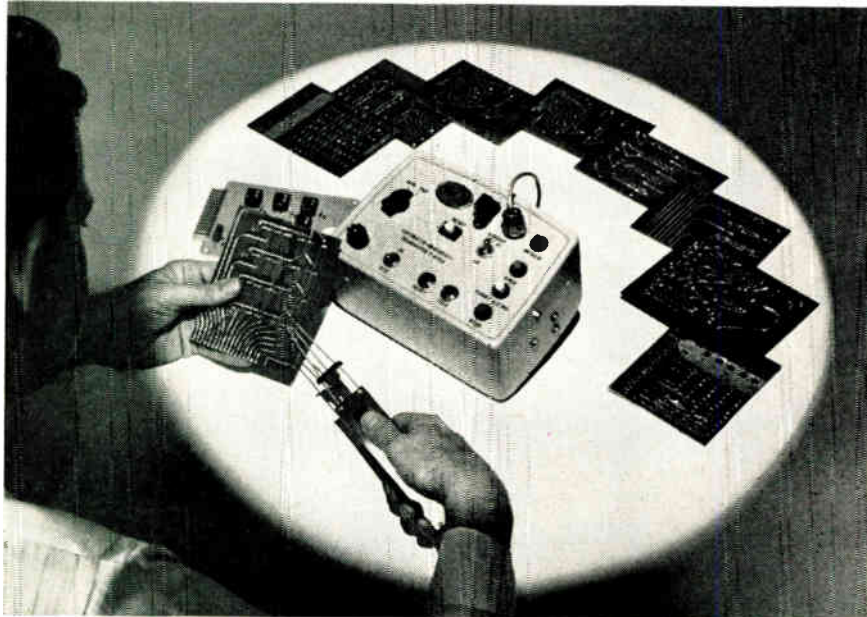

CHECK THESE OUTSTANDING FEATURES OF THE **AEL** IN-CIRCUIT TRANSISTOR TESTER

- You cannot damage transistor under test . . . this is an automatic lead finding, in-circuit transistor tester. You do not need to know the configuration of the leads.
- Saves countless transistors that would be damaged (through improper lead identification) with other transistor testers.
- No prior knowledge of transistor required . . . you DO NOT need catalogs, specifications, etc. to identify leads. Results in great savings of time.
- Tests transistors both in-circuit and out-of-circuit.
- Each test completed within 2-second time interval.
- Checks for opens—shorts—no gain.
- Tests virtually every type of transistor, including . . . power, switching, small signal, junction, alloy, point contact and military types.

- No meters to read — result immediately indicated by lights.
- No knobs to adjust—no potentiometers—no calibration required.
- Automatically determines silicon versus germanium for self-adjustment of voltages.
- Uses standard 115 volt — 60 cycle input. Power required — approximately 30 watts.



Revolutionary new automatic probe* (B) — permits rapid in-circuit testing with use of only one hand . . . probe contacts are adjusted with slight movement of fingers.
 (A) Clip lead probe supplied as standard equipment.
 (B) Automatic adjustable probe available as optional equipment. *Patent applied for

For additional information, write to . . .



American Electronic Laboratories, Inc.
 RICHARDSON ROAD, COLMAR, PENNSYLVANIA
 Just north of Philadelphia

Personals

Frank C. Arrance—named General Manager, Technical Ceramics Dept., Centralab, The Electronics Div. of Globe-Union Inc., Milwaukee, Wisc.

Louis H. Benzing—appointed Director of Operations, Military Systems, Lockheed Electronics Co., Div. of Lockheed Aircraft Corp., Plainfield, N. J.

Dr. Herbert N. Leifer — named Manager of the new Basic Physics Section of the Palo Alto Research and Development Laboratory of Fairchild Semi-conductor Corp.

James R. Breen—appointed Head of Manufacturing, Electronic Devices, Hughes Aircraft Co.'s Electronic Products Div., Newport Beach, Calif.



J. R. Breen



Dr. J. A. Narud

Dr. J. A. Narud—named manager of Circuits Research, Motorola Semi-conductor Products Inc., Phoenix, Ariz.

Jack I. Lee — named Application Engineer, Rotron Mfg. Co., Inc., Woodstock, N. Y.

Sol Maniloff — appointed Research and Development Scientist, GB Components, Inc., Van Nuys, Calif.

James J. Ward—appointed Operations Manager, Data Systems Div., Litton Systems, Inc., Beverly Hills, Calif.

Oscar C. Heller—named to the new position of Staff Engineer, Electronics Div., Bulova Watch Co., Inc., Woodside, N. Y.

Royden F. Estoppey — appointed Staff Engineer, Weston Instruments Div., Daystrom, Inc., Newark, N. J.

Norman L. Lingeman — appointed Product Manager, Fixed Wire-wound Resistor Dept., Clarostat Mfg. Co., Inc., Dover, N. H.

Texas Instruments Incorporated, Central Research Laboratories, Dallas, Tex., announces the following appointments: **Dr. Paul Keck**—appointed to direct research and development in lasers; and **Dr. Rolf Haberecht**—to manage programs in dielectrics, ferrimagnetic and thin films.

(Continued on page 68)



B&A[®] assures same or next day delivery of highest purity "Electronic-Grade" chemicals

Specify B&A chemicals today . . . use them today or tomorrow! Baker and Adamson delivers "Electronic-Grade" chemicals the same or next day—no matter which major electronics center your plant is in. B&A's coast-to-coast facilities make this speedy service possible.

"Electronic-Grade" chemicals are produced on the West Coast at El Segundo, Calif.; in the Midwest at Chicago; on the East Coast at Marcus Hook, Pa. Twenty-four B&A stock points strategically located across the country provide local service.

Fast, dependable delivery is only a part of B&A's policy. *Highest product purity* is another! B&A holds down impurities in its "Electronic-Grade" chemicals to the *lowest levels ever attained* . . . and insures this high purity through rigid chemical and instrument analysis.

When specifying chemicals for semiconductor production—wherever you are—get the finest, fastest . . . B&A "Electronic-Grade" chemicals.

For our brochure containing complete product lists and specifications—please write us on your letterhead.

BAKER & ADAMSON[®]
"Electronic-Grade"
Chemicals



GENERAL CHEMICAL DIVISION
40 Rector Street, New York 6, N. Y.

Please send export inquiries to: Allied Chemical International, 40 Rector Street, New York 6, N. Y.

What sets the stage for scientific discovery?

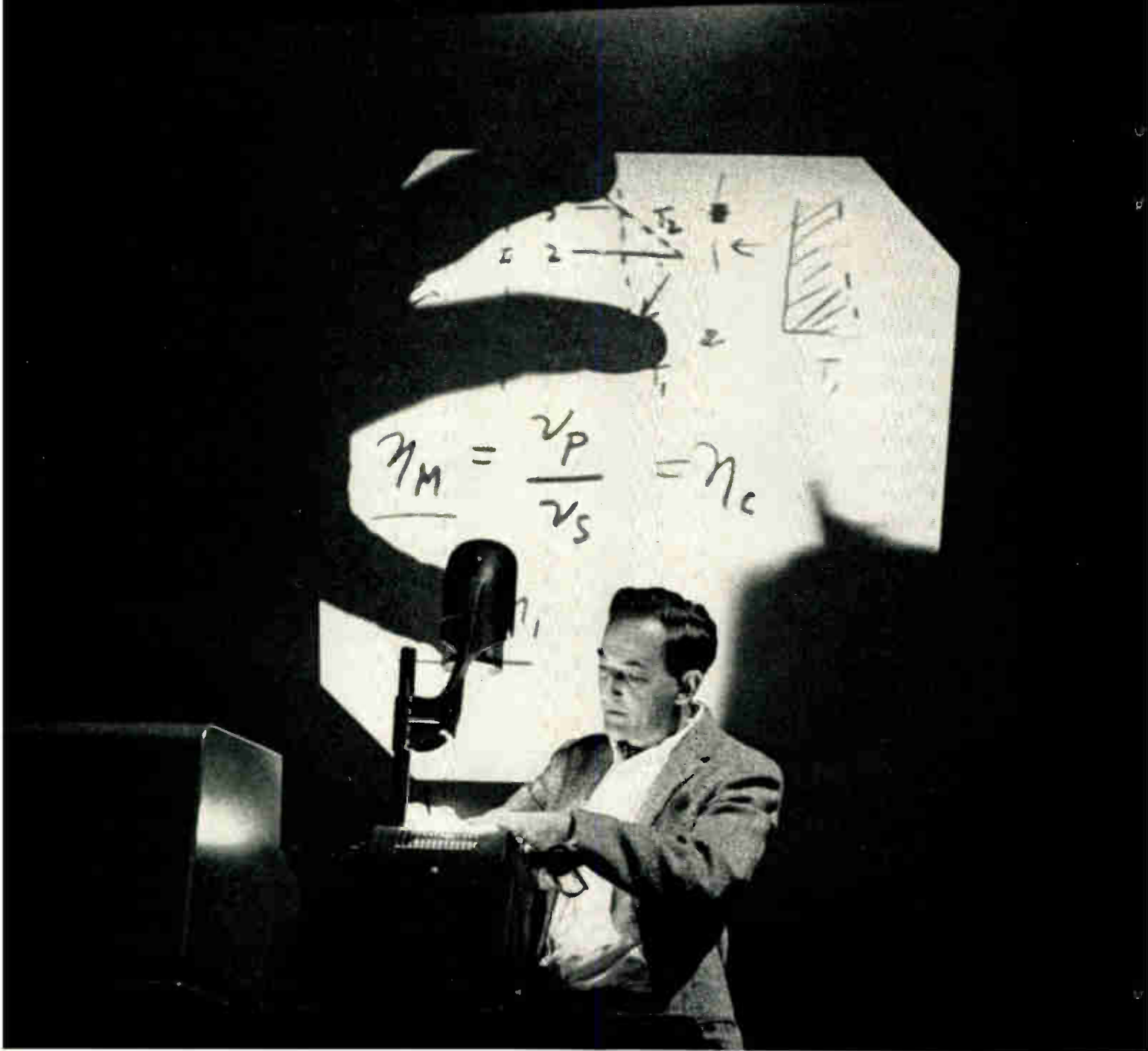

H. E. D. Scovil, pioneer developer of the solid state microwave maser, explains a point at a symposium at Bell Telephone Laboratories.

There is no one answer. But surely discovery is more likely when people are stimulated to think in new ways. And nothing more powerfully stimulates scientists and engineers than up-to-the-minute discussion of the latest developments.

Bell Laboratories scientists and engineers make a point of exchanging information on their latest advances not only among themselves but with the great world-wide professional community to which they belong. Last year, for example, Bell

Laboratories specialists delivered over 1200 talks to technical societies and universities. The stimulating exchange of new ideas plays an indispensable role at the world center of communications research and development.



Bell Telephone Laboratories

World Radio History



It Wasn't Easy

to engineer this new RF connector

because it had to meet the most advanced design criteria in the coaxial field. Now, after a lot of blood, sweat and tears, we honestly feel our new creation is the answer to a circuit man's prayer.

- ... Closed-entry socket inner contacts
- ... VSWR ratio less than 1.2:1 up to 4KMC
- ... Crimped terminations on both conductors
- ... Push-pull coupling with positive lock

But for all the facts on how this remarkable sub-miniature coax connector far exceeds current mil specs, contact your Deutschman. Or we can mail you complete technical information. Write for Data File U-4.

DEUTSCH

Electronic Components Division • Municipal Airport • Banning, California

ADVANCED SPECIFICATION MINIATURE ELECTRICAL CONNECTORS

Personals

(Continued from page 64)

Allen C. Potter—appointed Chief Development Engineer, Air Impeller Div., The Torrington Mfg. Co., Torrington, Conn.

John F. Binder — named Development Engineer, Industrial Development Unit, Laminated Products Dept., General Electric Co., Coshocton, Ohio.

Paul Schild—appointed Manager of Manufacturing, PRD Electronics, Inc., Brooklyn, N. Y.

Dr. Samuel G. Lutz — appointed Chief Scientist, Hughes Aircraft Co.'s Research Laboratories, Malibu, Calif.

Frederick J. Anderson—promoted to Director of Engineering, Eastern Operation, Sylvania Electronic Systems, Div. of Sylvania Products Inc., Waltham, Mass.



F. J. Anderson



R. B. MacAskill

Robert B. MacAskill — named Director of Engineering, J-V-M Div., Fidelitone Microwave, Inc., Brookfield, Ill.

Jacob Tellerman — named Chief Engineer and Director of Development, Systems Div., Tempo Instrument Inc., Plainview, L. I., N. Y.

Henry W. McMurtray—appointed Director of Quality Control and Reliability, Microwave Associates, Inc., Burlington, Mass.

Stewart Engineering Co., Santa Cruz, Calif., announces the following appointments: Harvey K. Holm — named Manager, Equipment Dept.; and Alfred J. Thompson—appointed Engineering Specialist, R&D Dept.

Transitron Electronic Corp., Wakefield, Mass., announces the following appointments: Alvin M. Silver — named Director of Corporate Quality Control; Richard L. Jones—promoted to Director of Corporate Reliability; Benjamin Z. Ranan — named Operations Manager, Silicon Alloy Diodes; Richard D. Dane—named Operations Manager, Diffused Diodes; Robert A. Painter—appointed Operations Manager, Bonded Silicon Diodes; and N. John Kiernan—appointed Operations Manager, Germanium Diodes and Melrose Plant Manager.

You get Continuing Assistance WITH YOUR TEKTRONIX EQUIPMENT

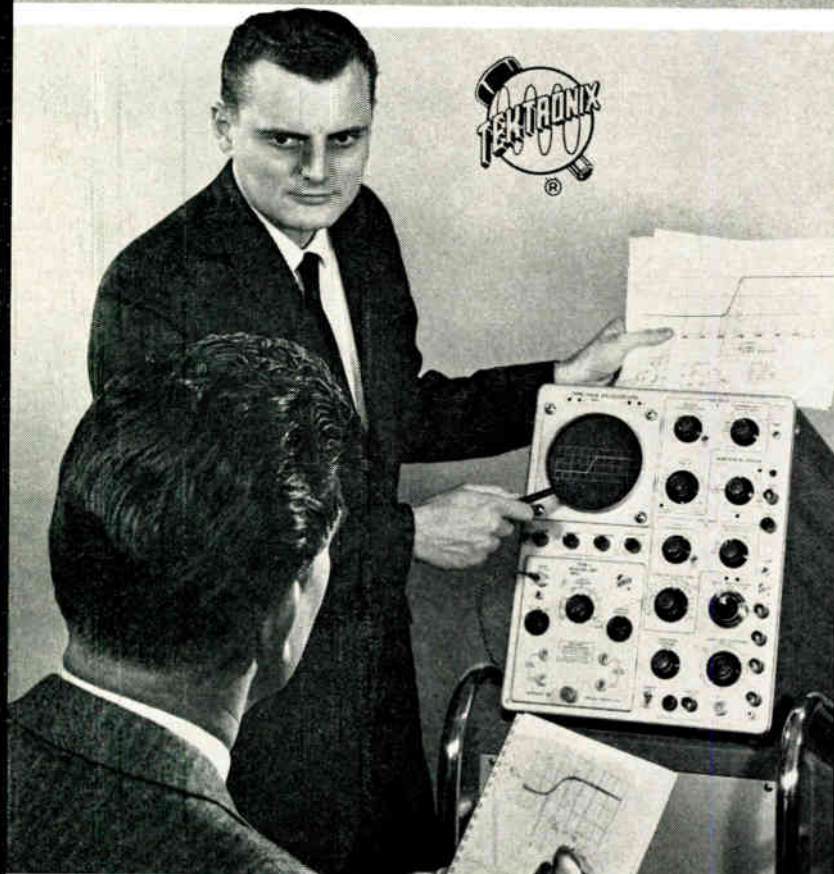

You get prompt help from your nearby Tektronix Field Engineer. He is Tektronix in your area, and he offers you comprehensive services *before, during, and after* the delivery of your Tektronix equipment . . . Talk to him about your needs and objectives in oscilloscope applications. He will know the tools and techniques to most effectively solve your measurement problem . . . Your Tektronix Field Engineer can help you in many ways . . . with additional training in oscilloscope theory . . . with simplified techniques for present applications . . . with new applications for present equipment . . . with instrument maintenance at repair centers . . . with additional equipment for your laboratory . . .

Primarily, however, he can help you realize and achieve the accuracy, the reliability, and the flexibility inherent in Tektronix equipment.

So call your Tektronix Field Engineer when you need him. Your selection of Tektronix equipment entitles you to his services—and through continuing assistance he can help you *maintain* the inherent capabilities in your Tektronix oscilloscopes and associated instruments.

Tektronix, Inc.

P. O. BOX 500 • BEAVERTON, OREGON / Mitchell 4-0161 • TWX—BEAV 311 • Cable: TEKTRONIX

TEKTRONIX FIELD OFFICES: Albuquerque, N. Mex. • Atlanta, Ga. • Baltimore (Towson) Md. • Boston (Lexington) Mass. • Buffalo, N.Y. • Chicago (Park Ridge) Ill. • Cleveland, Ohio • Dallas, Texas • Dayton, Ohio • Denver, Colo. • Detroit (Lathrup Village) Mich. • Endicott (Endwell) N.Y. • Greensboro, N.C. • Houston, Texas • Indianapolis, Ind. • Kansas City (Mission) Kan. • Los Angeles, Calif. Area (East L.A.) • Encino • Pasadena • West L.A.) • Minneapolis, Minn. • Montreal, Quebec, Canada • New York City Area (Albertson, L.I., N.Y. • Stamford, Conn. • Union, N.J.) • Orlando, Fla. • Philadelphia, Pa. • Phoenix (Scottsdale) Ariz. • Portland, Ore. • Poughkeepsie, N.Y. • San Diego, Calif. • San Francisco, Calif. Area (Lafayette • Palo Alto) • Seattle, Wash. • Syracuse, N.Y. • Toronto (Willowdale) Ont., Canada • Washington, D.C. (Annandale, Va.)

ENGINEERING REPRESENTATIVES: Kentrco Hawaii Ltd., Honolulu, Hawaii. Tektronix is represented in twenty-five overseas countries by qualified engineering organizations.

European and African countries, the countries of Lebanon and Turkey, please contact TEKTRONIX INTERNATIONAL A.G., Terrassenweg 1A, Zug, Switzerland, for the name of your local engineering representative.

Other Overseas areas, please write or cable directly to Tektronix, Inc., International Marketing Department, P. O. Box 500, Beaverton, Oregon, U.S.A. Cable: TEKTRONIX.



Another outstanding development by the makers of BUSS fuses

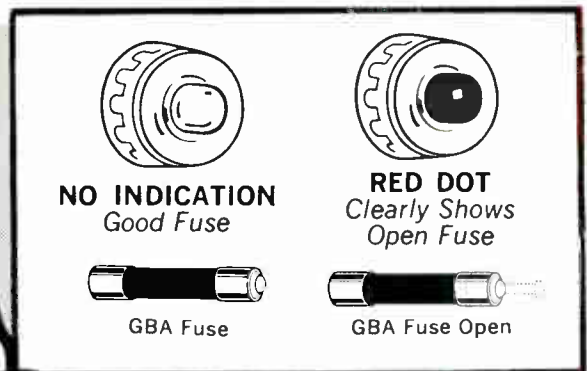

New! BUSS VISUAL INDICATING

HLD Fuseholders and GBA Fuses...

for all types of electrical and electronic equipment

New BUSS fuse and holder combination provides quick, positive, visual identification of faulted circuit.

When the fuse opens, an indicating pin pops out of fuse into transparent knob of holder. Head of pin is red. It is clearly visible and makes it easy to spot open circuit, even after power is off.

BUSS HLD fuseholders are for panel mounting in circuits of 125 volts or less. They take 1/4 x 1/4 inch BUSS

GBA fuses. Knob of holder grips fuse tightly and pulls fuse from holder when knob is removed.

Side terminal is held mechanically as well as by solder. Heat of soldering cannot cause it to loosen or come off.

Vibration will not cause failure of terminals as they are designed to withstand severe service.

Get the full story, write for BUSS Bulletin SFH-9.

BUSS: The complete line of fuses and fuse mountings of unquestioned high quality.



BUSSMANN MFG. DIVISION
McGraw-Edison Co.
St. Louis 7, Mo.

NEW SILICON TRANSISTORS FROM DELCO RADIO



ACTUAL SIZE

Silicon power transistors in a TO-37 package

Delco's unique new family of silicon NPN power transistors combines the benefits of miniaturization (TO-37) and light weight with the ability to withstand continuous junction temperatures of up to 175°C while operating at these absolute maximum ratings: collector diode voltage V_{cb} 100 volts; emitter diode voltage V_{eb} 4 volts; collector current, 1 amp.; base current, .2 amp. This entire 2N2340 family is particularly useful where moderate power handling capa-

bilities are required in a miniature package. The units have just two mounting holes and may be mounted with leads up, down or sideways on either side of the heat sink. Available in either single or matched units, they're characterized by low saturation voltage and high switching speeds. The transistors in this family are especially well suited for military or industrial applications in regulated power supplies, square wave oscillators, servo amplifiers and core driver circuitry. For complete engineering data, or applications assistance, write or call our nearest Sales Office or your nearest Delco Radio Semiconductor Distributor.

Number	IC Max.	V_{cb}	V_{ceo}	Sat. V @ IC Max.	Gain Min.—Max. @ IC	f_{ae} @ 250 ma IC (typical)
2N2340	1A	50V	40V	4V @ .75A	10— 40 @ .75A	900 kc
2N2341	1A	50V	40V	4V @ .75A	40—100 @ .75A	550 kc
2N2342	1A	100V	60V	3V @ .75A	10— 40 @ .75A	900 kc
2N2343	1A	100V	40V	2.5V @ .75A	40—100 @ .75A	550 kc

Thermal resistance of 8°C/watt max. Typical Alpha cutoff of 15 Mc

Rise Time of .2 μ seconds—.75A, I_B = 40 ma (V_{ce} = 12V), Fall Time of .5 μ seconds (I_C = 0 V_{eb} = 2v R_{eb} = 37 Ω)

Union, New Jersey
324 Chestnut Street
MUrdock 7-3770

Detroit, Michigan
57 Harper Avenue
TRinity 3-6560

Santa Monica, California
726 Santa Monica Blvd.
UPton 0-8807

Syracuse, New York
1054 James Street
GRanite 2-2668

Chicago, Illinois
5750 West 51st Street
PORtsmouth 7-3500

Division of General Motors • Kokomo, Indiana

DELCO
RADIO
RELIABILITY

Books

Automatic Control Systems

By B. C. Kuo. Published 1962 by Prentice-Hall, Inc., Englewood Cliffs, N. J. 504 pages. Price \$16.00.

Principles and techniques used in the analysis and design of feedback control systems are the theme of this book. Starting with a review of the mathematical background of control systems, the theory of feedback is developed from a general point of view. A knowledge of basic circuit theory is presupposed.

Throughout the book, the frequency domain technique, using the Nyquist criterion Bode plot, and Nichols chart shares equal emphasis with the s-plane, or root locus, technique. The author believes that one technique does not replace the other in practical design.

Theory of the Transmission and Processing of Information

By A. G. Vitushkin. Published 1961 by Pergamon Press Ltd., Headington Hill Hall, Oxford, England. 206 pages. Price \$15.00.

Book deals, in an abstract and rigorous manner, with the estimation of the information content of various problems in tabulation. Translated from the Russian it defines mathematically the concept of the complexity of a tabulation problem (the construction of tables for functions) by using concrete problems as examples.

Computer Handbook

Edited by Harry D. Huskey & Granino A. Korn. Published 1962 by McGraw-Hill Book Co., 330 West 42nd St., New York 36, N. Y. 1251 pages. Price \$25.00.

"Computer Handbook" is a comprehensive, practical reference book covering design of analog and digital computers and systems and their application to science and engineering. It was prepared by a group of experts including top representatives of every major computer manufacturer as well as leaders in computer applications in the aircraft industry and in major university centers.

Technical information is presented in the handbook in sufficient detail to be useful in actual design work. Many circuit diagrams have been included as concrete examples of design principles for direct adaptations to the designers problem. In addition, there are specific sections dealing with computer system design. For the younger engineer and for newcomers to the fields of computers and control, the handbook provides quick access to just that industrial know-how which is necessarily neglected in a modern engineering school curriculum stressing principle rather than technique.

(Continued on page 72)

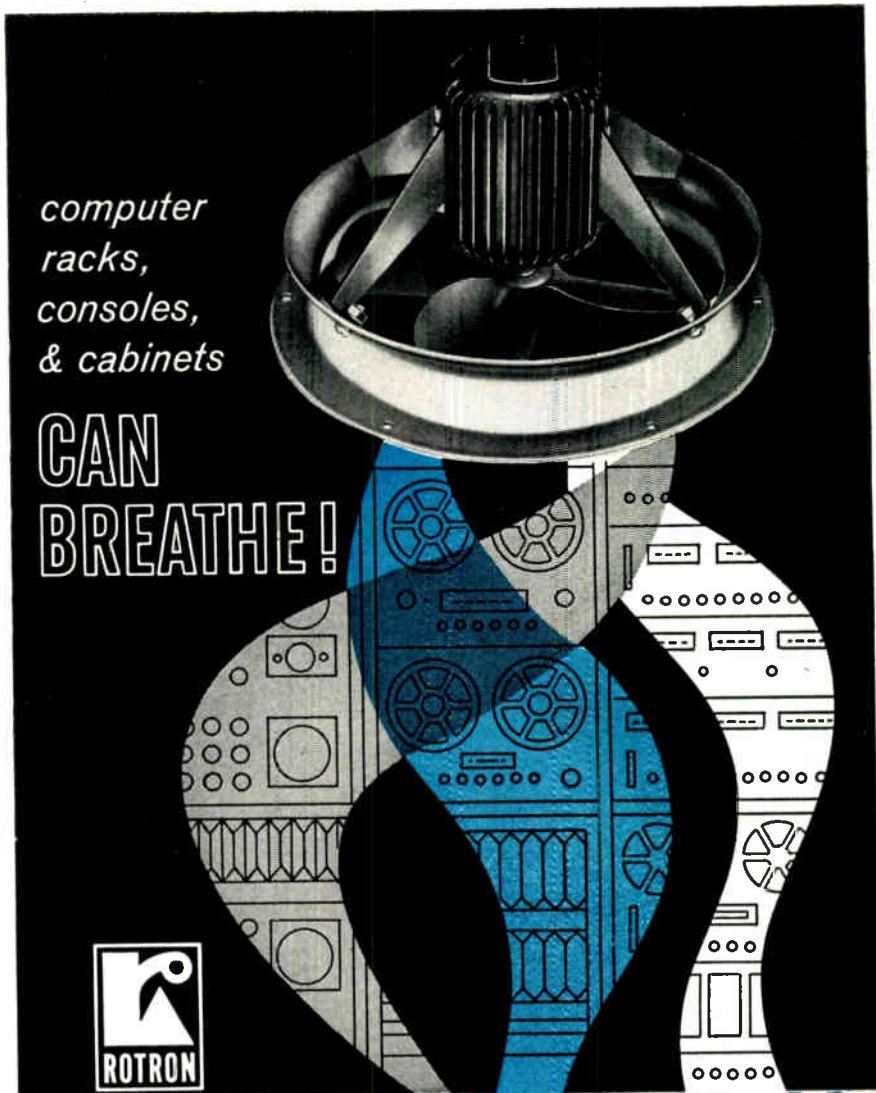

FLUSHING FANS

Models MF, NF and HF fans, with propeller diameters of 5½", 6½" and 8" respectively, are produced to fulfill such design criteria as: high output, light weight, compactness and self-contained construction.

Power requirements are 50-60 or 400 cps, 1Ø or 3Ø. The fans can be mounted with their shafts in any position. Motors can run in both high and low ambient temperatures and require no maintenance. Venturi ring permits simple mounting to a dust filter housing or cabinet wall. Push or pull air-flow available. Mil specs are met.

Write for complete catalog information for the fan that best meets your particular requirements.

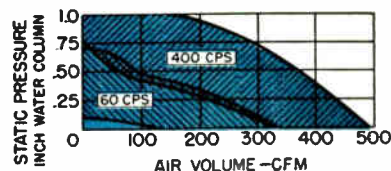

Motors are covered by U.S. Pat. Design No. 174,148. Other U.S. and Foreign Pats. Pend.



ROTRON mfg. co., inc.

WOODSTOCK, NEW YORK

In Canada: The Hoover Co., Ltd., Hamilton, Ont.

THE FIRST STEP TO RFI CONTROL...

The STODDART NM-62A Radio Interference-Field Intensity Measuring Set is the first step to RFI Compatibility for modern weapon and guidance systems in the 1 to 10 gc range. The critical radar frequencies can be investigated and analyzed to the highest degree of ACCURACY with the NM-62A. AUTOMATIC FEATURES, SCANNING SPEEDS, TIME CONSTANTS and BANDWIDTHS are engineered into the NM-62A for maximum versatility.

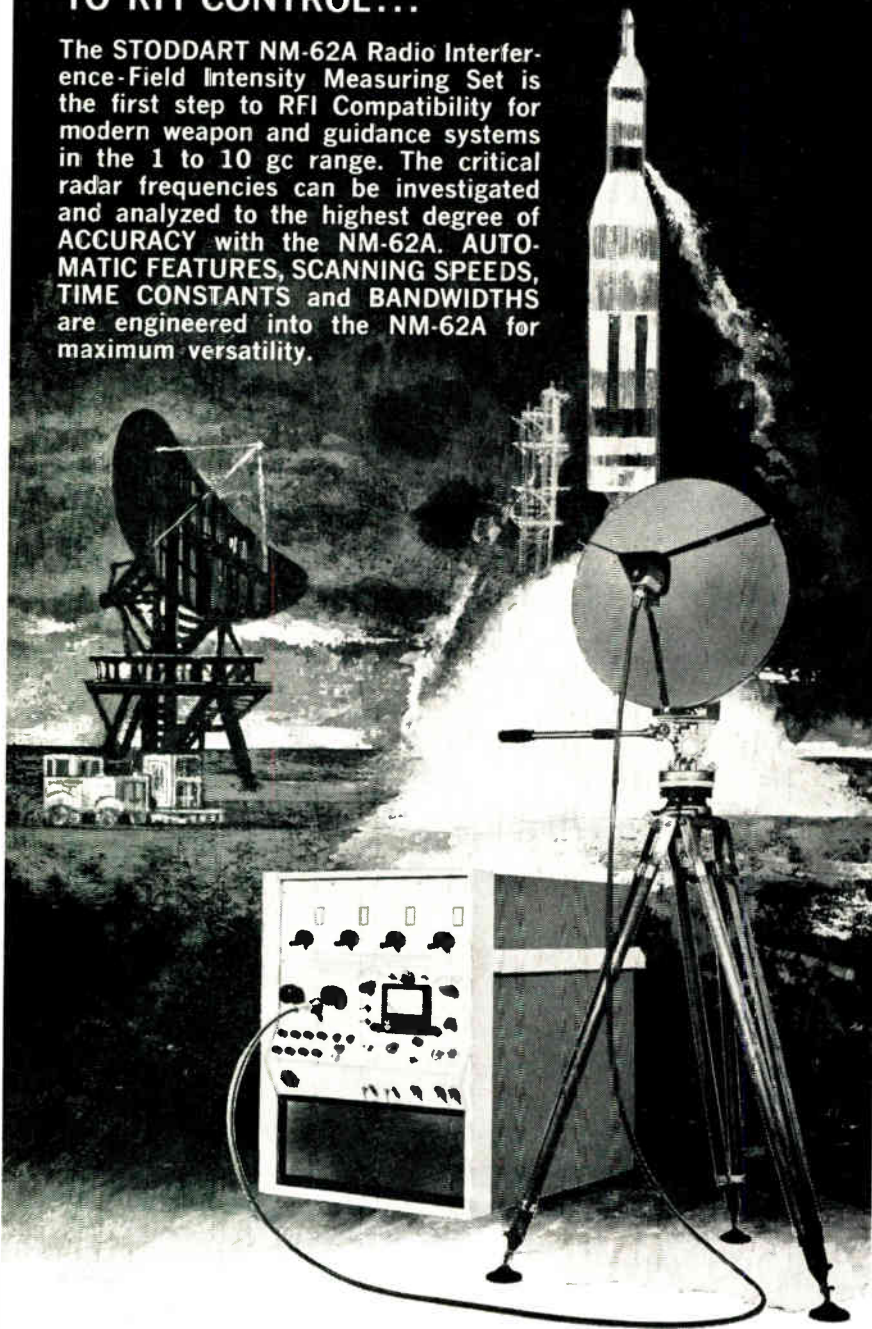

Applications include: Field Strength Measurements of a Radar Transmitter; Antenna Propagation Studies; Antenna Radiation Pattern Measurements and Antenna Development Measurement.

Operating Specifications include:

- Sensitivity:** 2 to 4 microvolts with 500 kc bandwidth; 6 to 12 microvolts with 5 mc bandwidth.
- Bandwidths:** 500 kc; 5 mc.
- Oscillator Radiation:** Less than 200 micromicrowatts.
- Case Shielding:** 90 db.
- Automatic Features Include:** X-Y Plotter Output; Automatic Bandswitching; AUTOSCAN (Automatic Frequency Scanning — with motor drive).

STODDART

AIRCRAFT RADIO CO., INC.
LEADER IN RFI CONTROL
6644 Santa Monica Blvd. • Hollywood 38, California
HOLLYWOOD 4-9292

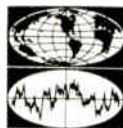

Books

(Continued from page 70)

Total Quality Control: Engineering and Management

By A. V. Feigenbaum. Published 1961 by McGraw-Hill Book Co., 330 West 42nd St., New York 36, N. Y. 627 pages. Price \$11.00.

This book gives details on how to plan a quality system, set up a suitable organizational structure, integrate the various functional activities, engineer the necessary plans and controls, and measure the result in terms of cost and product quality levels. In this book are the engineering and management essentials to produce or process any product so that it gives the buyer maximum quality and reliability at a given price.

Electronics: a bibliographical guide

By C. K. Moore & K. J. Spencer. Published 1961 by The Macmillan Co., 60 Fifth Ave., New York 11, N. Y. 411 pages. Price \$15.00.

Book describes and evaluates over 2,000 books and periodicals in 68 separate subject areas in the field of electronics. An all-inclusive bibliography of printed material in electronics and allied subjects, it is international in scope. Foreign titles are translated into English. The book is arranged according to the Universal Decimal Classification system and indexed by author and subject.

BOOKS RECEIVED

World Radio—TV Handbook 1962 Edition

Available from Gilfer Associates, Box 239, Park Ridge, N.J. 232 pages, softcover. Price \$3.00.

Six-Figure Logarithms, Antilogarithms & Logarithmic Trigonometrical Functions, Fourth Revised Edition

By C. Attwood. Published 1961 by Pergamon Press Ltd., Headington Hill Hall, Oxford, England. 139 pages. Price \$2.00.

Basic Radio Course

By John T. Frye. Published 1962 by Gernsback Library, Inc., 154 West 14th St., New York 11, N.Y. 224 pages, paperback. Price \$4.10. Hardcover, \$5.75.

Thinking Machines

By Irving Adler. Published 1962 by The New American Library of World Literature, Inc., 501 Madison Ave., New York 22, N.Y. 159 pages, paperback. Price \$0.60.

Fundamental Formulas of Physics, 2 Volumes

Edited by Donald H. Menzel. Published 1960 by Dover Publications Inc., 180 Varick St., New York 14, N.Y. 741 pages, paperback. Price \$4.00 for the set.

Engineering and Technical Conventions, 1962

Compiled by Deutsch & Shea, Inc. Published 1962 by Industrial Relations News, 230 West 41st St., New York 36, N.Y. 46 pages. Price \$4.00.

(Continued on page 78)

ANCIENT HISTORY



Reliable wideband performance at Mincom is an old story—and a good one. Mincom systems were recording and reproducing extremely complex signals at 1 mc as far back as 1955. Today Mincom's 1-mc system, the CM-100, is noted as a pioneer in operational predetection. Another system, the CMP-100, is a smaller mobile unit for recording in the field—also with 1 mc at 120 ips. The CM and CMP (as well as the other two basic Mincom systems) provide the simple, reliable data-gathering capability possible only with longitudinal recording on fixed heads. For all the details on Mincom's dependable wideband instrumentation, write us today.

Mincom Division **3M**
COMPANY
Los Angeles 25, California • Washington 4, D.C.



Cores in stock: SENT NOW

Specials: SENT ON TIME

BOTH ADD UP to assurance that *your* production will proceed on schedule no matter what kind of cores you need. Specials? Cores from Magnetics Inc. are sent **ON TIME** . . . exactly when promised.

Here's why we're so positive about delivery dates: tape wound cores specially made to exacting customer specifications account for nearly half of the millions we manufacture. The experience we've gained through the years in making these specials enables us to forecast *our* production time accurately . . . then ship to you on the date stated in our acknowledgment.

The standards . . . cores stocked in depots in Butler, Pasadena and New York . . . are sent as soon as your order is received. Most of the time it is a "same day" shipment . . . whether it's Permalloy 80, Supermalloy, Orthonol® or Magnesil® cores in anodized aluminum, phenolic or G.V.B. boxes.

What's more, *all* cores are tested to our published guaranteed limits using A.I.E.E. standard tests procedures.*

As we said at the top . . . on-time shipment of specials, immediate shipment on stocked cores, tested units . . . it all adds up to assurance.

Want proof? We'll shoot a sample stock core to you as soon as we receive your name on your letterhead. (If you have a special in mind let us know the specs and the quantity. We'll tell you the cost and delivery time.) Write Magnetics Inc., Dept. EI-02, Butler, Pa.

*C.C.F.R. Test per A.I.E.E. #432.

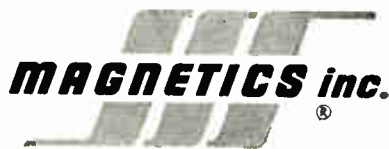

MAGNETICS inc.

How much better is MOTOROLA'S 2N960 Series Epitaxial Mesa?

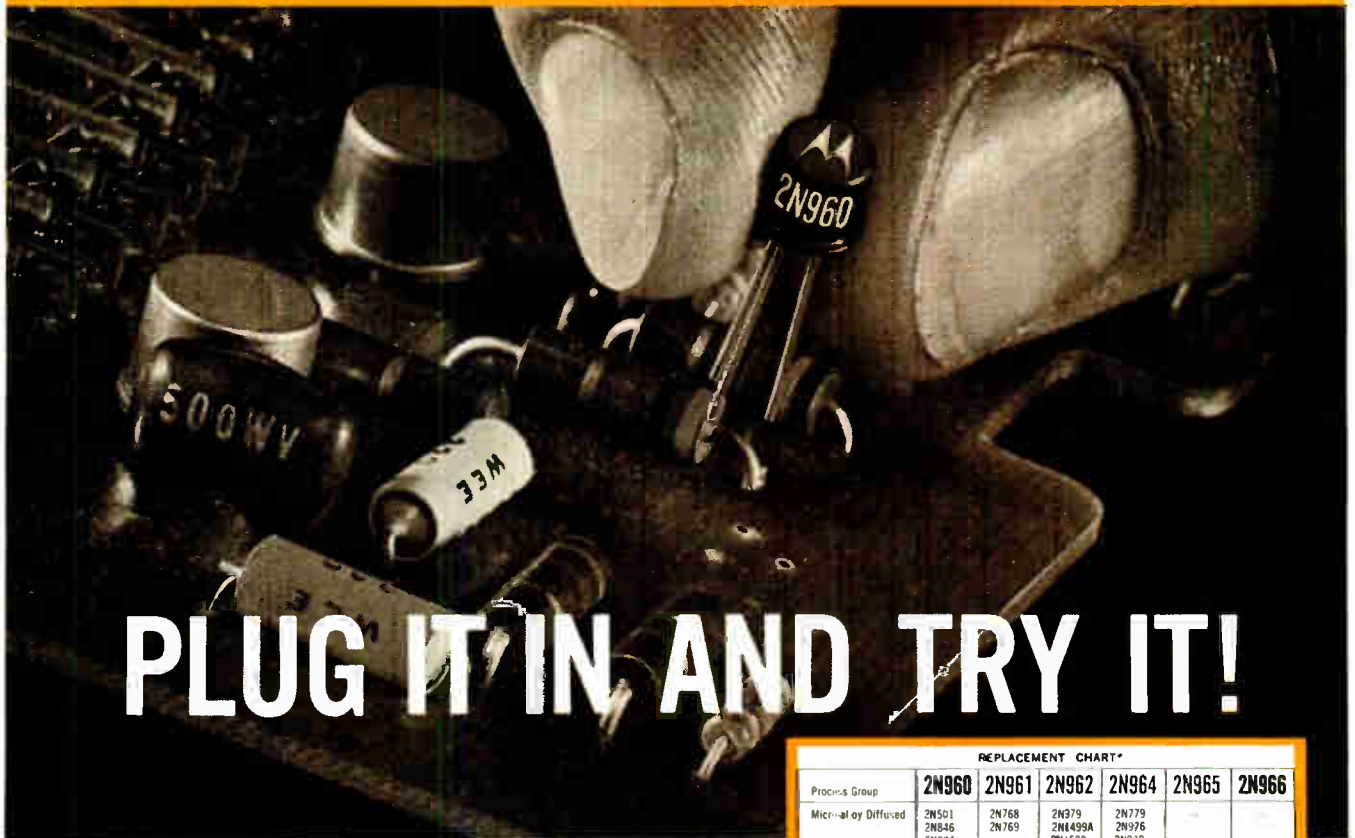

PLUG IT IN AND TRY IT!

Is it true that Motorola's germanium, epitaxial, 2N960 switching series will supplant nearly all other germanium micro-alloy, drift, mesa, and other transistor types for high-speed switching applications? And is it true that the Motorola series is even faster and performs better than advertised? The best way to find out is to try it!

Use the adjacent Replacement Chart and Specifications as a guide, and try any of these six remarkable new Motorola devices in your circuits. Judge for yourself what the advantages are. Samples are available from your local Motorola District Office. Ask also about Motorola's low prices — in many cases, they are considerably lower than those for old type devices.

Some of the Published Advantages of the Motorola 2N960 Series:

- faster switching time
- guaranteed minimum Beta over a wide current range ... specified at 10, 50, and 100 mA
- low saturation even at 100 mA
- rugged Motorola mesa construction
- the most comprehensive and conservative published specifications of any similar switching transistors
- proven reliability from the world's largest manufacturer of germanium epitaxial transistors



For more information on this important new mesa series, contact your Motorola District Office, or call or write: Motorola Semiconductor Products Inc., Technical Information Department, 5005 East McDowell Road, Phoenix 8, Arizona.

MOTOROLA DISTRICT OFFICES:
 Belmont, Mass. / Burlingame, Calif. / Chicago / Cleveland / Clifton, N. J. / Dallas / Dayton / Detroit / Garden City, L. I. / Glenside, Pa. / Hollywood / Minneapolis / Orlando, Fla. / Phoenix / Silver Spring, Md. / Syracuse / Toronto, Canada.

REPLACEMENT CHART*						
Process Group	2N960	2N961	2N962	2N964	2N965	2N966
Micro-alloy Diffused	2N501 2N645 2N964	2N768 2N769	2N979 2N499A 2N1500	2N779 2N976 2N982 2N983	—	—
Mesa	2N795 2N710 2N711B 2N741	2N711 2N711A	2N982	2N795 2N934 2N994 2N1301	2N795 2N1853	2N1300 2N734
Micro-alloy	—	2N1122A 2N1122	2N1411 2N1427	—	—	2N493
Alloy	2N543	—	—	2N582 2N584	—	—
Drift	—	2N643 2N644 2N645	2N602 2N1450	—	2N609	2N603

*Interchangeability of types shown is on the basis of performance in most switching circuit applications.

MOTOROLA GERMANIUM EPITAXIAL SWITCHING TRANSISTORS							
	2N960	2N961	2N962	2N964	2N965	2N966	UNITS
$f_{T(EMIN)}$ 10, 50, 100 mA	20	20	20	40	40	40	—
$V_{CE(SAT) MAX}$ @ 10 mA	.20	.20	.20	.18	.18	.18	Volts
@ 50 mA	.40	.40	.40	.35	.35	.35	Volts
@ 100 mA	.70	.70	.70	.60	.60	.60	Volts
$f_{T(MIN)}$ $I_C=20$ mAdc $V_{CE}=1.0$ Vdc	300 mc all types						
$Q_T(MAX)$ $I_C=10$ mAdc $I_E=1$ mAdc	80	80	90	80	80	90	pc
$I_C=100$ mAdc $I_E=5$ mAdc	125	125	150	125	125	150	pc
τ_{RE}	0.6 nsec typical all types						
τ_{FE}	0.5 nsec typical all types						

All types have 150 mw dissipation in free air, 300 mw at 25°C case temperature



MOTOROLA
 Semiconductor Products Inc.

A SUBSIDIARY OF MOTOROLA, INC.

1882

5005 EAST McDOWELL ROAD • PHOENIX 8, ARIZONA

Passivated Epitaxial Silicon Planar

High-Speed Switching NPN transistor

2N784A



Small signal device.
TO-18 package.

2N784A

Electrical Characteristics at 25°C

	Min.	Max.	Units
V_{CE} (Sat.) ($I_C = 10$ mA, $I_B = 1$ mA)	—	0.19	V
($I_C = 100$ mA, $I_B = 10$ mA)	—	0.65	V
BV_{CBO} ($I_C = 100$ μ A)	40	—	V
h_{fe} ($I_C = 10$ mA, $V_{CE} = 10$ V, $f = 100$ MC)	3.0	—	—
h_{FE} ($I_C = 10$ mA, $V_{CE} = 1.0$ V)	25	150	—
τ_s ($I_C = I_{B1} = I_{B2} = 10$ mA)	—	15	nsec
t_{on} ($I_C = 10$ mA, $I_{B1} = 3$ mA, $I_{B2} = 1$ mA)	—	20	nsec
t_{off} ($I_C = 100$ mA, $I_{B1} = 3$ mA, $I_{B2} = 1$ mA)	—	40	nsec

• 2N914 • 2N708

See your Sylvania representative for details.

- low saturation voltage at all currents, V_{CE} typ. @ 100 mA ... 0.35V!
- exceptionally fast typical t_{on} ... 14 nsec!
- unusually low typical C_{ob} ... 2.6 pfd!
- high typical h_{FE} ... 70 ($I_C = 10$ mA, $V_{CE} = 1.0$ V)!
- high typical power gain ... 13 db at 100 MC!

Designing new logic circuitry? Refining a current design? If extraordinary high-speed performance and reliability are among your objectives, investigate the benefits offered by Sylvania 2N784A. Famous Sylvania-Epitaxial process assures low saturation resistance. Planar passivated technique provides uniformity of electrical characteristics with extended life. Silicon material adds to reliability under severe environmental conditions.

You are invited to evaluate the unique capabilities of SYLVANIA EPITAXIAL SILICON PLANAR TRANSISTORS. Contact your Sylvania Sales Engineer or Sylvania Franchised Semiconductor Distributor for details. For tech data, write Semiconductor Division, Sylvania Electric Products Inc., Dept. 193, Woburn, Mass.

only **Sylvania** offers

Epitaxial

Silicon Transistors

in a choice of

4 Hermetic JEDEC Packages

- 1. TO-51 2. TO-46**
3. TO-18 4. TO-5

FEATURE

- high reliability hermetic packaging achieved through the use of KOVAR-matched glass-oxide seals, and resistance-welded closures.
- package dimensions held to exceptionally close tolerances.
- high heat dissipation capabilities in miniature and microminiature packages.

TO-46 "Pancake" Package

(large and small signal)

JEDEC-approved and based on a concept of geometry originated by Sylvania, the TO-46 "Pancake" combines package microminiaturization and relatively high-power dissipation capability. This permits an exceptional degree of volumetric efficiency with an extraordinary built-in reliability factor under environmental conditions of thermal and mechanical shock.

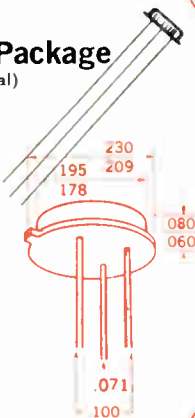

NEW! TO-51 Co-Planar Package

(small signal)

JEDEC-approved, the microminiature Co-Planar package with ribbon leads is dimensioned for insertion in 0.150" dia. hole-in-board for "Swiss-cheese" packaging technique. Or, leads may be omitted to enable leadless "dot" circuit packaging. Leads are nickel; may be soldered or welded.

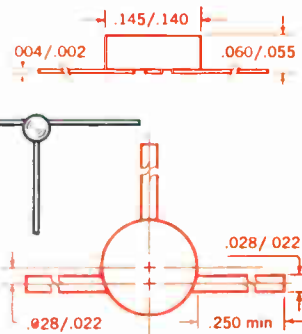

TO-18

(small signal)

TO-5

(large signal)

In addition to the microminiature TO-51 and TO-46 packages, Sylvania Epitaxial Silicon Transistors are available in the universally accepted TO-18 package as 2N783 and 2N784, in the TO-5 package as 2N1958 and 2N1959.

SYLVANIA

SUBSIDIARY OF
GENERAL TELEPHONE & ELECTRONICS



ALLIED CONTROL



RELAYS • SWITCHES

- MINIATURE RELAYS
- SUBMINIATURE RELAYS
- TELEPHONE TYPE RELAYS
- GENERAL PURPOSE RELAYS
- POWER RELAYS
- SENSITIVE AND PLATE CIRCUIT RELAYS
- SUBMINIATURE SWITCHES
- SOCKETS

**24 Hour
Delivery**

EASTERN REGION
ARCO ELECTRONICS, INC.
Community Drive
Great Neck, New York
HUnter 7-0500
TWX: GREAT NECK, N.Y. 639

WESTERN REGION
ARCO CAPACITORS, INC.
1548 So. Robertson Blvd.
Los Angeles 35, Calif.
Crestview 1-1151
TWX: BV 7012

ARCO

electronics inc.

RELAY DIVISION

ARCO CAPACITORS • ELMENCO CAPACITORS • HST TRANSFORMERS
DEUTSCH CONNECTORS • ALLIED CONTROL RELAYS & SWITCHES

Books

(Continued from page 73)

Photo and Thermolectric Effects in Semiconductors

International Series of Monographs on Semiconductors Volume 2. By Jan Tauc. Published 1961 by Pergamon Press, Inc., 122 East 55th St., New York 22, N. Y. 275 pages. Price \$7.50.

Design of Hydraulic Control Systems

By E. E. Lewis. Published 1962 by McGraw-Hill Book Co., 330 West 42nd St., New York 36, N. Y. 349 pages. Price \$12.50.

KEL Capabilities in Ground Support, Test & Automated Equipment

Booklet describes the capabilities and many electronic devices designed and manufactured by the Kidde Electronics Laboratories. Available on request on company letterhead only. Requests should be addressed to C. B. Dick at Belleville 9, N. J.

Computer Basics—5 Volumes

Published 1962 by Howard W. Sams & Co., Inc., 2201 East 46th St., Indianapolis 6, Ind. Price \$22.50 for all 5 volumes in a slipcase, or in separate volumes at \$4.95 each.

Who's Who in the Electronics Industry

By The Scientist and Engineer Technological Institute Staff. Published 1961 by The Scientist and Engineer Technological Institute, 176 East 75th St., New York 21, N. Y. 336 pages. Price \$49.50.

Transistor Specification Manual, Vol. II

Published 1961 by ARINC Research Corp., 1700 K St., N.W., Washington 6, D. C. Price \$8.00.

Governmental Publications

Orders for reports designated (OTS) should be addressed to the Office of Technical Services, U. S. Dept. of Commerce, Washington 25, D. C. Make check or money order payable to: "OTS, Dept. of Commerce." OTS reports may also be ordered through the Dept. of Commerce Field Offices. Prepayment is required. Use complete title and PB number for each report ordered. All other reports may be ordered from the Supt. of Documents, Government Printing Office, Washington 25, D. C.

Technical Resources Directory in Plastics

Published January, 1961 by the Department of Defense. 147 pages. PB171036. Price \$2.75. (OTS)

RADC Reliability Note book, Supplement 1

General Engineering Laboratory, RADC. 215 pages. PB 161894-1. Price \$3.50. (OTS)

Precision Measurement and Calibration, National Bureau of Standards Handbook 77, Vol. I, Electricity and Electronics

Issued 1961. 845 pages. Price \$6.00. (Supt. of Doc.)

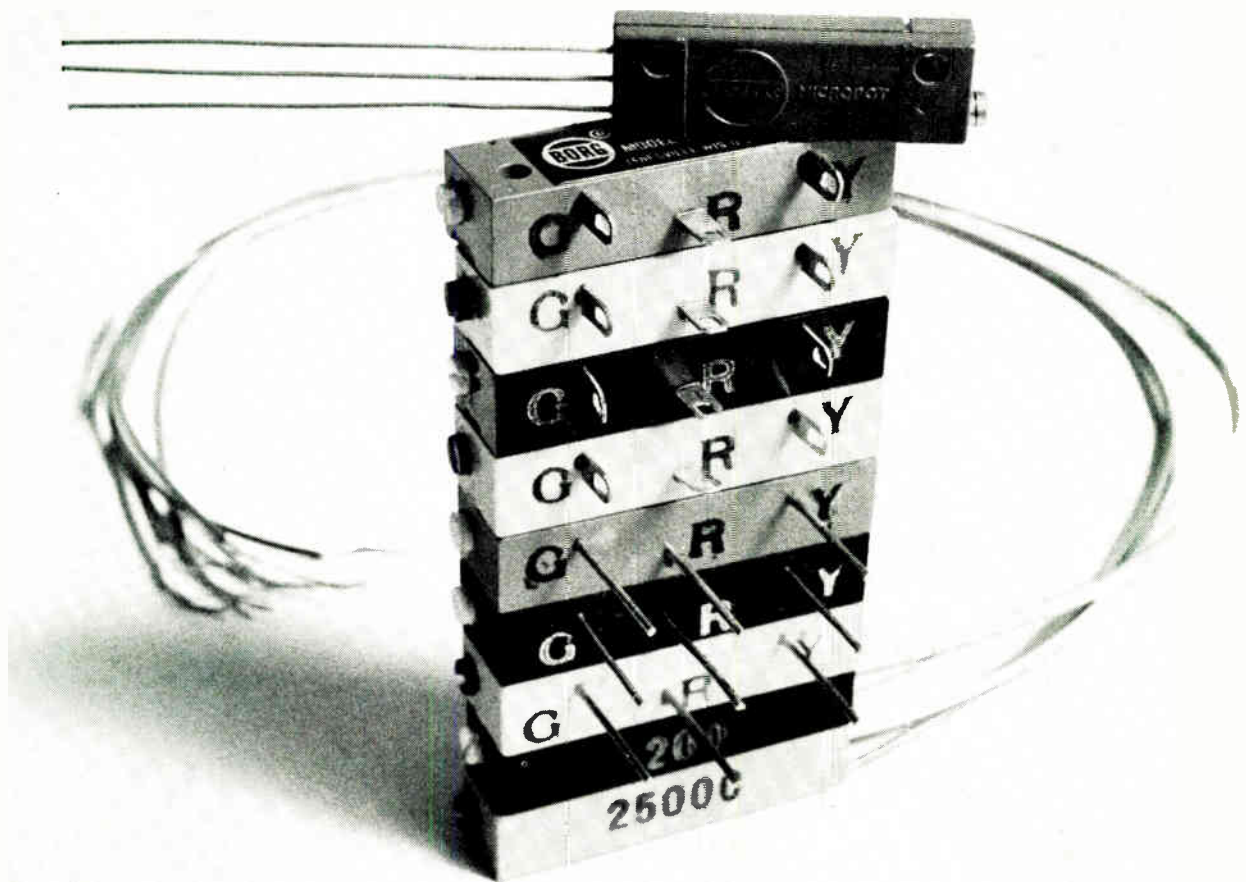

The complete Borg Trimmer line starts at the top

Everything must start someplace. The complete Borg line of Trimming Micropot® potentiometers can be said to start with its latest addition, the subminiature (1" x 3/16" x 5/16") 2700 series. This new Micropot is not only tiny, but a high-temperature, humidity-proof model as well.

However, if a quarter of an inch isn't important to your application, there are six other Borg Trimmer series from which to choose:

- 2800—High temperature, humidity proof, wirewound.
- 990—High temperature, wirewound.
- 992—General purpose, wirewound.
- 993—General purpose, carbon.
- 994—General purpose, humidity proof, wirewound.
- 995—General purpose, humidity proof, carbon.

Here are some of the advantages of-

- fered by Borg Trimmers: 1. Single-piece, welded terminations. 2. Low-mass contacts. 3. 100% noise test. 4. 100% contact resistance check. 5. 100% ratcheting test. 6. Resistances from ten ohms to one meg.

Selecting the right Borg Trimmer can be a lot easier if you'll call your nearby Borg technical representative or Amphenol-Borg Industrial Distributor. Or, if you prefer, write directly to R. K. Johnson, Sales Manager:

Circle 54 on Inquiry Card



BORG EQUIPMENT DIVISION

Amphenol-Borg Electronics Corporation,
Janesville, Wisconsin.

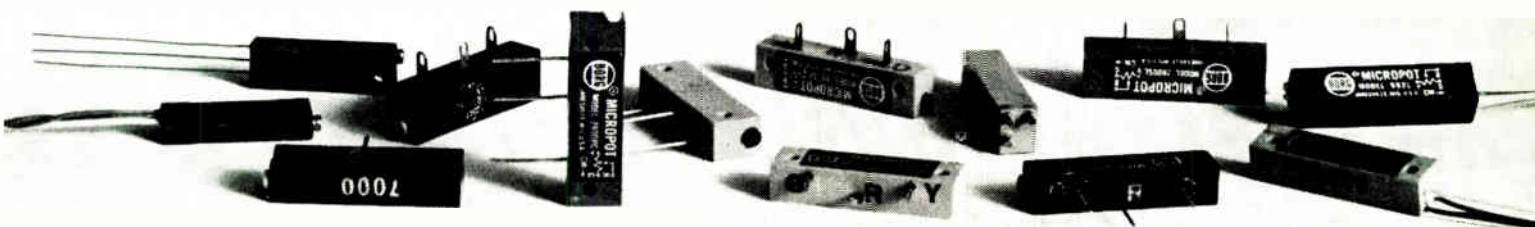

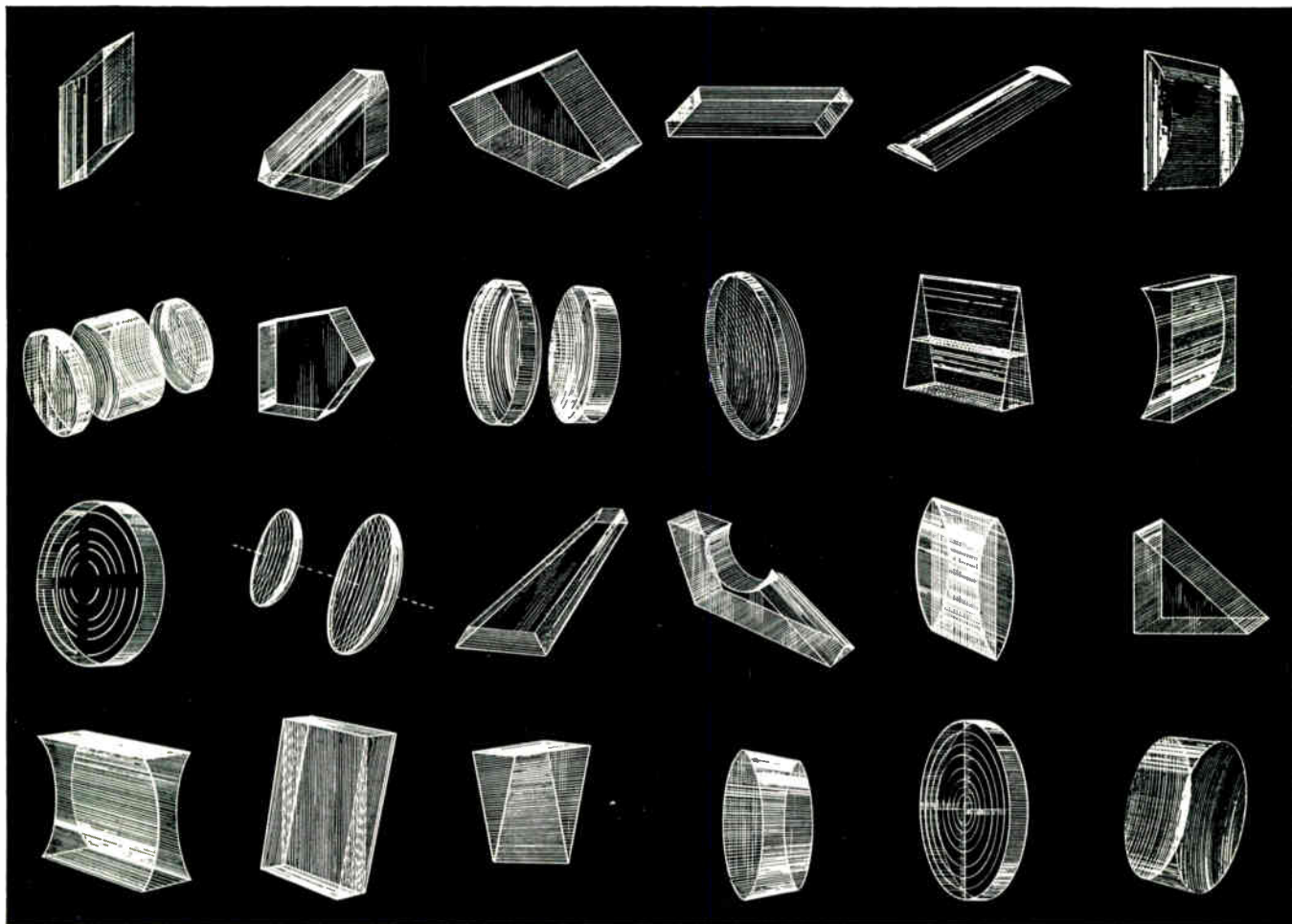

OPTICS FOR ELECTRONICS . . .

Components and systems for visible, ultraviolet, and infrared radiation. GEC's Astro-Optics Division specializes in design, development, and manufacturing of optical components and systems for the ultraviolet through infrared spectrum.

Here are a few of the optical components you can order from Astro-Optics: prisms, flats, spherical, aspherical and parabolic surfaces, reticles, information choppers, encoders, precision vacuum coating, and optically polished synthetic crystals.

Also available from Astro-Optics are infrared and optical-electronic systems.

For complete information regarding your precision optical requirements, write today to:

ASTRON OPTICS DIVISION

. . . precision optics at work



GENERAL ELECTRODYNAMICS CORPORATION

4 4 3 2 FOREST LANE • GARLAND, TEXAS

new



OUTPUT POWER METER



— a passive instrument
for measuring output power
and impedance of audio-frequency devices

- ★ **Power-measuring range** from 0.1mw to 20w in five decade ranges; auxiliary scale calibrated from -10 to 43db re 1mw.
- ★ **Impedance range** consists of 48 individual impedances . . . distributed approximately logarithmically from 0.6Ω to 32 KΩ.
- ★ **Quasi-rms meter** (25 μa full scale) reads rms even with 20% 2nd and 3rd harmonics present.
- ★ **Wide frequency range**
- ★ **Accuracy:**
Impedance Error — maximum error does not exceed ±5% from 70c to 10kc; does not exceed ±50% at 20c and 20kc. *Db Error* — maximum error does not exceed ±0.5 db from 70c to 10kc; does not exceed ±1.5 db at 20c and 20kc.
- ★ **Mounting** — General Radio Bench-Rack Cabinet with extendible legs.
- ★ **Low Price**
Type 1840-A
Output Power Meter . . . \$210.

Write for Complete Information

GENERAL RADIO COMPANY
WEST CONCORD, MASSACHUSETTS

NEW YORK, Worth 4-2722
District Office in Ridgfield, N. J.
WHitney 3-3140

CHICAGO
Oak Park
Village 8-9400

PHILADELPHIA
Abington
HAncock 4-7419

WASHINGTON, D. C.
Silver Spring
JUniper 5-1088

SYRACUSE
Syracuse
GLenview 4-9323

SAN FRANCISCO
Los Altos
WHitecliff 8-8233

LOS ANGELES
Los Angeles
HOLlywood 9-6201

ORLANDO, FLA.
Orlando
GArden 5-4671

IN CANADA
Toronto
Cherry 6-2171

Circle 56 on Inquiry Card

FOUR COMPARISON TESTS SHOW WHY YOU GET GREATER DEPENDABILITY WITH

NEW Fibremat[®] ELECTRICAL INSULATIONS

BRAND

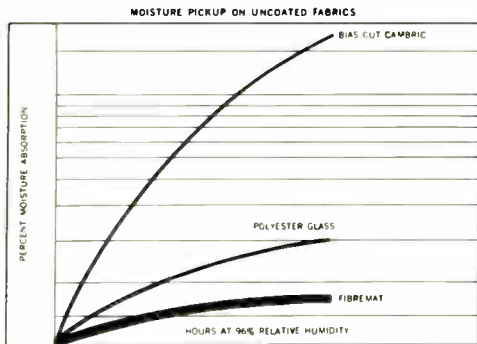

MOISTURE ABSORPTION - UNCOATED FABRICS - There's no pre-baking to drive out moisture when you use "Fibremat." The non-hygroscopic base fabric resists moisture. When exposed to 96 percent relative-humidity for 45 hours bias-cut cambric showed a moisture absorption of 25 percent, polyester-glass showed a moisture absorption of 25 percent, while "Fibremat" showed a moisture absorption of less than .7 of one percent. Proof of the superior moisture-resistance of "Fibremat" Insulation.

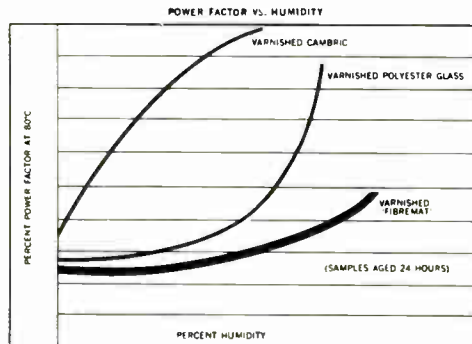

MOISTURE ABSORPTION - COATED INSULATIONS - In moist or humid environments "Fibremat" outperforms varnished cambric or polyester-glass materials. Continuous filaments in woven fabrics wick up moisture and offer a direct path for moisture to follow. The non-woven construction of "Fibremat" prevents wicking and moisture absorption. The power factor of varnished "Fibremat" remains relatively stable while the power factor of the other insulations zoom upward under increased humidity conditions.

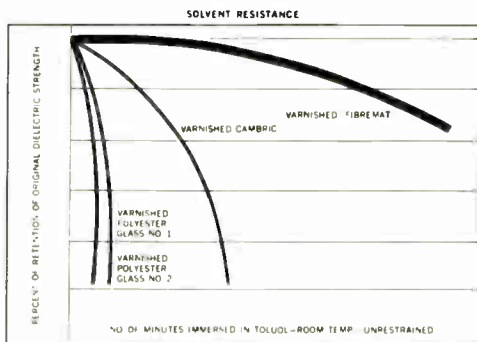

SOLVENT RESISTANCE - COATED INSULATIONS - "Fibremat" offers outstanding resistance to solvents used in dipping or impregnating operations. Conventional woven insulations leave relatively large unsupported areas of varnish film between the filaments. This unsupported film, when exposed to solvent, tends to swell and flake away from the base fabric and cause electrical failure. The uniform dispersion of fibers in "Fibremat" however, provides equal support for all areas of the varnish film and prevents this solvent-caused breakdown.

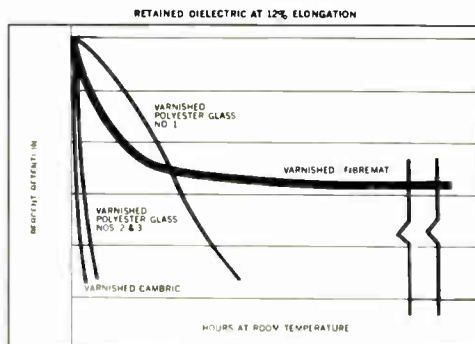

RETAINED DIELECTRIC AT 12% ELONGATION - COATED INSULATIONS - At 12% elongation varnished "Fibremat" retains a significantly greater percentage of its original electric strength than either varnished cambric or varnished polyester-glass materials. Woven insulation, when stretched, creates points of stress where filaments cross each other. Elongation produces a scissor-like action that weakens the structure, tends to tear the varnish film and rupture the insulation coating. Non-woven "Fibremat" has built-in stretch, doesn't "scissor", supports the entire film.

Irvington Division

3M MINNESOTA MINING & MANUFACTURING CO.

"FIBREMAT" IS A REGISTERED TRADEMARK OF 3M CO., ST. PAUL 1, MINN.

"Fibremat" is no ordinary insulation. It's formed from a non-woven web of polyester fibers without the use of adhesives or any other bonding agent. This unique non-woven construction gives "Fibremat" flexibility to conform snugly to irregular shapes without gapping or voiding. Helps it retain electric strength under elongation so fewer layers are needed to attain the same

electrical performance achieved with many layers of ordinary insulating materials. Use "Fibremat" for wrapping form wound coils, layer and phase insulation, slot liners, and high voltage cable. For more information, write: 3M Company, Irvington Division, St. Paul 6, Minn., or phone and ask for "Fibremat" at your nearest branch office listed below.

ATLANTA, GA 451-1661; BOSTON, MA 9-0300; BUFFALO, TX 4-5214; CHICAGO, IL 8-2200; CINCINNATI, OH 1-2313; CLEVELAND, OH 2-4300; DALLAS, TX 7-7311; DETROIT, MI 875-7111; LOS ANGELES, CA 3-6641; PHILADELPHIA, PA 2-0200; NEW YORK, NY 5-5520; ST. LOUIS, MO 1-1320; ST. PAUL, MN 6-8511; SAN FRANCISCO, CA 6-0800; SEATTLE, WA 2-5550.

NOW

CLARE gives you
choice of circuitry
in billion-operation
**Mercury-Wetted
Contact Relays**

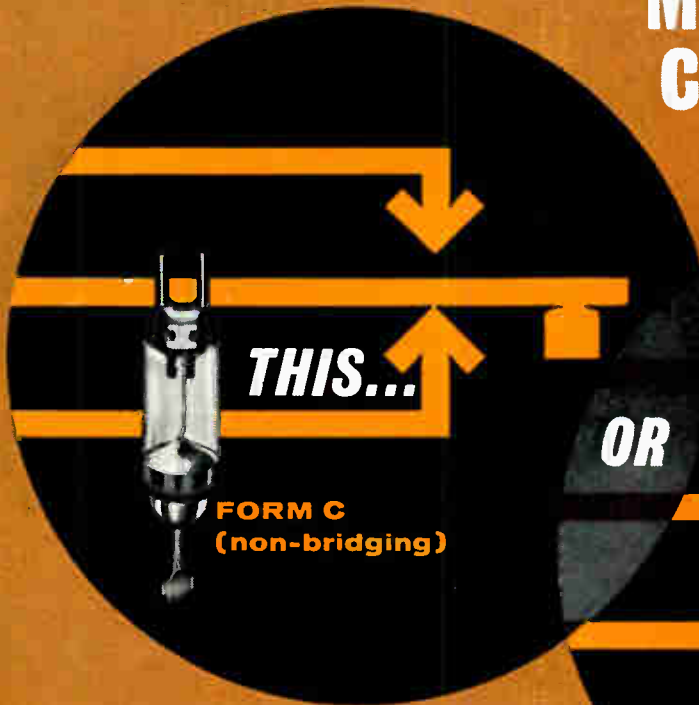

Now you can have the power gain and consistently low contact resistance of Clare HGS mercury-wetted contact relays...whether your circuit calls for break-before-make or make-before-break action.

Clare reliability, long life, high speed and sensitivity are readily available—without design compromise or expensive circuit modifications. You eliminate contact bounce and erosion, electric chatter and relay maintenance—because constantly-renewed mercury contact coatings never wear out, never get dirty, always provide uninterrupted metallic current path between closed contacts.

If only non-bridging action will satisfy your needs, specify the non-bridging mercury-wetted contact relay—the Clare HGS-5000. Like the bridging HGS-1000, it is available in cans with plug-in and solder connectors...steel or nylon encased units for direct printed circuit board use...or as integrated assemblies, mounted on printed circuit boards supplied by Clare or the user.

For reliability proved in thousands of critical applications, *plus* your choice of bridging or non-bridging action, count on Clare HGS relays!

Send for Design Manual 201A and Bulletin CPC-13

See your nearest CLARE representative or address C. P. Clare & Co., 3101 Pratt Blvd., Chicago 45, Illinois. Cable Address: CLARELAY. In Canada: C. P. Clare Canada Ltd., 840 Caledonia Road, Toronto 19, Ontario. In Europe: Europelec, les Clayes-sous-Bols (S. et O.), France.



C. P. CLARE & CO.

Relays and related control components

JENNINGS VACUUM CAPACITORS

OVER 300 TYPES

TO MEET HIGH VOLTAGE CIRCUIT DESIGN PROBLEMS

Of course this unusually large selection didn't just happen overnight. It represents the accumulation of twenty years experience in the manufacture of vacuum capacitors. During this time Jennings has developed exclusive vacuum processing techniques. Examine the representative types shown below, all of them proven successful in thousands of applications.

HIGH VOLTAGE

Type.....VMMHHC
Capacitance Range..... 25 to 200 mmfd
Peak Voltage..... 120 kv
RF Current..... 125 amps RMS
Length..... 20¼ inches



HIGH CURRENT

Type..... VMMHCW
Capacitance Range..... 50 to 400 mmfd
Peak Voltage..... 55 kv
RF Current..... 500 amps RMS
Length..... 17 inches



HIGH RATIO OF CAPACITANCE CHANGE

Type..... UCSL
Capacitance Range..... 7 to 1000 mmfd
Peak Voltage..... 5 kv
RF Current..... 42 amps RMS
Length..... 7-9/16 inches



SMALL SIZE

Type..... ECS
Capacitance Range..... 3 to 30 mmfd
Peak Voltage..... 15 kv
RF Current..... 20 amps RMS
Length..... 4¼ inches



Our radio frequency laboratory with 12 functioning transmitters ranging from 17 KC to 600 MC and up to 100 KW CW power is at your service to test our products under your particular circuit conditions.

Write for our special brochure describing our complete line of vacuum capacitors.

RELIABILITY MEANS VACUUM / VACUUM MEANS **Jennings**®

JENNINGS RADIO MFG. CORP., 970 McLAUGHLIN AVE., SAN JOSE 8, CALIF., PHONE CYpress 2-4025

Orbits Around Moon May be Man-Controlled

A recent Government research report has theoretically established man's ability to take control of a spaceship at the last stage of a Moon shot, and then establish a circular orbit only 10 miles off the Moon's storied surface. This report is "A Fixed-Base Simulator Study of the Ability of a Pilot to Establish Close Orbits Around the Moon." M. Queijo and D. Riley, Langley Research Center, for NASA, June 1961. 53 pages. (Order AD 257 804 from Office of Technical Services, U. S. Dept. of Commerce, Washington 25, D. C., price \$1.50.)

Display System Contract Awarded

LFE Electronics, Boston, Mass., has received a contract from Aircraft Armaments, Inc., Cockeysville, Md., for production of a digital data storage and display system. System is to be used in an anti-submarine warfare training device being developed by the U. S. Naval Training Center, Port Washington, N. Y. When installed in the Navy's new Submarine ASW Training Facility, Pearl Harbor, Hawaii, LFE's system will provide numerical display of target data using the digital output of a Control Data Corporation 1604 computer.

SOLAR RADIO



Mrs. J. Britton checks radio reception in fallout shelter she and her husband are building. Portable radio, manufactured by Hoffman Electronics Corp., gets its power from solar pack in left foreground. Solar pack will be attached to the roof. Power cable will double as an antenna. Radio has batteries for night operation.

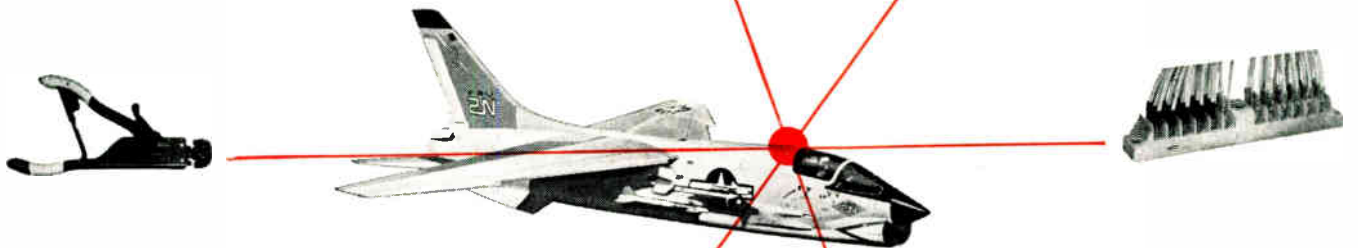
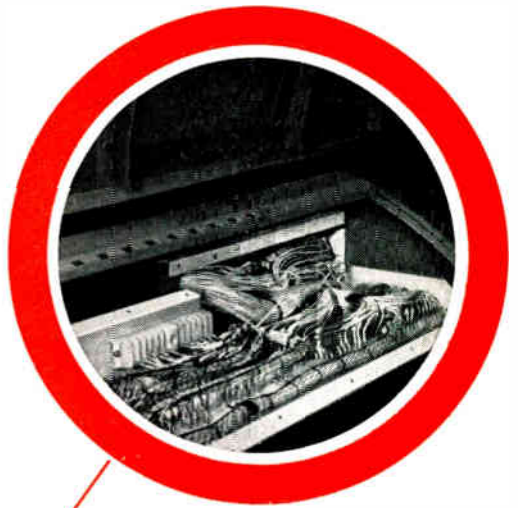

AND NOW...TAYP-AIR* PINS JOIN THE FLEET!

The carrier-based Crusader travels in the Mach 2 speed range . . . is all-weather, packs a variety of offensive punches and has a radar eye for alertness to conditions and target.

Chance Vought's requirements for "essential-to-flight" circuits included maximum density and reliability. They found what they needed in AMP Crimp-type TAYP-AIR pins and blocks. The design of AMP TAYP-AIR pins makes possible a high concentration of circuits in less space . . . heavy, bulky, standard terminal boards are replaced by lightweight, compact AMP TAYP-AIR nylon blocks. The tapered shape of the new terminal provides excellent electrical and mechanical characteristics and when subjected to vibration, retention values are actually increased. Insertion and extraction of the AMP TAYP-AIR pin is accomplished with easy to handle tools which simplify not only installation but also repairs and circuit changes. Other features include:

- **Plating:** gold over nickel on leaded bronze base material.
- **Wire Size:** pins available in three sizes to cover wire size ranges 16-24 AWG.
- **Blocks:** choice of three sizes: 48 single circuits in feed through block, 12-3 common circuits with potted back and 12-4 common circuits with potted back.
- **Color Coding:** insulation sleeves color coded to conform with matched AMP crimping tool.

AMP TAYP-AIR PINS may very well fit in with your designs on saving space and weight. A sure way to get your problem off the ground is to write for further information today. The complete story on AMP TAYP-AIR Pins and Block Assemblies will be sent on request.

*Trademark of AMP INCORPORATED

AMP

INCORPORATED
Harrisburg, Pennsylvania

AMP products and engineering assistance are available through subsidiary companies in: Australia • Canada • England • France • Holland • Italy • Japan • Mexico • West Germany

Aerotan® Solid Tantalum Capacitors

Answer Demand For Exceptional Reliability, Capacitance Stability And Small Size



proven in rugged military, industrial and commercial applications

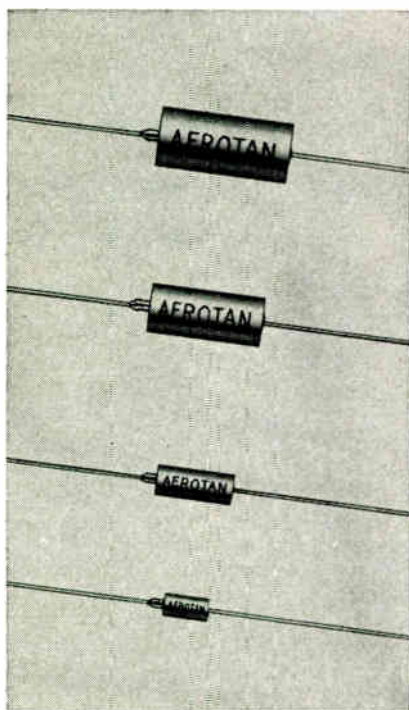

Aerotan capacitors are housed in hermetically sealed metal cases, and feature a semiconductor electrolyte to assure a completely dry assembly with absolute freedom from corrosion and leakage.

Wide Range of Applications

Aerotan Type ST capacitors are applicable in DC blocking, AC coupling, bypass and filtering, integration, storage phasing and timing, and other applications where the alternating-current component is small compared to the direct-current voltage rating. Their reliability has been proven in extremely demanding applications, including computers, missiles, high altitude aircraft, telephone and communications apparatus, airborne electronic equipment, atomic energy equipment, and oil drilling equipment.

Technical Facts

Manufactured in uninsulated case styles (Type ST12) and insulated cases (Type ST13), Aerotan capacitors are designed for continuous operation over a temperature range of -80°C to $+125^{\circ}\text{C}$ at the voltage ratings shown below:

Rated Voltage	+65°C	+85°C	+125°C
6 VDC	6 VDC	6 VDC	4 VDC
10 VDC	10 VDC	10 VDC	7 VDC
15 VDC	15 VDC	13 VDC	10 VDC
20 VDC	20 VDC	17 VDC	13 VDC
35 VDC	35 VDC	28 VDC	20 VDC

Environmental Tests

ST units will meet or exceed environmental requirements of MIL-C-26655A including vibration, moisture resistance, thermal stability, corrosion, terminal strength and tests upon insulating sleeves.

Availability

Aerotan solid tantalum capacitors are now available for immediate delivery from the factory. Prototype and small production quantities are also available for off-the-shelf delivery from your local Aerovox Industrial Distributor at OEM prices.

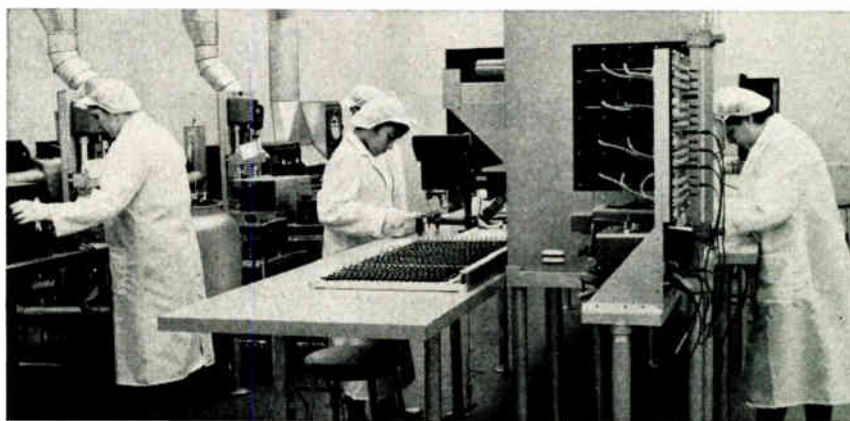

Aerotan solid tantalum capacitors are manufactured in specially constructed super-clean "White Room" production areas under a rigid system of step-by-step process control.

AEROTAN IN CROSS SECTION

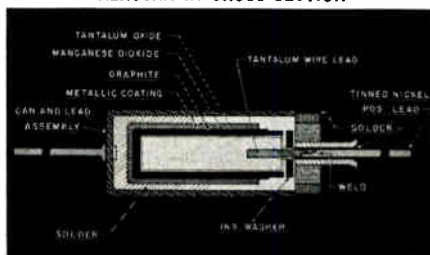

TECHNICAL LITERATURE

Call your nearest Aerovox field representative today or send direct for a free copy of Catalog Sheet 215B2.

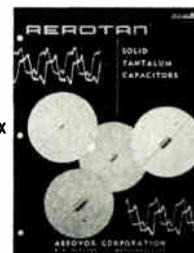

AEROVOX CORPORATION
NEW BEDFORD DIVISION NEW BEDFORD, MASS.

Technical Leadership - Manufacturing Excellence

A new concept in line voltage regulation in the KVA range...

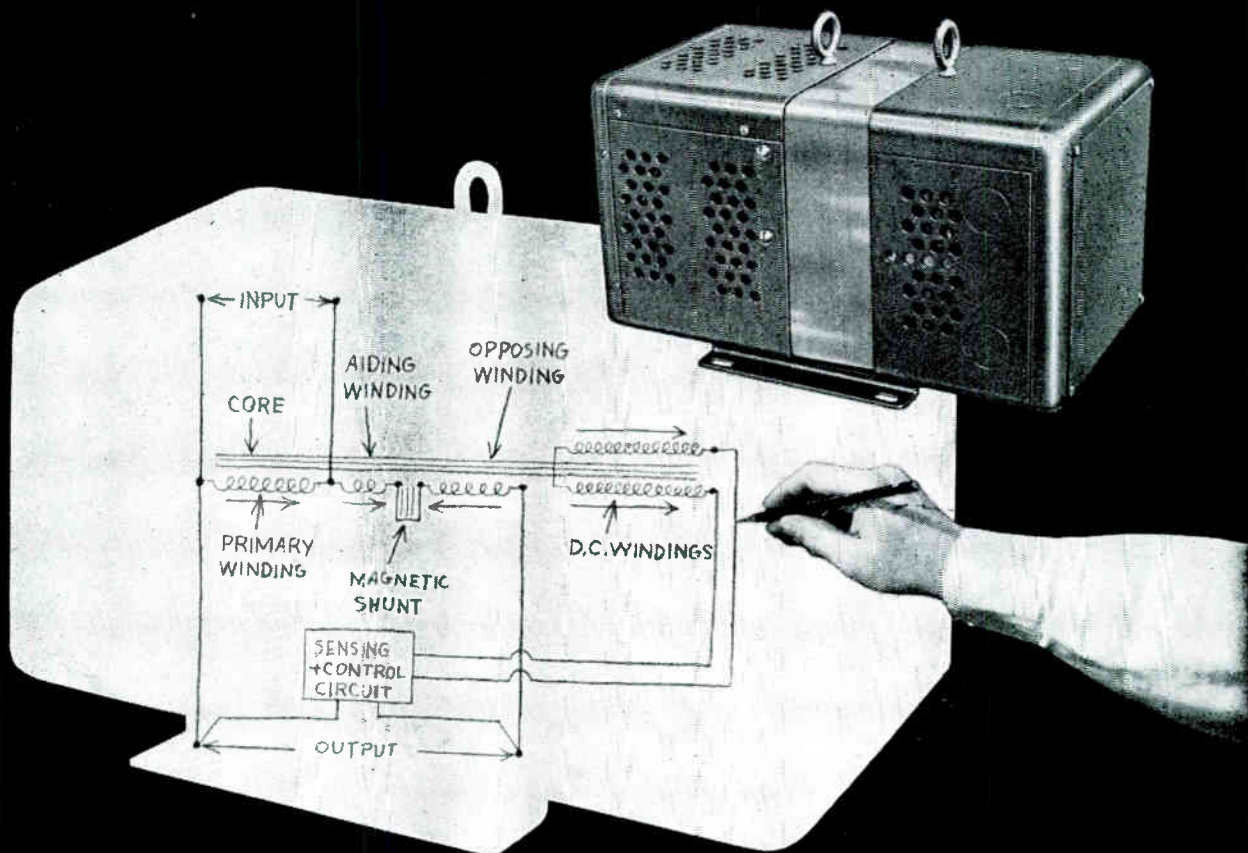

The SOLATRON Line Voltage Regulator

Sola now has developed a new uncomplicated breed of line voltage regulators. *Up to 10 times faster than mechanical regulators*, the new SOLATRON Line Voltage Regulator features no moving parts, lower operating cost per KVA, and is maintenance free!

Designed to cover the 3-100 KVA range, the SOLATRON Line Voltage Regulator offers corrective action the instant output departs from nominal . . . long before voltage even approaches boundaries of the regulation envelope! Output holds *stable* in the face of leading and lagging power factors. Efficiency — 95% at full load.

For more information on the new SOLATRON Line Voltage Regulator, send requests, on company letterhead, direct to our factory address.

- **EXCELLENT REGULATION** — $\pm 1\%$ from nominal, for any combination of line, load, and frequency change within specified parameters.
- **FAST RESPONSE** — practically instantaneous; even under extreme conditions, return to nominal will never exceed 10 cycles.
- **ULTRA-COMPACT** — Over-all dimensions for the 5 KVA measure approximately $8\frac{1}{4} \times 8\frac{1}{4} \times 16\frac{1}{4}$ ".
- **COMPLETE FLEXIBILITY** — designed for horizontal or vertical mounting; standard NEMA markings and color coding.

SOLA
Division of
Basic Products Corporation

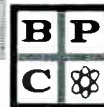

SOLA ELECTRIC CO.
1717 Busse Road
Elk Grove Village, Ill.
HEmpstead 9-2800
IN CANADA,
Sola-Basic Products Ltd.,
377 Evans Avenue,
Toronto 18, Ontario

this is
the Brush
Mark II . . .

anyone

can
plug
it in

put it
in writing
anywhere

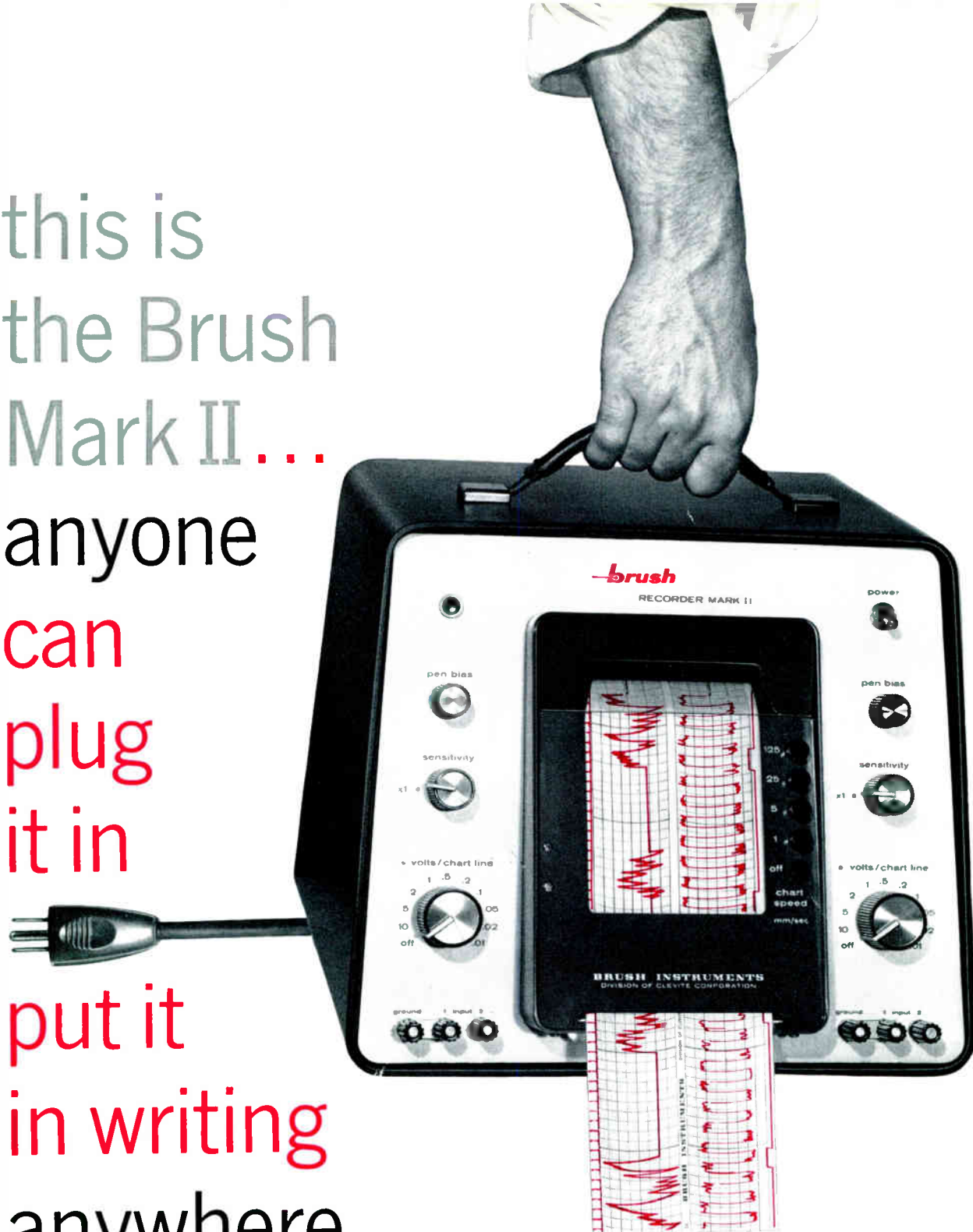

There is no direct writing recorder on the market that approaches the compact Mark II in sheer usefulness. It is a completely integrated engineering tool that can be operated by anyone . . . in the shop or in the field . . . for countless research or design requirements. Every function necessary for uniform, crisp, easily reproduced readouts is "built-in". The Mark II gives you two analog channels plus two event markers; 4 chart speeds; DC to 100 cps response with 40 mm amplitude; 10 mv/mm sensitivity; high input impedance. Ink or electric writing models. Immediate shipment from stock.

brush INSTRUMENTS
DIVISION OF
37TH AND PERKINS **CLEVITE** CLEVELAND 14, OHIO
CORPORATION

Next month

● KNOW YOUR ACCELEROMETER AND HOW TO USE IT

Accelerometers have been receiving widespread attention. However, one aspect of their use has been explored only lightly—that is the mount on which they are fastened. Under some conditions, the mount permits faithful reproduction; under others, distortion and worthless readings.

● DESIGNING HIGH-VOLTAGE POWER SUPPLIES

Due to the increasing variety of uses for CRT's, photomultiplier tubes, klystrons, and electrostatically controlled TWT's, there is a rapidly increasing demand for high-voltage power supplies. Components suitable for this work, as well as design techniques required, have not been widely understood; this article helps to improve the situation.

● RECENT DEVELOPMENTS IN HIGH FREQUENCY KLYSTRON OSCILLATORS

Much work has been done on developing klystron oscillators which will operate at frequencies above 20 GC. As a result of this work, a group of reflex and floating drift tubes has been produced. This group of tubes operates at frequencies up to 80 GC.

● CHEMICALS FOR THE ELECTRONIC INDUSTRY

More and more, disciplines are merging to advance technology. The chemical industry, once just a supplier, is now a full research partner in advancing solid-state electronics. Here's what it is doing.

Plus all other regular departments

Our regular editorial departments are designed to provide readers with an up-to-the-minute summary of world wide important electronic events. Don't miss Radarscope, As We Go To Press, Elec-

tronic Shorts, Coming Events, EI Totals, Snapshots of the Electronic Industries, EI International, News Briefs, Tele-Tips, Books, Representatives News, International Electronic Sources, Personals, etc.

COMING SOON

● THE 1962 ANNUAL ALL-REFERENCE ISSUE

The fifth consecutive annual edition containing year-round technical reference material for electronic engineers. The editorial staff is already at work compiling and selecting data for this issue. Suggestions from user-readers for new topics and compilations to be included will be given careful consideration.

Watch for these coming issues:

***JUNE**

All-Reference Issue

***AUGUST**

Annual WESTERN Issue

***NOVEMBER**

Annual MICROWAVE Issue

← Circle 63 on Inquiry Card

A fresh approach is needed to accomplish checkout and launching activities for the projected space systems of the 1965-1975 era. Some of the requirements and possible solutions are discussed here.



Automation for Future

THE application of automatic checkout equipment to the ballistic missile logistic problem has moved steadily forward. There are several systems being used in the factory and at the launching site that are fully automatic, or at least semi-automatic. Several second generation versions are under development.

Most systems use the principal of a tape or card programmed Programmer-Comparator, plus special purpose stimuli designed for a specific missile system. Typical examples are the Autonetics' "BACE" equipment for the Navy's Vigilante aircraft, the Nortronics' "DATICO" being used for tactical checkout of the Navy's Polaris missile, and the RCA "APCHE" for the Atlas missile. The Air Force issued MIL-P-26664 a few years ago and it is being used in A.F. programs such as the Skybolt ALBM.

First Generation Equipment

First generation equipment all operate in a like manner. For purposes of illustration they may be explained by the diagrams in Figs. 1 to 4. There are 4 major elements in such test equipment:

1. Instruction Center
2. Stimuli
3. Data Summary
4. Self-Test

The terms used by firms producing automatic checkout equipment varies. But in general, Items 1, 3 and 4 are all included in the Programmer-Comparator; i.e., all equipment required for test program selection, input and output lead selection of the items under test, data conversion, comparison with pre-desired test limits and provisions for self-test. Item 2, Stimuli, includes discrete, digital and primarily analog signal generation equipment that is needed to simulate input conditions found under actual operation. This latter category includes such items as programmed ac, dc, and R-F voltage generators, pressure generators, motion generators, etc. It is normally special purpose equipment, tailor-made for the missile system it is used with.

Second Generation Equipment

The second generation test equipment uses either a special purpose or general purpose digital computer. The computer operates with a tape or card input, and with memory capabilities. This approach has been used successfully in the factory assembly area by Lockheed Missile & Space Division for the Navy Polaris Missile System. The LMSD equipment is called "ACRE" (Automatic Checkout and Readiness Equip-

Fig. 1: First generation automatic check-out system.

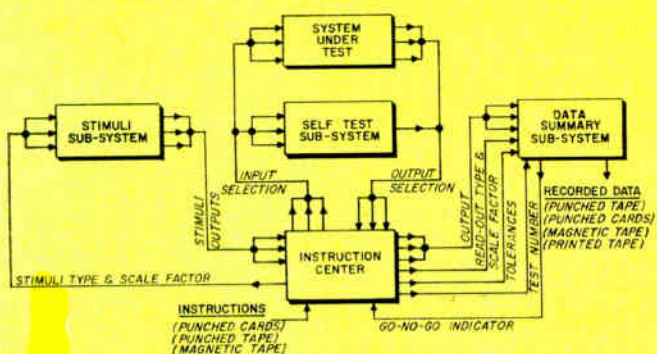
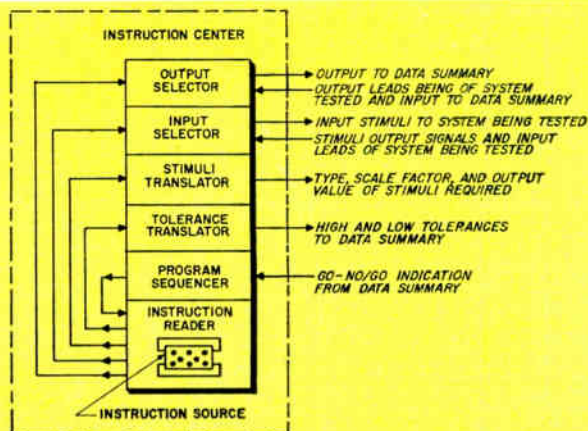

Fig. 2 (r): Block diagram of an instruction center.



By **LARRY S. KLIVANS**

Manager,
Aerospace Ground Equip. Systems Eng'g.
Lockheed Missile & Space Co.
Van Nuys, Calif.

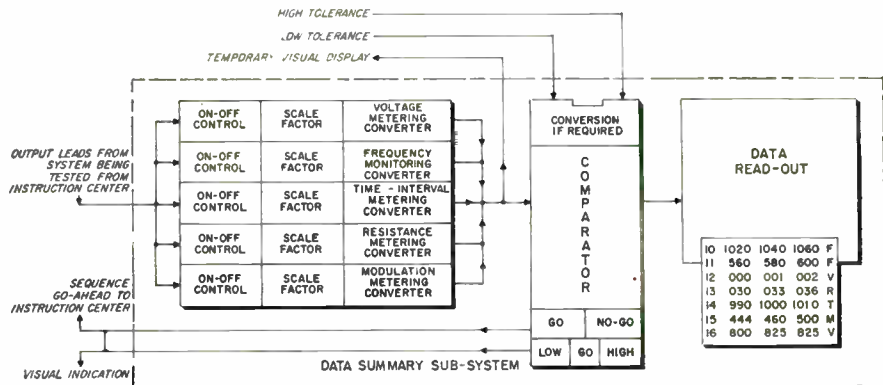

Fig. 4: Comparison and read out are the functions of the data summary sub-system.

Space System Launchings

ment). A simplified diagram is shown in Fig. 5. This system includes a test center with one or more digital computers and individual test stations that can be used for component, major assembly, sub-system, or complete vehicle system checkout. A photograph of the test center equipment is shown in Fig. 6. It is first necessary to load the computer memory with the test programs or, using tape or cards, program the proper information for use as the test needs arise. The individual test station operator then simply connects the equipment to be tested. He inserts a punched card, which in turn interrogates the comparator for the proper test program test limits, stimuli, commands, etc.

In the present system, "ACRE" transmits analog data from the system under test to the test center. Here it is converted to digital data and processed for comparison with pre-programmed test limits. However, it is feasible, and perhaps preferable, to change all information at the test stations to digital data before sending to the central computer. A complete record of test time, number, measured value, test limits, etc., is also obtained for inspection, reliability and preventative maintenance purposes.

The ACRE system is typical of the second genera-

tion of automatic test equipment called Computer-Controlled Checkout Systems. A few of the principal benefits of this approach to automatic checkout are as follows:

1. Test sequence is non-critical, since memory permits correlation of specific measurements with those previously made.
2. Enables the use of composite testing where statistical evaluation of several test parameters is needed. (Prevents rejection of acceptable systems due to minor No-Go measurements that do not effect overall system performance.)
3. Allows correction for zero drift.
4. Enables marginal testing by easy comparison of previous test results with those made weeks or months earlier, thereby identifying future malfunctions prior to actual failure.
5. Enables variation of test limits as a function of one or more other measured parameters.
6. Provides capability of stored logic, which predetermines course of action in the event of malfunction, thereby greatly reducing skill level of the test operator.

(Continued on following page)

Fig. 3: A typical stimuli sub-system used for first generation automatic checkout.

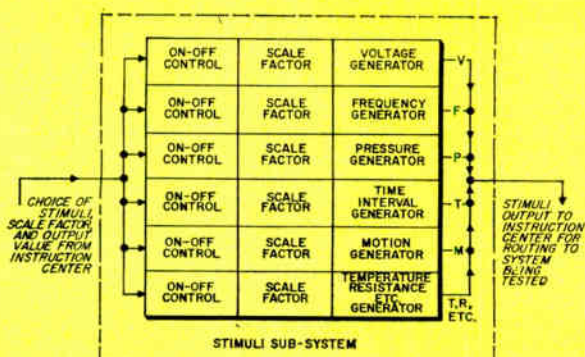
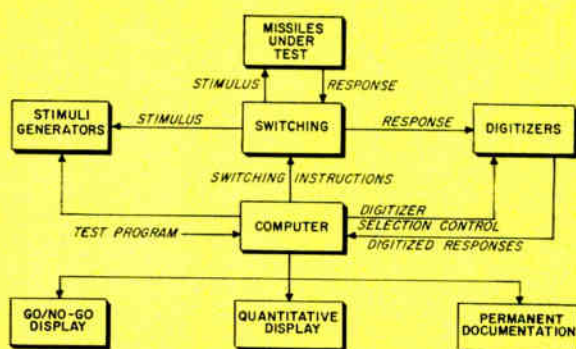

Fig. 5: A simplified block diagram of the second generation "ACRE" system.



Upon projecting checkout equipment requirements into 1965-1975 we see that the second generation approach must be greatly improved to provide future needs. By 1970 it is conceivable there will be hundreds of vehicles launched per year, with numerous variations in propulsion systems, guidance systems, payload equipment, etc. It is not economically sound to conceive that each of these systems will have their own automatic checkout equipment, designed for only one system. Also, considering manpower requirements, training, size of assembly and test areas at the two major launching site areas in the U. S., Pacific Missile Range and Atlantic Missile Range, it is not feasible to have a separate assembly building, blockhouse, and launching pad for each system. With the rapid advances in data processing, as well as automatic control systems growth in warehousing, we could greatly simplify the whole test base operation through assembly, checkout, pre-launch and launch operations by combining a master computer-controlled test station with semi-automatic logging and dispatching techniques.

One possible application is shown in Fig. 7 and operates as follows: Components, such as gyros, actuators, beacons, etc., are received in a central logging station. Here they are inspected for physical damage and correct identification. A master card file is interrogated and a pre-punched test data card, corresponding to the proper part number, is provided for attachment to the component. Using assembly line techniques, the card and component are routed to the test area where the card is then inserted into one of several card readers.

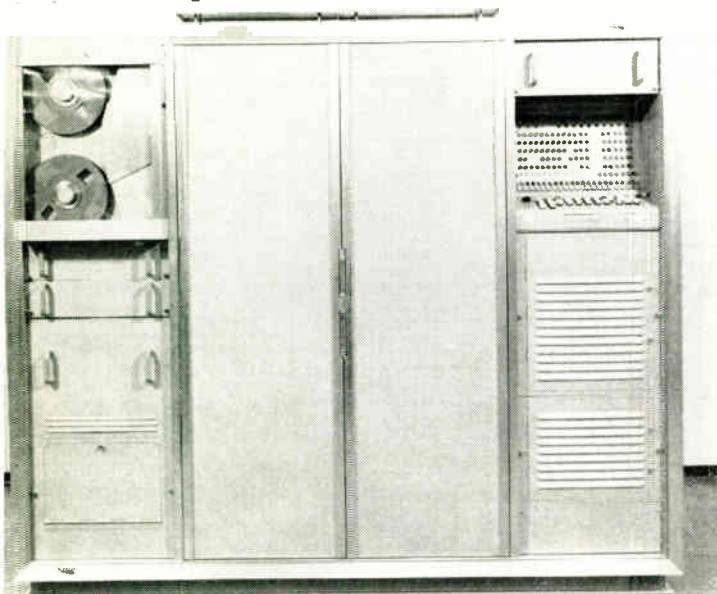
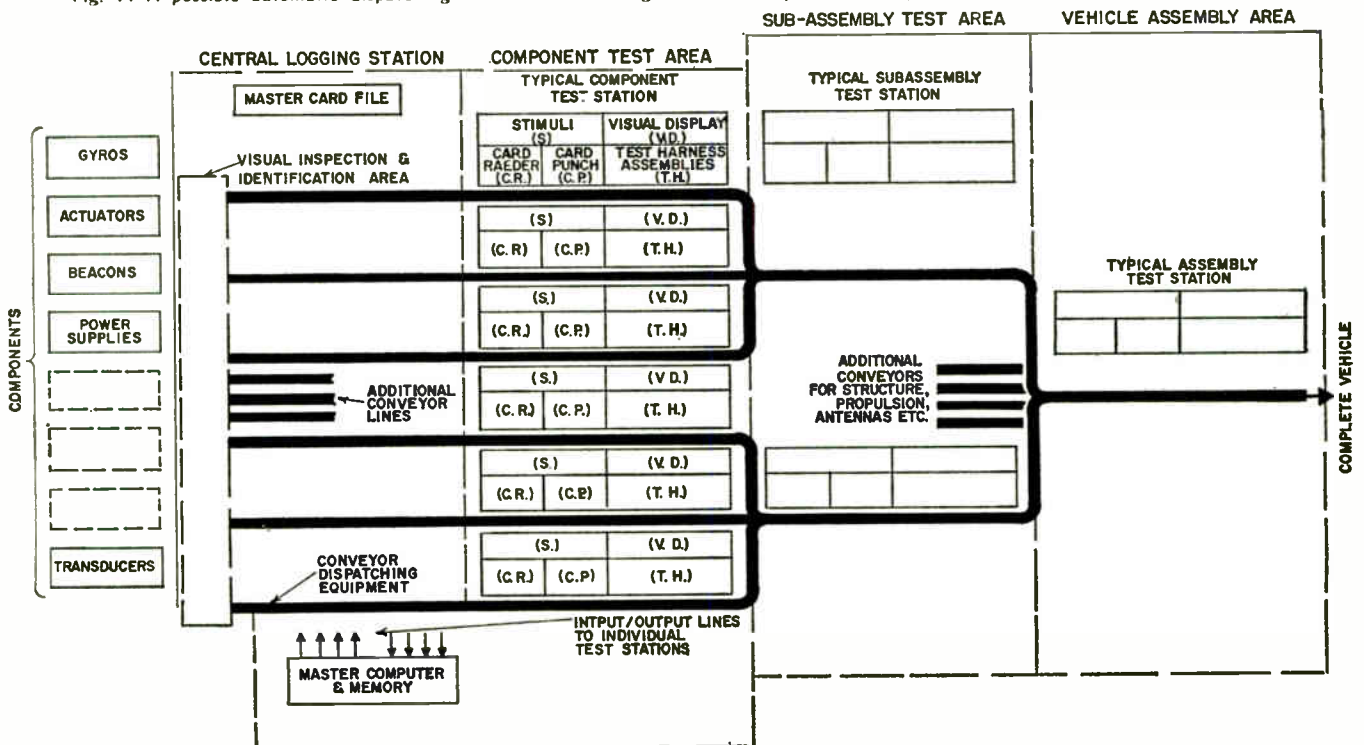

Fig. 6: Photo of the test center equipment in the "ACRE" system.

Automated Checkout (Continued)

Fig. 7: A possible automatic dispatching and checkout arrangement for complete assembly and checkout of future space vehicles.



Using the memory of the master computer test station, the correct test harness assembly is given. The test man connects the component to the harness and requests a test program from the central computer. Other instructions can be provided by means of a computer-actuated visual display if needed. A complete test record card is also prepared during the test. The component is removed from the harness and placed on a conveyor line going to the sub-assembly area. Here the procedure is repeated using a pre-prepared sub-assembly test card. It is again repeated through the sub-system, and finally complete vehicle system area.

All of the above techniques are available. With rapid advances being made, the complexity and costs of such a testing approach would be practical and very reliable. It would also be more flexible and economical, both from an equipment and a personnel standpoint.

Another area that requires a fresh approach is finding the philosophy to be followed in conducting pre-launch checkout and actual launching of the space vehicle system. Present day missile and satellite systems use giant complexes of harnesses for data transmission from pad to blockhouse, and include separate checkout and launching equipment installations within the blockhouse. A large improvement in efficiency, reliability and flexibility, with an accompanying reduction in cost and required personnel, can be achieved by extending the assembly area philosophy, proposed above, to the launch pad.

One possible approach is to provide a Master Launch Data Evaluator, located in a protected room beneath the launch pad. All test harnesses and umbilicals are routed to this area for conversion from analog to digital data. A master digital computer test station would again be used. The computer could handle many completely different space vehicles. Normal data transmission techniques, over land lines, can be

A REPRINT
of this article can be obtained by writing on company letterhead to
The Editor
ELECTRONIC INDUSTRIES, Chestnut & 56th Sts., Phila. 39, Pa.

used for visual display, interrogation, and sequencing by the launch operator. This would allow the blockhouse, with respect to the launch pad, to be a non-critical item. It could be located many miles away. The launch operator would simply interrogate the proper memory channels for the vehicle under test, and the proper test program and stimuli would be selected for pre-launch checkout. Visual data displays at both places would be used for instructing launch crews concerned with fuel servicing, squib arming, and other details requiring personnel.

Also feasible is the use of programmed logic to cut decisions and steps required by the launch operator in case of a malfunction. The same equipment could be used by selecting a new program for a shift from the pre-launch checkout to the actual count-down and launching. Another outgrowth of the above would use the same master computer-control concept, but use only telemetered digital data for checkout and launch operations. Thereby minimizing vehicle harness connections and analog to digital data converters.

Although these concepts for future support equipment may seem complicated and expensive at first glance, these techniques are being used commercially in private industry. Automation in banks, insurance firms, chemical plants, factories, etc., has already proved to be sound, both technically and economically. Therefore, it is proposed that the same techniques and equipments can be applied to the future space system assembly, test and launching operations by properly oriented systems analysis and engineering.

Fig. 8: A concept for a possible third generation automatic checkout and launch control for future space vehicles.

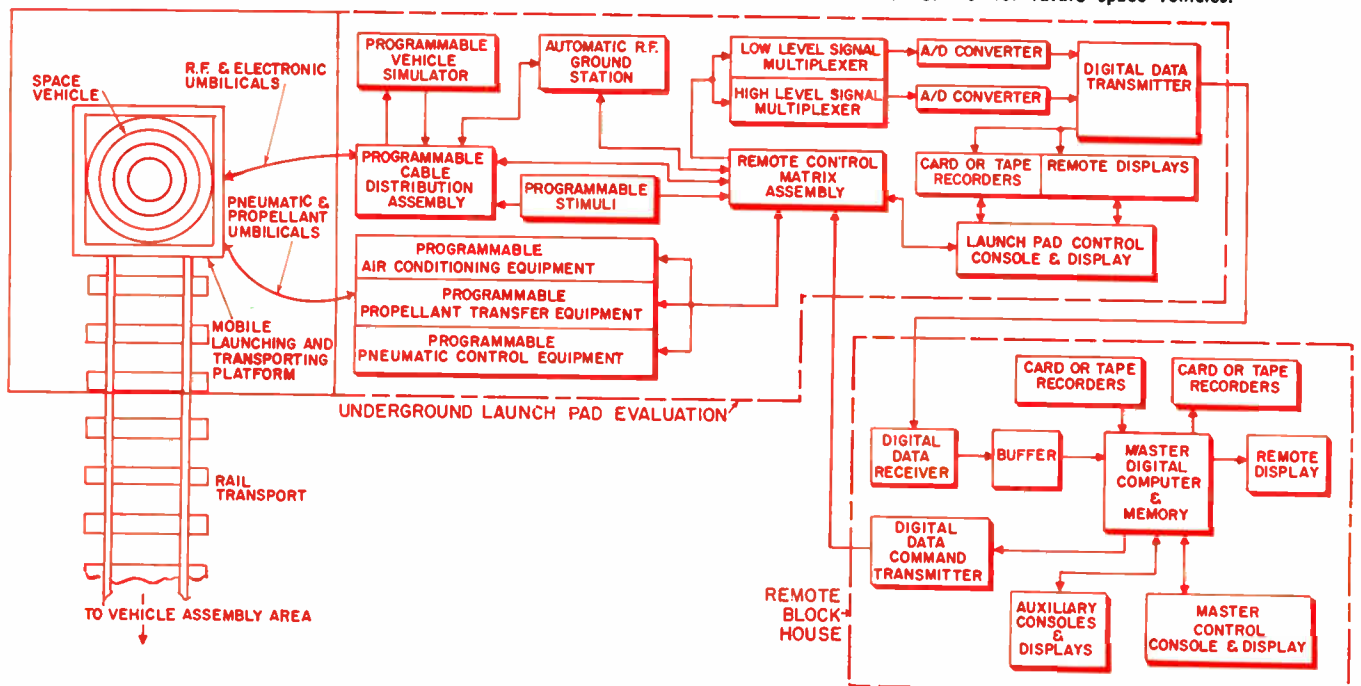

#62 Nomograph for Parallel Resistors, Series Capacitors and Parallel Inductors

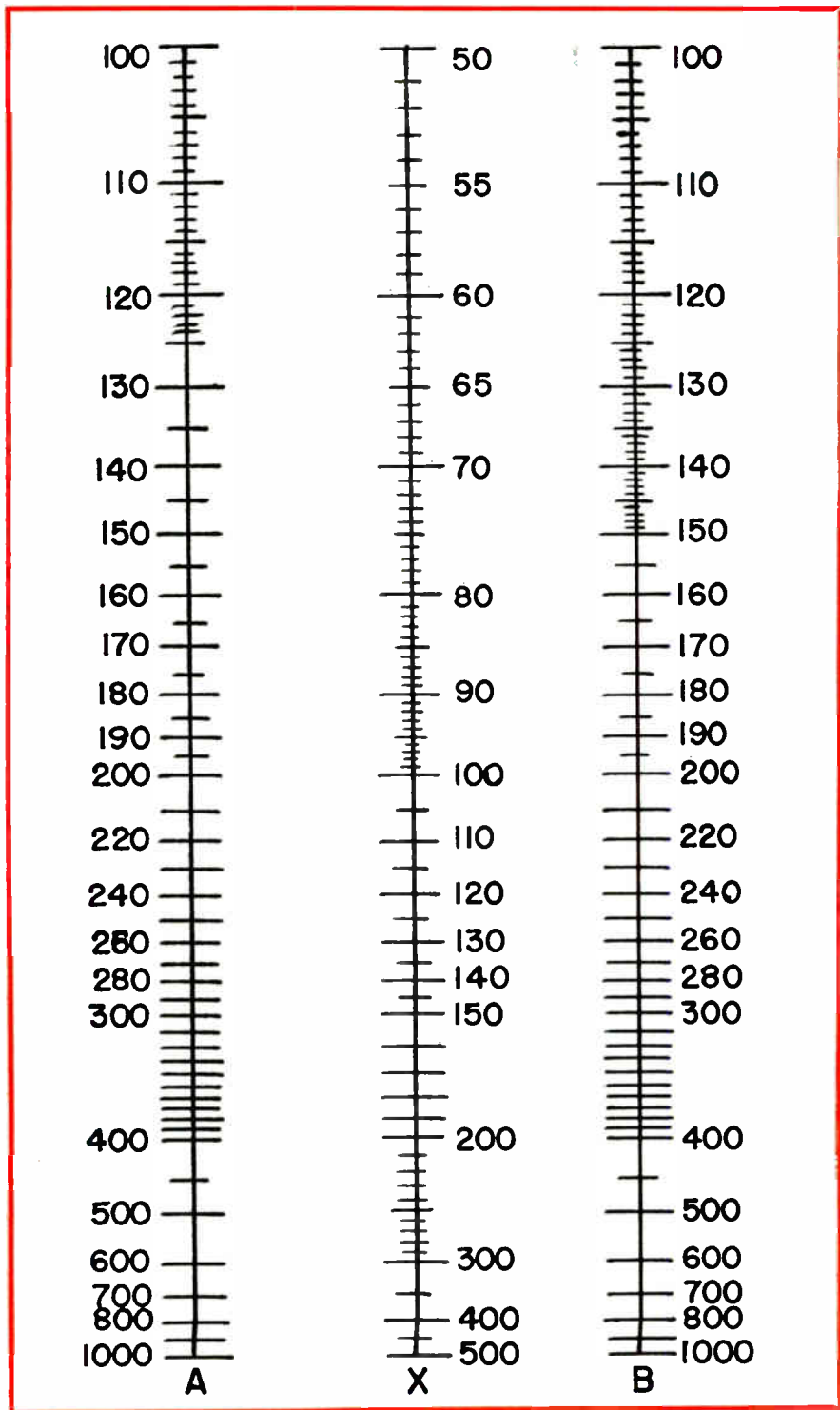

By **DR. L. B. HEDGE**

Research Engineer
 6219 Massachusetts Ave., N.W.
 Washington 16, D. C.

THIS nomograph provides a simple and accurate computation of parallel resistances, series capacitances, and parallel inductors. It will give the combined value (*X*) of two specific elements (*A* & *B*), or the element value (*A* or *B*) required to provide a specific combined value (*X*) with a specified element value (*B* or *A*).

The *A*, *X*, and *B* scales are used for the same units involved (ohms, farads, henrys) and all three can be multiplied by any common factor applicable, e.g., farads, microfarads, and picofarads.

Also the effective range can be changed by factor use; if the parallel resistance of 20 and 160 ohm units is desired, use of the factor 5 will give the *X* value on the line joining *A* = 100 = (5 × 20) and *B* = 800 = (5 × 160) with *X* = 89 = (5 × 17.8). The error here is less than 0.2% (the precise value is 17.77). Careful reading of this nomograph will provide errors consistently less than 1% and usually less than 0.5%.

A REPRINT
 of this article can be obtained by
 writing on company letterhead to
 The Editor
ELECTRONIC INDUSTRIES
 Chestnut & 56th Sts., Phila. 39, Pa.

By **SAMUEL DERMAN**

Electrical Engineer
FXR Inc.
26-12 Borough Place
Woodside 77, N. Y.



How to Derive . . .

Tunnel Diode Amplifier Gain

It is common knowledge that a tunnel diode exhibits a negative resistance over part of its volt-ampere characteristic curve. Because of this strange trait, it can be used for signal amplification. Here's how—mathematically!

MANY engineers still find it hard to believe that a two-terminal passive device can deliver power gain to a load. Despite all the literature on this subject, the specific derivation is not readily found. It is given here for three types of power gain: ordinary, available, and insertion.

Ordinary power gain is the ratio of power delivered to the load to power supplied by the generator.

Available power gain is the ratio of maximum power available to the load to maximum power available from the generator.¹

Insertion gain is the ratio of power supplied to the load with the tunnel diode in the circuit, to power delivered to the load without the tunnel diode.

For each type, we derive the results for two forms of tunnel diode connection: shunt connected and series

connected. Fig. 1 shows the equivalent circuit for the shunt connection; Fig. 2, the series connected case.

In Fig. 1, I_s , g_s , $-g$, and g_L equal the source equivalent current generator, the generator's output conductance, the tunnel diode's negative conductance, and the load conductance.

In Fig. 2, V_s , r_s , $-r$, and r_L equal the source equivalent voltage generator, the generator's output resistance, the tunnel diode's negative resistance, and the load resistance.

Derivations

Ordinary Power Gain

Shunt Connection

$$\text{Current out of generator} = I_s \left(\frac{g_L - g}{g_L + g_s - g} \right)$$

$$\begin{aligned} \text{Power out of generator} &= I_s^2 \left(\frac{g_L - g}{g_L + g_s - g} \right)^2 \frac{1}{g_L - g} \\ &= I_s^2 \frac{g_L - g}{(g_L + g_s - g)^2} \end{aligned}$$

$$\text{Current into load} = I_s \frac{g_L}{g_L + g_s - g}$$

$$\begin{aligned} \text{Power into load} &= I_s^2 \left(\frac{g_L}{g_L + g_s - g} \right)^2 \frac{1}{g_L} \\ &= I_s^2 \frac{g_L}{(g_L + g_s - g)^2} \end{aligned}$$

$$\text{Power gain} = \frac{\text{Power into load}}{\text{Power out of generator}}$$

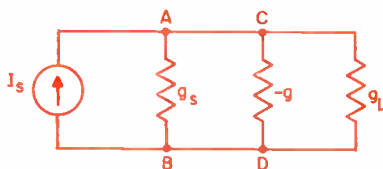

Fig. 1: Equivalent circuit for the shunt connected derivations

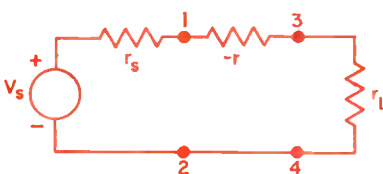

Fig. 2: This is the series connected equivalent circuit used in deriving the ordinary available, and insertion power gains.

Amplifier Gain (Concluded)

$$= \frac{I_s^2 \frac{g_L}{(g_L + g_s - g)^2}}{I_s^2 \frac{g_L - g}{(g_L + g_s - g)^2}} = \frac{g_L}{g_L - g}$$

For values of $|g| > 0$, power gain exceeds unity.

Series Connection

$$\text{Generator terminal voltage} = \text{voltage}_{1-2} = V_s \frac{r_L - r}{r_L + r_s - r}$$

$$\text{Generator output power} = V_s^2 \left(\frac{r_L - r}{r_L + r_s - r} \right)^2 \left(\frac{1}{r_L - r} \right)$$

$$= V_s^2 \frac{r_L - r}{(r_L + r_s - r)^2}$$

$$\text{Voltage across load} = V_s \frac{r_L}{r_L + r_s - r}$$

$$\text{Power into load} = V_s^2 \left(\frac{r_L}{r_L + r_s - r} \right)^2 \left(\frac{1}{r_L} \right)$$

$$= V_s^2 \frac{r_L}{(r_L + r_s - r)^2}$$

$$\text{Power Gain} = \frac{V_s^2 \frac{r_L}{(r_L + r_s - r)^2}}{V_s^2 \frac{r_L - r}{(r_L + r_s - r)^2}} = \frac{r_L}{r_L - r}$$

For values of $|r| > 0$, power gain exceeds unity.

Available Power Gain

Shunt Connection

Maximum power available from generator = maximum power available from terminals A-B = $\frac{I_s^2}{4g_s}$.

Output conductance looking back into tunnel diode amplifier = conductance seen looking into terminals C-D = $g_s - g$.

Maximum power available from amplifier =

$$\text{Available Gain} = \frac{\frac{I_s^2}{4(g_s - g)}}{\frac{I_s^2}{4g_s}} = \frac{\text{Available power out of amplifier}}{\text{Available power out of generator}} = \frac{I_s^2}{4(g_s - g)} = \frac{g_s}{g_s - g}$$

Series Connection

Maximum power available from generator = maximum power available from terminals

$$1 - 2 = \frac{V_s^2}{4r_s}$$

Output resistance of tunnel diode amplifier = resistance seen looking to the left of terminals 3-4 = $r_s - r$.

A REPRINT

of this article can be obtained by writing on company letterhead to
The Editor
ELECTRONIC INDUSTRIES, Chestnut & 56th Sts., Phila. 39, Pa.

$$\text{Maximum power available from amplifier} = \frac{V_s^2}{4(r_s - r)}$$

$$\text{Available gain} = \frac{\frac{V_s^2}{4(r_s - r)}}{\frac{V_s^2}{4r_s}} = \frac{r_s}{r_s - r}$$

Insertion Power Gain

Shunt Connection

Without diode:

$$\text{Current through } g_L = I_s \left[\frac{g_L}{g_L + g_s} \right]$$

$$\text{Power through } g_L = \left(\frac{I_s g_L}{g_s + g_L} \right)^2 \frac{1}{g_L} = I_s^2 \frac{g_L}{(g_L + g_s)^2}$$

With diode:

$$\text{Current through } g_L = I_s \left(\frac{g_L}{g_L + g_s - g} \right)$$

$$\text{Power through } g_L = \left(\frac{I_s g_L}{g_L + g_s - g} \right)^2 \frac{1}{g_L}$$

$$= I_s^2 \frac{g_L}{(g_L + g_s - g)^2}$$

$$\text{Insertion gain} = \frac{\frac{I_s^2 g_L}{(g_L + g_s - g)^2}}{\frac{I_s^2 g_L}{(g_L + g_s)^2}} = \left(\frac{g_L + g_s}{g_L + g_s - g} \right)^2$$

Series Connection

Without diode:

$$\text{Voltage across } r_L = V_s \frac{r_L}{r_L + r_s}$$

$$\text{Power through } r_L = \left(\frac{V_s r_L}{r_L + r_s} \right)^2 \frac{1}{r_L} = \frac{V_s^2 r_L}{(r_L + r_s)^2}$$

With diode:

$$\text{Voltage across } r_L = V_s \frac{r_L}{r_L + r_s - r}$$

$$\text{Power through } r_L = \left(\frac{V_s r_L}{r_L + r_s - r} \right)^2 \frac{1}{r_L} = \frac{V_s^2 r_L}{(r_L + r_s - r)^2}$$

$$\text{Insertion gain} = \frac{\frac{V_s^2 r_L}{(r_L + r_s - r)^2}}{\frac{V_s^2 r_L}{(r_L + r_s)^2}} = \left(\frac{r_L + r_s}{r_L + r_s - r} \right)^2$$

Reference

1. The available power from any source is the power that would be delivered to a load whose resistance is equal to the source's output resistance, i.e., a matched load.

Table 1

Summary of Results

	Series Connection	Shunt Connection
Power Gain	$\frac{r_L}{r_L - r}$	$\frac{g_L}{g_L - g}$
Available Power Gain	$\frac{r_s}{r_s - r}$	$\frac{g_s}{g_s - g}$
Insertion Power Gain	$\left(\frac{r_L + r_s}{r_L + r_s - r} \right)^2$	$\left(\frac{g_L + g_s}{g_L + g_s - g} \right)^2$

By **MORRIS ENGELSON**
 Polarad Electronics Corp.
 43-20 34th Street
 Long Island City 1, N. Y.



Field Intensity Meter

Characteristics

A wide variety of RFI meters are available for RFI investigations. But they differ widely in their performance characteristics. To select the proper meter, the purchaser must be able to evaluate the equipment for his needs. This article points the way.

ENGINEERS working on RFI problems, can select from several dozen available Radio Interference and Field Intensity Meters.^a However, all these units do not have the same characteristics with regard to bandwidth, detector functions and method of calibration. These characteristics are significant in finding what kind of measurements can be made, and how the measurement time and measured data will differ from device to device.

Here we will examine the special characteristics which make a field intensity meter different from a radio receiver. The parameters are divided into 3 sections—indicator circuitry, calibrators and an interpretation of measured results.

Fig. 1 is a block diagram of a field intensity meter. Performance is determined by the accuracy and stability of the individual blocks in the system. Time stability of the calibration source permits long term calibration of this secondary standard, and provides instrument calibration accuracy. Time stability of the entire unit allows precise, repeatable measurements. Ease and rapidity of measurement is dependent upon the number of controls and operations the operator

has to handle per measurement, and on the variation of equipment parameters with frequency.

Indicator Circuitry

The main concern in the indicator is the method of determining the peak level of the signal. Two methods are available; a direct reading peak VTVM or, a slideback peak VTVM.

The direct reading peak VTVM will, without adjustment, continuously indicate variations in input signal. Hence, it can be used for long term, direct observation and monitoring. Its use saves time and reduces human error.

On the other hand, one can distinguish between signals of different repetition rates or waveforms by using the aural slideback or by determination of the slideback cutoff point from observing the signal on video output. Thus, slideback is useful in RFI work by enabling the investigator to work on one type of interference at a time.

Aural slideback will also help in the measurement of pulses occurring at a slower rate than the low frequency response of the direct reading VTVM. Direct reading peak VTVM's capable of responding to pulse rates of less than about 3 cycles/sec are not very prac-

^a The reader will find a list of 25 instruments in Ref. No. 4.

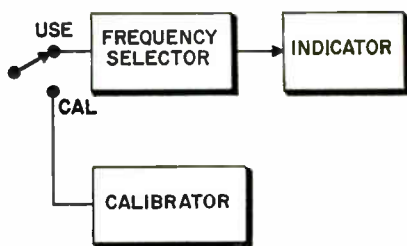
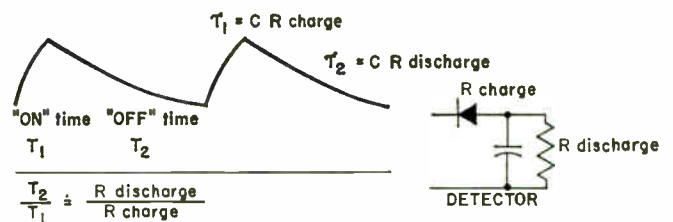

Fig. 1 (l): Block diagram of a field intensity meter.

Fig. 2 (r): Peak vacuum tube voltmeter characteristics.



REFERENCE PAGES

The pages in this section are perforated for easy removal and retention as valuable reference material.

SOMETHING NEW HAS BEEN ADDED

An extra-wide margin is now provided so as to permit them to be punched with a standard three-hole-punch without obliterating any of the text. They can then be filed in standard three-hole notebooks or folders

RIFI Meters (Continued)

tical. However, slideback VTVM's can, on the other hand, respond to pulse rates as low as 1 pulse/min.

The choice of time constants and consequently low frequency response of the direct reading peak VTVM depends upon the minimum frequency, minimum pulse width, and minimum pulse amplitude of the unknown signal to be measured. The minimum pulse width that the peak detector has to handle is independent of the incoming signal. It is determined by the impulse bandwidth of the receiver. For instance, the minimum input pulse width that the receiver may have to handle

Table 1
List of RIFI Meter Characteristics

Unit	Characteristic	Function	Notes
Frequency Selective Circuit	Superheterodyne	Frequency Resolution	Enables determination of frequency distribution of interference.
Calibrator	C. W.	Calibrate instrument or use in substitution measurements.	Primary standard in all measurements; saves time in c. w. measurements; can be used for susceptibility measurements.
	Impulse	Calibrate instrument or use in substitution measurements.	Saves time in broadband measurements; eliminates the need for accurate knowledge of impulse bandwidth when used in broadband substitution measurements.
Indicator	Average	Provide an indication which is proportional to the average value of the incoming signal modulation.	Used for narrow band signals.
	Quasi-Peak	Provides an indication which is weighted by the signal amplitude and duty factor.	Indicates the subjective degree of interference as a function of signal amplitude and duty factor.
Indicator	Direct Reading Peak	Provide indication of peak interference on a direct reading meter.	Provides continuous peak interference indication as a function of time without manual readjustment. Most useful when searching for interference at an unknown frequency.
	Slide-Back Peak	Provide indication of peak interference by means of a manual slide-back method.	Provide peak interference information at interference repetition rates and pulse widths below the capability of the direct reading peak VTVM. Aural slide-back can distinguish between different types of interference at equal signal strengths.

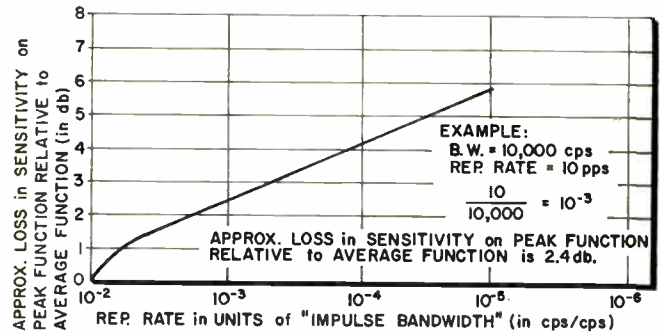

Fig. 3: Curve shows peak sensitivity vs. repetition rate.

would be an impulse. The pulse appearing at the detector, for an impulsive input at the front end, will have the shape of the i-f response curve.

The average pulse width of the impulsive response is the inverse of the i-f impulse bandwidth. If, for example, the impulse bandwidth of the i-f amplifier is 1.0MC/sec, the average minimum pulse width is 1.0 μ sec. This means that the direct reading peak VTVM charge time for a meter having a 1.0 MC/ μ sec impulse bandwidth has to be less than 1.0 μ sec, or less than 100 μ sec for a 10 KC/sec bandwidth.

The minimum frequency that one can accurately measure on a direct reading peak VTVM will be determined by the VTVM discharge time. This follows because the capacitors in the peak detector circuit must remain charged between pulses. If the only consideration governing the discharge time were the l-f response of the VTVM, the ideal solution would be to make the discharge time as large as possible. The sensitivity of the instrument is, however, greatly influenced by the l-f response of the direct reading VTVM. Therefore, it is the final determining factor of the VTVM discharge time.

The above follows because the VTVM will, within the limits of its l-f response, respond to the peak of the noise generated in the receiver front end. (For example, thermal noise of the first r-f stage). An ideal peak VTVM, one capable of responding to an impulse, would register a very high internal noise level that would mask the signal.

The relationship between the peak sensitivity and VTVM response characteristics can be determined as follows. There are curves^{1,2} which show the increase in VTVM noise indication, above the RMS value of the noise, as a function of VTVM discharge to charge resistance ratio. The ratio of charge to discharge resistance is, however, also the ratio of "on" to "off" time for a pulsed signal

(Fig. 2). The minimum "on time" (pulse width) that will appear at the detector input is, as previously discussed, the inverse of the receiver impulse bandwidth.

Using the above facts and the choice of a charge to discharge resistance ratio of 10^{-2} for the AVERAGE detector function, we obtain the curve in Fig. 3. Curve shows the approximate relationship between peak VTVM l-f response, receiver bandwidth, and loss in sensitivity on PEAK detector function in comparison with AVERAGE detector function.

Calibrators

Impulse generators are important calibration instruments. Their versatility, simplicity and large frequency range make them a very useful tool in noise measurements. There are instances, for example when measuring the purely sinusoidal local oscillator radiation of a receiver, when a sine wave generator is more useful and accurate.

The inclusion of both CW and impulse generator calibrators is desirable. This would tend to increase measurement accuracy while reducing the number of computations. The above follows because accurate impulse bandwidth data is no longer necessary.

A REPRINT
of this article can be obtained by
writing on company letterhead to
The Editor
ELECTRONIC INDUSTRIES
Chestnut & 56th Sts., Phila. 39, Pa.

The CW generator is used when making narrow band measurements and the impulse generator can be directly substituted for an unknown broadband signal. The removal of impulse bandwidth from the measurement will increase accuracy. This is true because both l-f bandwidth and gain may change due to aging or replacement of components. Use of the substitution method of measurement, which is essentially independent of gain and bandwidth, will tend to increase measurement accuracy.

An easy way of finding the absolute spectral intensity of the impulse generator is by a theoretical computation, based on the presumed area of the pulse, or to experimentally compare the impulse and

CW outputs for a tuned circuit of known impulse bandwidth. The latter cannot produce an absolute impulse generator spectral intensity calibration of greater accuracy than that of the impulse bandwidth measurement and the absolute accuracy of the CW generator combined, thus making the impulse generator the secondary and a CW generator the primary calibration standards.

Meaning of Measurement

For sinusoidal signals, the VTVM responds to the peak value in both

the AVERAGE and PEAK positions, and the meter face is calibrated in the RMS of a sine wave. For pulse, and amplitude modulated inputs, the VTVM responds to the actual peak of the carrier in the AVERAGE position^b and to the peak of the wave form in the

^b It will be noted that a Fourier analysis of pulsed r-f signals shows that the carrier (occurring at the r-f frequency which is being pulsed) has a peak signal level equal to the pulse duty factor times the peak pulsed signal level; i.e. the carrier is proportional to the average value of the pulse, hence the name AVERAGE for this function. For the case of an AM signal, the average value of the modulation is zero and the VTVM responds to the carrier only.

Table 2
Partial List of RIFI Meters Covering the Frequency Range of 0.15—10,000 MC/sec

Manufacturer	Nomenclature	Frequency Range MC/sec	Selector Functions	Calibrator
Empire Devices	NF-105	0.15-1,000	AVG. PK. SLBK. PK.	Fixed Frequency C. W. Generator Variable P. R. F. Impulse Generator
Empire Devices	NF-112	1,000-10,000	AVG. PK. SLBK. PK.	Impulse Generator
Ferris	32B	0.15-20	Q. P. 2	Random Noise Generator
Ferris	32J	0.15-1.6	Q. P. 1 Q. P. 2 Q. P. 3	Multi-Vibrator
Measurements	58AS	15-150	AVG. Q. P. 1 SLBK. PK.	Random Noise Generator
Polarad	AN/TRM-7	0.15-25	AVG. PK. Q. P. 1 Q. P. 3 SLBK. PK.	Variable Frequency C. W. Generator Impulse Generator
Polarad	F. I. M.	1,000-10,000	AVG. PK. Q. P. 1 SLBK. PK.	Variable Frequency C. W. Generator
Polarad	C. F. I.	1,000-10,000	AVG. PK. Q. P. 1 SLBK. PK.	Impulse Generator
Stoddard	NM-20B	0.15-25	AVG. Q. P. 1 SLBK. PK.	Random Noise Generator
Stoddard	NM-30A	20-400	AVG. Q. P. 1 SLBK. PK.	Impulse Generator
Stoddard	NM-52A	375-1,000	AVG. Q. P. 1 SLBK. PK.	Impulse Generator
Stoddard	NM-60A	1,000-10,000	AVG. Q. P. 1 SLBK. PK.	Impulse Generator

Abbreviations:
AVG.—Average.
PK.—Peak.
SLBK. PK.—Slide Back Peak.

Q. P.—Quasi Peak.
Q. P. 1—1 msec. charge 600 msec. discharge.
Q. P. 2—10 msec. charge 600 msec. discharge.
Q. P. 3—1 msec. charge 160 msec. discharge.

RIFI Meters (Concluded)

PEAK position. The meter in both cases being calibrated in terms of the RMS of a sine wave, whose peak is the level to which the VTVM responds.

Fig. 4 gives a graphical representation of these results.

References.

1. Bell "Electrical Noise."
2. G. R. *Experimenter*, Vol. 31, No. 7, Dec., 1956.
3. "Detection of Impulse Signals in Random Noise," A. A. Gottfried, K. Ikraht, *Proc. 1957 Conference on Radio Interference Reduction*.
4. "Instrumentation for Radio Interference Measurements," R. M. Showers, F. H. Haver, *Electronic Industries*, March, 1961.

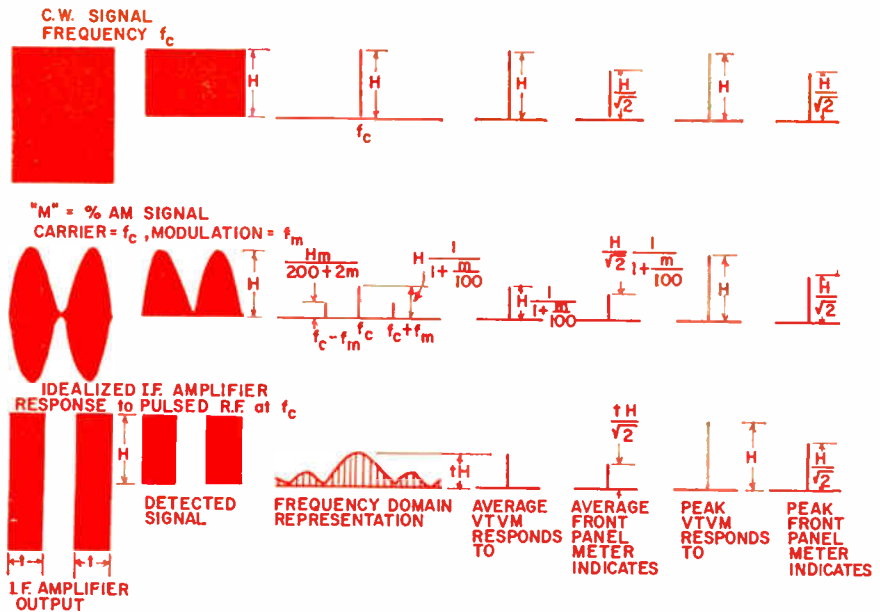

Fig. 4—Graphical representation of peak vacuum tube voltmeter response.

Circuit Designer's Shortcut

FROM systems study to prototype is usually a time consuming process. Here's how Autonetics Industrial Products Div. engineers reduced time, cost, and consternation over 50% in making the prototype read, write, and logic sections of the Recomp computer magnetic tape system.

The Recomp general purpose computer is operated with up to four tape transports, each of which can provide a one-million word memory. Circuitry had to be designed to allow the computer to order the transport into forward, reverse, high- or low-speed; to read from or write on the tape; and, to follow complex directions.

About 200 transistors and 100 stages are involved, including flip-flops, inverters, Schmitt triggers, pre-amps, amplifiers and other, more-or-less, standard circuits. Proto-Cards, made by Circuit Structures Lab of Laguna Beach, Calif., allowed developmental work to go directly from paper to neat, finished boards for all circuit blocks. Before, it took up to ten hours to build a flip-flop and to check it out. With one Proto-Card a comparable unit was built in two hours.

Three types of cards were used in the development of the read, write and logic circuitry. The all-purpose transistor card has five power busses, isolated transistor and component pads, and eight collector output lines with leads to connector pins, 15 of which terminate at eyelets.

The digital transistor card has four power lines, eight collector output and 16 input lines. The eight transistor emitters are bussed to a common line.

The third is a transistor-logic card which combines mounting pads for 48 components with four transistor circuits.

All of the Proto-Cards use 28-contact printed circuit connectors and fit standard chassis and card holders.

Rapid comparison of circuitry was easy. A peak detection circuit was built on one card and a level detection circuit on another. By plugging first one and then the other into the system it was easy to evaluate which was the better circuit for the purpose.

Trouble shooting was comparatively simple because each board was readily accessible through the use of an extender card.

Moving from the prototype stage to production is simplified. If the same number of cards are used, the designer can simply eliminate the unused leads and add the few extra connections required. The layout of a flip-flop board usually takes three days to complete. Working from a Proto-Card circuit to a similar layout requires about four hours.

A Proto-Card circuit is compared with equivalent pegboarded model.

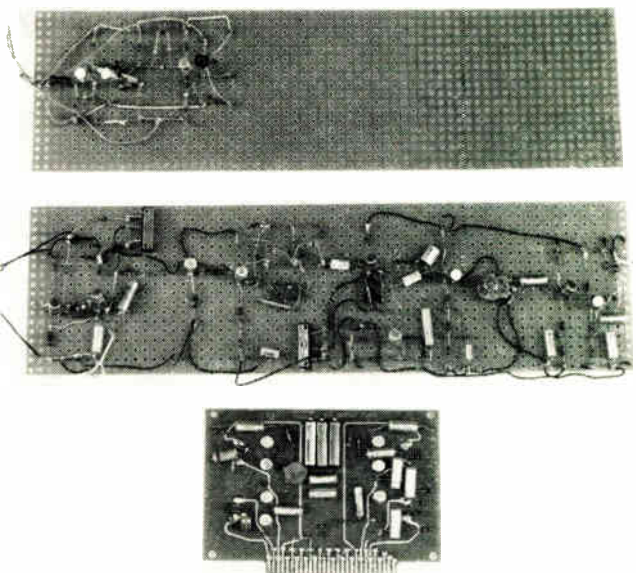

By DR. ERNEST JACOBS

Member of the Technical Staff
 Electronics Research Laboratory
 Aerospace Corporation,
 P. O. Box 95085
 Los Angeles 45, Calif.



Analyzing Power Transfer In Microwave Systems

In any microwave system, distributed parameter transmission line is normally used. It has become usual to specify power transfer between components in terms of the lowest feasible VSWR. But, while this is a convenient measurement, it does not tell the whole story. Here are the results of a comprehensive study which deals with other aspects of maximum power transfer.

SYSTEM designers are concerned with the power transfer between components. However, power transfer is not measured easily; but, VSWR can be without much trouble. Therefore, specification writers tend to equate desired power transfer as well as restrictions on reflected power in terms of VSWR.

The usual practice is to require the lowest VSWR feasible and hope that the resulting power relationships are suitable. However, the specification of VSWR by itself does not fix the power relationships.

Let's study the power transfer when components are separated by distributed parameter transmission line. We'll give the relationship between VSWR and power transfer as well as design methods for maximizing power transfer. Curves will show the possible variations of the power in the load for a fixed VSWR. This can be rather large.

We often assume that the load should be matched to a VSWR with a value of one to obtain the best power transfer between generator and load. However, this study shows that this is not always true. Greater power transfer can be achieved with larger load VSWR's!

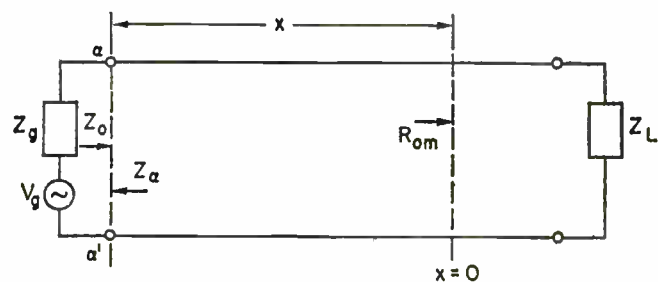

General Theory
 In a lossless line, Fig. 1, Z_o , the impedance looking toward the load at x , is given by Eq. (1).¹

$$Z_o = R_c \frac{1 + \Gamma e^{-j2\beta x}}{1 - \Gamma e^{-j2\beta x}} \quad (1)$$

where R_c = line's characteristic resistance

$$\Gamma = \sqrt{-1}$$

$$\beta = \frac{2\pi}{\lambda}$$

Γ = reflection coefficient

λ = wavelength

Editor: In the interest of clarity, lengthy equations have been grouped at the bottom of pages 103 and 104. Please refer there when an equation mentioned by number does not immediately follow in the text.

The point $x = 0$ is chosen arbitrarily where Z_o has greatest resistance, R_{om} , and zero reactance.

$$\therefore \Gamma = \frac{R_{om} - R_c}{R_{om} + R_c} \quad (2)$$

Since R_{om} is a real number and the line lossless, Γ is also a real number.

Fig. 1 (left): Typical lossless transmission line system used in stating the general theory.

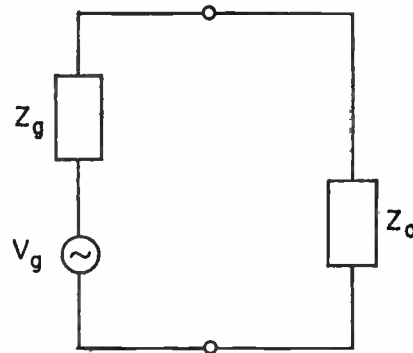

Fig. 2 (right): Equivalent circuit used in this analysis of power transfer between components in a system.

Power Transfer (Continued)

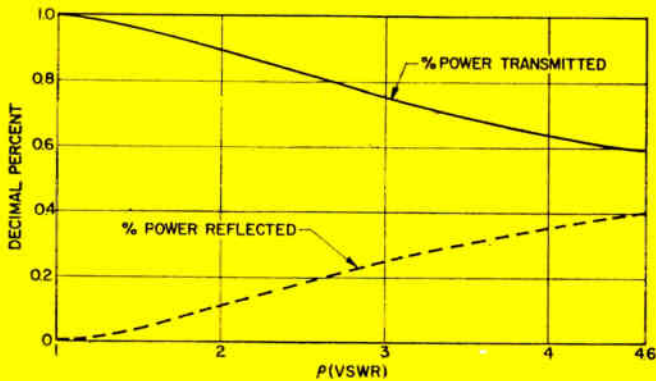

Fig. 3: Plot of transmitted & reflected power vs. computed VSWR. In this case, the normalized $X_g = 0$ and the normalized $R_g = 1$.

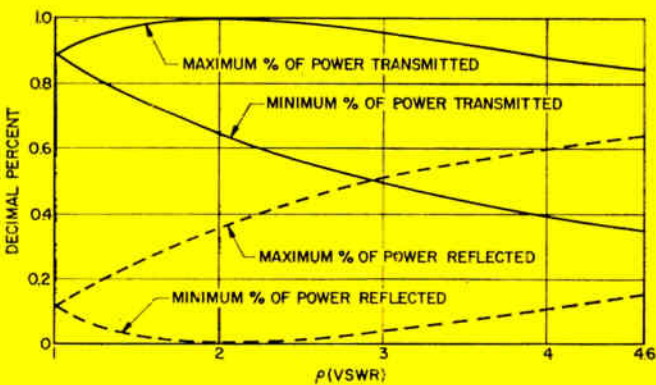

Fig. 4: Plot of maximum and minimum power transfer where the generator impedance is not matched to the line; normalized $X_g = 0$, $R_g = 2$ or $1/2$.

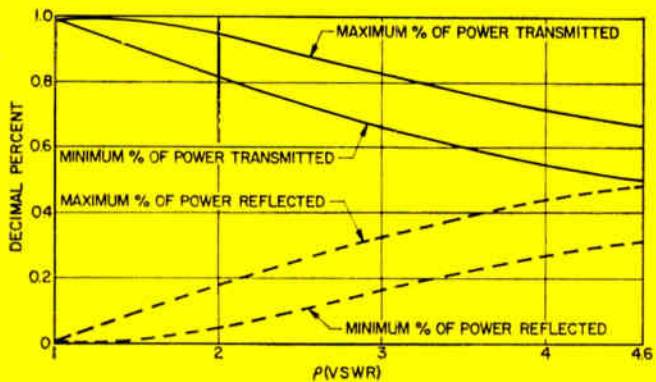
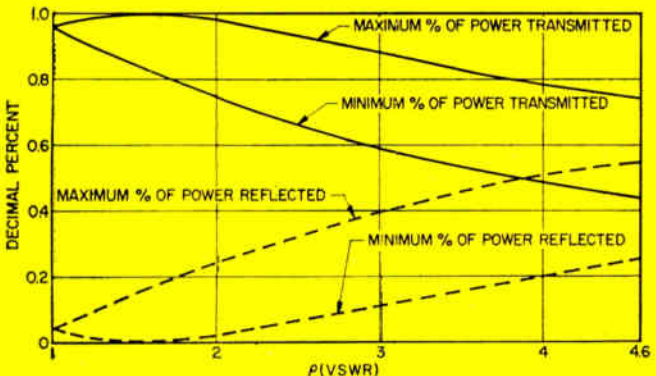

Fig. 5: Power vs. load VSWR for normalized $X_g = 0$ and $R_g = 1.25$.

Fig. 6 (below): In this case, normalized $X_g = 0$ while $R_g = 1.5$.



Expanding Eq. (1) we have

$$Z_g = R_g + j X_g \quad (3)$$

where

$$R_g = \frac{R_c (1 - \Gamma^2)}{1 + \Gamma^2 - 2 \Gamma \cos 2 \beta x} \quad (4)$$

and

$$X_g = - \frac{2 R_c \Gamma \sin 2 \beta x}{1 + \Gamma^2 - 2 \Gamma \cos 2 \beta x} \quad (5)$$

Suppose that a generator with an arbitrary internal impedance Z_g is connected to the line, Fig. 2. P_L , the power in the load, is given by Eq. (6).

$$P_L = \frac{V_g^2 R_o}{(R_g + R_o)^2 + (X_g + X_o)^2} \quad (6)$$

where

$$Z_o = R_o + j X_o$$

The power available to the load, P_A , is obtained by setting $R_o = R_g$ and $X_o = -X_g$ in Eq. (6).

$$P_A = \frac{V_g^2}{4 R_g} \quad (7)$$

Substituting Eqs. (4) and (5) into (6), the general expression of P_L when the source and load are separated by lossless distributed parameter line is found by Eq. (8).

Matched Generator Impedance

Letting $R_g = R_c$ and $X_g = 0$ in Eq. (8) yields the expression for P_L when the generator is matched to R_c .

$$P_L = \frac{V_g^2 (1 - \Gamma^2)}{4 R_c} \quad (9)$$

Dividing Eq. (9) by Eq. (7) we have the ratio of power in load to the power available. P_L/P_A of Eq. (10) can be referred to as the (decimal) per cent power transmitted; $(1 - P_L/P_A)$, the per cent power reflected.

$$\frac{P_L}{P_A} = (1 - \Gamma^2) \quad (10)$$

The relationship between ρ , the VSWR, and Γ is given by Eq. (11).

$$|\Gamma| = \frac{\rho - 1}{\rho + 1} \quad (11)$$

Substituting Eq. (11) into (10), P_L/P_A in terms of the VSWR becomes

$$\frac{P_L}{P_A} = \frac{4 \rho}{(\rho + 1)^2} \quad (12)$$

Since βx does not appear in the above, P_L is independent of the line length between the generator and load. Fig. 3 is a plot of the transmitted and reflected power versus VSWR computed from Eq. (12). Sometimes this curve is given without stipulating that the validity is restricted to when Z_g equals R_c .

Generator Impedance Purely Resistive

If Z_g does not equal R_c , Eq. (7) hints that P_L is a function of the line length between generator and load. Let us assume that Z_g is purely resistive, but not necessarily equal to R_c . P_L is then obtained from Eq. (13).

To find the line length for extreme (maximum and minimum) power transfer, we must find the roots of

$$\frac{\partial P_L}{\partial (\beta x)} = 0. \quad \text{See Eq. (14).}$$

The roots of $\frac{\partial P_L}{\partial (\beta x)} = 0$ are,

$$\beta x = \pm n \frac{\pi}{2} \quad (15)$$

where $n =$ any positive integer ($n = 0, 1, 2, \dots$).

For $R_g > R_c$, the positions of maximum power transfer are,

$$x = \pm n \frac{\lambda}{2} \quad (16)$$

Eqs. (13), (16) and (7) are combined and yield P_{LX}/P_A , the ratio of the maximum power in the load to the power available, Eq. (17).

Substituting Eq. (11) into (17),

$$\frac{P_{LX}}{P_A} = \frac{4 R'_o \rho}{(\rho + R'_c)^2} \quad (18)$$

The prime symbol shows normalization to R_c . Also for $R_g > R_c$, the positions of minimum power transfer are,

$$x = \frac{\lambda}{4} \pm n \frac{\lambda}{2} \quad (19)$$

Eqs. (19), (13) and (7) are combined to obtain P_{LI}/P_A , the ratio of the minimum power in the load to the power available, Eq. (20).

Substituting Eq. (11) into (20),

$$\frac{P_{LI}}{P_A} = \frac{4 R'_o \rho}{(R'_o \rho + 1)^2} \quad (21)$$

However, for $R_g < R_c$, the points of maximum power transfer are,

$$x = \frac{\lambda}{4} \pm n \frac{\lambda}{2} \quad (22)$$

The ratio of P_{LX} to P_A is,

$$\frac{P_{LX}}{P_A} = \frac{4 R'_o \rho}{(R'_o \rho + 1)^2} \quad (23)$$

Under the same conditions, the points of minimum power transfer are,

$$x = \pm n \frac{\lambda}{2} \quad (24)$$

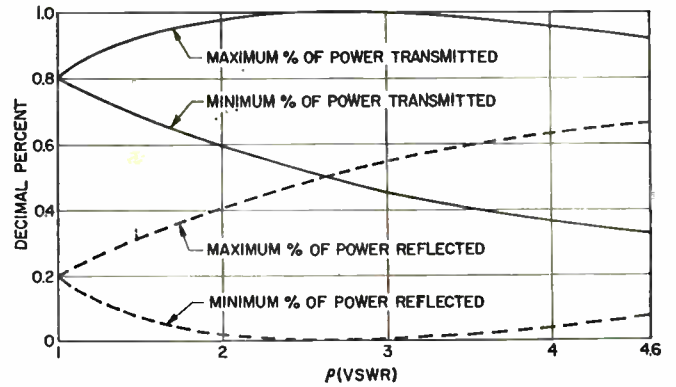

Fig. 7: Here the normalized values are $X_c = 1$ and $R_c = 1$ or 2 .

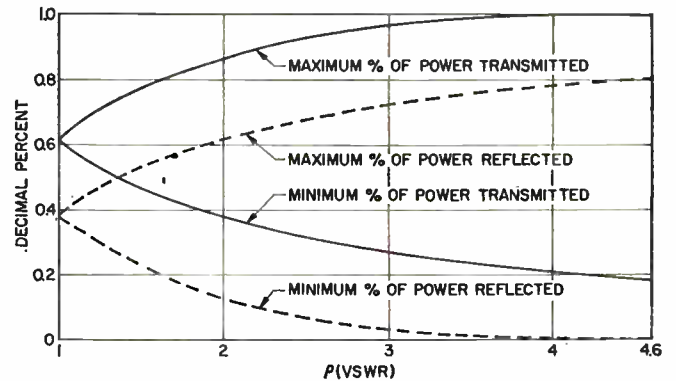

Fig. 8: This is the plot for normalized $X_c = 1$ and $R_c = 1/2$.

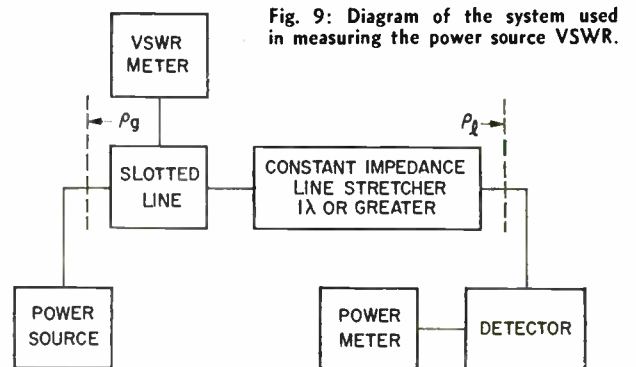

Fig. 9: Diagram of the system used in measuring the power source VSWR.

$$P_L = \frac{V_o^2 R_c (1 - \Gamma^2)}{(R_o^2 + X_o^2) (1 + \Gamma^2 - 2 \Gamma \cos 2 \beta x) + 2 R_c (R_o - R_o \Gamma^2 - 2 X_o \Gamma \sin 2 \beta x) + R_c^2 (1 + \Gamma^2 + 2 \Gamma \cos 2 \beta x)} \quad (8)$$

$$P_L = \frac{V_o^2 R_c (1 - \Gamma^2)}{(R_o^2 + R_c^2) (1 + \Gamma^2) - 2 \Gamma (R_o^2 - R_c^2) \cos 2 \beta x + 2 R_c R_o (1 - \Gamma^2)} \quad (13)$$

$$\frac{\partial P_L}{\partial (\beta x)} = - \frac{4 V_o^2 R_c \Gamma (1 - \Gamma^2) \sin 2 \beta x}{[(R_o^2) (1 + \Gamma^2) - 2 \Gamma (R_o^2 - R_c^2) \cos 2 \beta x + 2 R_c R_o (1 - \Gamma^2)]^2} \quad (14)$$

$$\frac{P_{LX}}{P_A} = \frac{4 R_c R_o (1 - \Gamma^2)}{(R_o^2 + R_c^2) (1 + \Gamma^2) - 2 \Gamma (R_o^2 - R_c^2) + 2 R_c R_o (1 - \Gamma^2)} \quad (17)$$

$$\frac{P_{LI}}{P_A} = \frac{4 R_c R_o (1 - \Gamma^2)}{(R_o^2 + R_c^2) (1 + \Gamma^2) + 2 \Gamma (R_o^2 - R_c^2) + 2 R_c R_o (1 - \Gamma^2)} \quad (20)$$

$$\frac{\partial P_L}{\partial (\beta x)} = \frac{4 V_o^2 R_c \Gamma (1 - \Gamma^2) [2 R_c X_o \cos 2 \beta x + (R_c^2 - R_o^2 - X_o^2) \sin 2 \beta x]}{[(R_o^2 + X_o^2) (1 + \Gamma^2 - 2 \Gamma \cos 2 \beta x) + 2 R_c (R_o - R_o \Gamma^2 - 2 X_o \Gamma \sin 2 \beta x) + R_c^2 (1 + \Gamma^2 + 2 \Gamma \cos 2 \beta x)]^2} \quad (26)$$

Power Transfer (Concluded)

The ratio of P_{LI} to P_A is

$$\frac{P_{LI}}{P_A} = \frac{4 R'_o \rho}{(\rho + R'_o)^2} \quad (25)$$

The points for maximum and minimum power transfer are interchanged whenever the quantity $(R_o - R_c)$ has a sign reversal.

Generator Impedance Not Purely Resistive

What if Z_o is complex or purely inductive? The P_L is given by Eq. (7). As before, the points for extreme power transfer are obtained by solving for the roots of

$$\frac{\partial P_L}{\partial (\beta x)} = 0. \text{ See Eq. (26).}$$

The roots of $\frac{\partial P_L}{\partial (\beta x)} = 0$ are given in Eq. (27).

From Eq. (27) we see that the line length required for extreme power transfer is independent of the load impedance. However, the point $x = 0$ is a function of the load impedance. Therefore, the line length between generator and load required for extreme power transfer is a function of both the generator and load impedances.

The positions for maximum power transfer are:

$$x = \begin{cases} \frac{\theta}{720} \lambda \approx n \frac{\lambda}{2} \\ \frac{\theta}{720} \lambda \approx \frac{\lambda}{4} \approx n \frac{\lambda}{2} \end{cases} \quad (28)$$

where $n =$ any positive integer ($n = 0, 1, 2, \dots$)

$\theta =$ first quadrant angle in degrees whose

$$\tan = \frac{2 X'_o}{(R'_o)^2 + (X'_o)^2 - 1}$$

The expressions for maximum power transfer are given in Eqs. (29) & (30).

The positions for minimum power transfer are:

$$x = \begin{cases} -\frac{\theta}{720} \lambda \approx n \frac{\lambda}{2} \\ -\frac{\theta}{720} \lambda + \frac{\lambda}{4} \approx n \frac{\lambda}{2} \end{cases} \quad (31)$$

The expressions for minimum power transfer are given in Eqs. (32) & (33).

Power Transfer, VSWR's Only Known

Let us assume that the source and load VSWR's are known; and, we want to know the possible range of power transfer. Referring to Fig. 1, let us again choose $x = 0$ as the point where Z_o has maximum resistance, R_{om} , and zero reactance. Therefore, the load resistance and reactance at any x are again given by Eqs. (4) and (5), respectively. However, it is now assumed that position a-a' is chosen as the point where the source impedance has greatest resistance and zero reactance.

$$\begin{aligned} Z_a &= \rho_o R_c + j 0 \\ \rho_o &= \text{VSWR of source} \\ \rho_l &= \text{VSWR of load} \\ \Gamma &= - \text{Reflection coefficient of load} \end{aligned} \quad (34)$$

Eqs. (4), (5), and (34) are substituted into Eq. (6) to obtain the load power, Eq. (35).

From the roots of $\frac{\partial \rho_l}{\partial (\beta x)} = 0$, the positions for maximum and minimum load power are found to be as follows:

$$\beta x = \pm 2 n \pi \text{ or } x = \pm n \lambda \quad (36)$$

for maximum power;

$$\beta x = \pm (2 n + 1) \pi \text{ or } x = \pm \left(n + \frac{1}{2} \right) \lambda \quad (37)$$

for minimum power.

Since $R_o = R_c$, P_A given by Eq. (7) becomes,

$$P_A = \frac{V_o^2}{4 \rho_o R_c} \quad (38)$$

Combining Eqs. (35), (36) and (38), the ratio of P_{LX} to P_A is,

$$\beta x = \pm \frac{1}{2} \tan^{-1} \frac{2 R_c X_o}{R_o^2 + X_o^2 - R_c^2} = \pm \frac{1}{2} \tan^{-1} \frac{2 X'_o}{(R'_o)^2 + (X'_o)^2 - 1} \quad (27)$$

$$\frac{P_{LX}}{P_A} = \frac{4 R_c R_o (1 - \Gamma^2)}{(R_o^2 + X_o^2 + R_c^2) (1 + \Gamma^2) + 2 R_c R_o (1 - \Gamma^2) - 2 \Gamma [(R_o^2 + X_o^2 - R_c^2) + 4 R_c^2 X_o^2]^{1/2}} \quad (29)$$

$$\frac{P_{LX}}{P_A} = \frac{8 R'_o \rho}{(\rho^2 + 1) [(R'_o)^2 + (X'_o)^2 + 1] + 4 R'_o \rho - (\rho^2 - 1) ([(R'_o)^2 + (X'_o)^2 - 1]^2 + 4 (X'_o)^2)^{1/2}} \quad (30)$$

$$\frac{P_{LI}}{P_A} = \frac{4 R_c R_o (1 - \Gamma^2)}{(R_o^2 + X_o^2 + R_c^2) (1 + \Gamma^2) + 2 R_c R_o (1 - \Gamma^2) - 2 \Gamma \frac{[(R_o^2 + X_o^2 - R_c^2) - 4 R_c^2 X_o^2]}{[(R_o^2 + X_o^2 - R_c^2) + 4 R_c^2 X_o^2]^{1/2}}} \quad (32)$$

$$\frac{P_{LI}}{P_A} = \frac{8 R'_o \rho}{(\rho^2 + 1) [(R'_o)^2 + (X'_o)^2 + 1] + 4 R'_o \rho - (\rho^2 - 1) \frac{[(R'_o)^2 + (X'_o)^2 - 1]^2 - 4 (X'_o)^2}{[(R'_o)^2 + (X'_o)^2 - 1]^2 + 4 (X'_o)^2}} \quad (33)$$

$$P_L = \frac{V_o^2 (1 - \Gamma^2)}{R_c \rho_o (1 + \Gamma^2 - 2 \Gamma \cos 2 \beta x) + 2 \rho_o + (1 + \Gamma^2 + 2 \Gamma \cos 2 \beta x)} \quad (35)$$

We see that Z_g influences the relationship between VSWR, line length and power transfer. If Z_g is matched to the characteristic impedance of the transmission line, the power transmitted and reflected is a function only of the load VSWR. This data is shown in Fig. 3.

$$\frac{P_{LX}}{P_A} = \frac{4 \rho_g \rho_l}{(\rho_g + \rho_l)^2} \quad (39)$$

Similarly, the ratio of P_{LI} to P_A is obtained by combining Eqs. (35), (37) and (38).

$$\frac{P_{LI}}{P_A} = \frac{4 \rho_g \rho_l}{(\rho_l \rho_g + 1)^2} \quad (40)$$

Note that 100% power transfer can be obtained only when $P_g = P_l$. If either VSWR is one, the power to the load is independent of the line length in that Eqs. (39) and (40) become the same.

Eqs. (39) and (40) can also be exploited to determine the VSWR of a power source while it is active. This can be done by measuring the ratio of the maximum to minimum load power and P_l . Fig. 9 is the block diagram of a possible circuit to make these measurements. Since it is only necessary to measure the ratio of the load powers, it is possible to use a VSWR meter in place of the power meter. Combining Eqs. (39) and (40) yields the following expression for the source VSWR:

$$\rho_g = \frac{\rho_l (N - 1) + (N)^{1/2} [(\rho_l^2) - 1]}{\rho_l^2 - N} \quad (41)$$

where N = Ratio of the maximum to minimum power in the load

$$N = \frac{P_{LM}}{P_{LI}} = \frac{(\rho_l \rho_g + 1)^2}{(\rho_l + \rho_g)^2} \quad (42)$$

An interesting sidelight conclusion that can be drawn from Eq. (41) is that,

$$N \leq \rho^2 \quad (43)$$

where ρ can be the VSWR of either the load or source.

A REPRINT

of this article can be obtained by writing on company letterhead to
The Editor
ELECTRONIC INDUSTRIES, Chestnut & 56th Sts., Phila. 39, Pa.

Figs. 4, 5, 6, 7 and 8 are plots of the maximum and minimum power transfer for several cases where the generator impedance is not matched to the line. From these curves, we see that the variation of power transfer with line length increases with the amount of generator mismatch. For example, suppose that R_c is 50 Ω and $P_l = 3$. If $Z_g = 50 + j0 \Omega$, 70% of the power is transmitted to the load regardless of the line length. However, if $Z_g = 75 + j0 \Omega$, the transmitted power can vary from about 60 to 88%. Also, if $Z_g = 100 + j0$ or $25 + j0 \Omega$, the variation can be between 49 and 96%.

This suggests that in the design of systems using transmission line, one can be misled by considering only component match by itself. The components match can be mediocre, but, by adjusting the line length properly, a rather high power transfer can be obtained. Since one is often ultimately interested only in obtaining P_{LX} , this approach may offer a more economical design.

Reference

1. Bronwell, A. B., and Bean, R. E.: *Theory and Application of Microwaves*. McGraw-Hill, New York, N. Y., 1947, page 161.

* * *

Torque Tests Ball Bearings

UP to 150 bearings/hr can be graded and sorted at 1/10th the cost of methods now being used for accurate testing. Instrumentation for "Spin Testing" provides a practical means of testing oil lubricated instrument ball bearings. Repeatability is about $\pm 3\%$ of an average for good bearings; defective or contaminated bearings give readings of 50% to several hundred per cent above the average. The speed of test is controlled.

"Spin-Testing" equipment consists of a gram torque meter, a spin test stand, and a spin test weight set. The torque meter registers as low as 0.05 gm-cm. It is mounted on the test stand which provides controlled torsional vibration to keep the torque meter bearings in motion at the lowest speeds.

The weight set includes 75 and 400 gram spin weights which accommodate standard inch bearing diameters between 5/16 and 1 3/8 in. The adaptors fit bores from 0.0937 to 0.625 in. The complete equipment is made by Power Instruments, Inc., 7352 N. Lawndale Ave., Skokie, Ill.

In use the proper spin weight is placed on the outer race of the bearing under test, and the torque meter shaft with bore adaptor fits into the inner race. The weight is then spun by hand and the torque of the bearings is read at either of two reproduceable speeds. This important control of spin speed takes advantage of the stroboscopic effect of any fluorescent lamp, which pulses at 7200 flashes/minute on 60 CPS. At predetermined

speeds, it will "freeze" the apparent motion of rows of holes on the circumference of the spin weights.

This is the only instrumentation that is required for "Spin Testing" oil lubricated ball bearings covered by MIL-STD-206A.

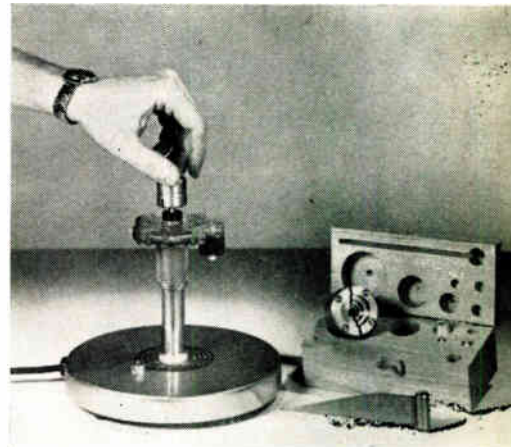



View of the test installation shows the capacitor test ovens on the left and a bank of variable resistor test chambers on the right.

A \$60,000 installation of test chambers and recording devices is speeding test data collection in the Electrical Test Laboratory of Centralab, The Electronics Division of Globe-Union Inc., Milwaukee 1, Wis.

The equipment, almost fully automated, records life tests for R&D and quality control. It is set up as three independent test units: one for capacitors; one for variable resistors and one for packaged circuits. The three units handle thousands of devices at one time.

This use is a first step toward complete automation of life-recording and quality control tests. It is typical of the efforts being made by progressive companies in the electronic field. To ease the planned future expansion, modular equipment was used.

The capacitor testing method is unusual and interesting. It automatically senses the degree of insulation resistance which in turn, is used as an indication of capacitor failure.

The failure sensing circuit is activated by a dc voltage across a one-megohm resistor in series with each capacitor. Failure is registered at 10 micro-amps or 10 volts across the one-megohm resistor. At a 1000-volt test voltage this is equivalent to an insulation resistance of 100 megohms; at 100 volts, 10 megohms.

The test scanner advance pulse also triggers the unit key on a 10 column adding machine. This accumulates the number of items tested. When the failure-sensing circuit is activated, the adding machine subtotal key is depressed. This causes a print-out of the failing unit number.

The first four columns of the machine indicate elapsed time; the center two are left open; and, the last four are for the items under test. Elapsed time is

What's New

Component Testing

accumulated by adding one digit each hour from a clock-operated switch. A typical reading might be 5213 1012. It means that at 5213 hours, number 1012 failed. The time on test is the difference between the failure time, or removal from the test chamber, and the starting time.

After scanning all positions, the item column returns to zero for the next test scan. The time continues to 9999 hours when it returns to zero and starts the cycle again.

This method automatically detects inferior material during a very early stage, thus saving many days of valuable testing time.

Due to the close temperature tolerances and gradients required by MIL-Specs for resistors and packaged circuits, test chamber selection was a problem. Tolerances are $\pm 2^{\circ}\text{C}$ for the capacitor testing oven temperature range; $\pm 5^{\circ}\text{C}$ for variable resistor testing ovens. Eventually, a suitable unit was developed.

The advantage of using a tape print-out is that tests, once started, can be carried on, completed, and the results recorded even when no personnel are present.

Power supplies are fully regulated and voltages can be varied according to the product under test. For instance, there is a choice of 12 different voltages for any given position in an oven and voltage can range from zero to 500v at currents of 200 milliamperes for the higher voltages and 750 milliamperes at the lower voltages.

Because of the tests run on variable resistors, a digital ohmmeter is used with this system. It is manually switched to each test chamber. In this way, results of one test can be automatically recorded when no personnel are present. However, the equipment was so designed that the present semi-automatic system may be readily modified to operate entirely automatically; and, the whole system expanded to handle a greater volume of tests.

The digital ohmmeter read-out and scanning equipment and test chambers similar to the capacitor test equipment, are used for conducting tests on packaged circuits.

More What's New
on page 120

Easing Spectrum Congestion

FREQUENCY separation of as little as $\frac{1}{4}\%$ has been achieved at 425 MC for 30 db rejection at the undesired signal with the Micro-Notch rejection filter. This development will have far-reaching effects upon system design, frequency assignment, and spectrum use for those frequencies where this effect can be duplicated.

The Micro-Notch rejection filter was developed by Applied Research Inc., 76 S. Bayles Ace., Port Washington, N. Y.

This adjustable notch filter provides the characteristics shown in Fig. 1. At a center frequency of 425 ($\pm 10\%$) MC, there is better than 30 db rejection. The notch bandwidth at 1 db insertion loss is 2 MC, or less than $\frac{1}{2}\%$; outside the notch it is about 0.5 db. One view shows a wide sweep; about 10% bandwidth is shown. The notch is extremely narrow and required re-touching for line weight.

Fig. 2 shows the same filter adjustment; only the sweep width has been changed. The ± 1 MC markers can be clearly seen at the 1 db down points—a very narrow steep-skirted frequency adjustable rejection filter. This filter provides better than 30 db difference in loss to two frequencies separated by $\frac{1}{4}\%$ or more while presenting an essentially resistive impedance at the input; insertion loss in the passband is extremely low.

Exploratory work hints that Micro-Notch methods can probably be duplicated at frequencies between 100 MC and 6000 MC. Units can be cascaded to provide even more spectacular results; an insertion loss of only 1 db would accompany a 60 db rejection at the unwanted signal frequency. There is good reason to believe that bands of frequencies could be rejected; alternately, it appears possible to provide more than one notch, if this were more desirable.

A discussion of applications becomes very exciting when held against the background of spectrum congestion. Many classic interference problems stem from the rectangular view of frequency assignments practiced by allocation agencies as they are applied to

Gaussian or Tschebycheff distribution or response curves. The Micro-Notch most nearly approaches the rectangular ideal so desirable for maximum spectrum usage.

These methods will reduce the time-sharing approach to system compatibility in many instances where $\frac{1}{2}\%$ frequency separation is available. The "Real Estate" solution (physical separation of facilities) with ancillary problems of supervision, link maintenance, and security will not be needed as frequently. Interesting possibilities for reception in normally untenable locations can be considered, if the overload comes from an out-of-band signal.

Closer frequency assignments permit better antenna design and/or adjustment. Where interference has limited use of systems of elements, full use may be possible. Critical facilities such as air-to-ground communication links, high priority military channels and missile or aircraft telemetry or control channels can be given a greater degree of protection from accidental or intentional interference.

Measurement and surveillance techniques can be improved. Where it is necessary to measure a small

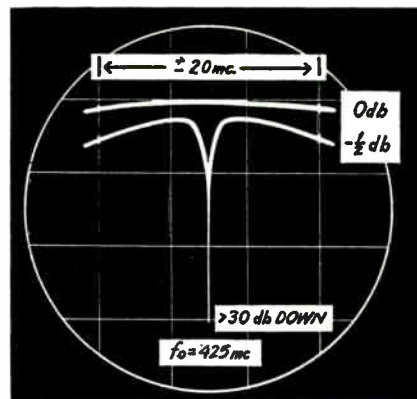
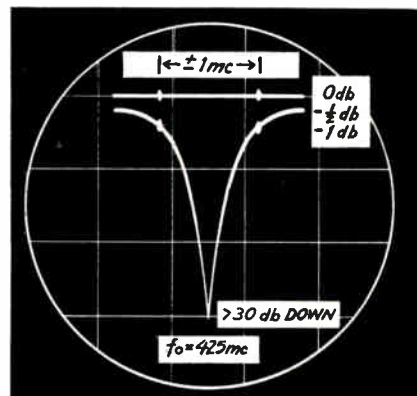

Fig. 1: Characteristics of the adjustable notch filter. Notch bandwidth at 1 db insertion loss is 2 MC; or less than $\frac{1}{2}\%$.

Fig. 2: Similar to the characteristics shown in Fig. 1; only sweep width changed.



signal near in frequency to a potentially saturating signal, the effective dynamic range of the receiver in this situation will be increased by 30 to 60 db with little loss of data.

* * *

Cleaning Tapes Ultrasonically

THE "Oscar" Award of Merit for outstanding achievement given by the Academy of Motion Picture Arts and Sciences is awarded not only to the famous screen personalities but to those whose technical contributions are

An attractive model holds "Oscar" awarded for development of film cleaner. The complete equipment is shown at the right rear.



of major significance to the motion picture industry. Recently, the award for the most important contribution for technical services was presented to the Lipsner-Smith Corp. and Robert Gutterman, the inventor, in recognition of the development of the CF_2 Ultrasonic Film Cleaner.

The Lipsner-Smith Corp. with Phillips Mfg. Co., Chicago, Ill., who are manufacturing the film cleaner, are continually making studies with respect to the economics of the cleaner in conjunction with cleaning film and electronic computer tapes.

Handling motion picture film, especially negatives which are irreplaceable and extremely valuable, is

(Continued on page 190)

Nuclear blast effects on electronic equipment outside of the heat and blast zones can be overcome. Methods such as shielding, component replacement, circuit design, and advanced circuit concepts can be used to make the equipment radiation resistant. The problem can be attacked in the same manner as for thermal or vibrational environments.

Design and Packaging for Nuclear Exposure

By Dr. GLENN L. KEISTER

Chief, Radiation Effects Unit
Physics Technology Dept.
Aero-Space Div.
The Boeing Co.
P.O. Box 3707
Seattle 24, Wash.

THE design and packaging of electronic equipment for operation in a nuclear environment can be considered no different than the design for thermal or vibration environments. To provide a reliable design, the designer needs only the information on how the electronic equipment reacts to the nuclear exposure and a suitable means for including this in the design of equipment.

The available techniques to reduce the effects of radiation on equipment are:

1. Shielding from the radiation environment.
2. Replacement of vulnerable components.
3. Circuit design and packaging concepts which reduce the effect of a nuclear environment on circuit operation.
4. Advanced circuit design concepts which allow the circuit designer to more fully understand the interaction of radiation with the circuit and optimize the design of his circuit for a particular nuclear environment.

Several aspects of these various methods will be discussed and examples given of their effectiveness.

Shielding

Shielding, to reduce the radiation environment, is most effective for those radiations which interact strongly with bulk material. As was indicated by Crittenden,¹ the reduction of the intensity of charged particle radiation, such as occurs in space, can be accomplished with much less massive shields than for neutrons or gamma rays of the same energy. Low energy charged particle space radiation can be simply shielded against for most applications. A thin quartz shield plate on space satellite solar cells can extend the life of the solar cells by months or years. This depends on the satellite orbit and the equipment power demand. Fig. 1 shows the mass of material in grams/cm² that is penetrated by protons of a given energy. As is seen, a layer of quartz 1 gram/cm² thick will stop protons of 40 Mev energy, which is typical of protons that are found in the Van Allen radiation belts.

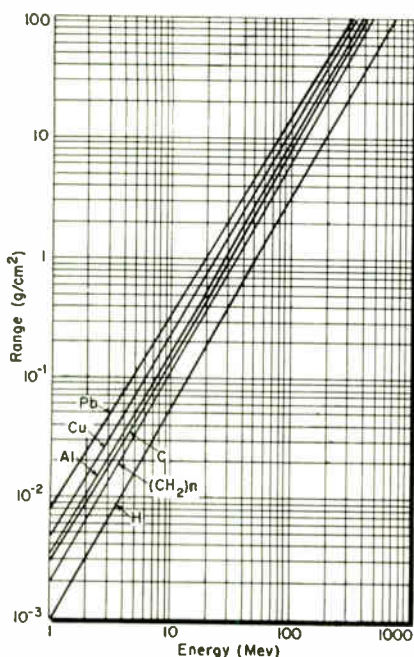
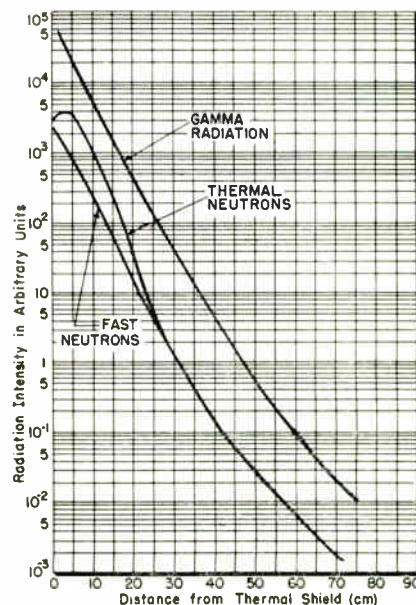
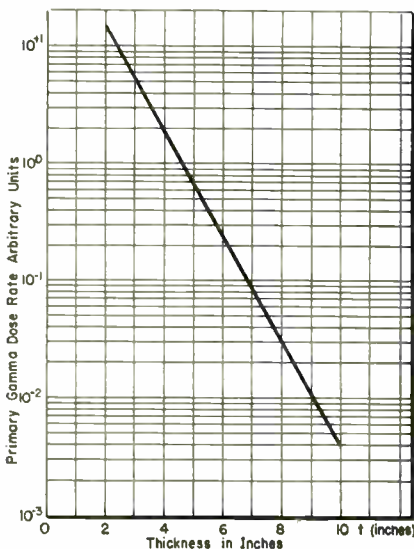

Fig. 1 (l.) Range-energy curves are shown for protons in several different materials.

Fig. 2 (below): Primary dose rate versus lead shield thickness in water media.

Fig. 3 (r.): Neutron and gamma intensities in barytes concrete shield of BEPO reactor.



To shield electronic equipment from neutrons or gamma rays, it is necessary to use much heavier and thicker slabs of material. The need for such shielding is generally associated with the protection required for equipment working near a nuclear reactor or nuclear weapon detonation. Assuming the spectrum of gamma rays and neutrons associated with the fission reactions, the reduction of gamma rays as a function of distance in lead is shown in Fig. 2. Since it is difficult to separate the neutrons and gamma rays from a fission reaction, the neutron and gamma intensity in a typical reactor concrete shield is shown in Fig. 3. For an order-of-magnitude reduction in the neutron and gamma radiation flux, a considerable mass of material is required. This type of shielding is generally only practical for ground-based installations, or where it is necessary for equipment to work near a reactor in an aerospace vehicle, such as a nuclear rocket or nuclear-powered satellite.

Some consideration has been given to the shielding provided by the components themselves. As is seen from the above, it is easy to use component configurations which will shield against low energy electrons and protons. However, shielding against gamma rays, neutrons, or high energy protons is much more difficult, and only if large volumes of equipment, fuel, or food are used could this be done. Many novel shielding concepts have been proposed for space vehicles. Most of these concepts depend on multipurpose use of shielding material.

Component Replacement

One common method of building equipment, which will withstand a nuclear environment, is to replace those components which are susceptible to nuclear radiation and retain those components which are not. Often this type of design technique can be used to construct electronic equipment which will withstand fairly large amounts of radiation. Fig. 4 shows some of the tolerance ranges for electronic equipment that is susceptible to permanent damage. Damage results from atomic displacements caused by fast neutron bombardment.

The reader is referred to the articles in this series^{1, 2} for a discussion of interactions of radiation with material and radiation units. In Fig. 4 the cross-hatched area shows where the components are affected but still can be used. The solid line indicates where the component is damaged beyond use. The letters on the right side of the chart indicate the reliability of the information. "A" indicates good design information, "B" indicates partial design information, and "C" indicates fragmentary information. Fig. 5 shows the components which are susceptible to ionization type damage or total absorbed energy. Fig. 6 shows those components which are susceptible to the radiation dose rate or flux. This type of effect is generally thought of as transient radiation which is related, in many instances, to nuclear weapon detonations. The same letter code is used on Fig. 5 and Fig. 6, except on Fig. 6 an arrow indicates the onset of the transient radiation effect.

From these figures we see that many of the components are quite susceptible to radiation whereas others are quite resistant, and that an order-of-

magnitude savings in the radiation tolerance can be obtained by selecting the proper components. A good

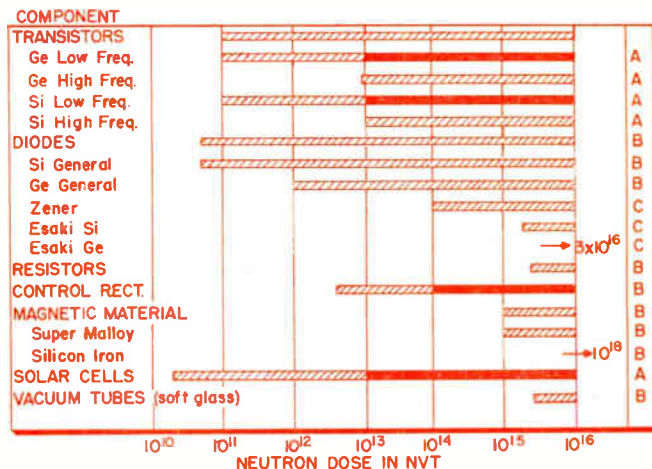

Fig. 4: Solid lines indicate neutron permanent damage levels.

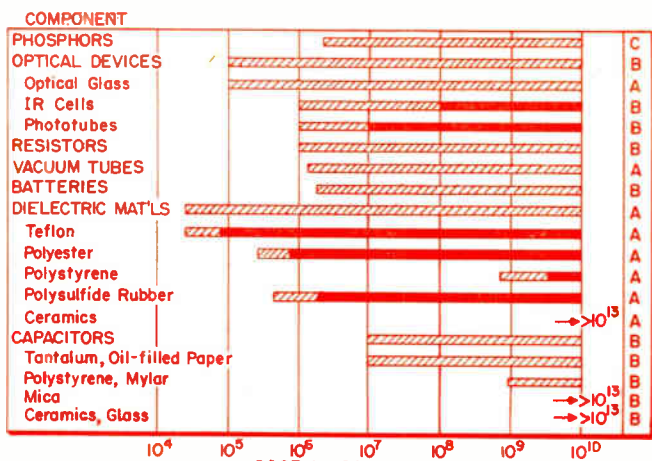

Fig. 5: Ionizing radiation permanent damage for materials.

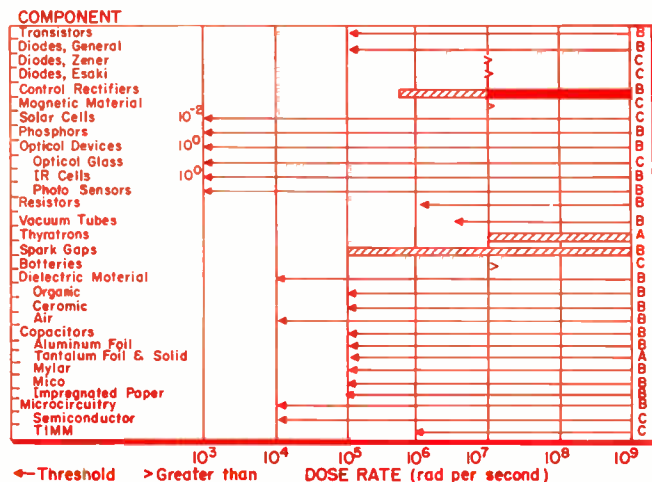

Fig. 6: Shown are levels causing transient radiation effects.

REFERENCE PAGES

The pages in this section are performed for easy removal and retention as valuable reference material.

SOMETHING NEW HAS BEEN ADDED

An extra-wide margin is now provided to permit them to be punched with a standard three-hole-punch without obliterating any of the text. They can be filed in standard three-hole notebooks or folders.

Nuclear Packaging (Continued)

example of this type of work is given by Blair, et al.,³ where a transistor amplifier circuit was constructed which would withstand a total radiation dose of 10^{16} nvt. However, in many instances there are upper limits on what range of radiation dose can be tolerated by certain types of equipment. For example, 10^{16} nvt is probably an upper limit for present day transistor configurations. Other components, such as infrared detectors and organic dielectric materials also have limited usefulness, as shown in Figs. 4 through 6.

One method of overcoming component limitations is to investigate new design concepts. For example, in solid state components the tunnel diode appears to have a higher intrinsic radiation damage level than normal transistors. It should also be noted that vacuum tube components, particularly ceramic vacuum tubes, have a very high permanent damage capability. They are also more resistant to transient radiation effects than are semiconductor devices, except perhaps the tunnel diode.

Fig. 7: Plot of E_{cox} versus dose rate of a 2D21 Thyratron tube.

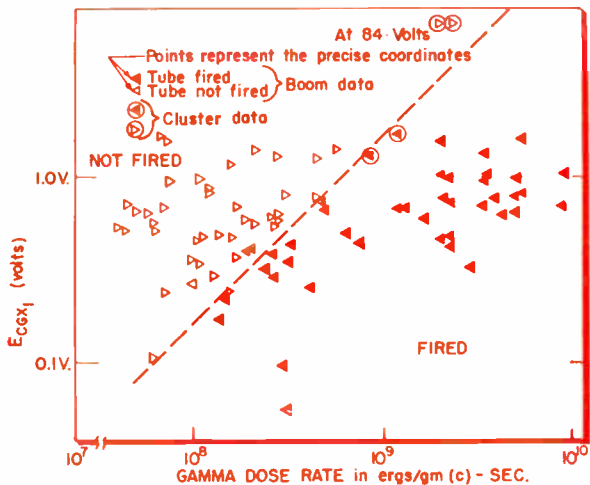
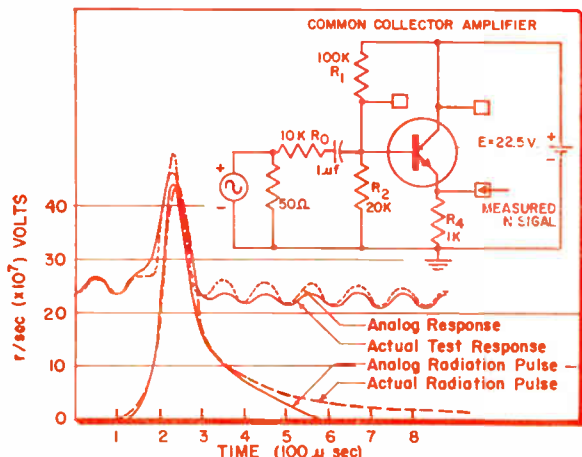

Fig. 8: Simulated and actual response of amplifier circuit.



People engaged in radiation effects testing work have discovered many rules of thumb that can be used to reduce the radiation susceptibility of their test instrumentation. These rules are also valid for general circuit design application. The rules apply to the particular type of environment considered and they must not be applied indiscriminately to all environments.

For a transient radiation effects environment, where very high radiation rates are encountered, it is quite common to cover all electronic leads that are exposed to air with some suitable potting compound, such as wax or silastic. This reduces the effects of air ionization. If the potting compound has a substantial thickness, the effect of Compton scattering from the electronic component material is also reduced. This reduction in Compton scattering is accomplished by the fact that Compton electrons are scattered into the components from the potting compound, as well as out of the component. In a reactor environment where the radiation rates are much lower, this technique may not be desirable due to the permanent radiation damage that could occur in the potting material itself if an organic potting material is used.

Another example which is of interest for a transient radiation environment is the construction of circuits which are tolerant to noise. The transient radiation pulse in electronic circuits can be quite similar to a noise pulse induced by an ordinary electrical transient. If a circuit is tolerant to noise pulses, the probability of malfunction due to transient radiation-induced pulses will be low. It is also desirable in many instances to keep impedances low. For example, when a vacuum tube is exposed to a radiation pulse, it appears as if a current generator having a strength $i_g = a\gamma$ is placed in series with the grid of the vacuum tube. (Where γ is the radiation rate in r/sec and a is 4×10^{-13} amp-sec/ r for a 7586 RCA nuvistor.) When the grid impedance is low, the voltage output of the tube will be small. If the input impedance is high, the radiation-induced output will also be high. It is also possible to increase the radiation rate at which thyratrons will trigger by biasing the thyratron grid more negatively. The grid bias characteristics for the 2D21 are shown in Fig. 7 as obtained by IBM,⁴ where E_{cox} is the excess grid bias above the voltage at which the tube normally fires.

Another aspect of radiation damage, particularly permanent damage to components, is that if the reduction in the performance of the component is known, circuit feedback can be used to reduce the effect of degradation of the component. This is a common technique. It has been used by Boeing designers to decrease the effect of the transistor gain reduction in transistorized circuits. The reduction in the gain of transistors due to neutron radiation is well known.^{5,6} It can be predicted easily within a factor of two for most transistor types. Once this degradation is known, it is very easy to apply standard design techniques and obtain transistor circuits which will have a usable output over a known radiation tolerant range.

Advanced Circuit Design Concepts

A new design concept is being developed at Boeing⁶ which can be used to predict the effects of a transient

radiation environment on equipment. The essential feature of this technique is the use of an analog computer. The computer simulates both the radiation environment and the response of the electronic components to the radiation environment. The response of simple transistor circuits to a critical assembly pulsed environment has been successfully predicted (Fig. 8). As this technique is developed and expanded to include other components and other types of environments, it should prove valuable in predicting the response of circuits to any arbitrary radiation-pulsed environment.

Summary

It has been shown that the methods of designing and packaging electronic equipment can be used to substantially reduce the effects of nuclear radiation. These techniques are in use or have been developed, and newer concepts should be available soon. Using these techniques, it will be possible to design electronic equipment which will function in radiation environ-

ments higher than normal electronic circuit design techniques would allow. The design engineer should be mindful of this problem. When he recognizes the possibility of a radiation environmental problem he should consult either the literature or persons competent in this field for aid. In so doing, he should be able to solve his electronic design problems.

References

1. J. R. Crittenden, "Basic Effects of Nuclear Radiation," *Electronic Industries*, Jan. 1962.
2. V. R. Honnold and C. W. Perkins, "Effects of Nuclear Radiation on Electronic Materials," *Electronic Industries*, Feb. 1962.
3. R. R. Blair, W. P. Knox, J. W. Easley, "Transistor Circuit Behavior at Exposures Greater Than 10^{16} fast neutrons/cm²," Appendix C of NSEP Second Triannual Technical Note, 15 Nov. 1959, WADC-TN-60-56.
4. "Pulsed Radiation Effects on Electronic Components," Fourth Triannual Report, IBM File No. 61-521-13, 31 Oct. 1961.
5. J. W. Easley and J. A. Dooley, *Journal of Applied Physics*, Vol. 31, p. 1024, June 1960.
6. "Predictions of Transient Nuclear Radiation Effects in Electronic Circuits-Summary," Report on Air Force Contract AF33(616)-7804. ARPA Order No. 179-61. Boeing Doc. DZ-9878.

Production Streamlining

To speed production and lower costs, Emerson Radio & Phonograph Corp., has designed what is virtually an automatic printed circuit production line.

Before the change, many operations were performed by hand. Circuit boards were placed in wire racks and hand dipped into a series of etch tanks. After dipping, the boards were hung to dry before shipment to the assembly areas. Twelve workers were needed to produce from 1,700 to 6,500 boards/day (depending on size). After streamlining, production increased to 2,500-10,000/day; workers reduced from 12 to 9.

The heart of the new set-up is a Monoflo Rotating Cable Conveyor which makes a complete circuit around the EMC (Etched Metal Circuit) Shop. From start to finish, the circuit boards are moved on the Monoflo.

At the start, a worker places 8 printed copper boards into a wire rack; then places the rack on the Monoflo. The rack and boards, approx. 10 lbs, are conveyed through acid spray tanks, inspection stations, and baths. After the final bath to remove the "Ink" used in printing the circuit, the Monoflo courses through a drying chamber

where forced hot air removes excess moisture.

After the drying chamber, the racks are automatically transferred to a second Monoflo Conveyor which air dries the boards through a run of approx. 20 ft. Then comes the final station where the boards are removed from the racks for inspection, collection and transfer to assembly areas. The Monoflo returns the wire racks to an "accumulating rail" at the starting point, where they are held in readiness for the next cycle.

While the conveyors used are only 180 ft long, they have provided many advantages. As already indicated, the system has not only made an increase in production possible but has also substantially reduced labor costs.

The Monoflo has proven exceptionally durable in withstanding the effects of the acids used. While

other equipment tends to pit and corrode, the Monoflo has shown no such effects after more than 5 years of use. Still another advantage is a reduction in floor space requirements made possible by Monoflo. Under the hand system, a good deal of space was required for drying. By use of the drying chamber and the "air-drying" conveyor run, no such space is needed.

An interesting highlight: the conveyors were not originally purchased for this use! They were purchased about 10 years ago to return "dollies" used for TV chassis assembly, to the start of the assembly line. With a change in procedure, the conveyors, no longer needed for this operation, were removed and re-installed for the printed circuit production.

Monoflo rotating cable conveyors are manufactured by M-H Standard Corp., Jersey City, N. J.

Final inspection station where the printed circuits are removed from racks and inspected. Empty racks are returned to the start of the line on the Monoflo Conveyor.

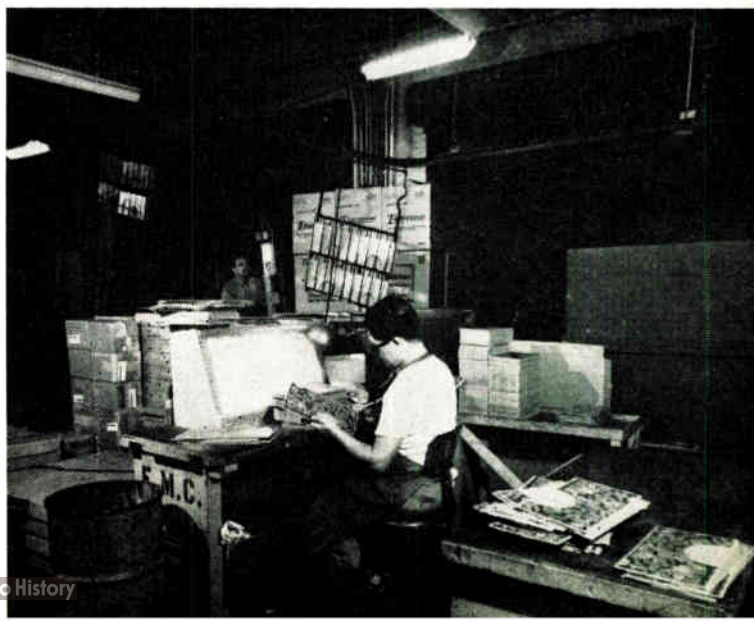

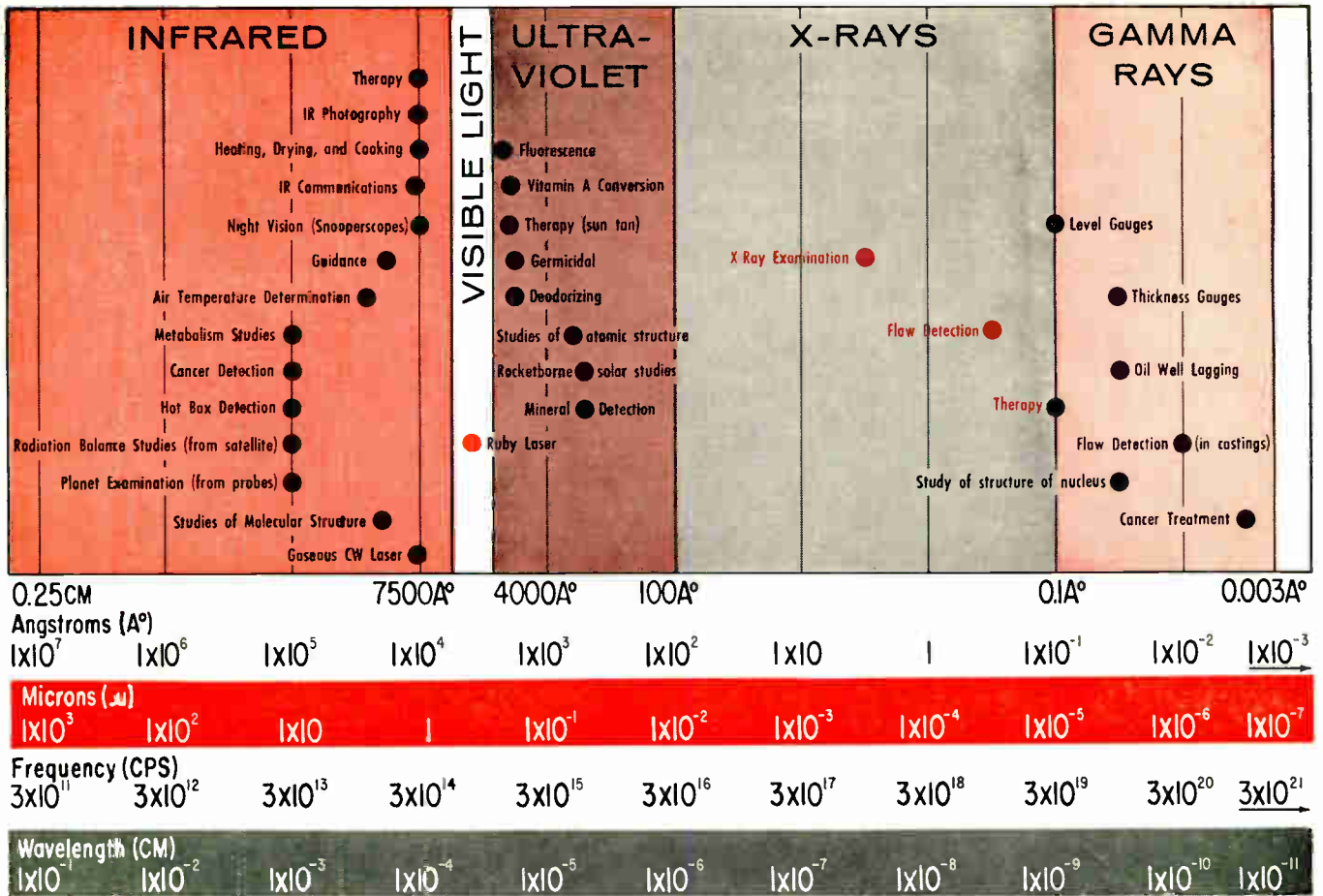

The Optical-Electronic

OPTICS was pushed into the background during and after World War II, as electronics dominated military equipment. Radar replaced most of the optical devices because it could locate objects at greater distances, see at night and through fog, and give more accurate ranges.

The trend is now back towards optical devices for some applications. The discovery of the maser and laser, and the extended use of infrared and ultraviolet have made optics once again an important subject. New types of material are being used for lens systems, such as germanium and fiber optics.

The pressing need for additional space in the electromagnetic spectrum has pushed us steadily higher in frequency. Many uses are being found today for the infrared region and higher portions of the spectrum. Infrared is being used for detection, guidance, communications, molecular structure studies, photography, etc. Generally, these require lens systems. Consumer type applications such as therapy, heating, drying and cooking have been with us for awhile, and are lens-free. Most of the ultraviolet applications are of a non-military nature at present. These generally do not require optical systems. However, as further exploitation of this region takes place, lenses will be needed.

Special Staff Report

It is difficult to split the various bands into small, definite bands. Reference sources and text books are not in agreement with each other as to band extents and boundaries. However, after much searching we have arbitrarily picked the limits shown in our presentation of the "Optical-Electronic Spectrum." At this time they appear to be reasonable and generally conceded band limits.

The complete spectrum chart shows the major applications of the various bands. The dots show where these applications are heaviest. The table opposite the chart lists these applications along with the highest and lowest ranges normally used for these applications. Also included here is a chart supplied by Hughes Aircraft Co. showing the most important segment of the infrared spectrum with expanded applications.

Most of this material was compiled with the assistance of Richard D. Hudson, Jr., Senior Staff Engineer, Infrared Labs., Hughes Aircraft Co.

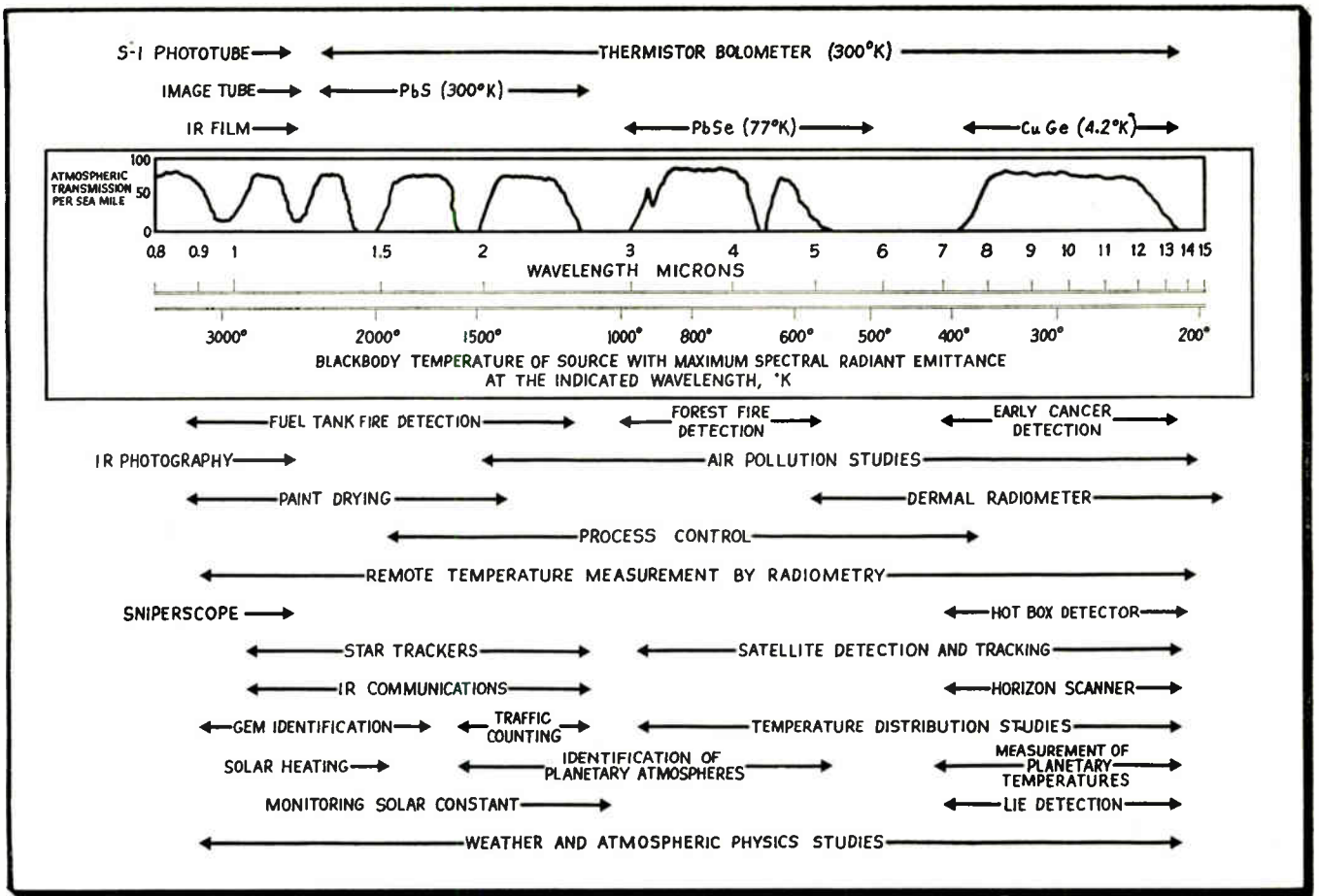

Spectrum

CONVERSION FORMULAS

Propagation Velocity
 $c = 3 \times 10^8$ meters/sec. $= \frac{984}{f \text{ in mc.}}$

Wavelength in Meters
 $\lambda_m = \frac{300,000}{f \text{ in kc.}}$
 $= \frac{300}{f \text{ in mc.}}$

Wavelength in Feet
 $\lambda_{ft} = \frac{984,000}{f \text{ in kc.}}$

1 Angstrom Unit
 $\text{\AA} = 3.937 \times 10^{-9}$ inch
 $= 1 \times 10^{-10}$ meter
 $= 1 \times 10^{-4}$ micron

1 Micron
 $\mu = 3.937 \times 10^{-5}$ inch
 $= 1 \times 10^{-6}$ meter
 $= 1 \times 10^4$ Angstrom

RADIATION APPLICATIONS

APPLICATION	APPLICATION CENTER, A°	BAND EXTENT, A°	APPLICATION	APPLICATION CENTER, A°	BAND EXTENT, A°
INFRARED			ULTRAVIOLET		
Therapy	10,000	8,000- 20,000	Fluorescence	3,300	2,500- 3,500
IR Photography	10,000	8,000- 12,900	Vitamin A Conversion	2,800	2,500- 3,000
Heating, Drying, and Cooking	10,000	8,000- 20,000	Therapy (sun tan)	2,900	2,500- 3,000
IR Communications	12,000	8,000- 13,000	Germicidal	2,536	2,000- 3,150
Night Vision (Snooper scopes)	10,000	8,000- 13,000	Deodorizing	2,536	2,000- 3,000
Guidance	25,000	18,000- 60,000	Studies of Atomic Structure	—	300- 4,000
Air Temperature Determination	42,500	—	Rocketborne Solar Studies	—	100- 3,000
Metabolism Studies	100,000	50,000-300,000	Mineral Detection	3,300	—
Cancer Detection	100,000	50,000-300,000	X-RAY		
Hot Box Detection	100,000	50,000-130,000	X-Ray Examination	5	1 -10
Radiation Balance Studies (from satellite)	100,000	50,000-350,000	Flaw Detection	0.5	0.1 - 1.0
Planet Examination (from probes)	100,000	50,000-500,000	Therapy	0.1	0.01 - 1.0
Studies of Molecular Structure	30,000	10,000-1,500,000	Study of Structure Nucleus	0.05	0.01 - 0.1
Gaseous CW Laser	11,000	10,000- 12,000	GAMMA RAY		
VISIBLE			Level Gauges	0.1	0.01 - 0.1
Ruby Laser	6,943	—	Thickness Gauges	0.05	0.01 - 0.1
			Oil Well Logging	0.05	0.01 - 0.1
			Flaw Detection (in castings)	0.01	0.01 - 0.1
			Cancer Treatment	0.005	0.003- 0.1

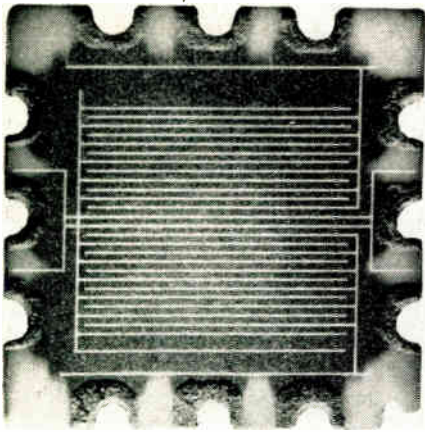

Fig. 1: Typical micro-element resistor magnified about 7 times its actual size.

By DR. ROBERT C. LANGFORD

Kearfott Division
General Precision, Inc.
Clifton, N. J.

Adjusting Micro-Element

Spiralling cylindrical, deposited resistors to range has long been practiced. But the flat Micro-Module resistors demanded a new system; and so, a wide search for new cutting methods ensued. This article presents the results of that search—and comments on each new method.

THERE are at least three efforts in the micro-miniaturization field. Among these concepts, the one being studied most actively is the Signal Corps' Micro-Module. This system mounts resistors on one wafer, capacitors on another, transistors on another, and so on. Often, the concept does not give the best packing density. However, the program is giving the greatest impetus towards new breakthroughs in raw materials which are needed for effective gains in micro-circuitry.

We are concerned with just one component—the resistor. This passive device is one of the most important in the stack. Their performance requirements are high. They must be as free as possible from unwanted side parameters—self-inductance and stray capacity. Up to four of them are mounted on each

wafer. Further, since micro-modules must reproduce as many analog circuits as are presently available, we must reproduce in this form almost all of the possibilities of conventionally-sized devices.

A typical micro-element resistor, Fig. 1, has a wafer 0.3 in. x 0.3 in. x .010 in. thick. On the alumina substrate are mounted the appropriate silver lands for solder connections. A metallized resistance alloy film of nickel-chrome is deposited over the substrate and lands. Also, unwanted terminals are isolated from desired resistors. Adjustment lines to raise the resistance between desired points within tolerance—1, 5, or 10%—are included. These resistor elements required new design and manufacturing approaches.

In the first process, silver had to be applied on both sides and in the notches for suitable solder adherence and strength. After baking, the units were metallized, and a further bake given to stabilize the resistance.

Dr. Langford was Director of Engineering, Weston Instrument Div., Daystrom, Inc., when this article was prepared.

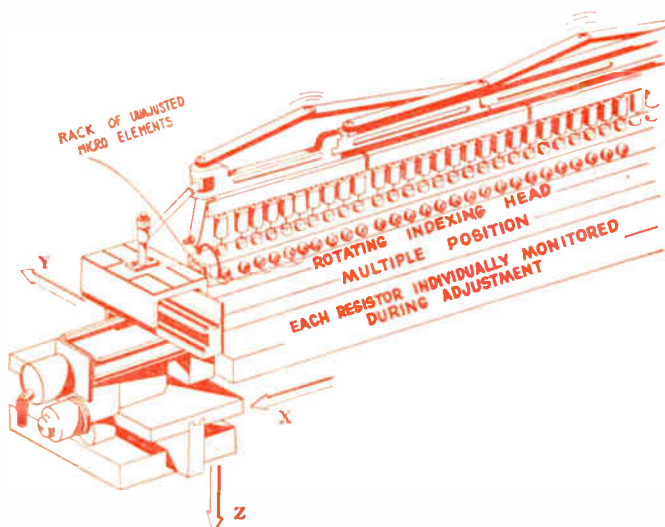
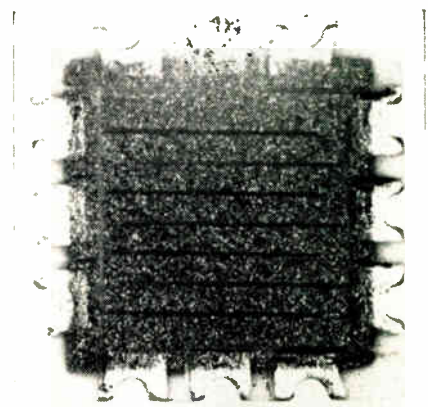

Fig. 2a (left): Panto-graph machinery used in diamond scribing.

Fig. 2b (right): Micro-element resistor adjusted by the diamond scribing method appears crude but gives desired performance.





Resistors

Then, the metallized blanks were sorted into appropriate batches. These batches were later cut to give the desired isolation and adjustment lines.

One process for adjusting isolation and adjustment lines is diamond scribing. In this process the units were first mounted individually on a pantograph machine and both isolated and cut to value. The cut track, Fig. 2, has a rough appearance; however, it does give desired performance. This concept meets the microminiaturization theory needs fairly well except for cost reduction and high volume production suitability. This method is now in use. But these limitations have caused a wide search for new methods. These are described in detail with comments.

Etching Methods Investigated

In "Electro Etch," the metallized unit is etched through a reusable mask in contact with the wafer. The final track width bears little or no resemblance to

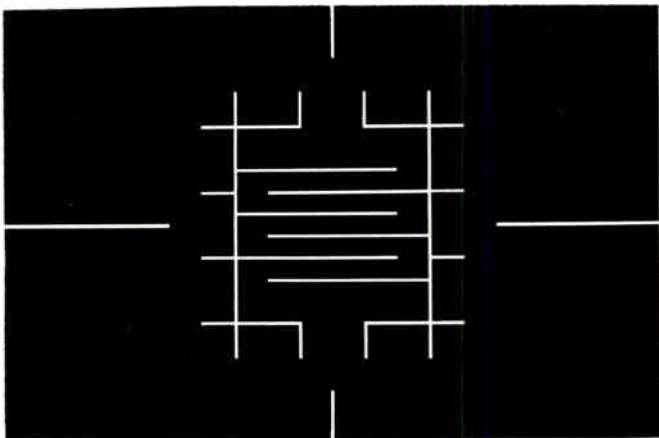

that of the stencil, Fig. 3.

It was expected that the pattern would be formed strictly in accordance with the stencil. Theoretically, if we start with a fixed resistance blank—uniform ohms per square, the end result is predictable; and, if another blank of the same material is used, the same end point should result. In practice, the resistivity changes over the micro-element area. Also, the exact contour by which current flows through the unit changes. For this reason, a large limitation was placed on its use. Despite this limitation, it is possible to cut a line by some other process which gives adjustment to the desired value; but, the value must be monitored during the cutting operation.

Another electro etch method is performed through a non-reusable film. In this system, a form of silk screen resist protects the film. While the results are exactly the same as those with the reusable mask, the configuration is different. Mainly, it contains chemical as well as electro etch. This is the difference between an active solution which needs no electrical current for etching and one that has a rather weak electrolyte but does depend on a current.

So far, about 40,000 ohms per resistor is the highest value which can be obtained. This is due to cut fineness limits. Other methods use either electro or chemical etching through a resist laid down and exposed by photography. The photo resist is sensitized by ultraviolet light passing through the appropriate negative. This method does have the advantage that it will produce final resistances of the order of 100,000 ohms without too much problem; and, thus raises the expected resistance upper limit.

Film Deposition

Another method—deposition of the resistive film over a previously silk screened pattern—is considerably different from the other methods. In it, a foreign body is placed on top of the substrate and the metal deposited on top of this. When the metal is so deposited, it can be abraded by a very light action which will remove areas having a poor adhesion to the basic substrate. The pattern is formed by a chrome oxide base. Satisfactory resistors can be made to a 40,000 ohm limit. The final resistance after abrasion is completely unpredictable, ranging over several hundred per cent away from the target value.

Sputtering

Deplating in a vacuum by using the sputtering action of heavy positive ions through a mask achieves

Fig. 3a (left): Stencil used in the first electro etch process. It offers a low capital investment.



Fig. 3b (right): This resistor's track width bears little resemblance to the stencil at left.

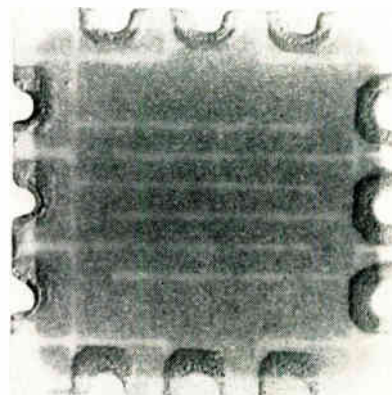

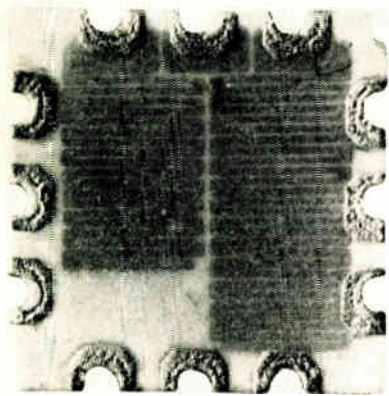
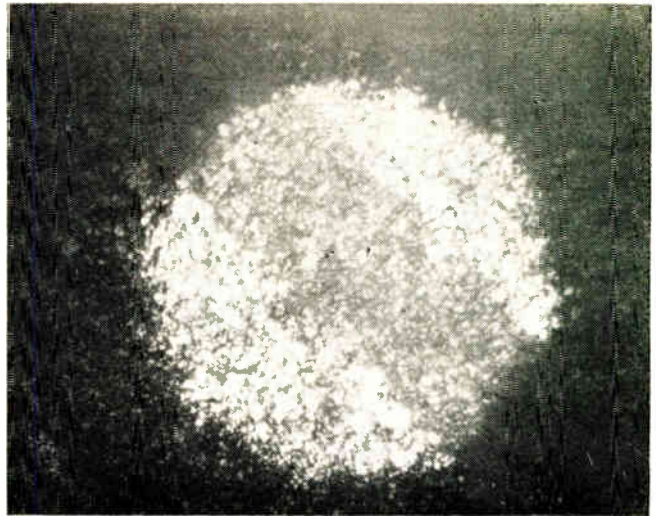

Fig. 4 (left): Resistors adjusted by sputtering through mask are suitable for high volume production runs.



Fig. 5 (right): Magnified portion of line cut by electron beam shows clear distinction between metal film and granular substrate.



Adjusting Resistors (Concluded)

a fine line, Fig. 4, of desired width. This width should preferably be controllable between one tenth and one thousandth of an inch wide. However, this fine line is only obtainable with an appropriately fragile mask. The mask is made of a Fotoceram and breaks after about two operations.

Particle Bombardment

The next method goes by the somewhat exotic title of particle bombardment. It is, in fact very old and is known as "grit blasting." A plasticized rubbery-type silk screen resist is placed over the micro-element front. Then a fine grit spray bombards the surface of the unit and cuts through the exposed area. The line width obtainable gives a ragged edge that results in a rather noisy resistor.

Other Cutting Methods

There are two other methods felt to be quite vital to micro-resistor design and manufacturing. They have been kept until last to emphasize their importance.

One method uses an electron beam. The beam is that of a modified electron microscope in which the accelerating potential is now about 100,000 volts and the beam current about 10 ma. When a focused electron beam of this intensity meets an object, the kinetic energy involved through stopping the motion of the electrons raises the temperature at this point to better than 100,000° K. By changing the electron beam, tem-

peratures anywhere between room temperature and 100,000° K can be obtained. Then, when there is a metal film on a ceramic base, the beam energy can be adjusted so the metal film is sublimated, while the state of the ceramic substrate remains unchanged, Fig. 5. It is possible to sublimate both the ceramic base and the metal film as desired, but there is a sufficient energy gap to discriminate effectively between these two substances.

With this method, it is possible to obtain figures of the effect by which individual squares can be isolated. Isolations better than 100,000 megohms can very easily be obtained. This method will probably yield most valuable results. There is inherently very little limitation on the maximum speed or minimum widths at which the cuts can be produced. The use of computer

A REPRINT

of this article can be obtained by writing on company letterhead to
The Editor
ELECTRONIC INDUSTRIES, Chestnut & 56th Sts., Phila. 39, Pa.

techniques to control the beam will make it possible to program a complete cut of the micro-element. Also, the individual element resistance can be monitored during cutting. Thus, a pattern can be cut and the cutting stopped at any desired point to achieve desired resistance. Very high production rates and substantial economies are possible. This is particularly true since electron beam widths can be set as small as needed to produce a fine cut.

The last method uses an electric probe, Fig. 6. Among this system's needs are a highly polished substrate with the metal deposited thereon, coupled with the cutting action of a current flow through a sharp-pointed electric probe. The current flow takes place through the sharp-pointed stylus through the metal film to the other electrode. Best results so far have been found making the stylus cathodic. The pressures are extremely low; so low, that if the stylus moved over the surface, no scratch would be visible. But, if the correct potentials are applied, the cutting action takes place cleanly, effectively and instantaneously.

* * *

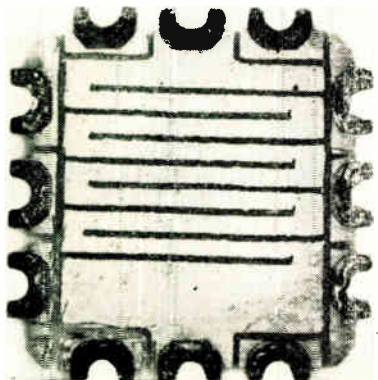

Fig. 6: The electric probe method consistently yields resistors with an accuracy better than one per cent.

ELECTRON TUBE INTERCHANGEABILITY CHART

By C. P. MARSDEN, W. J. KEERY, and J. K. MOFFITT

National Bureau of Standards
Washington 25, D. C.

Part Two:

Domestic vs. Foreign Microwave Tubes

Foreign vs. Domestic Microwave Tubes

Foreign vs. Foreign Microwave Tubes

As part of the function of the Electron Devices Data Service of the National Bureau of Standards, these tables were prepared as a service to the engineers, procurement and service personnel engaged in the field of electronics. All information was taken from manufacturer's published specifications and every effort has been made to assure accuracy and completion. However, the Bureau cannot assume responsibility for omissions nor for results obtained with these data.

No degree of interchangeability is indicated, as in most cases the geometrical shape or method of mechanical attachment vary considerably between manufacturers. In general, these types are stated as being similar to, a frequency variant of or a prototype of a given type. However, in most cases, a minor modification of the voltages, electrical connections and/or mechanical attachment will permit direct substitution of the similar type. Furthermore, old and developmental type numbers which have been assigned a new type number by the manufacturer are included.

CODE:

A three letter symbol in the column following the type number is used to describe the kind of tube for a given type number. These symbols are listed below:

AMA—Amplatron Amplifier or Platinotron
BWO—Backward Wave Oscillator
HEL—Helitron
KLA—Klystron Amplifier
KLO—Klystron Oscillator
MAG—Magnetron
TWA—Traveling Wave Amplifier

The code used for "Country of Origin or Availability" is:

C—Canada F—France H—Holland
E—England G—Germany J—Japan

An additional symbol is prefixed to the type number in the first column, i.e., the lozenge (◊), to indicate obsolete, old or developmental type numbers.

Domestic vs. Foreign Microwave Tubes

No.	Type/Similar to or Interchangeable With	No.	Type/Similar to or Interchangeable With
MAG3	MAG 2J42, 6027, 6271, 6817, 6818, 6819, 6820, 6821, 6822	◊M551	MAG 4J52A, L3036, L3037, L3103, L3106, L3168, 6510, 6543, 6543A
LA4-250	TWA 7637	M559	MAG 6027
6V26A	KLO 2K26	N1042M	TWA 6861
6V26B	KLO 2K26	THF1050	MAG 6843
7V20D	KLO VA220D	TH1249	MAG 2J49
7V26A	KLO 2K26	TH1250	MAG 2J50
7V26B	KLO 2K26	TH1452	MAG 4J52A
8A9-20	BWO 7635	TH1725A	MAG 725A
LA9-3	TWA 7638	TH1725C	MAG 2J48
JP9-7	MAG 2J42, 6027, 6271, 6817, 6818, 6819, 6820, 6821, 6822	TH2203B	KLO 6975
JP9-7A	MAG 2J42, 6027, 6271, 6817, 6818, 6819, 6820, 6821, 6822	TH2220	KLO SK220, VA220, SK222, VA222
JP9-15	MAG 2J42A, 6027, 6271, 6817, 6818, 6819, 6820, 6821, 6822	TH2225	KLO 2K25
◊JPD9-250	MAG 4J50A, 4J78, L3030, L3039, L3107, L3151, L3152, L3153, L3154, L3155, L3156, L3209, L3210, 6865, 6874, 7006, 7008, 7110, 7111, 7112	TH2412	KLO OK412
KS9-20	KLO 2K25, V261, V270, OK420, 723A/8, 6311, 6312, 6316	5609V	MAG 5609, 5609A
KS9 20A	KLO 2K25, V261, V270, OK420, 723A/8, 6311, 6312, 6316	7138	MAG SEE JP9-7 SIMILAR TYPES
TW5-10	TWA 7642	7139	MAG SEE JP9-7 SIMILAR TYPES
BA16-10	BWO 7636	7140	MAG SEE JP9-7 SIMILAR TYPES
LA16-2	TWA 7639	7141	MAG SEE JP9-7 SIMILAR TYPES
◊K306	KLO 2K33, 6253, 6254	7142	MAG SEE JP9-7 SIMILAR TYPES
K336	KLO V63	7143	MAG SEE JP9-7 SIMILAR TYPES
K345	KLO SK220, VA220, SK222, VA222	7815	KLO 2K28
K351	KLO VA201B	R9585	KLO 68M6, ZV1010, 5837
K353	KLO V54, V154	R9586	KLO 68M6, ZV1010, 5837
K358	KLO V54, V154	55340	TWA 7537
M502A	MAG SEE JPD9-250 SIMILAR TYPES	55390	KLO 2K25
M508	MAG 2J42, 6027, 6271, 6817, 6818, 6819, 6820, 6821, 6822	◊CV513	MAG 4J53
M509	MAG 2J42, 6027, 6271, 6817, 6818, 6819, 6820, 6821, 6822	RCV1807	MAG 2J31
◊M510	MAG 2J30 2J31, 2J33, 2J34	RCV1808	MAG 2J32
◊M511	MAG SEE JPD9-250 SIMILAR TYPES	RCV1809	MAG 2J33
◊M512	MAG 2J36	RCV1810	MAG 2J34
◊M518A	MAG 4J31, 4J32, 4J33, 4J34, 4J35, 4J53, 5586, 5657	RCV1828	MAG 2J36
M523	MAG SEE JPD9-250 SIMILAR TYPES	RCV1897	MAG 4J34
◊M526	MAG 2J42, 6027, 6271, 6817, 6818, 6819, 6820, 6821, 6822	RCV1898	MAG 4J35
M529	MAG SEE JPD9-250 SIMILAR TYPES	RCV1914	MAG 4J31
◊M536	MAG 4J43, 4J44	RCV1916	MAG 4J33
M539	MAG SEE JPD9-250 SIMILAR TYPES	RCV2116	KLO RK6112
◊M542	MAG 4J31, 4J32, 4J33, 4J34, 4J35 4J53, 5586, 5657	RCV2281	MAG 2J42
M543	MAG 7182	RCV2284	MAG SEE JPD9-250 SIMILAR TYPES
M546	MAG SEE JPD9-250 SIMILAR TYPES	RCV2412	MAG SEE JPD9-250 SIMILAR TYPES
M547	MAG SEE JPD9-250 SIMILAR TYPES	RCV2424	MAG SEE JPD9-250 SIMILAR TYPES
◊M549	MAG SEE JPD9-250 SIMILAR TYPES	RCV2425	MAG SEE JPD9-250 SIMILAR TYPES
		RCV2792	KLO 2K25
		RCV3569	MAG 4J52A
		RCV3611	MAG 5586
		RCV3615	KLO 68M6
		RCV3676	MAG 2J42
		RCV3939	KLO 68M6A
		RCV3976	MAG 2J42

Foreign vs. Domestic Microwave Tubes

No.	Type/Similar to or Interchangeable With	No.	Type/Similar to or Interchangeable With
2J30	MAG M510 @E	L3106	MAG M551 @E
2J31	MAG M510 @E, CV1807 @E	L3107	MAG SEE 4J50A SIMILAR TYPES
2J32	MAG M510 @E, CV1808 @E	L3151	MAG SEE 4J50A SIMILAR TYPES
2J33	MAG M510 @E, CV1809 @E	L3152	MAG SEE 4J50A SIMILAR TYPES
2J34	MAG M510 @E, CV1810 @E	L3153	MAG SEE 4J50A SIMILAR TYPES
2J36	MAG M512 @E, CV1828 @E	L3154	MAG SEE 4J50A SIMILAR TYPES
2J42	MAG MAG3 @E, JP9-7 @E,G,H, JP9-15 @E,G,H, CV370 @E, M508 @E, M509 @E, M526 @E, CV2281 @E, CV3676 @E, CV3976 @E, 7138 @C, 7139 @C, 7140 @C, 7141 @C, 7142 @C, 7143 @C	L3155	MAG SEE 4J50A SIMILAR TYPES
2J42A	MAG SEE 2J42 SIMILAR TYPES	L3156	MAG SEE 4J50A SIMILAR TYPES
2J42H	MAG SEE 2J42 SIMILAR TYPES	L3168	MAG M551 @E
B2J48	MAG TH1725C @F	L3209	MAG SEE 4J50A SIMILAR TYPES
2J49	MAG TH1249 @F	L3210	MAG SEE 4J50A SIMILAR TYPES
2J50	MAG TH1250 @F	5586	MAG M518A @E, M542 @E, CV3611 @E
2K25	KLO K59-20 @E, K59-20A @E, CV2792 @E TH2225 @F, 55390 @C,H	5609	MAG 5609V @G
2K26	KLO 6V26A @J, 6V26B @J, 7V26A @J, 7V26B @J	5609A	MAG 5609V @G
2K28	KLO 7815 @J	5657	MAG M518A @E, M542 @E
2K33	KLO K306 @E	5837	KLO R9585 @E, R9586 @E
4J31	MAG M518A @E, CV1914 @E	6027	MAG SEE 2J42 SIMILAR TYPES
4J32	MAG M518A @E	6253	KLO K306 @E
4J33	MAG M518A @E, CV1916 @E	6254	KLO K306 @E
4J34	MAG M518A @E, CV1897 @E	6271	MAG SEE 2J42 SIMILAR TYPES
4J35	MAG M518A @E, CV1898 @E	6311	KLO SEE 2K25 SIMILAR TYPES
4J43	MAG M536 @E	6312	KLO SEE 2K25 SIMILAR TYPES
4J44	MAG M536 @E	6316	KLO SEE 2K25 SIMILAR TYPES
4J50	MAG SEE 4J50A SIMILAR TYPES	6510	MAG M551 @E
4J50A	MAG JP09-250 @E, M502 @E, M511 @E, M523 @E, M529 @E, M539 @E, M546 @E, M547 @E, M549 @E, CV2284 @E, CV2425 @E	6543	MAG M551 @E
4J52	MAG SEE 4J52A SIMILAR TYPES	6543A	MAG M551 @E
4J52A	MAG M551 @E, TH1452 @F, CV3569 @E	6817	MAG SEE 2J42 SIMILAR TYPES
4J53	MAG CV513 @E, M518A @E, M542 @E	6818	MAG SEE 2J42 SIMILAR TYPES
4J78	MAG SEE 4J50A SIMILAR TYPES	6819	MAG SEE 2J42 SIMILAR TYPES
68M6	KLO CV3615 @E, R9585 @E, R9586 @E	6820	MAG SEE 2J42 SIMILAR TYPES
68M6A	KLO CV3939 @E, R9585 @E	6821	MAG SEE 2J42 SIMILAR TYPES
V54	KLO K353 @E, K354 @E	6822	MAG SEE 2J42 SIMILAR TYPES
BV63	KLO K336 @E	B6843	MAG THF1050 @F
V154	KLO K353 @E, K358 @E	6861	TWA N1042M @E
VA201B	KLO K351 @E	6865	MAG SEE 4J50A SIMILAR TYPES
SK220	KLO K345 @E, TH2220 @F	6865A	MAG SEE 4J50A SIMILAR TYPES
VA220	KLO K345 @E, TH2220 @F	6874	MAG SEE 4J50A SIMILAR TYPES
VA2200	KLO 7V20D @J	6975	KLO TH2203B @F
SK222	KLO K345 @E, TH2220 @F	7006	MAG SEE 4J50A SIMILAR TYPES
VA222	KLO K345 @E, TH2220 @F	7008	MAG SEE 4J50A SIMILAR TYPES
BV261	KLO K59-20 @E, K59-20A @E	7110	MAG SEE 4J50A SIMILAR TYPES
BV270	KLO K59-20 @E, K59-20A @E	7111	MAG SEE 4J50A SIMILAR TYPES
QK412	KLO TH2412 @F	7112	MAG SEE 4J50A SIMILAR TYPES
BQK420	KLO K59-20 @E, K59-20A @E	7138	MAG SEE 2J42 SIMILAR TYPES
723A/B	KLO K59-20 @E, K59-20A @E	7139	MAG SEE 2J42 SIMILAR TYPES
725A	MAG TH1725A @F	7140	MAG SEE 2J42 SIMILAR TYPES
ZV1010	KLO R9585 @E, R9586 @E	7141	MAG SEE 2J42 SIMILAR TYPES
L3030	MAG SEE 4J50A SIMILAR TYPES	7142	MAG SEE 2J42 SIMILAR TYPES
L3036	MAG M551 @E	7143	MAG SEE 2J42 SIMILAR TYPES
L3037	MAG M551 @E	7182	MAG M543 @E
L3039	MAG SEE 4J50A SIMILAR TYPES	7537	TWA 55340 @G,H
L3103	MAG M551 @E	7635	BWO 8A9-20 @E
		7636	BWO BA16-10 @E
		7637	TWA LA4-250 @E
		7638	TWA LA9-3 @E
		7639	TWA LA16-2 @E
		7642	TWA TWS-10 @E

Foreign vs. Foreign Microwave Tubes

No.	Type/Similar to or Interchangeable With	No.	Type/Similar to or Interchangeable With
KRN3/1	KLO CV217 @E	CD119	CAR F4003 @F
MAG3	MAG JP9-7 @E,G,H, JP9-15 @E,G,H, M508 @E, M509 @E, M526 @E	DX122	KLO PKX4 @H, DX123 @H, DX124 @H
LA4-250	TWA 7637 @E	DX123	KLO PKX4 @H, DX122 @H, DX124 @H
PKX4	KLO DX122 @H, DX123 @H, DX124 @H	DX124	KLO PKX4 @H, DX122 @H, DX123 @H
KR6/1	KLO CV116 @E	CO210	CAR F4005 @F
KR6/2	KLO CV237 @E	V230A/1K	KLO CV234 @E
KR6/3	KLO CV238 @E	V233A/1K	KLO CV2190 @E
6V26A	KLO 6V26B @J, 7V26A @J	V235A/1K	KLO CV2221 @E
6V26B	KLO 6V26A @J, 7V26B @J	V237C/1K	KLO V239C/1K @E, V241C/1K @E
W7/10	TWA CV235B @E	V239C/1K	KLO V237C/1K @E, V241C/1K @E
W7/20	TWA CV2188 @E	Z239/1G	KLO CV2187 @E
7V26A	KLO 6V26A @J, 7V26B @J	V240C/1K	KLO V240C/2K @E
7V26B	KLO 6V26B @J, 7V26A @J	V240C/2K	KLO V240C/1K @E, CV2189 @E
JPGB-01	MAG JPGB-01B @E, JPTB-01 @E, JPTB-01B @E	V241C/1K	KLO V237C/1K @E, V239C/1K @E
JPTB-01	MAG JPTB-01B @E, JPGB-01 @E, JPGB-01B @E	V246A/1K	KLO CV228 @E
JPGB-01B	MAG JPGB-01 @E, JPTB-01 @E, JPTB-01B @E	K301	KLO CV2161 @E
JPTB-01B	MAG JPTB-01 @E, JPGB-01 @E, JPGB-01B @E	K302	KLO CV2164 @E
MAG8	MAG CV2380 @E	K305	KLO CV2263 @E
BA9-20	BWO 7635 @E	K308	KLO CV2282 @E
JP9-7	MAG JP9-7A @E,G,H, JP9-15 @E,G,H, MAG3 @E, M508 @E, M509 @E, M526 @E	K312	KLO CV2273 @E
JP9-7A	MAG JP9-7 @E,G,H, JP9-15 @E,G,H, MAG3 @E, CV370 @E, M508 @E, M509 @E, M526 @E	CO315	CAR F4004 @F
JP9-15	MAG JP9-7 @E,G,H, MAG3 @E, M508 @E, M509 @E, M526 @E	K324	KLO CV2304 @E
JP9-80	MAG JP9-80A @E	K335	KLO CV2343 @E
JP9-80A	MAG JP9-80 @E	K345	KLO TH2220 @F
JP09-250	MAG M502 @E, M511 @E, M523 @E, M529 @E, M539 @E, M546 @E, M547 @E, CV2284 @E	K347A	KLA K347 @E
JP69-01	MAG JPT9-01 @E	K353	KLO K358 @E
JP69-02	MAG JPT9-02 @E	K358	KLO K353 @E
JPT9-01	MAG JP69-01 @E	M501	MAG M501A @E, M501B @E, M507 @E, M519 @E, CV1479 @E, CV1480 @E, CV1481 @E, CV1482 @E
JPT9-02	MAG JP69-02 @E	M501A	MAG M501 @E, M501B @E, M507 @E, M519 @E, CV3659 @E, CV3660 @E, CV3661 @E, CV3662 @E
K59-20	KLO K59-20A @E	M501B	MAG M501 @E, M501A @E, M507 @E, M519 @E
K59-20A	KLO K59-20 @E, CV2792 @E	Q503	MAG CV1866 @E
LA9-3	TWA 7638 @E	Q506	MAG M506A @E, M545 @E
TWS-10	TWA 7642 @E	M506A	MAG M506 @E, M545 @E, CV3982 @E
BA16-10	BWO 7636 @E	M507	MAG M501 @E, M519 @E, CV1475 @E, CV1476 @E, CV1477 @E, CV1478 @E
LA16-2	TWA 7639 @E	M508	MAG MAG3 @E, JP9-7 @E,G,H, JP9-15 @E,G,H, CV370 @E, M509 @E, M526 @E, CV3676 @E

Foreign vs. Foreign Microwave Tubes (Continued)

No.	Type/Similar to or Interchangeable With	No.	Type/Similar to or Interchangeable With
M509	MAG MAG3 @E, JP9-7 @E,G,H, JP9-15 @E,G,H, M508 @E M526 @E, CV3976 @E	CV1475	MAG M507 @E, CV1476 @E, CV1477 @E, CV1478 @E
M510	MAG CV1807 @E, CV1808 @E, CV1809 @E, CV1810 @E	CV1476	MAG M507 @E
◻M512	MAG CV1828 @E	CV1477	MAG M507 @E
M513A	MAG CV3528 @E	CV1478	MAG M507 @E
◻M518A	MAG CV2744 @E	CV1479	MAG M501 @E
M519	MAG M501 @E, M507 @E, CV1483 @E, CV1484 @E, CV1485 @E CV1486 @E	CV1480	MAG M501 @E
M521	MAG CV2376 @E	CV1481	MAG M501 @E
M523	MAG CV2412 @E	CV1482	MAG M501 @E
M525	MAG CV2362 @E, CV2363 @E, CV2364 @E, CV2365 @E CV2366 @E, CV2367 @E, CV2368 @E	◻CV1483	MAG M519 @E
◻M526	MAG MAG3 @E,G,H, JP9-7 @E,G,H, JP9-15 @E,G,H, M508 @E M509 @E, CV3676 @E	◻CV1484	MAG M519 @E
M528	MAG CV160 @E, CV1495 @E, CV1496 @E, CV1497 @E, CV1498 @E, CV1499 @E, CV1500 @E	◻CV1485	MAG M519 @E
M529	MAG CV2426 @E	◻CV1486	MAG M519 @E
M538A	MAG CV2473 @E	CV1495	MAG CV160 @E, M528 @E
M539	MAG CV2425 @E	CV1496	MAG CV160 @E, M528 @E
◻M542	MAG M518A @E, CV3611 @E	CV1497	MAG CV160 @E, M528 @E
◻M543	MAG 7182 @C,E	CV1498	MAG CV160 @E, M528 @E
◻M545	MAG M506 @E, M506A @E	CV1499	MAG CV160 @E, M528 @E
M549	MAG CV2424 @E	CV1500	MAG CV160 @E, M528 @E
◻M551	MAG CV3569 @E	◻CV1747	MAG M505 @E
N1004	TWA N1023M @E	◻CV1807	MAG M510 @E
N1005M	TWA N1024M @E	◻CV1808	MAG M510 @E
N1010	8WO CV2393 @E	◻CV1809	MAG M510 @E
N1018M	TWA N1025M @E	◻CV1810	MAG M510 @E
N1024M	TWA N1005M @E	◻CV1828	MAG M512 @E
N1025M	TWA N1018M @E	◻CV1866	MAG M503 @E
N1034	8WO CV2381 @E	◻CV1897	MAG M518A @E
TH2220	KLO K345 @E	◻CV1898	MAG M518A @E
◻F4003	CAR C0119 @F	◻CV1914	MAG M518A @E
◻F4004	CAR C0315 @F	◻CV1916	MAG M518A @E
◻F4005	CAR C0210 @F	CV2117	MAG VX4109 @E
◻BM4009	MAG CV2168 @E, CV2169 @E, CV2170 @E	CV2118	MAG VX4110 @E
◻VX4061	MAG CV2319 @E, CV2320 @E	CV2119	MAG VX4111 @E
BM4073	MAG VX4070 @E	CV2120	MAG VX4112 @E
◻VX4073	MAG BM4073 @E	CV2121	MAG VX4113 @E
◻VX4080	MAG CV2167 @E	CV2122	MAG VX4114 @E
◻VX4109	MAG CV2117 @E	CV2123	MAG VX4115 @E
◻VX4110	MAG CV2118 @E	◻CV2161	KLO K301 @E
◻VX4111	MAG CV2119 @E	◻CV2164	KLO K302 @E
◻VX4112	MAG CV2120 @E	CV2167	MAG VX4080 @E
◻VX4113	MAG CV2121 @E	CV2168	MAG BM4009 @E
◻VX4114	MAG CV2122 @E	CV2169	MAG BM4009 @E
◻VX4115	MAG CV2123 @E	CV2170	MAG BM4009 @E
8M4119	MAG VX4119 @E	◻CV2187	KLO Z239/1G @E
◻VX4119	MAG BM4119 @E	◻CV2188	TWA W7/2D @E
◻VX4122	MAG CV2313 @E	◻CV2189	KLO V240/2K @E
◻VX4130	MAG CV2333 @E, CV2334 @E, CV2335 @E, CV2336 @E, CV2337 @E	◻CV2190	KLO V233A/1K @E
◻VX5023	KLO R5146 @E	◻CV2221	KLO V235A/1K @E
VX5027	MAG R6138 @E	◻CV2263	KLO K305 @E
◻VX5028	KLO R5222 @E, R9501 @E	◻CV2273	KLO K312 @E
◻VX5048	KLO R9559 @E	◻CV2281	MAG M537 @E
◻VX5063	KLA R9570 @E	◻CV2282	KLO K308 @E
◻VX5089	KLA R9571 @E	◻CV2284	MAG M502 @E
R5146	KLO VX5023 @E	◻CV2304	KLO K324 @E
R5222	KLO VX5328 @E, R9501 @E, CV2346 @E	CV2313	MAG VX4122 @E
5609A	MAG 5609V @G	CV2319	MAG VX4061 @E
R6010	KLO CV2353 @E	CV2320	MAG VX4061 @E
R6015	KLO CV2354 @E	CV2333	MAG VX4130 @E
◻K6112	KLO CV2116 @E	CV2334	MAG VX4130 @E
R6138	MAG VX5027 @E	CV2335	MAG VX4130 @E
7138	MAG SEE JP9-7 SIMILAR TYPES	CV2336	MAG VX4130 @E
7139	MAG SEE JP9-7 SIMILAR TYPES	CV2337	MAG VX4130 @E
7140	MAG SEE JP9-7 SIMILAR TYPES	◻CV2343	KLO K335 @E
7141	MAG SEE JP9-7 SIMILAR TYPES	◻CV2346	KLO R5222 @E
7142	MAG SEE JP9-7 SIMILAR TYPES	CV2353	KLO R6010 @E
7143	MAG SEE JP9-7 SIMILAR TYPES	◻CV2354	KLO R6015 @E
7182	MAG M543 @E	◻CV2358	TWA W7/1D @E
7537	TWA 55340 @G,H	◻CV2362	MAG M525 @E
7635	8WO 8A9-20 @E	◻CV2363	MAG M525 @E
7636	8WO 8A16-10 @E	◻CV2364	MAG M525 @E
7637	TWA LA4-250 @E	◻CV2365	MAG M525 @E
7638	TWA LA9-3 @E	◻CV2366	MAG M525 @E
7639	TWA LA16-2 @E	◻CV2367	MAG M525 @E
7642	TWA TWS-10 @E	◻CV2368	MAG M525 @E
R9501	KLO VX5028 @E, R5222 @E	◻CV2373	MAG M502A @E
R9559	KLO VX5048 @E	◻CV2376	MAG M521 @E
R9570	KLA VX5063 @E	◻CV2380	MAG MAG8 @E
R9571	KLA VX5089 @E	◻CV2381	8WO N1034 @E
R9585	KLO R9586 @E, CV3615 @E	◻CV2393	8WO N1010 @E
R9586	KLO R9585 @E, CV3939 @E	◻CV2412	MAG M523 @E
55340	TWA 7537 @H	◻CV2424	MAG M549 @E
◻CV116	KLO KR6/1 @E	◻CV2425	MAG M539 @E
◻CV160	MAG CV1495 @E, CV1496 @E, CV1497 @E, CV1498 @E, CV1499 @E, CV1500 @E	CV2426	MAG M529 @E
◻CV217	KLO KRN3/1 @E	◻CV2473	MAG M538A @E
◻CV228	KLO V246/1K @E	◻CV2744	MAG M518A @E
◻CV234	KLO V230A/1K @E	◻CV2792	KLO KS9-20A @E
◻CV237	KLO KR6/2 @F	◻CV3528	MAG M513A @E
◻CV238	KLO KR6/3 @E	◻CV3569	MAG M551 @E
CV370	MAG JP9-7 @E, M508 @E	◻CV3611	MAG M542 @E
◻CV513	MAG M518A @E	◻CV3615	KLO R9585 @E
		◻CV3659	MAG M501A @E
		◻CV3660	MAG M501A @E
		◻CV3661	MAG M501A @E
		◻CV3662	MAG M501A @E
		◻CV3676	MAG M526 @E
		◻CV3939	KLO R9586 @E
		◻CV3976	MAG M509 @E
		◻CV3982	MAG M506A @E

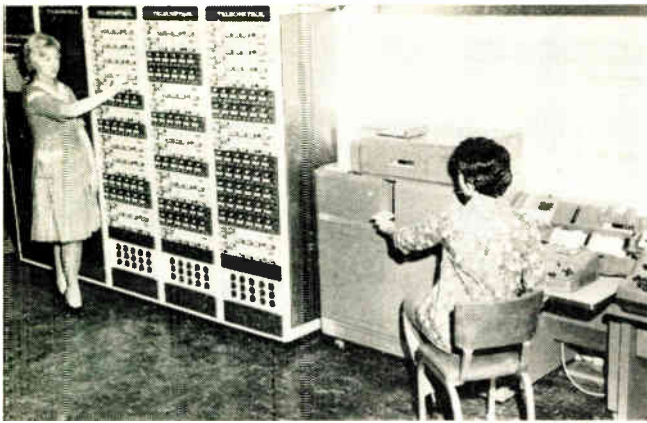

More On Automation . .

This equipment gathers and records on punched cards the precise status of every production tool in a factory. It is 180 times faster than manual operation.

up with specially wired plugs that include semi-fixed data on individual operators, part number, operation number, pay code, etc. They display productive time, downtime, units produced, and uncompleted balance of run for either a single machine or a group of machines.

AN automatic system gathers, organizes, and processes production data from every machine in a factory at a speed 180 times faster than heretofore.

This long stride toward automating factory control was developed by Hancock Telecontrol Corp., 320 Park Ave., New York City. This system is known as Readout-Telecontrol.

The new system will make every man and every machine in a plant more effective. In addition, it will increase profit margins, and, in many cases, wages. It will eliminate much drudgery.

The new system is a major advance upon standard Telecontrol which was introduced 4 years ago.

Here's how standard Telecontrol works:

The operator of a punch press runs into trouble. He throws a switch on his machine, alerting the control room supervisor by a flashing red light and a buzzer. The supervisor summons the foreman by the plant public address system.

The foreman reports to the punch press. He either corrects the difficulty by himself; asks the control room supervisor for a repairman, die-setter, stock-chaser, or other support personnel by means of a plug-in telephone which he carries; reassigns the operator if the punch press will be out of commission for a lengthy period; or takes any other indicated step. Meanwhile, Telecontrol counts the downtime.

This system gets the punch press back into production faster than ever before.

Thus the status of not merely a single punch press but of 100 or more tools is constantly mirrored in the control room.

With Readout-Telecontrol the above information is almost instantly transcribed onto punched cards for processing as required.

Basically, Readout-Telecontrol consists of a switching cabinet that connects the sensor from any machine to any control panel; a monitor cabinet in which permanent records are made (with an inkless strip-chart recorder) of up to 40 key operations; from one to nine control cabinets; and a standard EAM summary punch. Accuracy controls prevent readout if a double punch or no punch appears in any of the 80 columns.

Each control cabinet has 15 control panels, which are of two different types. Master control panels monitor the operations of one or a group of machines. They are set

Group control panels permit "plugging" of individual operator and pay-rate information (which differs from that of the group standard) for up to six operators per shift. A master control panel must be used with one or more group panels so that the semi-fixed data for the group will be punched into the individual cards for members of the group during readout.

Each control cabinet includes a rotary switch for each control panel so that any machine in the plant can be automatically assigned to any of three pre-set time schedules. These three programs control periods when machine counters will operate and thus establish starting time, rest periods, lunch period and shift changes.

* * *

Heat Exchanger Scaling

A NOVEL, experimental cooling tower installation that ties electronic control to chemical research is operating at the chemical research laboratories of Hagan Chemicals & Controls, Inc., Pittsburgh, Pa.

The installation is designed to study heat exchanger scaling and corrosion, and biological treatments of cooling tower wood.

There are 3 separate systems in the installation. Each system is comprised of one cooling tower, 3 heat exchangers, recorders for temperature, conductivity, corrosion and pH; feed pumps for makeup and treatment chemicals and pH control; circulation pump,

corrosion measuring and safety devices.

All 3 systems are served by twin deionization units packaged into a single system. Each unit delivers 100 gal./hr of deionized water, and will operate for 8 hours during periods of high dissolved solids before regeneration is necessary. Twin units were included to provide for continuous deionization. Switching of the units from service to regeneration is automatic at predetermined conductivity settings. The use of a two-pen recorder on the deionization controller gives a continuous record of the effluent conductivity of the columns being regenerated.



Jones

THE STANDARD OF THE INDUSTRY FOR OVER 30 YEARS

QUICK-CLAMP* Barrier Terminal Strips engage conductors 50% faster than standard strips and terminals without costly wire terminals—no bending the wire about the screw! Operation is simplified to (1) inserting conductors and (2) tightening screws to make positive contact.

The flared opening of the Quick-Clamp readily accepts prepared wires. Each wire is held firmly by serrations in the clamp.

Two built-in stops prevent conductors from extending beyond the rear of the terminal.

Costly man-hours are more productive.

You secure more conductors, more reliably, in less space.

Quick-Clamp is available in the following series: 141, 142, 341, 342, 441, 541, 542, Y, ¾ W.

Quick-Clamp terminals in the 142, 342 and 542 series are designed to accommodate No. 8 to No. 16 gauge conductors. The 141, 341, 441 and 542 series are designed to accommodate No. 14 to No. 22 gauge conductors.

For additional information on this terminal strip, or any similar requirement, write or call our Chicago office or contact your local Cinch and Jones representative.

make reliable terminations 50% faster with

QUICK-CLAMP!

*PATENT PENDING

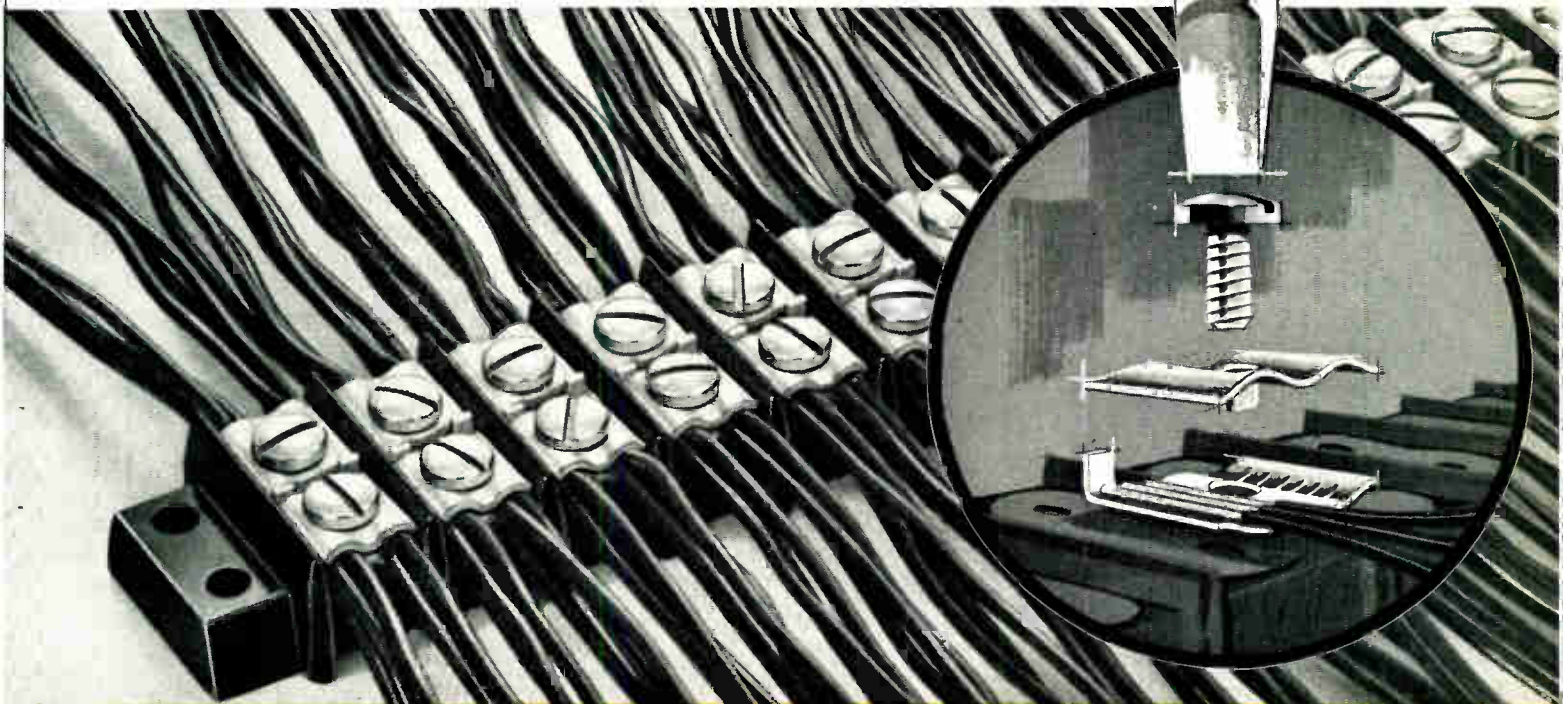

CINCH MANUFACTURING COMPANY

1026 South Homan Avenue, Chicago 24, Illinois
Plants located at Chicago, Illinois; Shelbyville, Indiana.
City of Industry, California; St. Louis, Missouri.

Circle 64 on Inquiry Card



A DIVISION OF UNITED-CARR FASTENER CORPORATION, BOSTON, MASSACHUSETTS

World Radio History

**New
Products**

... for the Electronic Industries

TEMPERATURE CONTROLLER

Model 312 responds to 0.2° temperature differentials.

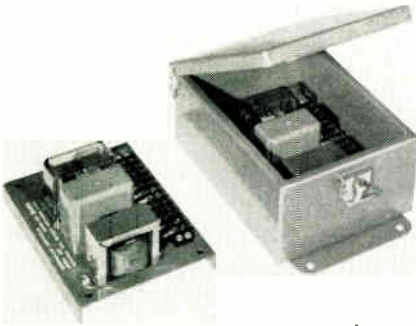

Application of this controller includes differential adjustment, time-proportioning temp. control, latching alarm and fail-safe circuitry. The set-point adjuster location and sensor location can be up to 1000 ft. apart. The input magnetic amplifier senses the balance of a temp. responsive dc Wheatstone Bridge and actuates a DPDT 5a. output relay. Model 312 operates directly from 115v, 60CPS, 3w. Acromag, Inc., 15360 Telegraph Rd., Detroit 39, Mich.

Circle 318 on Inquiry Card

TUNING FORK STANDARD

Features: stability, shock resistance, and low power consumption.



This 100KC tuning fork controlled freq. standard has freq. stability of 5 parts in 10⁷/mo. Use: secondary time or freq. standard for digital computers, radio transmitters and receivers, telemetry equipments and digital counters. Main feature: freq. stability over wide temp. ranges without heaters. Size: 2 x 2 7/16 x 3 1/2 in. Weight: approx. 18 oz. Supply voltages: 12 or 28v ±15%. Temp. range: -20° to +71°C. Accurate Instrument Co., P. O. Box 66373, Houston 6, Tex.

Circle 320 on Inquiry Card

SHAFT ENCODER

Resolution is 1 part in 8,192 for each revolution of input shaft.



This 13-bit Gray Code analog/digital shaft position encoder's readout accuracy of ±½ digit is maintained throughout life tests exceeding 2000 hrs. and 10 million revolutions. Model GSE 50-13 measures 5 in. in dia. by 1.75 in. axial length, weighs 18 oz., has a starting torque of 0.8 oz.-in. and a moment of inertia of 10.0 oz.-in.². Guidance Controls Corp., sub. of Warner Electric Brake & Clutch Co., Commercial St., Engineers Hill, Plainview, N. Y.

Circle 322 on Inquiry Card

WIRE WOUND RESISTORS

Miniature, bobbin-type units have molded coating resistant to moisture.

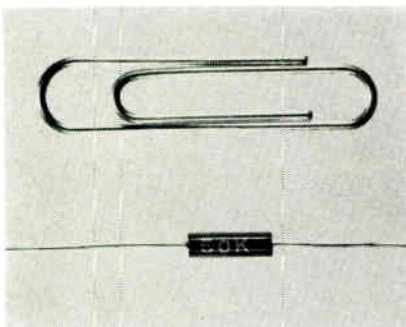

Designated as Type MWA, the new bobbin resistors are available in 2 physical sizes and power ratings: MWA-8, 1/10w, and MWA-10, (pictured) 1/8w. Operating temp. range is from -55° to 145°C. Max. working voltage of the MWA-8 is 27vdc or RMS; of the MWA-10, 37vdc or RMS. Resistance range is from 10Ω to 160KΩ, depending on type and tolerance. Tolerances: 0.5%, 1%. Temp. coefficient 20 PPM/°C. Axial leads are weldable and solderable. Dale Electronics, Inc., Columbus, Nebr.

Circle 319 on Inquiry Card

FUSE HOLDER

This low voltage indicating units isolates the load at fuse failure.

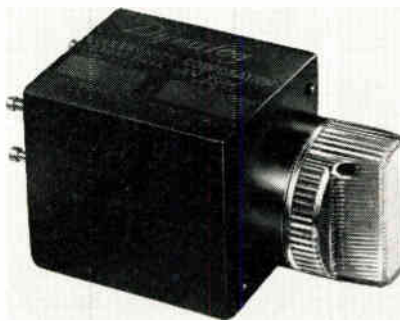

Model 2-10 Electronic Fuseholder is panel mounting. It indicates fuse failure without conducting lamp current to the fused circuits. The semiconductor circuitry is compactly molded into the fuseholder body. The fuseholder takes standard 1 1/4 x 1/4 cartridge fuses and is available in 3-11 or 11-30v ranges for positive or negative power supplies. External resistors can be connected to achieve optimum lamp brightness over each range. Dynalog Electronics Corp., 380 Great Neck Rd., N. Y.

Circle 321 on Inquiry Card

ELECTROLYTIC CAPACITORS

Type CRE ultra-miniature units used in bypass, filter and coupling.

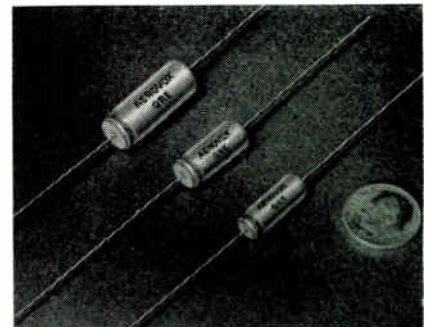

All internal connections are welded. Operating temp. range for computer and communication fields is: -40° to +85°C. Operating temp. range in personal radios, hearing aids, microphones, and wire receivers is: -30° to +85°C. Both types available in 7 sizes from 1/4 x 11/16 in. with voltage ratings of 1, 3, 5, 6, 10, 12, 15, 25, 50, 100 and 150vdc. Both types can be furnished with a tight-fitting plastic insulating sleeve if the application requires. Aerovox Corp., New Bedford Div., New Bedford, Mass.

Circle 323 on Inquiry Card

New Products

... for the Electronic Industries

PACKAGED CIRCUITS

Available in OR, AND, AND/OR, and various multiple gating circuits.

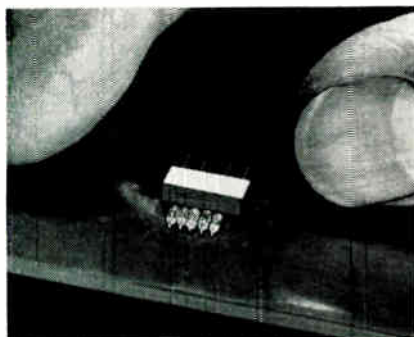

"Millipak" units use a milliminiature diode, $\frac{1}{8}$ th the volume of present "subminiature" diodes, and gives identical circuit performance. Mil-S-19500 specs. are exceeded. Custom units can be provided in most circuit configurations such as phase detectors, matched pairs and quads. The milliminiature diodes measure: 0.145 in. in length; 0.050 in. in dia.; and have a volume of 0.000284 cu. in. (Clevite Transistor Products, 241 Crescent St., Waltham 54, Mass.)

Circle 324 on Inquiry Card

RELAY

ML Series, telephone-type, has sensitivity of 20mw/movable arm.

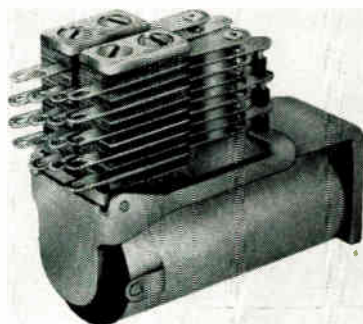

For use in transistorized computer networks, telephone systems and portable communications equipment where components are battery powered. Up to 18 springs (9/stack) for contact combinations up to 6 Form C, with single or bifurcated contact arms are available. Contact rating is 3a, 115vac resistive. Temp. range is -45° to $+85^{\circ}$ C. Hermetically sealed or dust cover enclosures available. Contact life is 100,000 operations min. at rated load. Potter & Brumfield, Princeton, Ind.

Circle 325 on Inquiry Card

SUBMINIATURE BLOWER

The VAX-1-DC, provides 8.5CFM of air at 0.5 in. H₂O back pressure.



This vaneaxial blower for dc operation is $1\frac{1}{2}$ in. dia. It will also give 11CFM free air. Designed for spot cooling where space or weight is limited. Standard units operate on 26vdc but special units available at lower voltage. Housing is black anodized aluminum with integral mounting ring for use with standard zero clamps. Life of 500 hrs. obtainable. Length is $1\frac{13}{16}$ in. max. and weight is 1.4 oz. Globe Industries, Inc., 1784 Stanley Ave., Dayton 4, Ohio.

Circle 326 on Inquiry Card

AUTOMATIC TAPE DECK

For broadcast automation, spot announcing, and data storage.

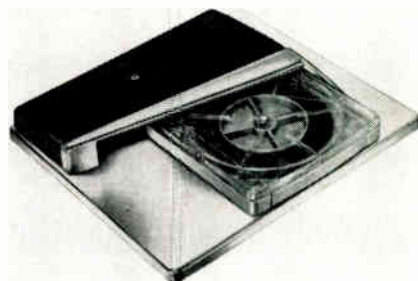

Fidelipac Automatic Deck works by: insert tape, it plays; remove it, it stops automatically. Maintenance: 3 drops of oil once every 3 mo. Features include: instantaneous stop and start; automatic cartridge lock; remote control operation; adaptable for rack mounting; 24 hr. performance; and heavy gauge steel construction. Multi-belt drive system gives $1\frac{1}{2}$ ips, $3\frac{3}{4}$ ips, and $7\frac{1}{4}$ ips operation. Conley Electronics Corp., 1527 Lyons St., Evanston, Ill.

Circle 328 on Inquiry Card

FREQUENCY STANDARD

Delivers 1 and 0.1MC output about 1v; source impedance is 50 Ω .

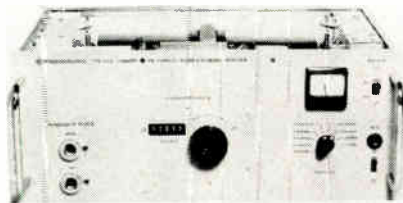

Freq. Standard Type XSC is fully transistorized and has proportional-action temp. controller. Freq. stability is 1 part in 10^{10} (24 hrs.). After 10 days, mean daily freq. drift less than 5 parts in 10^{10} . Incremental freq. tuning is possible, total amount being read directly in terms of parts in 10^{10} on a mechanical register. Ambient temp. fluctuations permissible between -10° to $+45^{\circ}$ C with built-in battery; -20° to $+50^{\circ}$ C without built-in battery. Rohde & Schwarz, 111 Lexington Ave., Passaic, N. J.

Circle 327 on Inquiry Card

POWER SUPPLIES

Line of 1 ϕ , de-to-sine wave units rated 50, 100, 150, 200 and 300w.

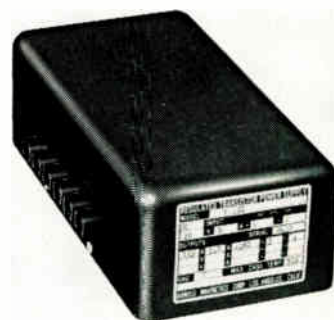

Circuitry is all solid-state. Designated series "K", these inverters drive ac motors, ac gyros and magnetic amplifiers from a 28vdc source. Standard output voltage is 115v RMS at 400cps. These power supplies are hermetically sealed and fully potted, to meet requirements of Mil-E-5272C, including heat, moisture and vibration. Size: from $2\frac{1}{2}$ x 4 x $2\frac{1}{2}$ in. feature self-protection against short-circuits, etc. Arnold Magnetics Corp., 6050 W. Jefferson Blvd., Los Angeles 16, Calif.

Circle 329 on Inquiry Card

New Products ... for the Electronic Industries

OHMMETER

Model 503 Milliohmmeter reads or records to $10\mu\Omega$.

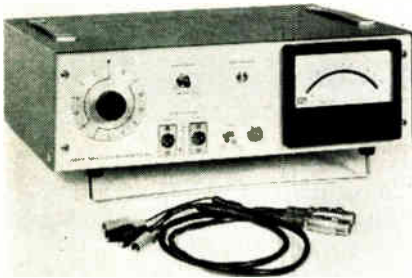

This line operated unit is direct reading, no balancing is required and exhibits no drift. Ranges from 0.001 to 1000 Ω full scale. Accurate to 1% full scale of meter reading and 0.5% full scale of output voltage. Max. power dissipating in sample is $10\mu\text{w}$. Uses: terminal and connector contact resistance determinations; resistivity of semiconductors; and resistance of welds. Keithley Instruments, 12415 Euclid Ave., Cleveland 6, Ohio.

Circle 330 on Inquiry Card

"C" CLAMPS

Plastic "C" Clamps are molded of high strength glass-filled nylon.

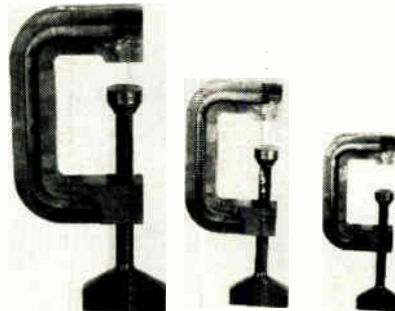

For use as laboratory and assembly line aids as they are non-conducting, will not affect magnetic fields, or rust. They can be used to hold parts for soldering or welding because they won't draw off heat. Clamps are lightweight, colorful and safe to work with. Made in 3 sizes: 2, 1 5/16 and 3/4 in. openings. Electronic Connectors Inc., Clamp Div., 84-45 Abingdon Rd., Kew Gardens 15, L. I., N. Y.

Circle 332 on Inquiry Card

DOUBLE-ENDED CONTACTS

Designed for relay, instrumentation, or switching assemblies.

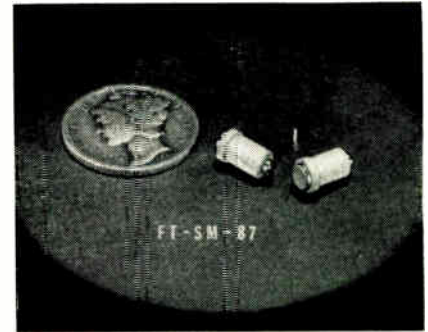

The double-ended contacts consist of a metal stud, silver-plated, or gold-plated, terminating in an appropriate configuration at each end to meet specific electrical and mechanical requirements. The metal stud is seated in a Teflon body of the "Press-Fit" design. The FT-SM-87 contact configurations may be dome, flat, cone, or truncated spherical. Sealelectro Corp., 139 Hoyt St., Mamaroneck, N. Y.

Circle 334 on Inquiry Card

LATCHING RELAY

Contact lead life is a min. 1 million operations at 1a, 28vdc.

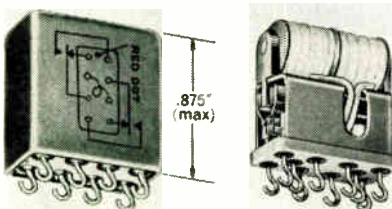

Type LF subminiature magnetic latching relay available in 2 forms: the LF2000, 2-coil giving control of the latching operation within the relay itself; and the LF1000, 1-coil, for use with existing circuits where outside control is present. Two-coil LF models sensitive to 150mw/coil with an operating time of 5msec. at 25°C. Single-coil LF models sensitive to 75mw with an operate time of 8msec. at 25°C. Type LF rated from -65° to +125°C. C. P. Clare & Co., 3101 Pratt Blvd., Chicago 45, Ill.

Circle 331 on Inquiry Card

DIODES

These diffused junction mesa diodes have a recovery time of 0.5nsec.

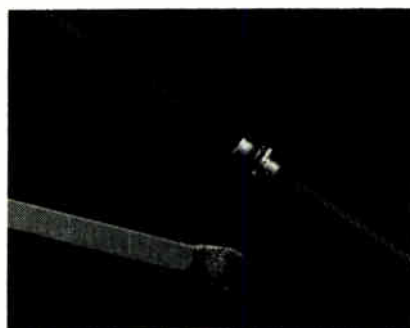

Types MS 2540 and MS 2541 have a hermetically sealed ceramic and metal package for operation to 200°C. Forward voltage drop at 20ma is 1.4v and 1.0v respectively. Max. zero bias capacitance is 1pf and 2pf respectively. Min. breakdown voltages from both is 6v with max. current at breakdown of 0.1 μa and 1.0 μa respectively. Max. power dissipation is 150mw and 250mw respectively. Max. forward current for both is 150ma. Micro State Electronics Corp., 152 Floral Ave., Murray Hill, N. J.

Circle 333 on Inquiry Card

CHOPPER

Model 10 Microchopper has a temp. range from -55° to +150°C.



Solidly encapsulated, it will connect and disconnect a load from a signal source. Linear switching or chopping of voltages can be accomplished over a wide dynamic range, down to a fraction of a millivolt and up to $\pm 20\text{v}$. This unit is an inertialess device that can be driven from dc to 100kc. Uses include low level voltage measurements, dc amplifier stabilization, high speed servo-mechanisms, and thermocouple instrumentation. Solid State Electronics Co., 15321 Royen St., Sepulveda, Calif.

Circle 335 on Inquiry Card

30

SECOND synchros & resolvers in BuOrd size 23 configuration

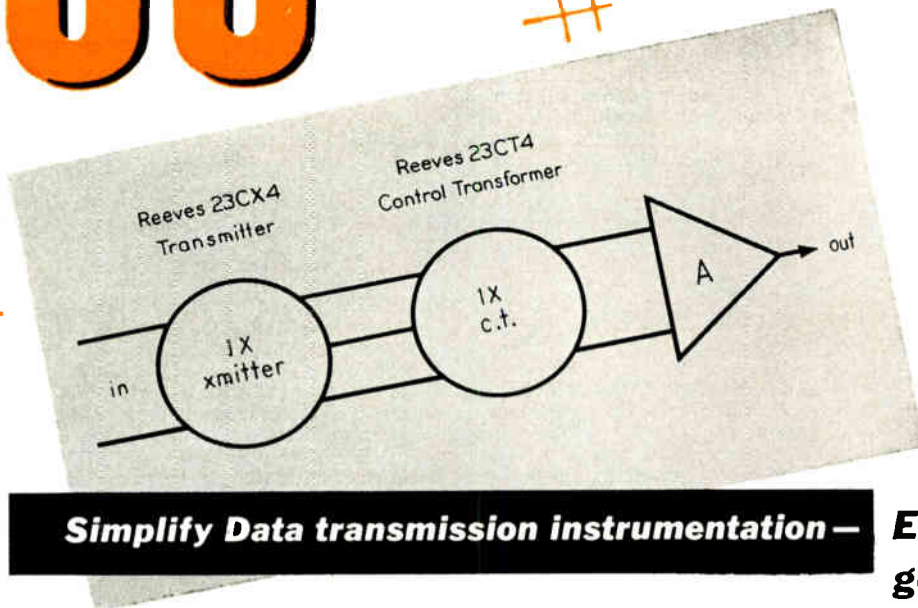

Simplify Data transmission instrumentation —

**Eliminate
gear boxes
component duplication
crossover network**



DESIGN FEATURES

- 30 second accuracy on production runs
- 20 second accuracy units available on special order
- Stainless steel housings
- High thermal stability
- Compensated and uncompensated resolver models
- Conform to MIL-S20708A requirements

Reeves high precision size 23 synchros and resolvers represent a major design breakthrough. Their extreme accuracy enables the design engineer to develop data transmission systems with a greatly reduced number of components for an equivalent over-all system accuracy.

Compare the circuit diagram shown above with conventional instrumentation for a basic data transmission system. Two synchros, two gear boxes, and the crossover network have been eliminated. Weight and space have been reduced by a factor greater than 2, and the system accuracy will directly reflect the superior synchro accuracies. Reliability is improved immeasurably and field maintenance reduced to a minimum.

The new Reeves Synchros are the only 30-second accuracy instruments currently available in BuOrd size 23. The series includes both transmitters and control transformers, available for either 60 or 400 cycle input. Write for Data File 304.



REEVES INSTRUMENT CORPORATION
A Subsidiary of Dynamics Corporation of America
Roosevelt Field, Garden City, N.Y.

New Tech Data

for Engineers

Power Supplies

Complete data and selection guide for a line of modular power supplies designed for microwave tubes is available from Micro-Power, Inc., 20-21 Steinway St., L. I. C. 5, N. Y. This data is presented in an 8-page catalog covering BWO's, voltage tunable magnetrons, Klystrons, and TWT amplifiers.

Circle 250 on Inquiry Card

Microwave Test Equipment

This catalog of microwave test equipment contains information on over 1000 standard precision instruments of a test equipment product line covering from 2.6 to 90.0Gc. Information is included on noise tube power units, attenuators, phase shifters, crystal mounts, elbows, transitions, terminations, tees, freq. meters, waveguide stands, directional couplers and accessories. Included are a number of engineering reports on noise measurements, attenuators, directional couplers and filters. Waveline Inc., Caldwell, N. J.

Circle 251 on Inquiry Card

Counter/Timers

Tech data is available on a line of 100MC solid state instruments for direct counting time interval and/or freq. measurements. The instruments which feature better than 10⁹ second resolution are Model 1060 Counter Timer, Model 1055 Pre-Time Interval Meter, Model 1050 Gated Counter, Model 1045 Gated Pre-Scaler, Model S-99 and S-88 Decimal Counting Units, and Model 1040 Pre-Scaler. Eldorado Electronics, 2821 10th St., Berkeley 10, Calif.

Circle 252 on Inquiry Card

Production Stations

The C-600 series of human-factor-ed, production stations, is described in an illustrated 4-page brochure available from the Applied Communication Systems Div. of Litton Systems, 18107 Sherman Way, Reseda, Calif.

Circle 253 on Inquiry Card

Electron Tube Guide

Calvert Electronics, Inc., 220 E. 23rd St., New York, is offering a 230 page reference and interchangeability guide of electronic tubes. The book is indexed in numerical-alphabetical order with more than 10,000 types shown. Also indicated are current armed forces service designations, types that are interchangeable, and descriptions and uses of each tube. Included is reference data on radio, TV, transmitters, klystrons, magnetrons, CRT's, and communication tubes. The guide normally \$2.75 will be supplied free of charge to qualified engineers requesting the manual on company letter head.

Toroidal Transformers

Tech data is available from the Polyphase Instrument Co., Bridgeport, Pa., on a series of toroidal power output transformers available for use with a pair of saturation driven transistors and a PIC, PF series, power filter. Standard units are rated 15, 30, 60, 125, 250, 500, and 1000w. Bulletin #77F.

Circle 255 on Inquiry Card

Transistor Guide

Tung-Sol Electric Inc., 1 Summer Ave., Newark 4, N. J., is offering a Quick Reference Guide (Form T-481) containing reference information on 5 lines of transistors. The guide covers high power types, power types, medium power audio and low speed computer types, medium power r-f and computer types, and the Dynaquad line.

Circle 256 on Inquiry Card

Crystal Standards

In primary standards, this glass mounted, optically polished, gold-plated fifth overtone quartz crystal, at 2.5MC, provides a stability of 1 part in 10⁹ with aging of only 5 parts in 10⁹. Bulletin 528 described Bliley type BG11AH-5 which has an average Q of 4.5 million. Bliley Electric Co., Union Station Bldg., Erie, Pa.

Circle 257 on Inquiry Card

Phase Measurement

Tech data is available entitled "How to Measure Phase at High Frequencies." Phase delay is compared with a continuously variable delay standard, using instruments that operate up to 2,000 MC with an accuracy of 0.1° or 1%. Ad-Yu Electronics Lab., Inc., 249 Terhune Ave., Passaic, N. J.

Circle 258 on Inquiry Card

Microwave Components

Lectronic Research Lab., 715-19 Arch St., Philadelphia 6, Pa., is offering Bulletin "73" describing microwave components and equipment, electronic test equipment, power supplies and components designed for industry, research, broadcasting and educational institutions.

Circle 259 on Inquiry Card

Surface Finish Control

A new 16-page, 3-color, illustrated booklet entitled "Precise Surface Finish Control" is available from Brush Instruments, Div. of Clevite Corp., 37th and Perkins, Cleveland 14, Ohio. Booklet PG-10 explains the significance of surface finish and describes surface characteristics as recognized by ASA standards. It also illustrates the use of Brush Surfindicators to accurately measure and control surface parameters.

Circle 260 on Inquiry Card

Power Systems

Tech. data is available from Kearfott Div., General Precision, Inc., Little Falls, N. J., on Precise Variable-Freq. Power Systems. The systems are designed for use with 440v, 3 ϕ , 60cps input power, and supply 5kva, 3 ϕ , 380 to 420cps, 120/208v, 1.0 P.F. power output.

Circle 261 on Inquiry Card

Servo Amplifiers

Diehl Mfg. Co., Small Motors Div., Finnerne Plant, Somerville, N. J., is offering tech data on its line of transistor servo amplifiers and associated solid state power supplies. Six, twenty-five and thirty-five watt models, designed to drive 60 and 400cps servomotors with 36v center-tapped control windings are described.

Circle 262 on Inquiry Card

Transformer Winder

Tech data is available from the Geo. Stevens Mfg., Inc., Pulaski Rd. at Peterson, Chicago 46, Ill., illustrating and describing Model 910 heavy duty foil and core transformer winder which finish winds, without pounding, aluminum or copper foil and silicon steel cores up to 0.075 in. and Model T-910 tensioning platform.

Circle 263 on Inquiry Card

Harmonic Filter

Caswell Electronics Corp., 414 Queens Lane, San Jose 12, Calif., is offering tech data on the first of a series of harmonic filters, designed to be used from 5.925 to 6.425Gc and giving a min. of 40db attenuation of the 2nd harmonic.

Circle 264 on Inquiry Card

Decimal Counters

Bowmar Instrument Corp., 8000 Bluffton Rd., Fort Wayne, Ind., is offering a 4 page combination tech bulletin and descriptive brochure on "Series LC" modular type decimal counters. General, as well as, detailed information is contained on 3, 4 and 5 drum counters.

Circle 265 on Inquiry Card

Measurements Facilities

Facilities and capabilities in the field of precision force and temperature measuring are described in detail in a new 24-page, 2-color booklet, available from the Electronics Div. of Baldwin-Lima-Hamilton Corp., 42 Fourth Ave., Waltham, Mass. The booklet furnishes background on the division and lists and describes the basic types of devices and equipment produced by the division. These include the SR-4 strain gages, BLH transducers—load cells, pressure cells, torque pickups — and an extensive line of strain gage and transducer instrumentation.

Circle 266 on Inquiry Card

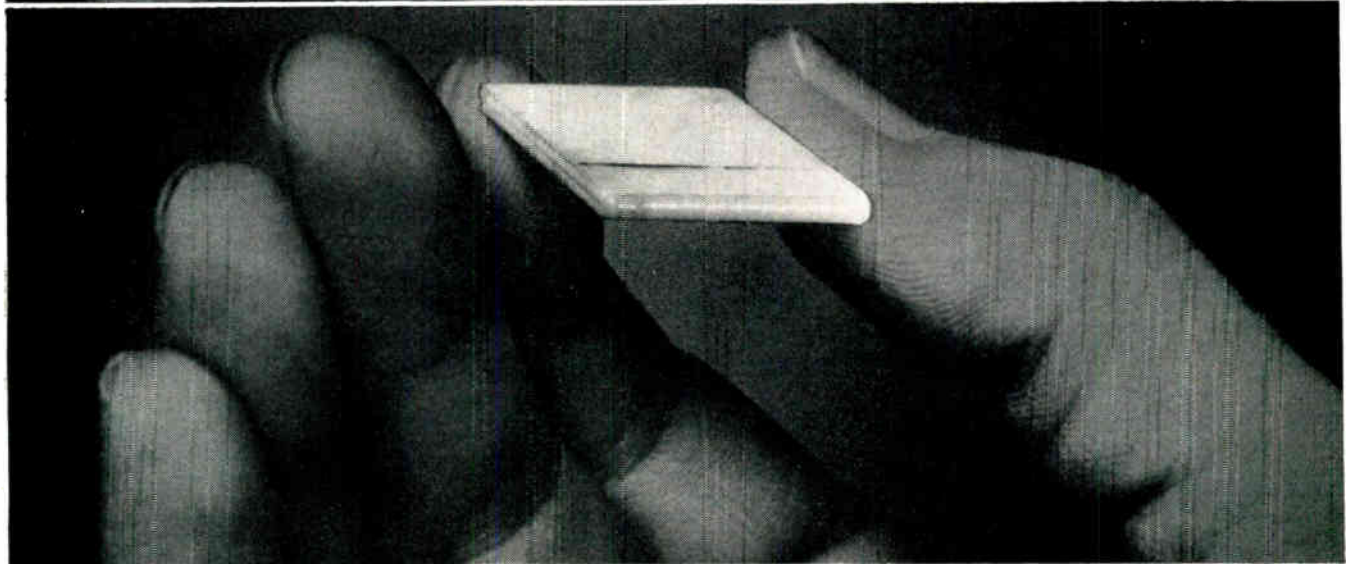
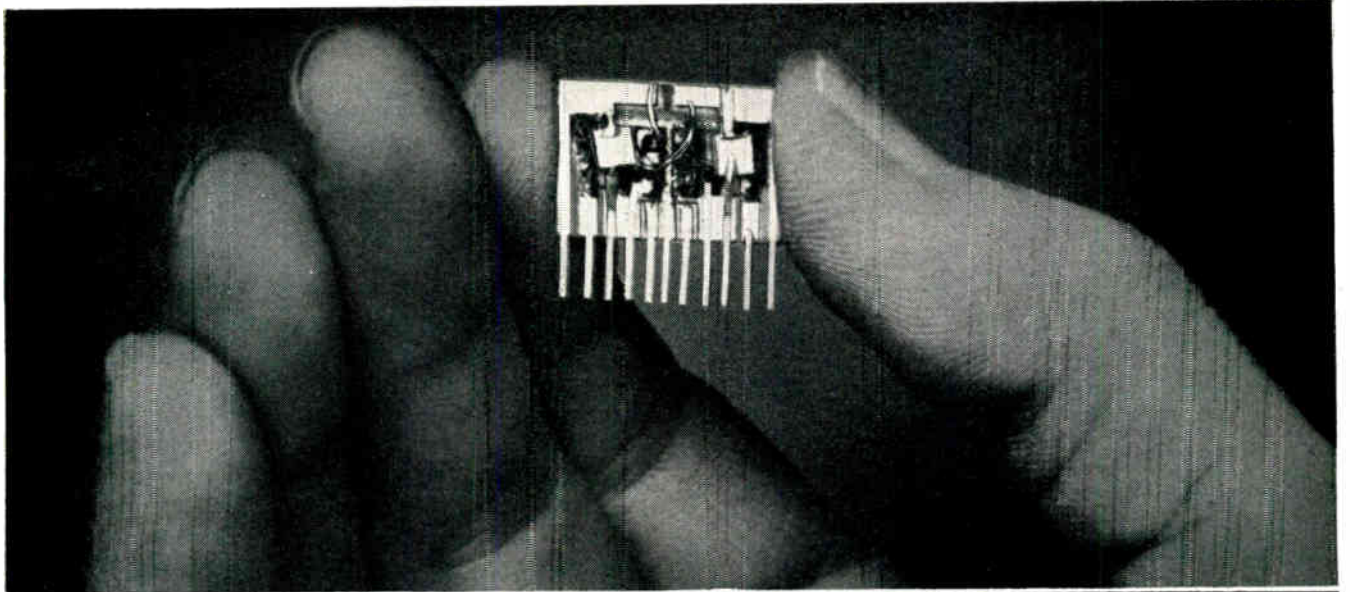

Micro-electronic welds to nickel-plated ceramic substrate (top) and two edge-welded aluminum oxide ceramic wafers (bottom) show versatility of Hamilton-Zeiss Welders.

ELECTRON BEAM WELDING . . . a new world of design at your fingertips

Hamilton-Zeiss Electron Beam Welders produce ultra-precise microminiature welds which set new standards of connection reliability. They also permit fabrication with difficult-to-join materials such as ceramics, refractories, and titanium. The Hamilton-Zeiss process allows designers of micro-electronic circuits and components to achieve optimum packaging density, reduced weight, and increased reliability.

The three exclusive Hamilton-Zeiss features which make these advantages possible are:

- Small beam diameter with high power density (37½ million watts per square inch).

- Optical viewing system which shows exact position of the beam on the workpiece at all times (40 mag.).
- Precise, repeatable control of beam energy, position, and penetration.

The process also permits component encapsulation and contamination-free joints of high structural integrity because the work is performed in a vacuum.

For full technical data on Hamilton-Zeiss Electron Beam Welder, write or wire: Electron Beam Systems, Hamilton Standard Division, United Aircraft Corporation, Windsor Locks, Connecticut.

Hamilton Standard DIVISION OF UNITED AIRCRAFT CORPORATION

**U
A**

New Tech Data

for Engineers

Microwave Testers

Over 45 pages of valuable information for engineers working in microwave are included in this 112 page catalog, entitled "Sperry Microline Test Instruments." The catalog also includes texts on microwave measurement techniques, "Tables of Constants for Rectangular Waveguides," and other data. Seven separate sections deal with freq. meters, slotted lines, tuners, directional couplers, attenuators, the Klystron Cooler, SWR indicator and microwave receivers. Sperry Microwave Electronics Co., Div. of Sperry Rand Corp., Dept. 121, Clearwater, Fla.

Circle 267 on Inquiry Card

Smith Chart

In Bulletin #1, from Kay Electric Co., 14 Maple Ave., Pine Brook, N. J., discusses various waveguide types to which the Smith Chart is applicable, and reviews elementary physical concepts of waveguide propagation. Bulletin #2 contains information on 2 fundamental waveguide constants, the "characteristic impedance" and the "propagation constant." Constants will be discussed in terms of traveling voltage and current waves, as well as in terms of primary circuit elements.

Circle 268 on Inquiry Card

Servo Instruments

North Atlantic Industries, Inc., Terminal Drive, Plainview, L. I., N. Y., is offering a general type brochure on their servo indicators, repeaters and data converters. Featured is a ready reference chart on the significant electrical and physical characteristics of 8 servo instruments.

Circle 269 on Inquiry Card

Plastic Capabilities

Chromerics, Inc., 341 Vassar St., Cambridge 39, Mass., is offering a brochure describing their capabilities in the field of plastic systems designed for electrical uses. Information includes data on packaging systems for potting, dipping, casting impregnating or encapsulating; coating systems for insulating or sealing; adhesive systems for bonding plastics, metals and wood; conductive systems for inks, adhesives, solders, etc.; surface chemicals and consultation and test facilities.

Circle 270 on Inquiry Card

Infrared Generator

Model 501 Infrared Signal Generator provides a tunable infrared source of variable wave-length from 1 to 14 microns and calibrated power to 10mw. Highly stable square wave modulation is available from 2 to 2600cps and a synchronous reference signal is provided for low level integrating measurements. Telewave Laboratories, Inc., 43-20 34th St., L.I.C. 1, N. Y.

Circle 271 on Inquiry Card

Cooling Fans

An 8-page catalog contains condensed specs. on Rotron fans. It includes information on vane-axial, tube-axial, and propeller types, in addition to a cooling package with filter for mounting in standard relay racks. Also described is the Rotron Gold Seal Muffin Fan and the Rotron airflow interlock switch. Rotron Mfg. Co., Inc., Woodstock, N. Y.

Circle 272 on Inquiry Card

High Vacuum Equipment

"High Vacuum Equipment for Thin-Film Deposition" Bulletin 2-2, 27 pages, 2 colors, is available from Consolidated Vacuum Corp., 1775 Mt. Read Blvd., Rochester 3, N. Y. Information included covers types of thin-films and 5 different standard systems for thin-film deposition. Also included are unit specs. and information on special and modified systems. Characteristics charts, technical tables, and photographs throughout.

Circle 273 on Inquiry Card

Crystal Grower

Model 2804 Crystal Growing Furnace will "pull" silicon, germanium and other material up to 1½ in. in dia., up to 16 in. in length by the "Czochralski growing method." It operates with either inert gas or under vacuum. NRC Equipment Corp., 160 Charlemont St., Newton 61, Mass.

Circle 274 on Inquiry Card

Resistance Welder

Precision Resistance "Spot" Welder features: 27 controlled weld heat positions; high power in small space—max. power input of 17.6kw over a period of 1/60 sec.; universal electrode holders; and automatic or manual firing. Stewart Engineering Corp., Santa Cruz, Calif.

Circle 275 on Inquiry Card

Magnetostriction

Spectran Electronics Corp., 146 Main St., Maynard, Mass., is offering a 6-page, 3-color brochure describing their facilities and capabilities in the field of magnetostriction devices. Photographs and short descriptions cover their staff and their line of magnetostriction rod filter, delay lines and multiple-filter spectrum analyzers.

Circle 276 on Inquiry Card

Pulse Generator

A tech bulletin describing the Model 1300A Programmed Current Pulse Generator is available from Rese Engineering Inc., A. & Courtland Sts., Phila. 20, Pa. Bulletin #62-B contains information on a high speed multiple output pulse generator, providing programmed, high amplitude current or voltage pulses with rise times of 50 nsec.

Circle 277 on Inquiry Card

Maser Bibliography

Bibliography of maser and laser references is now available from Trion Instruments, Inc., 1200 N. Main St., Ann Arbor, Mich. It lists 117 references of technical and semi-technical nature. Listed are articles on maser and laser systems, materials effects, phenomena and potentialities.

Circle 278 on Inquiry Card

Sub-miniature Relays

An illustrated 4-page bulletin containing full performance data on the BR-12 sub-miniature precision relay series, is available from Babcock Relays, Div. of Babcock Electronics Corp., 1645 Babcock Ave., Costa Mesa, Calif. Sensitivity ranges from 25 to 250mw, 5a contacts rated at 3a for 100,000 operations at 125°C to Mil-R-5757D.

Circle 279 on Inquiry Card

Infrared Capabilities

Servo Corp. of America, 111 New South Rd., Hicksville, L. I., N. Y., is offering an 8-page brochure giving a comprehensive picture of their abilities in the infrared area. Information on how Servo Corp. makes its own infrared glass, stages in bolometer production, and details on development of complex optics and optical systems is included.

Circle 280 on Inquiry Card

Plug Catalog

Catalog LS-7 describes the Cannon series of laboratory and switchboard plugs. These plugs provide quick disconnect switching and patching operations for switchboards, terminal boards, and panel boards. Cannon Electric Co., 3208 Humboldt St., Los Angeles 31, Calif.

Circle 281 on Inquiry Card

Deviation Ohmmeter

NLS D024 Digital Deviation Ohmmeter measures % deviation of resistance from -99.99% to +99.99%, in steps of 00.01%. Its resistance range is normally from 100 to 1 megohm. The standard resistance source in the instrument is a 6 decade unit variable in 1Ω steps up to 1.2 megs, accuracy is ±0.005% initially and ±0.03% long term. Non-Linear Systems, Inc., Del Mar, Calif.

Circle 282 on Inquiry Card

Conductivity Instruments

Several types of portable conductivity instruments, to be used by marine scientists and oceanographers, for field measurements of natural waters ranging from low solids stream water to sea water are described in tech. data available from Industrial Instrument, Inc., 89 Commerce Rd., Cedar Grove, N. J.

Circle 283 on Inquiry Card



SOLID STATE

IN

Electronics

Men of vision thrive here. And it takes men of vision to cope with today's electronics and space problems. Space in more ways than just up. Space problems of a different nature plague the manufacturer who must expand, but hasn't the land to expand on.

Here in Florida we have the space, the climate, the work force. Florida has more to offer electronics firms than any other area on earth. Men think better where life is pleasant, where off hours can be devoted to just plain *living*—and to just plain *thinking*.

Yes, Florida is a Solid State in Electronics. Already the sun, Mother of Life, shines on over sixty thriving electronics firms in our busy state.

Cape Canaveral is here, too, with its massive, awesome missiles blasting off to make space history. Electronics makes possible every thrust into the universe. Every hope of getting to the moon depends upon electronics—and the first American to the moon will definitely soar to history from Florida.

Engineers and their families dream of living here in Florida. Give them this dream by moving your plant here. Nurture the brains that will give your business a greater and greater stature in this, the Electronics Age.

For complete details of the many advantages Florida offers the Electronics Industry, write us. Let us tell you why some of the greatest names in electronics have impressive plants here in Florida.

FLORIDA'S ASSURANCE POLICY

"You have my personal assurance of a sunny business climate here in Florida. You have positive assurance of every aid and assistance possible from our Florida Development Commission and from the overwhelming majority of our businessmen, industrialists, and financiers. We have everything to make your large or small enterprise healthy and successful. Write, wire or phone us today. The only thing better than a FLORIDA vacation is having your plant here."

Lawrence Bryant
Governor, State of Florida



Investigate

Florida

...A 10 BILLION DOLLAR MARKET



Ask about free film "Profile of Progress."

Mr. Wendell Jarrard, Chairman
Florida Development Commission
Box 4121E
Tallahassee, Florida

Please send me the facts about Florida's labor, climate, schools, natural resources, taxes, etc.

Name.....
Firm Name.....
Address.....
City..... Zone..... State.....

FLORIDA FOR CONVENTIONS — Write for free information on Florida's wonderful facilities for your group meeting.

New Tech Data

for Engineers

Thermocouple Probes

Aero Research Instrument Co., 315 N. Aberdeen St., Chicago 7, Ill., is offering bulletin 3.13, describing a series of high accuracy thermocouple probes designed to measure the temp. of gasses (2000°F) or less at low and high velocities.

Circle 284 on Inquiry Card

Packaging

An Engineering Report on Poly-Bond, a packaging protection, including information on load bearing characteristics, "G" values, and cube savings is available from Delvaltex Corp., 34 Parker Ave., Box 1776, Trenton 9, N. J. PolyBond is a density controlled bonded urethane.

Circle 285 on Inquiry Card

Precision Wire

Kentucky Electronics, Inc., 2208 W. 2nd St., Owensboro, Ky., is offering a brochure describing their capabilities and facilities in the production and manufacturing of small wire and ribbon formed parts, and cut and beaded tubing. Round wire formed parts—lengths to 8 in., dia. from 0.0005 to 0.050; and tubing parts—lengths to 4 in. dia. to 0.090, wall thicknesses to 0.015.

Circle 286 on Inquiry Card

Voltage Standards

Jackson Electronic Div. of Bellows-Valvair, 695 Johnston St., Akron, Ohio, is offering Bulletin VS-24, describing its line of compact, rugged Voltaloc high stability solid state reference voltage standards. TC Series units have integral heaters and thermostats which maintain the device at a constant 60°C giving an overall accuracy better than 10 parts per million.

Circle 287 on Inquiry Card

Cable Brochure

Fourteen page brochure gives complete information on a recently developed $\frac{1}{8}$ in. O.D., 5,000v cable. Included are the ASTM Standard Specs., tests, tables relating to this type PFTX-5,000-20. The cable with high corona threshold is for use where temps. range from -80 to +200°C. Boston Insulated Wire & Cable Co., Bay St., Boston 25, Mass.

Circle 288 on Inquiry Card

Ratio Bridge

Two-color, 4-page, brochure offers tech data on an automatic complex ratio bridge with in-phase ratio accuracies greater than 0.005% of range.

Included are operating principles, complete specs, and a block diagram. Operating freq is 400, 800 or 1000cps. Gertsch Products, Inc., 3211 S. La Cienega Blvd., Los Angeles 16, Calif.

Circle 289 on Inquiry Card

Electron Guns

Catalog #775.0 contains specs. and prices of electron guns for welding, melting or vaporizing of tungsten and other refractory metals. Both internal and external guns with or without water cooling are listed together with accessories. Brad Thompson Industries, Inc., 83-810 Tamarisk St., Indio, Calif.

Circle 290 on Inquiry Card

Zener Diode Chart

Dickson Electronics Corp., 248 S. Wells Fargo Ave., Scottsdale, Ariz., is offering their new 14-page Zener Diode Reference Chart. The chart lists specs., package dimensions and other pertinent information for all zener diodes types presently registered under EIA numbers. It also includes an interchangeability section covering 400mw, 1w, 10w, and 50w zener diode ratings. Chart will be sent to engineers and purchasing personnel who write for a copy on company letterhead.

Hardware Brochure

This 8-page, 2-color brochure on standard and custom panel and chassis hardware for commercial and military OEM markets is available from Concord Electronics Corp., 37 Great Jones St., N. Y. 12, N. Y. Included are applicable Mil. specs. covering materials and finishes on round, oval and offset handles, ferrules, captive screws, bushings, thumb screws, clear, threaded, round and hex spacers and stand-offs, shaft and dial locks, and coupling and brackets.

Circle 292 on Inquiry Card

Gear Capabilities

Florida Gears & Systems, Inc., 16550 N. W. 10th Ave., P. O. Box 64-800, Miami 64, Fla., is offering a 12-page, 3-color brochure describing their facilities and capabilities in the field of precision gears, housings, gear reducers and gear assemblies.

Circle 293 on Inquiry Card

Timing Modules

Hi-G, Inc., 20 Bradley Field, Windsor Locks, Conn., is offering a 40-page, 2 color, catalog #861, which features their standard line of balanced armature relays, solid state timing modules, fixed delay and adjustable delay electronic time-delay relays, voltage sensors, and a special customer-designed line of electronic packages or assemblies. All items are presented with complete electrical and environmental specs., electrical diagrams and drawings of header and enclosure styles available.

Circle 294 on Inquiry Card

Silicon Rectifiers

Tarzian Series 1 Rectifiers include 3 basic voltage ratings with special voltages available on request. This series of low current silicon rectifiers is designed for use in printed circuit boards or special sockets. Bulletin 61-LC 10. Sarkes Tarzian, Inc., 415 North College, Bloomington, Ind.

Circle 295 on Inquiry Card

Voltmeter

Electronic Voltmeter, Model 300H, features: 30 μ v to 300v; freq. range from 10cps to 1mc; accuracy—10cps to 700kc, 2%, 700kc to 1mc, 3%; and input impedance—2 megs. shunted by 15pf, except 25pf on the most sensitive range. Ballantine Laboratories, Boonton, N. J.

Circle 296 on Inquiry Card

Power Tetrode Modules

A series of high-power tetrode modules which can be furnished as individual units or designed into a complete Microdot transmitter are described in bulletin PTM-1. These units can be used as power amplifiers or freq. multipliers. Microdot Inc., 220 Pasadena Ave., South Pasadena, Cal.

Circle 297 on Inquiry Card

Clean Room Equipment

Tech data is available from Sonic-Air Products Inc., 1246 Birchwood Drive, Sunnyvale, Calif., on their Briggs recirculating system for clean rooms. Information, on Model A a recirculating pressurized ultra-clean cabinet and Model B an efficient pressurized cabinet, contains outline drawings, photographs, layout drawings specs. and descriptions.

Circle 298 on Inquiry Card

Laminates

This 18-page catalog, TCDL-536, describes the complete line of Textolite® industrial sheets, rods, tubes and copper-clad laminates. Complete specs. are contained in an easy-to-use chart. General Electric Co., Laminated Products Dept., Coshocton, Ohio.

Circle 299 on Inquiry Card

Printed Circuits

Products for makers of printed circuits are described in tech. data available from Shipley Co. Inc., Walnut Park, Wellesley 81, Mass. Products include Copper Deposition for thru-hole plated circuits; LT-26 tin immersion to improve solderability; Stripper 77 for removing photo resist; Scrub Cleaner #1 for abrasive cleaning of copper; Neutra-Late for removing chromic acid residues, and Adhesive 200TF for making additive circuits.

Circle 300 on Inquiry Card

Wanted:

LINGUIST

with language fluency in MARTIAN, VENUTIAN, SATURNIAN

Job opportunity: as one of the nation's leading manufacturers of switches, read-outs, indicator lights and other control panel components, we must prepare for future application of our products to interplanetary vehicles. Here is a challenging opportunity for a multi-lingual human-factors expert to begin development of a set of control panel symbols and legends understandable to astronauts of all worlds.

For information on present product line, write:

CONTROLS COMPANY OF AMERICA
CONTROL SWITCH DIVISION
1420 Delmar Drive, Folcroft, Pennsylvania

Manufacturers of the ElectroSnap and Hetherington full line of switches, controls and indicators for all military and commercial applications. All standard units stocked for immediate delivery by leading parts Distributors.



15 NEW TYPES FROM BENDIX



MEDIUM POWER TRANSISTORS

The new, wider line of Bendix® Medium Power Transistors offers more advantages for audio frequency and switching applications, such as audio amplifiers, audio oscillators, power switches, servo controls, relay drivers. Among these many advantages: more linear current gain characteristics and lower distortion output, high voltage rating, high current gain, low saturation resistance, long life, and stable operation. Bendix Medium Power Transistors offer a maximum of reliability and versatility at low cost. Each transistor is 'Dynamically Tested,' an exclusive Bendix quality control process to assure uniformity and maximum reliability. For data on the complete line of Bendix Power Transistors and Power Rectifiers, write us in Holmdel, N. J.

Type Number	MAXIMUM RATINGS				CURRENT GAIN	
	V _{CES} Vdc	I _C mAdc	P _C mW	T _J °C	h _{FE} @	I _C mAdc
2N331	30	200	200	100	20	5
2N398,A	105	200	500	100	20	5
2N464-2N467	15-40	100	150	100	14-90	1
2N650-52,A	45	500	200	100	30&45&80	10
2N1008,A,B*	20-60	300	400	100	40-150	10
2N1009	40	300	400	100	40-150	10
2N1176,A,B	15-60	300	300	100	20	10
2N1287,A	35	300	300	100	40&60	10

*2N1008B also available per MIL-S-19500/196 (SigC)

Bendix Semiconductor Division



Main Office: South St., Holmdel, N.J.—Ph: SH 7-5480 • New England Office: 114 Waltham, Lexington, Mass.—Ph: VO 2-7650 • Detroit Office: 12950 W. 8 Mile Rd., Detroit 37, Mich.—Ph: JO 6-1420 • Midwest Office: 1915 N. Harlem Ave., Chicago, Ill.—Ph: 637-6929 • West Coast Office: 117 E. Providencia Ave., Burbank, Calif.—Ph: VI 9-3961 • Canadian Affiliate: Computing Devices of Canada, Ltd., P.O. Box 508, Ottawa 4, Ont. • Export Office: Bendix International, 205 E. 42nd Street, New York 17, N.Y. Stocking Distributors: Contact nearest sales office for name of local distributor.



**SEMICONDUCTORS NOW
AVAILABLE FROM
DISTRIBUTOR STOCK IN
QUANTITIES UP TO**

999

FACTORY PRICES APPLY!

- ATLANTA, GA.**
Ack Radio Supply Co.
331 Luckie St., N.W.—JA 4-8477
- BALTIMORE, MD.**
Electronic Wholesalers
3004 Wilkens Ave. So.—WI 5-3400
- BIRMINGHAM, ALA.**
Ack Semiconductors, Inc.
3101 Fourth Ave.—FA 2-0588
- BOSTON, MASS.**
(See Newton, Mass.)
- BUFFALO, N. Y.**
Summit Distributors
916 Main St.—TT 4-3450
- CHICAGO, ILL.**
Newark Electronics
223 W. Madison St.—ST 2-2944
- DALLAS, TEXAS**
Lawrence Electronic Co.
3422 Cridelle Ave.—FL 7-7679
- DENVER, COLORADO**
Denver Electronic Supply Corp.
2170 South Grape St.—SK 7-3351
- DETROIT, MICH.**
Rissi Electronic Supply
14405 Wyoming Ave.—TE 4-8420
- GLENDALE, CALIF.**
R. V. Weatherford Co.
6921 San Fernando Rd.—VI 9-2471
- HAMDEN, CONN.**
Cramer Electronics
60 Connolly Pkwy.—AT 8-3581
- INDIANAPOLIS, IND.**
Graham Electronics
122 S. Senate Ave.—ME 4-8486
- LOS ANGELES, CALIF.**
Radio Product Sales
1501 S. Hill St.—RI 8-1271
- MELBOURNE, FLA.**
Electronic Wholesalers
1301 Hibiscus Blvd.—PA 3-1441
- MIAMI, FLA.**
Electronic Wholesalers
930-90 27th Ave. N.W.—OX 6-1620
- MINNEAPOLIS, MINN.**
Stark Electronics Supply
112 Third Ave. North—FE 3-4241
- NEWTON, MASS.**
Cramer Electronics, Inc.
320 Needham St.—WO 9-7700
- NEW YORK, N. Y.**
Milgray Electronics, Inc.
160 Varick St.—YU 9-1600
- NEW YORK, N. Y.**
Milo Electronics
530 Canal St.—BE 3-2980
- NEW YORK, N. Y.**
Terminal—Hudson
236 W. 17th St.—CH 3-5200
- OAKLAND, CALIF.**
Elmar Electronics
140 11th St.—TE 4-3311
- PALO ALTO, CALIFORNIA**
R. V. Weatherford Co.
444 Page Mill Rd.—DA 1-5373
- PHILADELPHIA, PA.**
Radio Electric Serv. Co.
701 Arch St.—WA 5-5840
- SAN DIEGO, CALIFORNIA**
R. V. Weatherford Co.
7903 Balboa Blvd.—BR 8-7400
- SEATTLE, WASH.**
Seattle Radio Supply, Inc.
2117 Second Ave.—MA 4-2341
- WASHINGTON, D. C.**
Electronic Wholesalers
2345 Sherman Way, N.W.—HU 3-5200

**Bendix Semiconductor
Division**



New Products

HIGH VOLTAGE RELAY

Switches up to 5kVdc and can handle up to 1000 volt-amperes.

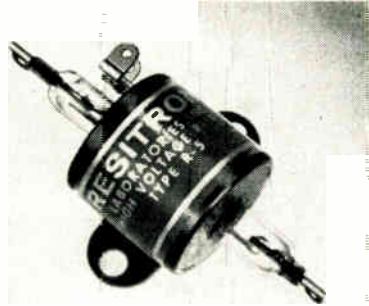

This miniature high voltage, high vacuum relay is designated the MINI-VAC R-5. The unit is actuated by means of a 26.5Vdc coil. Max. length is 2 in. and it is 3/4 in. in dia. It weighs only 1 oz. and is suited for airborne applications and high reliability instrumentation. Resitron Laboratories, Inc., 2908 Nebraska Ave., Santa Monica, Calif.

Circle 336 on Inquiry Card

VACUUM DEPOSITION SYSTEM

The Model SEL 421, dual bell jar system, is for production use.

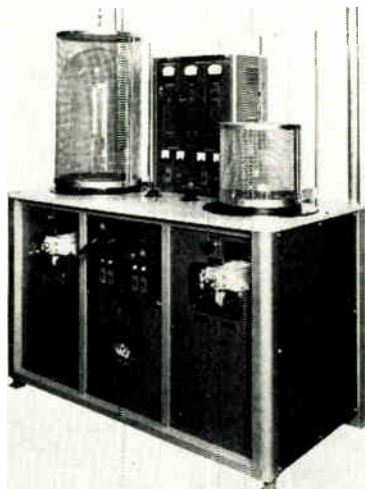

Each deposition station has complete, independent high vacuum pumping system including diffusion pump, mechanical pump, and high vacuum valving. Common high vacuum gauging switched from station to station by means of a selector panel. Accessory power supplies are common and switched from station to station. Low cost system has high performance with large area cold trapping for vacuum of 10^{-7} mm Hg. Scientific Engineering Laboratories, Inc., P. O. Box 607, Woodland, Calif.

Circle 337 on Inquiry Card

TRANSFORMERS

Subminiaturized units meet class R, grade 5, Mil-T-27A Spec.

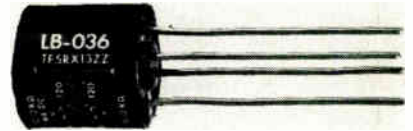

The units exhibit good response characteristics. Load distortion characteristics and power capabilities are also very good. Mounting of these subminiaturized transformers is by 1 in. leads for direct printed circuit application. Fifty-five different items available from stock. TOROTEL, Inc., 5512 E. 110th St., Kansas City 37, Mo.

Circle 338 on Inquiry Card

CAPACITOR TESTER

Model 955 measures 0.1 to 50µf at ±10% in or out of circuit.



Tester includes a Wien Bridge with a balancing circuit for in-circuit capacitor measurements even when shunt resistances are comparatively low. Short tests in or out of circuit with shunt resistance to 1Ω. Reliable to 2000µf; test freq. is 60cps. Open tests: capacitors as small as 15pf, in or out of circuit. The 955 will operate from 105-130vac, 60cps, consuming 8w. Dimensions, 8 1/2 x 5 3/4 x 6 in. (EICO) Electronic Instrument Co. Inc., 33-00 Northern Blvd., L. I. City 1, N. Y.

Circle 230 on Inquiry Card

New Tech Data

for Engineers

Grid Boards

Tech data is available on two new configurations of Fotoceram grid boards, used for prototype printed circuitry. Bulletin CE-3.01 lists electrical and physical characteristics, plus recommendations for use of the processing and mounting materials. Corning Electronic Components, Corning Glass Works, Bradford, Pa.

Circle 301 on Inquiry Card

Rotary Switches

An illustrated, 2 color, folder describing a line of conductive plastic precision rotary switches is available from the Markite Corp., 155 Waverly Place, New York 14, N. Y. The switches, using completely molded and flush switch plates, have hard, smooth switch plate surface, no stick-slip of wiper, long wear-life capabilities and resistance to environmental extremes.

Circle 302 on Inquiry Card

Aluminum Wire

Inorganic insulated aluminum wire in gages of 10 through 46; strips from 0.0008 to 0.060 x 8 in. wide is described in tech data available from Perma-luster Inc., 2801 W. Olive Ave., Burbank, Calif. The insulated material is impervious to nuclear radiation, gamma rays, corrosion, solvents and most alkalines or acids.

Circle 303 on Inquiry Card

Clean Rooms

Bulletin #303—case history presentation concerning construction of "Ultra-Clean Rooms" is available from the Unistrut Products Co., 1015 W. Washington Blvd., Chicago 7, Ill. The full-color, 6-page brochure contains actual "during construction" pictures of clean rooms.

Circle 304 on Inquiry Card

PC Cleaning Equipment

Bulletin 170 gives complete details, including specs. on a completely integrated automatic ultrasonic system for cleaning and drying printed circuit boards. Included are a semi-automatic model, and a manual system. National Ultrasonic Corp., 95 Park Ave., Nutley 10, N. J.

Circle 305 on Inquiry Card

Pressure Transducer

Datametries Inc., 87 Beaver St., Waltham 54, Mass., is offering The Datametries Engineering Report #2, which describes a differential pressure transducer called the BARO-CEL. The unit will measure pressure differentials from 1×10^{-6} psid to 25 psid. Voltage output can be up to 60v and accuracy when integrated into a system can be as low as 0.05% of full scale.

Circle 306 on Inquiry Card

Die Stamped Circuits

"Designing With Die Stamped Circuits" (Bulletin #D1) is available from Dytronics Inc., 115 Main St., Rochester, Mich., a sub. of Taylor Fibre Co. Included is a supplement tabulating the overload currents and resistances for 0.0014 and 0.0028 in. thick copper in 5 different line widths from $\frac{1}{4}$ to $\frac{1}{64}$ in. inclusive. The first section of the 12-page booklet compares each of the features of the die stamped circuits with those made by etching copper-clad laminated plastics. Included is a section with definitions for the most common terms used in printed circuit design.

Circle 307 on Inquiry Card

R & D Brochure

This 16-page, 2-color brochure describes the departments and capabilities of the DeJur-Amsco Corp. The illustrated booklet contains information on the Research and Development activities, Manufacturing Facilities, and the Electronics and Photographic Divisions. DeJur Amsco Corp., Northern Blvd. at 45th St., L. I. C., N. Y.

Circle 308 on Inquiry Card

Mica

Spruce Pine Mica Co., Spruce Pine, N. C., is offering a brochure entitled "A Guide for Users of Fabricated and Uncut Mica." Included is a chart of Mica qualities which list "ASTM Class," "Fed. Spec. types," "Commercial Class," "Uses" and an "Indicator Scale of Comparative Value."

Circle 309 on Inquiry Card

AC Amplifier

DeVar-Kinetics Div. of Consolidated Electrodynamics Corp., 494 Glenbrook Rd., Glenbrook, Conn., is offering 6 bulletins covering their High Level Input Module and High Level Recorder, Power Supply Module, Demodulator-Modulator Module, AC Amplifier, and Millivolt Input Module, and an Alarm Module. Complete performance specs., schematics, performance curves and operational data are included.

Circle 310 on Inquiry Card

Toroidal Cores

GENALEX Toroidal Cores are now available in the G62 size with O.D.'s of 0.655, I.D. of 0.400, and 0.250 in. thick to require less space than the popular "Wedding Ring" of 0.800 in. O.D. The tech data includes information on permeabilities of 200, 140, 125, 60, 26, and 14 available from stock in production quantities. Connolly & Company, P. O. Box 295, Menlo Park, Calif.

Circle 311 on Inquiry Card

Limiters

This line of solid-state limiters covers from 225 to 1480MC. They feature 18db min. isolation for high level signals and 0.2 to 0.3db insertion loss at low levels. Size including Type N connectors is $1\frac{1}{2} \times 1\frac{1}{4} \times 2\frac{3}{4}$ in. Peak power capability is 650w up to 1000MC and 450w to 1480MC. Micro State Electronics Corp., 152 Floral Ave., Murray Hill, N. J.

Circle 312 on Inquiry Card

Leak Detector

Tech data is available which describes the G.A.S. H-4 Leak Detector developed for fast, clean "search-out" of leaks of pressurized piping systems and gas tight components. The H-4 will indicate helium and hydrogen leaks of the order of 20p.p.m. Gas Analysis Systems, Inc., P.O. Box 38, Mountain Lakes, N. J.

Circle 313 on Inquiry Card

Telemetering Filters

Catalog #F-621 contains a technical discussion of the design, uses, construction, and costs consideration, in addition to listings of the company's standard lines of telemetering, tone channel, and interstage filters. Kenyon Transformer Co., Inc., 1057 Summit Avenue, Jersey City, N. J.

Circle 314 on Inquiry Card

Communications Antenna

Granger Associates, 974 Commercial St., Palo Alto, Calif., is offering a tech. bulletin on their Model 726, Vertically Polarized Monopole Log Periodic Antenna. This broadband antenna is for H-F communications and offers low and constant VSWR, 10 db gain and low take-off angle.

Circle 315 on Inquiry Card

Infrared Instrumentation

A 24-page brochure (Bulletin 0-014) is available from Barnes Engineering Co., 30 Commerce Rd., Stamford, Conn., containing a collection of articles on infrared instrumentation for space vehicles. These articles discuss the design of horizon sensors and other infrared instruments for guidance, stabilization, navigation, and tracking.

Circle 316 on Inquiry Card

Voltmeter

Calibration Standards Corp., 1031 Westminster Ave., P. O. Box 551, Alhambra, Calif., is offering tech. data on their Model AC-200A, AC/DC Precision Voltmeter. Completely solid-state, it offers accuracies of 0.003% for dc measurements and 0.05% for ac measurements. Long term stabilities (30 days) are better than 0.002% (dc) and 0.025% (ac).

Circle 317 on Inquiry Card

The Oak Approach!



Jack be quick! Your prototype switch in just 3 days

No surprise! OAK has the fastest delivery cycle in the industry for prototype rotary switches. How speedy? It's sketch to switch in just 72 hours after receipt of your drawings.

Your switch arrives in time because we rush it to the airport as soon as it's completed. But OAK speed begins as soon as we receive your order. It's spotted and routed through a special prototype department — hand-tended from applications engineering through final shipping. And your switch arrives safe-

ly — thanks to the same Oakote protected packaging that is used on regular OAK shipments. Inside, your prototype is attractively boxed in the "plasticase" shown at the left.

We make your sketching easier too! Special layout sheets are now available at no cost to help in diagramming your switch. For further information on "Jack be quick" prototype service, products or production scheduling, get in touch with us or the OAK Representative nearest you.

OAK MANUFACTURING CO.

CRYSTAL LAKE, ILLINOIS • Telephone: Area Code 815; 459-5000; TWX: CRYL LK 2350-U;
Plants in Crystal Lake, Illinois • Elkhorn, Wisconsin

Subsidiaries: OAK ELECTRONICS CORPORATION
Culver City, Calif.

DELTA-I, INC.
Geneva, Ill.

MCCOY ELECTRONICS CO.
Mt. Holly Springs, Pa.

ROTARY AND PUSHBUTTON SWITCHES • TELEVISION TUNERS • VIBRATORS • APPLIANCE
AND VENDING CONTROLS • ROTARY SOLENOIDS • CHOPPERS • CONTROL ASSEMBLIES

World Radio History

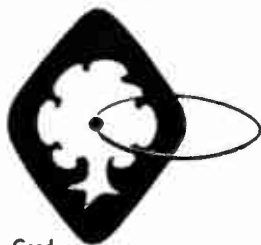

New Tech Data

for Engineers

Relay Catalog

Stock Relay Catalog 262 lists 249 relays available for off-the-shelf delivery including general purpose, telephone type, rotary and dry reed; twin contact with bifurcated contact springs, microminiature, subminiature; 50a power, latch-in and r-f switching types. Included are illustrations, specs. and prices. Magnecraft Electric Co., 5571 N. Lynch St., Chicago 30, Ill.

Circle 339 on Inquiry Card

Cooling Equipment

A 16-page short-form catalog on packaged equipment for electronic rack cooling is available from McLean Engineering Lab., P. O. Box 228, Princeton, N. J. The booklet contains features, specs. and illustrations on packaged blowers, propeller fans, ring fans, panel fans, single and dual centrifugal blowers, and special cooling equipment and accessories. McLean's Air Flow Test Chamber is also described and illustrated.

Circle 340 on Inquiry Card

Dust Caps

Bulletin #7 describes new shorting and non-shorting dust caps which have been added to the Gremer QDS coaxial cable connection line. Both male and female types are available. Also described are standard and non-standard QDS connectors. Gremer Mfg. Co., Inc., 7 North Ave., Wakefield, Mass.

Circle 341 on Inquiry Card

Antenna Catalog

TACO Ruggedized Yagi Catalog, 16 pages, gives data on over 100 types of ruggedized Yagis covering from 30 to 500MC. Detailed electrical and mechanical descriptions of each type within several antenna groups covers specific freq., weight, nominal H.P.-B.W. (in degrees) for E and H planes, number of driven elements, max. VSWR, max. power input (watts) and nominal gain above isotropic source. Catalog #600 is available from Technical Appliance Corp., Sherburne, N. Y.

Circle 342 on Inquiry Card

Interference Control

A 32-page brochure discussing the interference control techniques used by the Interference Control Field Service Dept. of Sprague Electric Co. is now available. It is intended as an aid to design engineers and contains the bulk of remedies for interference problems known in the art. Copies of Sprague Technical Paper 62-1, "Interference Control Techniques," are available upon letterhead request to Sprague Electric Co., 233 Marshall St., N. Adams, Mass.

Epoxy Mixing Dispenser

BIPAX is a method of storing, handling, mixing and dispensing 2-component Epoxy resin systems. It consists of a twin-compartment flexible package with an easily removed clamp that keeps the 2 components separate until they are ready to be mixed. Resin Systems Div., Tra-Con, Inc., 25 Ship Ave., Medford 55, Mass.

Circle 344 on Inquiry Card

GSE Vans

Wells Industries Corp., 6880 Troost Ave., N. Hollywood, Calif., is offering a 6-page, 2-color brochure describing their custom vans and trailers for mobile housing of ground support equipment and electronics, radar and communication equipment.

Circle 345 on Inquiry Card

Computer Circuits

Ess Gee, Inc., 15 Havens St., Elmsford, N. Y., is offering technical data covering 5 silicon transistor Logic Cards. Logic Card Series 1001 consists of individual tech. bulletins describing a FLIP-FLOP, AND GATE, STANDARD INVERTER, NEON DRIVER, and POWER DRIVER. The cards are suited for operation in extreme environments and operable from -55° to $+85^{\circ}$ C.

Circle 346 on Inquiry Card

Power Resistor Decades

"Dial and Read 1 to 999,999 Ω " is the title of a brochure on power resistor decades available from Clarostat Mfg. Co., Inc., Dover, N. H. Brochure covers theory, circuit diagrams, general application and operation information, plus parts and spec. details.

Circle 347 on Inquiry Card

Power Transistors

Tech. data is available from Kearfott Semiconductor Corp., 437 Cherry St., W. Newton, Mass., on their P-N-P germanium alloy junction power transistors. Types 2N156, 2N158, and 2N158A conform to EIA configuration and fit within the standard TO-13 case outline with matched glass-to-metal seals.

Circle 348 on Inquiry Card

Microwave Attenuators

"Medium and Low Power X-Band Microwave Attenuators" and spear configurations are described in tech. data available from Electronautics Corp., Maynard Industrial Ctr., Maynard, Mass. Information is also included on Medium and Low Power Attenuators for L, S, C, X, K_u, and K-bands and round microwave absorbers with a max. VSWR, over 90% of bandwidth, of 1.01.

Circle 349 on Inquiry Card

Microwave Devices

Consolidated Microwave Corp., 850 Shepherd Ave., Brooklyn 8, N. Y., is offering tech data on solid state devices including diodes for switches, modulators, attenuators, limiters power supplies, and ferrite isolators, circulators, limiters, switches, phase shifters, and duplexers.

Circle 350 on Inquiry Card

Matched Diodes

Bulletin 109 describes silicon micro diode Matched Pairs and Matched Modulator Quads which meet or exceed Mil-S-19500B and Mil-STD-202B testing. MicroSemiconductor Corp., 11250 Playa Court, Culver City, Calif.

Circle 351 on Inquiry Card

Transformers

Electro Engineering Works, 401 Preda St., San Leandro, Calif., is offering tech data on a complete integrated line of high voltage rectifier plate transformers and filter inductors for high power applications. Uses of these transformers include high voltage dc power supplies, radio and TV transmitters, radar transmitters, and microwave generators.

Circle 352 on Inquiry Card

Microwave Systems

Condensed Catalog and Product Summary No. 861, available from Melabs, 3300 Hillview Avenue, Stanford Industrial Park, Palo Alto, Calif., describes their line of microwave communications systems, countermeasures equipment, spectrum surveillance systems, microwave components, instruments, solid state techniques studies, and advanced systems studies. Included are photographs, descriptions and specs.

Circle 353 on Inquiry Card

Throat Fittings

An illustrated brochure describing insulated throat fittings is available from The Thomas & Betts Co., Inc., Elizabeth 1, N. J. The bulletin illustrates and catalogs a complete line of nylon-insulated connectors, elbows, bushings, sleeves and nipples. Sizes from $\frac{1}{2}$ in. up to 6 in. and standard packing quantities are indicated for each of 17 fitting types.

Circle 354 on Inquiry Card

Selenium Rectifiers

Edal Industries, Inc., 4 Short Beach Rd., E. Haven 12, Conn., is offering tech. data on their high voltage cartridges, hermetically sealed encapsulated selenium rectifiers, diode arc suppressors, multiple circuits and power rectifiers. Included are characteristic table, specs. and photographs.

Circle 355 on Inquiry Card

Moving air is easy...controlling it takes an expert

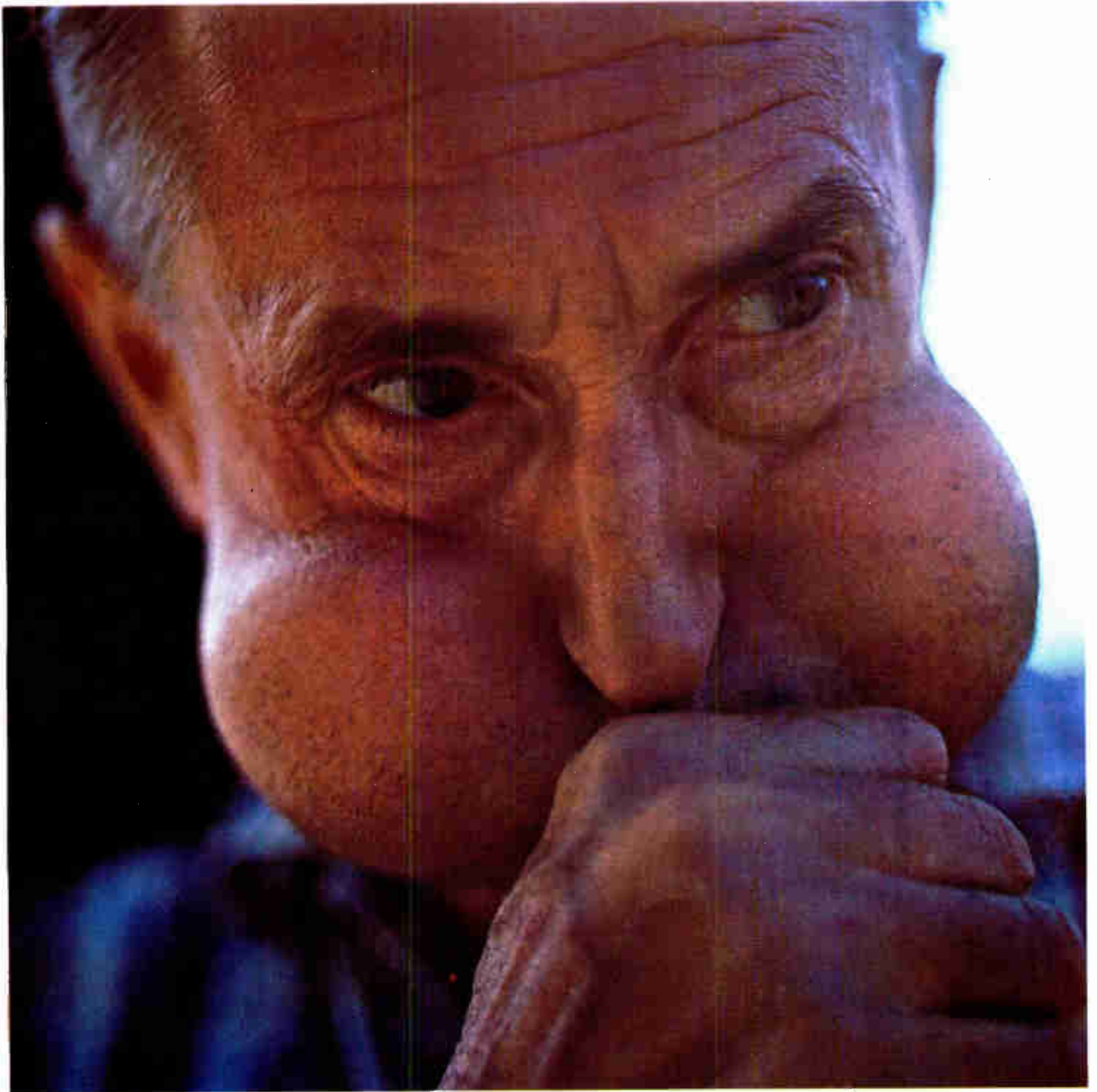

All the brawn in the world won't help this glass blower unless he has the ability to control it with the deft touch, the precise move that comes only with experience. Cooling and moving air can be tricky. We know because that's our business. Doing it efficiently, quietly and economically is our stock in trade. Over the years we have learned to control our production strength with creative design and imaginative engineering. You'll find the whole story in Brochure 102. Get a copy now from the Torrington Manufacturing Company, Torrington, Connecticut.



TORRINGTON

prime source for radar, too

In process is a new cycle of hardware development for radar, an upgrading of equipment that will tax engineering and productive skills, and oblige suppliers to provide more versatility, more reliability, and more compactness in component design. ■ For Lionel, a **prime connector source** for radar, these demands pose no problems. ■ Lionel-Anton connectors have chalked-up a myriad of successes in radar applications, ranging from simple to highly complex circuitry. The experience that's been gained in creating these devices may well suggest solutions to satisfy your connector requirements. ■ Before you decide on the use of a connector, be it rack and panel, or printed circuit type, in any size or configuration, or a special socket or plug, why not talk to your Lionel representative, or write to us outlining your specific need.

WHERE IMPORTANT CIRCUITS MEET...

LIONEL-ANTON CONNECTORS

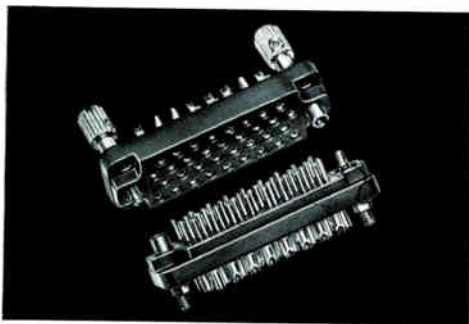

One of many Lionel-Anton connectors (Series SM-20) used in radar applications, particularly where space is at a premium. Features include excellent dielectric Diallyl Phthalate moldings; precision-machined male brass contacts and spring-temper phosphor bronze female socket contacts; consistent, minimum engagement and disengagement forces effecting low millivolt drop; positive polarization with reversed male and female guides; corrosion-resistant, stainless steel guides and screwlock jacking devices, which prevent unintended disconnection and provide a positive vibration lock; gold plating over silver to effect low contact resistance, prevent corrosion, and provide soldering ease. 10 sizes: 5 through 75 contacts. Meets applicable MIL specs. Materials and specifications modified to meet your specific needs. The last order for this standard item was shipped 10 days ahead of the promised delivery date.



LIONEL ELECTRONIC LABORATORIES, INC./A SUBSIDIARY OF THE LIONEL CORPORATION/1226 FLUSHING AVE./BROOKLYN 37, N. Y.

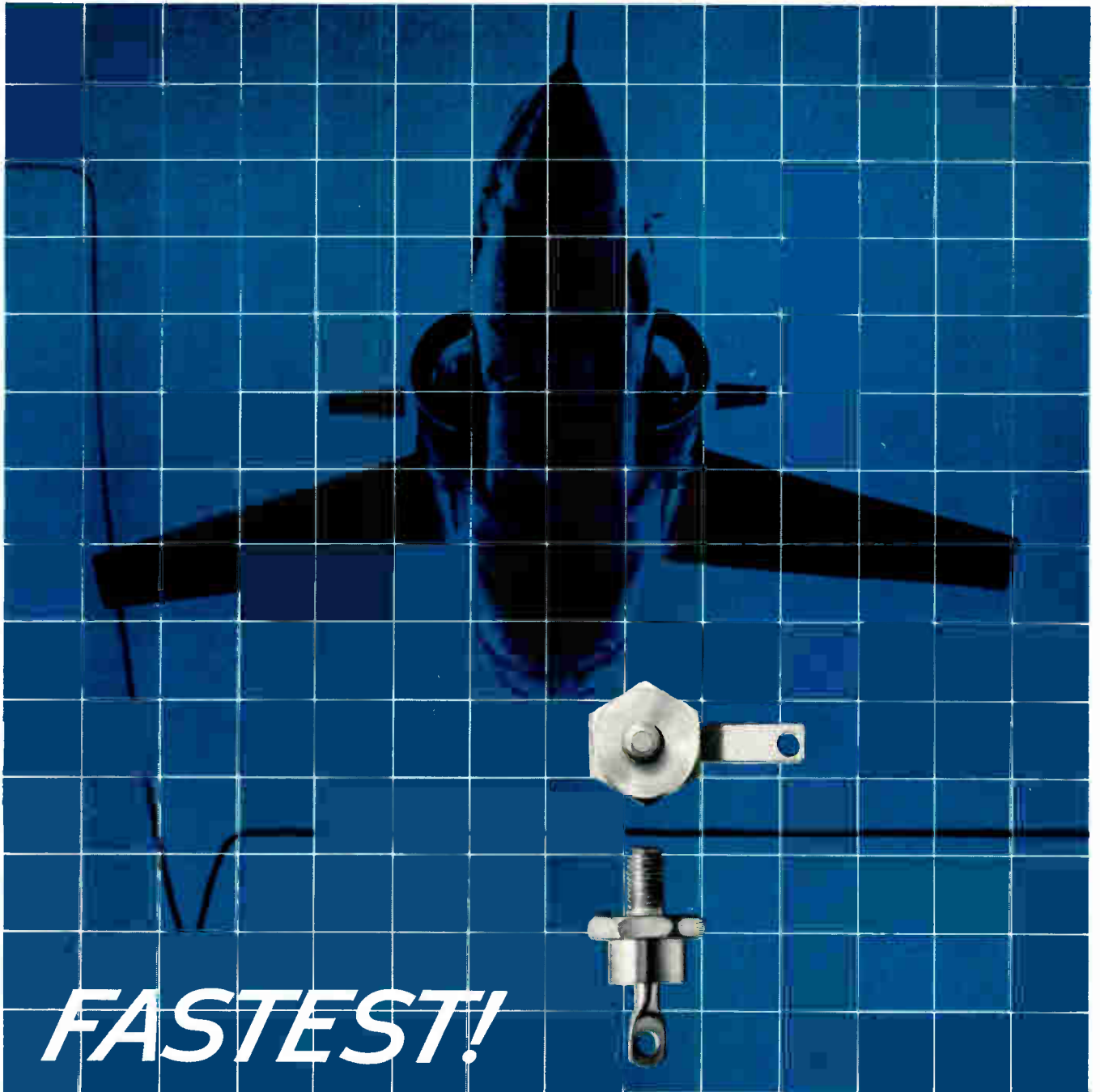

FASTEST!

Hughes new HF Series (1-35 amp.) "Golden Line" silicon power rectifiers have recovery times of 200 nanoseconds (max.).

Hughes new fast switching silicon power rectifiers are a unique combination of power, speed and reliability.

Typical recovery time of 0.08 μ sec. Typical room temperature reverse leakage currents at rated PIV of 1 to 35 microamps for 1 to 35 amp. device types. Maximum forward voltage drop of less than 1.5 volts at rated current.

Hughes 1 thru 35 amp. power rectifiers are available in quantity —today— in regular or insulated stud packages and in regular or fast switching types.

Ask for your copy of the new "Golden Line" rectifier brochure (C-22) from your Hughes representative. Or write Hughes Semiconductor Division, Marketing Department, Newport Beach, California.



Creating a new world with Electronics.

HUGHES

HUGHES AIRCRAFT COMPANY
SEMICONDUCTOR DIVISION

DIODES • TRANSISTORS • RECTIFIERS • PACKAGED ASSEMBLIES • ELECTRONIC COMPONENTS

Gertsch General Purpose RatioTran[®]

NOW... A LOW-COST AC INDUCTIVE VOLTAGE DIVIDER —ACCURATE TO 0.001%



In addition to the high accuracy, unit features high input impedance, low effective series impedance, and very low phase shift. You get characteristics comparable to those of more expensive instruments, in a Gertsch-quality unit.

5-decade transformer switching. Instrument is ideal for checking servos and resolvers... for voltmeter calibration, computer testing, and transformer turns ratio measurements.

Compact size—only 3½ inches high. Designed for bench mounting, and easily adapted to half-rack mounting with brackets furnished.

Send for literature on the RT-60 Series.

Gertsch

GERTSCH PRODUCTS, Inc.

3211 South La Cienega Boulevard, Los Angeles 16, California/Upton 0-2761 - Vermont 9-2201

Tech Data

for Engineers

Digital Modules

A complete listing of 86 fully coordinated solid-state circuit modules is included in a short-form catalog available from Digital Equipment Corp., Maynard, Mass. Information is also included on 40 pieces of accessory and high current pulse equipment.

Circle 361 on Inquiry Card

Component Catalog

This 40-page "Service Selector" catalog describing a line of capacitors, vibrators, rotors, decades, test instruments and other standard line components is available from Cornell-Dubilier Electronics Div., Federal Pacific Electric Co., 50 Paris St., Newark, N. J. The booklet also includes selection data such as design features, temp. ranges, material construction, applications and price.

Circle 362 on Inquiry Card

Delay Lines

PCDL Series of Miniature Constant Lumped Delay Lines is covered in a new catalog sheet containing charts, graphs, and schematics illustrating electrical and physical parameters of the series. PCA Electronics, Inc., 16799 Schoenborn St., Sepulveda, Calif.

Circle 363 on Inquiry Card

Diode Switches

These broadband devices for switching microwave energy at high rates of speed have a minimum of 1Gc bandwidth covering from 5 to 17Gc freq. range. These units have at least 30db isolation in the "off" condition, and cause no more than 1db signal attenuation or insertion loss in the "on" condition. They can be switched in less than 50nsec. Sylvania Electric Products Inc., 1100 Main St., Buffalo 9, N. Y.

Circle 364 on Inquiry Card

Temperature Measuring

Bulletin 61A, describing a new portable all-purpose temp. measuring instrument for plant and laboratory use, is available from Technique Associates, 1413 Cornell, Indianapolis 2, Ind. Thermotest, Model 11, handles temp. measurements, and checks calibration of pot type temp. controllers and recorders over a range from -200 to +2200°F.

Circle 365 on Inquiry Card

Laminated Plastics

Industrial laminated plastics and molded plastic parts are detailed in a new product folder from Formica Corp., 4614 Spring Grove Ave., Cincinnati 32, Ohio. The 8-page folder includes complete data on 41 laminates, 8 molding grades and Formica Engraving Stock. Also included is Formica M-3000, a high-impact cotton-phenolic molding compound.

Circle 366 on Inquiry Card

LAMINATE

Micarta grade H 13555 has very low sulfate and chloride content.

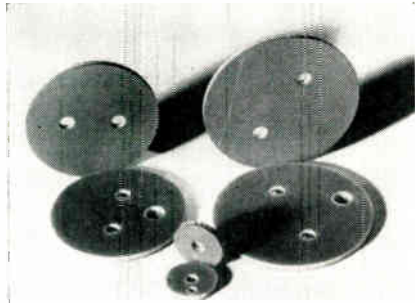

Synthetic-rubber-coated XP laminate is now being used as an improved closure material for electrolytic capacitor cans. It consists of a phenolic sheet with red Buna "S" rubber bonded on one side. The rubber serves as a cap liner in the can, giving high chemical resistance and a seal when the metal is crimped against it. Excellent punching quality is another feature. Six thickness combinations, laminate 0.40—3/32 in.; rubber 0.020 to 1/32 in., are available in 36×72 in. sheets. Westinghouse Electric Corp., Micarta Div., Hampton, S. C.

Circle 367 on Inquiry Card

ZENER DIODES

They have guaranteed dynamic resistance and 5 and 10% tolerance.



Two series include EIA types 1N-746 through 1N759 (400mw) and 1N-957 through 1N972 (500mw). The diodes of both series have a guaranteed dynamic resistance and may be stored and operated at temps. between -65°C and 150°C. Types 1N746 through 1N759 have a voltage range of 3.3v to 12v and are available in 5% and 10% tolerances. The voltage range for types 1N957 through 1N972 is 6.8v to 30v and are available in 5%, 10% and 20% tolerances. Computer Diode Corp., 250 Garibaldi Ave., Lodi, N. J.

Circle 368 on Inquiry Card

ENVIRONMENT-PROOF

Honeywell HM and HS series meters are immune to hazardous climatic or atmospheric conditions. True glass-to-metal hermetic sealing makes them completely dust-proof and moistureproof, and plated steel cases provide magnetic and electrostatic shielding. ■ HS series meters, in addition, are ruggedized to withstand exceptional levels of shock, vibration, stress and strain. HS2Z and HS3Z types have external gasket-sealed zero adjusters and conform to the requirements of MIL-M-10304B. ■ For a catalog describing the full line of Honeywell meters, write Honeywell Precision Meters, Manchester, New Hampshire. ■ There's no charge or obligation.

HM1-ET (3 1/2") ELAPSED TIME INDICATOR SHOWN. FULL RANGE OF CURRENT AND VOLTAGE MODELS AVAILABLE.

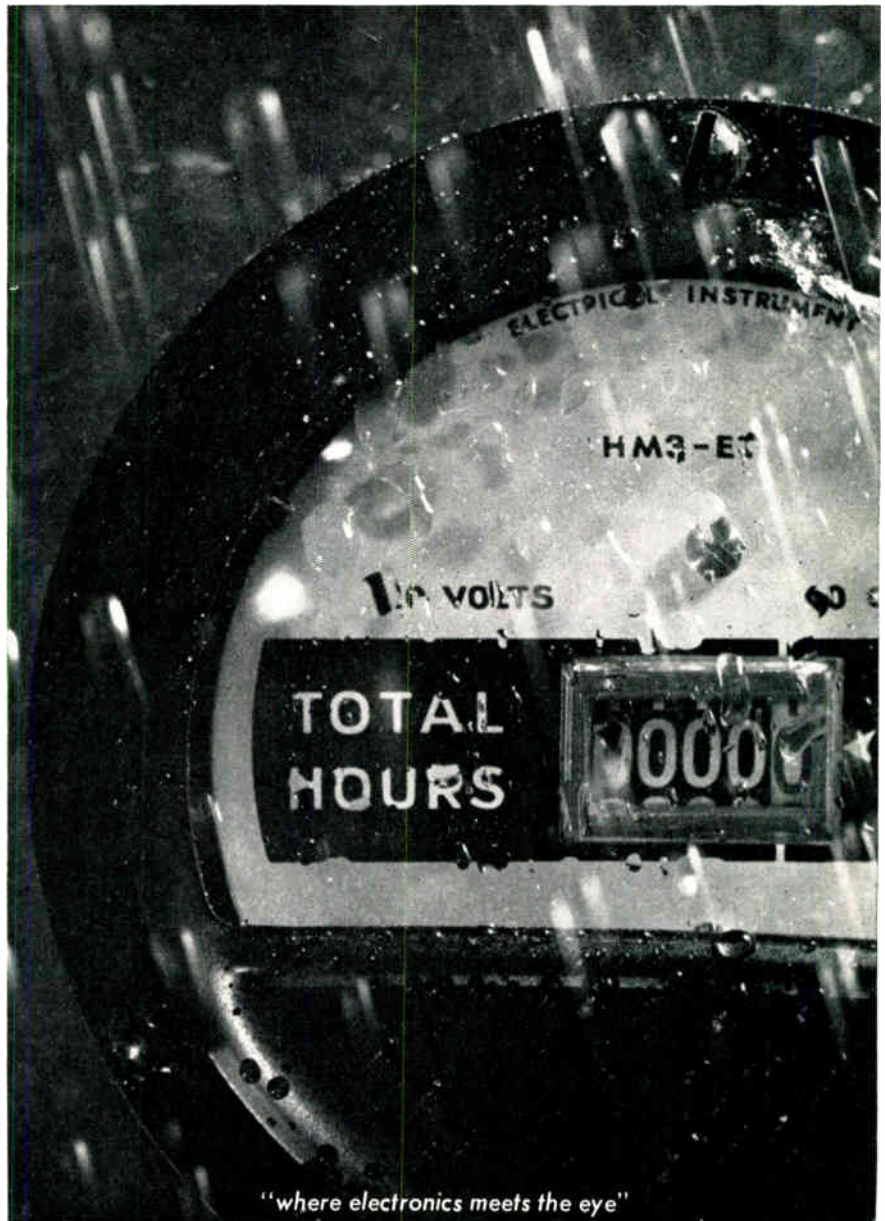

"where electronics meets the eye"

Honeywell



Precision Meters

EISLER

Makes the largest assortment of Precision Press Type Resistance Spot —Wire Butt—Seam—Tweezer—Gun and Flash Welders. We also carry in stock Welding Tips, Holders and other Welding Accessories.

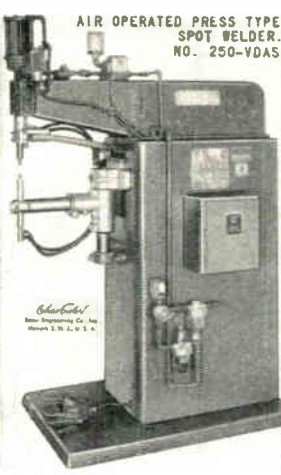
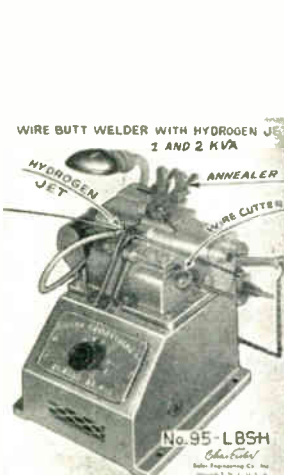
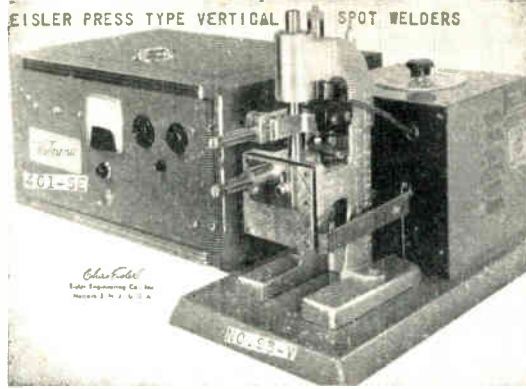

EISLER ENGINEERING CO., INC. 770 So. 13th St., NEWARK 3, N. J.

Circle 145 on Inquiry Card

New Products

MAGNETIC SHIELD

Designed for special projection and conventional display tubes.



This Netic Co-Netic magnetic shield is for close fit and retrofit display tube applications. All exposed edges of the dual lamina shield are completely sealed by a new fusion process. The Netic Co-Netic alloys are non-shock sensitive and non-retentive so the outer surface of the shield may be precision ground to dimensional tolerance after heat treatment. A cable guide bracket and access holes are provided for high voltage cable and associated circuitry. Magnetic Shield Div., Perfection Mica Co., 1322 N. Elston Ave., Chicago 22, Ill.

Circle 233 on Inquiry Card

MINIATURE POT

Watch-controlled unit for activating circuits in programming uses.



It is said to be capable of cycling operations for up to 35 hrs. before re-winding is necessary. Included in the integrating switch device are 2 potentiometers, switches, 17-jewel Bulova military-type watch movement, and an initiator to start the switch's operation. One pot. is driven by the minute-hand shaft at 1 cycle/hr. The other is set typically to complete one cycle in 24 hrs. and to shut down the device at the end of its revolution. Model No. 836 Miniature Potentiometer Drive is designed for mounting on printed circuit boards. Bulova Watch Co., Inc., Industrial & Military Products Div., Bulova Park, Flushing 70, N. Y.

Circle 234 on Inquiry Card

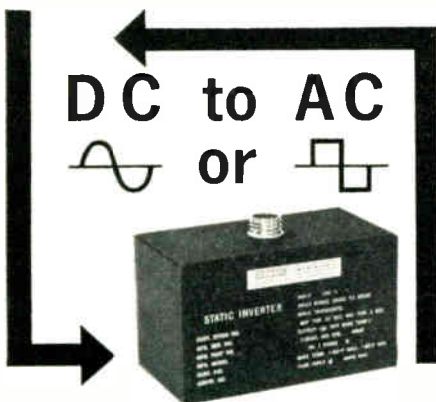

- Frequencies from 400 cps to 5 KC
- Output voltages from 5-500 VAC
- 50, 100, 200 VA Standard

Designed to change low voltage DC power to sine or square power, these small-size, transistorized inverters can be supplied in a wide range of output voltages and frequencies. Units feature regulation to 1/2% for input 24 to 30 VDC, short circuit protection, and meet the environmental requirements of MIL-E-5272C. Prices range from \$185. to \$595. Delivery of most units from stock.

Send for complete 20-page catalog.

abbott transistor
LABORATORIES, INCORPORATED
3055 Buckingham Rd. • Los Angeles 16
Direct Dial 213 • REpublic 1-9331

Circle 142 on Inquiry Card

How To Get Things Done Better And Faster

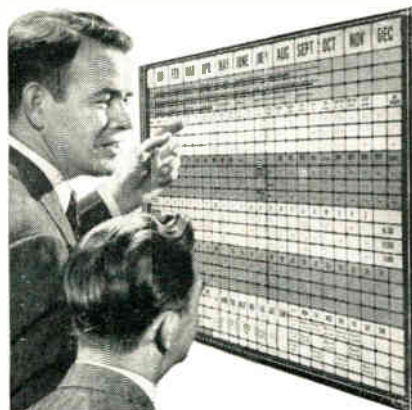

BOARDMASTER VISUAL CONTROL

- ☆ Gives Graphic Picture—Saves Time, Saves Money, Prevents Errors
- ☆ Simple to operate—Type or Write on Cards, Snap in Grooves
- ☆ Ideal for Production, Traffic, Inventory Scheduling, Sales, Etc.
- ☆ Made of Metal. Compact and Attractive. Over 750,000 in Use.

Full price **\$49.50** with cards

FREE

24-PAGE BOOKLET NO. Z-20
Without Obligation

Write for Your Copy Today
GRAPHIC SYSTEMS

Yanceyville, North Carolina
Circle 143 on Inquiry Card

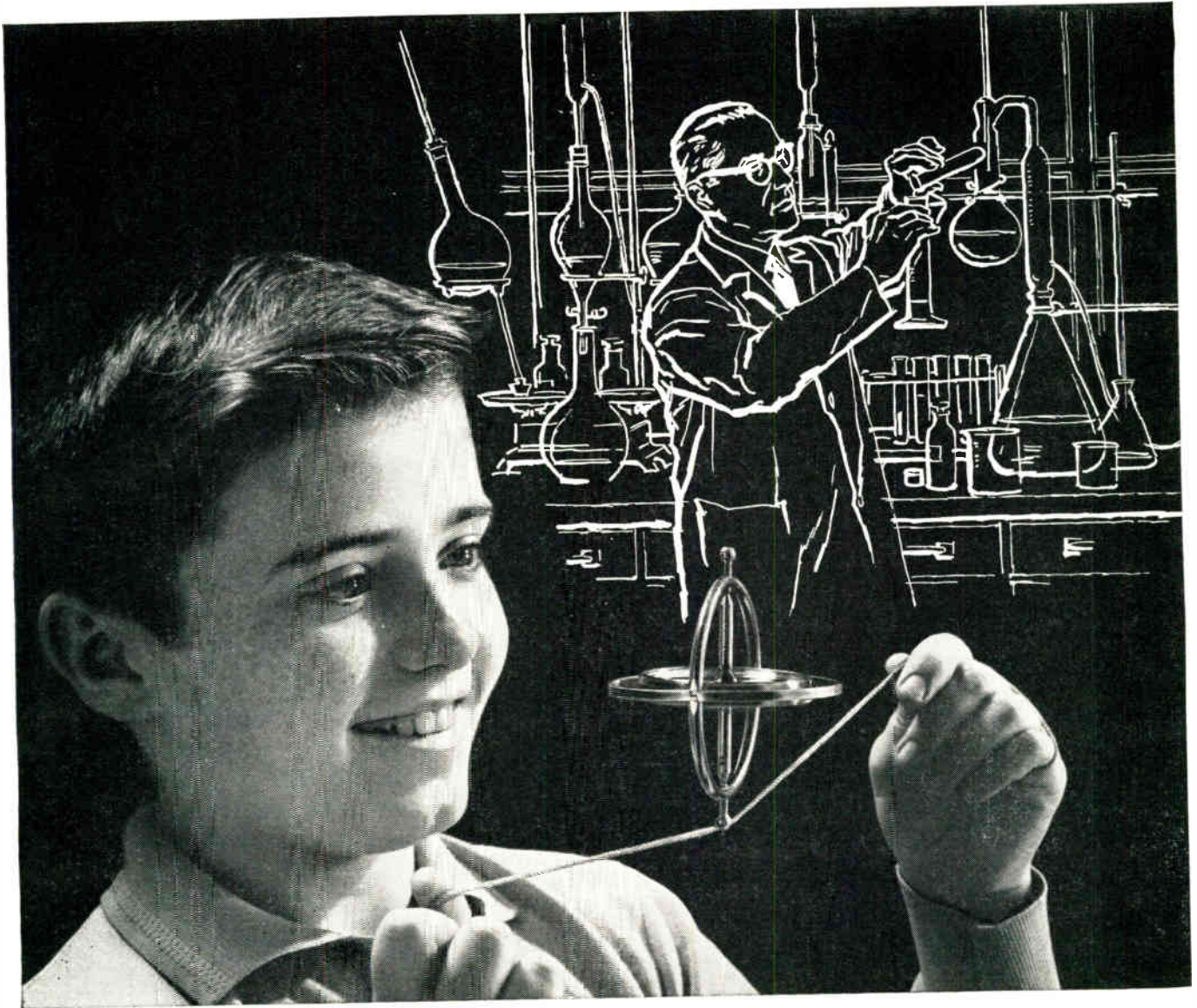

The Future of Your Business

MAY DEPEND UPON HIS EDUCATION

The young mind which today discovers an old principle may someday reveal a new one capable of revolutionizing your business and creating undreamed of growth. But this is possible only if he gets the finest education we can offer.

By the time today's youngsters are ready for college, business and industrial technology will be even more complicated and will require many more trained specialists. To fill this order we must provide our young people with the best possible college educations.

Unfortunately many colleges are already overcrowded. In ten years applications are expected to double. We will need more and better college classrooms and libraries, more efficient college laboratories, and additional top-quality professors. *You can help assure your own future by helping the college of your choice.*

If you want to know what the college crisis means to you, write for a free booklet, "OPEN WIDE THE COLLEGE DOOR," to Higher Education, Box 36, Times Square Station, New York 36, N.Y.



Published as a public service
in cooperation with The Advertising Council and
the Council for Financial Aid to Education



ADVANCES IN ELECTRONIC CIRCUIT PACKAGING

Volumes 1 and 2

Proceedings of the First and Second International Symposia, sponsored by the University of Colorado and Electrical Design News.

Edited by Gerald A. Walker
Assistant Editor, EDN.

Volumes 1-2, special set price: \$23.00
(\$12.50 each volume)

ISA TRANSACTIONS

A new technical journal devoted exclusively to the most significant literature in the fields of measurement, data handling, computation, automatic control, and systems engineering.

An Instrument Society of America publication.
Annual Subscription (4 issues): \$15.00

ISA TRANSDUCER COMPENDIUM

This comprehensive bound volume contains over 500 pages of detailed information on more than 3000 different models of transducers, including list of manufacturers.

An Instrument Society of America publication.
\$25.00

DEVELOPMENTS IN MECHANICS
Volume 1

Proceedings of the Seventh Midwestern Mechanics Conference, held September 6-8, 1961, at Michigan State University, East Lansing, Michigan.

Edited by Professors J. E. Lay and L. E. Malvern, Michigan State University.
\$19.50

BIOLOGICAL PROTOTYPES AND SYNTHETIC SYSTEMS
Volume 1

Proceedings of the Second Annual Biophysics Symposium sponsored by Cornell University and the General Electric Company, Advanced Electronics Center at Cornell University.

Edited by Dr. Eugene E. Bernard and Dr. Morley R. Kare.

\$12.50

ASPECTS OF THE THEORY OF ARTIFICIAL INTELLIGENCE

Proceedings of the First International Symposium on Biosimulation.

Edited by C. A. Muses, Ph.D.

in press

Complete contents upon request

PLENUM PRESS
227 W. 17 ST., NEW YORK 11, N. Y.

Circle 79 on Inquiry Card

Tech Data
for Engineers

Beam Power Pentode

A 10-page detailed booklet is now available on the Amperex type 6GB5, all-glass, beam power pentode with cavitrap plate for use in horizontal deflection stages in TV receivers. Included are photographs, diagrams and graphs. Booklet may be obtained by writing on company letterhead to Amperex Electronic Corp., Special Purpose Tube Div., 230 Duffy Ave., Hicksville, L. I., N. Y.

Stereo-Color TV Kit

A Stereo-Color Kit consisting of 2 sets of color filters, color temp. filters and a color compensator, to convert to full color any black and white industrial television equipment now available. Combined with other components (Stereo-Captor, Stereo-Screen and Stereo-Hood) of the Stereotronics System, the kit will optically convert a flat monochromatic picture to 3D and color. Stereotronics Corp., 1717 N. Highland Ave., Los Angeles 28, Calif.

Circle 356 on Inquiry Card

Filament Holders

Techni-Tool, Inc., 1216 Arch St., Philadelphia 7, Pa., is offering tech. data on their all-purpose magnifying inspection mirrors, filament holders, filament scissors, lock type holders and utility tweezers.

Circle 357 on Inquiry Card

Level Mechanism

Tech data describing Bailey Mini-Line Measuring Mechanisms and Transmitters is available from the Bailey Meter Co., 1050 Ivanhoe Rd., Cleveland 10, Ohio. The mechanisms are used with pneumatic transmitters, to measure boiler drum level or liquid level in pressure vessels and transmit measurements to indicating, recording and/or controlling equipment at remote stations. Product spec. sheets G31-4 and P31-4.

Circle 358 on Inquiry Card

Printed Circuit Masters

Drafting materials for use in the layout of printed circuit masters are described in a 12-page catalog available from Flexigraph, Inc., 15 Normandy Blvd., Morristown, N. J. The catalog includes information on precision grids and tapes accurate to ± 0.001 , and die-cut symbols accurate to ± 0.002 .

Circle 359 on Inquiry Card

Miniature Chopper

The 920 Series Choppers feature operation from 0 to 500cps while maintaining precise dwell time and balance. They have less than 5 μ v noise into 100K Ω at 60cps. Available in standard 7 pin miniature, 1 7/16 in. height at 0.670 dia. by 1 1/4 in. long. Cambridge Scientific Industries, Inc., Cambridge, Md.

Circle 360 on Inquiry Card



**CUSTOM
DESIGNED
TO GIVE
YOU
PRECISELY
THE
INDICATOR
YOU
NEED!**

Only specifically designed indicators can meet the critical electro-mechanical specifications and high reliability levels demanded for computers, data processing and control systems.

TEC engineers, who conceived the self-contained transistorized indicator, have designed literally hundreds of special TEC-LITES . . . indicators, "button-lites", switches and readout units . . . to give designers the exact device they need! Your problem may be met with one of these special units or a new TEC-LITE created to your specifications.

Write for detailed information on custom TEC-LITES . . . designed to give you precisely the indicator you need!

**ORIGINATOR OF PATENTED
TRANSISTORIZED INDICATORS**



**Transistor
Electronics
Corporation**

3357 Republic Ave. • Minneapolis 26, Minn.
TWX MP 331 • WE 9-6754

Circle 80 on inquiry Card

New Products

TANTALUM CAPACITORS

One micro-miniature solid tantalum unit measures 0.065 x 0.125 in.

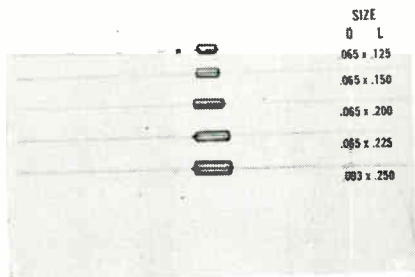

Specs. for this line include a temp. range from -55° to $+85^{\circ}\text{C}$; tolerance is -20% $+50\%$ (closer tolerance available on special request); dc voltage ratings are max. operating voltages at any point over the temp. range of -55° to $+85^{\circ}\text{C}$; capable of withstanding a 1000 hr. life test at max. temp. with rated voltage applied. GLP Div., Burnell & Co White Plains, N. Y.

Circle 369 on Inquiry Card

DC POWER SUPPLY

Delivers 2000a at 15v for research furnaces and industrial equipment.

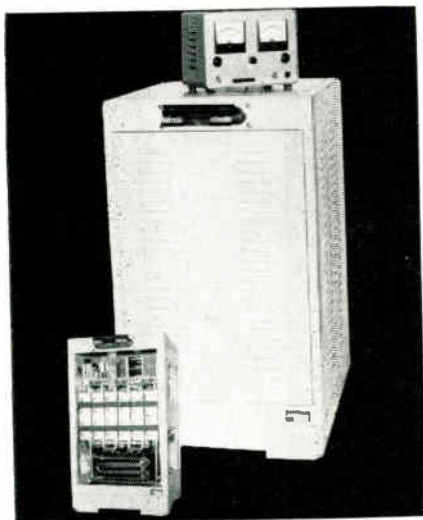

This high current dc power supply unit uses silicon controlled rectifiers. Current is regulated to $\pm 1\%$ from 100 to 2000a by a separate portable control console. It is water-cooled and compact. Outside dimensions measure 22 x 22 x 36 in. The weight is less than 700 lbs. Tylan Corp., Torrance, Calif.

Circle 370 on Inquiry Card

What Decides New Plant Site? Mainly, The Boss!

Small firms looking for new plant locations are frequently influenced by personal preferences of the owners, according to a new management research summary issued by the Small Business Administration.

The summary, available on request at all SBA offices, is based on a study made by the Univ. of Conn. under the 1959 research grant program of SBA. Conclusions of the study are based primarily on interviews with 83 small manufacturers in the Hartford, Conn., area.

Personal factors were mentioned by 45% of the executives interviewed on area and site location. Personal factors stressed were—a desire to be near home or family, and a personal attachment to the area.

Consultants and formal investigations are rarely used by small firms seeking a new location. Almost all of the executives interviewed had gathered information about the sites from personal friends, business associates, town officials and personal observation of vacant space.

Interviews indicated that executives also paid considerable atten-

NEMA SPEAKERS

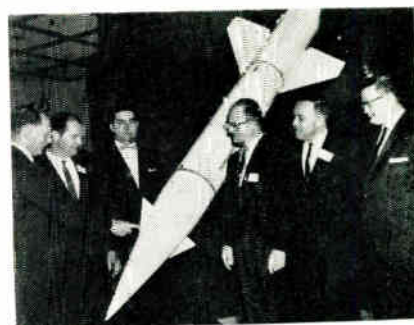

Speakers at a recent NEMA High Temperature Insulated Wire Section Government-Industry Forum at Orlando and Cape Canaveral, Fla., were (l to r) W. Angele, Geo. C. Marshall Space Flight Center; W. Rigling, Martin-Marietta Corp.; M. Taylor, Frankford Arsenal; S. S. Robinson, Western Electric Co.; G. Heller, Tensolite Insulated Wire Co., Inc. and L. B. Chabot, General Dynamics/Astronautics.

tion to proximity to customers or potential customers and suppliers, to employee relations, to transportation facilities and avoidance of downtown congested traffic and to cost-reducing factors.

Copies of the full report, titled "Personal Factors in Small Manufacturing Plant Locations," may be purchased for \$2 from the School of Business Administration, Univ. of Conn., Storrs, Conn.

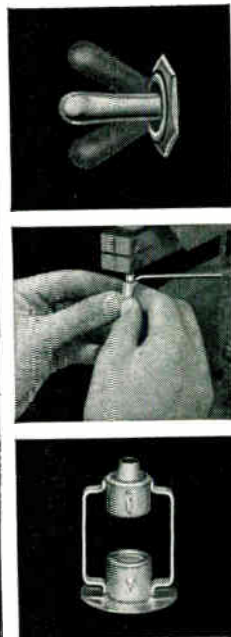
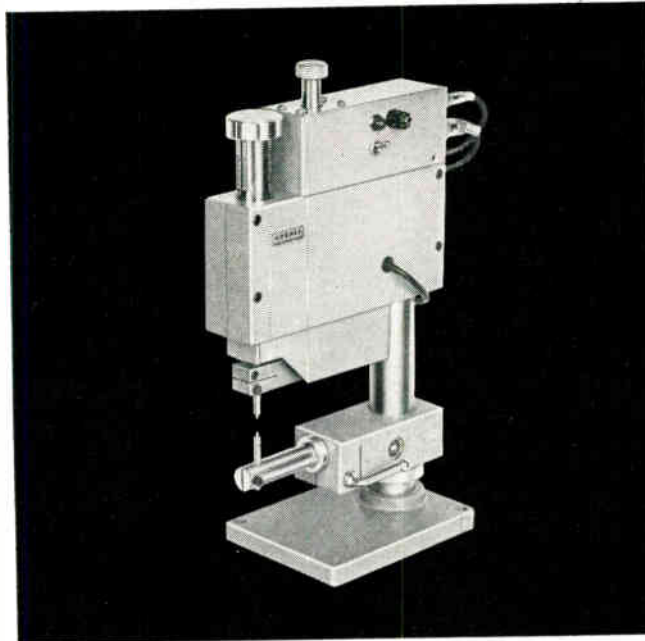

LOOKING FOR WELD RELIABILITY AT HIGH PRODUCTION RATES?

Here's your answer. Hughes air actuated, VTA-42-A Precision Weld Head gives you 3-way operating capability: (1) "hold... then weld" sequence (air), (2) pressure sensing (air), (3) pressure sensing (manual). New "stroke-stop" feature eliminates overpressuring, assures exactly repeatable welds. Ruggedly built for continuous production service. Minimizes operator fatigue. Price: \$380.00 (f.o.b. Oceanside).

Wire or write today for information on Hughes complete line of electronic welding equipment: HUGHES WELDERS, 2020 Short St., Oceanside, Calif.

Creating a new world with ELECTRONICS

HUGHES

HUGHES AIRCRAFT COMPANY
VACUUM TUBE PRODUCTS
DIVISION

DAYSTROM ROTARY POTENTIOMETERS

**GANG 24 CUPS IN 6 INCHES:
ADJUST IN SECONDS
AFTER GANGING!**



ACTUAL SIZE
MODEL 319



The Daystrom 319 Series gangable potentiometer offers a unique advantage never before possible . . . Twenty-four of these can be ganged in a space of six inches, then individually phased after ganging, with no interference to adjacent cups* . . . The result is finite adjustment in a matter of seconds . . . Many hours and dollars can be saved through this feature; you can order the potentiometers already ganged at Daystrom in the number needed, then make final phasing in your circuit . . . The Daystrom 319 Series is ideal for multi-channel applications where space and weight are critical, and offers exceptional stability to shock, vibration, and other severe environmental influences . . . Resistance winding is unique Daystrom "wire-in-the-groove" method . . . Resistance ranges from 100 ohms to 200K are available; power is 2 watts *in still air* at 40°C; operating temperature -55°C to + 150°C; meets or exceeds all applicable MIL specs.

*Patents pending on adjustment method.

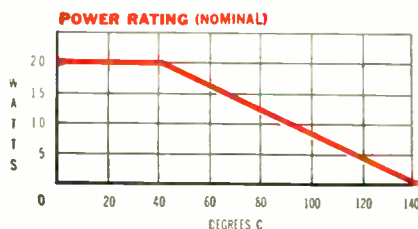

DAYSTROM, INCORPORATED
POTENTIOMETER DIVISION
ARCHBALD, PENNSYLVANIA • LOS ANGELES, CALIFORNIA

DAYSTROM ROTARY POTENTIOMETERS

**SUBMINIATURE MULTI-TURN
WITH RELIABILITY
OF LARGE MODELS:**

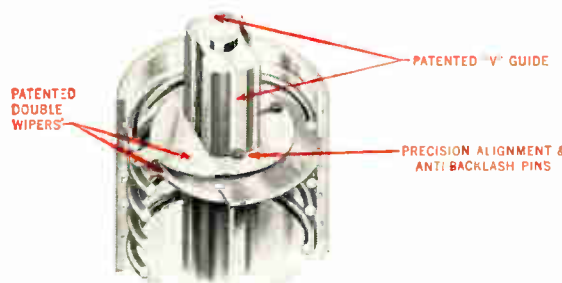

ACTUAL SIZE
MODEL 341

The Daystrom 341 Series offers the unusual benefit of a high-resolution ten-turn potentiometer in a 1"x½" package . . . Much smaller than conventional multi-turns . . . Patented V-Guide within the potentiometer eliminates backlash and resultant error . . . Patented double-wiper arrangement virtually eliminates intermittents due to shock and vibration, and effectively provides finer resolution . . . Patented precision "wire-in-the-groove" method of winding the resistance element still further assures stability to environmental stress . . . Coupled with subminiature size, these features make the 341 Series ideal for avionics systems (ASW, ballistic, and instrumentation) . . . Resistance ranges of 341 Series are from 1K to 600K; power dissipation is 2.5 watts at 40°C *in still air* . . . Meets all applicable MIL specs . . . Can be supplied with patented clutch for servo installation.

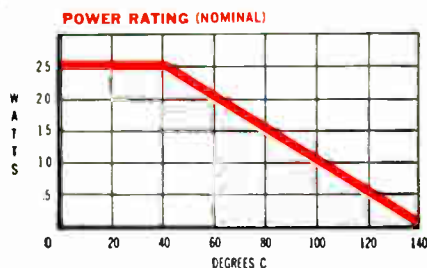

DAYSTROM, INCORPORATED
POTENTIOMETER DIVISION
ARCHBALD, PENNSYLVANIA • LOS ANGELES, CALIFORNIA

MEASUREMENTS' UHF Standard SIGNAL GENERATOR (400-1000 Mc.)



MODEL 84-TV

USES

Aligning and tracking of UHF receivers including sensitivity, signal-to-noise ratio, conversion gain, selectivity, overload, automatic gain control, image and intermediate frequency rejection ratios, quieting and stage gain.

Driving source for slotted lines, for R-F bridges, and

other impedance measuring devices.
Standing wave measurements on transmission lines.
Measuring antenna patterns and gain.
Testing and alignment of Citizen's Band, UHF television, FM, and Mobile communication equipment.

WRITE FOR BULLETIN

Laboratory Standards



MEASUREMENTS

A McGraw-Edison Division

BOONTON, NEW JERSEY

Circle 144 on Inquiry Card

New Products

RADIATION COUNTER

Input sensitivity ranges from 10mv. to 100v.

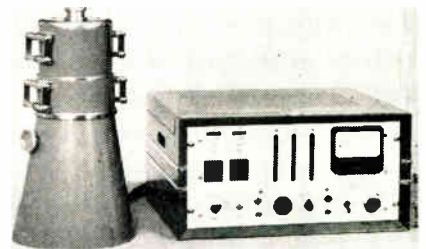

The Model S3HVD Vicount Scaler can be used for Geiger, scintillation, or proportional counting purposes. The instrument indicates both preset and elapsed time as well as preset and elapsed count up to 10 million total counts. Preset count is in 1000 count steps. Elapsed timer and preset timer are in steps of 0.01 up to 99.99 minutes. A single button resets the Sodeco registers and electronic decades. The Victoreen Instrument Co., 5806 Hough Ave., Cleveland 3, Ohio.
Circle 371 on Inquiry Card

New RELAY PROVIDES 0.000,000,001 WATT DC SENSITIVITY

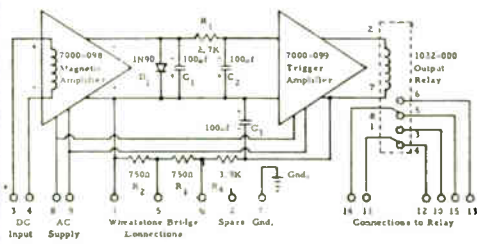

SCHEMATIC DIAGRAM, MODEL 301 INDUSTRIAL "ACRO-RELAY"

This industrial "ACRO-RELAY", Model 301, closes its output relay with a DC signal of 1.0 microamp and 1.0 millivolt into its 1000 ohm input winding—an input power of only 10^{-9} watts! It is the most sensitive, high-reliability industrial relay unit available. The input magnetic amplifier drives a trigger amplifier which drives the DPDT output relay . . . controlling up to 1800 watts!

Model 301 units available from stock for IMMEDIATE DELIVERY!
Price for 1-5 units: \$118.75 each.
Full details available in Bulletin No. 30-A.



TRIMMER CAPACITORS

Two glass piston units for panel or printed circuit mounting.

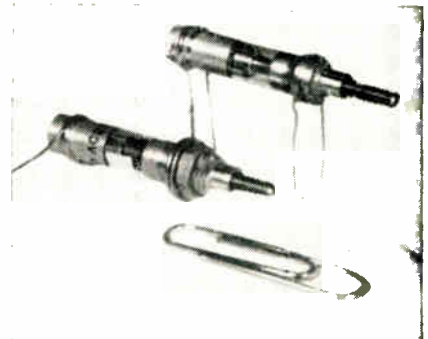

Featuring a direct traverse mechanism with an expandable self-aligning-spring piston, they are adjustable either from the base or through the opposite open end of the glass tube by means of the screwdriver slotted adjustment shaft. Models VC52 for panel mount and VC53 printed circuit mount feature 1.0 to 12.0p, 1000vdc; 2000vdc dielectric strength; 500 Q factor; -55°C to $+125^{\circ}\text{C}$ operating temp.; length above panel in less than 1 in.; and weight, 5 grams. JFD Electronics Corp., 6101 16th Ave., Brooklyn 4, N. Y.

Circle 372 on Inquiry Card

acromag
INCORPORATED

22515 TELEGRAPH RD. SOUTHFIELD (DETROIT), MICH.

PHONE: ELGIN 7-0030

TELETYPE:

SFLD-970

SHIELDING TAPE

Flexible foil adheres to any wire, cable termination or assembly.

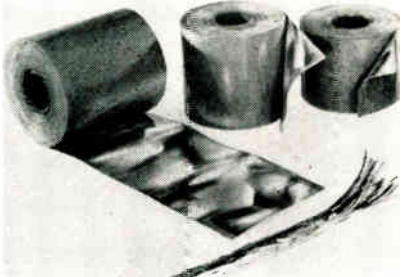

The tape consists of a flexible aluminum foil laminated to a Mylar film and coated with a pressure sensitive adhesive back. It is 0.004 in. thick. Provision for grounding is made by use of special grounding rivets with attached ground straps. A grounding kit is supplied with each 100 ft. roll of foil. The tape is available in 6 sizes from 1¼ to 4½ in. to cover wire and cable with outside dia. up to 1¾ in. Alpha Wire Corp., 200 Varick St., New York, N. Y.

Circle 373 on Inquiry Card

WELD-HEAT SELECTOR

Lets operator complete weld schedule without making heat adjustments.

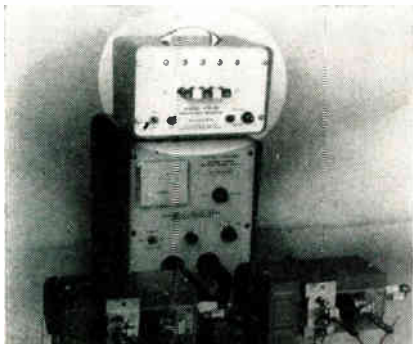

The standard unit, designated the VTA-53, permits preselection of 5 different weld heats from the electrolytic welding power supply to which it is connected. Push-button switches activate each channel and are self lighting to show the channel in operation. Weld heats are selected by potentiometer adjustments. No tape mechanisms are used. A second version, the Model VTA-52, is made for use with oil filled capacitor type welders. Hughes Aircraft Co., Vacuum Tube Products Div., 2020 Short St., Ocean-side, Calif.

Circle 374 on Inquiry Card

"NEW NAME" IN LOUDSPEAKERS



from a 3" tweeter to a 15" woofer

PADUCAH, KY. (Special)—

The name has changed. The world-famous quality has not. The industry's greatest pool of loudspeaker knowledge has been acquired by CTS from Magnavox.

The 106,000 sq. ft. modern Paducah plant makes only loudspeakers—including most of the components for maximum quality control. Facilities comprise the very latest in metal stamping equipment, precision coil winding, plating, assembly and inspection. Precision workmanship produces the closest tolerance between moving coil and magnet.

The respected long-established tradition of excellence will be continued . . . and further enhanced . . . by CTS, a firm with a world-wide reputation for dependable electronic components.

Get the whole story on this exciting "new" name in speakers from your nearby CTS engineer.

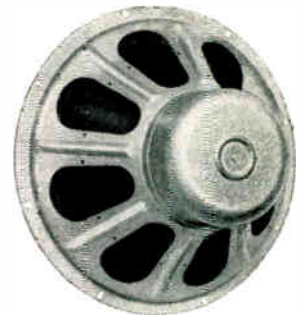

Send for Catalog P-101 today. It lists 128 standard loudspeaker models. Others can be "tailored" to your specific requirement.



CTS OF PADUCAH, INC.
1500 No. 8th Street, Paducah, Kentucky

a subsidiary of
CTS CORPORATION
Elkhart, Indiana

FORMERLY CHICAGO TELEPHONE SUPPLY CORPORATION

Here is MEASURED RELIABILITY!

DUR-MICA CAPACITORS TYPE M2DM

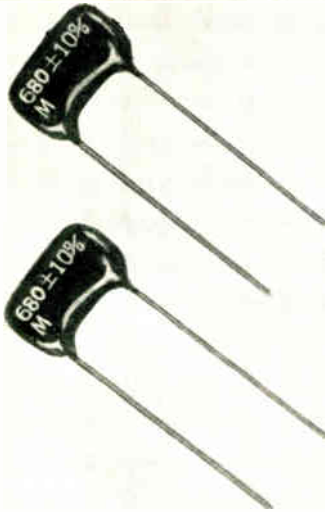

Ten thousand EL-MENCO high reliability dipped mica capacitors were put on life test at 85°C with 225% of the rated DC voltage applied—After 26,500,000 actual test unit-hours no failures of any type occurred.

The accumulated 26.5×10^6 test unit-hours without any failures can be used to calculate many different failure rates depending upon the confidence level desired. However, we shall explore the meaning of the results at a 90% confidence level.

Assuming no acceleration factor for either temperature or voltage, we have verified a failure rate of less than 0.01% per 1000 hours. (Actually, there is a temperature effect and it has been found that, with the DC voltage stress remaining constant, the life decreases approximately 50% for every 10°C rise in temperature. There is also a voltage effect such that, with the temperature stress remaining constant, the life is inversely proportional to the 8th power of the applied DC voltage.)

Assuming no temperature acceleration factor and assuming the voltage acceleration exponent is such as to yield an acceleration factor as low as 100, we have nevertheless verified a failure rate of less than 0.0001% per 1000 hours.

Assuming no temperature acceleration factor and assuming the voltage acceleration factor is on the order of 250 (test results are available to confirm this) we have accumulated sufficient unit-hours to verify a failure rate of less than 0.00004% per 1000 hours!

Note that all the above failure rates are calculated at a 90% confidence level!

Only 1 Failure in 14,336,000 Unit-Hours for 0.1 MFD Capacitors

Life tests have proved that El-Menco Mylar-Paper Dipped Capacitors — tested at 105°C with rated voltage applied—have yielded a failure rate of only 1 per 1,433,600 unit-hours for 1.0 MFD. Since the number of unit-hours of these capacitors is inversely proportional to the capacitance, 0.1 MFD El-Menco Mylar-Paper Dipped Capacitors will yield ONLY 1 FAILURE IN 14,336,000 UNIT-HOURS.

MINIMUM LIFE EXPECTANCY FOR 1.0 MFD ** MYLAR-PAPER DIPPED CAPACITORS AS A FUNCTION OF VOLTAGE & TEMPERATURE

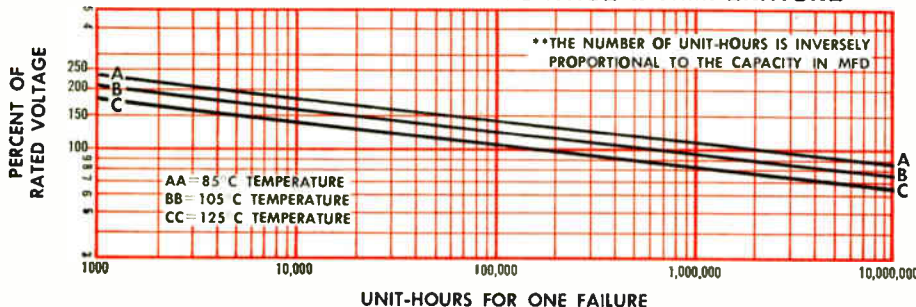

*Registered Trade Mark of DuPont Co.

Write for Reliability Study and technical brochures.

THE ELECTRO MOTIVE MFG. CO., INC. WILLIMANTIC, CONNECTICUT

*Dipped Mica • Molded Mica • Silvered Mica Films • Mica Trimmers & Padders
Mylar-Paper Dipped • Paper Dipped • Mylar Dipped • Tubular Paper*

ARCO ELECTRONICS, INC., Community Drive,
Great Neck, L. I., New York
Exclusive Supplier to Jobbers and Distributors
in the U. S. and Canada

West Coast Manufacturers Contact:
COLLINS & HYDE CO., 535 Middlefield Road,
Palo Alto, California
1250 E. Artesia Avenue, Long Beach, California

MYLAR-PAPER DIPPED CAPACITORS TYPE MPD

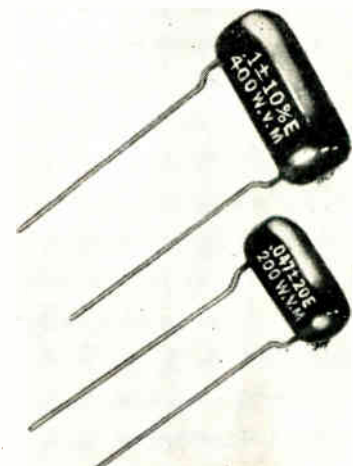

MANUFACTURERS OF
El-Menco
Capacitors

**Immediate
delivery!**
**ELMENCO
CAPACITORS**

in quantities up to
500 Per Item

**CONTACT THESE AUTHORIZED
ELMENCO INDUSTRIAL DISTRIBUTORS**

ARIZONA: Radio Spec. & Appl. Corp., Phoenix; Standard Radio Parts Inc., Tucson.
CALIFORNIA: Brill Elect., Oakland; Electronic Supply Corp., Pasadena; Federated Purchaser Inc., L. A.; Hollywood Radio & Electronics, Inc., Hollywood; Newark Electronics Corp., Inglewood; Pacific Wholesale Co., San Francisco; Peninsula Elect., San Jose; Shanks & Wright Inc., San Diego; Shelley Radio Co., Inc., L. A.; R. V. Weatherford Co., Glendale; Zack Electronics, Palo Alto.
COLORADO: Denver Electronic Supply Co., Denver.
DISTRICT OF COLUMBIA: Capitol Radio Wholesalers Inc., Wash.; Electronic Wholesalers, Inc., Wash.
FLORIDA: East Coast Electronics, Inc., Orlando; Elect. Supply, Melbourne; Elect. Supply, Miami.
ILLINOIS: Newark Electronics Corp., Chicago.
MARYLAND: D & H Dist. Co., Inc., Baltimore; Kann-Ellert Electronics, Inc., Baltimore; Wholesale Radio Parts Co., Inc., Baltimore.
MASSACHUSETTS: Cramer Electronics Inc., Boston; Radio Shack Corp., Boston.
MICHIGAN: Newark-Ferguson Electronics, Inc., Detroit.
NEW JERSEY: Federated Purchaser Inc., Mountainside; General Radio Supply Co., Camden; Radio Elec. Service Co., Inc., Camden.
NEW MEXICO: Electronics Parts Co., Albuquerque; Midl and Specialty Co., Albuquerque; Radio Spec. Co., Inc., Alamogordo.
NEW YORK: Arrow Elect., Inc., Mineola; Electronics Center, Inc., N.Y.C.; Harvey Radio Co., Inc., N.Y.C.; Lafayette Radio Elect. Corp., N.Y.C.; Milo Electronics Corp., N.Y.C.; Stack Industrial Elect., Binghamton; Terminal-Hudson Elect., Inc., N.Y.C.
NORTH CAROLINA: Dalton-Hege Radio Supply Co., Inc., Winston-Salem.
PENNSYLVANIA: Almo Radio Co., Philadelphia; George D. Barbey Co., Inc., Lancaster; George D. Barbey Co., Inc., Reading; D & H Dist. Co., Inc., Harrisburg; Phila. Elect. Inc., Philadelphia; Radio Elec. Service Co., Philadelphia; A. Steinberg & Co., Philadelphia; Wholesale Radio Parts Co., Inc., York.
TENNESSEE: Electra Dist. Co., Nashville.
TEXAS: All-State Elect., Inc., Dallas; Busacker Elect. Equip. Co., Inc., Houston; Engineering Supply Co., Dallas; Midland Specialty Co., El Paso.
UTAH: Carter Supply Co., Ogden.
WASHINGTON: C & G Electronics Co., Seattle.
CANADA: Atlas Wholesale Radio, Inc., Montreal 9, Que.; Electro Sonic Supply Co., Ltd., Toronto 5, Ont.

ARCO
electronics inc.

Community Drive, Great Neck, New York
NEW YORK • DALLAS • LOS ANGELES
Exclusive Supplier of ELMENCO Capacitors to
Distributors and Jobbers in U.S.A. and Canada

Circle 87 on Inquiry Card

**New
Products**

DECADE VOLTAGE DIVIDER

Terminal linearity is 1ppm; input resistance is 100k Ω , $\pm 0.005\%$.

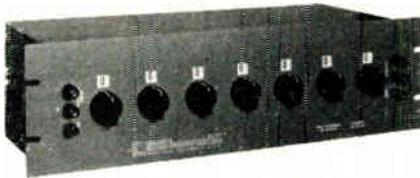

Model R7-722 Dekavider Decade Voltage Divider is a precision, 7-decade, resistive voltage divider using the Kelvin-Varley circuit. Resolution is 10 million divisions in 0.1ppm steps. Output voltage does not differ from the input voltage times the divider setting by more than 1/1,000,000 of the input voltage. The 7th dial reads in tenths of one part per million for increased resolution in making precision measurements. Electro Scientific Industries, 7524 S.W. Macadam Ave., Portland 19, Ore. (Formerly Electro Measurements, Inc.)

Circle 375 on Inquiry Card

COMMUTATOR

Suited to systems requiring break before-make operation.



The RSC Drireed Shutter Controlled Commutator provides precise phasing control between decks or of individual decks to any specific timing sequence. Rotating speeds up to 1200RPM are feasible and contact closure tolerances as low as 1.8° of input shaft position are available. The RSC commutator can be used for switching and commutating low level signals from pickups, transducers, thermocouples, strain gages, and accelerometers. Hathaway Instruments, Inc., 5800 E. Jewell Ave., Denver 22, Colo.

Circle 376 on Inquiry Card

**dial any output
from 0-1000 volts!**

Keithley Regulated DC Supplies provide the stability, ease and accuracy necessary for a wide range of laboratory tests. Typical applications include calibration of meters and dc amplifiers; testing insulation, diode, and capacitor leakage resistances; or furnishing potentials for photo-multiplier tubes and ionization chambers.

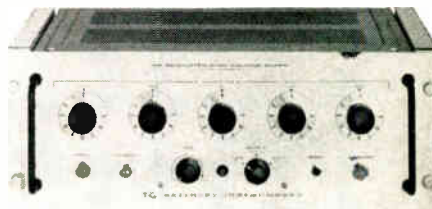

MODEL 241—0.05% accuracy

A dc secondary standard featuring a long-life photo-chopper and zener reference. It is immune to shock and vibration, and offers long-term calibration stability.

- Accuracy: 0.05% or 1 millivolt.
- DC Output Voltage: 0-1000 volts—plus, minus or floating, with 5 calibrated dials and 100 μ v resolution.
- Output Current: 20 milliamperes max.
- Stability: 0.005% short term.
- Ripple: less than 1 mv RMS.
- Overload Protection: fast-acting relay circuit.
- Price: \$800.00



MODEL 240—1.0% accuracy

A general-purpose version of the Model 241 available at lower cost.

- Accuracy: 1.0% or 100 millivolts.
- DC Output Voltage: 0-1000 volts—plus or minus, with 3 calibrated dials and 10 mv resolution.
- Output Current: 10 milliamperes max.
- Stability: 0.05% per eight hours.
- Ripple: less than 3 mv RMS above 5 cps.
- Overload Protection: Fast-acting relay circuit.
- Price: \$345.00



full details in latest catalog

**KEITHLEY
INSTRUMENTS**

12415 Euclid Avenue • Cleveland 6, Ohio

Circle 146 on Inquiry Card

OUNCER AUDIO TRANSFORMERS and REACTORS



IMMEDIATE DELIVERY From Stock

THE UTC OUNCER line consists of a full range of input, mixing, interstage, output transformers and reactors for both transistor and tube application. OUNCER items are ideal for aircraft, portable broadcast, hearing aid, concealed service, and similar applications. High fidelity characteristics are provided. These units, weighing only one ounce, are fully impregnated in a drawn aluminum housing $\frac{7}{8}$ " diameter. A hipermalloy shield is available providing 25 db shielding. Power levels run from milliwatts to 1 watt. Frequency range runs from 30 cycles to 20 KC. Impedances are available in practically any value from 7.5 ohms to 1 megohm.

"P" series units are identical to UTC OUNCERS but are sealed in bakelite housings of submersion proof design, weighing 2 ounces, with plug-in base to fit standard octal socket.

UNITED TRANSFORMER CORPORATION

150 Varick Street, New York 13, N.Y.

PACIFIC MFG. DIVISION

3630 Eastham Drive, Culver City, Calif.
EXPORT DIVISION

13 East 40th Street, New York 16, N. Y.

WRITE FOR LATEST CATALOG

Circle 88 on Inquiry Card

New Products

POWER SUPPLY

Model HVA 1000-102 is a compact 100kvdcc, 1 ma output unit.

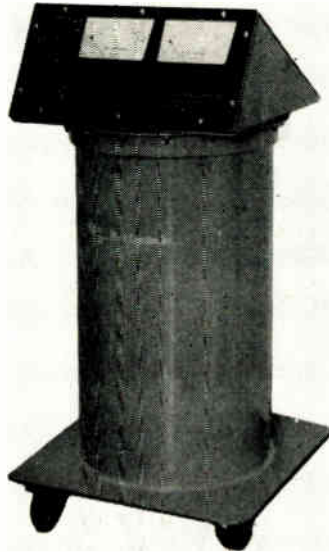

It is for use in the laboratory for ozone generation, cable or insulation fault testing, and dust precipitation. An oil filled cylinder houses the capacitors, rectifiers, resistors, etc. The instrument center, atop the HV assembly contains a voltmeter, current meter, overload relays, switches, output voltage controls, etc. It measures 16 x 16 in. base and height is 32 in. Weight: 120 lbs. Plastic Capacitors, Inc., 2620 N. Clybourn Ave., Chicago 14, Ill.

Circle 377 on Inquiry Card

MINIATURE RELAY

Type JR measures 0.2 x 0.4 x 0.5 in. and weighs 5 grams.

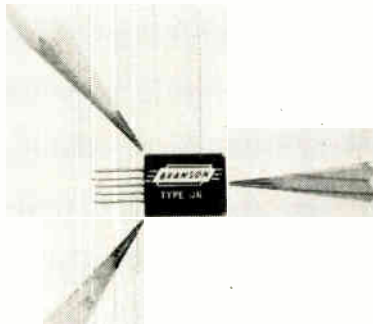

It is for printed circuit use in computers, data processing, and airborne instruments. The unit meets or exceeds all applicable Mil specs. and is available in several voltage ranges. It has contact rating of 1a, 28 vdc and may also be used in dry circuit applications. Branson Corp., 41 S. Jefferson Rd., Whippany, N. J.

Circle 378 on Inquiry Card

O-SCOPE CALIBRATOR

Direct reading dials set X and Y reference voltages.

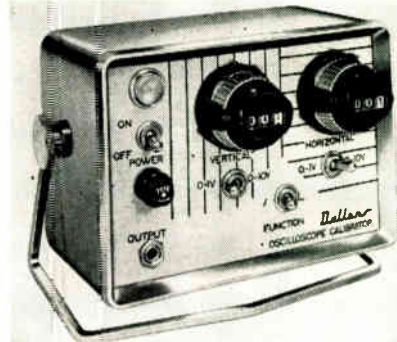

Model SC-100 has an accuracy of 0.25% and resolution of 0.001v and 0.01v depending upon the scale chosen. Voltages are displayed simultaneously on the oscilloscope in either of 2 modes—"L" shaped pattern or diagonal pattern, thus enabling setting of both axes at one time. Model SC-100 measures 7 x 5 x 6 in. including recessed knobs. It comes with a handle which can be used as a stand or shelf bracket. Dallons Laboratories, Inc., 120 Kansas St., El Segundo, Calif.

Circle 379 on Inquiry Card

SSB ADAPTER

Model SSB/DSB 61-1A's carrier freq. covers from 1.5 to 30MC.

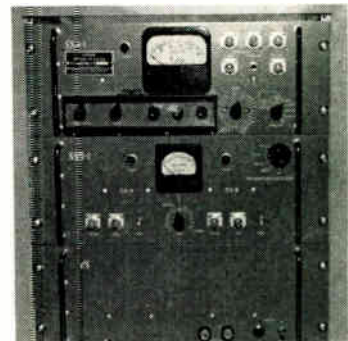

It is a complete, self-contained system allowing high level AM transmitters to be converted to SSB operation without modification. The Envelope Elimination and Restoration technique (EER) is used. Converted transmitters develop a PEP of 3 to 4 times normal AM carrier rating. It is housed in 3 rack panel units with outputs for 1 or 2 transmitters operating on separate radio freqs. but modulated by the same information. Kahn Research Laboratories, Inc., 81 S. Bergen Place, Freeport, L. I., N. Y.

Circle 380 on Inquiry Card

SCREWDRIVERS

Features: heat-treated alloy steel; non-flammable plastic handle.

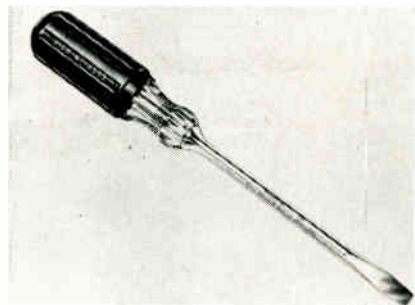

This line is fully chrome plated to prevent rust. The cushion grip is of nitrile rubber, locked onto the handle for a comfortable grip and greater turning power. Resistant to oil, gas and water. Available in square shank and round shank styles for regular slotted head or Phillips head screws. Sizes from 3 to 10 in. Mathias Klein & Sons, Inc., Chicago, Ill.

Circle 381 on Inquiry Card

MINIATURE POTENTIOMETER

The VL/8 is for printed circuit and high parts density module use.

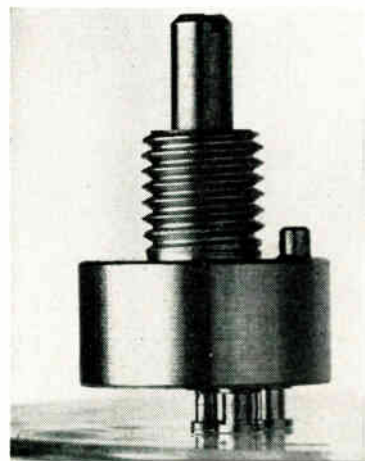

It has numbered positions on the case for fast and accurate reading of the wiper position over a rotational span of 320° controlled by mechanical stop. The metallic case and wire leads are color-coded at the base to permit simple connections into standard printed circuits or modules. Available in a resistance range from 10Ω to 15kΩ. Will operate over a temp. range from -55° to +150°C. Build to meet Mil-R-19A specs. Water Mfg., Inc., Wayland, Mass.

Circle 382 on Inquiry Card



Did he have wave filters in mind?

Чебышёв

Above is the original Russian spelling of Chebyshev, the name of a nineteenth century mathematician to whom modern network theory owes a debt of gratitude. His well known polynomials were published in "Oeuvres" Vol. 1, St. Petersburg, 1899, for use in studying the construction of steam engines. Obviously, he didn't have wave filters in mind.

When Chebyshev Polynomials are applied to modern filter synthesis they produce ladder networks with controlled pass band ripple, and roll-off which is more rapid than that produced by "classical" networks such as the image parameter "constant K".

The illustration below shows the improved sharpness at cutoff and increased roll-off rate for a one section Chebyshev Filter. Admittedly, this is a simplified example, but it provides an easily understandable comparison between "old" and "new" design methods.

When the use of more sophisticated tools such as elliptic functions and Bessel Polynomials are added to the Chebyshev Polynomials, Modern Network Synthesis becomes a powerful vehicle for the realization of today's computer and space oriented filtering problems.

ADC staff specialists are skilled in the art of Modern Network Synthesis. The classical, modern or computer approach to network design is used as each may fit a particular application. Facilities include those for design, prototype sampling, testing, and production.

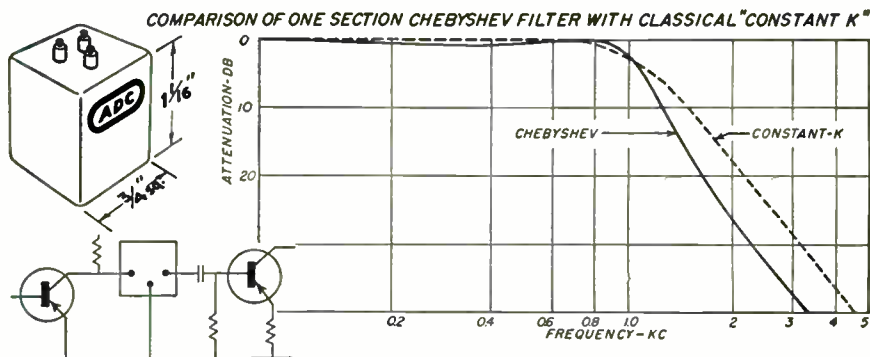

If modern network theory and its application is of interest to you, we'll be glad to send you a copy of "General Approaches to Wave Filter Design"—no charge, no obligation.



ADC PRODUCTS

A Division of Magnetic Controls Company

6405 CAMBRIDGE ST. • MINNEAPOLIS 26, MINNESOTA

TRANSFORMERS • REACTORS • FILTERS • JACKS AND PLUGS • JACK PANELS

REDCOR ACTIVE FILTER

MODEL 440

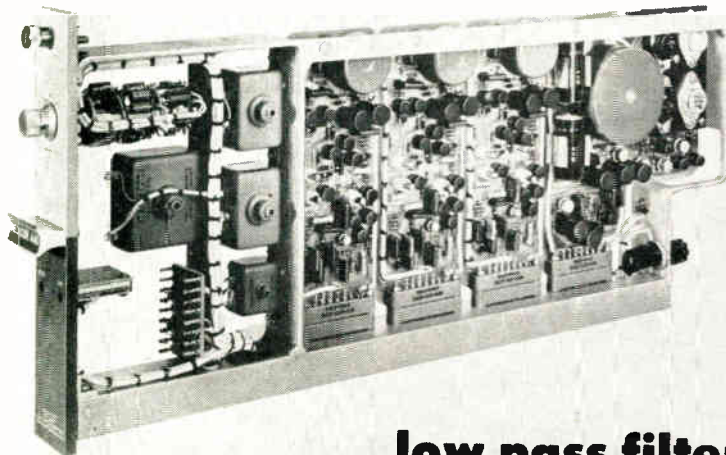

low pass filter

...with frequency & phase response identical to that of a fourth order Butterworth

DATA GATHERING SYSTEMS FOR SIGNAL CONDITIONING

... the accuracy of the 3db point, attenuation characteristic, and insertion loss is controlled within $\pm 0.05\%$ of a true Butterworth, thus allowing noise signals which are close to frequencies of importance to be filtered out without degradation of accuracy.

FOR COMPUTER OPERATION

... the attenuation characteristic can be logged into the computer memory for use as "table look-up" corrections to the data.

OTHER SPECIFICATIONS

The Redcor Model 440 active filter is completely solid state. The frequency response extends to DC and the DC stability is controlled by high gain chopper stabilized amplifiers. The input impedance of the filter is 1000 megohms and the source impedance can vary within the range 0 - 5000 ohms without degradation of accuracy.

Prices start from \$1300.00, F.O.B. Canoga Park, Calif.

Engineers: If your field is analog/digital data systems or component designs, a career opportunity awaits you at Redcor. Write to Personnel Director.



REDCOR CORPORATION

7760 Deering Avenue • P.O. Box 1031 • Canoga Park, California
Telephone: Diamond 8-5892 / TWX CNPK-5503

Write for full information today to Dept. EI 462

Circle 90 on Inquiry Card

New Products

TRANSISTOR TEST SET

Tests Unijunctions for η , R_{BB} , V_{BE} (SAT), $I_{B2}(MOD)$, I_P , V_{OBI} , and I_{BO} .

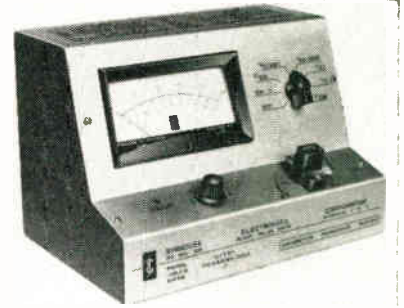

Wide range test set measures all the important parameters on standard commercial types of unijunction transistors. Suitable for lab. or limited production testing, this instrument measures stand-off ratio, inter-base resistance, emitter saturation voltage, base-two modulated current, peak point current, base one peak pulse voltage and emitter leakage current. For convenience of operation, a single switch selects the test to be performed and 6 of the tests are direct reading. Syracuse Electronics Corp., P. O. Box 566, Syracuse 1, N.Y.

Circle 383 on Inquiry Card

INSTRUMENT CART

This cart hold a variety of instruments and is ruggedly built.

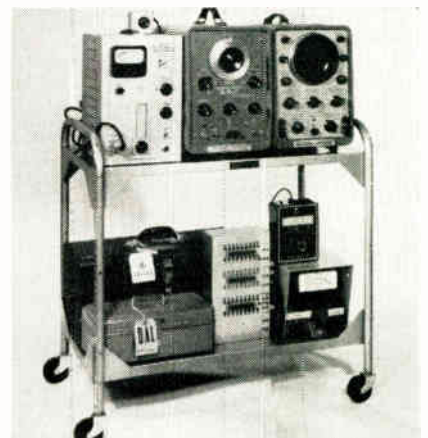

Constructed of quality 1 in. dia. steel tubing. It has 2 steel trays constructed of 20 gage steel. Mobility is provided by four 3-in. swivel caster wheels. Dimensions are 16 x 32 x 32 in. Finish is grey lacquer. The cart has a provision for an extra shelf. Atlantis Metal Products Div., P. O. Box 451, Garland, Tex.

Circle 384 on Inquiry Card

ELECTRONIC INDUSTRIES • April 1962

Circle 91 on Inquiry Card →



Space Restricted? Application Severe?

*Allen-Bradley
Miniature Hot Molded
Variable Resistors Provide
Smooth Control
Which Improves
With Use!*

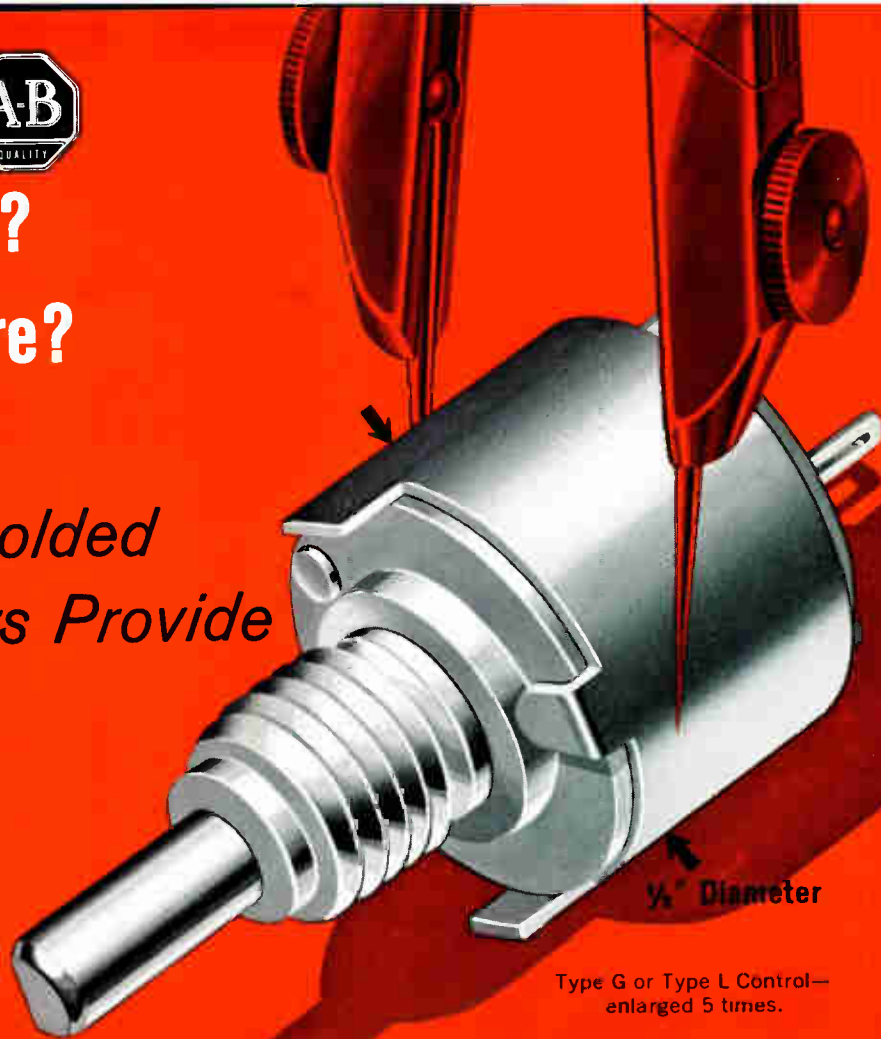

With locking bushing



With watertight panel seal



With encapsulation

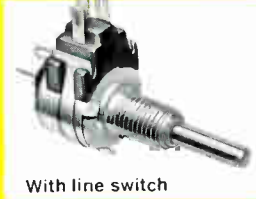

With line switch



For board mounting

The same reliability and superior performance of Allen-Bradley's famous hot molded construction is found in this "space-saving" size. The solid resistance element, collector track, terminals and insulating material are all hot molded—by A-B's *exclusive* process—into a single solid structure. Molded contact brushes eliminate sliding metal contacts. This assures exceptionally low "noise" initially, and this quality feature improves with use. Incidentally, the operational life exceeds 50,000 cycles with less than 10% resistance change.

These miniature controls are available as:

Type G—For use over ambient temperature range from -55°C to $+120^{\circ}\text{C}$. Rated 0.5 watt at $+70^{\circ}\text{C}$.

Type L—For use over ambient temperature range from -55°C to $+150^{\circ}\text{C}$. Rated 0.8 watt at $+70^{\circ}\text{C}$.

Both furnished in maximum resistances from 100 ohms to 5 megohms. For full details on these *quality* controls, please write for Technical Bulletin B5201.

ADDITIONAL A-B HOT MOLDED CONTROLS



The Type F controls are especially designed for printed board mounting. Terminals fit 0.1 inch spacing. Type F temperature range -55°C to $+120^{\circ}\text{C}$, rated 0.25 watt at $+70^{\circ}\text{C}$. Type O temperature range -55°C to $+150^{\circ}\text{C}$, rated 0.4 watt at $+70^{\circ}\text{C}$.

Type R adjustable fixed resistors allow stepless adjustment. Moving element is self-locking for absolutely stable settings. Watertight case permits encapsulation. For continuous use from -55°C to $+125^{\circ}\text{C}$, rated 0.25 watt at $+70^{\circ}\text{C}$.

Allen-Bradley Co., 222 West Greenfield Ave., Milwaukee 4, Wis. • In Canada: Allen-Bradley Canada Ltd., Galt, Ontario

5-62-E

ALLEN-BRADLEY

**QUALITY
ELECTRONIC
COMPONENTS**

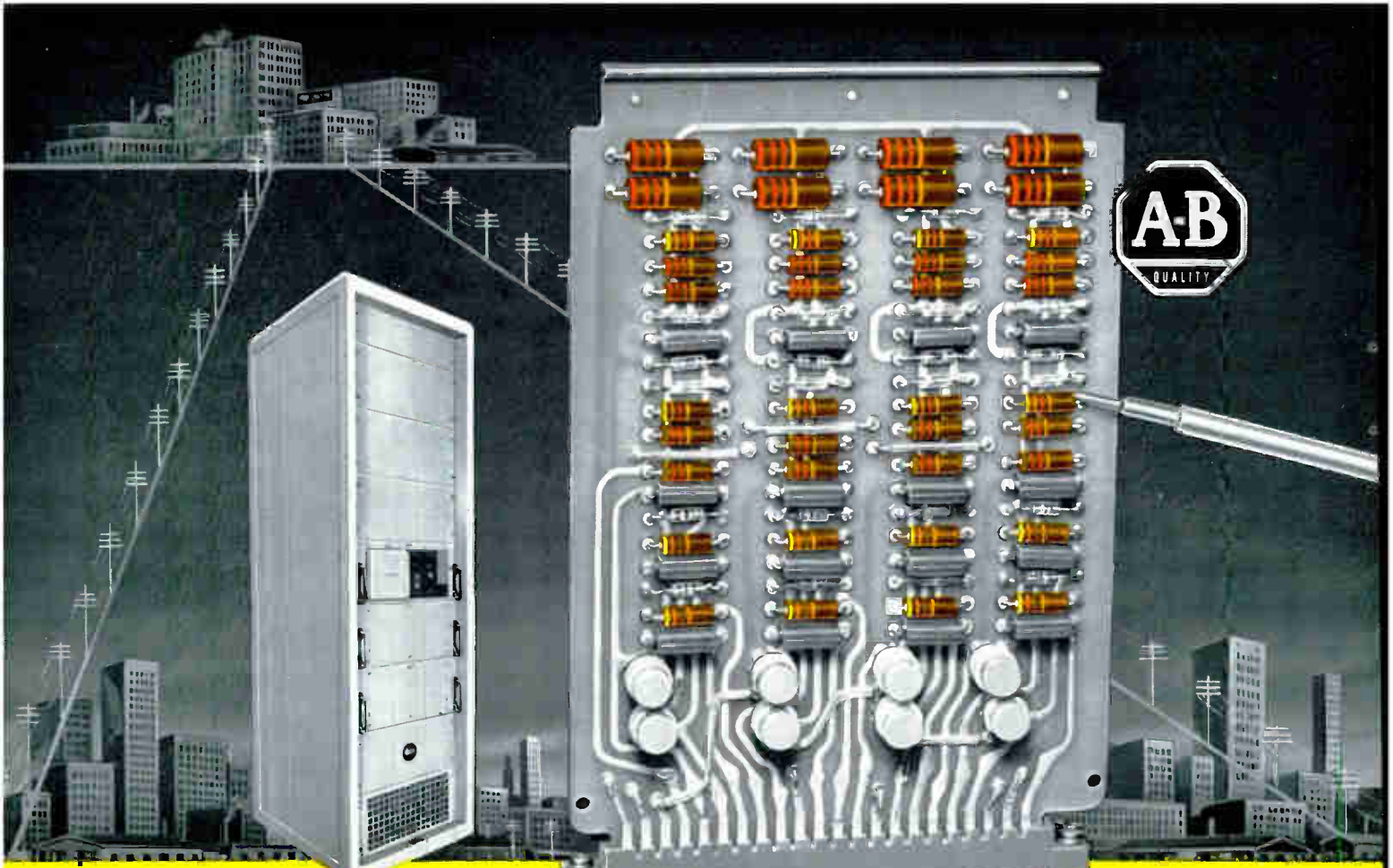

Collins TE-210 Kineplex modem capable of transmitting binary data at 2400 bits per second over 3kc voice band-width facilities, and close-up of a single circuit card showing large numbers of Allen-Bradley hot molded resistors.

COLLINS KINEPLEX® brings greater speed and efficiency to communications

Allen-Bradley Hot Molded Resistors Guarantee Reliable and Continuous Performance for This Part of the System

As today's communication equipment is called upon to handle far greater volumes of information quickly and accurately, uninterrupted operation becomes more and more important.

To obtain this needed reliability, modern high-speed transmission systems, such as the new Collins Kineplex, employ Allen-Bradley quality fixed resistors. Made by A-B's *exclusive* hot molding process, they are so remarkably uniform that their long term performance is

accurately predictable in service. Also, where Allen-Bradley hot molded resistors are used, "catastrophic failure" is unheard of!

Always insist on Allen-Bradley hot molded fixed resistors—at least thirty years of field experience have demonstrated that they have no equal on the market. For full details on the complete line of A-B quality components, please write for Publication 6024.

Allen-Bradley Co., 222 W. Greenfield Ave., Milwaukee 4, Wis. • In Canada: Allen-Bradley Canada Ltd., Galt, Ont.

ALLEN-BRADLEY Hot Molded Resistors

are available in all standard EIA and MIL-R-11 resistance values and tolerances.

*Pending MIL Spec Assignment

Type TR
1/10 watt
MIL Type
RC 06*

Type CB
1/4 watt
MIL Type
RC 07

Type EB
1/2 watt
MIL Type
RC 20

Type GB
1 watt
MIL Type
RC 32

Type HB
2 watts
MIL Type
RC 42

ALLEN-BRADLEY

Quality
Electronic
Components

New

Products

VIDICON

Features frame durations from 1/30th of a second to several minutes.

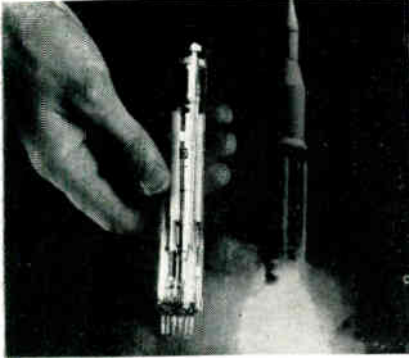

Electrostatically deflected and focused slow-scan vidicon tube is for space communications. The WX 4384 has low deflection voltages for use with transistorized deflection circuitry. It uses a type of slow-scan photoconductor to give high-sensitivity and high-resolution performance in narrow bandwidth systems. Option of flash exposure to "freeze" motion or the integration of low light level static scenes offered. Westinghouse Electronic Tube Div., Box 284. Elmira, N. Y.

Circle 385 on Inquiry Card

MICRO-VOLTMETER

Model A-60, transistorized, has full scale ranges of 3µv to 1000v.

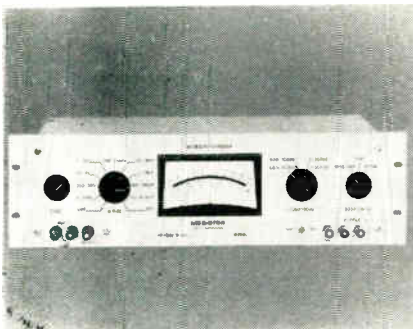

The input section is fully floating and guarded. Common mode rejection exceeds 140db at 500vdc. A logarithmic and continuously variable gain position is also provided. The accuracy of the calibrated ranges is within 2%. For use with resistance bridges, potentiometric voltmeters, and other null applications, as well as for general purpose voltage measurements. Medistor Instrument Co., 1443 Northlake Way, Seattle 3, Wash.

Circle 386 on Inquiry Card

ELECTRONIC INDUSTRIES • April 1962

← Circle 92 on Inquiry Card

YOURS TODAY-

A frequency standard so accurate that it measures time with a rate of change of less than one second in sixty years!

5 x 10⁻¹⁰/DAY



Total Dimensions, Standard and Power Supply: 7½" W x 6"H x 12½"D. Shown mounted in 7" x 19" rack panel.

THE JK-SULZER FS-1100T FREQUENCY STANDARD is a standard of frequency and time . . . born of and for the age of space. It is fully transistorized. A double proportional control oven houses a 1 mc precision quartz crystal having a Q exceeding 2 million. Each unit is built, aged, and calibrated at Washington, D.C., against groundwave signals of WWV. Simultaneous outputs of 1.0 mc and 100 kc. A companion power supply permits operation from 115 volt AC plus automatic 12 hours minimum of emergency or portable operation from batteries. Today, you can order this 5 x 10⁻¹⁰/Day stability, for early delivery, for a wide range of research and test applications. Write for technical literature.

The James Knights Company, Sandwich, Illinois

SPECIALISTS IN FREQUENCY MANAGEMENT for space exploration programming, high speed navigation, and spectrum conservation in the growing communications field. Circle 151 on Inquiry Card

- KEEP YOUR OPERATING COSTS WHERE THEY SHOULD BE!
- ELIMINATE DELAYS!

GREEN Pantograph Engravers

MODEL D-2 HEAVY-DUTY 2-DIMENSIONAL
Pantograph for milling, drilling and engraving.



Vertical adjustment of copy table automatic with Pantograph. Features: unobstructed on 3 sides to take large work; micrometer adjustment for depth of cut; ball bearing construction throughout; spindle speeds up to 26,000 rpm for engraving or machining; vertical range over 10"; ratios 2 to 1 to infinity—master copy area 26" x 10".

You Make Your Own Engraved Nameplates!

PORTABLE 40-POUND BENCH MODEL 106

Here is a speedy, economical 2 or 3-dimensional engraver used by thousands of dollar-conscious companies. It features 5 positive, accurate pantographic ratios; ball bearing spindle with 3 speeds up to 14,000 rpm. Is supplied with one copy carrier that accepts all standard master type sizes. Will actually work up to 10" by any width. Height of pantograph and position of cutter are continuously adjustable.

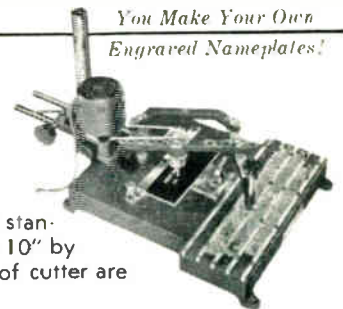

MODEL D2-201
PNEUMATIC
ATTACHMENT

for use with Model D2 Pantograph Engraver to rapidly drill holes in printed circuits by tracing templates. Drills as many as 100 holes per minute. Equipped with foot switch; spindle air cylinder; regulating valve and pressure gauge; filter and oiler. It's ready to use as soon as it's attached to an air compressor.

Write or call for full details and prices.

GREEN INSTRUMENT COMPANY, INC.

Dept. 59, 295 Vassar St., Cambridge 39, Mass. Tel. ELiot 4-2989

Circle 152 on Inquiry Card

157

SIZE 11 WINDING-COMPENSATED SYNCHRO RESOLVER



Precision, lightweight, high-accuracy components with applications in analog computers and automatic control systems. The compensator winding provides feedback voltage for a resolver isolation amplifier; the feedback loop automatically adjusts to compensate for temperature and frequency variations. Function error of the R980-018 is only 0.1%. A compatible transistorized amplifier, Kearfott number S3100-01A, is available.

	Part Number	5R980-41	CR9 0980 001 R980-018
CHARACTERISTICS	Excitation (volts) (max.)	60	26
	Frequency (cps)	400	400
	Total Null Voltage (mv)	25	10
	Max. Error from E.Z. (minutes)	5	5
	Operating Temp. Range (°C)	-55 to +125	-55 to +125

For complete data write Kearfott Division, General Precision, Inc., Little Falls, New Jersey.

KEARFOTT

DUAL- CHANNEL TRANSISTORIZED BUFFER AMPLIFIERS



These high-performance units are designed to drive Kearfott's Size 11 R980 winding-compensated synchro resolvers. The amplifier-resolver combination has stable gain characteristics and negligible phase shift through an ambient temperature range of -50°C to +85°C. Extremely high resistance to shock and vibration. Meet environmental requirement of MIL-E-5272.

	Part Number	S3100-01
CHARACTERISTICS	Number of Inputs	4 per channel
	Input Impedance (ohms resistive at 25°C)	100,000
	Voltage Gain	1±0.0005
	Phase Shift (rotor output to input at 25°C)	less than 15 min.
	Max. Signal Output Voltage	16 volts
	Gain Stability Over Operating Temp. Range	1±0.05%

For complete data write Kearfott Division, General Precision, Inc., Little Falls, New Jersey.



GENERAL PRECISION

New

Products

NEUTRON DETECTORS

Model WL-8105 features 8 decade operation and low cost.

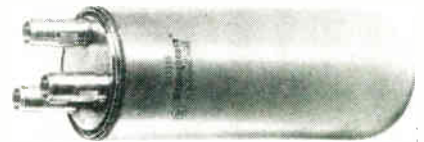

The detector, part of the new "Econoline" line, is a compensated ionization chamber. A full guard-ring construction and the use of stabilized polystyrene minimizes signals due to electrical leakage, resulting in a very low inherent noise level. At the operating voltage of 800v, the thermal sensitivity is approx. 2×10^{-14} a/neutron/cm²/sec. Gamma sensitivity when the detector is in uncompensated operation is approx. 5×10^{-12} a/R hr. Westinghouse Electronic Tube Div., Box 284, Elmira, N. Y.

Circle 387 on Inquiry Card

POWER SUPPLY

Voltage output: 5.000v adjustable to ½mv at 150ma.

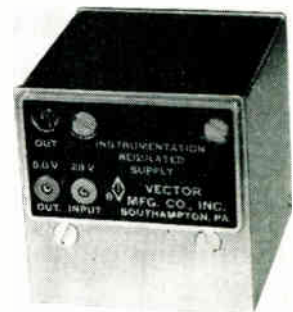

This 1½ in. cube instrumentation power supply incorporates dynamic short circuit and reverse polarity input protection and features high regulation of the output voltage over the specified temp. range. Voltages of up to 10v and currents of up to 500ma are available. Model TV-63 operates over a temp. range of -50° to +100°C. The option of remote voltage sensing is also provided. Designed to withstand aerospace environments. Vector Mfg. Co., Inc., Southampton, Pa.

Circle 388 on Inquiry Card

TRANSFORMERS

Response for the large unit is uniform from 10kc to 2Mc.

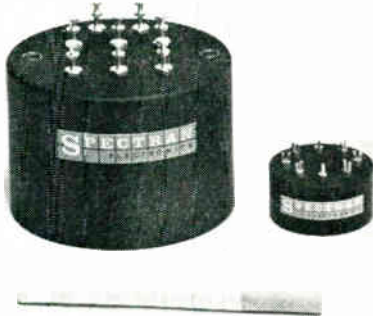

This family of transformers and inductors is for use with magnetostriction filters and devices operating between audio and video freqs. The small unit, Type S-005-30, uses a transposed quadrifilar winding giving a high degree of balance from 10 to 500 kc. The large unit, Type S-005-27, is an output transformer which can deliver 100w from four 6CA7 (EL) pentodes in push-pull parallel to a 4Ω load. Spectran Electronics Corp., 146 Main St., Maynard, Mass.

Circle 389 on Inquiry Card

TRIMMER POTENTIOMETER

Features a wirewound resistance element and ranges from 10 to 30,000Ω.

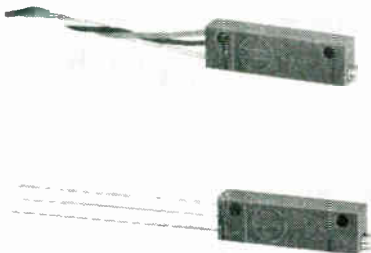

Series 2700, Trimming Micropot, measures 1 x 3/16 x 5/16 in. It is able to withstand temp. extremes to 175°C and is 100% humidity and moisture proof. Max. power rating is 1w. Termination includes color coded Teflon insulated wire leads and uninsulated copper wire leads. Actuation is leadscrew with a safety idle at each end of the resistance element. Complete adjustment is in 15 turns of leadscrew. Borg Equipment Div., Amphenol-Borg Electronics Corp., Janesville, Wis.

Circle 390 on Inquiry Card

PACKAGED SERVO ASSEMBLIES

Kearfott packaged servos combine all components (synchros, resolvers, motor-generators, amplifiers, etc.) of typical positioning servos. Available in two basic versions: BuOrd configuration with output shaft, and flat pack in-line configuration without shaft; transistorized amplifier can be built into either. BuOrd size 11 (with two size 5 components), size 15 (with up to four size 5 components), and size 18 (with up to six size 5 components). Flat pack type accommodates up to four wound components. Component complement and precision gearing in a wide range of ratios . . . to your specifications.

For complete data write Kearfott Division, General Precision, Inc., Little Falls, New Jersey.

KEARFOTT

HIGHLY RELIABLE

SHAFT POSITION-TO-DIGITAL CONVERTERS



Resistant to high shock, vibration, and temperature extremes. Applications include latitude, longitude, azimuth, or conventional angular shaft displacement conversion and decimal count conversion. Kearfott's exclusive drum design gives large conversion capacity (typical unit 2^{15}) in small size. Combination counter-converter assemblies for visual and electrical readout also available.

CHARACTERISTICS:

Part Number Code	P1241-11A	P1240-11A	Y1240-11A	Y1241-11A	U1240-11
	Cyclic Binary	Binary Decimal			
No. of Drums	5	3	3	2	4
Range	0-32,768 (2^{15})	(+)0 to (+)999 (-)999 to (-)0	0 to 359.9	0 to 359	0 to 359.9
Bits per Revolution	16	20	40	40	40
Revolutions for Total Range	2,048	100	90	9	90

For complete data write Kearfott Division, General Precision, Inc., Little Falls, New Jersey.



GENERAL PRECISION

New

Products

EDGE CONNECTOR

For memory planes, modular plug-in units or high density packaging.



Known as the TYKON, it has a contact spacing of 0.050 in. and is designed for double-sided 0.062 in. printed circuit boards. Key to TYKON's reliability is the flexing action provided by the flat ribbon of each individual contact. Available in various sizes from 6 to 25 contact positions (12 to 50 contacts) and will be furnished with conventional wiring tails, wire-wrapping, dip-soldering, or welding tails. Cinch Mfg. Co., 1026 S. Homan Ave., Chicago 24, Ill.
Circle 391 on Inquiry Card

WIRE MARKERS

The have 40 oz./in. adhesion and are for wires, cables and harnesses.

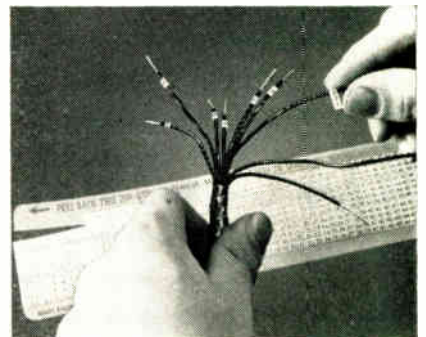

Brady B-400 Reinforced Plastic Wire Markers resist temp. to 150°C (300°F) indefinitely; up to 200°C (392°F) with little change in marker background color. Other properties are 6,000v dielectric strength, excellent resistance to fungus and most commercial solvents. They withstand 50 hrs. of ultraviolet exposure with no change. The markers are furnished on handy blue streak R dispenser cards, ready for instant use. They conform to Mil-E-5272A, Mil-D-10369B and other military specs. W. H. Brady Co., Dept. 403, 799 W. Glendale Ave., Milwaukee 9, Wis.

Circle 392 on Inquiry Card



OVER 1400 SIZES AND TYPES OF IERC HEAT-DISSIPATING ELECTRON TUBE SHIELDS

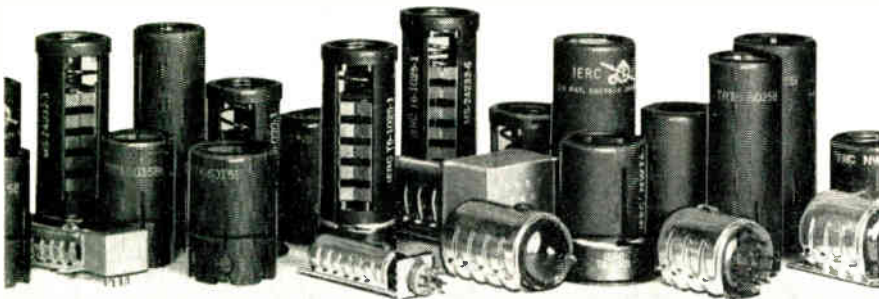

ARE EFFECTIVELY COOLING MILLIONS OF TUBES, EXTENDING LIFE AND RELIABILITY,



REDUCING DOWN-TIME AND MAINTENANCE COSTS IN THOUSANDS OF MILITARY AND



INDUSTRIAL ELECTRONIC EQUIPMENTS!

Write today for the facts on how you can improve equipment reliability with IERC Heat-Dissipating Tube Shields.

IERC  **DIVISION**

International Electronic Research Corporation
135 West Magnolia Boulevard, Burbank, California

Foreign Manufacturers: Europelec, Paris, France. Garrard Mfg. & Eng. Co., Ltd., Swindon, England

intercept!



The U. S. Army's NIKE-ZEUS is the only anti-missile missile system under advanced development. It is designed to meet the threat of enemy Inter Continental Ballistic Missiles. Developing a gigantic 450,000 lbs. of thrust at launch, the NIKE-ZEUS missile rises almost instantly to intercept enemy ICBMs traveling faster than 20 times the speed of sound.

HEART AND BRAINS OF THE NIKE-ZEUS DEFENSE SYSTEM CONCEPT

Extremely powerful long-range acquisition radar is designed to pick up the enemy ICBMs far from the defended area. Target track radars use the information provided by the long-range acquisition radar to "lock-on" to an incoming missile, relaying precise target information to electronic computers. These computers determine the most favorable point of intercept, automatically firing a NIKE-ZEUS missile at the correct time, guiding it to the intercept point.

CONTINENTAL ELECTRONICS TRANSMITTERS

Working under sub-contract to Bell Telephone Laboratories and Western Electric Company, Continental Electronics is designing, manufacturing and installing the powerful acquisition radar transmitters used in the Research and Development model of the NIKE-ZEUS Defense Complex scheduled for full scale testing on Kwajalein Atoll in the Pacific.



Continental Electronics

MANUFACTURING COMPANY

4212-South Buckner Boulevard • Dallas 27, Texas • EVERgreen 1-1135

Ⓜ SUBSIDIARY OF LING-TEMCO ELECTRONICS

Designers and Builders of the World's Most Powerful Radio Transmitters

ENGINEERS . . . FOR STIMULATING WORK ON THE ELECTRONIC FRONTIERS OF TOMORROW WITH A DYNAMIC, CREATIVE ORGANIZATION, ADDRESS RESUME TO CHIEF ENGINEER.

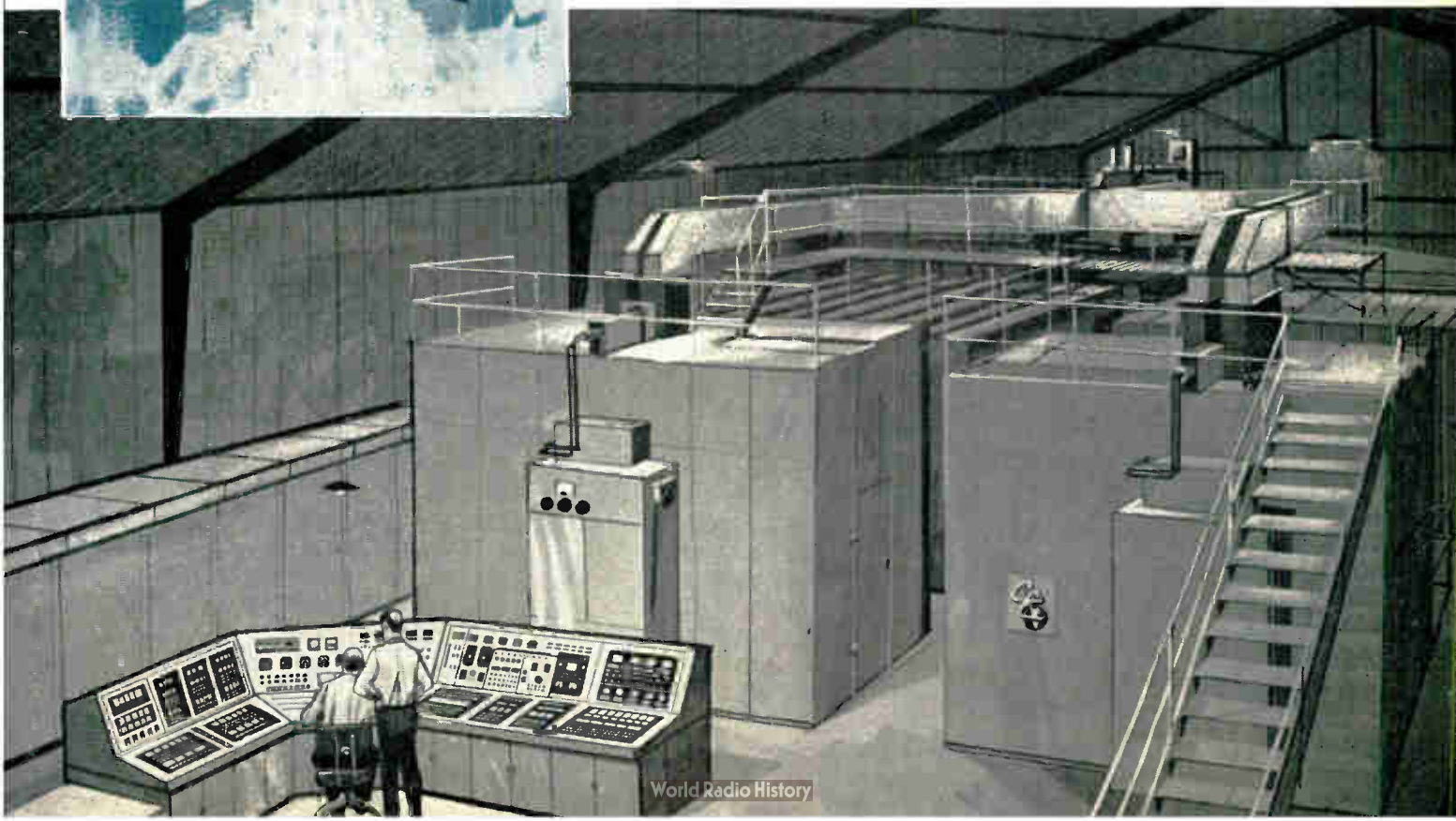

DEPENDABILITY...



Informative
fact sheet is
immediately available
by writing to:

Plastic Capacitors, inc.

2620 N. Clybourn · Chicago 14, Ill.
DI 8-3735

in the *Small*

PLASTIC DIELECTRIC CAPACITORS TYPE "OF" GLASS CAP

Designed for continuous operation for 10,000 hours at an ambient temperature of 85° C. Hermetically sealed glass tubular construction with metal end ferrules. Ideal for DC filter applications. Available 2KV to 60 KV; capacitance range .5 mfd. to .0001 mfd.

Custom  Engineering at
Production Prices
Circle 97 on Inquiry Card

New Products

NAVIGATIONAL COUNTERS

Units with slewing speeds to 1800RPM. or higher available.

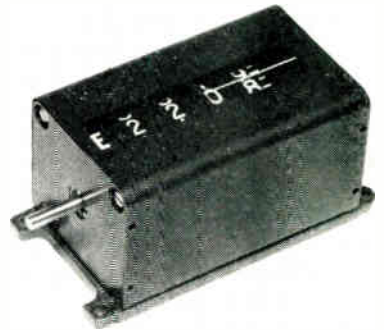

These special counters indicate positional information but differ from the standard line in such considerations as numerical size, physical configuration, and operating characteristics. Examples of special counters include digital counters (direct read units), bevel gear driven units, geared high speed latitude and longitude counters, and miniature counters. Kearfott Div., General Precision, Inc., 1150 McBride Ave., Little Falls, N. Y.
Circle 393 on Inquiry Card

STANPAT SAVES YOU MONEY IN DRAFTING TIME

New formula prevents "ghosting" on all drafting papers!

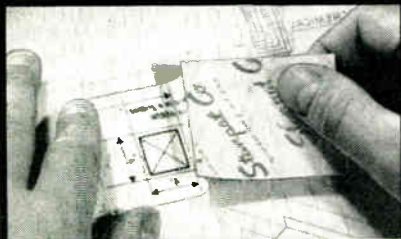

In this new atomic era, STANPAT engineers have developed a new adhesive formula containing a miracle additive that gives permanent adhesion — without ghosting! No matter what type of tracing media, material or fabric you use . . . this new revolutionary formula assures crisp, clean reproduction. No ghosting problems!

Now, with STANPAT, engineers and draftsmen save hundreds of man hours each week. Repetitive symbols . . . in fact any drafting detail, notes, specifications, etc. can be applied in seconds, rather than drawn in hours or days. Three hours can actually be reduced to seconds! That's why STANPAT is used by thousands of companies, in every industry.

Prove it yourself . . . send for STANPAT literature and samples, or enclose your symbols for quote.



STANPAT CO.

Whitestone 57, N. Y., Dept. C4
Phone: FLushing 9-1693-1611

Circle 99 on Inquiry Card

THE MOST COMPREHENSIVE MICROLINE OF SOLID STATE ELECTRONIC CHOPPERS

ACTUAL SIZE



MODEL 10



MODEL 70P



MODEL 30

HIGH SPEED
LOW POWER
LONG LIFE

MICROMINIATURE
NON-MECHANICAL
INERTIALESS

LINEAR
STABLE
RUGGED

The transistor chopper (or modulator) is a solidly encapsulated unit designed to alternately connect and disconnect a load from a signal source. It may also be used as a demodulator to convert an a.c. signal to d.c. It is capable of linearly switching or chopping voltages over a wide dynamic range which extends down to a fraction of a millivolt and up to 150 volts.

These units are practically immune to the effects of shock and vibration making them ideal for military, space vehicle and portable applications. The transistor chopper has an inherently long life and is not subject to contact bounce, wear, pitting or burning.

WRITE OR PHONE FOR BULLETINS



SOLID STATE ELECTRONICS CO.
15321 RAYEN STREET
SEPULVEDA, CALIFORNIA
Empire 4-2271 • State 5-4473

Circle 100 on Inquiry Card

THERMOELECTRIC DEVICE

It features low cost and is for special cooling applications.

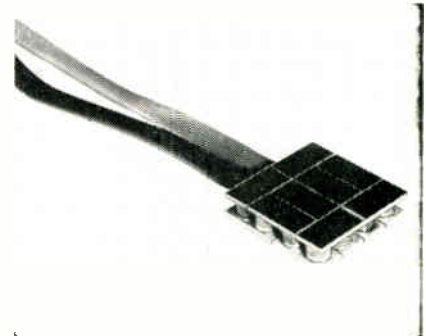

The TA-20M Thermo-Module of 8 thermoelectric junctions can pump as much as 30w or typically attain a temp. differential (ΔT) in excess of 80°C. It can be used in series or parallel to increase capacity and comes complete with electrically insulated aluminum mounting plates 1/16 in. thick. The TA-20M is for use as a complete thermoelectric unit for cooling or heat pumping purposes. It measures 7/16 in. high, including plates; 2 3/8 in. wide, including ears on bottom mounting plate; and 1 1/2 in. deep. Ohio Semiconductors, 1205 Chesapeake Ave., Columbus, Ohio.
Circle 394 on Inquiry Card

Circle 394 on Inquiry Card

VARIABLE TRANSFORMER

VT2F portable unit is for control of loads up to and including 1.5a.



Compact, rugged and designed to lie on its "back," it gives unobtrusive control in areas where space is at a premium. Transformer output is taken from an ac outlet mounted on the case. Control knob and fuse holder are readily accessible on the face panel. For lower power applications around the plant where one wishes to avoid tying up larger transformers. Ohmite Mfg. Co., 3696 Howard St., Skokie, Ill.

Circle 395 on Inquiry Card

ENVIRONMENTAL CABINET

For constant-air-temp. testing of electronic/electro-mechanical units.

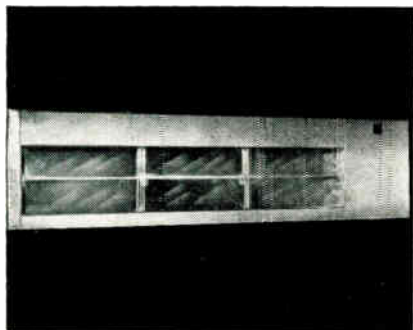

Process and test cabinet, Model 1500, is also for testing of O-ring seals, the stabilization of plastic, as well as catalytic materials, cryogenic fluids and other chemicals. Capable of producing temp. ranges from 0° to amb. and from 0° to -100°F., the 16 cu. ft. cabinet is particularly constant in internal temps. with a gradient of less than 1°. Available in 110 to 220v, 1 or 3 ϕ , cabinet has a built-in timing controller, fully automatic defrost circuit, and a self-contained or remote condensing unit, as required. Solar Systems, Inc., 11936 Valerio St., N. Hollywood, Calif.

Circle 396 on Inquiry Card



PRICE BREAKTHROUGH !!!

EECo T-SERIES DIGITAL CIRCUITS ON CARDS

...Yes, now you can have our new CT-Series family of circuit cards at prices even lower than the new low prices on T-Series modules.

■ The most popular of the more than 150 time-proven EECo T-Series digital circuits are now available from stock on epoxy circuit cards. These are proven circuits, electrically identical with the T-Series. And, of course, you can count on EECo's usual true "off-the-shelf" delivery.

Send today for information and price list. You'll find 250-kc flip-flops for about \$8.50 each in quantities.

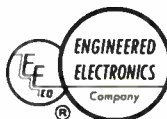

ENGINEERED ELECTRONICS Company

1441 EAST CHESTNUT AVENUE • SANTA ANA, CALIFORNIA
TELEPHONE Kimberly 7-5651 • CABLE ADDRESS: ENGELEX

Circle 101 on Inquiry Card

High quality, high reliability plus

PLUG-IN VERSATILITY

**hp 170A MILITARIZED
SCOPE — TO 30 MC!**

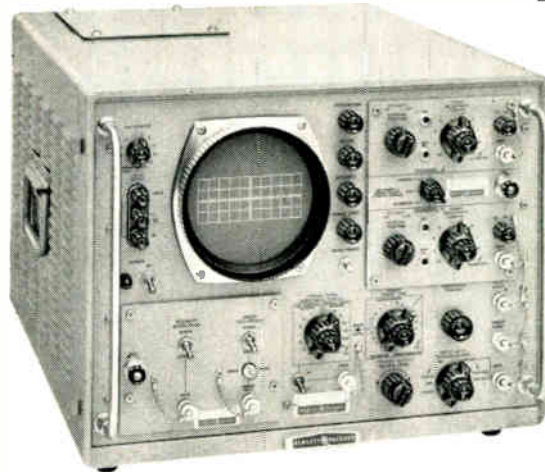

**hp 160B MILITARIZED
15 MC SCOPE**

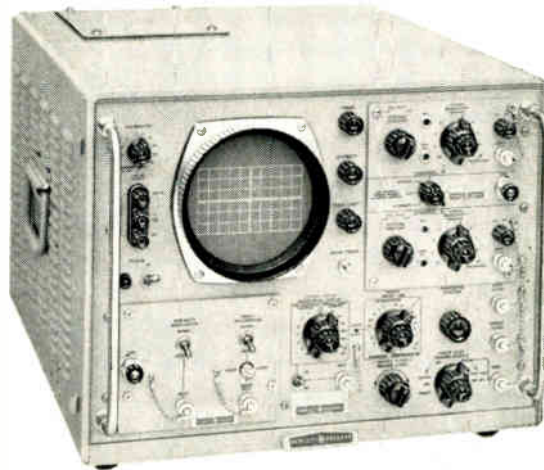

Seven horizontal, vertical plug-ins give

Ⓢ **166A Plug-in (Time-Axis)** furnished with the Ⓢ 160B and 170A Oscilloscopes (as pictured above), provides standard input connections for Z-axis modulation and single-sweep arming.



Ⓢ **166B Time Mark Generator** (Time-Axis plug-in) makes precise time measurements simple, provides intensity-modulated time markers on the oscilloscope trace of either Ⓢ 160B or 170A. Markers, at 0.1, 1 and 10 μ sec intervals, speed, simplify photographs, calibration of fast oscilloscope sweeps and operation between calibrated sweep ranges with sweep vernier. Markers may also be used as triggers or for calibration of other devices. Accuracy is $\pm 0.2\%$, 10° to 30° C. Ⓢ 166B, \$130.00.



Ⓢ **166C Display Scanner** (Time-Axis plug-in) provides output to duplicate, on an X-Y recorder, any repetitive waveform appearing on CRT trace. Resolution with permanent, large-scale records is higher than either scope CRT or photograph, and you can observe the scope trace while records are made. Unit converts high speed signals to slower signals having the same waveshape; scanning speed is arranged to keep Y output within the bandwidth of conventional recorders. Ⓢ 166C, \$300.00.



Ⓢ **166D Sweep Delay Generator** (Time-Axis plug-in) delays the main sweep of the 160B and 170A Scopes for detailed examination of a complex signal or pulse train. In addition, it offers a unique mixed sweep feature to show an expanded segment of a delayed waveform while still retaining a presentation of earlier portions of the waveform. Delay time 1 μ sec to 10 sec. Delaying sweep, 18 ranges. Delayed length 0 to 10 cm. Delay functions: trigger main sweep, arm main sweep, mixed sweep. Ⓢ 166D, \$325.00.

in these OSCILLOSCOPES

Vertical or horizontal plug-ins make possible

Dual trace amplification
Fast pulse amplification
High gain amplification

X-Y records of repetitive waveforms
New sweep delay convenience
Time markers for photos, calibration

Both oscilloscopes are highly ruggedized; both have conventional controls for simple, swift operation

Built to exacting military specifications, these  oscilloscopes offer instantly expandable measurement capability—when you need it. It's easy! Just add a moderately priced plug-in unit!



Both  160B and 170A employ the same vertical and time-axis plug-ins providing the widest range of application with minimum investment.

New  160B and 170A meet MIL specifications for shock, vibration, humidity and temperature. Important features include high stability tube/transistor circuits, regulated dc filament voltages and premium components throughout.

Etched circuits on translucent epoxy glass provide great mechanical stability and simplify circuit tracing. Improved preset triggering insures optimum operation for almost all conditions with just one adjustment—even on signals down to 2 mm deflection. A push-button beam finder automatically locates an off-screen beam or trace, especially important during operation by inexperienced personnel.

SPECIFICATIONS— 160B and 170A with 166A Plug-in

VERTICAL

Bandwidth:  160B, > 15 MC;  170A, > 30 MC
Voltage Calibrator: 18 calibrated ranges $\pm 3\%$, 0.2 mv to 100 v peak to peak

HORIZONTAL

Bandwidth: DC to 1 MC
Sensitivity: 7 ranges 0.1 v/cm to 10 v/cm. Vernier extends minimum sensitivity to 25 v/cm
Input Impedance: 1 megohm shunted by 30 pf

SWEEP GENERATOR

Internal Sweep: 24 ranges, 0.1 μ sec/cm to 5 sec/cm, $\pm 3\%$. Vernier extends slowest sweep to 15 sec/cm
Magnification: 7 ranges, X1, X2, X5, X10, X20, X50 and X100. Increases fastest sweep to 0.02 μ sec/cm
Triggering: Internal, power line or vertical input signal (2 mm or more vertical deflection); external ($\frac{1}{2}$ v peak to peak or more). Trigger level of external sync signal adjustable -30 to +30 volts

PRICE:

 160B, \$1,850.00 (cabinet or rack mount)
 170A, \$2,150.00 (cabinet or rack mount)

160B, 170A unmatched usefulness

162A Dual Trace Amplifier

plug-in (vertical) gives maximum sensitivity to 20 mv/cm, permits viewing of two phenomena simultaneously, offers differential input for common mode rejection. Electronic chopping extends simultaneous viewing of 2 signals to lower frequencies without flicker.  162A, \$350.00.





162D High Gain Vertical Amplifier

increases sensitivity to 5 mv/cm. 12 calibrated ranges, 5 mv/cm to 20 v/cm in 1, 2, 5, 10 sequence, accuracy $\pm 5\%$. Continuous vernier extends min. sensitivity to 50 v/cm. Differential input with at least 40 db common mode rejection included for ranges 5 mv/cm through 50 mv/cm. AC or dc coupling of either of two inputs.  162D, \$225.00.



162F Wide Band Vertical Amplifier

Vertical plug-in allows full utilization of the excellent transient response of the 160B and 170A main vertical amplifiers. Rise time with  170A is 12 nsec, dc to 30 MC; with  160B is 23 nsec, dc to 15 MC. Sensitivity is 0.05 v/cm to 50 v/cm, covered in 9 ranges; input impedance 1 megohm with 25 pf shunt.  162F, \$145.

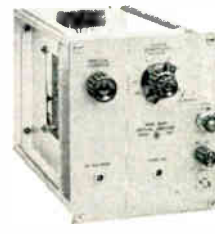

Data subject to change without notice. Prices f. o. b. factory.

HEWLETT-PACKARD COMPANY

1501 Page Mill Road Palo Alto, California, U.S.A.
Cable "HEWPACK" Davenport 6-7000
Sales representatives in all principal areas

HEWLETT-PACKARD S. A.

Rue du Vieux Billard No. 1 Geneva, Switzerland
Cable "HEWPACKSA" Tel. No. (022) 26. 43. 36

the big choice in fine variable transformers

Select from *four*, big, basic families . . .

VT2	VT4	VT8	VT20
1.5-1.8 amp	3.5-4.75 amp	7.5-10 amp	20-25 amp

- Get *immediate delivery* from your distributor or the factory on 49 stock sizes and types: single transformers, tandems, with and without over-voltage, low voltage, single-phase, three-phase, cased, fixed mounting, portable, 36V, 120V, 240V, and 480V.

- Choose from *many* special features: tandems, multi-taps, motor drives, concentric controls, special windings, shafts of all types, and job-matched enclosures among others.

- Specify from innumerable possibilities in "custom-engineered" combinations with unusual reciprocating motor drives, complex double-track arrangements, rheostats, toggle switches, and precision switches.

- Pick 36V transformers in 5-, 12-, or 22-amp ratings for your transistorized circuits.



OHMITE

OHMITE MANUFACTURING COMPANY
3662 Howard Street, Skokie, Illinois

Rheostats • Power Resistors • Precision Resistors • Relays • R. F. Chokes • Germanium Diodes • Variable Transformers • Tantalum Capacitors • Tap Switches



From every aspect, you'll find that Ohmite is a good place to purchase variable transformers. If you need a "special" . . . okay, just tell Ohmite. Need some engineering assistance? All right! What about quantity? Ohmite can handle big orders, medium, and small. The Ohmite VT line of variable transformers is broad and deep. So is the service. Find out by specifying "Ohmite" on your next requirement for variable transformers.

Write for Bulletin 151

A fine choice, too . . .

OHMITE Germanium DIODES

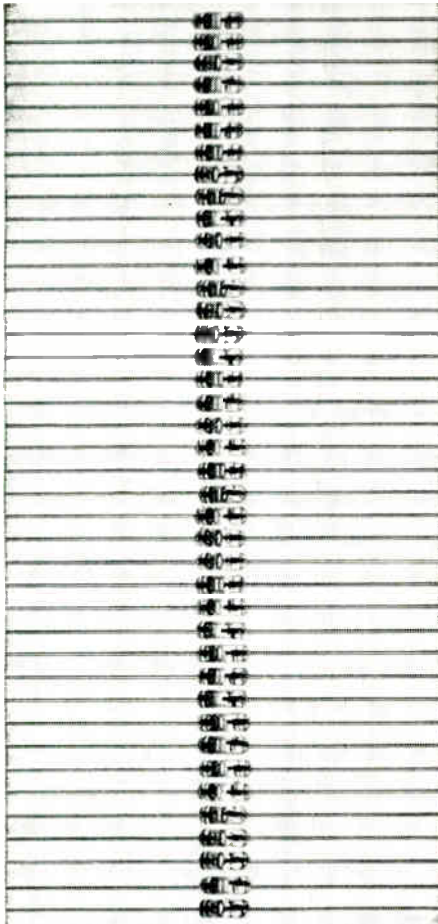

Discover, as other users have, how Ohmite achieves unusual reliability through manufacturing quality control.

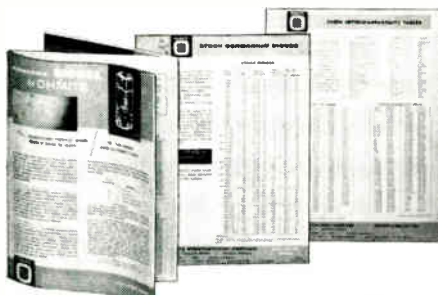

Specs and Listings.
BULLETIN 158

Cross Index to 24 Makes.
BULLETIN 1002

Ohmite Stock Diodes.
BULLETIN 164

**SEND FOR
A SET**

Ohmite Mfg. Co.
3662 Howard St.
Skokie, Illinois

Circle 149 on Inquiry Card



New Products

SIGNAL CONVERTER

The SC-300 handles both "live zero" and "true zero" instruments.



It will accept any standard input and convert it to any other standard output signal. The R.I.S. Signal Converter uses 6 silicon transistors, 4 as a stable dual-differential amplifier; 2 for power amplification and a constant current output. Only 2 controls are used. The "zero" pot. adjusts zero or min., and the "gain" pot. adjusts the full scale output. It operates on 105-125vac, 60CPS, 6w, and measures 1.78 x 4.1 x 11.0 in. Rochester Instrument Systems, Inc., 273 N. Union St., Rochester 5, N. Y.

Circle 397 on Inquiry Card

DIGITAL MODULE

The MV 100S, can be used as a fixed or variable clock.

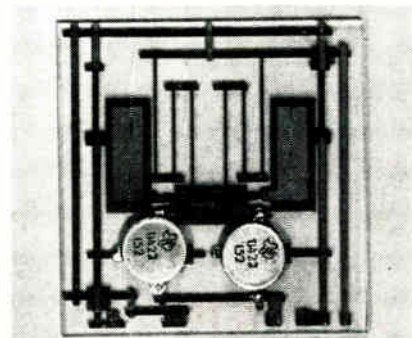

These units, available from stock, operate from a 6v supply, dissipating 40mw in a 0.165 cu. in. package weighing 12 grams. The present device contains evaporated resistors and capacitors plus inserted silicon semiconductors, with a unidirectional 5 pin output connector. For less restrictive temperature condition, the MV 100G is available with germanium devices. Advanced Microelectronics Co. (AME), 2414 Reddie Dr., Silver Spring, Md.

Circle 398 on Inquiry Card

DIGITAL VOLTMETER

Holds its accuracy despite high hum or spurious noise.



The DY-2401A Integrating Digital Voltmeter's circuitry gives an effective 140db common mode rejection at all freqs., including dc. It has a 5-digit Nixie® readout; indication of function; automatic polarity; and automatically positioned decimal point. Five dc voltage ranges from ± 99.999 mv to ± 999.99 v with 300% overranging on the 4 most sensitive ranges. The DY-2401 can measure from 2CPS to 300KC and also freq. ratio. Dymec, div. of Hewlett-Packard Co., 395 Page Mill Rd., Palo Alto, Calif.

Circle 399 on Inquiry Card

RECTIFIERS

These all diffused SCR's have breakdown voltages to 500v at 16a.

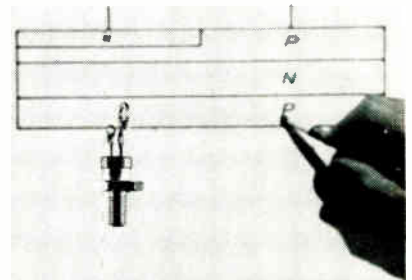

They offer high temp. stability up to 125°C. Offered in standard JEDEC ratings from 2N681 (25 PIV) to 2N689 (500PIV). Mechanically, the triple diffused SCR offers "hard glass" to Kovar seals; welded leads and case closures giving absolute hermeticity after repeated thermal cycling. Studs are selected copper alloy for high torque strength and low thermal resistance. General Instrument Corp., Semiconductor Div., 65 Gouverneur St., Newark, N. J.

Circle 400 on Inquiry Card

New

Products

COAXIAL ADAPTERS

Freq. range from 5.4 to 5.9 and 8.5 to 9.6GC. with max. VSWR of 1.25.

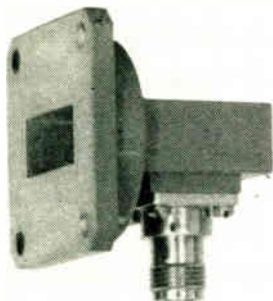

These adapters consist of a section of standard waveguide containing a specially designed optimum transition to coaxial line. The coaxial output end is provided with a type TNC connector and the waveguide section contains a standard military waveguide cover flange. The units have been designed from min. physical size configuration consistent with optical electrical performance. Standard models, 301-TNC and 601-TNC, are currently available in X and C-bands. Wave-line Inc., Caldwell, N. J.

Circle 235 on Inquiry Card

PRESSURE TRANSDUCER

Model P601, potentiometer-type unit, has multi-point shunt calibration.

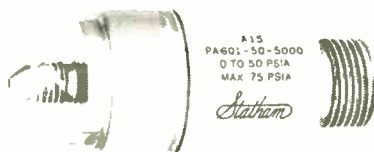

It is a high performance instrument for measurement of absolute, gage, or differential pressures. This light weight transducer, 3½ oz., operates accurately and reliably in ranges from 0 to 10psi through 0 to 300psi. It uses a constant modulus material as the force summing device for max. thermal stability throughout a wide temp. band. The 601 is for use in vibration and acceleration environments. Statham Instruments, Inc., 12401 W. Olympic Blvd., Los Angeles 64, Calif.

Circle 236 on Inquiry Card

FERRITE CIRCULATORS

Max. insertion loss is 0.25db with 25db isolation and a VSWR of 1.05.

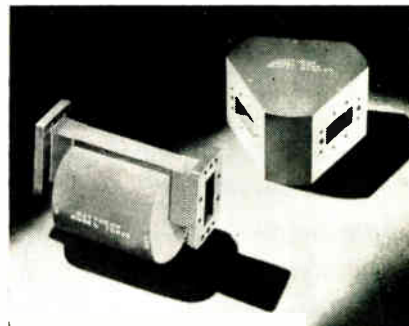

Four C-band ferrite devices for microwave relay link and communications uses are available in both the 5925 to 6175 and 6175 to 6425MC ranges. The circulators, CCM8 and CCM9, feature the low VSWR and insertion loss specified above. The other 2 devices are isolators, ICM38 and ICM40. They have 0.35db insertion loss with 20db isolation and a VSWR of 1.03. All units handle 100w average and 10kw peak power. Microwave and Power Tube Div., Raytheon Co., Foundry Ave., Waltham 54, Mass.

Circle 237 on Inquiry Card

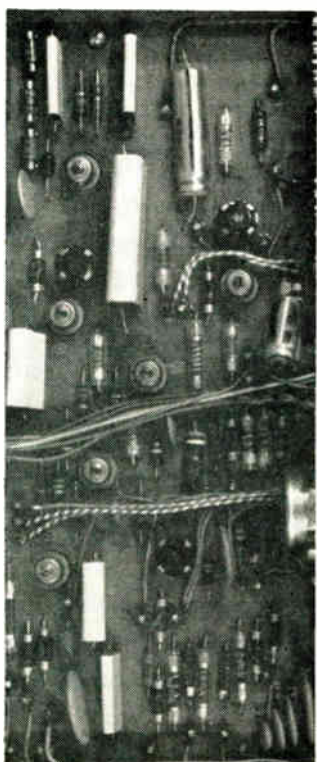
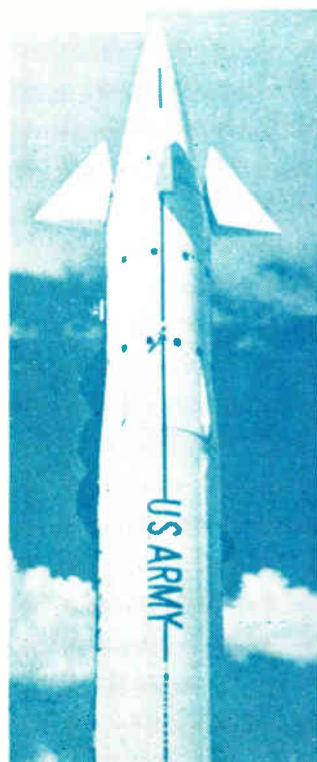

captron

a dynamic new company setting higher standards in foil tantalum capacitors.

- Controlled production for better quality, reliability.
- Reduced manufacturing cycle ensures fast delivery on all orders — small or large.
- Popular ratings delivered from shelf.



For data and information, write
CAPTRON, Dept. 1, 721 Rosewood Drive, Columbia 1, South Carolina

what's best for READOUT of BINARY DATA?

the "Applications-Oriented"

Beam-X SWITCH

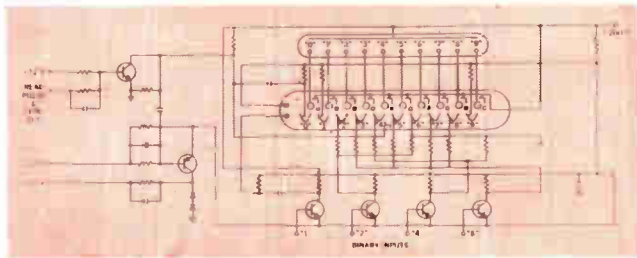

Fig. 1 Beam-X Switch Decoder Circuit

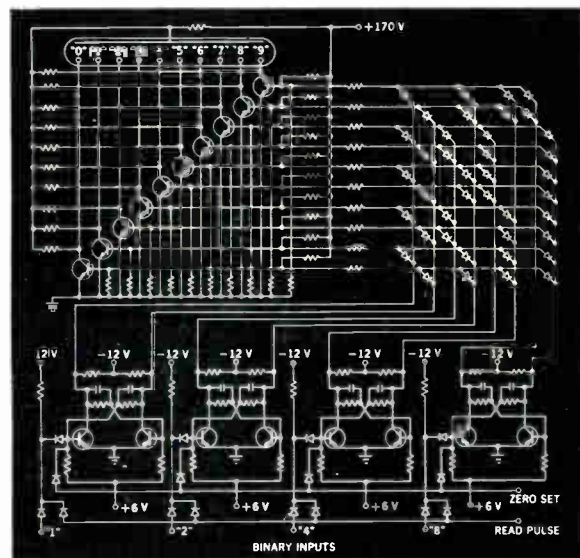

Fig. 2 Typical All-transistor Decoder Circuit

Now, Beam-X Switches are "applications-oriented" for optimum performance of specific digital functions. Typical is the new Type BX-2012, a Beam-X Switch designed to provide the ideal method of converting Binary Coded Decimal data to Decimal form. Ten electrical outputs drive Nixie® Indicator Tubes or printers for visual presentation of the binary data.

Figure 1 illustrates the simplicity of a typical Beam-X Switch Decoder circuit. It also shows the compatibility of the Beam-X Switch with semiconductor devices. Only 41 components are required to sample and store the BCD information in decimal form. In addition, the Beam-X Switch Decoder:

- PROVIDES AUTOMATIC MEMORY
- ACCEPTS 4-LINE BINARY INFORMATION
- NEEDS ONLY 1-LINE ADDRESS
- DECODES THE DATA IN 10 μ SECS

Now look at Figure 2, a typical all-transistor decoder which performs the same function. Almost four times as many components are required . . . increasing cost, size and circuit complexity.

Beam-X Switch Decoder performance is available in component or in complete plug-in modular form. Units are available to handle such codes as 8421, 2421, 4221, 5311, Cyclic Gray and other BCD codes. The complete module price . . . \$85 in single quantities . . . makes it the lowest cost, all-electronic binary decoder commercially available.

Write today for our new Circuit and Applications Brochure on the new "applications-oriented" Beam-X Switches and Modules.



Circle 25 on Inquiry Card

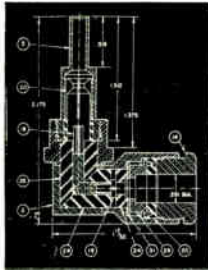

RF Connector problem?

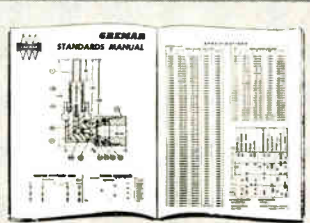

**YOUR SPECIALS
MAY BE
GREMAR'S
STANDARDS!**

Value analysis shows
Greomar's RF Connector
standardization pays off
— for you



Greomar pioneers in RF Connector value engineering — finding ways to make better connectors at less cost through interchangeability of components. Our Standards Manual has proved time and again that connectors ordered as custom-designed "Specials" may *already exist*, in ready-to-be-assembled components carried in stock! Your result: top quality connectors delivered days or weeks ahead of schedule!

Greomar has the broadest line of RF Connectors. On hand are over *three-quarter million* assembled units of more than *two thousand* types. Your "special" may be on our shelves right now!

Greomar has over 8,000,000 component parts in stock, ready for immediate assembly to your requirements.

Greomar delivered over 500 new types this year alone! If you require a new design, our Model Shop will get prototypes or limited production quantities into your hands — fast. *Proof? Write... wire... or phone!*

YOU NEED THIS NEW 8-PAGE STANDARDS MANUAL!
If you specify or purchase RF Connectors, send for the most concise, conveniently organized listing available in the field, including convenient new spec sheets to order new designs.

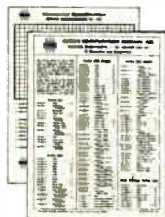

RELIABILITY THROUGH QUALITY CONTROL

GREMAR

MANUFACTURING COMPANY, INC. • WAKEFIELD, MASS. • Tel. 245-4580

New Products

SUBCARRIER OSCILLATOR

This transistorized low-level unit is for telemetry use.

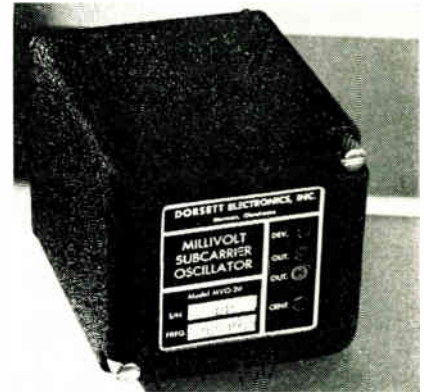

It is designed to accept signal inputs of $\pm 10\text{mv}$ or 0 to $+ 20\text{mv}$. AC common mode rejection is 100 db. min. from dc to 1000 cps. DC common mode rejection is 140db. min. Designated the Model MVO-20, the unit is packaged in the Dorsett module 2 configuration, 1.76 x 1.87 x 2.25 in., a die cast module compatible with many other solid state telemetry components in the Dorsett "20" series. Dorsett Electronics, Inc., P. O. Box 862, Norman, Okla.

Circle 238 on Inquiry Card

TRANSISTOR POWER SUPPLY

In portable operation, capacity is 3.5 ampere hours, 10a peak.

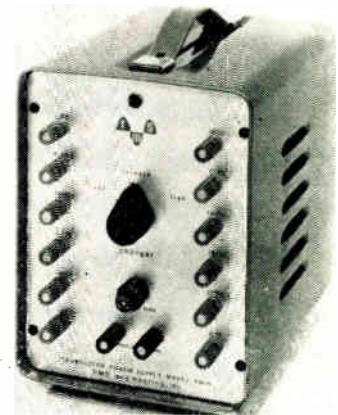

The Model PB-15 Power Supply consists of 12 nickel-cadmium batteries with a trickle charger. Both positive and negative voltages in steps of 1.25v are available simultaneously, spanning a range of 15v. In ac operation the batteries are series charged at 0.24a. The power supply is suited for lab. testing of transistor circuits and as an emergency power source. RMS Engineering, Inc., P. O. Box 6354, Station H, Atlanta 8, Ga.

Circle 239 on Inquiry Card

ELECTRONIC INDUSTRIES **MAP**

MARKETING ASSISTANCE PROGRAM



JOSEPH DRUCKER
56th and Chestnut Streets
Philadelphia 39, Pennsylvania
SHerwood 8-2000 (Area Code 215)

GERALD B. PELISSIER
(Metropolitan N. Y.)
100 E. 42nd Street
New York 17, New York
OXford 7-3400 (Area Code 212)

JOHN PICKERING, JR.
10 High Street—Rice Bldg.
Boston, Massachusetts
LIberty 2-4460 (Area Code 617)

AL KAISER
62 LaSalle Road
West Hartford, Connecticut
ADams 6-4237 (Area Code 203)

ROBERT COBURN
930 Keith Bldg.
Cleveland, Ohio
SUperior 1-2860 (Area Code 216)

GEORGE H. FELT
360 North Michigan Ave.
Chicago, Illinois
RANdolph 6-2166 (Area Code 312)

MENARD DOSWELL, III
198 S. Alvarado Street
Los Angeles, California
DUnkirk 7-4337 (Area Code 213)

BURT UNDERWOOD
198 S. Alvarado Street
Los Angeles, California
DUnkirk 7-4337 (Area Code 213)

DON MAY
1355 Market Street
San Francisco, California
UNderhill 1-7107 (Area Code 415)

JOHN W. SANGSTON
1776 Peachtree St., N.W.
Atlanta 9, Georgia
875-1255 (Area Code 404)

HAROLD E. MOTT
Meadows Bldg.
Expressway at Milton
Dallas, Texas
EMerson 8-4751 (Area Code 214)

MAX HOLSINGER
67/68 Jermyn Street
St. James'—Fifth Floor
London, England

MAX HOLSINGER
Huttenstrasse 17
Am Ernst Reuter Platz,
Dusseldorf, West Germany

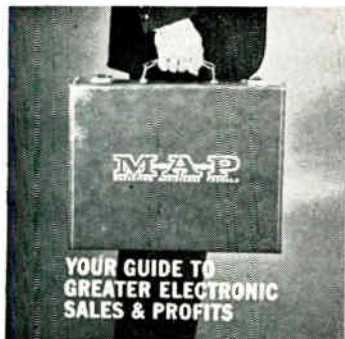

The full story of how ELECTRONIC INDUSTRIES' M-A-P (Marketing Assistance Program) can help you—is now available for viewing in a 14-minute film presentation. A phone call to your nearest "EI" Representative will bring him to your office.



A Complete Market Research Department at Your Disposal: The services of ELECTRONIC INDUSTRIES' Research Department are available to you, together with a corps of over 250 experienced, strategically located, field investigators. They can help you determine:

- Sales potentials by industry and territory
- Buying influences • Degree of product recognition and acceptance • Relative standing of competitors • New product applications
- Buyers' job interest and aptitudes . . . and virtually any other information essential to the effective marketing of your company's products.

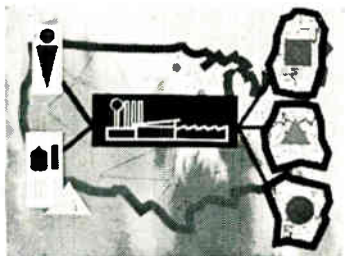

96% of Your Market: The ELECTRONIC INDUSTRIES Census—developed and maintained at a cost of over \$200,000, reports in depth on the 6000 electronic plants which account for 96% of the total annual purchase of electronic products.

ELECTRONIC INDUSTRIES' unique product classification system identifies, with complete information, plant by plant, on each industry product manufactured.

Punched on 45,000 IBM Cards: to simplify your task of isolating and organizing the precise marketing data you need, the complete findings of the ELECTRONIC INDUSTRIES CENSUS have been transferred to punched IBM cards.

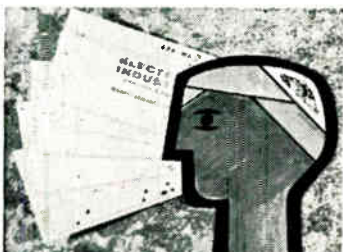

What are the Characteristics of Today's Electronic Engineer?

- What is his average age? • His average income? • His net worth? • How many children does he have? • What is his education? • What are his ambitions? • What would prompt him to change jobs?

These and many other important questions about the personal and job characteristics of the electronic engineer are answered in ELECTRONIC INDUSTRIES' Profile of the Electronic Engineer—available as a handy deck of 2,000 punched IBM cards, or (in summary form) in a printed report.

New Products

SUBMINIATURE PLUG

Ratings: 5a, 1200vac (RMS) at sea level, 375vac at 70,000 ft.



The DEDR is a sealed version of the rectangular D subminiature plugs, and is sealed by a grommet cemented to the insulator. The shell is diecast aluminum, and the monobloc insulator is Diallyl Phthalate. Contacts are copper alloy with a gold or silver plating spaced on 0.108 in. centers. Contact arrangements of 9, 15, 25, 37, and 50 are available. DEDR plugs are designed to meet Mil-C-8384. Cannon Electric Co., 3208 Humboldt St., Los Angeles 31, Calif.

Circle 240 on Inquiry Card

FERRITE SWITCH

Has 50db of isolation with 0.1db loss at midband frequency.

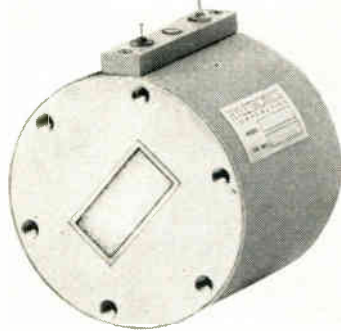

This is one of a new series of ON-OFF reflective type microwave ferrite switches. Over the band 6175-6425MC, Model SC1 exhibits a min. of 40db isolation and a max. of 0.2db loss. The unit, designed in RG50/U, can be switched in less than 100μsec. Two units can be packaged to provide a min. of 80db isolation and 0.4db loss over a 4% band. Switches with similar characteristics may be supplied for use from S to Ku-band. Hyletronics Corp., Burlington, Mass.

Circle 241 on Inquiry Card

POWER SUPPLY

Model R 300-60, transistorized unit, meets most military applications.

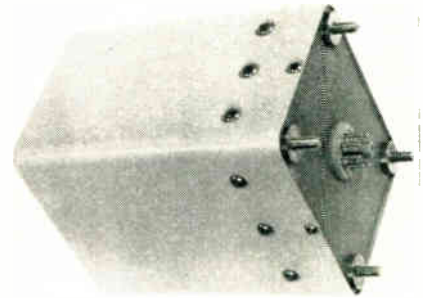

This modular plug-in ac to dc regulated silicon transistor power supply features: Input, 115vac ±10%, 60-400cps; output, 300v, 60ma; regulation, line and load better than ±0.5%; ripple, less than 20mv peak to peak; operating temp., -55°C to 85°C amb.; temp. coefficient, better than ±0.1%/°C; line surge protected, recovery in less than 10msec.; short-circuit protected; floating ground; and size, 4 31/32 x 3 15/16 x 4 1/2 in. Control Circuits, Inc., Portland, Conn.

Circle 242 on Inquiry Card

MAJOR BREAK-THROUGH IN MAINTENANCE-FREE POWER
HOWARD Unit Bearing Motors
 (Models 1075, 1085, 1175)

UNMATCHED FOR FAN APPLICATIONS GUARANTEED FOR FIVE YEARS

Performance-proved by leading manufacturers of no-frost refrigerators and electronic products. Permanently lubricated bearing permits mounting in hard-to-reach locations. Designed throughout for long, maintenance free service. Whisper-quiet operation. An important member of America's largest family of sub-fractional horsepower motors. Write for complete specifications and latest Howard Catalog.

HOWARD INDUSTRIES, INC.

1730 STATE ST., RACINE, WISCONSIN

Divisions:

Electric Motor Corp., Cyclohm Motor Corp., Racine Electric Prods., Loyd Scruggs Co.

Circle 108 on Inquiry Card

AVAILABLE WITH OPEN
 OR
 CLOSED CONSTRUCTION
 HP: 1/1000 to 1/100
 NO LOAD RPM*: 3400
 FULL LOAD RPM*:
 2600-3200
 INPUT WATTS: 8-35
 VOLTS:
 115 V. 60 cy. AC Std.
 230 V. 60 cy. AC
 *Lower full load
 speeds also available

POWERED BY

HOWARD

"WELL-NUT"

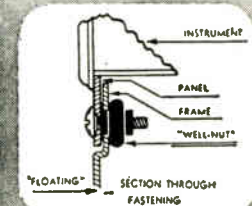
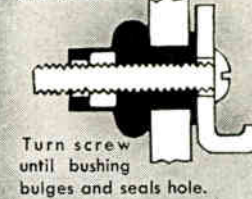
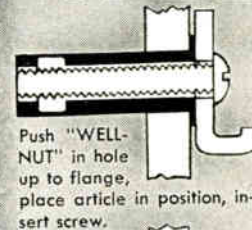

Typical installation—mounting instrument in wall or panel.

the versatile
 blind fastener that

- dampens vibration
- muffles noises
- prevents leaks

The "WELL-NUT" is a flanged neoprene bushing with a brass nut bonded inside the narrow end. In making an assembly, the narrow end is inserted into a hole in the inner panel until the flange rests against the outer surface. The outer part of the assembly is placed against the flange with the holes concentric. A conventional screw is then thrust into the bushing and turned into the nut, drawing the latter against the inner surface. The tension on the nut causes the bushing to bulge laterally, tightly sealing the hole and the threads of the screw. Access to the inner surface of the assembly is not necessary. The "WELL-NUT" works equally well in hole or cavity. 13 standard sizes; special sizes available in quantity.

ROCKWELL PRODUCTS CORPORATION

146 Central Avenue, Dept. A, Newark 3, N. J.

Tel.—MARKET 3-7650

Circle 109 on Inquiry Card

HERE ARE 10 GROUPS OF CENTRALAB SWITCHES THAT MEET

MIL-S-3786A

Finest quality materials and special engineering features result in ultra-reliable performance.

Index parts are heavy cadmium-plated, dichromate dipped steel to meet 100 hour salt spray tests (most MIL specifications call for 50 hour tests). Indexing balls are of stainless steel, not cold rolled steel.

Sections are of steatite Grade L533 (MIL-I-10A) for 125°C operation, of Type PBE phenolic (MIL-P-3115B) for 85°C operation.

Stationary Clips are of coin silver alloy, with double wiping action, 3-plane locking to section, and are lubricated to reduce wear.

For complete data on these and many other Centralab switches, write for Catalog 42-1195 available free on request from

Centralab.

THE ELECTRONICS DIVISION OF GLOBE-UNION INC.
900 East Keefe Avenue, Milwaukee 1, Wisconsin
In Canada: Centralab Canada Ltd., P.O. Box 400, Ajax, Ontario

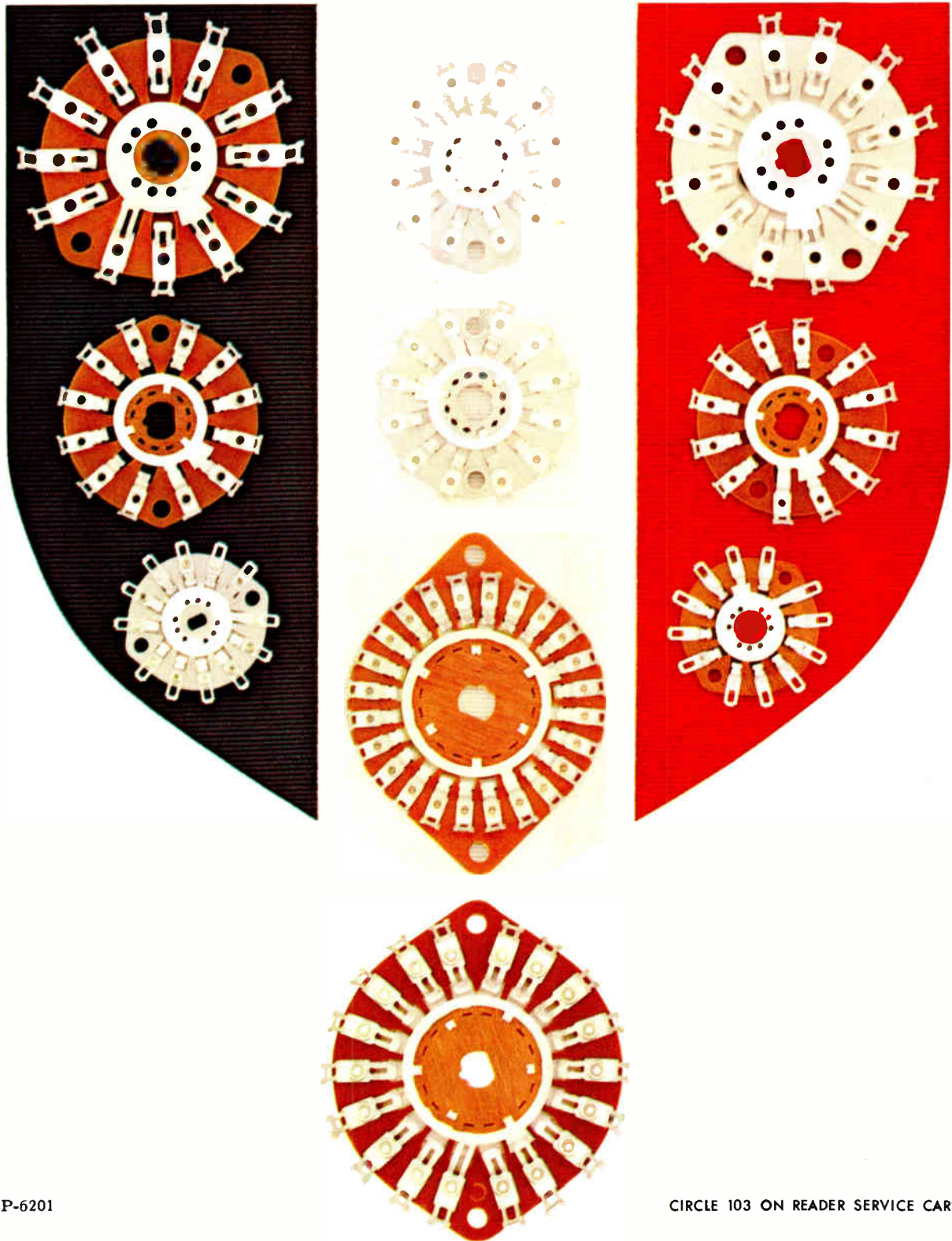

Fansteel silicon diodes: high-rated for rocket support gear

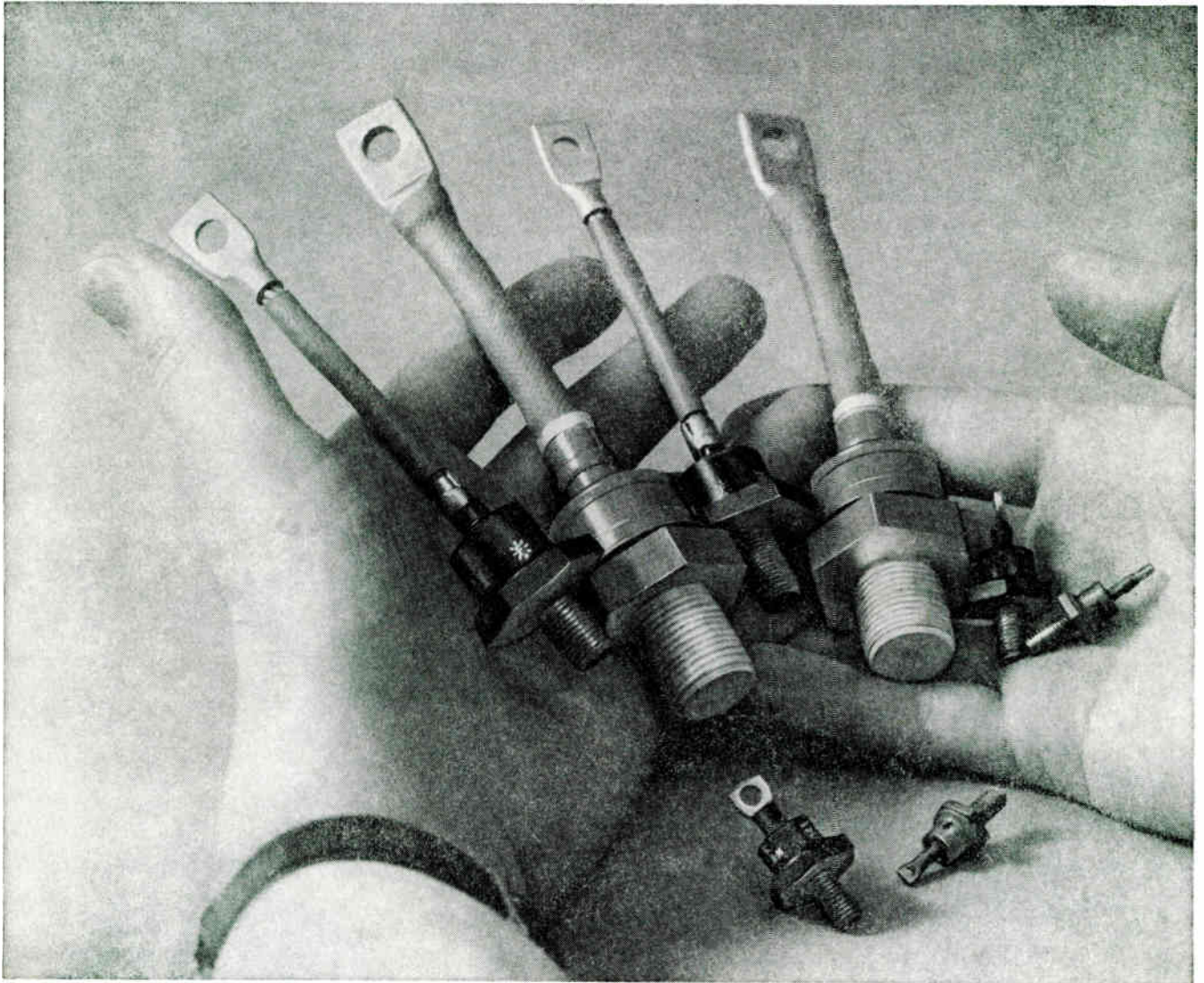

In recent evaluation tests for rocket ground support equipment, Fansteel silicon rectifier diodes were rated near perfect for their extremely high qualifying percentage. On applications demanding long shelf life, high reliability and close performance ratings, Fansteel silicon rectifiers consistently produce top results. What makes the difference? Attention. Attention to design, materials, packaging—to extreme caution in whiteroom procedures, and to a unique testing program that is uncannily accurate. Fansteel silicon stacks and Zener diodes get the same care. Silicon diodes are rated from 6 to 240 amps.; Stacks from 6 amps. up; Zeners available in 1- and 10-watt ratings. For specification data, write the Rectifier-Capacitor Division, Fansteel Metallurgical Corporation, North Chicago, Illinois.

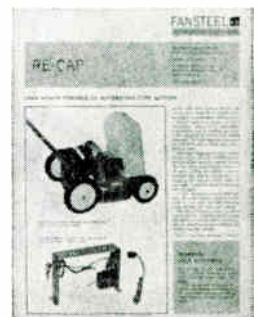

Additional data on Fansteel silicon rectifier diodes is presented in Re-Cap, a bi-monthly publication. To receive, write the Publications Department.

New

Products

DC POWER SUPPLIES

Inputs 3 ϕ , 200-240vac, 58-26cps. Output: 24-32vdc at 0-100a.



Portable Model 286VS100 has complete solid-state reference and control circuits with semi-modular construction, permitting plug-in type repairs. Regulation is within 1% for all line load, freq. and ambient variations; ripple is 1% RMS. Remote sensing and parallel operation capability is built in. Response time 0.1 sec. (full load swing). Weight: 100 lbs. Radio noise suppression meets Mil-I-26600 and Mil-I-6181D. Chatham Electronics Div., Tung-Sol Electric Inc., Livingston, N. J.

Circle 243 on Inquiry Card

THERMOSTAT

Series 1100 available in semi-closed, potted and encapsulated styles.

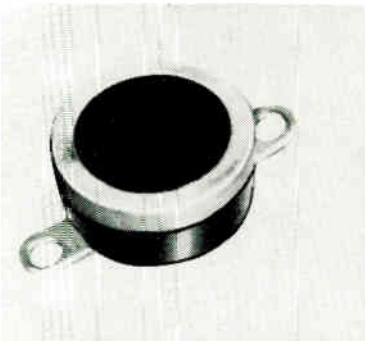

This thermostat features a "wiping contact" action. Wide variety of terminals, leads and mountings available, depending on enclosure style. Ratings of Stemco Series 1100 thermostats for 100KC are 8.3, 4.5, 3.6a for 120, 240, 277vac, respectively. The 6KC ratings are 16.6 and 8.3a for 120 and 240vac, respectively. Over-all diameter is approximately 5/8 in., plus terminals, etc. Stevens Manufacturing Co., Inc., P. O. Box 1007, Mansfield, Ohio.

Circle 244 on Inquiry Card

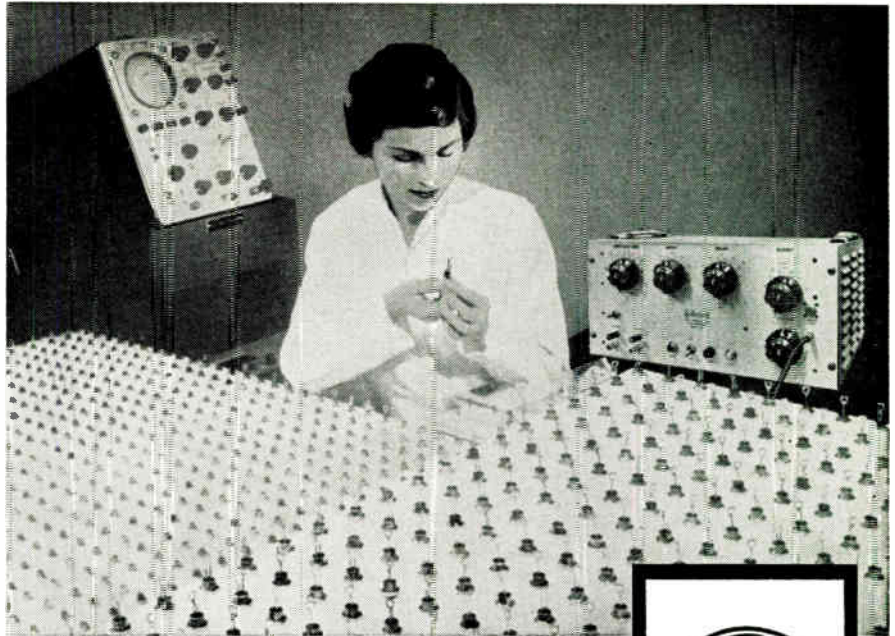

"A Rutherford pulse generator is being used to test silicon rectifiers at the Clyde, N.Y., facilities of the G. E. Semiconductor Products Department."

Rutherford PULSE GENERATORS for TESTING Semiconductors

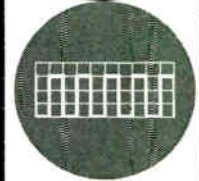

MODEL
B-7B

The Rutherford B-7B Pulse Generators are engineered to meet today's rigid standards of testing, research and development.

If your requirements are for high performance and wide versatility at low cost ... specify the Rutherford Model B-7B.



SPECIFICATIONS

Rack mountable ... single unit construction ... variable time rise control ... 50 volts into 50 ohms at 30% duty factor ... rep. rate to 2 mc ... widths .05 μ s to 10,000 μ s ... delays to 10,000 μ s.

Low budget price: \$720.00 F.O.B. Culver City, California

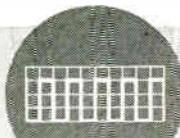

Rutherford ELECTRONICS CO.

Dept. EI 462 • 8944 Lindblade Street • Culver City, California • TWK-CVR-CY-4133

pulse generators / pulse systems / accurate time delay generators



a single pin...

completes the circuit!

↑
↓
← Y →
SEAELECTOBOARD
PROGRAM BOARDS

The most unique programming device ever offered! A *single pin* completes switching or component insertion in a circuit. Eliminate cord-clutter, dual-plug probes, multiple-point switches. Provide complete programming or channeling operations in any electric/electronic system by the fastest, simplest method and in a space-saving, cost-saving manner. Seaelectoboards are available in any modular or custom-designed configuration to meet your requirements— Write for complete catalog . . .

PROTO-KIT Complete Seaelectoboard programming systems, including shorting pins and diode holders in 9 x 8 or 10 x 10 sizes available from your local Seaelectro distributor.

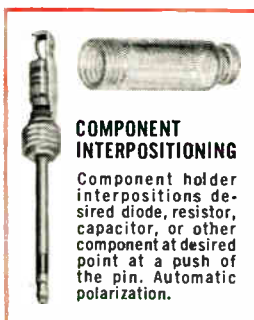

COMPONENT INTERPOSITIONING

Component holder interpositions desired diode, resistor, capacitor, or other component at desired point at a push of the pin. Automatic polarization.

Seaelectro and only Seaelectro

MAKES THE ↑
↓
← Y →
SEAELECTOBOARD

Seaelectro Corporation, 139 Hoyt Street, Mamaroneck, N.Y. British Branch: Surrey, England.

New
Products

SHIELDED COIL FORM

Meet immersion/moisture-resistance tests of Mil-C-15305-B, Gr. 1, Cl. 0.

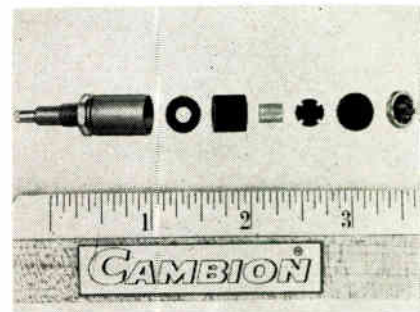

Designated No. 1176, it is electromagnetically and electrostatically shielded and is shock and vibration resistant. The tunable slug is provided with a stop to prevent possible damage to the powdered iron components. It is rated to 105°C and offers a wide range of operating freq. from 0.2 to 300.0MC; inductances from 0.55 mh to 1.00mh. The CAMBION® 1176 measures 0.406 OD and 1.477 in. max. overall length. Concord Ave., Cambridge 38, Mass. Cambridge Thermionic Corp., 445
Circle 245 on Inquiry Card

TINY SPOTLIGHT

The Pinlite, "Model Lens," has a total light output of 60 millilumens.

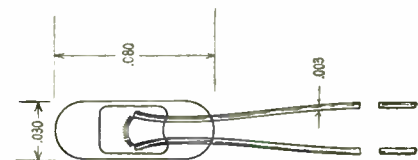

Measuring 0.080 x 0.030 in., it is for use in readout devices, medical and industrial light probes, transistor indicators, and pointer and meter scale illuminators. Specs: Operating voltage, 1.2v; operating current, 12ma; life expectancy, 1000 hrs. Manufacturing techniques permits a lens effect to be built into the lamp. Low thermal time-constant gives fast light modulating capability. Kay Electric Co., Old Bloomfield Ave., Pine Brook, N. J.

Circle 246 on Inquiry Card

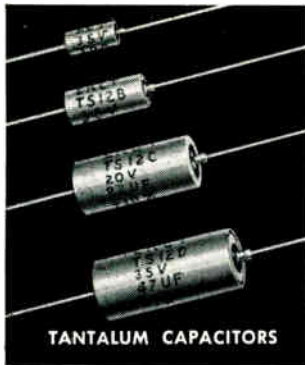

TANTALUM CAPACITORS



NEW from ELECTRA

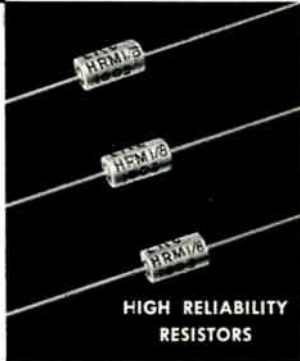
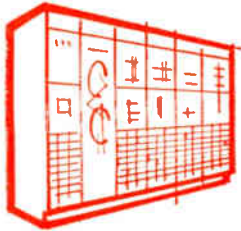

HIGH RELIABILITY
RESISTORS

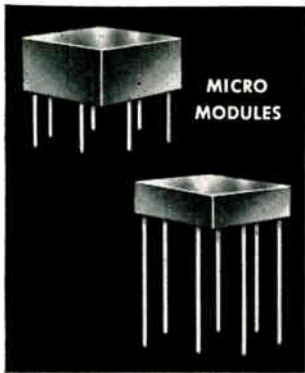

MICRO
MODULES

■ NEW TANTALUM CAPACITORS

Complete new facilities have been established by Electra Manufacturing Company for the production of solid slug tantalum capacitors. With this new division, Electra now offers hermetically sealed tantalum capacitors designed to meet or exceed MIL-C-26655A/2B specifications for the most exacting military and industrial applications. Improved manufacturing techniques provide higher quality performance even under exceptional environmental conditions. Available in insulated or uninsulated cases, capacities from 1 to 330 mfd, and working voltages from 6 to 35 vdc.

■ NEW HIGH RELIABILITY RESISTORS

Statistical reliability backed by continuing engineering investigation now makes the Electra HRM ultra-high reliability resistor available for demanding applications. Quantity production is now available for industrial as well as military use. Choice of the highest-quality raw materials combine with meticulous manufacturing processes to produce deposited metal film resistors which will increase the reliability of your equipment. Metal film and carbon film resistors made by Electra meet critical military specifications such as those for the Polaris program because of the assured performance delivered.

■ MICRO-MODULE WAFERS AND BLOCKS

For circuit modernization and miniaturization without quality sacrifice, Electra offers two approaches to compact solid-state design. The resistor wafers can be designed to fit your applications and encapsulated with the rest of your circuit components. Complete circuits can also be supplied to your specifications as encapsulated blocks. These complete circuit blocks permit an extremely high component per cubic inch density for those applications where space is at a premium and high reliability is essential.

ELECTRA MANUFACTURING COMPANY

4051 BROADWAY • KANSAS CITY 11, MISSOURI • PHONE WE 1-6864



- **Rack-mounted signal sources for 900-11,000 mc.**
- **High-power coaxial cable that's really flexible**
- **New crimp-type subminiature connectors**

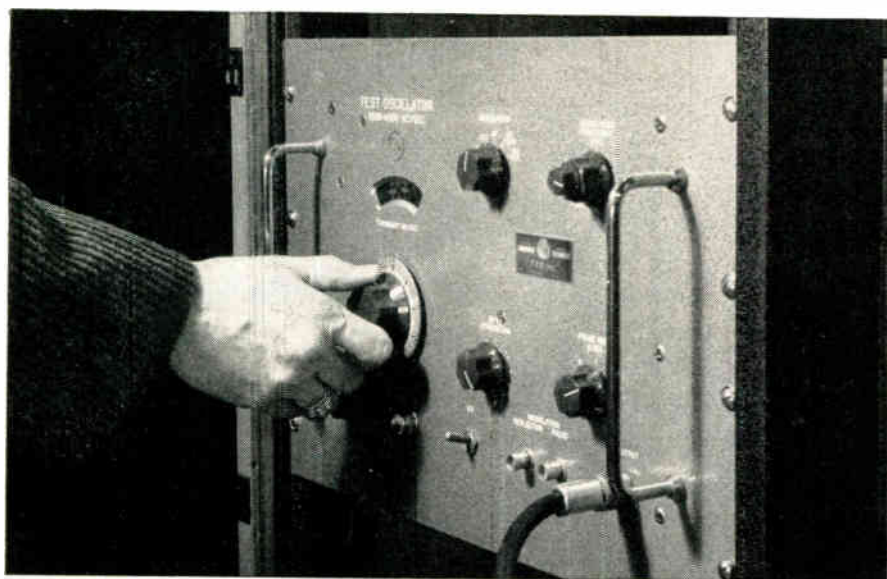

Rack-mounted signal sources for 900-11,000 mc.

Now you can mount FXR's series 772 test oscillators in standard 19-inch racks—for use in laboratories and other permanent test applications. Like the FXR portable models, these new rack-mounted signal sources provide ample RF power in the 900 to 11,000 mc. range.

In all signal sources, power supply and klystron are combined in a single unit. This makes operations safer—exposed klystron wires are eliminated. Klystron replacement is faster and less expensive—as little as 1/4 the cost of klystron replacement in separate power supply and klystron set-ups.

MODEL	FREQUENCY RANGES	PRICE
L772A	0.95 to 2.0 KMC	Portable \$1235. Rack \$1250.
S772A	1.9 to 4.0 KMC	\$1035. \$1050.
C772A	3.95 to 8.2 KMC	\$1340. \$1355.
X772A	7.0 to 11.0 KMC	\$1340. \$1355.
Power Output	10 MW to 100 MW max CW output. Power variable through use of an internal level-set attenuator.	
Modulated Outputs	Internal: CW, pulse or square wave External: Pulse, square wave or FM	
External Modulation Requirements	Pulse: Positive pulse of 30 v. amplitude across 100 K ohms. Pulse width from 0.5 microsecond to square wave. Reflector: sine wave or sawtooth FM, sensitivity from 100 to 200 kc/v.	
Connectors	RF Output: Type N jack. External pulse: Type BNC jack. Reflector modulation: Type BNC jack.	
Power Requirements	115/230 v. AC, 50 or 60 cycles, 150 w.	
Dimensions & Weight	Portable: 11" high X 16" wide X 15" deep; 45 lbs. Rack: 11" high X 19" wide X 15" deep; 45 lbs.	

Single-control tuning lets you set frequencies faster and more accurately ($\pm 1\%$). Frequency remains constant, no matter how you vary the power output, because the klystron reflector voltage automatically

changes with the positioning of a broad-band, non-contacting tuning plunger inside the oscillator cavity.

RF power output ranges from 10 to 100 MW. It's controlled from the front panel, through a level-set attenuator.

The portable models are available from stock; the rack-mounted models are shipped within a month. For more information, circle Reader Card Number 71. ■

High-power coaxial cable that's really flexible



This is a new FXR product—Amphenol type RG-281/U coaxial cable. It was developed for an Air Force electronic counter measures system, where small space required a cable that bends and flexes easily without changing electrical properties. Now, it is available commercially.

Perforated Teflon tape dielectric gives this cable extra flexibility. The tape continuously supports the center conductor...keeps center and outer conductors concentric even when the cable is bent over small radii.

Teflon tape also cuts down moisture condensation at dielectric interfaces because it eliminates voids between cable and connector dielectrics.

Type RG-281/U power cable gives you a VSWR of less than 1.2...a dielectric constant of 1.55...serves as general purpose RF transmission line, easy to install and operates at high temperatures. For more information, circle Reader Card Number 72. ■

New crimp-type subminiature connectors

FXR's new Subminax® Series 5116 quick-crimp micro-miniatures make faster, more reliable, less costly cable assemblies. And you don't have to re-design your product to use them, because Series 5116 micro-miniatures are interchangeable with competitive counterparts. In fact, the addition of this new Series to the Subminax line means that you can now specify a Subminax connector that mates with or is interchangeable with any known sub-miniature or micro-miniature coaxial connector on the market today.

The new Subminax Series 5116 has at least three major advantages over other micro-miniatures:

□ *Faster Assembly*—Quick-crimping feature, plus standard crimping tool, makes child's play of cable assembly. For example, Series 5116 plugs and jacks have only three parts, including body assembly. Easier, less critical cable stripping. No braid soldering.



□ *Dependable Delivery*—new FXR micro-miniatures are immediately available from factory stocks or your Amphenol distributor.

□ *Lower Price*—Series 5116 coaxial connectors are priced substantially below current prices for competitive "equivalents."

□ *Technical Facts*: 500 VRMS; impedance: 50, 75 or 95 ohms; gold-plated captivated contacts (solder type); Teflon* insulation; silver-plated body; screw-on or push-on coupling; color coding boots—optional. For use with coaxial cables in the .075 to .115 OD range. For more information, circle Reader Card Number 73. ■ *Registered trademark of DuPont

It takes a jeweler to make waveguides at new FXR facility

FXR recently expanded its microwave facilities at Woodside, New York, to meet the growing demand for millimeter waveguides. But expansion is only part of the story. Precision is the other.

The waveguides made here are used in space communications equipment. They have to be extremely

small and extremely accurate. The combination calls for some of the most delicate machining operations you'll see outside a jeweler's shop. Tolerances—as small as 0.0001 inch—are so critical that FXR technicians at Woodside put parts through a final diamond-lapping operation to achieve the necessary accuracy in dimension and surface.

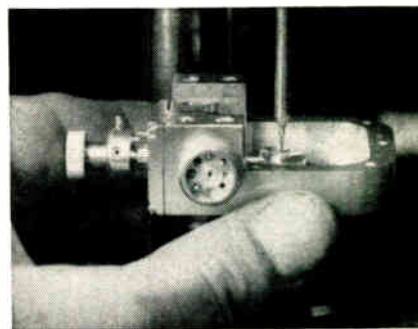

FXR uses Starrett Depth Gauge to check accuracy of slotted waveguide parts within ± 0.0001 inch.

A large engineering staff supports these precision manufacturing facilities. It works with customers in developing special products for microwave applications. ■

The RF, Products and Microwave Division Amphenol-Borg Electronics Corporation; 33 East Franklin Street, Danbury, Connecticut.

FXR™

MIL-W-8777
SILICONE RUBBER
AIRCRAFT ELECTRICAL WIRE

FOR QUALITY ASSURANCE

it's **Super-Temp**

You can rely on Super-Temp wire and cable for
HIGH CORONA RESISTANCE • HIGH RADIATION LEVEL
HIGH VOLTAGE APPLICATION

Super-Temp's MIL-W-8777 is available as hook-up wire, apparatus lead wire, aircraft wire, power cables, ignition cables. It has an ultra temp range of $-55^{\circ}\text{C} + 150^{\circ}\text{C}$. Extreme flexibility with long life. Extensive quality control assures "on center" and "to size." Fast delivery (7 to 10 days). Quality certification program with lot control and bonded area available for military programs. Write for sample and price quotation on your specific needs. Address Dept. EI-24.

AMERICAN SUPER-TEMPERATURE WIRES, INC.

A Subsidiary of Haveg Industries, Inc.

32 West Canal Street, Winooski, Vt.
 13151 Sherman Way, N. Hollywood, Cal.



Circle 115 on Inquiry Card

New

Products

CAPACITOR

This line offers radial or axial lead and flush mounting.

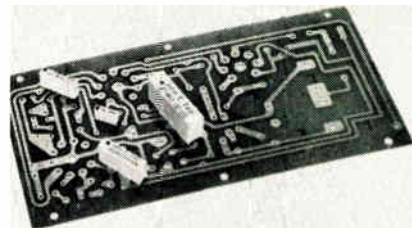

Fibre glass reinforced encapsulation gives high shock resistance and no damage under temp. variations of -55° to $+125^{\circ}\text{C}$. Uniform case size, accurate lead spacing, a channel allowing air passage, cleansing and firm mounting are features adopting it to printed circuit use. The package is available in various types of dielectrics such as mylar, metalized mylar polystyrene and others. John E. Fast & Co., a div. of Victoreen Instruments Co., 3580 N. Elston Ave., Chicago 18, Ill.

Circle 247 on Inquiry Card

CUT CONSTRUCTION DELAY

with pre-punched
VECTORBORD,
PLUGBORD and
Push-in TERMINALS

Make circuits the fast, easy way . . . simply insert Vector push-in terminals (wide variety available) and component wires into pre-punched Vectorbord, or use punched copper clad for do-it-yourself etching; and, for production, we're geared to omit the holes not required and assemble terminals, eyelets, etc. to your specifications. Seven patterns available with .062" and .093" holes, in XXXP phenolic, glass silicone, glass or paper epoxy and copper clad. Plugbords supplied in many sizes with etched pads, .040" dia. Edge-Pins or Elco Varicon contacts.

Save time — Save work — Save money!

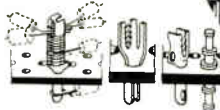

Send for complete literature

VECTOR ELECTRONIC CO., INC.

1100 Flower St., Glendale 1, California; Phone: CHapman 5-8971

Circle 116 on Inquiry Card

INSTRUMENT LATHE

Boley & Leinen instrument lathe is for production of precision parts.

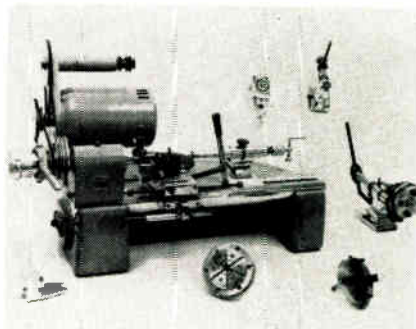

This German made precision, universal jewelers lathe features vibration-free operation. Bed of the WW 83 can be inclined forward and backward through 15° about its longitudinal axis and is firmly clamped in any intermediate position by means of a cam lever. It has as standard equipment: ground bed, vee slides; headstock with collet and carrier plate with centers; hand rest; tool rest; white viewing screen; rheostat controlled reversible motor (300-7500-RPM); and a switch gear. Alexander Machine Tool Sales, Inc., 5840 W. Adams Blvd., Culver City, Calif.

Circle 248 on Inquiry Card

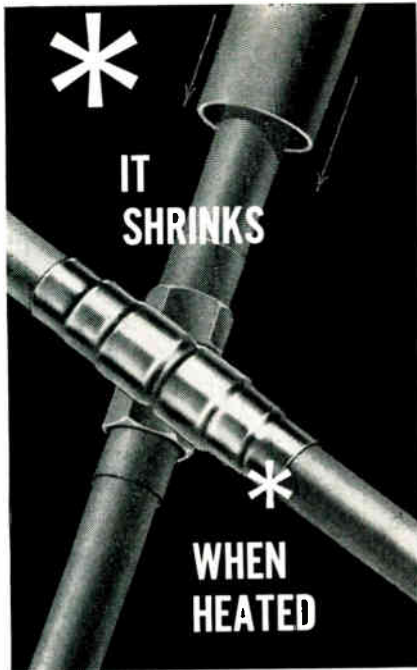

HYSHRINK

TUBING AND SLEEVING

Anaconda's Hyshrink tubing and sleeving gives you custom-fitting, insulating sheath on connectors, multi-pin connectors, cables, terminals, capacitors, pigtailed and many other similar applications.

HERE'S HOW IT WORKS

- 1) Cut a section of Hyshrink tubing the length you want. Slip it on.
- 2) Apply 275°F heat for a few seconds.
- 3) Hyshrink shrinks to form a protective sheath the exact shape of the area covered.

RESULT

You get a custom-molded mechanical bond with these outstanding features.

- **CONTROLLED SHRINKAGE** Hyshrink is an irradiated polyolefin material. The molecular cross-links control the shrinking—giving you the dimensions you require.
- **EXCELLENT TEMPERATURE CHARACTERISTICS** —minus 67°F to 275°F. Tubing will not run, flow, melt, harden, crack or blister.
- **HIGH DIELECTRIC AND MECHANICAL STRENGTH** Hyshrink is an excellent insulating material.
- **MOISTURE AND CHEMICAL RESISTANCE** Hyshrink protects against weathering. Is unaffected by most chemicals.

All of these features make Anaconda's Hyshrink the most versatile tubing and sleeving yet developed. For complete information, just write Anaconda Wire and Cable Co. 2201 Bay Road, Redwood City, California, Dept. JEB-2.

WRITE THE MAN FROM
ANACONDA

about HYSHRINK

AD NO. 62275

Circle 136 on Inquiry Card

Protective Coating For Space Equipment

A new non-conductive protective film coating for use on space equipment has been revealed in a scientific paper "Silicon Nitride Dielectric and Heat Protective Coating," authored by Dr. C. R. Geesner and Mr. C. R. Barnes.

This thin adherent nonporous film of pure silicon nitride discovery is the result of an in-house study to find a coating material that would be non-conductive and could resist high temperatures. Several tests performed during the study showed that silicon nitride is capable of maintaining non-conducting properties up to a temperature of 600 degrees C. Also, it is capable of protecting metal surfaces from atmospheric oxidation at much higher temperatures.

A capacitor, placed in an oven with the temperature maintained at 500 degrees C. for 400 hours, functioned satisfactorily both during heat exposure and after cooling to room temperature.

The tests were conducted at Aeronautical Systems Division, Air Force Systems Command, Wright-Patterson AFB, Ohio.

Electrical Space Engine Unveiled

A compact, electrical space engine, capable of operating indefinitely by battery and solar cell power, has been unveiled by Republic Aviation Corp., Farmington, L. I., N. Y.

The lightweight engine, which obtains its thrust from the magnetic "pinching" of an inert gas such as nitrogen, was described by company scientist Alfred E. Kunen as "the only electrical engine in existence capable of operating today just as it will in actual use of space ships and satellites." The company expects to have a "flyable" model ready for space flight early next year.

Main advantage of the plasma engine over other forms of space propulsion is its light weight due to its efficient use of fuel. Its specific impulse, a term used to show efficiency of fuel consumption, ranges from 1,000 to 7,000 secs. By comparison, the specific impulse of a rocket engine is in the order of only 100 to 350 secs. This means the plasma unit has the ability to operate over a much longer period of time.



AFTER HOURS..

relax
with **REK-O-KUT**—
the only
manufacturer of
single-play turntables
for studio and home

Engineers relax, but they don't relax their standards. At home, as at work—design and performance are their criteria. That's why so many engineers buy Rek-O-Kut single-play turntables for their home music systems. Send for full story about the *real* difference —"Single-Play Turntables vs. Automatics".

REK-O-KUT

REK-O-KUT COMPANY, INC.
Dept. EI-4
38-19 108th St., Corona 68, N.Y.

Name

Address

City Zone State

Circle 138 on Inquiry Card

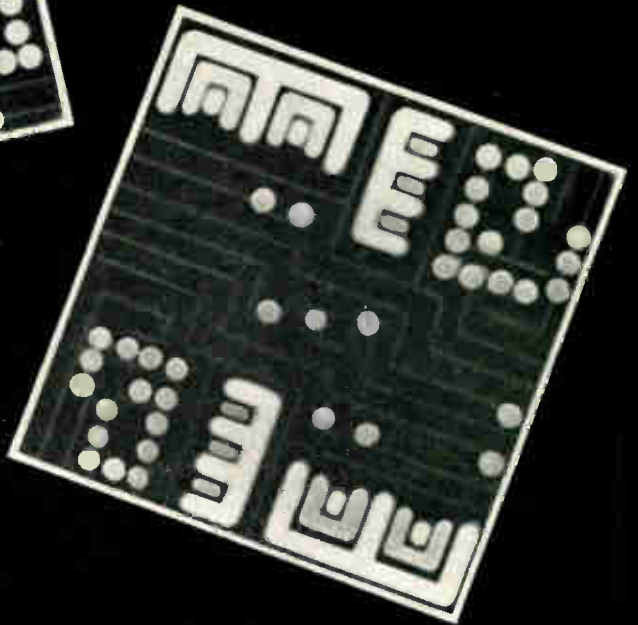
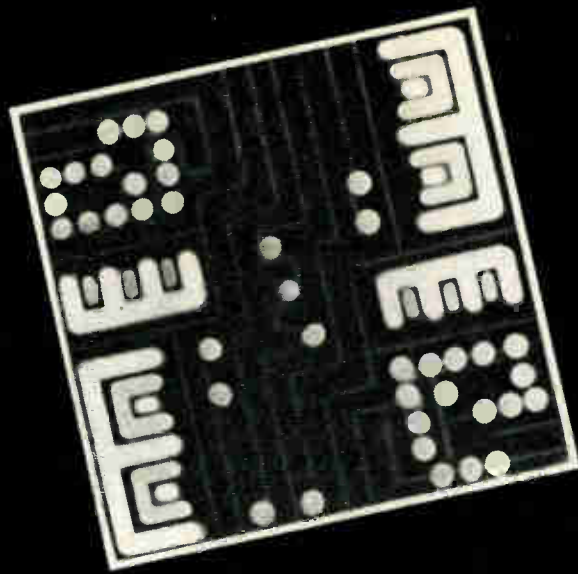

LOADED DICE

SEMI-NETS*

SEMICONDUCTOR
INTEGRATED
NETWORKS



*TRADE MARK
SPERRY RAND
CORPORATION



BOTTOM VIEW
OF HEADER

LEGEND

- DESIGNED CIRCUIT
- DISTRIBUTED CONSTANTS

NOTE: DIODES D_{91} , D_{107} , D_{137} , D_{14}
AND CAPACITORS C_9 , C_{10} , C_{13} , C_{14}
ARE PORTIONS OF TRANSISTORS

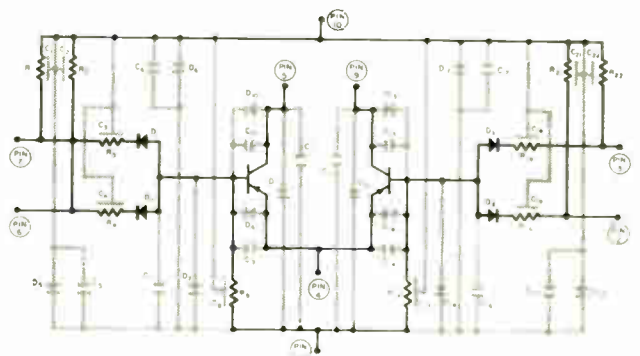

COMPLETE CIRCUIT ON A SILICON SLICE REDUCES ASSEMBLY COSTS... INCREASES CIRCUIT RELIABILITY.

Through the use of photoresists, planar diffusion, and surface passivation, the complete circuit, shown above, has been fabricated in one silicon slice — packaged in a multilead TO-5 case.

Because this high density device eliminates 75% of conventional connections, your circuit assembly costs are reduced. And because fewer interconnections mean less opportunity for circuit failure, your overall circuit reliability is increased.

In addition, SEMI-NETS offer design and systems engineers weight and volume reduction over conventional miniature components, between 100:1 and 1000:1. Low power requirements further the overall advantages of the SPERRY SEMI-NET.

If you are interested in the development of a SEMI-NET circuit for your equipment, we would like the opportunity to show you how we may help you.

Write today for comprehensive brochure describing the state of the art of SEMI-NETS.

SPERRY

SEMICONDUCTOR

DIVISION OF
SPERRY RAND CORPORATION
NORWALK, CONNECTICUT

SEMICONDUCTOR INTEGRATED NETWORKS (SEMI-NETS*),
ALLOY SILICON TRANSISTORS AND DIODES
SALES OFFICES: CHICAGO, ILLINOIS; LOS ANGELES, CALIFORNIA; OAKLAND, NEW JERSEY;
MEDFORD, MASSACHUSETTS; SYKESVILLE, MARYLAND; BETHPAGE, L. I., NEW YORK
SEMICONDUCTOR OPPORTUNITIES
AVAILABLE TO QUALIFIED ENGINEERS

*Trade Mark, Sperry Rand Corporation

Tele-Tech's ELECTRONIC OPERATIONS

The System Engineering Section of ELECTRONIC INDUSTRIES

APRIL 1962

SYSTEMS—WISE . . .

G. E. Machine "Learns" After Being "Punished"

Machine pictured learns from its mistakes and remembers the next time. After 6 or 8 wacks with the "punish lever" it will correctly answer coded questions put to it. It is the forerunner of devices able to recognize patterns from quantities of miscellaneous information fed them. Built by General Electric's Defense Systems Dept.'s Electronics Lab., it was demonstrated recently in New York City.



▶ The FCC has requested authority, from Congress, to regulate community antenna systems. The authority to make rules would cover: some requirements that a CATV (Community Antenna Television) system carry the signal of local stations if the latter desires it; the local signal be carried on the cable system without any degradation of quality; and protection for the local station(s) against duplication, on other channels on the cable system, of programs carried simultaneously by the local station(s).

▶ First phase of the Republic of Panama's new telephone and telegraph network is completed. General Telephone and Electronics subsidiaries, Automatic Electric International, Northlake, Ill., and Lenkurt Electric Co., Inc., San Carlos, Calif., completed the 226 mile microwave radio net in 7 months. Second phase of long distance and local facilities for 16 cities in 7 provinces is scheduled for completion in mid-1962. Completion of final phase of automatic service to remaining area is marked for the end of 1965.

▶ Two Universities have announced plans to erect 15-Mev (million electron volts) Van de Graaff "tandem" accelerators. Both will be used to investigate the structure and properties of atomic nuclei. Rutgers Univ., in collaboration with Bell Telephone Labs., expects to have its accelerator in use by the Fall of '63. Stanford Univ. (recently authorized by Congress to build a 20-Bev (billion electron volts), 2-mile long linear accelerator) plans to start using its 15-Mev by the end of 1965.

▶ The Army's new mobile weather radar is in its operational testing phase. Built by the Signal Corps and Raytheon Co., Lexington, Mass., it is housed in a 26 ft trailer. Tracking coverage is 600,000 square miles, or out to a distance of 400 miles. Display information includes: storm shape, density of precipitation, cross-sectional structure and direction of movement.

▶ A new type course computer and steering system is being built by United Aircraft Corp.'s Norden Div. for the U. S. Dept. of Commerce's Maritime Administration. The system is for computing bearing between two points 1,000 miles apart. Using automatic pilot techniques, it will assume steering control, keeping a ship on course to a preset destination. The system will give constant estimate of position, how far to go and how long to get there.

▶ Texaco Experiment Inc., will build prototype geophysical measurement instruments for Surveyor, under a contract from NASA's Jet Propulsion Laboratory. They will measure thermal diffusivity, density, magnetic susceptibility, hardness and sonic transmission on the lunar surface and in a 1¼ in. hole bored into the moon.

▶ Winner of G. E.'s 1961 Edison Radio Amateur Award for public service is William G. Welsh, W1SAD/6. Special citations went to: Robert T. Herndon, W5URW; Eugene M. Link, WOIA; and George L. Thurston, W4MLE.

▶ The Army's SD-5 combat surveillance system's drone successfully demonstrated its abilities on a "no hands" flight from Yuma to Fort Huachuca, Ariz. Built by Fairchild Stratos Corp., Electronic Systems Div., Wyandanch, L. I., N. Y., the SD-5 carries a high speed mapping camera, side-looking radar, infrared devices and other classified systems. The drone is of the recovery type.

▶ The NAB has announced it will present its Engineering Achievement Award to Ralph N. Harmon, Vice President-Engineering, Westinghouse Broadcasting Co., New York, N. Y. The award is in recognition of his long and valued contributions to the broadcasting art.

Defense Communications System Facilities

Control room shown is typical of those the DOD plans to install in area communications control centers in Washington, Europe, Alaska, Hawaii and Colorado. IBM's Federal Systems Div.'s Communications System Center, Rockville, Md., will equip the centers. IBM's 1410 will be used to store, organize and drive displays and printers, to give minute-by-minute status information on the system.



◀ Circle 63 on Inquiry Card

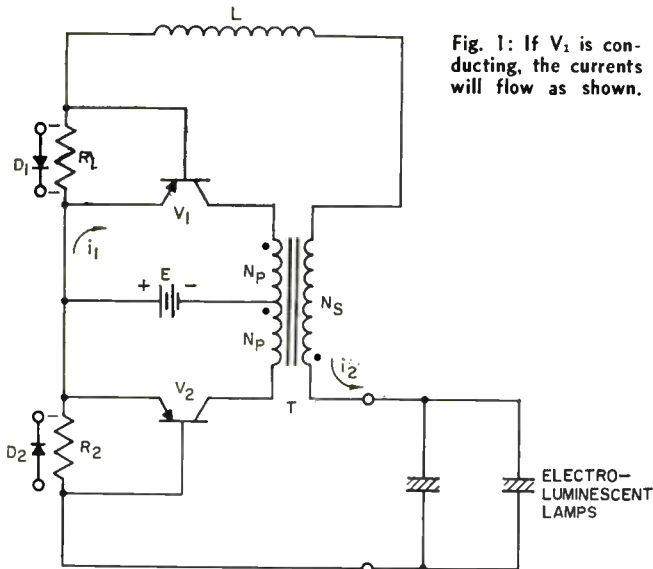

Fig. 1: If V_1 is conducting, the currents will flow as shown.



By THOMAS M. CORRY
 Supervising Engineer
 New Products Laboratory
 Westinghouse Electric Corp.
 Pittsburgh, Pa.

This unusual design produces significant economies. Not only are the base bias capacitors and separate feedback transformer eliminated, but, in one version, even the expensive output transformer. The circuit can energize large ceilings as well as small demonstration lamps.

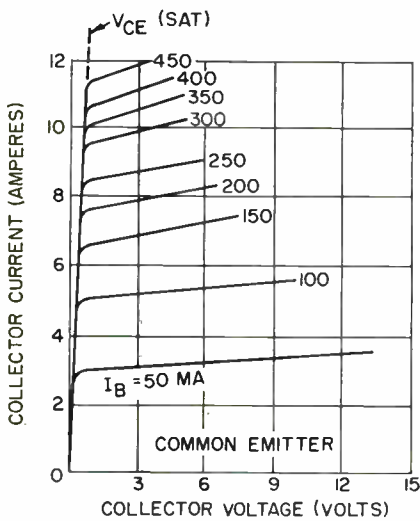

Fig. 2a: Some typical power transistor characteristics.

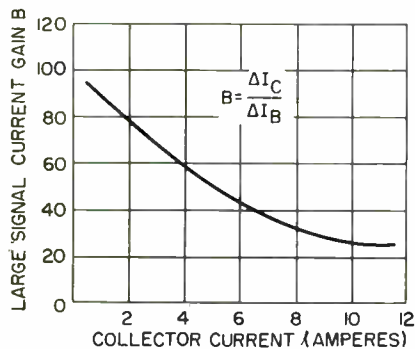

Fig. 2b: Notice the drop in the large signal gain as collector current increases.

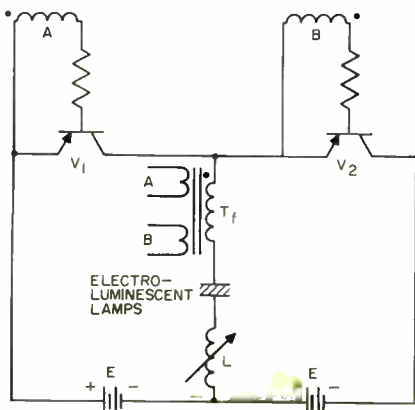

Fig. 3: A push-pull circuit that requires no output transformer but does need a small feedback transformer.

For Electroluminescent Lamps:

Designing a Low-Cost Power Supply

ELECTROLUMINESCENT lamps have properties similar to capacitors. They can act as capacitive reactors in series, or parallel, tuned circuits. In series LCR circuits, the amount of current flow, at resonance is decided by applied voltage and circuit resistance. Voltages across reactive components are limited by the ratio WL/R , or the circuit Q . The Q of the inductances often equals the Q of the circuit. However, since the lamp losses are significant, the Q of tuned circuits in which these lamps are used is $(WL)/(R_C + R_L)$. R_C and R_L are the dissipative elements in the lamp and inductor, respectively. By using the lamp as a tuned circuit component, a simple, efficient power oscillator can be designed.

Fig. 1 shows a power converter in which transistors V_1 and V_2 are connected in push-pull across the primary of transformer T and in series with the dc voltage E . The transformer secondary is connected in series with the lamp load, resistors R_1 and R_2 which are in parallel with the back-to-back base-emitter diodes of V_1 and V_2 , respectively, and the inductance

L. Polarity markings show the transformer output voltage phase. The resistances of R_1 and R_2 are greater than the forward resistances of the base-emitter diodes.

If V_1 is conducting; i_1 and i_2 flow as in Fig. 1. By neglecting transformer magnetizing current, we can write the relationship between primary and secondary currents as follows:

$$N_P i_1 = N_S i_2.$$

If the transformer turns ratio N_S/N_P does not exceed the large signal current gain of the transistors, and if the current feedback is positive, then the circuit can oscillate. Tracing the path of i_2 , we see that it cannot flow through the base-emitter diode of V_2 . Therefore, it flows through R_2 and from the emitter to base of V_1 in parallel with R_1 . The fraction of i_2 that flows from the emitter to base is enough to maintain V_1 in the conducting state.

For proper operation, V_1 and V_2 should function as switches. Therefore, i_2 must be large enough to keep the transistors saturated for all values of i_1 . For example, if $N_S/N_P = 10$ then $i_2 = i_1/10$. Assume that the total i_2 flows through the transistor bases. Look at the transistor characteristics, Fig. 2, if collector current $i_1 = 2$ amp. and base current $i_2 = 200$ ma., the collector voltage will be determined by the V_{CE} (SAT) voltage line. With a base drive of 200 ma., the collector current could be as high as 7.5 amp. and the transistor would still be in the saturated state.

The collector current lines compress as base drive current and the collector current increase. The plot of large signal current gain *versus* collector current shows the drop in gain as collector current increases. Therefore, to insure that the transistors will always be saturated when switched on, the ratio N_S/N_P must be less than the large signal current gain for the greatest value of collector currents.

Due to the nature of the secondary circuit, i_2 will be sinusoidal in shape. V_1 will conduct until the lamps are charged and i_2 drops to zero. Then V_1 will cut-off and the lamps will begin to discharge. The resultant reversal in the flow of i_2 will cause V_2 to switch on and hold V_1 cut-off. V_2 will continue to conduct until the lamps are completely charged; then, the cycle will repeat.

Since the lamps and inductor L form a series L-C resonant circuit, the voltage across the lamp can exceed the output voltage of T. The amount of lamp voltage will be a function of the applied voltage E , the transformer turns ratio, and the circuit Q .

In circuits requiring high Q operation and in which the base-emitter diode forward resistances of the transistors approach the resistance values of R_1 and R_2 , diodes D_1 and D_2 can be used to replace the resistors, Fig. 1.

If a split dc voltage supply is available, a push-pull circuit can be made without using an output transformer, Fig. 3. However, a small feedback transformer T_f is required.

A REPRINT

of this article can be obtained by writing on company letterhead to
The Editor

ELECTRONIC INDUSTRIES, Chestnut & 56th Sts., Phila. 39, Pa.



Performance Proven to MIL-S-3786A/4 (SRO4E36B3HP) and MS-16109B

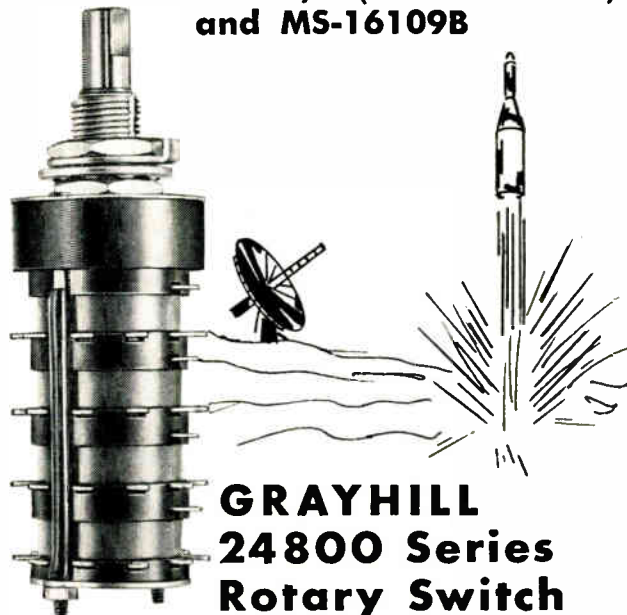

GRAYHILL 24800 Series Rotary Switch Meets Requirements per MIL-S-3786A, SR04 and MS-16109B (Substantiating Data On File)

Explosion Proof

Vibration

— 10-2000 CPS — Enclosed construction.

High Shock

— Approx. 2000 G's — High insulation resistance.

Moisture Resistance

— With 100 VDC polarizing voltage applied.

Marking

— In accordance with specification.

Break 1 amp, 115 VAC resistive or carry 5 amps, 1 to 10 deck, 2-10 positions per deck, shorting or non-shorting contacts.

Delivery

— 3-6 weeks depending on quantity.

"Immediate Delivery of Samples for Prototypes"

Special materials available for dry circuit, and elevated temperature and humidity environments.

SEE OUR SPECIFICATIONS IN
VSMF
THE MICROFILM CATALOG FILE



"N. Gineer"

Grayhill
INC.

Area Code 312, Phone 354-1040
543 Hillgrove Avenue
La Grange, Illinois



"PIONEERS IN MINIATURIZATION"

Cleaning Tapes Ultrasonically

(Continued from page 107)
much different from the normal bulk handling of metal parts.

Successful film cleaning requires means for removing the solvent from the film before it has a chance to evaporate. In this way, loosened dirt will not be redeposited on the film. The CF₂ Ultrasonic Film Cleaner employs a patented dryer design. The film enters the dryer with a layer of solvent. It is drawn

between two opposing air jets supplied with warm air and operating at a high volumetric rate. When this air flow encounters the wet film surface under a pre-determined condition, the fluid is stripped, carrying with it the remaining dissolved and dispersed soils. The removed solvent in the output air stream and the soils are carried away in the resulting mixture of air and vapor. High effici-

ency is necessary to prevent evaporative drying before the film enters the jet area; and, drying must be done at a uniform rate over the entire film surface.

The combination of cleaning and a non-redepositing dryer required the design of a fluid flow system and an air flow system. The fluid flow bath includes a cleaning bath with ultrasonic transducers operating from an electrical oscillator, a squeeze pressure rinse to complete removal of large masses of loosened soils and to provide a controlled layer of solvent entering the dryer, a fluid pump, and a filter to remove soil from the solution. The air-flow system includes the dryer, multi-stage blowers, air filter, and heat exchangers.

The machine is completely automatic requiring the operator only to load and unload the machine. Speed is variable up to a maximum of 120 feet per minute. There is an automatic elevator to simplify film threading and allow use of a tall, narrow tank for high cleaning efficiency. Numerous automatic and electronic controls and safety features are provided. The only materials that come in contact with the film are solvent and air.

Existing scratches, as well as sprocket holes are cleaned thoroughly. There is no static generation and film is completely static free when cleaned. In addition there is no water condensation or embrittlement. Difficult soils such as grease pencil, lacquer and tape adhesive are removed completely. Cleaning is uniform and end-for-end and across the full film width. Color balance is completely undisturbed.

Army to Receive Special Loudspeakers

University Loudspeakers, Inc., White Plains, N. Y., has been awarded a U. S. Army Signal Corps contract for special gun-blast-proof field intercommunication loudspeakers. These are rugged cone-type units mounted in small, impact-resistant, die-cast aluminum cases.

Speakers will withstand the direct concussion of a 16 in. naval gun, and may be submerged in water for considerable periods of time without injury to its operating efficiency. It will perform under extremes of temperature, and is transportable at altitudes up to 100,000 feet.



**CAN IT BE MADE
OF MAGNESIUM?**

It can at Lavelle. Lavelle specialists know magnesium . . . how to weld it, form it, control it to produce precision missile and aerospace components that meet critical specifications, exacting performance requirements. Major contractors rely on Lavelle for sheet metal craftsmanship . . . in magnesium, titanium, nickel, aluminum, stainless steel and other alloys. Write for brochure detailing Lavelle quality controlled services: Engineering / Production Planning / Sheet Metal Forming Welding / Machining / Metal Finishing.

Lavelle

LAVELLE AIRCRAFT CORPORATION • NEWTOWN, BUCKS COUNTY, PA.
Between Philadelphia, Pa., and Trenton, N. J.

IMPORTANT AUTHORITY—President Kennedy's selection of Dr. Irvin Stewart as Director of Telecommunications Management brings that post a highly qualified appointment. Dr. Stewart was a "charter" FCC Commissioner from 1934-37 and chairman of President Truman's 1950-51 Communications Policy Board. His broad experience in the field means that his new office can exercise important authority in the assignment of radio frequencies to the federal government agencies and their utilization. The executive order gave Dr. Stewart the objective of "utilization of the radio spectrum by the federal government in a manner which permits and encourages the most beneficial use thereof in the public interest." He has authority to assign government frequencies "with the approval of the President" and the Interdepartment Radio Advisory Committee (IRAC). The IRAC has, up to the present, assigned government frequencies and is to serve in an advisory capacity to him and his organization.

LONG-SOUGHT OBJECTIVE—Assurance that the federal government is not using too large a share of spectrum space has long been the subject of extensive criticism of federal management of frequency allocations by leading members of the Senate and House. The President's executive order creating the new post for Dr. Stewart spelled out in its text that "it is essential that responsibility be clearly assigned within the executive branch of the government. . . . for effecting the prudent use of the radio frequency spectrum by the executive branch of the government." The DTM, headed by Dr. Stewart, will work closely with the FCC in this field and in its other responsibilities over telecommunications plans and policies. The executive order brought out that "there is an immediate and urgent need for an examination of ways and means of improving the administration and utilization of the radio spectrum as a whole."

ESSENTIAL ELEMENT—Officials of the National Aeronautics & Space Administration have emphasized that an essential element in the success of the orbital flight of Lt. Col. John Glenn, Jr., was the worldwide Mercury tracking network. The 18-station global network was built for NASA by an industrial team headed by the Western Electric Co. as prime contractor. Other team members included Bell Telephone Labs.; Burns & Roe; and IBM. Lincoln Lab. of M.I.T. also advised and assisted NASA on special technical problems relating to the network. Radio Corp. of America played an important role in maintaining and operating the control center's instrumentation and communications at Cape Canaveral, the "nerve center" for Project Mercury. RCA also supplied the two small pencil-thin tubes which were

responsible for powering the voice radio broadcasts of Col. Glenn during his three-orbit flight. Collins Radio produced the multi-function communications system aboard the space capsule. Collins scientists also advocated the use of high frequency radio for transmission from the upper layer of the ionosphere, which produced such satisfactory transmission over a very long distance.

CONELRAD REPLACEMENT—The 11-year-old Conelrad system is to be replaced by a new system of control over broadcasting and TV to improve civil defense and military communications objectives. The new system, it is reported, will be designed to permit the President and other federal, state and local officials instantaneous access to the more than 2000 broadcasting and TV stations in the event of a national emergency. The broadcasting industry had spent more than \$20 million equipping their stations for the Conelrad mission since it was instituted in 1951, as well as loss of many hundreds of thousands of dollars of commercial time pre-empted by Conelrad drills.

*National Press Building
Washington 4*

ROLAND C. DAVIES

THE FCC'S PROPOSAL to keep daytime only local radio stations off the air until sunrise is running into heavy opposition from many areas. The ruling would eliminate the complication between daytime—only stations and the few big time stations on the air in the pre-sunrise hours. It is becoming apparent, however, that many rural communities depend heavily on their local stations for services that cannot be provided by any other medium of communication.

ELECTRONIC INDUSTRIES ASSOCIATION has telegraphed House Ways and Means Committee Chairman Wilbur D. Mills (D., Ark.) that the EIA Board of Directors has overwhelmingly approved reaffirmation of the Association position "strongly" supporting the Administration proposal for an 8% tax credit as an investment incentive.

In making public the telegram, EIA Tax Committee Chairman David Flower, Jr., tax counsel of the Raytheon Co., said the proposal "deserves the full support of American industry in view of Treasury Dept. plans to modernize present rates at which business is permitted to make tax deductions to allow for plant equipment depreciation."

The tax incentive program, coupled with depreciation allowance reform to be accomplished by the Treasury administratively "will contribute greatly to industrial modernization and expansion, stimulate economic growth, and enhance the ability of American business to compete with foreign industry," the telegram said.

Reliability Through Design Simplicity



Sensitive Micro-Miniature Relay/Style 6B

General Characteristics

Contact Combination:

2 Form C

Contact Rating:

2 amp resistive 26.5 VDC
1 amp inductive 26.5 VDC
Low level switching

Operating Characteristics:

40 milliwatts sensitivity
30,000 ohms max. coil resistance

Ambient Temperature:

-65°C to +125°C

Vibration:

10-55 cps at .120" DA
55-2000 cps at 20 G

Shock:

50 G operational

Acceleration:

100 G operational

Terminals:

Leads; solder; printed circuit
and spade types.

Attending the IRE Show?

See our complete line of relays at

Booth 2409

Discuss your relay requirements
with members of our relay development staff

For Additional Information, contact:

PRICE ELECTRIC CORPORATION

323 Church Street • Frederick, Maryland
Area Code 301: 663-5141 • TWX: Fred 565-U

Detonator to Aid Missile Reliability

McCormick Selph Assoc. of Hollister, Calif., has been awarded a contract in excess of \$50,000 by Douglas Aircraft Co., Inc., Santa Monica. Contract is for the design and development of an explosive detonator cartridge to be used in connection with a missile stage destruct system on the S-IV stage of NASA's Saturn launch vehicle.

Intended to assure greater safety and reliability, the detonator will be initiated by using the exploding bridgewire (XB) method.

System consists of passing a high energy pulse of electrical energy through a fine wire in a short period of time. The exploding bridgewire system eliminates using sensitive primary explosives and, as a result, is insensitive to all ordinary physical and electrical shocks that could cause inadvertent ordnance firing. This includes stray currents, r-f energy, etc.

New Type of Thermistor

A contract to develop manufacturing methods for a new type of thermistor has been awarded W. R. Grace & Co., New York, N. Y. Contract was awarded by the Mfg. Technology Lab, Aeronautical Systems Div., USAF.

Grace will utilize a single crystal semiconductor material which is more sensitive to temperature changes than substances now in use.

RETORT FURNACE



Operator at G.E.'s Power Tube Dept. lowers final steel bell enclosure over one of five hydrogen retort furnaces used to braze electronic tube components and metal-ceramic seals. Furnaces were designed to eliminate solder leakage and prevent braze erosion. They have a low power input of 20 kw.

CUES

for Broadcasters

Protecting HV Rectifiers

CLOVIS L. BAILEY, Ch. Eng.

KJEF, Jennings, La.

Here's a little idea for your "Cues for Broadcasters" section. We'll call it "The Poor Man's Substitute for High Priced Silicon Rectifiers," or "How to Thwart the Heavy-lidded Announcer Who's Too Fast with the Plate Switch."

All my life as an engineer in broadcast stations has been spent in trying to get operators, announcer-operators, etc., to come in early enough in the morning to warm up the transmitter filaments before they throw on the high-voltage switch.

This they very seldom do—keeping late hours entertaining their friends, etc.—rush in at 6:00 A.M., flip on the filaments, say a brief prayer and slam on the plate switch.

Many times there is a blinding flash and the least we need is a new pair of 872 mercury-vapor rectifiers. Sometimes it's worse—872's, sockets, overload relays, and even maybe the high-voltage transformer, too. This gets expensive over the years.

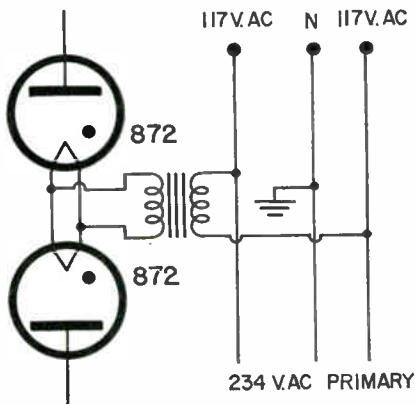

Being tired of all this, I looked into the silicon rectifier idea—a pair of 872 substitutes in silicon ran around \$300.00—somewhat discouraging. Then a simple idea occurred—why not disengage the rectifier filament transformer from the control circuits and hook the primary directly to the line voltage input. The 872's would stay hot all the time—cost of running only that one filament transformer is negligible—and that's what I did!

another TALL one
by

Stainless, serving jointly:

CHANNEL 9
W T V M
MARTIN THEATRES TV

WRBL-TV Channel 3
COLUMBUS BROADCASTING CO.

**NOW...
1749 FT!**

**ON ITS WAY UP—
WHEN COMPLETED, WILL BE THE
WORLD'S TALLEST STRUCTURE!**

We've said it before: nothing beats increased tower height! And wise broadcasters are now buying towers that can go still higher—for just a fraction of the cost per foot of a new one. If you're planning a new tower of any kind, here's a suggestion: Let Stainless' experienced engineering staff spare you problems and headaches. It's that easy. Get in touch with Stainless today.

S

Stainless, inc.
NORTH WALES • PENNSYLVANIA

Circle 121 on Inquiry Card

Electronic Sources

REGULARLY REVIEWED

Up-to-the-minute abstracts of articles appearing in the leading foreign electronic engineering manuals

AUSTRALIA

AWA Tech. Rev. AWA Technical Review
Proc. AIRE. Proceedings of the Institution of Radio Engineers

CANADA

Can. Elec. Eng. Canadian Electronics Engineering
El. & Comm. Electronics and Communications

ENGLAND

ATE J. ATE Journal
BBC Mono. BBC Engineering Monographs
Brit. C.&E. British Communications & Electronics
El Tech. Electronic Technology
GEC J. General Electric Co. Journal
J. BIRE. Journal of the British Institution of Radio Engineers
Proc. BIEE. Proceedings of Institution of Electrical Engineers
Tech. Comm. Technical Communications

FRANCE

Bull. Fr. El. Bulletin de la Societe Francaise des Electriciens
Cab. & Trans. Cables & Transmission
Comp. Rend. Comptes Rendus Hebdomadaires des Seances
Onde. L'Onde Electrique
El. & Auto. Electronique et Automatisme
Rev. Tech. Revue Technique
Telonde. Telonde
Toute R. Toute la Radio
Vide. Le Vide

GERMANY

AEG Prop. AEG Progress
Arc. El Uber. Archiv der Elektrischen Uebertragung
El Rund. Elektronische Rundschau
Freq. Frequenz
Hochfreq. Hochfrequenz-technik und Elektroakustik
Nach. Z. Nachrichtentechnische Zeitschrift
Rt. Regelungstechnik
Rundfunk. Rundfunktechnische Mitteilungen
Vak. Tech. Vakuum-Technik

POLAND

Prace ITR. Prace Instytutu Tele-I Radiotechnicznego
Roz. Elek. Rozprawy Elektrotechniczne

USSR

Avto. i Tel. Avtomatika i Telemekhanika
Radio. Radio
Radiotek. Radiotekhnika i Elektronika
Rad. i Elek. Radiotekhnika i Elektronika
Iz. Acad. Bulletin of Academy of Sciences, USSR.

- Photocopies of all foreign articles are available at 75 cents per page, remitted with order. Unless otherwise indicated, articles appear in language native to country of origin.
- A reprint of this section, "International Electronic Sources" is available without charge.

Requests for the above should be sent, on company letterhead, to:

Electronic Sources Editor
ELECTRONIC INDUSTRIES
Chestnut & 56th Sts.
Philadelphia 39, Pa.



ANTENNAS, PROPAGATION

The Influence of Irregularities on the Propagation of Mode TE₀₁ Waves in Circular Waveguides, G. Comte. "Onde." Oct. 1961. 13 pp. The author calculates the attenuation, phase and group-delay distortions caused by distributed and by lumped irregularities along a circular waveguide transmitting in the TE₀₁ mode. (France.)

Anti-Fading Broadcast Antenna, G. Z. Eisenberg, S. P. Belousoff, A. H. Lindeberg, and V. G. Yampolsky. "Radiotek" 16, No. 12, 1961. 10 pp. A description of a wideband anti-fading antenna circuit is given. Anti-fading bandwidth of this circuit is achieved by regulation of current distribution. (U.S.S.R.)

Radio Meteorology and its Significance in Long Distance Propagation of Metric, Decimetric and Centimetric Waves, B. R. Bean, et al. "Nach. Z." Jan. 1962. 8 pp. Basic principles of radio meteorology are summarized and its significance in the propagation of metric, decimetric and centimetric waves is discussed. (Germany.)



CIRCUITS

Passive Methods for Protection of Telemechanics Equipment Against Interference, B. Steinborn and J. Szalanski. "Prace ITR." Vol. 5 #4. 19 pp. Paper describes the passive methods for protection of remote operating techniques equipment against low intensity interference, employing series and periodic synchronization circuits. Circuits protecting the signal against occurrence of single or double errors of the same type are presented. (Poland)

Estimate of Work of an Asymmetrical Steel Arc Contrivance and Selection of its Optimum Working Conditions, F. Sondij. "Roz. Elek." Vol. 7, #3. 39 pp. An analysis of a three-phase circuit of an asymmetrical steel arc contrivance has been carried out in the paper. Analysis has been carried out for the state of current symmetry and for a symmetric arrangement of the tensions supplying the contrivance. As a result of the analysis parameters K_z and K_v , defining the degree of the furnace asymmetry for two characteristic states of its work have been obtained. Mentioned parameters are obtained on the basis of measurements of the constants in the considered circuit. (Poland)

Circuits That Are Conditionally Equivalent to a Bridge Circuit, Werner Herzog. "Freq." Dec. 1961. 14 pp. Paper investigates to what extent bridge circuits can be replaced by direct circuits in certain cases, hence with conditional equivalence. Such a substitution eliminates, apart from a transformer or differential transformer, also the degradation introduced by the latter. (Germany)

The Influence of a Parasitic Amplitude Modulation on the Operation of an FM detector with a Counter Circuit, P. A. Schpanion. "Radiotek" 16, No. 12, 1961. 7 pp. Influence of a parasitic amplitude modulation on the operation of an FM detector with a counter circuit, is analyzed. An approximated expression for the component, produced with the frequency of modulation, is derived. (U.S.S.R.)

Frequency Modulation of a Klystron in a phase AFC Circuit, L. A. Birger. "Radiotek" 16, No. 12, 1961. 5 pp. Application of the phase AFC technique makes possible the design of an FM generator with a highly stable center frequency. The system frequency response is calculated for FM operation. (U.S.S.R.)

Resonant Circuit With an Active Pulse Impedance, S. G. Segal. "Radiotek" 16, No. 12, 1961. 6 pp. Phase selectivity of a single resonant circuit with an active pulse impedance is discussed. In contrast to the synchronized detector, the signal separation by phase indication in this case is not accompanied by signal detection, making for definite advantages. An FM or PM signal, acting on such a circuit, is transformed into a constant frequency and phase AM signal. (U.S.S.R.)



COMPONENTS

Pilot Filters, A. J. L. Muir, R. R. Stoker. "ATE J." Apr. 1961. 6 pp. General aspects of the 12.5 MC system pilot filters are discussed in the introduction, then the design of 3 typical filters—one band-stop and two band-pass—is covered with regard to realization, components, layout and performance. (England.)

Electronic Components—Past, Present, and Future, G. W. A. Dummer. "Brit. C&E." Nov. 1961. 6 pp. This brief survey covers the evolution of electronic components since the first electrolytic capacitor was made in the early 1800's, and takes a look at possible future lines of development. (England.)



CONTROLS

The Isoperimetric Problem of Analytical Design, I. A. Litochenko. "Avto. i Tel." Dec. 1961. 7 pp. Problem of analytical design of an optimal controller under the isoperimetric condition and the condition of the saturation kind is considered. (U.S.S.R.)

Some Approximate Methods for Solving Problems of Optimum Control of Distributed Parameter Systems, A. G. Butkovsky. "Avto. i Tel." Dec. 1961. 11 pp. Approximate methods for solving the problems of the optimum control of the systems with distributed parameters are considered—the method of difference—differential equations and the method of moments. (U.S.S.R.)

Sources

Investigation of Non-Linear Non-Stationary Systems Under Quick-Changing Random Disturbances, M. I. Gusev. "Avto. i Tel." Dec. 1961. 8 pp. Non-linear non-stationary control systems are investigated which are acted by quick-changing forced random and determined disturbances. (U.S.S.R.)

Synthesis of Relay Systems According to Integral Quadratic Deviation Minimum, Chang Jen-Vey. "Avto. i Tel." Dec. 1962. 7 pp. A simple method of determining an optimum control as a function from phase coordinates is proposed. (U.S.S.R.)

About Accurate Determination of Periodic States in Relay Control System with Several Relay Elements, C. C. Belea. "Avto. i Tel." Dec. 1961. 12 pp. An accurate method of finding periodic states in a relay control system designed according to an arbitrary structural circuit with relay elements of any number is considered. (U.S.S.R.)

An Electronic Control Loop for Demonstration Purposes, O. Schafer. "rt." Dec. 1961. 4 pp. It was found possible, by combining a number of simple dc and ac amplifiers with a minimum of network elements, to build an electronic model control loop, enabling all the events taking place in a linear control loop to be shown repetitively with an accuracy fully sufficient for demonstration purposes. (Germany)

Dynamics of Relay Self-Oscillating Extremal Control Systems, V. Katkovnik and A. A. Pervozvansky. "Avto. i Tel." Dec. 1961. 9 pp. Dynamics of a relay self-oscillating extremal control system under random disturbances is analyzed. Approximate expressions for estimating the probability of an extremum drop are proposed. (U.S.S.R.)

About Basing an Approximate Method of Investigation of Transient Processes in Post-Action Automatic Control Systems, V. S. Kislyakov. "Avto i Tel." Dec. 1961. 2 pp. Problems connected with basing an approximate method of the investigation of the transient processes in the post-action automatic control systems are considered. (U.S.S.R.)



GENERAL

A Contribution to the Synthesis of Resistive Three-Ports, G. Biorci—P. P. Civaleri. "Alta Freq." Oct. 1961, 4 pp. It is shown that a third order conductance matrix in which one (at least) diagonal element is equal in absolute value to a non-diagonal one, is realizable on a network with 4 nodes (rather than 50 if it is realizable at all. (France in English.)

About Some Peculiarities of Second Harmonic Magnetic Modulator With Single-Phase and Double-Phase Supply, M. A. Rakov, L. A. Sinitsky. "Avto. i Tel." Nov. 1961 8 pp. Two kinds of magnetic modulators—with the single-phase supply and double-phase supply—are discussed. (U.S.S.R.)

The Influence of Residual Gas Upon the Quality of Evaporated Films, von R. Nossek, "Vak. Tech." Dec. 1961, 3 pp. The influence of the residual gas pressure during the formation of thin films by evaporation in vacuo has been investigated for potassium. Electrical resistivity of the deposited potassium film has been measured. (Germany.)

Methods of Realization of Optimum Filters with Finite Memory, S. N. Diligensky. "Avto. i Tel.", Nov. 1961, 12 pp. Methods of realization of the finite memory optimum filter which was defined in Zadeh—Ragazzini's problem are considered. (U.S.S.R.)

Lasers, by A. Blandin. "Onde" Nov. 1961. 9 pp. Having summarized the principles of Amplification by Stimulated Emission of Radiation, we study its applications in the optical range. We describe the main experiments and compare the interest and possible applications of Lasers and Masers (in the microwave range). (France.)

Alternate Transform, Giovanni Tamburelli. "Alta Freq." Oct. 1961, 6 pp. A transform similar to the z transform is proposed and its suitability to the study of the transmission of sampled functions with alternately positive and negative impulses is discussed.

Study of Transients in Similar Electrical Networks, Lorenzo Lunelli. "Alta Freq." Oct. 1961, 8 pp. Several types of similar electrical networks (formed by standard components: resistors, inductors and condensers) are illustrated. Similar networks are studied for frequency transformation and impedance transformation and the transformations between networks comprising only two types of components are listed. (France in English.)

Wide-Band Thirite Multiplier-Divider, F. B. Gulko. "Avto. i Tel." Dec. 1961. 7 pp. A multiplier with thirite resistances which has a band pass wider than the band pass of the well-known similar multiplier is described. (U.S.S.R.)



INDUSTRIAL ELECTRONICS

The Use of Electronic Counters in Industry, AEG. Prog. #2, 1961, 3 pp. Different applications are described, brief reference being made to the construction of counters and impulse transmitters. (Germany.)

The Electron Beam as a Heat Source for Welding and Erosion, S. Panzer. "El Rund" Dec. 1961, 7 pp. A brief discussion of the physical relations and electron-optical conditions is followed by a description of constructional details of machinery for material working by electron beam and of electronic controls therefore. (Germany.)

Electronics in the Wood Industry, M. Hammer, et al. "Phil. Tech." Vol. 23, #2, 19 pp. Description of a series of relatively new application of electronics in the Swedish wood industry, with emphasis on the character of the changes effected in manufacturing processes. Installations described include a high-frequency drying plant for shoe lasts, a photo electric device for eliminating defective strips of veneer in the manufacture of match boxes, a photoelectric device for sorting parquet blocks into four categories, and a number of electronic applications in the promotion process of a large sawmill. (Netherlands in English)

The Problem of Elaboration of High-Speed Automatic Regulators for Industrial Objects, G. D. Shirankov. "Avto. i Tel." Dec. 1961. 5 pp. A block-scheme of a regulator reproducing near-to-optimum control action with restriction of regulated element coordinate is described. (U.S.S.R.)



MATERIALS

Research Work on Ceramic Materials for Piezo-Electric Resonators, W. Pajewski. "Prace ITR." Vol. 5 #4, 21 pp. Paper deals with the properties of ceramic materials which may find applications in electric filters. There are given measurement results of ceramic materials of the barium titanate and lead zirconate-titanate groups fabricated at the Tele- and Radio Research Institute. (Poland)

SPECIAL TOOLS FOR SPECIAL PROBLEMS

Odd as they look, these are actual production tools. They were manufactured by Xcelite to increase efficiency on special assembly work where conventional hand tools proved inadequate.

Chances are that "special function" tools can speed your production. Supply prints (model if available) of part on which tool will be used. Prototype designed and tooled for your approval. Any quantity... to meet your production schedule. Contact factory direct.

Complete information in new "Custom-made Tool" Brochure No. 660. Request on your letterhead.

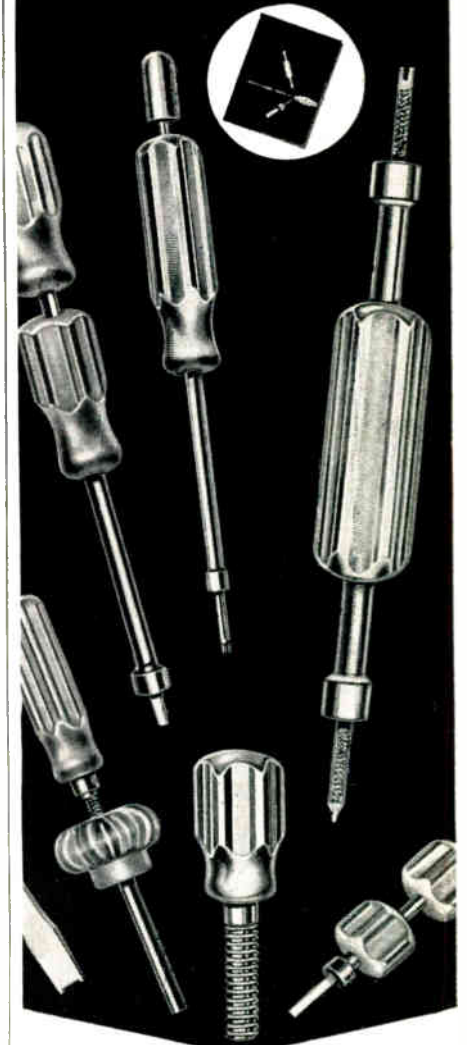

XCELITE

INDUSTRIAL HAND TOOLS

XCELITE, INC. • ORCHARD PARK, N. Y.
Circle 122 on Inquiry Card

The Influence of Substituted Small Amount of Cobalt-Oxide on the Magnetic and Magnetostrictive Properties of Nickel-Ferrite, R. Lappa. "Prace ITR." Vol. 5 #4. 15 pp. Paper describes the influence of substituted small amount of cobalt-oxide on the magnetic and piezo-magnetic properties of nickel-ferrite. It presents the mechanism of the magneto-crystalline anisotropy (based on the Van Vleck and Zenner theory) and indicates the cause of temperature dependence. (Poland)

Plastics Foil Used as Capacitor Dielectric, P. Chrobak. "Prace ITR." Vol. 5, #4. 6 pp. Data of the plastic foil materials used as capacitor dielectric are given. Emphasis is placed on thin lacquer-films used in the fabrication of miniature capacitors type ML. (Poland)



MEASURE & TESTING

The Determination of Electric and Magnetic Fields Through the Use of Models, R. Otto. "Freq." Oct. 1961. 7 pp. By reference to the example of a magnetic-head model the paper describes an arrangement for the rapid measurement of the field distribution on resistance foils. (Germany.)

The Measurement of the Radio Telegraphy Receiver Sensitivity Limited by Distortions, E. Jasienicki, et al. "Nach. Z." Oct. 1961. 4 pp. After a brief survey of the measurement of radio receiver sensitivity a report is given relating to a CCIR method for determining the sensitivity limited by distortions under FM-modulation conditions. (Germany.)

Investigations of a High-Frequency Mass Spectrometer in High Vacuum, von H. Klumb and H. Ihm. "Vak. Tech." Dec. 1961, 5 pp. 5-stage high-frequency mass spectrometer has been developed and its use for gas analysis in high vacuum has been investigated. (Germany.)

Precision Magnetic Measurements, G. Indrens, S. Ognev and V. Scegolier. "El. et Auto." Nov. 1961. 4 pp. Russian specialists have had to cope with the problem of precise measurement of magnetic field during final adjustment of cyclotrons. Several methods have been investigated. (France.)

The Accurate Measurement of Video Levels, Von L. E. Weaver. "Rundfunk." Dec. 1961. 3 pp. Method described in the paper has been found to allow levels to be set to an absolute accuracy of about ± 0.1 db under operational conditions. (Germany.)

Experiments on Photophoresis in Vacuum, von K. H. Schmitt. "Vak. Teck." Dec. 1961. 5 pp. The radiometer function, originally given by Wespahl, has been investigated on a sphere suspended in vacuum, whereby a constant temperature difference on the surface of the sphere was maintained. Results of the measurements have been compared with a relation for the radiometer function, as derived by S. Weber in 1944. (Germany.)

Thin Metal Films in Millimetric Wave Measurements, M. H. Cufflin. "Elec. Eng." Dec. 1961. 3 pp. In a millimetric wave measurement project it was necessary to design some coupling and reflecting disks for use in circular waveguide. (England.)

The Measurement of Luminescence, G. P. Burn. "Elec. Eng." Dec. 1961. 2 pp. This article describes how a very faint luminescence can be measured by counting the output pulses from a photomultiplier. (England.)

The Investigation of Fading in the UHF Range, J. Grobkopf. "Nach. Z." Dec. 1961. 15 pp. Paper gives a report on correlation measurements in the receiving end field of scatter links. These measurements have been carried out in order to provide some knowledge of the structure and dynamics of the scattering medium. (Germany.)

Magnetic Measurements of Pulse Controlled Iron Cores, G. Kas. "El. Rund." Nov. 1961. 4 pp. Tape-wound cores are investigated for their applicability to pulsed operation. (Germany.)

A Projection Oscilloscope, G. Kruse, "El. Rund." Dec. 1961. 2 pp. Described is an oscilloscope with magnetic deflection and Schmidt lens projecting a picture 5 x 5 ft of satisfactory brightness on to a matte screen. (Germany.)

D. C. Amplifiers in Nuclear-Reactor Instrumentation, AEG. Prog. #2, 1961. 6 pp. For measuring and monitoring the neutron flux in reactors D. C. amplifiers are used in conjunction with neutron-sensitive ionization chambers. A linear D. C. amplifier and a logarithmic D. C. amplifier followed by a period amplifier are described; data attained are also quoted. (Germany.)

Measurement of Density by Means of Isotopes, AEG. Prog. #2, 1961. 6 pp. Measurement of density by means of isotopes depends on the absorption of radioactive radiation, so that measuring equipment, as in the case of measurement of level with isotopes, can be mounted outside on the measuring pipe. (Germany.)

A New Pulse-Monitoring Oscillograph With Large Bandwidth, AEG. Prog. #2, 1961. 4 pp. A new oscillograph for pulse work is described. The high accelerating voltage of the CRT results in oscillograms of good

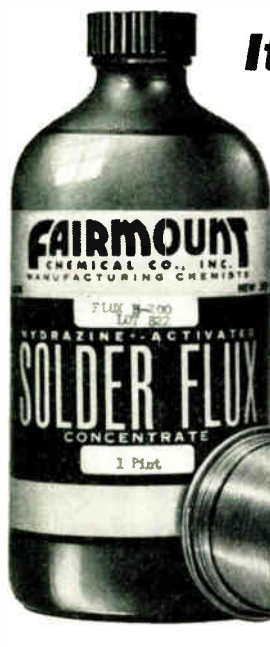

It stands alone

You can't buy HYDRAZINE-ACTIVATED FLUX[®] or Core Solder under any other brand name. Fairmount is the sole producer.

Hydrazine-Activated Flux and Core Solder offers an exclusive combination of advantages:

- High wetting properties for good "bite."
- Non-corrosive connections.
- Residues removed by heating or water rinse.
- No change on aging.

These performance characteristics were confirmed in a recent evaluation of leading fluxes used in the fields of printed wiring and etched circuitry.

No one flux is best for all purposes. TEST HYDRAZINE FLUX AND CORE SOLDER FOR YOURSELF. The liquid permits pre-fluxing, is useful for soft-soldering a wide range of copper and copper-based alloys. The core solder flows at an ideal rate, leaves a minimum of soldering residues. Write for samples of either, or technical literature.

*U.S. Patent No. 2,612,459 and others

Available only from Fairmount and its sales agents.

Fairmount
CHEMICAL CO., INC.
136 Liberty St., N. Y. 6, N. Y.

Circle 123 on Inquiry Card

actual size



Accurate time totalizing meter

Hermetically sealed 21 jewel watch movement and spring coupled D.C. (20-35 v) torque motor gives accuracy within 1% even under most critical operating conditions. Determine reliability, prevent failures, and facilitate maintenance procedures of aircraft or missile electronic equipment and systems. 1,000 and 10,000 hour readings. Parabam's sub-miniature meter meets all requirements of MIL-M-26550.

PARABAM

DIVISION OF HF HOUSTON FEARLESS CORPORATION
12822 Yukon Avenue, Hawthorne, Calif./OSborne 9-3393

Circle 124 on Inquiry Card

ELECTRONIC INDUSTRIES • April 1962

brilliance even under difficult pulse-scanning conditions. Further features are the single-shot time sweep and the 50 X expansion of the time base. (Germany.)

An Oscillograph With Sensitive D. C. Amplifier, AEG. Prog. #2, 1961. 6 pp. A cathode-ray oscillograph is described in which identical D. C. differential amplifiers of high sensitivity are employed for both deflection axes. Oscillograph has a versatile, triggered time-base equipment of excellent linearity. (Germany.)

Double-Beam Oscillograph With Interchangeable Amplifiers, AEG. Prog. #2, 1961. 4 pp. A new double-beam oscillograph has been developed which has a wide field of application owing to its interchangeable amplifiers. It is shown how by special adjustments in the amplifiers systems tolerances of the double-beam tube are compensated, resulting in an equipment with a high accuracy of measurement. (Germany.)

A New Potentiometer Equipment for Checking Scales of Wattmeters, "AEG. Prog." #2, 1961. 5 pp. A brief survey of equipment now in common use for testing precision wattmeters by the potentiometer method is given, and the operation and advantages of a new potentiometer equipment working on the summation principle described and compared with conventional equipment. (Germany.)

Dosemeters for X-radiation, J. Hesselink and K. Reinsma. "Phil. Tech." Vol. 23, #2. 12 pp. In therapeutic practice the dose received by a given part of the body is found from the radiation dose measured in roentgens, which is directly related to the ionization produced by the rays in air. A description is given of the ionization chambers and electrometer circuit of the Philips Universal Dosimeter, which can be used for this purpose. (Netherlands, in English.)

Plate Earthing in Telecommunication Equipment with a Power Supply Derived from a Low-voltage Overhead Line Grid, J. Vetter and R. Hannig. "Nach. Z." Jan. 1962. 10 pp. Many measurements of the potential difference between the neutral conductor of the power grid and the earth of telecommunication equipment have been evaluated by means of the cumulative frequencies. (Germany.)

Transistorization of the Digital Voltmeter, A. Sowinski. "Prace ITR." Vol. #4. 3 pp. The paper discusses the advantages of employing transistors instead of tubes. (Poland.)

Finding of Roots of Finite Equation System by Means of Electronic Machine Using Variable Structure Differential Equations, M. V. Rybashov. "Avto. i Tel." Dec. 1961. 11 pp. Ashby's idea of a random search of a structure with stable motions is applied to finding the roots of the finite equation system by means of an electronic machine. (U.S.S.R.)

Electronic Sector-Scanning Array, V. G. Welsby. "El. Tech." Jan. 1962. 6 pp. Electronic sector scanning is carried out by introducing a time-varying delay into one channel. There are several ways in which such a time-varying delay can be obtained, including the use of digital techniques. Method described here makes use of an auxiliary frequency modulation applied to the received waveform which is then passed through a ladder network having a quadratic phase-frequency characteristic. (England)

Transfer Function of Reactor Magnetic Amplifier with DC Active-Inductive Load Under Step Input Signal, E. L. Lvov. "Avto i Tel." Dec. 1961. 17 pp. An expression for the transfer function of the ideal reactor magnetic amplifier with dc active-inductive load when the load time-constant and power amplification gain are large, is found. (U.S.S.R.)

Comparison of Mixed Frequencies Using a Differentiating Oscillator, A. I. Furstenberg. "Radiotek" 16, No. 12, 1961. 10 pp. Article deals with the comparison of two fixed frequencies which are not related to two whole numbers by using an oscilloscope and a tunable differentiating generator. (U.S.S.R.)

Variation Methods of Measuring Discontinuity in Coaxial Cables, P. Szulkin. "Roz. Elek." Vol. 7, #3. 15 pp. Variation method has been applied in the paper to solve the problem of flat discontinuity in coaxial cables. An integral equation has been deduced for an admittance, fulfilling the conditions of discontinuities E_r and H_y in the aperture and disappearance of E_r in the remaining part of discontinuity plain. (Poland)

Investigation of the Stability of the Characteristics of Selenium Rectifiers, W. Ackmann. "Freq." Dec. 1961. 6 pp. A series of experiments are described that were designed to determine the influence of a steady forward load on the deformation of the inverse conductance characteristics of rectifiers. Numerical results are presented to enable the prediction of such deformation. Different types of plates were investigated to determine which ones had the most stable characteristics. (Germany)

Accuracy in Measurement of Micromotor Revolutions, J. Owczarek. "Roz. Elek." Vol. 7, #3. 15 pp. Paper deals with the measurement methods concerned with micromotors and is a continuation of the work set out by the author in *Electrotechnic Archives*, Nr. 1, 1961 on the measurement of the power drawn by such motors. (Poland)

Automatic Measurements of Complex Ratios in the Frequency Range 5-200mc by Means of Visual Indication, H. Eisemann and K. Lange. "Nach. Z." Jan. 1962. 8 pp. A swept frequency measuring equipment has been de-

Liquid-in-Glass Thermostats for Electronics · Missiles · Aircraft

**LOW PRICES . . .
FAST DELIVERY**

with **PRINCO** thermostats you can:

1. Control temperatures of high density electronic packages in ranges from -60° to $+300^{\circ}$ C . . .
2. Meet requirements for missile and aircraft applications . . .
3. Get wide range of factory set temperatures to accuracies of $\pm .05^{\circ}$ C . . . and with differentials as small as $.03^{\circ}$ C . . .
4. Specify thermostats as small as 1" long by $1/10$ " in diameter . . .
5. Get perfect repeatability after millions of cycles.

Write for free complete literature

Precision Thermometer & Instrument Co.

1434 Brandywine Street • Philadelphia 30, Pennsylvania

Circle 125 on Inquiry Card

NEW 1962 catalog



MINIATURIZED
TRANSFORMERS

MIL-T-27A and INDUSTRIAL
LAMINATED and TOROIDIAL

FROM STOCK

MICROTRAN company, inc.

YOURS
FOR THE
ASKING



MICROTRAN company inc.

145 East Mineola Avenue, Valley Stream, New York

Circle 126 on Inquiry Card

International ELECTRONIC SOURCES

veloped which indicates directly on a CRT complex voltage ratios in the frequency range 5-200Mc with voltage levels between approx. 10mv and 1 v. (Germany)



SEMICONDUCTORS

Precision Indicating Instruments for Direct and Alternating Current with Transistor Amplifiers. "AEG. Prog." #2, 1961. 4 pp. A series of recently developed highly sensitive instruments of the universal type is described. (Germany.)

A Transistorized Data Amplifier. H. Fuchs. "Elec. Eng." Dec. 1961. 5 pp. Article describes the design of a transistorized data amplifier suitable for simplifying microvolt signals from thermocouples, pressure transducers and other sources. (England.)

Complementary Transistors. R. Duchamp. "El. et Auto." Nov. 1961. 4 pp. Utilization of the principle of complementary symmetry of NPN and PNP transistors provides in many cases for diagram simplification, performance improvement, and maximum design economy. Characteristic differences between the two types of transistors are outlined. (France.)

Solid State Devices Change Economics of Microwave Systems. John E. Raftis. "Can. Elec. Eng." Dec. 1961. 4 pp. Relative cost of fixed plant and services, both of which are usually sub-contracted, has gone down. A description of new Motorola equipment is given after a discussion of economics. (Canada.)

AF Applications of Transistors. H. Toteig. "El. et Auto." Nov. 1961. 3 pp. Paper describes several practical designs: a portable 2-watt amplifier, an economy hi-fi amplifier, a 20-watt hi-fi amplifier, and finally a power supply for AF amplifiers. (France.)

A Transistorized Pulse-Pattern Generator. V. J. Phillips. "Elec. Eng." Dec. 1961. 4 pp. This article describes the design and construction of a pulse-pattern generator which produced repetitively a pattern of eight binary pulses in accordance with the settings of eight manually operated switches. (England.)

Silicon Junction Diodes as Variable Capacitors. J. Registrar. "Elec. Eng." Dec. 1961. 5 pp. The physical mechanism of the capacitance appearing at semiconductor junctions is explained. (England.)

Optimum Transistor Stabilization Networks. N. D. Meindi. "Elec. Eng." Dec. 1961. 5 pp. A comprehensive design theory for transistor stabilization networks is described wherein the temperature sensitive device parameters, I_{bo} , V_{be} and h_{pe} are recognized. (England.)



TELEVISION

Resolving Power of Television Systems. A. M. Khalin. "Radiotek" 16, No. 11, 1961. 14 pp. Evaluation of the resolving power, which takes into consideration only frequency or aperture characteristics is not sufficient. Limiting resolving power and sharpness are determined jointly by aperture (or frequency)

system characteristic, the law of distribution and the relative noise level. Aim of this article is to present an analysis of the problem of resolution, taking into account fluctuating noise arising in the generation and transmission of signals. (U.S.S.R.)

Modified N.T.S.C. Color TV Signal. J. Davidge. "El. Tech." Nov. 1961. 5 pp. Paper discusses the possibility of modifying the standard N.T.S.C. signal in order to obtain a better adaptation to the needs of single-gun display systems. (England.)

$$\Delta G = \Delta G / \epsilon n_i \mu_p \delta$$

THEORY

Problem of Determining Discrete Forming Filter. P. D. Krutko. "Avto. i Tel." Nov. 1961. 9 pp. Theory of determining difference equations of stationary and non-stationary discrete forming filters is described. (U.S.S.R.)

To Problem of Probability Characteristics of Reliability of Circuit Elements. S. E. Rostkovskaja. "Avto. i Tel." Nov. 1961. 9 pp. Method of the analysis of probability characteristics of the reliability is suggested which defines their connection with the law of distribution of element parameters. Examples of analyzing the characteristics under consideration obtained experimentally are described. (U.S.S.R.)

Determination of Connection Equations in Complex Objects. V. P. Borodjuk, G. K. Krug. "Avto. i Tel." Nov. 1961. 7 pp. Problem of formalization of regulating a complex object by using stasis probability equations is considered. (U.S.S.R.)

BRADY WIRE MARKERS STICK

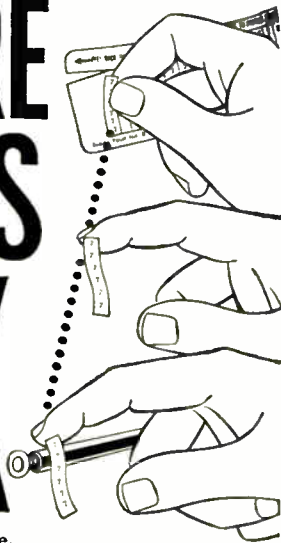

... TO YOUR FINGER from Card to wire. No troublesome tabs to remove... no chance to drop or lose Brady Markers.

... TO THE WIRE—any size wire up to 7/8" diameter—permanently stay stuck in temperatures to 300°F. 1 1/2" or 3/4" Markers available from distributor stocks in 200 major cities.

4 MARKER SIZES — 6 MATERIALS
3000 STOCK ITEMS

350 Distributors for Fast, Local Service

W. H. BRADY CO. • 719 W. Glendale Ave. • Milwaukee 9, Wis.
Manufacturers of Quality Pressure-Sensitive Industrial Tape Products, Self-Bonding Nameplates, Automatic Machines for Dispensing Labels, Nameplates, Masks and Tape
EST. 1914

Circle 127 on Inquiry Card

FREE NEW
Bulletin
and Testing
Samples.
Write:

107



Vlchek Model P-824

24 compartment, clear plastic box
one of largest compartmented boxes ever molded

*If you require plastic boxes for packaging or storing your electronic products, see Vlchek.

Vlchek, pioneer plastics manufacturer, stocks boxes in 30 standard sizes... ready for immediate shipment. These are available in 1,000 compartment arrangements... crystal clear, tinted transparent, or solid colors. Complete imprinting service.

Or, if you need a special box of any type or shape, Vlchek will design and custom-manufacture it. Write us today. Our representative will call promptly.

A-6470A

*good for fishing tackle, too!



Vlchek Plastics Co.
Middlefield, Ohio

Circle 128 on Inquiry Card

Mathematically Expected Value of the Voltage and the Average Number of Pulses Per Unit Time at the Output of a Coincidence Cascade. M. V. Maximoff. "Radiotek" 16, No. 11, 1961. 8 pp. Mathematically expected value $\bar{u}(t)$ of the voltage $u(t)$ and the average number of pulses per unit time N_{ave} at the output of a coincidence cascade are determined for the case where the coincidence cascade is acted on by the transmitted signals and random pulse noise. Formulae for the calculation of $\bar{u}(t)$ and N_{ave} as a function of false code formation and signal suppression are determined. (U.S.S.R.)

Common Channel Broadcasting With Frequency Modulation. A. Ekmann. "Nach Z" Dec. 1961, 7 pp. Theory of these interferences is discussed and possibilities for countermeasures or for avoiding them in the practical operation of common channel broadcasting networks are mentioned. (Germany.)

The Influence of the Differential Transformer on the Damping of Differential-type Bridge Filters. Von Wener Herzog. "Freq." Nov. 1961, 10 pp. After a discussion of its error and balanced condition, the differential transformer is calculated and built out to a differential-type bridge filter. Errors are broken down, discussed by reference to the example of a band-pass filter, and compared with the ideal curve. Approximation formulas are devised for determining the maximum of the ripple of the curve. (Germany.)

Method of Describing Function in Non-Linear Pulse Systems. M. M. Simkin. "Avto. i Tel." Nov. 1961, 11 pp. Theoretical principles of using the method of describing function for approximate determination of periodic states in non-linear pulse systems having different kinds of pulse modulation and arbitrary non-linearities in pulse elements are considered. (U.S.S.R.)

Common Channel Broadcasting with Frequency Modulation. "Nach Z" Dec. 1961 7 pp. When two signals are frequency modulated with the same information and arrive simultaneously at a receiver then characteristic interference effects are produced which impose certain limits on the application of common channel broadcasting networks. Theory of these interferences is discussed and possibilities for countermeasures or for avoiding them in the practical operation of common channel broadcasting networks are mentioned. (Germany.)

Discussion of Nonlinear Distortion in Ring-modulators. Von H. Meyer. "Freq." Nov. 1961. 8 pp. Nonlinear distortion in the ring modulator is investigated theoretically and experimentally with new methods. (Germany.)

Negative Feedback in Amplifiers—Generalizations. V. Biggi. "Onde." Oct. 1961. 13 pp. The negative feedback principle (being known) is analyzed here starting with a choice of the relevant physical characteristics to be considered. (France.)

Rectifier Modulators. "El Tech" Dec. 1961. 6 pp. It is shown that stray capacitances in rectifier modulators of nominally purely-resistive type always increase the conversion loss. Sets of experimental results and some theory are discussed. (England.)

On the Theory of Parametric Amplifiers. G. V. Voyshvillo, N. D. Poroshin. "Radiotek" 16, No. 6, 1961. 6 pp. It is shown that in the small-signal case, a parametric amplifier is equivalent to a 2 n-pole network, represented by $Y_{11} \dots Y_{nn}$ coefficients, in terms of which gain, input and output admittances, power gain and other properties can be expressed. This method is applied to analyze a low frequency amplifier, obtaining simple relationships convenient for calculations. (U.S.S.R.)

Theory of Magnetic Signalgrams of Varying Intensity. V. A. Gueranin. "Radiotek" 16, No. 12, 1961. 8 pp. Magnetic field, output effect and surface induction of a magnetic signalgram of varying intensity, on a powder magneto-dielectric carrier, are determined for the conditions of contactless signal reproduction. (U.S.S.R.)

Complicated Periodic States in Relay Extremal System. Yu. S. Popkov. "Avto. i Tel." Dec. 1961. 8 pp. Problem of determination of conditions and fields of complicated periodic states existence extremal systems for two kinds of approximation of the object non-linear characteristics, is solved. Problem of analyzing stability of the complicated periodic states is considered. (U.S.S.R.)

Thermal Feed-Back in a DC Transistor Amplifier. G. Faine and O. Svetlo. "Alta. Freq." Dec. 1961. 4 pp. A technique is described which is effective in reducing practically to zero the gain of a dc transistor amplifier at very low frequencies by means of a thermal feedback. (Italy, in English.)

Cross-Guide Coupler with an Aperture Containing a Ferrite. Z. Krzycki. "Roz. Elek." Vol. 7, #3. 10 pp. Coupling of a cross-guide coupler with an aperture containing a ferrite has been marked out. The considerations have been carried out on the basis of the Bethe's and Stinson's theory of a coupler with a small aperture. (Poland.)

Contribution to the Theory of Linear Pulse Filters. L. Prouza. "rt." Dec. 1961. 3 pp. In this article an attempt is made to describe the influence of parasitic delay on the performance of linear sampling filters. (Germany.)

Design of Carmatrons, Platinotrons, and Magnetrons. M. S. Neiman. "Radiotek" 16, No. 12, 1961. 12 pp. An orientative method for de-



WALDOM

solderless terminals and connectors

Over 1200 types and sizes for every wiring application

Every Construction Style . . . for the simplest termination to the most demanding.

Wire Ranges: #22 thru #2 A.W.G.

- ★ Butted Barrel Seam
- ★ Vinyl Insulated
- ★ Brazed Barrel Seam
- ★ Insulation Grip
- ★ Vibration Resisting Sleeve
- ★ Nylon Insulated
- ★ High Temperature
- ★ Heavy Duty
- ★ MS-25036, MS-20659

FAST DELIVERY at the right price through your Electronic Parts Distributor

Send for complete listings and prices

WALDOM

ELECTRONICS INC.
4625 West 53rd St., Chicago 32, Ill.

Circle 129 on Inquiry Card

EICO®

PUTS THE BEST IN CREATIVE ELECTRONICS INTO YOUR HANDS



Send for **FREE** Catalog

28 pages of professional electronic equipment in kit and wired form—for Lab . . . Line . . . Home

EICO, 3300 N. Blvd., L.I.C. 1, N. Y. EIN-4

Send free 32-page catalog & dealer's name.

Send new 36-page Guidebook to HI-FI for which I enclose 25¢ for postage & handling.

Name _____

Address _____

City _____ Zone _____ State _____

EICO 3300 N. Blvd., L.I.C. 1, N. Y.
Export Dept., Roburn Agencies
431 Greenwich St., N. Y. 13, N. Y.

Circle 130 on Inquiry Card

International ELECTRONIC SOURCES

sign of carmatrons, platinetrons and multi-segmented magnetrons is discussed for specific power and operating wavelength. The method is based on simple and transmittance relationships. (U.S.S.R.)

Electromagnetic Wave Scattering on a Statistically Irregular Surface with a Finite Conductivity. A. A. Kovalyoff and S. I. Pozdnyak. "Radiotek" 16, No. 12, 1961. 6 pp. Problem of electromagnetic wave scattering on a one-dimensional statistically coarse surface $z = z(x)$ with a limited conductivity is analyzed. (U.S.S.R.)



TRANSMISSION

Graphical-Analytical Determination Method of the Elements-Losses Influence on the Effective Attenuation in the Transmission Bands of Low-Pass and Band-Pass Filters. J. Chelmonski. "Prace ITR." Vol. 5, #3. 36 pp. Paper deals with the influence of the elements losses of an L-C ladder filter on its effective attenuation in transmission band, calculated with the aid of the image parameters theory. (Poland.)

An Introduction to the 12.5 MC Coaxial Line Transmission System. H. F. L. Cameron, G. E. Parrett. "ATE J." Jan. 1961. 13 pp. The history of development of coaxial line systems is given, leading up to the requirements for wide-band systems capable of transmitting both telephony and television. There follows a detailed description of the 12.5 MC coaxial line system (designated C.E.L.9A by the

B.P.O.), including all the ancillary equipment necessary for the maintenance and supervision of a route. Characteristics of the equipment are shown and the article concludes with a discussion of system stability, transient response and performance figures for a typical route. (England.)

Influence of Sidetone on Quality of Transmission. Piero Schiaffino. "Alta. Freq." Dec. 1961. 3 pp. Report gives the results of some subjective tests of the quality of telephone transmission, taking into consideration three variable factors, i.e., the intensity of the room noise, the reference equivalent of the main circuit and the reference equivalent of the sidetone circuit. (Italy, in English.)

The Influence of Special Transmitting Functions and Transfer Constants on the Frequency Shift of Frequency Modulated Telegraph Signals, Part I. H. Juergens. "Freq." Dec. 1961. 10 pp. After deriving a formula of general validity for calculating the receiving function for FM telegraph signals with a consideration of arbitrary transfer constants, filter curve (squared-cosine filter) is determined which yields an almost aperiodic buildup transient for a certain frequency swing and a linear phase/frequency response. (Germany.)



TUBES

High Voltage Laboratory Power Supply. H. Constans. "El. et Auto." Oct. 1961. 5 pp. This paper studies a regulated variable high voltage power supply, in which a single tube performs rectification and regulation. (France.)

Some Interesting Applications of Cold Cathode Tubes in Laboratory and Industry. R. Hubner. "El Rund" Nov. 1961, 3 pp. Report indicates some recently developed equipments where essential functions are carried out by time, light, and contact-protecting relays equipped with cold-cathode tubes. (Canada.)

The Continuous Wave Magnetron Valvo 55 125. W. Schmidt, "El Rund" Dec. 1961, 3 pp. Description of a continuous-wave magnetron for a power output of 5000 W at 2450 MC. (Germany.)

The Barrier Grid Storage Tube and its Use in Integration. "Brit. C&E." Jan. 1962. 5 pp. Many applications of electronics involve the examination of very small repetitive signals buried in noise. Signal-to-noise ratio can be increased by averaging over many occurrences of the signal. Some systems used are mentioned briefly and their disadvantages pointed out. The fundamental mode of operations of the barrier grid storage tube is explained and its characteristics are described and evaluated. (Germany.)

Cold Cathode Discharge Tubes Impedance and Noise Properties. J. F. Dix and K. B. Reed. "El. Tech." Jan. 1962. 7 pp. Impedance of a gas discharge tube type 85A2 was measured over the frequency range 20 cps to 10 MC and from the variation an equivalent circuit was deduced. (England.)

Improvement of the Transmission Quality of the Vestigial-Sideband System for Television by Introducing Quadrature Equalisation. Von H. Hopf and S. Dinsel. "Rundfunk." Dec. 1961, 9 pp. After briefly showing the effect of the so-called quadrature distortion on the picture quality in vestigial side-band television transmission, the authors report on the possibilities of removing or largely reducing the above-mentioned form of distortion. (Germany.)

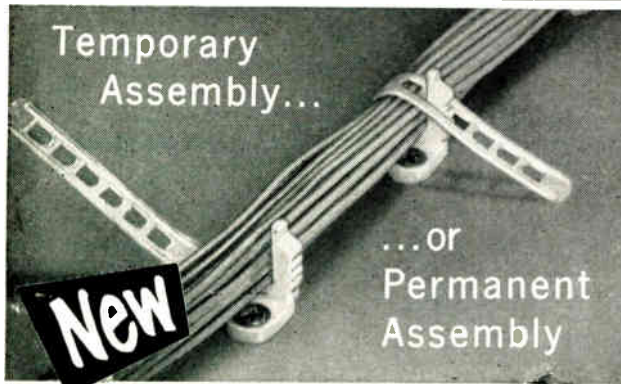

WECKESSER Tab-Loc Cable Clamps Handle Both Jobs

It's the first practical cable clamp for both temporary and permanent assembly. Easily opened for adjustment, removal or addition of wires. Handles bundles or single cables from $\frac{3}{8}$ " to $\frac{3}{4}$ " diameter. Made of top quality nylon for maximum dielectric strength and corrosion resistance. Test proven under severe vibration and impact conditions — without a single failure.

Send for Bulletin 817

Weckesser COMPANY, Inc.

5711 Northwest Highway • Chicago 46, Ill.

Circle 131 on Inquiry Card

Now-Specify

VARFIL
Sleeving and
Tubing...

and get these **5**
BIG Advantages

- HIGHER DIELECTRIC RETENTION
- GREATER FLEXIBILITY
- MORE HEAT RESISTANCE
- AVAILABLE IN COILS
- CAN BE AFTER-TREATED

Even under the most severe operating conditions, Varfil Sleeve and Tubing retains its average dielectric strength. Twist it, tie it, bend it, wrap it, knot it. Remains just as pliable as when you started. Won't crack, peel or suffer dielectric loss. Heat Varfil 2000 hours at 110° C.—1,000 hours at 125° C.—and even for extensive periods at 150° C. It won't break down. Can be after-treated in baking and varnishing operations. Reacts better than other oleoresinous materials and synthetic coated tubings. Available in handy coils so you can cut the exact lengths you need... no waste. Standard colors. Wide range of sizes. Exceeds or meets all A.S.T.M. specifications.

AVAILABLE IN FOLLOWING
NEMA CLASSES

CLASS B-A-1
7000 VOLTS AVERAGE

CLASS B-B-1
4000 VOLTS AVERAGE

CLASS B-C-1
2500 VOLTS AVERAGE

CLASS B-C-2
1500 VOLTS AVERAGE

Varflex
CORPORATION
Makers of Electrical
Insulating Tubing
and Sleeving

SEND TODAY
FOR FREE SAMPLE FOLDER

VARFLEX Corporation, 308 N. Court St., Rome, N. Y.
Circle 132 on Inquiry Card

Systems and Circuits

DOD HAS PROBLEMS with its long range communications. Two of the biggest headaches: variations of sun spot activity; and overcrowding of the frequency spectrum. One solution is the exploration of LF and VLF for additional channels. The big hope seems to be synchronous satellites—one system for commercial and one system for military use. Big hold-up in present systems is integration and switching. Areas being explored for pre-satellite solution: analog/digital switching—on a space basis and time basis, respectively; automatic switching of all types of teletype; and the "Store/Forward" technique.

SATELLITE COMMUNICATIONS SYSTEM ownership by common communications carriers with international interests is favored by the Senate Space Committee. A special report "Communication Satellites: Technical, Economic, and International Developments" just issued contains suggestions and proposals for such a program. Senator Keating (N. Y.) has proposed the sale of stock to the public to finance the system.

COMMUNICATIONS SATELLITES should develop into a lucrative market within the next 10 years. George Shaw, Sr., V.P. of Radiation Inc., told the EIA Military Marketing Data Committee of the EIA that the Government may be spending up to \$2 billion a year by 1967. Mr. Shaw believes that the spending will reach between \$3 and \$4 billion by 1976.

1962 COMPONENTS CONFERENCE papers program is a good reflection of today's trends. Several papers cover the thin film area and a paper is being presented discussing some uses of fiber optics, a new, growing field. However, the "older" components are not neglected and some interesting information will be presented in Washington, D. C., on May 8, 9, 10.

TV's PROBLEMS can, in part, be attributed to the TV channel allocation problem. A battle is shaping up, in Washington, with the FCC on one side and a combination of EIA, TV manufacturers and some members of Congress on the other. The NAB, with qualified support for bill S.2109 (advocating all-channel, VHF/UHF, television) is somewhere in the middle. The FCC sees the bill as "the beginning of the end for the television allocation problem." The TV manufacturers, etc., hold that S.2109 gives too much power to the FCC.

USAF HAS ACCEPTED first production inertial guidance system for the Minuteman missile from Autonetics Div. of North American Aviation, Inc., Downey, Calif. The NS-10P has successfully completed acceptance tests, which began December, 1961. The unit will be shipped to Boeing Co., Seattle, Wash., for use in a ground test missile for training USAF personnel.

TACAN AIR NAVIGATION sets will soon be installed in all U. S. Navy fighting planes. The sets will enable pilots to determine exactly how far they are from each other, in addition to telling their distance from TACAN ground stations. General Dynamics/Electronics will supply the modification kits.

Present TACAN systems are limited to giving the location of the plane with respect to a ground beacon. The modification kits will add an air-to-air ranging capability.

With a converted TACAN set the pilot can change from the normal mode of air-to-ground to air-to-air ranging by simply flipping a switch. In group operations, as many as five planes can determine their distances from a sixth aircraft, such as an air tanker or group leader.

(Continued on page 216)

0.1% AC
ACCURACY*

0.01% DC ACCURACY*
PRECISION
VOLTMETERS
Continuously
Self-Calibrating



Completely solid state, CSC's Continuously Self-Calibrating Precision Voltmeters feature carefully selected and aged Ultra-Stable Zener References and Precision Wire-Wound Resistors (Stability of $\pm 0.001\%$ for $\pm 10\%$ Line Change and $\pm 2\text{PPM}/^\circ\text{C}$ from $+10$ to $+40^\circ\text{C}$). Model AC-200A (\$1425.00) and AC-200AR (\$1445.00) AC-DC Voltmeters cover the full range of .05 to 1000 VAC and 0 to 1000 VDC.

Compact, lightweight and portable with a 6 digit readout, they measure both AC and DC voltages to a high degree of accuracy.

*Accuracies are of reading, not full scale.



Model AC-100A, completely solid state Precision AC-DC Voltmeter (\$795.00) features AC Accuracy of $\pm 0.2\%$ and DC Accuracy of $\pm 0.05\%$. The instrument and its companion rack mount, Model AC-100AR (\$815.00), cover the full range of .05 to 1000 VAC and 0 to 1000 VDC. Converter frequency range is 30 to 10,000 cps. By using a multiturn potentiometer at the end of the Kelvin-Varley divider very high resolution is obtained.

Write today for complete specifications.

CALIBRATION > STANDARDS
CORPORATION

A subsidiary of
ROYAL INDUSTRIES, INC.

1031 Westminster Avenue
Alhambra, California



ENGINEERS GAIN A NEW PERSPECTIVE AT AC

AC, the Electronics Division of General Motors, has made a distinct contribution to technological advancement in the field of low-altitude aircraft operation. You, too, can develop and improve your career in the areas of guidance and navigation if you are an Electrical Engineer, Mechanical Engineer, Physicist or Mathematician. Current projects include: Integration and Engineering of the AN/ASQ-48 Weapon System for the B-52c&d aircraft, Inertial Guidance Systems for the Titan II, and the development of a Stellar Inertial Guidance System for advanced missiles. If you have related experience and are interested in any of the following positions, please contact Mr. G. H. Raasch, Director of Scientific and Professional Employment, Dept. 5753, 7929 South Howell, Milwaukee 1, Wisconsin.

MILWAUKEE Weapon Systems Program Engineers ■ Radar Design and Development Engineers ■ Radar Systems Engineers ■ Radar Test Engineers ■ Reliability Program Engineers ■ Field Service Engineers ■ Electromagnetic Engineers ■ Supplier Contact Engineers ■ Quality Control Engineers/Analysts ■ Technical Writers and Editors ■ Scientific Programmers ■ Ceramic Engineers

LOS ANGELES RESEARCH AND DEVELOPMENT LABORATORY (Advanced Inertial Guidance Systems and Airborne Digital Computers)—Digital Computer Development Engineers ■ Research and Development Engineers ■ Transistor Circuit Design Engineers ■ Systems Engineers ■ Programmers-Mathematicians

BOSTON RESEARCH & DEVELOPMENT LABORATORY (Advanced Inertial Guidance Systems and Components)—Systems Engineers and Mathematicians ■ Electronic Circuit Engineers ■ Mechanical Design Engineers ■ Instrument Engineers ■ Electromagnetic Engineers ■ Radar Systems Engineers

AC SPARK PLUG  **THE ELECTRONICS DIVISION OF GENERAL MOTORS** *An Equal Opportunity Employer*

ACHiever Inertial Guidance for the TITAN II, MACE and THOR . . . Bombing Navigation Systems Integrator for the B-52c&d . . . POLARIS Gyros and Accelerometers . . . ALRI

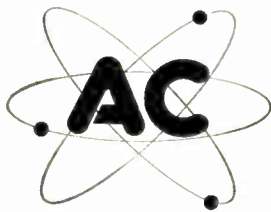

PROFESSIONAL OPPORTUNITIES

Reporting late developments affecting the employment picture in the Electronic Industries

Design Engineers • Development Engineers • Administrative Engineers • Engineering Writers
Physicists • Mathematicians • Electronic Instructors • Field Engineers • Production Engineers

Revenue Rise Expected In Telegraph Industry

Revenue of the domestic record communications (telegraph) industry is expected to be 3-4% greater in 1962 than in 1961, according to the Business and Defense Services Administration, U. S. Dept. of Commerce. Revenue in 1961 is estimated to be approximately \$280 million. Capital expenditures of some \$105 million were made in 1961 to expand facilities and services.

Revenue in 1960 amounted to more than \$277 million and is expected to reach \$280 million in 1961, based on the 9-month figure of almost \$209 million.

In 1961, an estimated \$105 million was spent on construction, an alltime high. Construction program includes work on: New transcontinental microwave system; "Comlognet" (Combat Logistics Network) system for the Air Force, which, upon its completion in 1962, will be the most advanced digital data network; various private wire and data systems; Wirefax, and Telex. Telex service was to be extended to 46 cities by the end of 1961 and to 127 major cities in 1962.

Machine Talks

A synthetic speech machine that produces natural sounds has been developed at Massachusetts Institute of Technology. Studies of artificial speech are expected to reveal details about production and perception of natural speech. An electronic device is used to represent the human body's major speech parts. Experiments consist of electronically changing ways in which vocal tract and nasal cavities react and noting the effects such changes produce on the synthetic sound.

FOR MORE INFORMATION . . .
on positions described in this section fill out the convenient resume form, page 204.

Growing Shortage of Engineers Concerns Administration Officials

The Administration has warned that the nation's shortage of engineers shows signs of worsening and may tip the "balance of brainpower against the U. S."

According to figures issued by the Office of Education, fewer young Americans are preparing for engineering careers, although overall college enrollments are steadily climbing.

Abraham A. Ribicoff, Sec. of Education and Welfare, released a study disclosing that the percentage of freshmen entering engineering colleges last fall had dropped for the third year in a row, as did the number of those who graduated.

He cited a Labor Dept. study which estimated that 72,000 engineering graduates a year would be needed to meet the nation's requirements during the next 10 years.

He also pointed to a recent National Science Foundation report that said the Russians were graduating three times as many engineers each year as the United States.

The one bright note in the study was the increase in the number of engineering students doing graduate work. They should eventually boost the number of teachers.

The survey of engineering schools reported the following: Last fall's freshmen engineering enrollments totaled 67,600, about the same as during the previous two years. Meanwhile total freshmen college enrollment in all fields rose 24% since 1959.

The percentage of engineering freshmen declined from 8.2% of the total 2959 freshmen enrollment to 7.3 in 1960 and 6.6 last fall.

The proportion of all undergraduate engineering students, from freshmen to seniors, dropped from 7.1% of the total 1959 college enrollment of 6% last fall.

Engineering bachelor's degrees awarded last year totaled 35,900, compared with 37,800 in 1960 and 38,100 in 1959.

LANGUAGE LAB



Dr. J. E. Englekirk, Chairman of the UCLA Spanish Dept., Dr. R. B. Haas (center) of University Extension, and Mrs. S. Klein, French instructor, inspect master panel in Automonitor Language Lab recently installed in University's Graduate Business Admin. Bldg. Panel is capable of distributing up to 10 simultaneous teaching programs. Electronic classroom was designed and developed by Berlant Automonitor Corp. of Culver City, Calif.

Proposed NASA Budget For 1963 is \$3.78 Billion

A \$3.78 billion budget is proposed for the National Aeronautics and Space Administration in fiscal year 1963. This includes about \$1.5 billion for financing projects assigned to the Marshall Space Flight Center. This amount, is approximately double the Center's current budget.

Most of the funds would be spent for developing large launch vehicles needed for the manned lunar exploration program, and preparing manufacturing, testing and launching facilities.

Of the proposed Marshall total, about \$1 billion would be spent for research, development and operations. Remaining half-billion dollars would be for construction.

ELECTRONIC INDUSTRIES

Professional Profile

The ELECTRONIC INDUSTRIES Job Resume Form for Electronic Engineers

Name _____ Tel. No. _____

Street Address _____ Zone _____

City _____ State _____

Single Married Citizen Non-Citizen Date of Birth _____

Will Relocate Yes No. If Yes Another City Another State

Salary Desired to Change Jobs in present area _____

Salary Desired to Change Jobs and relocate in another area _____

Professional Memberships _____

College or University	Major	Degree	Dates

RECENT WORK EXPERIENCE

Company	Div. or Dept.	Title	Dates

SIGNIFICANT EXPERIENCE AND OBJECTIVES

State any facts about yourself that will help a prospective employer evaluate your experience and job interests. Include significant achievements, published papers, and career goals.

Mail to: ELECTRONIC INDUSTRIES—Professional Profile—56th & Chestnut Sts.—Philadelphia 39, Pa.

This resume is confidential. A copy will be sent only to those Companies whose number you circle below.

800 801 802 803 804 805 806 807 808 809 810



By R. J. TRITSCHLER

Laboratory Library Manager
IBM Data Systems Division
Poughkeepsie, N. Y.

Indexes: Tools of the Engineer

Indexes belong in the same category as slide rules, voltmeters, and strain gages as engineering aids. As with any of these, efficiency increases with practice; but their purpose and potential must be understood.

COMPUTER engineers, information specialists, and librarians are struggling with the problems of information storage and retrieval. In the face of an immense expansion of the literature in recent years, automated aids in the control of technical and scientific information are becoming imperative.

New developments such as KWIC indexing and auto-indexing are described later. However, to make the most effective use of these new developments, we should be familiar with the benefits available from already existing services and methods.

Fortunately, these methods are quite useful, if we are willing to combine a little knowledge with some skill and insight in our search for useful and pertinent information.

Knowing the right librarian can be a big help in itself. As with most technical services, however, the librarian is best equipped to furnish tools and directions, and to help the engineer solve his own problem. In this case, "tools" are the many excellent indexes available in the technical library; the "directions" are a few simple hints on the best exploitation of these indexes.

There are four main types of index: (1) comprehensive indexes, (2) book indexes, (3) bound periodical volume indexes, and (4) card indexes. Any or all of these may help solve an information problem.

Comprehensive Indexes

Comprehensive indexes cover more than one particular journal, newspaper, or book. They are usually prepared by an independent publisher and sold on a subscription basis. The *Readers Guide to Periodical Literature* is a familiar example, but is seldom directly useful to most engineers. Here are a few more suitable excellent technical indexes of this type:

Applied Science and Technology Index: This may well be the most useful index for the engineer. It covers a great many engineering subjects in a thor-

ough way. Material on most subjects can be found with a few minutes searching. It is published monthly; cumulated every 3 months. An annual volume appears in hard covers. Having this index available covering the past several years is extremely helpful in a search.

Engineering Index: This index is published annually in hard cover book form; it includes not only the technical periodical literature, but also new books, conference proceedings, and translations. There is an abstract of each reference and an alphabetical author index listing every name in the entire volume. The *Engineering Index* is also available in 3 in. x 5 in. card form, in all or selected classifications, as a weekly service.

Business Periodicals Index: This index is of considerable interest to the engineer who also has business responsibilities. It covers 119 titles in the area of business and industry and is similar to the *Applied Science and Technology Index* in format.

Science Abstracts: Part A, Physics, and Part B, Electrical Engineering: This publication is also more than an index because it provides not only a subject and author guide to the literature but also a detailed abstract of the article. Often further search for the required information is not necessary.

Nuclear Science Abstracts: Another very good abstract journal of particular value to scientists in nuclear science, physics, and chemistry, and related engineering groups.

New York Times Index: Although this covers only the *New York Times*, it is of the same general form as other comprehensive indexes, and it is extremely useful when searching for news reports of new developments. The index is issued semi-monthly and cumulated into a bound annual volume.

Chemical Abstracts: This is the classic in its field, but lags considerably behind the current literature. It has tremendous value in retrospective searching.

(Continued on page 207)

Problem for you:

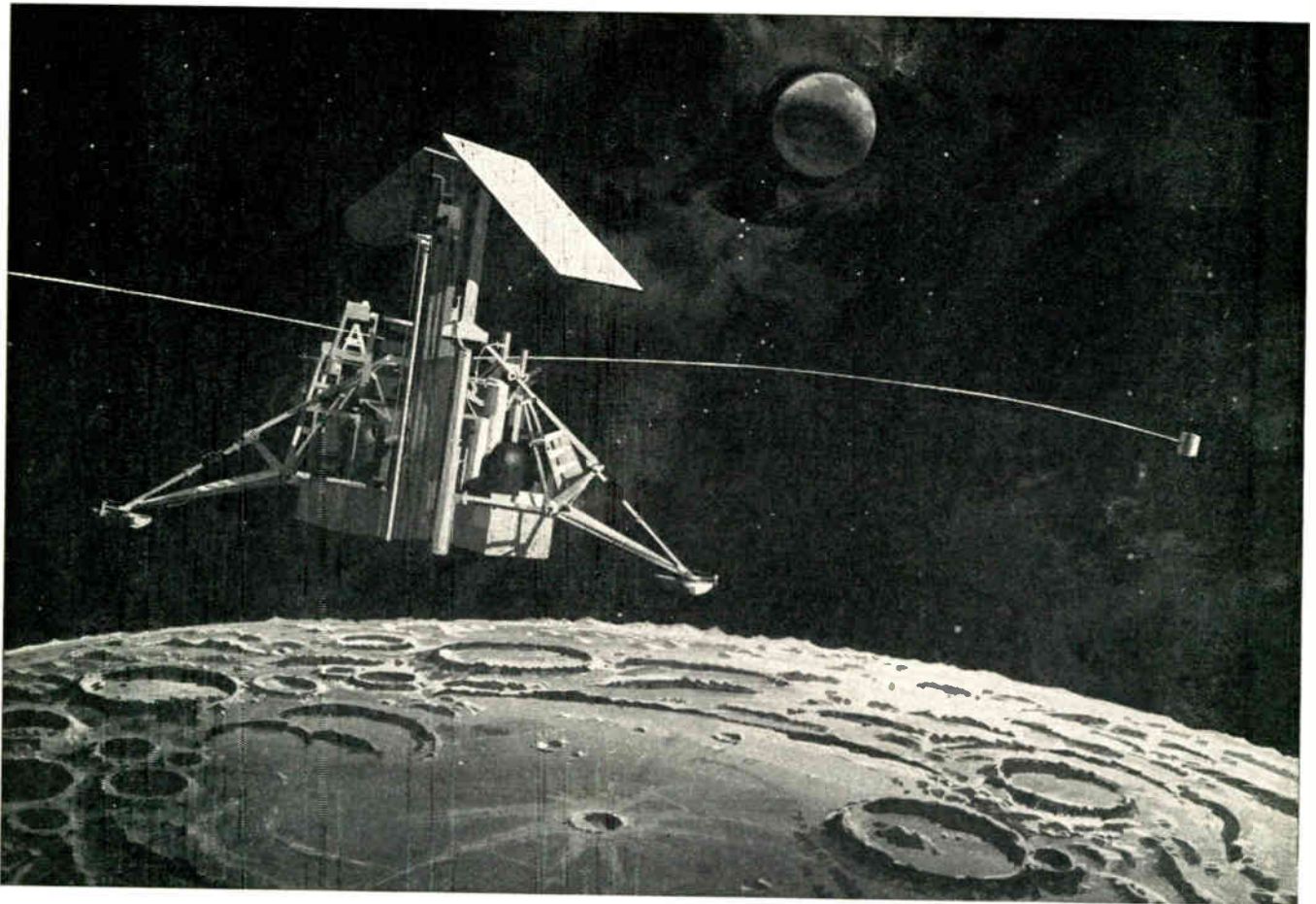

Soft land this vehicle on the moon

CONTROLS ENGINEERS. Concerns airborne computers and other controls related areas for: missiles and space vehicles, satellites, radar tracking, control circuitry, control systems, control techniques, transistorized equalization networks and control servomechanisms.

CIRCUIT DESIGNERS. Involves analysis and synthesis of systems for: telemetering and command circuits for space vehicles, high efficiency power supplies for airborne and space electronic systems, space command, space television, guidance and control systems, and many others.

This spacecraft is SURVEYOR, one of the many important projects now under way at Hughes. It will "soft" land on the moon sometime in 1963. Its mission: to pierce and analyze the moon's surface; to transmit back to earth high quality television pictures; and to measure the moon's magnetic and radiation characteristics. To accomplish these demanding objectives, Project Surveyor requires the talents of many imaginative junior and senior engineers and physicists to augment its outstanding staff. A degree from an accredited university and U.S. citizenship are required. Experience in Aerospace Vehicles is preferred but not necessary. A few of the openings include:

INFRARED SPECIALISTS. To perform systems analysis and preliminary design in infrared activities for satellite detection and identification, air-to-air missiles, AICBM, infrared range measurement, air-to-air detection search sets, optical systems, detection cryogenics and others.

SYSTEMS ANALYSTS. To consider such basic problems as: requirements of manned space flight; automatic target recognition requirements for unmanned satellites or high speed strike

reconnaissance systems; IR systems requirements for ballistic missile defense. Inquire today. Please airmail your resume to:

Mr. Robert A. Martin,
Supervisor of Scientific Employment,
Hughes Aerospace Divisions,
11940 W. Jefferson Blvd.,
Culver City 22, California.

We promise a reply
within one week.

creating a new world with electronics

HUGHES

HUGHES AIRCRAFT COMPANY
AEROSPACE DIVISIONS
An equal opportunity employer.



Indexes (Continued)

Book Indexes

These are probably the most familiar indexes to the engineer. They are usually located in the back of the book and may consist of either a subject index, a name index, or a product index; or they may contain several of these arranged into one alphabetical sequence.

Even a good book index is sometimes neglected. Quite often, it somehow seems easier to leaf through the book knowing that "it's right around here somewhere." Browsing is an excellent habit and leads to the acquisition of many types of useful knowledge, but when you need the answer to a specific question, the index habit will save both time and temper.

Bound Periodical Volume Indexes

Most learned journals and technical periodicals publish an index to their contents on a regular basis. *Electronic Industries*, for example, publishes an annual index to its contents in the December issue.

In most technical libraries which keep back files of periodicals, the annual or semi-annual index will be kept with the back issues; or, it will be permanently bound into the periodical volume. Some libraries keep all indexes together, but separate from the journals. In any case, the index to a journal with which you are familiar is extremely helpful.

Many periodicals also publish cumulative indexes which cover either two-year, five-year, or ten-year periods. Annual indexes as well as these cumulative indexes can usually be obtained by writing a short letter to the publisher. You will find all of these to be very valuable in making a quick review of what has been published in the last few years, and in surveying recent trends.

Card Indexes

Most are already familiar with the usual library card catalog. Some libraries have one alphabetic sequence containing subject, author, and title entries filed together; other libraries have the subject cards filed in one sequence and the author and title cards filed in another sequence. In either case, this index is an easily used detailed survey of your library's content. It is especially useful as a guide to the library's book collection. Furthermore, it lists other indexes available, and therefore, it is an excellent starting point in your search.

There are other card-type indexes. One of the most notable of these is the *Engineering Index*, mentioned previously. Engineering Index, Inc., publishes abstracts on cards in many different categories: these are issued every week and many technical libraries have them on file.

There are many, many other general-purpose and special-purpose index and abstract journals. To name but a few: *Abstracts Journal of Metallurgy (USSR)*, *ASM Review of Metal Literature*, *Analytical Abstracts*, *Applied Mechanics Reviews*, *Ceramic Abstracts*, *Computer Abstracts*, *Index to PB Reports*, *Library Literature*, *Mathematical Reviews*, *Mathematics of Computation*, *Monthly Catalog of U. S. Government Publica-*

tions, *Solid State Abstracts*, *Technical Translations*, and *U. S. Government Research Reports*.

Find out which indexes or abstract journals are most useful in your field and concentrate on those.

Using an Index

The theory of using an index is simple; material is usually in alphabetical order and one begins by looking up the word which describes the subject. However, there are some usage methods which will speed up index use and make searching more efficient. For example, when using an index for the first time, try to get the feel of the person who did the indexing. Try to establish whether the indexer used very broad general headings, or precise specific headings. For example, will an article on aluminum appear under the heading "Aluminum," or will there be a more general heading "Metals—light"? Or will it be under both? It takes only seconds to become acquainted with the general format of the index, and one can proceed immediately to search.

Another point: remember, though no results come from the first two or three headings checked, don't be discouraged. When you find the right area, the number of possible references discovered should increase almost geometrically. It is usually a case of "all or nothing."

Any language uses many similar words to describe almost the same thing. The compiler of the index may not have been thinking in exactly the same terminology as you are. For instance, he may have indexed all of the computer references under "data processing machines," rather than "computing equipment." Of course, a good index will anticipate and solve this problem by using a cross reference which includes both. However, even the best index won't anticipate every possibility. In this case, use a little imagination, and try to think of other terms or words used to describe your subject. Look up a few of these, and you will almost certainly meet with success.

Indexes vary a great deal. Some are well prepared; some are poorly prepared. Some indexes carry a particular article only under one or two headings, others carry an article under five, six or more headings trying to bring out all of the significant information in the article.

Future Indexes

Indexing and coding methods now being studied for future use will make possible a deeper and more meaningful analysis of the material being indexed. At the same time, these indexes will be made available to you in a form which makes them easier and quicker to use.

One such scheme is known as Key-Word-In-Context Index (KWIC Index). In a KWIC index, prepared by computer, the title is permuted automatically so that each "keyword" in the title is placed in its proper alphabetical position in the index. Thus, an article entitled "Resistance Potentiometers as Function Generators" would be listed in the index four times, under the headings: Function, Generators, Potentiometers, and Resistance. This scheme increases the probability that you will be able to find what you need when you need it. (Continued on page 210)

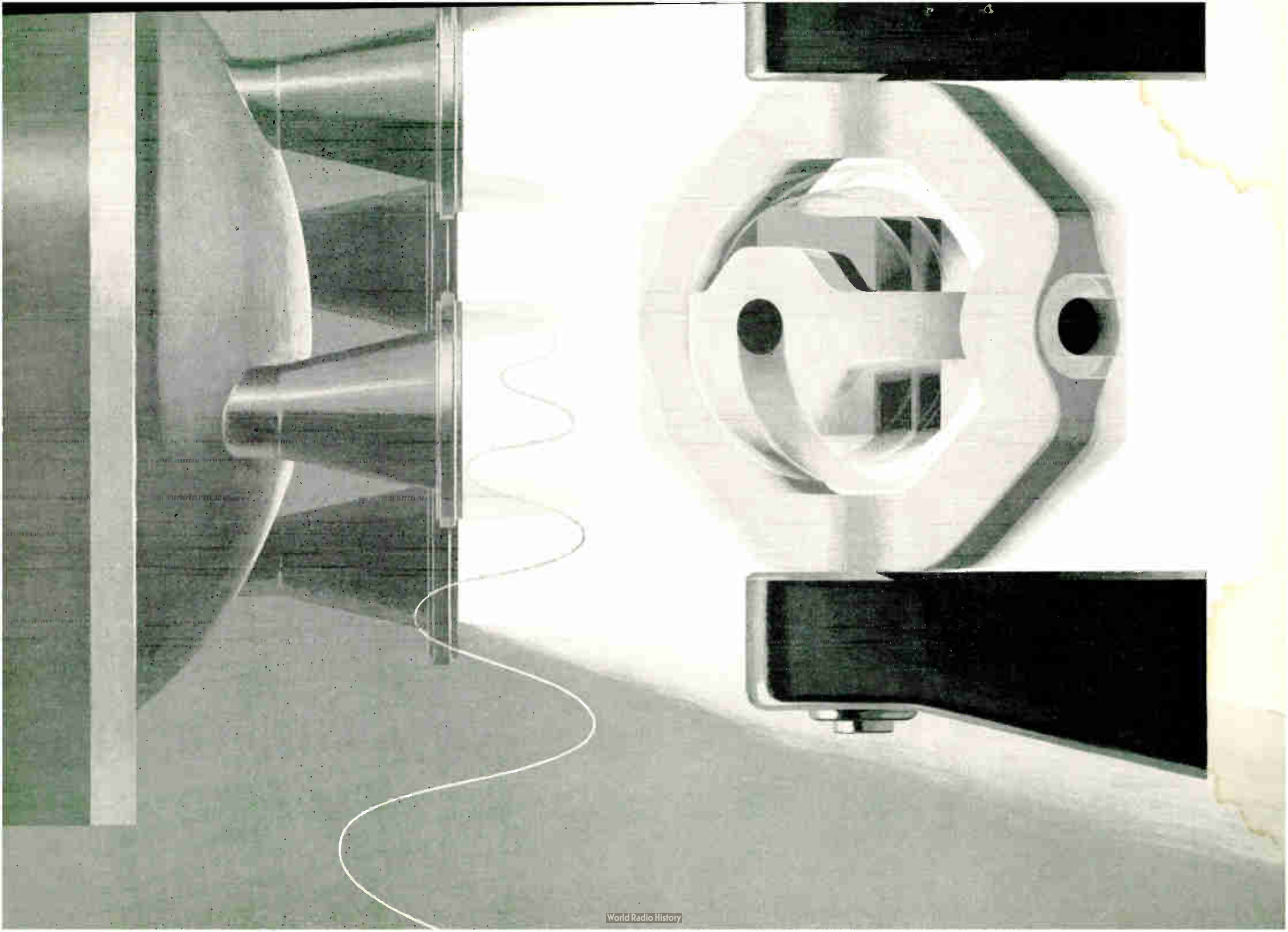

LABORATORY LAUNCH PAD

"In-house" missile flights are a daily occurrence at Lockheed Missiles & Space Company. The advantages of "flying" the POLARIS FBM inside the laboratory, on an amazing internally-developed simulator, are obvious.

The simulator performs many developmental and test functions. When the missile is first conceived, performance characteristics are cranked in; basic overall requirements are read out. Later, the simulator details the functional requirements of each subsystem and calculates specifications for hydraulic, electronic and pneumatic hardware. As each component is built, it replaces its computer counterpart.

Finally, the whole guidance and flight control package is put through simulated flights for final checkout. But that isn't all. The simulator also performs the role of post-flight evaluation detective when it is fed tapes of actual flights, and the effects are observed on earth-bound hardware.

It is with such elaborate equipment, guided by engineers and scientists of outstanding calibre, that Lockheed Missiles & Space Company has attained its place in the forefront of missile and space technology. And such progress is constantly creating key positions for other engineers and scientists of proved ability, so they may take up the exciting challenges offered by Lockheed and share in its rewards.

This unusual organization is located in Sunnyvale and Palo Alto, on the San Francisco Peninsula in California. For an informative brochure, "Your Place in Space," write to: Research and Development Staff, Department M-31A, 599 North Mathilda Avenue, Sunnyvale, California. An Equal Opportunity Employer.

LOCKHEED MISSILES & SPACE COMPANY

A GROUP DIVISION OF LOCKHEED AIRCRAFT CORPORATION

Systems Manager for the Navy POLARIS FBM and the Air Force AGENA Satellite in the DISCOVERER and MIDAS programs. Other current programs include SAINT, ADVENT and such NASA projects as OGO, OAO, ECHO, and NIMBUS.

SUNNYVALE, PALO ALTO, VAN NUYS, SANTA CRUZ, SANTA MARIA, CALIFORNIA
CAPE CANAVERAL, FLORIDA • HAWAII



RESEARCH

SOLID STATE PHYSICS

New programs in semiconductor and thin films research have created ground floor opportunity for qualified and vigorous research scientists in NCR's expanding research and development effort. Our interest is not temporary; rather it is an element of the stable long range viewpoint that has led to 78 years of leadership in the field of business equipment and systems. Perhaps you qualify to become a part of this respected organization.

Openings in our Physical Research Department include:

Ph.D. in physics, with at least five years experience in semiconductor component research and development, a theoretical understanding of semiconductor (silicon and germanium) physics, research and development experience in the semiconductor device fabrication techniques such as diffusion, alloying, masking etching, and in particular be familiar with the epitaxial formation of multilayer semiconductor structures.

Assignment involves technical leadership for a program in molecular electronics which will first be concerned with the investigation and exploitation of the epitaxial technique to determine its limitation and capabilities as related to the fabrication of functional semiconductor structures.

Ph.D. in physical chemistry with three years of experience in the areas of electro-chemistry, preferably as applied to the formation of thin magnetic films. He should be familiar with the process of electro-deposition as related to magnetic materials and alloys, and have considerable understanding of magnetic theory, processes of crystal nucleation and growth as they are related to the formation of metallic electro-deposited films. It is also desirable to have technical familiarity with X-ray and electron diffraction examination and analysis methods, so that these skills may be brought to bear on the problem of the relationships of film composition and crystalline structure to the magnetic characteristics of electro-deposited films.

Ph.D. in physical chemistry, with approximately 5 years experience and theoretical understanding of the problems of materials preparation, structural and compositional analysis and interpretation, and methods of materials evaluation. Particular emphasis should include solid state materials, such as semiconductors, magnetic materials, superconductors, and dielectrics.

To investigate these and other openings, write to:

**Technical Placement
The National Cash Register
Company
Main and K Streets
Dayton 9, Ohio**

An Equal Opportunity Employer

Circle Number 801
Professional Profile, page 204

Indexes (Concluded)

Auto-abstracting and auto-indexing are other goals which show more and more promise of being reached by the use of computer equipment. Because computers have the ability to manipulate large numbers of words many times and in many ways, it appears possible that an abstract or a set of index terms can be "extracted" statistically from the text itself. Devices which can convert printed symbols into magnetically stored symbols (character readers) will eliminate the need for keypunching large masses of data. Thus, by removing much of the tedious work from indexing, more time can be spent in the creative aspects of preparing indexes which are more useful.

Conclusions

Many engineers find that a periodic check through some comprehensive indexes is an excellent way of keeping posted on new developments. Often a reading of just the titles is quite helpful in following trends. At the same time, familiarity with available indexes makes

A REPRINT
of this article can be obtained by
writing on company letterhead to

The Editor
ELECTRONIC INDUSTRIES
Chestnut & 56th Sts., Phila. 39, Pa.

any information search that much easier and more efficient. Perhaps the best argument for the index habit is that when we most need the time for a reference search, we can least afford it. Under job pressure, few problems can wait, and simply knowing "where to find it" may be more than half of the solution. An engineer who respects his tools will know his indexes, and will use them effectively.

References

Barzun, Jacques, and Graff, Henry F., *The Modern Researcher*, Harcourt, Brace & Co., New York, 1957, chapter 4.

Cheydeur, Benjamin F., "Information Retrieval—1966," *Datamation* V7, No. 10, Oct. 1961, p. 21-25.

Luhn, H. P., "Keyword-In-Context Index for Technical Literature (KWIC Index)," *American Documentation* VII, No. 4, Oct. 1960, p. 288-95.

Luhn, H. P., "The Automatic Creation of Literature Abstracts," *IBM Journal of Research and Development* V2, No. 2, April 1958, p. 159-165.

Whaley, Fred R., "The Manipulation of Nonconnectional Indexing Systems," *American Documentation* V12, No. 2, April 1961, p. 101-107.

* * *

Revision Sought In Schools Curricula

Dr. L. F. Doty, Martin, Marietta scientist has called for a "dramatic updating" of engineering curricula in the nation's technical colleges to assure U. S. supremacy over Russia in space. He referred with approval to President Kennedy's call for action to step up enrollments in engineering schools. But he said "a mere increase in the scientific-engineering population is not enough to cope with the technological problems confronting this country."

In remarks delivered at the 30th Annual Meeting of the Inst. of the Aerospace Sciences, Doty said that aerospace technology today demands the solution of new problems on basic scientific principles. Space designers cannot depend entirely on prepared handbooks, as in the case of the more conventional engineering specialties.

"This means that recent college graduates must achieve a deeper understanding of fundamental subjects—such as physics, mechanics and mathematics—rather than a superficial familiarity with every

specialty that comes into fashion."

Members of the Institute were also called upon to press for more emphasis on oral and written expression in the nation's schools, recognizing the importance of English usage as a technical requirement as well as a valuable course in the humanities. "English writing is a subject that should permeate the undergraduate years—not taken only during the student's freshman and sophomore years," he said.

Research Foundation Receives Large Gift

Newark College of Engineering Research Foundation has received a gift of \$250,000 from Thomas M. Cole, President of Federal Pacific Electric Co., Newark, N. J. This brings Cole's total contributions to the college to over a half-million dollars since 1959. In 1959 he financed a study proposing the foundation and then gave \$300,000 to establish it.



**Mil Spec
Hook-Up Wire
by Belden**

Regularly exceeds the rigid requirements of Military Specifications for electronic or electrical applications. All colors, types, sizes, insulations, and temperature ranges in stock — for immediate shipment. Ask for Catalog 861.



magnet wire • power supply cords •
cord sets • portable cordage •
control cables • electronic wire

**STANDARD
NYLON CONNECTORS**

Molded of tough, low-loss, shock-proof nylon—will not chip or crack, even when subjected to extreme temperature changes or severe mechanical stress. Voltage breakdowns to 12,500 volts DC. Wide line: Tip Plugs and Jacks; Metal Clad and Rapid Mount Jacks; Banana Plugs and Jacks; Binding Post. Designed for fast, easy mounting—available in 13 colors for coded applications.

Other Connectors—Johnson also manufactures a complete line of standard connectors in addition to the nylon types. For complete information write for our newest components catalog.



**OPERATING VOLTAGES TO 1500 VOLTS RMS...
5 AMPERES MAXIMUM CURRENT CARRYING CAPACITY!**

These tiny Johnson Nylon Tip Plugs and Jacks are ideally suited for limited space applications! Extremely compact—highly resistant to extremes of shock, vibration, temperature and moisture. Body, tough low-loss polyamide per MIL-P-17091 (Du Pont Zytel 101 nylon.) Available in 13 colors, including basis colors for MS16108C coding applications. Contact Resistance: less than 2 milliohms. Capacitance between two adjacent jacks: less than one mmf. at 1MC.

Series 105-751 Horizontal Jack—Unique design accepts .080" diameter tip plug in either end, or from top or bottom. Formed silver-plated beryllium copper contact. Two terminals.

Series 105-851 Vertical Jack—Mounts through single .052" hole, requires minimum mounting area. Formed silver-plated beryllium copper contact.

Series 105-771 Sub-Miniature Tip Plug—For use with miniature jack, only .080" diameter. One-piece nickel-plated, machined brass tip. Solder type lead connection.

Series 105-881 Long Sub-Miniature Tip Plug—Identical to tip plug above, but with 4" nylon body to permit access to "hard to reach" test points.



E. F. JOHNSON COMPANY

3002 TENTH AVENUE S.W. • WASECA, MINNESOTA

**MINIATURE
Nylon Plugs and Jacks**

DESIGNED FOR PRINTED CIRCUIT USE!

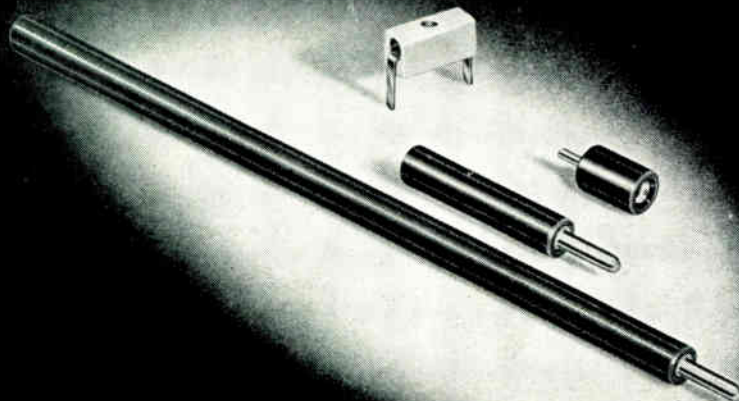

ACTUAL
SIZE

DETAILED COMPONENTS CATALOG AVAILABLE—Write today on company letterhead

• CAPACITORS • TUBE SOCKETS • CONNECTORS • PILOT LIGHTS • INSULATORS • KNOBS AND DIALS • INDUCTORS • HARDWARE

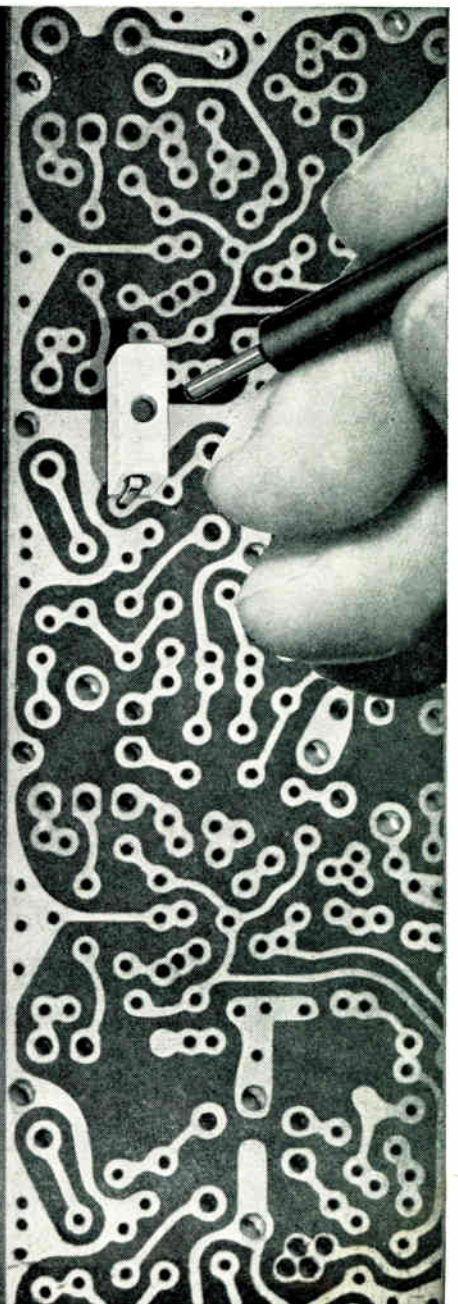

Industry News

David S. McNally—appointed Vice President of the Amphenol Connector Div., and General Manager, Amphenol-Western Div., Amphenol-Borg Electronics Corp., Chatsworth, Calif.

Leon I. Bawer—elected Vice President, General Communication Co., Boston, Mass.

American Machine & Foundry Co.'s Government Products Group, Stamford, Conn., has named two new Divisional Vice Presidents: Frank B. Carder, Engineering Unit; and Russell J. Keller, Manufacturing Unit.

Lawrence C. Oakley—elected President, Mid-Eastern Electronics, Inc., Springfield, N. J.



L. C. Oakley



M. W. Kremer

Merle W. Kremer—elected Sr. Vice President, with responsibility for the Electronic Tube and Parts Divs., Sylvania Electric Products Inc., Emporium, Pa.

Cecil L. Smith—named Manager, Advance Business Planning, General Electric's Heavy Military Electronics Dept., Syracuse, N. Y.

The Bendix Corp., Semiconductor Div., Holmdel, N. J., announces the following Regional Sales Managers appointments: V. T. Melin, Eastern area; Richard D. Mackowak, Mid-western area; and William R. Cordon, Western area.

Charles P. Brown—named Director of Manufacturing, Surprenant Mfg. Co., subs. of International Telephone and Telegraph Corp., Clinton, Mass.

Fansteel Metallurgical Corp., Rectifier-Capacitor Div., N. Chicago, Ill., announces the following appointments: Gordon J. Elsey—promoted to Superintendent, Capacitor Production; and Russell E. McDonald—appointed Manager, Production Planning.

Mones E. Hawley—appointed Associate Director, Systems Engineering Div., Planning Research Corp., W. Los Angeles, Calif.

John C. Washington—appointed Regional Sales Manager, West Coast, Weston Instruments Div., Daystrom, Inc., Newark, N. J.

Hathaway Instruments, Inc., Denver, Colo.—announces the following Vice-Presidential appointments: George J. Turre, Vice President, Marketing Div.; Paul Elson, Vice President, Operations; William L. Davis, Vice President, Engineering Div.; and Clark Shannon—Vice President, Manufacturing Div.

Roy E. Wendahl—appointed to the newly created post of Executive Vice President, Hughes Aircraft Co., Culver City, Calif.

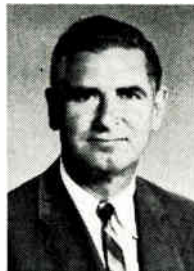

R. E. Wendahl



J. E. McCloskey

James E. McCloskey—appointed Vice President, Sales, Engineered Electronics Co., Santa Ana, Calif.

C. W. Frederick—appointed Manufacturing Manager of the New Bedford, Mass., plant of Cornell-Dubilier Electronics.

S. Raymond Luboyeski—named Director of Reliability and Quality Control, FXR, Div. of Amphenol-Borg Electronics Corp., Danbury, Conn.

Warren T. O'Brien—appointed Manager of Operations, Communications and Weapons Div., Philco Corp., subsidiary of Ford Motor Co., Philadelphia, Pa.

General Electric Co., Syracuse, N. Y., announces the following appointments: William E. Sollecito—Manager of Control and Instrumentation, Electronics Laboratory; and Harry E. Smith—Manager-Marketing, Technical Productions Operation.

Hobart W. Acker—appointed Production Manager, Granger Associates, Palo Alto, Calif.

Frank J. Siliwinski—appointed Group Supervisor, Quality Assurance Systems and Data Analysis Group, Philco Corp., Willow Grove, Pa.

(Continued on Page 214)

ONLY H-K DIGITAL LOGIC

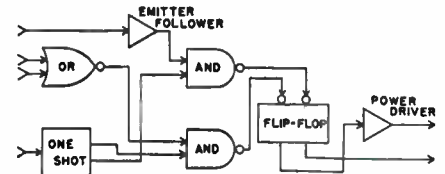

OFFERS THIS

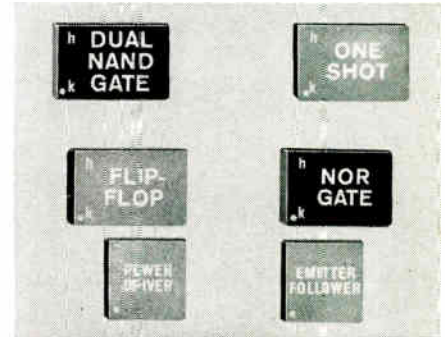

COMBINATION (and over 40,000 others)

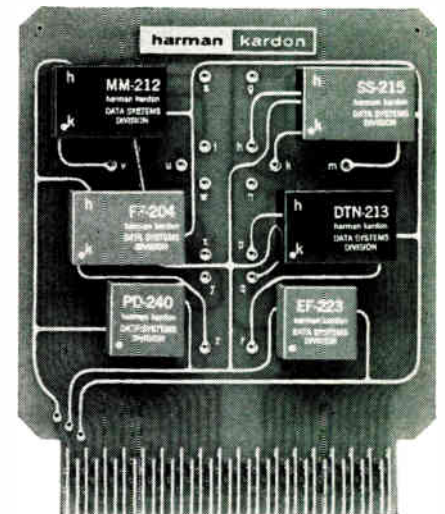

completely assembled FROM STOCK COMPONENTS (at competitive prices)

3 COMPLETE AND COMPATIBLE LOGIC MODULE SERIES 250KC • 125°C. • 5/10 MC

Write for complete details— and free guide to Boolean Algebra!

Data Systems Division



Incorporated ■ Plainview, Long Island Circle 141 on Inquiry Card

—an order of
magnitude
better stability
(1×10^{-9} PER DAY)



MOTOROLA HIGH STABILITY OSCILLATOR

... proven under rigid military environments for your use in:

- Single Side-Band
- Missile Systems
- Navigation
- Telemetry
- Instrumentation

... wherever a precision frequency source is required.

THIS OSCILLATOR IS THE HEART OF MOTOROLA'S PRECISION FREQUENCY STANDARDS—see next 2 pages. And the precision base of this unit—the sealed-in-glass "AT" cut quartz crystal—is backed by 20 years of Motorola volume production experience. Motorola plus values include Unexcelled Stability... Fastest Warm-up... Lowest Power Needs.

Here are basic operating facts:

Model SLN6039A Prices on request.

- $\pm 1 \times 10^{-9}$ per day stability
- $\pm 5 \times 10^{-10}$ per hour stability
- Warm-up at -40°C , 11 min. to 1×10^{-9}
- 26VDC ± 4 , input voltage
- At -55°C , 7 watts power consumption
- -55°C to $+77^\circ\text{C}$ operating temperature range
- Meets MIL specifications



For full precision facts, contact your local Motorola instrument representative, or write Dept. AE1214

MOTOROLA
PRECISION MEASURING INSTRUMENTS

Motorola Communications & Electronics, Inc.
4501 Augusta Blvd., Chicago 51, Ill.
A Subsidiary of Motorola Inc.

Circle 154 on Inquiry Card

Industry News

(Continued from Page 213)

John P. Dillon—appointed General Sales Manager, Clarostat Mfg. Co., Inc., Dover, N. H.

Emanuel Weintraub, Executive Vice President and General Manager, John E. Fast & Co., Chicago, Ill.—elected Vice President, The Victoreen Instrument Co., Cleveland, Ohio.

John C. Alexander—named to the newly created position of Market Manager, Minneapolis-Honeywell's Semiconductor Div., Riviera Beach, Fla.

Stewart Pfannstiehl—elected to the new position of Sr. Vice President, Oak Mfg. Co., Crystal Lake, Ill.



S. Pfannstiehl



B. A. Jackson

Boris A. Jackson—elected President, U. S. Components, Inc., New York, N. Y.

Edward H. Ridings, Jr.—named Manager, Industrial and Military Products Div., Bulova Watch Co., Inc., Jackson Heights (Queens), N. Y.

Dale Electronics, Inc., Columbus, Nebr., has created two new Vice Presidencies: **Ira E. Gates**—appointed Vice President, Marketing; and **Maurice A. Woodsworth**—appointed Vice President, Finance.

Frank J. Newman—appointed Manager, Berkeley Div., Beckman Instruments, Inc., Richmond, Calif.

Gerald A. Hoyt—named General Manager, Light Military Electronics Dept., General Electric Co., Utica, N. Y.

Cornell-Dubilier Electronics, div. of Federal Pacific Electric Co., Newark, N. J., announces the following appointments: **Anthony A. DeLisse** and **Glenn E. Ronk**—promoted to Vice Presidents of CDE.

Burton Silver—named Marketing Director, Microwave Tube Products, Litton World Trade Corp., Zurich, Switzerland.

Ken L. Burton—named Sales Manager, Industrial Products, Stancor Electronics, Inc., Chicago, Ill.

North Atlantic Industries, Inc., Plainview, N. Y., announces the following appointments: **Frederick G. Roberts**—named to the newly created position of Director of Marketing; and **Philip Greenstein**—appointed Instrument Sales Manager.

Mark C. Lewis—named Manager, Marketing, General Electric's Light Military Electronics Dept., Utica, N. Y.

Robert E. Keck—named Head, Marketing Research Dept., Sprague Electric Co., N. Adams, Mass.



R. E. Keck



M. A. Foster, Jr.

Murray A. Foster, Jr.—appointed Sales Manager, E-H Research Laboratories, Inc., Oakland, Calif.

Donald P. Davies—appointed West Coast Regional Sales Manager, Pioneer-Central Div., Bendix Corp., Davenport, Iowa.

Reginald G. Clarke—named Vice President of Central Administration Autonetics, a div. of North American Aviation, Inc., Downey, Calif.

Northrop Space Laboratories, Northrop Corp., Hawthorne, Calif., announces the following appointments: **Dr. Ludwig Roth**—Vice President and Manager, systems Engineering Dept.; **Dr. V. W. Howard**—Vice President and Manager, Research Dept.; **Alan Morgan**—Vice President and Manager, Business Administration Dept.; and **George Mangurian**, Management, Applications Engineering and Planning Dept.

L. H. Hyde—elected Vice President, Philco Corp. and named General Manager of Consumer Products Div., Philadelphia, Pa.

William F. Tait—appointed Division Vice President, Marketing, Government Services, RCA Service Co., Cherry Hill, N. J.

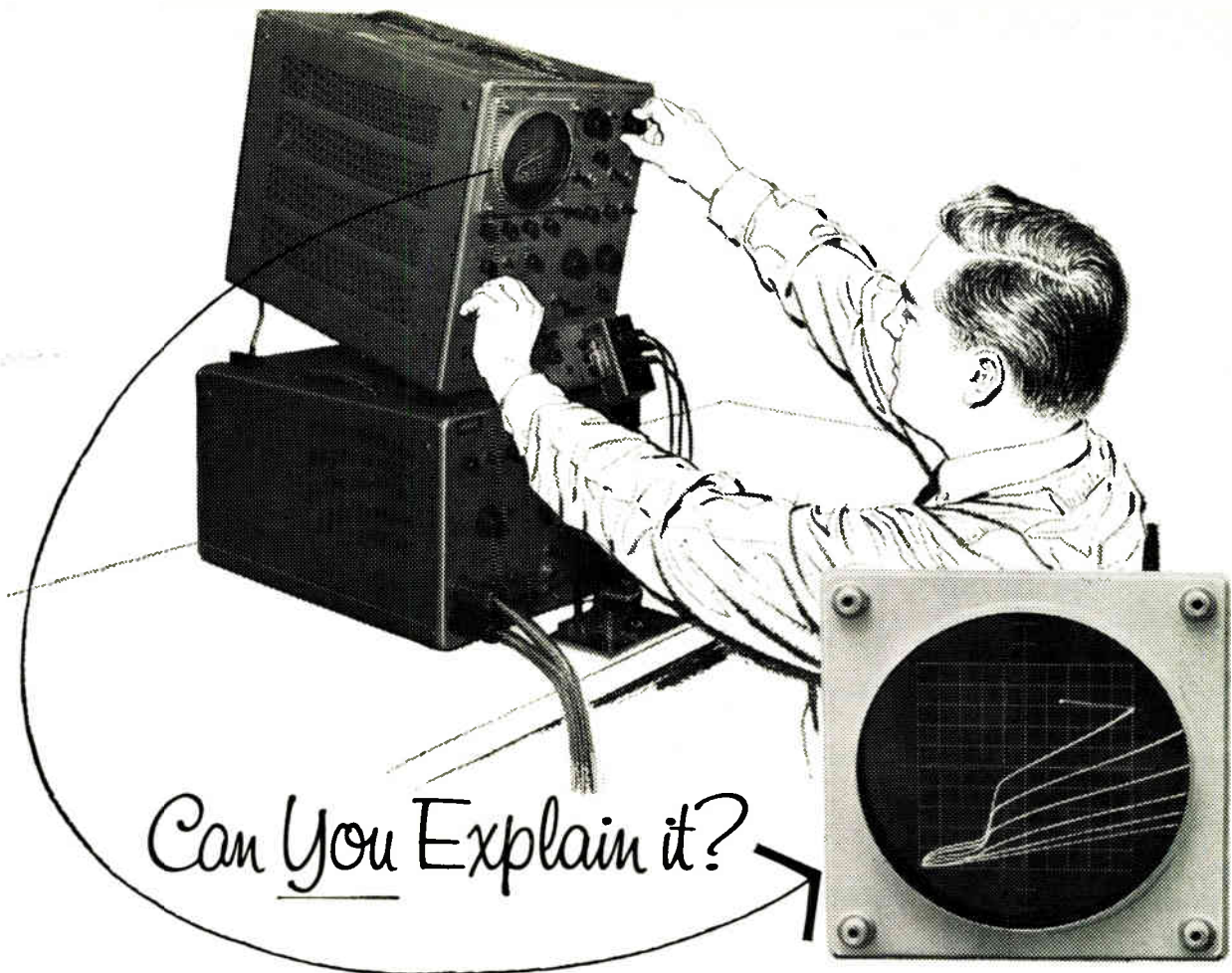

When a transistor performs like this on a curve tracer, we like to know why. Sometimes the answer is obvious. Then again, we may find it not so easily explained. This our semiconductor device people like. They enjoy sinking their teeth into a knotty problem and sticking with it till they shake out the answer—and it usually doesn't take long at Delco.

Why? Easy.

When you toss a problem to a group of talented men . . . provide the necessary research tools . . . in an environment that encourages personal initiative and achievement . . . you can't help getting results. This combination has helped build a position of leadership for Delco in the development and production of semi-conductor devices.

We intend to keep it that way—through expanding facilities and fresh talent.

Our new R&D center—125,000 sq. ft.—houses laboratories equipped with the latest in sophisticated research facilities. Our new semiconductor manufacturing center—226,000 sq. ft.—scheduled for operation this June, will provide an expanded capability in the production of silicon rectifiers. All of which adds up to new opportunities in research, development and production of silicon rectifiers.

solid state electronics ●



DELCO RADIO DIVISION OF GENERAL MOTORS

KOKOMO, INDIANA

Circle Number 803 on Inquiry Card

Professional Profile, page 204

• **SEMICONDUCTOR DEVICE DEVELOPMENT—**

BS in Physics, Metallurgy or Electrical Engineering; minimum of 2 yrs. experience in high current silicon rectifier development; must be capable of developing these devices and maintaining technical responsibility through pilot production.

• **PHYSICISTS, CHEMISTS AND METALLURGISTS**

For semiconductor device development; experience in encapsulation, alloying and diffusion, chemistry of semiconductor devices, materials (to lead a program on metallurgical research of new semiconductor materials).

• **ELECTRONIC ENGINEERS—**

Experienced in machine controls (relay and/or static) to assist in the development and application of static transistorized controls.

• **TRANSISTOR PROCESS ENGINEERS—**

EEs, MEs, and IEs to develop and create new processes for manufacturing germanium and silicon semiconductor devices and to develop automatic and semi-automatic fabrication equipment. Experience preferred.

If you're looking for an opportunity to fully exercise your personal competence . . . among men of like talent . . . in unmatched facilities . . . then let us hear from you. Send your resume today to the attention of Mr. Carl Longshore, Supervisor Salaried Employment,

An equal opportunity employer

-battery/AC powered portable frequency standard



From the Motorola High Stability Oscillator used as a basic reference, throughout the all-transistor circuitry, these new, highly stable, lightweight units provide:

- Highest accuracy in their price range
- 117VAC/26VDC operation
- Low power drain
- 1 mc and 100 kc simultaneous output frequencies

You can use this versatile, portable standard with full confidence for: Calibration of crystals and frequency synthesizers... calibration and checking of instruments, in-plant and out.

Here are the basic operating facts:

Model S1054A \$1,600.00
Model S1054B \$1,800.00

- $\pm 5 \times 10^{-10}$ per day (S1054B)
- $\pm 1 \times 10^{-9}$ per day (S1054A)
- Optional ni-cad standby batteries
- Completely transistorized
- Rack mounting same price
- Fine freq. adjust, parts in 10^{10}
- Includes detachable front cover



For full precision facts, contact your local Motorola instrument representative or write Dept. AE1215

MOTOROLA
PRECISION MEASURING INSTRUMENTS

Motorola Communications & Electronics, Inc.
4501 Augusta Blvd., Chicago 51, Ill.
A Subsidiary of Motorola Inc.

Circle 155 on Inquiry Card

Systems and Circuits

(Continued from page 201)

AUTOMATIC CONTROL still leaves a lot to be desired, reliability-wise. Such are the indications from Lt. Col. John H. Glenn's recent space journey. NASA officials, in trying to put across the significance of the astronaut's control of the craft, focussed, by omission, attention on the reliability of the vehicle's automatic guidance systems. They made no secret of the fact that if the capsule had been unmanned, it would not have performed 3 orbits. And what about the heat shield-relay-switch "sweat"?

THIN FILM devices are between 5 and 10 years off, according to most theoreticians and experimentalists at a recent symposium conducted by Philco's Scientific Laboratory at Blue Bell, Pa. While some reported the development of a new class of amplifiers from their studies of the hot electron transport across insulators in active thin film devices, others believe it is the passage of current through "pinholes" in the insulator. Non-uniformity of film evaporation is believed to be the cause of these holes. Film thickness has varied from 10 to 1000 A°. Dr. Pierre R. Aigrain, École Normale Supérieure, Paris, stated that in all materials, semiconductors or metals, hot electrons can be injected. He went on to say that in a recent experiment whereby hot electrons were injected by tunnel effects in gold films, and brought out in vacuum, there was a tendency for the gold to evaporate out of those spots where current density was highest. He went on to state that this might lead to a large over-estimation of energy-loss mean free path in the gold film.

VORTAC AIR NAVIGATION equipment will be studied to determine whether the capacity of existing equipment can be measured. The study program will be conducted by ITT Federal Labs, Nutley, N. J., under a contract is-

THE HARMON P-315A REGULATED POWER SUPPLY



GIVES YOU
... all these features
at this low price *

... and it is lightweight and compact enough to make it ideal for field work, despite the fact that it is in the category of the finest laboratory equipment by performance standards.

Whether you are working with transistorized circuits, hybrid tubes, or are involved in any test, maintenance or design work requiring 0 to 15 volts of d.c. at up to 3 amps, you will be delighted with this new Harmon Power Supply. The full wave filtered output will supply "lab-type" power at continuous current loads and the .1% regulation at inputs varying from 105 to 125 volts A.C. (55 to 65 cycles) insures 100 microsecond recovery time during voltage surges. This compact package weighs but $5\frac{1}{4}$ pounds and measures $8\frac{3}{8}$ " x $6\frac{7}{8}$ " x $5\frac{3}{8}$ ".

SPECIFICATIONS

Input Voltage Regulation	115 volts a.c., 55-65 cps. $\pm 1\%$ at 115 volts. Input voltage may vary from 105 to 125 volts.
Output	0-15 volts d.c., fully regulated, at up to 3 amperes.
Circuitry	Solid-state. 4 power transistors, heat-sink mounted.
Ripple	10 mv. RMS at 50% load current; 30 mv. RMS at full load.
Fusing	All components short-circuit protected.
Recovery Time	Less than 100 microseconds after full load surge.
Voltage Control	Precision Potentiometer

* INTRODUCTORY PRICE **99⁵⁰**

Available through your electronic distributor. Write for technical brochure and name of nearest distributor.

GEORGE HARMON
Company Inc.
18141 Napa St. • Di 5-1620 • Northridge, Calif.

Circle 137 on Inquiry Card

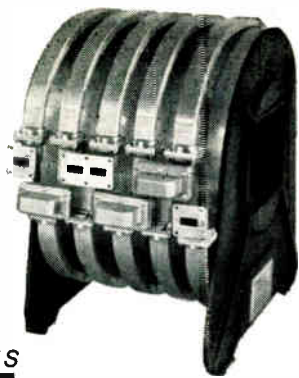

THIS

MICROWAVE DELAY LINE IS

ALL NEW

Tapped X-Band MicroDelay Lines for 8.2 to 12.4 Gc operation provide as many as 8 different delay times from 0.1 to 0.9 microseconds in 0.1 microsecond steps. Units can be employed to provide two or more delay times simultaneously; may be used in cascade with one or more fixed length MicroDelay Lines to provide range from 0.1 to 2.5 microseconds in 0.1 microsecond steps.

IT IS

- **Easily Interconnected** to experimental equipment.
- **Fully Tested** — individual data supplied with each assembly.
- **Fully Pressurized** to prevent moisture entrapment.
- **Compact and Light** yet rugged.

IT OFFERS

- **Low Attenuation** below 4.0 db per 0.1 microsecond.
- **Low VSWR Values** — including fine structures—across full operating band.
- **Reliable Performance.** There are no moving parts—no electrically controlled switches to fail.

PRICES RANGE FROM \$1150 TO \$2400. NORMAL DELIVERY SCHEDULE—10 DAYS.

Write for additional information. Your inquiries are also invited on special requirements which cannot be filled by standard microwave units.

MicroDelay

A Division of

FRANKLIN TECHNICAL CORP.
KULPSVILLE, PENNSYLVANIA

Telephone: ULYsSES 5-0019
Circle 139 on Inquiry Card

Systems and Circuits

sued by the Federal Aviation Agency. Increasing the capacity would provide enroute navigational information for more aircraft.

At present, a Vortac ground station has 79 channels and simultaneously can provide distance and bearing information for the same number of aircraft, one per channel. By increasing the number of channels per ground station transmitter, Vortac would be able to service that many more planes.

The Vortac system combines Tacan (military), with the commercial VOR navigation system. A VOR-equipped aircraft must add the distance measuring (DME) portion of Tacan to its equipment to obtain full Vortac service.

FIBER OPTICS and MEDICAL ELECTRONICS make a good team. One of the first uses of the former was as an aid in the education of dental students. The Office of Naval Research developed a system, a few years back, which used a bundle of fibers to transmit close-ups of the oral cavity to a vidicon CCTV chain. This permitted presentation on as many monitors as necessary to satisfy the audience. One of the most recent weddings of the pair has been at Children's Hospital Medical Center in Boston. There, surgeons and scientists from American Optical Co. are using a 4½-ft. long bundle of 1,300 fibers (0.002 mm diameter each) to transmit light from a tungsten lamp to a 7-in. long, ⅛-in. dia. stainless steel probe. The bundle is contained within a catheter. The probe, now a "cold light" source, is called an intercardiac illuminator because it is used to locate heart defects which are not otherwise visible. The light is used during open-heart surgery to detect holes in the inter-ventricular septum, the muscular portion of which usually hides holes from the standard room lighting.

* * *

FOR THE MAN WHO SPECIFIES AND THE MAN WHO BUYS...

List all your electronic requirements FREE OF CHARGE in PROCUREMENT GUIDE, a new weekly service. For simple source location and industry-wide coverage... Fill out the Listing Form below...

ACTION ↑	Lit, only <input type="checkbox"/>		Quote <input type="checkbox"/>		Ext. <input type="checkbox"/>		Send subscription rate info. <input type="checkbox"/>	
	Sales Call <input type="checkbox"/>		Name and title		Company		Address	City, Zone & State
SPECIFICATIONS Please do not write in above area								Quantity
								Delivery
							Send more forms <input type="checkbox"/>	

Mail to PROCUREMENT GUIDE

A REPORT ON CURRENT ELECTRONIC REQUIREMENTS
37 West 53rd St., New York 19, N.Y. PLaza 7-3355

Circle 140 on Inquiry Card

and a SOLID STATE fully automatic VLF Receiver Frequency Standard



Where maximum accuracy and precision is required in such applications as missile systems, navigation equipment, telemetering, single sideband communications equipment and others, this new Motorola Standard provides constant accuracy within $\pm 2 \times 10^{-9}$.

THE FIRST AND ONLY COMPLETE SOLID STATE STANOARD THAT AUTOMATICALLY CORRECTS ITS LOCAL OSCILLATOR TO VLF STATIONS

Using VLF transmissions from station NBA or WWVL, you are assured of long-term stability for laboratory requirements that cannot otherwise be provided by other types of standards.

Here are the basic operating facts:

Model S1055A \$5,850.00

- Precise no-drift standard
- Completely transistorized
- Receives NBA (18 kc) or WWVL (20 kc) VLF signals
- Expandable up to 6 station reception
- Automatic servo tracking and correction
- 10 kc, 100 kc, 1 mc and recorder outputs
- $\pm 2 \times 10^{-9}$ constant accuracy
- $\pm 5 \times 10^{-10}$ short term stability
- Eliminates diurnal shift problem
- Internal High Stability Oscillator



For full precision facts, contact your local Motorola instrument representative, or write Dept. AE1216



MOTOROLA
PRECISION MEASURING INSTRUMENTS

Motorola Communications & Electronics, Inc.
4501 Augusta Blvd., Chicago 51, Ill.
A Subsidiary of Motorola Inc.

Circle 156 on Inquiry Card

News of Mfrs' Representatives

General Electronic Labs., Inc. Names Representative

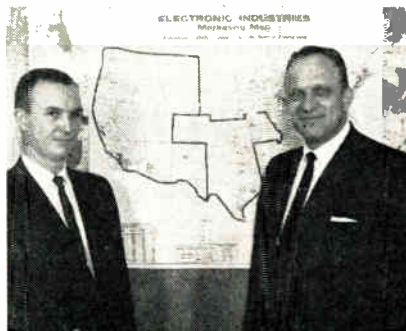

W. D. Collins, Jr. (left) of Collins and Hyde Co., Palo Alto and Long Beach, Calif., is the newly appointed sales representative for GEL in the 10 western states outlined on the ELECTRONIC INDUSTRIES' map in background. Appointment was announced by O. D. Page (right) Government and Industrial Sales Manager, General Electronic Laboratories, Inc., Cambridge, Mass.

Arnold Barnes Co., Dallas, Tex., announces the opening of their Houston office located at 2320 Southwest Freeway, Houston, Tex.

Component Sales Corp., North Miami Beach, Fla., has been appointed representative by Westinghouse Electronic Tube Div., Elmira, N. Y., to cover the state of Florida.

Ed Landa Co., Los Angeles, Calif., has been named representative by Transistor Electronics Corp., Minneapolis, Minn., to cover Southern California and Clark County, Nevada.

Moisan Assoc., Lowell, Mass., has been named representatives by Polyphase Instrument Co., Bridgeport, Pa., to cover the New England area.

Addelco Corp., West Roxbury, Mass., has been named representative by Lavoie Laboratories, Inc., Morganville, N. J., to cover Massachusetts, Vermont, Connecticut, Rhode Island, New Hampshire and Maine.

Silicon Transistor Corp., Carle Place, N. Y., announces the following representative appointments: Electro-Com, Cleveland and Dayton, Ohio, to cover Ohio; and Russell Forsythe, Garland, Tex., for Oklahoma and Texas.

Fred Wamble Sales Co., Montgomery, Ga., has been appointed representative by Omtronics Mfg. Inc., Omaha, Nebr., to cover North and South Carolina, Alabama, Tennessee, Mississippi and Georgia.

(Continued on Page 220)

NCR

ADVANCED
DEVELOPMENT

INTEGRATED ELECTRONICS

A new program has started in the development of Integrated Circuits for computers and business machines. Circuits both in thin films and in semiconductor blocks will be designed, made, and evaluated. Novel circuits, applications, and processes will be sought. This program will provide growth opportunities along technical or managerial lines for imaginative experienced individuals. Backgrounds are desired in thin films, semiconductors, or logic design. Specific openings comprise:

• SOLID STATE PHYSICS

To design and confirm integrated circuit structures

• ELECTRONICS

To design and evaluate integrated circuits

• LOGIC

To specify and evaluate integrated circuits in logical applications

• PROCESS

To establish and improve processes in thin film and semiconductor technology such as evaporation, diffusion, contacting, surface treatment, epitaxy, etc.

In addition to unexcelled facilities and opportunities, NCR offers many unusual and unexpected benefits both in living and working climate. Purposeful effort, long range planning, and good management backed with 78 years of systems experience underlie the stimulating program of research and development now emerging at NCR. To be considered for what may be your ground floor opportunity, write to:

T. F. Wade,
Technical Placement
The National Cash Register
Company
Main & K Streets
Dayton 9, Ohio

An Equal Opportunity Employer

Circle Number 802
Professional Profile, page 204

ELECTRONIC INDUSTRIES Advertisers—April 1962

This index is published as a convenience. No liability is assumed for errors or omissions.

A		Good-All Electric Mfg. Co. 21	Plastic Capacitors, Inc. 162
Abbott Transistor Laboratories, Inc. 142		Graphic Systems 142	Plenum Press 141
Acromag, Inc. 148		Grayhill, Inc. 189	Polarad Electronics Corp. 41
ADC Products 153		Greomar Mfg. Co., Inc. 170	Polyphase Instrument Co. 36
Advanced Technology Laboratories 13		Green Instrument Co., Inc. 157	Precision Thermometer & Instrument Co. 197
Aerovox Corporation 86			Price Electric Corp. 192
Allen-Bradley Insert fol. p. 154			Procurement Guide 217
Allied Chemical, General Chemical Division 65		H	
American Electronic Laboratories, Inc. 64		Hamilton Standard 127	
American Super-Temperature Wires, Inc. 184		Harman Kardon, Inc. 213	
AMP, Inc. 85		Harmon Co., Inc., George 216	
Anaconda Wire and Cable Co. 185		Heath Co. Insert fol. p. 52, 55	
Arco Electronics, Inc. 78, 151		Hewlett-Packard Company	
		Inside Back Cover, 164-165	
B		Hoffman Electronics Corp. 8	
Belden Manufacturing Co. Insert fol. p. 210		Honeywell Precision Meters 141	
Bell Telephone Laboratories 66		Howard Industries, Inc. 170	
Bendix Corporation, The		Hughes Aircraft Company	
Red Bank Division 48		Aerospace Division 206	
Scintilla Division 33		Semiconductor Division 139	
Semiconductor Division 132, 133		Vacuum Tube Products Division 44, 145	
Borg Equipment Division 79			
Bourns, Inc. 39		I	
Brady Co., W. H. 198		Ideal Industries, Inc. 45	
Brush Instruments Insert fol. p. 87		Industrial Exhibitions Limited 38	
Burroughs Corporation 169		International Electronic Research Corp. 160	
Bussmann Mfg. Division 69			
C		J	
Calibration Standards Corp. 201		Jennings Radio Mfg. Corp. 84	
Captron 168		Johnson Co., E. F. 212	
Centralab Insert fol. p. 172			
Cinch Mfg. Co. 121		K	
Clare & Co., C. P. 59, 83		Kearfott Division 158, 159	
Clevite Transistor 12		Keithley Instruments 151	
Continental Electronics Mfg. Co. 161		Keystone Carbon Company 52	
Controls Company of America 40, 131		Knight Co., The James 157	
CTS Corp. 149			
Curtiss-Wright Corp. 16		L	
D		Lavelle Aircraft Corp. 190	
Dale Electronics, Inc. Inside Front Cover		Lepel High Frequency Laboratories, Inc. 142	
Daystrom, Inc. 146, 147		Lionel Electronic Laboratories, Inc. 138	
Deutsch Electronic Components Div. 67		Lockheed Missiles & Space Co. 208-209	
E		M	
EICO Electronic Instru. Co., Inc. 199		Magnetics, Inc. 74	
Electra Mfg. Co. 181		Measurements 148	
Electro Motive Mfg. Co., Inc., The 150		Methode Electronics, Inc. 60	
Engineered Electronics Co. 10, 163		Microtran Company, Inc. 197	
F		Minnesota Mining & Mfg. Co.	
Fairchild Semiconductor 35		Irvington Division 82	
Fairmount Chemical Co., Inc. 196		Mincom Division 73	
Fansteel Metallurgical Corp. 174		Motorola Semiconductor Products, Inc. 75	
Florida Development Commission 129		Motorola Communications & Electronic, Inc. 214, 216, 218	
Fluke Mfg. Co., Inc., John 61			
Franklin Technical Corp. 217		N	
FXR 182-183		National Cash Register 210, 218	
G		O	
General Electric Power Tube Department. 30		Oak Mfg. Co. 135	
General Electrodynamics Corp. 80		Ohmite Mfg. Co. 166, 167	
General Motors		P	
AC Spark Plug 202		Parabam Div. of Houston Fearless Corp. 196	
Delco Radio 43, 70, 215		Philco, Lansdale Division 22	
General Radio Company 81			
Gertsch Products, Inc. 140		X	
		Xcelite Industrial Hand Tools 195	
		R	
		Radio Corp. of America Back Cover	
		Rayclad Tubes, Inc. 24	
		Redcor Corp. 154	
		Rek-O-Kut Co., Inc. 185	
		Reeves Instrument Corp. 125	
		Rockwell Products Corp. 172	
		Rohde & Schwarz 62	
		Rotron Mfg. Co., Inc. 71	
		Rutherford Electronics Co. 175	
		S	
		Sarkes Tarzian, Inc. 63	
		Sealectro Corp. 180	
		Silicon Transistor Corp. 47	
		Sola Electric Co. 87	
		Solid State Electronics Co. 162	
		Sprague Components 6, 14	
		Sperry Semiconductor 186	
		Stainless Inc. 193	
		Standard Telephones and Cables Ltd. 37	
		Stanpat Co. 162	
		Stoddart Aircraft Radio Co., Inc. 72	
		Superior Tube 32	
		Sylvania Electric Products, Inc. 26-27	
		Semiconductor 76-77	
		T	
		Tektronix, Inc. 68	
		Torrington Mfg. Co. Insert fol. p. 136	
		Transistor Electronics Corp. 144	
		Triplett Electrical Instrument Co. 49	
		Trygon Electronics, Inc. 46	
		U	
		United Transformer Corp. 152	
		V	
		Varflex Corp. 200	
		Vector Electronic Co., Inc. 184	
		Victoreen 56	
		Virginia Dept. of Conservation and Economic Development 58	
		Vitraman, Inc. 31	
		Vlchek Plastics 198	
		W	
		Woldom Electronics, Inc. 199	
		Waters Mfg. Inc. 57	
		Waveline, Inc. 42	
		Weckesser Company, Inc. 200	
		Westinghouse Electric Corp. 50-51	
		Weston Instruments Insert fol. p. 16	

NEW, NO-PARALLAX 120B

easiest-to-use, surest-reading

450 KC OSCILLOSCOPE

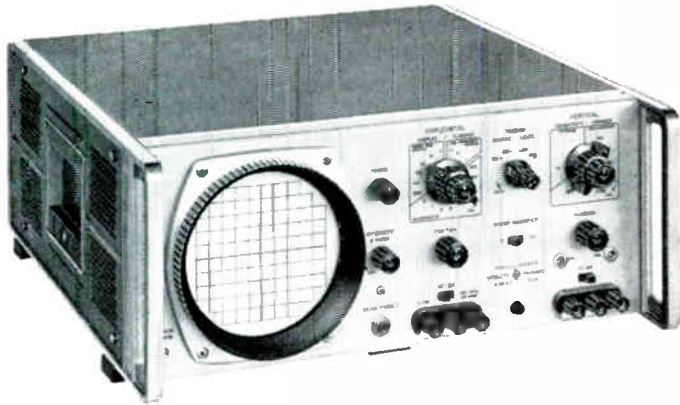

This new  120B Oscilloscope combines more actual measuring help and desirable features than any 450 KC scope ever produced. Not only are reading error from parallax and distracting reflections eliminated, but you have a genuinely unique array of electrical and convenience features for measurements from dc to 450 KC.

SPECIFICATIONS: Model 120B combines minimum controls with  automatic triggering for utmost speed, convenience. Horizontal amplifier dc to 300 KC, phase-shift within $\pm 2^\circ$. More X-axis information due to horizontal amplifier sensitivity control, 5% accuracy. Times-5 sweep expander, all ranges. 15 calibrated sweeps, 5 μ sec/cm to 200 msec/cm. Vernier for continuous adjustment of sweep time between calibrated steps, extends slowest sweep to at least 0.5 sec/cm. 10 mv/cm sensitivity calibrated vertical amplifier, drift-free trace. Balanced input on most sensitive range for noise rejection at low levels. Model 120B in new modular design for rack or bench use, \$475.00. Accessories available.

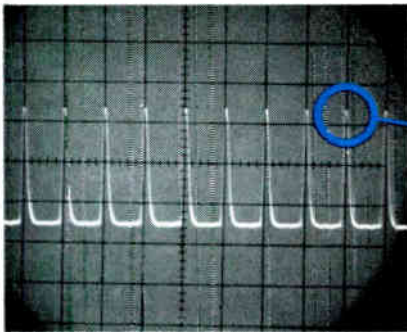

Perfectly linear signal *reads* perfectly. Exclusive  development places calibrating graticule in identical *inside* plane with trace. Since trace and graticule are on the same plane, there is no reading error— even at wide viewing angles.

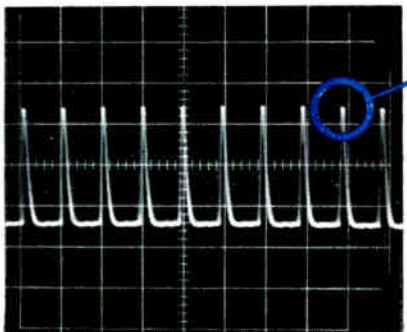

Conventional scopes have calibrating graticule a full $\frac{1}{4}$ inch in front of trace. Note identical signal on old-type cathode ray tube. Parallax is inescapable and errors up to 5% are possible.

Many engineers who have tested the new 120B feel it is perhaps the easiest-to-use, most widely versatile, and highest value commercial 450 KC scope ever offered. Why not confirm their opinions with a test on your own bench.

Data subject to change without notice. Prices f.o.b. factory.



HEWLETT-PACKARD COMPANY

1501 PAGE MILL ROAD, PALO ALTO, CALIFORNIA
AREA CODE 415, DA 6-7000

*Sales and service representatives in all principal U. S. areas;
Europe, Hewlett-Packard S.A., Rue du Vieux Billard No. 1, Geneva;
Canada, Hewlett-Packard (Canada) Ltd., 8270 Mayrand St., Montreal*

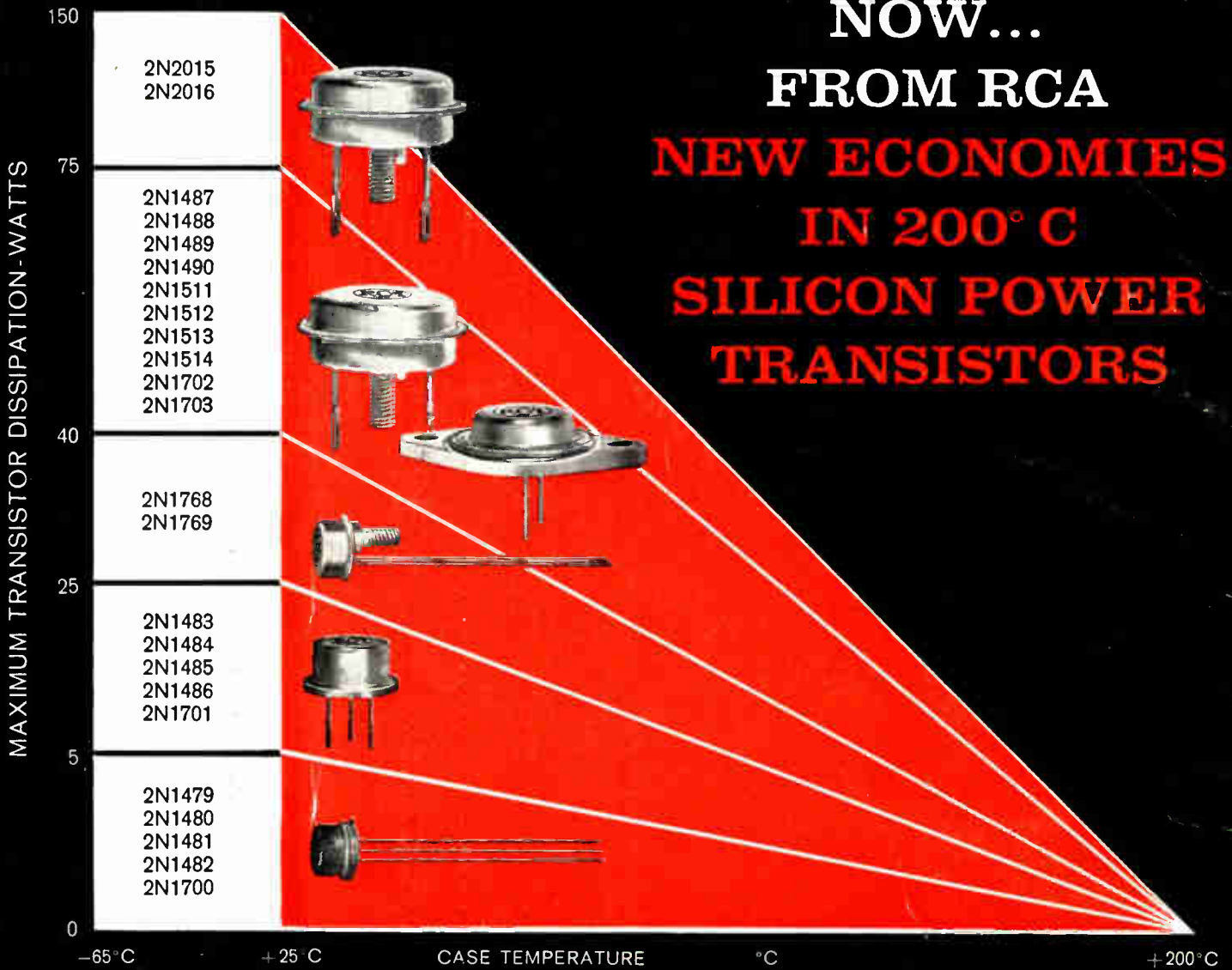

**NOW...
FROM RCA
NEW ECONOMIES
IN 200° C
SILICON POWER
TRANSISTORS**

Now Beta-Control Up To 10 Amperes...Extremely Low Saturation Resistance...

Power To 150 Watts At Prices Starting As Low As Comparable Germanium Power Types

Check out the outstanding features of these 24 RCA N-P-N diffused-junction silicon power transistors, immediately available at low prices to meet your industrial and military applications requirements:

- Maximum operating temperature—up to 200°C.
- Maximum dissipation capability—up to 150 watts
- Very low thermal resistance—as low as 1.17°C/watt max.
- Very low saturation resistance—as low as 0.25-ohm max.
- High minimum beta
- Narrow Beta Spread

AVAILABLE THROUGH YOUR RCA DISTRIBUTOR

Call your RCA Field Representative today for complete sales and price information. For further technical information, write for RCA Technical Bulletins on these types. For detailed application information on the design of military and industrial equipment using RCA Silicon Power Transistors, send for new 28-page Application Guide on RCA Silicon Power Transistors— (Price: 50 cents per copy). Write to RCA Semiconductor and Materials Division, Commercial Engineering, Section D-50-NN, Somerville, N. J.



The Most Trusted Name in Electronics
RADIO CORPORATION OF AMERICA

RCA FIELD OFFICES . . . EAST: Newark, N. J., 744 Broad St., HU 5-3900 • (Camden, N. J. area), Erlton, N. J., 605 Marllan Pike, HA 8-4802 • Syracuse, N. Y., 731 James St., Room 402, GR 4-5591 • Baltimore, Md., EN 9-1850 • NORTHEAST: Needham Heights 94, Mass., 64 "A" St., HI 4-7200 • SOUTHEAST: Orlando, Fla., 1520 Edgewater Drive, Suite #1, GA 4-4768 • EAST CENTRAL: Detroit 2, Mich., 714 New Center Bldg., TR 5-5600 • CENTRAL: Chicago, Ill., Suite 1154, Merchandise Mart Plaza, WH 4-2900 • Minneapolis, Minn., 5805 Excelsior Blvd., WE 9-0676 • WEST: Los Angeles 54, Calif., Box 54074, RA 3-8361 • (San Francisco area), Burlingame, Calif., 1638 El Camino Real, OX 7-1620 • SOUTHWEST: Dallas 7, Texas, 7905 Carpenter Freeway, FL 7-8167 • GOV'T: Dayton, Ohio, 224 N. Wilkinson St., BA 6-2366 • Washington, D. C., 1725 "K" St., N.W., FE 7-8500