

TELE-TECH

& Electronic Industries



CALIFORNIA

OREGON

WASHINGTON

NEVADA

UTAH

WYOMING

AUG 4 1954

**THIRD ANNUAL
WEST COAST ISSUE**

"WESCON 1954"

SHARE THIS COPY!
Please Route to

.....
.....
.....

Section 1
1954
Elements, Inc.



Greater
STABILITY

Smaller
SIZE

Greater
STRENGTH

RMC

Temperature Compensating

DISCAPS

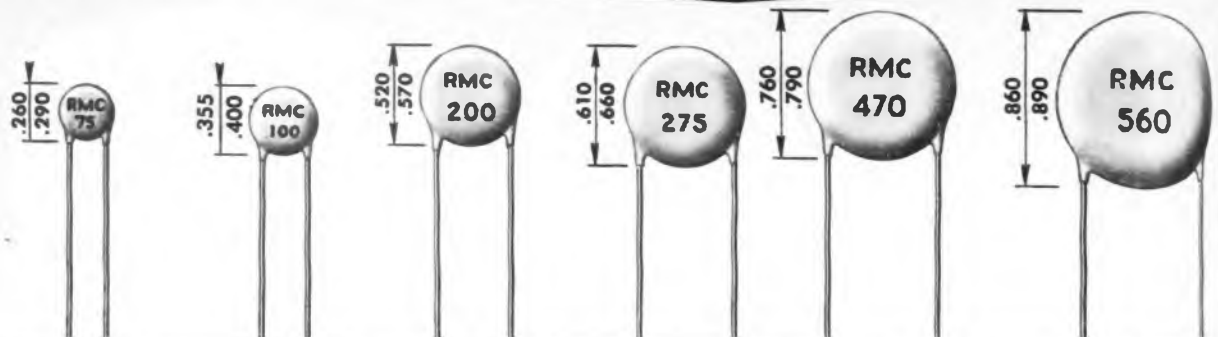

TC	1/4 Dia.	5/16 Dia.	1/2 Dia.	5/8 Dia.	3/4 Dia.	7/8 Dia.
P-100	1- 3 MMF	4- 9 MMF	10- 20 MMF	—	—	—
NPO	2- 12	13- 27	28- 47	48- 62 MMF	63-100 MMF	101-150
N- 33	2- 12	13- 27	28- 47	48- 62	63-100	101-150
N- 75	2- 15	16- 27	28- 56	57- 68	69-110	111-150
N- 150	2- 15	16- 30	31- 60	61- 75	76-140	141-150
N- 220	3- 15	16- 30	31- 75	76- 90	91-130	131-190
N- 330	3- 15	16- 30	31- 75	76-100	101-150	151-190
N- 470	3- 20	21- 40	41- 80	81-120	121-200	201-240
N- 750	5- 25	26- 56	57-150	151-180	181-300	301-350
N-1500	15- 50	51-100	101-200	201-250	251-330	331-560
N-2200	47- 75	76-120	121-200	201-275	276-470	471-560

Temperature coefficients up to N-5200 available on special order.

SPECIFICATIONS

POWER FACTOR: Over 10 MMF less than .1% at 1 megacycle. Under 10 MMF less than .2% at 1 megacycle.

WORKING VOLTAGE: 1000 V.D.C.

TEST VOLTAGE (FLASH): 1750 V.D.C.

CODING: Capacity, tolerance and TC stamped on disc

INSULATION: Durez phenolic-vacuum waxed

INITIAL LEAKAGE RESISTANCE: Guaranteed higher than 7500 megohms

AFTER HUMIDITY LEAKAGE RESISTANCE: Guaranteed higher than 1000 megohms

LEADS: No. 22 tinned copper (.026 dia.)

TOLERANCES: ±5% ±10% ±20%

The capacity of these condensers will not change under voltage.

These capacitors conform to the RTMA specification for Class 1 ceramic condensers.

RMC Type C temperature compensating DISCAPS are universally recognized as the ideal money-saving replacement for tubular ceramic and mica capacitors. Rated capacities will not change under voltage. Smaller size permits compact circuit designs. Greater mechanical strength assures rugged assemblies and lower costs in production line operations. Rated at 1000 working volts, Type C DISCAPS are available for a wide range of applications and cost no more than ordinary 600 volt capacitors.

Whatever your ceramic capacitor problem, standard or specialized, RMC engineers are prepared to solve it for you. Take advantage of a wealth of experience by writing today.

DISCAP
CERAMIC
CAPACITORS



RADIO MATERIALS CORPORATION

GENERAL OFFICE: 3325 N. California Ave., Chicago 18, Ill.

FACTORIES AT CHICAGO, ILL. AND ATTICA, IND.

DISTRIBUTORS: Contact Jobbers Sales Co., P. O. Box 695, Fairlaw, N. J.

Books
Bulletins
Coming

TELE-TECH
President:
of Bristol,
ada: \$8.00
Printed in

* Reg. U.

TELE-TECH &

TELE-TECH

& Electronic Industries

AUGUST, 1954

FRONT COVER: GOLDEN WEST COAST—This is the time of the year when the eyes of the electronic industries are focused on the Pacific Coast states with special interest, for it's time for WESCON 1954. The amazing growth of the annual Western Electronic Show and Convention to be held Aug. 25-27 in Los Angeles is representative of the rapid development of the region's electronic industries. See pages 61, 64 and 65. The complete Directory of West Coast Manufacturers is presented in Section Two of this issue. The Directory of West Coast Reps and Distributors is on page 106.

SECTION ONE:

Totals: TV Set Density by States; British Radio Exports	3
As We Go To Press	13
Look To The West	61
Off Dead Center	61
Only the Beginning	61
Radarscope: What's Ahead for the Electronic Industries	62
West Coast Societies	E. P. Gertsch 64
WESCON 1954	65
Techniques for Electronic Brain Mapping	A. R. Tunturi 66
"Stacked Tubes" in Production	69
Equipment for Testing Elliptically Polarized Antennas	Carrol W. Bradford 70
How West Coast Firm Meets Labor Shortage	72
Plant Noise Surveillance	John K. Hilliard 73
New Carrier System Links All Transmission Media	W. S. Chaskin 74
Locked Oscillators for Test Equipment	Leonard S. Cutler 77
Surface-Barrier Transistor Measurements and Applications	Roland J. Turner 78
Grids for Single-Gun Color Tubes	81
Cues for Broadcasters	82
Advance Work in Electron Tube Reliability	Harold E. Sorg 84
New Antenna Coupler for UHF Circuits	Robert I. Stainbrook 86
Timing System for Guided Missiles	89
New Military Field Radio	89
Determining Capacitor Leakage Resistance and Dielectric Soak ...	Ed Molloy 90
DYSEAC—New Electronic Computer	91
New 7-11 KMC Signal Generator Yields Valuable Design Data ..	Arthur Fong 92
Magnetic Recording—State of the Art	Walter Selsted & Ross H. Snyder 94
An Analysis of Resistance-Terminated Networks	Louis Weinberg 96
West Coast Representatives and Distributors	106
CBS' "205" Color Tube	134

SECTION TWO: WEST COAST ELECTRONIC INDUSTRIES DIRECTORY

DEPARTMENTS

Books	54	Industry News	208	Personal	160
Bulletins	195	Letters	50	Tele Tips	38
Coming Events	16	New Equipment	99	Washington News Letter	104
		News of Manufacturers Reps	204		

TELE-TECH & ELECTRONIC INDUSTRIES*, Vol. 13, No. 8. Published monthly by Caldwell-Clements, Inc. M. Clements, President; M. H. Newton, Assistant to President; John J. Borghi, Vice President and Secretary; M. B. Clements, Treasurer. Acceptance under section 34.64 Postal Laws and Regulations authorized at Bristol, Conn., June 9, 1954. Additional acceptance at New York, N. Y. 75¢ a copy. Annual Subscription Rates: United States and possessions: \$7.00; Canada: \$8.00; All Other countries: \$10.00. Please give title, position and company connection when subscribing. Copyright by Caldwell-Clements, Inc., 1954. Printed in U.S.A.

CALDWELL-CLEMENTS, Inc.

* Reg. U. S. Pat. Off.

Publication Office, Bristol, Conn.

Editorial/Business Offices 480 Lexington Ave., New York 17, N. Y., Tel. Plaza 9-7880

In Filter Networks & Toroids Your Specialist is "Burnell"

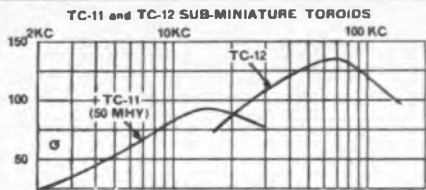

TC-11 Most useful frequency range lies between 2KC and 25KC. Maximum available inductance 1 HY for lower end of frequency range.

TC-12 Most useful range between 15KC and 150KC, maximum inductance 500 MHYS at the lower frequencies.

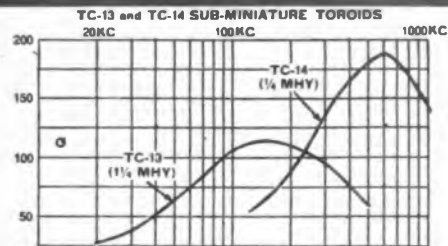

TC-13 Most useful frequency range between 40KC and 400KC. Available up to 100 MHYS with best optimum characteristics below 10 MHYS.

TC-14 Recommended for 200KC to 1 megacycle. This is best employed at inductances less than 1MHY.

MINIATURE TELEMETERING FILTERS

In view of the large number of filters that are employed in telemetering equipment, the size of the filters is a major contributing factor to the size of the equipment. As the approximate volume of a set of twenty standard telemetering band pass filters is 1500 cubic inches, even for ground based equipment this bulk can be objectionable. This is particularly true of mobile station. Our cognizance of this led to the development of a series of miniaturized filters that necessitates practically no sacrifice of desired attenuation characteristics.

The tremendous advantage of these new filters can be seen from the fact that a set of the same twenty filters would have a volume of less than 300 cubic inches representing a reduction by volume of 80%. Every telemetering filter now being supplied in the standard case is also available in the new miniaturized version.

INTERSTAGE FILTERS

These are economical band pass filters designed to operate either from a triode plate or cathode follower to the grid of a tube. A voltage gain of ten or more can be provided depending upon the desired band width. Range of center frequencies available lies between 60 cycles and 50,000 cycles.

Base dimensions: 1-3/16 x 1-11/16

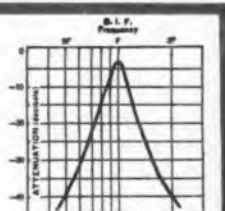

WE ARE PROUD OF OUR RECORD AS A MOST PROGRESSIVE FIRM IN THE ENGINEERING AND MANUFACTURING OF FILTER NETWORKS AND RELATED COMPONENTS. ENGINEERS AND ENGINEERING BUYERS AUTOMATICALLY THINK OF "BURNELL" IN RELATION TO FILTER DESIGN PROBLEMS AS WELL AS PRODUCTION REQUIREMENTS FOR FILTERS OR TOROIDS.

TO ACHIEVE THIS ENVIABLE POSITION WE CONSTANTLY STRIVE FOR THE DEVELOPMENT OF NEW AND BETTER PRODUCTS THAT WOULD BEST SERVICE OUR CUSTOMER'S NEEDS.

SINGLE SIDE BAND FILTERS

Shortly after these side band filters were introduced to the communications industry by Burnell & Company, a new interest in side band reception arose. Although other types of side band filters have been manufactured for some time, their use was limited because of extremely high cost, limited availability, and excessive volume. In attempting to overcome all of these disadvantages, our engineering staff concentrated on the development of a set of filters which would employ high quality toroids instead of crystal elements previously employed in such filters. As the effectiveness of a side band filter depends primarily upon how close the cut off frequency can be placed to the carrier frequency (and still provide sufficient attenuation) it was necessary first to determine the optimum carrier frequency at which the high Q of the toroids could permit a sharp enough rate of cut off and high enough attenuation to the opposite side band. It was for this reason that a choice of the 25kc carrier was made.

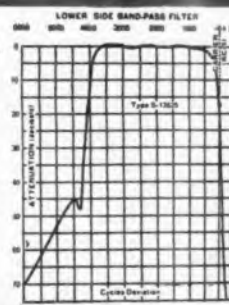

R. F. BAND PASS FILTERS

Until quite recently toroidal band pass filters were not too practicable at frequencies beyond the I. F. range. However, since developing toroids with much higher Q at radio frequencies than hitherto obtainable, we have extended the range of our filters to as high as two and three megacycles. A number of these attenuation filters have been able to replace types formerly employing expensive crystal elements. An additional important factor is the great reduction in size over R. F. filters, usually constructed with air core or "iron slug" coils.

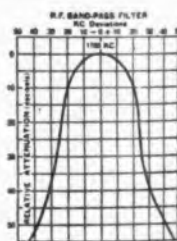

Write for new and enlarged 16 page catalog 102A



Exclusive Manufacturers of Communications Network Components

2 For product information, use inquiry card on last page.

Facts a



Broadc

Stations on Air

Under Construction (CP)

Applications Pending

Statistic In

A new v and operat munication Communic. cently been Available t uments W copy), the

Several Dept. v

STATE
Alabama
Arizona
Arkansas
California
Colorado

Connecticut
Delaware
District of Col
Florida
Georgia

Idaho
Illinois
Indiana
Iowa
Kansas

Kentucky
Louisiana
Maine
Maryland
Massachusetts

Michigan
Minnesota
Mississippi
Missouri
Montana

TELE-TECH &

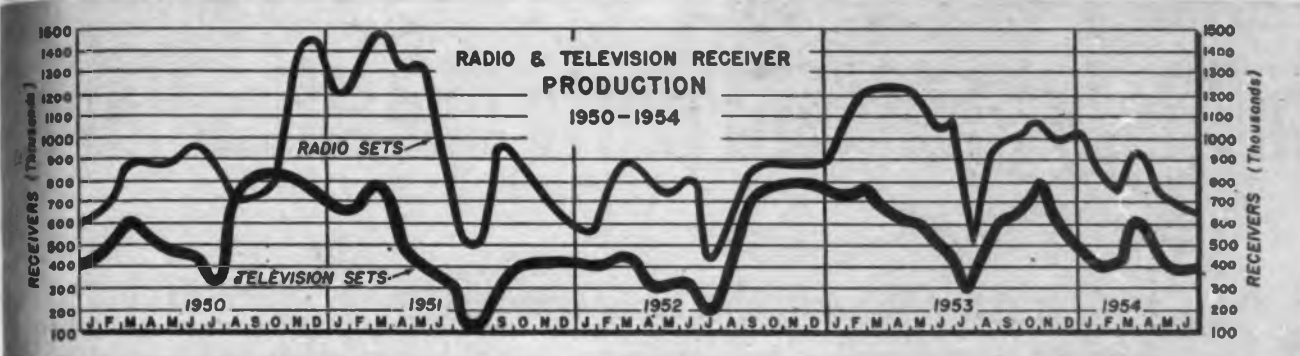

Broadcast Stations in U.S.

	AM	FM	TV
Stations on Air	2533	532	265
Under Construction (CPS)	137	59	78
Applications Pending	182	10	187

VHF } Comm'l.
 125 UHF }
 7 UHF Educ.
 VHF } Comm'l.
 114 UHF }
 24 UHF Educ.
 VHF } Comm'l.
 26 UHF }
 18 UHF Educ.

following three principal parts: (a) General Tables—Telephone and Telegraph, (b) Telephone Carriers, (c) Domestic and International Telegraph Carriers. The financial and operating data is complete for the year 1952.

Electronic Industries Safer!

The following figures from the National Safety Council are based on the number of disabling injuries per 1,000,000 man-hours:

Industry	Rate	% change from 1952
Communications	1.22	-10
Electrical Equipment	2.88	-15
Automobile	3.39	-6
Aircraft Manufacturing	3.58	-15
Cement	3.81	-18
Steel	3.90	-4
Tobacco	4.37	-13
Chemical	4.53	-11
Rubber	4.61	-23
Shipbuilding	5.33	+1
Textile	5.51	-14
Misc. Manufacturing	6.26	+3
Storage & Warehousing	6.45	-1
Printing & Publishing	6.54	-20
Railroad Equipment	6.77	+6
Machinery	6.92	-19
Glass	6.96	-9
Sheet Metal	7.07	+9
ALL INDUSTRIES	7.44	-11

Statistics of Communications Industry in U.S.

A new volume containing financial and operating data relating to communication carriers subject to the Communications Act of 1934 has recently been completed at the FCC. Available through the Supt. of Documents Wash., D.C. (50 cents per copy), the book is divided into the

British Radio Exports

Figures below have been made available in connection with the forthcoming British National Radio Show (Aug. 24-Sept. 4, 1954) at Earls Court, London, and show how the value of radio exports have grown during postwar years

Year	Value (Pounds)
1946	7,700,000
1947	10,250,000
1948	12,000,000
1949	12,000,000
1950	17,800,000
1951	22,200,000
1952	24,500,000
1953	25,800,000

TELEVISION OWNERSHIP BY STATE

Several readers have requested TV set density figures. The compilation below has been made available through the CBS Television Research Dept. whose survey was completed Nov. 1, 1953. By the end of 1954 the number of receivers in use is estimated to be 31,500,000.

STATE	TOTAL FAMILIES	TV FAMILIES	%	STATE	TOTAL FAMILIES	TV FAMILIES	%
Alabama	824,700	280,470	34%	Nebraska	427,300	177,410	42%
Arizona	253,100	107,570	43	Nevada	60,600	11,930	20
Arkansas	535,500	102,020	19	New Hampshire	162,600	84,690	52
California	4,029,500	2,809,640	70	New Jersey	1,568,100	1,374,790	88
Colorado	456,100	196,790	43	New Mexico	202,000	43,770	22
Connecticut	630,300	479,210	76	New York	4,800,100	3,712,620	77
Delaware	101,600	75,110	74	North Carolina	1,056,400	395,960	37
District of Columbia	246,900	197,710	80	North Dakota	161,200	13,320	8
Florida	968,800	337,350	35	Ohio	2,517,800	1,957,490	78
Georgia	955,500	389,720	41	Oklahoma	692,300	312,040	45
Idaho	180,100	24,820	14	Oregon	546,500	132,320	24
Illinois	2,828,700	1,862,390	66	Pennsylvania	3,102,200	2,276,640	73
Indiana	1,294,700	799,700	62	Rhode Island	243,800	217,720	89
Iowa	826,700	399,770	48	South Carolina	554,600	194,410	35
Kansas	662,400	212,600	32	South Dakota	189,000	17,890	9
Kentucky	830,100	354,110	43	Tennessee	915,900	381,190	42
Louisiana	790,100	278,770	35	Texas	2,412,800	1,068,520	44
Maine	260,000	67,970	26	Utah	207,600	120,320	58
Maryland	732,600	588,650	80	Vermont	108,500	25,930	24
Massachusetts	1,424,300	1,109,610	78	Virginia	919,100	510,970	56
Michigan	2,023,500	1,417,930	70	Washington	828,800	387,060	47
Minnesota	900,000	437,020	49	West Virginia	529,600	229,320	43
Mississippi	587,400	119,370	20	Wisconsin	1,045,000	518,880	50
Missouri	1,306,300	677,160	52	Wyoming	93,100	6,750	7
Montana	197,700	9,100	5	U. S. TOTAL	47,191,500	27,506,500	58

First 5KW engine-generator set built to military standard parts specifications!

the new **ONAN**
5VB-4M
5KW, A.C.



WINTERIZED MODEL

Equipped with engine heater and rugged sheet-metal housing to protect generating set against wind, rain and snow. Delivers full rated output at ambient temperatures from +125° to -65° F. Weight: 500 lbs.



Generator designed and listed in accordance with MIL-G-10228 (CE). Engine qualifies to MIL-E-11275A, 10 HP Class, on standardization of high mortality parts.

Built and tested for military service!

The Onan Model 5VB-4M meets all specified test requirements for Military Type II, Class A engine-generator sets. It's built to withstand braking and dropping shocks, to resist high humidity, to start at extreme temperatures and to operate at all angles up to 15° from horizontal.

After 1,000 hours of operation with full rated load, and under test conditions of 107° F. and 5,000-foot altitude, the Model 5VB delivers more than 150% of rated output at rated voltage, frequency and power factor.

The skid-mounted set has an actual dry weight of 445 pounds and requires 25% less space than many conventional units. Design of the suction air-cooling system allows the generator set to be "buried" within a large piece of equipment in space only slightly larger than actual generator-set dimensions.

Prime mover on the 5VB is a new Onan high-compression, overhead-valve, two-cylinder, V-type gasoline engine delivering 19 H.P. (with accessories) at 3600 R.P.M. It is equipped for manual starting using integral, self-winding rope starter. Electric starting can also be provided.

Designed specially for field service as a source of power for communications, lighting and operating motor-driven equipment, the Onan 5VB combines the portability, rugged construction and dependable performance demanded in military service, with the all-important advantage of being built with military standard parts.

GENERATOR DESIGNED TO MIL-G-10228 (CE)

Specially designed direct-connected generator supplies multiple voltages (1 and 3-Phase) with voltage regulation within a total band width of 4%. A single rotary switch selects the required voltage and phase. Rated at 5KW with 60-cycle output, this model is also available with D.C. output, up to 7½ KW in standard voltages.

Splash-proof generator is unusually accessible for inspection and adjustment. Equipped with all essential instruments conveniently located and protected from the weather.

OTHER ONAN GENERATING EQUIPMENT

Onan designs and builds engine and motor-generator sets including 400-cycle models for specialized electronic applications in military aircraft, communications, and commercial use. Onan Electric Plants in regular production range from 400 to 55,000 watts in all standard voltages . . . gas, gasoline and Diesel-driven models.

Write for complete specifications

(The Onan VB engine is also available separately as a prime mover in the military Class II, 10 H.P. basic size.)



D. W. ONAN & SONS INC.

7890 UNIVERSITY AVENUE SOUTHEAST • MINNEAPOLIS 14, MINNESOTA

Famous Kings in History

FERDINAND V, 1452-1516, was the Spanish King of Castile and Leon. As Ferdinand II he was also King of Aragon. His policies, though severe, founded Spain's imperial greatness. He married Isabella of Castile. King Ferdinand is best-known to Americans because he and the Queen aided Christopher Columbus in his famed voyages of discovery.



In the field of electronics, industries all over America have discovered that they can always depend upon Kings Connectors for both standard and special applications. Because of the highest standards of manufacture, plus long experience, the Kings organization can meet your own specific connector requirements, whatever they may be. You'll be glad you called on Kings first.



FAMOUS KINGS CONNECTORS

BNC SERIES



KINGS *Electronics* CO., INC.
40 MARBLEDALE ROAD, TUCKAHOE 7, N. Y.

Does your servo system
end up like this?



Of course, you've never bought an automobile in pieces, picking up a bumper here, a carburetor there, a clutch somewhere else. Even if you *could* arrive at the appearance and performance of a finished car, chances are it would require countless hours of work and a factory-full of fabricating equipment to integrate the odd sized parts.

Surprising, then, how many companies build servo systems just this way. Buying parts from different manufacturers . . . putting them together and hoping for an ideal system. Either the final result is far below potential efficiency, or the time, labor, machinery, and materials wasted in trying to "fit" the components together boosts the cost astronomically.

Experience proves that complete assemblies of Transicoil components not only assure improved system performance but actually cost less than the total purchase price of the individual components acquired from several sources.

If you are now purchasing servo components from several manufacturers, a serious talk with Transicoil will pay you dividends in lower costs and a better system. But if you require only one component, you can be sure of optimum performance from the Transicoil units you specify.

TRANSICOIL

CORPORATION 107 GRAND STREET
NEW YORK 13, N. Y.



Miniature
Control Motors



Motor and Gear
Train Assemblies

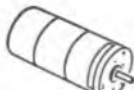

Motor, Generator, and
Gear Train
Combinations



Servo
Amplifiers



Plug-In
Assemblies

TELE-TECH & Electronic Industries

M. CLEMENTS *Publisher* DR. O. H. CALDWELL *Editorial Consultant*

BERNARD F. OSBAHR *Editor* ALBERT J. FORMAN *Associate Editor*

DR. A. F. MURRAY *Contributing Editor* JOHN H. BATTISON *Contributing Editor*

B. V. SPINETTA, *Directory Editor*
MARTHA USDIN, *Assistant Editor*
CARL THOMAS, *Assistant Editor*
R. C. DAVIES, *Washington News Editor*
CHARLES F. DREYER, *Art Director*
GAIL CARLSON, *Editorial Secretary*
Lt. Col. STANLEY GERSTIN, *Contributing Editor*

BUSINESS DEPARTMENT

M. H. NEWTON, *Business Manager*
HOWARD A. REED, *General Sales Manager*
PAUL J. CARNESE, *Sales Promotion Manager*
JOSEPH DRUCKER, *District Manager*
JAMES S. COLEMAN, *Asst. Sales Manager*
N. McALLISTER, *Asst. Business Manager*
CECILIA KAVANAUGH, *Adv. Records*
A. SHILLIN, *Production Manager*
480 Lexington Ave., New York 17, N. Y.
Telephone PLaza 9-7880

S. M. GASKINS, *Western Manager*
JOHN D. LUPTON, *District Manager*
201 N. Wells St., Chicago 6, Ill.
Telephone RAndolph 6-9225

CHRIS DUNKLE & ASSOCIATES
California Representatives
3257 W. 6th Street, Los Angeles 5, Calif.
Telephone DUmkirk 7-6149
1355 Market St., San Francisco 8, Calif.
Telephone KLondike 2-2311, Ext. 579

M. GROENING, *Asst. Circulation Manager*
JOHN J. BORCHI, *Controller*

CIRCULATION 21,000



TELE-TECH® & ELECTRONIC INDUSTRIES is edited for top-level engineers and executives throughout the electronic industries. It gives the busy engineering executive authoritative information and interpretation of the latest developments and new products, with emphasis on subjects of engineering import and timeliness. Special attention is given to:

MANUFACTURING

- Electronic equipment, communications, broadcasting, microwave relay, instrumentation, telemetering, computing.
- Military equipment including radar, sonar, guided missiles, fire controls.
- TV-FM-AM receivers, phonographs, recorders, reproducers.

OPERATION

- Fixed, mobile and airborne communications in commercial, municipal, aviation and government services.
- Broadcasting, video and audio recording, records, audio and sound systems, motion picture production.
- Military, civilian and scientific electronic computing and control systems.
- *Reg. U. S. Pat. Off.

THE ELECTRONIC INDUSTRIES DIRECTORY

Published annually as an integral
section of TELE-TECH in June



Variable Now Av

A new variable to a continuous-mum-to-m with 180° s matically s bility tun saturating nominal unlimited.

The mar 45 Warbur reports th Rotoroids lent to st the compa that two be placed month. T tions incl tors, vari servo sys networks, trochemic ing device

CBS An Color T

CBS m in the col the unve viewing, picture t nated th from the viewing a picture the conv Structu curved s

Charles F. demonstrate plate with glass funn

A C





As We Go To Press...



Variable Toroids Now Available

A new series of "Rotoroids"—variable toroidal inductors—provide a continuous three-to-one maximum-to-minimum inductance range with 180° shaft rotation. These hermetically sealed units are permeability tuned, and require no dc saturating current. The choice of nominal inductance is virtually unlimited.

The manufacturer, Burnell & Co., 45 Warburton Ave., Yonkers, N.Y., reports that the presently available Rotoroids are electrically equivalent to standard toroids made by the company. The firm also reveals that two miniature Rotoroids will be placed in production within a month. Typical Rotoroid applications include tunable audio oscillators, variable impedance devices, servo systems, variable phase shift networks, adjustable filters, electrochemical controls, and telemetering devices.

CBS Announces New Color TV Picture Tube

CBS made its bid for leadership in the color tube race recently with the unveiling of a 19-in. direct-viewing, all glass, color television picture tube. The new tube, designated the CBS-Colortron "205," from the square-in. area of its viewing surface, is said to provide a picture approaching the size of the conventional 21-in. b&w tube.

Structurally, the tube employs a curved shadow mask and tricolor

Charles F. Stromeyer, CBS-Hytron president, demonstrates new color TV tube. (l to r) face plate with phosphor dot screen, shadow mask, glass funnel, and three-beam electron gun



New Computation Center

The analog computation center opened recently near Princeton, N.J., by Electronic Associates Inc. meets the demand for a headquarters where members of industry can solve their problems in management operations control, dynamic systems analysis, applications engineering and simulation. The center provides a staff of scientists available for problem analysis as well as equipment, which may be rented on an hourly, weekly, or monthly basis for problem solution.

In announcing the opening, Lloyd F. Christianson, pres. of Electronic Associates Inc. pointed out that now, for the first time, computation facilities are available to the smaller companies unable to afford computers of their own.

For each problem, the Center assigns the necessary scientists, engineers or mathematicians experienced in the use and applications of analog computers. At the conclusion, a comprehensive report, with specific recommendations, is made.



Analog computation center opened by Electronic Associates provides facilities for small companies unable to afford computers of their own. Complete problem patch panels are preset and inserted

screen originated by CBS-Hytron, with a three-beam electron gun designed for electromagnetic convergence. More accurate convergence is said to result from electromagnetic as opposed to electrostatic means.

The additional screen area has been gained by positioning the three supports for the shadow mask above and below the desired screen area. The sides of the mask and screen are thus left free of interference.

The tricolor screen is printed directly on the face of the tube, eliminating "pincushioning," or bowing inward of the four sides of the picture.

Production plans are aimed at 10,000 tubes per month by late September.

See p. 134 for details.

RCA to Produce Ferrites

The Tube Div. of RCA has announced its first commercial ferrite cores. It will also custom produce ferrites to manufacturers' specs. Production at the Camden, N. J., plant will be supplemented by a new plant in Findlay, Ohio.

New G.E. Organizations

In line with the company's decentralization program, G. E. has announced the formation of two new organizations, a Meter Dept. and an Instrument Dept. Headquarters for the Meter Dept. will be in Somersworth, N. H. The Instrument Dept. will remain at Lynn, Mass.

MORE NEWS

on page 14



As We Go To Press . . . (Continued)

Air Force Flying Lab Detects Missiles

New electronic equipment capable of detecting and analyzing energy radiating from any missile in flight has been delivered to the Air Force by Servo Corp. of America.

The stratospheric lab employs a double monochromator which splits black light. System has advantage over radar because it can not be detected by enemy

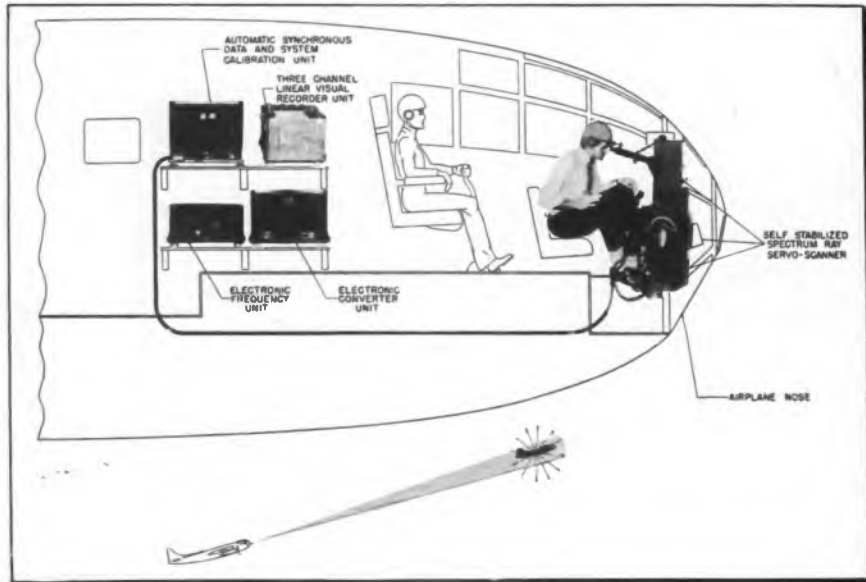

System for spotting enemy aircraft uses spectrum scanner to detect radiation

Four New TV Stations Join Bell Network

The Long Lines Dept. of A.T.&T. reports that WISH-TV, Indianapolis, Ind.; KCB-D-TV and KDUB-TV, Lubbock, Texas, and WDBO-TV, Orlando, Florida have been connected to the nationwide TV facilities of the Bell system.

With the addition of these four stations, network TV programs now reach 301 stations in 191 cities in the U.S.

RADIOACTIVE



Small lead chambers, shown here at El-Tronics, Inc., Phila., weigh 130 lbs. each, are used to transport radium. Keeping them presentable for repeated shipments is simplified by using Krylon

DuMont West Coast Depot

The Cathode-Ray Tube Div. of Allen B. DuMont Labs. plans to open new sales, service and warehouse facilities at 2545 S. Yates Ave., Los Angeles, effective Sept. 1. In the interim headquarters will be at 1235 E. Olympic Blvd., Los Angeles.

Remote Control Seen For High Power Stations

The National Association of Radio and Television Broadcasters will petition the FCC to extend remote control to high power and directional stations after sufficient data has been obtained, it was announced by A. Prose Walker, manager of engineering for the NARTB.

In citing the great economic merits, Walker pointed out that one station had realized savings in salary and overhead within 90 days after the installation of remote control. It was estimated that the equipment had paid for itself within seven months.

As to the reliability of remote control equipment, actual case histories of stations using such equipment showed that breakdowns were even less frequent than when the transmitters were attended.

Commenting on the practical limits of remote control, Walker fore-

saw remote operation of even the highest-powered broadcast transmitters within a short time. A plan for such operation is now being drawn up by the NARTB for submission to the FCC.

Transistorized Power Line Carrier Developed

A completely transistorized power line carrier is being tested on Potomac Edison's Marlowe-Frederick line by engineers of the Westinghouse Electric Corp. The operational tests started last year are expected to correlate field results with extensive laboratory tests already completed.

The equipment under test is designed for telegraphic functions, such as relaying and telemetering. The transmitter consists of a master oscillator, buffer amplifier, and output amplifier; the receiver has high-frequency amplifier, detector, and relay-operating stages. Both point-contact and junction transistors are used.

Dual-Purpose Portable

Raytheon Mfg. Co., Waltham, Mass. has announced a new portable radio, the GM 114A, which doubles as a marine direction finder to help boatsmen determine their positions at sea.



Fair mariner adjusts knob-shaped directional antenna to find direction of station

The "fix" is obtained by an adjustable, knob-like antenna which projects 2-in. above the case.

The radio covers the commercial broadcast band, the 1700-3400 kc "Marine" band, and the 200-415 kc "beacon" band. A cheaper 2-band model is also available.

MORE NEWS
on page 16





**COMPLETE GPL-WICKES COLOR TV SIGNAL GENERATING
AND TEST EQUIPMENT FOR:**

TELECASTING • RESEARCH • PRODUCTION • EDUCATIONAL

GPL now distributes color television operating and testing equipment designed and manufactured by Wickes Engineering and Construction Company, well known pioneers and specialists in this field.

The GPL-Wickes equipment is designed for strict adherence to the requirements of NTSC systems and for convenience in practical use. A careful program of quality control and final testing in the Wickes plant insures accuracy and reliability for research, testing, or on-the-air uses.

This equipment compliments the GPL line of monochrome television equipment which has become known for its advanced design and high standards of performance.

COLOR CONSULTATION SERVICE

GPL engineers will be glad to assist in determining your requirements. Color equipment is available in complete packages for station conversion or individual units to meet your requirements, with early delivery.

SPECIFICATIONS ON REQUEST: Write, wire or phone for specification sheets and prices.

General Precision Laboratory
INCORPORATED
PLEASANTVILLE NEW YORK

REGIONAL OFFICES: CHICAGO • ATLANTA • DALLAS • GLENDALE, CALIFORNIA

TELE-TECH & ELECTRONIC INDUSTRIES • August 1954

*The GPL-Wickes equipment available
for prompt delivery includes:*

INTERLACE SIGNAL GENERATOR
COLOR BAR GENERATORS
COLOR CODER
CONVERGENCE DOT GENERATOR
MULTI-BURST GENERATOR
AMPLITUDE LINEARITY TESTER
VIDEO DISTRIBUTION AMPLIFIERS
PULSE DISTRIBUTION AMPLIFIER
REGULATED POWER SUPPLYS
VECTOR DISPLAY EQUIPMENT
ENVELOPE DELAY TRACER
COLOR VIDEO MONITOR
PHASE CORRECTION NETWORKS
CROSSOVER FILTER



For product information, use inquiry card on last page. 15

As We Go to Press

Taping Gun Speeds Harness Wrapping

Electrical harness wrapping can be speeded up from 2 to 10 times, using plastic tape dispensed by a new taping gun marketed by Minnesota Mining and Mfg. Co., St. Paul, Minn.

Weighing less than 20 oz. the "Scotch" taping gun, model E-2, has



Tape gun speeds electrical harness wrapping

a capacity of 36-yds. in the circular magazine. A slender, curved tip serves as a needle to thread the tape around wires on a cable layout board or in spots difficult to reach.

New Gudeman Lab

The Gudeman Co. has opened new lab and production facilities at 9200 Exposition Blvd., Los Angeles 34, Calif., under the direction of Donald H. Allen, to produce pulse transformers and delay lines.

NEW COLOR YOKE



New magnetic deflection yoke for 19-in., 3-gun color TV tubes introduced by General Instrument's F. W. Sickles Div. is held by company's vice-president, Edgar Messing. High efficiency and close convergence are prime features

COMING EVENTS

Aug. 25-27—Western Electronic Show and Convention. Los Angeles and San Francisco IRE sections and WCEMA sponsored. (Show) Pan-Pacific Auditorium, Los Angeles. (Convention Hq.) Ambassador Hotel, Los Angeles, Calif.

Aug. 25-Sept. 4—National Radio Show, Earls Court, London. (Preview for overseas guests on Aug. 24)

September—First International Scientific Radio Union, Amsterdam, Holland.

Sept. 1-16—Golden Jubilee Meeting of the International Electrotechnical Commission, University of Pennsylvania, Philadelphia, Pa.

Sept. 5-9—International Frankfurt Fair, Frankfurt, Germany.

Sept. 13-24—International Instrument Congress and Exposition, Commercial Museum and Convention Hall, Philadelphia, Pa.

Sept. 15-17—IRE-MIT Symposium on the Information Theory, co-sponsored by the AIEE and URSI, Massachusetts Institute of Technology, Cambridge, Mass.

Sept. 15-21—ISA First International Instrument Exposition, Convention Hall, Philadelphia, Pa.

Sept. 16-18—Joint Electron Tube Engineering Council General Conference, Chalfont-Haddon Hall, Atlantic City, N. J.

Sept. 28-30—1954 National Packaging and Materials Handling Competition, sponsored by the Soc. of Industrial Packaging and Materials Handling Engineers. Chicago Coliseum, Chicago, Ill.

Sept. 30-Oct. 2—High Fidelity Show, International Sight and Sound Exposition, Inc., Palmer House, Chicago.

Oct. 4-6—Tenth Annual National Electronics Conference, Hotel Sherman, Chicago, Ill.

Oct. 11-15—AIEE Fall General Meeting, Morrison Hotel, Chicago, Ill.

Oct. 13-15—Joint Meeting of RTCM and IRE Professional Gp. on Communications Systems. Somerset Hotel, Boston, Mass.

Oct. 13-17—1954 Annual Convention, Audio Engineering Society. Hotel New Yorker, N. Y.

Oct. 18-20—RETMA Radio Fall Meeting, Hotel Syracuse, Syracuse, N. Y.

Oct. 18-22—42nd National Safety Congress and Exposition, Conrad Hilton, Congress, Morrison and La Salle Hotels, Chicago, Ill.

Oct. 21-23—8th New England Conference of the American Soc. for Quality Control. Ten Eyck Hotel, Albany, N. Y.

Oct. 26-28—2nd National Conference on Tube Techniques, sponsored by the Working Group on Tube Techniques of the Dept. of Defense. Western Union Auditorium, 60 Hudson St., N. Y. C.

Oct. 27-30—30th National Convention of the National Assoc of Education Broadcasters. Hotel Biltmore, New York.

Nov. 4-5—East Coast Conference on Airborne and Navigational Electronics, sponsored by the Baltimore section of IRE and IRE Professional Group on Aeronautical and Navigational Electronics. Sheraton-Belvedere Hotel, Baltimore, Md.

Nov. 10-11—AIEE Conference on Electronic Instrumentation and Nuclear Electronics in Medicine, Morrison Hotel, Chicago, Ill.

Nov. 10-12—18th Annual Time and Motion Study and Management Clinic, sponsored by the Industrial Management Society. Sherman Hotel, Chicago, Ill.

Nov. 12-13—National Symposium on Quality Control Methods in Electronics, sponsored by the Professional Group on Quality Control of IRE and Electronic Technical Comm. of the American Soc. for Quality Control. Hotel Statler, New York.

Nov. 18-19—6th Annual Electronics Conference, sponsored by the Kansas City Section of IRE, Hotel President, Kansas City, Mo.

Nov. 21-22—Automatic Control Equipment Exhibition. Waldorf-Astoria Hotel, N. Y. C.

Nov. 29-Dec. 4—First International Automation Exposition, 242nd Coast Artillery Armory, New York, N. Y.

Dec. 8-10—4th Annual Eastern Joint Computer Conference and Exhibition, jointly sponsored by the AIEE, IRE, and ACM. Bellevue-Stratford Hotel, Phila. Pa.

ACM: Assoc. for Computing Machines.
AES: Audio Engineering Society.
AIEE: American Institute of Electrical Engineers.
IRE: Institute of Radio Engineers.
ISA: Instrument Society of America.
NACE: National Assoc. Corrosion Engineers.
NARTB: National Assoc. of Radio and TV Broadcasters.
RETMA: Radio-Electronics-TV Manufacturers Assoc.
RTCM: Radio Technical Commission for Marine Services
URSI: International Scientific Radio Union
WCEMA: West Coast Electronics Manufacturer's Association
WESCON: Western Electronics Show & Convention.

Nameplate Firm Opens California Office

E. T. Turney, Jr., President of North Shore Nameplate Co., Bay-side, N. Y., has announced the establishment of the West Coast Nameplate Co., 418 W. Los Feliz Rd., Glendale 4, Calif., under the direction of C. V. Wilgus.

New West Coast Firm

Electro-Instruments, Box S, Old San Diego Sta., San Diego 10, Calif., has been formed, reports President Jonathan Edwards. Plant at 3796 Rosecrans will make digital voltmeters and data processors.

**MORE NEWS
on page 32**



Check
this
list of
**TRANSISTOR
APPLICATIONS**
already
in
hand
at...

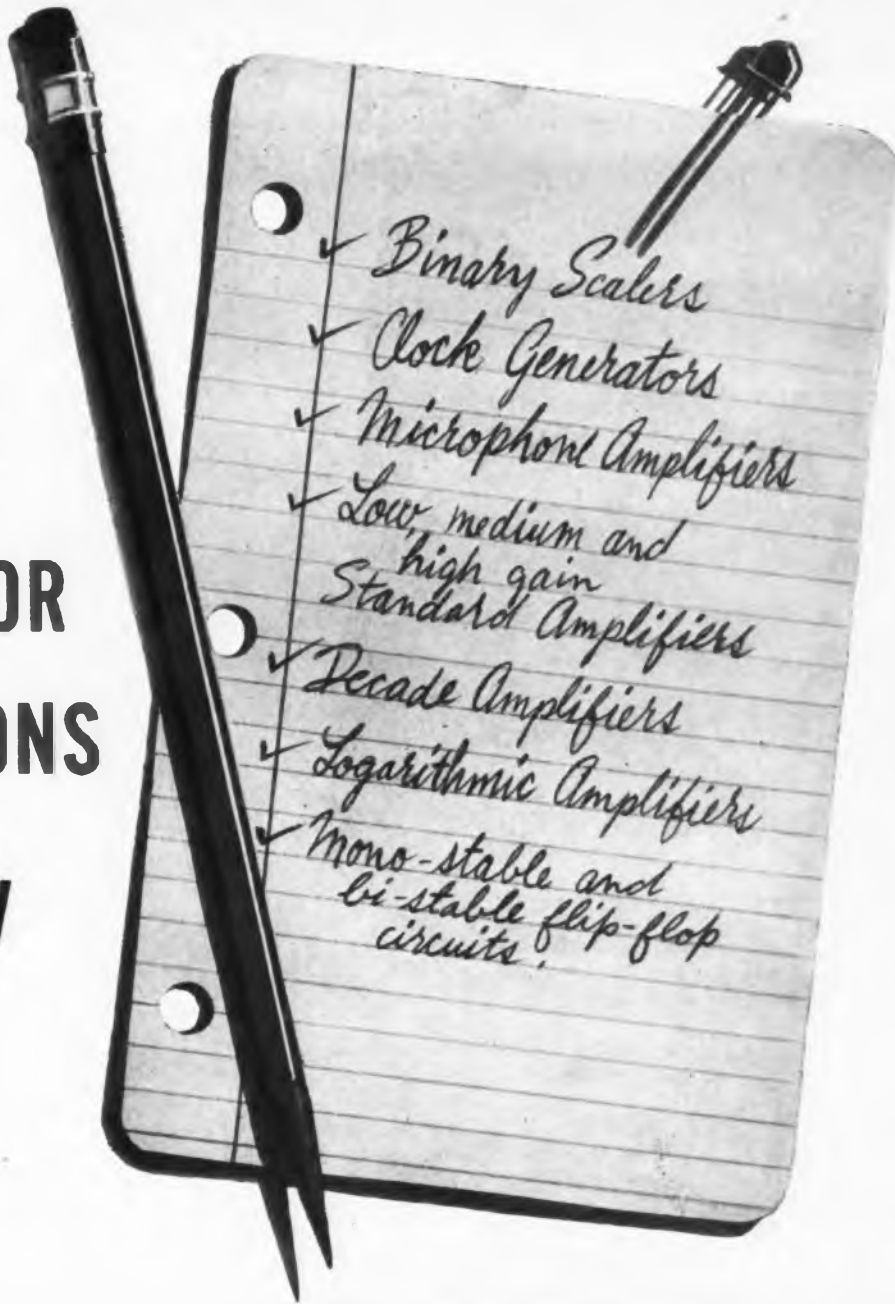

Is there an application here that is significant to your operation or product design? If so, our Transistor Application Engineers are ready to confer with you.

Hydro-Aire is manufacturing point-contact and junction Transistors to the very high standards of quality control for which all Hydro-Aire products have become famous. In addition, it is an essential part of the program to explore with energy and imagination the ever-widening field of new uses constantly opening up for Transistors. This is why it is in your interests to keep in touch with us, so that you will benefit from our work both in current applications and applications that will be developing in the coming months.

PLEASE WRITE ON YOUR COMPANY LETTERHEAD:



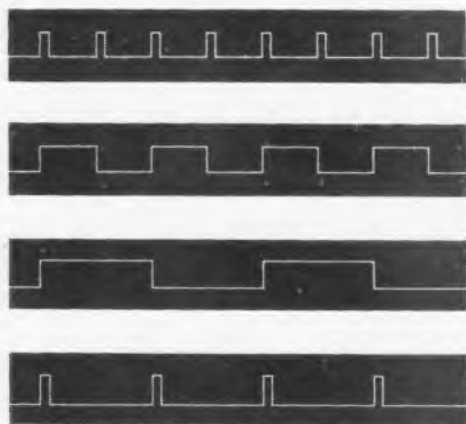

Burroughs
PULSE equipment
 lets you assemble
 your own system—
IN MINUTES

Just by connecting standard cables between Burroughs Pulse Control units, you can assemble virtually any pulse system you want.

Suppose you need a complex pulse sequence for testing. The basic units required to make up the system can be ordered from Burroughs—and delivered from stock. Connect them together, and there's your system. You've saved time-consuming "breadboard" engineering, equipment cost, and delay on your primary project. What's more, your Burroughs Pulse Equipment can be used over and over again on different, future projects.

To meet the growing need for

versatile pulse control systems, Burroughs offers a whole family of matched pulse handling units: pulse generators, coincidence detectors, flip-flops, gating circuits, etc. During the past four years, this equipment has been in use by such prominent organizations as MIT, Consolidated Engineering Corp., Wayne University, Stanford Research Institute, and many others.

Let us help you get started quicker on pending engineering work. Write us a letter outlining briefly your pulse system requirements. Dept. 2-H, Electronic Instruments Division, Burroughs Corp., 1209 Vine St., Philadelphia 7, Pa.



ELECTRONIC INSTRUMENTS DIVISION
Burroughs
 FIRST IN PULSE HANDLING EQUIPMENT

As We Go to Press . . .
**Electronic Thermometer
 For Clinical Use**

The Surgeon General's Office in Washington, D. C., has announced an electronic thermometer for clinical use manufactured by the Burlington Instrument Co., Burlington, Iowa. This new instrument is intended to replace the familiar glass stem mercury filled thermometer in use for the last 86 years.

The "Swiftem" thermometer consists of three parts. First is a small



Electronic thermometer takes reading in 3 to 5 seconds. Unit employs thermistor in tip

tapered stainless steel tube which is applied to the patient just as if it were the conventional glass thermometer. In place of a mercury filled tip as in the glass thermometer, the stainless steel tube has in its tip a very small piece of material—whose electrical resistance changes rapidly with changes in temperature. This stainless steel tube called a probe is plugged into a miniature socket such as is used in hearing aids. A thin, flexible electrical cord is the second important element and the third is the indicating instrument itself, to which the electrical cord is connected. The instrument is housed in a molded plastic case and is about the size of a photographic exposure meter. The instrument is calibrated in degrees Fahrenheit the same as the glass thermometer.

The remarkable speed of 3 to 5 seconds to obtain a reading with the Swiftem coupled with high accuracy contrasts sharply with the minimum of three minutes required with a mercury thermometer and less accuracy. To the busy physician this means he can save from 30 to 90 minutes a day.



HOW TO WIN THE SERIES

You can't play baseball with recording discs . . . nor, do baseballs provide an adequate surface for recording.

On the other hand, a cheap, poorly balanced baseball is useless in a professional game. And, a second rate, unevenly coated recording disc can spell doom for any professional recording job.

In recording, the risk is removed when you choose PRESTO. For here is a disc made with the same care and perfection that go into the world's finest recording equipment. Produced in the world's most modern disc manufacturing plant, PRESTO Green, White, Orange and Brown label discs are outstanding in quality, unbeatable in performance.

Whether you're recording one program, or an entire series, you're always on the winning side with PRESTO discs.

 **PRESTO** RECORDING CORPORATION
PARAMUS, NEW JERSEY

Export Division: 25 Warren Street, New York 7, N. Y.
Canadian Division: Walter P. Downs, Dominion Square Bldg., Montreal

WORLD'S LARGEST MANUFACTURER OF PRECISION RECORDING EQUIPMENT AND DISCS



**Precision
WHEATSTONE
BRIDGES**

**Highest Accuracy... Minimum Size
for Field, Lab, and Production Use**

There's a Shallcross Bridge for measuring resistance to any desired precision—indoors or out. Field models have aluminum cases with controls easily adjustable even with a gloved hand. Models for lab, production, and school use feature high readability and simple operation—even for unskilled users.

Accuracy, Stability, and Ruggedness—unsurpassed in any instrument of comparable price.

Selections from the complete Shallcross line are described below. Additional specifications on these, and many other types, are available from SHALLCROSS MFG. CO., 518 Pusey Ave., Collingdale, Pa.

**Deliveries
from
Stock**

WHEATSTONE—FAULT LOCATION BRIDGE No. 6100: 5-dial field model. Locates grounds, crosses, opens, and shorts by Murray, Varley, Hilborn, or Fisher Loop and Capacitance tests. Range: 1 to 1,011,000 ohms. Accuracy: $\pm 0.1\%$, $+ 0.01$ ohm. $8\frac{7}{8}'' \times 7\frac{3}{8}'' \times 5\frac{3}{4}''$. 8 lbs. Price: \$175.

KELVIN-WHEATSTONE BRIDGE No. 638-R: Shallcross has pioneered this compact combination of two bridges in one. Range: 0.001 to 11,110,000 ohms. Accuracy: $\pm 0.3\%$ - 1 to 111,100 ohms. $12\frac{1}{2}'' \times 10\frac{1}{2}'' \times 6\frac{3}{4}''$. 9 lbs. Price: \$260.

WHEATSTONE-LIMIT BRIDGE No. 6320: Combines 5-dial Wheatstone and Percent-Limit features. Range: 0.1 to 111,110,000 ohms. Accuracy—Ratio resistors: $\pm .01\%$, Rheostat: $\pm (.01\%$ to $.05\% + .005$ ohms). $15\frac{3}{4}'' \times 9\frac{1}{4}'' \times 5\frac{1}{2}''$. 15 lbs. Price: \$700.

Shallcross

TELE-TIPS

SEPTEMBER is "Sight-Saving Month," and the Society for the Prevention of Blindness grimly reminds us that 27,000 more Americans will become blind this year—half of them needlessly. Although we're a month ahead of schedule, it may not be too early to write to the society at 1790 Broadway, New York 19, N.Y. for their folder, "Your Wonderful Eyes."

COMMERCIAL TV has been approved by the British House of Commons, and is expected to be on the air next year. The Labor Party opposition warns that if it is returned to office it may modify or abandon the whole project.

SCHOOL CHILDREN watch TV about 20 hours per week, but 81% of them report that video programs do not interfere with their homework, according to a report, "Television and Youth," prepared by Prof. T. C. Battin of the Univ. of Florida, and made available by NARTB.

HUMIDITY may be measured quickly and accurately by means of a new hygrometer developed by Arthur D. Little, Inc., for the Signal Corps. It consists of a polystyrene strip coated with carbon powder in a water-sensitive binder. The binder absorbs water when air is moist, forcing the carbon particles apart and causing a greater measured resistance. Time lag is less than a second.

LIGHTING terminology used in TV studios is being standardized in a new glossary under preparation by the SMPTE. Equipment and instrumentation are next on the standardization list. Station participation in this program is being solicited by H. M. Gurin, TV Studio Lighting Committee, SMPTE, 55 W. 42 St., New York 36, N.Y.

"JIGGERS, THE BOSS" light in a new intercom system made by the DuKane Corp. insures employee privacy. It is integrated with an "executive priority" device which permits the top man to over-ride or
(Continued on page 44)

CHATHAM advance-designed yesterday

- in
industry-wide
use today!

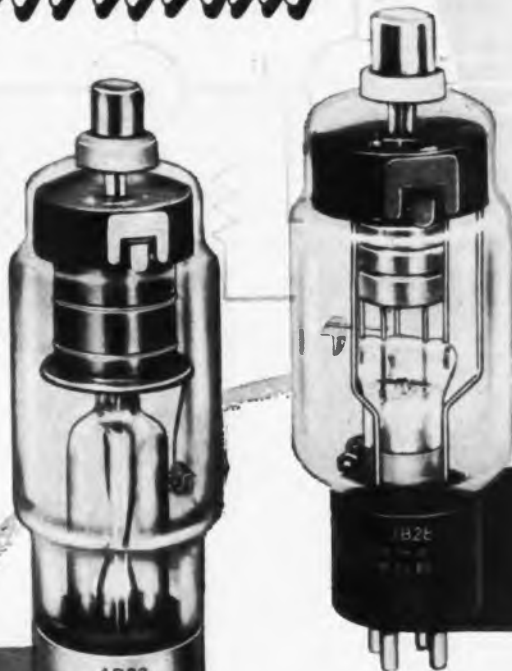

AMPLIFIERS • REGULATORS • INERT GAS
AND MERCURY RECTIFIERS • MERCURY,
INERT GAS AND HYDROGEN THYRATRON

CHATHAM SPECIAL-PURPOSE TUBES

● 3B28 RECTIFIER

Rugged half-wave Xenon filled rectifier. Operates in any position. Ambient temperature range -75° to $+90^{\circ}$ C. Inverse peak anode voltage 10,000, average current .25 amp. Filament 2.5v., 5 amp.

● 4B32 RECTIFIER

Ruggedly built, half-wave Xenon filled rectifier. Ambient temperature range -75° to $+90^{\circ}$ C. Inverse peak anode voltage 10,000, average anode current 1.25 amp. Filament 5v., 7.5 amp.

● VC-1258 MINIATURE HYDROGEN THYRATRON

for pulse generation. Handles 10 kw peak pulse power.

● 6336 TWIN TRIODE

for voltage regulation. Features high plate dissipation, hard glass envelope.

● 6394 TWIN TRIODE

Similar to 6336 except 26.5 volt heater instead of 6.3 volt heater.

● 5594 XENON THYRATRON

Operates over wide ambient temperature range -55° C to $+90^{\circ}$ C.



6336



5594



VC-1258



6394

STANDARD TYPES DIRECT FROM STOCK
PLUS SPECIAL DESIGNS BUILT TO REQUIREMENTS

Chatham specializes in the development of general and special purpose tubes for both electronic and industrial applications. Many of the tubes originally developed by Chatham to fill a specialized need, now number among the most widely used tubes in the industry. For complete information on Chatham tubes—either stock items or types built to your requirements—call or write today.



CHATHAM ELECTRONICS CORP.

Executive and General Offices: LIVINGSTON, NEW JERSEY
Plants and Laboratories: NEWARK and LIVINGSTON, NEW JERSEY

newest aids to

AUTOMATION!

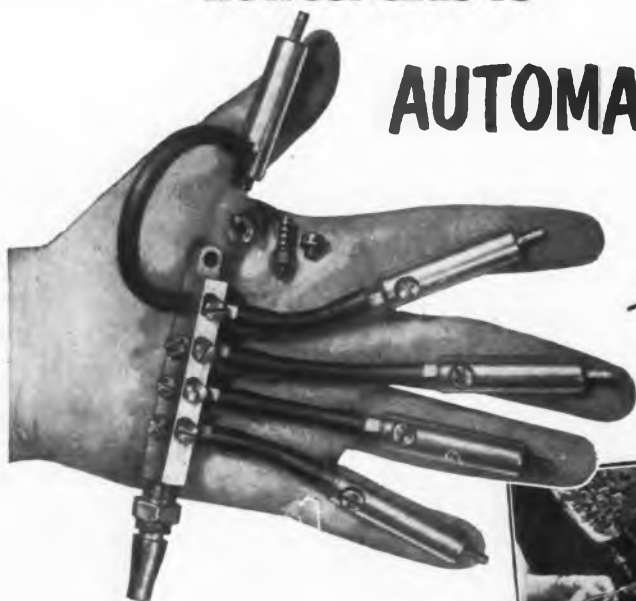

Here are three unusual "helping hands" which will enable you to reduce many of your present production and control operations to push-button simplicity. Because of their versatility, they will fire your imagination—suggest challenging new ways to manufacture better products faster, at lower cost.

Clippard Miniature Pneumatic Cylinders, for example, are so small they can be jig mounted on $\frac{1}{16}$ " centers, making them ideal for activating electrical contacts, valves or small work holding or feeding fixtures. In test operations (see jig illustration at right) they actually give an operator extra hands to work with thru use of a foot pedal air valve.

If your manufacturing process involves the testing, sorting, grading or matching of resistors, the Clippard P. R. 5 Automatic Resistance Comparator will pay for itself very quickly, permitting you to compare unknown resistors with a standard resistor simply by touching them across two terminals. Work can be handled either by unskilled operator or automatic production set-up.

The Clippard P. C. 4 Automatic Capacitance Comparator is a companion instrument permitting you to accurately check, grade, sort or match up to 8000 condensers of any type (10 mmfd to 1000 mfd) in one day. Either unskilled labor or automatic set-ups can be used.

Write for catalogue sheets describing these versatile new "helping hands" to automation, and literature showing how others are using them to produce higher quality products at lower cost, today!

Clippard

INSTRUMENT LABORATORY, INC.

7390 Colerain Road, Cincinnati 24, Ohio

MANUFACTURERS OF R.F. COILS AND ELECTRONIC EQUIPMENT



Clippard **MINIATURE PNEUMATIC CYLINDERS** (No. MAC 38), are shown above in a typical test jig set-up activating electrical contacts. Size of cylinders overall is $2\frac{1}{4}$ " x $\frac{1}{8}$ " dia., stroke $\frac{3}{8}$ " maximum, spring return piston. Operates on as little as 12 pounds air pressure.



P. R. 5 AUTOMATIC RESISTANCE COMPARATOR permits unskilled operator or automatic set-up to test, grade, sort or match as many resistors a minute as can be touched across two front terminals. Range 100 ohms to 100 megohms. Three scales of deviation from your standard: -5% to +5%, -25% to +30% or -50% to +100%.



P. C. 4 AUTOMATIC CAPACITANCE COMPARATOR grades, sorts, checks or matches all types of condensers (10 mmfd to 1000 mfd) at production speeds with laboratory accuracy. Requires no accessories other than the standard capacitor against which unknowns are to be compared.

TELE-TIPS

(Continued from page 38)

suspend busy connections at his discretion. The system is reportedly eavesdrop-proof, and the signal light indicates when the boss has used his priority key. The designers consider the light something of an electronic substitute for the old-fashioned office boy who, in a more unhurried era, could be relied upon for a *sotto voce*, "Jiggers, the Boss!"

"**THE 'FREEZE'** reserved to two networks the almost exclusive right to broadcast in all but 12 of the 63 markets which had television service. It meant that the two other networks did not have and have not had since the fall of 1948 more than a ghost of an opportunity . . ."—Dr. Allen B. DuMont before U.S. Senate Subcommittee on Communications.

GENTLEMEN, PLEASE! Engineering authors help to further technical progress when they write an informative article on their developments. They also build a professional reputation. But more harm than good is done when classified material is inadvertently included. So for the benefit of all concerned, contributors to scientific periodicals should make sure that an authorized security officer clears the article before it is submitted. This precaution can save an otherwise innocent neck.

SOUND BOX only 6 x 6 x 6 in. has been developed by Armour Research Foundation to evaluate electron tubes and other components subject to vibrational and acoustical disturbances in airborne equipment. Operating as a reverberant chamber, 150 db sound levels may be produced with only a modest power input. As a source for this jet engine sound level, a random noise generator and audio oscillator are employed.

WEATHER plays a vital role in the degradation of plastic materials. Monsanto scientists conclude that styrene is strongly affected by sunlight, and that weather resistance is significantly improved by the addition of pigment. Phenolic compound shows very little change in strength and electrical properties in semitropical weather—if it is aged in a hot dry climate.

For "Trouble-Free" Electrical Protection

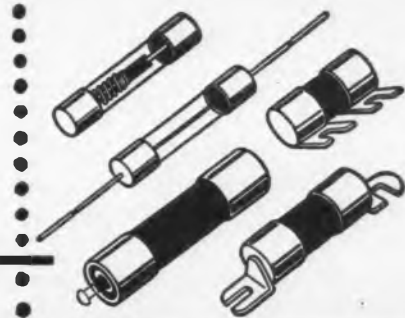

You can rely on BUSS FUSES!

Accuracy and dependability are built in every BUSS fuse at the factory and will be there no matter when the fuse is called upon to operate.

For every BUSS fuse normally used by the Electronic Industries is tested in a sensitive electronic device that rejects any fuse that is not properly constructed, correctly calibrated and right in all physical dimensions.

Proper construction prevents poor contact heating, correct calibration makes certain that the fuse will carry its rated current.

This insistence on perfection results in quality, 'trouble-free' fuses. That's why manufacturers and service organizations rely on BUSS fuses for dependable electrical protection under all service conditions.

If at any time you have an electrical protection problem, let BUSS save you engineering time. At your service are the facilities of the world's largest fuse research laboratory and its staff of engineers ready to help you select the right fuse or fuse mounting . . . and if possible, one already available from local wholesalers' stocks.

For More Information • Mail this Coupon

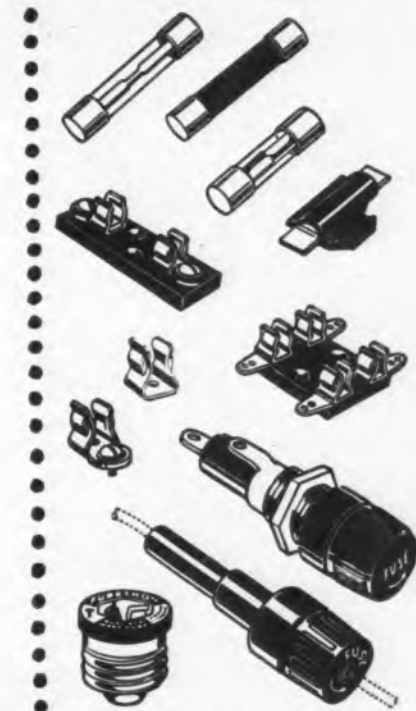

BUSSMANN Mfg. Co.
 (Division of McGraw Electric Co.)
 University at Jefferson, St. Louis 7, Mo.
 Please send me bulletin SFB containing facts on
 BUSS small dimension fuses and fuse holders.

Name _____
 Title _____
 Company _____
 Address _____
 City & Zone _____ State _____ TT854



**For instrumentation
tape recorders and tape**

Your West Coast Distributor is

**BING CROSBY
ENTERPRISES**

Representing



and.....



**MINNESOTA MINING
& MANUFACTURING CO.**

Bing Crosby Enterprises, INC.

ELECTRONICS DIVISION
 CRestview 4-5473 • BRadshaw 2-2771
 9030 Sunset Boulevard • Los Angeles, Calif.

LETTERS . . .

Editors, TELE-TECH:

I have read your recent editorial "Fear of the Unknown" with much interest.

Undoubtedly, had it been possible in the early stages of development for the major picture tube manufacturers to get together and pool their joint knowledge with a view to developing a single standardized color tube, this would probably have resulted in considerable saving in research expense and might even have developed the ultimate color tube, or at least a satisfactory color tube sooner.

However, at this stage of the game this does not seem to be possible. The various major manufacturers are too deeply involved going down paths of their own for them to be willing to pool their knowledge with others. However, by accident perhaps the equivalent of what you suggest may actually still happen.

What I mean is this: One of the various color tubes now under development—and I do not mean any particular one—because I wouldn't know which one it would be as yet—will undoubtedly before many months stick its head out in front of the pack. Whichever one it is, it will have to be one that can be manufactured in quantity on automatic machinery at a reasonable cost—and a reasonable cost is getting more and more to mean substantially under \$100.

DON G. MITCHELL
Chairman of the Board

Sylvania Elec. Prods. Inc.
1740 Broadway
New York 19, New York

Editors, TELE-TECH:

Your editorial "Industry Danger Signals" appearing on page 91 of your Electronic Industries Directory Issue of June 1954, is one of the best of its kind we have ever had the opportunity to read.

We, being a manufacturer of T.V. components, namely Deflection Yokes, congratulate you for bringing the foul conditions of the T.V. Industry out into the open.

We sincerely hope that your article may be effective to the point where some stabilization can be achieved.

R. E. KELUHN

Allied Manufacturing Corp.
605-07 61st Street
West New York, N. J.

LAST A TRULY FLEXIBLE AIR DIELECTRIC CABLE

ANDREW

HELIAX



Important "for the first time" story...

It has long been cable easy to install.

It has long been highly efficient cable.

HELIAX is the first cable to deliver both characteristics. It is as flexible in application as solid dielectric cable, but has the same efficiency as copper air dielectric. HELIAX is superior in design, in efficiency and in electrical performance at microwave and lower frequencies, yet it is comparable in cost to lower frequency cables.

HELIAX will be on display in Booth 532 at the Wesco Show.)

of installation (HELIAX can be pulled through conduit and bent readily without changing its characteristics) means substantial savings in installation costs.

HELIAX is crush proof, may be removed from one installation, coiled and stored. Now available in 7/8" size in continuous lengths. Soon available in other sizes. Send the coupon for detailed specifications.

ANDREW CORPORATION • 363 EAST 75th ST. • CHICAGO 19, ILLINOIS

Gentlemen:

Please send bulletin 70-A, giving technical details and specifications on your 7/8" diameter flexible HELIAX cable (Type HX-0).

NAME _____

POSITION _____

COMPANY _____

ADDRESS _____

COST-SAVING IDEAS  FOR DESIGN ENGINEERS

S. S. WHITE FLEXIBLE SHAFTS ELIMINATE ALIGNMENT AND VIBRATION PROBLEM

By coupling the tuning knobs to variable circuit elements with S.S.White remote control flexible shafts, the designer of the radio equipment illustrated was able to eliminate all problems of alignment and thus simplify assembly. The shafts also dampen vibration, preventing it from being carried to the sensitive parts of the circuit.



WHAT ABOUT YOU?

You'll find the S.S.White remote control flexible shafts the answer to many similar design problems. It will pay you to investigate their possibilities in your own product. Our engineers stand ready to answer your questions. There's no obligation, of course.

BULLETIN 5306 has basic information and data on flexible shaft application and selection. Send for a free copy. Address Dept. Q.



R-2

THE *S.S. White* INDUSTRIAL DIVISION
DENTAL MFG. CO.  10 East 40th Street
NEW YORK 16, N. Y.

Western District Office • Times Building, Long Beach, California

BOOKS

Handbook of Microwave Measurements

Edited by Moe Wind and Harold Rapoport. Published 1954 by Polytechnic Institute of Brooklyn, 55 Johnson St., Brooklyn 1, N. Y. 1000 pages. Price \$12.00.

This two volume study of microwave techniques is one of the most comprehensive and practical works on the subject published to date. It was prepared by the Polytechnic Institute of Brooklyn for the Signal Corps, and contains highly informative contributions by 25 authors. Volume I contains the text, and Volume II the associated illustrations. The subject matter is clearly broken down into 20 sections, each describing the measurement methods and related considerations of the following quantities: Frequency and wavelength; SWR; attenuation; power; Q; impedance; breakdown; propagation; spectrum; dielectric constant; leakage; junctions; couplers; noise; receiver characteristics; klystrons; magnetrons; duplexing tubes; and antennas. Helpful appendices cover use of the Smith Chart, Rieke Diagram, transmission line charts, and impedance matching techniques.

It is questionable whether the separation of the illustrations from the text is quite desirable, but the important consideration is the instructional value of the book's contents. In this latter respect, the authors and editors are to be congratulated for producing an extremely fine and much needed publication. This handbook is to be highly recommended, and doubtlessly will be regarded by many engineers in microwave development and production as a most essential addition to their technical library. AJF

Fundamentals of Transistors

By Leonard Krugman. Published 1954 by John F. Rider Publisher, Inc., 480 Canal St., New York 13, N. Y. 144 pages. Price \$2.70.

As a concise introduction to the transistor art, this book should prove helpful to those engineers not readily conversant with the subject. It describes how the transistor operates, and examines performance of the semiconductor with grounded base, emitter, and collector, respectively. The volume covers transistor amplifier, oscillator and high frequency applications. AJF

WCEMA Directory

Sixth edition of Product List and Membership Roster of the West Coast Electronic Manufacturers Association. 44 pages include data on products, facilities and personnel of 164 member firms. Available on company letterhead request from Don Larson, General Manager. WCEMA, 339 S. Robertson Blvd., Beverly Hills, Calif.

TELE-TECH & Electronic Industries

O. H. CALDWELL, Editorial Consultant ★ M. CLEMENTS, Publisher ★ 480 Lexington Ave., New York 17, N. Y.

Look to the West

It's a satisfying feeling to see an entire industry grow up in a new section of our country. That's exactly what has happened to the electronic industry on the West Coast. Not so long ago the electronic output of the Pacific Coast states didn't amount to a row of tubes, figuratively speaking. Back in 1946 the West Coast Electronic Manufacturers Association put on a show, and a handful of exhibitors turned out to display their wares in 50 booths.

But there were straws in the wind presaging monumental growth. For one thing the population of the West Coast, particularly California, was growing at a much faster rate than the rest of the country—48.8% compared to 14.5% for the U.S. during the 1940-1950 period. Today the West Coast boasts over 16,000,000 people. There were plenty of capable, enterprising engineers and executives. Universities were invaluable information centers. And most important, the vigorous competition that has marked the history of the elec-

tronic industries gave promise of new forces arising.

With these indications manifest, the editors of *Tele-Tech & Electronic Industries* foresaw the phenomenal growth of this region and undertook to focus special attention on the West Coast each year at the time of WESCON. This is what's happened. Many East Coast companies have opened plants in the West. Engineers constitute a larger percentage of the West Coast population than they do nationally. Right now some 569 manufacturers, 111 reps and 260 distributors are active in the West Coast electronic industries. From 170 WESCON booths in 1951, the number rose yearly to 220, 370, and this year it achieves a high of over 500. From near obscurity seven years ago, the West Coast grew to the point that it now is credited with 12% to 15% of the industry's entire output.

The West Coast is a striking example of accelerated growth . . . and it doesn't show signs of slowing down.

Off Dead Center

Heartening Color-TV news came from CBS-Hytron last month in the announcement that their Newburyport Mass. plant was in production on a new 19-in. tri-gun shadow-mask type tube. (See pages 13 and 134) The current price of \$175 for this tube is realistic and will come down as industry demand permits the stepping up of production. The news that broadcasting networks plan an increasing tempo of color programs starting in early Fall is also encouraging.

But television receiver manufacturer's "Fear of the Unknown," as reported in our editorial columns last month, still has to be overcome. None of the presently available designs, including CBS' new "205," are operationally interchangeable. And more than that . . . in

the absence of an "all-industry" committee (as we have recommended previously), there appears to be no organization which can act as a vehicle to permit the exchange of ideas that could lead to operational interchangeability.

The color tube situation can be considered akin to having six different types of electric wall outlets in a home. Today there are about six major tube manufacturers with individual color designs who have important production facilities available. Obviously some degree of standardization on color reproducers must be achieved in order to achieve a practical and manufacturable series of products, and to get color-TV off dead center more quickly.

Only the Beginning

Perhaps the most dramatic scientific report to come to our attention of late is one from a University of Chicago scientist who described how a 10 million billion volt particle from outer space struck a photographic plate sent aloft in the course of high-altitude research. Energy levels of this magnitude dwarf those produced in our most powerful betatrons and synchrotrons by monstrous proportions. It is a clue of vast resources still untapped. It is a preview, of new concepts and methods

with which electronic engineers will have to cope as the fund of scientific knowledge accelerates in growth. In the decades to come we may take advantage of the perfect vision hindsight affords and chuckle over the novice and crudity of our present techniques. But looking forward from today we can only admit we have just scratched the surface, and marvel at the wonder to come.

RADARSCOPE

Revealing important developments and trends throughout the spectrum for radio, TV and electronic research, manufacturing and operation

DON'T BE SURPRISED if a new line of extremely low-priced radio receivers hits the mass market before Christmas. When they do, these sets will sell for half the price of the most inexpensive radio on the market today.

TAPE RECORDER owners with machines capable of handling reels no larger than 7 in. will welcome the forthcoming introduction of half-mil magnetic tape. This thin tape permits about 2400 ft. to fit on a 7-in. reel, instead of the usual 10-in. reel required. Critics of the idea see serious problems in possible print-through from layer to layer, and greater susceptibility to stretch.

COLOR TV tube developments designed to bring costs down have been coming thick and fast. After the head

ELECTRON TUBES



Compactness and ruggedness are major features of "Stacked tubes" developed by Sylvania Electric Products. Conventional tube at top is compared with new type in a ceramic envelope. Both use the same 9-pin miniature basing, but the stacked type is half the height, not including glass type's tip. The new tube culminated in a development contract with the U. S. Navy's Bureau of Ships, and limited production is in progress at the company's Product Development Laboratories, Kew Gardens, N.Y. Details on page 65

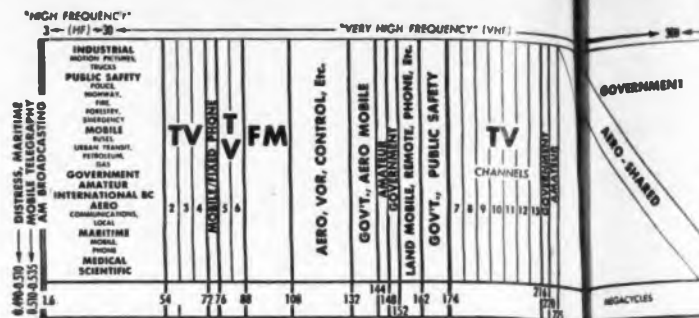

of one leading company saw the simple low-cost tricolor version a competitor had developed, he is reported to have junked his own "latest" tube—despite the fact that a Niagara of money had been poured into it. Prospects are that a limited stability will soon be arrived at, and that a considerable number of color sets with large screens will be rolling off the production lines by October.

RECENT SURVEY by *Fortune* on the prospects for a four-day work week turned up a wide reluctance to comment on the subject. Industrial leaders kept mum on the basis that to concede the coming of the four-day week would be to grant a bargaining point beforehand; to predict dire circumstances might make them look as foolish as the men who anticipated havoc with the coming of the five-day work week. Labor leaders generally were silent because they didn't want to detract interest from the growing issue of the guaranteed annual wage.

EXPORT of radio-TV equipment and components is on the rise despite the growth of foreign competition, reports Sprague's W. M. Adams, Chairman of the RETMA International Dept. Foreign shipments of electronic apparatus totaled \$247,839,764 during the calendar year 1953.

MOST AVID readers of American technical periodicals are the Russians. Although they are trailing us in many commercial aspects, their military electronic developments are nothing to scoff at. Cutting through the maze of propaganda concerning prior invention of almost anything conceivable, study of Soviet publications, particularly mathematical works, indicate that they are abreast of us in fields such as computers and electronic controls.

RADIO-TV business is in for a healthy manufacturing and sales boost this fall, forecasts R. S. Alexander of Wells-Gardner, Chairman of the RETMA Set Div. Curtailed production during the past year has enabled set makers to enter the second half of this year with production and inventories in balance.

SECURITY

SCIENTISTS have rarely had such divided and strongly felt opinions as they have on the Oppenheimer case. As has been widely publicized, President Eisenhower ordered a "blank wall" to be placed between the atomic scientist and secret data. Suspension of security

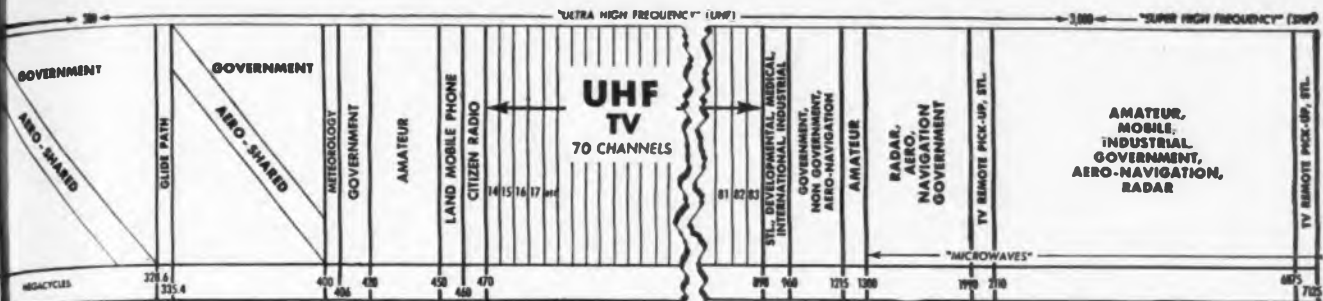

clearance was upheld by a special review board (2 to 1) and the Atomic Energy Commission (4 to 1), based on certain acts and associations by Dr. Oppenheimer, none of them including actual divulging of information. The justice and desirability of classifying the famous scientist as a risk will be debated for some time to come, but irrespective of the right or wrong of the matter, great harm has been done. The schism in the scientific family has left many disgruntled at a time when enthusiastic effort is almost a prerequisite to survival. To prevent a repetition of the case, a number of responsible scientists have proposed that the entire security program be reviewed with an eye toward making this unpleasant but necessary safeguard a protective barrier which will not alienate the very men who produce the knowledge which must be safeguarded.

ENGINEERING MANPOWER

CHALLENGING INDICTMENT of our Selective Service policy comes from the Engineering Manpower Commission and Scientific Manpower Commission at a time when reports are filtering through that technically trained Soviet manpower is making vast strides. In describing how our own practices are working at apparent cross purposes, the Commission notes:

"President Eisenhower stresses the vital importance of science and technology in every speech and directive concerned with our economic welfare and military strength. The Congress legislates that 'adequate provision for national security requires maximum effort in the fields of scientific research and development, and the fullest possible utilization of the Nation's technological, scientific, and other critical manpower resources.' The Departments of Labor and Commerce analyze our needs and prepare lists of critical occupations and essential activities in conformance with this provision of the law. The Office of Defense Mobilization gauges our ability to meet the specialized manpower requirements of stepped-up and full mobilization. Our universities train specialists in every critical professional field, with generous support from industry, which also gives them in-job training for greater technological usefulness and accomplishment—all, seemingly, for one purpose: to supply 1400-1500 (8%) of the 18,000 men monthly that Selective Service is currently delivering to the Army, where few of these skills can be put to the highest use for the national health, safety, and interest.

"Meanwhile, in Russia, 'this stream of trained experts is going to increase in volume.'"

MILITARY

ELECTRONIC ARMAMENT in any future war will utilize radiation detection equipment for aircraft and marine locating. Dual reason is that radar jamming techniques and radar source finding equipment has made use of radar somewhat risky. On the other hand, instruments capable of spotting infra-red and similar sources send out no signal of their own, and are less susceptible to jamming. This explains much of the strong military interest in optical and thermometric devices.

TRANSISTOR MICROPHONE



Performer Joan Diner demonstrates new wireless microphone which frees actors from restricting cables and booms. Unit developed by NBC uses eight 2N34 RCA transistors, weighs under 8 oz. total, and measures 3/8 x 2 x 3 3/8 in. Less than 100 μw of power at 530 kc is radiated from antenna worn around waist. Loop wire around studio picks up induction field. Battery needed is 45-volt alkaline type, provides 10 ma for the unit to develop 50 mw, and runs for five hours. Area of coverage is 5000 sq. ft. Biggest problem is noise from lights, elevators and other sources capable of inducing spurious signals in system. See page 155

West Coast Societies

Role of electronic organizations in rapid growth of Western industry highlighted. How these groups serve engineers and manufacturers employing 65,000 people

By **E. P. GERTSCH, President**
Gertsch Products, Inc.
11846 Mississippi Ave.
Los Angeles 25, Calif.

UNDoubtedly, the electronic industry of the West would not be the second largest in the country if it were not for the organizations and societies which have worked toward that end. Before and during the early days of World War II, Western electronic manufacturers found that, if nothing else, they had one thing in common. That was a long train or plane ride to the major buyers of the East, particularly in Washington. Being relatively small, these manufacturers and specialists in the electronic business of the Coastal States found that they must unite to compete on a basis equal to their Eastern counterparts. The united efforts were displayed in the organizations which have since grown in size and activity to be the force that has been most important in bringing success and national recognition to the industry of the West.

Best estimates are that the electronic research, development, and manufacturing organizations of the three Coastal States of Washington, Oregon, and California now employ approximately 65,000 people. This compares with a 12,000 employment during the year of 1946, or a 440% increase during the past eight years. The year 1946 was used for comparison in order to eliminate the unusual industry growth occurring during World War II.

Now let us consider the various organizations and societies of the Western electronic industry, all of which operate independently as well as together in many functions of joint interest.

Wescan

One cannot think of West Coast electronics without thinking of the Western Electronic Show and Convention. WESCON is unique in one



Mr. Gertsch is president and one of the original founders of the West Coast Electronic Manufacturers Association. He has served several times as a WCEMA director and as vice chairman. During the past four years he has been active as owner and manager Gertsch Products, Inc., Los Angeles. Positions prior to this period include works manager of Hoffman Radio Corp., chief engineer of Air Associates Radio Div., and superintendent and engineer with RCA Victor. Mr. Gertsch, an electrical engineering graduate from the University of Utah, class of 1930, is a senior member of the IRE and a member of Theta Tau engineering fraternity.

particular way. That is, it is probably the only organization of its type representing the merger of the engineer and the manufacturer on an absolutely equal basis. It is a separate and individual operation, a non-profit corporation, jointly sponsored by the West Coast Sections of the Institute of Radio Engineers and the West Coast Electronic Manufacturers Association. It is an annual affair alternating between the San Francisco and Los Angeles areas. Its purpose is to sponsor, manage, and promote the WESCON with the sole aim of providing the finest possible technical convention and product show in the electronics field. In the writer's opinion, this has been accomplished, as WESCON is second only to the national IRE show and convention in attendance and number of exhibitors.

Wescan attendance has increased 500% since 1946, while the number of exhibitors has increased 925%. On the basis of booth sales for 1954, and estimated attendance, it appears that

WESCON's further growth is definitely assured.

Institute of Radio Engineers

The IRE is so well known that it is not necessary to discuss, even briefly, its history and aims. Its position in the organizational set-up of the West Coast electronics industry, however, is of note.

The major Seventh Region or West Coast Sections of IRE are concentrated in the Los Angeles and San Francisco areas. Los Angeles is the largest, and is, in fact, the second largest in the nation. From statistics available it appears that the Seventh Region of IRE has kept pace with the electronic industry. For example, the Los Angeles Section has increased 340% in membership since 1946. Member engineers within the Seventh Region now account for over 17% of the national membership of IRE. Indications are that this organization growth will continue in line with the area trend, particularly since such a large percentage of West Coast products carry high engineering cost and development work.

In addition to its normal functions of serving the technical and professional needs of its membership, IRE on the West Coast participates in several activities on a cooperative basis with other organizations. Among these are its co-sponsorship of WESCON with WCEMA, outlined above, its annual Technical Conference in cooperation with various electronic manufacturers, the spearheading of the Electronic Components Symposium, now grown to a national scope, its Professional Group activities, and its Student Relations Programs.

WCEMA

The West Coast Electronic Manufacturers Association, born in wartime at the suggestion of a Signal Corps colonel, whose major interest was to increase the output of military electronics, has today become a major factor in Western electronics. Since 1946, WCEMA membership has increased more than 500%, today listing a membership of 164 companies, of size varying from six to 14,000 employees.

It is doubtful that the mere handful of founding fathers of WCEMA had visions of the growth that would take place in less than 12 years. Now, membership in WCEMA extends from Seattle on the north to San Diego on the south.

(Continued on page 136)

WESCON 1954

Three-day conclave in Los Angeles to feature 500 exhibit booths and presentation of more than 100 technical papers. Attendance of 20,000 expected

THE "City of the Angels" plays host to the largest electronic industry meeting ever held on the West Coast when WESCON (Western Electronic Show and Convention) convenes Aug. 25-27 in Los Angeles' Pan-Pacific Auditorium and Ambassador Hotel. About 20,000 engineers and industry leaders are expected to attend. More than 500 exhibit booths have been reserved, compared to 370 last year, and it has been necessary to add an 11,000 sq. ft. annex. (See accompanying exhibitor list and floor plan.)

More than 100 technical papers are to be presented in 27 sessions. (See below for list of papers.)

WESCON is sponsored jointly by WCEMA (West Coast Electronic Manufacturers Association) and the Los Angeles and San Francisco Sections of IRE. The "Reps," NEDA, and other groups lend active support. Each year the show rotates between Los Angeles and San Francisco.

The efforts of many people, too numerous to mention, have gone into making WESCON 1954 a notable success. Presented on this page are the eight-man WESCON Board of Directors, the business manager, and the recording secretary. For further information, write to WESCON, 344

N. La Brea Ave., Los Angeles 36, Calif.

Technical Papers Program

NEW DEVELOPMENTS IN TELEMETERING

Session Chairman: R. E. Rawlins, Lockheed Aircraft
 "Delay Line Controlled Subcarrier Discriminator"—K. A. Morgan and R. F. Blake, Naval Research Lab.
 "A Temperature Stable Transistorized V. C. O."—F. M. Riddle, Jet Propulsion Lab., Cal. Tech.
 "A Transistorized FM/FM Telemetering System"—R. E. Colander and C. M. Kortman, Bendix Aviation Corp., Pacific Div.
 "A High Performance R. F. Pre-amplifier and Multicoupler"—W. S. Knowles, formerly of Applied Science Corp. of Princeton, and K. M. Uglow, Consulting Engineer, Washington, D. C.
 "Slope Modulator for FM Magnetic Recording of Analog Data"—L. W. Erath and F. C. Smith, Jr., Southwest Industrial Electronics.

APPLICATION OF COMPONENT PARTS

Session Chairman: M. Barry Carlton, Coordinator of Reliability Office of Assistant Secy. of Defense.
 "Short Time Ratings for Paper Capacitors"—W. M. Allison, Sprague Electric.
 "Rotating Components and Their Application to Advanced Electronic Systems"—R. N. Brown, Kearfott Co.
 "Appraisal of Wire Wound Potentiometers"—J. A. Csepely, Westinghouse Electric.
 "Relay Characteristics and Application"—C. F. Cameron, Oklahoma A & M College.

PROFESSIONAL GROUP ON ELECTRONIC COMPUTERS

"A Dependent Variable Analog Function Generator"—C. J. Savant, Jr., North

(Continued on page 116)

Pan-Pacific Auditorium, Los Angeles, location of 1954 WESCON exhibits, on display Aug. 25-27



W. Hershberger
WESCON Chairman



Leon B. Ungar
Secy.-Treas.



Thomas Walker
Vice-Chairman



C. F. Wolcott
Vice-Chairman



W. E. Noller
Board Member



R. A. Huggins
Board Member



Noel Porter
Board Member



J. H. Landells
Board Member



Mal Mobley, Jr.
Business Mgr.



J. W. Jarrett
Record. Secy.

Techniques for Electronic

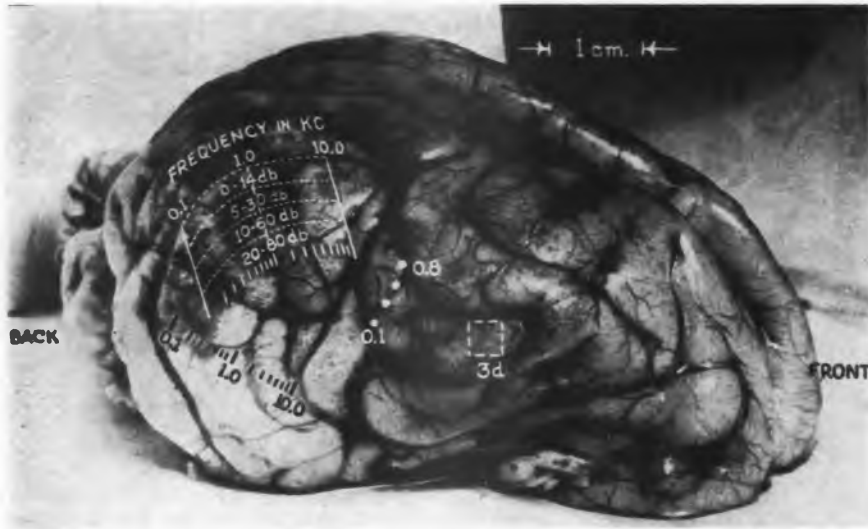

Fig. 1: Dog's brain with four mapped areas from which electrical responses to sounds were obtained. Location of response region depends on frequency and intensity of sound stimuli

To advance medical treatment and explore application to computer design, brain electrical response to auditory stimuli is investigated

By **A. R. TUNTURI**, Director
Navy Acoustic Research
University of Oregon
Portland 1, Oregon

THE brain is an enormous universe, when one considers the large amount of information that it is capable of handling during its lifetime, the large amount of information it contains in its memory, and the enormous complexity of its

structure and function. Although anatomists and physiologists have studied it for many years very little progress has been made on the way it handles information. For diagnosis and treatment of neurological diseases, and the possible importance of applying the knowledge of how the brain works to the development of mechanical brains for guided missiles, study of the brain is important.

Mapping of the brain in its crudest sense began perhaps about a

couple centuries ago. At that time anatomists described the brain's holes, grooves, bumps, projections and what-nots with unrestricted terminology, resulting in a confusing picture. Another era of mapping of the brain began with the discovery of the microscope, and with the discovery by the two Nobel Prize winners, Golgi and Cajal, that the nervous system was made up of single units consisting of cells which gave the nervous system the general structure of a reticulum or network. Following this discovery and extending to the present time, more and more of this network characteristic has been uncovered so that it is now possible to form a fairly coherent map of this network of nerve cells. Then as late as the 1930's the electrical sign of the nerve impulse was discovered. Today a great deal of mapping of the networks in the brain is performed by means of cathode-ray tubes, ink writers and the like. Thus we come to the subject of electronic mapping of the brain. The general problem of the mapping of the brain can be regarded as concerned with the determination of the major pathways of the networks over which nerve impulses are transmitted from one location to another.

Brain Structure

The brain is a highly complicated structure somewhat similar to a telephone network consisting of trunk lines and exchanges. In the nervous system trunk lines are those

Fig. 2: (l) Room adjoining soundproof room where animals are tested holds "huge kluge" containing 10-channel oscilloscope-camera recorder, master control unit, sound generator and calibration equipment. Fig. 3: (r) Huge kluge system arranged for typical experiment

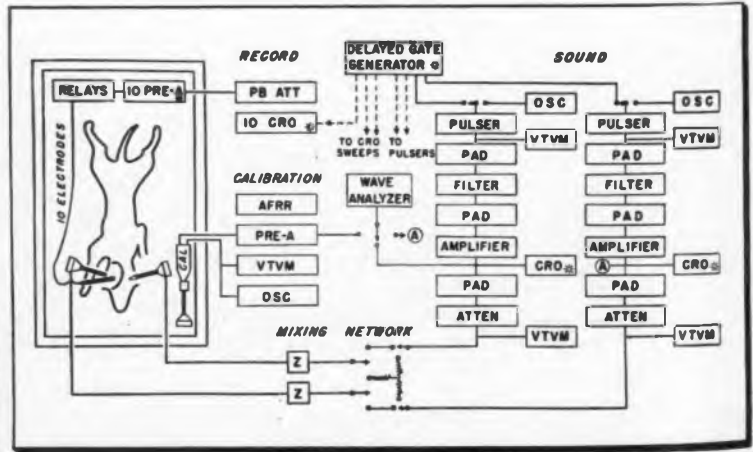

Fig. 4: Oscillation signal, called

periment system it (Fig. 5) which is nervous

The ne of a pie swelling a ter and about one having a meter. It tions th transmit nervous nerves m either on swelling. mission o in one di portan networks are form of these tions, Al tions are

Mapping of the Brain

nerves and nerve pathways that carry impulses for considerable distances, and the exchanges are those groups of nerve cells and their projections which form the complicated networks or circuits for analysis and memory. There are certain regions where the trunk lines are more abundant (white matter) and other regions where the analyzing circuits (grey matter) are more numerous. The cerebral cortex is an example of the analyzing system where the trunk lines terminate and new trunk lines originate. The ramifications are so minute in the cerebral cortex that there may be as many as 5,000 connections or contacts in a cubic millimeter of the tissue. To understand the phenomena which one observes in the ex-

perimental work on the nervous system it is necessary to take a look (Fig. 5) at the nerve cell or neuron which is the unit of structure in the nervous system.

many of them are of a random character. We have very little knowledge of the statistical distribution functions of these random connections. The statistics are extremely important because the nervous system was not put together as an accurately designed device and there is a great deal of evidence that the behavior of the nervous system is, at least in part, if not all, in the form of an analog device.

The characteristic of the nerve impulse, which each one of these neurons and their projections show, is an electrical field in the surrounding medium due to the passage of minute currents across the membrane of the nerve cell. The field of the nerve impulse, since it is in a volume conductor, in general, obeys the laws of electrical field as it is expressed by the Laplacian equation. It is not possible to record the entire field from each of the individual nerve fibers, first because electrodes can not be made small enough and, secondly large electrodes will not record the field of individual units. We generally use large electrodes to record potentials from groups of cells or nerve fibers; a sort of summed potential of numerous nerve cells. This does not allow always a high degree of precision, nor does it give an insight

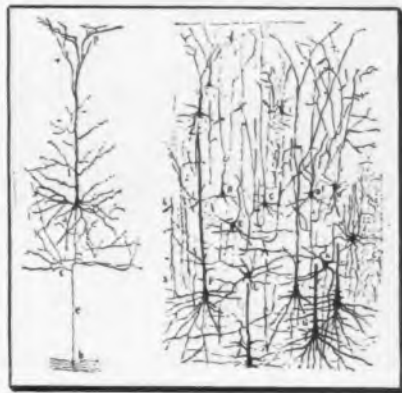

Fig. 5: Nerve cell or neuron structure

as to what the individual neurons are doing. However, it serves to map out connections in a rather coarse manner in the nervous system. Most of the work in mapping of the brain has been done with the large types of electrodes.

Electrical Activity

The electrical activity of the brain is manifest in many ways, depending on where the electrodes are placed. The electroencephalogram is obtained by placing the electrodes on the scalp and recording from the unanesthetized subject a time-amplitude varying picture of electrical activity. The electrodes are too far

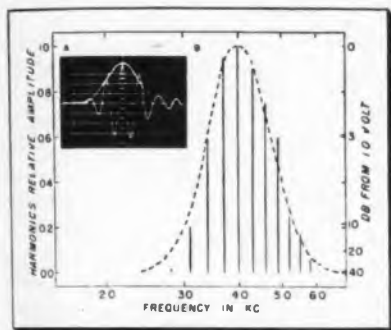
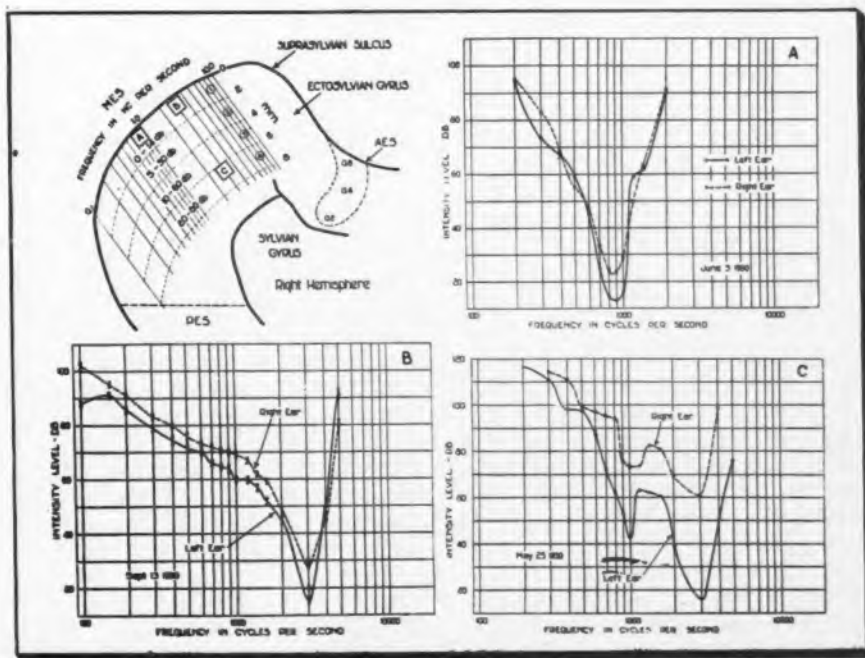

Fig. 4: Oscillogram and spectrum of auditory signal, called probability pulse or tone pip

The nerves make contact with each other either on the projections or on the swelling. These contacts allow transmission of the nerve impulses only in one direction. This polarity is important in the design of computer networks. The networks of the brain are formed by the conglomeration of these neurons and their projections. Although some of the connections are fairly well ordered, a great

permental work on the nervous system it is necessary to take a look (Fig. 5) at the nerve cell or neuron which is the unit of structure in the nervous system.

Fig. 6: Location and spectra of nerve fibers activated. Strychnine magnifies response



Brain Mapping (Continued)

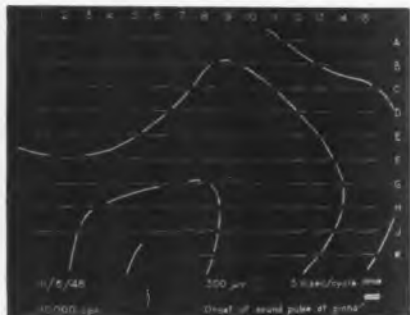

Fig. 7: Oscillograph recordings show variation of brain potential over surface locations

away to give much knowledge as to the underlying activity of the brain. By putting the wires directly on the brain somewhat similar electrical activity is obtained, but it is more localized in its origin. This allows mapping connections to a reasonable degree of precision. Likewise, wires can be stuck into the brain to record from a deeper structure. Small wires, called micro-electrodes (measuring one to three microns at the tip), have been used from time to time for obtaining records from single neurons. Their usefulness is limited because it takes hours before a single satisfactory record can be obtained. The best method at the present time of recording appears to be the use of large wire electrodes, either in contact with the surface or inserted into the substance of the brain.

Nerve Pathway

Electronic mapping of the brain consists of amplifying by electronic devices, these small voltages, displaying them on a suitable indicator, and from this data constructing a map showing the location of a nerve pathway. The brain potentials have a magnitude of from 10 to 300 μv , and therefore require low noise level and high gain amplifiers. The method of display varies. People use various devices such as galvanometers, ink writers, intensity modulation of lights and the cathode-ray oscilloscope. With the CRO, moving film can be used or the sweep of the oscillograph can be employed as the time base. In our problem we have found that the time amplitude pattern has been the most useful. To obtain the records one can use a single channel, moving the wire electrode for successive observations or one can use multi-channel equipment to observe simultaneously. For several years we have used a 10-



Fig. 8: Unanesthetized animal activity does not resemble previously considered potentials

channel CRO, consisting of 3-in. tubes with the same linear time base on each one. We are now installing an additional 50-channel CRO, which will allow us to record from 60 different parts of the brain simultaneously. Our tubes possess P7 screens which permit visualization of the trace for some period after the initial sweep.

The 10-channel instrument is photographed on 35 mm film which is subsequently printed with 10 records on 8½ x 11 in. paper. The 50-channel instrument will be photographed with a 4 x 5 in. aircraft camera. These pictures have a great deal of information in them, amplitude and time wise. Since we are interested in the brain principally as a communication device, the electrical map itself is of little interest to us, except that it contains the information from which we are trying to interpret how the brain handles information. What we are really interested in is the set of measurements obtained from these signals and their relevance to the communication aspects of the system. Thus, one of our major problems that we are struggling with now is that of data measurement and reduction.

Communication Channel

To regress a moment, we should consider briefly what a communication channel is and why it is pertinent to our problem. Our work on the nervous system has been concentrated on the connections from the ear to the cerebral cortex of the brain, or as it is referred to, the auditory system. Thus we identify the sending end of the communication channel with a space A which is the sound field consisting of physical characteristics of sound such as frequency spectra, time relationships, and the relative intensities that are necessary for auditory communica-

tion. The receiving end of our communication channel, or space B, is the representation in the auditory cortex by virtue of spatial arrangements of the nerve connections, delay times, and other manifestations of nervous activity. A coding process in the ear transforms the information in the auditory signals into information in the nerve impulses which are transmitted from the ear to the cortex. It is the representation in space B of the representation in space A that we are primarily interested in.

Equipment Setup

To obtain the data, a soundproof room is used with ear phones and couplers by which sounds are delivered to the ears of the animals. Wire electrodes which are pressed against the brain, and are used to pick up the brain potentials. The brain potentials are amplified by 10 preamplifiers. Condenser microphones are used to calibrate the ear phones. The amplified brain potentials are fed by the wires along the wall to another room where the "huge kluge," shown in Fig. 2, is located. The "huge kluge," as someone has aptly called it, consists of the 10-channel recording unit, the master control unit, and the sound generator and calibration equipment. Going from left to right in the picture one sees first the single frame 35 mm camera for recording photographically the 10 channel cathode-ray oscillograph. The rack behind the camera contains the sound calibration gear. The next rack has the final amplifiers, pulsers, and mixing panels. The third rack contains three sine wave generators, one thermal noise generator and the automatic frequency response recorder. The fourth rack is the filter rack and has two half-octave filters. The fifth one is an amplifier section. The sixth is the master control unit which generates rectangular pulses with all sorts of time relations for synchronizing the activity of the sweeps and sound gates. The final rack is the 10-channel CRO. The two extra oscillographs on the right are used for monitoring the sound signals. All the sounds are generated and the recording is done in this room.

A 50-channel CRO is being installed. This equipment has fifty 3-in. tubes with two sweep expanders to allow three sweeps for each record. This will give us a total of 60 recording channels from the brain.

A schematic of the huge kluge is shown in Fig. 3 arranged for a typical (Continued on page 146)

"Stacked Tubes" in Production

Radically new design permits elements to be assembled on top of each other on jig and riveted in single operation to facilitate automatic production. Excellent reliability under extreme temperature and vibration conditions

A REVOLUTIONARY concept of an electron tube, believed to have vast potentials, has been announced by Sylvania Electric Products Inc. The new development, known as the "stacked tube," is the result of several years' study by the Sylvania Research Laboratories, culminating in a development contract with the U. S. Navy's Bureau of Ships, and limited quantities are now being made at the company's Product Development Laboratories, Kew Gardens, L. I., N. Y.

The new tube features a ceramic envelope or cap, instead of the usual glass bulb, and the various parts are "stacked" one atop the other in the assembly process, a procedure radically different from conventional methods. A further feature is the use of ceramic spacers, instead of mica. These design innovations not only make possible the tube's unique performance and reliability, but also enable high mass production because of design simplicity.

Assembly is a simple stacking operation, and sealing is done with a "bell-jar" system, a glass dome under which the stacked parts are placed, air-evacuated, and the tube envelope sealed over the stacked parts. These stacking, sealing, and evacuating procedures, not only provide excellent reliability, but also lend themselves to completely automatic production methods. Contributing to the tube's ruggedness is the substitution of ceramic spacers for mica spacers. In extreme operating conditions, mica has a tendency to spall and flake under vibration and shock.

Whereas an outstanding feature of the new development is the ceramic envelope, the stacked structure of the tube lends itself to the use of either a glass or ceramic envelope, depending upon the ultimate application. The ceramic envelope would be used for severe environmental conditions where glass has not proved feasible, but glass would be utilized for other applications.

The complete mount of the new tube is assembled on two small pins. First a plate, a spacer ceramic, a grid, a spacer ceramic, a cathode, a spacer ceramic, and so until the top is reached. When the stack is com-

pleted, the small pins are then electrically riveted, giving a compact tight mount assembly.

The ceramic material used for the envelope and stem is aluminum oxide. Sealing the envelope and stem together is a single-step process. No mica is used in the mount, and it can, therefore, be placed on a ceramic stem and sealed in a ceramic envelope under temperatures of about 950°, substantially higher than

mica can withstand. Aside from sealing the tube, this process also provides a high "baking-out" temperature which sealing glasses could not withstand. The finished tubes consequently have less gas to begin with, and, therefore, have a longer gas-free life. The tube can be strapped directly to the equipment chassis, or it can be socketed. Lead wires can also be soldered directly to the pins.

(Continued on page 156)



Compactness of "stacked tube" is demonstrated by comparison with match. Ceramic envelope (l) and assembly (c) are placed in bell jar device for evacuation to produce finished tube (r)

Exploded view of "stacked tube" parts (top) shows progression on two small pins of plate, spacer ceramic, grid, spacer ceramic, cathode, and so on until top. Cathode support assemblies (bottom) show conventional vacuum tube type at left, and new type. Wire loops of cathode fit over rivet insulator posts, and two ceramic washers at the top then are lodged over the loops

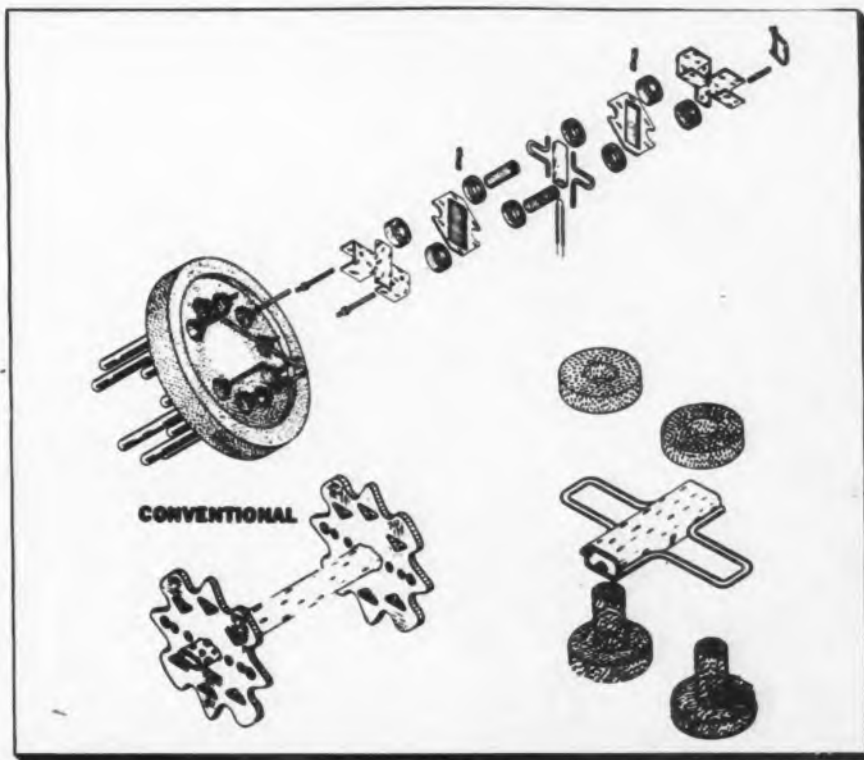

Equipment for Testing

Radiation and impedance data may be plotted with one-tenth the number of man-hours ordinarily required in hand plotting. Modified graphic recorder facilitates measurements

TESTING time being a major factor in production costs of cavity recessed helical antennas, the equipments to be described are designed to appreciably reduce the expense of recording pattern and impedance data, while improving overall accuracy of the tests.

Recently, two complete sets of radiation and impedance data were taken for a certain antenna over a 160% band of frequencies. Hand plotting these data required 5½ man-hours' time, whereas only 0.6 man-hours were necessary to complete the same data with the assistance of the test setup illustrated in Figs. 1 and 2.

Automatic graphic recording of VSWR vs. frequency occurs directly beneath the ground plane, while pattern and axial ratio measurements are recorded by the equipment shown to the left of the ground plane.

A graphic recorder was modified to accommodate the test installa-



By **CARROLL W. BRADFORD**
Dalmo Victor Co.
San Carlos, Calif.

tion. Mechanical considerations required that a dual pen device be employed, in addition to two individual marker pens. Each of the four pens is individually actuated as described in the procedural portions of this paper. Fig. 3 shows the pattern recorder with cover removed to illustrate how the original paper drive mechanism is disconnected and replaced with a Delco synchronous repeater.

The antenna under test mounts at the center of a 5 ft. dia. horizontal ground plane, horizontal positioning being employed to minimize spurious reflections from adjacent objects. A balanced coaxial receiving dipole, suspended so that it may swing over a 5 to 8 ft. radius above the ground plane's center, has bearing mounts which permit the dipole's rotation about its own axis. Using $2D^2\lambda$ as minimum separation criterion between test antenna and sampling dipole, only 2.3 ft. of separation is necessary at the upper frequency of 2600 mc. with a cavity diameter of 8 in., thus a reasonable safety factor is afforded by employing a minimum 5 ft. separation.

Received power from the dipole is detected with a 1N23B crystal at a level commensurate with proper square law operation. A rotary transformer couples the rectified signal to an amplifier, the output of which drives the pens of the graphic recorder.

Fig. 1: (l) Equipment for making antenna measurements. Fig. 2: (r) Schematic of test set-up which plots antenna patterns quickly and accurately

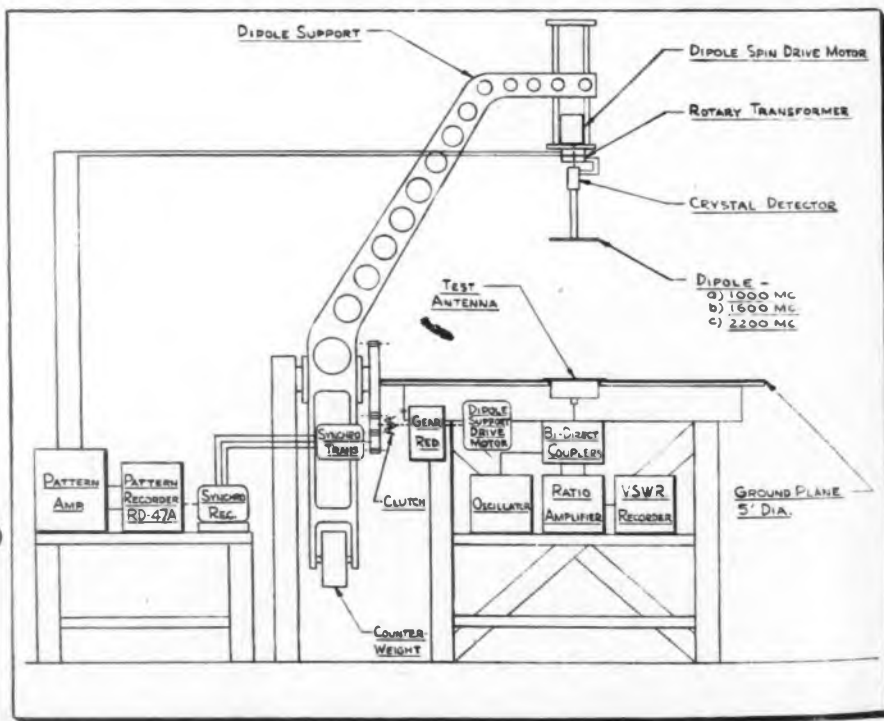
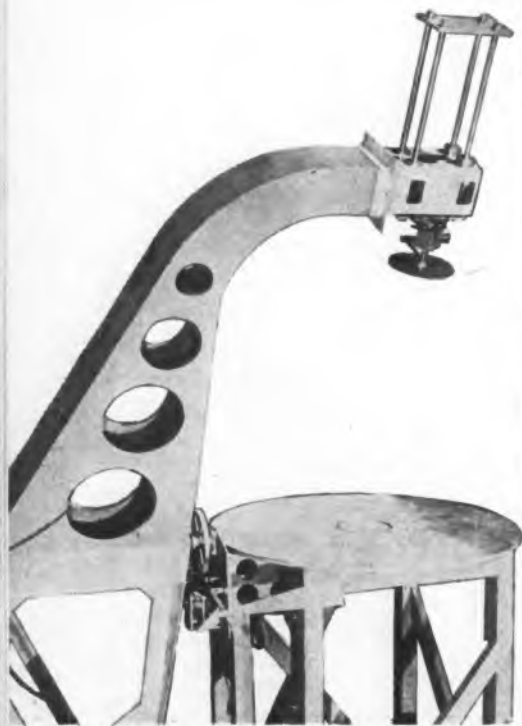

Ellip



Fig. 3:

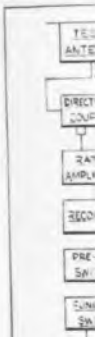

Fig. 5 (l)

The ply dipole m... usually or e... axis thro... plane, ca... 190° of a... antenna... geared to... in conjun... recorder... lows cali... No. 4300... division... receiver... recording... Fig. 4... pattern... polarized... tates thr... for and... polarizat...

Elliptically Polarized Antennas

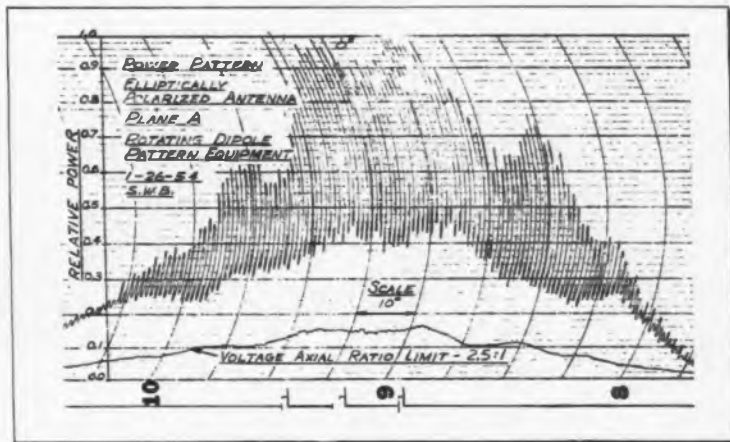

Fig. 3: (l) Pattern recorder with synchronous repeater replacing original paper drive. Fig. 4: (r) Pattern for elliptically polarized antenna

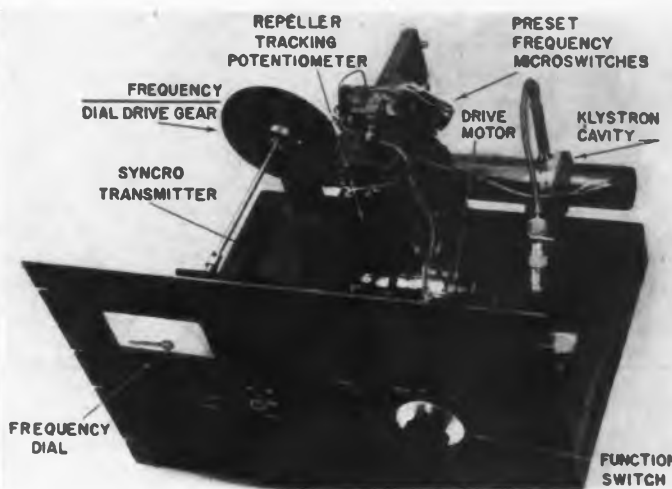
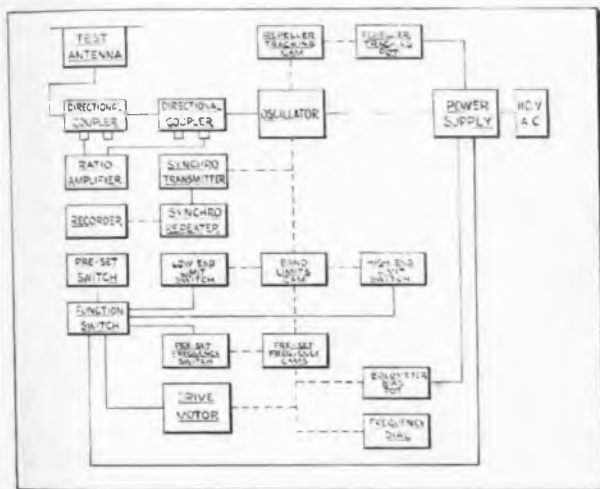

Fig. 5 (l) Block diagram of antenna measuring system. Fig. 6: (r) Signal generator with modified cavity plunger which extends range to 2600 mc

The plywood boom supporting the dipole may be driven either manually or electrically, and pivots on an axis through the center of the ground plane, carrying the dipole through 190° of arc over and across the test antenna. A synchro transmitter geared to the boom drive, operating in conjunction with a repeater at the recorder paper drive mechanism allows calibration of Esterline-Angus No. 4300-C paper at 10° per chart division. A linear amplifier pattern receiver drives the "Relative Power" recording pen.

Fig. 4 illustrates a representative pattern measured for an elliptically polarized antenna. As the dipole rotates through the planes of the major and minor axes of the voltage polarization ellipse, a maximum and

minimum response is recorded. As the rotating dipole travels through 190° of arc, a complete record of voltage maxima and minima in the plane under observation is traced on the recorder paper.

With reference to the pen functions of the graphic recorder, one signal pen delineates the following record:

1. Power pattern in the plane of the major axis of the voltage polarization ellipse (envelope of maximum response).
2. Power pattern in the plane of the minor axis of the voltage polarization ellipse (envelope of minimum response).
3. Power axial ratio (excursion from maximum to minimum). The second signal pen records the

specification limit on axial ratio, while the marker pens provide identification upon the paper's edges at 0° and ±10° for boresight reference. For the antenna tests shown in Fig. 3, the specification on voltage axial ratio was 2.5:1, or 7.95 db. The pattern amplifier incorporates a peak reading voltmeter circuit which follows the outside envelope of the pattern, attenuates it 7.95 db. and supplies data to the second recorder pen. This pen records the axial ratio specification limit, shown in Fig. 4 as not having exceeded 2.5:1. Had this specification been exceeded, the pattern pen's lower excursion would have crossed over the line traced by the specification pen.

The rotational speeds of the various components were fixed by con-

Polarized Antennas (Continued)

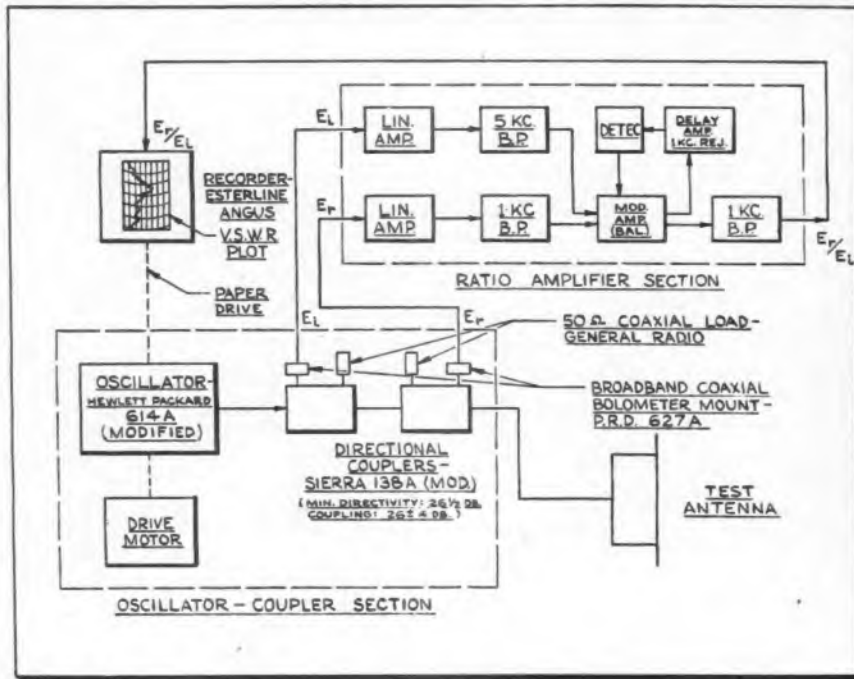

Fig. 7: Block diagram shows functional details of VSWR plotter

sideration of the desired patterning time, in addition to recorded response. A pattern is completed in 2 min., corresponding to boom rotation of $180^\circ/2$ min., or $\frac{1}{4}$ RPM. Synchro gearing was utilized to elicit graph paper major division spacing equivalent to 10° calibrations. Dipole rotation was chosen to produce a

maximum number of cycles/degree with good inking, resulting in a figure of 1 cycle per degree, or 180 cycles per two minutes. Since one revolution of the dipole produces two electrical cycles, the dipole rotates at 45 RPM, and the pattern pen must follow at 1.5 cps. The recorder shown in Fig. 3 is capable of a re-

sponse of 10 cps.

Fig. 1 illustrates a typical test setup. Note the reflector placed behind the dipole to improve its forward gain and to provide shielding from boom reflections. To further check the effects of unwanted reflections from the boom's lower structure, the boom was covered with microwave absorbent material, although the difference between patterns taken with and without the absorbent material are insignificant.

The rectangular box above the dipole reflector is a mu-metal housing for the rotary transformer, and is necessary to prevent adjacent power line pickup.

Impedance Measurements

The same oscillator is used for both radiation and impedance tests. Oscillator power passes through two directional couplers, where incident and reflected waves are sampled, fed to the inputs of a ratio amplifier, and the output plotted by an Esterline-Angus Model AW graphic recorder.

Fig. 5 shows the basic mechanical configurations of the device. The signal source is comprised of the oscillator section of a Hewlett-Packard Model 614-A Signal Generator, modified to the requirements of the system. The 5837 klystron and associated cavity were removed from the signal generator and were mounted as shown in Fig. 6, provision being made to extend the cavity's upper
(Continued on page 165)

How West Coast Firm Meets Labor Shortage

PERSONNEL directors in Southern California's mushrooming post-war electronics industry are tempted to view their companies' soaring sales curves and corresponding production requirements with the same kind of mixed emotions experienced by the man who watches his mother-in-law drive over a cliff in his new Cadillac.

Business is booming—profits are breaking all previous records of the youthful industry, new plants are being built at a phenomenal rate, and training programs are being accelerated. But the fact remains, constant depletion of a limited manpower pool possessing the highly developed skills essential to many of the intricate processes inherent in the electronic field, has sorely taxed the duodenal tracts of person-

nel directors who find it difficult to continually explain to operating executives why manpower supply falls short of production needs.

Employee Benefits Program

It is no longer enough to provide only an attractive working environment, the finest tools, or wages that meet the going rate in comparable jobs in the same area. Competition for suitable new employees is as intense as is the continuous need to solicit enduring employee loyalty in an effort to reduce turnover rates.

Consolidated Engineering Corp., Pasadena, Calif., manufacturer of electronic analytical and measuring instruments, believes it has found a partial answer through the establishment of one of the nation's most

comprehensive employee benefits programs. Consolidated points to its steady increase in number of employees from 13, in 1937 when the company was formed, to a personnel roster that now numbers over 1000 people, and a turnover rate that has been consistently below the average for the industry.

Unusually broad insurance and medical benefits, which include a \$5,000 major medical feature, a carefully conceived profit-sharing and retirement plan, three group life insurance programs, one of which is provided to the employee without cost, paid vacation and sick leave, and some of the most attractively landscaped plant facilities in the nation are among the ingredients contributing to the success of
(Continued on page 167)

By
Chief E
93

THE t
Engin
at the ti
frame cr
1. The
sonn
men
The cr
ity is not
time so
limits ca
ers are
environm
strong p
age will
advisabl
vironmen
2. The
amc
nois
the
leve
The n
interfere
factors.
follows:
1. The
ing
2. The
vid
3. The
per
4. The
ing
5. Wir
tion
Comm
systems
the plan
tion of
trum of
At th

TELE-TECH

Plant Noise Surveillance

Monitoring system for jet aircraft plants guards against personnel injury and community disturbance from high engine noise level



By **JOHN K. HILLARD**
Chief Engineer Altec Lansing Corp.
9356 Santa Monica Blvd.
Beverly Hills, Calif.

THE testing of jet engines at an engine manufacturing plant and at the time of installation in an air frame creates two noise problems:

1. The protection of operating personnel from physical impairment.

The criterion for physical disability is not sufficiently complete at this time so that precise damage risk limits can be set. However, if workers are consistently employed in an environment of high noise there is a strong possibility that hearing damage will result. In these cases it is advisable to have a record of the environmental noise.

2. The determination of the amount and reduction of the noise in the neighborhood of the installation to acceptable level.

The nature and magnitude of the interference depends upon several factors. Some of these are as follows:

1. The number of jet engine testing cells in operation.
2. The amount of attenuation provided initially in each test cell.
3. The rate of fuel consumption per engine.
4. The nature of the surrounding terrain.
5. Wind and temperature conditions.

Community noise survey monitor systems are now being used so that the plants have a continuous indication of the sound level and spectrum of the noise. See Fig. 1.

At the same time an automatic

warning system is provided when the level exceeds a certain specified amount at all community microphone monitor locations.

The system is divided in two parts:

1. The microphone pickup units, associated amplifiers, and power supplies for each check area.
2. The sound control center at the plant where the receiving amplifiers, analyzers, recording

equipment, warning lights, and audio monitor is provided.

These two basic parts of the system are several hundred feet to a few miles apart and are connected by leased telephone circuit facilities. Specifications for such a system are as follows:

1. The overall equipment shall be capable of a minimum dynamic range of 50 db.

(Continued on page 190)

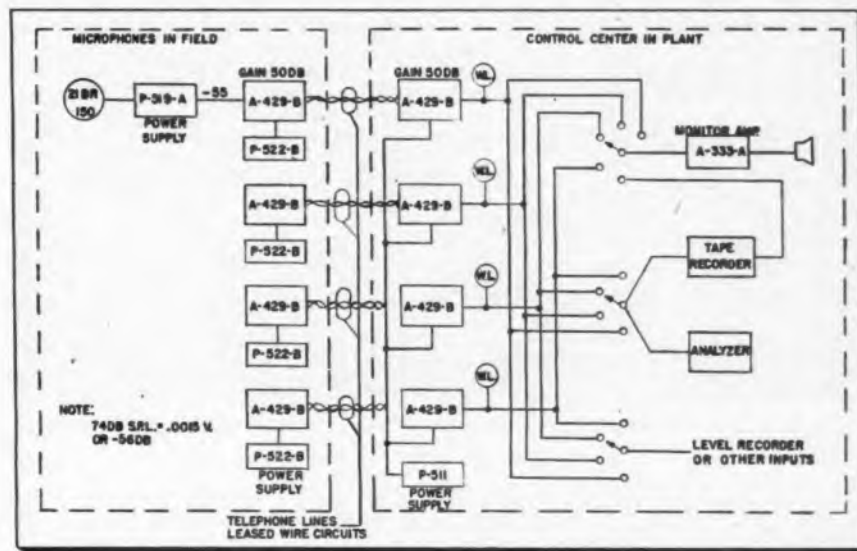
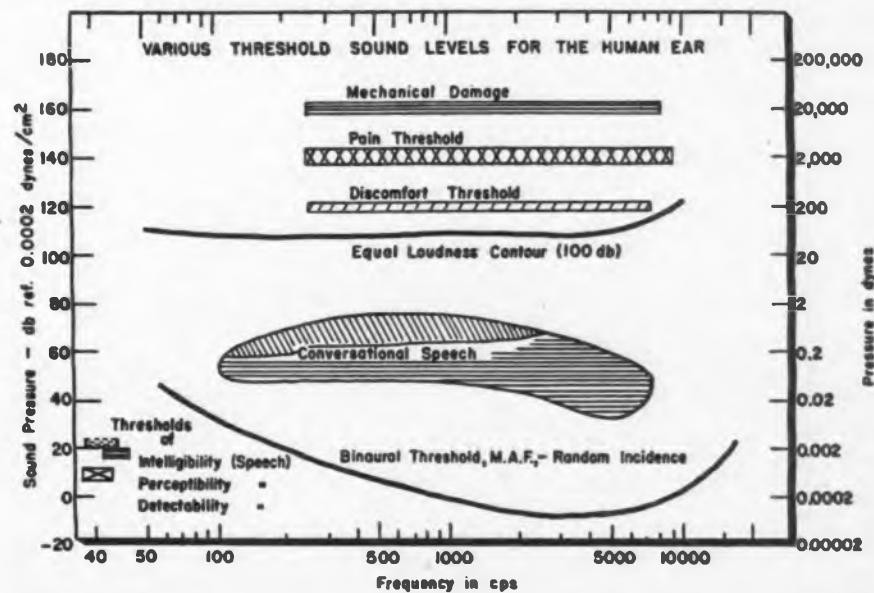

Fig. 1: Community noise monitor system provides continuous indication of sound level

Fig. 2: Threshold sound levels encountered by personnel in aircraft engine plants



New Carrier System Links All Tra

Open wire, cable, radio and microwave circuits can be directly interconnected to form a single toll route with '45-class' terminal equipment

By W. S. CHASKIN
Carrier Development Dept.
Lenkurt Electric Co.,
San Carlos, Calif.



Fig. 1: Two complete 48-channel terminals for Type 45BX system for multiplexing wide band radio

Fig. 2: Modulation plan and basic frequency allocations for the 45A, B, BX and D systems

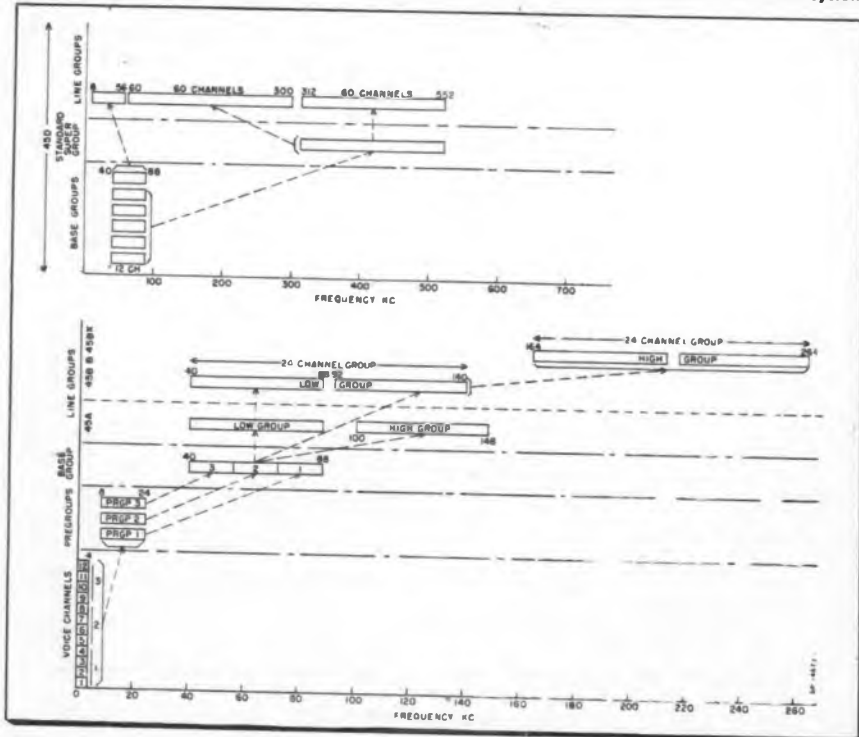

RAPID expansion of long distance telephone facilities in recent years has, to a large extent, been made possible by the availability of modern carrier telephone equipment. Many new and different types of carrier systems have been designed to fully utilize the practical frequency range of every physical circuit. With these various systems, up to 16 carrier-derived voice channels can be transmitted over a single open-wire pair by utilizing frequencies up to about 150 kc. Up to 24 channels are transmitted over symmetrical cable pairs using frequencies up to 264 kc.

In addition, the expanding field of multichannel microwave radio has still further increased the requirements for carrier equipment. Transcontinental microwave systems transmit hundreds of telephone channels over a single radio circuit, and many shorter routes use microwave for transmission of the smaller channel groups which make up an essential part of all toll telephone networks.

Network Planning

The increasing use of carrier systems on different transmission media has posed a number of problems for engineers concerned with telephone network planning. One of the major problems has been the procurement of carrier equipment which would permit the use of more than one method of transmission between the end terminals of a single toll route. For example, it is often desirable to transmit a multichannel group part way by open wire line and part way by cable or radio. Unless the carrier equipment used is capable of operation over both media, it would be necessary to terminate the carrier channels at the junction between them. In an open wire-microwave route, for example, an open wire carrier system would

be used
At the j
have to
frequenc
carrier s
to carrie
sion to
Not only
cause of
nals at
line and
impairm
since son
mitted sp
stages of
tion req
is slight,
ly by in
To ov
inherent
of carrie
mission
rier equ
for univ
mon tra
equipme
of basi
which ca
of ways
mission
for open
A typica
new eq
designat
1.

Tra

Specifi
tinguish
of modu
number
frequenc
the syst
ing arr
characte
medium.
Three
velopme

Transmission Media

be used on the open wire section. At the junction, the channels would have to be brought down to voice frequency, transferred to a radio carrier system, and converted back to carrier frequency for transmission to the ultimate end terminal. Not only is this method costly because of the complete carrier terminals at the junction between wire line and radio, but it also results in impairment of transmission quality since some degradation of the transmitted speech results from the extra stages of modulation and demodulation required. Although impairment is slight, it can be avoided completely by inter-connection.

To overcome the disadvantages inherent in the use of different types of carrier systems for different transmission media, a new class of carrier equipment has been developed for universal application to all common transmission media. This new equipment class utilizes a single type of basic channelizing equipment which can be arranged in a number of ways to provide the proper transmission levels and frequency ranges for open wire, cable or radio circuits. A typical system arrangement of this new equipment, which has been designated '45-class' is shown in Fig. 1.

Transmission Characteristics

Specific 45-class systems are distinguished in two ways. The number of modulation steps varies with the number of channels and the final frequency allocation desired; and the system regulating and equalizing arrangements vary with the characteristics of the transmission medium.

Three interrelated engineering developments have helped to obtain

practical realization of the universal application aspect for the 45-class systems. These are:

1. A modulation plan providing standardized channel groups for open wire, cable, and radio systems.
2. Simple interconnectors for junctions between different transmission media so multi-channel groups can be interconnected between the various systems at carrier frequencies.
3. Miniaturized plug-in components and subassemblies which permit standard chassis and equipment self arrangements to be used for a wide variety of equipment options.

Modulation Plan

The modulation plan for all 45-class systems utilizes two multi-channel groups as shown in Fig. 2. The first (called a pregroup) consists of four channels occupying the frequency spectrum from 8 to 24 kc. The second (called a basegroup) consists of three pregroups modulated to occupy the spectrum from 40 to 88 kc. By further group modulations, basegroups can be shifted to any position in the frequency spectrum required by the different transmission media.

Interconnection

The use of standard pregroups and basegroups in all 45-class carrier systems allows simple interconnection at carrier frequencies between different types of systems. In the modulation and demodulation processes in all systems employing 12 or more channels, there is a common step of modulation in which the channels are arranged in groups of

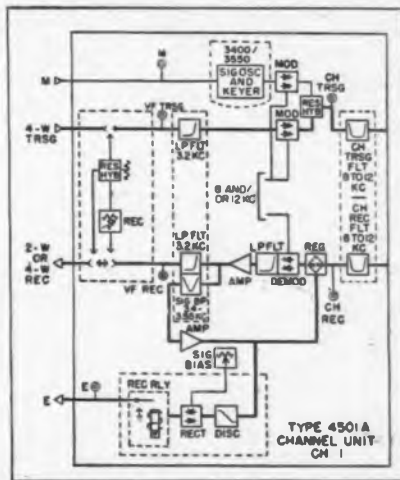

Fig. 3: Block diagram of channel terminal unit

12 at the basegroup frequencies of 40 to 88 kc. At this stage of modulation, 12-channel groups can be interconnected with very little additional equipment. Groups of four channels can also be interconnected if desired at the pregroup frequencies of 8 to 24 kc.

Carrier frequency interconnection eliminates all of the individual channel equipment. Consequently it is much less expensive than the voice frequency connections which would be necessary with previous types of carrier equipment.

Plug-In Construction

Full realization of a universal carrier system would be impossible without some kind of unitized plug-in construction. Each equipment arrangement would have to be individually engineered and manufactured; and once manufactured could not easily be rearranged to accommodate changing toll circuit layouts. In 45-class carrier equipment, these major obstacles have been largely overcome by the development of unitized plug-in construction to an extent not previously achieved in carrier manufacture.

Two important advantages accrue

Fig. 4: (l) Basic chassis and plug-in assemblies for terminal unit Fig. 5: (r) System regulator unit and line group amplifier



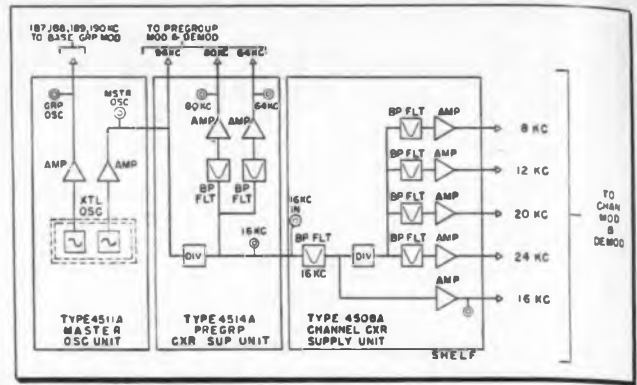
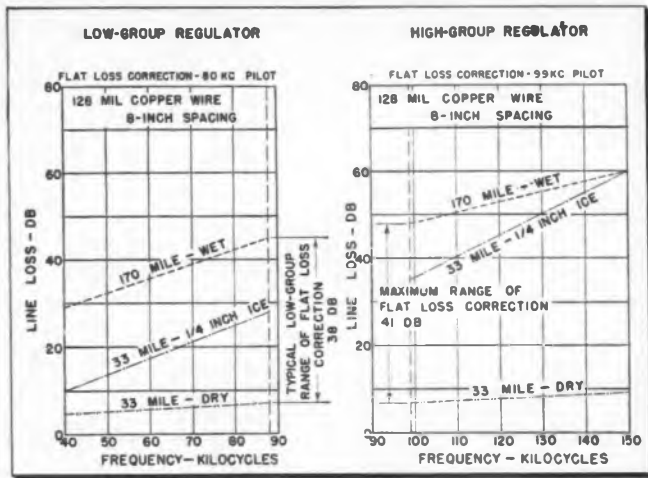

Fig. 6: (1) Attenuation varies with weather on open wire lines
Fig. 7: (above) Diagram of West-East and East-West system regulators

Carrier System (Continued)

from this extensive use of plug-in construction. First, interchangeability of various subassemblies allows a wide variation in equipment arrangements to meet different operation requirements. Second, the cost, both in initial investment and subsequent maintenance, is less. Fewer spare parts are required and, when repair becomes necessary, the defective unit can be replaced with a spare while it is sent to a centralized repair depot for service. Interruption of service is reduced to a minimum.

45-Class Systems

Four different arrangements of 45-class terminal equipment are either in production, under development, or planned. These four systems will meet all important requirements for carrier equipped open-wire lines, cable, or radio circuits. Frequency allocations for all of these systems are shown in Fig. 2. The 45A 12-channel open wire line system and the 45BX 48-channel radio system are now in volume production. The 45B 24-channel cable carrier system is now undergoing extensive field tests prior to finalization of design. The 45D radio system, providing 60-channel supergroups for heavy traffic routes, is undergoing active engineering development.

Design Problems

One of the principal design requirements for 45-class systems was to produce highly compact equipment which could reliably provide proper transmission quality. To achieve this objective, full advantage was taken of recent progress

in the design and manufacture of miniaturized electronic components. For example, tantalitic capacitors, miniature paper capacitors, and miniature toroidal inductors are used extensively throughout.

Many man-hours of labor went into producing the best possible packaging arrangements with the net result being that the equipment occupies approximately one-fifth the rack space required by previous systems of equivalent performance. This reduction in size was accomplished without degrading the performance of the equipment or sacrificing reliability and life expectancy.

Channel Terminal Unit

The channel terminal unit shown in Fig. 4 is a basic building block element in all 45-class systems. Because of this multiple use, particular attention was paid to making the unit as flexible as practical. Circuitry has been developed to obtain maximum component utilization compatible with straightforward design.

A block diagram of the channel terminal unit is shown in Fig. 3. Voice frequencies enter the panel on either a two-wire or a four-wire basis by a choice of plug-in elements. On the transmitting branch, the voice frequency bandwidth is restricted either to 3100 cps or to 3400 cps, depending on whether out-of-band frequency shift signaling is to be used, by a low-pass filter packaged as a plug-in subassembly along with a receiving low-pass filter and a signaling pick-off filter. From the transmitting low-pass filter, voice frequency energy is converted upwards in frequency by a simple germanium diode modulator.

Two such modulators are included in the transmitting branch. The second modulator is used to modulate the output of the signaling oscillator and keyer unit. Carrier power to the modulator in the message transmitting branch is deliberately restricted to provide desirable limiter characteristics. Purpose of the two modulators in the transmitting branch is to reduce interaction between voice frequency and signaling energy at high message input signals. This is particularly important because the signaling frequencies are also used to operate an individual channel flat gain regulator at the receiving end. The proper sideband is selected by a transmitting band filter which is housed in a plug-in subassembly along with a receiving band filter. One of four different filter subassemblies is used, depending on the channel position in the frequency spectrum from 8 to 24 kc. Attenuation slopes of these band-pass filters are made symmetrical to permit changes of sideband location. Conversion to either upper or lower sideband is made by moving the channel carrier frequency from one end of the band to the other.

Single Demodulator

Demodulation is also accomplished by a germanium diode modulator. A single demodulator is used for both signaling and voice. This is possible because, in the receiving branch, sufficient carrier power may be supplied to the modulators to obtain linear characteristics for normal operating levels. A simple low-pass filter following the demodulator suppresses upper sidebands and therefore reduces the load handling requirements for the receiving amplifier. Output of the receiving amplifier is fed to parallel connected
(Continued on page 185)

Locked Oscillators for Test Equipment

As a frequency controller, frequency multiplier or power amplifier these circuits can prove valuable in the design of frequency measuring equipment

A locked oscillator is an oscillator which is controlled absolutely in average frequency by some synchronizing signal. This synchronizing signal may be the same frequency as the oscillator output frequency or bear some harmonic relationship to this frequency. Used in the latter manner, locked oscillators may be used as either a multiplier or divider of the synchronizing frequency. In some systems the output of the locked oscillator is very much larger than the synchronizing input and in this way the locked oscillator becomes a power amplifier of good sensitivity. Furthermore, most locked oscillators tend to discriminate against unwanted signals away from their operating frequency. Spurious signals which are present in the synchronizing input and are far enough removed from the actual operating frequency are greatly attenuated in the output of the locked oscillator.

Heterodyning Action

These features make the locked oscillator a desirable circuit to use in frequency measuring equipment of the heterodyne type. Accurately known frequencies may be generated by mixing harmonics of a standard crystal source with a low frequency oscillator. The desired frequency from the mixing process can be used as synchronizing signal for a locked oscillator which serves not only to discriminate against unwanted mixing products, but to amplify the desired mixing product and provide it or its harmonics for use in the output of the frequency measuring equipment. An oscillator may be synchronized to a high order harmonic of a standard signal and thus provide a new harmonic sequence directly related to that of the standard crystal and extending its frequency range. They may also be synchronized at some sub multiple of a control frequency and their uses in this manner for timing, gating, etc. are well known. There are certain disadvantages as-

sociated with locked oscillators. In the absence of a synchronizing signal they still tend to produce an output. If the parameters in the circuit drift far enough the oscillator may jump out of synchronization and produce a spurious output. They may tend to synchronize on a wrong harmonic or wrong sub-multiple of the control frequency in the case where they are being used as multipliers or dividers. There is usually a certain amount of phase jitter associated with the output signal with respect to the synchronizing signal. The amount of jitter depends upon the system being used as well as the parameters in that particular system. There is always the static

phase error in the output as referred to the synchronizing input.

Phase Jitter

Most of these disadvantages are of no major consequence in frequency measuring and generating equipment. Checks can always be made to be certain that the oscillator is synchronized properly and at the right frequency. Phase jitter can be objectionable if it is large enough to cause noticeable frequency deviations in the output. Static phase error is of no importance. Drifts in static phase can cause error if measurements of a high order of accuracy are being made. Since frequency change is the derivative of phase, a rate of change of phase of 2π radians/sec. will produce a frequency error of 1 cps. Locked oscillators can tolerate only a given amount of phase shift between the output and the synchronizing input. If this amount is exceeded the oscillator will jump out of synchronization. Therefore, if the oscillator remains locked, these frequency errors are

(Continued on page 196)

By **LEONARD S. CUTLER**
Gertsch Products Inc.
11846-48 Mississippi Ave.
Los Angeles 25, Calif.

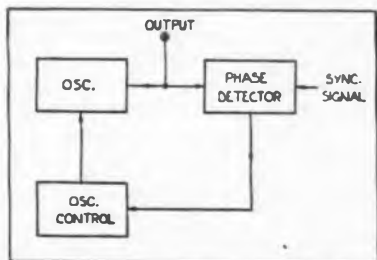

Fig. 1: (above) Simple feedback locking

Fig. 2: (r) Double mixer feedback system

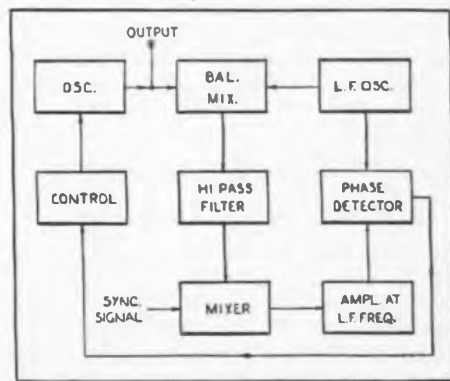

Fig. 3: (l) Direct reading VHF frequency meter

Fig. 4: (below) Microwave frequency multiplier



Surface-Barrier Transistor

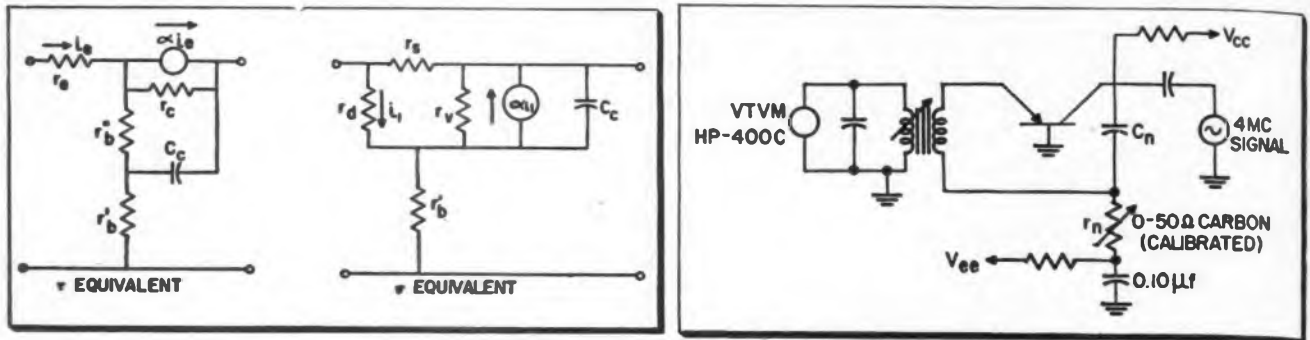

Fig. 1: (l) Surface-barrier transistor equivalent circuits, T and pi types. Fig. 2: (r) Set-up for making r_b' measurements

New semiconductor permits high-frequency operation at low power levels. Testing and design techniques presented for bandpass amp, oscillator, mixer and flipflop

IN the latter part of 1953, the development of a revolutionary new semi-conductor device, the surface-barrier transistor (SBT), was announced^{1,4}. This new transistor is of special interest to the design engineer because he now has available a transistor that is capable of high-frequency operation at low power levels. The surface-barrier transistor has been used in such typical circuits as bandpass amplifiers, wide-band low-pass amplifiers, oscillators, mixers, and high-speed switching circuits.

Equivalent Circuit

As an aid in designing SBT cir-

cuits with predictable performance, an adequate equivalent circuit must be adopted. Two equivalent circuits (Fig. 1), a π type² and a conventional T, were tested. It was found that the π best describes the surface-barrier transistor. The main advantage of the π equivalent circuit is that its resistances are independent of frequency. This was verified by the agreement between measured and calculated values of input impedance vs. frequency. (The active current generator, alpha, is the only frequency-dependent parameter in the π equivalent circuit.) Furthermore, the emitter diode resistance of the π , r_d , closely follows the theoretical kT/qI_e relationship (k is Boltz-

mann's Constant, T is the absolute temperature, q is the electronic charge, and I_e is the dc emitter current) whereas r_e , in the T equivalent circuit, varies widely. Equations relating the T and the π equivalent circuits are given below.

$$r_d = r_e + r_b' (1 - \alpha_0)$$

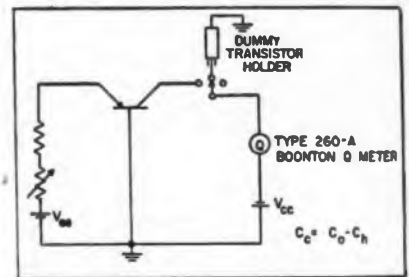
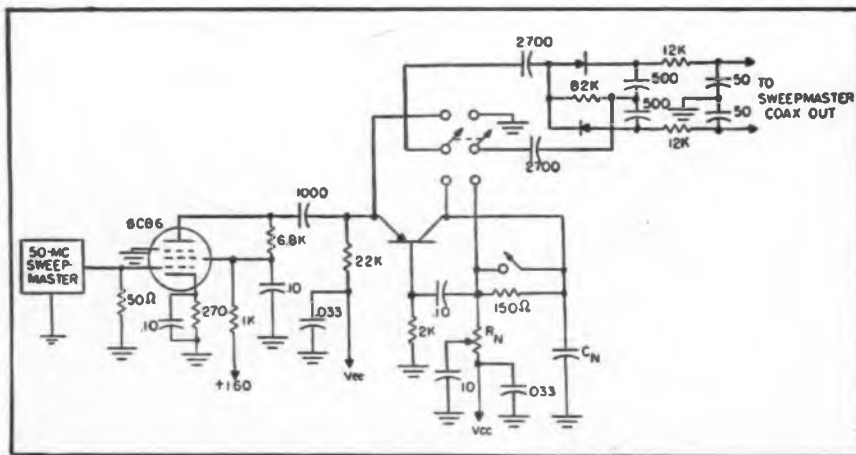

Fig. 3: Circuit for C_c measurements

$$r_v = \frac{r_c}{r_e}$$

$$r_s = \frac{r_c}{r_b'}$$

Fig. 4: Schematic of 50 mc alpha cut-off bridge. Neutralization eliminates load reactive effect



where r_d = emitter-diode resistance (kT/qI_e)

r_v = output-barrier reverse resistance

r_s = shunt resistance due to space-charge layer widening of the output barrier

α_0 = short-circuit, low-frequency current gain

C_c = collector capacity

r_b' = bulk spreading resistance of the base region

r_b'' = low-frequency component of base resistance due to space-charge layer widening

r_e = series emitter resistance

Me

B
P

r_e
 f_{co}
 I_e

The l
the sur

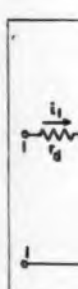
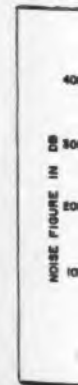

Fig.

measur
mercial
(such a
T-61).

Fig.



Measurements and Applications



By **ROLAND J. TURNER**
Research Div.
Philco Corp.
Philadelphia 34, Penna.

r_c = collector resistance
 $f_{c\alpha}$ = frequency at which alpha is 0.707 α_0
 I_{c0} = collector current with zero emitter current

Measurement Techniques

The low-frequency parameters of the surface-barrier transistor are

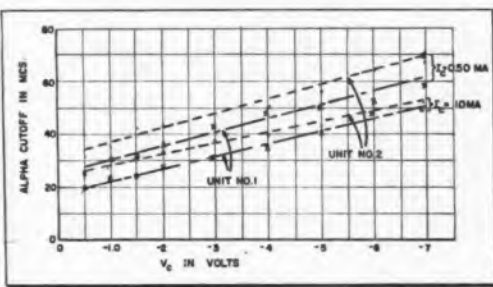
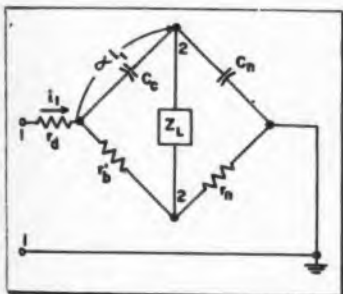

Fig. 5: (l) Neutralized bridge as equivalent circuit. Fig. 6: (r) Alpha cut-off characteristic

measured on a conventional commercially available bridge circuit (such as Transistor Products model T-61). The parameters of eight typi-

cal surface-barrier transistors are listed in Table 1. A great similarity can be noted between these units. For alpha cutoff frequencies between 50 and 60 mc, the barrier-to-barrier spacing is on the order of 0.0002 inch $\pm 5\%$. This indicates that the fabrication process is capable of holding tolerances measured in frac-

tions of a wavelength of light. The figure of merit for a bandpass amplifier is²

$$G_p = \frac{\alpha_2}{8} \frac{1}{(2\pi f C_c r'_b)^2}$$

where G_p is the power gain, and α is the common-base current gain at the frequency f . The figure of merit for a wide-band, low-pass amplifier with equal source and load impedance is

$$\text{Gain} \times \text{Bandwidth} = \alpha_0 f_{c\alpha}$$

Consequently, three parameters,

$$C_c, r'_b, \text{ and } f_{c\alpha}$$

describe the high-frequency performance of the surface-barrier transistor.

As can be seen from Table I, the collector capacitance of SBT's are very small. Therefore, it is necessary to eliminate the capacity of the

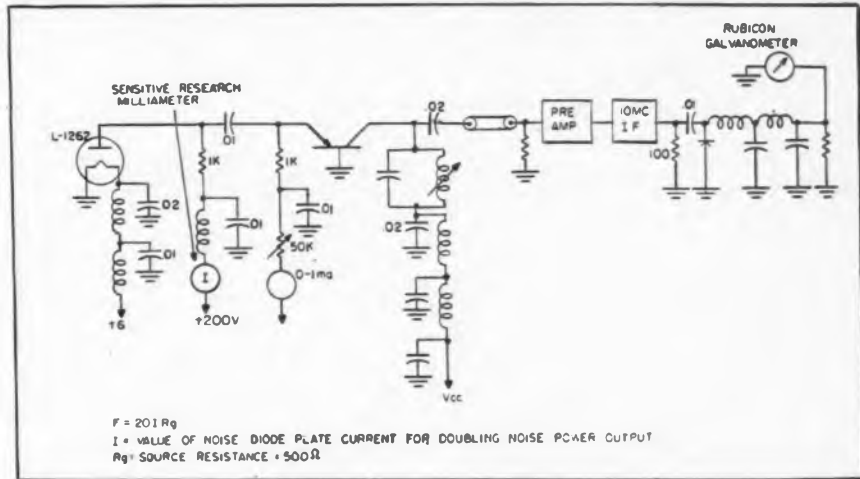
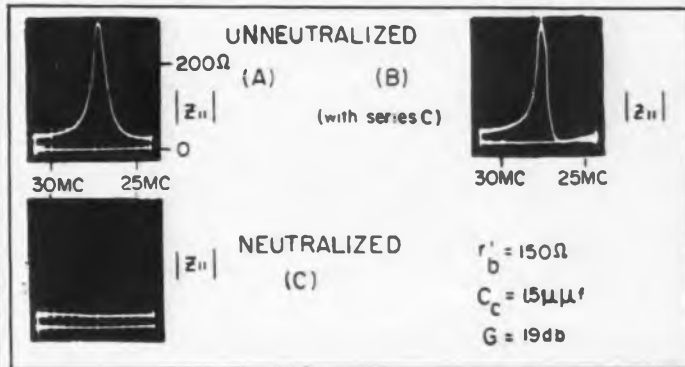
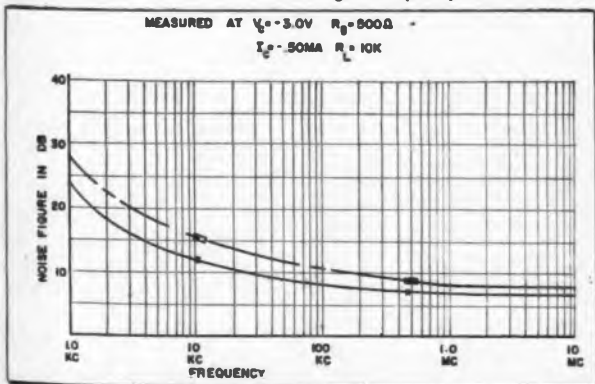

Fig. 7: Circuit for measuring transistor noise figure employs noise diode for high frequencies

Fig. 8: (l) Surface-barrier noise figure-frequency characteristic. Fig. 9: (r) Emitter input impedance-frequency response of tuned amplifier



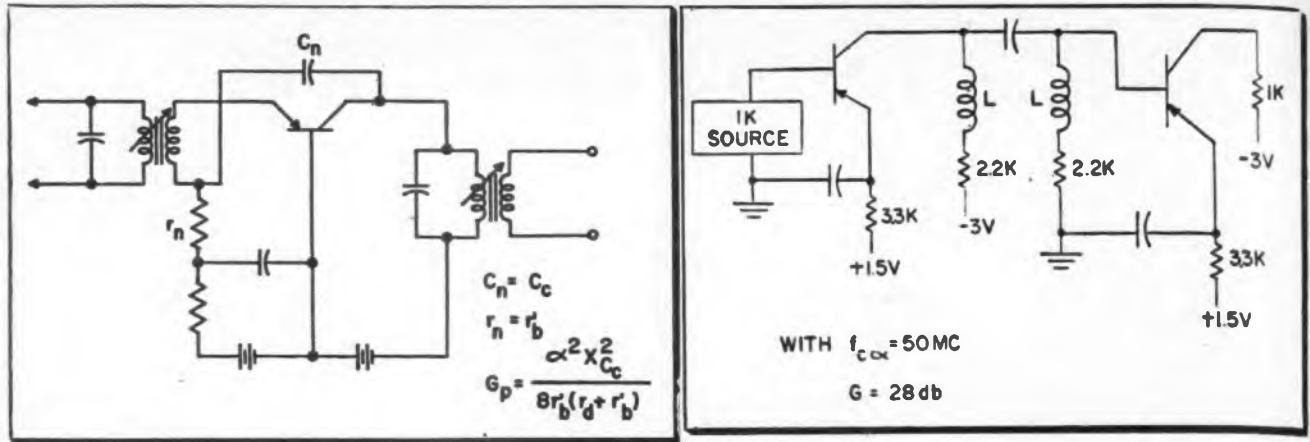

Fig. 10: (l) Neutralized bandpass amplifier. Fig. 11: (r) Surface-barrier transistor two-stage video amplifier. Gain is 28 db

Barrier Transistor (Continued)

transistor holder C_h in measuring C_c because C_n , which is about 1.35 μf , can be tuned out by means of an external reactance. By using the circuit shown in Fig. 3, the capacity of a dummy transistor, C_h , and the output capacity of the SBT under test, C_o , are measured separately. C_c is then determined by subtracting C_h from C_o .

Typical neutralized bridge circuits for measuring

$$r'_b \text{ and } f_{ca}$$

are shown in Figs. 2 and 4. Neutralization is necessary to eliminate the effect of a reactive component of load current at high frequencies (due to the relative magnitudes of

$$r'_b \text{ and } X_{C_c}).$$

The ac equivalent of these circuits is shown in Fig. 5. The SBT π equivalent has been used; r_s and r_v are not included because they are negligibly large. When the bridge is balanced,

$$r'_b C_o = r_n C_n$$

the only output-producing source is the active current generator, and the open-circuit impedances are

$$Z_{11} = r_d + \frac{(2 - \alpha) r'_b}{1 + j r'_b / X_{C_c}},$$

$$Z_{12} = 0,$$

$$Z_{21} = -j \frac{X_{C_c}}{2},$$

and

$$Z_{22} = \frac{r'_b - j X_{C_c}}{2}$$

Because $Z_{12} = 0$, the accurate measurement of f_{ca} and r'_b is simplified.

In measuring r'_b (Fig. 2), r_n is varied for a null on the VTVM. At the null point, $r'_b = r_n C_n / C_o$.

In measuring

$$f_{ca} \text{ (Fig. 4),}$$

r_n is set at the position which causes

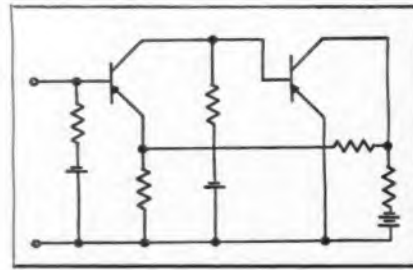

Fig. 12: Two-stage feedback amplifier

the input impedance to be unchanged when the load is shorted. The input frequency is increased to a value such that alpha is 0.707 α_o . This frequency is, by definition,

f_{ca} . The variation of f_{ca} with V

for two typical surface-barrier transistors is shown in Fig. 6. A voltage dependency of approximately 5.0 mc/v is noted for these units.

A figure of merit relating device noise to a known thermal noise present in a resistor is called noise figure. Several methods exist for measuring noise figure. A cw method is used at low frequencies (below 100 kc) and a noise-diode method at high frequencies (above 400 kc). The latter method (Fig. 7) is by far the more accurate and reliable since it is independent of the gain and the noise bandwidth of the measurement system. At low frequencies the SBT noise figure varies inversely with frequency, but from 455 kc to 10 mc SBT noise figure is independent of frequency. A plot of noise figure vs. frequency for two typical surface-barrier transistors is shown in Fig. 8.

Applications

The necessity for bandpass amplifiers capable of operating in the
 (Continued on page 162)

TABLE I

SBT Parameters

measured at $V_c = -3.0\text{v}$ and $I_c = -0.50\text{ma}$

Unit	α_o	f_{ca} (mc)	C_o (μf)	r'_b (Ω)	T-Equivalent			I_{co} (μa)	π -Equivalent			10-Mc Noise Figure (db)
					r_e (Ω)	r_o (K Ω)	r'_b'' (Ω)		r_d (Ω)	r_v (meg Ω)	r_n (K Ω)	
C-238	.830	52	2.7	52	19	145	170	5.0	48	.376	41.0	...
C-239	.920	55	2.7	67	19	270	470	1.5	56.7	.805	32.6	...
C-242	.915	60	2.1	67	26	195	370	1.0	57.5	.412	30.3	...
C-245	.860	48	2.0	73	19	200	255	1.0	54.8	.576	43.0	7.0
C-248	.866	55	2.1	70	7	260	350	.50	54	2.00	40.1	6.5
C-249	.934	60	2.7	81	7	210	780	.60	58.5	1.76	15.8	4.9
C-250	.880	52	2.4	60	15	310	340	.50	55.8	1.15	50.8	5.2
C-251	.947	50	2.1	170	11	500	1050	1.0	66.7	3.03	31.8	4.6

Grids for Single-Gun Color Tubes

The West Coast plant of Chromatic TV-Labs, Inc. has swung into mass production of Chromapacs, the color structures that are the heart of the single-gun Chromatron, or Lawrence tube.



1 At right is a 22-in. metal Chromatron, at left, a developmental 21-in. rectangular glass model. Rectangular glass bulb is better suited for mounting in receiver cabinets.



2 Color phosphor 'ink' is applied to glass target plate by silk-screen process. Squeegee passed over stencil forces color through spaces, printing the desired parallel strips



3 After printing on target plate, phosphor is baked and coated with silicate. A plastic film is then applied by floating on a water surface, which is allowed to drop



4 Plates are mounted in a vacuum tank for aluminizing. Aluminum is vaporized under vacuum conditions creating a film on the exposed glass surface of the target plate



5 Whether glass or metal, color TV bulbs are of two-piece construction to allow mounting of the color structure near the face of the tube. Metal flanges hold sections



6 This demountable vacuum system and test equipment for viewing and testing color grid structures assures top performance of units delivered to widespread licensees



7 Face plate sealing machine seals the glass face plate to the stainless steel ring of a 22-in. round metal tube. Tubes shown here are samples being made in lab



8 Glass lathe inserts single electron gun into base of 22-in. tube. These functions are now being undertaken by licensees. Chromatic production is limited to grid units



9 Dynamic tests of finished Chromatrons call for complex color generation equipment though deflection systems for receivers will be the same as for b&w sets

CUES for BROADCASTERS

Practical ways of improving station operation and efficiency

Simple Bracket Makes Log-Keeping Easy Job

FULTON H. TRAVIS, KREW,
Sunnyside, Wash.

EVER feed a standard log sheet into your typewriter, bat out the schedule, then unwind it, run in your times and certifications with a pen, then wind it back into the typewriter . . . and on through the shift?

Try a simple plate which rides down within an eighth of an inch of the platen and swings back out of the way when not wanted. The log sheet goes into the platen, the writing platform slides down, as illustrated and when it's in place, the log can be typed and the writing plat-



Writing platform folds back when not in use

form, which rides with the carriage, provides backing for pen notations. The end result—a typed and written log in a single operation, without the annoyance of removing the sheet every few lines for penned notations.

To gain stiffness on the aluminum sheet (obtained by removing acetate from an old transcription) it's necessary to allow enough material over—about $\frac{3}{8}$ of an inch on each side—to be turned down at right-angles to the working surface. To get a smooth fit on the platen, the right-angle section must be tapered as shown, to match the curve of the platen. When not in use, it is flipped back out of the way, like the paper bales on standard typewriters.

\$\$\$ FOR YOUR IDEAS

Readers are invited to contribute their own suggestions which should be short and include photographs or rough sketches. Typewritten, double-spaced text is requested. Our usual rates will be paid for material used.

Plastic Spray Saves Work

JOHN F. CLEARY, WFBL,
Syracuse, N. Y.

NEXT time storage batteries get you down clean them up, tops, sides, all over. Cover the vent holes with tape, and then spray the batteries all over with the new Krylon acrylic spray. Next maintenance trick they will still be shining like new so, just flick a cloth or clean paint brush across the tops. After shining up the name plates on motors, generators, transmitters, and other equipment, give them a shot of acrylic spray too. They'll stay bright for quite some time.

If your hands get dirty with the sludge off plastic electrical tape after taping hand tools, such as pliers; or you want to keep other taped objects, taped splices, taped plugs in good condition and looking new try the same acrylic spray. For protecting decals and panels it works wonders. After decaling a panel and letting the decals dry for an hour or so, use masking tape where necessary and spray the panel.

Use the recommended cautions when spraying: keep the spray moving at all times, this is very important; do not spray too close to object being sprayed, or too much will be applied over too small an area and the spray will run. Use the spray in a well ventilated area and allow 5 to 10 minutes between sprayings. For maximum protection

and beauty more than one spraying is advised.

Remote Insurance

DONALD M. WHEATLEY, Chief
Engineer, WJOY, Burlington, Vt.

WHEN a remote kit is taken into the field a spare is an inconvenience but added insurance. To get around this headache an emergency remote kit was devised using a hearing aid with a built in mike. The headphone was removed and the output fed into a matching transformer and then to line. The unit was made with two headphone jacks and binding posts, as one of our regular remote kits uses a phone plug and others use binding posts. The transformer and jacks were mounted in a small tin can which had been slotted to hold the hearing aid. The can was then wrapped with electrical tape to dress up the looks. The entire unit is self contained, and while the quality is only fair it can be the difference between no program and a program if the regular remote kit fails while in the field.

Automatic Overload Reset

STAFFORD E. DAVIS, Chief
Engineer, KGVL, Greenville, Texas

THE heart of our automatic reset equipment is a thermostatic Amperite relay. This reset equipment will work on any transmitter that has an extra set of contacts on the overload relay. If the relay does not have extra contacts, one can make existing contacts do double duty and release one pair, or use an additional relay in parallel with the

Hearing aid and matching transformer form inexpensive emergency remote kit

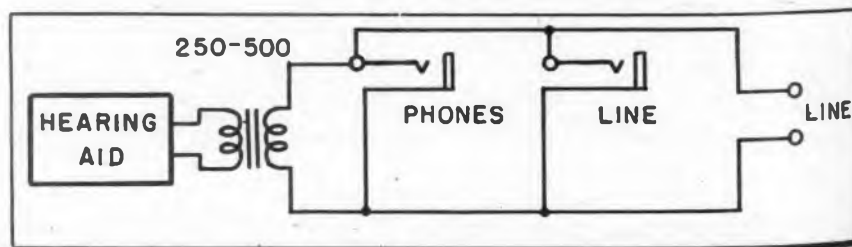

OVERLOAD
EXTRA CON



NORMALLY C
OPEN ON
OVERLOAD

Automatt

existing re
set equipm
ence if the
on an ove
parts need
equipment

Our ec
overtime,
cal storms
the equipm
ter back
due to an
three seco
static elec
or for any
to have 1

Multi Mik
WILLIAM

I N our
uses a

Contact b

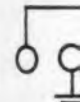

R. F. IN
FROM
MOD-MO
Xm1.
PICK-UP
COIL

100
μm



TELE-TECH

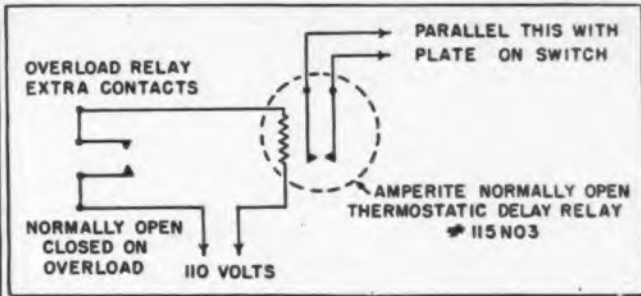
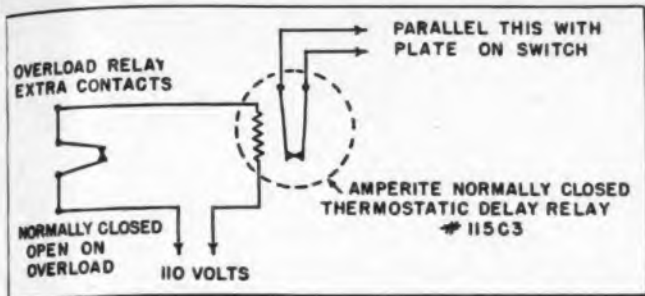

Automatic reset circuit designed around thermostatic relay puts transmitter back on the air within 3 secs. after overload condition occurs

existing relay for the automatic reset equipment. It makes no difference if these contacts close or open on an overload. Two circuits, with parts needed, are shown so that the equipment will work either way.

Our equipment really works overtime, especially during electrical storms. It takes 3 seconds for the equipment to put the transmitter back on the air once it is off due to an overload condition. This three second period is ample for static electricity to pass to ground, or for any other overload condition to have passed.

Multi Mike Input to Console

WILLIAM NARAMORE, WGSM,
Huntington, N. Y.

IN our recording studio, which uses a Gates 52-CS Studioette,

we had need for more microphones. This problem was overcome by using the Gates turntable pre-amp. with a double-pole-double-throw switch using the turntable gain control for control of both microphones.

Air Monitor Problem & Baby (Transmitter) Sitter

MANLY ST. JEAN, WPIN,
Chief Engineer, St. Petersburg, Fla.

TWO studios, two announcers and TV gave rise to two problems when the two studios and two announcers were six miles apart yet "ON AIR" simultaneously and even converse with each other on the same program!

Studio 1 is at the transmitter where its announcer with Restricted Operator License must

watch the Gates 1-D transmitter. We must alert him to any variations of power line voltage or arcs in the transmitter that do not open the circuit breakers. (Sometimes the Gates 1-D will arc in the tank condenser of either the final, or driver,—it stays on the air but with a power reduction of 50 to 75 per cent. Studio 2 is downtown where its announcer must hear everything and wear air monitor earphones when at the mike.

Two lines are leased between studio 2 and studio 1 transmitter. Line 1 carries program of studio 2, and line 2 carries air monitor back to studio 2, while the phantom is used for talk circuit and other things. At the transmitter the 6H6 air monitor rectifier was modified to two completely different and (Continued on page 108)

Contact between distant yet simultaneously operating studios was achieved with this circuit, which provides for indication of transmitter breakdown

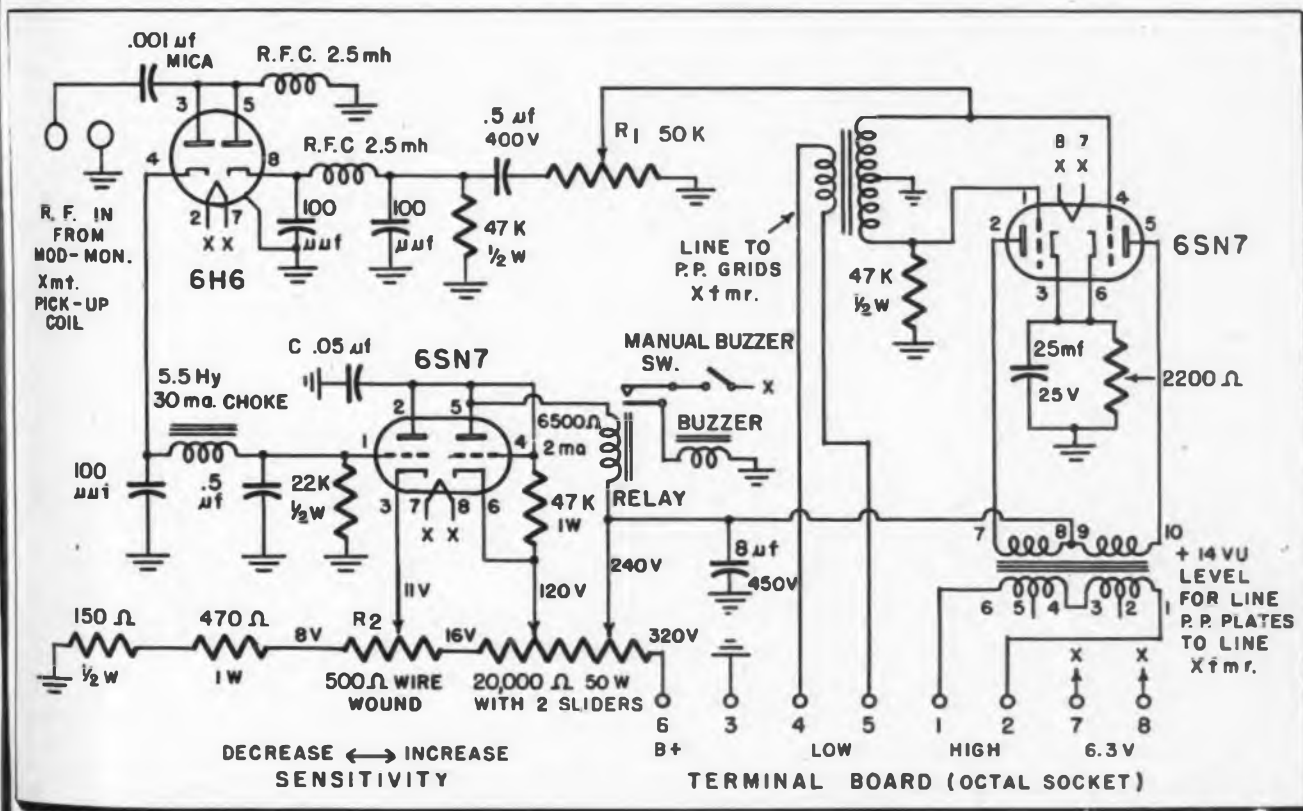



Fig. 1: Ceramic-to-metal for high temperatures

By **HAROLD E. SORG**
 Director of Research and Patent's
 Eitel-McCullough Inc.
 San Bruno, Calif.

LET us first set up the following definition: "Electron tube reliability is the probability that a tube will give satisfactory performance for a specified period of time, when used in the manner and for the purpose intended."

This definition takes into account the fact that in some applications, as in missiles, the required life span of the tube may be relatively short and thus, the importance of other factors will outweigh that of life hours in the socket. This definition may seem an oversimplification, but it is submitted here as a working definition and to provide some sort of frame of reference.

Types of Failures

Considerable effective work is presently being done in military surveillance programs, collecting data on electron tube failures in the field. These data are generally reported under two classifications: Mechanical failures and electrical failures. The first of these includes such things as envelope and seal failures, mechanical faults, heater defects and shorts or opens. These are considered catastrophic failures—that is, the tube functions up to a point and then fails abruptly. The second, or electrical category, constitutes failures due to tube characteristics, such as cathode emission, transconductance, or the like, having shifted or dropped out of electrical limits during the operational life of the tube.

The distribution of failures between the above classifications varies widely, depending, as one would suspect, upon the particular tube type and also upon the environmental conditions. For example, if tubes are subjected to more severe environmental conditions, such as shock, vibration and higher ambient temperature, the mechanical type of

Advance Work in

Research directed at reducing the number of mechanical failures in transmitting and receiving tubes is coming up with a number of interesting design changes

failure increases. If the environment is favorable, losses due to mechanical failures decrease relative to those attributable to electrical failures.

It is worth while observing at this point that, while it is desirable to reduce the number of tube failures in all categories, the most urgent problem lies in the mechanical type failures. With this type of failure the equipment suddenly and without warning fails to function.

Envelope

For a long time we had been convinced that the envelope itself was responsible for many of the difficulties. The electron tube inherited its glassware from the older lamp industry. Many electron tubes today still look like electric light bulbs. It is true that metal has replaced part of the glass in some tube designs, but the glass-to-metal seal problems remain. Glass is bad for several reasons. One obvious thing is that it is fragile and breaks easily. This introduces handling problems and limits ability to withstand shock and vibration.

Another factor is that glass and glass-to-metal seals have limited operating temperatures, which puts a severe restriction on the operational environment. Likewise, the temperature limitations imposed by glass make it difficult to do a good outgassing and exhaust job during

tube manufacture. Another thing is that electrolysis in glass causes premature seal failure. Still another and less obvious factor is that glass is not stable chemically under elevated temperatures and electron bombardment, which produces a source of contaminants unhealthy for the cathode during tube life. Some different kind of envelope material was clearly desirable.

Ceramics

Ceramic of proper composition is a logical choice, because it has the essential properties of electrical insulation and vacuum tightness. The better ceramic bodies of the high alumina type, such as Coors A1-200, have many advantages compared to glass. They are very strong mechanically, having tensile strengths of the order of 25,000 p.s.i. They will withstand high temperatures of over 1500° C, and they are stable chemically. Another advantage from the standpoint of tube fabrication is that ceramic bodies can be produced to precise dimensions and lend themselves well to improved automatic tube assembly operations.

Work on ceramic tubes at Eimac started in 1946. The first years were spent on developing and perfecting ceramic metalizing techniques, i.e., applying a metallic film to the ceramic body so that the metalized ceramic can then be brazed to another part, such as metal. We prefer a

Fig. 2: (l) Ceramic-to-ceramic eliminates metal parts. Fig. 3: (r) An experimental all-ceramic triode

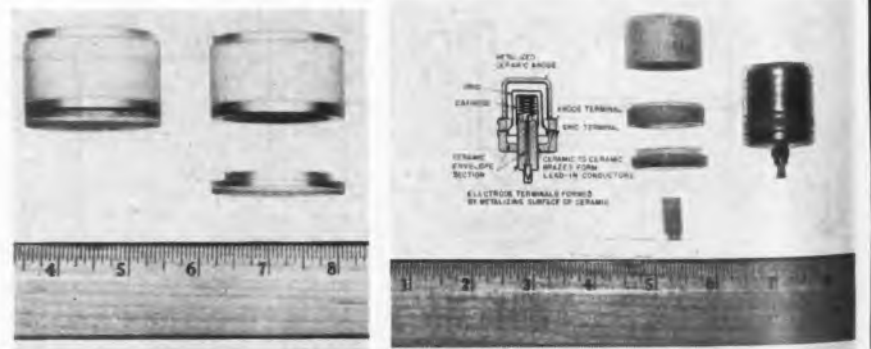

Ele

process powder the ceramicers are temperature ing proced by arriving procedur metal br

Fig. 1 to-metal with high loys, such silver, and was not tures wh avated aments, b at high during t

Very of type of s ramic-to Fig. 2. T fications used the lead-in was to n the cera provide ble to el in the c Eimac co izing ma The vacu a stage c techniqu Fig. 3 triode o The cer self-jigg stacked i of the i

Fig. 4:



Electron Tube Reliability

process of metalizing in which metal powder is sintered to the surface of the ceramic. Refractory metal powders are used to permit high temperature brazing. Various metalizing processes have also been developed by others in this country. After arriving at a suitable metalizing procedure, we perfected ceramic-to-metal brazing techniques.

Ceramic-to-metal Seals

Fig. 1 shows a variety of ceramic-to-metal seals. These seals are made with high melting point brazing alloys, such as copper-gold, copper-silver, and the like. The desire here was not only to provide tube structures which would operate in elevated ambient temperature environments, but also to enable bake-out at high temperatures on exhaust during tube manufacture.

Very early we developed another type of structure which we call a ceramic-to-ceramic seal as shown in Fig. 2. This permitted great simplifications in tube design, because we used the brazed joint itself as a lead-in conductor. The next step was to metalize the outer surface of the ceramic adjacent the joint to provide a terminal. It thus is possible to eliminate all the metal parts in the envelope. New methods at Eimac comprise applying the metalizing materials by printing processes. The vacuum tube is thus arriving at a stage comparable to printed circuit techniques.

Fig. 3 shows an early developed triode of all-ceramic construction. The ceramic envelope sections are self-jigging and are assembled in stacked relationship. After mounting of the internal electrodes, the en-

tire envelope is brazed together in one operation. It is interesting to note that the anode itself is formed by a metalized section of the envelope. This is possible because ceramic bodies are fairly good thermal conductors and a considerable amount of heat can be dissipated through the wall of the tube.

Extensive tests have been run on this kind of integral anode structure. We also have a small test tube using for convenience a stem having cathode and grid of a planar triode known as the 2C39A. The upper part of the tube is simply a ring of ceramic having a metalized ceramic disk brazed to the top and forming the anode, the braze serving as the anode lead-in conductor. The anode disk diameter is $\frac{3}{4}$ in. Such tubes are operating satisfactorily on life with anode dissipations up to 20 watts.

Transmitting Triode

Fig. 5 illustrates a 450-watt ceramic triode in the power tube category compared to an Eimac 450T of like characteristics. The ceramic version has an external metal anode and an envelope comprising two ceramic pieces, one cylindrical and the other disk-shaped. The grid lead-in is at the brazed joint between the ceramic sections, and the filament leads are at pins through the ceramic disk. Reduction in size of the ceramic version compared to the glass tube is notable.

Fig. 4 shows an improved ceramic version of the 450-watt tube having a coaxial stem. The tube has fins for dissipation and will dissipate the 450 watts without forced cooling of any (Continued on page 170)



Fig. 5: 450 watt ceramic triode compared to 450T



Fig. 6: 20 kw tetrode has ceramic-to-metal seals

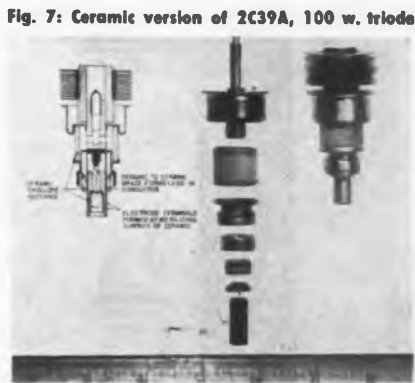
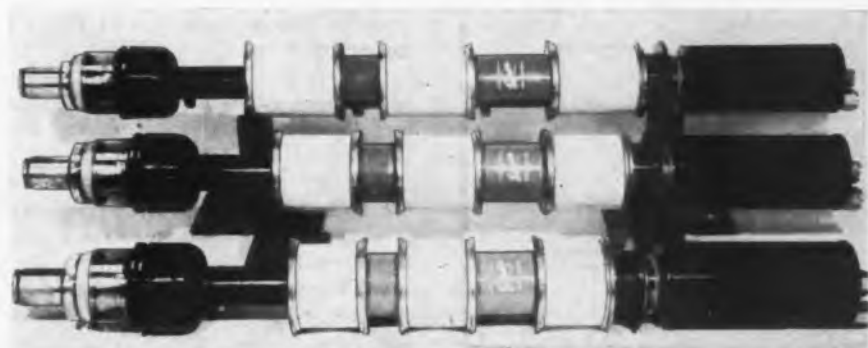

Fig. 7: Ceramic version of 2C39A, 100 w. triode

Fig. 4: Improved 450 watt ceramic triode



Fig. 8: Power klystrons for UHF TV frequencies



New Antenna Coupler for UHF



By **ROBERT I. STAINBROOK**
Hoffman Laboratories
Los Angeles, Calif.

IN communication centers where numerous transmitters, receivers, and other equipment are used, the large number of antennas usually required results in such congestion that it is difficult to obtain the unobstructed locations necessary for efficient antenna operation. A situa-

Fig. 1: Automatic antenna coupler (CU-255/UR)



By permitting the simultaneous operation of up to six transmitters from a single antenna, this new coupler greatly reduces antenna congestion and boosts station efficiency

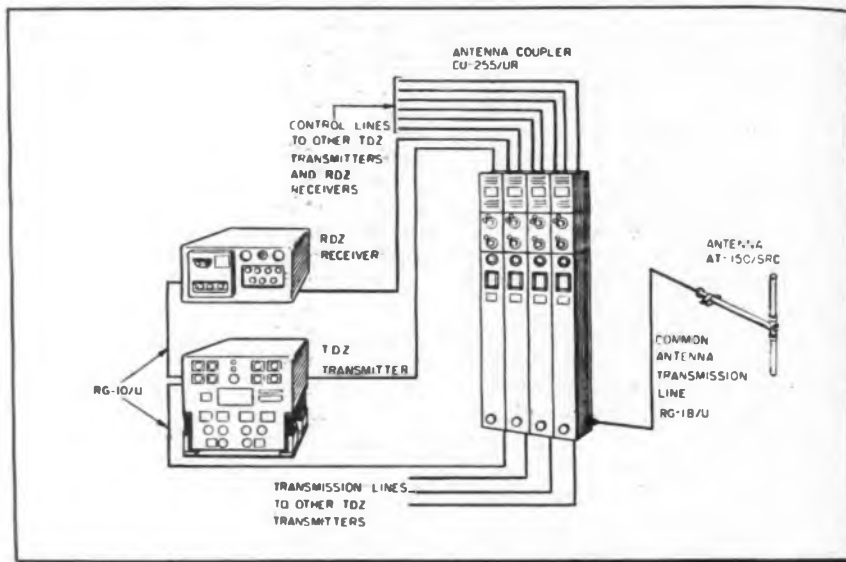

Fig. 2: Typical shipboard installation. Long, thin construction permits mounting on bulkhead

tion of this type created an urgent need in naval radio communications aboard ship for a system permitting the simultaneous operation of several transmitters and/or receivers on a single antenna. From this need resulted the antenna coupler of Fig. 1, which was developed in conjunction with the Naval Research Lab. and produced by Hoffman Labs Inc., Los Angeles, Calif.

These couplers, the CU-255/UR an automatic coupler, and the CU-332A/UR, a manually-adjusted model, provide the circuitry necessary to perform the following functions:

1. They properly couple several simultaneously operating radio transmitters or receivers to a single antenna.
2. They provide an efficient transfer of energy between the antenna and the individual transmitters and receivers.
3. They match the impedance of the antenna system to the impedance of the particular transmitters and receivers.
4. They tune the antenna system to any frequency between 230 to 390 MC.

5. They provide adequate channel isolation to minimize interaction between independent equipments.

6. They reduce the total number of antennas required for numerous communication circuits.

Increased Range

These antenna couplers when arranged in a group of from two to six units provide a system in which two to six radio transmitters, receivers, or transmitter-receiver systems can be operated simultaneously on a single antenna within the frequency range from 230 to 390 mc. See Fig. 2. One antenna coupler is required for each transmitter, receiver, or transmitter-receiver system. They are intended for use either aboard ship or at shore stations. These antenna couplers not only affect a reduction in the number of UHF communication antennas required in communication centers, but also increase the communication range through improved radiation patterns by having the few antennas required installed in unobstructed locations. In addition, these equipments provide an

efficient
ance-mal
tem.
The a
(CU-255
primarily
ceivers
tune" ty
ten pres
manually
presettin
sequent
one of
when th
transmitt
trol equ
necessary
The r
(CU-332
automati
vides for
must be
change
ated tra
antenna
with any
ceiving
provide
ages or
type of

Each
couple
to the
the ante
use in m
and 3. W
of coaxi
wise to
This cut
the "se
When th
antenna
tion of
with, an
tenna tr
A cou
quarter
frequency
positions
semi-co
when th
located
an, effici
between
end of t
opposite
cited s
correct
short c
into the

Circuits

efficient power-coupling, impedance-matching, and filtering system.

The automatic antenna coupler (CU-255/UR) is designed for use primarily with transmitters and receivers which provide the "autotune" type of automatic selection of ten preset channels. It can also be manually tuned, as required when presetting the ten channels. Subsequent automatic selection of any one of these channels is effected when the channel is dialed on any transmitter, receiver or remote control equipment which includes the necessary "autotune" type circuitry.

The manually adjusted coupler (CU-332A/UR) is the same as the automatic model except that it provides for manual operation only. It must be manually reset for each change of frequency in the associated transmitter or receiver. This antenna coupler is intended for use with any UHF transmitting or receiving equipment which does not provide the necessary control voltages or facilities for the "autotune" type of automatic operation.

Multiple Operation

Each antenna coupler serves to couple one receiver or transmitter to the coaxial transmission line to the antenna. They are designed for use in multiple, as shown in Figs. 2 and 3. Within each coupler, a section of coaxial line is cut away lengthwise to expose the inner conductor. This cut-away line is referred to as the "semi-coaxial" antenna line. When the coupler is connected in an antenna system, this cut-away section of line is connected in series with, and becomes a part of, the antenna transmission line. See Fig. 3.

A coupling stub adjustable to a quarter wavelength over the frequency range from 227 to 396 mc is positioned close to the cut-away or semi-coaxial section of line so that, when the stub is tuned and correctly located along the line, there will be an efficient transfer of r-f energy between the stub and the line. The end of the antenna transmission line opposite the antenna is short-circuited so that, when the stub is the correct electrical distance from the short circuit; r-f energy coupled into the line from the stub will flow

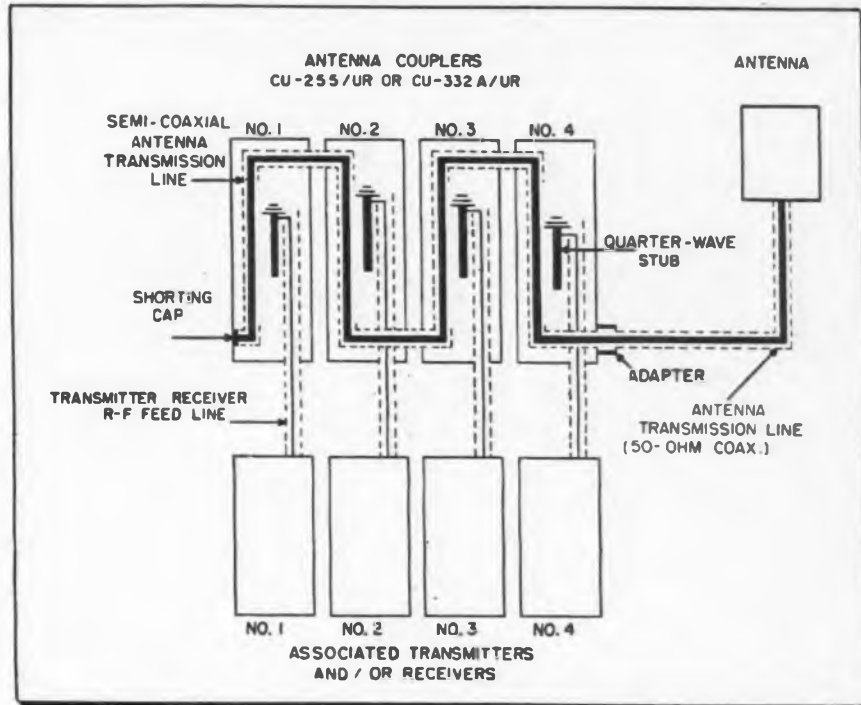
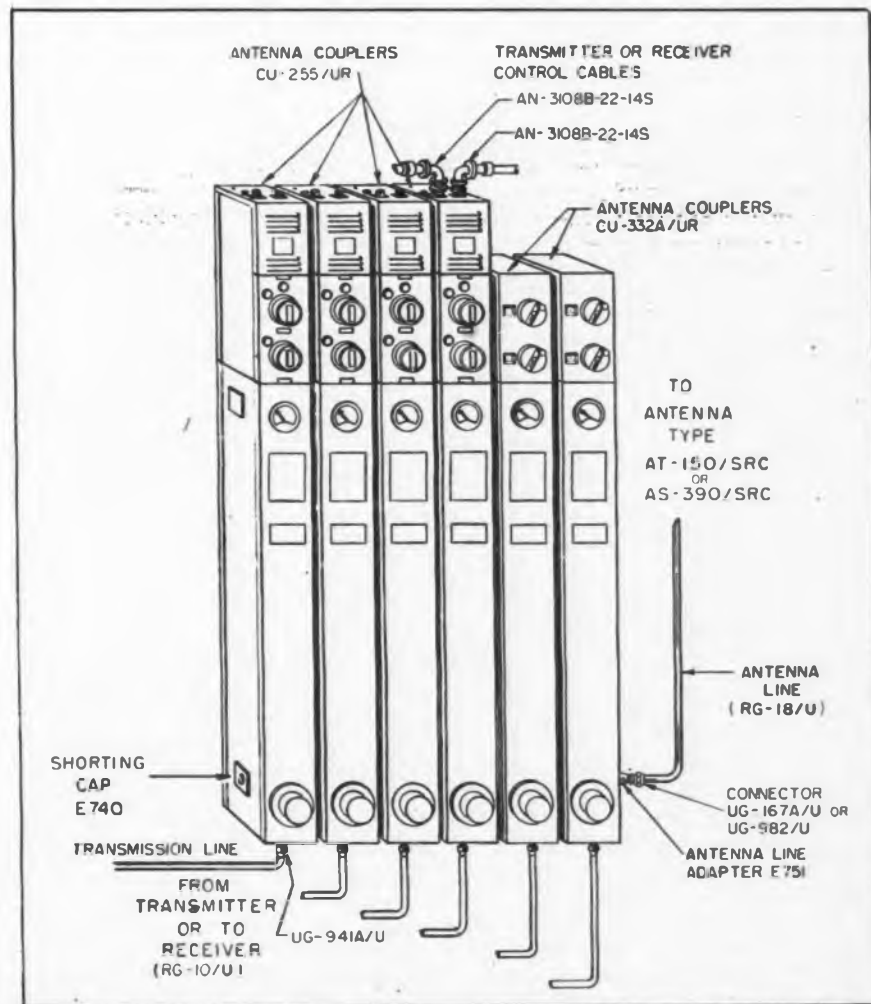

Fig. 3: With coupler connected to system, "semi-coaxial" section is effectively in series with line

Fig. 4: Grouping of 4 automatic and 2 manual couplers. Minimum frequency spacing is 15 MC



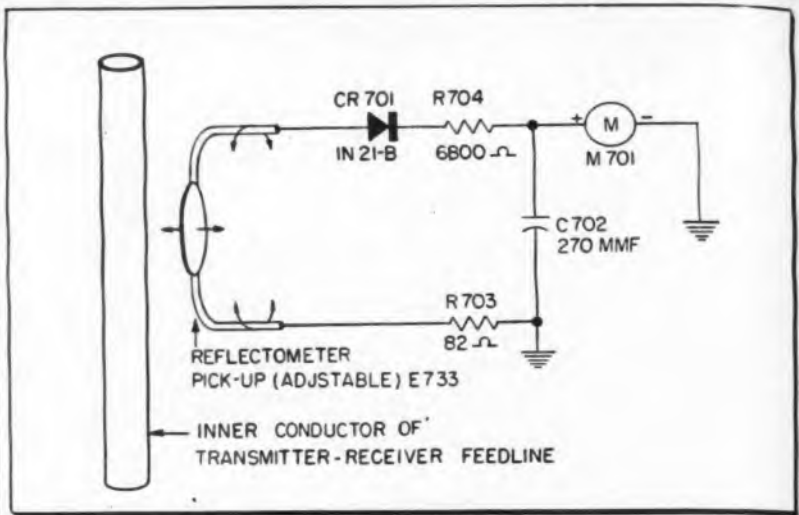
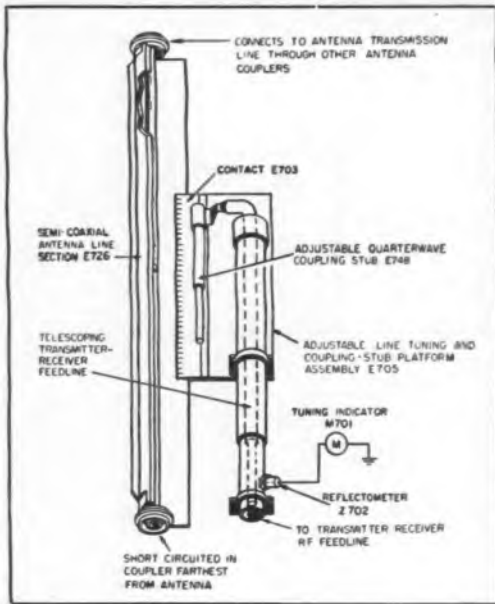

Fig. 6: (l) Diagram of the RF Coupling Section. Fig. 7: (r) Reflectometer rectifies the wave reflected from the coupling circuit back toward transmitter. 0 reading on meter denotes properly tuned coupler.

Antenna Coupler (Continued)

toward the antenna, or conversely, energy coming from the antenna will be coupled into the stub. The transmitter or receiver is connected to the quarter-wave stub through a coaxial line called the "transmitter-receiver r-f feedline."

In a transmitter system, power from the transmitter is fed through the r-f feedline to the quarter-wave stub, coupled from the stub to the antenna transmission line, and, hence, to the antenna. When a receiver is used, the signals picked up by the antenna are fed down the antenna transmission line where they are coupled to the quarter-wave stub and fed through the transmitter-receiver r-f feedline to the receiver.

Tuning Indicator

A reflectometer circuit including a pick-up probe, rectifier, and meter is included for use as an indicator for tuning the coupler when used with a transmitter. In a receiver installation, the tuning meter on the receiver is used as an indicator for tuning the coupler.

The r-f coupling section of the unit contains a section of air-dielectric coaxial line cut away lengthwise so as to expose the inner conductor. Adjacent to and parallel to this cut-away line is a quarter-wave stub coupling element, or coupler as shown in Fig. 3 which is adjustable to a quarter wavelength at any frequency from 230 to 390 mc. R-f power is transferred from this coupler to the exposed inner conductor

of the main line as a result of the mutual coupling between them when the coupler is tuned to resonance. The lower end of the main line in unit No. 1 in the system is short-circuited. The quarter-wave stub is mounted on a platform which can be moved along the main line, thus permitting adjustment of the posi-

Operating Characteristics	
Frequency Range	227.5 to 396.4 MC
Insertion Loss	for single coupler—0.65 db
	for each of 6-unit group—0.66 db
	for each of 6-unit group with 15 MC separation—0.8 db
Power Isolation	minimum isolation level—16.20 db with 15 MC separation over the band
Interaction	with 15 MC separation—0.2 db
Cross Modulation	(in terms of decreased S/N ratio)
	227.5 to 311.95 MC with 5 MC separation—1 db
	with 8 MC—negligible
	311.95 to 396.4 MC with 6 MC separation—4 db
	negligible

tion of the stub with respect to the short circuit. The electrical length and the position of the stub determine respectively the resistance and the reactance presented at the transmitter-receiver feed-line input terminal. These two variables make possible accurate impedance-matching between the coupling circuit and the line to the transmitter or receiver even though the antenna may present as much as a 2-to-1 mismatch with respect to the 50-ohm line used in the system. This results

in maximum transfer of power from transmitter to antenna or from antenna to receiver.

When used with a transmitter, the unit is tuned to a frequency by adjusting the length of the stub and its position with reference to the short circuit until the reflectometer output meter shows a reading of zero. This indicates that the coupling-circuit impedance matches the 50-ohm line to the transmitter; hence, no energy is reflected back to the transmitter. This condition is also optimum for transfer of energy from the antenna to a receiver.

Physical Construction

Each coupler consists of three major parts, namely, the r-f coupling section, contained in the main body of the unit; the reflectometer; and the tuning section. These parts are demountable, and all internal components are made accessible by removal of the side shields. The couplers are designed with a view to the least objectionable space requirements for installation aboard ship; that is, it is made tall and thin so that, when several are grouped together as shown in Fig. 4, the group can be installed on the bulkhead between the vertical ribs of the ship. The automatic tuning section provides a means for tuning the (CU-255/UR) coupler automatically and remotely in conjunction with a TDZ transmitter to ten preset channels.

RF Coupling Section

The coupling cavity is enclosed by the framework and side shields of
(Continued on page 178)

TIME in the guided center of the dual 1), dev Eng. C curate ti being co range fr This u time sign the cons eration c of the sy outgoing ferent a time cod nals is n the elect wide v; equipme theodolit tracking ing equip has its o therefore time cod

A NEW develop for the U manufac is now b military the milit channel links poi radio tr principle

Testing the by Western



Timing System for Guided Missiles

TIME is a common denominator in the range instrumentation of guided missiles. From the nerve center of the A. F. Guided Missile Range in Cape Canaveral, Florida the dual timing Signal System (Fig. 1), developed by the Electronic Engrg. Co. of Calif., is providing accurate timing signals for test flights being conducted over the 1,000 mi. range from Florida to Puerto Rico.

This unit consists of two separate time signal generating systems, plus the console which controls the operation of the two systems. Each leg of the system produces 30 different outgoing timing signals with 13 different available pulse rates and 4 time codes. This assortment of signals is necessary for the operation of the electronic firing system and the wide variety of instrumentation equipment, consisting of radars, theodolites, special cameras and tracking telescopes, and telemetering equipment. Each of these devices has its own specialized purpose, and therefore, a particular time signal or time code is required for its use.



Fig. 1: Dual Timing Signal System installation at A.F. Guided Missile Center, Cape Canaveral, Fla.

To understand why a timing system is necessary, visualize the scores of different instruments located on the islands making up the 1,000 mi. test range. Launched from Cape Canaveral, the missile is tracked by radar, photographed by an assort-

ment of cameras, and subjected to many other kinds of external observation throughout its time of flight. The missile is radioing to the nearest ground station in the range a mass of data which is sent through a
(Continued on page 168)

New Military Field Radio

A NEW field radio equipment developed by Bell Telephone Labs. for the U. S. Army Signal Corps and manufactured by Western Electric is now being delivered for extensive military use. Radio Set AN/TRC-24, the military designation, is a multi-channel communication relay that links points 25 or 30 miles apart by radio transmission, similar to the principle in the Bell System relay

Testing the new AN/TRC-24 Transmitter made by Western Electric for Army Signal Corps.



links now serving the nation's TV networks.

By cascading the equipments in multi-link fashion the relay can be extended to great distances. It replaces or supplements in the Army the relay sets of older design and more limited capabilities, and is used in some cases in place of Western Electric "Spiral-Four" cables, as between communication points not readily accessible due to terrain.

Since the requirements of all military groups was represented by the Signal Corps in guiding the development work, it is believed other military services also will employ this new equipment.

The AN/TRC-24 consists of complete transmitter and receiver components, from power source to antenna and carries spare parts for emergency and maintenance purposes. It provides FM transmitting and receiving facilities in the range 100 to 400 mc for relaying a broad band signal of 250 to 68,000 cps over a line of sight path of transmission. One link would require only one radio set at each end, but where

multi-link coverage is desired, one set would be used at each end of the system and two sets would be used at each relay or intermediate point connected "back to back."

The AN/TRC-24 Radio Set can be used as a single link or multi-link radio circuit between attended wire repeaters, between an attended wire repeater and wire terminal equipment, or between wire terminal equipments. In general, it is used with four or twelve channel carrier trunk systems using Spiral-Four cable connections.

The antenna consists of two half wave dipoles, which may be polarized horizontally or vertically. It has a 5 to 9 db gain with front-to-back ratio of 10-20 db or more. Two antennas may be used on one 45-ft. mast at intermediate relay points. The transmitter has a power output of 100 watts, with tuning calibrated directly in channel numbers. The receiver has a 30 mc i-f, with automatic frequency control, automatic gain control with a manual sensitivity adjustment and a 1600 cps signaling tone.

Determining Capacitor Leakage

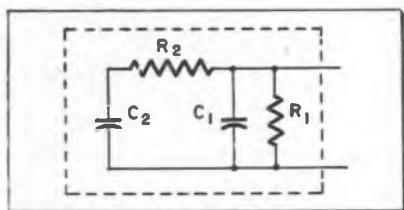

Fig. 1: Equivalent circuit for capacitor

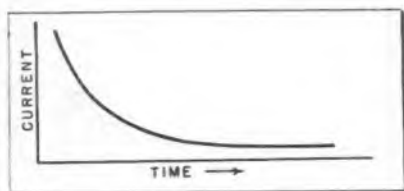

Fig. 2: C_2 current decreases logarithmically

By **ED MOLLOY**
 Research and Engrg. Div.
 Beckman Instruments Inc.
 South Pasadena, Calif.

THE determination of capacitor quality is difficult in several respects. The capacitor value can be established through the use of frequency generators and suitable detection systems, but leakage resistance and dielectric soak characteristics are more difficult to measure. The difficulties encountered have led to confusion in respect to capacitor quality and the performance of precise amplifiers can be impaired because sufficient information about capacitors is lacking.

Equivalent Circuit

The equivalent circuit for a capacitor is shown in Fig. 1 where C_1

is the working capacitor and R_1 represents the leakage resistance; the series components R_2 , C_2 represent the "soak" capacitor and time constant.

The usual method of evaluation is to apply a voltage to the unit and observe the current in one of the leads for some time thereafter; the characteristic curve shown in Fig. 2 indicates that the charging current

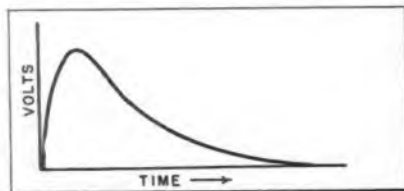

Fig. 3: Peak indicates ratio of C_2 to C_1

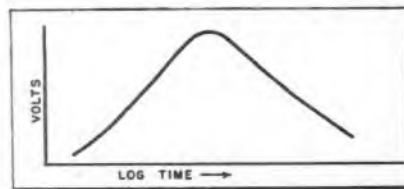

Fig. 4: Semi-log plotting improves curve

for C_2 decreases logarithmically with time until a steady dc current remains which is interpreted as the leakage current of C_1 thru R_1 . If it

is desired to measure the leakage current of the capacitor, sufficient time must lapse after the voltage is applied to assure equilibrium of C_2 before making the current measurement to indicate leakage thru R_1 . The initial part of the curve supplies information about R_2C_2 , but yields no value for either component.

Test Method

The method employed for this investigation is to connect the capacitor to a voltage source for a time long compared to the time constant R_2C_2 , then short the unit for one minute, remove the short and from time to time make observations of the voltage across the terminals by a high impedance voltmeter. Under these conditions the general shape of the function appears as in Fig. 3.

The first portion of the curve denotes the change in voltage across C_1 as a result of charging by C_2 through R_2 . The last part of the curve is the result of the leakage resistor R_1 acting as a shunt or C_1 and C_2 in parallel. If R_2 is small compared to R_1 (which seems to be the case in all experimental data) then the two halves of the curves are relatively pure functions and the magnitude of the peak is an indication of the size of C_2 compared with C_1 .

If the graph is plotted on semi-log

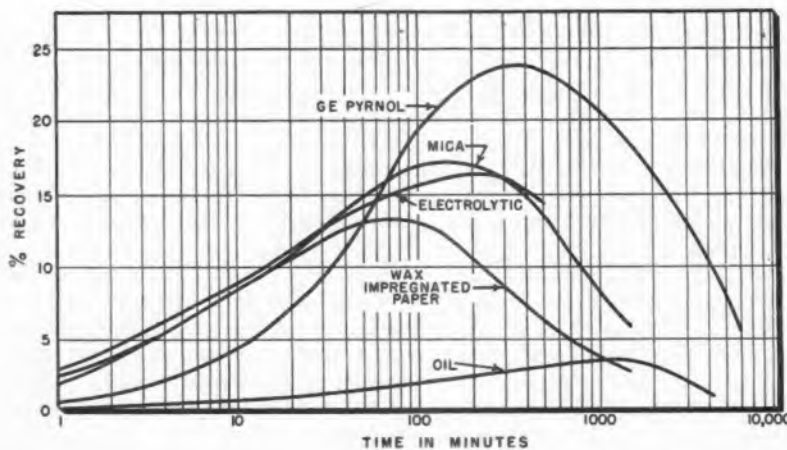
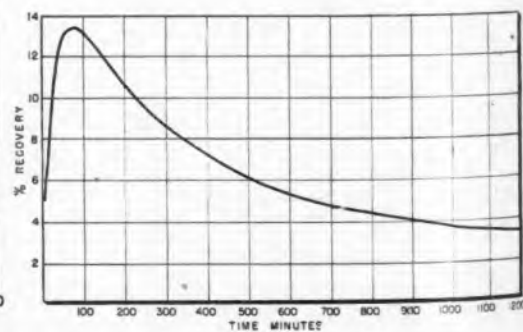

Fig. 5: (I) Performance of various conventional capacitors.

Fig. 6: (below) Typical results plotted on linear time base



Resistance and Dielectric Soak

paper, the interpretation is improved. (See Fig. 4).

Comparison

Tests were conducted on several types of common capacitors: oil filled, wax impregnated paper mica, polystyrene and Mylar dielectric and Mallory F.P. electrolytic capacitors. The results are shown in Fig. 5. Fig. 6 represents a typical set of results plotted against a linear time base.

From a study of the graphical information, it is apparent that this technique can serve as a useful tool in the evaluation of capacitor components. For instance, it is quite clear that Mylar film capacitors do not approach polystyrene dielectric capacitors for "low soak". And while the leakage characteristics of wax impregnated capacitors are poor at higher temperatures compared to oil filled capacitors, the soak effect is more nearly constant as a function of temperature.

In an effort to more thoroughly

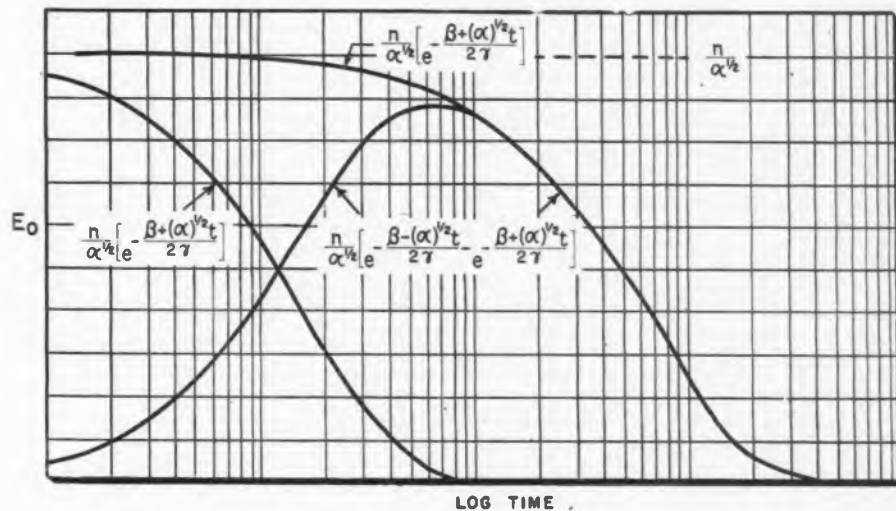

Fig. 7: Resultant and two functions derived from the equivalent circuit of Fig. 8 and calculations

evaluate the experimental data a mathematical solution to the problem was sought. The equivalent circuit of Fig. 8 was used.

Where C_2 is the working capacity, R_2 is the leakage resistance and C_1

and R_1 represent the "soak" components. SW_1 and SW_2 are switches with normally open contacts. The switches are closed briefly, then opened and the voltmeter reading is (Continued on page 161)

DYSEAC—New Electronic Computer

DYSEAC, a high-speed digital computer designed to serve as the experimental nucleus for a complex data-processing network, has been completed by the National Bureau of Standards. The flexibility with which this machine controls and responds to a variety of external devices, which may include one or more full-scale computers of similar design, should enable scientists to explore diverse new areas of interest. Examples include the automatization of industrial and commercial operations, or any field where rapid information-processing and real-time control systems are necessary.

DYSEAC utilizes electronic circuit techniques similar to those used in SEAC. These dynamic circuitry techniques involve the performance of all logical operations by diode gating, the use of electrical delay lines for all incidental pulse storage, and the use of transformer-

(Continued on page 112)

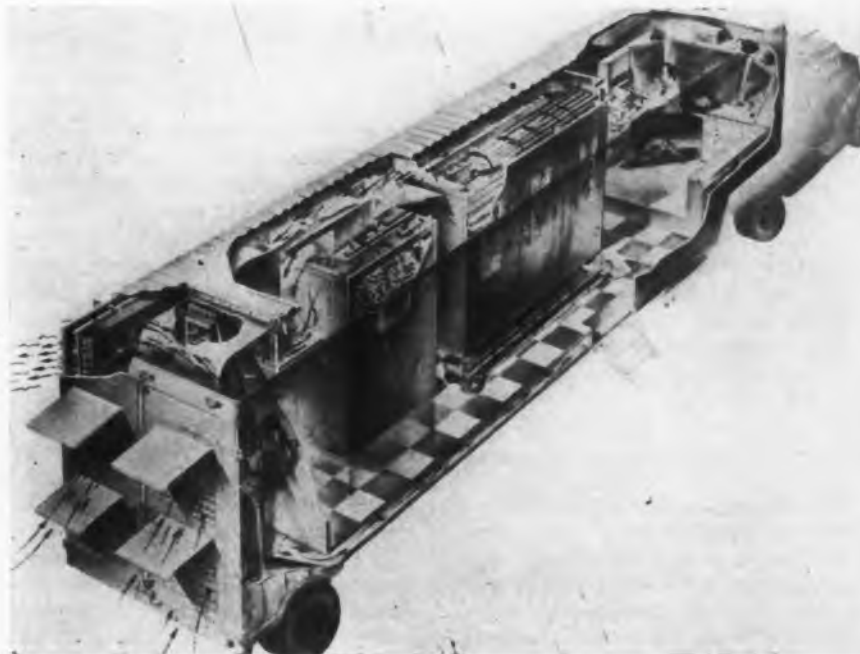

Fig. 1: Cutaway of 40-ft. DYSEAC trailer shows forward part containing control console and magnetic wire input-output. Three center cabinets are computer proper. Immediately behind are cabinets containing 512-word acoustic delay line memory. Air conditioning shipment is at rear

New 7-11 KMC Signal Generator

Yie

By **ARTHUR FONG**
Development Engineer
Hewlett-Packard Company
Palo Alto, California

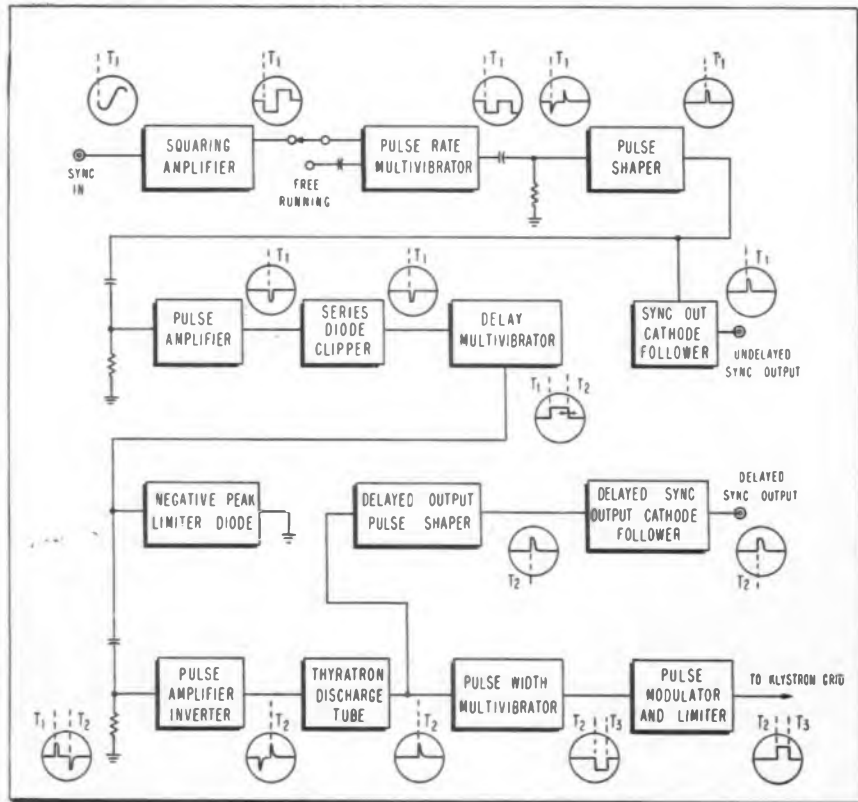

Fig. 1: Block diagram of new Model 620A super high frequency (SHF) signal generator

ably for external triggering purposes. The rise time of the sync pulses is less than 1 μ sec. The modulation system can also be synchronized with external sine or pulse voltages of either polarity and as low as 5 v amplitude.

A third type of internal modulation available is sawtooth f-m. The repetition frequency of the sawtooth is adjustable from 40 to 4,000 cps,



Fig. 2: Model 620A (SHF) Signal Generator

A look at the problems encountered in designing this new test equipment provides helpful information for designers of circuits using the new super high frequency (SHF) range

AS another step toward extending the usable frequency spectrum, a new signal generator covering the range 7-11 KMC has recently been developed. Since the problems involved in producing such test equipment will be characteristic for any circuits operating in this frequency range, a review of the considerations which influenced its design should prove interesting.

Modulator Circuitry

The flexibility of the modulation system is such as to enable the generator to be used for nearly any application desired for a signal source in this frequency region. For radar work and other pulse type applications, the modulation system includes a pulser so that any r-f pulse width is obtainable from $\frac{1}{2}$ to 10

μ secs. at any repetition rate from 40 to 4,000 pps. Both the pulse width and pulse repetition rate are selected by direct-reading controls.

For applications such as slotted line work, the modulation system provides for a square-wave modulated r-f output which is adjustable over a range of from 40 to 4,000 cps. The repetition frequency of the square-wave modulation is selected by the same direct-reading controls that select the repetition frequency for pulse modulation.

The modulator further provides two synchronizing pulses of at least 25 v peak amplitude into 1,000 ohms. One of these pulses begins concurrently with the start of the pulsed r-f output. The other sync pulse is adjustable over a range from 3 to 300 μ secs. ahead of the r-f output in order to position the sync pulse suit-

while the r-f deviation is adjustable up to at least ± 3 mc. Both the external synchronization feature and the sync out pulse feature are available for use when internal sawtooth modulation is used.

The oscillator portion of the signal is gated externally by pulses (a-m) or by external sine or sawtooth voltages, r-f deviations of up to ± 5 mc externally-applied modulating voltages for frequency modulation. On are obtainable. The deviation is adjustable by the same panel control that adjusts deviation when using internal f-m.

A block diagram of the modulator circuit is shown in Fig 2, which illustrates the operation with a sine wave synchronizing input.

RF Oscillator Design

The oscillator portion of the signal generator uses a type 5721 reflex klystron with a $\frac{3}{4}$ -wave coaxial-line resonator (Fig. 3). To make the oscillator cover a wide frequency range, the repeller voltage must be

varied a
make th
in frequ
the posit
plunger.
met by u
chanicall
nism to
selects th
The co
frequency
covered
modes: th
and the 4
tuning m
tive switc
repeller v
KMC in o
mode cha
erated in
througho

A cross
resonator
oscillator
within th
firm cont
the cavity
of the tu
inner con
tact there
on the in
able plun

Fig. 3: C
Fig. 5: I



Fig. 3: C
Fig. 5: I



Yields Valuable Design Hints

varied and, at the same time, to make the oscillator direct-reading in frequency, it must be tracked with the position of the resonator tuning plunger. These two requirements are met by using a system which mechanically links the plunger mechanism to a potentiometer which selects the proper repeller voltage.

The complete 7 to 11 KMC frequency range for the oscillator is covered by using two repeller modes: the $3\frac{3}{4}$ mode from 7 to 9 KMC and the $4\frac{3}{4}$ mode above 9 KMC. The tuning mechanism includes a sensitive switch that provides a step in repeller voltage at approximately 9 KMC in order to accommodate the mode change. The resonator is operated in the $\frac{3}{4}$ -wavelength mode throughout.

A cross-sectional drawing of the resonator is shown in Fig. 3. The oscillator tube is axially mounted within the coaxial cavity and makes firm contact with the outer wall of the cavity. The upper grid structure of the tube is mounted within the inner conductor and makes firm contact thereto through slotted fingers on the inner conductor. The movable plunger makes contact to the

outer wall by means of long-life contact fingers.

λ -1 Mode Suppression

As in all cavity resonators the system will prefer to oscillate in the lowest resonant mode, in this case the quarter-wave cavity mode. If at all possible it is advantageous to operate in the quarter-wave cavity mode; however, as frequency increases one finds that in this mode the mechanical placement of the plunger is the limiting factor. For example, if one were to place the shorting plunger directly against the glass envelope of the klystron, the top frequency would be only approximately 6,000 mc. It is therefore necessary to use the three-quarter wave cavity mode to obtain the desired 7,000 to 11,000 mc range.

Fig. 4 (a) illustrates the effect of the quarter-wave resonance with a short circuit plunger of ordinary variety. This chart can be directly compared with Fig. 4 (b) where a plunger of special design was used. It will be seen that the quarter-wave cavity mode has been completely suppressed in Fig. 4 (b). To

accomplish this a plunger using a new suppression technique was evolved. This technique leaves the resonator without recesses, slots, chimneys, tuning probes or protruberances of any kind except for the output couplings.

An examination of the undesired 1,1 mode disclosed that its frequency was everywhere below 6,000 mc, considerably below the 7,000-mc lower frequency limit of the generator. In considering this fact, an arrangement was devised whereby the space between the inner surface of the plunger and the surface of the inner conductor was designed to appear to the resonator as a low-pass filter having a cutoff frequency of approximately 6,500 mc. The filter consists of a number of low- and high-impedance line sections in cascade. The filter is terminated at the back of the plunger with a powdered iron mixture to absorb the energy passed by the filter.

The use of such a low-pass filter prevents the undesired mode from supporting itself and thus is an effective suppression measure. At the same time the relatively high ca-
(Continued on page 181)

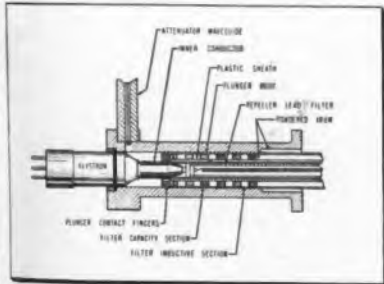

Fig. 3: Cross-sectional view of resonator

Fig. 5: Enlarged view of pick-up loop

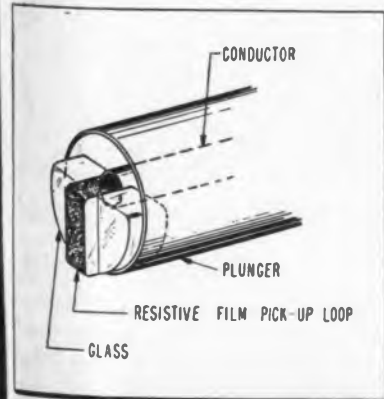
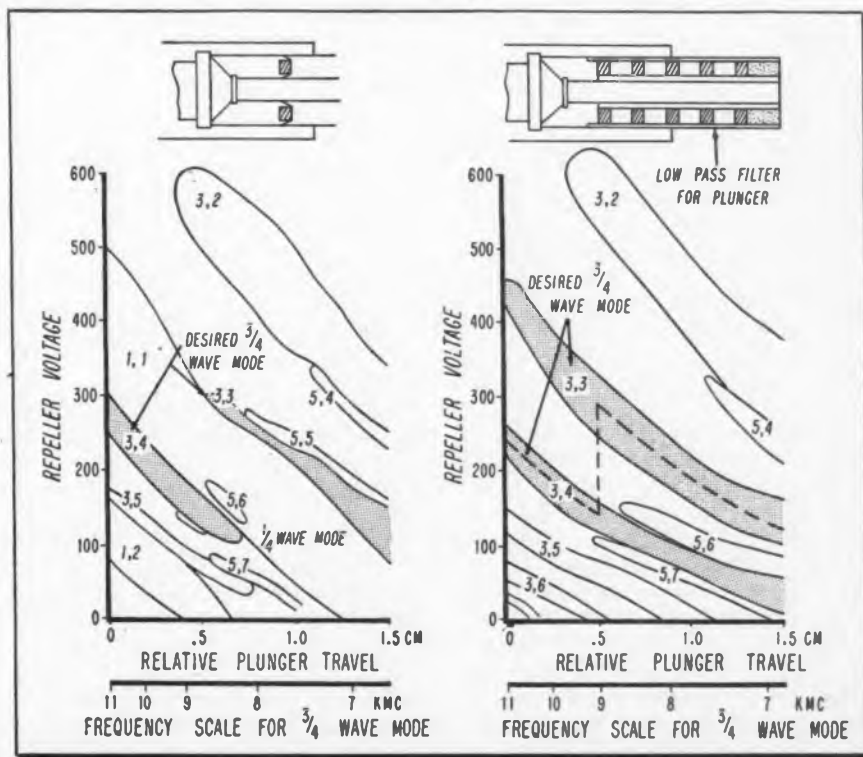

Fig. 4: $\lambda/4$ mode operation was suppressed by use of new type plunger



Magnetic Recording—

A review of the methods presently available for magnetic recording of audio, instrumentation and digital data. Magnetic tape is seen most serious limiting factor.

By **WALTER T. SELSTED** and
ROSS H. SNYDER
Ampex Corporation,
Redwood City, Calif.

PULSE WIDTH MODULATION

WITH this technique the intelligence to be recorded modulates the duration of a series of uniformly spaced pulses, generated within the electronics of the recorder, the commonest type using a pulse repetition rate of approximately 1,000 PPS, and a quiescent pulse length of approximately 500 μ sec. Intelligence modulates this pulse length from a minimum of about 100 μ sec. to a maximum of about 900 μ sec. These pulses may be recorded on tape in several ways: 1) Incoming pulses may be differentiated, and the pulses thus derived impressed on the record head, marking the leading and trailing edge of each pulse, later to be reconstructed. 2) The square pulses may be impressed directly on the record head so that the reproducer head produces a pulse at each flux change. Both methods are employed without bias.

This type of recording is most suited to the handling of low frequency analog information such as the output of thermocouples, strain gauges, pressure gauges, velocity indicators, etc. The frequency spectrum of such instruments is generally limited to less than 100 cps. This recording technique is especially applicable to aircraft and other vehicular instrumentation.

Multi-Channel Operation

The advantages of this method are several: 1) By commutation techniques it is very convenient to record large numbers of separate channels of low frequency information on a single magnetic track. For example, when a commutation rate of two samples per second is used, a frequency response of approximately 0 to 1 cps on each channel, a total of 30 channels of information may be recorded on a single mag-

(Continued on page 174)

DIRECT RECORDING

DIRECT recording is that type of recording in which the audio signal, with suitable pre-emphasis, is impressed upon the record head with an associated biasing signal consisting of high frequency ac. While primarily used for audio recording, this method is also suitable for those instrumentation purposes in which the information is to be analyzed on a logarithmic basis rather than on a direct amplitude basis.

The prime advantages of direct magnetic recording are, 1) a very high dynamic range, which was among the characteristics which first brought wide attention to the magnetic technique, 2) excellent frequency response, and 3) relatively low distortion. These characteristics are so widely understood, that more emphasis will be placed here on the defects and limitations of direct magnetic recording when it is applied to purposes other than audio, such as instrumentation and data recording.

Direct magnetic recording of certain kinds of scientific information, such as noise and vibration analyses, is very satisfactory. Wherever interest is in the relation between frequency and logarithm of amplitude, this recording method would be the logical choice.

Dropouts

For all of its many desirable characteristics, direct magnetic recording possesses certain limitations, which have led to the development of other techniques for specialized purposes. The direct method lacks precision in the reproduction of absolute amplitude variation, since occasional "dropouts" of as much as 80% may occur because of the nature of the recording medium. The ultimate limit on precision in the reproduction of absolute amplitude variations is imposed by the medium itself, of which more will be said later in this report. Furthermore, the lowest frequency which may efficiently be

recorded by the direct method is limited; those purposes in which dc variations and very low frequency ac effects are of interest require other recording means. Direct recording is also characterized to some extent by "modulation noise" or "noise behind the signal." This is caused by a combination of residual flutter in the transport mechanism and by variations in tape roughness. Its elimination is, for certain applications, desirable.

Flutter and Wow

The mechanical and electrical requirements which must be met by machines designed to realize the ultimate capabilities of direct magnetic recording include a tape motion sufficiently smooth that flutter and wow (irregularity of tape motion) shall be very low. The ear is especially sensitive to variations which occur at the rate of 0 to 7 cps, and progressively less sensitive



Portable direct recorder, for audio applications

to variations which occur between 7 and about 200 cps, above which these variations may be regarded as

(Continued on page 173)

State of the Art

FM RECORDING

THIS technique involves feeding to the record head one or more carrier frequencies upon which are superimposed by FM the intelligence to be recorded. When only one channel of information is to be recorded, a single carrier is recorded at saturation level without bias, using a relatively wide frequency deviation. When several carriers are to be recorded on a single magnetic track, each must be recorded not above approximately that level at which 1% distortion occurs due to the approach of tape saturation, using bias, and generally with deviations of only a few % each.

The application of FM recording is most advantageous with any sort of electrical signals in the spectrum from 0 to some upper limit which is usually approximately 20% of the carrier frequency, this being determined by the tape velocity. Such equipment is especially usable for multi-channel recorders of the type needed in geophysical explorations. The method is also used for the recording of transient phenomena, vibration, strain and stress studies,

analog data such as pressure, temperature, velocity, altitude, etc.

Advantages

Among the advantages of FM recording are: 1) phase, amplitude, and frequency may all be faithfully recorded and reproduced on an absolute basis, in contrast with direct recording, in which "dropouts" and other effects impose severe limitations; 2) such recordings deteriorate insignificantly with storage. Accidental erasure, especially with saturation level recordings, would have to be almost complete before any material deterioration of the signal would occur. This is contrasted with recordings of the direct type, in which relatively small accidental magnetic effects may seriously damage the shorter wave lengths recorded; 3) the FM technique permits the recording and accurate reproduction of frequencies down to 0 cycles; 4) amplitude effects caused by tape conditions have little or no effect on the accuracy of the recording; 5) "print-

(Continued on page 176)

DIRECT PULSE RECORDING

THIS technique involves the magnetizing of the medium at discrete points in a discontinuous fashion. Two types of direct pulse recording are in common use: 1) Short areas of the moving tape are successively magnetized, or left neutral. 2) The record head is maintained at a constant high flux density in an arbitrarily assigned polarity in the absence of information, bits of information being recorded by alternate reversals in the polarity of the recording signal.

The application of this technique is primarily to the recording of digital information wherein the data can be represented by groups of pulses. This includes any memory

A discussion of
MAGNETIC TAPE
will appear in the Sept. issue of
TELE-TECH & Electronic Industries

storage apparatus for any class of digital information. This type of system is commonly used with magnetic drums for short term memories, and with tape for long term large quantity memory systems. The principal current use of this technique is in connection with computers and other high precision electronic systems.

High Accuracy

The advantages of the technique include the following: 1) Extreme precision may be achieved; indeed, by the application of readily available techniques of automatic accuracy-checking, almost any desired degree of accuracy may be attained. Accuracies of the order of one error in many million parts are readily achievable. 2) The precision of informational storage is almost independent of the speed stability of the transport. 3) The technique is of particular advantage since digital information otherwise stored in written form may conveniently be recorded on a re-usable medium. 4) Information may be removed or replaced rapidly, on a partial or whole basis. 5) The technique lends itself readily to the rapid and automatic location of information inside a large storage volume. 6) Ex-

(Continued on page 175)

This precision recorder boasts 80 db signal-to-noise ratio, records 4 channels on a single 1/2 in. tape



Terminated Networks

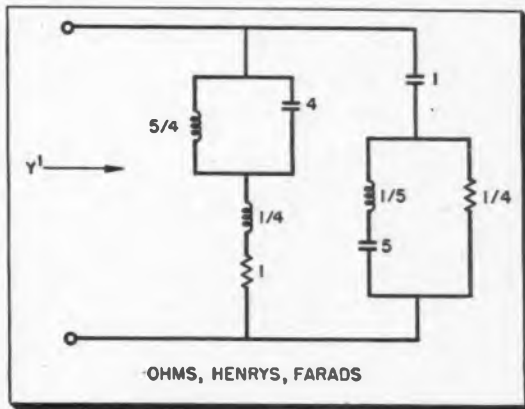
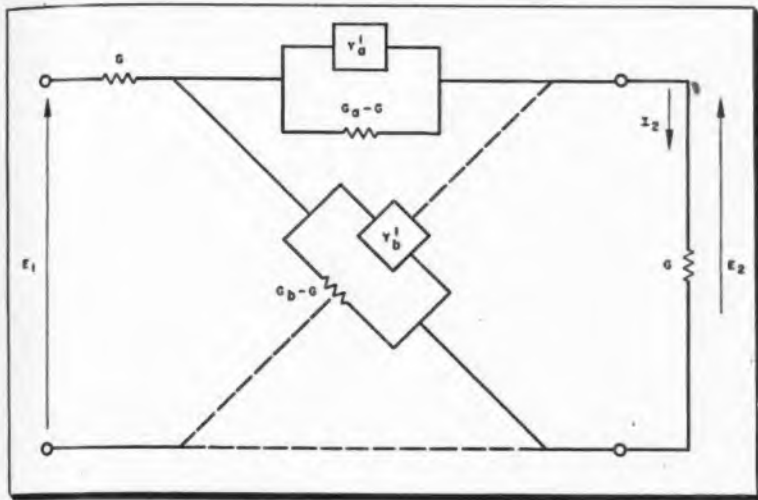

Fig. 5: (I) Lattice of Fig. 4 from Thevenin's theorem. Fig. 6: (above) Lattice corrected for predistortion

may be realized as the open-circuited lattice shown in Fig. 1 for which

$$Z_{12} = \frac{1}{2} (Z_b - Z_a). \quad (2)$$

If the poles of Z_{12} are simple and its numerator is of lower degree than the denominator, the partial fraction expansion of the impedance of each of the lattice arms has the form

$$Z = \sum_{\mu=1}^n \frac{k_{\mu}}{s - s_{\mu}}. \quad (3)$$

Considering complex conjugate poles as combined into one term, we find that each of the partial fraction terms has the significant positive real characteristic, that is, the terms are separately realizable by inspection. Thus the two types of terms that occur are given by

$$z_1 = \frac{k_1}{s - s_1} \quad (4)$$

$$= \frac{\alpha_1}{s + a}$$

and

$$z_2 = \frac{k_2}{s - s_2} + \frac{\bar{k}_2}{s - \bar{s}_2} \\ = \frac{\alpha_2 + j\beta_2}{s + \sigma_2 - j\omega_2} + \frac{\alpha_2 - j\beta_2}{s + \sigma_2 + j\omega_2} \quad (5) \\ = \frac{2\alpha_2(s + d_2)}{s^2 + \sigma_2 s + |\omega_2|^2},$$

where a , α_1 , α_2 , d_2 , and σ_2 are real and positive constants, and d_2 is not greater than $2\sigma_2$. These terms are

immediately realizable in the forms shown in Figs. 2 and 3, and the complete lattice has arms containing a series connection of such networks.

When $m = n$ one or both of the expansions for the lattice arms contains a constant term, and when $m = n + 1$ at least one of the arms will contain a pole at infinity. Corresponding to these terms a series resistance and a series inductance, respectively, will be present in the lattice arms. For a Z_{12} that possesses multiple poles the method of realization explained in reference 4 introduces a constant term into each of the lattice arms. We shall see that this precludes obtaining a shunt capacitance at both input and output when $m < n$; however, the method of reference 5 permits the desired capacitance to be obtained for this case.

Real Part Of Z

We now show that the real part

$$\text{of } Y = \frac{1}{Z} \text{ for } s = j\omega,$$

denoted hereafter by $\text{Re} [Y(j\omega)]$, has no zeros for all real values of ω including infinity, where Z represents the form of the driving-point impedance of each of the lattice arms; that is, the lattice arms have nonminimum-conductive driving-point admittances. As a result a conductance may always be removed from each of the lattice arms without destroying the positive real quality of its driving-point function.

Since z_1 and z_2 , given respectively in (4) and (5), represent driving-point impedances, their real parts along the j axis are never negative. It is furthermore clear from inspection of (4) that the real part of z_1 is nonzero at the origin and decreases monotonically to a zero value at infinite frequency. Similarly, for terms of the form of z_2 , inspection of (5) shows that $\text{Re} [z_2(j\omega)]$ is also finite and nonzero at the origin and has a zero value at infinite frequency, though its intermediate variation is not monotonic. It, too, possesses no zero in the real part for finite frequencies. If we consider the given Z_{12} as a proper fraction with simple poles, then each of the lattice arms is of the form given by (3) and the real part of Z is the sum of the real parts of the two types of terms considered above. Suppose we now write

$$Z = \frac{m_1 + n_1}{m_2 + n_2}, \quad (6)$$

where m_1 and n_1 represent respectively the even and odd parts of the numerator, while m_2 and n_2 play the same roles for the denominator. Then

$$\text{Re} [Z(j\omega)] = \frac{m_1 m_2 - n_1 n_2}{m_2^2 - n_2^2} \Big|_{s = j\omega} \quad (7)$$

and the above reasoning yields the conclusion that the numerator $(M_1 m_2 - n_1 n_2)$ possesses no zeros for real ω and is therefore always positive. The total function $\text{Re} [Z(j\omega)]$ has a zero at infinity. As for

Network Analysis (Continued)

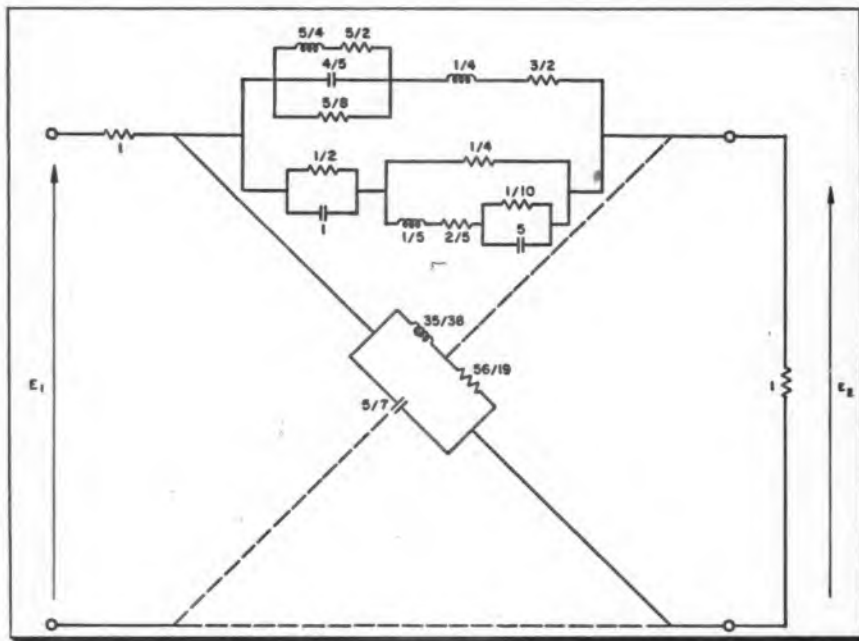

Fig. 7: Network realized by applying Thevenin's theorem to the lattice of Fig. 6

the admittance $Y = \frac{1}{Z}$, its real part is given by

$$\operatorname{Re} [Y(j\omega)] = \frac{m_1 m_2 - n_1 n_2}{m_1^2 - n_1^2} \Big|_{s = j\omega} \quad (8)$$

from which we note that it has the same numerator as $\operatorname{Re} [Z(j\omega)]$. Therefore $\operatorname{Re} [Y(j\omega)]$ is always positive and nonzero except possibly at infinite ω . But it is also nonzero at infinity, for the degree of the denominator will be greater than that of the numerator in (8) only when Z possesses no other terms except one or more of the form of z_2 in each of which the constant d is equal to 2σ . Since it is always possible⁴ to make d less than 2σ , we may state the conclusion: the $\operatorname{Re} [Y(j\omega)]$ is always positive and nonzero for all (finite and infinite real) values of ω .

For Multiple Poles

Restricting the discussion to a proper fraction containing only simple poles represents no loss in generality, for the same conclusion applies in the other cases. If multiple poles are present in the given transfer impedance Z_{12} , a term whose real part is positive and nonzero for all ω is added to the lattice arm impedances. If in Z_{12} the degree of p is equal to the degree of q , a constant is added to one or both of the lattice arm impedances. Finally, if the degree of p exceeds that of q , none of the transfer functions is physically

realizable with a resistance termination at both input and output, as is demonstrated below.

It has been shown³ that a transfer voltage ratio is not physically realizable if the degree of its numerator is greater than the degree of its denominator, that is, if a pole at infinity is present. But we desire networks terminated in resistance at both input and output. For such networks the same rational function within a constant multiplier represents the transfer voltage ratio, the transfer admittance and the transfer impedance. Thus all three types of transfer functions are unrealizable in the form of the desired network if the degree of the numerator exceeds that of the denominator. Another way of seeing this is to note that if an open-circuited lattice is synthesized whose transfer impedance is given by such an improper rational fraction, then at least one of the impedances of the lattice arms must have a pole at infinity. Consequently a conductance cannot be removed from the corresponding admittance because its real part will have a zero at infinite frequency.

Completing the Synthesis

The open-circuited lattice that has been derived may now be converted to the desired form. We have seen that the real part of each of the lattice-arm admittances will have one or more positive nonzero mini-

ma; we now determine the smallest minimum of both admittances and denote them respectively by G_a and G_b . It is then possible to obtain an equivalent lattice⁵ by removing from each of the arms a conductance of value less than the smaller of G_a and G_b , and placing it in parallel with the input and output terminals of the lattice. This transformation, shown in Fig. 4, thus yields the desired resistance terminations for Z_{12} . To obtain

$$K = \frac{E_2}{E_1} \text{ and } Y_{12} = \frac{I_2}{E_1}$$

requires merely an application of Thevenin's theorem to the input; this yields the network of Fig. 5 for which:

$$K = \frac{E_2}{E_1} = K \frac{GE_2}{E_1} \quad (9)$$

$$= GZ_{12}$$

and

$$Y_{12} = \frac{I_2}{E_1} = \frac{GE_2}{E_1} \quad (10)$$

$$= GK$$

$$= G^2 Z_{12}$$

It is clear from the above equations that the constant gain factor achieved for the transfer voltage ratio is directly proportional to G . This makes it desirable, if one is interested in gain, to remove as large a conductance as possible from the arms. However, one may be more interested in using low- Q coils for the realization of the lattice arms, which problem we discuss below; in this case it is necessary to retain a large conductance in each of the lattice arms.

Bott-and-Duffin Method

For realizing the remainder of the lattice arms, that is, the admittances Y'_a and Y'_b in the network of Fig. 5, we may use the Bott-and-Duffin procedure⁶. This yields a network containing pure inductances but no mutual inductance. However, we desire that every inductance possess an associated series resistance; to achieve this we substitute a new variable ($s-h$) where h is a suitably chosen real positive constant; that is, we make use of the technique of predistortion introduced by Darlington⁷.

Predistortion requires that for each arm admittance we first determine the equation of the curve in the

(Continued on page 140)

CAPS AND

Caps and octal and feature roll are design condenser.



with gener mica phen have 1 1/8 Octal units Laminated and nine p available w solderless Manufactu ill St., Ch & ELECTR

KLYSTR

The VA- is a low-tube design radar appl frequency tial, the un



mw power A small sc adjustment tures inclu guide out miniature 4 oz. weigh Hansen W TECH & E

New Electronic Products

CAPS AND SOCKET

Caps and socket combinations for octal and noval size high voltage tubes feature rolled outer edges. Assemblies are designed for screw-mounting to condenser studs or stand-offs. Available



with general purpose black or low-loss mica phenolic insulators. Noval caps have $1\frac{3}{16}$ or $1\frac{1}{2}$ in. major rim diameters. Octal units have insulating fibre liners. Laminated and molded miniature seven and nine pin "Wire Wrap" sockets are available with terminals for high speed solderless lead attachment. Methode Manufacturing Corp., 2021 W. Church St., Chicago 47, Ill.—TELE-TECH & ELECTRONIC INDUSTRIES.

CONVERTER

An analog-digital converter recently announced, was especially designed for data handling or digital computers. Present models include 7, 13, 17, and 19 digit units—all 2 in. in diameter—vary-



ing from $2\frac{9}{64}$ to $4\frac{13}{16}$ in. in length. Input torque is under 0.2 oz./in. Current carrying capacity, 2 ma per pick-off brush. Digit output frequency can vary from 500 cps to 1 mc or higher. Operates independently of voltage, temperature, frequency, and frequency limitations over a wide range. Weight 8 oz. Librascope, Inc., 1607 Flower St., Glendale, Calif.—TELE-TECH & ELECTRONIC INDUSTRIES.

POWER DIODES

Seven junction type power diodes are announced: Nos. 1N91, 1N92, and 1N93 are the types in the foreground of the illustration. Nos. 1N151, 1N152, and 1N153 are single diodes shown mounted



on a cooling fin. Two diodes, No. 1N158—indicated by arrows—are connected in series on a cooling fin. Type 1N153, for example, with a peak inverse voltage rating of 300 v is capable of delivering 0.5 amps into a resistive load with a voltage drop of only 0.7 v. Semiconductor Division, Radio Receptor Co., Inc., 251 West 19th St., New York 11, N.Y.—TELE-TECH & ELECTRONIC INDUSTRIES.

KLYSTRON

The VA-94 K-Band reflex Klystron is a low-voltage local oscillator type tube designed especially for missile and radar applications up to the 17 kmc frequency range. At 300 v beam potential, the unit provides a minimum of 20



mw power output and 55 mc bandwidth. A small screw tuner enables frequency adjustment at a slow tuning rate. Features include the convenience of waveguide output, matched load operation, miniature size of $2 \times 1\frac{1}{4} \times 1\frac{1}{4}$ in., and 4 oz. weight. Varian Associates, 611 Hansen Way, Palo Alto, Calif.—TELE-TECH & ELECTRONIC INDUSTRIES.

PLASTIC

Developed to eliminate difficult melamine machining properties, a new plastic, designated "Phenolic Grade Y-2401," lies approximately midway between paper-base phenolic (NEMA Grade XXX) and paper-base melamine (NEMA Grade XX-M). Arc resistance, 113 arcs/min. 15 kv, 30 ma, $\frac{3}{8}$ in. gap. Specimens $\frac{1}{8}$ in. thick. Can be punched in thicknesses $\frac{1}{8}$ in. thick. Sections up to $\frac{3}{8}$ in. can be shaped by shaving dies. The material is available in 39×47 in. sheets in thicknesses of $\frac{1}{32}$ to 1 in. inclusively. National Vulcanized Fibre Co., Wilmington, Del.—TELE-TECH & ELECTRONIC INDUSTRIES.

SOLDER FLUXES

The "Alpha" extended line of external solder fluxes, it is said, includes a flux for every purpose of the electrical, electronics, and printed circuit industries—ranging from the mild non-corrosive rosin type to the strong, highly-active stainless steel type. All are scientifically formulated for maximum wetting, rapid fluxing, and minimum corrosive after effects. All have water-soluble residues, and each lot is laboratory approved and identified by number to assure an accurate flux quality check. Alpha Metals, Inc., 56 Water St., Jersey City 4, N. J.—TELE-TECH & ELECTRONIC INDUSTRIES.

CONNECTORS

Plugs developed for high-altitude atmospheric pressure conditions, and aluminum hoods for positive cable support and strain relief are now available for use with "E-Z" release Continental connectors. The hoods have either top



or side cable openings. Hex nuts on the hood activate the bayonet receptacles and permit easy disconnection of the units with a screw driver. Illustrated engineering literature is available. Electronic Sales Div., DeJUR-Amsco Corp., 45-01 Northern Blvd., Long Island City 1, N. Y.—TELE-TECH & ELECTRONIC INDUSTRIES.

New Components and Tools

ROTARY SWITCH

The new "Eldec" sub-miniature rotary switch is 0.908 in. long and has a maximum diameter of 0.875 in. Weighs less than 1/4 oz. including the knob. For use in low current applications. Manu-



factured in 1, 2, and 3 pole units; 15 terminals per switch. Available in 2, 3, and 4 gang. Maximum working voltage, 300 v RMS. Maximum working current, 1 amp. Maximum working power, 100 w. Maximum contact resistance, 0.05 ohm. Breakdown voltage, 1500 v RMS. Electro Development Co., 6006 W. Washington Blvd., Culver City, Calif.—TELE-TECH & ELECTRONIC INDUSTRIES.

CAVITIES

A recently announced line of high-precision reference cavities cover six frequencies. The units, essentially, are fixed-frequency, vacuum-sealed, transmission-type tubes. They are primarily used as frequency determining references and frequency stabilizers in radar



beacon applications. Temperature stability from 100° C is ± 0.3 mc; 0° C to -55° C is ± 1.0 mc. By cushioning the tube within the block, resonant frequency is held to ± 0.1 mc under vibration, and shock up to 50 G's. Bomac Laboratories, Inc., Salem Road, Beverly, Mass.—TELE-TECH & ELECTRONIC INDUSTRIES.

CAPACITORS

Two lines of subminiature metal-clad capacitors have silicone end seals to provide maximum resistance to thermal and physical shocks. One line with solid dielectric is for operation from



-55 to 125° C, without derating. Second line has liquid dielectric, operates from -55 to 85° C, and are 20% smaller than comparable oil-filled units. Both lines supplied in various capacities and with dc working voltages of 100, 200, 400 and 600 v., tab or exposed foil designs. General Electric Co., Schenectady 5, N. Y.—TELE-TECH & ELECTRONIC INDUSTRIES.

PRECISION RESISTORS

Grouped type of precision resistors are made up of from two to six lug type "Riteohm" resistors arranged end-to-end in a molded resin body. Units are available in lengths to 3 in., in individ-

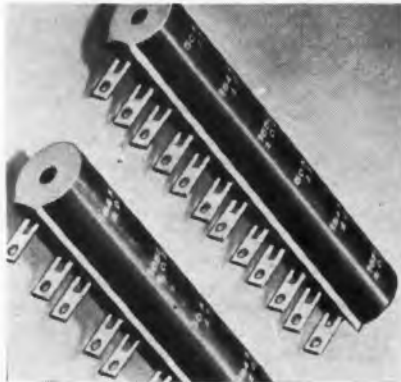

ual resistor wattage ratings of 1/4, 1/2 and 1 watt, and in resistances up to 1.95 megohms. Tolerances as close as $\pm 0.1\%$ are available. Individual resistors of group consist of enameled alloy wire on steatite bobbins. Ohmite Mfg. Co., 3664 Howard St., Skokie, Ill.—TELE-TECH & ELECTRONIC INDUSTRIES.

TRANSFORMERS

A new 32 model line of subminiature transformers, especially designed for transistor and other miniaturized circuit applications, ranges from 3/8 x 3/8 x 1 1/2 in. to 3/4 x 7/8 x 1 in., with power

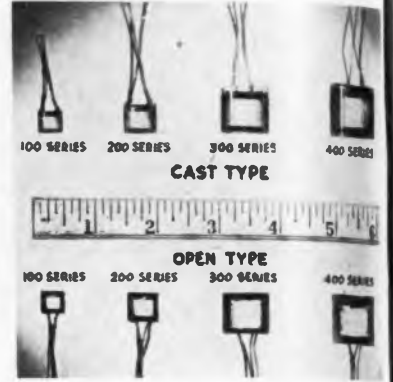

capabilities ranging from less than 1 mw. to over 100 mw. Each of four different series sizes has input, interstage, choke, and output models. Each of the 16 basic units is manufactured in both open type and cast construction. All 32 models operate satisfactorily over the temperature range of -25° C. and 100° C. Texas Instruments, Inc., 6000 Lemon Ave., Dallas 9, Texas.—TELE-TECH & ELECTRONIC INDUSTRIES.

NEEDLE-NOSE PLIERS

Special plier for precision work is designed with extra long nose, severely tapered to a point less than 1/16 in. Replaceable tempered steel spring keeps plier in open position. Overall length



is approximately 6 3/4 in. Refer to No. 301-6-SCP-L for plier with leaf spring. No. 301-6-SCP for plier without leaf spring. Pliers with cutters are 203-6-SCP-L (leaf spring) and 203-6-SCP (without leaf spring). Mathias Klein & Sons, 3200 Belmont Ave., Chicago 18, Ill.—TELE-TECH & ELECTRONIC INDUSTRIES.

TUBE CA

The "Hot recommende tremely high pecially des high volta

integral un thus prev points. Excum curre conditions signed with These extra polyethylen Co., 117 N Mass.—TEL INDUSTRI

RESISTO

The Type measures 2 wound res positioned sistent and chassis on machine so type. Resis

to 3 megoh of the unit enclosure f are the only stands salt ceering C 1100 Chest TELE-TEC TRIES.

New Technical Products

TUBE CAP

The "Hot Spot" in-line tube cap is recommended for applications of extremely high tube temperature. Especially designed for molding into the high voltage anode lead, the cap is an



integral unit sealing the wire holes—thus preventing arc-over at these points. Excessive tube heat from maximum current drain under "Black Tube" conditions is met by a similar cap designed with extra long "Nylon" sleeves. These extra long sleeves safeguard the polyethylene insulation. Alden Products Co., 117 North Main St., Brockton, Mass.—TELE-TECH & ELECTRONIC INDUSTRIES.

VECTOR DISPLAY

The Model VDE-3A is a completely rack-mounted monitoring and test instrument that displays in vector form the chrominance components of standard color bar signals. It also checks the



accuracy of the color signal, the drift in color coders and associated equipment. The display oscilloscope overlay is calibrated in degrees and amplitude. Scales are provided for "I" and "Q." The unit comprises a DK-1 decoder and keyer, a BCO-2 burst-controlled oscillator, a RS-1 display oscilloscope and a PS-2 regulated power supply. Wickes Engineering and Construction Co., 12th & Ferry Ave., Camden 4, N. J.—TELE-TECH & ELECTRONIC INDUSTRIES.

PHOTOCELL

The B2M selenium photoelectric cell measures $2\frac{3}{32} \times \frac{1}{16}$ in. and is mounted by a self-contained bracket extension. The active area is only 0.26 sq. in., yet it generates an average output of 60 μ a at 100 foot candles illumination. The



unit can be connected directly to a 0-1 millimeter by its 6 in. pigtail leads and used as a light measuring device. Further, it can be operated as a "sun battery" to convert solar energy into a power supply for transistorized equipment and portable devices. A number of cells can be mounted in series or series-parallel to produce higher output power. International Rectifier Corp., 1521 E. Grand Ave., El Segundo, Calif.—TELE-TECH & ELECTRONIC INDUSTRIES.

RESISTOR

The Type 38042 encapsulated resistor measures $2 \times 1 \times 1\frac{1}{4}$ in. The wire wound resistive element is precisely positioned in the epoxy body for consistent and accurate capacity, effect to chassis on which it is mounted by 8-32 machine screws. Terminals are turret type. Resistance values are $\frac{1}{10}$ th ohm



to 3 megohms. The outstanding feature of the unit is that it affords complete enclosure from the elements. Terminals are the only exposed metal parts. Withstands salt spray tests. Cinema Engineering Co., Div. of Aerovox Corp., 1100 Chestnut St., Burbank, Calif.—TELE-TECH & ELECTRONIC INDUSTRIES.

MINIATURE PENTODE

New 9-pin miniature pentode tube for communications equipment, 404A, features long operating life achieved by "Polioptic" manufacturing process which prevents contamination of tube elements. In Polioptic process, chamfered button stem and envelope are op-



tically polished to form good seal, allowing use of lower temperature during final seal. Heater rating is 6.3 v., 0.3 amp. Max. anode voltage is 180 v., anode dissipation 3 watts. American Radio Co., 445 Park Ave., Dept. 135, New York 22, N. Y.—TELE-TECH & ELECTRONIC INDUSTRIES.

CONNECTORS

Two new rack, panel, and chassis connector series occupy approximately 35% less area than the standard DPD series. The shell of type DPA measures $2 \times 1 \times 2\frac{3}{32}$ in.; the DPX, $2\frac{5}{16} \times 1\frac{1}{8} \times 1\frac{1}{8}$ in. Straight and angle 90° junction shells with integral clamps are available for the DPA type. Contact arrange-



ments currently available include standing 5, 10 amp and coaxials (5 amp) up to a total of 32 contacts with two DPA and seven DPX layouts. Insulation materials used are the latest high dielectric strength melamine or Dial 51-01. Cannon Electric Co., 3209 Humboldt St., Los Angeles 31, Calif.—TELE-TECH & ELECTRONIC INDUSTRIES.

New Electronic Products

COMMUNICATIONS UNIT

The Type MRT-10 () series communication unit consists of a separate transmitter, receiver, and power supply mounted in a single housing. Operating in the frequency range from 25 to 50 mc,

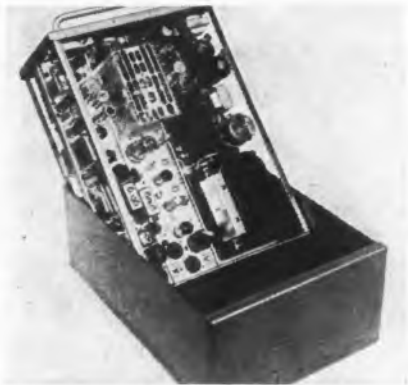

it is designed for mobile two-way communication in fixed station, marine, aeronautical, and other types of service. Frequency range in 3 bands, 25-30.5 mc, 30-38 mc, and 37-50 mc. Transmitter power output, 40 w (nominal), crystal multiplication 12 times, output impedance 52 ohms (nominal). Receiver audio output, 4 w (nominal) at less than 10% distortion. Bendix Radio Div. of Bendix Aviation Corp., Baltimore 4, Md.—TELE-TECH & ELECTRONIC INDUSTRIES.

TERMINATIONS

A series of primary standard calorimetric wattmeter terminations have been extended to cover the spectrum from 100 to 26,500 mc. Model MC-1B, with associated adapters, covers the



range from 2,600 to 26,500 mc. Model MCX-1A, a coaxial type, covers the range from 100 to 3,000 mc. The MCL-1A L-Band waveguide unit covers the range from 1,120 to 2,600 mc. All models feature very low residual VSWR, primary standard accuracy, and direct-reading of average power up to 600 w over a plurality of expanded scales. Cubic Corp., Scott & Canon St., San Diego 6, Calif.—TELE-TECH & ELECTRONIC INDUSTRIES.

ALUMINUM TOWERS

TM series of semi-portable guyed aluminum towers for communications systems are designed in accordance with RETMA standard TR-116. They are supplied in 10-foot sections up to



200 ft. Rapid assembly with no tools is made possible by "Cam-Lok" connectors. Erection or dismantling accomplished by three men in less than one day. Towers are also supplied with splice plates for permanent installations. Available separately or as part of system package. Prodelin, Inc., 307 Bergen Ave., Kearny, N. J.—TELE-TECH & ELECTRONIC INDUSTRIES.

X-Y RECORDER

The Model 2 "Autograph" X-Y recorder for use with 11 x 16½ in. standard graph papers features a flat-bed paper table for curve observation and labeling. The unit may be equipped



with curve follower attachment, or modified for digital point plotting; and, additional equipment, as keyboards, card and tape readers, are available. Maximum sensitivity on both axes, ½ mv/in. Other specifications are similar to the original portable "Autograph" Model 1. Measures 23 x 16½ x 8½ in. F. L. Moseley Co., 409 N. Fair Oaks Ave., Pasadena 3, Calif.—TELE-TECH & ELECTRONIC INDUSTRIES.

GENERATOR

Model 608D VHF signal generator covers the frequency range from 10 to 420 mc. Residual FM is less than 0.1 kc; drift less than 0.005%. Sensitivity measurements to 0.1 µv. A directly set



and read output of 0.1 µv to 0.5 v is available through the instrument range. A built-in crystal calibrator provides frequency checks accurate within a few kc every 5 mc. The instrument provides flat response from 20 cps to 1 mc, AM modulation to 80%. Other forms of modulation include internal, external, external-pulsed, and FM. Hewlett-Packard Co., Dept. P, 395 Page Mill Road, Palo Alto, Calif.—TELE-TECH & ELECTRONIC INDUSTRIES.

I-F AMPLIFIER

Type 1216-A unit i-f amplifier with a type 874-MR mixer-rectifier and a suitable unit oscillator, provide a sensitive detector for signals in the frequency range from 25 to 5,000 mega-



cycles. Signal to be detected is heterodyned in the crystal mixer with a signal from a local oscillator to give a 30 mc difference frequency which is fed to the i-f amplifier. Bandwidth; 0.7 mc at 3 db down, 9.5 mc at 60 db down. Two separate internal power supplies are used, one for operating a unit oscillator. General Radio Co., 275 Massachusetts Ave., Cambridge 39, Mass.—TELE-TECH & ELECTRONIC INDUSTRIES.

** CI

AT T
INDU
PRO
WITH
FOR

**We're
the center

Holds min
14, 21, 34
available in
for chassis m
tion.

CINCH comp
able at leadi
anywhere.



**** CENTER OF THINGS ELECTRONIC**

CINCH

**AT THE GEOGRAPHIC AND
INDUSTRY CENTER CAN AND DOES
PROVIDE THE SERVICE WANTED...
WITH THE *STANDARD COMPONENT
FOR THE PURPOSE**

****We're a growing market right in
the center of things.
— Chicago Daily News.**

**Molded miniaturized connectors,
14, 21, 34 and 50 contacts
available in low loss material
for chassis mounting applica-
tions.**

**Centrally located plants
at Chicago, Shelbyville,
Indiana and St. Louis.**

**CINCH components avail-
able at leading jobbers —
everywhere.**

***CINCH metal plastic assemblies fully
perform the service for which they were
designed and often have anticipated
the engineering needs of the future.
So that today, judged by demand and
usage, CINCH components are "the
standard".**

CONSULT CINCH



**Cinch
ELECTRONIC
COMPONENTS**

CINCH MANUFACTURING CORPORATION

1026 South Homan Ave., Chicago 24, Illinois

Subsidiary of United-Carr Fastener Corporation, Cambridge, Mass.



WASHINGTON

News Letter

Latest Radio and Communications News Developments Summarized by TELE-TECH's Washington Bureau

ROTATING CHAIRMANSHIP—The first Republican FCC commissioner appointed by President Eisenhower, Commissioner John C. Doerfer, has been named Chairman by Mr. Eisenhower for a one-year term, succeeding Chairman Rosel H. Hyde. Mr. Hyde, during his year at the Commission helm, achieved a notable record of accomplishments, particularly in reducing the backlog of television station applications. Commissioner Doerfer has an excellent background, having headed, for three years before he came to the FCC, the Wisconsin Public Service Commission, one of the nation's most efficient state regulatory bodies. In addition, Commissioner Doerfer during his FCC service directed for Attorney General Brownell a high-level government committee in the important work of streamlining governmental hearing procedures for all federal agencies, including the FCC.

SENSIBLE SOLUTION—While it had been a foregone conclusion there would be no Congressional legislation on UHF television before the adjournment, now slated for July 31, it had been previously reported the Senate Commerce communications subcommittee might issue a report on UHF TV that would be detrimental to the constructive progress of television. Under the excellent leadership of Senator Potter, Michigan Republican, the Senate subcommittee had decided the difficult problem of the overhauling of the allocation system for VHF and UHF television areas or markets should be a subject of intensive analysis jointly by the FCC and the technical leadership of the VHF-UHF and network television industry. This would lead to a realistic solution of the problem rather than an emotional and one-sided determination.

GLOBAL COMMUNICATIONS—Approximately 600 communications engineers recently attended the briefing on the international aspects of communications in Washington held under the auspices of the Institute of Radio Engineers—and from the standpoint of the nation's economic progress and defense it was possibly one of the most significant sessions ever staged by the IRE. Haraden Pratt, former IRE President and its present Secretary who served as the telecommunications advisor to Presidents Truman and Eisenhower, in discussing the 35-channel transatlantic telephone cable stated that while development of additional transoceanic cables may be slow because of the huge costs "achievement of a series of links girdling the globe is not an impossibility." George W. Gilman, Bell Telephone Laboratories Systems Engineering director, in another major address at the meeting, stated that in frequency conservation there was not much more to be done in research aimed at improved frequency stability but there was room for improvement in directive

transmission and reception and in more effective organization and use of existing radio facilities.

LAW ENFORCEMENT VALUE—The increasing role and value of communications and electronics in law enforcement was described by Brig. Gen. David Sarnoff, RCA Board Chairman, in the graduation exercises of the FBI National Academy. Gen. Sarnoff pointed to the growing use of mobile radio equipment, microwave systems employed on the Pennsylvania and New Jersey turnpikes, radar as a speed detection device and television and radiophoto for rapid transmission of fingerprints and pictures which are such important tools for the police.

PUBLIC OFFICE HARDSHIPS—Constructive criticism of top-ranking government officials is certainly essential, but the airing of charges of bias and prejudice without previous investigation to determine whether they were well founded in facts, such as occurred in the Senate committee hearings on the reappointment of FCC Commissioner John C. Doerfer, appeared to be overstepping the boundaries of proper scrutiny of the conduct of an official. Commissioner Doerfer had to present his denial of the allegations by a disgruntled applicant for a television station which the latter widely publicized. The outcome—unanimous rejection of the charges by the 15-member Senate committee—was proof of their fallaciousness, but government officials should not have to be subjected to such attacks.

PRIVATE SYSTEMS—The major group in the mobile radiocommunications field are increasing their organizational strength to oppose the entrance of the telephone companies into their sphere of operations and during the past two months several steps in this direction were accomplished. The American Petroleum Institute, through the radio coordinating committees of that industry, was surveying a policy stand to oppose vigorously before the FCC utilization of present and future lease-maintenance radio communications services provided by telephone companies on petroleum frequencies. The state forestry conservation organization adopted a plan to establish continuance of state-owned and controlled radio services and the American Trucking Association's radio committee met June 22 to propose to the FCC the establishment of a common carrier motor radio service in place of the present highway truck radio service. The leading radio manufacturers in the mobile field such as RCA, GE, Motorola, Bendix and DuMont are ready to provide the groups seeking private systems with the latest types of equipment.

National Press Building
Washington, D. C.

ROLAND C. DAVIES
Washington Editor

Send for this *Free* **SAMPLE FOLDER...**

Contains
25

**different Test Samples of
high-dielectric
INSULATING
TUBING and SLEEVING**



**INCLUDES SAMPLES AND DESCRIPTIONS OF
THE FOLLOWING...**

VARGLAS SILICONE Class H insulating materials were pioneered by our Laboratory. Retain flexibility, electrical properties and mechanical strength in temperatures ranging from -85°F . to 500°F . Available in tubing, sleeving, lead wire, tying cord.

PERMAFIL-IMPREGNATED VARGLAS TUBING Fiberglass braid coated with General Electric's Permafil resin. Extremely tough, resistant to solvents and elevated temperatures, highly flexible. Can be bent or twisted with little or no loss of dielectric strength. Coils and standard 36" lengths.

VARGLAS SLEEVING AND TUBING Numerous types and grades—including synthetic-treated, varnished, lacquered, saturated, litewall and others.

VARGLAS NON-FRAY SLEEVING Fiberglass braid normalized to remove all organic impurities. It will withstand temperatures up to 1200°F . Recommended where dielectric properties are not paramount. Three types available.

VARFLO TUBING AND SLEEVING Vinyl-coated Fiberglas in full range of sizes, colors and grades. Extremely flexible with excellent heat aging qualities. Low priced.

VARFLEX COTTON TUBING AND SLEEVING Varnish or lacquer impregnated—for applications where MIL-I-3190 Class A materials are specified. All NEMA grades.

SYNTHOLVAR EXTRUDED TUBING Made in various standard formulations of vinyl polymers. Has high dielectric and tensile strength—will not support combustion nor absorb moisture. Type EG Approved under MIL-I-631A. Several others to meet special requirements.

NEW! VARGLAS SILICONE RUBBER SLEEVING AND TUBING—the culmination of 5 years of research—for applications requiring extraordinary flexibility. Details on request.



MAIL COUPON TODAY FOR SAMPLES!

**VARFLEX CORPORATION,
508 W. Court St., Rome, N. Y.**

Please send me free folder containing samples of your electrical sleeving and tubing.

I am particularly interested in insulation for:

NAME

COMPANY

STREET

CITY ZONE STATE

"Reps" & Distributors Serving the West

REPRESENTATIVES

This section lists those representatives operating as independent "reps" who handle two or more lines and located in Calif., Ore., and Wash. They do not include factory staff salesmen. Asterisks (*) indicate membership in "The Representatives" of Electronic Product Manufacturers, Inc. Telephone numbers are given to speed contacts. Code after cities refers to location on map at right.

CALIFORNIA

LBS ANGELES AREA N-27

- *Appleton Co Harry 136 San Fernando CA 1-2171
- Barros-Jaroe 817 S Hoover St DU 3-5248
- *Barstow & Doran 1406 S Grand Ave BI 6191
- Banghman Co E J 350 S Central Ave MA 9-1403
- *Becker Co Herb 1140 Crossway Blvd WE 1-1257
- Borman Co J 1141 LaClay St BR 2-9138
- Cohn S H 1769 S Holt Ave TE 0-4398
- *Cochrane Co Irv M 408 S Alvarado DU 5-1715
- Craig Ralph P 719 N Harper Ave WE 0-4658
- *Davis Sales Co George 5259 E Beverly Blvd UN 3-3594
- Dunkle B 3257 W 6 St
- *Ealy & Hastings P O Box 264 (N Hollywood) ST 7-5621
- *Edwards & Co Jackson 6047 Hollywood Blvd HO 5-1141
- *Emmet F A 2837 W Pico RE 3-9111
- *Feldman Co Henry 1244 S Grand PR 8803
- Fox Associates 2519 W 7 St DU 3-2148
- Gardner Co R H 134 N Edgewood DU 3-6851
- *Harman Co W S 1638 S LaClay St BR 2-3321
- *Hill Sales Co J T 800 W 11 St BI 7-5384
- *Hitt Co W C 1169 S Broadway PR 2105
- *Kittleson Co 7614 Melrose Ave WH 1167
- *Knight Co W Bert 10373 W Pico Blvd BR 2-5647
- Kossler Sales 6907 Melrose Ave Y0 6271
- La Moreo G B 1325 San Julian BI 6378
- *Lasera Co Harry A 9041 W Pico Blvd CB 6-4185
- *Leahota Co Douglas 10462 Magnolia Blvd (N Hollywood)
- Lynch & Son C B 210 W 7 St VA 3805
- Lynn & Brooks 3055 Wilshire Blvd DU 2-2255
- *Marsh Co J W 4216 W Jefferson BE 2-0145
- *Marshall Co G S 40 S Los Robles (Pasadena) NY 1-8345
- *Marshall Sales 672 S Lafayette Pt DU 7-8235
- Maynard Sales Co 6214 W Manchester BR 8-3150
- *Miller Co Gerald B 1350 N Highland (Hollywood) HO 9-6305
- Mitchell Co C H 256 S LaPeer Dr Beverly Hills CH 1-8382
- *Neely Enterprises 7422 Melrose Ave WE 3-9201
- Olshansky & Co Roland 7225 Beverly Blvd WY 0028
- Osborne B E 1044 S Park View DU 8-1039
- *Orvino Co Leo H 2331 W Washington BE 0230
- *Perrin-Smith & Assoc 2419 S Grand Ave BI 7-4321
- *Power Ralph L 767 Cantalar St HU 5277
- Renz Roy E 207 S Orange St (Glendale) CH 9-2047
- *Rinaldi J 2724 S Peak Rd (Monterey) DO 6-2135
- *Roberts & Assoc E V 5068 W Washington WE 8-2541
- *Rupp Co V T 2230 W 11 St DU 3-4197
- *Saul & Assoc Howard M 3015 San Vicente Blvd. WE 1-8901
- *Seigel Co Samuel 1145 S LaClay St BR 2-4183
- Slowers Edward S 5171 Hollywood Blvd BR 2-1105
- Smalley A B Box 67-G (Pasadena) SY 8-1174
- Saltzer Y Louis 5777 W Pico Blvd WE 1-5566
- Stary Edwin E 4101 Rhodes Ave (N Hollywood) ST 7-5879
- *Stolaroff Co M A 4614 Northridge Dr AX 3-6219
- Stone Assoc Carl A 1102 S Western Ave B 2-8103
- *Strasser Co Conrad B 1863 N Western Ave HO 7-7086
- Thy George S 1148 S Grand Ave BI 7-7553
- *Taborson Co John B 2232 W 11 St DU 9-3173
- Van Ercoo Co 14515 Dickson St (Sherman Oaks) ST 7-7882
- Vermillion Co Charles 3440 Wilshire Blvd DU 2-5695
- Wallace D C A W H 1206 Maple Ave BI 7-0401
- *Waber Co Wedge 1206 Long Beach Ave VA 2009
- *Western Electronic Enterprises 3348 W Compton Blvd (Gardena) OR 8-4817
- *Wiley Paul F 1632 Silverlark Blvd NO 3-8028
- *Wood Co A M Box 150 (Elmonte) CU 3-1201

SAN FRANCISCO AREA C-19

- Ault C E 625 Laurel Ave (Monte Park) BA 5-4983
- *Belchamber P A 1401 Middle Harbor Rd (Oakland) GL 1-4460
- *Borman Co E L 738 Netoma St UN 3-0317
- Brainerd W V 721 Clementine St UN 1-2569
- Detrich & Co 341 10 St MA 1-2788
- Eichorn & Moschler 501 Indiana St UN 1-8309
- Frazier & Hansen Ltd 301 Clay St EX 2-5112
- *French S P 721 Garland Dr (Palo Alto) BA 3-0397
- Harris Sales Co L N 383 Brannan St YU 6-1084
- Held Norman E 147 10 St UN 3-4250
- *Hormans Co James P 1234 Folsom St MA 1-4166
- *Hitt Co W C 1355 Market St KL 2-2311
- *Howard O M 782 Bryant St 2-6320
- Kittleson Co 2166 Market St NE 1-5304
- *Lewis Assoc Dean 219 S St UN 3-1414
- Logan Assoc 725 Greenway GA 1-0076
- *Logan Sales Co 530 Gough St NE 1-5127

- Marshall Harry E 104 Olive St OR 3-2173
- *Meyer & Ross 1355 Market St KL 2-2311
- *Moulthrop & Hunter 160 10 St NE 1-2625
- Moxan Sales G E 422 LaJolla Ave (San Mateo) FI 5-2866
- *Neely Enterprises 2830 Geary Blvd WA 1-2361
- *Newman Harold L 420 Market St YU 6-3897
- *Nickerson & Redat 381 Brannan St YU 2-2982
- *Nott & Co L A 1061 Howard St NE 1-4758
- *Purdy Co W J 312 7 St UN 3-4321
- *Rea Co David N 534 El Camino Real (San Carlos) LY 3-8224
- *Blair Arnold A 63 9 St UN 1-6259
- Striker Co John E 1369 Laurel St (San Carlos) LY 3-5403

OREGON

PORTLAND D-6

- *Nursham Co Don H 510 N W 19 Ave BR 3830
- Nursham Electronics 700 SE Nursham Blvd FI 9375
- Logg Co Richard 2118 SE Division St EM 8918
- *Nursham Co L L 7521 NE Gilman St KE 0010
- *Weber Co Dale 2342 Sherlock Bldg AT 5403

WASHINGTON

SEATTLE E-3

- Backer Co Jan J 2321 2 Ave MA 8811
- Carlson Co Fred W 2307 5 Ave EL 6630
- *Walight Co Fred M 3212 Eastlake EA 1818
- Normil Sales 1250 1 St S EL 4214
- Jensen Co Vernon B 2616 2 Ave EL 6871
- *Lee Co Dave M 2517 2 Ave MA 5512
- *Marsh Associates 2601 1 Ave MA 8762
- Merritt Co Ron 120 W Thomas GA 6644
- Morris Co George B 3013 1 Ave EL 1344
- *Northwestern Agencies 4130 1 Ave S EL 8882
- *Parsons & Co C B 3028 1 Ave BU 3933
- Porter Co Bert C 4310 Roosevelt Way ME 6828
- *Stream Co S W 1612 Broadway FB 7515
- *Wohl Co Frank 3215 Western Ave GA 0222
- *Widdeland Co M K 216 1st Ave M EL 6981

DISTRIBUTORS

These are the names and addresses of organizations handling the distribution of radio-TV-electronic parts and equipment in Calif., Ore., and Wash. Asterisk (*) indicates membership in National Electronic Distributors Association (NEDA). Telephone numbers are given to speed contacts.

CALIFORNIA

ALHAMBRA H-27

- *Coast Electronic Supply 527 W Main Co J-4049
- BAKERSFIELD G-24
- Arbachio J C 500 E 19 St 5-5816 Ndrs Fresno
- General Electric 1134 33 St 5-5514
- Gough Industries 3125 Jewett St
- Valley Radio Supply 716 Baker St FA 7-8831
- BERKELEY H-27
- Pacific Radio Supply 1940 Ashby Ave TH 3-8900
- BURBANK H-27
- Dean Co F S 1500 W Burbank Ch 8-4408 Ndrs Long Beach
- Pacific Radio Exch 4101 W Burbank Ndrs Hollywood
- Valley Electronic Supply 1302 N Magnolia Blvd
- CATHEDRAL CITY J-27
- Wholesale Electronic Specialists 537 Broadway
- CHICO E-16
- Radio Television Products 738 Cherry Fl 2-8140
- COMPTON H-27
- Electronic Parts Distrib 1508 E Compton
- EL CENTRO H-27
- Aliza-Huffman Distrib 1125 W Main 2307
- EL MONTE H-27
- Kimball-Stark 713 S Tyler FB 0-2594
- EMERYVILLE C-19
- General Electric Supply 5400 Hollis St MA 7141
- EUREKA A-13
- Commercial Radio & Elec 317 W 7 St HI 2-4179
- FRESNO G-22
- Arbachio J C 2349 Kern 4-6355
- Billings Wholesale Radio 260 Falton St
- Dajarnatt White B J 223 Falton 2-2153
- Dooley Harry 725 L St 2-4108
- General Elec Supply 1234 0 St 4-4746
- Graybar Electric 101 Van Ness Ave 2-4175
- Kierulff & Co 725 L St Ndrs Los Angeles
- Kinney & Fann 1740 Van Ness 6-8321
- Mayberry Co L J 2930 Butler Ndrs San Francisco
- Parts Wfg Co 3265 Belmont 3-6728
- Schlofer Sound 2121 Blackstone 7-7234
- Westinghouse Elec 2608 Calif 4-5091
- FULLERTON H-27
- United Radio & Electr 122 W Pampoa St
- GLENDALE H-27
- Hagerly Radio 6826 San Fernando Rd CH 8-2453
- *Weatherford Co B V 6921 San Fernando BR 9-2281
- HOLLYWOOD H-27
- Hollywood Radio 5606 Hollywood 4-8321
- Pacific Radio Exch 1407 Cahuenga HW 2-1393
- Yale Radio Elec 6616 Sunset Blvd GL 4169
- HUNTINGTON H-27
- Martin Dist Co 2475 E Florence Ave
- INGLEWOOD H-27
- Acron Radio 4736 W Century

LONG BEACH H-28

- Dean Co F S 969 American 6-5281
- General Electric Co 840 W 12 St 68-8419
- Gough Industries 838W12 Ndrs Los Angeles
- Graybar Electric 800 W 16 St 70-2911
- Kierulff & Co 1760 Pacific Ave 6-8268
- Ley Co Elynn W 5550 Dairy Ave 20-5444
- Lynde Electronics 1526 E 4 St 7-4807
- Radio & TV Equip 2227 Pacific Ndrs Santa Ana
- *Scott Radio Supply 266 Alhambra 7-8629
- Walker Lee H T 645 W 15 St 35-4844
- Westinghouse Elec Supply 938 Pine Ave
- LOS ANGELES H-27
- Allied Radio Supply 7319 S Normandie Ave PL 2-3134
- Bull Radio Supply 1311 W Florence Ave PL 2-7191
- Call Electronic Supply 11801 W Pico Blvd BR 2-2126
- Coonan J H Co 3535 S Broadway AD 1-9133
- Dunkle Radio Parts 2506 W 8 St
- *Federated Purchasers 911 S Grand TR 1761
- Figart's Radio 6320 Gumm Sloat Dr Y0 6218
- General Elec Supply 700 Turner St MA 7141
- Garstman Dist 745 E Pico
- G.L. Electronics 905 S Vermont DU 7-5104
- Gough Industries 560 S Mission Rd MA 6-2474
- Graybar Electric 210 Anderson AN 3-7282
- Henderson Co 628 N Alvarado DU 2-8301
- Henry Radio Shop 11240 W Olympic Blvd BR 2-1440
- Hollywood Electronics 7460 Melrose Ave WE 3-8208
- Kierulff Electronics 820 W Olympic RI 7-0271
- Los Angeles Radio 10215 Vanice LO 8-3177
- Martin Dist Co 2475 E Florence VE 5-7111
- Nirshamco Music 2920 W Pico Blvd RE 4-2177
- National TV Supply 4032 S Figueroa AD 3-8058
- Olympic Elec 1440 W Olympic DU 8-2233
- Pacific Radio Exch 1407 Cahuenga Blvd NU 8-1393
- Pacific Television 4032 S Figueroa AD 3-8058
- *Papal Bros 2605 E 4 St AN 2-5251
- Quality Dist 1235 E Olympic Blvd TB 9761
- *Radio Equip Dist 1340 S Olive RI 9-9151
- Radio Parts Sales 5220 S Vermont TW 9178
- *Radio Prod Sales 1501 S Hill PR 7471
- Radio Spec 1956 S Figueroa PR 7271
- Radio TV Sep 341 W 18 St BI 9131
- Revolveroff Co 2320 S Hill PR 1317
- Shelley Radio 2008 Westwood AB 7-6741
- United Radio & Elec 1924 S Grand RI 7-0441
- *Univ Radio Sep 1729 S Los Angeles PR 5841
- Victor Distr Co 2027 S Figueroa RI 7-4457
- Westinghouse Elec Sep 905 E 2 MA 9-4161
- Wholesale Radio & TV Sep 4305 S Figueroa AD 3-8171
- Yale Radio Electric 6616 Sunset Blvd GL 4169
- MAYWOOD H-27
- Kierulff 6058 Walker Ave LO 5-5461
- MODESTO F-20
- Dunlap Whole Radio 1216 K St Ndrs Stockton
- Pacific Television & Radio Sep 417 7 St 3-7751
- NORTH HOLLYWOOD H-27
- Hyzer Sales 11423 Vanowen St N Hollywood Radio 4212 Lankershim Blvd ST 7-3003
- OAKLAND C-19
- Brill Co W D 198 10 St TE 2-6100
- Cann Altschuler Co 6038 Telegraph Ave OL 3-7557
- *Elmer Electronics 140 11 St HI 4-7011
- Graybar Elec 1911 Union St GL 1-5451
- *Millers Radio & TV 336 E 8 St TW 3-3848
- Raycraft Co 568 3 St TW 3-9668
- Wenger Co E C 1450 Harrison GL 1-1020
- Westinghouse Elec 711 E 8 TE 4-9900
- PALO ALTO C-20
- Zach Radio 225 Hamilton DA 5-5678 Ndrs San Francisco
- PASADENA H-27
- Dow Radio 1799 E Colorado NY 1-6683
- Electronic Supply 2615 E Foothill NY 1-7188
- Empire Electronic Dis 37 E Union St NY 1-7671
- POMONA H-27
- Anderson-Watts 936 E Holt LY 9-2650
- REDWOOD CITY C-20
- Television-Radio Supply 415 Lathrop St Ndrs San Francisco
- RICHMOND C-19
- Millers Radio & TV 319 37 St BE 5-4424 Ndrs Oakland
- RIVERSIDE J-27
- Electronic Supply 2486 Binalo St 8420
- Hazy's Radio Supply 2992 B St
- SACRAMENTO D-18
- Brill-Parke 2225 19 St GI 2-2983
- Brown Co C 1714 10 St GI 3-5931
- Capitol Electronics 1714 10 St GI 3-5931
- *Donlan White 1628 "G" St GI 2-1031 Ndrs Stockton
- General Elec Supply 1131 "G" St GI 3-9001
- Graybar Electric 1900 14 St GI 2-8976
- *Kemp Co E M 1115 B St GI 3-4668
- Radio Television Prod 2012 19 St GI 2-7691
- *Sacramento Electronics 1219 "G" St GI 2-7679
- Westinghouse Elec 1730 14 St GI 3-6525
- SALINAS D-21
- Peninsula TV & Radio 42 W Gabriel 2-6503
- SAN BERNARDINO H-27
- Arrowhead Radio & Television 1212 D St 2-5981
- Electronic Equip 1123 W Base Line
- Featherstone Radio & TV 1010 E St 81-1306
- General Elec Supply 483 S "I" St
- Gough Industries PO Box 222 Ndrs Los Angeles
- Graybar Electric 653 S "H" St
- HIFI Supply 418 Baseline 2-5181
- *Inland Electronic Supply 843 Colton Ave 6-5971
- Kierulff & Co 1123 W Base Line Ndrs Los Angeles
- SAN DIEGO—J-30
- Electric Supplies Dist 435 2 Ave

Electronic Ec
General Elec
Gough Indus
Los Angele
Graybar Ele
Kierulff & C
Radio Part
Shanks & S
Silvergate Ra
Western Rad
SAN FRANCISCO
*Acme Radio
*Brown Co C
Century Dist
Et-Noble & C
General Elec
Graybar Ele
Kammer &
*Mayberg Co
*Pfeiffer & C
*Pacific Whit
*Poppley Co G
Radio Part
*San Franca
*Smith & C
*Tel-Radio St
Tilton Indus
Westinghouse
*Wholesale
*Zach Radi
SAN JOSE C-1
*Pantalone T
*Amment I
CY 4-04
SAN LEANDRO
Stylos & Er
SAN RAFAEL
*Abbott Co E
SANTA ANA H
Graybar Ele
Harley Elect
Radio & TV
SANTA BARBA
*Connell Ba
*Gough Indus
SANTA MONICA
Santa Mon
SANTA ROSA
Santa Rosa
SHERMAN DA
Sh Radio
SOUTH GATE
*Sh's Radi
STOCKTON C-
*Dunlap W
*Kemp Co E
*Shoeken I
VALLEJO C-1
*Dooley's W
VENTURA H-
*Dooley's W
VERNON H-27
Westinghou
WALNUT CRE
*Willers Rad
WEST LOS AN
California
ENGINE D-7
*Carlson M
*Gilbert Br
*Graybar El
*United Rad
KRAMATH F
*F Suppl
*HEDFORD C-
*Walker C
*Westinghou
*Penderleto
*Harold Ba
PORTLAND H-
*Applianca
*Central D
*Cooney C
*General El
*Gilbert Br
*Graybar El
*H & B Bar
*Instrument
*Johnson Cr
*Warshall V
*North Pac
*Northwest
*Pacific Str
*Portland
*Salem Ba
*Salem Ba
*Televisio
*Tracy &
*Baldwin E
SALEM D-5
*Westinghou
*Gilbert Br
*Johnson C
BELLINGHAM
*Walters S
*BREMSTON
*G & G
*EYEWET
*Priage

West Coast Electronic Industries

Electronic Equip Dist 140 W rt BE 2-3155
 General Elec Supply 668 S Ave FR 9-0271
 Gough Industries 3255 S Ave WB 0659 Hdqrs
 Los Angeles
 Graybar Electric 720 State St FR 1361
 Kleroff & Co 2426 4th Ave
 Radio Parts Co 2060 India BE 9-9361
 Shanks & Wright 2045 Kettner F BE 9-0176
 Silverstone Radio Supply 2361 India FR 9-6125
 Western Radio & TV 1415 India St FR 0361

SAN FRANCISCO C-19

*Asano Radio Distr 1251 Folsom St NE 1-0212
 *Brown Co C 61 9 St MA 1-7000
 Century Distr 1111 Front St YU 2-1480
 Ets-Nobis & Gairman 551 Mission St EX 2-0432
 General Electric Supply 1201 Bryant St UN 3-4000
 Graybar Electric 1750 Alameda St MA 1-5131
 *Kamper & Barrett 1850 Miso UN 3-3080
 *Koyberg Co L J 33 Gough St MA 1-3400
 *Mehlich & Remos 1564 Market St KL 2-2100
 *Pacific Wholes 1850 Mission St UN 1-4843
 *Pogray Co G M 1201 Howard St KL 2-3488
 Radio Parts Supply 281 9 St MA 1-0552
 *San Francisco Radio 1284 Market UN 3-6000
 *Smith & Crawford 789 Stevenson St UN 3-2043
 *Tel-Radio Supply 408 Market EX 2-2898
 TITON Industries 1850 Mission St UN 1-4843
 Westinghouse Elec 201 Potrero UN 1-5051
 *Wholesale Radio 140 9 St NE 1-3680
 *Zach Radio Supply 1424 Market MA 1-1424

SAN JOSE C-19

*Palesola TV & Radio 881 S 1 St CY 4-8781
 *Regmont Inc Frank 161 W San Fernando St
 CY 4-0464

SAN LEANDRO C-19

Stiles & Engleman 2255 Bancroft Ave LQ 9-9433

SAN RAFAEL C-19

Abbott Co E B 345 Francisco GL 3-1130

SANTA ANA F-28

Graybar Electric 301 French St
 Harley Electronics 1434 S Main KI 3-9237
 Radio & TV 207 Oak KI 2-6741

SANTA BARBARA F-26

Channel Radio Supply 523 Anacapa 2-3429
 Gough Industries 404 State St Hdqrs Los Angeles

SANTA MONICA H-27

Santa Monica Radio 117 Santa Monica EX 3-8231

SANTA ROSA H-27

Santa Rosa Electro 205 Sebastopol 4486-W

SHERMAN OAKS H-27

Oak Radio Supply 13454 Ventura ST 7-6666

SOUTH GATE H-27

Wor's Radio Supply 8320 Long Beach KI 4111

STOCKTON C-19

*Barnett Whole B J 515 N Hunter Hdqrs Fresno
 *Dunlap Whole Radio 27 N Grant HO 6-7907
 *Kemp Co E M 50 N Wilson Way HO 5-5976
 *Stockton Electronics 710 E Main St HO 6-8832

VALLEJO C-19

Walker Co B Lyman 1401 Hwy 40 VA 3-5321

VENTURA H-27

Deater's Whole 265 S Laurel MI 3-6147

VERNON H-27

Westinghouse Elec Supply 4601 S Boy L St KI 0141

WALNUT CREEK C-19

Gilbert Radio 2497 Mt Diablo Blvd

WEST LOS ANGELES H-27

CalHorn Electronics 11801 W Pico BR 2-2126

OREGON

EUGENE D-7

*Carlson Matten & Hay 96 E 10
 Gilbert Bros 424 Charleston St Hdqrs Portland
 Graybar Electric 2180 6 Ave 4-2224
 United Radio Supply 712 W 6 Ave Hdqrs Portland

ILANATH FALLS

B F Supply 2367 S 6 St

NEEDHAM C-10

*Walker Co V G 205 W Jackson 2-4558
 Westinghouse Elec Supply Co 1233 Court St

PENDLETON

Harold Radio Supply 320 SW Court Ave 1956

PORTLAND D-6

Applianco Whole 600 N W 14 AT 6384
 *Central Distr 1131 NW Couch AT 0146
 Connolly Co F B 905 NW 12th Ave CA 1755
 General Electric 300 N W 14 Ave BR 0651
 Gilbert Bros 826 S W 2 Ave BR 5641
 Graybar Electric Park & Flanders BR 6641
 H & B Radio Supply 5210 NE Sacramento TR 0057
 Instrument Lab 1720 SW Harbor Dr CA 6863
 Johnson Co Lou 422 N W B St CA 9551
 Marshall Walls 1420 NW Lovejoy BR 6421
 North Pacific Supply 2344 NW 21 Pl CA 1011
 Northwest Radio Supply 717 S W Ankeny AT 1021
 Pacific Stationery 414 S W 2 CA 4221
 *Portland Radio 1234 W Stark St AT 8647
 Saelens Radio 1605 N W Everett BE 2423
 *Stobbe Electric 33 N W Park Ave BR 5404
 Television & Radio 720 SE Alder EA 1104
 *Tracy & Co M W 10 & Gilman Sts BE 6263
 *United Radio Supply 22 N W 9 Ave BE 6323

SALEM D-6

Westinghouse Elec 815 N W 12 Ave CA 9851
 Gilbert Bros 355 N High St Hdqrs Portland
 Johnson Co Lou 1051 S Commercial Hdqrs Portland

WASHINGTON

BELLINGHAM

Watkins Supply 110 Grand Ave 274

BREMERTON

*C & G Radio Supply 1301 Pacific Ave 3-3370

EVERETT

*Pringle Radio Whole 2514 Colby Ave

KENNEWICK

Wible Radio Supply Inc Hdqrs Tacoma

SEATTLE E-3

Alaska Radio Supply 1946 Westlake N AL 8777
 Associated Industries 1752 Rainier St MI 4400
 Central Electronic 2023 7th Ave
 Coast Radio 110 University St MA 9133
 Connolly Co F B 1015 Republican St SE 4155
 Electronic Supply 5601 Calif Ave
 Fidelity Electric 960 Republican St SE 5100
 Garretson Radio Supply 2416 2 Ave MU 4380
 General Elect 1212 1 Ave S SE 6400
 *General Radio 100 Wall St
 Graybar Elec King & Occidental MU 0123
 Instrument Lab 934 Elliott W AL 4940
 Marshall-Walls 1258 1 SE 7447
 *Radio Products Sales 1214 1st Ave MA 1035
 Radio TV & Appl 500 Westlake Ave N MA 0787
 *Seattle Radio Supply 2117 2 Ave SE 2345
 Stussor Electric 2246 1st Ave S SE 5285
 *Western Electronic 717 Dexter Ave AL 9000
 Westinghouse Elec 1051 1 Ave S EL 7001
 Westlake Electronic 511 Westlake N MA 6601
 *Zobrist Co H E 2121 Westlake MU 2121

SPOKANE J-4

Columbia Electric S 123 Wall St RI 3131
 Connolly Co F B S 124 Wall St RI 6174

Frank's Radio Supply 161 S Adams St MA 8108

Graybar Electric 152 S Post St RI 3151
 General Electric S 122 Monroe TE 1421
 Johnson Co E M W 615 1 Ave RI 5432
 Northwest Electr N 102 Monroe MA 9289
 Prudential Distr 318 W Trout Ave MA 6002
 Spokane Radio Supply 305 W 2 Ave RI 8441
 Standard Sales 1219 W 1 Ave RI 7196
 Taylor Distributing E 206 Augusta EM 3301
 Westinghouse Elec N 1023 Monroe EM 3371

TACOMA E-3

*C & G Radio Supply 2502 Jefferson Ave BR 3181
 General Electric 2316 South A St BR 8454
 Graybar Electric 2112 A St MA 0164
 Stewart Co A T 711 Broadway BR 3174
 Westinghouse Elec 1930 Pacific BR 8417
 *Wible Radio Supply 2360 S Fawcett St BR 8395

VANCOUVER

Saelens Radio 310 W 8 St 4-2671

WALLA WALLA I-5

Kar Radio & Electric 12 & Pine Sts 4572

WENATCHEE

Mid-State Radio 611 1/2 N Wenatchee Ave 510

YAKIMA

Lay & Nord 112 S 2 St J-5591
 Westinghouse Elec 210 W B YA 3-4701

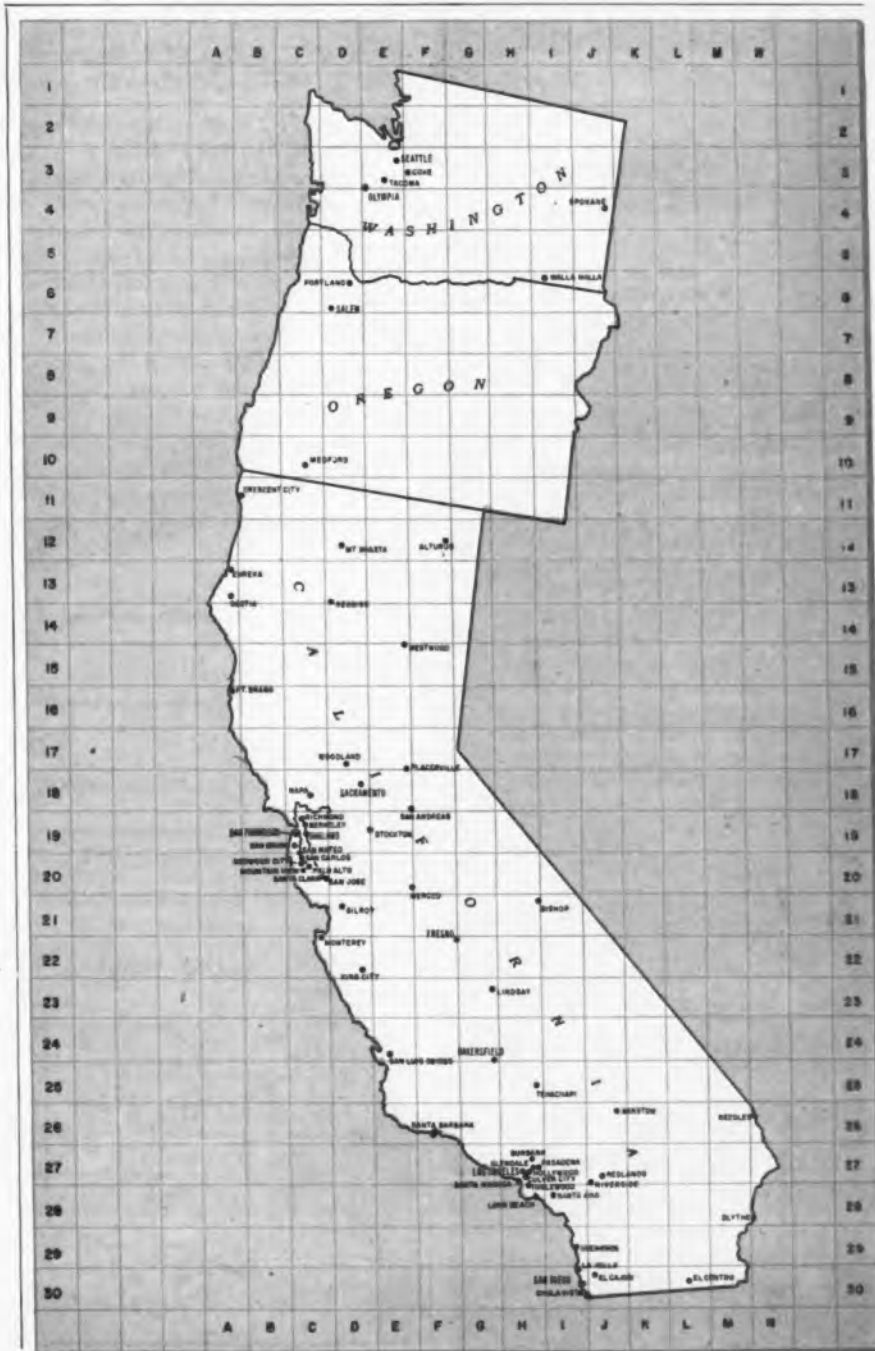

17 years
of experience

... and know-how goes
into your purchase of a
cinema equalizer ...



NEW 6517-E
SOUND EFFECTS FILTER

Made to fit the truly fine requirements of high quality laboratory sound equipment. Used throughout the world on the finest sound equipment. Priced so that you, too, may join our many friends. Write direct today for literature.



CINEMA ENGINEERING CO.
DIVISION AEROVOX CORPORATION
1100 CHESTNUT STREET • BURBANK, CALIF.

FACTORY REPRESENTATIVES
THROUGHOUT THE NATION

EXPORT AGENTS: Fraxer & Hansen, Ltd
301 Clay St. San Francisco, Calif. U.S.A.

CUES for BROADCASTERS

(Continued from page 81)

separate functions.

The second half of the 6H6 rectifier feeds audio through the volume control, pot R₁, then into one side of the secondary push-pull grid-to-line transformer. Thus from the audio section we now have two output levels: (1) the same low level for the audio rack's air monitor amplifier as before, and (2) a line level output of +14 VU which is fed along the spare program line to studio 2. Here it is equalized and fed to the input of its air monitor amplifier which has a switch to select "Line Tuner."

Tape Mechanism Circuit

DON V. R. DRENNER, Engineer,
KGGF, Coffeyville, Kansas

ERRATIC performance in a new Magnecord PT63-AM tape mechanism led to the discovery that the published schematic was not correct. The machine ran constantly in the rewind mode of operation—the cause was a shorted condenser across the rewind switch. Examination of the components mounted on the sub-panel housing the bias oscillator revealed several that were not shown in the schematic. To assist other users, the corrected schematic of our machines, Serial No. 24951 et. seq., is shown. The condensers labeled a, b, and c, are

across the contacts of the d.p.s.t. switches, and if shorted complete the circuits without manual operation of the function switch lever

Additional Note on Coaxial Line Leaks

W. A. MILLER, 522 San Pascual Avenue, Los Angeles 42, Calif.

PRESTOLITE makes a Halide type leak detector that fits into a Prestolite handle, in place of the brazing tip, which is designed for the purpose of such leak detection. Suggest that all air or nitrogen be purged, or evacuated, from lines under test to make the operation more conclusive. This process has been used in the refrigeration industry for twenty years.

Preventing 45 rpm Disc Slippage

STEPHEN POPP, WIL,
St. Louis 8, Mo.

Iwould like to submit what we at WIL believe to be an improvement over two articles published in reference to 45 rpm. disc slipping on turntables. We at WIL just cut out the necessary felt from the original turntables letting the humped portion of the 45 rpm disc fall into the well, thus no need to put on or take off an extra disc when changing to different type records.

Corrected schematic includes condensers A, B and C, which effectively shunt the d.p.s.t. switches.

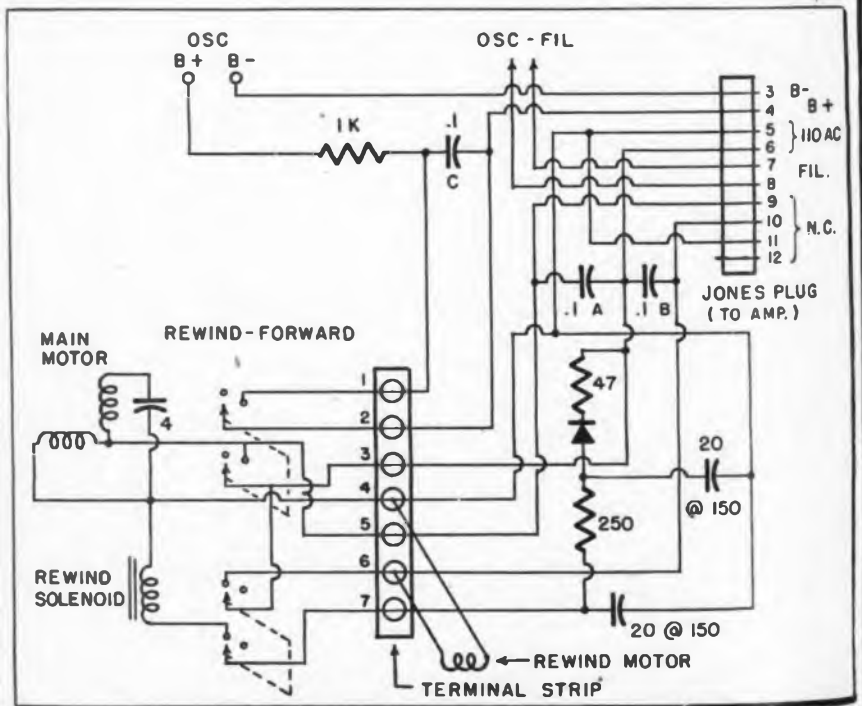

audiotape

TRADE MARK

on **Mylar***



polyester film offers you these important new advantages

1. many times stronger
2. withstands extreme temperatures
3. impervious to moisture
4. maximum storage life
5. most permanent magnetic recording medium ever developed

Audiotape on "Mylar" polyester film provides a degree of permanence and durability unattainable with any other base material.

Its exceptional mechanical strength makes it practically unbreakable in normal use. Polyester remains stable over a temperature range from 58° below zero to 302° Fahrenheit. It is virtually immune to humidity or moisture in any concentration—can be stored for long periods of time without embrittling of the base material.

The new polyester Audiotape has exactly the same magnetic characteristics as the standard plastic-base Audiotape—assures the same **BALANCED PERFORMANCE** and faithful reproduction that have made it first choice with so many professional recordists all over the world.

If you have been troubled with tape breakage, high humidity or dryness, Audiotape on "Mylar" will prove well worth the somewhat higher price. In standard thickness (1½ mil), for example, the cost is only 50% more than regular plastic base tape.

Ask your dealer for our new folder describing Audiotape on "Mylar". Or write to Audio Devices, Inc.

PHYSICAL PROPERTIES

"Mylar" polyester film compared to ordinary plastic base material (cellulose acetate)

PROPERTY	1 MIL "MYLAR"	1.5 MIL "MYLAR"	2 MIL "MYLAR"	1.5 MIL Acetate
Tensile Strength, psi	25,000	25,000	25,000	11,000
Impact Strength, kg-cm	90	170	200	10
Tear Strength, grams	22	35	75	5
Break Elongation, %	80	95	105	20
Softening Point, °F	464-473	464-473	464-473	149-230
Moisture Absorption, % (at 100% RH)	0.3	0.3	0.3	9.0
Bending Modulus, psi	500,000	500,000	500,000	350,000
Flex Life, cycles at 0° F	20,000	—	—	500

AUDIO DEVICES, Inc.

444 Madison Ave., New York, 22, N. Y.

Export Dept., 13 East 40th St., New York 16, N. Y., Cables "ARLAB"



audiotape
audiorecords
audiopoints
audiofilm

For product information, use inquiry card on last page. 109

Survey of

New Products of the Month

Capsule summaries of latest electronic developments provide handy reference for engineers in the market for new equipment and components

COAXIAL TERMINATION. A miniature unit made by the Hansen Electronics Co., 7117½ Santa Monica Blvd., Los Angeles 46, Calif., by the tape resistor process as a terminating resistor is also applicable as a replacement for the conventional ½ w resistor.

THERMAL RADIOMETERS of two types, produced as portable units by Beckman & Whitley, Inc., 915 E. San Carlos Ave., San Carlos, Calif., are in the Model 188 series; one for total-hemispherical thermal radiation measurement, the other for net-exchange measurements.

QUICK SET THERMOREGULATOR, produced by Philadelphia Scientific Glass Co., 4 Eckard Ave., Abington, Pa., can instantly adjust from room temperature to 500° F. with a sensitivity of 0.02° F. 75 lbs. hydrogen pressure prevents sparking.

BREADBOARD CHASSIS, introduced by the Replacement Sales Dept. of the Cathode Ray Tube Div., Allen B. Du Mont Laboratories, Inc., 750 Bloomfield Ave., Clifton, N.J., consists of a 4 x 12 x 3 in. cadmium-plated frame mounted with 6-32 self-tapping screws and phenolic sub-chassis.

SLUG CERAMIC CAPACITOR, encased in casting compound, offered in the "Cartwheel" units by the Hi-Q Div. of Aerovox Corp., 740 Belleville Ave., New Bedford, Mass., are permanently sealed in one operation. For color TV primarily. Rated up to 30 kv.

LOW-MU POWER TRIODE, Type 6337, by Chatham Electronics Corp., 630 Mt. Pleasant Ave., Livingston, N.J., features high plate dissipation. Plate current is held within ±10% absent of drift. Capable of withstanding 500 G shock.

INSULATING MATERIALS for motors, generators, and transformers recently developed by National Vulcanized Fibre Co., Wilmington, Del., are called NACO Insulation and NACO-Mylar Combination Insulation. The former is a 100% rag base type of vulcanized fibre.

POT CORE made of Ferroxcube Type 3 ferrite material produces very small coil assemblies having moderate inductance values with relatively high Q. Data given in Bulletin FC-5109 available on letterhead request to Ferroxcube Corp. of America, Saugerties, N.Y.

TRANSFORMERS AND CHOKES announced by Audio Development Co., 2833 13th Ave., S. Minneapolis, Minn., measure ¾ x 15/16 x 1 1/8 in. The miniature hermetically sealed units are available in standard steel and mu metal.

ROTARY SOLENOID, Model BD4, by G. H. Leland, Inc., 123 Webster St., Dayton 2, Ohio, is 1-9/16 in. in diam. Available in 25°, 35°, 45°, 67½°, and 95° rotation, either clockwise or counterclockwise. Starting torques to 5.39 lbs.-in.

CONVERSION DRIVE ASSEMBLY. A 3-speed turntable conversion kit, introduced by Fairchild Recording Equipment Co., 154th at 7th Ave., Whitestone, L. I., N.Y., enables the easy conversion of certain two-speed transcription tables to three speeds.

SWEEP GENERATOR, WR-86A, for use in designing, production-line testing, and UHF TV equipment, replaces RCA's two laboratory-type UHF sweep generators, according to the Radio Corporation of America, Tube Div., Harrison, N.J.

"AIRBRASIVE UNIT" Model C, by S. S. White Dental Mfg. Co., Industrial Div., 10 East 40th St., New York 16, N.Y., can be used for precision cutting, drilling, etching, and light deburring on hard, brittle materials. With smallest nozzle, 0.008 in. lines can be cut.

CAPACITOR of a new type called "Flat Pan Ceramic" by the Sprague Electric Co., 233 Marshall St., North Adams, Mass., consists of one of four sections in a shallow metal pan filled with a phenolic resin for moisture protection. Ranges from 100 to 500 v dc.

TV LENS, 75 mm imported by Ponder & Best, 814 N. Cole Ave., Hollywood 38, Calif., provides faster focusing and higher resolving power than standard 50 mm. Lens speed, f1.9. Iris diaphragm steps down speed to f stop.

RADAR ANTENNA DRIVE, motor designed by Mission-Western Engineers, Inc., 132 W. Colorado St., Pasadena 1, Calif., is a new start and run ac induction type that conforms to government specifications MIL-M-1940.

AIRBORNE REFERENCE GYRO announced by Summers Gyroscope Co., 2328 Broadway, Santa Monica, Calif., accelerates to operational control speeds in 10 seconds. Withstands acceleration and shock up to 60 G. Operates without excessive drift up to 10 G at 1,500 CPS.

TETRODE TRANSISTORS, grown junction, for audio amplifier AGC circuits have been announced by Texas Instruments, Inc., 6000 Lemmon Ave., Dallas 9, Texas. The germanium hermetically sealed units have two base layer connections.

PULSITOMETERS, announced by Electronic Specialty Co., Contract Div., 3456 Glendale Blvd., Los Angeles, Calif., are designed for use as flashers or keyers in fire detection and overheated circuits of jet aircraft.

DC POWER SUPPLY, Model 500A, manufactured by Universal Electronics Co., 2012 S. Sepulveda Blvd., Los Angeles, Calif., is precision regulated to better than 0.06%. High voltage output range is 0 to 500 v. Current capacity, 0 to 500 ma.

CIRCUIT CONTROL RELAYS, Parts Nos. 9094 and 9194, by Leach Relay Co., 5915 Avalon Blvd., Los Angeles 3, Calif., are designed for electrical and electronic commercial and industrial control applications. Measure 3 x 1 1/8 x 1-15/16 in.

WAVE ANALYZER Model 20 covers frequency range of 50 to 50,000 CPS. Calibration accuracy is 3%. Input voltage is 50 mv to 500 v, on dc to 600 v. Donner Scientific Co., 2829 7th St., Berkeley 10, Calif.

STRAIN GAGE TRANSDUCERS for pressure measurement are made by Electronic Engineering Assoc., 1116 Brittan Ave., San Carlos, Calif. Linearity is 2%; resonant frequency 8 kc; available in 7 ratings to 200 psi.

TETRODE TRANSISTORS for high frequency oscillators and amplifiers are produced by Germanium Products Corp., 26 Cornellson Ave., Jersey City, N.J. Types are RD-X302, RD-X301 and RD-X300.

ELECTRONIC SPOTWELDER utilizes capacitor discharge for high speed welding of metals and electronic components. Model 1015 weighs 35 lbs. Unitek Corp., 275 N. Halstead Ave., Pasadena 8, Calif.

LIQUID FLUX No. 30 is non-corrosive and non-resinous. This soft solder flux by Superior Flux & Mfg. Co., 1302 Ontario St., Cleveland 13, Ohio, contains no zinc, ammonium chloride or other strong acids.

PRECISION RATIO METER announced by Cal-Tronics Corp., 11307 Hindry Ave., Los Angeles 45, Calif., determines impedance ratios or absolute values of resistors to five significant figures.

POWDERED METAL can electrify any liquid or moist material so it yields ac and dc indications. Material made by Chemalloy Associates, Santee, Calif., permits identification and evaluation of many substances.

HIGH-VOLTAGE TESTER Model 421 DC Hypot manufactured by Associated Research, Inc., 3758 W. Belmont Ave., Chicago 18, Ill., is rated at 0-10 kv dc and 0-500 microamps, providing continuously variable output. Insulation tests to 1000 megohms.

POWER SUPPLY with magnetic amplifier regulation of ±1% is rated at 10-32 dc at 50 amps. for ac input of 220 v. ±10%. Model MR 1032-50 is made by Perkin Engineering Corp., 345 Kansas St., El Segundo, Calif.

MINIATURE R-F FILTER No. C-646 provides minimum of 50 db rejection from 10 to 300 MC. It is designed for feed-through or coax mounting. Essex Electronics, 551 Springfield Ave., Berkley Heights, N.J.

COMPARATOR-PUNCH Model FCP-100 transcribes keyboard data onto punched paper tape. Speed is 15 characters per second. Automatic digit counting available. Soroban Eng'g. Co., Box 117, Melbourne, Fla.

SPECTRUM ANALYZER for X-band, U. S. Navy type UPM-33, civilian model TS-149/UP, has been redesigned to provide more rugged construction and simplified access for service. G & M Equipment Co., 7315 Varna Ave., N. Hollywood, Calif.

MAGNETIC AMPLIFIERS. Three new amplifiers—RG-60-D series—announced by Atlas Engineering Co., 3 Edgewood St., Roxbury, Mass., have three control windings, one to provide a lead (anticipation) signal when fed from a conventional differential network.

SOLVENT. Rho Solvent, produced by the Rho Co., Box 101, Mar Vista, Calif., breaks down most potting resins. Does not corrode most metals used in electronics. Non inflammable and requires no special equipment in application.

CAPACITORS in ceramic encasement have high moisture resistance properties. "Cera-caps" made by American Radionic Co., Inc., 33 Flatbush Ave., Brooklyn 17, N.Y., are of tubular type.

MAGNETIC FLUID TRANSMISSION, Model 795, by Raymond Engineering Laboratory, Smith St., Middletown, Conn., serves as a transmission link between the prime mover and the load in a servo actuator, or any device that requires power, compactness, and precision control.

DOT GENERATOR, Model 712, announced by Jackson Electrical Instrument Co., 16-16 S. Patterson Blvd., Dayton 2, O., produces color bars, white dots, or cross patch pattern. Also, provides complete NTSC color difference signal. Available soon.

MINIATURE TRANSFORMERS. New line of miniature hermetically-sealed transformers and chokes produced by Industrial Sales Div., Audio Development Co., 2833 13th Ave., S. Minneapolis, Minn. Measure 3/4 x 15/16 x 1 7/8 in. Available in standard steel and mu metal.

SERVO MOTORS that can operate at 160°C. are available at American Electronic Mfg. Inc., 9503 S. Jefferson Blvd., Culver City, Calif. Include BuOrd Mark VII and Mark VIII and 15 variations in a wide choice of plain or pinion shafts.

More New Products on p. 114

ASTRON Hy-Met[®]

scaled for small size, light weight



operation
up to
125°C

Metalite Hy-Met* ASTRON capacitors are crafted to feature small size, light weight, and to operate up to 125°C for all types other than cardboard tubular MLL (100°C). ASTRON technicians process the fine quality materials that comprise the famous Hy-Met capacitor line with skillful attention to minute details. *Self-healing* Hy-Met capacitors accept momentary overvoltages and surges without permanent damage—possess high dielectric strength and vastly improved insulation resistance over conventional metallized paper types—*effectively protected* from humidity—give *low r.f. impedance* due to small size—are ideal for R.F. filters and noise suppression. All these features are common to the Metalite Hy-Met *plus* the greater dependability and longer life derived from added care in construction and quality control. Write today for ASTRON capacitor and filter literature.

*Trademark

ASTRON
CORPORATION



255 GRANT AVENUE

EAST NEWARK, N. J.

Export Division: Roche International Corp., 13 East 40th St., N. Y., N. Y.
In Canada: Charles W. Pointon, 6 Alcina Ave., Toronto 10, Ontario



SIMPLIFY CIRCUIT TRIMMING with

BOURNS

sub-miniature

TRIMPOTS

TRADE MARK

3 TIMES
ACTUAL
SIZE

One of many applications
when space is at a premium

Actual size
only $\frac{1}{4} \times \frac{5}{16}$ "

- RESOLUTION: AS LOW AS 0.25%
- POWER RATING: 0.25 WATT AT 100° F.
- WEIGHT: ONLY 0.1 OZ.

BOURNS **TRIMPOT** is a 25 turn, fully adjustable wire-wound potentiometer, designed and manufactured exclusively by BOURNS LABORATORIES. This rugged, precision instrument, developed expressly for trimming or balancing electrical circuits in miniaturized equipment, is accepted as a standard component by aircraft and missile manufacturers and major industrial organizations.

Accurate electrical adjustments are easily made by turning the exposed slotted shaft with a screw driver. Self-locking feature of the shaft eliminates awkward lock-nuts. Electrical settings are securely maintained during vibration of 20 G's up to 2,000 cps or sustained acceleration of 100 G's. BOURNS **TRIMPOTS** may be mounted individually or in stacked assemblies with two standard screws through the body eyelets. Immediate delivery is available in standard resistance values from 10 ohms to 20,000 ohms. BOURNS **TRIMPOTS** can also be furnished with various modifications including dual outputs, special resistances and extended shafts.

BOURNS also manufactures precision potentiometers
to measure Linear Motion; Gage, Absolute, and
Differential Pressure and Acceleration



BOURNS LABORATORIES

6135 MAGNOLIA AVENUE, RIVERSIDE, CALIFORNIA

Technical Bulletin On Request, Dept. 172

© B. L. PATENTS PENDING

DYSEAC

(Continued from page 91)

coupled pulse amplifiers utilizing only one tube type for all amplification. In DYSEAC, this circuitry has been reduced to standardized packages. (see Fig. 2.) Only two types of etched-circuit plug-in packages are required as basic building blocks in this machine. Thus, it has been possible to use modular construction throughout the computer and to simplify design practice, construction, and maintenance.

DYSEAC is similar to SEAC in several other aspects. For example, it operates at a basic repetition rate of 1 mc, uses a serial mode of data representation, and employs a serial acoustic memory. However, its operating capabilities have been extended considerably beyond those of SEAC by the incorporation of several special logical design features. These features enable the computer to communicate in an extremely flexible manner with a large group of external devices performing many diverse functions. Among the devices which may be attached to the computer are those that store, tabulate, file, convert, display, and sense information; or devices that actuate mechanisms such as servo equipment in response to signals sent out by the computer as a result of information being processed within it. Even other full-scale computers employing the same digital language may be attached to this machine.

Arithmetic Powers

The arithmetic powers of DYSEAC have not been greatly expanded over those in SEAC. Instead, major design emphasis was placed on providing versatility of control facilities and latitude for expansion. It was deemed important to provide for future expansion of the high-speed internal storage capacity in case this becomes important for a particular application. Accordingly, the system has been provided with convenient means for supplementing the initial memory capacity of 512 words with additional storage units up to a total capacity of 4096 words.

The engineering features of DYSEAC are directly related to its intended use as a data-processing center that can be located at various operating sites without particular difficulty. The equipment is distributed between two 40-foot trailer

(Continued on page 126)

custom transformers:

what's
behind
the
swing
to

KEYSTONE?

KEYSTONE answers the needs of engineers and designers who have special transformer problems—gives them a recognized and established source for dependable quality.

KEYSTONE makes available special transformers of any type—400 cycle, plate filament or bias, saturable reactors (magnetic amplifiers), instrument, precision matched, and many others—with operating characteristics suited to any unusual or difficult specifications.

KEYSTONE transformers are tested under the most rigid conditions throughout production—can be qualified for approval under MIL-T-27 and other military and civilian specifications right in the plant, saving delay and costs.

When you have an unusual or difficult transformer application—when an ordinary transformer won't solve the problem—call on KEYSTONE for complete engineering and production to meet your *exact* requirements.



PERFORMANCE AND OPERATING CHARACTERISTICS OF THIS TYPICAL KEYSTONE TRANSFORMER:

driver transformer:

3-0 plates to 3-2 grids

primary impedance:

15,000 ohms; Sec. Imp. 240 ohms

freq. response:

2.3 db/dec. up to 100 kc

ratio: 3:1

balanced windings

prl. d.c.:

15 MA, D.C. Unbalanced 1.5 MA

electrical center:

100 ohms

harmonic distortion: less than 1%

mfg. in accordance with mil-t-27

size: 2 x 2 x 2 1/2"

keystone  PRODUCTS COMPANY

UNION CITY 2, N. J. UNIon 8-5400

Survey of

New Products of the Month

Capsule summaries of latest electronic developments provide handy reference for engineers in the market for new equipment and components

DELAY LINES. Several designs added to its standard group, provides Neutronics Inc., 2908 Nebraska Ave., Santa Monica, Calif., with a complete range of miniature lumped constant delay lines in a standard impedance range from 25 to 3,000 ohms.

POWER RECTIFIERS. McColpin-Christie Corp., 3410 W. 67th St., Los Angeles 43, Calif., have announced a new line of "Stablevolt" dc power rectifiers. No tubes, lamps, carbon piles, or varistors are employed. Ten standard 28 v production models with capacities up to 1,000 amps.

TUBE SHIELDS, a new heat-dissipating series of subminiature units, announced by International Electronic Research Corp., 177 W. Magnolia Blvd., Burbank, Calif., have no resonances when shaken at 10 G from 0 to 2,000 cycles. Meet the conditions encountered in missile applications.

"QUAD KARDS" in standard 2 in. square segments can be furnished by Methode Mfg. Corp., 2021 W. Churchill St., Chicago 47, Ill., with or without conductors printed to specification. Have standard hole punchings for tube sockets, transformers, and conductors.

INTERFERENCE REDUCTION KITS by Hallett Mfg. Co., 1601 West Florence Ave., P.O. Box 59, Inglewood, Calif., meet all military radio interference specifications and fit the majority of commercial and automotive engines. Available for 4, 6, and cylinder engines.

DATA REDUCING DEVICE, Oscar F. designed by Benson-Lehner Corp., 2340 Sawtelle Blvd., Los Angeles, Calif., is a machine that enables the rapid semi-automatic reading of oscillographic and film records. Provides a link between graphical information and high speed computers.

AIRCRAFT BATTERY ELIMINATOR. by Opad-Green Co., 71 Warren St., New York 7, N.Y., tests and operates aircraft electrical and communication equipments. The Model K101F operates on 115 v ac, 60 CPS, single phase and provides a continuously variable output from 0 to 28 v dc.

NOISE FIGURE METER, Model NFT, by Electronic Research Associates, Inc., P.O. Box 29, Caldwell, N.J., accurately measures noise figures of transistors, transistor amplifiers, and related devices. Eliminates present manual step-by-step procedure.

CIRCUIT ANALYZER for testing aircraft electrical systems has been announced by DIT-MCO, Inc., 505 W. 9 St., Kansas City, Mo. Model 200 automatically analyzes 200 circuits in 20 seconds.

VARIABLE TRANSFORMERS by Superior Electric Co., Bristol, Conn., include "Powerstat" types 136 for 120 v., and 236 for 240 v. Also available in motor driven assemblies and ganged units.

WINDING MACHINES for making toroidal coils and variable transformers available through Rex Rheostat Co., 3 Foxhurst Rd., Baldwin, L.I., N.Y.

ARBITRARY FUNCTION GENERATOR, type G-1A, can relate output to input by any predetermined function of form $y=f(x)$. Produced by William Miller Instruments Co., 325 N. Halstead Ave., Pasadena 8, Calif.

MAGNETIC RECORDING HEAD for audio and computing is available from Brush Electronics Co., 3405 Perkins Ave., Cleveland 14, Ohio. Model BK-1500 series is in cast resin blocks of 1 to 14 channels.

VACUUM TUBE CURVES on $8\frac{1}{2} \times 11$ in. pads aid circuit design. Types made available recently are 5687, 5751, 5718. Others include 12AU7, 6L6, and 6AQ5. Technical Pub. House, 15-B Everett St., Cambridge 38, Mass.

TAPE REPRODUCER Model 814 CK for continuous automatic playing of 8 hours of prerecorded music from a single reel has been announced by Magnecord, Inc., 225 W. Ohio St., Chicago 10, Ill.

ELECTRONIC GENERATOR Model 1425 delivers 900 va from 80 to 135 v. or 160 to 270 v. Four ranges from 50 to 6000 CPS. Communication Measurements Lab., 350 Leland Ave., Plainfield, N.J.

DC POWER SUPPLY, Model PS-503, is capable of supplying 5,000 v dc at 300 μ a. The transformer is hermetically sealed in an epoxy resin casting and operates on 30 KC. Ripple is less than 1% at full load. Measures $4 \times 2\frac{1}{2} \times 5\frac{1}{2}$ in. Servo Corp. of America, 20-20 Jericho Tpk. New Hyde Park, N.Y.

MAGNETIC AMPLIFIER, "Stablevolt" Type A, utilizes no vacuum tubes or moving parts. Features dual magnetic regulation, 6, 12 and 28 v. models at up to 100 a. Magnetic Research Corp., 318 Kansas St., El Segundo, California.

DIFFERENTIAL REWIND "Gimmick" re-winds 16 mm and 35 mm film reels simultaneously with uniform take-up. Unit is placed on rewind spindle. S. O. S. Cinema Supply Corp., 602 W. 52 St., New York 19, N.Y.

TV CAMERA CHAIN by Kalbfell Labs., Inc., P.O. Box 1578, 1090 Morena Blvd., San Diego 10, Calif., uses economical 16 mm lenses. Accessories allow remote control of pan, tilt, lens iris and focus.

MINIATURE CRT for industrial applications has 5-in. face and overall length of 7 in. It may be read in bright daylight. National Union Electric Corp., 405 Lexington Ave., New York 17, N.Y.

TIME DELAY RELAY Model 13100 for airborne equipment is 3 in. long, 1 in. diameter. Weight is under 3 oz. Delay is 125 to 250 milliseconds. Neomatic Inc., 9010 Bellanca Ave., Los Angeles 45, Calif.

POWER SUPPLY Model 2 by Audio Products Corp., 2265 Westwood Blvd., Los Angeles 64, Calif., increases flexibility of firms modular system. Output is 300 v. dc, 80 ma; —150 v. dc, 15 ma; 6.3 v. ac, 8 a.

CRYSTAL PHOTOCELL Type CL-1 employs cadmium sulphide as light sensitive element. 100 μ a at 100 v. at 2 ft. candles. Light to dark current 60 db at 1 ft. candle. Clalrex Corp., 50 W. 26 St., New York 10, N.Y.

WIRE WOUND RESISTORS, types WWL and WWA, manufactured by Dale Products, Inc., Columbus, Neb., are now being encapsulated for hermetic sealing. They are non-inductive, pi-wound on cores molded from the same material as the encapsulating resin.

SYNCHRONIZING GENERATOR, type 2204 for monochrome, and the type 2203 color synchronizing generator, manufactured by Tel-Instrument Co., Inc., 728 Garden St., Carlstadt, N.J., deliver six outputs for sync, blanking, drive and linearity.

SIGNAL-GAIN GENERATOR, for UHF testing, has been made available by Graco Products Inc., 36-17 20th Ave., Long Island City 5 N.Y. Compact and light weight, this generator features continuous tuning over UHF band and gain control.

SYNCHROS, weighing 1.8 oz. and having a maximum overall length of 1.281 in., are available from Clifton Precision Products Co., Inc., Marple at Broadway, Clifton Heights, Pa. These size 10 synchros feature 12 in. leads, with radial terminals or axial terminals.

ROTARY SWITCH, series No. 7551, manufactured by Ark-Les Switch Corp., 51 Water St., Watertown 72, Mass., is rated at 3 a. and 125 v. Applications include fans, drink mixers, ranges and other appliances requiring a rotary switch.

WIRE WOUND RESISTORS, Type EM, of the encapsulated miniature type, and manufactured in accordance with MIL-R-93 by the Brown Corp. Ltd., San Diego, Calif., are available in range from 10-30,000 ohms. Higher resistances on special order. Available from Electronics Div., Eastman Pacific Co. 2320 E. 8th St., Los Angeles 21, Calif.

SUB-MINIATURE RELAY, designated Class 33, is manufactured by Magnecraft Electric Co., 1442 E. W. Van Buren St., Chicago 7, Ill. Open type model with DFDT contacts is $1\frac{11}{32}$ in. long, $11/16$ in. wide and 1 in. high. Furnished for voltages up to 110 vdc and 6 contact arms per stack.

FREQUENCY TIME COUNTER, Model 3149, is designed for making direct frequency measurements, up to 150 KC, and time measurements under field conditions with laboratory accuracy. Features gold-plated switch contacts and turret-lug mounted components. Potter Instr. Co., Inc., 115 Cutter Mill Rd., Great Neck, N.Y.

HI-VOLTAGE SWITCH, a high-vacuum type, developed for switching purposes in dc pulse systems and radar. Designated part #NVS-300, it is a normally closed, single pole, double throw high voltage device. Naer Corp. 2301 S. Purdue Ave., W. Los Angeles.

VECTOR IMPEDANCE BRIDGE manufactured by Republic Engineering Co., Inc., Beltsville, Md., reads impedance directly in magnitude and phase angle. Tolerances are held to 1%, except resistance measurements to $\frac{1}{2}$ %.

COAX STRIPPER AND CUTTER, in two sizes, the #400 for RG8-U, and the #300 for RG59-U and smaller sizes, is manufactured by K. Miller Tool & Mfg. Co., Inc., 6 Cass St., Springfield 4, Mass. and marketed directly by them to industry.

SUBMINIATURE SWITCH $\frac{3}{4}$ in. sq. Brown-Hill wafer type has 1300 v. breakdown rating. Rotor blades and stator contacts are solid silver alloy. R-F Electronics, Inc., 291 NE 61 St., Miami, Fla.

Big Savings Ahead

**2 New SYLVANIA SOCKETS save
Assembly Time... Cut Costs
... Improve Performance!**



1. New Sylvania 7-pin Miniature Printed-circuit Sockets. Contacts and center shield are shaped so that sockets can be stacked one upon another for automatic feeding and assembly. Small slots are used on the circuit board to receive the contacts, resulting in stronger chassis construction. Only one socket assembly need be stocked since terminals can be interconnected by printing the circuit on the chassis board rather than using a metallic connector on the socket itself.

Insulator is molded of general-purpose or low-loss phenolic. Contacts are brass or phosphor bronze, plated to suit your specification. Supplied with or without center shield. Now available in 7-pin construction with 9-pin miniature and other types to follow. Tube Shield Ground Strap can also be furnished.

2. New Sylvania Solderless-type Sockets for wire-wrapped connections are now being made in all 7 and 9-pin miniature sizes. Contacts are shaped to provide reliable connections with the use of present wire-wrap-ping tools.

For full information concerning these or other Sylvania parts, or special quality components engineered to your own specifications, write to Dept. 4A-4408, Sylvania today.



See the full story of Sylvania's Fabricating Services in Sweet's Catalog — Product Design File. Look for **1b**
5y

SYLVANIA

Sylvania Electric Products Inc., 1740 Broadway, New York 19, N. Y.

In Canada: Sylvania Electric (Canada) Ltd., University Tower Building, St. Catherine Street, Montreal, P. Q.

LIGHTING • RADIO • ELECTRONICS • TELEVISION

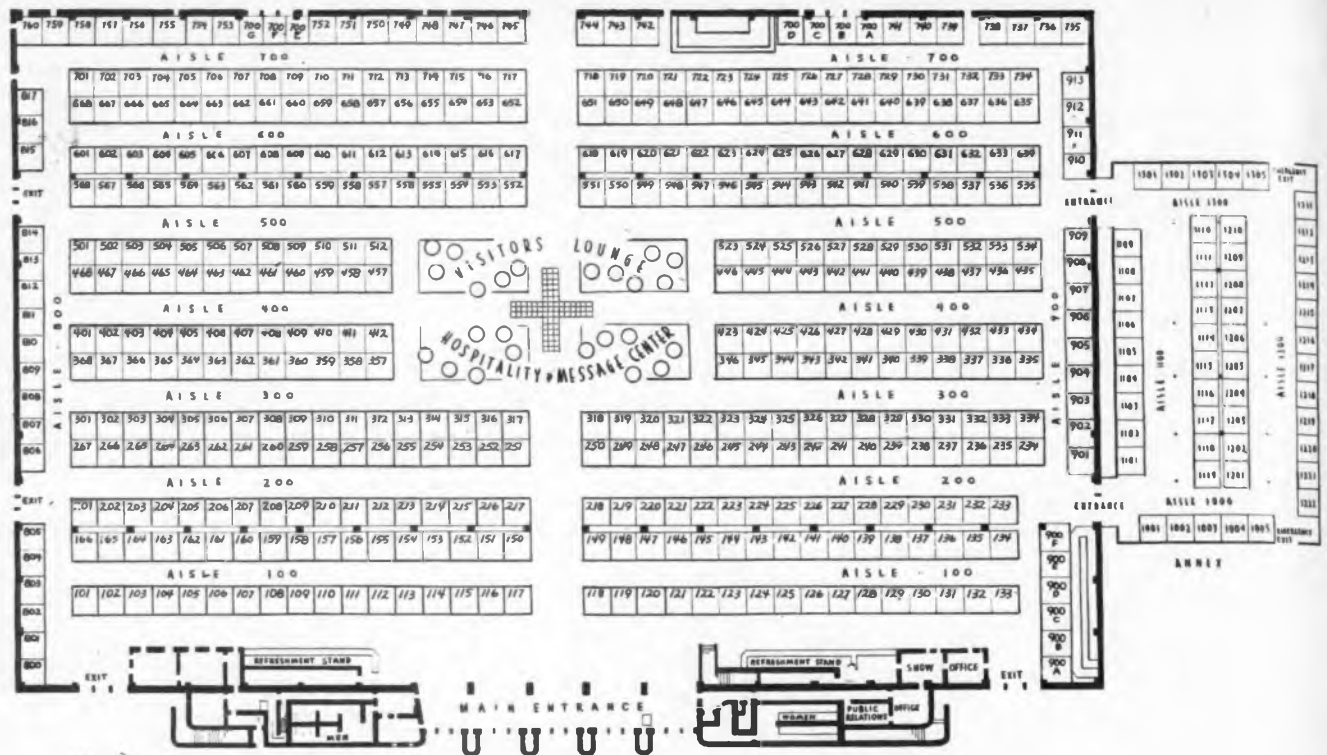

Floor plan and booth locations in Pan-Pacific Auditorium and adjoining annex

WESCON 1954 (Continued)

American Aviation, and R. C. Howard, Bell Tel. Labs.
 "Automatic Iteration on an Electronic Analog Computer"—L. B. Wadel, Chance-Vought Aircraft.
 "A Logarithmic Voltage Quantizer" by E. M. Glaser and H. Blasbalg, John Hopkins Univ.

TELEMETERING APPLIED TO AIRCRAFT

"A Phase Compensated Data Processing System for Piloted Aircraft"—H. E. Seibert, Convair.
 "A Complete Telemetering System for the Flight Testing of Piloted Aircraft"—M. L. Van Doren, Douglas Aircraft.
 "Versatile Automatic Data Separation Equipment for Pulse Multiplex Telemetering Systems"—I. P. Magasiny, Raymond Rosen Eng. Prod.

RECENT DEVELOPMENTS IN PARTS

"The User Looks At The Component Parts Problem"—A. M. Okun, Bell Aircraft.
 "Packaging of Component Parts for High Intensity Vibration Environments"—M. G. Comuntzis, Jet Propulsion Lab.
 "A Sensitive Nonmagnetic Relay"—Mullenbach Electrical Mfg. Co.
 "Temperature Stabilization of Transistor Amplifiers"—R. B. Hurley, Convair.
 "Reliable Electronics Through Protective Coating Techniques"—E. R. Gamson and A. Hennesian, Stanford Research Inst.

COMPUTERS

"Transistor Flip-Flops for High-Speed Digital Computers"—E. U. Cohler, MIT.
 "Computer-Programmed Preventive Maintenance for Internal Memory Sections of the E.R.A. 1103"—S. R. Gray, Engineering Research Associates Div., Remington Rand.

CIRCUIT DESIGN

"The Transistor Emitter-Coupled Amplifier"—D. W. Slaughter, Cal. Tech. Jet Propulsion Lab.
 "Wideband Frequency Discriminators for AFC Systems"—L. S. Stokes, Hughes Aircraft & L. Mautner, ESC.
 "A Transistorized Recorder for Transportation Shock & Vibration Studies"—R. I. Anderson, Electronic Eng. Co. of Cal.
 "Measurements of a Series of Discrete Values of a Changing Current"—A. A. Windsor, U. of Cal.

TELEMETERING THEORY

"Interpretation of Sequential Samples from Commutated Data"—L. L. Rauch, Univ. of Mich.
 "Frequency Response as a Function of Sampling Rates in Time Multiplexed Systems"—L. Katz, Woburn, Eng.

MANAGEMENT

"Are Engineers People?"—A. M. Zarem, Stanford Research Inst.
 "Some Factors Related to Management of an Applied Research Project"—H. Iams, Hughes Aircraft.
 "More Engineering per Dollar"—B. Dempster, Electronic Engineering Co.
 "Quality in Production"—R. Weller, Naval Air Missile Test Center.

COMPUTERS

"Efficient Linkage of Graphical Data and Digital Computers"—E. D. Lucas, Jr., Benson-Lehner.
 "An Input-Output System for a Digital Control Computer"—L. P. Retzinger, Librascope.

VEHICULAR COMMUNICATIONS

"Effect of Front End Receiver Design on Overall Receiver Performance, and Resulting Systems Performance"—A. C. Manke, General Electric.

BROADCAST AND TV RECEIVERS

"Amplitude and Phase Compensation in Color Television Receivers"—E. L. Michales, Packard-Bell.
 "The Planning and Performance of a Completely Integrated Source of Television Signals from Film"—A. D. Emurian, Philco.

(Continued on page 118)

EXHIBITORS and their BOOTH NUMBERS

Abbott Instrument & Engineering Co.	206-207
Ace Engineering & Machine Co.	760
Advance Electric & Relay Co.	308
Aerovox Corporation	546-547
Air Associates, Inc.	1218
Air-Marine Motors, Inc.	639
Aircraft-Marine Products, Inc.	444-445
Airpax Products Co.	750
Airtron, Inc.	463
Allied Chemical & Dye Corp.	1201
Altec Lansing Corporation	550-551
American Electric Motors, Inc.	265
American Lava Corporation	245
American Microphone Co.	326
American Phenolic Corp.	523-524
Ampex Corporation	112
Andrew Corporation	532
Harry Appleton Co., Inc.	667
L. H. Appleman	742
Applied Science Corp. of Princeton	447
Arco Electronics, Inc.	816
Aremac Associates	630
Arga Div., Beckman Instruments, Inc.	1114
The Arnold Engineering Co.	320-321
Assembly Products, Inc.	233
Audio Devices, Inc.	409
Audio Products Corporation	138
Automatic Electric Sales Corp.	345
Avery Adhesive Label Corp.	221-222
Ballantine Laboratories, Inc.	814
Barron-Jur Company	900A
Barry Corporation	34
Herb Becker Company	154
Belden Manufacturing Co.	635

Bendix Aviation Corp.	745-746
Computer Division	711-712
Eclipse-Pioneer Division	719-720
Pacific Division	743-744
Radio Division	716-717
Red Bank Division	650-651
Scintilla Division	606
Bennett Products Mfg. Co.	722-723
Benson-Lehner Corp.	243-244
Berkeley Scientific Corp.	502-503
Div. of Beckman Instruments	363
Jack Berman Company	510
Beta Electric Corp.	158
Bird Electronic Corp.	1211
Bliley Electric Company	1211
Bodnar Industries, Inc.	702
Boesch Manufacturing Co., Inc.	110
Bogus Electric Manufacturing Co.	461-462
Bomac Laboratories, Inc.	507-508
Boonton Radio Corporation	440
Browning Laboratories Instrument Sales Corp.	1301
Browning Laboratories, Inc.	123
Brubaker Manufacturing Co., Inc.	330
Brush Electronics Company	128
Burgess Battery Co.	115
Burlington Instrument Co.	427A
Burnell & Company	1303
Burroughs Corporation	136
Bussmann Manufacturing Co.	340-341
Calldyne Company	700F
California Computer Products	201-202
Cal-Tronics Corporation	362
Cambridge Thermionic Corp.	

(Continued on page 119)

NEW!

OHMITE[®]

Proudly announces the

RITEOHM[®]

**completely encapsulated
precision resistor
type 85 and 86**

Ohmite-compounded, special resin encloses all parts. Its coefficient of expansion closely matches that of bobbin, wire, and terminals.

Rigid steatite bobbin keeps pie windings in place.

Resistance wire welded to terminals insures perfect connections.

Bobbin is completely encapsulated—ends and even center hole.



Exceeds
MIL-R-93A
Amendment 2
at 125°C ambient

Now . . . a new Ohmite encapsulated, wire-wound, precision resistor, designed to provide absolute stability. Winding is protected against moisture or mechanical damage by a rigid steatite bobbin encapsulated in Ohmite-compounded, special resin. Resistance wire is welded to terminals. Axial-lead and lug types, in sizes from 1/4 to 1 watt (125°C ambient) in a wide range of resistance values. Tolerances to ± 0.1%.

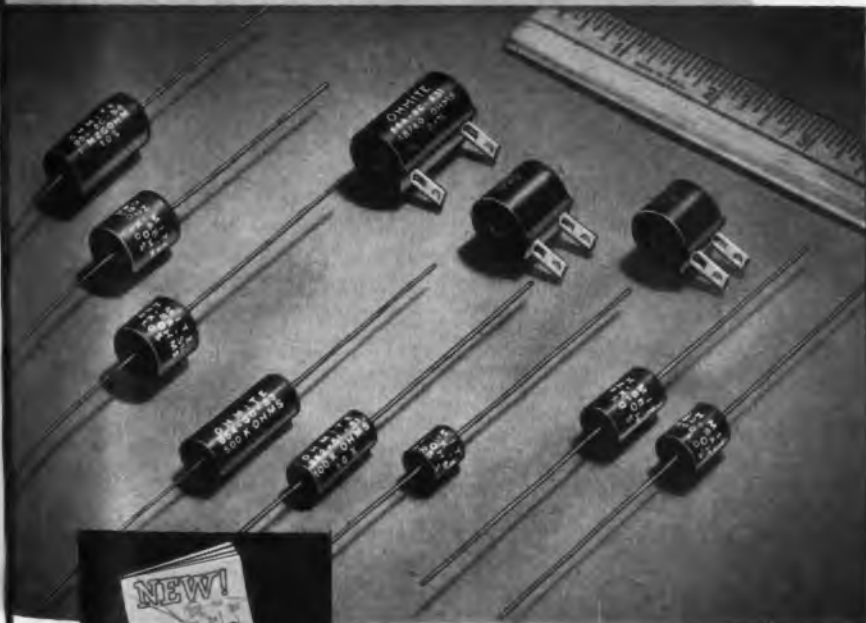

NEW!

Write for New
Descriptive Bulletin

Be Right with

OHMITE

**RHEOSTATS
RESISTORS
TAP SWITCHES**

OHMITE MANUFACTURING COMPANY, 3662 Howard Street, Skokie, Illinois (Suburb of Chicago)

For **STANDARD** or **CUSTOM-BUILT R. F.**
or **Pulse Connectors**

select ...



Diamond manufactures
a broad line
of high quality
connectors, including ...



**CO-AXIAL
CABLE
CONNECTORS**

BNC and BNC High Voltage

**N
C
HN**

**SKL
LN
LC
BN**

**PULSE CONNECTORS
ADAPTERS (cable to rigid line)
TERMINATIONS
COUPLINGS**

**CRYSTAL HOLDERS
ADAPTERS (between series)
SUB-MINIATURE
CONNECTORS**

**TEST JACKS
CABLE ASSEMBLIES**

Send for catalog 53E

DIAMOND MANUFACTURING

C O R P O R A T I O N

7 North Avenue, Wakefield, Massachusetts

WESCON Program

(Continued from page 116)

"Some Advances in Color Television Receivers"—A. V. Loughren, Hazeltine.
"A Color Camera for the NTSC System"—R. J. Stahl, Color Television, Inc.
"Improved Performance in Vidicon Camera Systems"—J. P. Day, Kalbfell Labs.
"A Method for Determining the Q and Selectivity of Low-Loss Parallel Resonant Circuits"—R. C. Skar, Collins Radio.

SYSTEMS ANALYSIS

Session Chairman: L. Weinberg, Hughes Aircraft.
"Frequency Memory in Multiple-Mode Oscillators"—W. A. Edson, Stanford Univ.
"A Mathematical Analysis of a Series Circuit Containing Periodically Varying Resistance"—L. A. Pipes, Univ. of Calif. and U. S. Naval Ordnance Test Station.
"Analytical Determination of Response of Certain Time-Varying Linear Feedback Systems"—W. E. Mathews, Hughes Aircraft.
"An Optimized Cross-Correlation Type Tracking Filter for Missile Instrumentation"—L. Katz, Ralph M. Parsons Co.

VEHICULAR COMMUNICATIONS

"Some Basic Considerations in Selective Signaling Systems"—T. W. Sanders, Sanders and Sanders Electronic Engineering.
"Integration of Mobile VHF with Microwave Radio Solves Vexing Problems"—J. R. Neubauer, RCA.
Panel Discussion: "Communication Frequency Allocations"—moderated by Commissioner E. M. Webster, FCC.

AIRBORNE ELECTRONICS

"Simplified Aircraft Response Functions"—R. F. Drenick and R. B. Headley, RCA.
"A Servo Mechanism Approach to the Problem of Communication for Aircraft Control"—S. J. O'Neill, Air Force Cambridge Research Center.
"Cumulative Probability of Radar Detection"—L. Rider, T. Rooney and B. Rudwick, General Electric.
"A Thunderstorm Avoidance Radar for Civil Aircraft"—G. W. Church and C. L. Greenslit, Bendix Radio.

MICROWAVE THEORY AND TECHNIQUES

"Design of Broadband Waveguide Rotary Joints"—J. Guarraera and J. Fisch, Reeves Instrument.
"Design Considerations for Multichannel Coaxial-Line Rotary Joints"—J. D. Hall, Sperry Gyroscope.
"Theory and Design of a High Power Diplexing Filter"—F. S. Cole, Sperry Gyroscope.

MICROWAVE THEORY AND TECHNIQUES

"Microstrip—A Printed Microwave Transmission System"—H. F. Engelmann, Federal Telecommunication Labs.
"Precision Microwave Measurements of Waveguide Voltage Standing Wave Ratios"—I. N. Anderson, Airtron.

AIRBORNE ELECTRONICS

"PARAN—A Precision Automatic Ranging System"—R. W. Johnson, R. M. Parsons Co.
"Isolating Devices for Use with Tail-Cap Aircraft Antennas"—R. L. Tanner, Stanford Research Inst.
"Cooling Requirement Charts for Electronic Equipment"—L. J. Lyons, Heat Transfer Consultant.
"Rotating Machine Power Supplies for Airborne Applications"—A. A. Hagedorn, Hughes Aircraft.

ULTRASONIC ENGINEERING

"Ultrasonic Cleaning of Miniature Devices"—Q. C. McKenna, McKenna Labs.
"Composite Piezoelectric Resonators"—W. G. Cady, Cal. Tech.

ELECTRON TUBES

"Some Recent Improvements to the Design of Power Amplifier Klystrons"—D. H. Preist, Eitel-McCullough.
"Space Charge Waves in Crossed Electric and Magnetic Fields"—S. S. Solomon, U. of Cal.
"Non-Reciprocal Loss for Traveling-Wave Tubes"—J. S. Cook, Bell Labs.
"A UHF Backward-Wave Oscillator"—R. W. Grow and D. A. Watkins, Stanford U.
"Rippled-Wall and Rippled-Stream Amplifiers"—C. K. Birdsall, Hughes Aircraft.

INFORMATION
"On the Multiple Statistics"—C. McC...
"Design Circuits for Forming Signals"—Tech...
"On the Noise in son, H...
AUDIO
"Recent Commu...—D. I... Sound...
"The 'Li... phone... Noble... Progress...—W. T. S...
ELECTRON
"Transist...—J. S...
"Recent...—H. T...
"Recent... Transis... Wannlu... Hughes...
"Recent... Devices...
"Reliability in Low... Dukat...
SEMICONDUCTORS
"Junction... tions"—...
"P-N-I-P... Bell L...
"Junction... Anders...
"Temper... Character... sion L...
"Noise C... Transis...
NOTE: A... to be ann...
WESCON
(C...
Camloc Fa... Cannon El... Corad Corp... Allen D. C... Cargo Pack... Caruthers... Carstedt R... Carter Mo... Cascade R... CBS—Hydra... CEC Instru... 15ub. of... Controlab... Div. Glo... Century G... Chicago St... Cinch Man... Howard... Cinema En... Clarostat... Gary Multi... Clear Beam... Irv M. Co... Call Windi... Collins Rec... Coleman E... Color Tele... Communic... Communic... Condenser... Connecticut... Conrac, In... Conrad, In... Consolidat... I. L. Cons... Central Pr... Cornell Du... Corning Gl... E. W. Cro... Crucible S... Cubic Corp... Dago Elect... Dale Prod... The Daven... Joe David... George Da... De Jhr Am... Diamond I... Digital Ins... Deakom C...
TELE-TECH

INFORMATION THEORY

"On the Modulation Levels in a Frequency Multiplexed Communication System by Statistical Methods"—R. L. Brock and R. C. McCarty, Boeing.
 "Design and Performance of Phase-Lock Circuits Capable of Near-Optimum Performance Over a Wide Range of Input Signals"—R. Jaffe and E. Rechten, Cal. Tech.
 "On the Response of Linear Systems to Noise Inputs"—J. Hellfron, U. of Cal.
 "Noise in Driven Systems"—J. M. Richardson, Hughes Aircraft.

AUDIO

"Recent Developments in Industrial and Community Noise Control Problems"—D. B. Callaway, District Industrial Sound Control.
 "The 'Lipstik' Miniature Condenser Microphone System"—J. K. Hilliard and J. J. Noble, Altec Lansing.
 "Progress Report on Magnetic Recording"—W. T. Selsted, Ampex.

ELECTRON DEVICES

"Transistors for High Power Applications"—J. S. Saby, General Electric.
 "Recent Developments in Power Transistors"—H. T. Mooers, Minneapolis-Honeywell.
 "Recent Developments in Silicon Fusion Transistors"—R. A. Gudmundsen, A. Wannlund, W. Waters and W. Wright, Hughes Aircraft.
 "Recent Reliability Tests on Semiconductor Devices"—W. J. Pietrol, Bell Labs.
 "Reliability of Quality Produced Transistors in Low Power Audio Applications"—F. M. Dukat, Raytheon.

SEMICONDUCTORS

"Junction Diodes—Features and Applications"—F. Finnegan, Raytheon.
 "P-N-I-P Junction Triodes"—J. M. Early, Bell Labs.
 "Junction Devices for Switching"—A. E. Anderson, Bell Labs.
 "Temperature Stabilization of Transistor Characteristics"—S. Sherr, General Precision Lab.
 "Noise Considerations for P-N-P Junction Transistors"—J. W. Englund, RCA.

NOTE: At press time, several papers are yet to be announced.

WESCON Exhibitors

(Continued from page 116)

Comloc Fastener Corporation	908
Cannon Electric Company	134
Carad Corporation	726
Allan D. Cardwell Mfg. Co.	113
Cargo Packers, Inc.	753
Caruthers & Fernandez, Inc.	701
Carsted Research Laboratory	721
Cartor Motor Company	211
Cascade Research Corporation	141
CBS-Hytron Div. CBS, Inc.	226-227
CEC Instruments, Inc.	130-131
(Sub. of Consolidated Eng. Corp.)	
Contralab Div.	718
Div. Glove-Union, Inc.	
Century Geophysical Corp.	609-610
Chicago Standard Transformer Corp.	541
Cinch Manufacturing Corp.	906-907
Howard B. Jones Div.	
Cinema Engineering Co.	548
Claroal Manufacturing Co.	213
Clay Multiplier Corp.	255
Clear Beam Antenna Corp.	543
Irv M. Cochran Co.	258
Cell Winding Equipment Co.	301
Collins Radio Company	911-912
Coleman Engineering Co., Inc.	104
Color Television, Inc.	231
Communication Accessories Co.	608
Communication Products Co., Inc.	1206
Condenser Products Co.	566
Connecticut Telephone & Electric Corp.	638
Conrad, Inc.	127
Conrad, Inc.	705
Consolidated Vacuum Corp.	137
L. L. Constantin & Co.	900C
Control Products, Inc.	529
Camell Dubilier Electric Corp.	228-229
Corning Glass Works	142-143
B. W. Cramer Co., Inc.	204
Crucible Steel Co. of America	107-108
Cubic Corporation	903
Dago Electronics Corp.	1219
Dale Products, Inc.	601-602
The Daven Company	209
Joe Davidson & Associates	266-267
Georgia Davis Sales Co.	614-615
De Juv Amco Corporation	754
Diamond Mfg. Corp.	539
Digital Instrument Co., Inc.	427B
Dookam Corporation	1205

For **STANDARD** or **CUSTOM-BUILT** co-axial line and waveguide **COMPONENTS** and **TEST EQUIPMENT**, select...



Microwave Products



DIC-2217 — KLYSTRON MOUNT FOR 2K25, "X" BAND
 A standard DICO design for operation in the range of 8.5 to 9.6 kmc. An adjustable uncalibrated output padding attenuator is provided. Incorporated in each shielded D.C. input lead is a polyiron absorbing slug, to prevent entrance of interfering energy or radiation of local oscillator energy in the "X" Band region.

DIC-6113 — DUPLEXER ASSEMBLY
 This is a typical custom made waveguide component, demonstrating Diamond's ability to manufacture accurately to customer's specifications.

DIC-6028 — FREQUENCY METER, "S" BAND
 This reaction type frequency meter covers the range of 2.15 to 4.3 kmc. Similar meters for the 1.4 to 2.3 kmc and 3.5 to 6.5 kmc ranges are available. Normally manufactured as reaction type meters, they are also available in the transmission type.



Illustrated above are a few of the many DICO designed and manufactured microwave components, produced under highest quality-control standards. For more complete information on DICO microwave components and test equipment send for catalog 953.

DIAMOND
 MICROWAVE CORPORATION

7 North Avenue, Wakefield, Mass.



Ability to handle the tough ones...

Stone's Accurate
Fabrications

Small diameter spiral wound paper tube manufacturing is an exacting business. There are many points along the way where a minor misstep may ruin the entire job.

Naturally, some jobs are tougher than others.

Stone has the ability to handle the toughest jobs with speed and economy. Reason: long experience and large volume.

Hi-dielectric strength and close tolerances are important features of Stone tubes of kraft, fish paper, and plastic films.

Low moisture absorption and good dimensional stability qualities are pointed up in *Stonized*, our phenolic impregnated spiral tube.

We would like to have one of our conveniently located representatives call on you. Write or phone us today.

Stone PAPER TUBE CO.

AFFILIATED WITH

STONIZED PRODUCTS CO. INC.

900-922 Franklin Street, N.E., Washington 17, D. C.

WESCON Exhibitors

(Continued from page 119)

The Robert Dellar Co.	807
Donner Scientific Company	737
Dresser-Barnes Corporation	567-568
Allen B. DuMont Laboratories, Inc.	536-537
Duncan-Rohne & Co.	700C
Ealy & Hastings	802
EBY Sales Co. of New York	1208
Jackson Edwards & Co.	760
Eitel-McCullough, Inc.	150-151
Elastic Stop Nut Corp. of America	582
Eico Corporation	708
Electra Manufacturing Co.	532
Electro-Data Corporation	1214
Electro-Measurements, Inc.	540
Electro-Mechanical Specialties Co., Inc.	145
Electro-Pulse, Inc.	861
Electronic Associates, Inc.	253
Electronic Engineering Associates, Ltd.	254
Electronic Engineering Co. of Calif.	459-460
Electronic Products Corp.	1209
Electronic Specialty Co.	629
Elgin Metalformers Corp.	1108-1109
Frank A. Emmet Co.	142
Empire Devices Products Corp.	622
Endevco Corporation	334
Enright Engineering Co.	1217
Erie Resistor Corporation	544
Essex Wire Corporation	528
R-B-M Div.	
Fairchild Camera & Instrument Corp.	220
Potentiometer Div.	
Federal Telephone & Radio Co.	900D-900E
Felts Corp.	1207
Microdot Div.	
Fenton Company	621
Filtron Company, Inc.	428-429
T. R. Finn & Company, Inc.	1111
F-R Machins Works, Inc.	1105
Furane Plastics, Inc.	700D
Fusite Corporation	620
Gabriel Co., Electronics Div.	643
The Gamewell Company	1104
Garrard Sales Corporation	114
Gates Radio Company	1119
General Ceramics & Stealtite Corp.	358
General Electric Company	
Apparatus Sales Division	811-812
Electronics Division	616-617
General Radio Company	251-252
Genisco, Incorporated	663-664
Gertsch Products, Inc.	511-512
M. B. Gilbert Co., Inc.	645
Girard-Hopkins	425
Glass Solder Engineering	720
Globe Industries, Inc.	284
Goodyear Aircraft Corp.	1117-1118
Gonsel Company	161
Gramer Transformer Corp.	1203
Graphik Circuits, Inc.	709
Gremar Manufacturing Co., Inc.	728
The Gudeman Company	404
Hammarlund Manufacturing Co.	504
W. S. Harmon Company	749
Hainemann Electric Co.	166
Hellipot Corporation	246-247
Hermetic Seal Products Co.	905
Carl W. Herrmann	803
Hetherington, Inc.	208
Hewlett-Packard Co.	552-553
Mickel Electrical Instrument Co.	1001
Hi-G Inc.	1002
J. T. Hill Sales Co.	539
Hoffman Radio Corporation	110-111
Huggins Laboratories, Inc.	505
Hughes Aircraft Company	564-565
Hycor Manufacturing Company	160
Hycor Company, Inc.	901
I E Manufacturing Co.	220
Indiana Steel Products Co.	428
Induction Motors Corporation	655A
Industrial Laboratories Publishing Company	1113
Institute of Radio Engineers	145
Instruments Publishing Co.	263
Insulation & Wires, Inc.	533-534
International Electronic Research Corporation	909
International Rectifier Corp.	412
International Resistance Co.	527
Iron Firearm Manufacturing Co.	1102
Jennings Radio Manufacturing Corp.	265
Kaar Engineering Corporation	646
Karp Metal Products Co.	618-619
Kay Electric Company	342
KAY-LAB (Kalbfell Laboratories, Inc.)	562-563
Kearfoot Company, Inc.	752
Kepec Laboratories	223-224
Ketay Manufacturing Corp.	105-106
Kings Electronics Co., Inc.	715
Kittleson Company	467-468
The James Knights Co.	441
W. Bert Knight Co.	241-242
Krongel Manufacturing Co., Inc.	703
Kulku Electric Mfg. Co., Inc.	654
Laboratory for Electronics, Inc.	444
Lambda-Pacific Engineering, Inc.	1115
James B. Lansing Sound, Inc.	327
Harry A. Lasure Company	116-117
Lavoie Laboratories, Inc.	622
Leach Corporation	713-714
G. H. Leland, Inc.	103
Lenkurt Electric Co., Inc.	344
Lenz Electric Manufacturing Co.	1638
Librascope, Inc.	561
Litton Industries	611

Under overload conditions...

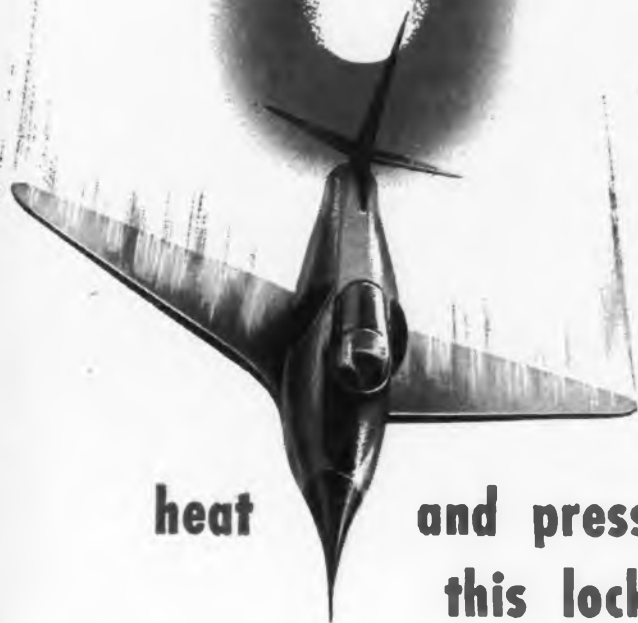

heat and pressure can't affect this lock-ring's grip—

HERMETIC'S new lock-ring for mounting hermetically sealed headers gives maximum mechanical security at lower cost!

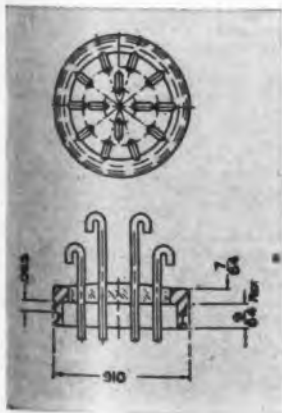

A simple hole is all you need to mount this VAC-TITE[®] glass-metal bonded header. Hermetic's new lock-ring design assures mechanical security without requiring shaped recesses. The ring will hold against internal pressures far in excess of any which can be encountered in service, and all the advantages and flexibility of round headers are retained.

Stripping and re-use of headers is facilitated by the lock-ring and by the intrinsic nature of the VAC-TITE[®] seal.

In co-operation with the Armed Services, Hermetic has developed a variety of other header and plug types which do not depend on solder alone for mechanical security of headers.

*VAC-TITE is HERMETIC's new, vacuum-proof, compression-construction, glass to metal seal. In addition to special shapes, many standard sizes such as .800 O.D. and .900 O.D. multi-terminal headers and a large variety of individual terminals are available in VAC-TITE Compression Seals.

Write to Hermetic for assistance and samples to meet your problems.

Hermetic Seal Products Co.

33 South Sixth St., Newark 7, New Jersey



FIRST AND FOREMOST IN MINIATURIZATION

807
737
568
537
006
802
208
260
151
008
542
520
214
560
165
662
253
254
460
1209
639
1109
142
623
324
1217
544
528
220
908
1287
628
4-420
1111
1105
7000
620
643
1104
114
1119
358
1-812
6-417
1-253
3-644
1-512
641
425
730
284
1118
161
1203
709
720
404
504
799
164
16-247
905
805
804
32-553
1001
1002
534
10-119
505
64-545
160
901
230
425
655A
1112
145
263
33-534
909
412
527
1102
244
446
10-419
342
62-563
752
23-224
05-106
715
67-468
441
241-242
703
658
664
1115
327
16-117
652
713-714
183
346
1638
561
611

For precision control of
oscillators, and as High-Q
elements in wave filters

REEVES

Crystal Units

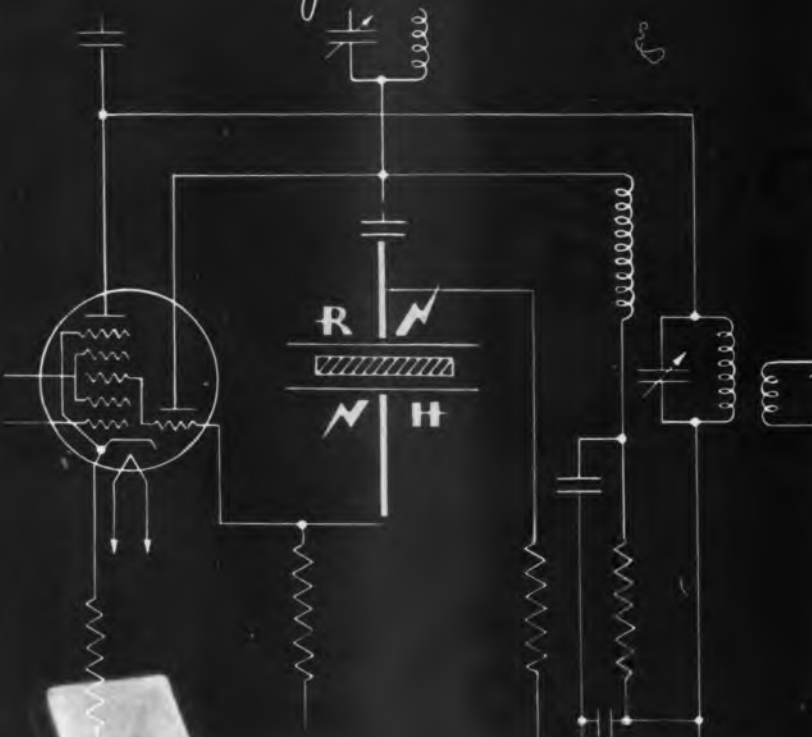

Write today

for your free copy of the
latest fact-filled Reeves-Hoff-
man Crystal Unit Brochure.

REEVES-
HOFFMAN
CORPORATION

a subsidiary of Claude Neon, Inc.
CHERRY AND NORTH STREETS
CARLISLE, PENNSYLVANIA

WESCON Exhibitors

(Continued from page 120)

Lowell Manufacturing Co.	659
Lynn Electronic Research Co.	435
McColpin-Christie Corporation	758
McCoy Electronics Co.	817
McGraw-Hill Publishing Co., Inc.	648
McKenna Laboratories	1305B
Machlett Laboratories, Inc.	747
Magnavox Company	1112
Magnecord, Inc.	328
Magnecraft Electric Co.	651
Magnelic Research Corporation	645
Magnetics, Inc.	236-237
D. E. Makepeace Co. Div., Union Plate & Wire Co.	725
P. B. Mallory & Co., Inc.	634
Marian Electrical Instrument Co.	361
J. W. Marsh Company	101
G. S. Marshall Co.	430-431
Marshall Sales Co.	523-528
Master Mobile Mounts, Inc.	219
Meridian Metalcraft, Inc.	132
Merit Coil & Transformer Corp.	157
Claude Michael Agency	625
Midland Manufacturing Company	212
Midwestern Geophysical Lab.	221
Gerald S. Miller Co.	337-338
J. W. Miller Co.	808
William Miller Instruments, Inc.	164A
Miller Dial & Name Plate Co.	724
Milwaukee Transformer Co.	666
Minneapolis-Honeywell Regulator Co.	1213
Mission-Western Engineers, Inc.	603-604
Monitor Products Co.	758
F. L. Moseley Co.	418
Mosley Electronics Inc.	401
G. E. Moxon Sales	612
Mycalex Corporation of America	129
Nassau Research and Development Associates, Inc.	1302
National Carbon Co. Div., Union Carbide & Carbon Corp.	643
National Company, Inc.	152-153
National Electric Products Corp.	159
Neely Enterprises	554-555
Neomatic, Inc.	405-406
Newcomb Audio Products Co.	314-315
New Hermes Engraving Machine Corporation	727
New Lenden Instrument Co.	704
The J. M. Ney Co.	104
North American Instruments, Inc.	1116
North Electric Manufacturing Co.	434
North Shore Research Corp.	653B
Northwest Lead Company	1003
N.R.K. Manufacturing & Engineering Co.	731
Oak Manufacturing Co.	254
Offner Electronics, Inc.	729
Ohmite Manufacturing Co.	111
Optical Coating Laboratory, Inc.	708
Oregon Electronics Mfg. Co.	700A
John Oster Manufacturing Co.	1214
Lee H. Owens Company	301
Panoramic Radio Products, Inc.	1302
The Ralph M. Parsons Co.	1004
PCA Electronics, Inc.	913
Penta Laboratories, Inc.	433
Perkin Engineering Corp.	111
Perimath-Colman & Associates	214-215
Permutex Corporation	148
Phaestron Company	184
Phillips Control Corporation	1212
Photo Chemical Products of California, Inc.	661
Photocircuits Corporation	232
Photocon Research Products	1220
Plastic Capacitors, Inc.	654
Pioneer Electronics Corporation	753
Polarad Electronics Corporation	403
Polytechnic Research & Development Co., Inc.	313
Potter & Brumfield	133
Potter Instrument Co., Inc.	225
Premier Metal Products Co.	660
Presto Recording Corporation	204
Pyramid Electric Company	501
Radell Corporation	902
Radio Corporation of America Engineering Products Dept.	120-121
Tube Department	146-147
Radio Magazines, Inc.	635
Radio Receptor Co., Inc.	739
Radio & Television News	343
Ram Electronics	637
Raytheon Manufacturing Co.	216-217
Rea Magnet Wire Co., Inc.	163A
Read and Rease, Inc.	700C
Reeves Instrument Corp.	439-440
Reeves Soundcraft Corp.	379
Remier Company, Ltd.	549
Resin Industries	626
The Rex Corporation	665
Al J. Rissl	621-622
E. V. Roberts & Associates	359-360
Rabinson Aviation, Inc.	644
Rahn Manufacturing Co.	735
Raymond Reson Engineering Products, Inc.	904
Retron Manufacturing Co.	736
Rutherford Electronics Co.	613
Sanborn Company	262
San Fernando Electric Mfg. Co.	432

know-how

PLUS

show-how

...right now!



Or putting it another way, you get *more* than high-quality electronic equipment from Neely.

You get *expert help* with your specific instrumentation problems—whether they concern application or operation—from highly-trained Neely Field Engineers. You get *doorstep demonstrations* of the very latest electronic instruments—brought by Neely's exclusive, fully-equipped MOBILE LAB which constantly crisscrosses California, Arizona, Nevada, and New Mexico. And you get *swift service*, from one of six conveniently located Neely offices.

It's these "extras" that save you time and dollars!



NEELY ENTERPRISES *Electronic Manufacturers' Representatives*
7422 MELROSE AVENUE • LOS ANGELES 46 • CALIFORNIA

Los Angeles Office	WE 3-9201
San Francisco Office	WA 1-2361
Sacramento Office	GI 2-8901
San Diego Office	AC 3-8106
Albuquerque Office	5-5586
Phoenix Office	AL 2-5290

Exclusive factory representative for: BIRD ELECTRONIC CORP.; BOONTON RADIO CORP.; ELECTRO-MEASUREMENTS, INC.; GERTSCH PRODUCTS, INC.; HEWLETT-PACKARD CO.; KAY-LAB; LIBRASCOPE, INC.; SENSITIVE RESEARCH INSTRUMENT CORP.; SIERRA ELECTRONIC CORP.; TEKTRONIX, INC.; and VARIAN ASSOCIATES... in CALIFORNIA, ARIZONA, NEVADA, and NEW MEXICO.

METER-RELAYS

RUGGEDIZED SEALED

LOOK LIKE THIS:—



MADE LIKE THIS:—

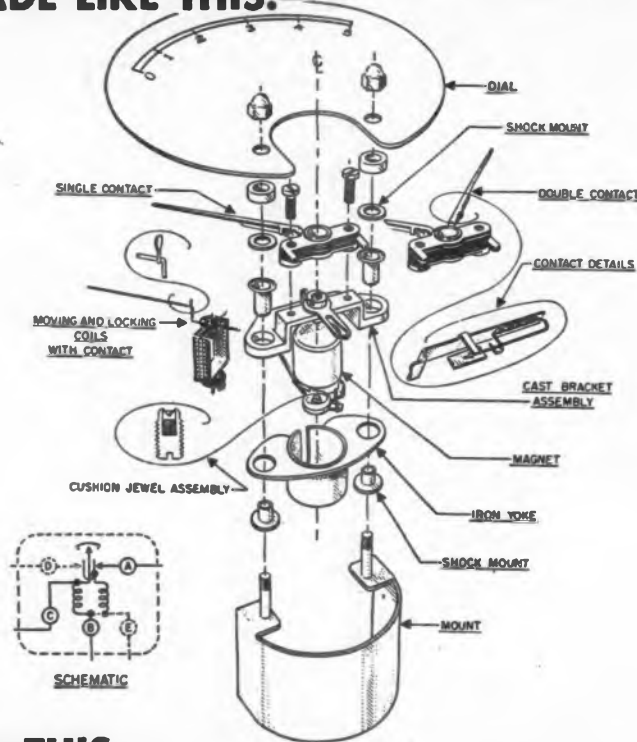

DO THIS:—

These two instruments will meet the physical dimensions—and environmental limits of shock—vibration—temperature—humidity—of similar specification relays and meters. Samples are being tested for compliance. Prospective users can have a list of deviations.

Meter-relays are indicating meters with built-in relay contacts. One contact is carried on the moving pointer. The other is carried on a semifixed pointer. When the two pointers meet the contacts close and lock. Locking coil is wound directly over moving coil. Reset can be manual or automatic. It consists of opening locking circuit. Spring action in contacts kicks them apart forcefully. There are no pushers nor solenoids inside meter case.

Usual meter ranges can be supplied from 0-20 Ua. to 0-50 A., or, 0-5 Mv. to 0-500 V. All ranges can be supplied either AC or DC except low millivolts (under 0-250 Mv). These come only in DC because of limitations of instrument rectifiers. Higher voltage or current ranges are made with external multipliers.

Contact setting is adjustable from front to any point on scale arc. Or, it may be preset at any fixed point. Contact arrangements are (1) single high (2) single low (3) double, high and low. When used only as relays they can be made to operate on as little as 0.2 microamperes (3000 ohms) or 0.05 millivolts (20 ohms).

Bulletin 112 shows 11 circuits and lists components and specifications for meter-relays. Write or phone Bradley Thompson, Assembly Products, Inc., P. O. Box 191, Chagrin Falls 21, Ohio, telephone CHagrin Falls 7-7374.

WESCON Exhibitors

(Continued from page 122)

Sangamo Electric Company	156
Howard M. Saul & Associates	732
Sealcraft Corporation	657B
Sensitive Research Instrument Corp.	506
Sequoia Process Corporation	256
Servo Corporation of America	466
Servomechanisms, Inc.	310-311
Shallcross Manufacturing Co.	365
Shasta Div.	
Beckman Instruments, Inc.	225
Samuel Siegel Co.	238
Sierra Electronic Corporation	509
Sigma Instruments, Inc.	366
Simpson Electric Co.	313
Div. American Gage & Machine Co.	
Claude C. Slate & Associates	738
Herman H. Smith, Inc.	657A
L. J. Smith Company	1003
T. Louis Snitzer	633
Sola Electric Co.	137-140
Sorenson & Co., Inc.	335-336
South River Metal Products Co.	815
Southern Electronics Co.	644
Southwestern Industrial Electronics Co.	125-126
Sperry Gyroscope Company	357
Spencer-Kennedy Laboratories, Inc.	465
Sprague Electric Company	318-319
Standard Coil Products Co.	908
Standard Wire & Cable Co.	756-757
Starling Engineering Co.	437
George Stevens Manufacturing Co.	707
Stewart Stamping Co.	531
M. A. Stelara Co.	205
Conrad R. Strassner Co.	656
Superior Electric Co.	
Powerstat Division	809-810
Regulator Division	367-368
Surprenant Manufacturing Co.	
Switchcraft, Inc.	261
Sylvania Electric Products, Inc.	249-250
Synhane Corporation	668
Taylor Fibra Company	1110
Tech Laboratories, Inc.	813
Technology Instrument Corp.	339
Tektronix, Inc.	556-557
Tela-Tech & Electronic Industries	1305A
Telatronics Laboratory, Inc.	1304
Texas Instruments Inc.	1204-1205
Tensolite Insulated Wire Co.	441
Thermador Electrical Mfg. Co.	545
Thomas & Skinner Steel Products Co.	331
Thompson Products, Inc.	203
Transformer Engineers	1448
Transistor Products, Inc.	332
Transitron Electronic Corporation	1210
Triad Transformer Corporation	149
Triplett Electrical Instrument Co.	731
Tri-State Supply Corporation	302
Trutone Electronics, Inc.	303
Tung-Sol Sales Corporation	309
Tuu-Bo Jet Products	307
UM&F Manufacturing Corp.	803-804
Ungar Electric Tools, Inc.	122
Union Switch and Signal	1221-1222
United Catalog Publishers	124
Universal Electronics Company	1215
U. S. Engineering Co., Inc. (USECO)	218
U. S. Naval Ordnance Laboratory	801
United States Radium Corporation	748
United States Time Corporation	759
United Transformer Co.	652
Unitek Corporation	210
Van Cleef Bros., Inc.	306
Van Groos Co.	1106B-1107
Varian Associates	558-559
Vector Electronic Co.	135
Vectron, Inc.	535
Victoreon Instrument Co.	641
Victory Engineering Corp.	627
Viking Electric	257
Vitramon, Inc.	436
V-M Corporation	101
Waldis, Kohnoor, Inc.	410-411
The Walkirt Company	443
Don C. Wallace & William M. Wallace	740-741
Walisco Electronics Corp.	423-424
Ward Leonard Electric Co.	239-240
Ward-Products Corporation, Division of The Gabriel Co.	624
Waters Manufacturing, Inc.	540
Waveline, Inc.	710
Weightman & Associates	234-235
Western Control Equipment Co.	724
Western Electronics News	1106A
Western Lithograph Co.	900F
Westinghouse Electric Corp.	457-458
Weston Electrical Instrument Corp.	333-334
S. S. White Dental Mfg. Co.	631
Wiancko Engineering Co.	708
Winchester Electronics, Inc.	605
Ash M. Wood Co.	407-408
Wright Engineering Co.	322
Wyco Metal Products	607
Xcelite Incorporated	344

PERFORMANCE - WISE CERAMIC BUYERS

ASK
ABOUT

press facilities

ALSiMAG[®]

Invariably this question is brought up by seasoned buyers. Experience has taught them that no amount of good intentions can compensate for inadequate production machinery. To such practical and fore-sighted men, the following facts are presented for consideration:

To meet customer requirements for quality tested ALSiMag ceramics, American Lava Corporation maintains lineups of modern high speed presses which can produce *in one three-shift working day over 9,000,000 uniform, accurate ALSiMag pieces* (more than enough, laid end to end, to reach from Philadelphia, Pa., to Washington, D. C.)*

Why risk dole delivery when you can command ALSiMag production facilities ready to serve you?

* Based on an ALSiMag part 1" square. Our presses can produce pieces up to 14" x 14" and, of course, much smaller parts than the size mentioned.

33RD YEAR OF CERAMIC LEADERSHIP

AMERICAN LAVA CORPORATION
CHATTANOOGA 5, TENNESSEE

A SUBSIDIARY OF MINNESOTA MINING
AND MANUFACTURING COMPANY

OFFICES: METROPOLITAN AREA: 671 Broad St., Newark, N. J., Mitchell 2-8159 • SYRACUSE, N. Y., 647 S. Warren St., Phone 74-4889 and 74-4880 • CLEVELAND: 5012 Euclid Ave., Room 2007, Express 1-6685 • NEW ENGLAND: 1374 Mass. Ave., Cambridge, Mass., Kirkland 7-4498 • PHILADELPHIA: 1649 N. Broad St., Stevenson 4-2823 • ST. LOUIS: 1123 Washington Ave., Garfield 1-4959 • CHICAGO: 228 N. LaSalle St., Central 6-1721 • SOUTHWEST: John A. Green Co., 6815 Oriole Dr., Dallas 9, Dixon 9918 • LOS ANGELES: 5603 N. Huntington Dr., Capitol 1-9114 • SOUTH SAN FRANCISCO: 320 Shaw Rd., Plaza 6-0800
PITTSBURGH: 911 Plaza Bldg., Atlantic 1-2075



AEROVOX

high-temperature

metallized-paper CAPACITORS

Aerolene* does it! This Aerovox-exclusive solid impregnant accounts for the higher temperature ratings and longer life of Aerovox metallized-paper capacitors. The accompanying curve (Operating Voltage vs. Temperature) tells the story. Further gains from permanently-embedded sections in solid Aerolene impregnant are: maximum immunity to vibration and rough handling. And of course minimum size and maximum convenience. Install them—forget them!

Available in a wide variety of case styles including modified molded tubular, and all types of metal-cased hermetically-sealed construction with capacitance ratings from .0005 mfd. to 100. mfd. at voltages up to 600 VDC.

Get the FACTS!

*Trade Mark

Ask for literature on Aerovox metallized-paper capacitors in both standard and special types. Our metallized-paper specialists will gladly collaborate on your extra-compact-capacitor needs.



AEROVOX CORPORATION

NEW BEDFORD, MASS.

HI-Q
DIVISION
OLEAN, N. Y.

ACME
ELECTRONICS, INC.
MONROVIA, CALIF.

CINEMA
ENGINEERING CO.
BURBANK, CALIF.

In Canada: AEROVOX CANADA LTD., Hamilton, Ont.

DYSEAC

(Continued from page 112)

vans. The major portion of the equipment—three computer racks, the memory cabinet, and the control console with input-output facilities—is installed in the computer van. (See Fig. 1.) The second van houses regulated dc power supplies and provides a general-purpose area for special equipment, storage, and work space. Each van also has its own air-conditioning equipment.

Overall Organization

The computer is organized around the high-speed memory. This unit receives and distributes to the other internal units the information (numbers and instructions) to which the most rapid access is needed for carrying out the work program of the machine. The memory communicates principally with five major units of the system. Of these, two are primarily concerned



Fig. 2: Standardized etched circuit package is one of two types used as basic building blocks. This delay line unit is one of nearly 800 such packages which provide for 90% of circuit, excluding memory and input

with internal processing activities and three with external relations. A continuous flow of digital information may be maintained simultaneously between the memory and the inward-looking and outward-looking types of units. The latter types, which serve to communicate with the external devices, include the input-output buffer, the external selector, the concurrent input-output control, the display staticizer, and the serializer.

The input-output buffer transmits information at the proper repetition rates from the external unit to the internal memory during an input operation and in the reverse direction during an output operation. The buffer receives words from the memory at the normal 1 mc internal repetition rate and then transmits them out, digit by digit,



TELEQUIPMENT NEWS

Published by the General Electric Company, Electronics Park, Syracuse, N. Y.

COLOR
CAPSULE
EDITION

NEW SLIDE SCANNER KICKS-OFF G-E'S PYRAMID PLAN FOR COLOR TV

2" x 2" unit highly rated for performance, accessibility,
safety, small size, and unique block-building features



E. H. LEDERER

Recognition for much of the technical perfection of this slide scanning system immediately focuses an author's spotlight on E. H. Lederer, Mechanical Design Engineer. Of many contributions which Lederer made, his simplified optical wipe technique is particularly outstanding. In application, this development speeds slide changing to a point where normally used supplementary electronic equipment is eliminated. Mr. Lederer has specialized in Studio Engineering at G-E headquarters in Electronics Park for the past seven years.

The Editor, G-E Teleequipment News, Section X4884,
Electronics Park, Syracuse, New York

If you want to be in on the ground floor of color telecasting, be ready to transmit network programs and be ready to cash in on the rapidly growing demand for local color commercials. The Pyramid Plan shows you how. General Electric is set now to supply this and every other level of your color pyramid needs with such outstanding equipment as the new slide scanning system. Note, particularly, that it is applicable to black and white programming as well as color.

There are several current exclusives in design of the PR 8-A slide scanner worthy of mention and imitation. First among these...it has the fastest (F 1.9) non-shading optical systems in the industry today. Iris control permits use of slides having wide density range. Next, the automatic slide changer feature makes it easy to operate from either local or remote sources. And, slide carriages are provided to handle as many as 125 cardboard or 65 glass framed slides.

All adjustments for the lenses and mirror mountings can be made outside the cabinet. Thus, optimum alignment of the system is achieved with all extraneous light shut out. A unique and highly desirable function of the 2" x 2" slide changer is the outside to center, and center to out-

side mechanical and optical wipe action which occurs when changing slides. Normally, this is completed in less than .6 second and provides acceptable slide change-over. As a result of this high speed, added electronic equipment usually required for this action is not necessary.

Work was co-ordinated with
Eastman Kodak and Bausch & Lomb

Both of these well known companies provided valued assistance in developing the scanner system. Final design consists of heavy 1/2" plate of high strength tempered aluminum alloy to which all lens, mirror mounts and slide changing mechanism are attached. This plate is mounted in a heavy 14-gauge steel reinforced cabinet. Alignment is no problem since permanent location of the plate in the cabinet permits compensation for uneven flooring or other mis-alignment conditions.

Universal Acceptance Predicted

This unit satisfies the most critical broadcaster's demand with award-winning features at a reasonable price. General Electric has attained its objective of manufacturing a slide scanner with exceptional appeal to small and large broadcasters alike.

GENERAL ELECTRIC



NOTE EXTREME
ACCESSIBILITY VIA
SWING-OUT PANELS



Scanner Tube element (right) is located in a pedestal cabinet. This chassis is almost identical to the corresponding scanning source used in the 16 mm motion picture camera. Both work into a common set of 3 photo-electric cells and associated dichroic beam splitters, filters and preamplifiers.

Slides are stacked above cabinet for automatic feeding. Raster control from the panel at lower left provides adjustment for accurate scanning. Operating safety assured with detailed interlocking and shielding. The combination of slide scanner plus two continuous motion film scanners occupies just 32 1/2 square feet.

LAB
**here
 at last!**

**THE FIRST
 TV-TELEPHONE
 INTERCOM**

**THE ULTIMATE
 IN COMMUNICATIONS**



SEE IT ... USE IT

at WESCON

August 25, 26, 27

**KAY LAB BOOTHS
 562 - 563**

**Tomorrow's Promise
 Fulfilled Today**

Industrial TV Camera Systems
 Broadcast TV Camera Chains
 Chopper Stabilized Wide Band
 D C Decade Amplifiers
 Absolute D C Power Supplies
 Meter Calibrators



REPRESENTATIVES IN ALL MAJOR CITIES

**PRECISE ELECTRONIC
 INSTRUMENTS**

LAB

1090 Morena Blvd., San Diego 10, Calif.

DYSEAC (Cont'd from p. 126)

at the proper measured rate appropriate to the external unit. The external unit itself (via the external selector) specifies the word format and the repetition rate appropriate to it.

The external selector, a high-speed switching device, selects the external unit with which an input-output operation is to be performed. It provides the signal required to complete the circuit connections for the lines carrying both the digital information and the control signals needed to operate the external unit. The external selector is capable of selecting among 48 external mechanical relay switches, but it can be expanded to handle 256 distinct information channels, such as individual parallel magnetic-drum channels or high-capacity magnetic filing systems.

The concurrent input-output control regulates the detailed progress of all input-output operations requested in the course of the internal program. It directs the flow of traffic between the memory and the input-output buffer, and between the buffer and the external selector.

Display Staticizer

The display staticizer and the serializer are specialized input and output organs adapted especially for real-time operations. The display staticizer is a register storing 28 binary digits in parallel for controlling, for example, a digital-to-analog converter that provides deflection voltages for a cathode ray-tube visual display. The serializer unit is provided for continuous external input devices. It can accept one full word of 45 binary digits delivered in parallel in the form of asynchronous pulses from an external unit, and can then transmit the word in synchronized normal serial form to any other units of the system capable of reading words out of the high-speed memory.

The arithmetic unit carries out arithmetic or logical choice operations. Arithmetical results are written directly into the high-speed memory, and control signals specifying the outcome of the discrimination operations are sent directly to the program-sequencing and control unit, where they serve to modify the choice of memory location from which the next instruction is to be read. An additional route of communication to the input-output buffer provides for the loading or printing out of the con-

tents of the arithmetic accumulator register directly via the electro-mechanical typewriter or magnetic input-output units.

The remaining unit in direct communication with the high-speed memory is the instruction register. Instruction words are transferred, one at a time, from the high-speed memory into the instruction register. From this unit, information contained in different segments of the instruction word is selected by the program control unit and transmitted to various other internal units throughout the system, and simultaneously to the concurrent input-output control for checking against possible conflict with concurrent input-output operations.

The last major unit in the functional organization of DYSEAC is the manual-monitor control unit, which is responsible for regulating and synchronizing the carrying out of joint internal-external operations. It interprets the conditions specified by the external switches on the switch panel, under which monitor operations are to be performed; it observes the progress of the internal program and recognizes when these specified conditions arise; and it delivers signals temporarily halting the internal program, if necessary by setting up the required special word-transfer routes and by initiating the specified interpolated internal or external operation.

New Quarters

In a move to combine all their operations under one roof, Elco Corp. has transferred all facilities, including its Varicon plant, to their new building on "M" St., south of Erie Ave., Phila., Pa.

MEDAL OF HONOR



Robert C. Sprague (l), receives the RETMA Medal of Honor from president Glenn McDaniel at the 1954 Annual Meeting in Chicago. Mr. Sprague was being honored for his contribution to the progress of the electronic industry



11,000 WAYS to QUALITY

The quality of any product depends upon the quality of its parts—particularly in electronics where precision is a must and all component parts are interdependent. At AMPHENOL the design and manufacture of electronic components to high quality standards has been carried on for over twenty years, and today the specification of AMPHENOL cables and connectors is your best guarantee of the final quality of your product.

There are over 11,000 separate AMPHENOL components that show the way to quality. Besides the standard AN and RF connectors, and RG cable, there are many special AMPHENOL components that will prove of value to you. These include the famous *Blue RIBBON* connectors, miniature AN-type 165 series connectors, field-serviceable audio and power plugs and receptacles, new 172 series Hermetic Seal receptacles (which mate with standard AN plugs), new QWIK microphone connectors and many others.

Write to the Product Sales Department at AMPHENOL for information about any of the above components.

AMERICAN PHENOLIC CORPORATION

AMPHENOL

KLEIN Quality Pliers

SPECIALLY DESIGNED

FOR THE ELECTRONICS INDUSTRY

Now, Klein quality pliers are available in new compact patterns for precision wiring and cutting in confined space. Note, too, the replaceable leaf spring that keeps the plier in open position,

ready for work. All are hammer forged from high-grade tool steel, individually fitted, tempered, adjusted and tested—made by plier specialists with a reputation for quality "since 1857."

LONG NOSE PLIER

307-5-1/2—Extremely slim pattern ideal for the really tight spots. Jaws are knurled to insure a positive grip.

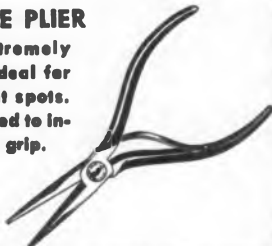

OBLIQUE CUTTING PLIER

210-5L—For cutting small wires or trimming plastic. Entire length of cutting knives works flush against cutting surface. 5 or 6-inch sizes.



CHAIN NOSE PLIER

317-5L—A full inch smaller than standard pattern. Has a very fine knurl that will not damage soft wire. Also available without knurl.



LIGHTWEIGHT OBLIQUE CUTTING PLIER

209-5—Smaller than 210-5L with an extremely narrow head. Entire length of cutting knives works flush against cutting surface.



TRANSVERSE END CUTTING PLIER

204-6—Useful in precision work where ordinary oblique or end cutters are too bulky. Gives a clean, flush cut.

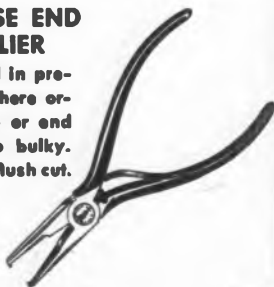

PRINTED CIRCUIT PLIER

052-L—Special knives shear and crimp wire in one operation. Crimped wire holds loose parts in position for dip soldering. Knives face operator for visual inspection. Ask for Bulletin 753.

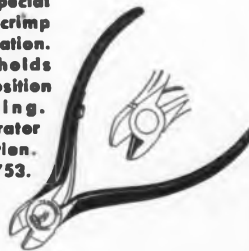

This Klein Pocket Tool Guide gives full information on all types and sizes of Klein Pliers. A copy will be sent without obligation.



ASK YOUR SUPPLIER

Foreign Distributor:
International Standard
Electric Corp.,
New York

"Since 1857"



Mathias **KLEIN** & Sons
Established 1857 Chicago, Ill., U.S.A.

3200 BELMONT AVENUE, CHICAGO 10, ILLINOIS

RCA's New 21-in. Color Tube

A new and improved 21-in. tri-color kinescope with a picture area of 250 sq. in. has been developed by RCA, and will be demonstrated on Sept. 15. The tube has a round metal envelope, is relatively shorter than those produced previously, and is 25% lighter than 19-in. glass color tubes. A filter glass face plate and new gun provide improved picture contrast.

The most significant improvement is the new RCA curved shadow mask and mounting system, which make possible simplified mechanical mounting in the tube, and greater beam power input during operation without objectionable mask distortion. The phosphor dots are on the face plate. The manufacturer reports accurate and stable registration, and absence of color impurity around the picture edges.

Introductory price of the tube to equipment manufacturers is \$175.

WCEMA Scholarships Presented to 11 Schools

The West Coast Electronic Manufacturers Association has presented a total of twelve scholarships to eleven Western colleges and universities, for use by students entering the field of electronic engineering. The fund, made up of donations by firms which are members of the association, are presented each year to schools with departments or colleges of engineering.

SKY COMPASS



Reported to be the first practical instrument for accurate aerial navigation in high latitudes, this Sky Compass developed by Kollsman Instrument Corp., Elmhurst, N. Y., gives the true heading of an aircraft by determining the position of the sun when it is below the horizon, an important factor in Arctic regions.

select your
semiconductor devices
from TI's wide range

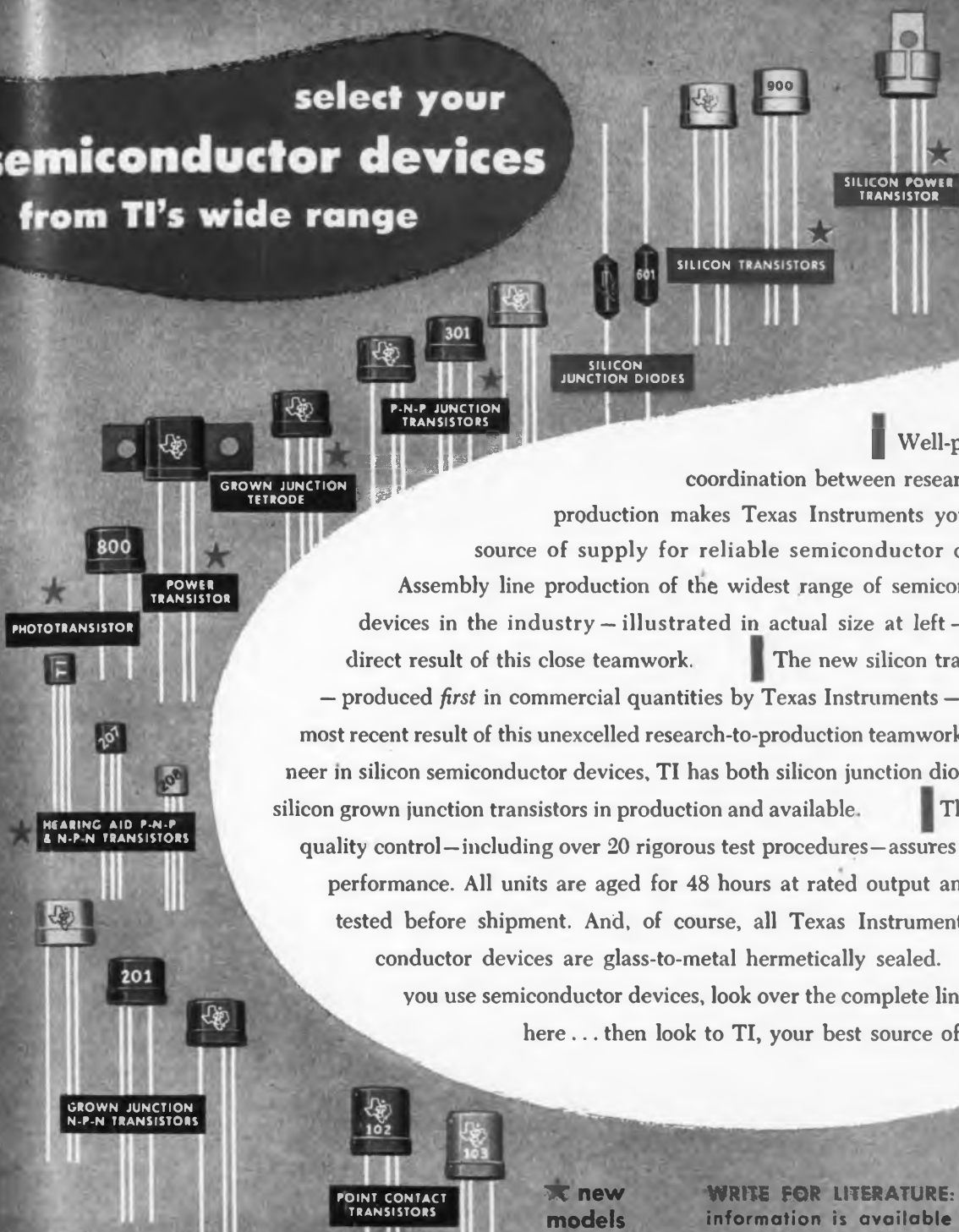

Well-planned coordination between research and production makes Texas Instruments your best source of supply for reliable semiconductor devices. Assembly line production of the widest range of semiconductor devices in the industry — illustrated in actual size at left — is one direct result of this close teamwork. The new silicon transistors — produced *first* in commercial quantities by Texas Instruments — are the most recent result of this unexcelled research-to-production teamwork. A pioneer in silicon semiconductor devices, TI has both silicon junction diodes and silicon grown junction transistors in production and available. Thorough quality control — including over 20 rigorous test procedures — assures reliable performance. All units are aged for 48 hours at rated output and again tested before shipment. And, of course, all Texas Instruments semiconductor devices are glass-to-metal hermetically sealed. If you use semiconductor devices, look over the complete line shown here . . . then look to TI, your best source of supply.

★ new models

WRITE FOR LITERATURE: Detailed information is available on every model in the complete TI line shown above. Write!

TEXAS INSTRUMENTS

INCORPORATED
6000 LEMMON AVENUE DALLAS 9, TEXAS



SEE OUR EXHIBIT AT THE WESCON SHOW

STAINLESS, INC.

NORTH WALES,

PENNA.

AM

FM

TV

Mobile

Microwave

TOWERS

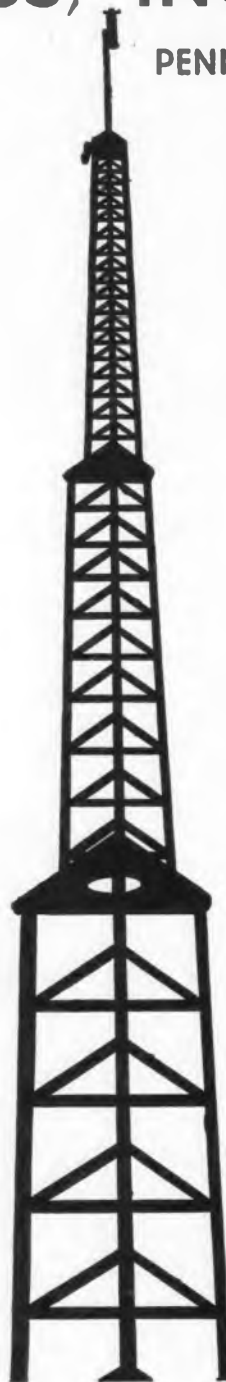

We are fully equipped to
maintain all our towers

New Product Briefs

DELAY LINES now miniature standard with PCA, cover an impedance range from 500 ohms to 2,000 ohms. Standard 50 ohm and 100 ohm lines are still available in their original sizes at PCA Electronics Inc., 2180 Colorado Ave., Santa Monica, Calif. All lines meet MIL-T-27 specifications.

TELEMETERING FILTERS available at Hycor Co., Inc., 11423 Vanowen St., N. Hollywood, Calif. in a range of frequencies from 400 CPS to 70 KC and bandwidths of 7½% to 15%, have nominal impedance of 500/500 ohms, and frequency response greater than 45 db.

WIRE STRIPPER announced by Technical Devices Co., 2350 Centinela Ave., Los Angeles 64, Calif., with proper cartridge, automatically cuts and strips both ends of any solid or stranded wire from 14 through 24 gauge in one operation.

ELASTOMER called "Tufsil," developed by Pacific Moulded Products Co., 905 E. 59th St., Los Angeles 1, Calif., is said to have tear strength up to 210 lbs/in. Maintains flexibility over a temperature range of -120° F to 600° F.

SAMPLING SWITCH for high-speed multi-channel use operates to 10,000 contacts per minute. Series 4000 with motor drive. Series 6000 without motor. General Devices, P.O. Box 253, Princeton, N.J.

TWIN CONNECTORS of seamless copper accommodate two wires. MU 250 for 250MCM-6 wire, MU 350 for 350-4 wire, MU 600 for 600 MCM to 4/0 wire. Ilasco Copper Tube & Prod., Marlemont Ave., Cincinnati 27, Ohio.

POWER SUPPLY Model FR-2 provides line regulation of 0.01%. Four adjustable dc voltages for klystron modulation are provided to 5 kv. Clegg Labs., Inc., 142 S. Livingston Ave., Livingston, N.J.

VIDEO VTVM with range of 20 CPS to 10 MC, MV-22B, has been announced by Millvac Instrument Corp., 444 Second St., Schenectady 6, N.Y. Sensitivity is 70 μ v., range to 1 kv. Accuracy 3.5% full scale.

TUBES recently announced by CBS-Hytron, Danvers, Mass., are three CTS-rated units designed for use as horizontal deflection amplifiers in TV receivers—designated, 6CU6, 12CU6, and 25CU6. They are interchangeable with the 6BQ6GT, 12BQ6GT, 25BQ6GT.

TV REBROADCAST RECEIVER, Model TR-1, announced by Clarke Instruments, Div., of National Electrical Machine Shops, Inc., 919 Jesup-Blair Dr., Silver Spring, Md., has been designed for use in direct pickup and rebroadcast of TV signals.

ELECTRIC RESISTANCE WIRE, produced by The Kanthal Corp., Amelia Pl., Stamford, Conn., is a low temperature coefficient wire with resistivity of 812 ohms per circular mil ft. at 20° C. Maximum working temperature 300-350° C. Tensile strength 120,000 psi. Designated Kanthal D-R.

BOLOROMETER PREAMPLIFIER, Model BA-1, by Weinschel Engineering Co., Inc., 10503 Metropolitan Ave., Kensington, Md., makes precision measurements of power ratios in the frequency range from 20 to 10,500 MC. Used to measure r-f ratios from 1 to 30 db with an overall accuracy of 0.10 db.

RECORDING SYSTEMS made by Kollman Instrument Corp., 80-80 45th St., 45th Ave., Elmhurst, N.Y., are designed to record and reproduce frequencies up to 1. MC. Have a medium storage capacity of 60,000 impulses or binary digits on their magnetic coated drums.

CRYSTAL PHOTCELL, miniature, made by Standard Piezo Co., P.O. Box 164, Carlisle, Pa., operates small relay without amplification. Measures ¼ in. in diam., ¼ in. deep. Delivers 2 to 5 ma when exposed to 50 to 100 ft./candle light with approx. 100 v. across cell and load.



ML-200 Series
Crystals for color television are available to your specific calibration for either the ringing or oscillator circuit. This new design provides hermetic seal at an economical cost.

NOW IN PRODUCTION . . . Newly-Designed CRYSTALS for COLOR TELEVISION

MIDLAND is ready *now* to supply you in quantity with color TV crystals to your exact specifications . . . and to advise with you on any phase of this subject.



MIDLAND MINIATURES

Midland has developed, and is expanding, a new series of crystal units which will comprise the MIDLAND MINIATURE line. Their small glass enclosures insure true hermetic seal and long-term stability.



Type ML-6 Range 1.0 mc.—100 mc. Supplied per mil Type CR-12, CR-13, CR-20, CR-27, CR-28, CR-32, CR-33, CR-35, CR-36, CR-37 when specified. Hermetically sealed glass holder with glass seal and wire leads of size $\frac{1}{16}$ in. Pin spacing .050" dia. spaced at .486"

Type ML-6A Identical to Type ML-6 except provided with .093" diameter pins.

Type ML-5E Range 2.0 mc.—100 mc. for those applications in which long-term stability is the paramount requisite.

Type ML-4B Range 2.0—15.0 mc. This unit is similar to Type ML-4 except wire leads are provided, eliminating need for crystal sockets.

Midland

PAY OFF IN PERFORMANCE

CRYSTALS

The quality of Midland Crystals—which is another way of saying the completely dependable job they will do for you—is assured by exacting tests and controls through every step of processing. The finest precision equipment and most advanced techniques known to the industry are used by Midland from selection of raw quartz to final sealing of the crystal.

That's a big reason why Midland has climbed to its present position as the world's largest producer of quartz crystals for use in 2-way communications and other electronic devices.

Midland's engineering staff is ready to help in any project involving the use of crystals.

SEE US AT WESCON!

BOOTH 212, Western Electronics Show and Convention, August 25-26-27, Pan-Pacific Auditorium, Los Angeles.



MANUFACTURING CO., INC.
3155 Fiberglas Road Kansas City, Kansas

WORLD'S LARGEST PRODUCER OF QUARTZ CRYSTALS



Type ML-4 Range 1.0 - 10.0 mc. Supplied per mil Type CR-5, CR-6, CR-8, CR-10 when specified. Holder is phenolic, gasket sealed. Holder size is $1\frac{1}{4}$ x $1\frac{1}{8}$ x $\frac{7}{16}$ with .093" diameter pins $\frac{1}{2}$ " long spaced .486".



Type ML-13 Units of this type are currently undergoing tests on experimental basis. The unit is hermetically sealed. Pin dimensions are the same as our Type ML-6. Height of can is $1\frac{1}{2}$ -inch.



Type ML-1A Range 2.0 - 15.0 mc. Supplied per mil Type CR-1A when specified. Holder is phenolic, gasket sealed. Holder size is $1\frac{1}{4}$ x $1\frac{1}{4}$ x $27/64$ " with .125" diameter pins $\frac{3}{8}$ " long, spaced at .500".



Type ML-10 Range 15.0 - 50.0 mc. Supplied per mil Type CR-24 when specified. Overall length is 1.055". Pin contacts, .062" diameter.

3 ϕ to 2 ϕ
@ 380-1500 cycles

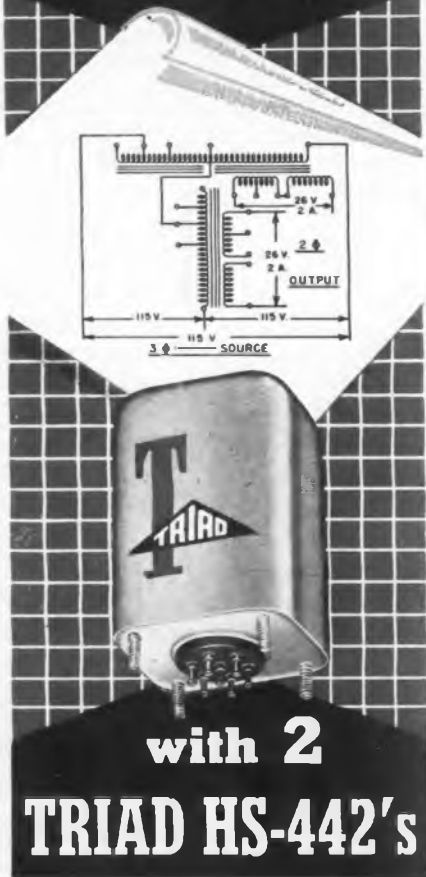

with 2
TRIAD HS-442's

Aircraft electronic equipment designers, with this one stock type of transformer, can supply needs for a 3-phase to 2-phase conversion or for single phase filament power. This limits the necessity for special transformers, necessarily of high cost because of small quantities.

This universal, compact, MIL-T-27 style transformer, with 2 units Scott-connected, supplies at the secondary 2-phase 26 or 13 volt power for resolvers, computers, remote indicators and control devices. One transformer, single phase, will supply 26 volts C.T. at 2 amperes, 12.6 volts C.T. at 4 amperes, or two 12.6 volt, 2 ampere windings, one center tapped.

All this in a MIL-T-27 case only 1 1/8" x 1 1/2" x 2 3/4" high, with the proved-in-service Triad Hermetic Seal Terminal and permanently affixed schematic decal.

Type No.	List Price	Primary Volts	Secondary	
			Volts	Amperes
HS-442	22.50	57.5-96-115-120 Single phase.	26 C.T. 12.6	2 4

Two HS-442's can be used, 115 volt 3 phase to 26 volt 2 phase, Scott-connected.



CBS' "205" Color Tube

LAST month CBS-Hytron announced that their new 19-in. aluminized glass envelope, tri-gun color picture tube was now in production at the plant in Newburyport, Mass. Termed the "CBS-Colortron 205," (RETMA type 19VP22) this new shadow-mask design offers viewers 205 sq. in. of picture area. The tube is electrostatically focused and incorporates an electromagnetic convergence system. A deflection angle of 62° is employed. Fig. 1 shows the outline drawing of the 205 while the exploded view in Fig. 2 illustrates the internal structure.

The steps employed in the manufacture of the 205 are very similar to those employed in the manufacture of black-and-white tubes. The stamped shadow masks are first blackened so that they will not reflect light and to radiate heat. The

employs 300,000 phosphor triads. Following the application of the phosphors, the face plate is aluminized.

The electron gun structure for convergence is of particular interest. Three matched electron beam sources are triangularly spaced and with each gun tilted toward the common tube axis so as to provide proper beam convergence at the

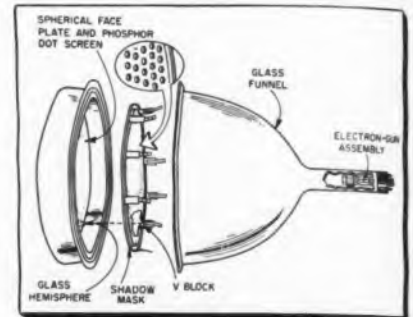

Fig. 2: Construction features

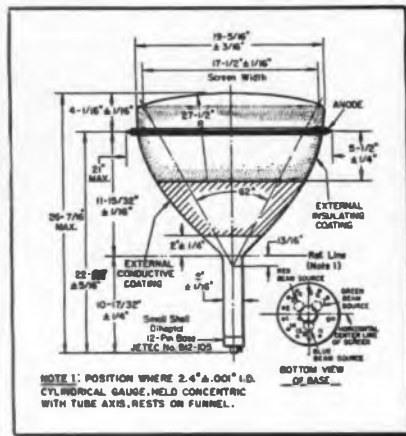

Fig. 1: Dimensional diagram of 205

glass hemisphere and funnel are turned and the metal sealing rings are shaved to assure perfect roundness. These units are then thoroughly washed.

Shadow masks and glass hemispheres are then paired and remain together during all subsequent manufacturing steps. In the application of color phosphors, the spherical faceplate first receives an overall coating of green. Following this, a photosensitive solution is coated over the phosphor. The mask is placed on its V-block type mount in the glass hemisphere. A light source, located at the position of the green electron gun exposes the photosensitive material through the shadow mask. A chemical solution then washes away the phosphor in the unexposed areas. The entire process is repeated for the red phosphor and finally for the blue. In all, the design

center of the screen. Three pairs of pole pieces are mounted in the tube above the anode and spaced 120° apart. Three external electromagnets, mounted on the tube neck, create magnetic fields which are induced into the pole pieces to provide dynamic convergence control of each of the three electron beams. Small dc fields may also be induced in these pole pieces to compensate for slight manufacturing variations.

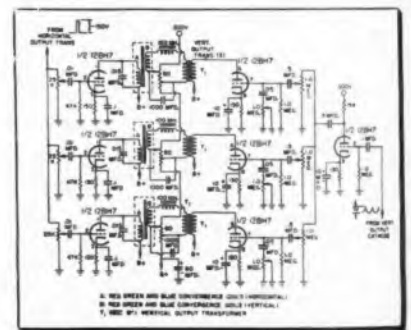

Fig. 3: Circuit for dynamic convergence

The electromagnets provide radial adjustment of each of the three beams. Since it may not always be possible to properly converge the three beams by radial adjustment only, an external blue-beam positioning magnet is used to provide tangential movement of the blue beam. The combination of the three external electromagnets and the blue-beam positioning magnet insures the realization of center convergence.



MICROWAVE SIGNAL GENERATORS

Complete coverage of the range 950-10,800 mcs/sec.

with Polarad single dial operation

Four new Microwave Signal Generators covering the range 950-10,800 mcs/sec. All with famous Polarad single dial operation. Each provides the maximum working range possible in one compact signal generator. And, additional Polarad Signal Generators are available to cover 12.8 to 39.7 kmc.

These features on all MSG units assure fast and simple operation: direct reading, single dial frequency control that tracks reflector voltages automatically . . . direct reading attenuator dial . . . conveniently placed controls, in logical sequence . . . high visibility on the face of each instrument.

Polarad Signal Generators are built to the same high standards required for military equipment. They are practical for the factory assembly line—engineered ventilation assures continuous and stable operation of all instrument functions. Components are readily accessible for easy maintenance. And laboratory accuracy is guaranteed under the most rigorous operating conditions.

Write directly to Polarad or your nearest Polarad representative for details.

	MSG-1	MSG-2	MSG-3	MSG-4A
Frequency Range	950-2400 MCS/sec.	2150-4600 MCS/sec.	4450-8000 MCS/sec.	6950-10,800 MCS/sec.
(Frequency set by means of a single directly calibrated control)				
Frequency Accuracy	±1%	±1%	±1%	±1%
Power Output	1 MW	1 MW	.2 MW	.2 MW
Attenuator Range	120 db	120 db	120 db	120 db
Attenuator Accuracy	±2 db	±2 db	±2 db	±2 db
Output Impedance	50 ohms	50 ohms	50 ohms	50 ohms
Input Power	115V±10% 60 cps	115V±10% 60 cps	115V±10% 50-1000 cps	115V±10% 50-1000 cps
Internal Pulse Modulation:				
Pulse Width	0.5 to 10 microseconds			
Delay	3 to 300 microseconds			
Rate	40 to 4000 pulses per second			
Synchronization	Internal or external, sine wave or pulse			
Internal FM:				
Type	Linear sawtooth			
Rate	40 to 4000 cps			
Synchronization	Internal or external, sine wave or pulse			
Frequency Deviation	±2.5 MCS	±2.5 MCS	±6 MCS	±6 MCS
External Pulse Modulation:				
Polarity	-Positive or Negative			
Rate	40 to 4000 pulses per second			
Pulse width	0.5 to 2500 microseconds			
Pulse separation	(For multiple pulses) 1 to 2500 microseconds			
Output Synchronizing Pulses:				
Polarity	Positive, delayed & undelayed			
Rate	40 to 4000 pps			
Voltage	Greater than 25 volts			
Rise time	Less than 1 microsecond			
Size Approx. weight	17" long x 13¼" high x 15½" deep 60 lbs.		17" long x 15" high x 19½" deep 100 lbs.	

*Also available—MSG 4A: 6,950—11,500 MCS/sec.

"THE FINEST SIGNAL GENERATORS OF THEIR KIND"



ELECTRONICS CORPORATION 100 METROPOLITAN AVENUE,
BROOKLYN 11, NEW YORK

REPRESENTATIVES Albuquerque • Annapolis, Canada • Atlanta • Boston • Chicago • Cleveland • Fort Worth • Kansas City • Los Angeles • New York • Philadelphia • San Francisco • Seattle • St. Paul • Syracuse • Washington, D. C.

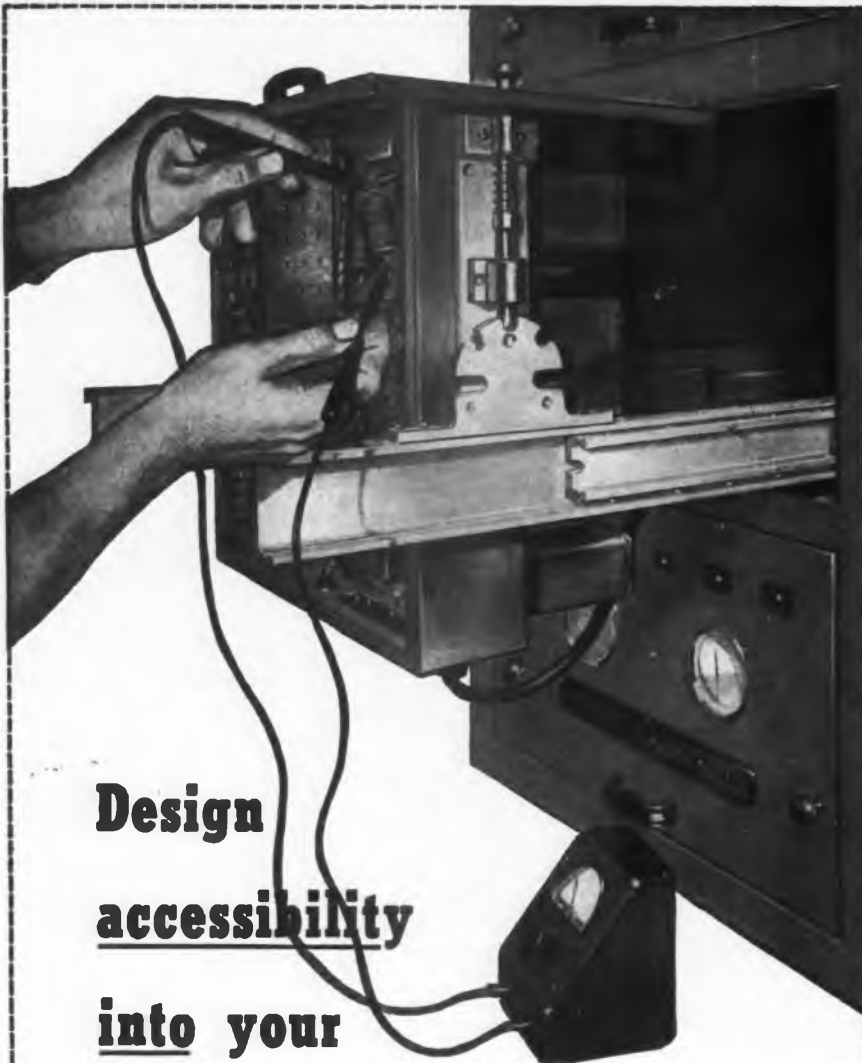

**Design
accessibility
into your
equipment**

When repairs and maintenance of electronic equipment are needed, wasted time costs money! Alert manufacturers have totally eliminated the laborious step of "getting at" vital components by installing Grant Industrial Slides. Is your equipment mechanically up to its high electronic standards? If not, Grant offers you:

Stock Slides. A great variety of types, suitable for most needs is in stock and available for immediate delivery.

Custom Slides. Our engineering staff will assist you at your plant and develop slides that fit your requirements perfectly.

Write today for our complete Industrial Slide Catalog.

Grant Industrial Slides

*Grant Pulley and Hardware Corporation
31-75 Whitestone Parkway, Flushing, New York*

West Coast Societies

(Continued from page 64)

Over 50,000 people are employed by the 164 member companies, with floor area totaling over 7-1/2 million sq. ft.

WCEMA Functions

WCEMA functions include such widely diversified activities as the following:

1. Co-sponsorship of WESCON, with Western Sections of IRE, as described above.

2. A self-contained Distributor Sales Group, composed of members with distribution and sales through jobbers. This group cooperates with such organizations as RETMA, EP and EM, SMC, NEDA, and The Reps.

3. Sponsorship with AIEE, IRE, and RETMA, of the Electronic Component Symposium. This activity has been in existence for the past three years. Events are held on the West Coast during alternating years, and attract national attendance.

4. Cooperation with RETMA in the West Coast area in problems peculiar to the Western industry.

5. WCEMA Scholarship Fund. Under this program, funds are solicited from members and non-members alike, on a voluntary basis, for the purpose of establishing scholarships in schools of the area and thus encouraging more students to enter fields which will fit them for the electronic industry. A Board of Trustees allocates the funds to various schools for distribution to deserving students. Selection is left entirely to the judgment of the schools, with the only limitation that students planning to enter fields leading to electronic engineering be given the awards.

6. An annual Wage and Salary Survey is conducted by each council of WCEMA. This statistical compilation has been the basis for labor negotiations by many West Coast companies, and has afforded a fair and equitable means of negotiating and establishing rates by many newcomers to the area as well as established firms.

7. Monthly meetings presenting prominent and interesting speakers.

8. This year WCEMA published its sixth edition of the Membership Roster and Product List. This attractive 44-page brochure is sent into thousands of offices across the country to further acquaint pur-

8 Dependable Solutions TO HERMETIC SEALING PROBLEMS...

E-I

HERMETICALLY-SEALED

AND MINIATURE

E-I Hermetically-Sealed Terminals and Miniature Closures are available to solve practically every electrical and electronic sealing problem. Recommendations on specific applications and samples will be sent promptly on receipt of your specifications or sketches. There is no obligation.



MULTIPLE HEADERS—Vacuum tight, cushioned glass construction. Strain-free, tin dipped for easy soldering and silicone treated for maximum dielectric strength.

OCTAL HEADERS—Plug-in and multiple types. Feature new principle of hermetic sealing. Solid metal blanks assure maximum mechanical strength and rigidity.



SEALED TERMINALS—Featuring cushioned glass construction, high thermal shock resistance. Available in economical preferred types and special designs.

TRANSISTOR CLOSURES—For transistors and other components requiring hermetic sealing. Available in standard types or custom design to specifications. Cases supplied round, rectangular or square.



END SEALS—For condensers, resistors and other tubular components. Completely strain-free and provide a permanent hermetic seal. Standardized, economical types.

LUG-TYPE, LEAD-THRU INSULATORS—For "bath tub" condensers, transformers, other applications requiring voltage ratings from 2000 to 4000 (rms.). Compression sealed, super rugged. Inside or outside mounting.



COMPRESSION TYPE HEADERS—Super rugged, absolutely rigid, practically indestructible multiple headers. Exclusive E-I development offers greatly increased resistance to shock and vibration.

COLOR-CODED TERMINALS—Feature glass inserts in standard, easily identified RMA color codes. Coloring is in the glass.



E-I... HEAD-
QUARTERS FOR
HERMETICALLY-SEALED
MULTIPLE HEADERS,
OCTAL PLUG-INS, TER-
MINALS, COLOR CODED
TERMINALS, END SEALS
PATENT PENDING
ALL RIGHTS RESERVED

New Catalogs on Request—Illustrated literature on any of the above is available without obligation. Call or write for new bulletins, today!



E-I DIVISION OF AMPEREX
ELECTRONICS CORPORATION

ELECTRICAL INDUSTRIES
44 SUMMER AVENUE, NEWARK 4, NEW JERSEY

NEW lower priced FOCOMAG USES SINGLE FERRITE MAGNET

Another HEPPIER First

- Lower priced, compact. Cuts receiver costs. Uses only ONE ferrite magnet (an exclusive feature).
- Superior focusing - more uniform field. The sintered ferrite is extremely uniform throughout. Focuses all tubes up to 27".
- Completely shielded. No harmful external field.
- Extended focus range has very fine adjustment to exact focus.
- Built-in centering device.
- Flexible nylon adjusting shaft eliminates breakage.
- Picture positioning lever. You specify mounting arrangement.



Lower your set costs with this NEW FOCOMAG. Write today for further information.

HEPPNER
MANUFACTURING COMPANY

Round Lake, Illinois (50 Miles Northwest of Chicago)
Phone: 6-2111

SPECIALISTS IN ELECTRO-MAGNETIC DEVICES

Representatives: **John J. Kepple**
60 E. 42nd St., New York 17, N. Y.
James C. Muggleworth
506 Richey Ave., W. Collingswood, N. J.
Ralph Haffey
R. R. 1, U. S. 27, Coldwater Rd.,
Ft. Wayne 8, Indiana
Irv. M. Cochran Co.
408 So. Alvarado St., Los Angeles, Calif.

West Coast Societies (Continued from page 136)

chasing and procurement personnel with the products and facilities of WCEMA members.

AIEE

The American Institute of Electrical Engineers is one of our oldest professional engineering groups. Originally, their members consisted primarily of those engineers interested in power generation and transmission. This is not true today, at least on the West Coast. This group has a very aggressive and growing electronic section, which fosters groups having primary interests in communication. It appears from a rather casual survey that this particular group represents as much as 50% of the AIEE membership, and the percentage is growing at a rapid rate.

Aircraft Industry

The brief organizational discussion included above has been confined entirely to those organizations dedicated primarily to the electronic industry. No consideration has been given to the electronic phases of the vast West Coast aircraft industry, which utilizes electronic equipment on a very major scale. Practically every aircraft manufacturer on the West Coast includes within its organization a major electronic division. The organizations and societies included within the aircraft framework are of such a magnitude, both in number of societies and membership, that they would require and deserve a separate study of their organization makeup and their growth over the past years.

It is significant that this article has not mentioned any one individual. Probably that fact, more than any other, is the key to the success and growth of the electronic industry of the West. For it has not been any one individual, but rather hundreds and thousands working together in harmony and with unity of purpose that has brought about the greatest growth that any industry has seen since the invention of the automobile. And even that was a snail's pace growth compared with the time it has taken to bring the Western electronics industry into adulthood. Unity and cooperation through organizational efforts have been the driving forces and will continue to be as the assured further expansion takes place.

You
need
BOTH!

These two books constitute a TV station operator's "bible." Together they present 240 pages of descriptive information, system diagrams, tables, data, specifications, prepared on a professional level and designed to serve as a Video buying and planning guide. The two books represent the most complete authoritative and up-to-date presentation of this kind in the Broadcast industry. For your copies, ask your RCA Broadcast Sales Representative, or write Dept. H-199, RCA Engineering Products, Camden, N. J. on your station letterhead. In Canada, write RCA Victor Ltd., Montreal.



CONTENTS

BOOK 1

- Studio Cameras
- Field Camera
- Camera Accessories
- Lenses
- TV Audio
- Custom Equipment
- Switching
- Monitors
- Amplifiers
- Special Effects
- Rack Equipment
- Plugs, cables, cords, etc.

BOOK 2

- Film Camera
- Projectors
- Film Accessories
- Slide Equipment
- Kinophoto & Developers
- Monoscope
- Mobile Unit
- Microwave Relay
- Sync Equipment
- Power Supplies
- Lighting
- Equipment Lists



RADIO CORPORATION of AMERICA
ENGINEERING PRODUCTS DIVISION

CAMDEN, N.J.

VLF

... Very Low Frequencies



• **RADIO INTERFERENCE**
 • **and FIELD INTENSITY***
 • **measuring equipment**

• Stoddart NM-10A • 14kc to 250kc

• Commercial Equivalent of AN/URM-6B

VERSATILITY... The NM-10A is designed to meet the most exacting laboratory standards for the precise measurements, analysis and interpretation of VLF radiated and conducted radio-frequency signals and interference. Thoroughly portable, yet rugged, the NM-10A can be supplied with accessories to fulfill every conceivable laboratory and field requirement.

EXCELLENT SENSITIVITY... The NM-10A sensitivity ranges from one microvolt-per-meter to 100 microvolts-per-meter, depending upon whether rod or shielded loop antennas or line probe are used.

ACCURACY... Each equipment is "hand calibrated" in the Stoddart Test Laboratories by competent engineers. This data is presented in simplified chart form.

DRIPPROOF... Sturdy dripproof construction allows long periods of operation in driving rain or snow without adverse effects.

FLEXIBLE POWER REQUIREMENTS... The ac power supply permits operation from either 105 to 125 volts or 210 to 250 volts ac, at any frequency between 50 cps and 1600 cps.

Stoddart RI-FI* Meters cover the frequency range 14kc to 1000mc

HF NM-20B, 150kc to 25mc
 Commercial Equivalent of AN/PRM-1A. Self-contained batteries. A.C. supply optional. Includes standard broadcast band, radio range, WWV, and communications frequencies. Has BFO.

VHF NM-30A, 20mc to 400mc
 Commercial Equivalent of AN/URM-47. Frequency range includes FM and TV bands.

UHF NM-50A, 375mc to 1000mc
 Commercial Equivalent of AN/URM-17. Frequency range includes Citizens band and UHF color TV band.

STODDART AIRCRAFT RADIO Co., Inc.

6644-G Santa Monica Blvd., Hollywood 38, California • Hollywood 4-9294

Network Analysis

(Continued from page 98)

left half of the complex plane that represents the locus on which the admittance has a zero real part. For example, working with the series arm,

$$Y_1 = Y_n' + (G_n - G) \quad (11)$$

$$= \frac{u_1(\sigma, \omega) + jv_1(\sigma, \omega)}{u_2(\sigma, \omega) + jv_2(\sigma, \omega)}$$

we obtain the curve

$$\text{Re } \{Y_1\} = 0 \quad (12)$$

$$\therefore u_1v_2 + v_1v_2 \equiv f(\sigma, \omega) = 0$$

Considering σ as an implicit function of ω given by $f(\sigma, \omega)$ and evaluating the derivative

$$\frac{d\sigma}{d\omega} = - \frac{\frac{\delta f}{\delta \omega}}{\frac{\delta f}{\delta \sigma}}, \quad (13)$$

we find the smallest minimum value of σ , that is, the point at which the curve is closest to the j axis. To each of the zeros and poles of Y_1 , we may now add the positive constant h , which is chosen less than or equal to this minimum distance, without destroying the positive real quality of Y_1 . Then, after realization of the arm by the Bott-and-Duffin procedure, the network obtained is corrected for the predistortion: for every L a series combination of L and a resistance of Lh ohms is substituted, while every C is replaced by a parallel combination of C and a conductance of Ch mhos. A similar procedure is followed for the diagonal arm.

Shunt Capacitance

Finally, if the given transfer function is a proper fraction, it is clear that the admittances of both of the lattice arms will possess a pole at infinity and a corresponding shunt capacitance in their network representations. Thus, a capacitance may be removed from each of the arms yielding an equivalent lattice with a shunt capacitance at the input and output terminals.

The steps in the synthesis procedure may now be summarized as follows:

1. Realize the given function as an open-circuited lattice by the method of reference 4 or reference 5.

2. Obtain an equivalent lattice with a shunt conductance at the input and output terminals. If the de-

Think

of all the ways ADLAKE Mercury Relays
can save money in your business!

● In any installation that requires both sensitivity and lasting dependability . . . from traffic control systems to chick incubators to long range navigation . . . ADLAKE Mercury Relays can do the jobs that conventional relays do in an uncertain manner at best!

For instance, ADLAKE Relays have proved their ability to stand up under the most adverse conditions of temperature and moisture. Their time-delay characteristics are fixed and non-adjustable . . . normal line voltages and ambient temperatures from -38.8° to 200° have little effect on these characteristics. They require no maintenance whatever . . . are silent and chatterless . . . and their mercury-to-mercury contact prevents burning, pitting, and sticking.

If you don't find the relay you need in the ADLAKE catalog, it will be custom-built for you. Write for full information today: The Adams & Westlake Company, 1175 N. Michigan, Elkhart, Indiana. In Canada, address Powerlite Devices, Ltd., Toronto.



Type 1123 ADLAKE double pole load relay
Contacts Normally Open

EVERY ADLAKE RELAY IS TESTED
—AND GUARANTEED—
TO MEET SPECIFICATIONS!



THE **Adams & Westlake** COMPANY

Established 1857 • ELKHART, INDIANA • New York • Chicago
Manufacturers of ADLAKE Hermetically Sealed Mercury Relays

Get into the

SOLAR SYSTEM...



Capacitors Since 1932

Ceramic capacitors have become the byword in electronics, offering smallest of sizes, wide temperature ranges, stability and lower prices. SOLAR is the buy-word for the most complete line of ceramic capacitors, competitively priced. Investigate the Solar System of capacitors today.

Let us help you improve your product and reduce your product costs. Write to our Engineering Service for information.



SOLAR MANUFACTURING CORP., New York, N. Y.

ADDRESS INQUIRIES TO: 2660 East 46th Street, Los Angeles 58, California

Network Analysis

(Continued from page 140)

gree of the numerator of the given transfer function is lower than that of the denominator, also remove a shunt capacitance from each of the lattice arms.

3. Predistort each of the remaining lattice admittances as explained above. Then realize each arm by the Bott-and-Duffin procedure, after which the networks obtained are corrected for the predistortion.

4. If necessary use Thevenin's theorem on the input to obtain the given type of transfer function.

To demonstrate the complete procedure, we realize the non-minimum-phase voltage ratio

$$K = \frac{E_2}{E_1} = \frac{s^2 - s - 12.4}{10s^2 + 46s + 60}$$

as a resistance-terminated lattice.

First we represent the above function as the transfer impedance of an open-circuited lattice. Using the method of reference 4 we find

$$Z_h = \frac{s^2 + 6s + 10}{5s^2 + 23s + 30}$$

$$Z_a = \frac{7s + 22.4}{5s^2 + 23s + 30}$$

The series impedance Z_h is immediately realizable by inspection as

$$\frac{1}{Z_a} = \frac{5}{7} - s + 1 + \frac{7.6}{7s + 22.4}$$

Upon attempting to remove a conductance of one mho from Y_h , we obtain the positive real remainder
(Continued on page 144)

KOVR ATOP MT. DIABLO



FCC has approved call letters KOVR for new Channel 13 station of Television Diablo, Inc., Stockton, Calif. Principal stockholder Les Hoffman reports programming to begin in Sept. Map shows how 12-bay antenna with 144 kw ERP will cover 40% of state's population from 4000-ft. Mt. Diablo. A. Jostelyn is gen. mg.

NEW!

A 3-WAY PACKAGING SERVICE

offering complete protection
for the most delicate instruments
and components

CARGO PACKERS

1. Contract packaging for electronic, photographic and aircraft equipment.
2. Packaging kits for packaging delicate components in your own plant.
3. Packaging design and consulting service to work with your engineers on new and re-designed products.

CARGO PACKERS serves leading manufacturers including J. M. Loge, Federal Telephone & Radio Corp., Amperex Electronics Corp., Eastman Kodak Recordak Div., Allen B. Dumont Labs., Pioneer Electronics, Times Facsimile Corp. and many others.

FOR COMPLETE
INFORMATION
MAIL COUPON!

MARSHANK SALES CO.
672 SO. LAFAYETTE PARK PLACE
LOS ANGELES 5, CALIFORNIA

As authorized Western representatives for Cargo Packers, Inc., please

- SEND ILLUSTRATED CATALOG
 HAVE A SALES ENGINEER CALL

NAME _____
 COMPANY _____
 STREET _____
 CITY _____
 STATE _____

IF YOU NEED EXTRA-FAST SERVICE,
 TELEPHONE **Dunkirk 7-8235**
Dunkirk 8-5055
 Visit us at Booth 753 WESCON.

NOW

NEW YORK —
73 RUTLEDGE ST., BROOKLYN 11, N. Y.

CARGO PACKERS EAST & WEST COAST PACKAGING SERVICE!

CALIFORNIA —
2050 BROADWAY, SANTA MONICA

Individually-engineered CLIMATE-PROOF, SHOCK-PROOF PACKAGING

To meet the increased, country-wide demands of the electronics industry. Cargo Packers has now inaugurated complete facilities in the West Coast area also, for packaging protection of delicate instruments, equipment and components, including



12-PAGE BROCHURE tells how to avoid the pitfalls, gives complete detailed information on C-P methods of protective packaging.

- Special Assembly Equipment
- Experts in Military Specifications
- Economical Production line methods
- Full Compliance in Every Detail
- Competent Consulting Service

Whether in storage or in transit anywhere, absolute protection against strain, stress, shock, vibration, temperature or humidity fluctuations, moisture—or even skin damage—is assured by Cargo Packers' individual attention to every job. For recommendations on specific packaging problems, call or write our Sales-Engineering Department today.

CARGO PACKERS

INCORPORATED
New York — 73 RUTLEDGE ST., BROOKLYN 11, N. Y.
California — 2050 BROADWAY, SANTA MONICA

CLIMATE-PROOF PACKAGING



SPECIALISTS IN
CLIMATE-PROOF, SHOCK-PROOF
PACKAGING FOR ORDNANCE AND INDUSTRY



Another NEW Fairchild Precision Potentiometer

**TYPE
910
Rectilinear**

The basic Type 910 rectilinear potentiometer is flexible in design to accommodate dual resistance elements, various stroke lengths, double shaft extensions, external fixed resistors, various methods of actuating, and a broad range of shaft speeds. It meets or exceeds military specifications for vibration and high and low temperature exposure. A mandrel resistance element of all-welded construction, aged and stabilized for accuracy and long life, provides small diameter, uniform cross section and a smooth operating surface for the new one-piece wiper design. Rigid mechanical construction maintains initially-tight electrical tolerances throughout stringent environmental and performance conditions.

Another reason why Fairchild can supply ALL your precision potentiometer needs

Fairchild makes a complete line of precision potentiometers to fill all your needs—linear and nonlinear potentiometers, singly or in ganged combinations . . . single-turn, helical and linear motion . . . and with resistance elements to meet your requirements.

Fairchild guarantees accuracy of $\pm 1\%$ or better in nonlinear types and $\pm 0.5\%$ or better in linear types. Highly accurate production methods and close mechanical tolerances, plus thorough type-testing and quality control, provide high resolution, long life, low torque and low electrical noise level in every Fairchild potentiometer. For more information, or for help in meeting your potentiometer problems, call on Fairchild Camera and Instrument Corporation, Potentiometer Division, 225 Park Avenue, Hicksville, L. I., N. Y., Department 140-57E.



Network Analysis

(Continued from page 142)

$$Y_b - 1 = \frac{4s^2 + 17s + 20}{s^2 + 6s + 10}$$

Thus this conductance may be removed from the lattice arms to yield an equivalent resistance-terminated lattice. The remainder of the diagonal arm admittance has a zero real part curve whose closest point to the j axis occurs at $\sigma = -2$. Substituting the new variable $(s-2)$ for s in the remainder, we obtain

$$Y' = \frac{4s^2 + s + 2}{s^2 + 2s + 2}$$

which we now realize by the Bott-and-Duffin procedure⁶ as the network shown in Fig. 6. This network is then corrected for the predistortion.

Now applying Thevenin's theorem to the input of the lattice thus obtained, we finally realize the lattice shown in Fig. 7.

Any realizable transfer voltage ratio, transfer admittance or transfer impedance may be realized by the method presented in this paper as a lattice terminated in resistance at both its input and output terminals. No mutual inductance is necessary and each inductance has an associated series resistance so that low-Q coils may be used in building the network. When the transfer function is a proper fraction, a shunt capacitance may also be obtained at both the input and output terminals.

This paper was presented at the 1954 I. R. E. Convention, New York City.

References

1. H. W. Bode, "Network Analysis and Feedback Amplifier Design," D. Van Nostrand Co., N. Y., N. Y., 1945.
2. E. A. Guillemin, "Summary of Modern Methods of Network Synthesis," *Advances in Electronics*, vol. 3, Academic Press, N. Y., N. Y., 1951.
3. R. Kahal, "Synthesis of the Transfer Function of 2-Terminal Pair Networks," *A. I. E. E. Proceedings*, vol. 71, 1952.
4. L. Weinberg, "RLC Lattice Networks," *Proc. I. R. E.*, pp. 1139-1144; Sept. 1953.
5. L. Weinberg, "A General RLC Synthesis Procedure," *Convention Record of the I. R. E.*, 1953; also *Proc. I. R. E.*, Feb. 1954.
6. R. Bott and R. J. Duffin, "Impedance Synthesis Without Use of Transformers," *Jour. Appl. Phys.*, p. 816; Aug. 1949.
7. S. Darlington, "Synthesis of Reactance Four-Poles," *Jour. Math. Phys.*, pp. 257-353; Sept. 1939.
8. For details on the realization of this driving-point function, see E. A. Guillemin, loc. cit., where the dual of the admittance is synthesized.

Palnut to United-Carr

Arthur W. Kimbell, President of United-Carr Fastener Corp., Cambridge, Mass., has announced the company's acquisition of the Palnut Co., Irvington, N.J.

eldec

SLIP RING & BRUSH HOLDER ASSEMBLIES

Meet your most RIGID requirements!

The finest sub-miniature components available!

ELDEC TYPICAL RINGS



ELDEC HOLLOW RINGS



ELDEC PRECISION RINGS



ELDEC DESIGNED RINGS



ELDEC SLIP RINGS

Precision molded Eldec slip rings meet and surpass your most exacting requirements. They're molded in *one piece* for maximum insulation, high dielectric strength and higher hi-pot. Turned rings are of solid coin silver, platinum, silver or gold alloys. Concentricity to conform to your standards. Four micro-inch finishes are standard with higher finish as required. Send us your requirements. Eldec prices are competitive.

ELDEC BRUSH ASSEMBLIES

One-piece Molded Eldec brush assemblies are the perfect companion part to Eldec slip rings. Send us your requirements.



ELDEC sub-miniature Rotary Switches

are miniatures, sturdily constructed for dependable long life expectancy, fully enclosed and weigh less than 1/4 ounce including the knob... These miniature molded 1, 2 and 3 pole switches can be ganged by closed coupling to accommodate up to 60 circuits.

ELDEC BRUSH HOLDER



ELDEC BRUSH & RING



SEND US YOUR REQUIREMENTS

6006 West Washington Blvd., Culver City, Calif.

ELDEC REPRESENTATIVES

MR. HAROLD F. BARDWELL
11 Winthrop Office Bldg.
30 Winthrop St., Rochester 7, N.Y.

MR. HARRY VARRELMAN
Box 503, Hicksville, N.Y.

HARRISON REYNOLDS CO.
313 Washington St., Newton 58, Mass.

HARRISON REYNOLDS CO.
R. L. Helms
211 State St., Bridgeport, Conn.

E. A. DICKINSON AND ASSOC.
744 North Fourth St.
Milwaukee, Wisconsin

MAGERTY-SCOTT CO.
10116 Puritan, Detroit 38, Mich.

MR. HARVEY RASMUSSEN
2513 - 23 1/2 Ave., Rock Island, Illinois

JIM BIERHAUS SALES CO.
Mr. Jim Bierhaus
4804 W. Madison St., Chicago, Ill.

LET OUR ENGINEERS
PROPOSE A
SLIP RING AND
BRUSH HOLDER
ASSEMBLY
TO SUIT YOUR
EXACT
REQUIREMENTS!



**THIS
RELAY
IS FOR
THE
"birds"**



In spite of the fact that we've often wished we had more things non-military to crow about, we've just found another adaptation of our (admittedly military)* Series 73 relay which may have a future in guided missiles that can't be ignored. Quite prosaic — merely as "another" midget SPDT relay. The point is that several others now available about the same size seem to leave something to be desired in vibration resistance and sensitivity.

In this adaptation, coded 73Y, omission of the three-position null-seeking features of the 73X gives a biased polar relay with outstanding abilities at straight switching. It withstands 30 g's at frequencies up to 500 cps, which do not interfere with operation at adjusted sensitivities of 40 milliwatts (e. g. 2.5 ma. in 6400 ohm coil). It operates in less than 1 millisecond without bounce in most circuits, although, having bearings, it is not suitable for extended keying service. Mechanical life is 10,000,000 operations conservatively.

Our occasional pleas for *non-military* uses of sensitive relays should not be construed as a lack of interest on our part in *military* business. So if you think you can use a 73Y in your "bird", get the word on it.

*See "Null-Seeking Shark . . .", January advertisement.

SIGMA

SIGMA INSTRUMENTS, INC.
86 PEARL STREET, SO. BRAintree, BOSTON 85, MASS.

Brain Mapping

(Continued from page 68)

cal experiment. On the left hand side is the sound proof room with the animal in place. The ear phones are connected to the ears and the wires are shown in contact with the brain. The recording equipment consists of the control unit at the top of the figure which generates the control pulses. Just below this is the 10-channel CRO which is connected to the animal, and on the right is the sound generation equipment consisting of two channels which follow the conventional audio design. The filters shown are of the $\frac{1}{2}$ octave push-button type and are used to filter out harmonics and are also being used to generate the short pulses of sound. The output of these two audio channels can be mixed or sent independently to the earphones at the two ears.

The sound calibration system is located here and consists of a condenser transmitter connected to an automatic frequency response recorder. The condenser transmitter is a Western Electric 640AA originally calibrated by the reciprocity method. The ear phones form a closed system with the animal's ear and this closed system is calibrated with a coupler to the transmitter. The calibration is of the open circuit type. The intensity levels are represented as db above the standard reference level of 10—16 watts /sq. cm. The spectra of the audio signals we use were determined with a wave analyzer having a 4-cycle band pass. The frequency of the steady tones was read from the oscillator dials.

Pure Tone Effect

When our work was begun in 1942 we accidentally discovered that the rather abrupt onset of a pure tone caused an electrical response at one spot in the brain of the anesthetized dog. The position of this spot was found to depend systematically on the frequency of the tone. The electrical changes were not seen during the steady portion of the tone because of certain physiological effects of the anesthetic. This discovery that the sudden change in amplitude of a sound would produce a potential under anesthesia has served as a useful tool for determining the connections from the ear to the brain for different frequencies of sound. From the standpoint of communication, the onset of a pure tone was not a satisfactory signal because its spectral

SCINFLEX

ASSURES YOU HIGHEST EFFICIENCY FOR RUGGED REQUIREMENTS!

When operating conditions demand an electrical connector that will stand up under the most rugged requirements, always choose Bendix Scinflex Electrical Connectors. The insert material, an exclusive Bendix development, is one of our contributions to the electrical connector industry. The dielectric strength remains well above requirements within the temperature range of -67°F to $+275^{\circ}\text{F}$. It makes possible a design increasing resistance to flashover and creepage. It withstands maximum conditions of current and voltage without breakdown. But that is only part of the story. It's also the reason why they are vibration-proof and moisture-proof. So, naturally, it pays to specify Bendix Scinflex Connectors and get this extra protection. Our sales department will be glad to furnish complete information on request.

- Moisture-Proof • Radio Quiet • Single Piece Inserts •
- Vibration-Proof • Light Weight • High Insulation Resistance
- High Resistance to Fuels and Oils • Fungus Resistant •
- Easy Assembly and Disassembly • Fewer Parts than any other Connector • No additional solder required.

The Finest
**ELECTRICAL
CONNECTOR**
MONEY CAN
BUY!

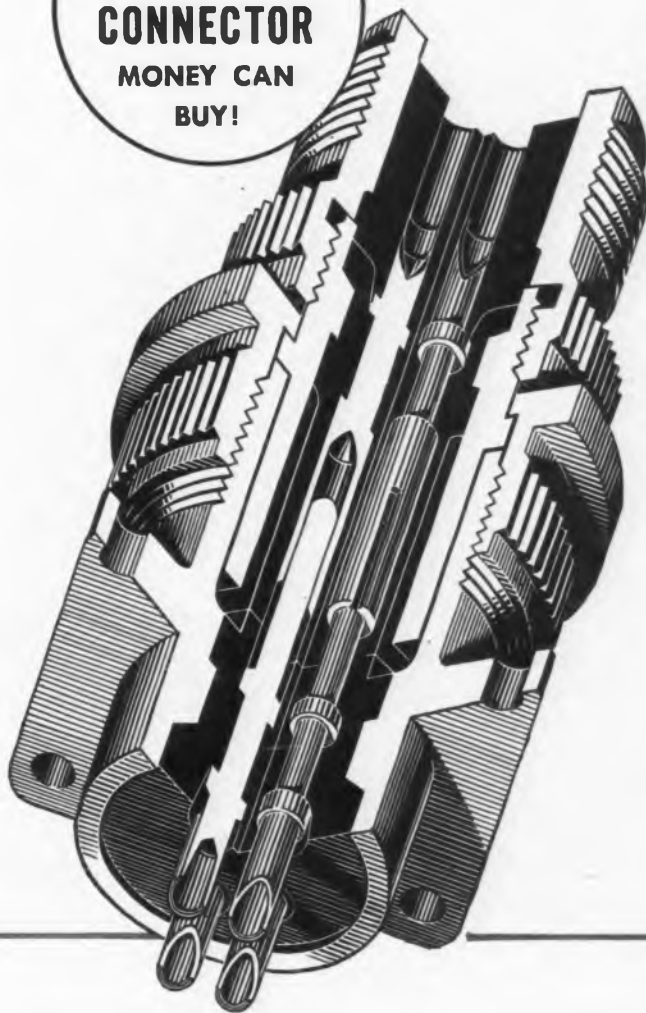

BENDIX SCINFLEX

ELECTRICAL CONNECTORS

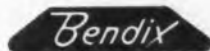

SCINTILLA DIVISION of
SIDNEY, NEW YORK



Expert Sales: Bendix International Division, 285 E. 42nd St., New York 17, N. Y.

FACTORY BRANCH OFFICES: 117 E. Providencia Ave., Burbank, Calif. • Stephenson Bldg., 6560 Cass Ave., Detroit 2, Michigan • 512 West Ave., Jenkintown, Pa. Brouwer Bldg., 176 W. Wisconsin Avenue, Milwaukee, Wisconsin • 8401 Cedar Springs Rd., Dallas 19, Texas • American Bldg., 4 S. Main Street, Dayton 2, Ohio.

Simul-Scopic* Signals

TAKE THE GUESSWORK OUT OF SCOPES

It's all done by combining any number of electron guns up to ten in a single cathode ray tube. Then, when you have to measure simultaneous phenomena, you've actually got a number of oscilloscopes in one—all operating continuously without the disadvantages of electronic-switching or an optical system. And only ETC multi-channel scopes and multi-gun tubes make Simul-Scopic signals available to meet such a wide variety of individual needs.

MULTI-CHANNEL SCOPES



... with the combination you need of band width, gain, sensitivity, frequency response, with or without film strip recording. Separate intensity, focus, and axes controls for each channel.

MULTI-GUN TUBES



... with 2 to 10 guns ... round or square face ... 3 to 12 inches. Special purpose tubes made to specification, including every type capable of commercial manufacture.

THIS FREE CATALOG



... entitled "Oscillography—Key To The Unknown", shows why there is no other equipment so easy to use, so comprehensive in its presentation, and so economically practical for simultaneous oscillography. Write for your copy.

*Simul-Scopic — *Two or more simultaneous events which can be observed on a cathode ray tube (Reg. Applied for)*

ETC

electronic tube corporation

1200 E. MERMAID LANE, PHILADELPHIA 18, PA.

Brain Mapping

(Continued from page 146)

and temporal characteristics were difficult to analyze, and complicated the picture because of the combination of transient and steady state signals.

To define the sending end of our communication channel more clearly, we have adopted for our auditory signal a new type of sound which is variously called the probability pulse, the logon, or the tone pip. Fig. 4 shows an oscillogram of the probability pulse and its spectral properties. This type of signal was studied by Gabor from the standpoint of communication theory and he has pointed out that it contains one bit of information. In other words, it fits the requirements in communication theory where the product of bandwidth and duration is a constant. In the sense of Wiener, it also has something to do with the concept of ideal filtering. As a matter of fact, we generate this probability pulse by ringing or "ideally" filtering with a half-octave filter, a rectangular pulse whose duration is equal to one-half the period of the mid-frequency of the half-octave section. The rectangular pulse results in an envelope of sinusoidal waves as indicated with a normal or probability curve drawn on the face of the CRO to show the general fit of the probability pulse. The spectrum is a half octave wide, 3 db down, and one octave wide, 40 db down. As a matter of fact, this spectral curve represents the design curve of the filter. The spectrum of the pulse is actually log normal rather than normal because the filter was designed on a log normal basis. Because the ear is logarithmic frequency wise, this fact is probably of no importance. The intensity of these pulses we measure at the peak which is equal to the amplitude of a steady tone of the same frequency.

Time Relationships

We therefore are able to characterize the sound field or the sending end of our communication channel in terms of the following parameters: The spectral properties of the pulse are half octave at 3 db and one octave at 40 db. The number of cycles are the same but the duration of the pulse varies with frequency. This allows us to examine precisely the time relationships of the various cycles of the probability pulse with the received signal in the brain. Finally the intensity of the

ere
ted
ma-
tate

our
rly,
ory
ich
ity
Fig-
ba-
er-
ied
of
has
bit
it
ea-
of
on-
also
on-
ter
ity
er-
ec-
is
the
ve
re-
dal
or
ace
fit
ec-
db
db
ec-
ign
a of
mal
fil-
mal
mic
bly
of
mak
e of
cy.

ips

nc-
ing
nel
ne-
the
and
e of
ra-
re-
line
of
ity
the
the

954

for durable and dependable

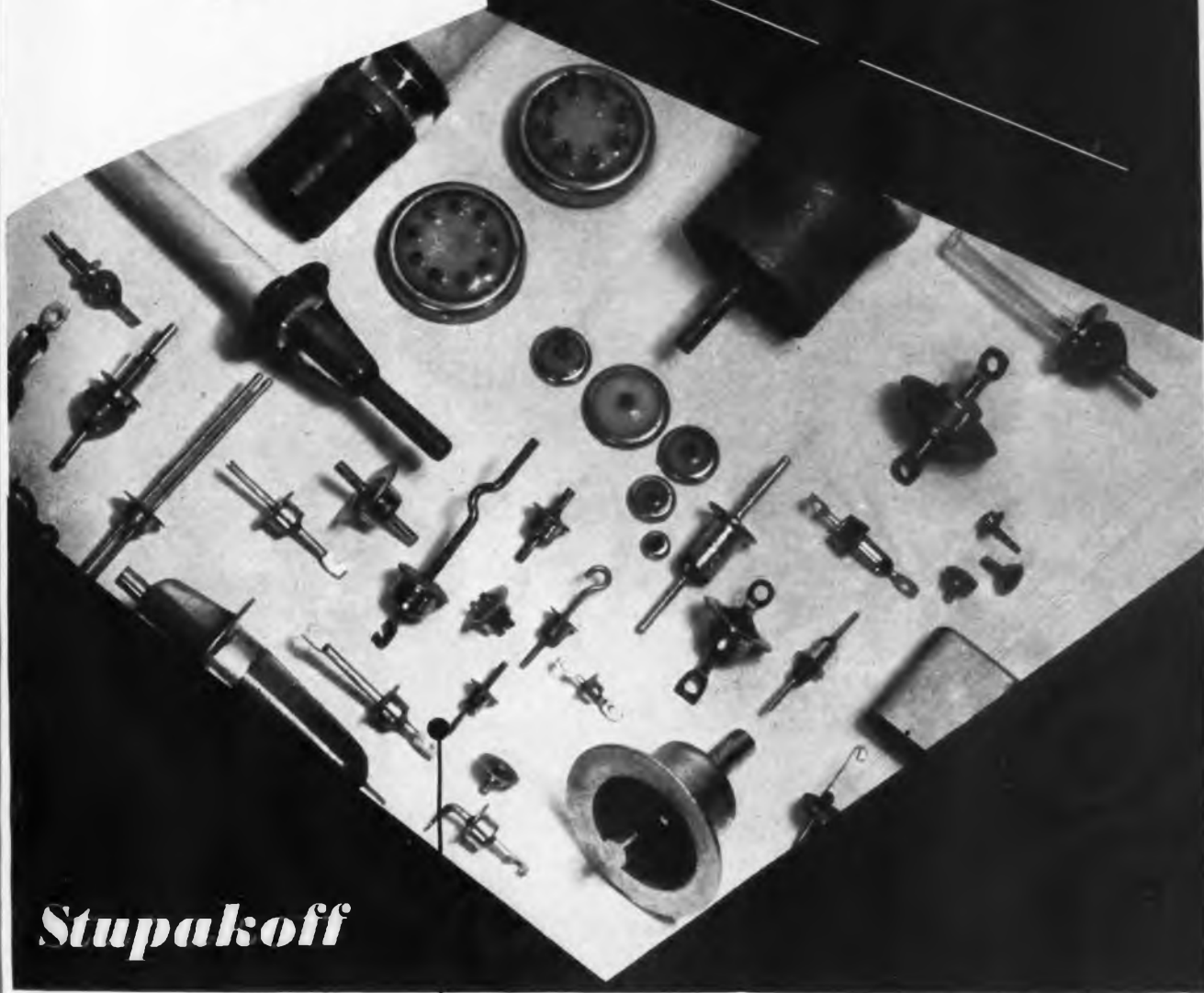

Stupakoff

glass-to-metal
seals

A complete range of sizes and designs of terminals, lead-ins and stand-offs for hermetic sealing is offered by Stupakoff. Made with Kovar metal, the ideal alloy for sealing to hard glass, Stupakoff Seals are durable and dependable. These are not mechanical compression seals, but are permanently fused by chemical interaction. They may be installed by conventional assembly techniques.

Write for a copy of the new Stupakoff Catalog 453, giving details of over a thousand sizes and styles of Stupakoff Seals.

**STUPAKOFF CERAMIC
& MANUFACTURING COMPANY**

LATROBE, PENNSYLVANIA



high stability MINIATURIZED JK GLASLINE CRYSTAL

- Minimum Aging Drift • Miniature Size
- High Q. For Maximum Performance



No need to insulate the G-3 case even in the most compact wiring assemblies.



ACTUAL SIZE



THE NEW STABILIZED JK-G3

Smaller than a thumbnail, the miniature JK G-3 was developed in anticipation of today's growing need for minimum size with maximum stability. The smallest of the JK Glasline crystals to match today's most critical requirements. The frequency range is 10 mc to 100 mc. Sealing crystals in glass makes possible the techniques necessary to set new stability records.* Consult us for your requirements.

The JAMES KNIGHTS Company
Crystals for the Critical - SANDWICH, ILLINOIS



JK
STABILIZED G-9J
1 kc to 10 kc
Frequency tolerance
over range of -40 to
+70°C:
w/o ckt. adj. ±.03%
with ckt. adj. ±.02%



JK
STABILIZED G-9
4 kc to 500 kc and 1.2
to 5 mc



***JK**
STABILIZED G-12A

540 kc to 1600 kc
At 1000 kc has proven a
stability potential of one
part in 100 million.*
Available for standards
or non-temperature controlled
broadcast use
(F.C.C. approved). *As
tested in leading U.S.
Gov't Lab.



JK STABILIZED G-12
99 kc to 180 kc
Frequency tolerance:
±.0005%, 25 to 70°C

Brain Mapping

(Continued from page 148)

pulses are known. By setting up these precise signals in advance we can establish *a priori* the probability of the message that we send to the brain. We also use a steady pure tone, thermal noise and pulsed thermal noise with known bandwidths to produce a phenomenon known as masking, in which a signal due to the probability pulse is obliterated as a certain function of the frequency and intensity of the masking sound. Masking is very common in hearing and although we do not understand its function we can measure its effects very precisely. Having defined the sending end of our communication channel we can not look at the receiving end or the auditory cortex of the brain.



Fig. 9: 50-channel cathode ray oscilloscope

Fig. 1 shows the summary of our results in receiving end of the dog brain concerning the mapping of frequency and intensity. There are four regions from which electrical responses are obtained to sounds and these are indicated on the photograph. In three of these regions there appears to be a space-wise representation of frequencies. Ordinarily this representation of frequencies can be shown by placing electrodes on the surface and stimulating the ear with a sound of a given frequency. This results in electrical responses at the points indicated by the frequencies marked in the photograph. Thus, a 100-cycle sound produces responses across this strip, 1.0 kc at this strip, and

so on.
a reed
the pos
indicate
pressed
sition c
dicates
pressed
of the
sented
cells th
The
tions,
Beaus
ductor
not all
these
measur
have u
which
crease
thus
due to
Fig. 6,
paper
strychu
strychu
causes
usual
nerve
where
acts sc
in tha
pulses
ment.
and in
discha
one ge
sent th
activa
of thi
much
tave.

If th
the fr
bandp
depen
If we
curve
move:
one-h
per it
1/10 c
curve
0.2 m
differ
incre
repre
enorm
in m
partic
are s
range
as a
exten
Ass
octav
small

so on. This is somewhat similar to a reed frequency analyzer in which the position of the vibrating reed indicates the frequency of the impressed sound. In this case the position of the electrical response indicates the frequency of the impressed sound. Thus, the frequency of the sound appears to be represented by the position of the nerve cells that respond.

The distribution of these positions, is on a logarithmic basis. Because the brain is a volume conductor the electrical response does not allow precise measurements of these positions. To improve our measurements of these positions we have used a rather artificial device which works beautifully here to increase the signal-to-noise ratio and thus eliminates misinterpretations due to electrical fields. As shown in Fig. 6, we simply put a piece of paper 1 sq. mm. in size, soaked in strychnine on the surface. The strychnine by some uncanny means causes a potential 10 to 20 times the usual magnitude to appear if a nerve impulse enters the region where the strychnine is located. It acts somewhat like a bandpass filter in that it indicates only those impulses which enter the 1 mm segment. By measuring the frequency and intensity of the sounds which discharge this enormous potential one gets a bandpass curve to represent the spectra of the nerve fibers activated. The high frequency slope of this bandpass curve may be as much as 90 db per one-fourth octave.

Connection Measurement

If the piece of paper is moved in the frequency axis of the area, the bandpass curve shifts by an amount dependent upon the displacement. If we move it 2 mm, the bandpass curve shifts one octave; 4 mm, it moves two octaves; 1 mm, it moves one-half octave. By moving this paper it has been possible to detect a $\frac{1}{10}$ octave displacement of the curve when the paper was moved 0.2 mm. Thus, there are apparently different frequencies represented in increments of 200 microns which represent $\frac{1}{10}$ octave. This is an enormously high degree of precision in measurements of connections, particularly if the finer connections are somewhat random in their arrangement. Some of the nerve cells, as a matter of fact, have processes extending 100 to 300 microns.

Assuming that there are about 7 octaves in the area and that the smallest interval is 0.2 mm then

THESE EXTREMES
—or anything in between!

Langevin

TRANSFORMERS

—custom-built to military specifications
at your specific performance needs

THREE LANGEVIN TIME-SAVERS

1 Complete MIL-T-27 tests for qualification approval can be made in our own laboratory—often saves weeks on contract completion.

2 Samples and short runs are handled in our model shop, staffed and equipped for high speed, economical service on small quantities.

3 Large stocks of materials prevent delays. Hundreds of types and sizes of wire, core materials, cases, terminals, brackets, etc., always in stock.



TINY OR
MAN-SIZED!

23 1/2" x 15" x 13 3/8" HIGH



Langevin

specialization insures faster
delivery and highest quality

You can depend on LANGEVIN for every transformer requirement, large or small, including pulse transformers, charging reactors, saturable reactors, high cycle transformers and units built to the most rigorous specifications. Highly specialized facilities permit fast handling of short or long runs with maximum economy and rigid quality control. For prompt quotations or engineering collaboration, call or write today without obligation.



LANGEVIN MANUFACTURING CORPORATION
37 WEST 65th STREET, NEW YORK 23, N. Y.

A SUBSIDIARY OF THE W. L. MAXSON CORPORATION

let's peek
behind the panel

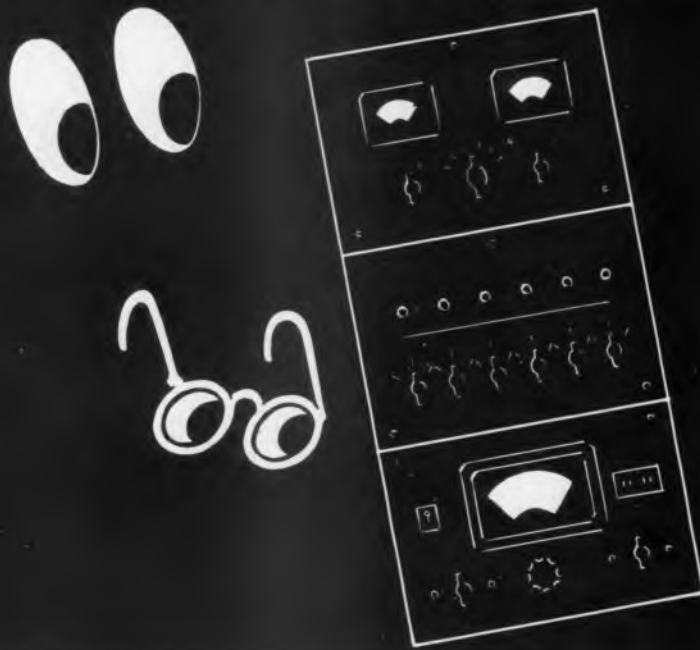

... and see why the
Rust Remote Control System is your best buy

First . . . you'll find that no two Rust systems are exactly alike. They are not "packaged" units, but *engineered* systems, specifically designed to fit *your* transmitter.

Second . . . you'll see that the Rust system is *complete* — you have nothing else to buy "to fit *your* equipment". You even get interconnection diagrams, especially made for your transmitter and monitors.

Third . . . there are no tubes, so there are no tube failures. There are no adjustments, so there are no maladjustments. The Rust system functions as it should . . . with practically no maintenance.

If you are considering Remote Control, investigate before you buy. Take a peek behind the panel and you'll choose Rust.

FOR EXAMPLE — Rust offers you Breaker Resetting

The RI-108-11A Linear Actuator, used for resetting manually operated overload breakers, permits linear movement of any mechanism to which it is coupled. In many cases it is possible to reset several Heinemann overload breakers simultaneously with one unit. Send for Brochure showing what you get when you buy the Rust system.



the rust industrial company, inc.



608 WILLOW STREET, MANCHESTER, N. H.

Brain Mapping

(Continued from page 151)

there would be seventy $\frac{1}{10}$ octave intervals in 1.4 cm of cortex. Further assuming that each one of these intervals is a binary digital device it would allow for two to the 70th or ten to the 24th power different sounds to be represented. An enormous capacity for such a small structure. It is becoming apparent, however that this is not entirely a digital device but rather an analog device, and therefore the amount of information is dependent on the signals impressed on the ear in the form of probability pulses. Undoubtedly this part of the cortex will have to be represented as a continuous distribution of nerve connections representing different frequencies rather than a purely digital series of units. However, the precision of $\frac{1}{10}$ octave allows us to define the distribution functions more clearly.

Frequency Positions

The other two areas in the brain do not show the same precision of representation of frequencies. At least they appear to be more complex and we have not worked on them as intensely as in this area. You will notice on this line an intensity scale. We have found that the frequency positions are actively represented by strips of cortex rather than points. The entire strip responds to one frequency at one intensity level for the ear on the opposite side of the brain but for the ear on the same side a different intensity is required to excite different parts of the strip. This is apparently a sort of intensity representation of sound. It is very crude at best and its significance is not known at the present time.

We have thus shown how the frequency characteristics of sound are represented in the brain by the positions of the nerve cells. A communication channel really is concerned with the information transmitted during an interval of time. Thus far we have not mentioned the temporal character of the signals that we receive in the brain. There is no evidence that the frequency of a sound is represented in any way temporally in the brain. This makes it necessary to consider what information we get from the auditory cortex temporally.

As seen in Fig. 7 the potentials that we record oscillographically from the surface of the brain show



"STEPS UP"

SUPERIOR PERFORMANCE

*makes Philco Transistors
the recognized standard.*

With Philco

Alloy Junction Transistors

you gain the advantages of

small size, low power consumption

and simplified circuitry to

improve your product.

RELIABILITY . . . six years of Philco research and development in semi-conductors have established the quality, uniformity and production standards (from basic materials to tested transistors) required for large scale production.

AVAILABILITY . . . recognizing the potential transistor requirements of the electronic industry, Philco planning has resulted in production facilities which assure an unfailing supply of high quality transistors—now!

Phone, write or wire Dept. T today for descriptive literature and specifications on Philco transistors.

PHILCO TRANSISTORS FEATURE . . .

- *Maximum reliability*
- *Uniform characteristics*
- *Hermetically-sealed resistance-welded case . . . leads fused in glass*
- *Minimum size*
- *Ruggedized construction*



PHILCO CORPORATION

GOVERNMENT & INDUSTRIAL DIVISION • PHILADELPHIA 44, PA.

**MADE
TO
SURVIVE**



Also Available — RM Types — 25, 50 and 250 Watts

Miniature POWER Resistors

Carefully crafted for matchless performance, Dalohm miniature power resistors are made to survive the most severe environmental, shock, and vibration conditions. Smallest in size, they also represent the answer to the space problem.

Dalohm RS type miniature power resistors are completely welded from terminal to terminal; silicone sealed, offering maximum resistance to abrasion, and high dielectric strength. They are 100% impervious to moisture and salt spray.

- Temperature coefficient 0.00002/deg. C
- Ranges from 0.1 Ohms to 55,000 Ohms, depending on type
- Tolerance 0.05%, 0.1%, 0.25%, 0.5%, 1%, 3% and 5%
- Manufactured in accordance to applicable JAN and MIL specifications.

DALE PRODUCTS, INC.

GLAS - GUIDE

**R. F. COMPONENTS
MADE OF
LAMINATED
GLASS CLOTH**

*Microwave Transmission Lines
Fabricated in This Manner
Offer the Following Superior
Properties:*

- NON CORROSIVE
- NON HEAT CONDUCTING
- HIGH STRENGTH TO WEIGHT RATIO
- CLOSE MECHANICAL TOLERANCES
- FINE SILVERED CONDUCTING SURFACE

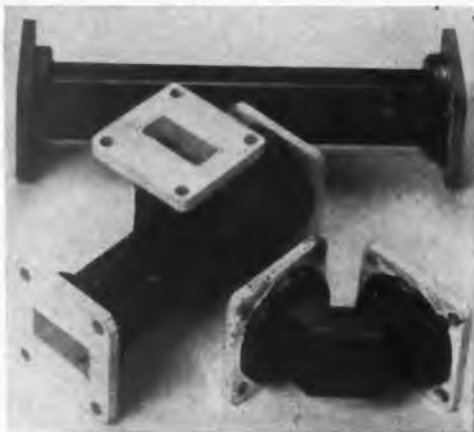

Straight sections, tees and mitered elbows are among the many components available as standard items. GLAS-GUIDE can also be made to your print.

"Don't say waveguide, say Glas-Guide"

Write today for complete data.



LEE LABORATORIES, Inc.
Genesee, Pennsylvania

Brain Mapping

(Continued from page 152)

considerable variation from one location to another, but in general have an initial positive deflection beginning about 12 msec from the onset of a sound. This represents the conduction time from the ear to the brain. Duration of the positive potential is about 10 msec and this is followed by a negative one lasting perhaps about 30 milliseconds.

Pattern Variations

There are numerous variations of this pattern present over the cortex, and their origins have not been defined. These potential characteristics are important, and a knowledge of their distribution as a function of place, frequency, intensity, and ear are important for our problem. Another aspect that we will investigate is the fact that when a potential appears in a given group of nerve cells, these nerve cells are incapable of complete response for about 10 msec, and are capable of incomplete response for about 250 msec. This is what we call a refractory or unresponsive period characteristic of nerve tissue which represents the recovery of excitability in the cells. The temporal characteristics of the refractory period must be determined for the function of place, frequency, intensity, ear, etc. The refractory period may be significant for two reasons: one, that it limits the amount of information transmitted in time; and two, it may represent a delay or memory by which information is temporarily stored for analysis purpose. Incidentally, the potential itself is a form of short memory because its duration outlasts the duration of the P pulse, particularly at high frequencies. Because of the long duration of the P pulse we sometimes see as many as three potentials from the cortex for very low frequency sounds since the duration of the refractory period is shorter than the period of the frequency of the P pulse. We consider the temporal aspects of the signals so important that we are installing a 50-channel cathode-ray oscilloscope in order to observe simultaneously activity from as many different points.

Thus far we have considered conditions from the anesthetized animals, but soon we will start recording from the unanesthetized animal in which case the amount of information in time is increased considerably as Fig. 8 indicates. Here we

find the problem of medium term memories lasting for one to two seconds and activity that occurs during the steady portions of tones. These potentials have no resemblance to the potentials that we have considered thus far, and their time course is independent of the events of the previous potentials. Under these considerations the spontaneous electrical activity of the nervous system is greater and represents noise as far as this communication channel is concerned.

At this point our mapping problem begins to look like a real universe. When we consider that we shall have 60 channels with perhaps as many as 100 measurements per channel, each record taken with 14 frequencies for each ear and each frequency taken at about 10 intensity levels, a little arithmetic will show the extent of the measurements necessary for a given experiment.

We are already up to our necks in measurements with the 10-channel instrument, but we still are not getting the maps of the parameters of the brain that are necessary for interpretation of the findings from a communication standpoint. Thus, we are turning more and more toward electronic devices for help in automatic measurements and data reduction. We are considering such devices as the Oscar as an interim device for exploratory purposes and we have already begun thinking about such electrical analyzers as auto-correlation devices and probability analyzers, since the probability of events is likely the only means of getting to the ultimate capacity of the nervous system. Even our present results involving a function of place, frequency, intensity, ear and time and amplitude of the potential would require some high power statistical analysis. Thus, we are conscious of the need of high speed computations on our data as it stands today.

WIRELESS MICROPHONE



Close-up view of wireless microphone worn by Joan Diener as shown on page 63. Note location and size of transistor circuitry and power supply battery.



STACKS OF STABILITY

Bradley rectifiers invariably exceed performance requirements, but this quality bonus does not carry a premium price. Our exclusive vacuum process not only assures stability and long life; it also assures low cost. We would like to prove it by quoting now on your rectifier needs. Please fill out the form below — you'll get quick action.

VACUUM PROCESSED — for performance as rated

BRADLEY LABORATORIES, INCORPORATED
170A COLUMBUS AVE., NEW HAVEN 11, CONN.



DC Output: Volts Min. _____ Amperes Max. _____ Circuit _____	FINISH REQUIRED: _____
AC Input: Volts Max. _____ Phase _____	QUANTITY: _____
LOAD: Res. _____ Ind. _____ Cap. _____ Battery _____	NAME _____
DUTY: Continuous _____ Intermittent _____ On _____ Off _____	ADDRESS _____
COOLING: Convection _____ Forced _____ Ft. Per Min. _____	_____
Max. Ambient Temp. _____ °C	_____



ZOOMARS
for Television

TELEVISION'S NEW HORIZONS



REFLECTAR LENSES
for Television,
Motion Picture
and Still Photography

courtesy of

ZOOMAR



ZOOMAR 16MM
for Motion Picture
Photography
and Industrial Television

ZOOMAR LENSES were aptly described in a recent article in the American Mercury Magazine and reprinted in Readers Digest (July 1954). The author refers to the use of ZOOMAR at a football game as an improvement on a 50-yard-line seat, at a baseball game as being alongside the umpire and as riding the winning horse at the Kentucky Derby. By adding zoom to television cameras ZOOMAR has truly added new life and interest to television programs.

For further information write Dept. T

ZOOMAR Glen Cove, New York

"Stacked Tubes"
(Continued from page 69)

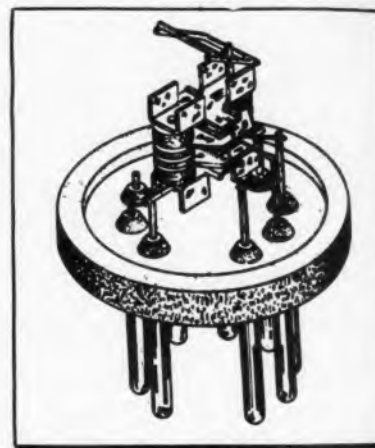

Difference in design between "stacked tube" (bottom) and conventional tube is indicated by illustration of stem and mount of each



Viewing test of new tube which functions normally at over 1000°F are (l to r) M. Ward Zimmer, Sylvania President; Don G. Mitchell, Sylvania Board Chairman; Vice Admiral John Gingrich, Chief of Naval Material; and Capt. Rawson Bennet of Navy Bureau of Ship

The ce
stronger
and the
shipped v
ramic en
rugged
temperatu

Parts of m
gether in
shown, per

removed
-195° C
water a
Tubes
cycled
to 450°

Expan

The
sion of
pected
duction
levels r
was ann

Produ

Effect
product
Lennox
Euclid
transfer
6900 W

Divisi

Radi
has an
name o
Div. to

West

Cent
Centur
chased
will no
Inc., W
sion, 1
Calif.

The ceramic envelope is much stronger than the glass envelope, and the tube can be handled and shipped without breakage. The ceramic envelope is also extremely rugged under widely fluctuating temperature conditions. It has been



Parts of new tube are stacked and riveted together in single operation on mounting jig shown, permitting automatic mass production

removed from liquid nitrogen at -195°C . and immersed in boiling water at 100°C . without fracture. Tubes have also been thermally cycled from room temperature up to 450°C . without damage.

Expand Radio Line

The radio communications division of Bendix Aviation Corp. is expected to double its car radio production in order to meet output levels required for 1955 models, it was announced recently.

Production Transferred

Effective July 15, 1954, all high production manufacturing done by Lennox Engineering Assoc., 6007 Euclid Ave., Cleveland, Ohio, was transferred to Park Products Co., 6900 Wade Park Ave., Cleveland.

Division Changes Name

Radio Receptor Co., Inc., N.Y.C., has announced the change in the name of its Seletron & Germanium Div. to "Semi-Conductor Division."

West Coast Purchase

Century Electronics, division of Century Metalcraft, has been purchased by the Kearfott Co., Inc. and will now be known as Kearfott Co., Inc., Western Manufacturing Division, 14844 Oxnard St., Van Nuys, Calif.

New WHAT'S IN SCOPE ...for RADAR?



CUBIC'S New VSWR INSTRUMENTATION SYSTEM for continuous . . . automatic . . . measurement of VSWR

The New Model 620 is CUBIC'S contribution to higher efficiency and higher economy in that new RADAR design you may be planning. Designed for field and production use—where frequent VSWR measurements of radar, and other amplitude modulated microwaves are required, it has certain important features entirely new:

- Measurement of VSWR is continuous and automatic over two calibrated ranges, covering ratios 1.02 to 1.2, and 1.2 to ∞ .
- Can be used with CUBIC'S matched directional coupler—permanently or temporarily installed in waveguide run.
- Available too as JAN AN/UPM-12 Military version.
- And available in Model 621, for VSWR measurements at signal generator levels.
- For x-band only, at present. RF components will be ready shortly for operation on S thru Ku band.

New designs make new demands. CUBIC engineers are constantly conducting research to develop new products to enable those new Electronic designs—still on the drafting boards, to become reality. In this connection, our Engineering and service departments are always at your disposal on any Electronic problem.

Write for latest edition of our catalog of microwave instruments



CUBIC
CORPORATION

ELECTRONIC EQUIPMENT
RESEARCH .. DEVELOPMENT
SAN DIEGO, 6. CALIFORNIA

THE YEARS AHEAD

... a preview of electronic things to come

— an exclusive article by Dr. A. N. Goldsmith of vital importance to the electronic industries, and the world at large!



Dr. Alfred N. Goldsmith, noted scientist, inventor, and consulting engineer. The "only" person to hold both the Founder's Medal and Medal of Honor from the Institute of Radio Engineers.

in the October issue of TELE-TECH

Twenty five years ago Dr. Alfred N. Goldsmith, the well-known scientist, gave his predictions of the growth of electronic industries in the years ahead. At that time he penned his estimate of the relative importance of the communications, sound broadcasting, sound movie, television, electronic phonograph, industrial electronics, etc. segments of the industry.

In the past 25 years we have witnessed the amazing accuracy of Doctor Goldsmith's estimates of electronic progress and how his predictions have been fulfilled.

ELECTRONIC PROGRESS IN YEARS AHEAD

Once again this famous scientist honors the publisher of TELE-TECH with exclusive predictions of future electronic developments. He cuts through the haze of imagination and guesswork and gives a realistic preview of electronic things to come. Everyone directly or indirectly connected with the electronic industries will be able to look into the future via the editorial pages of the October issue of TELE-TECH.

AN INVALUABLE REFERENCE

This amazing forecast by a scientist with a keen insight, proved accurate, may very well set the stage for future electronic planning and development. You can be certain, therefore, that this tremendous OCTOBER issue will be a much sought after reference work for many years to come.

Telesensory Communications . . .

Telegustatory Transmission . . .

Centercasting . . .

Micronization . . .

Electrobot . . .

. . . are but a few of the pioneer words describing developments anticipated in the next 25 years, in Dr. A. N. Goldsmith's exclusive article.

October issue of TELE-TECH

— Featured in the October issue of TELE-TECH & Electronic Industries

In addition to the spectacular preview of electronics progress in the years ahead, TELE-TECH's top 21,000 engineer readers will be given:

★ **A First Hand View of 10th Annual National Electronics Conference (Oct. 4-6, Chicago)**

TELE-TECH will give a complete preview of this outstanding electronic engineering event of the fall including . . . technical paper program, important events, a list of exhibitors, and additional 11th hour conference news.

★ **Compilation of Procurement Agencies**

This TELE-TECH extra (in the form of a reference insert) will list important information for all government procurement activities involving electronic equipment purchased by the military services.

An example of TELE-TECH's famous procurement data presentations

★ **Regular Monthly Editorial Coverage**

The features described above will be combined with TELE-TECH's usual permanent reference articles and broad treatment of current and timely new developments and progress in the electronic industries.

★ **Winner of All Surveys**

For the past three years, TELE-TECH has been voted the preferred technical publication in all surveys made to chief engineers in the electronic industries. Don't be misled by clock-and-dagger, nondescript surveys which are not representative of administrative and specifying engineering personnel among manufacturers.

8 independent surveys

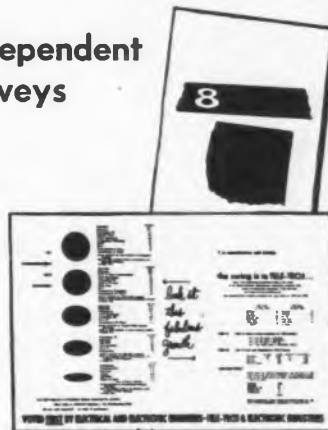

Available upon request

Make sure you are represented in this monumental OCTOBER issue which will be referred to for years to come by the 21,000 key engineer readers who make the thousands upon thousands of buying decisions for the electronic industries.

RESERVE SPACE NOW FOR THE OCTOBER ISSUE OF TELE-TECH

Write, wire, or phone for details about rates, closing date, special positions, etc.



21,000 circulation

A **BPA** member

TELE-TECH
ELECTRONIC INDUSTRIES

VICTOREEN SHOULD BE YOUR FIRST CHOICE FOR RESISTORS

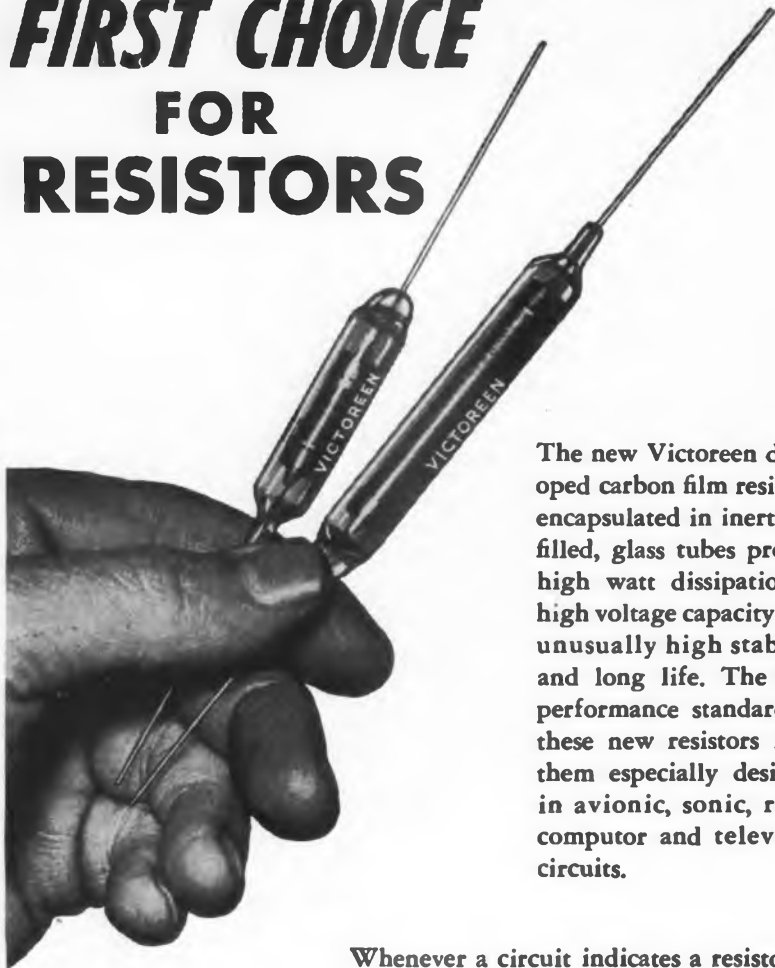

FOR YOUR REFERENCE FILE

The Victoreen catalog providing reference data on Vibrator Power Supplies, Vibrators, Hi-Meg Resistors, Voltage Regulator Tubes, Electrometer and DC Amplifier Tubes, Special Tubes, Current Regulator Tubes and Counter Tubes is available on request.

Whenever a circuit indicates a resistor for extraordinary high performance standards, specify Victoreen as your first choice for stability and long-life. From engineering, thru all manufacturing processes these resistors are made to the highest possible quality. To many manufacturers, the use of Victoreen resistors has meant the elimination of costly field failures.

VICTOREEN HI-MEG RESISTORS

Resistor elements are vacuum sealed in glass tubes, which have been processed to maintain stability under high humidity conditions and artificially aged to maintain their characteristics. Such processing assures the accuracy needed in circuit applications of very high impedance levels.

The new Victoreen developed carbon film resistors, encapsulated in inert, gas-filled, glass tubes provide high watt dissipation or high voltage capacity with unusually high stability and long life. The high performance standards of these new resistors make them especially desirable in avionic, sonic, radar, computer and television circuits.



The Victoreen Instrument Co.

COMPONENTS DIVISION: 3814 Perkins Ave. • Cleveland 14, O.

PERSONAL

Dr. Augustus B. Kinzel is the new director of research at Union Carbide and Carbon Corp., 30 E. 42nd St., N.Y. 17. Dr. Kinzel has been with Union Carbide since 1926 when he joined the company as a research metallurgist.



B. Ballou



W. McAulay

Byron Ballou and William McAulay have recently been added to the field engineering staff at the San Bruno, Calif. plant of Eitel-McCullough Inc., manufacturers of electron power tubes. Ballou has been with the Eimac research labs for the past ten years. McAulay was formerly a station engineer and transmitting engineer at NBC.

E. B. Jones has been appointed chief engineer in charge of estimating and engineering in the newly formed "Field-Erected Equipment Div." of the Lindbergh Engineering Co., 2450 W. Hubbard St., Chicago. Until recently Mr. Jones had been with Continental Industrial Engineers, Inc.



E. B. Jones



R. M. Soria

Dr. Rodolfo M. Soria has been appointed director of engineering at the American Phenolic Cpro., succeeding Richard M. Purinton, who now represents the company in the New England area.

Erwin M. Weiss has been named chief engineer in charge of instrumentation, and Michael G. Seidl, chief engineer in charge of the commercial music division, at Magnecord, Inc., Chicago.

Capacitor Leakage

(Continued from page 91)

The relationship was found to be:

$$E_o = E_\beta \frac{R_2 C_1}{\alpha^{1/2}} \left[e^{-\frac{\beta - \alpha^{1/2}}{2\gamma} t} - e^{-\frac{\beta + \alpha^{1/2}}{2\gamma} t} \right]$$

where

$$\alpha = [R_1 C_1 + R_2 (C_1 + C_2)]^2 - 4R_1 R_2 C_1 C_2$$

$$\beta = R_1 R_2 + R_2 (C_1 + C_2)$$

$$\gamma = R_1 R_2 C_1 C_2$$

to normalize

$$\text{let } C_1 = nC_2$$

$$R_1 = pR_2$$

also let $C_2 = 1$

$$R_2 = 1$$

$$\text{then } E_o = E_\beta \frac{n}{\alpha^{1/2}} \left[e^{-\frac{\beta - \alpha^{1/2}}{2\gamma} t} - e^{-\frac{\beta + \alpha^{1/2}}{2\gamma} t} \right]$$

Where $\alpha = (np + n + 1)^2 - 4np$

$$\beta = p + n + 1$$

$$\gamma = np$$

To simulate a case close to the observed results, let

$$n = .2$$

$$p = .05$$

$$E_\beta = 1.0$$

$$\text{then } E_o = E_\beta 0.168 [e^{-3t} - e^{-122t}]$$

Fig. 7 shows the plot of this result, and also the two functions of which it is the sum.

While the picture here shows close resemblance to the experimental data it would be hazardous to extrapolate the experimental information to extract accurate values for the system components.

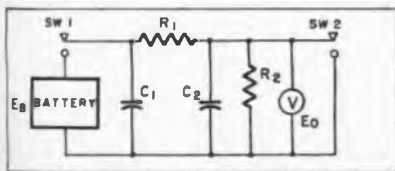

Fig. 8: Equivalent circuit for evaluating data. C_1 is working capacity; R_2 is leakage resistance; C_2 and R_1 are "soak" components

Conclusion

The method described may be an important tool for the evaluation of capacitors components, both for the user and manufacturer of such components. It may also be useful in the evaluation of dielectric materials, cable performance and be helpful by furnishing criteria of importance concerning waxes and oils. It is doubtful that fundamental measurements can be made in this manner unless the systems involved are relatively simple. The instrumentation can be relatively simple, inexpensive, and can be operated by inexperienced personnel.



Presenting the only BROADCAST MICROPHONE with "all three"—!

- Small size, slim design!
- Smooth, extended frequency response!
- World-famous, patented, Uniphase system!

THE SHURE
Concert-Line

UNIDIRECTIONAL MICROPHONE

Out of the Shure Laboratories has come a slim, small Broadcast microphone so remarkable in its over-all performance that we have given it a special name—the "Concert-Line."

The "333" is the only small, slim Broadcast microphone in the world with the world-famous, patented, Uniphase system!

The small, slim "333" provides the fine quality formerly found only in the conventional-type, large size Broadcast microphones. The Concert-Line "333" is truly an important advancement in microphone development and design.

The Unidirectional "333" is AVAILABLE NOW—in limited quantities—for the most discriminating users.

The Mark of Quality—SHURE

Model "333"
Concert-Line
Microphone
List Price
\$250.00

SHURE BROTHERS, Inc.
Manufacturers of
Microphones and
Acoustic Devices
225 West Huron Street
Chicago 10, Illinois
Cable Address: SHUREMICRO

another raypar first transformers for printed circuits

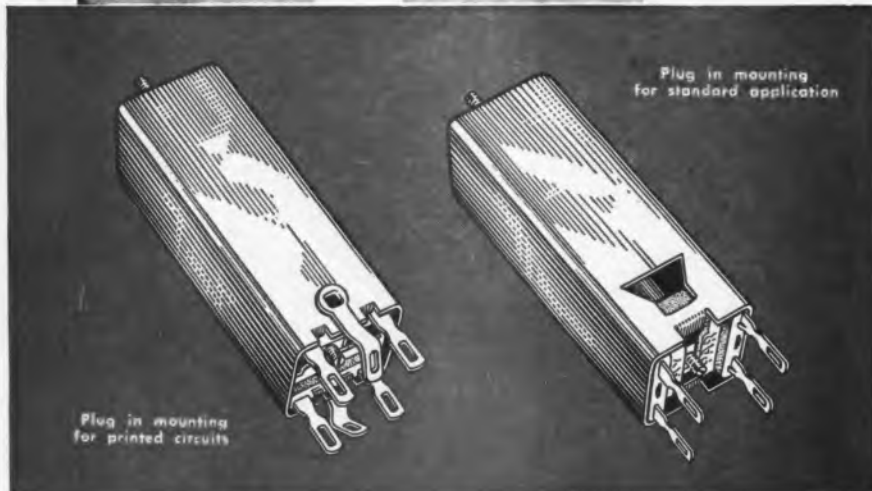

Compare these features . . .

- * Wide range of impedances to cover all applications
- * Excellent Stability & High Gain
- * Micrometer core adjustment
- * Compression moulded plastic base for auto radio and other high temperature applications
- * Individually tested and visually aligned and preset before shipping

Send us your inquiries for delivery and quotations. Request our free catalog and engineering handbook.

RAYPAR

incorporated

7800 WEST ADDISON STREET

CHICAGO 34, ILLINOIS

MAKING AMERICA'S LEADING RADIO & TV MANUFACTURERS

Barrier Transistor

(Continued from page 80)

megacycle region is well known. Surface-barrier transistors have been used in bandpass amplifiers from 5 to 55 mc. The common-base connection proves to be the most practical in this application since a high cutoff frequency is required. It is desirable to minimize interaction between stages of cascaded bandpass amplifiers to facilitate tuning and increase over-all amplifier stability. This is accomplished by using bridge neutralization.

Input Impedance

Fig. 9 shows the input impedance vs. frequency for a tuned amplifier, both neutralized and unneutralized. For the unneutralized case, a slight detuning of the output tank (or an equivalent signal-frequency shift) can cause Z_{11} to go to zero or even negative (Fig. 9B) and produce os-

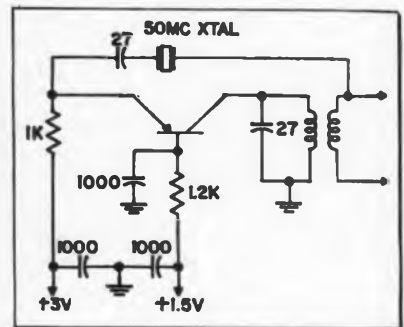

Fig. 13: Surface-barrier transistor oscillator

cillations. The input impedance of the neutralized amplifier, however, is independent of frequency and output tank resonance (Fig. 9C) since $Z_{12} = 0$.

A typical neutralized bandpass amplifier is shown in Fig. 10. The agreement between measured and predicted values of power gain, as shown in Table II, proves the utility of the π equivalent circuit.

SBT wide-band low-pass amplifiers have gains of 14 db per stage and over-all bandwidths as high as 9 mc. The common-emitter connection has proven to be the most useful configuration in directly cascading many of these stages. Each stage, having a load impedance equal to its input impedance, has a voltage gain equal to its current gain, $+a_o/1 - a_o$, and a cutoff frequency closely equal to

$$f_{ca}(1 - a_o)$$

Therefore, the voltage-gain band-

width product equals

$$\alpha_o f_{ca}$$

This is a realistic figure of merit since optimum match is not required for this application. A typical two-stage video amplifier operating between equal source and load impedances is shown in Fig. 11. With the coils short-circuited, the bandwidth was 3.2 mc and the gain was 28 db. Even though

f_{ca} was 50 mc, the stage gain-bandwidth product was only 25 mc. This discrepancy was due to losses in the interstage coupling resistances. When the effect of these losses was compensated for

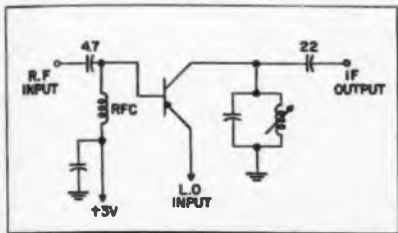

Fig. 14: Surface-barrier transistor mixer

by adding the two coils, the bandwidth doubled, giving good agreement between the theoretical and measured gain-bandwidth product.

A method of trading gain for bandwidth and vice versa would prove valuable in circuit design. Conceivably, a feedback amplifier with proper phase relationships should achieve this result. A typical two-stage feedback amplifier utilizing resistive feedback from the collector of the second stage to the emitter of the first stage is shown in Fig. 12.

TABLE II

Typical SBT Performance in Bandpass Amplifiers

Frequency (mc)	Measured Power Gain (db)	Calculated Power Gain (db)
5	20.6	23.0
28	19.0	18.3
55	12.2	13.0

Surface-barrier transistors have been operated in both LC and crystal-controlled oscillators. A 50-mc crystal-controlled oscillator delivering 400 microwatts at 25% efficiency is shown in Fig. 13. A standard LC oscillator with even better efficiency is obtained by shorting the crystal. The parameters limiting the maximum frequency of oscillation are basically the same ones governing power gain. The maximum oscillat-

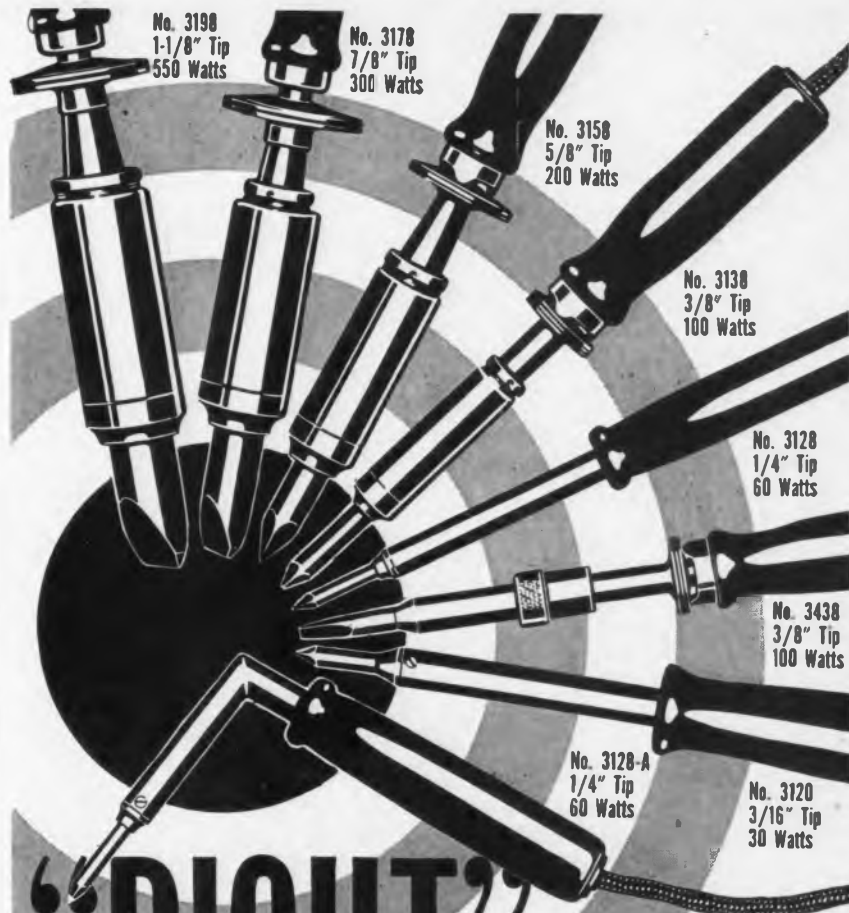

'RIGHT' AT THE TIP!

THAT'S WHERE THE HEAT IS CONCENTRATED IN ALL
American Beauty

ELECTRIC SOLDERING IRONS

. . . and that's why ANY model of American Beauty Electric Soldering Iron can be chosen with the assurance that it is absolutely **DEPENDABLE—DURABLE—EFFICIENT** . . . from tip to attachment-plug cap.

Four new models have recently been added to our line. They are No. 3120, 3/16" tip, and its companion iron (No. 3118, 1/4" tip) and No. 3438, 3/8" tip, and its companion iron (No. 3438-EP, 3/8" Eternalloy-Plated tip).

The first two are "Bantam" irons—extremely light but ruggedly-built, small-diameter tip irons designed especially for television, radio, radar and similar precision instrument soldering.

The last two are production-line irons embodying a new type of heat application with the element permanently embedded in the tip for maximum heat-conductivity from tip to the work.

Write for descriptive literature.

AMERICAN ELECTRICAL HEATER COMPANY

DETROIT 2, MICHIGAN



No. H-142

**At last!
Printed Circuit
Tube Sockets that**

**-Withstand punishing
shock and vibration**

**made of
MYCALEX® 410
glass-bonded mica**

- LOSS FACTOR .014 at 1 mc/s
- POWER FACTOR .0015 at 1 mc/s
- HIGH DIELECTRIC STRENGTH
- NO CARBONIZATION
- ZERO COLD FLOW
- IMMUNE TO FUNGUS

MYCALEX printed circuit tube sockets effectively eliminate broken or loose connections that ordinarily result from tube insertion and removal, shock and vibration. An exclusive MYCALEX contact design permits a positive mechanical attachment in conjunction with a soldered connection. The mechanical attachment safeguards against stress at all times, insures the permanence of the soldered connection between printed circuit and socket contact. Troublesome intermittent contacts, costly repairs are thus eliminated.

Application of these sockets to your printed circuit can speed production, reduce rejects, improve performance. For information call or write J. H. DuBois, Vice President-Engineering, at Clifton, N. J., address below.

NOTE: MYCALEX 410 glass bonded mica is an exclusive formulation of and manufactured only by the Mycalex Corporation of America. It meets all the requirements for Grade L-4B under Joint Army-Navy Specifications: JAN-1-10.



MYCALEX TUBE SOCKET CORPORATION

Under exclusive license of Mycalex Corporation of America,
World's largest manufacturer of glass-bonded mica products

ADDRESS INQUIRIES TO -

General Offices and Plant: 112 Clifton Blvd., Clifton, N. J.



Barrier Transistor

(Continued from page 163)

ing frequency on the basis of unity power gain, is

$$f_{max} = \sqrt{\frac{\alpha_0 f_{ca}}{25r'_b C_c}}$$

Predicted values of f_{max} are within 10% of experimental values. Maximum oscillating frequencies well in excess of 100 mc can be obtained using surface-barrier transistors.

A vital component in the transistorization of a VHF receiver is a transistor mixer. The surface-barrier transistor performs very well in this application (Fig. 14) and has a typical measured conversion gain, from 55 mc to 5 mc, of 8.6 db. The transistor performs a two-fold function. Mixing action occurs at the base-to-emitter diode, and the detected signal at the base is amplified by transistor action; thus, an amplified i-f output is developed across the collector tank circuit.

In computer applications, quick

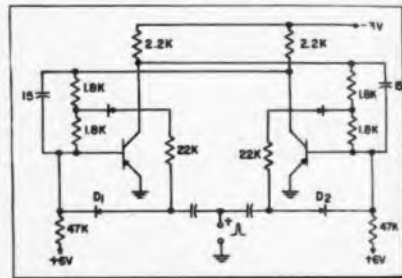

Fig. 15: Non-saturating flip-flop circuit

response is of prime importance. SBT flip-flops, requiring only a 3-v collector supply, have rise times of 0.07 μ sec and fall times of 0.15 μ sec. One of the basic computer circuits is that of a collector-coupled flip-flop employing common-emitter connected transistors. To achieve the fast rise and fall times noted above, the transistor must have a high cut-off frequency and a reasonable current gain, and the circuit must be designed to eliminate the effects of hole storage on fall time.

Flip-Flop Circuit

Embodiment of the above features in a non-saturating flip-flop circuit³ is shown in Fig. 15. Circuit performance is independent of wide variations in current gain. This is desirable and relaxes the transistor specifications. The non-saturating features of this flip-flop are obtained by the use of diodes and dividing resistors which prevent the "on" transistor from saturating. When the

collector voltage of the "on" transistor drops to approximately $-\frac{1}{2}$ v, the diode conducts and a continued rise in base current is prevented. This reduces the adverse effects of hole storage since there are less holes to be removed from the base region when the "on" transistor is triggered "off." The use of steering diodes (D_1 and D_2) allows the trigger to be a pulse or a square wave, relaxing specifications on pulse width, and provides isolation between the two sections of the flip-flop. The non-criticalness of this circuit aids the designer and should be welcomed by the manufacturer of transistors.

References

1. "The Surface-Barrier Transistor," *Proc. I.R.E.*, vol 41, pp. 1702-1720; Dec., 1953.
2. J. B. Angell and F. P. Keiper, "Circuit Applications of Surface-Barrier Transistors," *Proc. I.R.E.*, vol 41, pp 1709-1712; Dec., 1953.
3. J. Warnock, "Junction Transistor Switching Circuits," Paper given at IRE Transistor Symposium, Philadelphia, Pa., February, 1954.
4. "Philco Develops 'Surface-Barrier' Transistor," *Tele-Tech & Electronic Industries*, p. 87, Jan. 1954.

Polarized Antennas

(Continued from page 72)

frequency range from 2200 mc to the desired 2600 mc. This is accomplished by a modification of the cavity plunger, which is motor driven, sweeping the frequency from 1000 mc to 2600 mc in only 30 seconds' time. To insure that operation be conducted within only one mode throughout this frequency range, a wider range of reflector tracking voltage is required, in this instance approximately 500. Excellent tracking is obtained by mechanical cam variation of a resistance network which varies the reference voltage of a differential regulator power supply. Bias for the bolometers used for sampling incident and reflected power is reduced at the band's upper limit. This is done because the klystron's power output varies over a greater range than is acceptable by the ratio amplifier's input, even though the amplifier operates satisfactorily with as much as 15 db. input variation. In addition, an increase in output power becomes magnified by the one-hole couplers' characteristics, since their coupling factor decreases 6 db per octave.

Function Switch

The function switch shown in Fig. 5 controls the pre-set frequency cams. For VSWR measurements, these cams are rendered inoperative, and the oscillator sweeps continu-

for **MICROWAVE**...

for **TV...**

it's—

pdc

MICROWAVE

COAXIAL TRANSMISSION LINES

$\frac{7}{8}$ " 50 OHM— $1\frac{1}{4}$ " 50 OHM

Ideal for applications to 3000 mc, without regard to frequency. Furnished with RETMA flanges, which feature locating pins and anchor insulator connectors for positive concentricity between sections. Can be supplied with PDC "Air-lite" couplings for rapid, leak proof assembly in the field. Proved in use in many critical applications. More in use than all other types combined.

TOWERS

Prodelin all-aluminum guyed towers are available, in 10-foot increments, to a height of 200 feet. They can be raised or dismantled by 3 men in a half day, without special tools or footings. No wrenches, nuts or bolts required to erect towers.



ANTENNAS

Cavity-Fed Corner Reflector

All-aluminum, high gain, from 890 to 2700 mcs. Ideal for short distances, as in local "side hops." Lightweight. Low wind resistance, facilitating pole mounting. Inexpensive. (See illustration right.)

2000 MC. Horn

All-aluminum, 20 db antenna for 2000 mc microwave communication. Low cost. Replaces more expensive parabolic antennas for short-distance transmission. (See illustration left.)

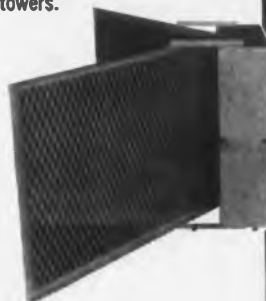

Parabolic. High gain, center and offset fed, from 890 to 2700 mcs. Spun or mesh aluminum. Superior electrical and mechanical performance. Many features incorporated as a result of years of actual experience and user case histories.

TV BROADCAST



COAXIAL TRANSMISSION LINES

51.5 and 50 ohm teflon and steatite insulated transmission lines and components provide very low attenuation, low VSWR, and flat impedance systems. Nominal 51.5 ohm lines are currently supplied in both teflon and steatite. Teflon lines are available with either RETMA flanges or PDC "Air-lite" couplings at no additional cost. $6\frac{3}{4}$ " teflon lines are supplied only with RETMA flanges; steatite insulated lines with RMA.

UHF-TV WAVEGUIDE

Prodelin is first choice in UHF-TV installations using waveguide. Prodelin pioneered in commercial TV waveguide proving exceedingly efficient over a long term of service in many installations. Special sexed flanges, which allow for expansion, permit rigid hanging direct to the tower members. This also eliminates the 24 bolts previously required and reduces installation time more than 50%.



UHF "TELEPLEXER"

The Prodelin "teleplexer" consists of a vestigial sideband filter and a diplexer. It combines the output of the aural and visual transmitters, rejecting and absorbing the unwanted portions of the signal. The resultant signal is fed to a single transmission line. The "teleplexer" is designed for inexpensive conversion to 50 KW operation.

Write for Fully Descriptive Catalog on all these Prodelin Products

Prodelin Inc

World's Finest Transmission Lines

307 BERGEN AVE. • KEARNY, N. J.

pdc



Where
**High Humidity—
 High Temperature**

are encountered, specify Sarkes Tarzian "Centre-Kooled" rectifier construction. Heavy bakelite core eliminates rectifier-to-chassis shorting. (Ask for information on the conversion Plug-In chassis.)

New replacement guide available at your distributor's.

Sarkes Tarzian "Centre-Kooled" SELENIUM RECTIFIERS

Dept. T4, 415 North College Avenue, Bloomington, Indiana
 In Canada: 700 Weston Road, Toronto 9—Tel. Murray 7535

Polarized Antennas

(Continued from page 165)

ously from 1000 to 2600 mc. The sweep may be stopped at any frequency within this range by means of a manual switch. For pattern measurements, the cams halt the sweep at predetermined frequencies at which radiation measurements are required.

Electrical details of the VSWR plotter are shown in Fig. 7, a block diagram of the system. The incident wave passes in series through two modified Sierra Electronics Model 138A coaxial directional couplers. Information supplied to the ratio amplifier could be obtained from one coupler only; however, directivity depends upon how well the arms of coupler secondary line are matched. The bolometer mounts present a VSWR of as high as 1.25:1, thus separate couplers are employed for sampling incident and reflected waves. The unused arms are dry-load terminated.

Identical Coupling

For maximum accuracy the couplers must have identical coupling characteristic and constant coupling with frequency. A small error is introduced due to variation of coupling with frequency, since the ratio amplifier is calibrated at one coupling only. This error becomes negligible if the coupling is greater than 20 db; the couplers employed have a minimum coupling of 22 db.

It is important that the coupler nearest the generator sample the incident wave, otherwise a portion of the reflected wave will appear in the incident arm. Unmatched coupling characteristics of the individual couplers leads to a direct measurement error which is a function of the coupling difference and the VSWR being measured. In this equipment, the coupling tracks to within 0.2 db, corresponding to an error of ± 0.003 in VSWR when measuring 1.10 and ± 0.07 when measuring 2:50 VSWR. Directivity of the couplers is better than 26.5 db, enabling accurate VSWR measurements to as low as 1.10.

A sample of the incident and reflected waves is detected and fed to the terminals of the ratio amplifier. The reflected component, E_r , is passed through a 5-kc bandpass filter for identification by means of frequency content. The filtered components then feed to a balanced modulator-amplifier stage. The incident component then passes

through a high gain voltage delay loop, providing acc potential to the modulator, this voltage being proportional to $1/E_1$. The modulator-amplifier output is then proportional to E_1/E_1 . Note that the ratio amplifier provides visual panel meter indication of VSWR, while a range switch enables accurate reading of VSWR from 1 to 1.3 and from 1.2 to 2.5.

Labor Shortage

(Continued from page 72)

the company's industrial relations formula.

Group term life insurance and accidental death and dismemberment insurance valued at \$2,000 is automatically provided without cost to the employee, after 90 days of employment. Similar insurance with maximum values to \$20,000 is available to employees on a contributory basis. Costs in excess of employee contributions are paid by the company. A third life-accidental death plan permits personnel with two years of service to purchase from \$2,000 to \$25,000 worth of insurance with paid-up values at low group rates.

Voluntary Insurance Plan

Outstanding is an insurance plan offered to employees on a voluntary and contributory basis which provides hospital coverage for as long as three months, maximum surgical benefits of \$300, and special accident expense up to an additional \$300. Most important, it also pays for major medical expenses resulting from either severe non-occupational accidents or prolonged illness to a maximum of \$5,000.

To show appreciation of the contributions of employees to the progress of the company and at the same time to provide a means to help them build estates for retirement, Consolidated launched an Employee Profit Sharing and Retirement program in Dec. 1952, following study of more than 200 such plans operated by other industrial and commercial organizations. Consolidated, and its subsidiaries, contribute 12% of each year's combined net profits before taxes, but not more than 15% of that year's total payroll, for all participating employees. An employee participating in the plan must contribute a minimum of 4% of his gross salary or wage with the option of increasing the amount up to a maximum

PRECISION components

tuned to tomorrow

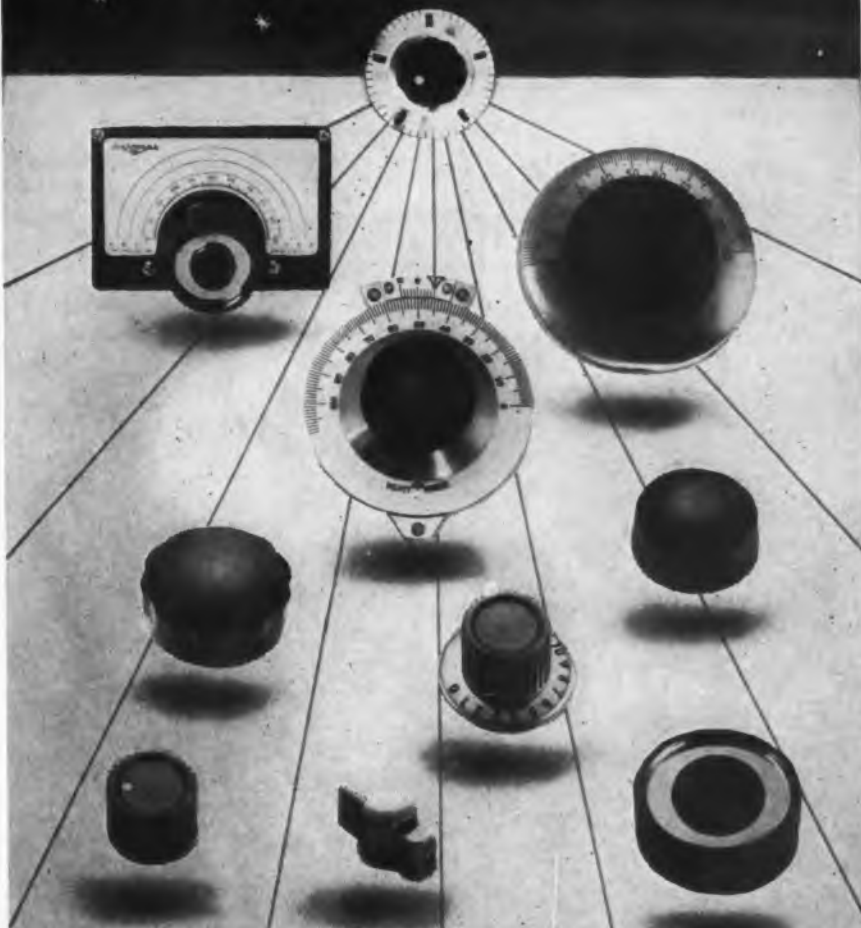

POPULAR DIALS AND KNOBS

For years, NATIONAL dials and knobs have been the popular choice of amateurs, experimenters, and commercial users.

NATIONAL dials feature smooth, velvety action, easily-read scales and quality construction. Many dials, like the N and ACN dials shown, can be specially calibrated or supplied with blank scales for commercial applications.

NATIONAL knobs — distinguished by their clean, functional, chrome and plastic styling and sturdy construction — are the most popular of their type ever produced. All fit $\frac{1}{4}$ " shafts. For commercial applications, they can be supplied in special colors and with special calibrations.

Write for new NATIONAL catalog of dials and knobs to Dept. E-854

National

NATIONAL COMPANY, INC., 6 SHERMAN ST., MALDEN 48, MASS.



TYPE 324-A VIDEO PHASE METER

This instrument of laboratory precision makes possible the rapid and accurate measurement of phase angle THROUGH THE VIDEO RANGE. It provides verification of design calculations, a criterion for optimum adjustment of delicate

phase relationships, or a maintenance

checking tool in the wide-band electronic system in modern use.



SPECIFICATIONS

- METER RANGES:** Phase angles from 0° to 360° full scale; and 90° quadrants full scale; no ambiguity.
- FREQUENCY RANGE:** 20 Kc. to 4.5 Mc. — Range down to 20 cycles may be supplied on special order.
- WAVEFORMS ACCEPTED:** Sine waves and any complex waves having not more than one positive-going zero axis crossing per cycle. Phase angle measurement is defined as phase difference between corresponding positive going zero axis crossings of the periodic signals being compared.
- AMPLITUDE RANGE:** 2 volts to 300 volts peak.
- ACCURACY:** ± 4° on quadrant scales. Incremental change of 0.25° is easily read.
- INPUT IMPEDANCE:** 10 megohms shunted by 14 mmf.
- FULL DETAILS UPON REQUEST**

TECHNOLOGY INSTRUMENT CORP.

545A MAIN ST., ACTON, MASS., COLONIAL 3-7711

West Coast Engineering Facility 731 North LaBrea Avenue, Hollywood, Calif. Telephone WHitney 0108.

Labor Shortage

(Continued from page 167.)

of 10%. Contributions are made through payroll deductions. Eligibility for plan membership is established when the employee completes a year's service and has reached the age of 21. To date, almost 88% of employees eligible joined the plan.

In the short history of the plan, company contributions of \$280,000 and employee contributions of approximately \$294,000 have been pooled in an investment trust. Returns on the investments have averaged more than 8% a year.

Consolidated believes the aesthetic side of the picture is important too. It has invested a great deal of money to provide one of the most attractively landscaped industrial settings in the country.

Consolidated is proud of the high regard with which it is held by its people. Its management is fully aware that "man lives not by bread alone"—that research, development and sound financing, vital as they are to continuing success in the highly competitive electronic industry, spell only part of a successful business operation. Much more is required to convert ideas to products. The answer lies with a company's people and how they feel about their company.

Timing System

(Continued from page 89)

telemetry system and recorded on charts, graphs, film, or magnetic tape. When a missile flight of even a few minutes has ended, a mountain of data results. In order to evaluate the operation of the missile, a scientist must evaluate this data. He must know, for instance, what happened 1 min. and 27 sec. after the launching. He must know what photographs were taken at that instant; which foot of magnetic tape contains information transmitted by devices inside of the missile via radio to the ground stations. He must know which position of certain graphs and charts covered the 1 min. and 27 sec. of the missile's flight. All this—plus the correct time of launching—is provided by signals from the dual timing Signal System control console.

One half of this system could provide all of the required signals necessary for correct operation.

However, in order to reinforce the reliability, two systems were built to give dual operation. Either of the two systems may be operated separately, but without dual reliability, to provide signals for a double launching. But, the paramount reason for a dual system is to provide as successful a launching and recording of flight data as possible. The dual system reduces the possibility of losing missile flight data because of power failure, tube failure, or even a system failure. For example, one system is connected with the local power mains at Cape Canaveral, while the other system receives its power from a public utility source. Each of the systems is synchronized with the other, to retain the highest degree of accuracy when a system switchover is necessary. The importance of such reliability is immediately evident since the cost of one missile can exceed the cost of the timing system.

Design Data

The dual timing Signal System consists of two identical electronic time base generators which are coupled together by means of the control console. Four racks of terminal equipment are located directly behind the operator to provide the signals necessary for the operation of instrumentation equipment which is located in the vicinity of the master control at Cape Canaveral. These four racks of terminal timing equipment are similar to those which are located at the downrange stations. These equipments give the operator an indication of how the output signals of the systems are functioning at the receiving end. The four racks contain terminal timing equipment for telemetering, raydist, radar, and tracking telescope systems, plus a special pulse shaper.

The basic signal of the time base generator originates from 128 kc temperature controlled crystal oscillator with a basic accuracy of one part in 10^7 . A pulse rate divider consisting of chains of flip-flops divides the basic 128 kc signal time into the pulse rates which are used by the A. F. Missile Test Center timing system. This system consists of central equipment located at island stations along the 1,000 mi. range and of terminal equipment located in or adjacent to range instrumentation equipment. The 30 output signals of the dual timing system are generated with a pulse width of 300 μ sec. with an amplitude of approximately 1 v. These signals are distributed over 250-ohm balanced lines. The outgo-



New!

**"P" TYPE
ENCAPSULATED
RESISTORS**

**Stable... Small...
Light-weight...**

Shallcross "P" Type Encapsulated Resistors are ideal for installation where stability, dependability, and minimum size and weight are a must. These radically new resistors offer the performance advantages of hermetically-sealed steatite resistors at less cost.

Because of the unique Shallcross method of encapsulating windings, "P" type resistors have greater maximum resistances, longer leakage paths, and higher wattage ratings.

Shallcross "P" type resistors are available in six MIL-R-93A lug-type styles and five axial lead styles with wattage ratings ranging from .500 to 3.5 watts. All styles meet and exceed JAN-R-93A, Characteristic A.

Complete information on sizes, ratings, and test results of Shallcross "P" type precision wirewound resistors is available in Engineering Bulletin L-30. Write for your copy today.

SHALLCROSS MANUFACTURING CO.
518 Pusey Avenue, Collingdale, Pa.

Shallcross
Our 25th Year 1929-1954

CORRECT COMBINATION

*of Size and Power Rating — offered
by Jennings Vacuum Capacitors!*

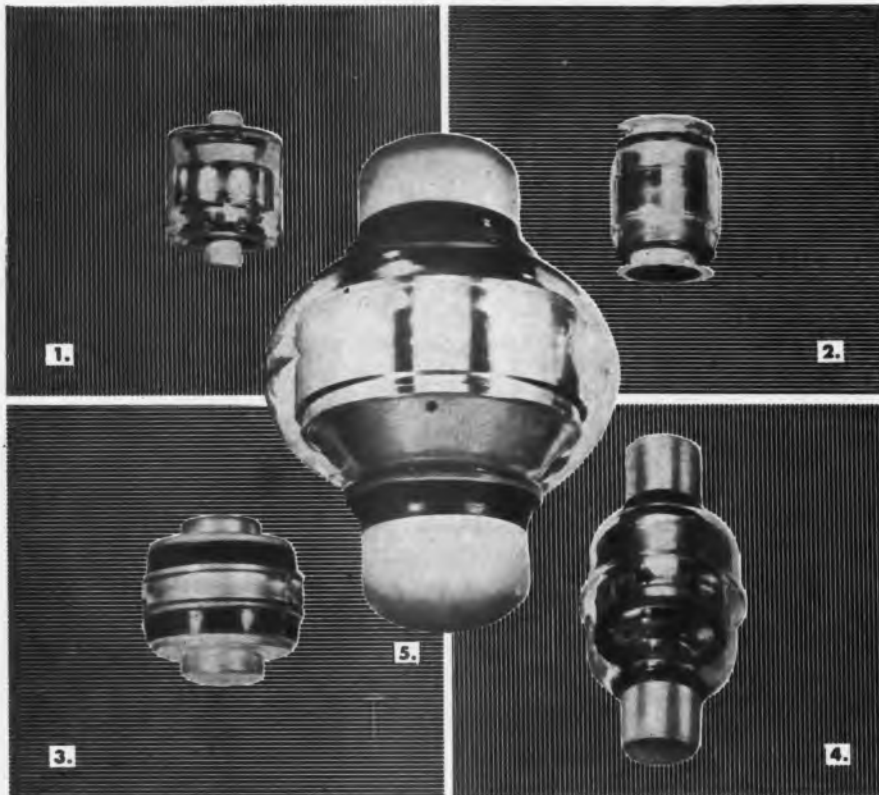

- | | |
|---|--|
| 1. JCSL 1000 mmfd.; 3 KV; 42 amps rms | 4. MC 1000 mmfd.; 10, 15, 20 KV;
120 amps rms |
| 2. JCS 1000 mmfd.; 7.5, 10, 12 KV;
42 amps rms | MLC 1000 mmfd.; 25, 30 KV;
120 amps rms |
| 3. MC-1 1000 mmfd.; 10, 15 KV;
75 amps rms | 5. MMHC 1000 mmfd.; 35, 40, 45 KV;
125 amps rms |

The wide choice of size and power ratings for a given capacity is illustrated by these five units all having capacities of 1000 mmfd. JENNINGS functional designs thus permit you to select the smallest fixed or variable vacuum capacitor that will meet your voltage and current requirements.

Send for our catalogue summary describing over 150 types and sizes of vacuum capacitors and switches.



JENNINGS RADIO MANUFACTURING CORPORATION • 970 McLAUGHLIN AVE.
P. O. BOX 1278 • SAN JOSE 8, CALIFORNIA

See us at the August Western Electronic Show and Convention, Booth No. 248.

Timing System

(Continued from page 169)

ing signals are distributed directly from the console which has controls to permit individual signal selection from the outputs of either time base generator.

The sine wave and pulse signals are available from the dual timing system in graduated steps from 1 pulse per minute to 64 kc.

The following binary "presence-absence" code signals are available: 10-digit, 20 pps readout, binary code 10-digit, 100 pps readout, binary code 10-digit, 500 pps readout, binary code 9-digit, 1 pps readout, binary code

Additional output lines are provided in the dual system in order to accommodate any special signals which may be required at the A. F. Missile Test Center.

Tube Reliability

(Continued from page 85)

kind, either on the anode or on the envelope. This is something new in the art of electron tubes at that power level and is made possible because the envelope sections and seals can take the temperature. During operation at 450 watts anode dissipation, the anode seals runs 400° C. and the ceramic itself runs 350° C. Such temperatures are well below the capabilities of both the seals and the ceramic bodies.

Also incorporated in this tube is an improved ruggedized thoriated tungsten filament developed under a Navy sponsored contract. Under shock tests this filament will withstand 380 G. compared to 125 G. for a standard thoriated tungsten filament of similar construction—an improvement of about 200%.

Fig. 6 illustrates a 20KW ceramic tetrode involving a metal anode and ceramic-to-metal seals. This shows the stem and anode structures separated prior to making the final seal, which is a heli-arc weld between metal flanges.

Klystron

As is fairly well known, we have also incorporated ceramics as R.F. windows in an improved design of klystron amplifier tube. Fig. 8 shows a series of three power klystrons covering the UHF TV frequencies. The purpose here was to provide an externally tunable klystron, while keeping the tube itself as simple as possible. The resulting simplicity

eliminates structural problems and permits outgassing and exhaust by good high vacuum techniques.

All of the above ceramic tube work has been sponsored by Eimac. Certain of this is already in factory production. Some very important work is also being carried on under the sponsorship of the Air Force. These company and government sponsored programs are thoroughly integrated so that each project gets the benefit of results accomplished under the other. The military work particularly benefits from the concurrent Eimac production experience.

Fig. 7 illustrates a ceramic version of the 2C39A, the new tube being called the 2C39B. The simplicity of the envelope in its ceramic form is noteworthy.

A very important government sponsored program at Eimac is concentrating on tube reliability in the smaller tube category. This is a long range program, and the approach to the problem constitutes a radical de-



Fig. 9: Exploded view of ceramic twin triode. When assembled, all parts are brazed solidly

parture from previous designs. Fig. 9 shows a new experimental twin-triode comparable with the 6SN7. From appearance it would be difficult to tell that it was a vacuum tube. It is of all-ceramic construction and is of flat cylindrical shape resembling a pill box. Flexible leads are provided because the inherent reliability is expected to permit soldering the tube permanently into a circuit, as one would a resistor or condenser. No socketing which invites removal is expected. Ceramic end disks comprise the anodes. Grids and cathode are separated by ceramic spacer rings, all assembled in stacked relationship in a confining ceramic envelope cylinder. The grids are made by a photographic electroforming process for accurate high speed production. The cathode button contains a packaged heater which is a structurally integral part of the unit. Since the heater is integrally formed, it cannot move or vibrate. All of the



Look here **FOR ANSWERS TO YOUR ANTENNA PROBLEMS**

Facing new antenna problems?

Find important new ideas and advanced techniques leading to the ultimate answers in Gabriel's new Facilities Report. For design . . . development . . . or production, you need this 24-page well illustrated brochure.

It is, we believe, by far the most complete in the field. A few of the projects described — typical of Gabriel experience that can help you — are:

RADAR — Design and production of search antennas; IFF parasitic antennas; conical scan for gunlaying and tracking.

MISSILES — Flush-mounted antennas for intelligence transmission; beacon antennas for tracking.

AIRCRAFT — Blade, flush mounted, and block antennas for navigational radar, Shoran, communications, and homing.

MICROWAVE RELAY — For mobile military communications, railroad, TV network, and public utilities.

SEND FOR YOUR COPY. Write on your letterhead, please, indicating antenna problem involved. Address Consulting Engineering Department.

GABRIEL ELECTRONICS DIVISION

Formerly Workshop Associates Division
THE GABRIEL COMPANY, 300 Endicott Street, Norwood, Mass.



the KEY
to your problems

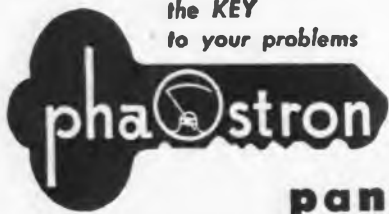







6" CUSTOM panel instruments

METAL-CASED TO INSURE THEIR CONTINUED INTEGRITY

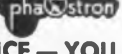

We don't recommend mounting the instrument in this position
this **FULL SIZE ILLUSTRATION**
will be better appreciated by turning the magazine

-  TIME PROVEN MOVEMENTS
-  ANTI-MAGNETIC SHIELDING
-  LARGE, EASY-TO-SEE SCALES
-  1% ACCURACY
-  MIRROR SCALES
-  PRICE — YOU CANNOT BUY BETTER

Inquiries are invited and catalogue sheets are available on this
NEW LINE of CUSTOM INSTRUMENTS which also include 2½" & 3½" sizes.

PHAOSTRON CO. • 151 PASADENA AVE. • SO. PASADENA, CALIF.

172 For product information, use inquiry card on last page.

Tube Reliability

(Continued from page 171)

parts, including the electrode supports, are brazed solidly in position. Spot welds have been eliminated.

The stacked construction was selected because it permits assembly without requiring skilled operators. It is also ideal for automatic machine assembly operations, that also being one of the objectives of our program. The stacked construction illustrated is a basic design, adaptable for a variety of tube types. Thus by eliminating the grids, one has a twin-diode. By inserting more grids we make a twin-tetrode. While a twin structure has been illustrated, it is understood that this stacked structure is adaptable for the commoner single unit tubes, such as diodes, triodes, and the like. We have laid out designs in which the disk at one end of the tube supports the cathode and the disk at the other end forms the anode, thus providing a simple diode. This basic diode may then be expanded into a triode, tetrode or pentode simply by stacking in the requisite number of grids. Certain tube parts, not unlike building blocks, are therefore common to a variety of tube types, depending upon the particular combination desired.

Exhaust

The proposed method of pumping these tubes is of interest. There is no exhaust tubulation on the tube. All parts are assembled and brazed together except one of the end wall disks. The exhaust then takes place in a vacuum chamber, while the end disk is held separated from the main body of the tube, thus providing a wide opening for withdrawal of gas. Exhaust problems associated with restricted pumping tubulations are thus avoided. As a final step, the end disk is lowered and brazed in place while the tube is still in the vacuum chamber. Many tubes can be exhausted simultaneously in this manner.

Bakeout and exhaust at high temperatures of, say, 650° C is permitted because of the absence of glass and other low melting point materials. Flash getters are eliminated. In high vacuum work one knows that such active getters are employed as a crutch for inadequate pumping procedure. Some gettering action is planned for the tube, but it is of a stable, high temperature kind earlier developed by Eimac in its power tube work.

This paper was presented at the National Conference on Airborne Electronics.

Direct Recording

(Continued from page 94)

inaudible. It appears that flutter effects will be below audibility if the RMS value of flutter components in the range from 0 to 200 cps, as measured on an unweighted basis, total less than 0.15%, provided these components are of random distribution with respect to frequency, and provided that the level of variations in the 0 to 7 cps rate area is very low compared to this total.

While the ultimate limit on signal-to-noise is imposed by tape velocity, tape characteristics, and equalization, the highest limit which may be reached at conventional audio tape speeds and current equalization practices, is from 60 to 65 db, and is imposed by the nature of the tape itself. If the uppermost frequency of the transmission is extended by increasing the velocity of the tape, and if, simultaneously, equalization practices were optimized, we would reach a point at which the tape and electronic playback noise would contribute equally to the fundamental noise level, at which point the level of hum would become the lower limit of noise in the system. Other low frequency noises, such as cathode flicker, would also be significant contributors under these circumstances.

The electronic requirements of apparatus designed to reach the limit of attainable performance in a direct magnetic recorder are severe. Appropriate equalization practices must be employed, and every conventional technique for reducing the level of hum and hiss must be used in the playback equipment. The output from the magnetic playback head, under optimum circumstances, is such that electronic circuits possessing a signal-to-noise ratio of about 65 db will be needed, the corresponding effective input noise level being about -130 dbm, which is about the limit to which noise in the electronic circuitry can be reduced at the current state of the art. The application of such expedients as dc heater supply, ceramic film resistors, and low currents through low level stages, are appropriate.

PRD Opens Chicago Office

Polytechnic Research and Development Co., Brooklyn, N. Y., has opened a new office at 1 South Northwest Highway, Park Ridge, Ill., under the direction of K. W. Meyers.

Cutting and shaping fragile crystals...



... another way the electronics industry uses

THE *S.S. White*

INDUSTRIAL "AIRBRASIVE" UNIT

The S.S. White "Airbrasive" Unit is opening up vast, new approaches in the development of improved electronic components by providing a practical solution to many of the difficult "problem-jobs" encountered in producing these parts. Cutting spiral bands on film-type resistors, cutting germanium, accurately removing deposited surface coatings, and drilling thin sections of glass and other hard, brittle materials are but a few of the difficult jobs now made practical by this highly versatile machine.

For example, exasperating difficulties had been encountered in cutting and shaping crystals for X-ray and neutron diffraction work. Ordinary cutting and grinding operations were prone to cause fracture. One laboratory applied the S.S. White "Airbrasive" Unit to this task and reported, "There is absolutely no other convenient way to do crystal-shaping for our work than by means of the Unit." The crystals are first manually cut into sections of

roughly correct size with the "Airbrasive" Unit. Then, as illustrated, the rough crystal is mounted on a standard goniometer head and oriented optically or by X-ray. The goniometer head is placed on a small lathe, and the "Airbrasive" tool is mounted on a toolholder. Fragile materials have been successfully shaped into accurate cylinders with diameters to a fraction of a mm and lengths of 1.5 to 2 cm. S.S. White engineers will be glad to conduct tests on any of your parts and will advise you as to the suitability of the "Airbrasive" Unit for your needs.

SEE IT IN ACTION

at the West Coast IRE Show
Pan Pacific Auditorium, Los Angeles
AUGUST 25-27

If you plan to attend, bring along actual work samples for an "on-the-spot" demonstration of the "Airbrasive" Unit.

BOOTH 631

WRITE FOR BULLETIN 5307 It contains complete facts and data on how the "Airbrasive" Unit operates and how it can be adapted to specific operations.

THE *S.S. White* INDUSTRIAL DIVISION
DENTAL MFG. CO.

Dept. QB, 10 East 40th St.
NEW YORK 16, N. Y.

Western District Office • Times Building, Long Beach, California

Lights! Action! Camera!



Typical Installation of B & M Spotlights in "I Love Lucy" TV Show

"Paint With Light" with

BARDWELL & McALISTER'S TV SPOTS

Engineered Television Lights



TV SPOT
Model 5000

This complete line of television spotlights was especially designed and engineered for television stage lighting. The many years of experience in the production of studio lights for stage and motion pictures was drawn upon to produce the B & M TV Spots which make possible painting with light. Painting with light is the ability to control the light source in order to emphasize the necessary highlights and all the important shadows. Only through controlled light can the scene and subject be given the desired brilliance, beauty, and third dimensional effects to produce ideal screen pictures.

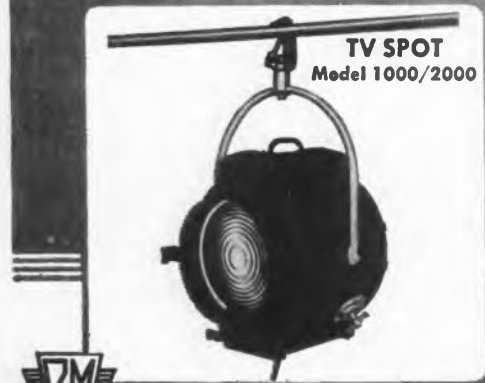

TV SPOT
Model 1000/2000



TV SPOT
Model 500/750

Our specialists are always ready to assist and advise your engineering staff so that your studios and stages will be fully equipped to properly paint with light. Write for complete specifications and prices of these B & M TV Spots.



BARDWELL & McALISTER, Inc. 2950 ONTARIO STREET
BURBANK, CALIFORNIA

Pulse Width

(Continued from page 94)

netic track. 2) Economy of tape medium is high, by reason of the efficiency of information storage already mentioned. 3) High accuracy is easily attainable, since automatic calibration of the system can readily be applied at frequent intervals, commonly resulting in accuracies of the order of 0.5% of full scale. 4) Recordings of this type are inherently insensitive to speed variations in the transport mechanism, since recalibration occurs at approximately a 30 cps rate in the usual systems of this kind. 5) The record equipment is relatively compact and efficient, permitting portable installations. 6) The signal-to-noise is relatively high, compared to FM systems, primarily because the band width for each channel is narrow.

The pulse width modulation technique is limited to narrow frequency range data, and hence limited to applications in which such frequency ranges are useful. Playback circuits for this type of recording are more complex than those for direct-recording playback.

The equipment, both mechanical and electrical, for pulse width modulation recording, may meet specifications which are comparatively loose on speed stability. The primary requirement for pulse width modulation techniques are, as for any recorder, those of compactness and reliability. The characteristics of the electronic apparatus used with this technique will determine performance specifications with regard to signal-to-noise frequency range, distortion, and accuracy. As in the FM system, precision is gained by care in design, taking advantage of those electronic techniques which result in low drift with temperature and line-voltage variations.

HIGH-SPEED PHOTOS



New framing camera, Model 222, made by Beckman & Whitley, 915 San Carlos Ave., San Carlos, Calif., produces photos at rate of 2.4 million per second. Controls include EPUT motor and variable time delay generator

Direct Pulse

(Continued from page 95)

tremely simple record circuitry is involved. 7) Comparatively simple playback circuitry is needed.

Among the disadvantages of this technique are the comparative inefficiency of information storage, especially when extremely high accuracies are required. In contrast to some non-magnetic storage techniques, the accuracy of the system may be almost indefinitely extended by extensions in the use of the recording medium, with consequent reduction in storage efficiency. Occasional errors will occur because of the nature of the tape medium (dropouts), which can in certain cases be serious. Reduction of these errors involves the use of checking apparatus, with increased complication of circuitry, and increased use of medium.

Severe Requirements

The requirements of the recorder for this method are usually severe, although if recording is to be accomplished on a continuous basis, at constant speed, the mechanical requirements are looser. In the majority of applications a special type of mechanism is required. When the apparatus is to operate on a discontinuous basis, its mechanical components must be able to handle the tape, which is usually wide, with great gentleness. Furthermore, the apparatus must start and stop this wide tape smoothly, quickly, and with a minimum of stresses. Typical of the numerous special application requirements could be a start time, from 0 to 95% of full speed, of 10 msec; tape velocities up to 100 ips have to be reached; and stopping time usually must be similar to starting time. The flutter and wow characteristics of the mechanism are of secondary importance. The electronic apparatus associated with recording digital information is comparatively simple in design, but must be made just as reliable as must the rest of the system, in relation to the application. This may involve the use of highly redundant electronic circuits, with components of great reliability and consequent high cost.

TIC in California

Technology Instrument Corp. has opened a new office at 731 N. La-Brea Ave., Hollywood 31, Calif. Joseph Looney is engineer in charge.



*A new, large size,
flat bed,
versatile
2-axis recorder...*

AUTOGRAF^{trademark} MODEL 2



Curves are available for observation and labeling while they are being drawn.

The versatility and labor-saving convenience of the original portable Autograf have now been built into an instrument which handles standard 11" x 16½" graph papers. Model 2 has the same scales and ranges as Model 1 (0-5 millivolts to 0-100 volts each axis); same speed (full scale X and Y in one second); same input impedance (200,000 ohms per volt). In addition, depressed zero available each axis, larger recording area (twice as big), flat bed, easy-reading design.



THE AUTOGRAF MODEL 1

general purpose 8½" x 11" X-Y recorder — is doing duty in hundreds of laboratory applications: chemical, electrical, electronic, wind tunnel, computer... And on production lines: measuring motors, filters, tubes, transistors, airfoils, amplifiers, rectifiers, magnetic circuits and materials, nuclear devices, etc. . . .

BOTH AUTOGRAF

MODELS ARE OUTSTANDING

FOR THEIR VERSATILITY

NEW MODEL 20 SERIES

DC VOLTMETER



**AUTOGRAF
CURVE FOLLOWER**
plots or reads out Y vs. X. Either Model 1 or Model 2 can be furnished as a recorder/curve follower.



**AUTOGRAF
POINT PLOTTER**
Models 1 and 2 may be fitted for point plotting from keyboard or other digital sources.

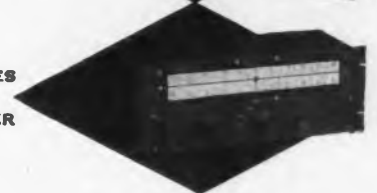

A new high accuracy, easy-to-read, multi-range servo-voltmeter with fast response. Scales 0-3 millivolts to 0-300 volts. Zero left or zero center. Designed for indication, control, or analog to digital conversion.

Bulletins describing these instruments are available, and we will be glad to send you the ones you want. Write...

F. L. MOSELEY CO., 509 NORTH FAIR OAKS AVENUE, PASADENA 3, CALIFORNIA

BLOCK UNITIZED PULSE INSTRUMENTS

- EACH INSTRUMENT COMPLETE—AND EXPANDABLE. UNITS MAY BE ADDED TO EXTEND RANGE AND APPLICATION.

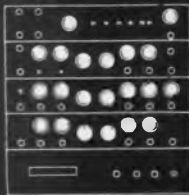

USE INDIVIDUALLY
OR IN MULTIPLE
COMBINATIONS

FUNCTION CHANGE EFFECTED BY SIMPLE SWITCH OF REAR PLUG-IN CABLE

PULSE GENERATOR

Model 2120A

- Internal sync. pulse source (10 cps to 100 KC)
- Variable main pulse delay (0 to 10,000 μ s)
- Variable width main pulse (.1 to 1,000 μ s)
- .02 μ s rise time main pulse
- Accurate, high resolution controls

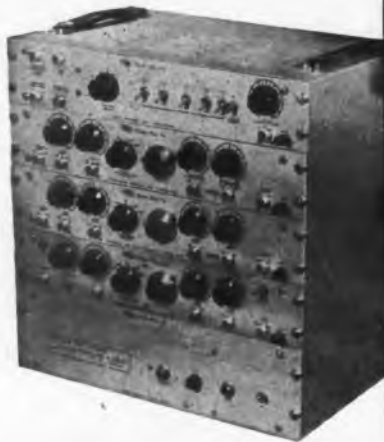

See our Complete Display and Demonstrations at the WESCON Show—Booth No. 631

Write for complete specifications: our Bulletin No. 2100-1/A and the Name of Our Representative in your area.



Electro-Pulse, Inc.

11811 MAJOR STREET, CULVER CITY, CALIF.

EXbrook 8-6764



1



2



3

- 1 **Glasseal hermetically sealed sub-miniature paper tubulars. Manufactured to the highest commercial standards and engineered to the exacting performance requirements of Military Specification MIL-C-25-A.**
- 2 **Oil paper capacitors of finest possible commercial quality, meeting MIL-C-25A and Jan-C-25 standards of precision.**
- 3 **Electrolytics of superior commercial performance characteristics, meeting Jan-C-62.**

Write for Catalog J-8 for further detailed information. Or call your local Pyramid Sales Representative or write to:

PYRAMID ELECTRIC COMPANY

Dept. 123, 1445 North Hudson Blvd., North Bergen, New Jersey

FM Recording

(Continued from page 95)

through" does not occur. The wave lengths recorded routinely with the FM technique are comparable to the thickness of the tape itself, effectively eliminating the occurrence of "print-through." Moreover, FM systems are highly selective to higher amplitude signals, further reducing the effectiveness of such "print-through," even if it should occur; 6) FM systems are characterized by the absence of "modulation noise" or "noise behind the signal." This effect is produced in direct recorders by AM components which are the result of flutter, and variations in tape roughness.

High Costs

The disadvantageous aspects of FM recording are almost entirely associated with cost. The circuitry, both record and playback, is somewhat more complex than that for direct magnetic recording. The signal-to-noise ratio of any FM magnetic recorder is limited by the motional stability of the tape transport, since wow and flutter are equivalent to FM so far as the carrier is concerned, and therefore constitute modulation, producing output in the form of noise. Thus flutter and wow in the tape transport mechanism are represented directly as noise in recorders of this type. In comparison with direct recording, tape economy is poor when compared on an information basis, since the upper frequency limit of FM systems is approximately 20% of that possible with direct recording at similar velocities. This is because the upper frequency recorded on the tape as information may ordinarily not exceed 20% of the carrier frequency. However, since recording is possible essentially down to 0 cycles, the number of octaves of information which may be recorded on FM systems approaches infinity.

The requirements imposed upon the mechanical and electronic components of the system in order to exploit the advantages of this type of recording include the reduction of speed variations in the transport mechanism to very low limits. For example, it is necessary to limit flutter and wow to approximately 0.2% rms throughout the entire pass band of the recorder in order to reach a signal-to-noise ratio of 46 db. This is, of course, a much more severe limitation than that which is imposed upon the direct recorder

of audio saturated
ments mu
carriers o
flutter re
more stri
rower pe
permissib
the usual
carrier fr
ditions th
about se
with, for
standard.
get an o
channel
speed va
transport
be limite
peak-to-
flutter is
respond
flutter-m
accuracie
tape is
precision
With a
the mech
essary to
formance
use FM
ings wh
capabilit
and wh
be restr
the asso
tional i
this, is
track s
permits
record
nate pe
further
noise du
The e
of the
netic re
ac and
require
ers, dri
stabilize
filamen
with sn

Leslie F.
Certificat
accepted
Mittou's
Similar
well and
of TELE-

TELE-TE

of audio material. With a single saturated carrier the above requirements must be met. With multiple carriers on one track, however, the flutter requirements become still more stringent since a much narrower peak frequency deviation is permissible. Using R.D.B. standards the usual deviation is $7\frac{1}{2}\%$ of the carrier frequency. Under such conditions the effect of the flutter is about seven times greater than with, for example, a 50% deviation standard. Under such conditions, to get an overall accuracy through a channel of the system of 1%, the speed variations due to the recorder transport mechanism would have to be limited to approximately 0.1% peak-to-peak. If we assume that the flutter is sinusoidal, this would correspond to 0.035% on the usual RMS flutter-measuring standard. Such accuracies can be obtained when the tape is handled with the greatest precision.

With a machine which embodies the mechanical characteristics necessary to reach this degree of performance, the possibility is open to use FM systems for audio recordings whose ultimate signal-to-noise capability might be as high as 80 db, and whose frequency range would be restricted only by the design of the associated amplification. Additional improvement, even beyond this, is conceivable with multiple track systems, whose multiplicity permits flutter compensation and record track redundancy to eliminate pops from "dropouts," and further to reduce the background noise due to flutter.

The electronic apparatus for any of the various FM forms of magnetic recording must have excellent ac and dc drift characteristics. This requires feedback type ac amplifiers, drift-compensated dc amplifiers, stabilized dc supplies, regulated filament supplies, and components with small temperature coefficients.

RETMA AWARDS



Ledlie F. Muter (l), RETMA treasurer, presents Certificate of Award to A. V. Loughren, who accepted for all members of NTSC, for Committee's work in developing color TV standards. Similar awards were made to Dr. O. H. Caldwell and Dr. A. F. Murray of the editorial staff of TELE-TECH & ELECTRONICS INDUSTRIES.

ARE YOU READY FOR THE 45'S?

Newest Fairchild Turntable gives exact timing at all 3 speeds

If the recent decision of the Record Industry to standardize disc jockey releases at 45 rpm makes your present equipment inadequate, you need the Fairchild 530 Transcription Turntable.

Exact timing of all transcribed program material for radio and television applications is assured. The Fairchild 530 reaches stable speed quickly without overshoot... completely eliminates rumble or noise caused by vibration.



IMPORTANT

The drive used in the Fairchild 530 is also available in kit form, permitting easy conversion of your present equipment to 3-speed operation.

WRITE FOR ADDITIONAL INFORMATION TODAY!

FAIRCHILD RECORDING EQUIPMENT

154th STREET AND 6th AVENUE, WHITESTONE, N. Y.

There is Always One Leader in Every Field

BODNAR INDUSTRIES, Inc.

leads in the field of

TRANSILLUMINATED PLASTIC LIGHTING PLATES

**BECAUSE OF Quality • Uniformity • Performance
Design & Layout "Know-How Service"
Quantity Production Promptly**

NEW YORK—19 Railroad Ave., New Rochelle (Home Office)
CALIFORNIA—4440 Lankershim Blvd., P.O. Box 264, North Hollywood
CANADA—44 Wellington Street, East, Toronto

VISIT WITH US AT WESCON—BOOTH 1211

CO-AX

4 mf/ft

ULTRA LOW capacitance & attenuation

WE ARE SPECIALLY ORGANIZED TO HANDLE DIRECT ORDERS OR ENQUIRIES FROM OVERSEAS SPOT DELIVERIES FOR U.S. BILLED IN DOLLARS—SETTLEMENT BY YOUR CHECK CABLE OR AIRMAIL TODAY

TYPE	µF/ft	IMPED. Ω	O.D.
C1	7.3	150	.36"
C11	6.3	173	.36"
C2	6.3	171	.44"
C22	5.5	184	.44"
C3	5.4	197	.64"
C33	4.8	220	.64"
C4	4.6	229	1.03"
C44	4.1	252	1.03"

TRANS RADIO

NEW MX and SM SUBMINIATURE CONNECTORS
Constant 50Ω 63Ω 70Ω impedances

TRANSRADIO LTD. 138A Cromwell Rd. London SW7 ENGLAND CABLES: TRANSRAD, LONDON

For easier-to-tie knots that will not slip!



HEMINWAY & BARTLETT

Fungus-Proof

NYLON

LACING CORDS and

FLAT BRAIDED TAPES

- Revolutionary synthetic resin coating prevents knots from slipping.
 - Laces faster and tighter with less effort. Unique "plastic memory" actually causes lacing to tighten itself after knot is made!
 - Its greater strength means minimum breakage — minimum rejects.
 - The synthetic resin coating retains the desirable malleability of wax and yet has a melting point of over 190°F. It is non-toxic to humans.
 - Complies with ALL construction and fungus-proof requirements of Govt. Spec Jan-T-713 and Jan-T-152.
- Cords and tapes are also available with wax finish.*

For FREE SAMPLES and prices write:

The Heminway & Bartlett Mfg. Co., ELECTRONICS DIVISION, 500 Fifth Ave., New York 36, New York
Sales Offices: Chicago, Philadelphia, Boston, St. Louis, Cincinnati, San Francisco, Los Angeles, Charlotte, N.C., Gloversville, N.Y. Foreign Agent: Turner, Halsey Co., Inc., 40 Worth St., New York. Cable Address: THECOTEX

Antenna Coupler

(Continued from page 88)

the unit and contains all components in the coupling circuit, including the following major items: (See Fig. 5)

(1) a section of the main coaxial transmission line, cut away lengthwise so as to expose the inner conductor;

(2) a coupling element or stub, adjustable to a quarter wavelength at any frequency in the operating band;

(3) a movable platform which supports the stub and carries it parallel to the cutaway section of line;

(4) a contact spring and an apron extension of the cutaway outer conductor to provide a sliding contact between the platform and the main line;

(5) a coaxial transmitter-receiver feed line consisting of two telescoping sections to permit motion of the platform; and

(6) part of the drive mechanism and a counter-balancing spring assembly.

The ends of the cutaway section of main line are provided with elbow fittings so as to bring the line out through the sides of the unit. At the lower left side of unit No. 1, (numbering from left to right) in the coupler system, the elbow is fitted with a shorting bar which short-circuits the main transmission line. All the other main-line elbows in the system have alternating plug and receptacle-type fittings which plug together when the units are arranged into a group so that the line is continuous from the short circuit to the antenna (see Fig. 3).

Coupling Stub

The quarter-wave coupling stub consists of two telescoping sections of tubing with the outer member secured to the platform by a short post. A "finger" spring located at one end of the stationary part provides electrical contact between the two sections. The mounting post projects at right angles to the coupler, and thus serves not only to secure the coupler to the platform but also to space the coupler the proper distance above the platform and to hold the coupler parallel to the main line. Furthermore, this post provides an r-f ground for the coupler and a point of attachment for the feed-line inner conductor. The movable portion of the coupler is driven by a lead screw which in turn is driven by a train of bevel gears and

shafts passing down through the ground post and the platform to a pinion gear. The latter is driven by a pinion rod which extends over the length of the platform travel, thus providing a means for driving the coupler regardless of the position of the platform in the r-f coupling section.

The platform is supported by four rollers which engage with a pair of guide rails. It is capable of moving 20 in., or approximately 0.4 wavelength at 230 mc. Thus the coupler or coupling point in any unit in the system can be shifted by this amount with respect to the short circuit on the main line. The platform serves as a ground for r-f in the coupling circuit and hence must make positive electrical contact with the outer conductor of the cutaway line. The motion of the platform requires this to be a sliding contact, which is provided by a spring secured to the platform and bearing against an apron extension of the main-line outer conductor. The spring is specially designed to produce sufficient contact pressure on the apron to give a low-resistance contact but not overload the automatic drive mechanism.

Platform-Drive

The platform-drive mechanism consists of a system of bevel gears, shafts, sprockets, and a chain. The platform and stub main-drive shafts are coupled to the tuning section mechanism by means of multi-jaw couplings so that the drive assembly can be readily disengaged from the r-f coupling section assembly.

Since one end of the feedline is attached to the movable platform, the length of this line must be variable. This line is therefore made up of two telescoping sections of coaxial line having a characteristic impedance of approximately 50 ohms to match the other lines in the system. The inner conductor of the feed line attaches to the supporting post on the stub at a point $\frac{1}{32}$ -in. above the platform. This feed-point dimension which was arrived at experimentally presents a resistive load of 50 ohms at the input terminal of the feed line when the coupler is properly tuned to an operation frequency.

The counterbalancing spring is added to assist the tuning section in lifting the mass of the platform against the gravitational force and against friction in the sliding contacts. It is of the flat spiral type which is wound up for energy storage when the platform descends in the r-f coupling section. The energy stored is used during the first

NOW...

A SUPER LINE OF ACCESSORIES THAT SURPASS ACCEPTED STANDARDS—for STUDIO, MOBILE and MICRO-RELAY EQUIPMENT

Famous BALANCED TV Head supporting a TV camera. Both are mounted on one of our all-metal tripods, which in turn is mounted on a Coco Spider Dolly. Here is a "team" outstanding for versatility and maneuverability in studio or on location.



New Model C BALANCED TV Head provides correct center of gravity in a FLASH—without groping.



No matter what focal length lens is used on the turret, the camera may be balanced by the positioning handle without loosening the camera tie-down screw. Something every cameraman has always desired.

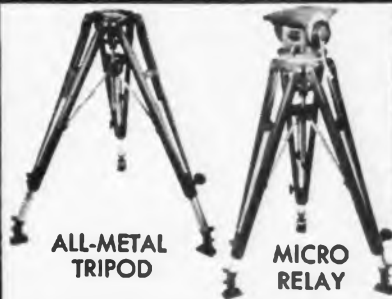

ALL-METAL TRIPOD

MICRO RELAY

Micro wave relay beam reflector head, also metal tripod. Head is perfect for parabolas up to 6 ft. diameter, withstands torque spec's environmental treated. Tripod legs work in unison, one lock knob, spurs and rubber foot pads included.

ROOFTOP CLAMPS

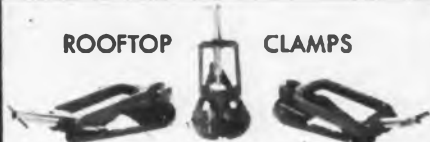

Secures tripod of camera or beam reflector to car top. Made of bronze and brass, with ball-type, yoke-swivel construction. A lot depends on roof clamps—that's why these are made with EXTRA care.



Similar to BALANCED TV head but much lighter in weight (only 20 lbs.), this new Professional Junior Spring head is ideal for Vidicon cameras weighing up to 25 lbs. Spring head tilt assures camera will return to neutral position when lever is in unlocked position... a wonderful safety factor.



MINI-PRO New lightweight all-metal MINI-PRO Tripod fulfills a tremendous need—especially for Vidicon cameras weighing up to 8 lbs. Low height measures 33" and maximum height 57". Reversible spur and rubber cushions. Maximum leg spread 35°.



NEW PORTABLE 3-WHEEL COLLAPSIBLE DOLLY

Dolly folds to fit into carrying case—18"x12"x36". Weighs only 60 lbs. Has wheel in rear for steering, which may be locked for straight dollying.

DOLLY COLLAPSED

FRANK C. ZUCKER
CAMERA EQUIPMENT CO.

DEPT. T-8-13 1600 BROADWAY • NEW YORK CITY

Are you using the TELE-TECH & Electronic Industries DIRECTORY?

... an important where-to-buy source book including ...

- complete listing of electronic products
- up-to-date list of manufacturers
- exclusive new Localizer Index
- extensive listing of trade names
- directory of electronic distributors
- directory of representatives ("Reps")
- TV-electronic consulting engineers
- TV-radio-electronic engineering societies
- complete finding index (alphabetical)



Caldwell-Clements, Inc.

480 Lexington Ave.,
New York 17, N. Y.

Telephone: Plaza 9-7880

Close
Tolerance
is
Standard
Tolerance

with **EFCON**[®]

MINIATURE PLASTIC FILM CAPACITORS

The new EFCON[®] plastic Film Capacitor, Type MH, is produced with tolerances of $\pm 5\%$, $\pm 2\%$ and $\pm 1\%$ in standard production! High stability without derating. DuPont's "Mylar"[®] polyester film with low dielectric absorption. Leads soldered directly to foil.

Hermetically sealed in metal cases.

Also available: Type MC—"Mylar" polyester film capacitor in wax impregnated cardboard tubes; Type S—Molded silvered mica capacitor.

Write Dept. G for informative brochure.

ELECTRONIC FABRICATORS, INC.

682 Broadway, New York 12, N. Y.

[®] DuPont Trademark

X-Y PLOTTER AND RECORDER



LIBRASCOPE, INCORPORATED

RECORDS TWO INDEPENDENT VARIABLES FROM ANALOG OR DIGITAL INPUTS

A compact, desk-size unit designed for general purpose graphic recording from analog or digital inputs with standard Librascope converters or special modifications engineered to customer requirements. Unique pen travel, fast and dependable. Full chart visibility allowing curve generation to be observed at all times. Write for detailed catalog information.

Mechanical and electrical analog computers, digital computers, input-output devices and components.

Computers and Controls

LIBRASCOPE

A DIVISION OF GENERAL PAPER PRODUCTS CORPORATION
1607 FLOWER ST., GLENDALE, CALIF.

Antenna Coupler

(Continued from page 179)

half of a tuning cycle when the platform travels to the upper end or "home" position in the r-f coupling section. Also it adds support to the platform when at rest either in the automatic or manual coupler.

Reflectometer

A schematic diagram of the reflectometer is shown in Fig. 6. This device, located in the feedline between the input terminal and the telescoping section, is a detector or directional coupler which, when properly oriented in its mounting, will pick up and rectify the wave reflected from the coupling circuit back toward the transmitter, the rectified dc being shown on a microammeter. When the coupler is energized at some operating frequency and the reflectometer output meter reads zero, then there is no reflected wave and the coupler is properly tuned and presents a 50-ohm resistive load to the transmitter.

The pickup loop couples to the inner conductor of the feed line. The plane of this U-shaped loop is normally parallel to the axis of the feed line, one end being connected to ground through resistor R700 while the other connects to crystal detector CR701 and thence through current-limiting resistor R704 to dc microammeter M701 and to ground. Capacitor C702 is an r-f by-pass for meter M701. Capacitor C701 is a small capacitance which adds to the capacitance between inductance L701 and the inner conductor of the transmission line to provide the correct amount of capacitive coupling.

The voltage applied to the detector is the vector sum of the components due to inductive and to capacitive coupling. R703 controls the relative magnitudes of these two components. As the angle which the loop makes with the axis of the line changes, the amplitude of the inductive component varies from zero to a maximum while the capacitive component remains constant. The phase of the inductive component is reversed by rotating the loop through 180°. Therefore, at some orientation of the loop the currents due to the two components will cancel, provided that resistor R703 is the correct value. Cancellation occurs when there is no reflected wave on the line if the following conditions are satisfied:

(1) The capacitive coupling

very small.

(2) The inductance of the loop be negligible compared with resistance R703.

(3) Resistance R703 be noninductive.

Under these conditions cancellation is independent of frequency. Thus, when the loop is oriented to pick up the reflected wave on the line and when the coupling-circuit impedance in the coupler is adjusted to match the 50-ohm feed line, then there is no reflected wave and the meter M701 will read zero.

Automatic Tuning Section

The drive mechanism for the (CU-255/UR) automatic coupler, which permits either manual or automatic tuning of the two variable elements (coupler and line tuning), is an electrically-controlled mechanical-drive system designed to work primarily in conjunction with the Model TDZ transmitting equipment. Automatic tuning of the coupler to ten preset channels is obtained merely by dialing the desired channel number on the TDZ transmitter. In this drive system the same type of autotune mechanisms and electrical components and the same circuit arrangement are used as in the master automatic-tuning-control system in the TDZ transmitter and many other common communications equipments. Hence the same power-supply and control voltages are required (115 volts ac and 48 volts dc). Both of these voltages are available in the transmitter and thus no auxiliary power is needed.

The drive mechanism for the CU-332A/UR coupler provides two hand cranks for coupler and line tuning and must be reset manually each time the operating frequency is changed.

Signal Generator

(Continued from page 93)

Capacity of the input to the first filter section appears as a low impedance at the higher frequencies of the desired mode, so that the terminating characteristics of the plunger are not significantly affected in this region. As a result of this arrangement, the resonator appears to the tube as a terminated transmission line at frequencies below 6,500 mc and as a shorted, tunable, high-Q transmission line resonator at frequencies above 6,500 mc.

Peripheral resonances, if they occur in or near the frequency range of the resonator and are not sup-



The Miller K-Tran I.F. Transformers are available for the following frequencies: 262 KC, 455 KC, 1500 KC, 4.5 MC and 10.7 MC.

4.5 MC transformers are for use in television receivers having an intercarrier sound channel. 10.7 MC transformers find their main application in FM receivers and tuners.

All transformers are shell core permeability tuned, thus providing a magnetic shielding of the windings and reducing the influence of the aluminum can. Stable silver mica fixed capacitors are enclosed in the low-loss terminal base.

CAT. NO.	Frequency	Use	NET PRICE
12-H1	262 KC	Input Transformer	1.50
12-H2	262 KC	Output Transformer	1.50
12-H6	262 KC	Output Transformer diode filter	1.59
12-C1	455 KC	Input Transformer	1.32
12-C2	455 KC	Output Transformer	1.32
12-C6	455 KC	Output Transformer diode filter	1.41
12-C7	455 KC	Input Transformer for Battery Radios	1.32
12-C8	455 KC	Output Transformer for Battery Radios	1.32
12-C9	455 KC	Input Transformer for AC-DC Radios	1.32
12-C10	455 KC	Output Transformer for AC-DC Radios	1.32
13-W1	1500 KC	Input Transformer	1.44
13-W2	1500 KC	Output Transformer	1.44
13-PC1	455 KC	Input I.F. Transformer For Printed Circuits	1.44
13-PC2	455 KC	Output I.F. Transformer For Printed Circuits	1.44
6203	4.5 MC	Input or Interstage Transformer	1.65
6204	4.5 MC	Discriminator Transformer	1.98
6205	4.5 MC	Ratio Detector Transformer	1.98
1463	10.7 MC	Input or Interstage Transformer	1.65
1464	10.7 MC	Discriminator Transformer	1.98
1465	10.7 MC	Ratio Detector Transformer	1.98
SUB-MINIATURE K-TRAN - Only 1/2" Square by 1 1/2" High			
10-C1	455 KC	Input Transformer	1.50
10-C2	455 KC	Output Transformer	1.50

(Available through your local distributor.)

*Manufactured under "K-TRAN" patents of Automatic Mfg. Co. *K-TRAN is registered trademark.

J. W. MILLER COMPANY

5917 South Main Street • Los Angeles 3, California

Canadian Representative: Atlas Radio Corporation, Ltd. 560 King Street, W. Toronto 28, Canada

Cunningham
ESTABLISHED 1928



crossbar

A truly superior switch for MASTER CONTROL AND MONITOR SWITCHING OF AUDIO & VIDEO CIRCUITS Also COMPUTERS • TELEMETERING TELEPHONE • DELAY LINES ETC.

Advantages

- Extreme flexibility
- Fast quiet switching
- Crosstalk down 60 Db at 10 MC
- Any group of setups may be held intact while setting up others
- Provision for spot or remote control
- Strapwiring eliminated
- Excellent HF characteristics
- Palladium contacts
- Reduced cost
- Compact design, small size
- Low operating power—2.5 watts
- Simple "package" installation



- Individual magnets at each cross-over.
- Maximum, six conductors per circuit.
- Life-tested to 100 million operations.

JAMES CUNNINGHAM, SON & CO., INC.

Dept. T-1, Rochester, New York Tel: BAKER 7240

See us at
BOOTH 751
 Western Electronics Show
 and Convention

August
25, 26, 27
 Pan Pacific Auditorium
 Los Angeles, Cal.

Microwave
 Assemblies,
 Radar
 Components,
 and Precision
 Instruments

...manufactured
 and designed to your
 specifications.

**N.R.K. MFG. &
 ENGINEERING CO.**

4601 W. ADDISON STREET,
 CHICAGO 41, ILLINOIS

Represented by **TUBERGEN ASSOCIATES**
 2232 West Eleventh St., Los Angeles 6, Cal.

plan your
 production
 with
KAHLE
 machinery

built specifically for your operation...



Industry leaders in electronics, glass, and allied fields have continuously keyed their operations to KAHLE Machines for over a quarter of a century. Your production rate, your specifications, your requirements—are "planned-in" KAHLE Machines.

Call KAHLE for
 "machines
 that think for you!"

Kahle
 ENGINEERING
 COMPANY

1314 SEVENTH STREET
 NORTH BERGEN, N. J.

Signal Generator

(Continued from page 181)

pressed, will absorb power from the resonator and will usually damp the oscillations completely. Such resonances can occur with a non-contacting type plunger because the periphery of the plunger acts with the surface of the resonator to form a type of strip transmission line which is circled back on itself.

To suppress a peripheral resonance that occurred in the gap between the plunger and the center conductor, the gap has been dielectrically loaded by means of a plastic sheath. This has the effect of lowering the frequency of the resonance to a frequency below the frequency range of the generator where it is ineffective.

Output Attenuator

A feature which is unusual for a wide-band generator in this frequency range is that the output attenuator is direct-reading and does not require correction for frequency effects. The attenuator used in the generator is a waveguide-beyond-cutoff type, a type which is unexcelled for signal generator use because of its high accuracy.

In designing such an attenuator for use over wide frequency and attenuation ranges, it is desirable that the cutoff frequency of the attenuator be approximately 10 times the highest frequency at which the attenuator is to be used. In this case, where the highest frequency used is 11 KMC, this requirement would mean that the cutoff frequency of the attenuator would have to be in excess of 100 KMC, or in physical terms about 1.6 mm in diameter. The attenuator plunger and pickup loop would thus have to be constructed to clear this small diameter. At best this would be a painstaking and consequently expensive assembly operation.

To avoid this situation, an arrangement has been used whereby the diameter of the attenuator waveguide has been increased to more practical dimensions. However, the frequency effect that is incurred by increasing the attenuator dimensions has been held to a quite acceptable value by distributing the total effect over the frequency and attenuation range of the generator.

It should be emphasized that the accuracy of the output level from the generator has a wider tolerance than 0.5 db in order to accommodate impedance mismatches arising from

connector reflections and an imperfect source impedance for the generator.

Because of the small dimensions of these waveguides as described above, the pick-up loops have been designed with a new approach. Instead of forming the pick-up loops from pieces of small wire, the construction shown in Fig. 5 has been used. The leads for the pick-up loops are attached to small glass beads located in the ends of the attenuator and monitor waveguide plungers. A recess is provided in each bead to make this connection mechanically secure. Across the radius of the bead is a raised surface of approximately the same width as the diameter of the lead secured to the bead. This raised surface is coated with a special mixture of platinum so as to have a resistance of approximately 50 ohms. The end result is that the pick-up loop has low inductance and at the same time has a resistive value of approximately the correct value to represent the 50-ohm source impedance desired for the generator. The internal VSWR of the attenuator is better than 2:1 as measured through the panel connector.

Power Monitoring System

The direct-reading power output feature is obtained by providing a reference point for the operation of the output attenuator. This reference point is obtained by sampling the power level in the resonator with a built-in power meter.

The power sample applied to the power meter and the power absorbed by the output attenuator are received by identical pick-up loops that operate in identical waveguides opening into the resonator.

The output attenuator and the power monitor attenuator are each operated by identical gear trains coupled to separate drive shafts on the front panel. The shaft from the output attenuator is coupled to a calibrated dial, while the power monitor is coupled to a concentric shaft operating a fiducial index on the periphery of the calibrated dial.

Since both attenuators are identical and since both are operated by identical gear trains, any change in the field level within the resonator will be reflected in a change in the power monitor meter. When such a change is compensated by adjusting the monitor attenuator, so as to keep a constant meter reading, the fiducial for the attenuator dial will be automatically rotated the proper amount to correct the reading of the attenuator.

(Continued on page 184)

EXCLUSIVE ADVANTAGES WITH— *Noblette and Nobleloy* METAL FILM RESISTORS

THEY ARE!—better frequency response—less inductance—initial accuracy and excellent resistance stability under adverse operating conditions. Proclaimed by many users as advantages that assure high stability performance. In the range of 1/2 watt to 5 watt they are your best buy because they possess the important qualities found only in metal film resistors. Noblette and Nobleloy are precision resistors developed from our more than a quarter century of resistor manufacturing.

NOBLELOY X & PX
1/2, 1, 2 & 5 WATT



NOBLETTE
NA15 1/2 WATT



WM WIRE WOUND RESISTORS

Composed with a minimum of .0015 inch wire that is wound automatically for true parallel winding to prevent shorting at turns. They are moisture resistant and recommended for circuits requiring very low resistance, which is not ordinarily available in the carbon style.

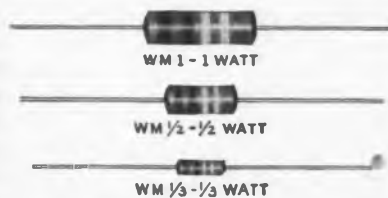

Write Today for latest catalog and prices

CONTINENTAL CARBON, INC.

13900 LORAIN AVE. CLEVELAND 11, OHIO CLEARWATER 1-6500



HARDWARE for ELECTRONICS

ONE SOURCE OF SUPPLY FOR FASTENINGS

We carry in stock thousands of STANDARD and SPECIAL items used in the ELECTRONIC INDUSTRY.

SCREWS - NUTS - WASHERS - TERMINALS - GROMMETS - RIVETS
EYELETS - ACCESSORIES.

SPECIAL Cold Headed Products - Stampings - Screw Machine Parts
Made to order in all metals.

WRITE FOR CATALOG 54

FEDERAL SCREW PRODUCTS INC.

224 W. HURON ST.

CHICAGO 10, ILL.



**Miniature,
Hermetically Sealed, Aircraft Type Relays**

Have a New, Wider Range of Performance Characteristics

If you need a small, light 4 PTD or DPDT relay to operate consistently under extremely critical or downright adverse conditions, chances are your requirements can be readily met by one of the multitude of variations possible with the basic "Diamond H" Series R relay. Originally designed to meet all requirements of USAF Spec. MIL-R-5757B, they far surpass many. For example: Various brackets of vibration resistance from 10 to 2,000 cps. plus temperature ranges from -55° to $+200^{\circ}$ C., coil resistances from 1 to 50,000 ohms, contact capacities from 350 V., D.C., 400 MA, to 10 A. at 30 V., D.C. (20 A. for reduced life). Also reliable in signal circuits. Operating time (24 V. models) 10 ms. or less; dropout less than 3 ms. Dielectric strength 450 to 1,250 V., RMS. Insulation resistance 1,000 megohms at room temperature (100 at 200° C.). Operational shock resistance 30, 40 or over 50 "G". Mechanical shock resistance to 1,000 "G". Single or two independent coils, either or both of which will operate unit. All standard mounting arrangements.

Call on "Diamond H" engineers to work with you in developing a variation to meet your specific needs.

THE HART MANUFACTURING COMPANY
218 Bartholomew Ave., Hartford, Conn.

**A Sequential Relay That
Counts, Stores or Remembers**



KELLOGG
MAGNETIC
IMPULSE
COUNTER

PROVED IN USE!

- SEQUENTIAL OPERATION**—10 operations in sequence but one relay pulse coil
- DIGITAL STORAGE**—Once read-in, stored without power but no latches
- TELEMETERING**—Counting or controlling from a distance but minimum wiring
- COMPUTERS**—Series read-in parallel read out
- STEPPING**—Replaces 2 magnet 10 point stepping switch at pulse rates up to 20 per second

WRITE FOR FREE TECHNICAL DATA TODAY, DEPT. 46-H



KELLOGG SWITCHBOARD AND SUPPLY COMPANY
A Division of International Telephone and Telegraph Corporation
SALES OFFICES: 79 West Monroe Street, Chicago 3, Illinois

Signal Generator

(Continued from page 183)

The power meter consists of a coaxial thermistor mount and d-c Wheatstone bridge of which one arm is the r-f thermistor. As the power monitor attenuator is adjusted, the amount of r-f received changes, thereby changing the resistance of the thermistor and causing a deflection on the bridge circuit.

R-F Leakage

Leakage from the resonator itself is kept 90 db below 1 milliwatt as measured with a waveguide horn held next to the resonator. R-f leakage is held to a minimum by use of waveguide-beyond-cutoff techniques and polyiron loaded plastics in the resonator housing. New techniques involving in-place casting of an epoxy resin and polyiron mixture were used to obtain this low value of leakage. The aluminum cabinet adds another 20 or 30 db of protection over and above the 90 dbm leakage.

Forced air cooling is used to keep parts from operating beyond design limits. A blower is located in the lower part of the equipment and forces part of the cool air directly onto the glass seals of the klystron. Comparative tests show glass-to-metal seal temperature near 300° C. without cooling as compared to 140° C. with cooling. Maximum recommended temperatures for seals are 160° C. The remainder of the cool air is circulated around the resonator, power transformer and tubes. A renewable air filter element is mounted at the air intake.

New Industrial Film

"Stampings for Electronics," a new full color and sound motion picture filmed for John Volkert Metal Stampings Inc. at their plant in Queens Village, N. Y., shows the many processes which go into the production of electron gum elements, tube lugs, shields, and similar metal products.

Each department—design engineering, through the final shipping—is shown making its specific contribution. The film concerns itself particularly with pointing out how precision in the tooling stages, and the designing of accurate progressive dies, can lower production costs.

The 16 mm film will be available for free showings to industrial management, technical societies and other groups.

Carrier System

(Continued from page 76)

pass and bandpass filters. The low-pass filter selects voice frequencies up to 3100 or 3400 cps depending on whether or not out-of-band signaling is used. The bandpass filter picks off signaling frequencies only (3400 and 3550 cps).

Signaling frequencies are fed to an additional amplifier which drives the discriminator and relay circuitry. Signaling frequencies are also used to control the channel unit flat gain regulator which is located between the receiving bandpass filter and the demodulator.

Operation of this regulator is briefly as follows: Because signaling is on a carrier shift basis, one of the signaling tones is always present in the output of the signaling amplifier. A portion of the signaling tone is rectified and the dc obtained is used to vary the plate current of the amplifier tube. Because the plate current of the amplifier tube flows through a thermistor located in the regulator bridge, variations in plate current cause the gain in the receiving branch of the channel unit to vary.

Transmission characteristics of the channel terminal unit meet requirements for links in the nationwide toll network. Voice frequency bandwidth is essentially flat from 250 to either 3100 or 3400 cps, at the option of the user. When the unit is connected for four-wire operation, the transmitting branch will operate from speech levels as low as -16 db (referred to the toll switchboard). Output level of the receive branch is +7 db. The flat gain regulator in the channel unit will correct for deviations in received level of approximately ± 7 db to within ± 1 db. The out-of-band signaling system will reproduce dial pulses at speeds of 7 to 20 cps with negligible distortion. Ringdown signaling can also be used.

System Regulator

An essential part of any carrier system used for open wire line applications is the equipment providing for maintaining received levels constant over a wide range of line attenuation. In the 45A system this function is accomplished by a completely electronic slope and flat gain regulating device. It corrects for changes in line attenuation, both as it affects the flat gain and the frequency response of the system.

Plug-in subassemblies adapt the

WEST COAST ELECTRONIC MANUFACTURERS and LABORATORIES DEPEND UPON.....

KIERULFF ELECTRONICS, INC.

The West's largest industrial electronic components and equipment distributor. Local stocks on these and other leading lines . . .

Ampenol
Ampex
Belden
Bud
Burgess
Cannon Electric
Centralab
Cinch-Jones, Mfg. Co.
Cornell Dubilier
Dage Electric
Erie Resistor Co.
Eveready
F.T.R.

General Electric Co.
Hammarlund Mfg. Co.
Hickok
J.B.T.
Littlefuse
Mallory
Ohmite
Potter & Brumfield
R.C.A.
Raytheon Mfg. Co.
Superior Electric Co.
Triad Transformer
Triplet Electric Co.

20 incoming trunk lines for immediate phone service.

Richmond 7-0271

ZE 0271

KIERULFF ELECTRONICS, INC.

820-30 W. Olympic Blvd.

Los Angeles 15, Calif.

IF YOU NEED IT —

Dage can make it!

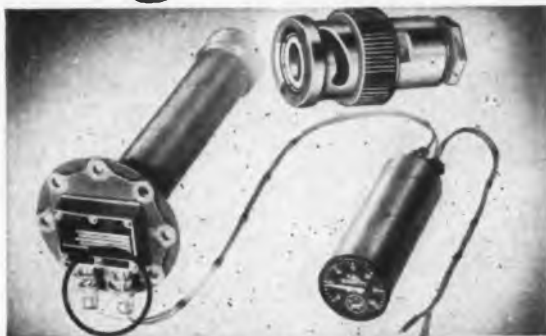

LEFT: DAGE Type BNC Connectors are used in this Avian capacitor type two unit fuel gage.



Dage CBSN-552
Snap-on BNC
Connector

Dage Radio Frequency Connectors

Your special RF Connector requirements receive special attention at DAGE . . . masters of custom design and manufacture.

DAGE makes all standard connectors, including new sub-miniatures, to precise military and commercial specifications.

DAGE invites your request for details,

Write DAGE today!



quotations, recommendations, and your order for standard or special RF Connectors.

DAGE MAKES RF CONNECTORS FOR—

Federal Telephone & Radio Corp.
The Magnavox Company
Capehart-Farnsworth Company
Radio Receptor Company, Inc.
Bendix Aviation Corp.
Motorola Inc.
Federal Telecommunication Laboratories
Boeing Airplane Company
Lavoie Laboratories, Inc.
Thompson Products, Inc.
Western Electric Company
Stamford Electronics Company
AND MANY OTHERS

DAGE ELECTRIC COMPANY, INC. • BEECH GROVE, INDIANA

Don't ANGLE for a reliable source

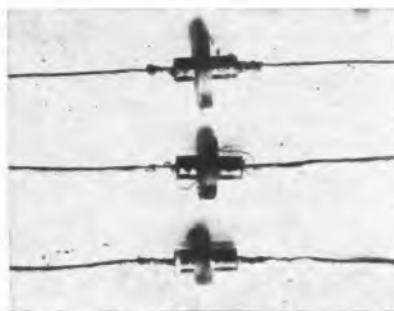

LINE UP with TEL-RAD

Quality manufacturer of Deflection Components and Coils. NEW! 90° high efficiency yokes. Let us TACKLE your parts problem. We are always ready to promptly send sample to your specifications. Our prices always reflect our favorable labor market and low overhead.

TEL-RAD MFG. CO., INC.

Radio and Television Components

7th and Madison Street, Phone: Green 270, Fennimore, Wisconsin

HUBBELL *Interlock* provides automatic locking ... low contact resistance connection for BRUNO MULTIMETERS!

meter leads cannot
disconnect accidentally!

Bruno Multimeters take advantage of Hubbell Interlock's exclusive contact and locking features. Leads lock automatically when plugged into meter — disconnect only when intended. Contact resistance is extremely low, and stays constant because of unchanging coil spring pressure. Exclusive design and nylon insulation make Interlock jacks waterproof and weatherproof.

Hubbell Interlock connectors may be put to a multiplicity of uses for both electrical and electronic devices. Our development laboratory will cooperate with your engineers to adapt Interlock for your specific applications.

For Further Information,
Write Dept. C:



HARVEY HUBBELL, Inc.
Interlock Dept., Bridgeport 2, Conn.



Meter Mfrd.
by Bruno—
New York
Industries
Corp.

Hubbell Interlock connectors, shown, are nylon insulated . . . color-coded in black and red with a terminal wire connection. The Type S connectors used in Bruno Multimeters accommodate wire sizes #14 to #18 with 15 amps. capacity.

Carrier System

(Continued from page 185)

regulator for either the 40 to 88 kc frequency range used in the West-East direction or the 100 to 150 kc frequency range used in the East-West direction. A typical regulator unit is shown in Fig. 5.

The chart in Fig. 6 indicates loss and slope conditions for various typical telephone lines. A 170-mi. line in wet weather has a loss of approximately 48 db at 100 kc and 60 db at 150 kc. Net slope is 12 db. This same line when dry has an attenuation of approximately 38 db at 100 kc and 46 db at 150 kc. The system regulator will automatically correct for loss and slope of this line for either condition with an accuracy of about 1½ db. An even more extreme condition is the case of a 33-mile telephone line in sleet country. This line when dry has a loss of approximately 7 db at 100 kc and about 9 db at 150 kc. During sleet weather with ¼ in. ice on the line, the loss rises to approximately 34 db at 100 kc and to about 60 db at 150 kc. For this extreme the regulator must make up for a maximum attenuation change of approximately 51 db and simultaneously correct for a change in slope of about 24 db. This the regulator does with an error not exceeding approximately 1½ db.

Regulator Operation

Operation of the regulator is controlled by two continuously transmitted pilot tones. These tones are located approximately at opposite ends of the frequency spectrum. In the high frequency direction, for example, the pilot which operates the flat gain corrector is at 99 kc. The pilot which operates the slope correction device is at 150 kc. The regulator samples these two pilots and from them determines the amount of attenuation and slope in the telephone line. It then compensates for this attenuation and slope so that all frequencies between the range of 99 and 150 kc passing through the regulator receive the proper amount of gain and slope correction to make them appear at equal level and at the proper system level at the output of the regulator.

A block diagram showing regulators for both directions of transmission is shown in Fig. 8. The regulator might be considered as an electronic servo-mechanism. In the West-East direction (low frequency group), all frequencies first pass through a line filter equalizer and

CHANGEABLE CHASSIS



Speed-Chassis

The Speed-Chassis is a flexible breadboard assembly with interchangeable socket arrangements which can be mounted on a relay rack. A shield can and panel are available to make successful breadboard assemblies both permanent and neat.

Two insulated tie-point strips and one grounded tie-point strip are provided, each 14" long. Individual plates are available, with holes already punched, to fit most all needs. In addition, three sizes of blank plates are cataloged.

IMMEDIATE DELIVERY



SPECIFIC PRODUCTS

14515 DICKENS STREET
SHERMAN OAKS 4, CALIF.

PILOT LIGHTS

Protect valuable equipment with

JOHNSON pilot lights . . .

Used as indicators, inexpensive pilot lights can protect your equipment from further damage should circuit failures occur. Available in a wide variety of types, JOHNSON panel indicators include continuous indication neon types, and models for high and low voltage incandescent bulbs. Standard or wide angle glass and lucite jewels available in clear, red, green, amber, blue, or opal lenses. Variations from standards, including those meeting military specifications, are available in production quantities.



For further information write for pilot light catalog.

E. F. JOHNSON COMPANY

229 2nd Ave. S. W. • Waseca, Minnesota.

5 idea starters for product improvement in Metallized Glass

In each of the components shown here, the unique properties of metallized glass have helped solve a design problem and make a better product.

A basic idea starter is the Metallized Glass Enclosure Tube. You see six of the many available sizes at the right.

You can use these tubes to hermetically enclose many kinds of components. Such enclosure gives the components performance characteristics they otherwise do not have.

Corning's metallizing process makes possible a true hermetically sealed enclosure. Components encased in metallized glass enclosures are impervious to moisture, moulds, and atmospheric changes. Assemblies complete with end caps are capable of withstanding severe temperature changes. Glass has excellent electrical characteristics, and its transparency permits visual inspection. Bond strength for metallizing used on enclosure tubes has been measured at 1500 to 2000 pounds per square inch.

These characteristics can perhaps broaden your use of some product, expand its performance limits, or reduce servicing and minimize breakdown possibilities.

Illustrated below are other applications of Corning's metallizing process. If none of them exactly meets your needs—or, if metallized glass characteristics suggest solutions to other problems, write us your requirements. Chances are, we'll be able to help you. There is no obligation.



CORNING METALLIZED GLASS INDUCTANCES are made with a precision that guarantees duplication within close limits. When used in either FM or TV circuits, you can be sure that they will contribute negligible drift even under unusual temperature changes.



METALLIZED GLASS INSTRUMENT WINDOWS are made of both tempered and untempered glass with metallized bands on the edges. They can be easily soldered into a bezel to form a hermetic seal. Available in sizes and shapes to meet your needs.



MIDGET TRIMMER CAPACITORS are available in standard types from 0.5 to 12.0 mmfds., or they can be designed to your requirements. Temperature coefficient for brass core units is approx. 200 ppm/deg. C.; for invar core units, approx. 50 ppm/deg. C.



METALLIZED BUSHINGS AND STANDOFF INSULATORS for high voltage applications. Bushings can provide hermetically sealed insulators for high voltage transformer and capacitor terminals. Standoff insulators are made of tempered low loss glass. Both can be furnished in special sizes.



CORNING GLASS WORKS, CORNING, N. Y.

New Products Division

Corning means research in Glass

Engineers! Technicians!

SeeZak®

Expandable Chassis

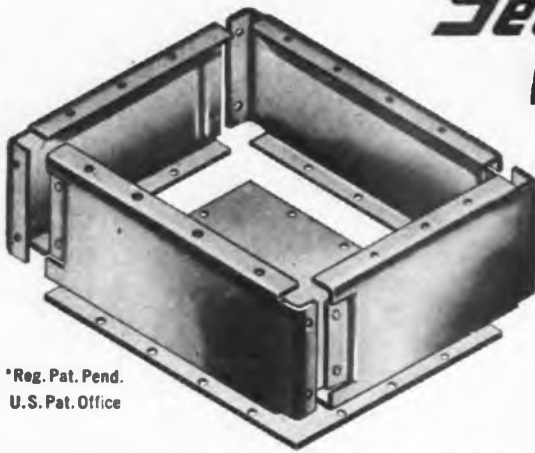

*Reg. Pat. Pend.
U.S. Pat. Office

VISIT US AT
BOOTH 803-804
WESCON SHOW

Contact your local jobber.
For a sample model chassis
write direct...

U.M. & F. Mfg. Corp. 10929-10939 VAN OWEN STREET
NORTH HOLLYWOOD, CALIFORNIA

- Professionally and technically engineered
- Actually works with you...
- For bread board problems...
- Top or bottom plate at least one gauge heavier than usual

- 315 standard chassis sizes 4" to 17" in any direction in one inch increments plus unlimited combinations
- 196 standard cabinet sizes
- Only 14 rail lengths, 2", 3" and 4" high required
- Unlimited expansion in any direction

"INDUSTRIAL" FOR ELECTRONIC COMPONENTS

Precision engineered electronic components and connecting devices for all your needs.

- Laminated Sockets
- Terminal Strips
- Wired Assemblies
- Duo-Decal Sockets
- Anode Connectors
- Terminal Board Assemblies
- Metal and Bakelite Stampings
- Tuner Strips, Sockets and Brackets for UHF

Our extensive design and production facilities are available for developing your special requirements and applications. Representatives in principal cities throughout U.S.A.



INDUSTRIAL HARDWARE Mfg. Co., Inc.
109 PRINCE STREET • NEW YORK 12, N. Y.



Write for samples and information
Dept. T-8

Carrier System

(Continued from page 186)

then through a fixed line equalizer which applies a fixed compromise slope correction. Signals then pass through an attenuator network and a feedback controlled amplifier. From there signals pass through a pair of amplifiers whose frequency characteristics can be altered by means of slope networks in their feedback paths. The circuitry up to this point could be considered the mu path of a servo system. At the output of this mu path, an amplifier with highly selective crystal pick-off filters separates the two pilot frequencies from the message frequencies, combines them, and amplifies them. Then they are again separated

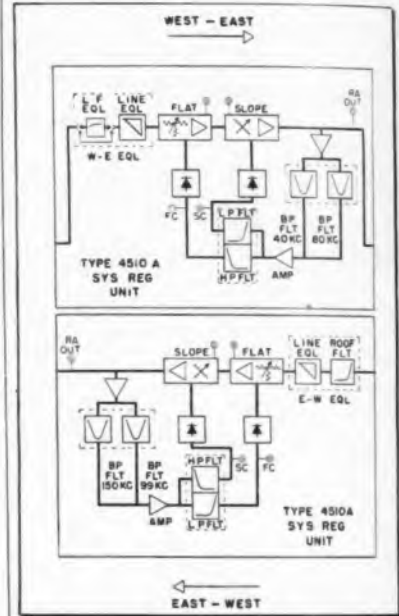

Fig. 7: Regulators for both directions of transmission operate as servos to correct for changes in frequency response and attenuation

by a pair of filters and converted to direct current. This direct current or voltage is compared to a fixed reference voltage and the differential voltage obtained is used to operate a pair of dc control tubes. In the case of the flat gain pilot, the dc control tube operates a group of thermistors in such a way as to cause the gain of the mu path to vary but without respect to frequency. The control tube operated by the slope pilot controls a pair of thermistors which are part of frequency sensitive networks placed in the feedback paths of the slope amplifiers. Variations in control current through these thermistors will cause variation in frequency characteristic of the slope amplifier and these characteristics are so arranged that the flat and

slope pilots always appear at the output of the mu path amplifiers at equal levels or approximately equal levels. Operation of the slope correcting networks is a linear function. Therefore, if the servo action of the regulator causes the slope and flat pilots to appear at equal level at its output, the mu path of the regulator has automatically assumed a slope that is the reciprocal of the slope of the telephone line. This corrects for changes in the frequency response and attenuation of the transmission line.

Frequency Generation System

The carrier frequency supply for the 45A system is contained in three interconnecting units indicated in the block diagram of Fig. 7. Two oven regulated, crystal controlled oscillators are included in one unit. Overall frequency stability of the two oscillators is in the order of magnitude of one part in 10^9 . Because all carrier frequencies used in the system are derived from these exceptionally stable oscillators, synchronization of carriers is never required.

One of the master oscillators supplies carrier voltage to the system base group modulator. A choice of four crystals is used to provide a frequency between 187 and 190 kc depending upon the allocation at which the system is to be operated. The other master oscillator provides a 96 kc signal to one pregroup modulator and to the first frequency divider network. This network divides the 96 kc down to 16, and multiplies it back up again to 64 and 80 kc, the carrier frequency used in the pregroup modulators. The 16-kc output is fed through appropriate filters both directly to one channel carrier supply and to the next frequency divider network. This network divides the 16 kc down to 4 kc, and multiplies it up again to obtain 8, 12, 20 and 24 kc, all of which are channel carrier frequencies. The dividers used are of the regenerative type and require no synchronization. Outputs of the frequency generators are extremely level and stable, and they are free from unwanted harmonics or interfering frequencies.

Conclusions

The three units described briefly here are representative of all equipment developed for 45-class carrier systems. Soundness of the development program has been demonstrated by the performance record

MAGNETIC STEEL LAMINATIONS FOR THE ELECTRONIC AND ELECTRICAL INDUSTRIES

Serving Manufacturers of

TRANSFORMERS . . . MOTORS
GENERATORS . . . REACTORS
DYNAMOTORS . . INVERTERS
CONVERTERS . . . SOLENOIDS
AND OTHER ROTARY AND
SPECIALIZED MAGNETIC
DEVICES

TEMPEL *Manufacturing Company*

1939 BRYN MAWR AVENUE
CHICAGO 26, ILL. • PHONE AR 1-8100

Remarkable performance in the

TWO-STAGE DUO-SEAL® VACUUM PUMP

Ideal for backing-up Diffusions Pumps
GUARANTEED VACUUM—0.0001 mm. (0.1 Micron)
FREE AIR CAPACITY—375 Liters Per Minute
SPEED—185 Liters Per Minute at 1 Micron Pressure

**Exceptionally
Quiet
Operation**

**Built-in Trap
prevents oil from
backing up into
system.**

**Indicator window
shows oil level at
all times.**

**Convenient oil drain
permits oil change
without dismantling
system.**

COMPACT

Size 26 x 14½
x 18½ inches



Patent No.
2337849

No. 1397-B

COMPLETE \$575.00

New Vacuum Pump catalog sent free on request. Write today.

*Manufacturers of
Scientific Instruments and
Laboratory Apparatus.* **W. M. WELCH SCIENTIFIC COMPANY**
DIVISION OF W. M. WELCH MANUFACTURING COMPANY
ESTABLISHED 1880
1515 Sedgwick St., Dept. J, Chicago 10, Illinois, U.S.A.

FORD INSTRUMENT COMPANY



PRECISION

CAMS

- offered in a variety of types
- with tolerances to $\pm 0.0005''$
- for wide range of computing and motion applications

Whatever your computing or motion application, Ford Instrument can make the cam to meet your exacting needs... 3-D Cams, grooved flat cams, external flat cams, grooved cylindrical cams. Our unique cam-producing facilities guarantee a "custom" job every time. Check us today.

WRITE FOR ILLUSTRATED CAM BROCHURE, COMPLETE DETAILS ON ALL TYPES. ADDRESS BOX TT.



FORD INSTRUMENT COMPANY

DIVISION OF THE SPERRY CORPORATION
31-10 Thomson Avenue, Long Island City 1, N.Y.



25

Carrier System

(Continued from page 189)

of dozens of 45A and 45BX carrier systems installed during the past year. In all cases, performance has met design objectives in a highly satisfactory manner. A continuing development program is underway to complete the 45-class equipment line and to further improve the utility of various electrical and mechanical equipment features.

Plant Noise

(Continued from page 73)

2. The range of levels remote from the plant shall be 40-90 db.
3. The near or plant range shall be 80-150 db.
4. Community and plant sound level readings shall be recorded at the central control point.
5. The overall frequency response of the system shall be 20-8000 CPS.
6. The microphones shall be suitable for continuous operation in all types of weather.
7. The equipment shall be installed to be capable of quick repair and replacement.

Microphone Pickup Equipment

An Altec 21BR type microphone and its associated 157A base is used. This unit, comprising the microphone and its cathode follower tube, is mounted on a pole, approximately 20 ft. high. A sharp spike is provided over this equipment to prevent birds perching on it. At the base of the pole, a weatherproof box is used to enclose the microphone power supply, line amplifier, its power supply, and the leased wire circuit termination. A supply source of 110 volts ac at 3 amperes is required.

Leased Wire Facilities

Between the remote field pickup point and the control center, leased wire circuits are used. These are 600 ohm balanced telephone lines.

Usually the largest portion of the circuit is composed of #19 gage pairs having an attenuation of 1 db per circuit mile at 1000 cycles. Small portions of the total length use smaller gage cable but this added attenuation is negligible compared to the total amount. The 1000 cycle realized equivalent attenuation varies with the square root of the

Simplifying HF Power Measurement

Model 67 TERMALINE DIRECT-READING R-F WATTMETER

30 mc to 500 mc
(to 1000 mc if specified)

50 ohms

Triple Range 0-25 watts
0-100 "
0-500 "

Type N Input Connector
(Adaptor for PL-259 supplied)

• Model 67 is a larger type Wattmeter than the well-known AN-ME-11/U (our Model 611) R-F Wattmeter. Specifically designed for fixed station transmitters to 500 watts output, it may be used nicely on low range for mobile gear. Provided with an aluminum cased, shock-mounted meter, Model 67 is as simple to use as a DC voltmeter. Now in general use throughout the industry, TERMALINE Wattmeters may be depended upon for fast, accurate and repeatable power readings



NON-RADIATING
... Accuracy - 5%

RUGGED CONSTRUCTION
... Size - 17" x 9" x 6"
Wght. - 30 pounds



BIRD ELECTRONIC CORP.

1800 EAST 38TH ST., CLEVELAND 14, OHIO
TERMALINE Coaxial Line Instruments

NEELY
ENTERPRISES
Hollywood • San Francisco
Albuquerque

EARL LIPSCOMB
ASSOCIATES
Dallas • Houston

For
& ME
Ne

JON
PLUGS

Improved S
vidual flexi
tact over
length.
Both f
mounted
ly incre
CREAS
Plug
mium
gran
Inte
Jon
An



NEED



BADA-SWEEP
Radar IF Amplif.
Alignment



MEGA-MATCH
Measurement o
Reflection Coeffici



MEGA-PULSER
Transient Testin
Video Amplifier

CON

14 MAPLE AVE

For **HIGHEST ELECTRICAL & MECHANICAL Efficiency!**

New
JONES 2400 SERIES PLUGS & SOCKETS

Improved Socket Contacts. Four individual flexing surfaces. Positive contact over practically their entire length.

Both Plug and Socket Contacts mounted in recessed pockets greatly increasing leakage distance, **INCREASING VOLTAGE RATING.**

Plug and Socket Contacts cadmium plated. Add to appearance of your equipment. Interchangeable with Jones 400 Series.

Ask for Catalog 20. Complete line Jones Plugs, Sockets, Terminal Strips.



P-2406-CCT Plug—with cable clamp in top.



S-2406-SB Socket with shallow bracket for flush mounting.

Jones

HOWARD B. JONES DIVISION
CINCH MANUFACTURING CORPORATION
CHICAGO 34, ILLINOIS
SUBSIDIARY OF UNITED-CARR FASTENER CORP.

NEED INSTRUMENTS TO SOLVE ELECTRONIC PROBLEMS?

WRITE FOR FACTS



RADA-SWEEP
Radar IF Amplifier Alignment



MARKA-SWEEP RF-P
TV Tuner Alignment



MEGA-MATCH
Measurement of Reflection Coefficient



RADA-PULSER
Radar IF Transient Testing



MEGA-PULSER
Transient Testing Video Amplifiers



CALIBRATED MEGA-SWEEP
Wide Range Sweeping Oscillator Single Dial Tuned



CONSULT THIS LATEST CATALOG FOR THESE AND NUMEROUS OTHER INSTRUMENTS

KAY ELECTRIC CO.

PINE BROOK, N. J.

14 MAPLE AVE.



FOR WEST COAST ELECTRONICS

and

PHALO Plans To Play A Current Part in this Future!

We congratulate the aggressive electronic manufacturers of the West Coast on their amazing growth over the past few years.

Phalo is confident the West Coast will continue to expand as a leading center of the electronics industry and is proud to offer the finest quality in product and service to aid in this expansion.

these

PHALO Products are Designed to Serve Electronics Leaders!

Radio — Television Wire • 300 OHM Lead
Transmission Line Cables • Microphone Cables
Intercommunicating and Public Address Cables
Indoor Aerial Wire • Rotor Cables
Cord — Cords Sets and Power Supply Cords

Phalo representatives on the West Coast are:



Plastics Corporation

21-25 Foster Street
Worcester, Massachusetts

Southern Plant —
Monticello, Mississippi

Southern California
John B. Tubergen Company
2232 West 11th Street
Los Angeles 6

Northern California
Meyer & Ross
113 10th Street
San Francisco 3

Washington, Oregon,
Idaho, Montana
Richard Legg Company
2118 S. E. Division Street
Portland 2, Oregon

For product information, use inquiry card on last page.



KINESCOPE RECORDING

with **Guaranteed Results!**
OR YOUR MONEY BACK

NOW, A DUAL-PURPOSE
AURICON
"SUPER 1200" CAMERA
with TeleVision-Transcription
"TV-T" Shutter...

...designed for Kinescope Recording...and also shoots regular Live Action 16 mm Sound-On-Film Talking Pictures with no Camera modification! The "Super 1200" Camera with "TV-T" Shutter (Pat. Appl'd. for 1949) can Kinescope Record a 30 minute continuous show using 1200 foot film magazines. Write today for information and prices.

USE AURICON "TV-T" KINESCOPIES FOR:

- ★ DELAYED RE-BROADCASTING
- ★ SPONSOR PRESENTATIONS
- ★ COMPETITION CHECKS
- ★ PILOT KINESCOPIES
- ★ SHOW-CASE FILMS
- ★ "HOT KINES"
- ★ AIR CHECKS

Auricon 16 mm Sound-On-Film Cameras are sold with a 30-day money-back guarantee. You must be satisfied!

Auricon 50 ft. Kinescope "TV-T" Demonstration Films are available on loan to TV Stations and Film Producers. Please request on your letterhead.



BERNDT-BACH, INC.

6926 Romaine St., Hollywood 38, Calif.

MANUFACTURERS OF SOUND-ON-FILM RECORDING EQUIPMENT SINCE 1931

Plant Noise

(Continued from page 190)

frequency range. The total loss or attenuation is approximately 4 db per circuit mile for an equalized circuit up to 8,000 cps.

The maximum level on the circuit before cross talk appears in adjacent circuits is plus 10 db above the 1 milliwatt reference and the input to the line should be maintained below this value.

The signal-to-noise ratio on a balanced telephone line by the selection of pairs can be as high as 75 db on cable lengths of two to three miles and not less than 50 db.

Central Plant Equipment

The output of the leased wire is terminated in jacks. Each circuit is then supplied with a line amplifier to compensate for the wire loss and provide sufficient output for the recorder, warning lamp, etc.

Selector switches are provided to:

1. Switch any microphone on monitor amplifier.
2. Switch any microphone on recorder.
3. Switch any microphone on analyzer.

In addition the warning light relay is permanently connected across each channel.

A typical installation of this system has been in operation for a period of several months and the observed drift is less than 2 db per month.

A calibration system may be provided with the use of an acoustic calibrator. This unit is placed in close proximity to the microphone and a standardized voltage applied to the unit. This gives an overall sensitivity at 400 cycles for the complete acoustical and electrical equipment.

Factors Influencing Noise

While the emphasis is on gas turbine noise, the power output of propeller driven aircraft has increased during the past several years by a factor of 50%. When the turbo prop operates above Mach No. 1, the noise adds 10-15 db at the blade frequencies and their harmonics.

Many factors are involved in the variation of the sound from aircraft and aircraft engine testing on the ground. Ingard has shown that the short range sound propagation attenuation by wind irregularities (gustiness) often is of major importance in comparison with humidity, fog and rain. The attenuation is a function of the height of the source and the receiver off the ground.

New Components for designing Electronic Equipment for RELIABILITY-IN-SERVICE

Alden Components for Plug-in Unit Construction enable you to design to these Bold New Standards —

1. Circuitry subdivided function by function into plug-in units.
2. Tiny Tell-Tales spot troubles instantly
3. Plug in replacement spares in 30 seconds
4. All leads brought to single accessible point of check, numbered and color coded so layman can make first-level tests.

It's as simple as this —

- 1 Organize your circuitry function by function in compact vertical planes using Alden Terminal Mounting Cards, Ratchet-Slot Terminals and Card-mounting Sockets.



Alden Terminal Card Mounting System — for Packages — for Chassis.

- 2 Mount the circuitry planes in Alden Plug-in Packages and Basic Chassis which can be yanked out and replaced in 30 seconds.

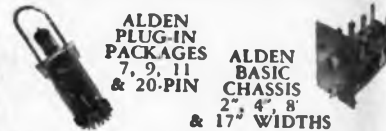

ALDEN PLUG-IN PACKAGES 7, 9, 11 & 20-PIN ALDEN BASIC CHASSIS 2", 4", 8" & 17" WIDTHS

- 3 Monitor each plug-in unit with tiny Alden Tell-Tales that spot trouble instantly, permit checks while operating, from front of panel.



ALDEN MINI-TEST POINT JACK #110BCS ALDEN MINIATURE PAN-I-LITE #86L ALDEN MINIATURE FUSE-LITE #440-4FH

- 4 Centralize unit interwiring at a single accessible point of check, with Alden Back Connectors and Serve-A-Unit Lock which allow color coding and symboling that "reads like a book".

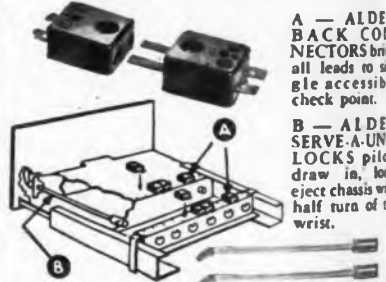

A — ALDEN BACK CONNECTORS bring all leads to single accessible check point. B — ALDEN SERVE-A-UNIT LOCKS pilot draw in, lock, eject chassis with half turn of the wrist.

ALL THIS CAN BE ACCOMPLISHED WITH STANDARD ALDEN COMPONENTS

To get details request free: "Plug-in Handbook Data"



7123 N. Main St., Brockton 64, Mass.

FOR CLEANING ALL SMALL CLOSE-TOLERANCE PRECISION PARTS IN WHICH ABSOLUTE CLEANLINESS IS A "MUST"



how clean is
CLEAN?

Dallons ULTRA-KLEEN

Ultrasonic Cleaning Machine

NEW, MODERN.
ECONOMICAL ULTRASONIC
CLEANING GETS
THINGS REALLY CLEAN!

Cleanliness is a relative term. What may appear to be "clean enough" for one scientific application may be so loaded with minute, microscopic sludge that accurate operation of small precision instruments is impossible. Only Ultrasonic Cleaning will help!

Dallons ULTRA-KLEEN will quickly, positively and economically eliminate all dirt, oils or other external deterents to accurate operation. This "cold" process prevents distortion and permits many scientific and industrial applications.

manufactured by **DALLONS LABORATORIES, INC.**

"First in Ultrasonics"

5066 Santa Monica Blvd., Los Angeles 27

Write today for Descriptive Literature, Specifications, Prices.

**PRINTED
CIRCUITS**

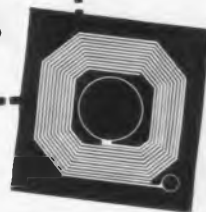

USECO announces expanded production facilities in a separate new plant devoted exclusively to production of

- Printed Circuits • Etched Circuits
- Terminal Boards (Standard and Custom Built)

Our additional facilities permit MASS PRODUCTION techniques without forfeiting the QUALITY or FAST DELIVERY for which USECO is noted.

Printed and etched circuits in sizes to 18"x 18". Samples on request. We meet all Mil Specs. Complete line of Standardized Electronic Hardware. 24-hour service on quotations. Write today for further information.



U. S. ENGINEERING CO.

521 Commercial St., Glendale 3, Calif.

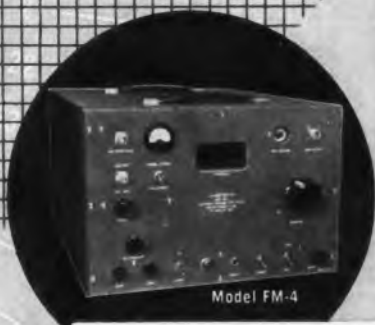

Model FM-4

GERTSCH "New" **MICROWAVE
FREQUENCY MULTIPLIER**

To measure or generate
microwave frequencies up to 12,500 mc...

- Wide Frequency Range
- Continuous Coverage
- Extremely High Accuracy and Stability

Containing a new and original circuitry development, the FM-4, with suitable driving source allows you to measure frequencies from 100 mc. to 12,500 mc., or to generate frequencies from 500 mc. to 12,500 mc. with continuous coverage, and extreme accuracy and stability.

ACCURACY: (with Model AM-1 Driver) .0001%
(with Model FM-3 Driver) .001%
POWER SOURCE: 105-127 volt. 60-cycle AC

GERTSCH PRODUCTS, INC

For further information, contact your nearest Gertsch Engineering Representative or write...
11848-48 Mississippi Avenue
Los Angeles 25, California

See Us At WESCON—Booth 511-512

NEW

PANORAMIC SPECTRUM ANALYZER **SPA-1**



now 50 mc
to 4000 mc

WITH TWO TUNING HEADS

Check these outstanding features:

- Low noise input, less than 0.5 microvolts across 50 ohms, for high usable sensitivity
- Continuously variable differential markers, ± 50 kc to ± 5 mc
- Continuously variable resolution (I.F. bandwidth) 9 kc to 100 kc
- 1 cps to 60 cps sweep rate, continuously variable with single control
- 10 MC maximum sweepwidth, continuously reducible to 0 MC
- DC coupled video amplifier for analysis of CW signals
- Three selectable amplitude scales, 40 db leg, 20 db linear and square law
- Low frequency swept oscillator provides high inherent stability
- Excellent construction and design make the equipment unparalleled for minimum down time
- Optional bezels and CRTs for visual examination or camera use
- Low cost

Tuning Heads

RF-2 50 mc—250 mc
RF-3 220 mc—4000 mc in five ranges
Inquiries invited on Panoramic Spectrum Analyzers for special problems. Write today for descriptive literature.



Makers of
• Panadapter
• Analyzer
• Panoramic
Sonic
Analyzer
• Panoramic
Ultrasonic
Analyzer

22 South Second Ave., Mount Vernon, N. Y.
MOUNT VERNON 4-3970

Plant noise

(Continued from page 192)

Normally the wind increases with height above the ground. The presence of wind gradients will reduce shadow formation caused by temperature gradients and the noise reduction due to temperature is available only in the direction against the wind. Therefore, over distances of less than 1 mile gustiness seems to be of major importance in changing attenuation of the sound as it is propagated out from the source into the surrounding community.

Continuous monitoring of the sound is considered necessary because of the many variations encountered. During the day the temperature generally decreases upward and the sound rays will be refracted upward and for some distance the observer will be in a sound shadow. At night there is a general inversion of the temperature gradient and the sound rays will be bent downward. Often the audibility during the night is reported

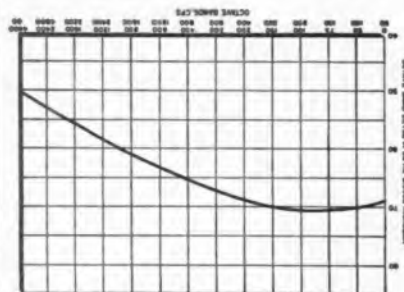

Fig. 3: Maximum daytime sound level permitted in a community before complaints originate

to be greater than during the day.

The maximum daytime sound level permissible in a community before complaints originate has been derived, and general agreement has been reached on data as shown in Fig. 3. It is anticipated that nighttime complaints may occur unless the level is held 3 db lower than the curve.

It is on this basis that the warning lights are operated:

Fig. 2 (after Parrack), indicates the various threshold sound levels for the human ear, for sounds throughout the wide range of pressures which could be encountered at aircraft engine plants, as well as by operating personnel working around jet aircraft on the ground.

The sensitivities of the 21BR type microphones are in several ranges and microphones are selected on the basis of the maximum level to be expected in each location.

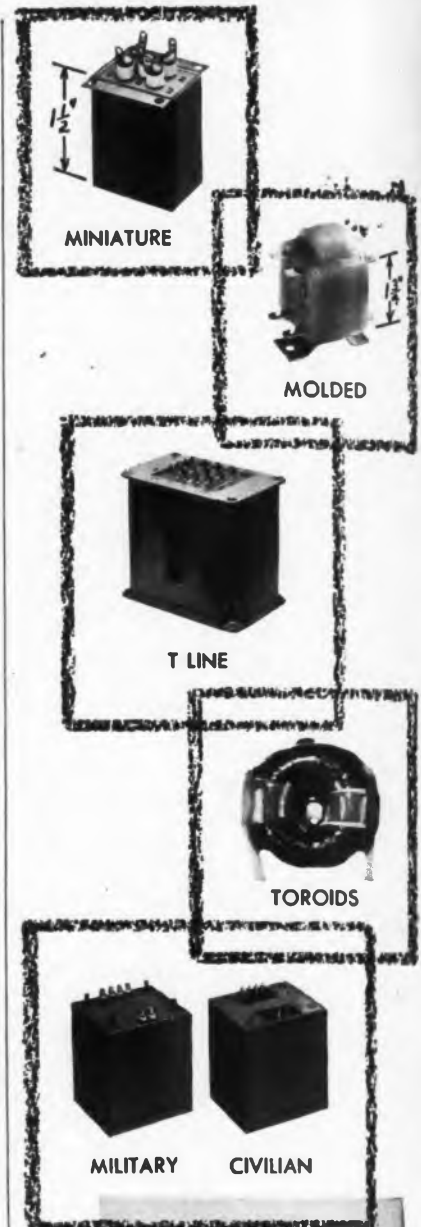

KENYON
TRANSFORMERS
Meet All Government and
Commercial Requirements
Inquiries Invited



KENYON
TRANSFORMER CO., INC.
840 Barry St., New York 59

Waveguide

Bulletin T...
wave duplex...
manufactured by

Toroids

Information...
toroidal coils...
available from...
Lafayette St., N.

Capacitors

Information...
Elmenco line...
new release...
Lafayette St., N.

Transformers

A line of...
designed for...
supplies, cat...
amplifiers an...
shown in th...
Write to Tri...
wood Ave., V

Tape Splices

A method f...
magnetic rec...
catalog descr...
Available fro...
33rd St., L.I.C.

Potentiometers

Titled "New...
a release fr...
Magnolia Av...
six new mod...
ture and prec

Printed Circuits

Six stand...
designed to s...
board" circui...
finishing equi...
available from...
1207, Lindsay,

Ultra-Violet

A descripti...
Products Inc...
dena, Calif...
techniques ha...
organizations.

Test Instruments

The Model...
and the Supr...
brochures rel...
973 East San

Metal Powder

A three-pa...
Electronics...
Calif. covers...
metals, metal...
liquids, and s

Klystrons

A 1-page re...
Palo Alto, Cal...
relay klystron...
band. First sh...
the WESCON

Pulse Equipment

A line of pu...
ment is descri...
ford Electronic...
Culver City, C

Components

A bulletin f...
S. Santa Fe, I...
nical data on...
ucts, which in...
lar parts.

BULLETINS

Waveguides

Bulletin T-2200 describes a line of microwave duplexers and related equipment manufactured by Airtron Inc, Linden, N.J.

Toroids

Information on a line of adjustable toroidal coils is contained in Bulletin PR available from Hycor Co., Inc., 11423 Vanowen St., N. Hollywood, Calif.

Capacitors

Information on three new additions to the Elmenco line of capacitors is contained in a new release from Arco Electronics Inc., 103 Lafayette St., N.Y. 13, N.Y.

Transformers

A line of new transformers specifically designed for use in voltage regulated power supplies, cathode ray tube supplies, pre-amplifiers and vacuum tube voltmeters, are shown in the new Triad Catalog TR-54. Write to Triad Transformer Corp., 4055 Redwood Ave., Venice, Calif.

Tape Splicer

A method for quick and simple editing of magnetic recording tape is described in a catalog describing the MT-1 Presto-Splicer. Available from Prestoseal Mfg. Co. 37-27 33rd St., L.I.C., N.Y.

Potentiometers

Titled "New Potentiometer Developments," a release from Bourns Laboratories, 6135 Magnolia Ave., Riverside, Calif., describes six new models in their line of sub-miniature and precision potentiometers.

Printed Circuits

Six standard pre-fabricated printed circuits designed to save time in assembling "bread-board" circuits and troubleshooting of the finishing equipment are described in a folder available from Tri-Dex Electronics, P.O. Box 1207, Lindsay, Calif.

Ultra-Violet Techniques

A descriptive folder from Ultra-Violet Products Inc., 145 Pasadena Ave., S. Pasadena, Calif. shows uses to which ultra-violet techniques have been applied by industrial organizations.

Test Instruments

The Model 110A X-Band VSWR Indicator and the Supertester are described in two brochures released by Color Television Inc., 973 East San Carlos Ave., San Carlos, Calif.

Metal Powders

A three-page release from Chemalloy-Electronics Inc., Gillespie Airport, Santee, Calif. covers their line of anti-friction metals, metal powders for electrification of liquids, and soldering and welding rods.

Klystrons

A 1-page release from Varian Associates, Palo Alto, Calif. describes their new VA-220 relay klystron designed for the 6-8 KMC band. First showing of this tube will be at the WESCON show.

Pulse Equipment

A line of pulse forming and timing equipment is described in a release from Rutherford Electronics Co., 3707 S. Robertson Blvd., Culver City, Calif.

Components

A bulletin from the Wm. Porter Co., 1007 S. Santa Fe, Los Angeles, Calif. gives technical data on their line of Fibreglass products, which includes coil bobbins, and tubular parts.

2 Fungus Resistant NYLON FLAT-BRAIDED LACING TAPES

WAX FINISH

GUDELACE*

Easy on Hands
Easy to tie

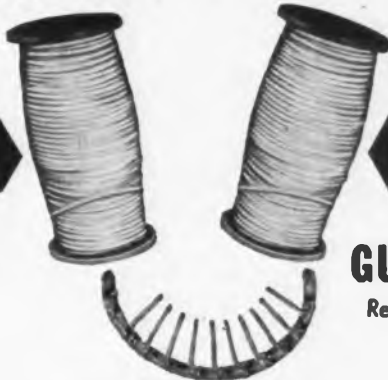

WAX FREE

**All-Nylon
GUDE-NYLACE***

Resists High Temperature

Both tapes save time and money— and cut down rejects. Neither will bite through insulation. Gudelace ties easier, tighter and cuts down knot slippage. Gude-Nylace is the perfect product where the use of wax is not indicated.

*Patent Applied For

WRITE FOR COMPLETE INFORMATION AND A FREE TRIAL SUPPLY TODAY!

GUDEBROD BROS. SILK CO., INC.

ELECTRONICS DIVISION
225 W. 34th Street, New York 1, N.Y.

EXECUTIVE OFFICES
12 S. 12th Street, Philadelphia 7, Pa.

CLARK CRYSTALS For UHF



Type HSM-2UH

Frequency range now extended from 15 mc to 200 mc.

- Modes of vibration 5th, 7th, 9th & 11th.
- Series resistance 40 to 100 ohms.
- Static capacitance 5 to 15 mmf.
- Calibration within $\pm .002\%$.
- Stability .0001% with oven and .004% without oven.
- For use in oscillator or filter circuits.

Sample quantities available from stock. Packaged oscillators are available for use in the 15 to 200 mc frequency range.

CLARK CRYSTAL CO., Inc.
MARLBORO, MASS., U. S. A.

Phone MARLBORO 1411 • Cable—CRYSTAL



BRUSHES CONTACTS

SLIP RINGS

...AND SUP RING ASSEMBLIES

BRUSH HOLDERS • BRUSH ASSEMBLIES
CONTACT ASSEMBLIES



... Use **SILVER GRAPHALLOY** for applications requiring low electrical noise; low and constant contact drop; high current density and minimum wear.

EXTENSIVELY USED IN:

**SELSYNS • GUN FIRE CONTROLS
ROTATING THERMOCOUPLE and
STRAIN GAGE CIRCUITS
ROTATING JOINTS • DYNAMOTORS**

Wide range of grades available for standard and special applications.

Other Graphalloy Products



Oil-free, self-lubricating Bushings and Bearings (applicable -100° to +300° F.; with expansion coefficient half that of steel will not seize shaft at low temperature); oil-free Piston Rings, Seal Rings, Thrust and Friction Washers, Pump Vanes.

GRAPHITE METALLIZING CORPORATION

1002 Nepperhan Ave. • YONKERS, NEW YORK

- Please send data on Graphalloy BRUSHES and CONTACTS.
 Send data on BUSHINGS.

NAME & TITLE _____
COMPANY _____
STREET _____
CITY _____ ZONE _____ STATE _____

Locked Oscillators

(Continued from page 77)

only of a transient nature and the average frequency remains exactly the same as the synchronizing input.

Locking Systems

The simplest system for locking an oscillator might be termed a "brute force" system. The synchronizing signal is injected directly into some portion of the oscillator circuit. Synchronization occurs because of non-linearity in the oscillating circuit. This produces cross modulation between the synchronizing signal and the oscillator signal. The net result of this cross modulation is that the oscillator frequency is shifted towards the synchronizing frequency. The cross modulation is evidenced by the presence of numerous side bands in the output of the oscillator. If the free running frequency of the oscillator is close enough to the synchronizing frequency, the oscillator

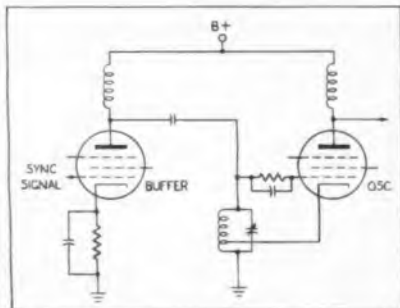

Fig. 5: Frequency meter uses "brute force"

will lock to the synchronizing frequency. The range of turning over which an oscillator will lock depends on several factors among which are the following:

1. In order for lock to occur, there must be some non-linearity in the circuit so that cross modulation can occur.
2. The oscillator must have relatively poor frequency stability in order to lock over a wide range. This is due to the fact that the oscillator can shift only $\pm\pi/2$ radians in phase with respect to the synchronizing signal, referred to the same frequency, before it jumps out of lock. Therefore, a rapid rate of change of phase, with respect to frequency, in the feedback elements of the oscillator will tend to produce a narrow synchronizing range. A rapid rate of change of phase is also a criterion of good fre-

How to whip your relay problems!

Just call **ADVANCE...**
we're ready and willing to make the relays you need.



CONTACTS, for example

Say the word and we'll up the sizes... switch from fine silver to tungsten, palladium, silver-cadmium oxide, gold contacts, or... you name it!

INSULATION

Laminated phenolic, silicone glass, ceramic steatite, linen-base bakelite, or... you name it!



ANYTHING SPECIAL...

ADVANCE will engineer, develop and produce the custom relays you need in minimum time. Call ADVANCE for action.

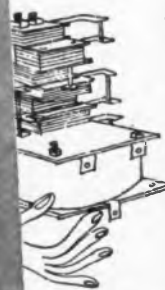

For ELECTRONIC USES

We build a vast variety of sensitive, reliable relays...create superior new designs quickly. You'll find our quality control is now the tightest in the industry.

Write—and let us solve your relay problems



ADVANCE ELECTRIC AND RELAY CO.

2435-F NORTH NAOMI STREET
BURBANK, CALIFORNIA

**PACKAGED
CIRCUITRY**

The Walkirt Co. manufactures a line of units for measuring time intervals, or highly repetitive activities up to 3 megacycles per second. Other units, also available from stock, will readily accomplish such functions as time sequential switching, pulse delays, gating, amplifying, and pulse shaping.

Write for Catalog • Write our Engineering Service Department for specialized applications.

**Now Available Resin Encapsulated or "Open" Construction. Your Circuits Economically Packaged.*



TYPE M 1243

DELAY MULTIVIBRATOR

The Walkirt Type M 1243 Delay Multivibrator is one of several stock delay units providing an externally variable delay pulse.

Freq. Range: 0-10 KC (higher speed units available) • input: 75 V negative pulses (available from Walkirt counters) • Output: 120 V peak to peak, nominal 25 microsecond delay • Diameter: Only 1 1/4 inches.

Immediately Available in Quantity

THE WALKIRT co.

145 WEST HAZEL ST., INGLEWOOD 3, CALIF.

TRANSFORMERS . . .

*. . . specified for the usual
. . . demanded for the unusual*



"GTC" Transformers for television receiver applications . . . custom designed for high quality at minimum cost.



"GTC" Transformers for industrial and commercial applications . . . accurately engineered and fully recognized for finest quality.



Manufacturers specify "GTC" . . . for audio uses, communication, radar devices, test equipment, transmitters, and various other electronic controlled devices.



"GTC" Military Transformers . . . designed to meet rigid government specifications and to perform under the most severe and continuous operating conditions. MIL-T-27 and JAN-T-27.

Skilled engineering techniques make GTC a source for transformers in highly specialized and extremely unusual applications. Utilization of these techniques results in greater dependability, quality and better construction.

Our completely self-contained plant's modern equipment guarantees transformer production in any quantity to meet your requirements. We welcome your inquiry and will supply production samples where desired.



**GENERAL
TRANSFORMER COMPANY**

serving industry since 1928

18240 Harwood Avenue, Homewood, Illinois
(Suburb of Chicago)

See our exhibit at Western Electronic Show & Convention, Aug. 25-27, Los Angeles

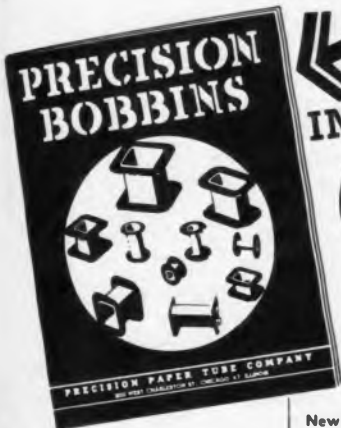

**IMPORTANT
facts**
about
**COIL
BOBBINS**

SALES REPRESENTATIVES

New England:
Framingham, Mass., Framingham 7091

New York, New Jersey:
Jersey City, New Jersey,
Journal Square 4-3574

Upstate New York:
Syracuse, N. Y., Syracuse 76-8056

Maryland:
Baltimore, Maryland, Plaza 2-3211

Philadelphia:
Philadelphia, Pa., Chestnut Hill 8-0282

Northern Ohio, Western Pennsylvania:
Cleveland, Ohio, Atlantic 1-1060

Indiana, Southern Ohio:
Logansport, Indiana, Logansport 2555

Missouri, Southern Illinois, Iowa:
St. Louis, Missouri, Sterling 2318

California:
Pasadena, California, Sycamore 8-3919

Canada: Montreal, Quebec, Canada,
Walnut 2715

SPECIFICATIONS

—any size, shape, length, with flat, recessed or embossed flanges.

MATERIALS

—dielectric kraft, fish paper, acetate, phenol impregnated material or combinations.

INFORMATION

—Bulletin contains important data on bobbin construction, heat factor and cost.

Request your free copy today.



PRECISION PAPER TUBE CO.

2037 W. CHARLESTON ST. CHICAGO 47, ILL.
Plant No. 2: 79 Chapel St., Hartford, Conn.
Also Mfrs. of Precision Paper Tubes

SEND FOR YOUR COPY
OF THIS BOOKLET
TODAY!



SHOWS MANY USES FOR THE APPLICATION OF RADIUM AND ALL OTHER TYPES OF LUMINOUS MATERIALS!

DIALS, POINTERS, KNOBS, etc. accurately processed to your tolerances according to Government Specifications! From Blueprint to finished Product, our materials and methods of application are Government Approved! Newly developed photo-screen method for applying materials to curved and odd shaped surfaces.



SAMPSON CHEMICAL AND PIGMENT CORP.
2830 W. Lake St. • Chicago 12, Ill. Dept. TT-8

USE COUPON FOR YOUR FREE COPY!

SAMPSON Chemical & Pigment Corp. Dept. TT-8
2830 W. Lake St.
Chicago 12, Illinois

Please rush by return mail your free "Handbook of Radioactive and other Luminous Materials."

CO. NAME.....
ADDRESS.....
CITY..... STATE.....
BY.....
TITLE.....

Locked Oscillators

(Continued from page 196)

quency stability in an oscillator, therefore, good frequency stability automatically means a narrow "lock-in" range.

3. The larger the synchronizing signal, the wider will be the "lock-in" range.

Oscillator Injection

There are numerous methods of injecting the synchronizing signal. They can be injected in any place in the circuit where it can cause effective cross modulation. One method which has several advantages is shown in Fig. 5. Here the oscillator to be locked is a Hartley oscillator. The tuned circuit for the oscillator acts as a plate load to a pentode. Synchronizing signal is applied to the grid of the pentode. Since pentodes have a fairly high plate resistance, this arrangement produces a very little loading on the oscillator itself. If the oscillator is tuned to the synchronizing frequency, its tuned circuit presents a high impedance to

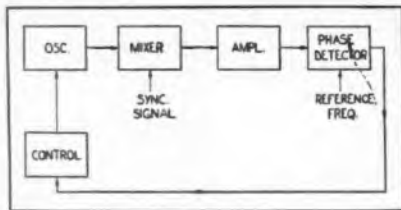

Fig. 6: 500-12,500 MC generator

the plate of the pentode and, therefore, a relatively large amplitude of synchronizing signal is built up across the tuned circuit of the oscillator. This method presents a high impedance to the synchronizing voltage source and produces a substantial amount of gain in the synchronizing voltage. Also this synchronizing source is very effectively isolated from the oscillator so that interactions between the two are greatly reduced. This system cannot be used at very high frequencies, however, because of the capacitive loading due to the pentode buffer. Some improvement may be obtained in this respect by tapping the pentode down on the tuned circuit at the expense of reduced gain for the synchronizing voltage.

Another method for locking an oscillator is the feedback system. Here the phase of the oscillator is compared against the phase of the synchronizing signal in a phase sensitive detector. The output of the

If you have design
experience in

**MAGNETIC
AMPLIFIERS**

**CRYSTAL and
L-C FILTERS**

**MINIATURE
TRANSFORMERS**

**PLASTIC
ENCAPSULATION
TECHNIQUES**

(or if you are an engineer
desiring experience in these
fields)

... you owe yourself an investigation of the career advantages offered by Communication Accessories Company, Hickman Mills, Missouri . . . located in South Suburban Kansas City, where you and your family can enjoy advantages of:

1. Management-owned expanding organization
2. Rural atmosphere — 25 minutes to metropolitan Kansas City
3. Newly developed housing facilities, schools and shopping centers.

For confidential negotiations, address inquiries to W. S. Bonebright, V.P.,

**COMMUNICATION
ACCESSORIES
COMPANY**

HICKMAN MILLS, MISSOURI

**FROM
MIKE**



**TO
ANTENNA**

Collins

**Your one best
source for
broadcast equipment**

855 35th St., N.E.,
Cedar Rapids, Iowa
261 Madison Avenue,
New York 16
1930 Hi-Line Drive,
Dallas 2
2700 W. Olive Ave.,
Burbank
Dogwood Rd., Fountain City,
Knoxville, Tenn.
Petroleum Bldg.,
Tallahassee, Florida



phase sensitive detector is fed back to a control on the oscillator. As the oscillator attempts to depart in phase from the synchronizing signal the control attempts to correct it, provided the feedback is in the proper direction. All the criteria of stability, band width, etc. associated with feedback amplifiers apply to this type of circuit. Since when the system is operating properly there can be only departures in phase, the frequency of the oscillator must be the same as the synchronizing signal. A block diagram of this type of system is shown in Fig. 1.

Frequency Control

Most types of electronic controls which can be applied to oscillators actually control the frequency of the oscillator. An example of this is the common reactance tube type of control. Since phase is the integral of frequency change, the phase output of such a controlled oscillator is proportional to the integral of the input voltage to the control circuit. This is equivalent to introducing a 90° lag into the circuit. Inasmuch as there are other inevitable lags around the feedback loop, it is almost certain that the loop will be unstable at some frequency unless precautions are taken such as the insertion of a correcting network.

The feedback system offers many advantages. The lock may be made very wide, the only limitations being, (a) the gain around the loop, (b) the frequency response of the loop and (c) linearity of all the circuits. The pull-in range, that is, the maximum discrepancy which can exist between oscillator frequency and synchronizing frequency before the oscillator pulls into synchronization is determined by both the gain and bandwidth of the system. Phase jitter is inversely proportional to both gain and band width. Good frequency stability helps reduce phase jitter.

This type of control can be applied at very high frequencies and even offers a possibility of synchronizing Klystron oscillators whose frequency can be readily controlled by varying the repeller plate voltage. Circuits can be made which will allow synchronization with very weak synchronizing signals. Synchronization can also be made to occur at a frequency a fixed difference from the synchronizing frequency. The major disadvantage of these systems is their relative complexity.

The phase comparison need not be performed at the same frequency as the oscillator signal or the synchro-



This is why COAXIAL CONNECTOR CO. makes a line of connectors that is top-rated throughout the industry:

If "know-how" means precision-engineered JAN Connectors;

If "know-how" means the superior product of the knowledge of engineering specialists;

If "know-how" means economy, workmanship, and a short production cycle: then Coaxial Connector Co. has the kind of know-how that will help you keep your manufacturing operation smooth, superior, and trouble-free!

Rugged service in field and laboratory give our Connectors a *proven dependability*. Quality-controlled to give insurance-plus when you use a Coaxial Connector Co. precision-made Connector.

UHF SERIES CONNECTORS

For dependable low-cost, general purpose use. Satisfactory up to 200 megacycles and may be used with caution up to 500 megacycles.



PL-259, PLUG (NT. 49190)

Non-weatherproof type. Mates with UHF female. Two-piece construction. For use with Cable RG-/U: 8, 9, 10, 11, 12, 13, 63, 65.

PL-259A, PLUG (NT. 49195)

Similar to PL-259. It is a 3-piece unit for ease of handling. Non-weatherproof. Mates with UHF female. SO239.



SO-239, NT. 49194 Receptacle

Mates with male plugs PL-259, PL-259A, UG-203/U. Non-weatherproof, single piece construction. For use with Cable RG-/U, 8, 9, 10, 11, 12, 13, 63, 65.

Also available special Adaptor for the above Plugs (UG-175/U, UG-176/U) used with RG-58/U, RG-59/U, RG-62/U and other small cables.

Design Problems? Engineering information? Special requirements? Our engineering specialists will help you solve your problems.

FREE! Cross Reference Chart! Just ask for it or for more information.

COAXIAL CONNECTOR COMPANY

37 No. 2nd Ave., Mt. Vernon, N. Y.
Mount Vernon 8-6416
Government Designation C B W U

YOU TOO CAN HAVE THESE!

We're the source of these imported television lenses which greatly increase camera versatility. Complete the range of your TV camera lenses with these previously unavailable focal lengths. Supplement the lenses you are now using for increased versatility and performance.



ANGENIEUX RETROFOCUS

wide angle lens (35mm focal length) f2.5. Focusing mount with iris diaphragm. Highest resolution for sharpest images.

MEYER PRIMOPLAN

(75mm focal length) f1.9. Focusing mount with iris diaphragm. Longer than normal focal length for universal application.



MEYER TELEPHOTO

(250mm focal length) f5.5. In focusing mount with iris diaphragm and built-in lens shade. The light weight construction permits a balanced turret action.



All Lenses Fully Guaranteed for Optical Quality and Top Performance

Write today for our complete price list of all of our special lenses for television cameras—28mm through 250mm. Samples for test purposes available on request.

PONDER & BEST

TELELENS DIVISION
Importers of Fine Photographic Equipment

814 North Cole Avenue
Hollywood 38, California

Locked Oscillators

(Continued from page 199)

nizing signal. They may be heterodyned down by means of a common local oscillator and compared at some lower frequency. In this system precautions must be taken to prevent the synchronizing signal from feeding down the oscillator channel and vice versa. Another system is shown in Fig. 2. Phase to amplitude conversion and also frequency conversion takes place in the double mixer system. The oscillator frequency is first mixed with the output from a fixed low frequency oscillator in a balanced mixer. The resulting side bands are then mixed with the synchronizing frequency in a second mixer. The resultant output, assuming equality between the oscillator frequency and the synchronizing frequency, is a frequency equal to that of the low frequency oscillator whose amplitude varies as a function of the

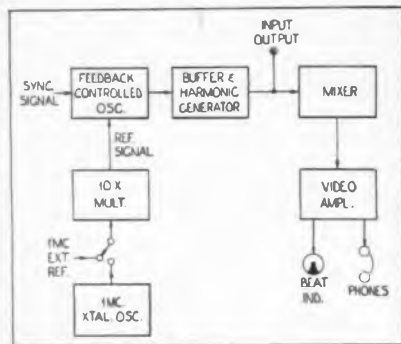

Fig. 7: Oscillator covers range of 500-1,000 MC

phase difference between the oscillator and the synchronizing signal. For certain values of phase difference the output of the mixer is zero and as it passes through zero the output changes its phase with respect to the fixed frequency oscillator. This furnishes a means of determining the sense of phase and, therefore, the loop can be completed by a phase detector which does not limit.

Another system is shown in Fig. 6. Here the oscillator is heterodyned against the synchronizing signal, a fixed frequency away from it. The difference frequency is fed through a filter and amplifier system to one input of a phase detector. The other input to the phase detector is a reference frequency which is equal to the difference frequency. Synchronization occurs when the oscillator frequency is equal to the synchronizing frequency plus or minus the

new
laboratory kit
saves design-in time

ACTUAL SIZE!

MICRODOT®
World's smallest COAX connectors, cables and assemblies

The unique flexibility of Microdot Kit #553 provides scores of coax assembly combinations. Save valuable time in "try-out," pre-production and design-in... keep products design competitive with Microdot advantages. Order Kit #553 today.

MICRODOT
1826 FREMONT ST.
50 PASADENA CALIF.

WIRE STRIPPING: Your jobs are peculiar to your own business and may be governed by such variables as kind and size of wire, what you use it for, your production requirements, and other similar factors.

So we may serve you promptly and efficiently, tell us what you are now doing and your hopes in the way of improved quality, increased production and lower costs.



Illustration shows a MODEL "D-1" Two-Wheel Stripper, which is but one of the many different types of machines made. This one uses 1 1/4" diameter stripping wheels and is ordinarily used to strip any type of Film Insulation from wires in the range of AWG #25 to AWG #44. A wide variety of stripping wheels are available, made from FybRglass and Brush Wire, all designed to provide economical service.

This particular machine is only \$156.25, f.o.b. Syracuse, exclusive of stripping wheels. It is available on a Test-Rental Plan or may be purchased out of savings over a ten month period.

For a confidential report containing our recommendations, send samples and complete information to

**Rush Wire Stripping Division,
The Eraser Company Inc.**
1060 South Clinton St., Syracuse 4, New York.

The leading quartz crystal developments of the past 25 years have been produced by Standard Piezo!

For an exact match of exacting specifications, it pays to choose frequency control crystals from the world's largest, most complete line . . . fully tested and proved in the world's most critical services.

NEW 20-PAGE CRYSTAL CATALOG SENT ON REQUEST

STANDARD PIEZO COMPANY
Carlisle, Pa.



STANDARD PIEZO Crystals

THE LINE THAT SETS THE QUALITY STANDARDS



Locked Oscillators

(Continued from page 200)

reference frequency.

There are many other possible systems, however, this discussion will be limited to those outlined above.

An instrument using the "brute force" lock technique is shown in Fig. 3. This is a heterodyne frequency meter having a fundamental range of 20-40 mc. Frequencies are generated within the instrument by mixing harmonics of a 1-mc crystal with an oscillator covering the range of 1 to 2 mc. The difference frequency is used. It is fed to a pentode buffer and used to lock an oscillator as previously described. The output of the locked oscillator is fed to a diode type harmonic generator. The fundamental frequency and its harmonics are then fed either out of the instrument or to a mixer where they can be heterodyned against signals fed into the instrument for measuring purposes. The lock-in range of this particular locked oscillator is of the order of 0.1%.

Feedback Application

An instrument using the feedback type of locked oscillator is shown in Fig. 4. This instrument is used to measure or generate frequencies in the range of 500 to 12,500 mc. It requires for its operation a small synchronizing signal in the range of 500 to 1,000 mc. A block diagram of this instrument is shown in Fig. 7. The oscillator, which covers a range of 500 to 1,000 megacycles, is controlled by a circuit similar to that shown in Fig. 4. The reference frequency used in this case is 10 mc. This is derived either from the internal standard or from external sources. The controlled oscillator is followed by a buffer amplifier and diode type harmonic generator. The fundamental frequency and its harmonics are then fed out of the instrument and also to a mixer for measuring frequencies by comparison against a signal fed into the instrument. The reactance modulator used for control is a shunt type switched diode reactance modulator. The diode used is a germanium diode. The phase detector is a 6BN6 gated beam pantode which is ideal for this system since the reactance modulator requires a constant current source to drive it. Lock-in range varies considerably over the tuning range of the oscillator since the gain of the reactance modulator varies considerably with frequency. The range is of the order of 0.2 to 0.3%. Satisfactory synchro-

ADC SECOND IN A SERIES



TINY TRANSFORMERS can pack a real wallop!



Ever wonder about Aladdin's genie? A lot of power to squeeze into one tiny container, yet we're doing something almost as unbelievable at ADC.

Take for example ADC's radically new line of tiny, hermetically sealed transformers and chokes. Measuring only 3/4" x 15/16" x 1-3/8", these tiny units have performance ratings equal to transformers and chokes of a far larger size. (Mu-metal cases.)

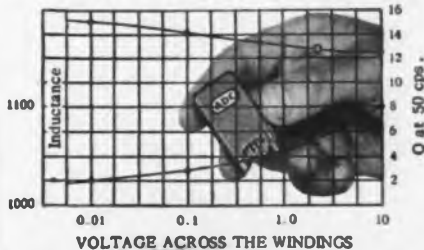

Curve showing Ni-Cr low frequency inductance illustrates the unusual characteristics of these tiny units.

Designed originally for the Geophysical field, modifications in these power-packed units are finding ready acceptance in transistor and other sub-miniaturized circuitry. Write for our unique catalog and data sheets on these tiny units.



AUDIO DEVELOPMENT COMPANY
2833 13th Avenue So., Minneapolis, Minn.



POWER OSCILLATOR

MODEL 1040

PRICE
\$119.00
F.O.B.
NEW YORK

**A COMPACT
PRECISION OSCILLATOR
PROVIDING 3 WATTS OUTPUT**

- Excellent Accuracy and Stability
- Transformer Isolated Output
- 3 Output Impedances
- Low Internal Impedance
- Output Variable Up To 120 Volts

SPECIFICATIONS

Frequencies.....400 or 1000 C.P.S. by selector switch
(other frequencies on request)
Distortion.....Less than 1 %
Hum Level.....Approximately .05% of rated output
Output Power.....3 watts into matched resistive load
Power Supply.....115 volts, 60 C.P.S., 40 watts
Dimensions.....5-11/16 x 9 x 6 1/8 inches

Representatives in Principal Cities

INDUSTRIAL TEST EQUIPMENT CO.
55 EAST 11th STREET • NEW YORK 3, N. Y.

BARRIER STRIPS NEW DESIGN

SAVES
ASSEMBLY TIME
AND
MONEY



Molded
as a unit —

Require no
insulating
backing —

Choice of body
materials —

Send for Technical
Bulletin

Patent
Pending



GARDE
MANUFACTURING COMPANY
588 Eddy St. Providence 3 R. I.

when there's a soldering job to be done...



On industrial assembly lines
... in home workshops ...
in electronic labs ... for
production, repair,
maintenance ... the
world's most versatile
family of pencil soldering
irons is on the job,
doing a better job! No
wonder they're called
"Ungar's Little Angels"!

- Interchangeable tips for every soldering need from repair to high-speed production soldering.



- Feather-light, designed for hard-to-reach jobs.



Write for
Catalog U-19



UNGAR ELECTRIC TOOLS, INC.
P. O. Box 312, Venice, California

Locked Oscillators

(Continued from page 203)

nization can be obtained with inputs of the order of 100uv. Output of the instrument is of the order of 1 μwatt in X-band.

Reference

1. Leonard S. Cutler, "An Improved Direct-Reading VHF Frequency Meter," *Tele-Tech*, p. 72, Sept., 1952.



Richard R. Legg Co., 2118 S.E. Division St., Portland, Ore. has been appointed rep for the Clear Beam antenna line for the states of Washington, Oregon and Montana.

Frank A. Emmet Co., 2837 W. Pico St., Los Angeles, has been appointed to represent the G.E. Co. of England in southern Calif., Ariz., Nevada and N. M. Items for U.S. consumption include telephone relays and measuring instruments. The Emmet organization has also been appointed to represent the Geo. F. Wright Co., Worcester, Mass. manufacturers of steel guy wire and other products.

John B. Tubergen Co., 2232 W. 11th St., Los Angeles, now represents Wen Products, Chicago, makers of soldering guns and sanders, and Videocraft Mfg. Co., Chicago, manufacturers of deflection yokes and magnetic focalizers.

Robert E. McClendon, 3907 Central Ave., E., Albuquerque, N. M., has been named rep for the state of New Mexico by C. P. Clare & Co., Chicago relay manufacturers.

V. T. Rupp Co., 2230 W. 11th St., Los Angeles, Calif., has been appointed rep for Color Television Inc., San Carlos, Calif. for the southern California, Ariz., N.M., and El Paso area.

FATHER-SON TEAMS



Five father-and-son teams at the annual summer meet of the Los Angeles chapter of the Reps are (seated l to r) the dads: D. Wallace, C. Strassner, D. Marshank, J. Hill and C. Stone. Their offspring (standing l to r): W. Wallace, R. Strassner, E. Strassner, N. Marshank, J. T. Hill, J. J. Hill, D. Hill, C. Stone, Jr., and R. Hill. Chapter has membership of 57

ADAMS & WE
Agency—Hens
ADVANCE ELE
Agency—West
AEROVOX CO
Agency—Aust
AIR ASSOCIAT
Agency—de C
AIRCRAFT RAD
Agency—Burk
ALDEN PRODU
Agency—Rich
AMERICAN EL
Agency—F. B
AMERICAN LA
Agency—Fov
AMERICAN PH
Agency—Burr
AMPEX CORP.
Agency—Boh
ANDREW COR
Agency—Burr
ANNOLD ENGI
Agency—Walk
ASSEMBLY PR
ASTRON CORP
Agency—Cont
AUDIO DEVEL
Agency—Fires
AUDIO DEVICE
Agency—Rick
AVERY ADHES
Agency—Mart
BARDWELL &
Agency—Elm
BENDIX AVIAT
MAGNETO I
Agency—Mach
BENDT-BACH
Agency—Abb
BIRD ELECTRO
BLAW-NIXON
Agency—Kath
BODNAR INDU
BOMAC LABO
Agency—Larc
BOURNS LABO
Agency—McC
BRADLEY LAB
Agency—Char
BURNELL & C
Agency—Mitt
BURRELLS C
Agency—Gray
BUSSMANN M
CALDWELL-CLE
CAMERA EQUI
Agency—J. M
CARGO PACKE
Agency—Gear
CECO DISTRIB
Agency—J. M
CHATHAM ELE
Agency—Geo
CHICAGO TEL
Agency—Burr
CINCH MANU
Agency—D. T
CINEMA ENGI
Agency—R. L
CLARK CRYSTA
Agency—Rob
CLAROSTAT MI
Agency—Aust
CLEVELAND C
Agency—Nes
CLIFFARD INS
Agency—S. C
COAXIAL CON
Agency—Frie
COLLINS RADI
Agency—W.
COMMUNICAT
Agency—Carl
CONTINENTAL
Agency—Nich
CORNING GLA
Agency—Char
CROSBY ENTER
Agency—Perr
CUBIC CORP.
Agency—Fran
CURRINGHAM
DAGE ELECTRI
Agency—Jim
DALE PRODU
Agency—Ayre
BALLONS LAB
Agency—Harr
DIAMOND MA
Agency—Rob
DIAMOND MI
Agency—Rob
DUMONT LABS
Agency—Aust
ETHEL-MCCULL
Agency—Conn
ELECTRICAL I
Agency—Geo
ELECTRO DEV
ELECTRO-PULS
Agency—Fran
ELECTRONIC
Agency—Gott
ELECTRONIC T
Agency—Harr
EQUIPTO DIV.
Agency—Arth
ERASER CO.
Agency—Rich
FAIRCHILD CA
Agency—G.

TELE-TECH ADVERTISERS — AUGUST, 1954

ADAMS & WESTLAKE CO. 141	Agency—Henri, Hurst & McDonald, Inc.	FAIRCHILD RECORDING EQUIPMENT CORP. 177	Agency—Goynor & Co., Inc.	PHALO PLASTICS CORP. 191	Agency—George T. Metcalf Co.
ADVANCE ELECTRIC & RELAY CO. 196	Agency—Western Advertising Agency, Inc.	FEDERAL SCREW PRODUCTS, INC. 183	FORD INSTRUMENT CORP. 190	PHIASTRON CO. 172	Agency—Teri Pall Adv.
ASBOVOX CORP. 126	Agency—Austin C. Lescarbourea & Staff	FREED TRANSFORMER CO., INC. 208	Agency—G. M. Bosford Co.	PHIELS DODGE COPPER PRODUCTS CORP. ... 28	Agency—Compton Advertising, Inc.
AIR ASSOCIATES, INC. 11	Agency—de Garmo Inc.	GABRIEL ELECTRONICS DIV., GABRIEL CO. 171	Agency—Franklin Advertising Service	PHILCO CORP. 7, 153	Agency—Julian G. Pollock Co.
AIRCRAFT RADIO CORP. 30	Agency—Burke Dowling Adams, Inc.	GARDE MFG. CO. 204	Agency—Larcom Randall Adv.	PHILLIPS CONTROL CORP. 36	Agency—Schnell & Associates
AIDEN PRODUCTS CO. 192	Agency—Richard Thorndike Agency	GENERAL ELECTRIC CO. 19, 127	Agency—Franklin Advertising Service	POLARAD ELECTRONICS CORP. 135	Agency—James R. Flanagan Adv. Agency
AMERICAN ELECTRICAL HEATER CO. 163	Agency—F. B. Hubert Adv. Counselors	GENERAL PRECISION LAB., INC. 15	Agency—Maxon, Inc.	POLYTECHNIC RESEARCH & DEVELOPMENT CO. 17	Agency—George Homer Martin Assoc.
AMERICAN LAVA CORP. 125	Agency—Power and Condon Adv.	GENERAL RADIO CO. 33	Agency—Burke Dowling Adams, Inc.	PONDER & BEST 200	Agency—Elmer W. Ayer Advertising
AMERICAN PHENOLIC CORP. 129	Agency—Burton Browne Advertising	GENERAL TRANSFORMER CO. 197	Agency—K. E. Morang Co.	PRECISION PAPER TUBE CO. 197	Agency—Symonds, MacKenzie & Co. Inc.
AMPEX CORP. 51	Agency—Boland Associates	GERTSCH PRODUCTS, INC. 193	Agency—Sander Rodkin Adv. Agency, Ltd.	PRESTO RECORDING CORP. 37	Agency—Lewin, Williams & Saylor, Inc.
ANDREW CORP. 53	Agency—Burton Browne Advertising	GRANT PULLEY & HARDWARE CORP. 136	Agency—Western Advertising Agency, Inc.	PRODELIN INC. 165	Agency—Josephson, Gulick & Cuffari Adv.
ANNOLD ENGINEERING CO. 18	Agency—Walker & Downing, General Agency	GRAPHITE METALLIZING CORP. 196	Agency—Milton Herder Advertising	PYRAMID ELECTRIC CO. 176	Agency—Burton Browne Advertising
ASSEMBLY PRODUCTS CO. 124	Agency—Walker & Downing, General Agency	GRAYHILL 205	Agency—Kotula Co.	RADIO CORPORATION OF AMERICA 52, 139, Cover 4	Agency—Al Paul Lefton Co.
ASTRON CORP. 111	Agency—Conti Advertising Agency, Inc.	GUDEBROD BROS. SILK CO., INC. 195	Agency—Lee Ramsdell & Co. Inc.	RADIO MATERIALS CORP. Cover 2	Agency—Turner Advertising Agency
AUDIO DEVELOPMENT CO. 203	Agency—Firestone Goodman Adv. Agency, Inc.	HART MANUFACTURING CO. 184	Agency—Wilson, Haight, Welch & Grover, Inc.	BAYPAR INC. 162	Agency—Buti-Roberts & Assoc.
AUDIO DEVICES INC. 109	Agency—Richard & Company, Inc.	HELIPOT CORP. 202	Agency—Darwin H. Clark Co.	RAYMEON MANUFACTURING CO. 47	Agency—Walter B. Snow & Staff, Inc.
AVEY ADHESIVE LABEL CORP. 29	Agency—Marlin R. Killien Co., Inc.	HEMINWAY & BARTLETT MFG. CO. 178	Agency—R. T. O'Connell Co.	REEVES HOFFMAN CORP. 122	Agency—W. H. Long Co.
BAIRDWELL & McALLISTER, INC. 174	Agency—Elmer W. Ayer Advertising	HEPPNER MFG. CO. 138	Agency—Burton Browne Advertising	RUST INDUSTRIAL CO., INC. 152	Agency—Robert Hartwell Gabine Adv.
BIBDIX AVIATION CORP., SCINTILLA MAGNETO DIV. 147	Agency—MacManus, John & Adams, Inc.	HERMETIC SEAL PRODUCTS CO. 121	Agency—Art-Copy Advertising Agency	SAMPSON CHEMICAL & PIGMENT CORP. 198	Agency—Sander Rodkin Adv.
BEHNDT-BACH, INC. 192	Agency—Abbott Kimball Co. of California, Inc.	HEWLETT-PACKARD CO. 25	Agency—L. C. Cole Company	SARKES TARZIAN INC. 166	Agency—Argyle Wampler Adv.
BIRD ELECTRONIC CORP. 190	Agency—Blaw-Knox Co. 59	HOFFMAN RADIO CORP. Sec. Two pp 1, 4, 5, 8	Agency—Foote, Cone & Belding	SHALLCROSS MANUFACTURING CO. 38, 169	Agency—Harry P. Bridge Co.
BLAW-KNOX CO. 59	Agency—Ketchum, MacLeod & Grove, Inc.	HOUSTON FEARLESS CORP. 27	Agency—Taggart & Young Advertising	SHURE BROTHERS, INC. 161	Agency—Henry M. Hempstead Co.
BOONAR INDUSTRIES, INC. 177	Agency—BOMAC LABORATORIES, INC. Cover 3	HUBBELL INC., HARVEY 186	Agency—Ted Sommers Inc.	SIGMA INSTRUMENTS, INC. 146	Agency—Meissner & Culver, Inc.
BOMAC LABORATORIES, INC. Cover 3	Agency—Larcom Randall Advertising	HUGHES AIRCRAFT CO. 10, 55	Agency—Foote, Cone & Belding	SOLAR MANUFACTURING CO. 142	Agency—Western Advertising Agency, Inc.
BOURNS LABORATORIES 112	Agency—McCarthy Co.	HYDRO-AIRE INC. 31	Agency—Roy S. Durstine Co.	SPECIFIC PRODUCTS CO. 187	Agency—Allen, Dorsey & Hatfield, Inc.
BRADLEY LABORATORIES, INC. 155	Agency—Charles Brunelle Co.	INDUSTRIAL HARDWARE MFG. CO., INC. 188	Agency—Walter J. Bergman Adv.	SPRAGUE ELECTRIC CO. 60	Agency—Harry P. Bridge Co.
BURNELL & CO., INC. 2	Agency—Mitchell Advertising Agency	INDUSTRIAL TEST EQUIPMENT CO. 204	Agency—MacBerman Adv.	SPRAGUE ELECTRIC CO. 12	Agency—Stuart Sande Advertising
BURROUGHS CORP. 32	Agency—Gray & Rogers Adv.	INTERNATIONAL RESISTANCE CO. 205	Agency—Arndt-Preston-Chapin-Lamb & Keen, Inc.	STAINLESS INC. 132	Agency—Harry P. Bridge Co.
BUSMANN MANUFACTURING CO. 49	Agency—Caldwell-Clements, INC. 158, 159	JENNINGS RADIO MFG. CORP. 170	Agency—L. H. Waldron Advertising Agency	STANDARD PIEZO CO. 203	Agency—Stoddart Aircraft Radio Co.
CADWELL-CLEMENTS, INC. 158, 159	Agency—J. M. Kesslinger & Associates	JOHNSON CO., E. F. 187, 201	Agency—Firestone Goodman Advertising	STONE PAPER TUBE CO. 120	Agency—Robert M. Gamble, Jr. Adv.
CAMERA EQUIPMENT CO. 179	Agency—George Homer Martin Associates	JONES DIV., HOWARD B., CINCH MFG. CORP. 191	Agency—Symonds, MacKenzie & Co.	STUPAKOFF CERAMIC & MANUFACTURING CO. 149	Agency—Walker & Downing
CARGO PACKERS INC. 143	Agency—George Homer Martin Associates	KAHLE ENGINEERING CO. 182	Agency—Conti Advertising Agency	SWITCHCRAFT, INC. 202	Agency—Jacobson & Tonne Adv.
CECO DISTRIBUTING CORP. 201	Agency—J. M. Kesslinger & Associates	KAY ELECTRIC CO. 191	Agency—Felt Adv., Inc.	SYLVANIA ELECTRIC PRODUCTS INC. 35, 115	Agency—Cecil & Presbrey Inc.
CHATHAM ELECTRONICS CORP. 43	Agency—George Homer Martin Associates	KAY-LAB, INC. 128	Agency—Glenn-Jordan-Stoetzel Inc.	SYNTHANE CORP. 201	Agency—Arndt, Preston, Chapin, Lamb & Keen, Inc.
CHICAGO TELEPHONE SUPPLY CORP. 8, 9	Agency—Burton Browne Advertising	KELLOGG SWITCHBOARD & SUPPLY CO. 184	Agency—Picard, Marvin & Redfield	TECHNOLOGY INSTRUMENT CORP. 168	Agency—Tippett & Co., Inc.
CINCO MANUFACTURING CORP. 103	Agency—D. T. Campbell, Inc.	KENYON TRANSFORMER CO. 194	Agency—Paul J. Steffen Co.	TELECHROME INC. 56	Agency—Powerad Co.
CINEMA ENGINEERING CO. 108	Agency—R. L. Power	KESTER SOLDER CO. 58	Agency—Keystone Products Co.	TEL-RAD MFG. CO. 186	Agency—Sander Rodkin Adv. Agency
CLARK CRYSTAL CO., INC. 195	Agency—Robert Hartwell Gabine Adv.	KEYSTONE PRODUCTS CO. 113	Agency—Conti Advertising Agency, Inc.	TEMPER MANUFACTURING CO. 189	Agency—Burton Browne Adv.
CLAROSTAT MFG. CO., INC. 45	Agency—Austin C. Lescarbourea & Staff	KIERULFF ELECTRONICS INC. 185	Agency—Kings Electronics Co., Inc.	TEXAS INSTRUMENTS INC. 131	Agency—Don L. Baxter, Inc.
CLEVELAND CONTAINER CO. 20	Agency—Nesbitt Service Co.	KINGS ELECTRONICS CO., INC. 5	Agency—Howard Advertising Associates, Inc.	THOMSON ENGINEERING SERVICE 202	Agency—Meldrum & Fawcsmith, Inc.
CLIFFARD INSTRUMENT LABORATORY 44	Agency—S. C. Baer Co.	KLEIN & SONS, MATHIAS 130	Agency—Buchen Co.	TINNERMAN PRODUCTS, INC. 23	Agency—Meldrum & Fawcsmith, Inc.
COAXIAL CONNECTOR CO. 199	Agency—Friend, Krieger & Rader, Inc.	KNIGHTS CO., JAMES 150	Agency—Kenneth B. Butler & Associates	TRANSCOIL CORP. 6	Agency—Horry P. Bridge Co.
COLLINS RADIO CO. 199	Agency—W. D. Lyon Co.	LANGVIN MANUFACTURING CORP. 151	Agency—George Homer Martin Assoc.	TRANSRADIO LTD. 178	Agency—Reynell & Son, Ltd.
COMMUNICATION ACCESSORIES CO. 198	Agency—Carl Lawson Advertising Co.	LEE LABORATORIES 154	Agency—Weber, Geiger & Kalat, Inc.	TRIAD TRANSFORMER CORP. 134	Agency—Mann Advertising Co., Inc.
CONTINENTAL CARBON, INC. 183	Agency—Nicholas Masso Adv. Agency	LELAND CO., G. H. 48	Agency—Western Advertising Agency, Inc.	TRUSCON STEEL DIV., REPUBLIC STEEL CORP. 34	Agency—Meldrum & Fawcsmith, Inc.
CORNING GLASS WORKS 187	Agency—Charles L. Rumrill & Co., Inc.	LIBRASCOPE, INC. 180	Agency—Aitkin-Kynatt Co.	TUNG-SOL ELECTRIC INC. 40, 41	Agency—E. M. Freystadt Assoc., Inc.
CROSBY ENTERPRISES, BING 50	Agency—Parrell Co.	MALLORY & CO., INC., P. R. 21	Agency—Aitkin-Kynatt Co.	U.M. & F. MANUFACTURING CORP. 188	Agency—Frank M. Smaildome Adv.
CUBIC CORP. 157	Agency—Francis C. Charles Adv.	MAY ENGINEERING CO. 202	Agency—Aitkin-Kynatt Co.	UNGAR ELECTRIC TOOLS INC. 204	Agency—Stiller-Rouse Adv.
CUNNINGHAM, SON & CO., INC., JAMES DAGE ELECTRIC CO., INC. 185	Agency—Jim Bradford Advertising Agency	MEASUREMENTS CORP. 206	Agency—Frederick Smith Advertising Agency	UNION SWITCH & SIGNAL DIV. WESTINGHOUSE AIR BRAKE CO. 42	Agency—Batten, Barton, Durstine & Osborn, Inc.
DALE PRODUCTS, INC. 154	Agency—Ayles and Associates, Inc.	MELPAR, INC. 208	Agency—Lewis Edwin Ryan Adv.	UNITED-CARR FASTENER CORP. 46	Agency—H. B. Humphrey, Alley & Richards, Inc.
DALLONS LABORATORIES, INC. 193	Agency—Harry G. Willis & Associates	MICRODOT DIV., FELTS CORP. 200	Agency—Hicks & Greist of California, Inc.	U. S. ENGINEERING CO. 193	Agency—O. K. Fagan Adv. Agency
DIAMOND MANUFACTURING CORP. 118	Agency—Robert Hartwell Gabine Adv.	MIDLAND MANUFACTURING CO. 133	Agency—R. J. Potts-Calkins & Holden, Inc.	UNIVERSITY LOUDSPEAKERS 26	Agency—George Gero Adv.
DIAMOND MICROWAVE CORP. 119	Agency—Robert Hartwell Gabine Adv.	MILER CO., J. W. 181	Agency—Industrial Advertising Co.	VARFLEX CORP. 105	Agency—Barlow Advertising Agency, Inc.
DUMONT LABS., INC., ALLEN B. 39	Agency—Austin C. Lescarbourea & Staff	MITCHELL INDUSTRIES 202	Agency—F. L. Moseley Co., F. L. 175	VICTOREEN INSTRUMENT CO. 160	Agency—Scheel Adv. Agency
ETHEL-McCULLOUGH, INC. 24	Agency—Conner-Jackson-Walker-McClure Adv.	MOSELEY CO., F. L. 175	Agency—John S. Morris	WALKERT CO. 197	Agency—Western Advertising Agency, Inc.
ELECTRICAL INDUSTRIES 137	Agency—George Homer Martin Associates	MYCALEX CORP. OF AMERICA 164	Agency—George Homer Martin Assoc.	WECKESSER CO. 202	Agency—W. M. Welch Mfg. Co., W. M. 189
ELECTRO DEVELOPMENT CO. 145	Agency—Frank A. Wood Advertising	NATIONAL CO. 167	Agency—John C. Dowd, Inc.	WHITE DENTAL MFG. CO., S. S. 54, 173	Agency—Peterson & Kemper, Inc.
ELECTRO-PULSE, INC. 176	Agency—Electronic Fabricators, Inc. 180	NATIONAL VULCANIZED FIBRE CO. 57	Agency—Harris D. McKinney Inc.	WIEDEMANN MACHINE CO. 22	Agency—Renner Advertisers
ELECTRONIC FABRICATORS, INC. 180	Agency—Gotham Advertising Co., Inc.	NEELY ENTERPRISES 123	Agency—Western Advertising Agency, Inc.	ZOOMAR CORP. 156	Agency—Seymour Kameny Assoc.
ELECTRONIC TUBE CORP. 148	Agency—Harry P. Bridge Co.	N.R.K. MFG. & ENGINEERING CO. 182	Agency—Kraiker & Melan, Inc.		
EQUIPTO DIV., AURORA EQUIPMENT CO. 205	Agency—Arthur R. Mogge, Inc.	OHMITE MANUFACTURING CO. 117	Agency—Fensholt Advertising Agency, Inc.		
ERASER CO., INC. 200	Agency—Richards & Webb, Inc.	ONAN & SONS, D. W. 4	Agency—Groves & Associates		
FAIRCHILD CAMERA & INSTRUMENT CORP. 144	Agency—G. M. Bosford Co.	PANORAMIC RADIO PRODUCTS INC. 194	Agency—Harold Marshall Adv.		

FREED

Sets A NEW
Standard for performance

PRECISION TEST INSTRUMENTS



No. 1040 VACUUM TUBE VOLTMETER. Self contained — A.C. operated. High impedance — wide frequency. For use at audio and supersonic frequencies.



No. 1010A COMPARISON BRIDGE. Self contained — A.C. operated. Ideal for laboratory and production testing of resistors, condensers and inductors.



No. 1020B MEGOHM-METER. DIRECT READING. Self contained—A.C. operated. Electronically regulated supply, 1 megohm to 2 million megohms.



No. 1060 VACUUM TUBE VOLTMETER. A 50 megohm input impedance wide frequency range V.M. for use at audio and supersonic frequencies.



No. 1030 LOW FREQUENCY "Q" INDICATOR. DIRECT READING. Measures "Q" factor of coils, also inductances, distributed capacity, impedances and dielectric loss.



No. 1110A INCREMENTAL INDUCTANCE BRIDGE. For accurate testing of communication and television components under load conditions.

TRANSFORMERS & FILTERS



TOROIDAL INDUCTORS. 60 CPS to 1 MC. Also miniature inductors from 1000 CPS to 100 KC.



MILITARY PULSE TRANSFORMERS. Constructed to MIL - T - 27 specifications. Designed for optimum pulse performance.



MINIATURE AUDIO. Hermetically sealed — constructed in accordance with MIL - T - 27 specifications.



HERMETICALLY SEALED COMPONENTS. Constructed in accordance with MIL - T - 27 specifications.



PRECISION FILTERS. 10 CPS to 1 MC.



HIGH FIDELITY. 1/2 DB
20 CPS to 30 KC.

COMPLETE CATALOG ON REQUEST
FREED TRANSFORMER CO., INC.
1726 Weirfield St.
Brooklyn (Ridgewood) 27, N. Y.

INDUSTRY NEWS

Frank W. Edmonds has been named president of the recently formed Pacific Div. of Burnell and Co., designers and manufacturers of toroidal coils, audio and r-f filters and related networks. He will make his headquarters at the company's new plant, 720-726 Mission St., S. Pasadena, Calif.



F. W. Edmonds



J. R. Butler

James R. Butler has been appointed director of advertising and sales promotion for Magnecord Inc., manufacturers of magnetic tape equipment. Butler was formerly merchandising and eastern sales manager at Raytheon Mfg. Co.

William J. Gagnon has been appointed general sales manager at Bradley Laboratories Inc., New Haven, Conn., manufacturers of dry disc rectifiers and photoelectric cells. Gagnon was formerly national contract manager for Ultrasonic Corp.

Bennett Archambault has been elected president and a director of Stewart-Warner Corp., Chicago, Ill. He was formerly vice-pres. and general manager of the M. W. Kellogg Co.



B. Archambault



R. L. Weber

Ralph L. Weber, secretary of Gramer Transformer Corp., Chicago, has also been named executive vice-pres. Other promotions were Burt Anderson, to vice-pres. in charge of sales and Fred R. Cooper, to vice-pres. in charge of engineering.

engineers ... physicists ... STYMIED?



Have you come to a standstill in your work — future stymied?

Then by all means let us tell you about Melpar and the interesting assignments it can offer qualified men. We're increasing our engineering staff again . . . for the eighth consecutive year — and that means a real "ground-floor opportunity" for you.

We have a variety of challenging project assignments, both military and commercial including the following:

- Data Handling Equipment (magnetic cores, magnetic recording equipment, digital computing techniques, analogue to digital conversion, shaft digitizers)
- Flight Simulation (servomechanisms, pulse, circuitry, electronic cabling)
- High Frequency Antennas
- Audio and Video Circuit Design
- Small Mechanisms Design
- Mechanical Packaging of Electronic Components
- Measuring Techniques and fundamental investigations of the behavior of Mechanical Systems
- Radioactive Tracer Techniques
- Instrumentation and Control Devices (servo, pneumatic and electric control)

A grand future awaits you at Melpar — and pleasant living in the delightful suburbs of the Nation's Capital. Write us today for personal interview in your locality.

Address Personnel Director

melpar
INCORPORATED

440 Swann Avenue
Alexandria, Virginia
or Galen Street
Watertown, Mass.

A SUBSIDIARY OF THE
WESTINGHOUSE AIR BRAKE CO.

TELE-TECH & Electronic Industries

CALDWELL-CLEMENTS, INC. 460 Lexington Avenue, New York 17, N. Y.



PLaza 9-7880

Hoffman

LABORATORIES, INC.

IS MOBILIZED TO GET THINGS DONE

RESEARCH

DESIGN

DEVELOPMENT

PRODUCTION

For more than a decade the personnel and facilities of Hoffman Laboratories have been *getting things done* for its military and civilian customers.

Hoffman is engaged in projects covering every phase of electronics. These include the anticipation of future needs, the development of quality electronic products to meet them, and the actual production of equipment as specified by the armed forces.

At Hoffman, project development is closely integrated with production. This means that each new product is developed with the practical problems of quantity production in mind—so that at the moment the first prototype is ready for testing, the production department is well advanced in plans for actual production. This close integration means that Hoffman products arrive at the manufacturing point designed, developed and ready for production.



WEST

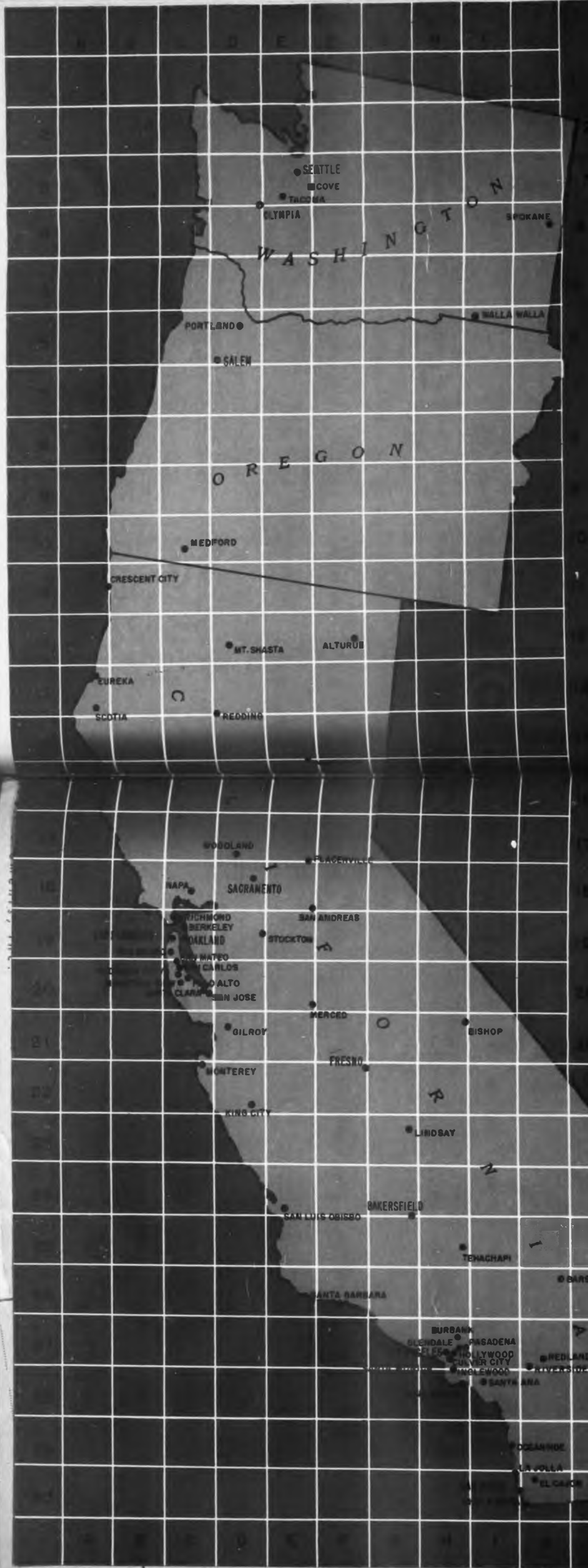

- Acme Camera 2704 W Olive Burbank J Kiel VI 9-3144 N-27
- Acme Electric 1375 W Jefferson Los Angeles RE 4-3194 M-27
- Acme Electronics 2724 Peck Monrovia R D Mallock DO 6-2135 I-27
- Acousti-Craft 48 E San Jose Burbank TM 8-7682 M-27
- Acra Instruments 168 Vista Pasadena R E Frazier RV 1-7646 M-27
- Adel Div General Metals Burbank C A Kehle ST 7-2611 N-27
- Advance Elec & Relay 2435 N Naomi Burbank G Wagner VI 9-1446 M-27
- Aero-Coupling 3015 Winona Burbank VI 9-3101 M-27
- Aero Instr 11423 Vanowen N Hollywood HP Studt ST 7-5433 N-27
- Aerosemic Mfg 2015 Pentius Los Angeles L E Bissell AR 3-0634 M-27
- Airborne Electronics Van Nuys L W Cannon ST 5-3867 M-27
- Aircraft Armaments Pomona R G Hill LY 9-6414 I-27
- AIRResearch Mfg 9851 Sepulveda Ln Angls W Ramser OR 8-3942 M-27
- Ajax Condenser 10905 Chandler N Hwy W Krausich ST 7-1385 M-27
- Allied Elect 425 Brannan San Francisco E Crandall EX 2-0215 C-19
- Allied Record 1041 N Las Palmas Hwy S Salzman HO 9-5107 M-27
- Allied Recrd 1041 N Las Palmas Hollywood M Dike HO 2-1251 M-27
- Allroy Die Casting 2211 Firestone Ln Angls C Scott LO 5-7411 N-27
- Alpha Radio & TV 330 W Bway Long Beach H Putnam 7-4716 M-27
- Algar Mfg Redwood City C R Parmenter EM 8-4701 M-27
- Altec Lansing 9356 S Monica Bvly Hills J Hilliard BR 2-6356 M-27
- Amolec 2040 Colorado Santa Monica Glenn Carlson EX 3-7281 M-27
- American Dia 11858 Miss Ln Angls F Christian AR 7-5627 M-27
- American Elec Mfrs 4811 Telegraph Ln Angls J Serafin AN 9-7551 M-27
- American Electronics 2040 Colorado Santa Monica EX 3-7281 M-27
- American Electronic 9503 W Jfrn Culver City M Steele YE 0-5581 M-27
- American Gyro 1509 Colorado Santa Monica R Benson EX 5-6755 M-27
- American Melle 1800 Rosecranz Mhntn Beh E Roberts OR 8-7631 M-27
- American Microphone 370 S Fr Oks Pasadena J Brown RY 1-7444 I-27
- American Vacuum 11779 S Monica W Ln Angls R Halle AR 9-6212 H-27
- Ampex Corp 934 Charter Redwood City Walter Seasted EM 8-1471 C-20
- Ampex Ldshkr 6915 Farmdale N Hollywood J Revenstine ST 7-6057 M-27
- Anahelm Div Robertshaw-Fulton Anaheim T M Jeffers KE 5-8151 M-27
- Anglo Computer 1709 Standard Glendale R Wallace CH 5-2983 M-26
- Annia Co 6570 Telegraph Los Angeles R D Randall RA 3-4547 M-27
- Applied Electrics 1246 Folsom San Franc S Konigsberg MA 1-2634 C-19
- Applied Physics 362 W Colorado Pasadena R Vaniman RY 1-7423 M-27
- Applied Research Labs Box 1710 Glendale R Lindhurst CH 5-2688 M-26
- Arkay Prods 4111 W Jefferson Los Angeles PI 3-2621 M-27
- Audio Products 2265 Westwood Los Angeles D Kinsey BR 2-4266 M-27
- Avery Adhesive Label 1616 S Calif Monrovia J Lockridge RY 1-5237 M-27
- Aves Electric 2010 S Westgate Los Angeles F D Aves BR 2-2958 M-27
- Avia Products 7266 Beverly Los Angeles A C Pearson YO 7-295 M-27
- Avionex Electronics 2838 N Naomi Brnkn L Davidson VI 9-3814 M-27
- Babcock Radio 7942 Woodley Van Nuys B V Deltour ST 5-8648 M-27
- Background Engrs 7313 Santa Monica Hwy W Tillisch HO 5-4161 M-27
- Barwell & McAllister 2950 N Ontario Burbank J Bogue VI 9-2341 M-27
- Baughman E J 350 S Central Los Angeles E C Baughman MA 9-1403 M-27
- Beckman Instruments 820 Mission S Pasadena A Beckman PY 1-2141 M-27
- Beckman & Whitley 985 San Carlos San Carlos E Whitley LY 3-7824 C-20
- Bender Co 1011 Venice Los Angeles DU 7-6995 M-27
- Bendix Av Pac Div 11600 Sherman N Hwy W Litch ST 7-2651 M-27
- Bendix Comp Div 5630 A Vitae Los Angeles J Williams OR 8-2128 M-27
- Bennett Labs 2700 Bay Rd Redwood City A E Bennett EM 6-6845 C-20
- Bennett Products P O Box 1055 Palo Alto T Tarrar DA 2-2119 C-20
- Benson-Lahner 2340 Sawtelle Los Angeles M J Bonds BR 2-4629 M-27
- Berkly Div Beckman Instr 2200 Wright Richmond J Gordon LA 6-7730 C-19
- Berkly Div Beckman Instr 2300 North Berkeley J Wink JH 4-1100 C-19
- Bircher Corp 4371 Valley Los Angeles A G Baboux CA 2-9101 M-27
- Bodde Servan 8829 Venice Los Angeles B M Bodde YE 0-3277 M-27
- Boeing Airplane Seattle 14, Wash K C Gordon MO 3333 E-3
- Bon-Air 711 S Victory Burbank N L Behman VI 9-3001 M-27
- Bone Eng's 701 W Bway Glendale P E Alpino CH 5-2638 M-26
- Booth Arthur E 265 S Alexandria Los Angeles W Stewart DU 9-4863 M-27
- Borns Labs 6135 Magnolia Riverside M E Harrison 7290 J-27
- Brown Electronics 12450 W Washington Vanies J E Brown 7-2156 M-27
- Brubaker Mfg 9151 Exposition Los Angeles S F Arn TE 0-6441 M-27
- Burnett Radio Lab 4818 Idaho San Diego W L Burnett AT 2-2740 J-30
- Burton Mfg 11201 W Pico Los Angeles W B Warren RA 2-3445 M-27
- Calbest Eng's 828 N Highland Hollywood M Fremont HO 3-2119 M-27
- Calif Chassis 5445 Centary Lynwood RE 6-7777 M-27
- Calif Computer Prods 3927 W Jefferson Los Angeles RE 8355 M-27
- Califone Corp 1041 N Sycamore Hollywood R G Metzner HO 2-2353 M-27
- Calif Electronics 21332 Ventura Woodland Hills DI 8-1558 D-18
- Calif Magnetic Cntrl 7245 Atoll N Hwy M Hornlehel ST 7-5927 M-27
- Calrean Corp 4543 Brazil Los Angeles W C Lockwood M-27
- Caltech Electrics 8930 Lindblade Civr Cty F Miller YE 0-5745 M-27
- Cal-Tronics Corp 11307 Hindry Los Angeles Ray Floyd OR 1-7694 M-27
- Caltron Products 1310 S Hobart Los Angeles L Klein RE 4-6144 M-27
- Calvideo Tube 5232 W 104 Los Angeles Ringo Shima OR 8-3979 M-27
- Cannon Electric 3209 Humboldt Ln Angls Roger Bowen CA 5-1251 M-27
- Canoga Corp 5955 Sepulveda Van Nuys G H Wibbe ST 5-8694 M-27
- Capitol Records 5515 Melrose Hollywood E H Enche HO 3-7114 M-27
- Carad Corp 2850 Bay Rd Redwood City N Kovalevski EM 8-4846 C-20
- Carrothers & Fernandez 1501 Clrdo S Monica F Fernandez EX 4-6768 H
- Cascade Msrch 53 Victory Ln Los Gatos D Caswell EL Gato 4-1305 D-20
- Cntrl Electrics 4875 San Fernando W Los Angls F Fisher CM 5-3611 M-27
- Century Electronics 14844 Oxnard Van Nuys A Pratt ST 7-1178 M-27
- C & N Supply Boeing Field Seattle 8 Wash RA 8111 E-3

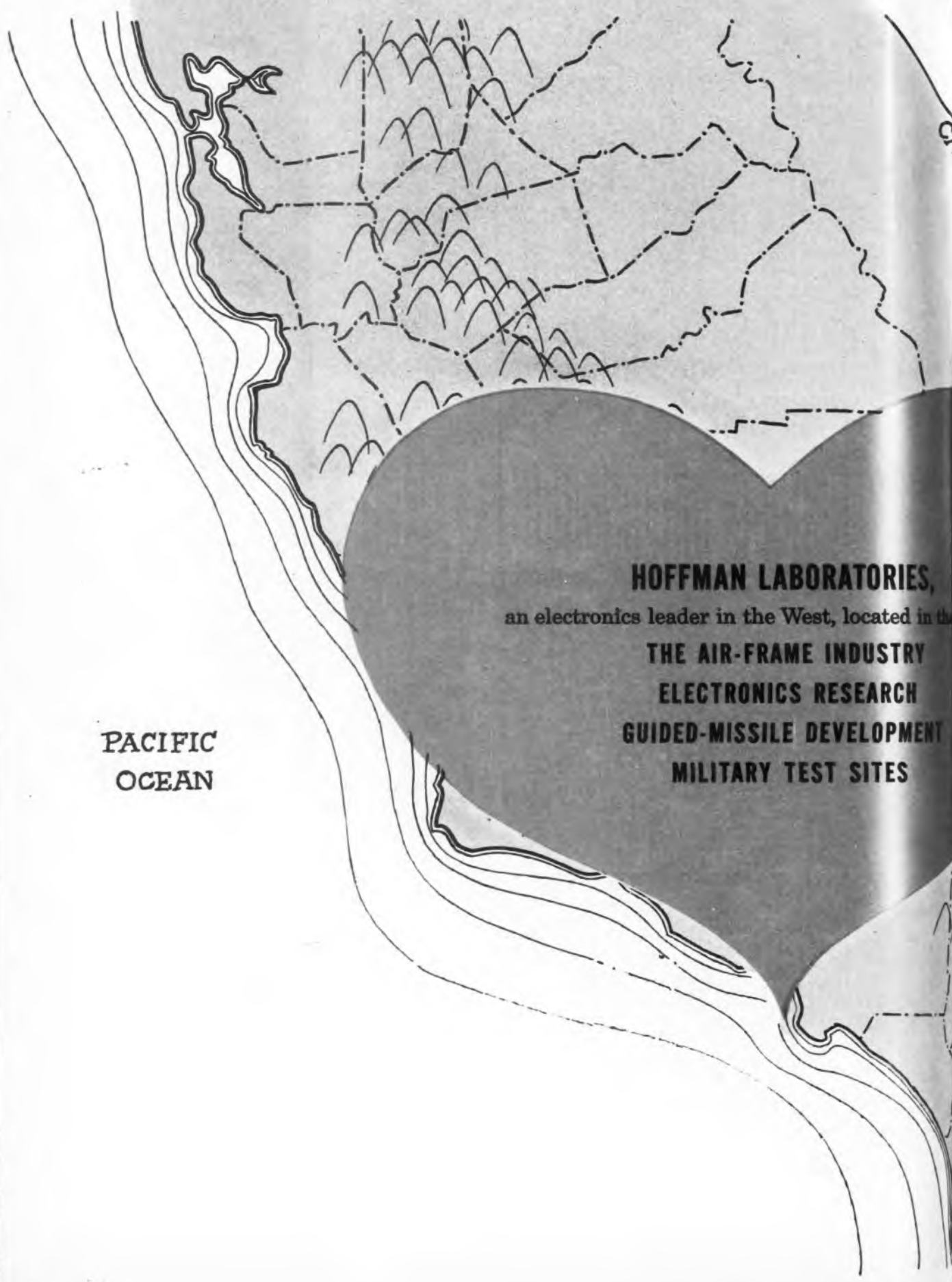

NEV.
CALIF.

PACIFIC
OCEAN

HOFFMAN LABORATORIES,

an electronics leader in the West, located in the heart of:

- THE AIR-FRAME INDUSTRY**
- ELECTRONICS RESEARCH**
- GUIDED-MISSILE DEVELOPMENT**
- MILITARY TEST SITES**

NEW
FALIE.

Getting things done . . . where they're needed most!

Since early in World War II, Southern California has become a center of the electronics industry in the United States. Hoffman Laboratories, a western leader and pioneer in this vital field, has grown and expanded with the industry.

Today, Hoffman personnel and the facilities of five Hoffman plants in Los Angeles are geared to meet the requirements of civilian and military users of electronic equipment. And Hoffman has the advantage of being located right in the area where this equipment will be used.

By co-ordinating research, design, development and production with the research centers and air-frame plants of the West and with nearby military installations and test sites, Hoffman Laboratories *gets things done* exactly how, where and when they're needed.



Hoffman
LABORATORIES, INC.

OPPORTUNITY FOR ENGINEERS

The constant expansion of Hoffman Laboratories means many unusual and challenging opportunities for outstanding electronic and mechanical engineers. These are permanent positions in the Los Angeles area. For information, send resume to: Director of Engineering, Hoffman Laboratories, Inc., 3761 South Hill Street, Los Angeles 7, California.

Applications are not solicited from those engaged in vital defense activities.

- **RADAR**
- **SONAR**
- **GUIDED-MISSILE CONTROLS**
- **COUNTERMEASURES**
- **FIRE-CONTROL APPARATUS**
- **NOISE REJECTION**
- **COMMUNICATIONS**
- **NAVIGATION EQUIPMENT**
- **COMPUTERS**

Hoffman Laboratories military projects have a wide scope. Hoffman has won national recognition for contributions made in developing communications equipment ranging from heavy transmitter-receivers to miniature transceivers employed in missile guidance.

The Navy pilot flying high above the clouds relies on his Hoffman-produced airborne navigation gear to compute the exact distance and direction to his carrier. Hoffman developments in underwa'er devices include sonar countermeasures. And Hoffman has made world-famous advances in the field of noise rejection.

These and many more contributions to our national security are dramatic evidence that now, as always, Hoffman Laboratories *gets things done.*

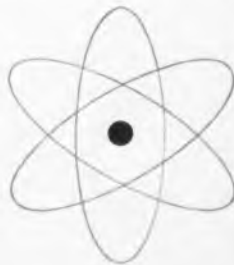

Hoffman
LABORATORIES, INC.





FREED

Sets A NEW Standard for performance

PRECISION TEST INSTRUMENTS

	No. 1000 VACUUM TUBE VOLTMETER. Self contained — A.C. operated. High impedance — wide frequency. For use at audio and supersonic frequencies.
	No. 1010A COMPARISON BRIDGE. Self contained — A.C. operated. Ideal for laboratory and production testing of resistors, condensers and inductors.
	No. 1020B MEGOHM-METER. DIRECT READING. Self contained—A.C. operated. Electronically regulated supply. 1 megohm to 2 million megohms.
	No. 1060 VACUUM TUBE VOLTMETER. A 50 megohm input impedance wide frequency range V.M. for use at audio and supersonic frequencies.
	No. 1030 LOW FREQUENCY "Q" INDICATOR. DIRECT READING. Measures "Q" factor of coils, also inductances, distributed capacity, impedances and dielectric loss.
	No. 1110A INCREMENTAL INDUCTANCE BRIDGE. For accurate testing of communication and television components under load conditions.

TRANSFORMERS & FILTERS

	TOROIDAL INDUCTORS. 40 CPS to 1 MC. Also miniature inductors from 1000 CPS to 100 KC.
	MILITARY PULSE TRANSFORMERS. Constructed to MIL - T - 27 specifications. Designed for optimum pulse performance.
	MINIATURE AUDIO. Hermetically sealed — constructed in accordance with MIL - T - 27 specifications.
	HERMETICALLY SEALED COMPONENTS. Constructed in accordance with MIL - T - 27 specifications.
	PRECISION FILTERS. 10 CPS to 1 MC.
	HIGH FIDELITY. 1/2 DB 20 CPS to 30 KC.

COMPLETE CATALOG ON REQUEST
FREED TRANSFORMER CO., INC.
 1726 Weirfield St.
 Brooklyn (Ridgewood) 27, N. Y.

INDUSTRY NEWS

Frank W. Edmonds has been named president of the recently formed Pacific Div. of Burnell and Co., designers and manufacturers of toroidal coils, audio and r-f filters and related networks. He will make his headquarters at the company's new plant, 720-726 Mission St., S. Pasadena, Calif.



F. W. Edmonds J. R. Butler

James R. Butler has been appointed director of advertising and sales promotion for Magnecord Inc., manufacturers of magnetic tape equipment. Butler was formerly merchandising and eastern sales manager at Raytheon Mfg. Co.

William J. Gagnon has been appointed general sales manager at Bradley Laboratories Inc., New Haven, Conn., manufacturers of dry disc rectifiers and photoelectric cells. Gagnon was formerly national contract manager for Ultrasonic Corp.

Bennett Archambault has been elected president and a director of Stewart-Warner Corp., Chicago, Ill. He was formerly vice-pres. and general manager of the M. W. Kellogg Co.



B. Archambault R. L. Weber

Ralph L. Weber, secretary of Gramer Transformer Corp., Chicago, has also been named executive vice-pres. Other promotions were Burt Anderson, to vice-pres. in charge of sales and Fred R. Cooper, to vice-pres. in charge of engineering.

engineers ... physicists ... STYMIED?



Have you come to a standstill in your work — future stymied? Then by all means let us tell you about Melpar and the interesting assignments it can offer qualified men. We're increasing our engineering staff again . . . for the eighth consecutive year — and that means a real "ground-floor opportunity" for you.

We have a variety of challenging project assignments, both military and commercial including the following:

- Data Handling Equipment
(magnetic cores, magnetic recording equipment, digital computing techniques, analogue to digital conversion, shaft digitizers)
- Flight Simulation
(servomechanisms, pulse, circuitry, electronic cabling)
- High Frequency Antennas
- Audio and Video Circuit Design
- Small Mechanisms Design
- Mechanical Packaging of Electronic Components
- Measuring Techniques and fundamental investigations of the behavior of Mechanical Systems
- Radioactive Tracer Techniques
- Instrumentation and Control Devices
(servo, pneumatic and electric control)

A grand future awaits you at Melpar — and pleasant living in the delightful suburbs of the Nation's Capital. Write us today for personal interview in your locality.

Address Personnel Director



440 Swann Avenue
Alexandria, Virginia
or Galen Street
Watertown, Mass.

A SUBSIDIARY OF THE
WESTINGHOUSE AIR BRAKE CO.

Do you want more information about

PRODUCTS

advertised in

TELE-TECH

& ELECTRONIC INDUSTRIES

Use the convenient postage-free cards below to get information quickly about products listed here—all advertised in this issue

LEADING MANUFACTURERS

are using space in this issue to acquaint you with their products. Perhaps you want more information on some of them—on one or two, or possibly a score. You can cover all of your needs with the cards below. They are convenient and postage-free.

- | | |
|--|--|
| 101 Adams & Westlake Co.—Mercury relays | 149 Daga Electric Co., Inc.—Connectors |
| 102 Advance Electric & Relay Co.—Relays | 150 Dale Products, Inc.—Miniature power resistors |
| 103 Aerovox Corp.—Metallized-paper capacitors | 151 Dallens Laboratories, Inc.—Ultrasonic cleaning machine |
| 104 Air Associates, Inc.—Engineering | 152 Diamond Manufacturing Corp.—Connectors, test jacks |
| 105 Aircraft Radio Corp.—Navigational equipment | 153 Diamond Microwave Corp.—Microwave products |
| 106 Alden Products Co.—Plug-in components | 154 Dament Labs., Inc., Allen B.—Color TV picture tubes |
| 107 American Electrical Heater Co.—Soldering irons | 155 Eitel-McCullough, Inc.—Reflex klystrons |
| 108 American Lava Corp.—Ceramics | 156 Electrical Industries—Terminals & closures |
| 109 American Phenolic Corp.—Cables & connectors | 157 Electro Development Co.—Slip ring & brush assemblies |
| 110 Ampex Corp.—Tape recorder | 158 Electro-Pulse, Inc.—Pulse Generator |
| 111 Andrew Corp.—Air dielectric cable | 159 Electronic Fabricators, Inc.—Miniature film capacitors |
| 112 Arnold Engineering Co.—Magnetic materials | 160 Electronic Tube Corp.—Oscilloscopes |
| 113 Assembly Products, Inc.—Meter-relays | 161 Equipto Div., Aurora Equipment Co.—Steel shelving |
| 114 Astron Corp.—Capacitors | 162 Eraser Co., Inc.—Wire stripper |
| 115 Audio Devices, Inc.—Magnetic tape | 163 Fairchild Camera & Instruments Corp.—Precision potentiometers |
| 116 Audio Development Co.—Transformers & chokes | 163A Fairchild Recording Equipment Co.—Phono turntable |
| 117 Avery Adhesive Label Corp.—Pressure-sensitive labels | 164 Federal Screw Products, Inc.—Hardware for electronics |
| 118 Bardwell & McAllister, Inc.—TV spots | 165 Ford Instrument Corp.—Precision saws |
| 119 Bendix Aviation Corp., Scintilla Div.—Connectors | 166 Freed Transformer Co., Inc.—Test instruments |
| 120 Berndt-Bach, Inc.—Kinescope recording camera | 167 Gabriel Electronics Div., Gabriel Co.—Antennas |
| 121 Bird Electronic Corp.—R-F wattmeter | 168 Garde Mfg. Co.—Barrier strips |
| 122 Blaw-Knox Co.—Antenna towers | 169 General Electric Co.—Germanium diodes |
| 123 Bodnar Industries, Inc.—Plastic Lighting plates | 170 General Electric Co.—TV slide scanner |
| 124 Bomac Laboratories, Inc.—Reference cavities | 171 General Precision Lab., Inc.—Color TV test equipment |
| 125 Bourne Laboratories—Subminiature potentiometers | 172 General Radio Co.—Vacuum tube bridge |
| 126 Bradley Laboratories, Inc.—Selenium rectifiers | 173 General Transformer Co.—Transformers |
| 127 Burnell & Co., Inc.—Filter networks, toroids | 174 Gertsch Products, Inc.—Microwave frequency multiplier |
| 128 Burroughs Corp.—Pulse equipment | 175 Grant Pulley & Hardware Corp.—Industrial slides |
| 129 Busman Manufacturing Co.—Fuses | 176 Graphite Metallizing Corp.—Brushes contacts |
| 130 Camera Equipment Co.—TV tripods, dollies | 177 Grayhill—Push button switch |
| 131 Cargo Packers, Inc.—Shock-proof packaging | 178 Gudebros., Silk Co., Inc.—Nylon lacing tapes |
| 132 Ceco Distributing Corp.—All-directional dolly | 179 Hart Manufacturing Co.—Hermetically sealed relays |
| 133 Chatham Electronics Corp.—Special-purpose tubes | 180 Helipot Corp.—Free potentiometer manual |
| 134 Chicago Telephone Supply Corp.—Variable resistors | 181 Hemingway & Bartlett Mfg. Co.—Lacing cords & Tapes |
| 135 Cinch Manufacturing Corp.—Miniaturized connectors | 182 Heppner Manufacturing Co.—Magnetic focusing unit |
| 136 Cinema Engineering Co.—Sound effects filter | 183 Hermetic Seal Products Co.—Glass-to-metal seals |
| 137 Clark Crystal Co., Inc.—Crystals | 184 Hewlett-Packard Co.—Signal generators |
| 138 Clarostat Mfg. Co., Inc.—Miniaturized controls | 185 Hoffman Radio Corp.—Engineering, Engineering personnel |
| 139 Cleveland Container Co.—Phenolic tubing | 186 Houston Fearless Corp.—TV film processor |
| 140 Clippard Instrument Laboratory—Aids to automation | 187 Hubbell Inc., Harvey—Multimeters |
| 141 Coaxial Connector Co.—Coaxial connectors | 188 Hughes Aircraft Co., Semiconductor Sales Div.—Germanium diodes |
| 142 Collins Radio Co.—Broadcast equipment | 189 Hughes Research & Development Labs.—Engineering personnel |
| 143 Communication Accessories Co.—Engineering personnel | 190 Hydro-Aire Inc.—Transistors |
| 144 Continental Carbon, Inc.—Metal film resistors | |
| 145 Corning Glass Works—Capacitors, insulators | |
| 146 Crosby Enterprises, Bing—Tape recorder, distributor | |
| 147 Cubic Corp.—VSWR instrumentation system | |
| 148 Cunningham, Son & Co., Inc., James—Crossbar switch | |

Listings continued on next page ▶▶▶

Use these postage-free cards to get further information



Write in boxes the code numbers of products for which you want information. See list above and on next page.

--	--	--	--	--	--	--	--

Your company

Address

Your name

Your title

TELE-TECH—AUGUST 1954

CALDWELL-CLEMENTS, INC., 480 Lexington Avenue, New York 17

INQUIRY CARD Not good after Oct. 1, 1954

Write in boxes the code numbers of products for which you want information. See list above and on next page.

--	--	--	--	--	--	--	--

Your company

Address

Your name

Your title

TELE-TECH—AUGUST 1954

CALDWELL-CLEMENTS, INC., 480 Lexington Avenue, New York 17

INQUIRY CARD Not good after Oct. 1, 1954

PRODUCT INFORMATION?

If that is what you need, use the cards below to get it quickly, through . . .

TELE-TECH
ELECTRONIC INDUSTRIES

Listings continued from preceding page

- | | |
|--|--|
| <p>191 Industrial Hardware Mfg. Co., Inc.—Sockets, terminal strips, anode connectors
192 Industrial Test Equipment Co.—Power oscillator
193 International Resistance Co.—Wire wound resistors
194 Jennings Radio Mfg. Corp.—Vacuum capacitors
195 Johnson Co., E. F.—Pilot lights
196 Johnson Co., E. F.—Tip jacks
197 Jones Div., H. B., Cinch Mfg. Corp.—Plugs & Sockets
198 Kahle Engineering Co.—Manufacturing equipment
199 Kay Electric Co.—Test Instruments
200 Kay-Lab., Inc.—TV-telephone intercom
201 Kellogg Switchboard & Supply Co.—Magnetic impulse counter
202 Kenyon Transformer Co.—Transformers
203 Kester Solder Co.—Solder
204 Keystone Products Co.—Custom transformers
205 Kiersiff Electronics Inc.—Electronic components & equipment
206 Kings Electronics Co., Inc.—Connectors
207 Klein & Sons, Mathias—Pliers for electronics
208 Knights Co., James—Crystals
209 Langevin Manufacturing Corp.—Transformers
210 Leo Laboratories—Glass R. F. components
211 Leland Co., G. H.—Rotary solenoids
212 Librascope, Inc.—X-Y plotter & recorder
213 Mallory & Co., Inc., P. R.—Capacitors
214 May Engineering Co.—Delay line
215 Measurements Corp.—Test equipment
216 Melpar, Inc.—Engineering personnel
217 Microdot Div., Felts Corp.—Coax connectors
212A Midland Manufacturing Co.—Crystals for color TV
213A Miller Co., J. W.—Miniature I.F. transformer
214A Mitchell Industries—Solder iron
215A Moseley Co., F. L.—Graphic recorder
216A Mycalex Corp. of America—Printed circuit tube sockets
217A National Co.—Popular dials & knobs
218 National Vulcanized Fibre Co.—Laminated plastic products
219 Neeley Enterprises—Engineering
220 N.R.K. Mfg. & Engineering Co.—Microwave assemblies
221 Ohmite Manufacturing Co.—Encapsulated resistors
222 Onan & Sons, D. W.—5KW engine-generator
223 Panoramic Radio Products, Inc.—Spectrum analysers
224 Phale Plastics Corp.—Microphone cables, power supply cords
225 Phasotron Co.—Panel instruments
226 Phelps Dodge Copper Products Corp.—Coaxial cable
228 Philco Corp.—TV remote pickup equipment
229 Radio Corporation of America—TV broadcast manual
229 Phillips Control Corp.—Relays
230 Polarad Electronics Corp.—Microwave signal generators
231 Polytechnic Research & Development Co.—Microwave test components
232 Ponder & Best—TV lenses
233 Precision Paper Tube Co.—Coil bobbins
234 Presto Recording Corp.—Recording discs
235 Prodolin Inc.—Coaxial transmission lines, towers
236 Pyramid Electric Co.—MIL capacitors
237 Radio Corporation of America—UHF, color TV tubes</p> | <p>238 Radio Corporation of America—Deflection yokes, flybacks
239 Radio Corporation of America—TV broadcast manual
240 Radio Materials Corp.—Disc capacitors
241 Raypar Inc.—Transformers for printed circuits
242 Raytheon Manufacturing Co.—Microwave for color TV
243 Reeves Hoffman Corp.—Crystals
244 Rust Industrial Co., Inc.—Remote control system
245 Sampson Chemical & Pigment Corp.—Free handbook of radioactive materials
246 Sarkes Tarzian Inc.—Selenium rectifiers
247 Shallcross Manufacturing Co.—Wheatstone bridges
248 Shallcross Manufacturing Co.—Encapsulated resistors
249 Shure Brothers, Inc.—Broadcast microphone
250 Sigma Instruments, Inc.—Relays
251 Solar Manufacturing Co.—Capacitors
252 Specific Products Co.—Changeable chassis
253 Sprague Electric Co.—Precision resistors
254 Sprague Electric Co.—Ceramic capacitors
255 Stainless, Inc.—Broadcast towers
256 Standard Piezo Co.—Crystals
257 Stoddart Aircraft Radio Co.—R-F measuring equipment
258 Stone Paper Tube Co.—Paper tubing
259 Stupakoff Ceramic & Manufacturing Co.—Glass-to-metal seals
260 Switchcraft, Inc.—Switches, jacks
261 Sylvania Electric Products, Inc.—Planar triodes
262 Sylvania Electric Products, Inc.—Sockets
263 Synthane Corp.—Laminated plastics
264 Technology Instrument Corp.—Video phase meter
265 Telechrome Inc.—Video test equipment
266 Tel-Rad Mfg. Co.—Deflection yokes
267 Tempel Manufacturing Co.—Magnetic steel laminations
268 Texas Instruments Inc.—Semiconductors
268A Thomson Engineering Service—Sales engineering
269 Tinnerman Products, Inc.—Metal fastenings
270 Transicoll Corp.—Servo components
271 Transradio Ltd.—Coaxial cable
272 Triad Transformer Corp.—Transformers
273 Truscon Steel Div., Republic Steel Corp.—Antenna towers
274 Tung-Sol Electric Inc.—TV receiving tubes
275 U. M. & F. Manufacturing Corp.—Expandable chassis
276 Ungar Electric Tools Inc.—Soldering irons
277 Union Switch & Signal Div., Westinghouse Air Brake Co.—Railroad signaling systems
278 United-Carr Fastener Corp.—Electrical assemblies
279 U. S. Engineering Co.—Printed circuits
280 University Loudspeakers—Loudspeaker
281 Varflex Corp.—Insulating tubing & sleeving
282 Victoreen Instrument Co.—VSWR instrumentation system
283 Walkirt Co.—Delay multivibrator
284 Weckesser Co.—Plastic cable clips
285 Welch Mfg. Co., W. M.—Vacuum pump
286A White Dental Mfg. Co. S. S.—Crystal manufacturing equipment
287 Wiedemann Machine Co.—Color TV chassis
288 Zoomar Corp.—Special purpose lenses for TV</p> |
|--|--|

MAIL CARD
TODAY



NOT GOOD AFTER
OCT. 1, 1954

TELE-TECH & ELECTRONIC INDUSTRIES

480 LEXINGTON AVENUE

NEW YORK 17, N. Y.

FIRST CLASS
PERMIT No. 22273
(Sec. 34.9, P.L.&R.)
NEW YORK, N.Y.

BUSINESS REPLY CARD

NO POSTAGE STAMP NECESSARY IF MAILED IN UNITED STATES

POSTAGE WILL BE PAID BY

TELE-TECH

& ELECTRONIC INDUSTRIES

480 LEXINGTON AVENUE
NEW YORK 17, N. Y.

Caldwell-Clements, Inc.

FIRST CLASS
PERMIT No. 22273
(Sec. 34.9, P.L.&R.)
NEW YORK, N.Y.

BUSINESS REPLY CARD

NO POSTAGE STAMP NECESSARY IF MAILED IN UNITED STATES

POSTAGE WILL BE PAID BY

TELE-TECH

& ELECTRONIC INDUSTRIES

480 LEXINGTON AVENUE
NEW YORK 17, N. Y.

Caldwell-Clements, Inc.

Bomac

REFERENCE CAVITIES



Bomac has developed a line of high-precision Reference Cavities covering six different frequencies. Essentially, Bomac cavities are fixed-frequency, vacuum-sealed, transmission-type tubes. They are used primarily as frequency determining references, and frequency stabilizers in radar beacon applications. The performance and stability of Bomac Reference Cavities over a wide range of temperatures is far superior to many other commercial cavities. Stability of the resonant frequency is maintained under severe conditions of shock and vibration by a unique cushioning arrangement that prevents excessive movement of the tube within the block.

CHARACTERISTICS AND RATINGS OF 1Q23 RESONANT CAVITY

RESONANT FREQUENCY (mc)	9280 ± 0.5 mc
VIBRATION 10 G's	± 0.1 mc
SHOCK 50 G's	± 0.1 mc
AVERAGE Q	2100
INSERTION LOSS	4.0 db — 6.0 db
TEMPERATURE COMPENSATION	
Room Temp. to 100° C	± 0.3 mc
Room Temp. to 0° C	± 0.3 mc
Room Temp. to -55° C	± 1.0 mc
ATMOSPHERIC PRESSURE	
To 45 psi (abs.)	± 0.15 mc
To 5 in. hg. (abs.)	± 0.15 mc
ALTITUDE RATING	50,000 ft. (max.)

CAVITIES FOR OTHER FREQUENCIES

1Q22 — 9250 mc	6040 — 9308 mc
1Q24 — 9310 mc	6041 — 9312 mc
5846 — 9280 mc	

MATCHED CAVITIES — For special applications, matched cavities are now available. We invite your inquiries regarding special applications for our reference cavities.

We invite your inquiries regarding

- ENGINEERING
- DEVELOPMENT
- PRODUCTION

Bomac Laboratories, Inc.

BEVERLY, MASSACHUSETTS

GAS SWITCHING TUBES DIODES HYDROGEN THYRATRONS DUPLEXERS—MAGNETRONS
MODULATORS

Catalog on request
Write (on your company letterhead)
Dept. T-8 BOMAC
Laboratories, Inc.
Beverly, Mass.



**INSIST ON
COMPONENTS WITH THE BEST PERFORMANCE
RECORD IN THE INDUSTRY!**



Year after year, most of the successful TV receiver designs use deflection components made by RCA.

RCA deflection yokes and flyback transformers are first choice among leading circuit designers today because their outstanding quality and performance have been proved by satisfactory service in millions of receivers since they first made history in the famous "630" chassis.

The fact is, more yokes and flybacks produced by RCA are in use now than any other make. You'll consistently find them in the industry's "best-sellers".

For information on the latest RCA yokes and flybacks contact your RCA representative at the nearest district office.

(EAST)

Humboldt 5-3900.
415 S. Fifth Street,
Harrison, N. J.

(MIDWEST)

Whitehall 4-2900.
589 E. Illinois Street,
Chicago 11, Ill.

(WEST)

Madison 9-3671.
420 S. San Pedro Street,
Los Angeles 13, Cal.



RADIO CORPORATION of AMERICA
ELECTRONIC COMPONENTS

HARRISON, N. J.