

ELECTRONIC INDUSTRIES

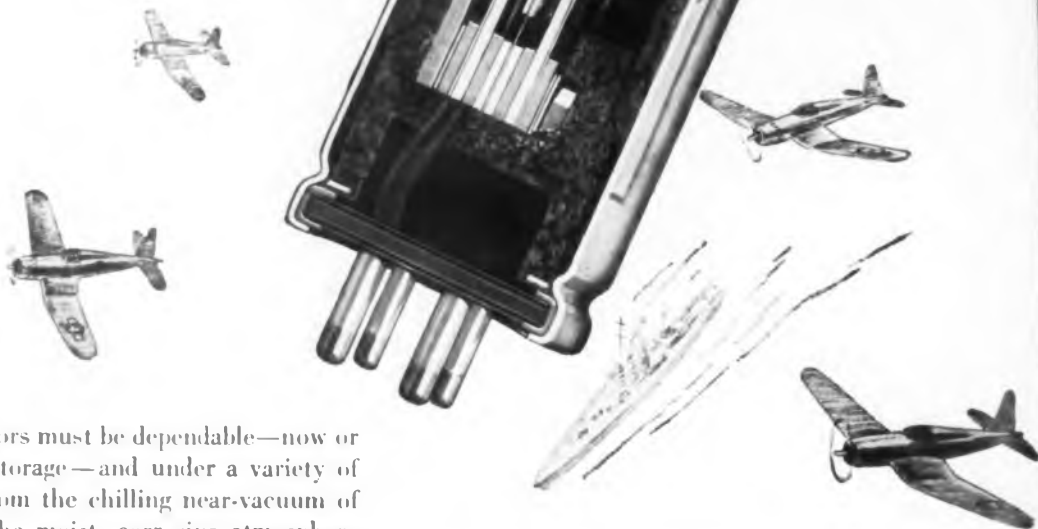

NOV 30 1944

This Vibrator Carries Its Own Air Protection



"FIGHTING" vibrators must be dependable—now or after months of storage—and under a variety of conditions ranging from the chilling near-vacuum of the stratosphere to the moist, corrosive atmosphere of a submarine. Ordinary peacetime vibrators just can't meet these war requirements. Their containers breathe and admit trouble-making fumes. They fail to function in some types of high-altitude aircraft equipment, because lack of internal air pressure causes ionization breakdowns.

That's why this Mallory vibrator is enclosed in a specially designed case, hermetically sealed to keep it air-tight. This is double assurance that fine tungsten contacts and other precision parts will function perfectly under the toughest assignments.

Today, Mallory hermetically sealed vibrators flow from the production line to every battle front. They're used on ships and planes and tanks—and they take their own three cubic inches of normal atmosphere with them. To test this "breathing space," each vibrator is subjected to an internal pressure of twenty pounds per square inch.

If you manufacture receivers or transmitters for wartime use—or any other battery-powered equipment subject to unusual atmospheric stresses—get the complete facts about Mallory hermetically sealed vibrators. See your Mallory distributor, or write direct.

Built to Take Rough Treatment— MALLORY Vibrapack*



Flexible heavy-duty vibrator power supplies, built to take rough handling and to operate under great extremes of heat, cold and humidity. Widely used under war conditions: ideal for peacetime products.

*Vibrapack is the registered trademark of P. R. Mallory & Co., Inc., for vibrator power supplies.

P. R. MALLORY & CO., Inc., INDIANAPOLIS 6, INDIANA

Buy More
War Bonds

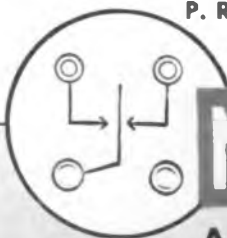

P. R. MALLORY & CO. Inc.
MALLORY

VIBRATORS

AND VIBRATOR POWER SUPPLIES



ELECTRONIC INDUSTRIES

Including INDUSTRIAL ELECTRONICS

★ IN THIS ISSUE DECEMBER, 1944 ★

FRONT COVER	See Page 4	
EDITORIAL	75	
RECORDING TWO VARIABLES—R. K. Hellman	76	
POSTWAR HORIZONS—Roland C. Davies	79	
ELECTRON TUBE DEVELOPMENT	81	
MEASURING POTENTIALS in GROWING THINGS—Dr. Harlan T. Stetson ...	82	
LOW VOLTAGE RECEIVER—Joseph Lorch	86	
FACTORY SHORT CUTS	88	
ENGINEERING PROBLEMS OF PICTURE ENGINEERS	90	
ELECTRONIC EXECUTIVES	94	
ELECTRONIC MAGNETIZER—H. J. Hague	96	
COMMUNICATIONS in COMBAT	97	
X-RAY ADJUSTMENT of QUARTZ PLATES—Dr. C. Frenzel	98	
TUBES on the JOB	101	
TELEVISION SERVICE HINGES on FREQUENCY	102	
TORTURE CHAMBERS	105	
Survey of Wide Reading	106	Television Today
What's New	108	New Patents Issued
Washington News	110	New Books
Association News	112	New Bulletins
ANNUAL INDEX	216	

ORESTES H. CALDWELL, Editor M. CLEMENTS, Publisher

EDITORIAL STAFF—Ralph R. Batcher, consulting editor; Stanley P. McMinn, managing editor; William Moulie, electronic theory and design; Gilbert Sonbergh, industrial applications; Josepha Zentner, Ph.D., patents and foreign reviews; H. L. M. Capron, engineering management relations; E. T. Bennett, editorial records; Charles Dreyer, art director; Carl Buhner, circuit diagrams; Barbara Chasen, layout and production; Roland C. Davies, Washington editor.

READER SERVICE—L. D. Chesson, H. Mirtel; data research, H. Kulik.

CIRCULATION—B. V. Spinetta, circulation director; Subscriptions; list compilation: B. Gollub, M. Groening, B. Ruchaisky, A. Warsaw.

BUSINESS—M. H. Newton, business manager; John Samborn, eastern manager; Richard Fitzpatrick, western manager; O. H. Sutter, New England Manager; Lee Robinson, district manager; N. McAllister, production manager; J. E. Cochran, make-up; E. P. Butler, E. Hekking; W. W. Swigert, credit manager; W. Kenneth Reynolds, M. Feldman, D. Williams, E. Callahan.

CHICAGO MANAGER—R. Y. Fitzpatrick, 201 N. Wells Street, Tel. RAN 9225.

Electronic Industries, December, 1944, Vol. III, No. 12. Regular price per copy 35 cents. Published monthly by Caldwell-Clements, Inc., 450 Lexington Avenue, New York, N. Y. M. Clements, President; Orestes H. Caldwell, Treasurer; M. B. Clements, Assistant Secretary. Subscriptions: United States and possessions, Mexico, Central and South American countries, \$3.00 for one year; \$5.00 for two years; \$6.50 for three years. Canada, \$3.50 per year; \$5.50 for two years; \$7.15 for three years. All other countries \$5.00 a year. Entered as Second Class Matter, September 20, 1943, at the Post Office at New York, N. Y., under the act of March 2, 1879. Copyright by Caldwell-Clements, Inc., 1944. Printed in U. S. A.

CALDWELL-CLEMENTS, INC.—TEL. FLAZA 3-1345—450 LEXINGTON AVENUE, NEW YORK 17, N. Y.

NOV 27 1944

This Vibrator Carries Its Own Air Protection



F"IGHTING" vibrators must be dependable—now or after months of storage—and under a variety of conditions ranging from the chilling near-vacuum of the stratosphere to the moist, corrosive atmosphere of a submarine. Ordinary peacetime vibrators just can't meet these war requirements. Their containers breathe and admit trouble-making fumes. They fail to function in some types of high-altitude aircraft equipment, because lack of internal air pressure causes ionization breakdowns.

That's why this Mallory vibrator is enclosed in a specially designed case, hermetically sealed to keep it air-tight. This is double assurance that fine tungsten contacts and other precision parts will function perfectly under the toughest assignments.

Today, Mallory hermetically sealed vibrators flow from the production line to every battle front. They're used on ships and planes and tanks—and they take their own three cubic inches of normal atmosphere with them. To test this "breathing space," each vibrator is subjected to an internal pressure of twenty pounds per square inch.

If you manufacture receivers or transmitters for war-time use—or any other battery-powered equipment subject to unusual atmospheric stresses—get the complete facts about Mallory hermetically sealed vibrators. See your Mallory distributor, or write direct.

Built to Take Rough Treatment— MALLORY Vibrapack *



Flexible heavy-duty vibrator power supplies, built to take rough handling and to operate under great extremes of heat, cold and humidity. Widely used under war conditions: ideal for peacetime products.

*Vibrapack is the registered trademark of P. R. Mallory & Co., Inc., for vibrator power supplies.

P. R. MALLORY & CO., Inc., INDIANAPOLIS 6, INDIANA

Buy More
War Bonds

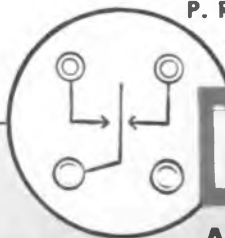

P. R. MALLORY & CO. INC.
MALLORY VIBRATORS
AND VIBRATOR POWER SUPPLIES



ELECTRONIC INDUSTRIES

Including INDUSTRIAL ELECTRONICS

★ IN THIS ISSUE DECEMBER, 1944 ★

FRONT COVER	See Page 4	
EDITORIAL	75	
RECORDING TWO VARIABLES—R. K. Hellman	76	
POSTWAR HORIZONS—Roland C. Davies	79	
ELECTRON TUBE DEVELOPMENT	81	
MEASURING POTENTIALS in GROWING THINGS—Dr. Harlan T. Stetson... ..	82	
LOW VOLTAGE RECEIVER—Joseph Lorch	86	
FACTORY SHORT CUTS	88	
ENGINEERING PROBLEMS OF PICTURE ENGINEERS	90	
ELECTRONIC EXECUTIVES	94	
ELECTRONIC MAGNETIZER—H. J. Hague	96	
COMMUNICATIONS in COMBAT	97	
X-RAY ADJUSTMENT of QUARTZ PLATES—Dr. C. Frondel	98	
TUBES on the JOB	101	
TELEVISION SERVICE HINGES on FREQUENCY	102	
TORTURE CHAMBERS	105	
Survey of Wide Reading	106	Television Today
What's New	108	New Patents Issued
Washington News	110	New Books
Association News	112	New Bulletins
ANNUAL INDEX	216	

ORESTES H. CALDWELL, Editor M. CLEMENTS, Publisher

EDITORIAL STAFF—Ralph R. Batcher, consulting editor; Stanley P. McMinn, managing editor; William Moulie, electronic theory and design; Gilbert Sonbergh, industrial applications; Joseph Zentner, Ph.D., patents and foreign reviews; H. L. M. Capron, engineering management relations; E. T. Bennett, editorial records; Charles Dreyer, art director; Carl Buhner, circuit diagrams; Barbara Chasen, layout and production; Roland C. Davies, Washington editor.

READER SERVICE—L. D. Chesson, H. Mirtel; data research, H. Kulik.

CIRCULATION—B. V. Spinetta, circulation director; Subscriptions; list compilation: B. Gollub, M. Groening, B. Ruchaisky, A. Warsaw.

BUSINESS—M. H. Newton, business manager; John Samborn, eastern manager; Richard Fitzpatrick, western manager; O. H. Sutter, New England Manager; Lee Robinson, district manager; N. McAllister, production manager; J. E. Cochran, make-up; E. P. Butler, E. Hekking; W. W. Swigert, credit manager; W. Kenneth Reynolds, M. Feldman, D. Williams, E. Callahan.

CHICAGO MANAGER—R. Y. Fitzpatrick, 201 N. Wells Street. Tel. RAN 9225.

Electronic Industries, December, 1944. Vol. III, No. 12. Regular price per copy 35 cents. Published monthly by Caldwell-Clements, Inc., 480 Lexington Avenue, New York, N. Y. M. Clements, President; Orestes H. Caldwell, Treasurer; M. B. Clements, Assistant Secretary. Subscriptions: United States and possessions, Mexico, Central and South American countries, \$3.00 for one year; \$5.00 for two years; \$6.50 for three years. Canada, \$3.50 per year; \$5.50 for two years; \$7.15 for three years. All other countries \$5.00 a year. Entered as Second Class Matter, September 20, 1943, at the Post Office at New York, N. Y., under the act of March 2, 1879. Copyright by Caldwell-Clements, Inc., 1944. Printed in U. S. A.

CALDWELL-CLEMENTS, INC.—TEL. PLAZA 3-1348—480 LEXINGTON AVENUE, NEW YORK 17, N. Y.



...WHY

AMPEREX

**WATER and AIR COOLED
TRANSMITTING and RECTIFYING TUBES**

AMPEREX

*... the high
performance
tube*



Amperex engineers have made many important contributions to the refinement of electron tubes. One "Amperextra" of note is the development of a means of assuring positive contact between the plate and wire support. Varying and unreliable high resistance contacts have been eliminated by **clinging and riveting**. And it is this method of joining the plate and its supports that makes for a steady, constant flow of plate current.

The sum total of all "Amperextras" adds up to cost efficiency in broadcasting, industrial, electro-medical and amateur radio applications. An Amperex engineer is available for consultation on your present or postwar problems.

AMPEREX ELECTRONIC CORPORATION



79 WASHINGTON STREET, BROOKLYN 1, NEW YORK

Export Division: 13 E. 40th St., New York 16, N. Y. Cables: "ARLAB"

IN THIS WAR, YOU GIVE WHAT YOU'VE GOT...DONATE A PINT OF BLOOD TO THE RED CROSS TODAY

Stalwart *against* Time

THE REPUTATION of Tobe Capacitors for *long life* rests on a record of practically no "returns". Ratings are always conservative. Constant research . . . manufacturing skill born of long, specialized experience . . . frequent, rigid inspections—these are the "secrets" of Tobe's ability to master difficult specifications, like those of the new American War Standards. The "DP" Molded Paper Capacitor shown below is an example. It is made of high grade Kraft tissue paper and aluminum foil—mineral oil impregnated and molded in low-loss Bakelite. Leads are tin copper wire. Whatever your capacitor problems, Tobe engineers will gladly work with you. Inquiries and requests for samples will receive prompt attention.

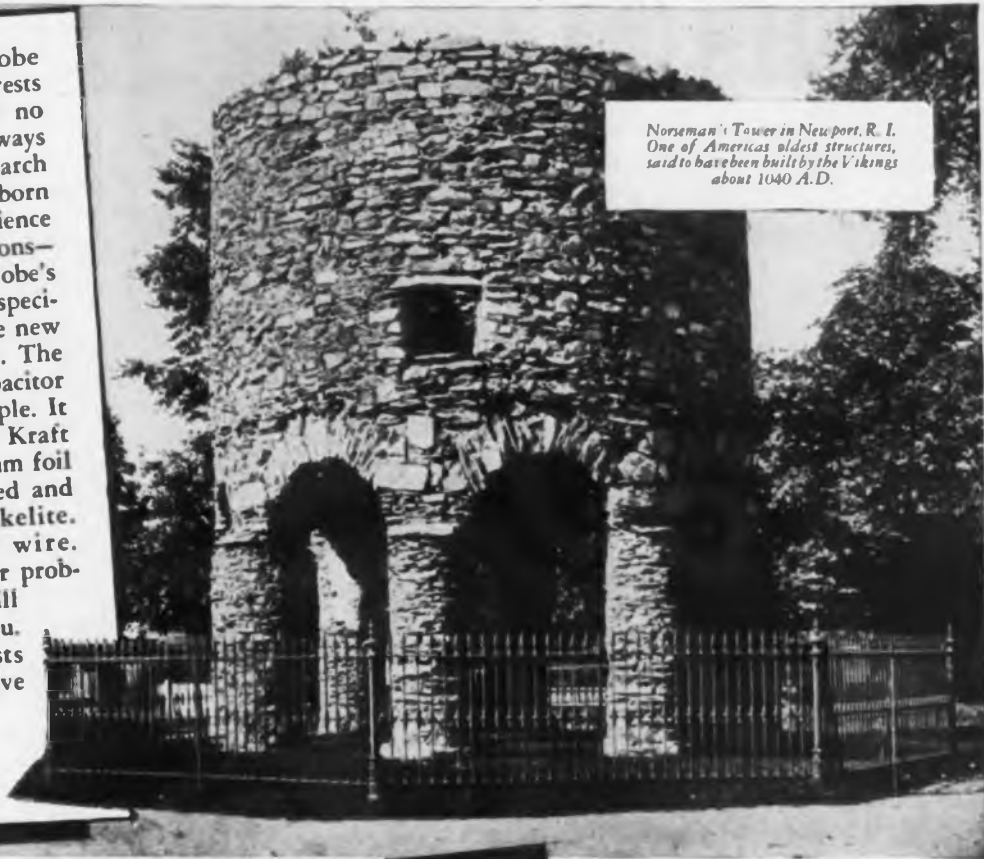

Norseman's Tower in Newport, R. I. One of America's oldest structures, said to have been built by the Vikings about 1040 A.D.

LONG LIFE ASSURED



SPECIFICATIONS "DP" MOLDED PAPER CAPACITORS

CAPACITANCE001 to .04 MFD
 WORKING VOLTAGE See chart at right
 Flash test 3 times rated DC working voltage
 SHUNT RESISTANCE . . . At 185°F— 1000 megohms or greater
 At 72°F—50000 megohms or greater
 WORKING TEMPERATURE RANGE . . . Minus 50° F to plus 185° F
 OPERATING FREQUENCY RANGE . . . Upper limit 40 megacycles
 Q at one megacycle—average 20
 POWER FACTOR At 1000 cycles .004 to .006
 DIMENSIONS 13/16" x 13/16" x 19/64"

Capacity in MMFD	DC Working Voltage Rating	TOBE & AMERICAN WAR STANDARDS DESIGNATIONS	
		"A" Characteristic	"B"
1000	600	CN35A102	CN35B102
1500	600	CN35A152	CN35B152
2000	600	CN35A202	CN35B202
2500	600	CN35A252	CN35B252
3000	600	CN35A302	CN35B302
4000	600	CN35A402	CN35B402
5000	600	CN35A502	CN35B502
6000	600	CN35A602	CN35B602
7000	600	CN35A702	CN35B702
8000	600	CN35A802	CN35B802
10000	400	CN35A103	CN35B103
20000	200	CN35A203	CN35B203
30000	150	CN35A303	CN35B303
40000	100	CN35A403	CN35B403



A SMALL PART IN VICTORY TODAY

A BIG PART IN INDUSTRY TOMORROW

Products of "MERIT"



MERIT COIL & TRANSFORMER CORP.

4427 North Clark St.

CHICAGO 40, ILL.

The Cover

Another application of electronics in industry is pictured in the Kodachrome reproduced on the cover. It was made by Eitel and McCullough's photographer in the Elmac San Bruno plant and shows a 50 mmfd 32,000 volt vacuum capacitor in the final stages of evacuation. The electrodes in the unit are being induction heated to incandescence to drive out occluded gases. Radio frequency energy for this heat treatment is supplied by an oscillator built around a pair of Elmac 450T tubes and a bank of vacuum capacitors. These capacitors, first developed by Elmac in 1938, have found wide application in military, broadcast and other communications transmitters as well as in commercial heating equipment.

Monogrammed Waffles!

"Personally monogrammed waffles are one of the adjuncts of gracious living that can be yours in the postwar world," so reads the lead of an Associated Press story that seems to have made newspapers and magazines around the world, telling about some of the things American inventors have patented recently, as disclosed by the Official Gazette of the U. S. Patent Office.

And believe it or not, the inventor of the monogram waffle-iron is none other than vice-president and general manager, William W. Garstang of Electronic Laboratories, Inc., Indianapolis. The waffle-iron provides the customary ribbed design for the lower plate of the iron, and a novel top section into which individual monogram plugs can be inserted.

Most Mentioned Industry Publication—

In the six-week FCC Allocations Hearings, "Electronic Industries" provided the basis of exhibits more than any other publication, except the Institute of Radio Engineers Proceedings. The "Electronic Industries" Allocation Table was inserted in the record by Dr. W. R. G. Baker, Chairman of the Radio Technical Planning Board, together with his own article in the General Electric magazine for which the editor of "Electronic Industries" had written a foreword. The Television Broadcasters Association's technical witnesses utilized an "Electronic Industries" article on "Radio-wave Propagation" by Dr. Harlan T. Stetson, Director of Massachusetts Institute of Technology's Cosmic Terrestrial Research Laboratory.

FG-235A
—The G-E ignitron
for resistance welding

FG-238B
—The G-E ignitron
for converting a-c to d-c

The
steel-jacketed
sealed ignitron

... another G-E electronic
FIRST!

THE glass ignitron facilitated the application of electronic tubes to high-speed resistance welding and to the conversion of a-c to d-c without the use of rotating equipment. But it was General Electric's development of the sealed, water-cooled stainless-steel envelope or jacket that gave the ignitron the sturdiness that made it practical for industry's use.

Steel, instead of glass, not only gave the ignitron the ruggedness to avoid mishaps from external sources, but, more important, permitted water cooling which enabled tubes to be built that handle ten times the power for a given size of tube.

The present G-E steel-clad ignitron has the newly developed G-E low-current ignitor points that fire accurately and uniformly; that possess longer life and require less power. The G-E steel ignitron also incorporates a new type of anode seal with increased resistance to electrolysis.

As a result of these G-E developments, G-E steel ignitrons offer an exceptionally long life and dependable performance. Their operating costs are lower compared to motor-generator equipment, because of higher efficiency over the entire load range. This efficiency provides appreciable power savings.

Descriptive literature available. G-E electronic tube engineers will be glad to discuss the selection of G-E steel ignitrons for your products or manufacturing processes. Write for Bulletin ET1-12, a convenient listing of all G-E electronic tubes for industrial application. Address *Electronics Department, General Electric, Schenectady, N. Y.*

OTHER G-E TUBES ARE FIRST IN INDUSTRY, TOO! For example, General Electric developed the thyatron tube, which usually teams up with the ignitron where precision control is needed—as in “timing the shots” in high-speed spot welding. The G-E thyatron is also used to maintain constant speed in power tools regardless of variations in load.

Tune in “The World Today” every eve. except Sun. at 6:45 E.W.T., CBS. Sunday listen to G-E “All Girl Orchestra,” 10 P.M. E.W.T., NBC.

G. E. HAS MADE MORE BASIC ELECTRONIC-TUBE DEVELOPMENTS THAN ANY OTHER MANUFACTURER

ELECTRONIC INDUSTRIES • December, 1944

GENERAL  ELECTRIC

101-CB-8930



AAC CRYSTALS

The recognized quality and dependability of AAC quartz crystals is the result of AAC's wide experience as one of America's largest producers of transmitters and other precision radio equipment. AAC quartz crystals and crystal units have proved so outstanding in meeting intricate specifications and exacting requirements that they are today demanded by many of the world's greatest airlines, radio manufacturers, various branches of the armed services and other government agencies.

This practical achievement background—plus AAC's staff of skilled engineers and modern-to-the-minute manufacturing facilities is ready to meet your crystal needs advantageously. Rapid delivery of standard types—also special types, ground and mounted to your specifications.

ELECTRONICS DIVISION
Kansas City, Kansas



WRITE now for your free copy of the new AAC crystal catalog giving detailed facts about AAC quartz crystals and crystal units.





AIRCRAFT
RADIO and
Kansas City, Kans.



PRECISION MADE FOR PRECISE PERFORMANCE

and

PROVED IN USE!



There is no question about AAC crystals meeting the most exacting requirements under severe operating conditions. Their reliability has been tested and proved a thousand times over . . . in battlefront service to the armed forces . . . in helping to keep the communication systems of many leading airlines working efficiently . . . in meeting the quality demands of radio manufacturers. The list of users of AAC crystals shown below is a tribute to the engineering skill and fine manufacturing facilities behind AAC crystals.

Braniff Airways, Inc.
Chicago & Southern Air Lines, Inc.
National Airlines, Inc.
Northwest Airlines, Inc.
Pan American Airways System
Pan American-Grace Airways, Inc.
Pennsylvania-Central Airlines Corp.
Transcontinental & Western Air, Inc.

Colonial Radio Corp.
Columbia Broadcasting System, Inc.
Stewart-Warner Corporation
Western Electric Company, Inc.
Zenith Radio Corporation

Remember, crystal production is only one of AAC's services to the aviation and electronics industries. The production of airborne and ground radio equipment at the rate of more than 30 million dollars yearly for U. S. government and leading airlines demonstrates the wide scope and high rating of AAC manufacturing ability.

E-134

ACCESSORIES CORPORATION

ELECTRONICS

New York, N. Y.

ENGINEERED POWER CONTROLS

Burbank, Calif.

Cable Address: AACPRO



Acadon "B"

Flexible at -100°F and has many of the electrical properties of Polystyrene. Ideal for numerous electrical applications. Write for information on forms now available, and data on physical and electrical properties.

Write Today

Send for complete data giving physical properties of Acadia Polystyrene, plus a table of specifications on its electrical properties.

• For any electrical application, Acadia Polystyrene is the outstanding plastic in the field. Combining highly desirable electrical properties, Acadia Polystyrene offers dielectric strength and power factor superior to any other commercial plastic, and comparing favorably with mica and ceramics.

Compression molded sheets of Acadia Polystyrene have properties superior to sheets fabricated by other methods—no shrinkage at normal temperatures—better heat resistance.

Consider also these additional values: zero water absorption; relative freedom from adverse effects by acids, alkalis,

alcohol, stack gases, weather, etc.; an excellent dielectric constant value, and high tensile strength of 3500 to 5000 lbs. per sq. in. Add to these Acadia's wide experience in the plastics field, and you have the reasons why Acadia Polystyrene merits your investigation.

Complete details are available on request—for quick reference some of Polystyrene's outstanding values are given here:

Dielectric Constant.....	2.5 to 2.6 at frequencies 10 ⁴
Power Factor, 60 cycles.....	.0001 to .0003
10 ⁴ cycles.....	.0001 to .0003
10 ⁶ cycles.....	.0001 to .0008
Dielectric Strength, Volts/Mil 1/8" thickness	Short time 500 to 700
	Step by Step 450 to 600
Volume Resistivity, ohms-cms.....	10 ¹⁷ to 10 ¹⁸
Heat Resistance.....	150° F to 250° F
Softening Point.....	190° F to 250° F
Specific Gravity.....	1.05

ACADIA



Processors of Synthetic
Rubber and Plastics • Sheets
Extrusions • Molded Parts

Synthetic
PRODUCTS

DIVISION WESTERN FELT WORKS

LARGEST INDEPENDENT MANUFACTURERS AND CUTTERS OF FELT
4035-4117 Ogden Avenue • Chicago 23, Illinois • Branch Offices in All Principal Cities



For Your Postwar Needs in Connectors and Related Units

Will coaxial cable connectors, cable plugs or special design parts in this general category, play roles in your postwar products? If so, we suggest you carefully consider both our offerings and exceptional facilities.

Connector Division, in addition to making a representative line of standard units, is uniquely staffed and equipped to serve your needs in this field on a mass production basis.

Our engineers will be happy to consult with you on specific problems or send you more detailed information.

AVAILABLE ON PRIORITY ORDERS

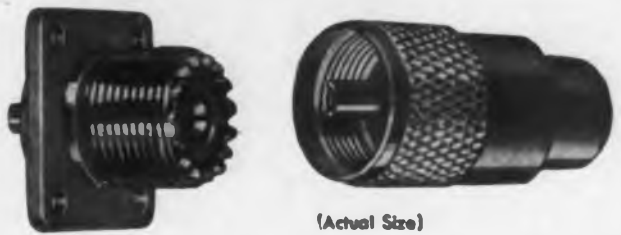

(Actual Size)

U. S. ARMY-NAVY COAXIAL CONNECTORS

Built in accordance with U. S. Army-Navy designs and specifications, these precision units interlock firmly, when coupled, to assure positive, vibration-proof contact. The die cast, zinc housings and other metal parts are heavily silver plated. Contact parts (both pins and sockets) are made of specially tempered spring-brass. Cable plugs and receptacles alike are insulated with low-loss mica filled bakelite. Plugs may be had in either Signal Corps #PL-259, or Navy #C1-49195 models. Connector receptacle #50-392-1 is standard for each of these designs.



Write for Bulletin 4



*CONNECTOR DIVISION OF
INTERNATIONAL RESISTANCE CO.

401 N. BROAD ST., PHILADELPHIA 8, PA.
FORMERLY CONNECTOR CORPORATION

COLONEL JOHN CASEY, Manager,
Chicago Municipal Airport . . .

Colonel Casey said, "The growing complexities of airport traffic make it ever more important that private planes and regular operating passenger aircraft be equipped with up-to-date, reliable two-way radio, if high standards of safety are to be maintained. One important factor is . . ."



"A FOOLPROOF POWER SUPPLY FOR AIRCRAFT RADIO OPERATION"

Colonel Casey, Electronic Laboratories has long been aware of the need for reliable power supplies especially adapted for aircraft use. One of E-L's exclusive developments along this line involves vibrators operating in parallel which assures a reserve power source for extra protection. These Vibrator Power Supplies—both light and heavy duty—are specially designed for complete reliability at very high altitudes.

The life of E-L Vibrator Power Supplies is far beyond the customary overhaul requirement. With these units maintenance time is cut to a minimum—only a small fraction of the time previously required.

Other E-L developments for the aircraft field include units for flashing wing lights and for instrument panel illumination. This equipment has wide application for the light plane field as well as for large aircraft.

The economy and versatility of Vibrator Power Supplies are also available to the marine field—where units have been designed to provide fluorescent lighting, radio-telephone operation and electrical appliance use—as well as many other fields where it is necessary to convert current to specific voltage and type requirements . . . Let E-L engineers consult with you on your power supply problem.

STANDARD POWER SUPPLY MODEL SC-1096

Model SC-1096 is a typical E-L Vibrator Power Supply which meets the requirements of aircraft radio use. This unit was designed for the Canadian Signal Corps to operate radio transmitters. Input voltage: 12 volts DC, or 110-117 volts AC at 50-60 cycles. Output voltage: 2000 volts at 125 ma., 400 volts at 25 ma., 250 volts at 10 ma., 250 volts at 5 ma., 10 volts at 5 amps., 12 volts at 1 amp. Output power: 480 watts. Dimensions: 17" x 12 $\frac{1}{2}$ " x 7 $\frac{3}{4}$ ".



Electronic

LABORATORIES INC.
INDIANAPOLIS

VIBRATOR POWER SUPPLIES FOR LIGHTING, COMMUNICATIONS, AND ELECTRIC MOTOR OPERATION • ELECTRIC, ELECTRONIC AND OTHER EQUIPMENT

**STRONG,
SMOOTH,
STABLE.**

*That's Formica
Pregwood!*

PREGWOOD is a relatively new material possessing many unusual qualities that have adapted it to many uses—such as switch gear in heavy duty switches, picker sticks on textile looms, ski bottoms on military skis.

The test figures shown below indicate the remarkable strength of the material—which has a lower specific gravity than aluminum.

Pregwood has a certain measure of efficiency as an electrical insulator. It is non-absorbent and does not take up moisture. It is chemically inert and can be used for apparatus parts that will be exposed to acids and alkalis.

Changes in humidity have relatively little effect on dimensions; and a low co-efficient of thermal expansion holds the material stable under marked changes in temperature.

It has the quality of wearing smoothly without slivering or cracking. This makes it especially desirable for parts of textile machinery where it will not snag threads of fabrics.

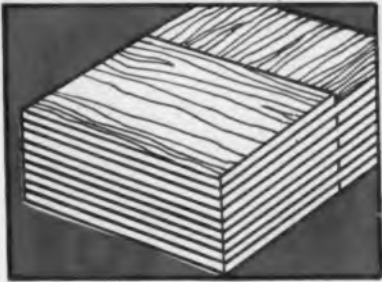

Pregwood is built up by impregnating wood laminations with phenolic resins and pressing them together under heat and pressure. The laminations may be arranged with grain running one direction. This method produces high strength products such as Pregwood 1100.

THE FORMICA INSULATION COMPANY
4647 Spring Grove Avenue
CINCINNATI 32, OHIO

TENSILE STRENGTH

#/sq. in. 30,000

COMPRESSIVE

#/sq. in. 20,000

IZOD IMPACT

Ft. Lbs./In.

Notch Width

PREGWOOD 1100

FLEXURAL

#/sq. in. 48,000

Flatwise

7.0

Edgewise

6.0

Test samples are available on request—

FORMICA



A STRONG STRAIGHT TUBE STANDS MORE ABUSE

When Electronic Tubes give unusually long service under adverse conditions, it is no happy accident. It means that those tubes are properly designed and properly made. One of the problems, especially in the case of miniature tubes, is to build sufficient strength into them and to be sure of perfect assembly.

Tung-Sol engineers, by applying the principles of plane geometry, have helped meet the situation by designing mount assemblies which are supported at three points by straight lead wires from the stem. This assures an absolutely straight assembly of mount and stem, as well as giving the most rugged type of support.

Features like these are the result of the continuous research at TUNG-SOL to produce better Electronic Tubes. The record of TUNG-SOL Tubes in this war has proved the effectiveness of this research. Manufacturers of and users of Electronic Devices and controls will find TUNG-SOL Tubes for transmitting, receiving and for special purposes that exactly meet their needs. Let TUNG-SOL engineers work with you in planning your postwar Electronic Controls.

TUNG-SOL
vibration-tested
ELECTRONIC TUBES



**TUNG-SOL
MOUNT SUPPORTS**



1. Better support makes a sturdier tube.
2. Prevents assembly from misaligning in respect to the straightness between the stem and mount assembly.
3. Determines the straightness of the finished tube.



TUNG-SOL LAMP WORKS INC., NEWARK 4, NEW JERSEY

ALSO MANUFACTURERS OF MINIATURE INCANDESCENT LAMPS, ALL-GLASS SEALED BEAM HEADLIGHT LAMPS AND CURRENT INTERMITTORS

WHAT WILL YOU NEED TO PRODUCE BETTER POST-WAR PRODUCTS?

**CORNING
GLASS
GIVES YOU**



Special Electrical Qualities

Thermal Endurance

Hermetic Sealing

Mechanical Strength

Corrosion Resistance

Precision

Permanence

Metallizing

Dimensional Stability

High dielectric strength—high resistivity—low power factor—wide range of dielectric constants—low losses at all frequencies.

Permanent hermetic seals against gas, oil and water readily made between glass and metal or glass and glass.

Commercial fabrication to the fine tolerances of precision metal working.

Corning's metallizing process produces metal areas of fixed and exact specification, permanently bonded to glass.

AS YOU plan post-war electronic products, give a thought to versatile glass. We really mean glasses, for Corning has, at its fingertips, 25,000 different glass formulae from which to select those especially suited to your electronic applications. Let us show what glass can do for you. We may already have a solution — or Corning Research can find the answer for you. Address Electronic Sales Dept., I-12, Bulb and Tubing Division. Corning Glass Works, Corning, New York.

CORNING
means
Research in Glass

Electronic Glassware



"PYREX" and "CORNING" are registered trade-marks of Corning Glass Works



MEC-RAD

MANUFACTURERS OF MECHANICAL-ELECTRICAL
COMPONENTS FOR RADIONICS

TRAVELING WITH YOU ON THE STRAIGHT ROAD OF POST-WAR PLANNING

The period after the war may well become known as the "Electronic Era". In the development of the many ingenious post-war products, there will be a need for specialized engineering of precise and intricate high frequency components. This is our field. Our organization, with years of experience designing and making such products is at present devoting its manufacturing facilities 100% to war work. These unusual facilities will soon be available for the peacetime needs of our industry, and our engineering "know-how" is at your service now to help you with your post-war planning.



MEC-RAD

DIVISION-BLACK INDUSTRIES

1400 EAST 222ND STREET ★ CLEVELAND 17, OHIO

**WE GOT A TASTE
OF ELECTRONICS**

... and LIKED it



AS part of our war work, we started to build transformer housings, cabinets, shelf assemblies and other units of equipment for leaders in the electronic industry. Did a good job if we do say so. Met rigid specifications right on the nose. Priced our work right. Delivered it promptly.

Frankly Corry-Jamestown facilities and experience seemed to fit into the field very nicely. And now, we intend to *stay* in it — in addition, of course, to producing our pre-war products.

This is a bid for *your* business, both now and postwar — strictly on a basis of our proven ability to *produce*.

Won't you send us your specifications?

Steel Age

CORRY - JAMESTOWN

MANUFACTURING CORPORATION ★ CORRY, PENNA.

What will you need...

IN THE FIRST SIX POST-WAR MONTHS

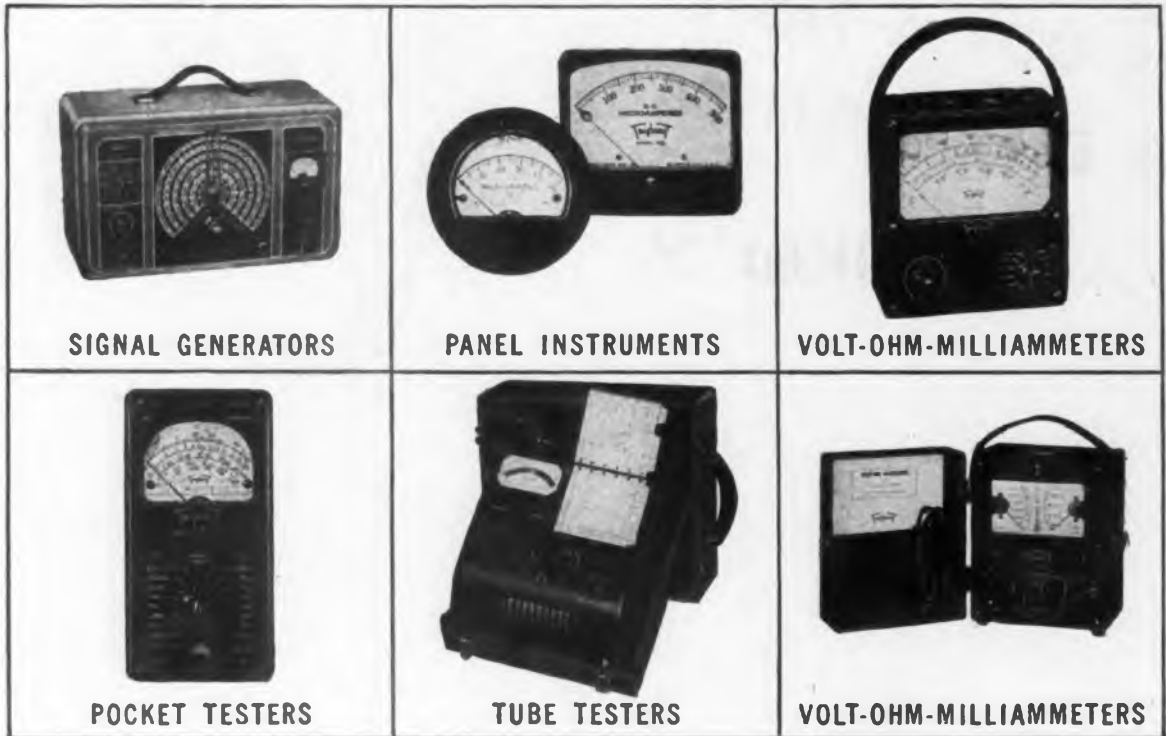

✓ CHECK THE TYPES AND QUANTITY

Now—right now—is the time to protect your post-war business by estimating your future equipment needs. Check those needs, list them and place a *tentative post-war order* with your jobber now. This foresight will enable him to stock the Triplet instruments you will need, and will assure you quicker resumption of civilian business than you could expect if you wait till the last minute. Give best priority you can obtain to facilitate deliveries as production is available.

Newly perfected developments now being produced on important war contracts, and many other outstanding instruments, will be incorporated in Triplet offerings for the first time beginning with our initial civilian production. Be sure you get the complete list of Triplet instruments and radio test equipment.

Triplet
ELECTRICAL INSTRUMENT CO.
BLUFFTON OHIO ***

STANDARDS ARE SET BY
TRIPLET

FROM ONE SMALL TOWN TO THE EARTH'S FAR CORNERS



OUT to the Far East, to ports on the seven seas identified only in code on the packing cases, goes war material so vital that it is needed on every beachhead and before the beachhead is created—poured out of *one* shipping room in just *one* factory in just *one* small Connecticut town!

Incredible? Not when Yankee ingenuity is taken into consideration—the same Yankee

ingenuity that stems from many lifetimes of meeting difficult situations.

That's the case here at Ansonia—typical of our approach to the problems which any form of electrical cables can solve. However difficult the requirements of peace may be, we feel that we can be of assistance in meeting them in new ways, as we have met the changing problems of war *and* peace before.

ANKOSEAL multi-conductor insulated cables are among the most promising of Ansonia war-proven developments. If you have, or expect to have, a use for electrical cables—

CHECK ANKOSEAL!

THE ANSONIA ELECTRICAL COMPANY



Specializing in "Ankoseal" a Thermoplastic Insulation
ANSONIA • CONNECTICUT



A Wholly-Owned Subsidiary of

NOMA ELECTRIC CORPORATION

GENERAL OFFICES • NEW YORK, N. Y.

—In peacetime makers of the famous Noma Lights—the greatest name in decorative lighting. Now, manufacturers of fixed mica dielectric capacitors and other radio, radar and electronic equipment.

COLE

STEEL EQUIPMENT COMPANY

Experience and "know-how" are why so many of America's leading manufacturers depend upon "Cole Steel Equipment" for

sheet metal fabrication

We welcome tough assignments . . . instrument housings . . . water-test boxes . . . chassis; some made to extreme precision, others to gauge limits. Send us your blueprints!

Send for our Brochure
"The Plant Behind Your Plant"

349 Broadway, New York 13, N. Y.

Factory: Brooklyn, N. Y.



**COLE STEEL
OFFICE EQUIPMENT**

will again be available
after the war



How many Klystrons *are* there?

COMPARED with the early Klystrons which Sperry first developed some years ago, the more recent forms represent dramatic improvements in both size and performance.

And this is only the beginning!

Information on the newer types is presently restricted to those qualified under Military regulations.

But Sperry Klystrons are in use on many battle fronts, and in many applications . . .

There are small Klystrons, and large ones . . . low-powered ones and high-powered ones. There are Klystrons which generate, amplify, and multiply. Where required, frequency stability (better than that required for

broadcast purposes) is readily applied by conventional means.

Klystrons are easily modulated for new and all conventional purposes. And, by means of a single knob, they can be tuned continuously over a wide band, or the operator can snap-tune them to previously selected bands.

Write us for further information.

Sperry Gyroscope Company

GREAT NECK, N. Y. • DIVISION OF THE SPERRY CORPORATION

GYROSCOPICS • ELECTRONICS • RADAR • AUTOMATIC COMPUTATION • SERVO-MECHANISMS

ELECTRONIC INDUSTRIES • December, 1944

19



TYPE 648—Heavy duty dual power pack with parallel output. 300 volts at 200 ma. from 6 volt battery

TYPE 650—Standard: 200 volts at 50 ma. Optional: 200 volts at 75 ma. This type available for 6, 12, or 32 volt operation. Has built-in filter. Notice simplicity of construction.



TYPE 649—Provides 240 volts at 50 ma. Available at other standard ratings, and for operation from 6 or 12 volt batteries. Type 647, not illustrated, provides 240 volts at 75 ma.

KAAR POWER PACKS

- Engineered for
- ✓ SIMPLICITY
 - ✓ EFFICIENCY
 - ✓ DEPENDABILITY

Use this West Coast source for vibrator power packs

Kaar Engineering Company offers prompt delivery of standard and special types of vibrator power packs for operation from 6, 12, or 32 volt sources. In addition, laboratory facilities are available for a variety of power

packs designed to your own specifications. Take advantage of this convenient West Coast source of exceptionally efficient low-drain packs, designed for simplicity and dependability.

KAAR
ENGINEERING CO.
PALO ALTO, CALIFORNIA



Export Agents: **FRAZER & HANSEN**
301 Clay Street • San Francisco 11, Calif.

MOBILE RECEIVERS—Crystal controlled superheterodynes for medium and high frequencies. Easy to service.



CRYSTALS—Low-drift quartz plates. Fundamental and harmonic types available in various holders.



TRANSMITTERS—Mobile, marine, and central station transmitters for medium and high frequencies. Instant heating, quickly serviced.



MICROPHONES—Type 4-C single button carbon. Superb voice quality, high output, moisture proof.



CONDENSERS—Many types of small variable air condensers available for tank circuit and antenna tuning.



BETTER TUBES, 13% CHEAPER...

**LOOK AT
THE
RECORD!**

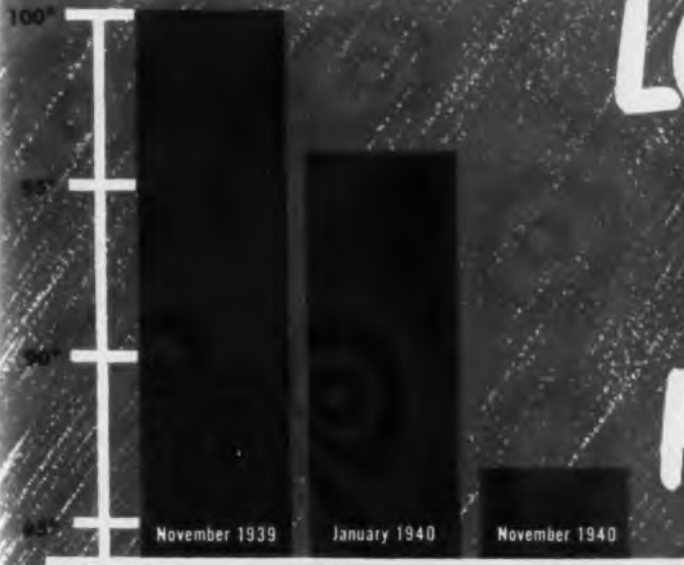

AVERAGE COST PER PREFERRED TYPE TUBE

November 1939 average cost = 100, all costs based on same tube types

WHY YOU'RE SURE OF BETTER TUBE PERFORMANCE AT LOWER COST IF YOU BASE POSTWAR DESIGNS ON RCA PREFERRED TYPE TUBES



JANUARY, 1940—To provide higher quality tubes, and reduce costs at the same time, RCA introduced the Preferred Type Tube Program. The idea was to concentrate a larger demand and production on fewer tube types. The longer manufacturing runs which would result, meant greater production efficiency... more uniform, lower-cost tubes for you.

NOVEMBER, 1940—The average cost to you of tubes on the RCA preferred list was already 13% lower than that of the same tubes in November, 1939...before the program started. Yet the tubes had *improved* in quality and performance. And fewer types meant simpler tube stocking for both the manufacturer and the dealer-serviceman.

DECEMBER, 1944—Another record has since substantiated the value of the preferred type idea... that of military equipment designed almost entirely around an Army/Navy Preferred List of Vacuum Tubes. From Saipan to Soissons, our fighting men have been sure of speedy replacements of high-performance tubes.

V-DAY, 194X—Look to RCA for continuing the Preferred Type Program after Victory. If you already have specific tube complements in mind for post-war and would like to know if the tubes you plan to use will be on RCA's preferred list, write (stating tube types) to RADIO CORPORATION OF AMERICA, Commercial Engineering Section, Dept. 62-131, Harrison, New Jersey.

The Magic Brain of all electronic equipment is a Tube... and the fountain-head of modern Tube development is RCA.

1919
1944



25 Years
of Progress
in Radio
and Electronics

62-4121-12

RADIO CORPORATION OF AMERICA

RCA VICTOR DIVISION • CAMDEN, N. J.

LISTEN TO "THE MUSIC AMERICA LOVES BEST,"
SUNDAYS, 4:30 P.M., E.W.T., NBC NETWORK

2 power sources



THE G-E DYNAMOTOR

Designed to deliver high output from small frame size, G-E dynamotors have earned a reputation for thoroughly dependable service under adverse conditions. Compactly constructed and light in weight, these units are available in outputs of 15 to 350 watts intermittent (15 to 200 continuous) and with output voltages ranging up to 1500 volts d-c when operated on a 12- or 24-volt battery source. Weights range from 3 to 31 lb. These dynamotors are specially designed to minimize objectionable a-c ripple and consequent need for radio filtering.

THE G-E INVERTER TRANSFORMER

Custom-designed for individual applications, G-E inverter transformers are compact and light in weight. They are specially designed for low internal heating, are quiet and efficient in operation, and readily interchangeable with correspondingly rated dynamotors. They can be designed for operation on a 6-, 12-, or 24-volt battery source, to supply wide range of output voltages—either a-c or d-c. Where conditions require, these units can be made dust-tight and can be shockmounted on rubber cushions.



to choose from . . .

Another example of how the variety of G-E components enables you to choose your own method of accomplishing a desired result.

● If you have a problem involving a portable power supply for radio or allied electronic equipment, it will pay you to look into the merits of the dynamotor and inverter shown at the left. Similarly, if you have need for any of the many other components in the diversified G-E line, you can profit by discussing those needs with our engineers.

For every one of these G-E products has been worked out in close co-operation with designers in the electronic industries. All have been thoroughly tested—in our laboratories, in our customers' laboratories, and in labora-

tories operated by the Armed Services. More impressive still, many have been tested on the field of combat, where their dependability has proved a contributing factor in the success of a variety of radio and allied equipment.

Whether you are designing new electronic equipment or improving old designs, take advantage of the extensive line of G-E components and G-E electronic "know-how." Whatever your objectives, find out how G.E. can help you achieve them more simply or more economically. The G-E office near you will gladly furnish details. *General Electric, Schenectady 5, N. Y.*

Buy all the Bonds you can—and KEEP ALL YOU BUY

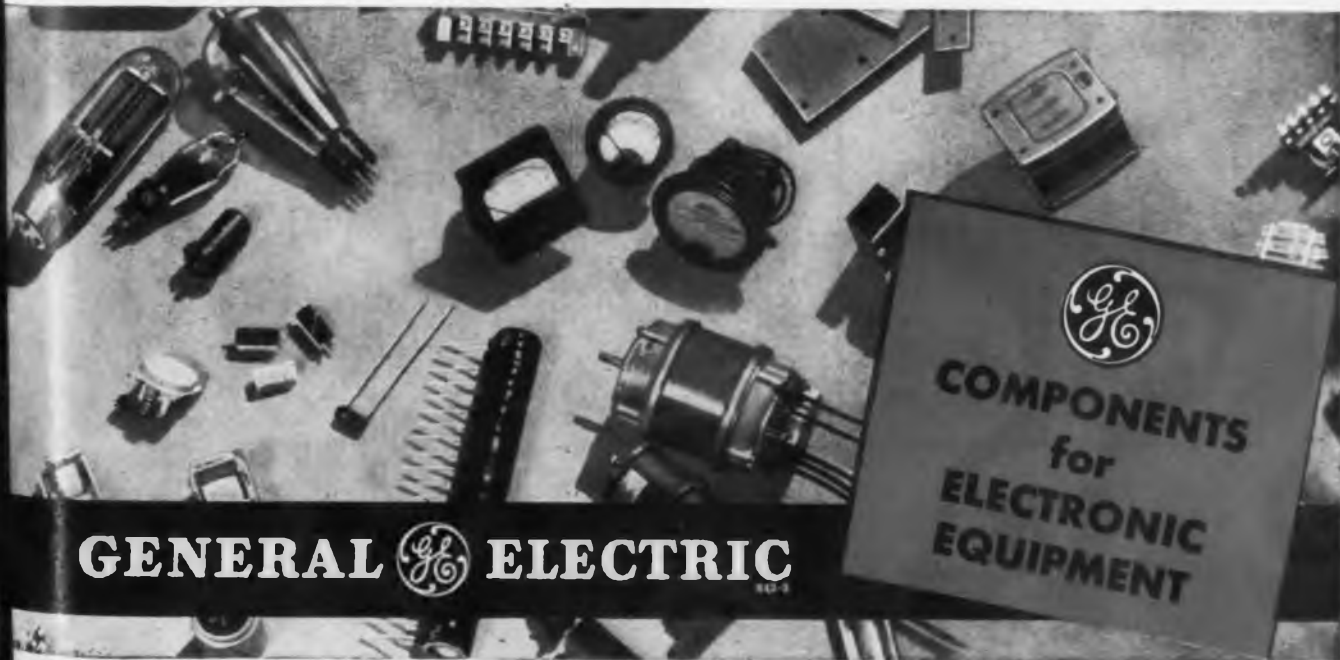

GENERAL  ELECTRIC



Plugs

FOR VICTORY

**70 Types
PLUGS & CONNECTORS**

SIGNAL CORPS • NAVY SPECIFICATIONS

Types :		PL		
50-A	61	74	114	150
54	62	76	119	159
55	63	77	120	160
56	64	104	124	291-A
58	65	108	125	354
59	67	109	127	
60	68	112	149	

PLP		PLQ		PLS	
56	65	56	65	56	64
59	67	59	67	59	65
60	74	60	74	60	74
61	76	61	76	61	76
62	77	62	77	62	77
63	104	63	104	63	104
64		64			

NAF

1136-1

No. 212938-1

Other Designs to Order

Remler is equipped for the mass production of many types of radio and electronic devices from humble plugs and connectors to complete sound amplifying and transmitting systems. Ingenious production techniques contribute to Remler precision, reduce costs and speed up deliveries. • The Axis is on the run and final Victory is in sight. Let us help you finish the job.

Wire or telephone if we can be of assistance

REMLER COMPANY, LTD. • 2101 Bryant St. • San Francisco, 10, Calif.

REMLER

SINCE 1918

Announcing & Communication Equipment

RESEARCH



Continual research in chemistry, metallurgy and effects of various atmospheres on different plating finishes assures you that your Hammarlund variable capacitor will stay on the job.



ESTABLISHED 1940

HAMMARLUND

THE HAMMARLUND MFG. CO., INC., 460 W. 34TH ST., N. Y. C.
MANUFACTURERS OF PRECISION COMMUNICATIONS EQUIPMENT

A matter of inconvenience—nothing more!

OUR stranded friend is the victim of a faulty measuring device. The gauge said "quarter-full" when the tank was empty. The result—a little profanity and an hour's inconvenience.

But not all instruments can be excused so lightly. At work in this war, and in readiness for the years to follow, are thousands of instruments whose accuracy may mean the difference between success and failure, be-

tween safety and danger, between life and death. These instruments *must not lie!* Too much depends upon them.

Boes is building instruments of this character. To date, we have not been asked to create instruments in which an element of error could be tolerated. Quite on the contrary, we've been expected to produce instruments of greatest accuracy and, most important, instruments of *sustained accu-*

*racy.** The methods and facilities that are available for this work may be useful to you now, and will certainly be available to you in the years ahead.

* **SUSTAINED ACCURACY** is not an easy quality to achieve. It must take into account all factors of use—must then employ the design, the alloys, the construction that infallibly protect an instrument against all threats to its reliable performance. Such instruments, obviously, must be built with performance—not price—in mind. We invite the inquiries of those who are interested in such standards.



Boes instruments

for Measuring, Metering & Testing Equipment ☆ The W. W. Boes Co. Dayton, Ohio

THE GREEKS HAD **TWO** WORDS FOR IT:

TELE MEANING DISTANCE

EIKON MEANING IMAGE

WE COINED **ONE** WORD:

TELICON



CRYSTALS

FOR FREQUENCY CONTROL

SUPERSONIC GENERATORS

DESIGNED TO INDIVIDUAL REQUIREMENTS

ELECTRONIC EQUIPMENT

AND

TELEVISION

FOLLOWING VICTORY



TELICON

Corporation

305 EAST 63rd STREET, NEW YORK 21, N. Y.



Long before the war, at a time when others were satisfied with television pictures limited in terms of *inches*, S. SAGALL pushed ahead with the development of *large screen* television. TWO FOOT pictures for the home and pictures which were large enough to be viewed by thousands at London Motion Picture Theatres (in 1939) were actually realized by his organization.

A pioneer of large screen television, the founder in 1930, and head—for many years—of SCOPHONY LTD., British television company—S. SAGALL is president of TELICON CORPORATION.

**THE N-Y-T SAMPLE DEPARTMENT
will check-mate your post-war
transformer problems too!**

Diversification in transformer engineering, for vital equipment and apparatus, has been a "must" in this highly-specialized field ever since electronics superseded the human element in various operating phases. Aircraft applications—with attendant drastic temperature fluctuations, marine installations—with constant corrosion and moisture influences, mobile units—with vibration and impact as deterrents—all required unusual

transformer design technique. The N.Y.T. Sample Department has aided materially in forestalling or solving problems for the Army, Navy and Air Forces. Practically every conceivable obstacle to efficient transformer performance has been overcome—unequivocally—by N.Y.T. Your post-war transformer, rectifier or solenoid perplexities can be check-mated in similar immediate manner.

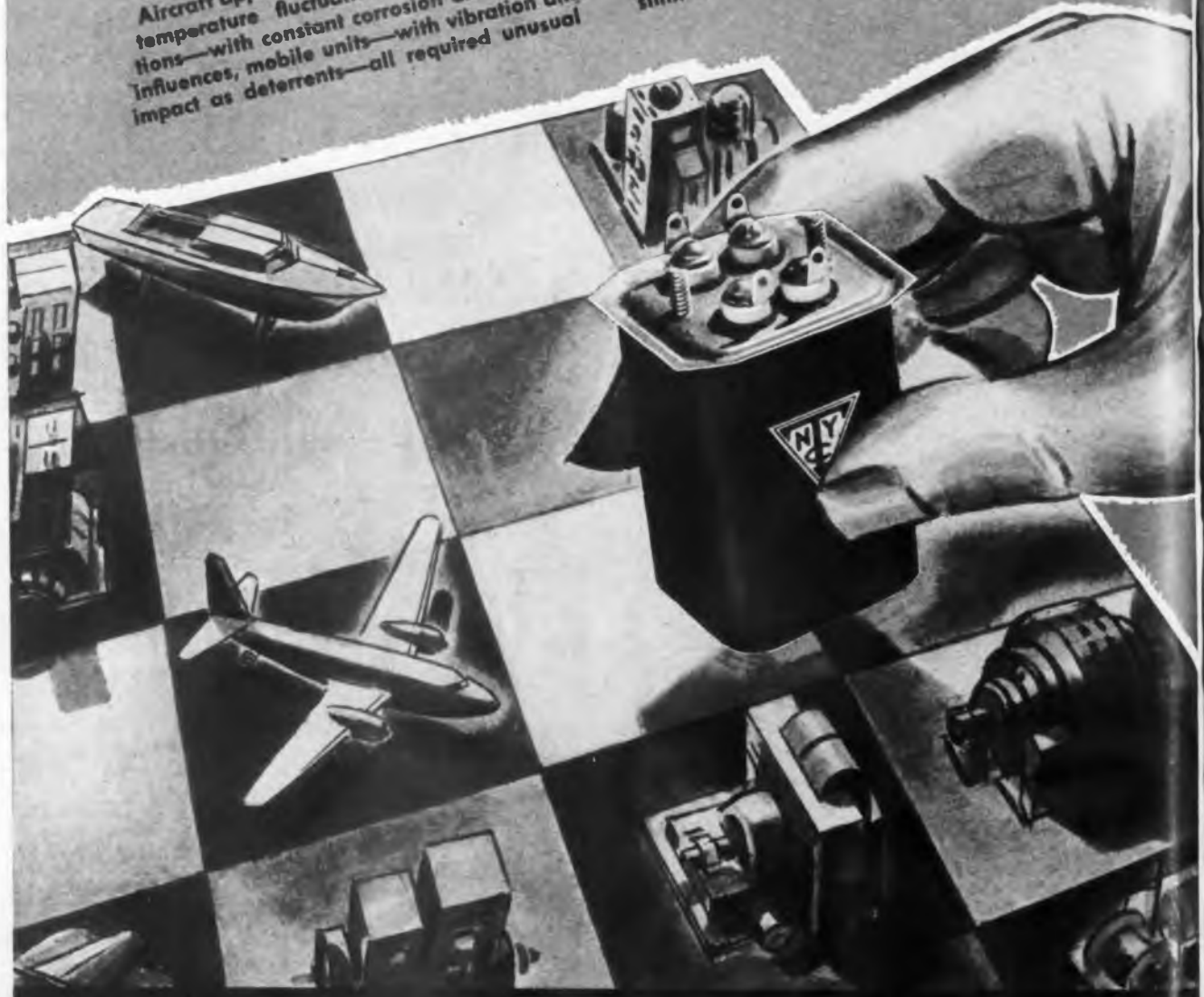

NEW YORK TRANSFORMER COMPANY

22-26 WAVERLY PLACE, NEW YORK, N. Y.



History of Communications. Number Ten of a Series

COMMUNICATION BY THE HELIOGRAPH



World War I saw the Heliograph play a prominent part in communications. The Heliograph, a device which flashes the rays of the sun in coded intervals, has been used since the days of Ancient Greece. Dependent upon the elements of nature for its power, its operation is prohibited by bad weather. Typical of means of communication other than Electronic Voice Communication, translation of its signal must be made by specially trained personnel.

After Victory is ours, civilian electronic voice communications will again be placed in the hands of the skilled Universal Engineers for still further advancements in microphones and recording components.

Model CU-2, illustrated at left, is a palm microphone with press-to-talk switch. One of the several military types available through your Radio Parts Jobber.



EXCELLENCE IN PRODUCTION

UNIVERSAL MICROPHONE COMPANY

INGLEWOOD, CALIFORNIA



**THE N-Y-T SAMPLE DEPARTMENT
will check-mate your post-war
transformer problems too!**

Diversification in transformer engineering, for vital equipment and apparatus, has been a "must" in this highly-specialized field ever since electronics superseded the human element in various operating phases. Aircraft applications—with attendant drastic temperature fluctuations, marine installations—with constant corrosion and moisture influences, mobile units—with vibration and impact as deterrents—all required unusual

transformer design technique. The N.Y.T. Sample Department has aided materially in forestalling or solving problems for the Army, Navy and Air Forces. Practically every conceivable obstacle to efficient transformer performance has been overcome—unequivocally—by N.Y.T. Your post-war transformer, rectifier or solenoid perplexities can be check-mated in similar immediate manner.



NEW YORK TRANSFORMER COMPANY
22-26 WAVERLY PLACE, NEW YORK, N. Y.



History of Communications. Number Ten of a Series

COMMUNICATION BY THE HELIOGRAPH



World War I saw the Heliograph play a prominent part in communications. The Heliograph, a device which flashes the rays of the sun in coded intervals, has been used since the days of Ancient Greece. Dependent upon the elements of nature for its power, its operation is prohibited by bad weather. Typical of means of communication other than Electronic Voice Communication, translation of its signal must be made by specially trained personnel.

After Victory is ours, civilian electronic voice communications will again be placed in the hands of the skilled Universal Engineers for still further advancements in microphones and recording components.

Model CU-2, illustrated at left, is a palm microphone with press-to-talk switch. One of the several military types available through your Radio Parts Jobber.



UNIVERSAL MICROPHONE COMPANY
INGLEWOOD, CALIFORNIA



FOREIGN DIVISION: 301 CLAY STREET, SAN FRANCISCO 11, CALIFORNIA · CANADIAN DIVISION: 540 KING STREET WEST, TORONTO 1, ONTARIO, CANADA

ELECTRONIC INDUSTRIES • December, 1944

"REASONS WHY"

FOR GREATER RELIABILITY OF WESTINGHOUSE D-C INERTEEN CAPACITORS

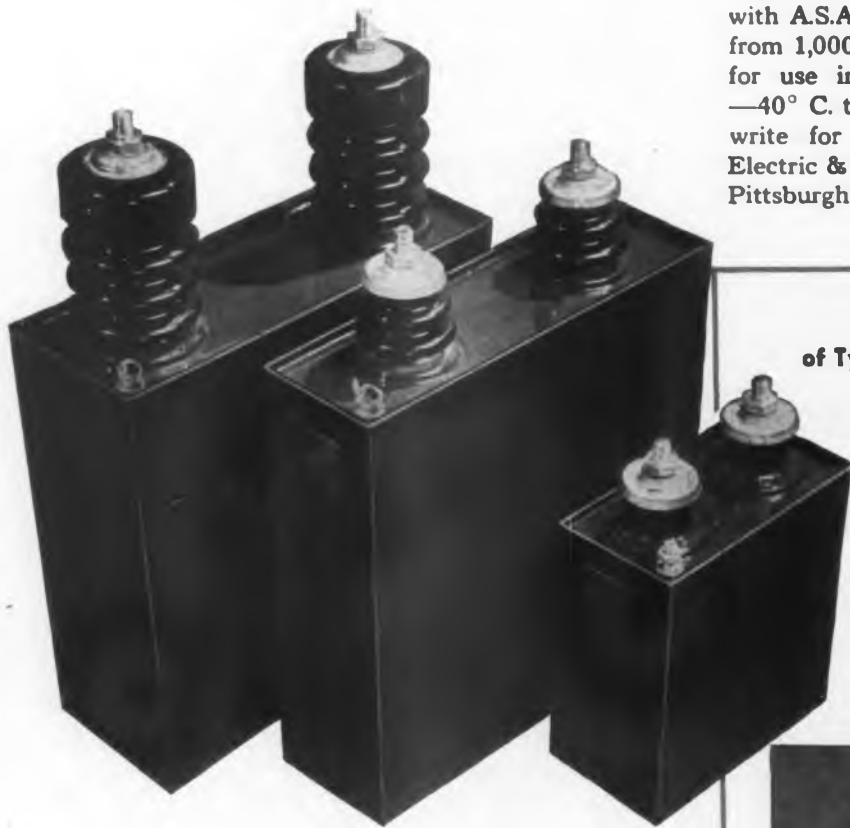

Westinghouse INERTEEN CAPACITORS For The Communications Industry

When a product scores an outstanding service record—there's always a sound "reason why".

In the case of Westinghouse D-C Capacitor materials . . . processing . . . assembly techniques . . . are combined to produce units that will give maximum life under the most severe operating conditions on land, sea and air.

- 1 **NONINFLAMMABLE, NONEXPLOSIVE "INERTEEN"**—the new dielectric impregnating liquid. Its high dielectric constant provides greater capacitance per weight and volume than other insulating mediums. It gives maximum stability for high temperature service.
- 2 **"SOLDER-SEALING"**—an exclusive Westinghouse development. It creates a hermetic seal between porcelain and metal, in all Type FP Capacitors. It gives positive protection against leaks, moisture entrance or any contamination that might result from breathing.
- 3 **ELECTRONICALLY-CONTROLLED WINDING**—insures freedom from wrinkles and mechanical damage for the aluminum foil and Inertex dielectric paper which provide the capacitance.

Designers of communications equipment find that the complete Westinghouse line meets all requirements. Capacitors are made in accordance with A.S.A. standards CP-70 and CP-71. Range from 1,000 to 250,000 volts d-c; 400 to .001 mfd for use in ambient temperatures ranging from -40° C. to 75° C. For complete application data write for your copy of B-3300. Westinghouse Electric & Manufacturing Company, P.O. Box 860 Pittsburgh 30, Pennsylvania.

J-6050

NOTE THESE FEATURES of Type FPC (Porcelain-clad) Capacitors for higher ratings

- End closures act as capacitor terminals.
- Metal case and bushings required by conventional capacitors are eliminated.
- Over-all dimensions and space are held to a minimum.
- For higher voltage ratings, units can be mounted in series.



PERMANENT MAGNETS MAY DO IT BETTER



OFFICIAL U. S. NAVY PHOTOGRAPH

Battle Commands Reach All Hands!

ON a modern U. S. dreadnaught, about 2200 telephones and more than 300 loudspeakers link all battle stations. They flash orders and reports instantly—make possible the split-second timing that wins battles.

Vital parts of each telephone and speaker are permanent magnets. They are also employed in radio and sub-detection equipment, firing systems, compasses, instruments and numerous other devices, raising the total per battleship high into the thousands.

Because we manufacture permanent magnets for virtually every use known to science, our specialized knowledge of design and production is unusually complete. If you have a problem involving permanent magnets, our engineers will be pleased to consult with you. Write for a copy of our "Permanent Magnet Manual".



Copyright 1944—The Indiana Steel Products Co.

The
INDIANA STEEL PRODUCTS
Company

★ SPECIALISTS IN PERMANENT MAGNETS SINCE 1910 ★
6 NORTH MICHIGAN AVENUE • CHICAGO 2, ILLINOIS

Craftsmanship

KNOWN THE WORLD OVER



This is the new 1 1/2" diameter, wire wound variable resistor, 352 Series, with resistance value up to 20,000 ohms linear and with the same bakelite housing and grounded metal construction as the popular 1 1/4" 252 Series. (This resistor only, shown at actual size.)



Chicago Telephone Supply Company is an internationally known manufacturer of the finest variable resistors for all applications. Behind these products are a modern scientific mass production organization and many years of intensive research.

When wartime demand slackens, Chicago Telephone Supply Company's tremendous production facilities and unexcelled craftsmanship will be turned once again to civilian production of wire wound and carbon types resistors.

Manufacturers of Quality Electro Mechanical Components Since 1886

VARIABLE RESISTORS, PLUGS AND JACKS SWITCHES, TELEPHONE GENERATORS, RINGERS

REPRESENTATIVES

R. W. Farris
2600 Grand Avenue
Kansas City 8, Missouri
Phone: Victory 3070

Frank A. Emmet Co.
2837 West Pico Boulevard
Los Angeles 6, California
Phone: Rochester 9111

BRANCH OFFICES

S. J. Hutchinson, Jr.
401 North Broad Street
Philadelphia 8, Pennsylvania
Phone: Walnut 5369

IN CANADA

C. C. Meredith & Co.
Streetsville, Ontario

CHICAGO TELEPHONE SUPPLY
Company

ELKHART • INDIANA

Made in One Piece...

by **STUPAKOFF**

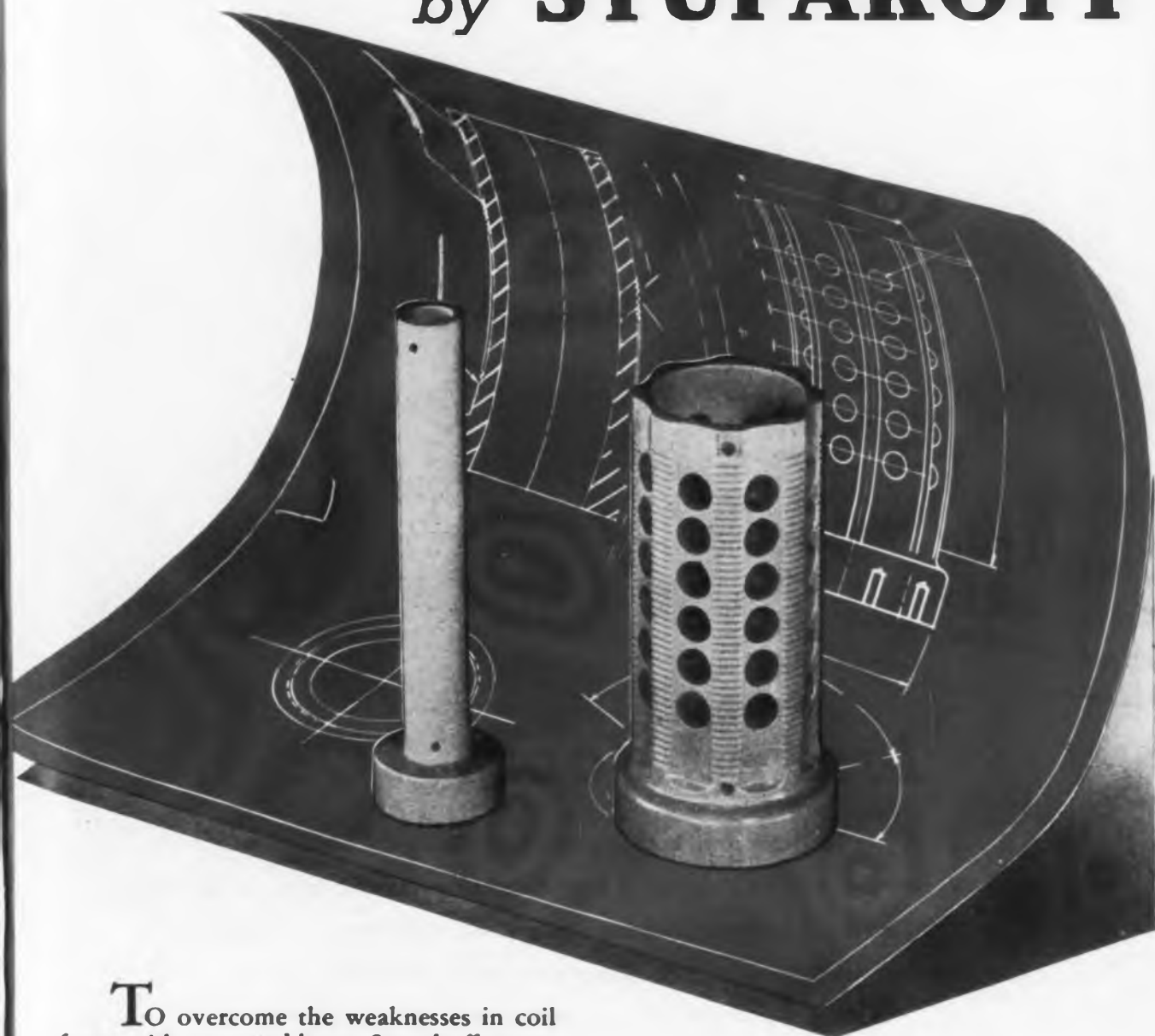

TO overcome the weaknesses in coil forms with cemented bases, Stupakoff manufacturing ingenuity has produced single unit construction. The illustrated result—coil forms of optimum mechanical and insulating properties that assure permanence and stability in operation. Vibration and humidity tests prove the superiority of this design.

Backed by two generations of experi-

ence in the manufacture of precision ceramics, Stupakoff engineers will give dependable assistance in developing insulators for your electronic apparatus. An inquiry will put our technical knowledge and manufacturing facilities at your disposal.

Do More Than Before—Buy EXTRA War Bonds



STUPAKOFF CERAMIC AND MANUFACTURING CO., LATROBE, PA.

Ceramics for the World of Electronics

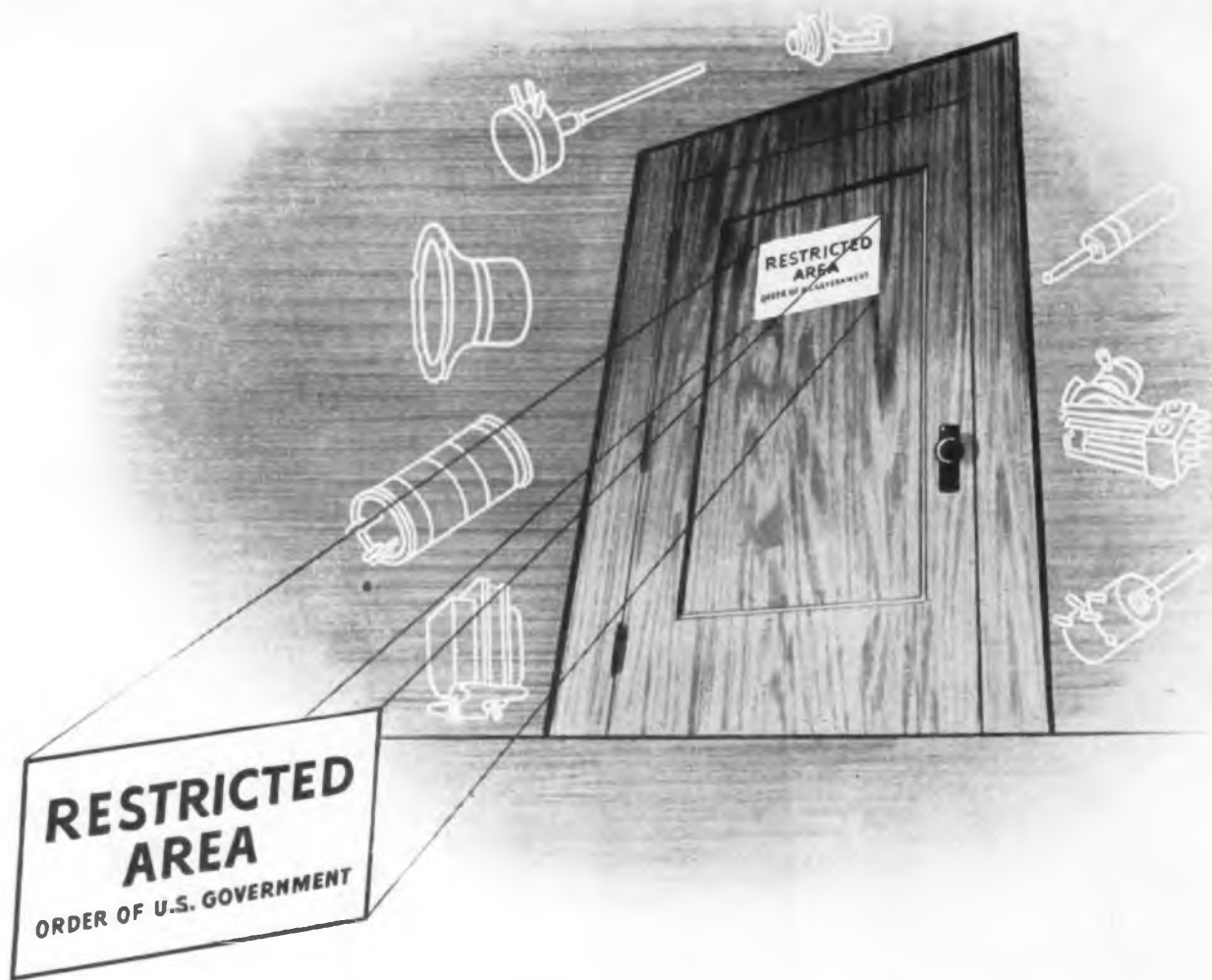

locked door...

● Forbidden to all but top government officials and Utah technicians
 . . . this room has been the birthplace of many miracles in radio, electronics and electricity.

Behind this locked door, Utah has developed vital equipment . . . earmarked
 for military needs. Inevitably, the wartime secrets of this forbidden room will
 be adapted to commercial and consumer needs . . . assume a
 prominent role in the pursuits of peace.

★ ★ ★

Every product made for the trade, by
 Utah, is thoroughly tested and approved

*Keyed to "tomorrow's" demands: Utah transformers,
 speakers, vibrators, vitreous enamel resistors, wirewound controls,
 plugs, jacks, switches and small electric motors.*



Utah Radio Products Company, 850 Orleans Street, Chicago 10, Ill.

EVEN UNDER A DEAD SHORT



Can't **A HYDENT CONNECTION
LOOSEN OR MELT OUT!**

The Burndy HYDENT connection is one point in the circuit that has caused no concern during this period of heavy overloads . . . when the "heat" really has been on. Being securely and permanently indented to the wire or cable with the Burndy HYTOOL, no loosening could occur even under a dead short!

It's this complete *freedom from worry about connector troubles* that has made the HYDENT connection so widely preferred not only by utilities and contractors but for electrical equipment as well. It provides a *permanent* connection, of high electrical efficiency, and it cuts installation time 50% to 90%.

HYDENT connectors, made in the form of lugs, links, reducers, taps, tees and crabs, are available for all wire and cable sizes. For complete information, write . . . Burndy Engineering Co., 107 Bruckner Boulevard, New York 54, N. Y.

IN CANADA: Canadian Line Materials, Limited, Toronto 13



Headquarters for
CONNECTORS

Burndy

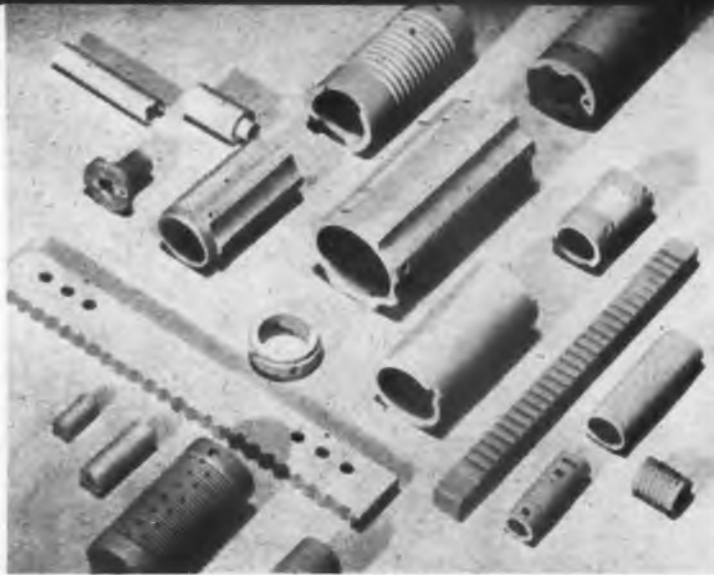

GREATER EFFICIENCY FOR YOUR 1945 DESIGNS.

MASTER of power and heat, ALSiMAG is the ideal insulation for tomorrow's Electronic devices.

ACCURATE—manufactured to close tolerances.

ECONOMICAL—because of high speed production methods.

ALSiMAG Steatite Ceramic Insulators are permanent materials. They are strong, hard and rigid—do not distort by loading, nor do they shrink with time. Impervious to heat up to 1000° C. Non-corrodible. Do not absorb moisture.

No matter what insulation you have been using, investigate ALSiMAG. Send us a sample or design drawing. Let us prove that ALSiMAG will meet your requirements for improved efficiency and performance.

Write for Property Chart containing complete data on physical characteristics.

AMERICAN LAVA CORPORATION
CHATTANOOGA 5, TENNESSEE

42ND YEAR OF CERAMIC LEADERSHIP



CHARACTERISTICS OF ALSiMAG INSULATORS

High Mechanical Strength
Permanent Rigidity
Low-Loss Factor
High Dielectric Strength
Will Not Absorb Moisture
Chemically Inert
Heat Resistant
Precision Made of Purest
Raw Materials



ALCO has been awarded for the fourth time the Army-Navy "E" Award for "continued excellence in quantity and quality of essential war production."



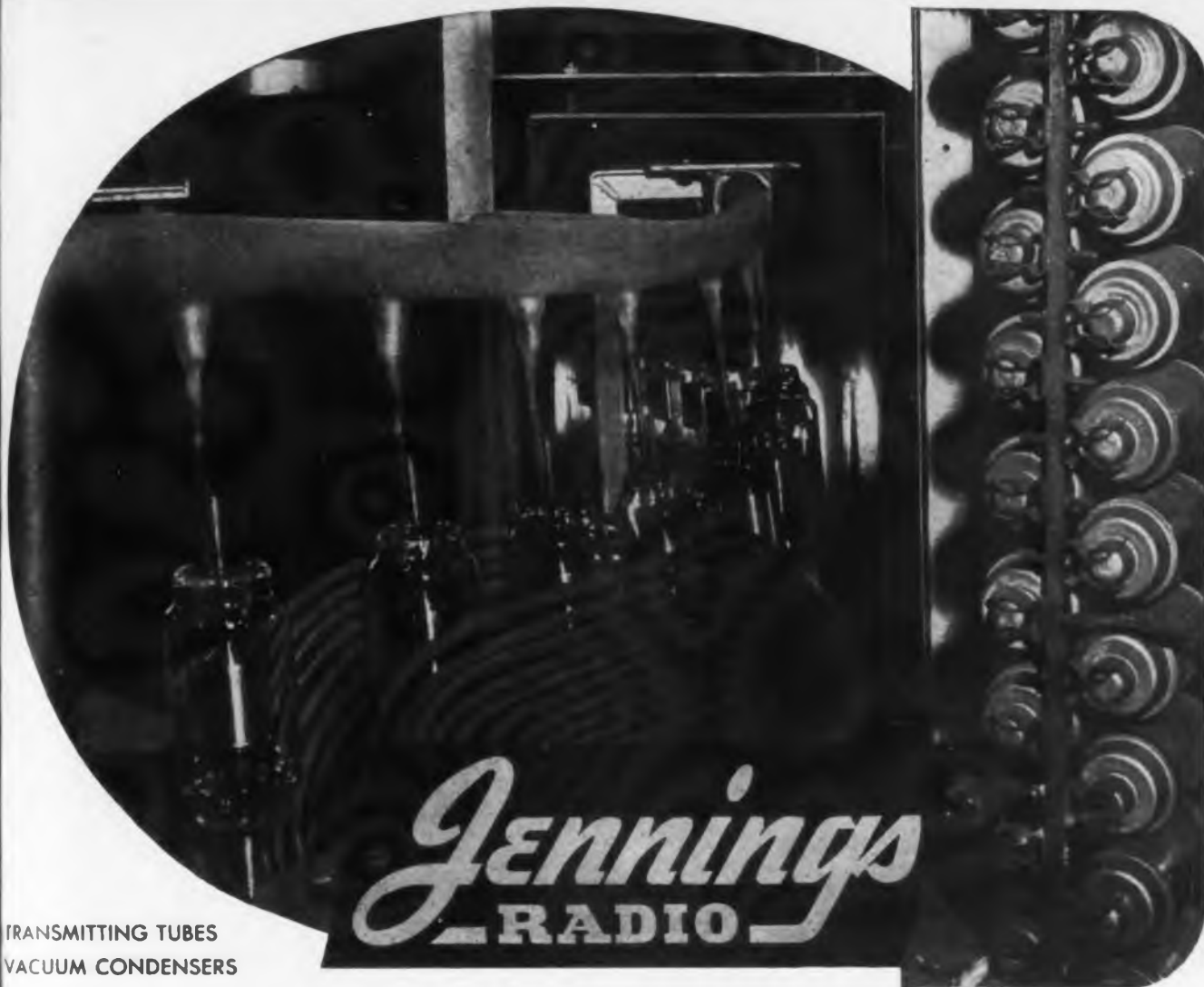

TRANSMITTING TUBES
VACUUM CONDENSERS

HIGH VACUUM CONDENSERS

VC 50 TO 250 give higher efficiency

Photograph shows Jennings Condensers passing through induction heating coils on the automatic rotary high vacuum pumps where the present large production is meeting the exacting requirements of the U. S. Signal Corps Transmitters and the advanced standards of

MODERN ELECTRONIC HEATING EQUIPMENT

Jennings Vacuum Condensers and Transmitting Tubes are used in many critical communication operations in all theatres of war. In the South Pacific where dampness and tropical heat cause corrosion and deterioration, Jennings

Vacuum Condensers are helping the Signal Corps **TROPICALIZE*** their Transmitting Equipment. Electronic Engineers realize the importance of this protection in choosing Jennings Condensers for their transmitters now in development.

* Prevents corrosion and deterioration

TROPICALIZE YOUR EQUIPMENT WITH JENNINGS UNITS
Literature will be sent on request

JENNINGS RADIO MANUFACTURING COMPANY, Dept. EI

1098 EAST WILLIAM STREET • SAN JOSE 12 • CALIFORNIA

COMIN' AT YOU!



Buy War Bonds

... and some for all!

Here comes aluminum . . . rolling out to meet the highest *record* demand in its history . . . and back to do a bigger and better job in PRESTO RECORDING DISCS!

PRESTO *ALUMINUM* RECORDING DISCS are now available in all sizes from 6½ inch to 17¼ inch. That's *good news* for broadcasting stations, recording studios and schools all over the nation . . . who know through valued experience that PRESTO is

simpler to handle—doesn't require fussy adjustments . . . and, in fact, is the smoothest cutting disc they've ever used!

Order PRESTO *ALUMINUM* DISCS from your regular electronics distributor. May we suggest that you split your order—50% aluminum and 50% glass base for the time being, so that we can fairly distribute PRESTO *ALUMINUM* DISCS over the first big demand?

PRESTO RECORDING CORPORATION

242 West 55th Street

New York 19, N. Y., U. S. A.

Walter P. Downs Ltd., in Canada

In **QUARTZ CRYSTALS**, the most significant advancements
have been introduced by *Bliley*

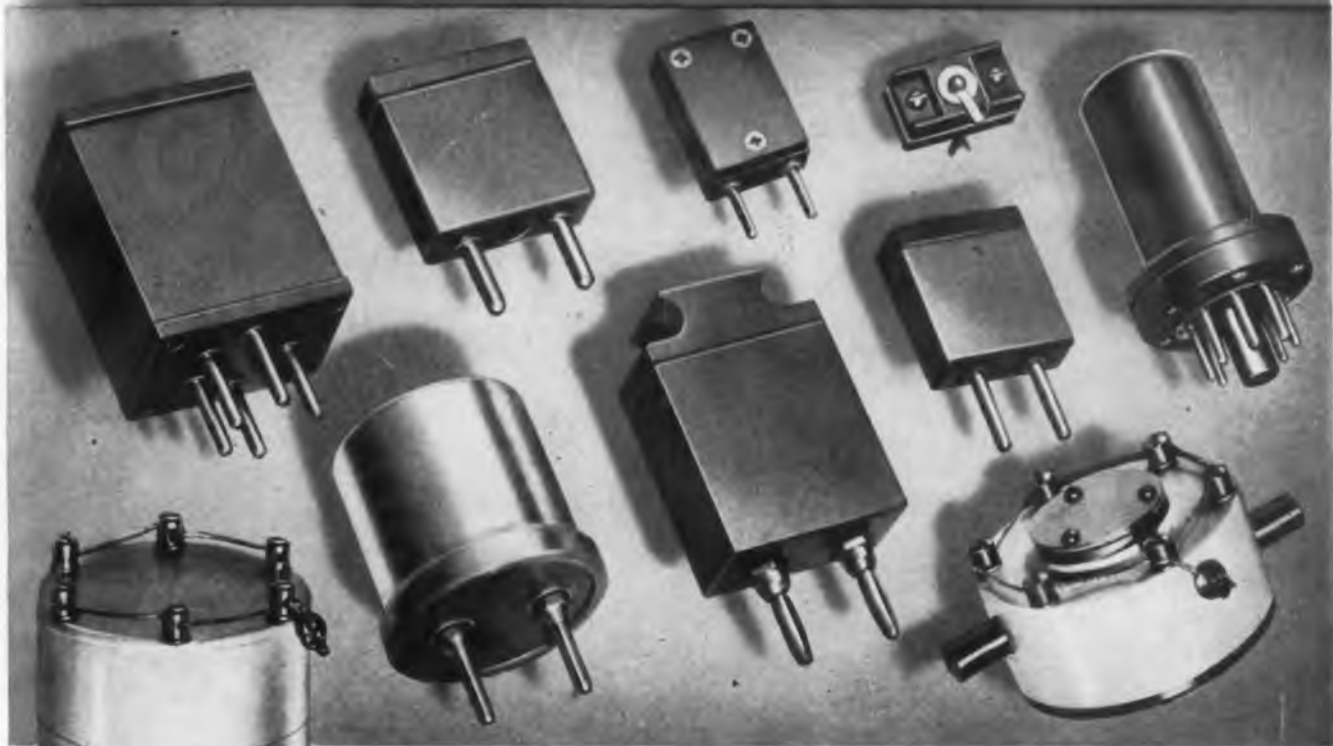

This is a message from Bliley to the thousands of amateurs and professional engineers who are now serving their country in the armed forces and in essential communications industries. Bliley "grew up" with them.

To these men and women Bliley crystals are still a familiar sight. They recognize, in the military crystal units used by our armed forces, many basic features that were pioneered by Bliley for application in peacetime services.

When tremendous production was demanded by our armed forces Bliley had the engineering background, the facilities and the production experience to provide a firm corner stone on which this volume production of radio crys-

tals was successfully built. And, from the ranks of talented amateurs and radio engineers came a host of long-time friends who knew exactly how to use them.

But research has continued and experience has grown mightily to meet the challenge of war requirements. With the return to peace, and relaxation of wartime restrictions there will be better Bliley crystals for every application as well as new Bliley crystals for the new services that loom on the horizon. That's a promise.

To our old friends, amateurs and professional engineers, we say, "Look to Bliley for crystal units that embody every advanced development."



Bliley
CRYSTALS

Do more than before . . .

buy extra War Bonds

BLILEY ELECTRIC COMPANY
UNION STATION BUILDING • ERIE, PENN.

I Hear That Bridgeport
Is Making Mine Detectors
By the Carload . . .



Yes, That Company's Going
To Be a Big Factor in the
Coil Business After the War!



HERE'S WHAT BRIDGEPORT MEANS TO YOUR POSTWAR PLANS



HIGH PRECISION! Here you have hundreds of workers skilled in making delicate radionic equipment surpassing the most rigid military specifications. This experience will be invaluable to you and your company in days to come.



CARLOAD SHIPMENTS of highly important search coils and variometers for the world's war fronts are now moving regularly from Bridgeport to tidewater. When you want a big job done well . . . think of Bridgeport Manufacturing Company!



CENTRAL LOCATION: Bridgeport, Illinois, is almost exactly on the geographer's star indicating the population center of America. Fast, trunk line service to every part of America. For earliest possible delivery, get in touch with us NOW.

BRIDGEPORT

MANUFACTURING COMPANY

Bridgeport, Illinois

R. F. Coils • R. F. Chokes • I. F. Transformers
Transmitting Coils • Transmitting Chokes

THESE GENERAL
INDUSTRIES MOTORS ARE
CERTAINLY SMOOTH

YES, AND YOU
CAN'T BEAT THEIR
PLASTIC PARTS



SMALL MOTORS and molded plastic parts, both from General Industries, meet frequently on assembly lines of leading manufacturers. When they do, they match up with precision because of the care and ability which goes into their manufacture.

YOU CAN DEPEND UPON **BOTH** FROM GENERAL INDUSTRIES



Our *Smooth Power* drives have been proved for years in our own lines of recorders, record-changers and turntables. Their quick pickup, unvarying speed, velvety smoothness and dependability have kept them favorites for many peacetime products, and have been responsible for their wide military use. Most buyers find what they want in our standard lines, but when specifications are unusual, we design and build them to order.



In our molded plastics division, your blueprints or sketches get close scrutiny by engineers who know plastic compounds and how to use them. Our mold designers study every job to find ways of doing it better, quicker and more economically. As for close tolerances and fine finishes, we refer you to the assembly men and inspectors in the many plants which depend upon us for their molded plastics.

So, you can depend upon General Industries for your postwar needs in both these products. You'll save time by starting general discussions now, to be followed by details when our military commitments have been finished. Please address the specific division... *motors or molded plastics.*

THE

GENERAL
INDUSTRIES
COMPANY
ELYRIA, OHIO





The telephone was still a novel device when Connecticut Telephone & Electric opened the doors of its first modest factory. Ever since, its people seem to have formed the habit of contributing to each revolutionary step ahead in communications.

For example, they helped to take the electronic tube out of the laboratory, and put it to work for everybody, by producing one of the first such tubes to be manufactured on a commercial scale.

For the past four years, every ounce of our engineering and production experience has been at work for Uncle Sam. Postwar American industry will naturally seek to draw on the know-how developed during the war. Ours applies not only to communications, but to the general field of electronics and precision electrical engineering and manufacturing. If you have a problem involving communications, product improvement, product control, ignition, or the manufacture of precision electrical devices, our particular know-how is at your disposal.

CONNECTICUT TELEPHONE & ELECTRIC DIVISION

GREAT AMERICAN INDUSTRIES, INC.
MERIDEN, CONNECTICUT

TELEPHONIC SYSTEMS • SIGNALLING EQUIPMENT • ELECTRONIC DEVICES • ELECTRICAL EQUIPMENT • HOSPITAL AND SCHOOL COMMUNICATIONS AND SIGNALLING SYSTEMS • IGNITION SYSTEMS



BACKGROUND FOR KNOW-HOW



Take advantage of
Centralab's
 experience in ceramics



Centralab

engineers with their wealth of experience, through which millions of Ceramic parts have been produced, have learned the HOW and WHY.

Each shape and form has its own peculiarities. The slide rule and the logarithmic scale do not always apply.

Sometimes TRIAL and ERROR produce the final result. One of the many intangibles in the manufacture of ceramics is the sizeable shrink factor. Witness these unretouched illustrations.

Some things can and some things CANNOT be done. So before you make a complete design in which ceramics are a vital part, we welcome your consultation with our engineers.



Centralab

Division of GLOBE-UNION INC., Milwaukee



Producers of Variable Resistors • Selector Switches • Ceramic Capacitors, Fixed and Variable • Steatite Insulators

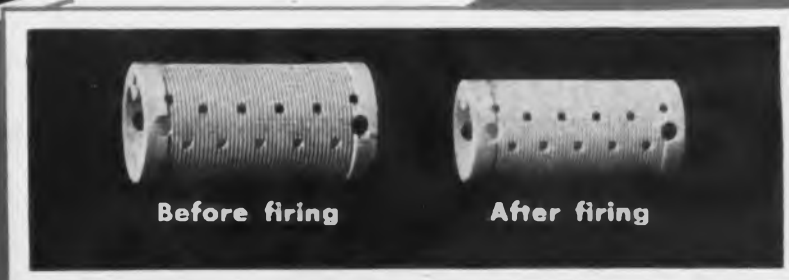

Variable Tuning Condensers, Push Button Tuning

Mechanisms and Actuators, Phonograph Record Changers



**A NEW DIVISION
UNDER THE DIRECTION OF
LEE GOLDER**

identified for more than 20 years with
the manufacture of radio speakers.

Millions of radio components on the far flung battle areas of the world bear the G.I. insignia. What they have accomplished is already in the archives.

Behind General Instrument's record of achievement in the quantity production of electronic equipment for military use, stands nearly a quarter century of highly specialized production and experience in the field of radio components for home receiving sets.

GENERAL ELECTRONIC APPARATUS CORP.

A SUBSIDIARY OF

GENERAL INSTRUMENT CORP.

829 NEWARK AVE., ELIZABETH 3, N. J.

... and now
speakers
by G.I.

The addition of a complete line of speakers is, therefore, not a venture into a new field, but the logical outgrowth of our expanded facilities, developed by wartime activities and increased resources in the radio equipment industry.

The resourcefulness and ingenuity—the expanded and perfected facilities that made this mammoth production possible will be put, without stint, behind our new speakers. Set manufacturers will know what this will mean.





*Partners in
Development...*
**HOW PHILCO ENGINEERS
WORKED WITH THE
AUTOMOBILE INDUSTRY**

Philco's long association with the automobile industry has been a fruitful partnership. Philco engineers worked with automotive experts to develop the first practical auto radio. It was an immediate success. Then Philco went a step further, setting up laboratories and an engineering staff devoted exclusively to designing and developing automobile radios.

Soon this research organization became the world's largest of its kind. Close cooperation with motordom's leading technical brains led to many brilliant "firsts" by Philco engineers. Among them, the first superheterodyne circuit in a com-

mercial auto radio; the first electro-dynamic speaker; the first A.V.C.; the first cowl antenna; the first instrument panel controls; pioneering in motor noise suppression; invention of the Loktal tube, universally used in modern auto radios. Year by year, Philco radio design kept pace with automotive design.

Meanwhile, car manufacturers found in Philco production facilities the answer to their radio requirements—for quantity, quality and value. The manufacturers of thirty-one leading American automobiles standardized on Philco radios. And Philco earned world leadership in building automobile as well as home radios—for 12 straight years before the war.

After Victory, when Philco turns its vast research and manufacturing resources again to peacetime progress, there will be new opportunities for similar partnership. Then Philco engineers will again welcome the responsibility of working with and for American industries... as well as American homes.

PHILCO

Famous for Quality the World Over



Wherever in the World your product goes from the assembly line, there goes with it your reputation . . . your responsibility for its peak performance in the field.

Vitally important to the quality and continuity of that performance is the ease and simplicity with which your job may be "un-buttoned" for adjustments and buttoned-up again for speedy resumption of operation.

CLUTCH HEAD Screws, with their logical design for "screw-driver control" at all times, definitely disposes of this field service problem. Only CLUTCH HEAD gives you this advantage because it is the *ONE* modern screw on the market specifically designed to be operative with an ordinary type screwdriver or any flat blade of reasonably correct width. Note that the thickness of the blade is secondary, the roominess of the Clutch permitting of a wide latitude in this respect.

This simplification of field service problems is *just one of seven major features* provided for safer and lower-cost production with better performance when you standardize your assembly on CLUTCH HEAD Screws.



Discover for yourself by personal test why this is The Screw That Sells Itself. Your request will bring you,



BY MAIL, a package assortment of CLUTCH HEAD Screws and sample Type "A" Bit; also illustrated brochure



UNITED SCREW AND BOLT CORPORATION
CHICAGO 8 CLEVELAND 2 NEW YORK 7

...another
new tube
Ready for
Delivery!



GENERAL ELECTRONICS' new Transmitting Triode is a medium power tube which may be used as an oscillator or modulator. Designed by one of America's leading, pioneer tube engineers, it offers many unusual qualities—operates up to 30 megacycles; exceptionally rugged design; three pillar grid support; anode almost totally encloses grid and filament—an essential feature for operation at ultra-high frequencies; grid terminal at side reduces inter-electrode capacitances—important in high frequency circuits.

Available now—get top performance in the 808 through General Electronics' superior engineering!

GET HIGH WATT-VALUE
PER OUNCE IN
GENERAL
ELECTRONICS'
24 G



90 watts continuous output (as a Class C, unmodulated UHF amplifier) from this amazing tube that weighs only 1.5 ounces . . . and at 3 meters! Output of 65 watts even at 1.5 meters (200 Mc). No insulators or supports to evolve gas on the first overload; no exposed filament to spray envelope with energy-wasting electrons; tantalum plate and grid eliminate flashed-film type getter, allowing tube to run cooler; well adapted for pulse operation where very high voltages are applied in instantaneous pulses . . . all these are features that recommend General Electronics' 24 G to your consideration.

**GENERAL
ELECTRONICS
INC.**

Sales: 1819 Broadway, N.Y. 23, N.Y. • Factory: 101 Hazel St., Paterson, N.J. • Export: 89 Broad St., N.Y. 4, N.Y.

... your **SIMPSON** representative
can help solve your instrument problems



Brewer Murphy ATLANTA—Murphy & Cota
5 Ivy St.
N. C., S. C., Ga., Ala., & Fla.

John J. Cota

P. R. Sturgeon BOSTON
25 Huntington Ave.
Mass., N. H., Vt.,
Main., Conn., Ill.

J. V. Costello BUFFALO
647 Ellicott Sq. Bldg.
New York state
except New York City

J. L. Vergilio

L. M. Waldrip

J. C. Lehner CLEVELAND—J. L. Vergilio Co.
504 Erie Bldg.
State of Ohio

J. A. Baiger

M. C. Lavin



J. Y. Schoonmaker DALLAS
2320 Griffin St.
Texas, & Oklahoma

R. C. Merchant DETROIT
4829 Woodward Ave.
State of Michigan

B. L. MacPherson FORT WAYNE
1724 Alabama Ave.
Indiana & Kentucky

C. R. Lynch LOS ANGELES
210 W. Seventh St.
Calif., below Fresno,
and Arizona

J. M. Cartwright MEMPHIS
1276 Peabody Ave.
Tenn., Miss., La., & Ark.

W. C. Cartwright

M. E. Foster MINNEAPOLIS
Andrews Hotel
Minn., N. Dak., S. Dak.,
Ia., Neb., Western Wis.

John M. Farshay NEW YORK
27 Park Place
New York City and
New Jersey north of
Trenton

Don H. Burcham PORTLAND
917 S. W. Oak St.
Wash., Ore., Idaho,
Mont., Br. Col., and
Alaska



S. K. MacDonald

J. C. Muggleworth PHILADELPHIA—S. K. MacDonald
1343 Arch St.

John J. Mahoney
Southern N. J. including Trenton, Del., Md., Va., & W. Va.

R. G. Brown SALT LAKE CITY
83 E. Fort St.
Utah, Nev., Colo.,
Wyo., & N. Mex.

W. J. Purdy SAN FRANCISCO
420 Market St.
Northern Calif.,
including Fresno

N. W. Kathrins ST. LOUIS
1218 Olive St.
Mo., Kan., & Ill.
south of Peoria

Noble C. Shilt WASHINGTON
S. K. MacDonald
Riggs Bank Bldg.
Regional office of
S. K. MacDonald, Phila.

L. D. Cahoon TORONTO
2271 Danforth Ave.
Ontario, Quebec, &
New Brunswick

H. F. DREW WINNIPEG
Sporling Sales Ltd
273 Fort St.
Alberta, Saskatchewan,
& Manitoba



SIMPSON ELECTRIC COMPANY

5200-5218 Kinzie Street
Chicago 44, Illinois

Simpson

INSTRUMENTS THAT STAY ACCURATE

Buy War Bonds and Stamps for Victory



John C. Hill, Mgr.
EXPORT DEPT.
300 W. Washington St.
Chicago, Ill.

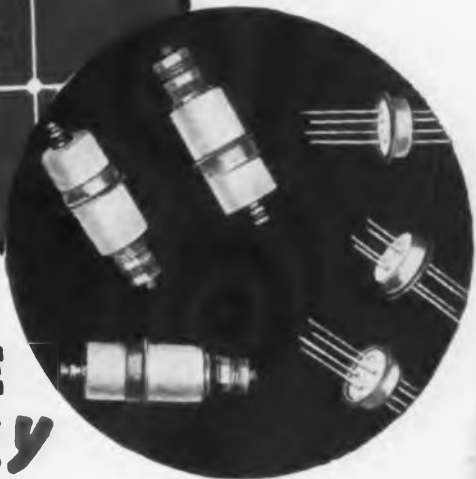
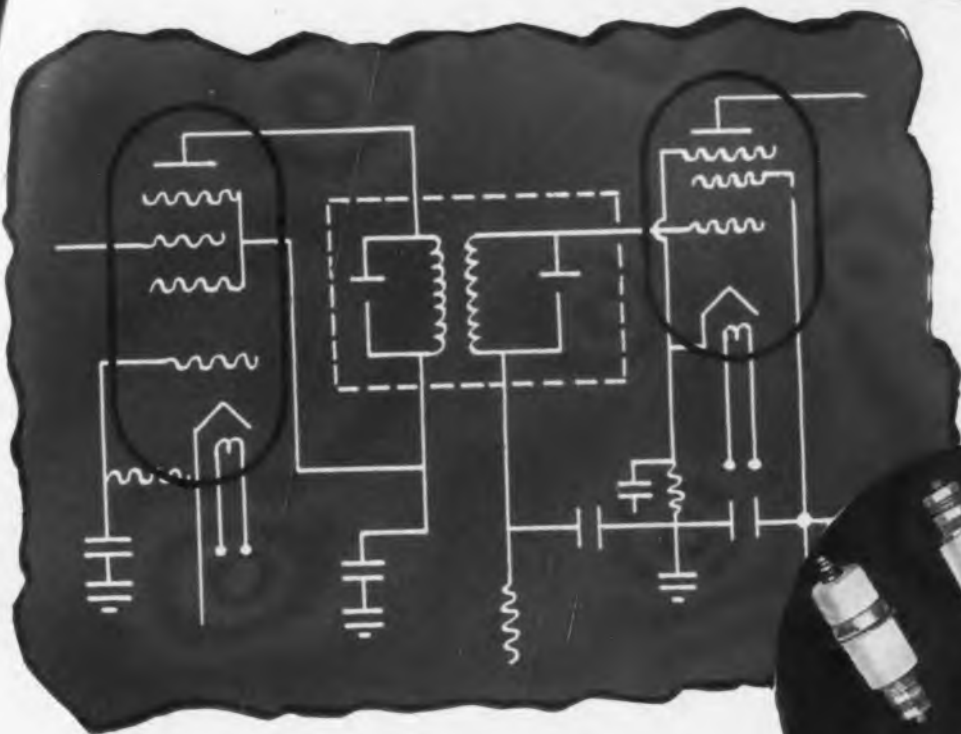

STEEL and STEATITE bonded *PERMANENTLY*

The high mechanical strength of steel and the excellent, permanent insulation qualities of STEATITE have been combined by General Ceramics through its development of a new method of hermetically sealing and permanently bonding together STEATITE and metals in various combinations.

These SEALEX combinations successfully withstand the most severe temperature changes, and show no vibration fatigue. The metal parts are tinned to facilitate soldering where desired.

The General Ceramics method of fusing steatite and steel solves the problems of hermetically sealing and permanently protecting equipment against moisture.

For long-life, dependable, efficient service specify "Steatite" and "Sealex" Combinations.



General Ceramics
AND STEATITE CORP.
GENERAL KEASBEY
NEW JERSEY

PAN AMERICAN USES EIMAC TUBES

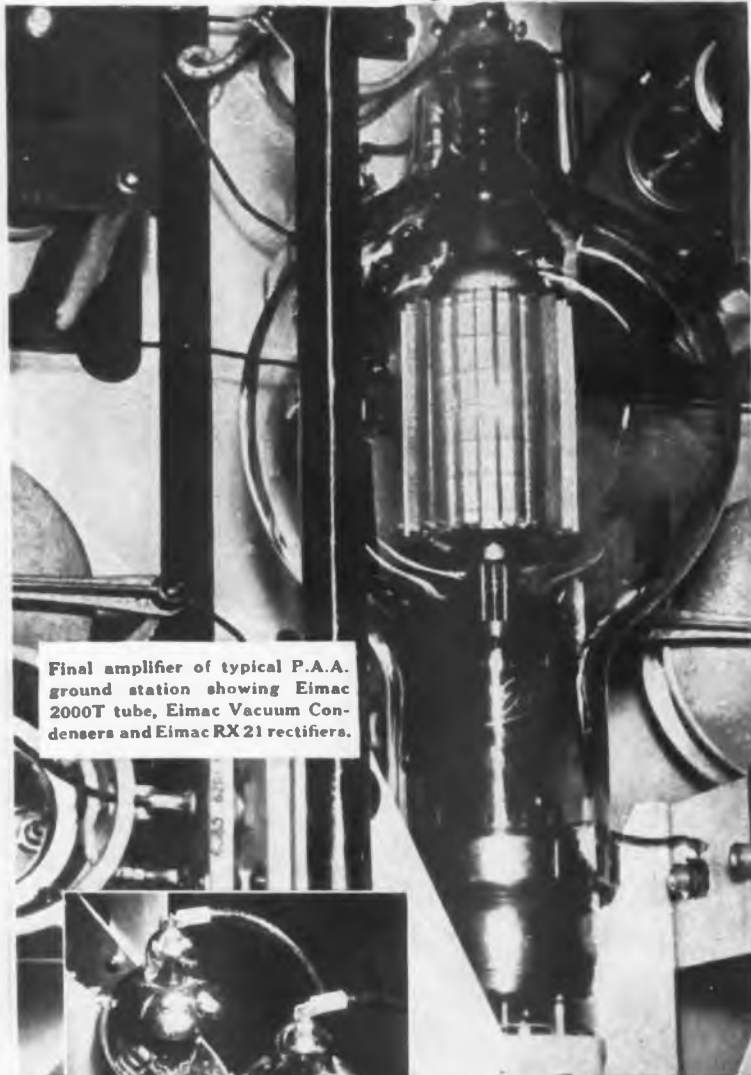

Final amplifier of typical P.A.A. ground station showing Eimac 2000T tube, Eimac Vacuum Condensers and Eimac RX 21 rectifiers.

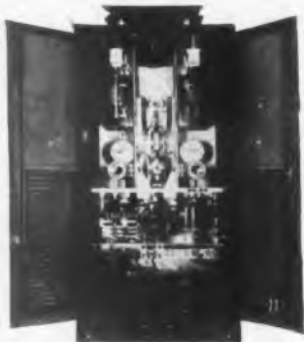

Write for your copy of *Electronic Teletis*—a 64 page booklet fully illustrated—covering fundamentals of Electronics and many of its important applications. Written in lay-man's language.



Pan American World Airways, which has done so much to advance the war-time goals of the nation, has just announced a plan for a new service to South America. Employing a fleet of stratosphere planes, carrying 108 passengers, flying at more than three hundred miles an hour, Pan American proposes to take travelers from New York to Rio de Janeiro in less than twenty hours instead of the present sixty-six hours, charging \$175 for the trip, as against the current rate of \$491.

Pan American Airways and all its associated and affiliated companies, which comprise the P. A. A. World System, have been using Eimac tubes in the key sockets of all ground stations for a number of years.

Because of the extensive operations of Pan American World Airways, these tubes have been subjected to about every test possible—altitudes; ground level; extremely cold climates and high temperatures found at the equator; conditions of high and low humidity; and in some instances, when new bases are being built, perhaps somewhat trying power conditions. The high regard which P. A. A. engineers have for Eimac tubes is clearly evidenced by their continued and more extensive use, as the years roll by.

The fact that Eimac tubes are the number one favorite of the commercial airlines is important evidence to substantiate the oft repeated statement that "Eimac tubes are first choice of leading electronic engineers throughout the world."

Follow the leaders to



EITEL-McCULLOUGH, INC., 947 San Mateo Ave., SAN BRUNO, CALIF.

PLANTS LOCATED AT: SAN BRUNO, CALIFORNIA AND SALT LAKE CITY, UTAH

Export Agents: **FRAZAR & HANSEN, 301 Clay Street, San Francisco, California, U. S. A.**



CONTROL

Unique research, engineering, tool design and production skills combine, not only to build control devices that fulfill the most exacting requirements, but also to build special purpose devices for which no specifications exist. Our list of customers, the most exacting in government, aviation and manufacturing, attest to these skills.

Manufacturers of Electrical, Electronic & Mechanical

Control Devices



EASTERN AIR DEVICES, INC.

589 Dean Street • Brooklyn 17, N. Y.

An Affiliate of THE FRED GOAT CO., INC., Est. 1893

ELECTRONIC INDUSTRIES • December, 1944



MODEL J 80 A

**AXIAL FLOW BLOWER
AIR DELIVERY (FREE AIR)**

170 C.F.M. (NEMA CODE)

65 C.F.M. (NAFM CODE)

60 cycles • 115 volts • single phase capacitor run • 3100 R.P.M. • 12 watts input • 1 oz. in. starting torque • 1 mfd. condenser required • Weight 16½ oz. Overall length 3 11⁄16" • Motor diameter 1¾" • Fan: 4 blade propeller type, 4" diameter.

We invite inquiry!

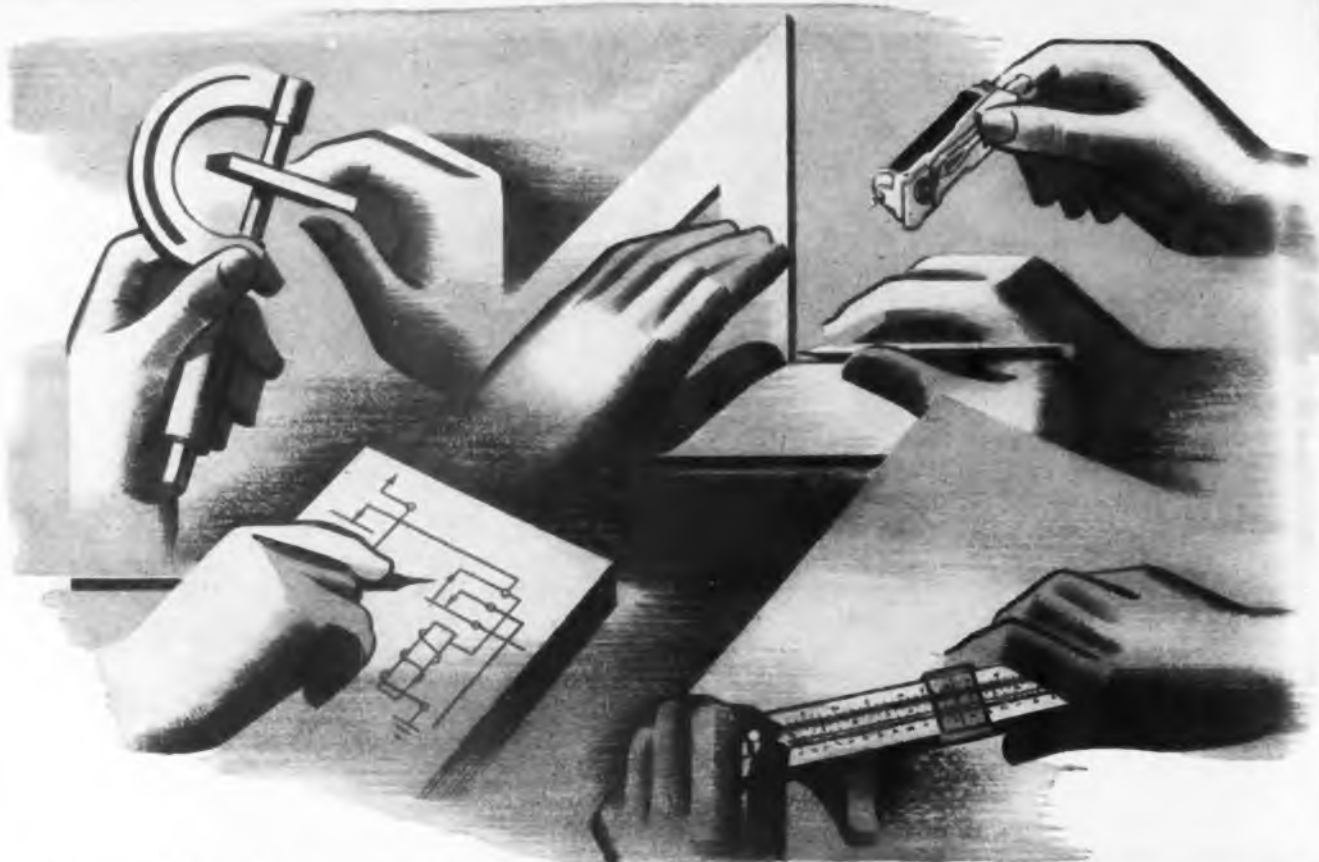

Your New Product may need the Magic of Electrical Control

TAKE another look at that new product your designers are planning. It may be that Automatic Electric control devices can make it function better—at lower cost. It's worth checking into.

To help designers perfect new developments—or improve old ones—Automatic Electric offers this unique three-point service:

1. Technical advice by experienced field engineers, who know the "how" and "why" of control technique.
2. A complete range of relays, stepping switches, and other control units—time-proved products readily adapted to your needs.
3. A design and manufacturing service for complete engineered assemblies.

Ask our field engineer for a copy of our catalog of control devices. He will be glad to show you how they can serve you.



Here are jobs that can be done easier and better with Automatic Electric control devices:

Automatic Selection and Switching of Circuits • Time, Temperature and Sequence Control • Counting and Totalizing • Inspection and Sorting Operations • All Types of Electrical and Electronic Control.

Relays
AND OTHER CONTROL DEVICES
by **AUTOMATIC
ELECTRIC**



AUTOMATIC ELECTRIC SALES CORPORATION
1033 West Van Buren Street • Chicago 7, Illinois

In Canada: Automatic Electric
(Canada) Limited, Toronto

PARTS AND ASSEMBLIES FOR EVERY ELECTRICAL CONTROL NEED

Micarta antenna masts to
"HIT THE BREEZE"
 at 600 mph!

Another Example of Versatile Micarta at work

That thin, long mast rides outside in the fury of a 600 mph gale. It is made of Micarta—the light, tough plastic.

Requirements for antenna mast performance are exacting. The mast must withstand extremes of air pressure and temperature. It must be rigid, hold the antenna taut without yield or wobble.

Micarta's unusual combination of characteristics—strength with lightness, resistance to heat, cold, humidity and chemicals—has been of particular interest to the Communications Industry for many years. All these same properties are retained in Micarta "444"—a new development in plastics—a process of manufacture permitting the formation of structural shapes from completely cured flat sheets. A versatile product . . . suited to simple and low-cost fabrication . . . with unlimited application possibilities in the Communications Industry.

Investigate Micarta and the new "444" product—write for the new Micarta Data Book—B-3184A. Westinghouse Electric & Manufacturing Co., P. O. 868, Pittsburgh 30, Pa.

J-06347-B

OFFICES EVERYWHERE



PLANTS IN 25 CITIES

Micarta

THE INDUSTRIAL PLASTIC



CAMS, made of Micarta, are used where high dielectric plus long wear are important. Other applications include terminal blocks, coil forms, switch spacers and tube sockets.



AMMUNITION FEED CHUTES made of the new Micarta "444" guide bullets accurately into firing position. It is thin, light, strong, easily formed with inexpensive dies.



BOMB RACKS have been successfully molded with Micarta . . . furnish an excellent example of Micarta's strength and the skill of Westinghouse engineers in intricate molding assignments.

**TYPICAL USES
FOR YOUR
POST-WAR
RADIO**

SS-2 FOR LOOP OR OUTSIDE
ANTENNA SELECTION

SS-15 PUSH SWITCH FOR
DIAL LIGHT ON BATTERY SETS

SS-7 FOR FIXED SETTING FOR
BAT.-A.C.-D.C. OPERATION

SS-7
SS-2 POWER TRANS. PRIMARY TAPS
OR A.C.-D.C. CHANGE OVER

LPSS-3 MAY BE USED
AS VARIABLE TC &
WAVE BAND SWITCH
INSTEAD OF SS-2
AND SS-7

SS-1 POWER SWITCH

SS-7 3-POSITION
TONE SWITCH

SS-15
SS-9 SOLENOID TYPE
PUSH BUTTON TUNING

SS-3 WAVE BAND SWITCH

THE SWITCHES OF HUNDREDS OF APPLICATIONS

*Line, Slide, Rotary-Action Types
Inexpensive but Dependable*

FROM post-war radio equipment to toys; from instruments to appliances. Stackpole switches afford a complete engineering selection. They are compact, dependable, low in price, and are subject to countless adaptations designed to match your specifications *exactly*.

Standard types include 1-, 2-, 3-,

and 4-pole styles, with or without spring return, detent, or other optional features. 3-position and various other types are available. Write today for a copy of the 36-page Stackpole Electronic Components Catalog including Switches, Fixed and Variable Resistors and Iron Cores for a variety of uses.

STACKPOLE CARBON COMPANY, St. Mary's, PA.

STACKPOLE

OTHER STACKPOLE PRODUCTS

BRUSHES - CONTACTS (All carbon, graphite, metal, and composition types)
POWER TUBE ANODES PACKING, PISTON, and SEAL RINGS
BATTERY CARBONS POWDER METALLURGY COMPONENTS

WELDING CARBON PRODUCTS
VOLTAGE REGULATOR DISCS
RHEOSTAT PLATES and DISCS, etc.

STANDARDIZATION!

FLEXIBILITY!



AMP
SIMPLIFIED WIRING

IMMEDIATE
OR GRADUAL
ADAPTATION TO
YOUR PRODUCT!

For the First Time

**ONE Simple BASIC UNIT
USED THROUGHOUT** in

the design and manufacture
of wiring systems, harnesses,
connections and electrical
and electronic components

*... eliminating all complex,
cumbersome, unnecessary parts!*

WRITE FOR YOUR COPY TODAY

Our new publication, **AMP SIMPLIFIED WIRING**, explains the limitless possibilities of this new system and presents photographs and complete data on many typical installations. You will want others in your organization to have a copy. Add their names to yours in sending for **AMP SIMPLIFIED WIRING** (Bulletin 33).

AIRCRAFT - MARINE PRODUCTS INC.

1521-24 N. 4TH ST. HARRISBURG, PENNA. TELEPHONE: HARRISBURG 4-4191

A. E. W. ACCESSORIES, LTD., TORONTO, ONTARIO, CANADA

Trade Dressing M. S. Pat. 2,111,111



Leeuwenhoek Saw a New World in a Tiny Bead of Glass

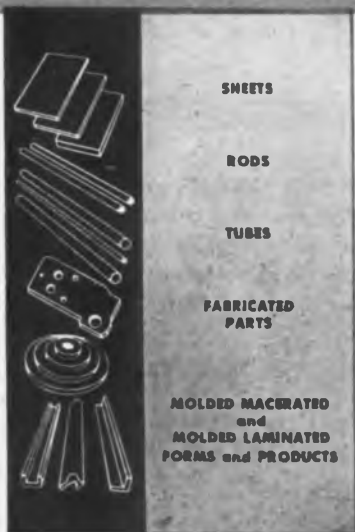

SHEETS

RODS

TUBES

FABRICATED
PARTS

MOLDED MACERATED
and
MOLDED LAMINATED
FORMS and PRODUCTS

HISTORY does not reveal who invented the microscope. But it was a Dutch merchant, Anthony Van Leeuwenhoek, who made it practical. Peering through a tiny bead of glass he ground into a lens, he became the first to see the organisms of the microscopic world.

This kind of inquisitiveness still pays. For example, present-day investigators are bringing into view many practical new uses for plastics. You

may initiate and benefit from these newer or wider uses. Here's how. You know best what properties—physical, electrical, chemical or mechanical you require of a material. Give us this information to start on and we'll be glad to let you know whether our type of technical plastics can help you in current or future plans. In any case, write today for the complete catalog of Synthane technical plastics. Synthane Corporation, Oaks, Penna.

SYNTHANE TECHNICAL PLASTICS

SHEETS • RODS • TUBES • FABRICATED PARTS

SYNTHANE

MOLDED-LAMINATED • MOLDED-MACERATED

Plan your present and future products with Synthane Technical Plastics

THERE ARE A THOUSAND USES FOR SYNTHANE LAMINATED PLASTIC TUBING

Tubing is the start in the production of many products

SYNTHANE TUBING is produced in various shapes, diameters, wall-thicknesses, lengths, colors and finishes. The uses of tubing, simply as tubing, however, are obviously limited. It is imagination and machining plus a combination of many desirable properties that make Synthane tubing the useful material it is. Tubes can be easily and quickly machined into coil forms, fuse cases, chemical piping, motor brush holders, bushings, ferrules, ball bearing retainers, pump valves and a legion of other products. Tubing, then, is the first step in the ready and economical production of many parts.

Machining can be done by you or by us. Many prefer us to handle the complete job to relieve them of the responsibility for dies, jigs, tolerances, and other production details.

PROPERTIES—GENERAL (Varies with grades)

PHYSICAL: Hard, Rockwell M-60 to M-100, dense, uniform. Light in weight (specific gravity 1.1 to 1.3), non-hygroscopic, (24 hour water absorption 0.5 to 5.0 per cent). Stable over wide temperature range. Low coefficient of thermal conductivity.

MECHANICAL: High tensile, compressive and crushing strength. High resistance to rupture (under internal pressure). May be easily sawed, turned, punched, riveted, drilled, reamed, milled, threaded, tapped or polished.

ELECTRICAL: High dielectric strength, low dielectric constant, low power factor, low loss factor.

CHEMICAL: Resists common solvents, oils, weak acids. Will not corrode metal inserts, bushings, ferrules, etc.

Kinds of stock, properties

There are three principal kinds of SYNTHANE tubing, classified according to the materials used in their manufacture:

1. The paper base grades—X and XX.
2. The fabric base grades—C, CE, L and LE.
3. The asbestos base grades—A and AA.

The properties and characteristics of SYNTHANE tubing depend mainly upon the base used, the type of resin and the time of cure. By combining the raw materials and varying the method of manufacture, it is possible to alter the physical, mechanical, electrical or chemical properties, strengthening one without wholly sacrificing the others, to secure the exact balance of properties required.

The services of SYNTHANE engineers are at your disposal to aid in selecting or developing tubing to meet your particular needs.

Special shapes

Special tubular sections can be produced in a wide variety of forms by applying the basic principles of tube molding. SYNTHANE sections, being laminated, are considerably stronger than ordinary powder molded shapes.

The simplest molded-laminated shapes are square, rectangular or oval. More intricate examples include horns, cones and irregular inside or outside contours.

Automatic screw machining can be advantageously used for low cost quantity production of numerous parts from Synthane tubing.

From tubes like these...

products like these →



SYNTHANE CORPORATION, OAKS, PENNA.

REPRESENTATIVES IN ALL PRINCIPAL CITIES



THE COLLINS RADIO organization has always been driven by the urge to pioneer . . .

To introduce professional standards of design and performance in transmitters and receivers for radio hams in the early thirties.

To engineer a radio outfit that stood up to the rough-and-tumble of Admiral Richard E. Byrd's second expedition to Little America.

To take high quality broadcast equipment out of the laboratory and make it economically practicable for any broadcasting station.

To meet the individual requirements of some of our great airlines with specially engineered communication equipment, including the Collins Autotune.*

To be prepared on December 7, 1941, to go into

production of airborne and ground based radio gear of highly advanced design for the Armed Forces—the result of research and development looking years ahead.

Very soon, we hope, this restless Collins urge to pioneer beyond present horizons will be exerting itself again for the airlines and other commercial and private users of radio communication equipment. *Collins Radio Company, Cedar Rapids, Iowa.*

*The Collins Autotune is a repositioning mechanism which quick-shifts all transmitter or receiver controls simultaneously and with extreme precision to any one of a number of pre-determined frequencies. U. S. Patents issued and pending.



WARNING

TO FIRST-TIME
USERS

DON'T LOOK FOR A JACK-OF-ALL-TRADES IN ELECTRONIC HEATING MACHINES

ELECTRONIC HEATING is rapidly outmoding many industrial heating processes because of its numerous advantages, recognized and acknowledged by all leading industries.

It is, however, important to realize that the maximum time-and-money-saving advantages of the process can only be realized by using it correctly in every application. Each heating process requires a definite FREQUENCY and POWER combination.

To use any combination of frequency and power other than the one ideally adjusted to the process implies a waste of power and the use of a "misfit" size machine.

No electronic heater has ever been built that can provide a large enough variety of frequency and power combinations to permit economical application to more than one type of heating operation.

For 23 years we have pioneered and specialized in electronic heating. As recognized experts we urge all first-time users to consult our engineers and to investigate the many advantages of our complete variety of units before buying. Write to us for detailed information.

Our equipment offers you a selection of frequencies up to 300 megacycles—and the following power range, with stepless control from zero to full load: 3, 5, 7½, 10, 12½, 15, 18, 25, 40 and 100 Kw.

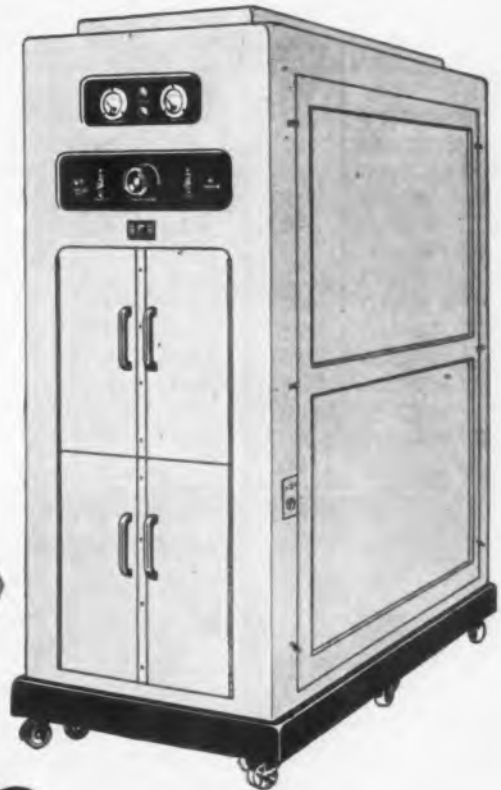

Scientific Electric



DIVISION OF "S" CORRUGATED QUENCHED GAP COMPANY
119 MONROE STREET GARFIELD, NEW JERSEY

Manufacturers of Vacuum Tube
and Spark Gap Converters
Since 1921

Oil Type EC CAPACITRON

... in a Wide Range
of Ratings for
Single Hole Mounting!

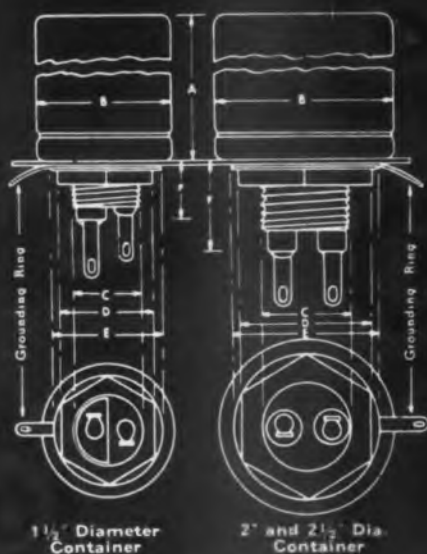

Catalog Number	Capacity in Mfd.	Working Voltage D.C.	DIMENSIONS IN INCHES					
			A	B	C	D	E	F
6EC200	2.0	600	2 3/4	1 1/2	3/4 x 16thd	1	1 1/4	5/8
6EC300	3.0	600	4 1/2	1 1/2	3/4 x 16thd	1	1 1/4	5/8
6EC400	4.0	600	4 1/2	1 1/2	3/4 x 16thd	1	1 1/4	5/8
6EC600	6.0	600	4	2	1 x 14thd	1 7/16	1 5/8	1
6EC800	8.0	600	4 1/2	2	1 x 14thd	1 7/16	1 5/8	1
6EC1000	10.0	600	4	2 1/2	1 x 14thd	1 7/16	1 5/8	1
10EC100	1.0	1000	2 3/4	1 1/2	3/4 x 16thd	1	1 1/4	5/8
10EC200	2.0	1000	4 1/2	1 1/2	3/4 x 16thd	1	1 1/4	5/8
10EC400	4.0	1000	4	2	1 x 14thd	1 7/16	1 5/8	1
10EC600	6.0	1000	4	2 1/2	1 x 14thd	1 7/16	1 5/8	1
10EC800	8.0	1000	5	2 1/2	1 x 14thd	1 7/16	1 5/8	1
15EC50	.5	1500	2 3/4	1 1/2	3/4 x 16thd	1	1 1/4	5/8
15EC100	1.0	1500	4 1/2	1 1/2	3/4 x 16thd	1	1 1/4	5/8
15EC200	2.0	1500	4	2	1 x 14thd	1 7/16	1 5/8	1
15EC400	4.0	1500	4 1/2	2 1/2	1 x 14thd	1 7/16	1 5/8	1

All of the Above A.W.S. Army-Navy Submersion Proof Units Available in Production Quantities for Prompt Delivery. Write, Wire or Telephone — Now!

Telephone: MICHigan 9656

The CAPACITRON *Company*

318 West Schiller St.

Chicago 10, Illinois



Sensitive **SNAP-ACTION**

**...in a new,
simplified design**

The new, simplified construction of the Struthers-Dunn Type 79XAX Sensitive Snap-Action Relay makes it particularly suitable for a wide range of applications because of its ease of adjustment. Snap-action contacts eliminate the erratic, undependable action normally encountered in ordinary sensitive relays when a slowly varying coil current tends to balance the armature tension spring, and to hold closed the normally closed contacts.

The armature of the 79XAX almost completes its travel in either direction before the contacts snap into the new position. This feature permits an unusually broad range of use from vacuum tube circuits, to overcurrent protection, pulsing circuits, and jobs where extremely close differential or extreme sensitivity of operation is required.

The standard adjustment using 60 ampere turns in the coil at approximately .02 watts results in contact pressures of 5 grams with contacts rated 5 amperes, 115 volts a-c; or 0.5 amperes, 115 volts d-c, non-inductive. Contact ratings up to 10 amperes, 115 volts a-c may be obtained with 100 or more ampere turns and a corresponding increase in power. A sensitivity of 0.005 watts, with 30 ampere turns, is obtainable with reduced contact pressures and ratings, and at an increase in price of the unit.

STRUTHERS - DUNN INCORPORATED
1321 ARCH STREET, PHILADELPHIA 7, PA.

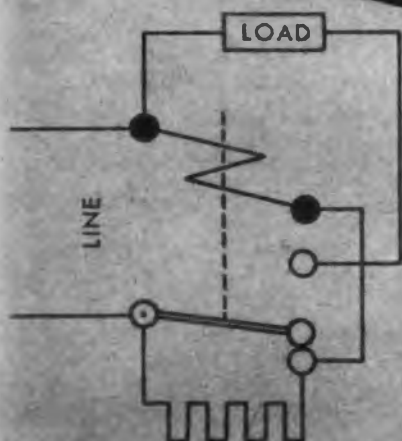

A TYPICAL CLOSE DIFFERENTIAL APPLICATION

In using the Struthers-Dunn 79XAX Relay, extremely close differential between pick-up and drop-out may be obtained for potential operation as shown above. The resistor is chosen so that, when the armature closes, the coil current is automatically reduced to a value just sufficient to hold it closed. Any further decrease in voltage will cause the relay to return to its normal de-energized position as shown.

STRUTHERS-DUNN

5,312 RELAY TYPES

DISTRICT ENGINEERING OFFICES: ATLANTA · BALTIMORE · BOSTON · BUFFALO · CHICAGO · CINCINNATI · CLEVELAND
DALLAS · DENVER · DETROIT · HARTFORD · INDIANAPOLIS · LOS ANGELES · MINNEAPOLIS · MONTREAL
NEW YORK · PITTSBURGH · ST. LOUIS · SAN FRANCISCO · SEATTLE · SYRACUSE · TORONTO · WASHINGTON

SHORT RUN PIERCING

(1 to 500 Pieces of a Kind)

can be **ECONOMICAL!**

The Wiedemann Turret Punch Press for short run piercing is the **ONLY** equipment that will produce otherwise expensive work at long run low cost.

Short run piercing of sheets and plates up to $\frac{3}{8}$ " thickness is performed in less than one-quarter the time required on conventional equipment and traditional methods.

A Wiedemann Turret Punch Press will pay for itself in two years or less in labor time saved to produce short run work.

On long run jobs, where the quantity of pieces be-

ing produced makes it economical to tool up with mass production multiple punches and dies, you'll find a Wiedemann ideal for pre-production piercing of sheets and plates. You need not wait weeks or months to tool up . . . a Wiedemann Turret Punch Press will absorb the time lag.

Typical Short Run Work

Custom-made instrument panels, chassis and frames, experimental models, knock-out boxes, bus bars, general sheet metal and plate work, etc. Write today for Bulletin 92 . . . facts about speed-

ing up short run piercing with the Wiedemann Turret Punch Press.



WIEDEMANN MACHINE CO.

1833 SEDGLEY AVENUE • PHILADELPHIA 32, PA.

TURRET PUNCH PRESSES (HAND OPERATED UTILITY MODELS TO 80-TON PRODUCTION UNITS)

TYPE R-7

With gauge table—for handling large sheets without conventional layout of job. (Saves 80% of layout and piercing time.) 2 to 3 seconds to put correct punch in punching position. Work-positioned in a matter of seconds by hand wheels.



TYPE R-2

Hand operated, rugged and accurate. Will handle wide variety of miscellaneous piercing done in every metal working shop.



TYPE R-44

For piercing through templates. Handles piercing operations of longer runs, up to 1200 pieces of a kind. The work is pierced entirely through templates, thereby assuring accuracy and duplication at high rate of speed.



TYPE R-5

Highly versatile—for short runs on such work as special outlet and conduit boxes as well as thin sheet and other piercing. Also used for piercing copper.

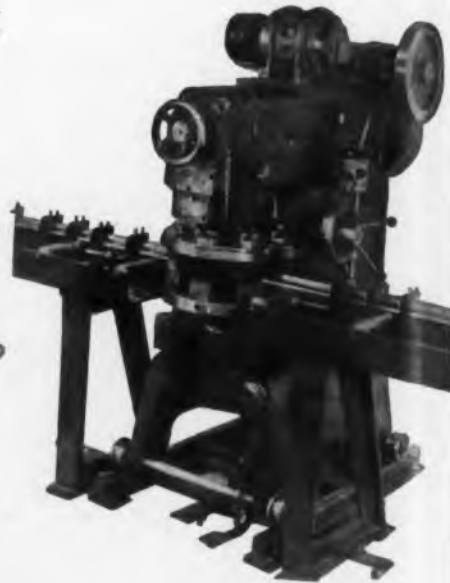

WIEDEMANN TURRET PUNCH PRESSES & GAUGE TABLES

BH NON-FRAYING FIBERGLAS SLEEVING



BH EXTRA FLEXIBLE FIBERGLAS SLEEVING

2 WAYS BETTER



THIS



NOT THIS

NON-FRAYING



THIS

NOT THIS

NON-STIFFENING

ASSEMBLERS and electricians don't have to be contortionists when working with non-fraying BH *Extra Flexible* Fiberglas Sleev- ing. Remarkably resistant to stiffening, this always supple insulation won't crack or rot with age. Whether in tough, active service or dead storage, it remains "fresh" and easy to work, retaining its full insulating efficiency *indefinitely*.

This special-processed sleev- ing won't burn and is non-crystallizing at low temperature. It offers all the natural advantages of Fiberglas—high dielectric and tensile strength—chemical and moisture resistance—and many more—in addition to its own unusual properties.

You'll want to see for yourself the cleaner cutting, non-fraying and non-stiffening features of the sleev- ing that simplifies assembly, lasts longer and cuts repair costs. BH *Extra Flexible* Fiberglas Sleev- ing is available in all standard colors. Sizes from No. 20 to 5/8", inclusive. Write for *your* samples today and compare!

BH SPECIAL TREATED FIBERGLAS SLEEVING FLEXIBLE AS STRING!

Here's another high quality BH Fiberglas Sleev- ing. Due to the BH exclusive process no saturant is used, yet it will not fray out when cut and will withstand heat up to 1200°F. Made in natural color only—all standard sizes. Test it and try it!



NON-BURNING IMPREGNATED MAGNETO TUBING • NON-BURNING FLEXIBLE VARNISHED TUBING • SATURATED AND NON-SATURATED SLEEVING

BENTLEY, HARRIS MANUFACTURING CO.

Dept. I, Conshohocken, Penna.

NEW

FREQUENCY METER and MONITOR

for HIGH FREQUENCY
SERVICES—1500 kc
to 200 Mc



For measuring and monitoring the carrier frequency of a-m transmitters, these two new G-R instruments offer many operating advantages over equipment formerly available.

With the Frequency Meter, readings are substantially independent of amplitude of modulation, input waveform and input voltage. Over very wide ranges, changes in any of these do not affect the meter indications. The instrument requires no direct connection to the transmitter . . . a foot or two of wire provides ample coupling. The indicating meter has six ranges with full-scale values of 200 cycles, 600 cycles, 2 kc, 6 kc, 20 kc and 60 kc.

One of the most useful features of the Frequency Monitor is its great sensitivity. It can be used to monitor mobile stations. The numerous operating conveniences include: a panel switch to select any one of four temperature-controlled quartz plates; a "stand-by" control to maintain operating temperature continuously with the tube circuits disconnected; positive indication of the direction of frequency deviation; panel terminals for the audio output and for the output of the crystal buffer stage for calibrating or adjusting transmitters or receivers.

You'll find that this combination of instruments is one of the best G-R has developed for high-frequency communications monitoring.

Because we are in full-time production of war orders, none of these instruments are available for shipment, and probably will not be until after the war. We ARE accepting reservation orders, however, and will fill them in rotation as soon as production starts.

FREQUENCY METER

RANGE: 0 to 60,000 cycles in six ranges
ACCURACY: $\pm 2\%$ of full scale
INPUT VOLTAGE: Any between 0.25 and 150 volts

MOUNTING: Relay-rack panel; walnut end-frames (illustrated) for table mounting, extra

TYPE 1170-A FREQUENCY METER
\$185.00

FREQUENCY MONITOR

CARRIER RANGE: 1500 kc to 200 Mc
ACCURACY: 0.003% with our quartz plates

QUARTZ PLATES: Up to four, not included in price; ground to channel frequency

MOUNTING: Same as Frequency Meter

TYPE 1175-A FREQUENCY MONITOR
\$250.00

GENERAL RADIO COMPANY

CAMBRIDGE 39, MASSACHUSETTS

New York 6

Chicago 5

Los Angeles 38



**"THE BOARD OF DIRECTORS JUST LEARNED THAT ALBION
COULD SHIP ALL THE COILS THEY NEEDED!"**

SUPER-QUALITY COILS . . . WHEN YOU NEED THEM!

More and more every day, the industry is turning to Albion for fast, quality and quantity production of coils, chokes, and transformers. That's because here you benefit from the unbeatable combination of management "know how," skilled workmanship, streamlined facilities, and central location. Your requirements will be given prompt and thoughtful attention.

**ALBION
COIL COMPANY**

ALBION, ILLINOIS

**R. F. AND TRANSMITTING COILS AND CHOKES;
I. F. TRANSFORMERS**



FINEST PICTURE QUALITY IN BLACK AND WHITE AND IN FULL COLOR!

Sharper, more brilliant pictures than ever before possible are now a reality with Federal's new broad-band television technique . . .

In a revolutionary contribution to the television art, Federal's system permits combining *sight and sound* on one carrier frequency . . .

For the broadcaster—a single transmitter, and consequently, lower first cost, lower power consumption, less space requirement, and fewer high power tubes . . .

For the television audience — a

simpler, less expensive receiver, more compact and efficient, and requiring fewer tubes.

This great forward stride is the logical outcome of Federal's long list of achievements in the field and the contribution of Federal's engineers to the development of the "Micro-ray" more than a decade ago . . . the forerunner of modern television technique.

And as a result . . . Federal has been selected by the Columbia Broadcasting System for the construction

of its new television transmitter atop the Chrysler Tower in New York.

Federal's modern television technique will also be reflected in an equally advanced Federal television receiver for the home . . . producing the finest picture quality.

Federal has the experience, the facilities, the technique, needed to build television equipment for any broadcasting requirement. For the best in television — see Federal first.



Federal Telephone and Radio Corporation



Newark 1, N. J.

PRECISION AT

2,000,000

VOLTS



WE ARE not going to tell you here why this tube was made, what it does, or what it is for. The important thing about it to you as a user of radio oscillator, amplifier and

rectifier tubes for communications or induction heating is that it represents the toughest assignment ever handed the electronic tube industry, and that of all tube makers only Machlett perfected the techniques that made the tube possible.

The tube is sealed-off, vacuum-tight, and operates at 2,000,000 volts, direct current. These and other difficult conditions were essential to assure high and constant power, reduction of heat, and precise focusing of the electron beam.

Electrical and mechanical problems presented by the tube were so severe that some scientists doubted they could be solved, but Machlett, drawing upon its long experience, met every requirement in a little over two years.

This is significant to you because every electronic tube, whether it produces X-rays, or radio waves, or is a rectifier, depends for its success in your service upon correct design, proper vacuum, adequate insulation, and precision-made parts, to assure precise control of the electrons that make any such tube function.

The perfection of this 2,000,000-volt direct-current tube is the best proof we can offer of the value of the Machlett skills that go into the design and manufacture of every tube bearing our name . . . Machlett Laboratories, Inc., Springdale, Connecticut.



APPLIES TO RADIO ITS 46 YEARS
OF X RAY TUBE EXPERIENCE

COPPER
SULPHIDE

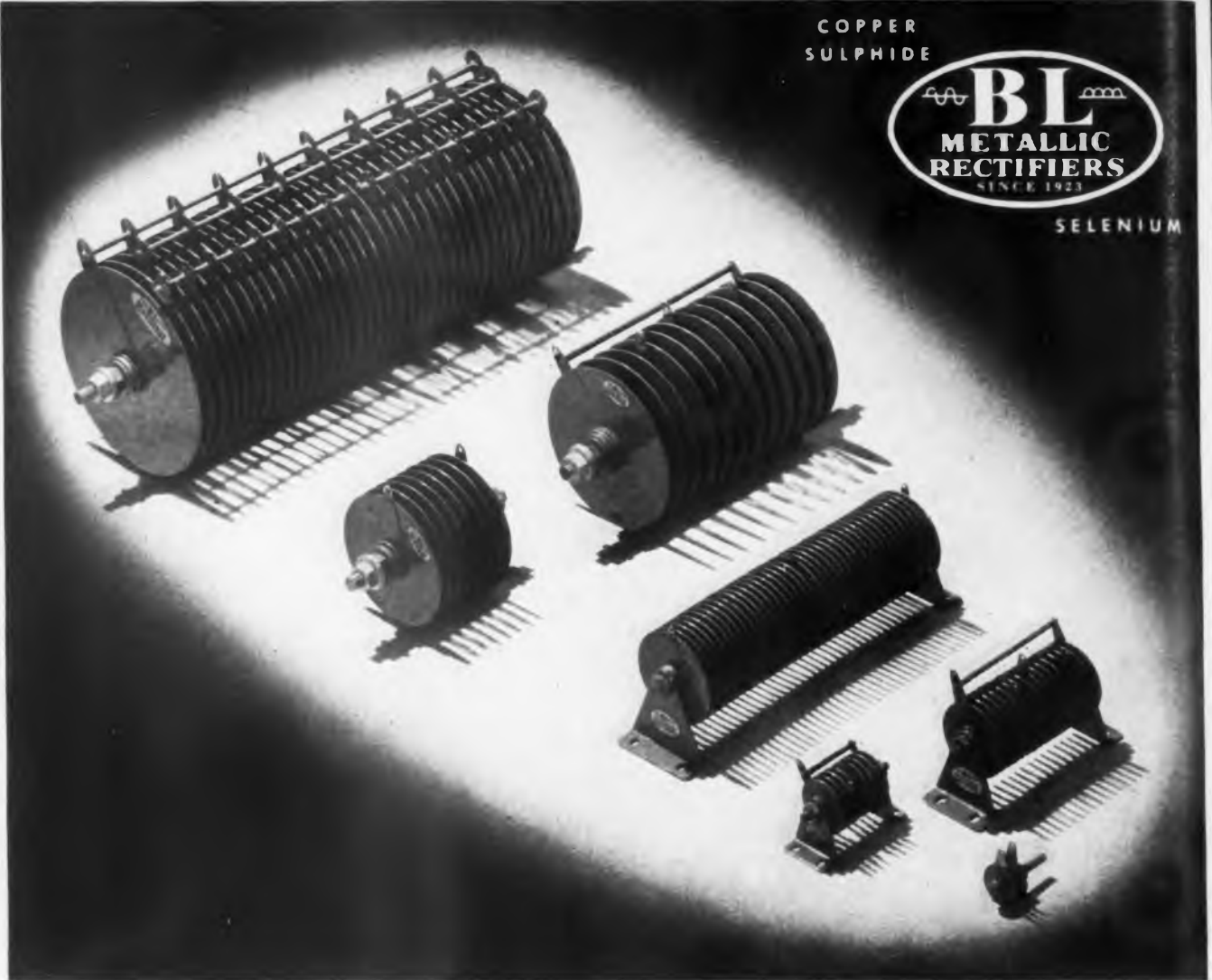

B-L METALLIC RECTIFIERS from Milliwatts to Kilowatts

If you have an A. C.-D. C. conversion problem, let B-L engineers help you. We have successfully produced many appliances formerly thought impractical.

B-L Metallic Rectifiers have been favorably known to the electrical industry for

many years. They are reliable, efficient, designed to get *your* job done right!

No matter what rectifier applications you are considering, B-L will be glad to work with you. Selenium and Copper Sulphide Rectifiers for all needs are available.

*Write today for Bulletin R-41 giving full details about B-L Selenium Rectifiers.
Bulletin R-38 for full details about B-L Copper Sulphide Rectifiers.*

COPPER
SULPHIDE



SELENIUM

THE BENWOOD LINZE COMPANY

1815 Locust Street • • • St. Louis 3, Mo.

DESIGNERS AND MANUFACTURERS OF COPPER SULPHIDE AND SELENIUM RECTIFIERS,
BATTERY CHARGERS, AND D.C. POWER SUPPLIES FOR PRACTICALLY EVERY REQUIREMENT.



Free from the built-in
hazards of ordinary insulation

LUMARITH* stays the
BLACK HAND OF CORROSION

• Even under severe conditions of humidity and current load, Lumarith films thin enough for hairlike copper wire protect against corrosion.

• Open circuit coils especially require extra protection against electrolysis associated with moisture and leakage of current through insulation. Here Lumarith is ideal.

The best protection against electro-chemical corrosion is insulation that does not in itself promote decomposition when subjected to unfavorable conditions.

In electrical applications Lumarith is outstanding for chemical inertness. It does not combine with moisture to form free acids, nor is it subject to failure through oxidation. Even in direct current applications it protects against the usual sources of corrosion.

You can depend on Lumarith for high dielectric and tensile strength and freedom from cracking. It stands up under abrasion hazards while retaining necessary flexibility.

Supplied in films, sheets, rods, tubes and molding materials. Films available plain or in special mat finish for easier winding, reducing slippage and increasing visibility. "Lumarith for the Electrical Industry" is a reference booklet you'll want to keep handy. Send for

it today. Celanese Celluloid Corporation, a division of Celanese Corporation of America, 180 Madison Avenue, New York 16, N. Y.

Celanese yarns and fabrics with the same basic electrical characteristics as Lumarith are especially manufactured for the electrical industry. For data, address Celanese Corporation of America, 180 Madison Avenue, New York 16, N. Y.

LUMARITH*
A Celanese Plastic

*Reg. U.S. Pat. Off.

HOW

Excellence



NIMBLE FINGERS Experienced Sangamo operators develop such a pronounced sense of touch that their handling of MICA in its initial state of preparation—that of splitting—is accomplished with the greatest dexterity and finesse. "Nimble fingers" inaugurate a quality control through ability that is maintained through each process of CAPACITOR production. Thus, faithful performance of the smallest to the largest unit has its beginning in the intricate art of MICA SPLITTING.

SANGAMO ELECTRIC

ESTABLISHED 1898 . . . MICA CAPACITORS . . .

IS BUILT INTO . . .

SANGAMO MICA CAPACITORS

The many processes that are required in producing Sangamo MICA CAPACITORS involve numerous critical operations. Some of these are MICA SPLITTING, MICA GAUGING, MICA PUNCHING, MICA INSPECTION, and CAPACITOR STACKING. The large photo shows a group of operators performing the highly specialized operation of splitting films from block Mica. Note the specially designed tables, the modern lighting, and the spacious layout to facilitate excellence of production.

★ *Mica Splitting*

Only the finest obtainable electrical MICA is used for the dielectric of Sangamo MICA CAPACITORS. The largest quantities of high grade block Mica (so called because it is still intact as a block and not split into individual laminations) come from India, although some Brazilian, Argentine, and domestic Micas are equally satisfactory.

For the manufacture of Capacitors, block Mica must be split into uniform, thin laminations. The voltage breakdown depends upon the thickness and quality of the Mica laminations, while the uniformity of the finished capacitors depends, in large measure, upon the uniformity of the thickness of laminations.

Even in these days of mass production and automatic processing machinery, Mica Splitting is still necessarily a hand operation, for no machines have been developed to split Mica satisfactorily. Deft fingers can usually split Mica into laminations to within 0.0005 inch of the required thickness.

There are many methods of splitting Mica. Some operators prefer to split Mica using a flat knife—others use a needle. In some cases the Mica is laid on a glass, plastic, or wooden plate and laminations are split from a flat surface—other operators hold the Mica in the air while splitting. But no matter which method is used, it is imperative that injuries, such as scratching of the surface, or fracturing of the edges, be avoided during the splitting operation.



COMPANY SPRINGFIELD
ILLINOIS

• • • WATT HOUR METERS • • • TIME SWITCHES • • •

For special requirements

DeJUR ELECTRICAL INSTRUMENTS

1 1/2 INCH METER • SQUARE TYPE • MODEL 112

This miniature instrument may be successfully used in a variety of applications, and it is particularly useful where space is an important factor. The DeJur 112 measures only 1 3/4" square and 25/32" deep, and uses basically the same carefully designed components as our larger instruments. In order to conserve space, soldering lugs are used for the terminal connections instead of the conventional studs. Available in standard ranges.

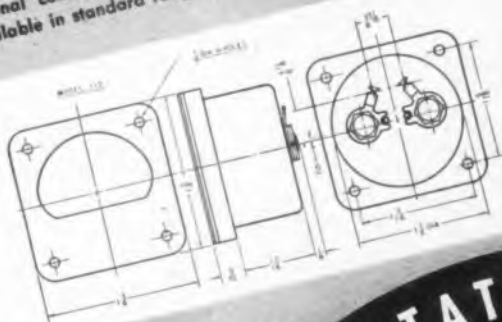

DeJUR RHEOSTAT-POTENTIOMETERS

MODEL 241 D

A dual unit model, with both units mounted together. The Model 241 D is typical of the many types developed by DeJur engineers for special requirements. We are equipped to serve your needs, too.

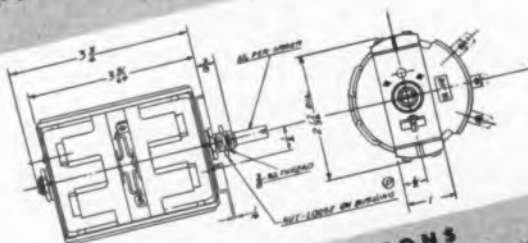

SPECIFICATIONS

	RANGE IN OHMS	MODEL NO.
50 WATTS	0. 10	241 D
RANGES—10 to 10,000 Ohms	0. 50	241 D
MECH. ROTATION—300°	0. 100	241 D
ELEC. ROTATION—270°	0. 500	241 D
WEIGHT—7 Oz.	0. 1,000	241 D
	0. 5,000	241 D
	0. 10,000	241 D



Write for the NEW DeJur Catalog



Buy and Hold More WAR BONDS

De Jur-Amsco Corporation

GENERAL OFFICE: NORTHERN BLVD. AT 45th ST., LONG ISLAND CITY 1, N. Y.

BENDIX

EXPRESSOR AMPLIFIER

Maintains selected threshold level Attenuates background noise



Designed to fit standard 19-inch relay racks, this unique amplifier occupying only $3\frac{1}{2}$ inches of panel space provides definite advantages—for it unites in one compact unit both an expander and a compressor.

In fact the name "expressor" has been coined by Bendix to denote the combination of these features—a union which effectively solves two major problems of communications equipment operation from noisy control points.

The compressor so sharply limits gains beyond a selected threshold level that a 20 db increase in

input level above threshold selected results in no more than a 1.5 db increase in output level.

The expander effectively attenuates background noise and other undesirable interference until modulation is supplied. The amount of expansion and the levels at which expansion and compression become effective are adjustable by screw driver slots in the panel.

An outstanding example of Bendix Radio Creative Engineering, this development is available to all users of communications equipment.

For complete details write direct to the Sales Department.

BENDIX IS A TRADE-MARK OF THE BENDIX AVIATION CORPORATION

Bendix

RADIO DIVISION

BENDIX AVIATION CORPORATION, BALTIMORE 4, MARYLAND

STANDARD FOR THE AVIATION INDUSTRY

ELECTRONIC INDUSTRIES • December, 1944

73

*Made in Japan**



A recent UTC analysis of Japanese components substantiates the conclusive superiority of products of American design and construction . . . for example, on transformer components . . .

*
Japanese components illustrated obtained from the Pacific war theatre for the UTC Research Laboratory



JAPANESE unit weighs **8 oz.**
... failed on 15 minute submersion test
... fails below frequency range.



UTC automatic reactor weighs **1 oz.**
... takes full automatic welding wire
... has twice the frequency range.

MAY WE COOPERATE WITH YOU ON DESIGN SAVINGS FOR YOUR APPLICATION . . . WAR OR POSTWAR

United Transformer Co.
150 VARICK STREET NEW YORK 13, N. Y.
EXPORT DIVISION: 13 EAST 40th STREET, NEW YORK 16, N. Y. CABLES: "ARLAB"



ELECTRONIC INDUSTRIES

Including INDUSTRIAL ELECTRONICS

O. H. CALDWELL, EDITOR ★ M. CLEMENTS, PUBLISHER ★ 480 LEXINGTON AVE., NEW YORK (17), N. Y.

Discarded Short Cuts

In every industrial plant, proposals to save time and material—many of them electronic—have come to the management's attention, only to be discarded or postponed because the savings involved seemed insufficient.

But now, with the manpower and womanpower shortage becoming more acute, it is worthwhile going back and reviewing those discarded electronic proposals to see whether some may not now have real value under present conditions. It is time to re-examine every electronic expediter, in the light of the situation today.

Radio, Television, and Jobs

The threat to drive television off its present familiar channels into the uhf and so delay video by five years or more—is actually a threat to delay employment—to hold up jobs for 600,000 people, postwar, at a time when jobs will be so vitally needed.

Let us look at radio's past record as a producer of employment.

The radio broadcasting industry since 1920 has produced at least 18 billion dollars worth of employment; or 30 billion man-hours of jobs. This means 600,000 prewar jobs—all created out "of the blue!"

And now television, if continued on its present channels, has a potential employment-creating value at least equal, if not double, that of present radio-broadcasting.

This means that television can shortly be creating 600,000 or more new jobs—beginning immediately after European hostilities cease, when four million workers will be in search of employment.

Let Research Go Along With Practice

While the ultra-high channels show much promise—particularly for point-to-point relay applications—the problems of television broadcasting, receiver design, etc., at such frequencies may not be solved in three years, five years or even longer. Experimentation and research on television service in these ultra-high sections of the spectrum should be pushed with all zeal. But meanwhile, domestic commercial television broadcasting must carry on in its present location, at least until uhf operation is time-proven. And, of course, experimental channels in the uhf range are available for unlimited study.

Five Years,— and Then Five More!

If television were to be postponed another five years, then at that time there will be the same interests,—or other interests,—who will see possibilities of more improvement if another five years were permitted for development.

The research and development engineer can always see new opportunities long distances ahead. And as knowledge increases these vistas appear brighter and more attractive.

Always in industry there comes a time when the step must be taken from research and development, over to commercialization.

So far as television is concerned, in our opinion, that time is now!

Annual Index — See page 216

The Electromagnetic Spectrum in Terms of Employment and Business



30 billion man-hours
\$18,000,000,000



15 billion man-hours
\$9,000,000,000



30 billion man-hours
\$18,000,000,000

The radio spectrum is familiar to most of our readers, but J. R. Poppo, chief engineer of WOR, has suggested relabeling the spectrum in terms of the total dollars of business and man-hours of employment which have been produced by its various frequency-bands "out of the blue." Our chart shows the number of peacetime jobs, direct and indirect, actually created by peacetime broadcasting, together with accumulated man-hours of employment and total dollar business, or sales, from 1920 to date. Further along the spectrum, for FM and Television we project the number of jobs and total dollar business which these new services can be expected to produce, as they are commercially developed postwar

RECORDING Two Variables

by R. K. HELLMAN

Connecticut Telephone & Electric Division,
Great American Industries, Inc., Meriden, Conn.

Multiple recorder, developed for simultaneous measurement of quartz crystal characteristics, has many industry uses

● As production processes become more complex it no longer suffices to make random and more-or-less infrequent spot checks of an instrument reading, and it is wasteful time to watch changes continuously. For this reason the continuous recording of instrument readings has become an important part of any efficient production program. Numerous methods have been available that produce continuous records of a single variable. Likewise there are ways of making single checks on each of a rapid succession of items.

In the case of many items, however, a single check is not reliable, because the characteristic under investigation can only be represented by a curve, evaluated in accordance with the variations of some operating parameter. Sometimes even more than one curve is desired. It is therefore of interest to describe a recorder built for the

exact job of simultaneously recording two factors, actually those associated with the efficiency of quartz crystals, but which may find use in many other industrial tests, where a succession of individual items must be handled.

It is well known that the frequency temperature, and even more so, the "activity" temperature curve of mounted crystals may show unexpected dips or peaks, in addition to variations of a more steady nature. Temperature readings in production tests, therefore, must be taken either at close intervals or, if tests are confined to readings, closer tolerances must be applied at a few temperatures.

Either of these test procedures has imposed limitations on production and due to an obvious need various manufacturers have attempted to speed up these tests through development of labor-saving semi-manual arrangements. The best solution would be fully automatic test equipment that simultaneously takes frequency and "activity" curves of a large number of crystals versus temperature in a single temperature run. Heretofore such automatic recording equipment was considered too involved and its cost too high to find general use throughout the industry.

Description of recorder

Production test equipment developed and used at Connecticut Telephone & Electric Division of Great American Industries, Inc., combines accepted methods of frequency deviation and activity measurement with a novel type of multiple recorder. Due to its inherent simplicity it can be built at reasonable expense.

The requirements for such automatic test and recording equipment are:

- It should be possible to test at one time a large batch of crystals which may be made up with any number of frequencies.
- The time for a complete temperature run should approach the minimum time allowed in specifications.

- At the end of each temperature run a permanently recorded diagram should be available, containing detailed information on each individual crystal.

- Each curve should consist of a large number of measuring points to detect even small irregularities.

- Diagrams should be visible while they are being produced.

While it might be desirable to add automatic rejection of crystals whose frequency or activity exceed the limits, this was not considered essential in view of the inspection procedure at present established by the Government Services.

To meet these requirements, a recorder incorporating a new principle was built for which the name "Sweep-balance recorder" was coined. The use of this principle as well as the general arrangement of the recorder elements were contributed by George Keinath with whose close collaboration the author supervised the development and initial application of the device.

The recording strip is an endless band of Teledeltos paper on which the diagrams follow each other as shown in Fig. 1. The paper band moves through the recorder continuously, passing beneath a recording stylus. The position of the latter across the width of the paper (X-coordinate) represents temperature in the chamber which is varied within the required range by cooling and heating, at as fast a rate as permissible.

The Y-coordinate is marked on the paper by a condenser discharge of short duration which occurs at a lengthwise distance from the zero line of each diagram. The drive that moves the chart through the recorder also advances the crystals into test position in the temperature chamber.

It is apparent that the same crystal and the same diagram will be in recording position again at fixed intervals, and that all the other crystals in the test chamber are measured in turn. As the endless paper strip becomes rather long for a large number of crystals it can be folded as shown in Fig. 6.

Since each diagram represents

Fig. 1—Roll chart used to record frequency drift and activity (Y-axis) vs. temp. (X-axis)

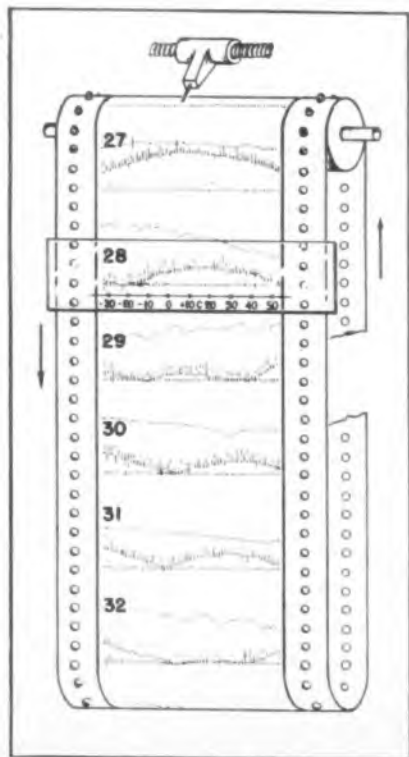

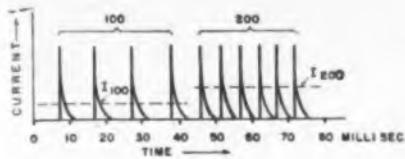

Fig. 2—Waveform of frequency indication

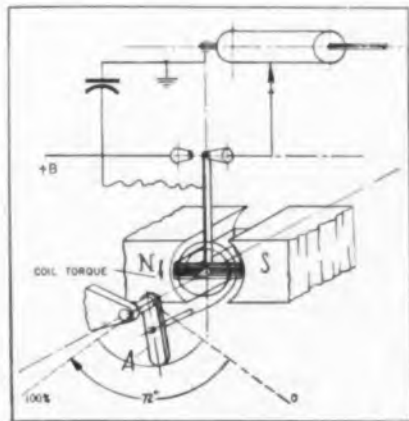

Fig. 3—Moving coil integrator

frequency and activity, two measuring elements are required and cause the release of the condenser discharge at a point and at a time representing the quantity to be measured.

It has been generally accepted that the "activity" of a crystal should be represented by the dc

current flowing in the grid circuit of a standard oscillator. A measuring element with 1 ma full deflection sensitivity is satisfactory and power levels up to 1 mw are available. For the determination of frequency, the standard method is to compare the unknown frequency with a standard frequency and to bring the deviation to visual indication by means of a "frequency counter." The output of such devices consists of a saw-tooth like pattern of constant amplitude, the spacing of the impulses indicating frequency, as shown in Fig. 2. Therefore an integrating type instrument is needed.

The sensitive element shown in Fig. 3 was developed for that purpose. Basically it consists of a moving coil system in which the pointer is replaced with an insulated movable contact arm. The end of one of the torque springs, instead of being fixed, is attached to an arm A which carries it with uniform speed around the coil axis through a given arc. A given current through the moving coil imparts a torque to the frame and causes the movable contact arm to rest against the left contact.

At the beginning of each measuring cycle the torque of the spring is zero but as the spring is tensioned by the movement of the arm, the torque increases uniformly up to the point of equality with the coil torque. At this point the contact arm moves to the right con-

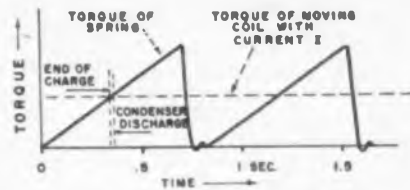

Fig. 4—Cycle of moving coil integrator

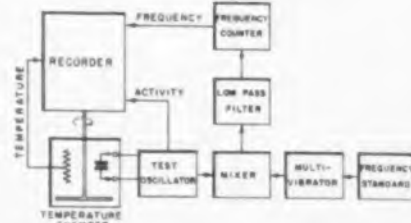
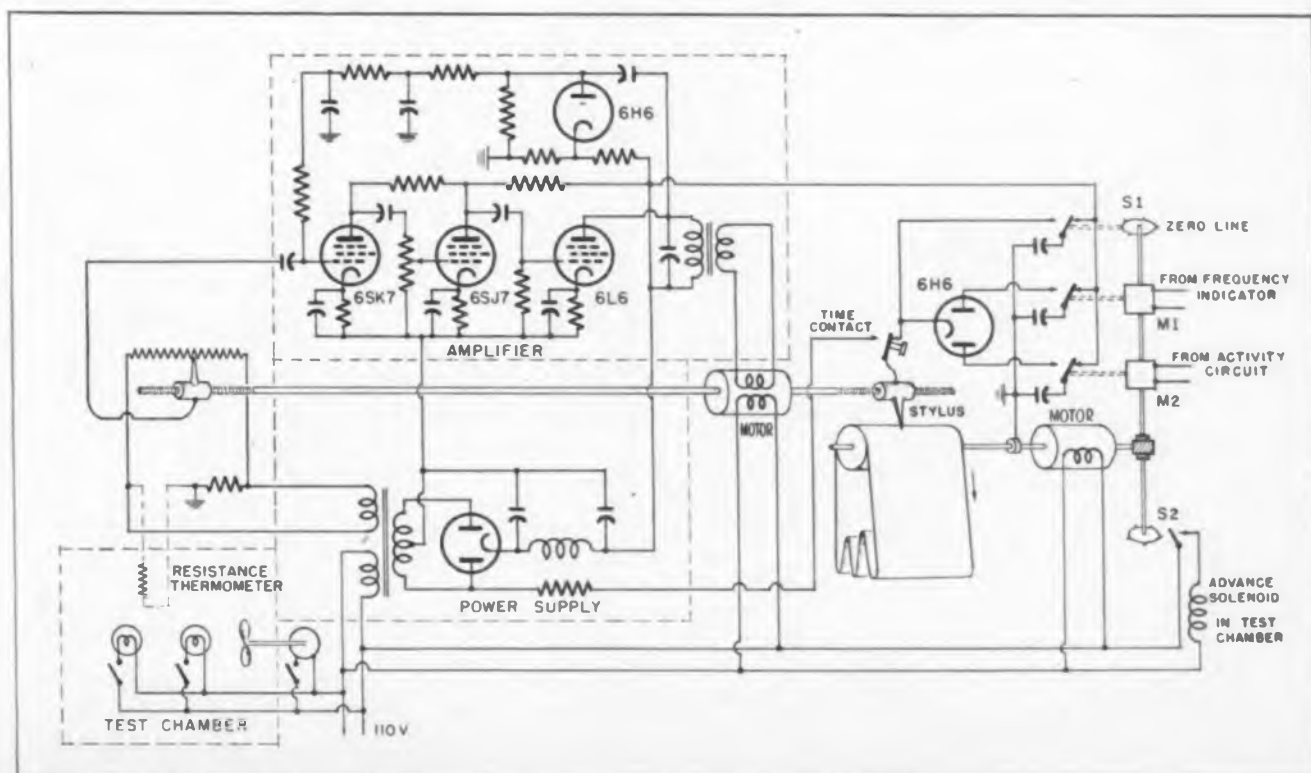

Fig. 5—Block diagram of characteristics recorder

tact and effects the paper-marking condenser discharge. Fig. 3 also shows the associated charging and discharging circuits. It is obvious that the drive mechanism of the spring arm must be in mechanical synchronism with the chart advance.

The necessary mechanical driving movement provides for a quick return of the arm which time is also utilized for switching a new crystal into test position. Since there is no interruption of the steady advance of the strip chart,

Fig. 6—Recorder including stylus control according to temperature, capacitor discharge circuits for frequency and activity signals and power supplies



it is desirable to place the arm return during the "lost" time between two diagrams. Details and performance characteristics of this "oscillating spring relay," although interesting, must be omitted here for the sake of brevity. Fig. 4 shows an operating cycle of a mechanism according to Fig. 3.

As shown in block diagram, Fig. 5, standard frequencies for each crystal channel encountered in testing, are produced in one of two ways, depending on what they are. If they are spaced by an equal amount (arithmetic progression), a single standard frequency can be used (this case is assumed in Fig. 5). The standard is then chosen as twice the spacing between channels, and controls a multivibrator.

In the subsequent mixer stage the frequencies present in the output spectrum of this multivibrator are compared with the frequency controlled by the crystal in test position in the temperature chamber. As the mixer is followed by a low-pass filter with a cutoff point at approximately 3,000 cps., only beat frequencies produced with the nearest standard frequency will

pass. Irrespective of the channel of the crystal under test, this arrangement, therefore, always produces the frequency deviation from the proper frequency present in the reference spectrum.

If the channels of the crystals to be tested are not spaced by constant amounts, the multivibrator can be replaced by a bank of individual standard oscillators, each equipped with a master crystal kept at constant temperature.

This system provides no indication of the sign of the deviation, i.e., whether the crystal frequency is above or below the reference frequency. From an analysis of the frequency curves obtained it will be clear that such a distinction is not necessary as the shape of the frequency-temperature curve itself discloses the direction of the deviation. This eliminates the necessity of elaborate modulation circuits sometimes used to shift the zero line in the frequency diagrams.

As shown in Fig. 5, the grid current of the test oscillator and the output of the frequency indicator are fed into the measuring elements inside the recorder proper.

The third measuring quantity, namely the temperature inside the test chamber, is obtained through an ac-fed resistance thermometer bridge. The temperature sensitive nickel resistance is arranged inside a crystal holder and brought out of the chamber by slip rings. The bridge always adjusts itself to balance automatically by means of a phase-sensitive motor and slide-wire arrangement discussed later, which govern the position of the recording stylus in the temperature direction.

According to the above, the following electronic circuits are required for the various functions in the recorder:

- a. Test oscillator to produce activity signal.
- b. Reference frequency and mixer arrangement to produce frequency signal.
- c. Bridge and amplifier circuit to produce stylus movement according to temperature.
- d. Capacitor discharge circuit to produce markings in accordance with frequency and activity signals.

(Continued on page 158)

Fig. 7—Recorder (with chart swing out) and temperature chamber. Fig. 8 (left)—Test batch of reworked crystals

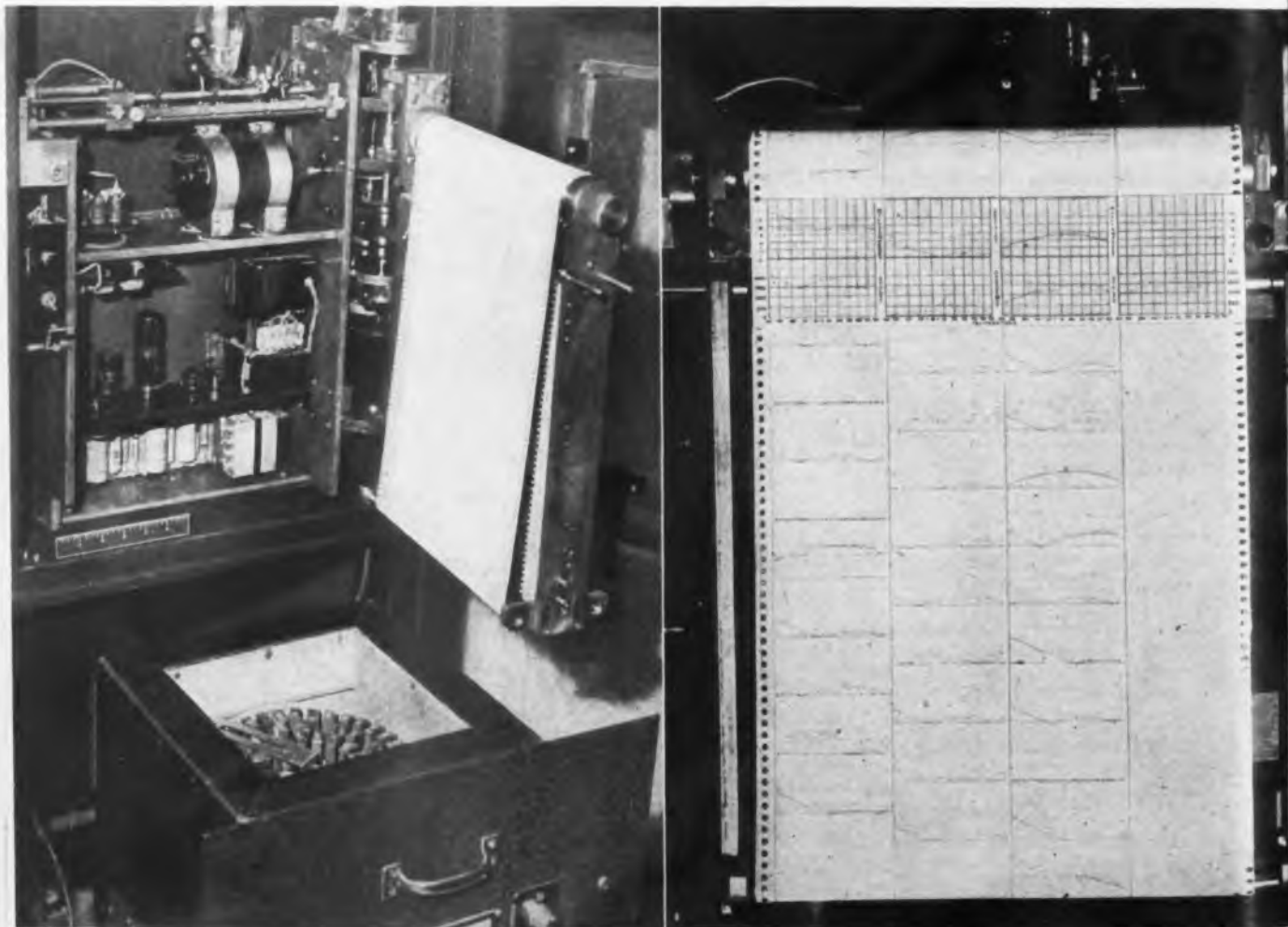

POSTWAR HORIZONS

by **ROLAND C. DAVIES**

Electronic Industries, Washington Bureau

Tremendous markets for radio, television and other electronic equipment revealed at Allocation hearings

● Postwar horizons for the radio-electronic manufacturing industry were depicted in bright colors during the recent FCC Allocations hearings.

By the end of November, too late for the press time of "Electronic Industries" December issue, the FCC was slated to formulate a general pattern of the spectrum allocations for the two-fold purpose—the use of the State Department in preparing for the projected international telecommunications conference and for the American manufacturing industry to get "on its mark" for civilian production. "Electronic Industries" was informed that the allocations for FM broadcasting and television would be nailed down among the first decisions so that the industry could be fully prepared in its postwar plans after Victory in Europe. So that the decision could be reviewed or could be made a subject of appeal if unsatisfactory, it may be issued in a "Proposed" report form.

These are the equipment possibilities which were outlined in the FCC hearings in terms of different radio services:

HOME RECEIVERS—When the "green light of reconversion is flashed on, the bulk of production is slated to be AM broadcasting sets, probably most of them in the smaller, low-priced types.

Combination AM-FM sets, if the FCC allocations do not move FM broadcasting up higher, will be produced to the tune of approximately 5,000,000 receivers during the first year or 18 months after reconversion. FM proponents forecast this production and a total distribution of 20,000,000 FM sets in the first four or five years. Because of the delay in redesigning and retooling of FM portions of combination receivers, the FCC, the industry feels, should act on this issue without procrastination. Reason: if V-E Day comes next Spring, as Churchill recently indicated, time is growing short. Furthermore, as one manufacturer's spokesman at the FCC proceedings cited, a move upward for FM would increase the cost of the FM portion of the combination receiver by 30 to 50 per cent.

CAUTION—WPB authorities warn that a flood tide of civilian production after V-E Day (and while the war with Japan is in progress) may be retarded by the lack of vital elements for the assembling of completed sets. Namely, certain types of tubes, loudspeakers, electrolytic condensers and cabinets. A number of manufacturers, however, believe these hurdles can be licked speedily just as they conquered war output problems.

TELEVISION—FCC will undoubtedly allow television to be established in both the present lower portion of the spectrum and in the upper bands where wide band development of high definition and color video can occur. Locations of the television stations will be initially in the major cities such as the already established stations in New York, Philadelphia, and Los Angeles and the projected ones in Boston, Washington, Chicago, etc. As television network relaying via coaxial cable or radio relay grows, television will branch into the smaller cities and towns in the form of intermediate stations.

It is forecast that when the impact of the war releases full development of television there will be at least 100 master television stations throughout the nation within five years or a decade after

peace. Transmitters will be a major element for the postwar radio manufacturing industry as their cost will range from \$250,000 to \$300,000 each and an equal expenditure for antenna, studios, buildings and land. The intermediate stations to serve the adjacent smaller cities will cost for their transmitters between \$140,000 and \$165,000; and the satellite stations will cost for their transmitters \$48,000 to \$51,000 for unattended stations and \$55,000 to \$58,000 for attended, while those attended stations with film facilities will cost \$66,000 to \$69,000.

Television receivers will be generally in the higher-priced brackets compared to AM sets. RCA has, however, planned a \$150 table model video set. But bulk of buying will be in the \$200-\$395 range. This is the prospect, it was voiced at the FCC hearings, for the immediate future after Reconversion, but, as television takes hold of the public imagination, mass production will cut down those sale prices.

TRANSMITTERS—Between 3,000 and 4,000 FM stations are slated to be on the air within five years after the end of the war. Besides established broadcasters, there will be many "groups" applying to the FCC for stations—labor, especially the CIO; educators who plan for several FM stations in each state, possibly up to a nationwide total of 160; farm organizations, etc. To date there are 53 authorized FM stations and 233 applications. (Over 500,000 receivers are in the hands of the public representing a \$30,000,000 investment and to move FM upwards would mean their scrapping.) The cost of FM transmitters range according to power from \$10,000 for 1 kw; \$13,750 for 3 kw; \$25,000 for 10 kw and \$75,000 for 50 kw with installation costs also rising from \$2500 to \$15,000 for the highest power station.

MOTION PICTURES—This is the field to watch on the development of television because the motion picture industry is seeking 75 channels for the transmission of multiple address radio theatre television. The industry wants the FCC to consider it "communication of a

In Five Years—

100 television stations
\$60,000,000

4,000 FM transmitters
\$120,000,000

20 million FM receivers
\$2,000,000,000

6,000 airports, all radio-
radar equipped

200,000 vehicles with
radio transmitters

5,000,000 interstate trucks
with 2-way radio

Sixteen railroads installing
radio in yards

private nature" not classified as regular television broadcasting. The theatres want television for them given parity treatment and equality of the opportunity to develop along with public television broadcasting. If the movie industry jumps into television in a big way, it will open a huge transmitter and theatre screen receiver market.

AVIATION—Very fertile postwar market, despite enormous war production and even though surplus disposal may be large in this radio bailiwick. Predicted at the FCC proceedings by most competent authorities that there will be at least 250,000 private aircraft in the United States and over 3,000 domestic and international scheduled aircraft by 1950. Airports will have been increased to 6,000. (CAA has requested \$1,000,000 to construct 3,000 new airports.) Radio and radar are the essential weapons of flying and the FCC is providing ample spectrum space for aviation.

Radar will be a most important element after the war—present equipment may be largely replaced by better apparatus at higher frequencies.

Radio apparatus for the expansion of aviation will be for ground-plane communications, including facsimile or radio teletype, radio ranges at airports and along airways and instrument landing systems. The surplus aircraft of the armed services for civilian flying uses, according to authoritative sources, will need substantial improvement and modification in connection with their radio-radar equipment.

FACSIMILE—This is the "sleeper" in the postwar radio services promising huge development and expansion. John V. L. Hogan outlined to the FCC the picture of postwar facsimile uses in public communications, press transmission and reproduction and broadcast facsimile. And it only wants 20 exclusive FM broadcast facsimile channels, each 10 kc wide, between 100 and 200 megacycles. The equipment costs will be comparable in price to television receivers. Color facsimile has been far developed, especially by Finch Telecommunications. It is the radio service that is already to go at full speed come reconversion.

SAFETY SERVICES—Police, fire, forestry—Police radio, regarded as the greatest weapon against postwar crime, will be expanded from 5 to 10 times after peace comes. Only 1,300 of the 16,752 incorporated cities are now equipped with police radio, according to Captain Donald S. Leonard, Chairman of the Communications Committee of the International Asso-

ciation of Chiefs of Police, and this number will be multiplied by at least five times. Besides two-way cars and fixed stations there will be walkie-talkies and handle-talkies for mounted policemen, together with radio equipped police airplanes.

Ninety per cent of all cities above 10,000 population are without fire department radio systems and these need to be equipped after war as wire facilities are not satisfactory for fire department operations. Forestry service and state conservation departments will need during next three to five years 10,000 transmitter-receiver units. Federal Bureau of Public Roads and state highway department estimate huge demand for two-way radio equipment. In all these governmental and semi-public safety radio services, the Army-Navy surplus will be a big factor and for the manufacturers this is a most important outlet for the disposal of the military excess equipment in their capacity as distribution agents for the Government's Surplus War Property Administration.

MOBILE SERVICES—Urban and highway mobile radio is to be a significant new service if FCC gives adequate space in the spectrum. In New York City alone, the AT&T estimates 10,000 vehicles as potential radio equipped customers, including utilities, burglar and fire alarm companies, taxis, express and trucking companies, buses, ambulances, doctors and refrigerating companies. There are 5,000,000 interstate trucks which are potential users of two-way radio (test to be made in Chicago area with 10 interspersed 40 kc channels in the 30-40 mc band, with 10 relay channels in addition and a single clear channel between 2 and 4 mc with fixed stations of 1 kw power scattered throughout the nation). Interstate buses cover 300,000 miles compared to 229,000 miles of railroads and want two-way radio between terminals and buses because they travel through isolated areas without telephone and telegraph service. If taxi-cabs find the current tests of radio communication and dispatching useful in Cleveland, now in progress, several scores of thousands of taxis in the major cities loom as possibilities for being radio equipped.

RAILROADS—Yard and terminal radio will come first and it is anticipated that during the first postwar year about 16 railroads will spend a total of \$1,000,000 in this field. After full testing of space radio (between fixed stations and moving trains) this will be a much larger market, many times in terms

of equipment than the yard and terminal operations. Carrier radio is being tested by the New York Central, Pennsylvania, Rock Island and Kansas City Southern railroads.

PUBLIC UTILITIES—Besides the telephone and telegraph communications companies which plan to increase most substantially their portable emergency radio stations, the other utilities are going to expand their radio emergency systems 10 times. The electric power utilities expect to have over 3,300 transmitters in operation within five years after the war compared with 750 now operating. The natural gas industry wants to use radio for patrolling pipeline networks and of walkie-talkies for emergency situations in cities. Water supply industry, which has two fixed transmitters and 200 mobile transmitters will need 1,824 if regulations are relaxed five years after the war. Huge increase for radio stations along pipelines, on gasoline and fuel delivery trucks and for use by pipeline inspectors in planes, automobiles or horseback; geophysical exploration radio stations to be expanded possibly by three times.

RURAL TELEPHONY—Bell System and Independent telephone industry view radio as real weapon for overcoming previous bugaboo of bringing telephone service to isolated communities, mining camps, ranches, farms, islands, resorts.

Use of VHF radio relay systems vs. coaxial cables or at least as a supplement to the coaxials projected. AT&T New York to Boston system to cost over \$1,000,000; IBM and General Electric plan test system from Schenectady to Washington via New York; Raytheon projects nationwide radio relay networks paralleling the airway routes.

OVERSEAS COMMUNICATIONS—International radio telegraph companies plan to reach 125 different points throughout the world instead of the present 87. The AT&T expects an expansion to 81 points in overseas telephone instead of the present 32 points with a half million overseas telephone calls a year within five or ten years.

INDUSTRIAL - MEDICAL—War production has made induction heating and dielectric heating, together with drying, molding and curing drugs, and milk pasteurization, most important tool of industry. HF radio most significant in high quality cabinet making (important for radio set manufacturers). Physicians and hospitals anticipate huge expansion of diathermy and high frequency radio medical apparatus.

ELECTRON TUBE DEVELOPMENT

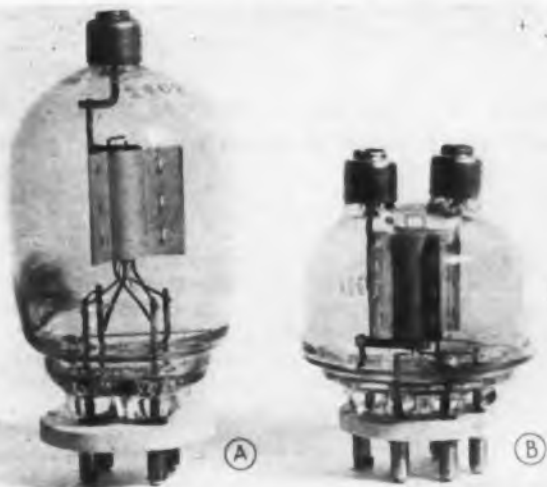

(A) Type 356A 50 watt triode generally used in push-pull bridge-neutralized output circuits. A more modern redesign, type 364A at (B) has decreased transit time, shortened electrode leads and duplicate plate and grid leads, all of importance for use in multiplex circuits. (C) shows the 350 watt pentode used to modulate the above triode capable of delivering 65 watts audio, operating at 1250 volts. It is designed with short leads of low inductance. It can be operated at full ratings up to 85 megacycles. G_m is equal to 1200

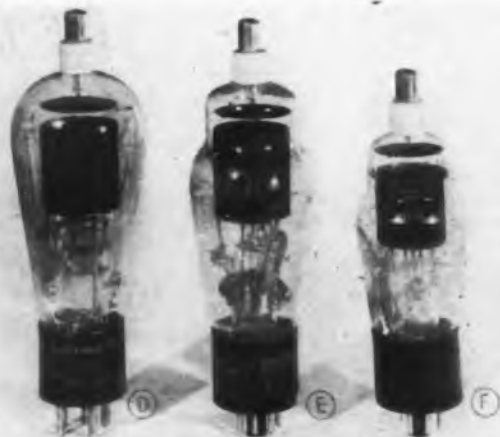

Western Electric 323A tube at (D) with a newer version, type 393A at (E) is a three element thyratron used in regulated rectifiers for storage battery charging in smaller plants, such as telephone central offices. A small version of the latter, type 394A, is shown at (F). Voltage and power amplifier tubes, types 373A and 374A at (G) and (H), are used in recent carrier cable amplifiers. These pentodes have low wattage filaments with G_m values of 1300 and 3000 respectively

A description of a number of electron tubes which have applications in the telephone system, was given by Dr. S. B. Ingram, engineer, Bell Telephone Laboratories, at the National Electronic Conference in Chicago in October. One interesting application is the 12-channel carrier system at 160 mc between Cape Charles and Cape Henry, Va. He described a few amplifier tubes developed for broad band carrier telephone systems and some ultra high frequency tubes used in an ultra short wave multiplex radio link. Some typical tubes used in the non-transmission part of the telephone plant were described.

(I) represents a cold cathode gas-filled relay, used for four-party selective ringing. The tube acts as a rectifier in series with the ringer and discriminates between positive and negative polarities. A smaller and more recent development is the 359A tube at (J). The 384A or 386A coaxial cable amplifier tube is shown at (K). Small indirectly heated one watt cathodes are provided. A useful band of 3mc is obtained with these tubes as carrier line amplifiers

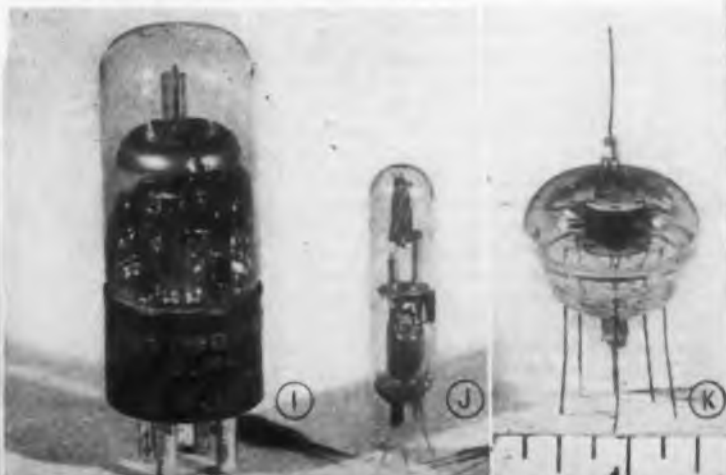
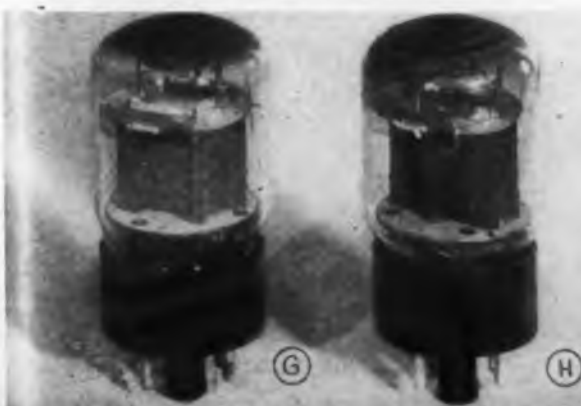

MEASURING POTENTIALS

by DR. HARLAN T. STETSON

Cosmic Terrestrial Research, Massachusetts Institute of Technology

Every plant appears to have an electrical pattern and living cells a field that may determine their growth

● Electronics entering industry has speeded up manufacturing and changed methods along the production line from ship building to bread baking. Changes in design and in operation have been brought about with nearly every step of progress in the field of electronics. Now it appears that Nature has been using electrical methods in her production lines long before "electronics" ever became a household word. Every plant and growing thing appears to have its electrical pattern, and every living cell its own peculiar electrical field surrounding it that may determine its own manufacturing process.

These startling statements come from twelve years of research conducted by Dr. H. S. Burr and his associates at Yale University. Dr. Burr has mapped the electrical field around a frog's egg, and from determining the point of highest potential on those little gelatinous spheres he has been able to predict where the brain of the embryo frog would develop and has scored every time. He has rotated salamanders between electrodes and measured the alternating current resulting from the head or the tail of this little protoplasmic armature passing between specially contrived electrodes designed to receive the minute currents. With ingenious electrical devices he has recorded minute by minute and hour by hour the changes in electrical potential developed as a kernel of corn sprouts and sends out its roots first in one direction and then another.

Not content to restrict his investigations to the seeds of living things, he measures the potential along the trunk of a growing maple tree and finds that the growing tree is a veritable generator of electricity. The potential generated varies in cycles that not only follow the time of day and the season of the year, but curiously enough he is strongly suspicious that one of these cycles follows the moon in its monthly course around the earth. Thus all Nature seems to behave according to a certain universal electrical

pattern. With the collaboration of Dr. F. S. C. Northrup, noted Yale philosopher, all this has led to an electro-dynamic theory of the universe, postulating electrical fields inherent in matter wherever it is found in the universe.

Dr. Burr is a specialist in Neuro-anatomy of the Yale Medical School, but from his early days he has been fascinated with radio and electrical circuits. Some ten years ago he became convinced that a properly designed electronic apparatus could be made to wrest from nature some of the secrets of the electrical basis of life. Where do plants and animals get their form? How do the genes bring about their characteristic results? What determines the pattern of nerve fibers? What is the blueprint that determines the forms for reproduction? These and similar questions intrigued his curiosity.

Fig. 1—Circuit diagram of Dr. Burr's microvolt meter. Fig. 2—Dr. Burr's microvolt meter and recorder measuring potentials developed during plant growth

and he believed that if organic cells were determined by electrical pattern it should be possible to map their surrounding fields and this might yield the secret for determining their direction and rate of growth.

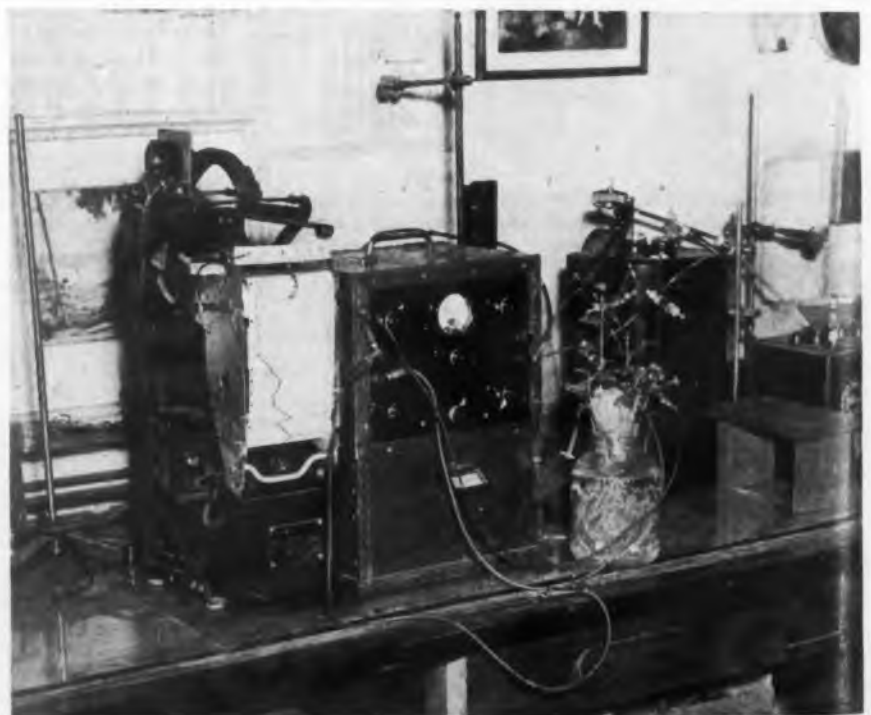
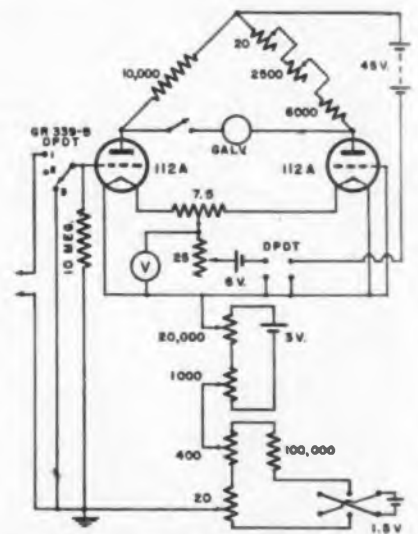

IN GROWING THINGS

To measure the minute potentials developed in living cells required a new technic. Even the most sensitive high resistant galvanometers drew so much current, relatively speaking, that the difference of potential at adjacent points on a nerve cell, when electrically connected, would be so reduced or rendered so nearly nil as to defy measure by the older methods. Undaunted, and refusing to take "no" for an answer, Dr. Burr pursued his interest in electronic technic and soon with the enthusiastic help of Drs. Lane and Nims he pioneered in the development of a high impedance electronic voltmeter capable of measuring electrical potential differences of but a few microvolts and consuming less than a micro-micro ampere of current from a specimen under examination.

Microvolt meter

The circuit of the new vacuum tube microvolt meter as illustrated in Fig. 1, is based on the Wynn-Williams Bridge with certain modifications to render it a practical biological instrument. To get rid of the troublesome spurious grid current the principle of the "floating grid" was adopted. It is now common knowledge that if the grid of a vacuum tube is isolated from electrical contact with other elements of the tube the grid will acquire a certain characteristic potential generally called the "floating grid potential." By means of an adjustable bias from a battery maintaining precisely this potential the grid current can be eliminated.

The grid leak on this first tube is of the order of 10 megohms. The switch which is utilized for biasing the floating grid potential was built with amber insulation, and to further eliminate leakage the vacuum tubes were removed from their conventional sockets and soldered connections made to each element terminal. After constructing his bridge circuit a "breaking in period" proved necessary.

After operation continuously day and night for 250 hours, the apparatus was found to perform with remarkable stability. It will be noted that the two tubes in Fig. 1 form two arms of a Wheatstone bridge arrangement, the other two arms of which are fixed resistors. The first tube is the one upon which the unknown potential is impressed while the second tube acts as a dummy. Its purpose is to

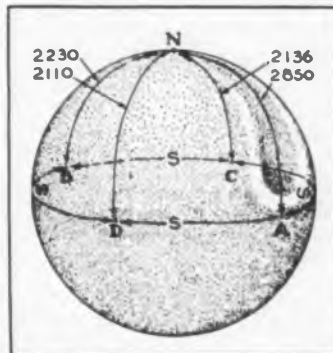
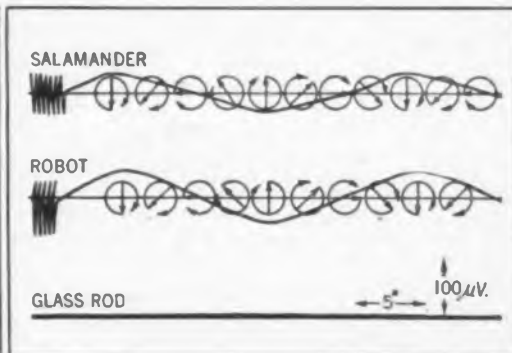

Fig. 3—Voltage distribution pattern in frog's egg. Fig. 4—(Above right) Alternating current developed by salamander and robot



balance out the steady plate current of the input tube so that no current flows through the galvanometer if no potential difference is imposed on the first tube. The galvanometer for continuous measurements is a G-E strip type photoelectric recorder.

The successful design of the vacuum tube microvolt meter is, however, but half of the story. The problem of applying conducting electrodes to living cells, without giving rise to contact potential, was the next major difficulty to be overcome. This problem was solved by the ingenious device of utilizing small glass tubes or micro-pipettes containing a normal saline solution brought in contact with the specimens to be examined (Fig. 2). Into these glass tubes silver-silver-chloride electrodes are immersed and make the electrical contact with the external circuit.

No potential difference is created between the silver-silver-chloride electrodes and the normal solution of sodium chloride; and similarly contact potential is eliminated between the saline solution and the fluids of the living cell with which it is in contact. In this way true potential differences may be measured at pleasure with complete confidence in the galvanometer readings.

With his technic perfected, a series of experiments at the biological end of the laboratory was undertaken to try to find the answer to four questions:

1. Do living things possess a relatively steady potential difference, which can be measured with reasonable certainty?
2. If such voltage gradient exists, do they form some recognizable patterns?
3. Is there evidence that voltage



Fig. 5—Salamander rotated in saline solution between electrodes developing alternating current. Notice the glass pipettes composing non-polarizing electrodes dipping into saline solution near periphery of dish

gradient is indicative of an electro-dynamic field?

4. If such a field exists is it in any sense an electrical photograph of biological activity, or is this field in any way a determiner of the pattern of organization?

After six years of extensive study it is believed that the answer to the first three questions is in the affirmative, and more recent work indicates that we are fast finding an affirmative answer to question 4, which is perhaps the most important question of all.

Inanimate field patterns

The arresting results of Dr. Burr's painstaking measurements have given new impetus to the Northrup and Burr theory of the electro-dynamic basis of living things. "If the field determines the pattern or organization," Dr. Burr points out, "it should be possible to change development of an organism by modifying the field." Sufficient experiments have already been made with X-rays to demonstrate that the bombardment of an organism from without can either arrest or grossly modify subsequent development.

To exhibit one example of a field pattern, frog's eggs are rolled

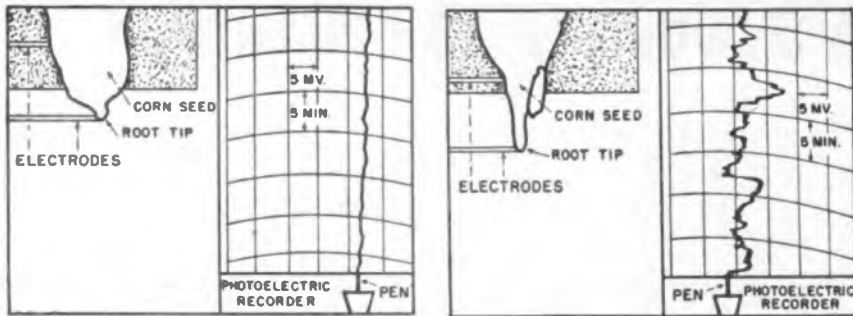
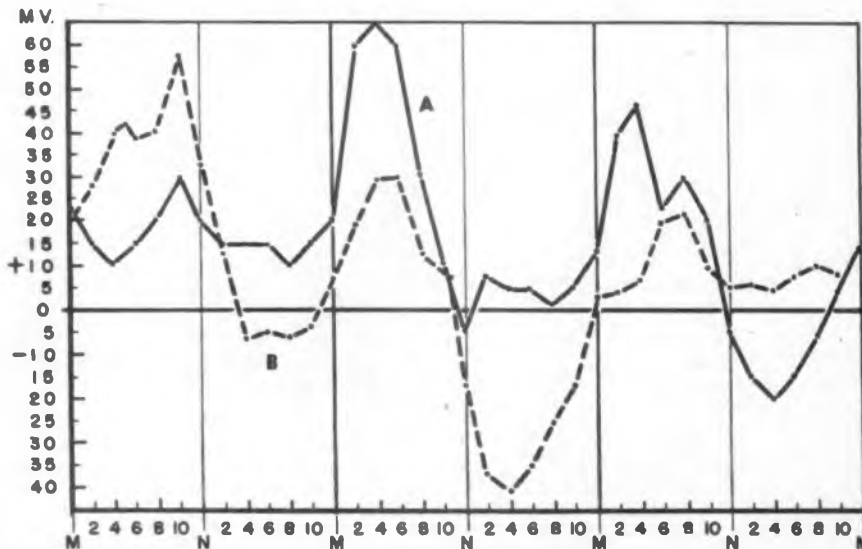

Fig. 6—(Left) Record showing steady potential difference between root tip and kernel of corn seed. Fig. 7—(Right) Potential difference between corn seed and root tip shows violent fluctuation when growth starts



Figs. 8 and 9—Graphs of hourly potential differences in Maple. Curve A taken during 3 days of August, 1943. Curve B taken during November, 1943, at two hour intervals



Fig. 10—Tomato plants grown with and without electrical fields, thirty-three days from seed

around between electrode applicators by means of a micro manipulator with the same ease that a poultry man handles his eggs for market. Fig. 3 represents one of these eggs that have been electrically surveyed for potential differences with one electrode at the point N and the other electrode migrating around the equator, of which N is the pole. The potential differences in microvolts are indicated.

Six thousand determinations of potentials on frog's eggs have been made in this manner showing the

same underlying pattern on statistical analysis. Voltage gradients persisted even when the electrodes were a few millimeters away from an egg immersed in a saline solution, thus showing the actual existence of an electrical field surrounding the egg.

Probably the most striking exhibition of an electrical field surrounding a biological specimen is to be found in a motion picture film which Dr. Burr has in his possession. This shows a crystalizing dish containing a saline solution in which a salamander is

immersed with two silver-silver-chloride electrodes dipping into the salt solution near the periphery of the receptacle.

As the crystal dish and salamander are slowly rotated the recording galvanometer records a fluctuating potential closely simulating a sine wave curve. (Figs. 4 and 5.) This is to be explained on the assumption that an electrical field surrounds the salamander with the potential at the head end positive with respect to the tail.

To test the validity of this assumption the motion picture then portrays a robot salamander, consisting of a piece of copper wire, with a glob of ordinary solder for the "head" of the artificial salamander, again immersed in the salt solution in the rotating dish. Here again the recording galvanometer depicts a sine curve very similar to that produced by rotating the living salamander. Now to show that the sine curve is produced by the electrical action of the object in the dish, and not through some other fault of the mechanism, replace the robot by a small glass rod of the same length and no electrical potential change is indicated on the recording galvanometer.

From such experiments we are led to believe that an electrical field is characteristic of all living cells, and while the potential across the field appears minute, since it is measured in microvolts, one is startled at the magnitude of these potentials when reduced to engineering units of volts per centimeter.

The thickness of some of the organic membranes across which potential differences have been measured may be of the order of 0.001 millimeters and the corresponding potential differences amount to 100 millivolts or more. The millivolts across this minute linear path therefore, correspond to thousands of volts per centimeter as the engineer sees it.

What is the reason then, one may ask, for the relatively small potential differences measured between two electrodes attached to the human body, as across the skull, and separated by several centimeters? The answer would appear to lie in the fact that probably the individual cells, like molecules in an unmagnetized iron bar, are heterogeneously arranged.

In such a picture positive and negative potential differences, across individual cells, cancel one another, with the result that the actual potential measured across the brain as in an encephalograph is a residual unbalanced potential which may be registered in m.v.

Remarkable progress has been made in the electrical shock treatment of insanity patients of the most serious type. Apparently cases considered hopeless so treated have not only yielded to improvement, but in many cases to more or less complete recovery. We still do not know much about the electrical mechanism of the brain. One may speculate that to a certain degree electrical polarization of the brain cells may be the cause, or at least the concomitant of mental diseases, and that the effect of the ac voltage applied is to depolarize the abnormal residual potential, very much as an alternating current demagnetizes an iron bar which has been magnetized through proximity to a magnetic field.

Currents in corn

If such an hypothesis is correct then Dr. Burr's micro-volt meter might be advantageously used in a diagnosis of such brain abnormalities, and prove an efficient guide to the voltage, frequency and time of application of shock treatment which it would be reasonable to suppose should be varied according to the condition of the individual patient.

That a sudden electrical change takes place in the metamorphosis of growing things is well illustrated by photographic records of the growth of corn. With his usual nicety Dr. Burr determined the potential between the two opposite ends of the longitudinal axis of corn kernels. Invariably the point of the kernel nearest the cob was found to be positive with respect to the opposite ends. (Figs. 6 and 7.)

The magnitude of the potential difference he found definitely correlated with the degree of vigor in the case of hybrid corn. With the starting of the sprouts there was marked increase in the potential gradient. The fluctuations in the potential seemed to correspond to morphological changes apparent to the eye. All of this shows that electrical fields not only accompany growth, but may play a major part in determining the shape and design of all living things.

In addition to salamanders, frog's eggs, and corn kernels, measurements of potential differences have been extended to alligator pears and to maple trees. Continuous day and night measurements of potential differences have been recorded by placing electrodes two meters apart on the trunk of a young maple tree.

Again utilizing the usual precautions, the electrodes were non-polarizable and of the silver-silver-

chloride variety. They were introduced between the bark and the cambium of the trunk, the lower electrode being but six inches from the ground. Leads from the two electrodes extended to one of his micro-volt meters feeding continuously to a General Electric photoelectric recorder.

In general the upper electrode was found positive to the lower electrode, although under certain conditions this relationship might be reversed. Fig. 8 shows the variation in potential recorded in a maple tree at Lyme, Connecticut, during three days of August, 1943, and Fig. 9 exhibits hourly potential differences in a maple tree in New Haven, Connecticut, during three days in November, 1943. It will be seen from these curves that the range of potential in the case of the maple at Lyme extended from a -20 to +65 millivolts during August, while the extreme range in potential in the New Haven specimen was from +60 millivolts to -45 millivolts. In his records Dr. Burr has traced the effects of temperature, barometric pressure, and relative humidity and strongly suspects the phases of the moon.

It will be noted from the graphs that between peaks of potential

differences there were short periods during which the potential difference is very low. During the time of maximum potential difference an extraordinary and pronounced change in the character of the recorded potential differences has been noted. As the potential rises to a maximum, the steady state character of the potential gives way to slow oscillation, rising and falling thirty or forty millivolts every minute or two. This suggests a respiratory fluctuation such as one might expect to find in a living animal. Dr. Burr comments that, in general "there seems to be no significant relationship between meteorological data and the electrical potentials," and from records so far available, he concludes, "the peaks of electrical activity seem to be more closely associated with the phases of the moon than with any other discernable factors."

Should records continue to substantiate these findings it may appear after all that some electrical or ionizing stimulation should be found associated with the lunar cycle and give a lead toward explanation of other lunar cycles found to be associated with biological

(Continued on page 180)

Fig. 11—Mustard plants grown with and without electrical field, thirty-eight days from seed. Fig. 12—Plants grown hydrophonically under an electric field gradient. Silhouetted growth curve shows potential gradient of 4 volts per cm. as optimum for growth

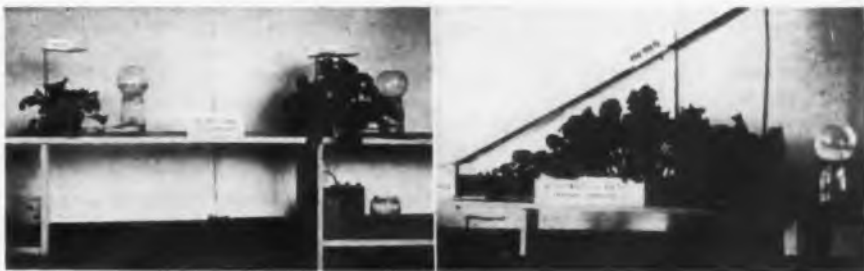
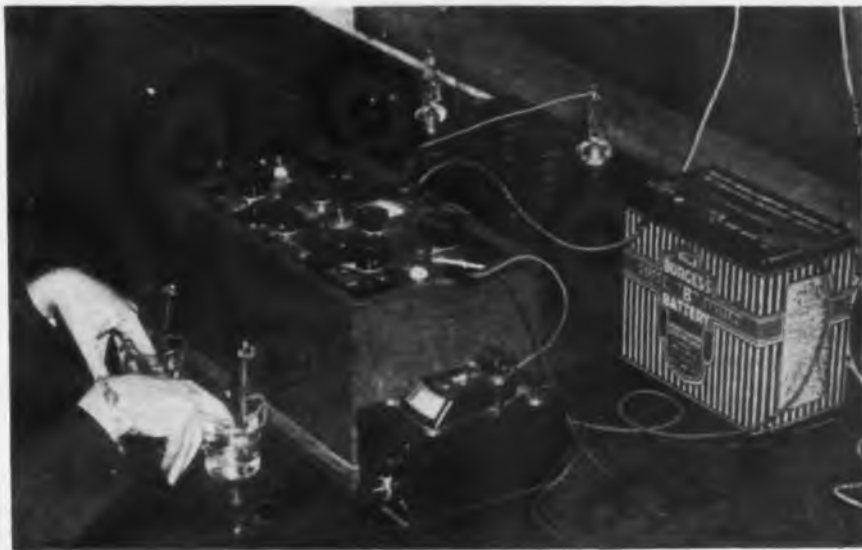

Fig. 13—Potential differences between fingers of right and left hand show rhythm in electrical fields of humans. Abrupt changes have been found to accompany ovulation in the female



LOW VOLTAGE RECEIVER

by JOSEPH LORCH

Research Engineer, Harvey-Wells Communications, Inc., Southbridge, Mass.

Design considerations in the construction of equipment to operate from 24-volt battery as sole source of power

● A great amount of development work has been carried out in recent months on radio equipment using "B" voltages ranging from 12 to 32 volts. It has been conclusively shown that satisfactory operation of receivers, amplifiers, small transmitters and other electronic devices can be obtained with plate and screen voltages of this order.

Up to the present time by far the greatest amount of low voltage equipment has been developed for aircraft use. This is not surprising since very often a small difference in size and weight of a piece of apparatus will determine whether or not it can be carried in the already crowded plane. Weight and size considerations will assume even greater importance in small private airplanes of postwar production. Commercial airlines, too, will prefer light weight radio equipment since each and every pound saved in equipment will increase the pay load by that amount.

There are many other fields in which low voltage equipment eventually will play an important part. To mention but a few of the important ones: home radio for farm use, communication systems for railways and receiving equipment for small seacraft will greatly benefit by this development.

Amazing as it may seem, only in the case of power output tubes was the design of new tubes required in order to provide acceptable performance. All other functions can be fulfilled by existing tube types that originally were introduced for use at higher voltages. This does not mean that all tube types operating satisfactorily at higher plate and screen voltages, other than output tubes, can be used to advantage at these low voltages. It has rather been established that in order to obtain optimum performance the selection of proper tube types becomes of paramount importance.

In the frame of this discussion a sensitive receiver circuit will be described that has been tried out in practice. Specific circuit considerations and problems of tube

Successful construction of low voltage radio equipment depends upon three factors:

1. Correct choice of tubes.
2. Full utilization of the supply voltage by proper dimensioning of all components apt to cause undesired voltage losses in plate and screen circuits.
3. Special treatment of bias circuits in order to maintain tube uniformity.

selection will be pointed out. Sufficient information will be included to enable the reader to modify the circuit for his particular requirements.

The receiver, of which a schematic diagram is shown in Fig. 1, was developed for an aircraft application and uses a 24-volt aircraft battery as its sole source of power. By proper selection of component parts the total weight is kept below three pounds. Under flight conditions (battery voltage of 28 volts) the sensitivity is better than 5 microvolts for 50 milliwatts power output.

Power output

The maximum power output obtained with the circuit shown ranges from 200 to 250 milliwatts at approximately 10 per cent distortion. Means of increasing the power output to 600 milliwatts are also described. The total power consumption at 28 v is 20 watts. The receiver is designed to operate satisfactorily under supply voltage variations from 22 v to 32 v. Basically, the circuit employs the superheterodyne principle using a total of five tubes.

The frequency band ranges from 200 to 400 kc permitting reception of the low frequency "beacon" and weather stations. The intermediate frequency amplifier operates at 90 kc. By proper choice of tuning components other frequencies up to the ultra high frequency region

can be covered. Tests performed by the writer at frequencies up to 100 megacycles indicate that no ill effects arise from the use of low supply voltages at such high frequencies. The reader intending to build a low voltage receiver from the material furnished in this discussion may, therefore, select any frequency band or a number of frequency bands of greatest interest to him.

The tube types and their respective functions are as follows:

Tube Type	Function
12SK7...	RF amplifier
12SA7...	Oscillator and mixer
12SK7...	IF amplifier
12SR7...	2nd detector, avc generator, and 1st audio amplifier
28D7....	Power output stage

The 12SK7 was chosen as RF and IF amplifier for several reasons. While at 28 v its transconductance is not quite as high as that of some other types available, the variation in transconductance from tube to tube is very small resulting in little change in performance in case of tube replacement. In addition, a relatively small variation of transconductance is experienced under supply voltage fluctuations. This feature is of importance wherever storage batteries are used, in order to insure satisfactory receiver sensitivity should the battery voltage drop to a low value. Furthermore, the 12SK7 maintains very desirable remote cut-off characteristics at low supply voltages, an important factor when automatic volume control is employed.

The 12SA7 used displays substantially the desirable features mentioned for the 12SK7. In addition, it represents a stable oscillator at low voltages. In order to obtain the required amount of excitation it is necessary to move the cathode tap considerably higher on the oscillator coil than normally recommended. While, as a thumb rule, for the 12SA7 the cathode tap should occur one-tenth the total number of turns from the ground end of the coil, for correct excitation at 28 v "B"

supply the winding should be tapped at one-quarter the total number of turns. This, incidentally, represents the only departure in coil design from normal practice.

The second detector and the means of obtaining avc voltage are entirely conventional. However, the first audio amplifier is by necessity a low Mu triode (12SR7). While one would at first assume that better results could be obtained when using a high Mu triode, experience has shown that consistent sensitivities from tube to tube cannot be obtained if a high Mu triode is used. This behavior is caused by the effect of varying amounts of contact potential which may develop grid bias sufficiently high to cause almost complete cut-off in the amplifier. For low Mu triodes this impairment is considerably less evident.

The power amplifier is a Sylvania Type 28D7. This type of tube, specifically designed for low voltage use combines two power pentode systems in one envelope which in the particular application here described are operated in parallel in Class "A1" (plate impedance—2000 ohms). The resistor inserted in series with the heater protects the tube should the supply voltage ever exceed 28 volts. In order fully to utilize the available plate supply voltage of 28 volts two precautions are taken:

1. The dc resistance of the primary winding of the output transformer is kept extremely low (approximately 50 ohms) resulting in a very low voltage drop across this winding.
2. The necessary bias voltage of 3.5 volts is introduced as "C" bias obtained from a voltage

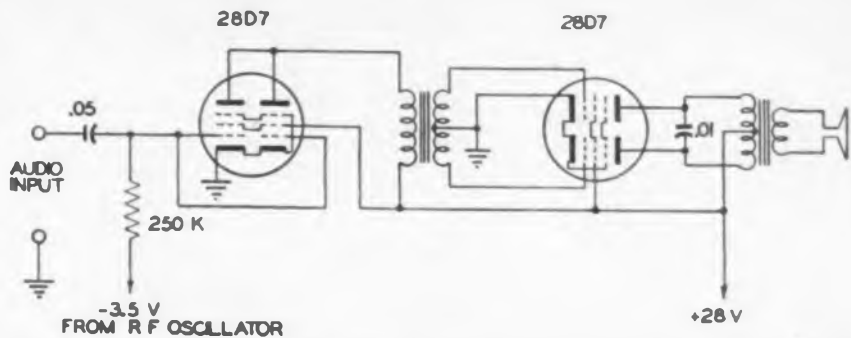

Fig. 2—An arrangement such as this may be used to boost power output to about 600 milliwatts

divider in the grid circuit of the RF oscillator. If the tube were self-biased the effective plate voltage would be decreased from 28 volts to 24.5 volts thus causing an appreciable drop in power output.

No cathode bias is applied to any tube in this receiver. Instead, grid leak bias was found to create better tube uniformity and, at the same time, permit optimum tube operation. The RF amplifier and mixer tubes are supplied with avc voltage through their respective grid leaks, the avc voltage being generated in the second detector.

Interference prevention

Since the receiver is supplied by storage batteries which may be charged during periods of reception, elaborate precautions are taken to prevent generator hash from entering the receiver through the power supply leads, the antenna and the phone leads. In addition to the general considerations governing the design of such filters it is important that the dc resistance

of all chokes involved be kept as low as possible. Thus, the dc resistance of the common supply filter choke does not exceed 2 ohms, and that of the "B" filter choke measures about 10 ohms, both filters using polyiron cores.

The filter chokes used in the antenna and phone circuits consist of ten turns wound on 5 megohm, 1/2 w resistors. Besides the hash filters a ripple filter is required for the "B" supply voltage of all tubes except the output tube. The ripple filter, in this case consisting of a 1000 ohm series resistor in the "B" line, by-passed by 20 mfd electrolytic condensers is highly essential for a receiver deriving its "B" supply directly from a storage battery under charge.

The audio power output of 200 to 250 milliwatts is ample for phone reception. It is sufficient for modest requirements of loud speaker reception, especially if a high efficiency speaker is used. When higher values of power output are desired Class "A2" operation will do the trick. As shown in Fig. 2, the audio signal is applied

(Continued on page 188)

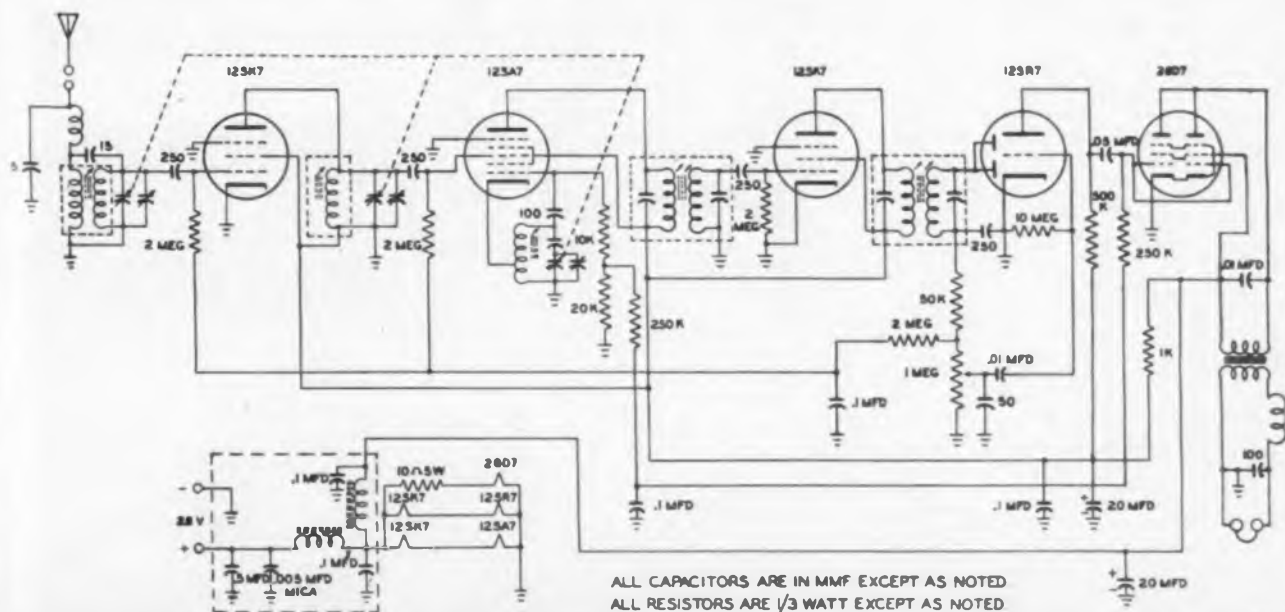

Fig. 1—By proper selection of components, this receiver, operating from 24-volt aircraft battery, can weigh under three pounds. Sensitivity is 5 microvolts and output 50 milliwatts though output can be increased to 600 milliwatts as shown in Fig. 2



1—Mass production isn't always best way. Top seal operator at United Electronics Co., Newark, N. J., upped production six times on 967 rectifier with jig to handle them individually, reducing breaking off of anodes, cracked seals, and other shrinkage



2—Catch pan proved to be a war bond oil well to North American Phillips Co. worker, if you don't mind mixing metaphors. Oil is ammunition and many other things to this quartz wafer saw worker, who devised simple catch pan, to save and re-use the vital coolant

FACTORY SHORT CUTS

Ideas, methods, gadgets and new products are helping win the battle of radio-electronic production

3—Ingenious fixture devised by engineering staff of Carter Motor Co., Chicago, does three truing up jobs at once, which formerly involved separate operations. Bearings, shafts, and commutators of rotating power units must be concentric within close tolerances for proper operation. This new type gage gives a check accurate to .0001-in. within a few moments. Armature is simply set into jig in its own bearings and rotated. Indicating gages measure eccentricities for easy truing up



4—Motor driven eraser drafted from the drafting room solved a tough problem by salvaging four thousand dollars worth of rusty miniature ball bearings at the plant of International Business Machines Corp., Endicott, N. Y. Used in delicate assemblies, the bearings can not be oiled because of the burden of the oil's viscosity. Only satisfactory way to remove rust before installation proved to be by "burnishing" the balls and races with rapidly vibrating soft steel wire held in chuck. Best "tool" for the purpose was paper-clip wire!



5—Accurate quantitative analysis of chemical and metallurgical materials is made in a matter of minutes with X-ray spectrometer unit developed by North American Philips Co., New York City. Sample of the material to be analyzed is placed in X-ray beam. Various amounts of the different wavelengths composing the beam are deflected at various angles. Geiger counter tube traverses its quadrant measuring angular displacement and intensity, which is read for various angles on the dc microammeter. A stepping counter, employed in conjunction with a specially developed scaling circuit, provides a means for exacting quantitative determination of intensity

6—Abrasives used in the grinding of quartz crystals are not particularly beneficial to micrometers. Photo below shows "Lucite" methyl methacrylate resin disk or shield, slightly convex, placed over vernier adjustment mechanism of a crystal orientating table for protection and insurance that production retains high degree of accuracy needed.

7—The Navy, in collaboration with Owens-Corning Fiberglas Corp., has worked out an effective way to seal cables against moisture and vapor leaks at joints and terminations. Demonstration unit at lower left shows materials



used. Crotch at joint is filled with moisture-proof wax and wound tightly with treated fiberglas tape, E at the point A. Specially treated cord, F, is served on at B and C, working toward center of tape, forcing compound into crotch and out towards ends J, H, and D. Insulating sheaths are then tied down with cord G, available in colors

8—Drop tester, immediately below, was specially designed to test packaging of tubes, particularly cathode ray tubes, by C. F. Sprague, who holds patent rights, at G-E, Nela Park, Cleveland, Ohio. The inexpensive device may be mounted on any wall and so positions the packages that they will fall and land in any predetermined position from any desired height



ENGINEERING PROBLEMS

Annual SMPE conference reveals late developments in theater sound recording and reproducing technics

● The 56th semi-annual technical conference of the Society of Motion Picture Engineers since its formation in Washington in 1916, brought to New York some 300 engineers and technicians who for the three days, October 16-18,

learned again of the extraordinary extent to which the entertainment industry depends upon vacuum tubes. Approximately half the lengthy program had to do with the application of electronic principles and technics. Projection tele-

vision for theater showing held particular interest with several papers on that subject. Several papers of general interest to electronic engineers are briefed herewith.—Editor.

Fig. 1—Small capacitance plates on both sides of needle form pickup device for measuring record cutter characteristics in new push pull FM system which permits studying cutter action during actual recording. Fig. 2—below, shows cutting load losses plotted against groove velocity

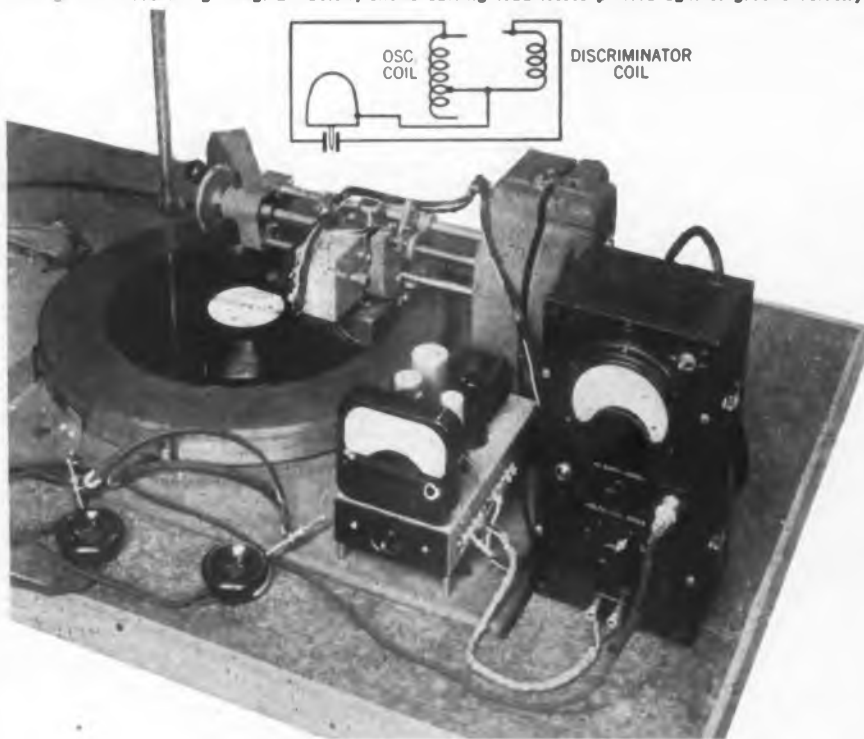

FM Cutter-Head Calibrator

H. E. Roys (RCA, Indianapolis) described a new device for calibrating disk recording heads during actual cutting, one of several advantages over previous optical methods using sunlight pattern, microscope, or photoelectric cell technics. As shown in Fig. 1, tiny capacitance plates are mounted on opposite sides of the stylus shank, whose motion changes the tuning of both the oscillator and discriminator of the "push-pull" FM system. The amplified output is measured on an electronic voltmeter.

The new system for the first time permits the study of frequency response as a function of cutting load, including such factors as the type of record material, shape of stylus, depth of cut, turntable speed, and recording diameter. Fig. 2 shows cutting load losses versus groove velocity at several frequencies, using a sapphire stylus with 2 mil tip radius, 90 deg. included angle, and conventional burnishing edge. The greatest loss occurred at 1,000 cycles, fundamental resonant frequency of the mechanical system. Over the diameters and turntable speeds normally covered in 33 and 78 rpm recording, the loss is small. The average loss at the innermost diameter of a 33 rpm recording, as compared with the outermost, is 1.2 db with this particular stylus.

A good calibrator must be free from distortion so that accurate measurement of the recording head distortion may be made. An overall measurement that includes the head, the disk, and the pickup is not of much use, since it does not permit segregation. Since the FM calibrator is an amplitude device, it is only necessary to limit the range over which the system operates in order to keep the distortion at a very low value so that accurate measurements can be made.

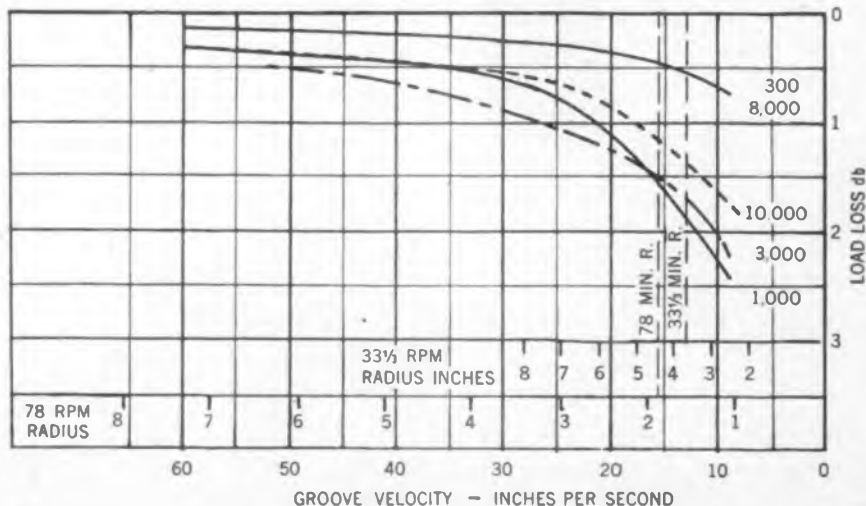

OF PICTURE ENGINEERS

To determine what spacing between the FM plates and the stylus was necessary to fulfill the requirement, tests were made using the recording head with its viscoloid damping block removed, so that at the fundamental frequency, about 1,000 cycles, very little electromagnetic energy was required to give normal amplitudes of vibration. The distortion introduced by the recorder under these conditions would be quite low.

Numerous measurements at 100 cycles were made at various amplitudes of vibration and plate separation, and input-output or linearity measurements were made. As a result, a plate separation of .015-in. is recommended for distortion measurements at the lower frequencies, where the amplitude of the stylus is plus or minus 3 mils. The spacing may be decreased, increasing the sensitivity, at the higher frequencies.

With the .015-in. separation, distortion at 1,000 cycles was less than one per cent for the system, including the recording amplifier and the one used to amplify the output of the FM calibrator. These amplifiers measured somewhat less than one half of one per cent each, so that the distortion of the FM system was of the same order for the highest amplitudes of vibration likely to be encountered. With the damper block in place, the overall measured distortion at 1,000 cycles was about 1.5 per cent at normal recording level. The distortion measurements were made using the RCA distortion meter in which a signal from the oscillator balances out the fundamental of the signal being measured, the residue being the total harmonic distortion.

Although designed primarily for calibrating purposes, the FM calibrator may also be used for monitoring. It is ideal when cutting frequency recorders for reproducer tests. The recorder can be carefully calibrated beforehand and the correct input level for each band determined. Then when cutting the final disk the calibrator may be used as a check on the recording level, making slight corrections if necessary, or if it is undesirable to change the level during recording, the correction can be noted and applied later when using the disk. A test frequency record was made using the latter procedure and its "sunlight pattern" photographed. The variation of the constant velocity section from true flatness was only a few tenths of a decibel.

Electron Multiplier Densitometer

Monroe H. Sweet (AnSCO Research Laboratories, Binghamton, N. Y.) described a new type of densitometer, pictured in Fig. 3, for sensitometric work with multilayer color films. The instrument is based upon the secondary emission gain effects in the RCA 931 electron multiplier phototube.

Sensitometric studies in black and white photography are concerned with measurements, of relatively low accuracy, of emulsion speed, gradation, and fog characteristics. Reversible color film requires much closer control of the sensitometric variables—lighting, exposure, and processing—and since the original image is the one intended for viewing, no correction is permitted in printing. Advances in the art of color photography in the past few years have depended to a large extent upon sensitometric data. Further color developmental work will be assisted by the use of more sensitive, more accurate densitometric instruments with narrow spectral bandwidth features. To avoid some of the limitations of commercially available densitometers, Mr. Sweet developed the present unit.

The type 931 electron multiplier phototube provides a sensitivity of the order of 10^4 times that of the common phototube. The nine dynode stages provide amplification as high as 200,000 when the cascaded elements are provided with the proper progressive potentials. The complete wiring diagram is shown in Fig. 4. Direct coupling of such a

tube to the high impedance grid circuit of the logarithmic amplifier stage used in a densitometer is difficult, because polarity relationships demand that the entire power supply be connected to the 6F5 grid and also be shielded and insulated to an extent comparable in impedance to the 1,000 megohm grid resistor. Obviously, no ordinary ac supply would meet these requirements. Further, stability of the output voltage would be inadequate without special circuits.

By connecting ten miniature 67½ volt batteries in series, a compact power supply is obtained which provides the necessary number of voltage taps as well as the 700 volt total

Fig. 4—Complete circuit diagram of the densitometer, showing battery-powered multiplier phototube and zero adjusting scheme for three colors. Fig. 5—(shown below) Diagram of optical control system of color densitometer

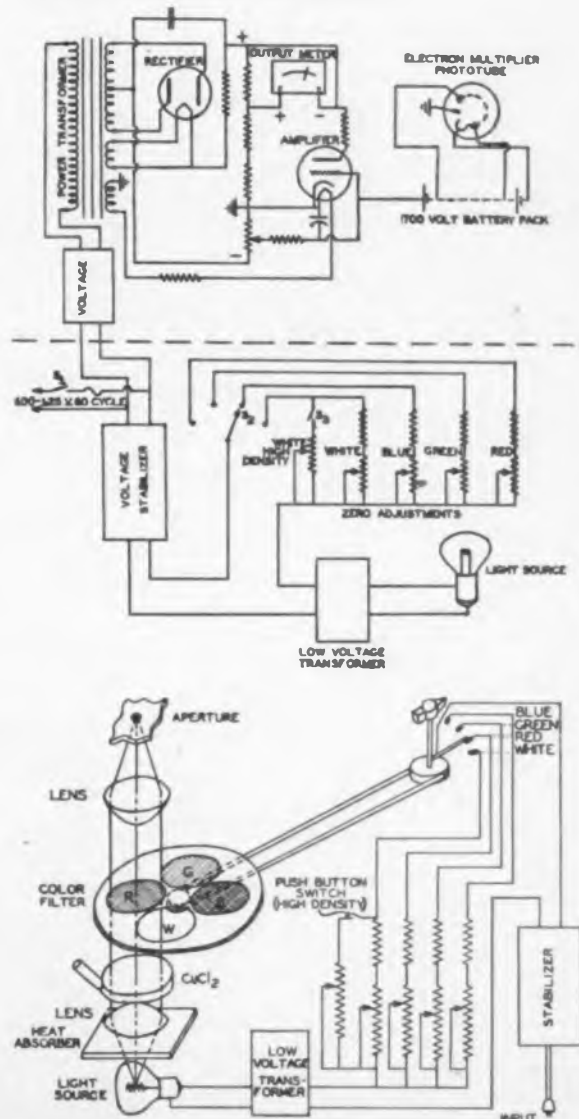

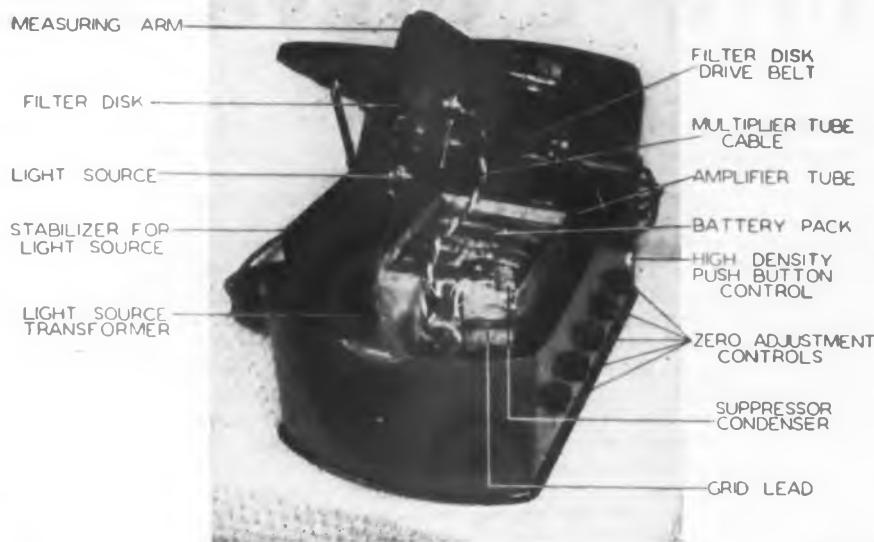

Fig. 3—Electron multiplier densitometer for accurate research on multilayer color emulsions

needed for efficient operation of the multiplier tube. The entire pack measures only 4 by 5 by 7 in., and is easy to shield and insulate. The voltage stability is excellent. Current drain is infinitesimal except for the last stage, which draws 30 microamperes maximum (zero density in light beam) which is negligible by comparison with the design load. The life of the pack is about equal to the shelf life, or well over one year with the instrument in constant daily use.

However, three troublesome factors accompany the use of the multiplier phototube in this application. First, the dark-current of the majority of commercial multiplier phototubes is appreciable in terms of the operation of the triode amplifier stage. Since a density range of 0-3 is to be covered, this means that the ratio of multiplier tube output currents must cover a range of 1,000 to 1.

Since it is difficult to operate small triodes in the desired logarithmic manner at grid currents in excess of 50 microamperes, and since the red sensitivity of available multiplier phototubes is low (and the maximum output for the red filter readings will be correspondingly low) the grid current for a density reading of 3.0 will be of the order of magnitude of 0.05 microamperes and dark currents greater than about 0.01 microamperes cannot be tolerated. Difficulties due to excessive dark current may be avoided by careful "special selection" of multiplier phototubes.

Second, at this writing there are no multiplier phototubes commercially available in photo surfaces which have high sensitivity throughout the visible spectrum. The best compromise was found to

be the type 931 tube which has a caesium-rubidium (S-4) surface characterized by relatively high blue-green sensitivity and very low red sensitivity. As a result it is necessary to alter the optical system in order to obtain the maximum possible red energy for the red filter reading. There is a very large individual variation in the far red sensitivity of photo elements having a caesium-rubidium photo surface and by choosing a tube which not only has low dark current but also high red sensitivity

the second difficulty may be minimized.

Third, the high gain associated with the multiplier tube, together with the extensive physical area of elements (battery pack and multiplier tube leads) connected in the triode grid circuit forms a system which has a strong tendency to oscillate, particularly at low levels of illumination wherein the net grid-ground impedance is high. Oscillation may be avoided by proper shielding alone, although it is also helpful to insert a grid bias bypass condenser of about 0.001 μ f to act as a suppressor. (Higher capacitance values would cause sluggish meter response at high density levels where the grid to cathode dc impedance is high.)

The optical control system is diagrammed in Fig. 5. A 50 cp lamp, energized by a separate stabilizer and low voltage transformer served as the light source. A filter disk holding three sets of gelatin filters was mounted on a shaft. The shaft of an electrical tap switch was coupled with the filter disk in such a manner that as each filter was brought into the beam, a different variable resistor was connected in series with the primary of the light-source transformer so that once all three resistors are properly set, changing from filter to filter will not necessitate readjustment of the zero setting. This has the additional advantage of preventing accidental overload of the grid circuit. By using fixed resistors in series with the rheostats, it becomes

Fig. 6—Photoelectric equipment to measure light intensity distribution across crater of carbon arc

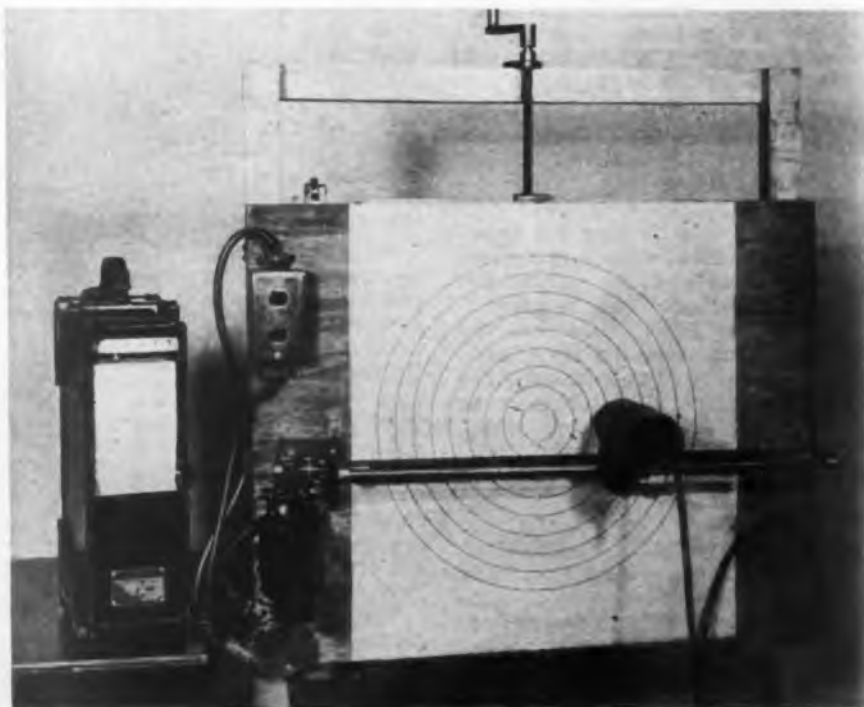

possible to effect a relatively fine adjustment of the zero setting and also to avoid the possibility of accidentally closing the lamp circuit completely and thereby increasing the lamp intensity beyond safe limits.

Arc Brightness Recorder

Projection of intense beams of light requires a light source of high brightness, such as the carbon arc used in motion picture and other applications. A technic has been worked out by Jones, Zavesky and Lozier (National Carbon Co., Inc., Cleveland, O.) for recording conveniently and accurately the absolute value and distribution of brightness across the crater of a carbon arc. This is accomplished by photoelectric measurement of light intensity on an enlarged image of the arc crater. Equipment for performing this measurement is illustrated in Fig. 6. A photocell is passed across the image along vertical and horizontal crater diameters by means of a synchronous motor driven screw. The photocell output is recorded on a meter on which the chart is also driven by a synchronous motor so that the brightness distribution across the arc crater is plotted by the recording meter. The system is calibrated so that the meter can be made to read directly the brilliancy of the arc crater and so that a given distance on the chart in the direction of its travel corresponds to a known distance on the crater.

Fig. 8—Illustrating efficiency of new projection system, using plastic lenses. Bright image of the Philadelphia skyline inverted in center lens is not destroyed by full daylight illumination

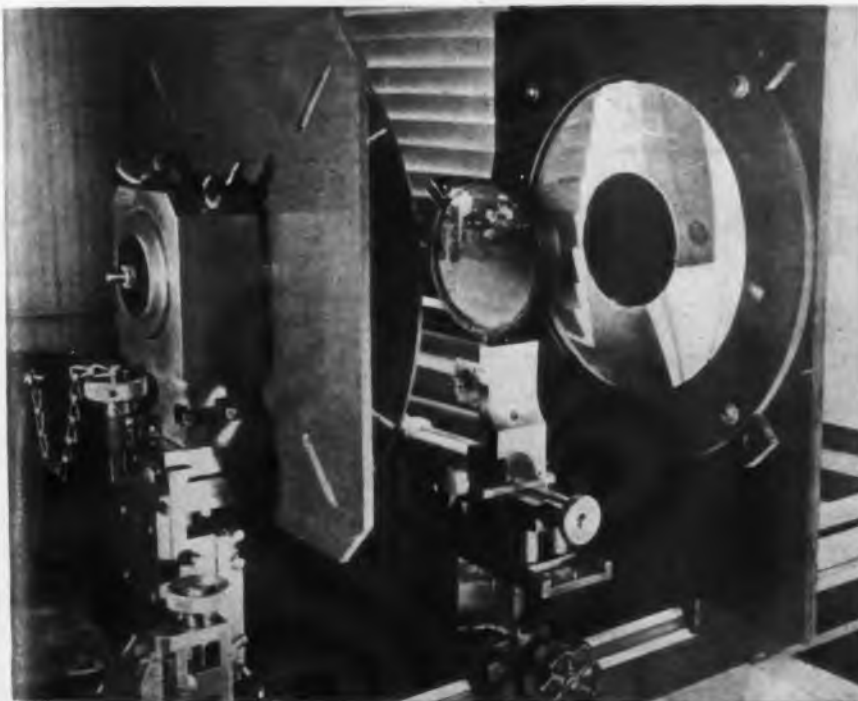

Projection Television

Projection television (subject of paper by D. W. Epstein and I. G. Maloff, RCA) which is simply the projection on a large viewing screen of the picture originating on a cathode-ray tube seems, at present, to be the most practical means of producing large television pictures.

The two basic problems of projection television are:

(1) The problem of providing a cathode-ray tube capable of producing very bright pictures with the necessary resolution and,

(2) The problem of providing the most efficient optical system so as to utilize the largest possible percentage of the light generated.

These problems were very vigorously attacked over a period of years and the progress made toward their solution has been very satisfactory.

Problem (1) has been solved largely by the development of cathode-ray tubes capable of operating at high voltages. Tubes were made in 1940 which delivered 150 candle power, as compared with 10 cp in 1935.

Problem (2) has been solved by the development of a reflective optical system about 6 to 7 times more efficient than a good F:2 refractive lens. The reflective optical system consists of a spherical front face mirror and an aspherical correcting lens.

A handicap of this optical system, for use in a home projection

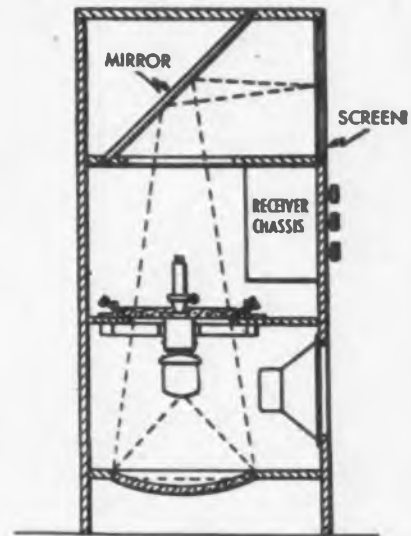

Fig. 7—Diagram of RCA's new projection television set design

receiver was the high cost of the aspherical lens. This has been overcome by the development of machines for making aspherical molds and by the development of a process for molding aspherical lenses from plastics. RCA reflective optical systems are designed for projection at a fixed throw and require cathode-ray tubes with face-curvatures fixed in relation to the curvature of the mirrors in the system. A number of such systems, suitable for projecting television pictures with diagonals ranging from 25 inches to 25 feet, have been developed.

MV Arc and Control Circuit

A new type of mercury vapor light source and control circuit involving inverse feedback via phototube pickup was described by Lester F. Bird (Hanovia Chemical and Mfg. Co., Newark, N. J.). The lamp and control combination is expected to find wide application in all-electronic sound-on-film recording and as a steady, instantly variable, highly actinic light source in motion picture and other printing processes.

Early attempts to modulate mercury vapor arcs for recording met with many difficulties, chief among them being lack of linearity of light output, instability, and a high frequency hiss believed due to ionization effects. The new lamp incorporates heating coils which maintain the correct vapor pressure without regard to arc input. The control circuit (Fig. 9) uses parallel 810's in series with the arc itself. Grids of the 810's are driven by a

(Continued on page 184)



ELECTRONIC

EP's candid camera snaps who attended the Chicago



- 1—J. R. Scanlan, Vice-pres., Electronic Products Mfg. Co., Dexter, Mich.; Herbert Clough, Belden Mfg. Co., Chicago (General Chairman of Conference).
- 2—R. Y. Fitzpatrick, Western Mgr., Caldwell-Clements, Inc.; N. A. Triplett, Pres., Triplett Electrical Instrument Co., Bluffton, O.
- 3—Joseph Erwood, John Erwood, The Erwood Co., Chicago.
- 4—Wayne Potter, North Chicago, Ill.; Harry Holubow, Chief Engr., and W. W. Carroll, Electronic Engineering Co., Chicago.
- 5—S. W. Muldowny, Pres., Dr. L. Grant Hector, Director of Engineering, National Union Radio Corp., and F. J. Wessner, Radio Service Laboratory, Manchester, N. H.
- 6—F. D. Bliley, Pres., George Wright, Sales Mgr., Bliley Elec. Co., Erie, Pa.
- 7—W. W. Jablon, Sales Mgr., A. E. Stevens, Asst. Sales Mgr., Hammarlund Mfg. Co., New York, N. Y.
- 8—A. W. Sattenfield, District Mgr., Arthur Peterson, Sales Mgr., American Phenolic Corp., Chicago.
- 9—E. C. Nickerson, Nickerson & Rudat, San Francisco; R. W. Gothard, Gothard Mfg. Co., Springfield, Ill.
- 10—Herbert Becker, Liaison Engr., Eitel-McCullough, Inc., San Bruno, Calif.
- 11—Harry Ehle, Vice-pres., Robert N. Baggs, Sales Mgr., Replacement Div., International Resistance Co., Philadelphia.
- 12—Robert Williams, Sales Mgr., Hickok Electrical Instrument Co., Cleveland; W. E. Aikins, New London, Conn.
- 13—R. M. Ellis, P. R. Mallory & Co., Indianapolis; McMurdo Silver, Vice-pres., Grenby Mfg. Co., Plainville, Conn.
- 14—Wm. Garstang, Vice-pres., Norman Kevers, Pres., Electronic Laboratories, Indianapolis.





EXECUTIVES

*some of the 1400 delegates
Equipment Industry Conference*

- 15—Oden F. Jester, Vice-pres., Moissner Mfg. Co., Chicago; Myron S. Seybert, Seybert's Radio Co., Anderson, Ind.
- 16—M. A. Gardner, Director of Purchases, Oscar Dane, Senior Partner, Templetone Radio Co., Mystic, Conn.
- 17—R. C. Reinhardt, Pres., Atlas Sound Corp., Brooklyn, N. Y.
- 18—Alfred Crossley, Pres., Electro Products Laboratories, Chicago.
- 19—R. F. Laycock, Pres., Miss Georgia Parr, The Capacitron Co., Chicago.
- 20—H. L. Kalker, Gen. Sales Mgr., Sprague Products Co., North Adams, Mass.
- 21—Frank Mann, Gen'l Sales Mgr., Roy C. Myers, Mark W. Will, E. F. Johnson Co., Waseca, Minn.
- 22—Stanley Manson, Director of Advertising, Stromberg-Carlson Co., Rochester; Ben Gross, Pres., Gross Sales Co., New York, N. Y.
- 23—G. W. Davis, Hallicrafters Co., Chicago; G. J. Timmerman, Midwest Timmerman Co., Davenport, Ia.; R. W. Durst, Vice-pres., Hallicrafters Co.
- 24—E. Tilton, Jerry Kleker, V. N. Zachariah, Thordarson Elec. Mfg. Co., Chicago.
- 25—J. J. Kahn, Pres., Standard Transformer Co., Chicago; Samuel R. Joseph, Radio Maintenance Supply Co., Worcester, Mass.
- 26—J. C. Hindle, Gen'l Mgr., New York Transformer Co., New York.
- 27—Floyd W. Bell, Pres., Bell Sound Systems, Inc., Columbus, O.
- 28—A. Haselman, Vice-pres., Communication Products Co., Newark, N. J.
- 29—Charles Koch, Pres., Merit Coil & Transformer Corp., Chicago; Marty Camber, New York; J. J. Crockett, Jr., Sales Mgr., Merit Coil & Transformer Corp.
- 30—Rex L. Munger, Vice-pres., Taylor Tubes, Inc., Chicago; Earl K. Moore, Radio Specialties Co., Phoenix, Ariz.



ELECTRONIC MAGNETIZER

by H. J. HAGUE

Electronic Engineer, Westinghouse Electric & Mfg. Co., Pittsburgh

Controlled half cycle capacitor discharge circuit speeds up the precision treatment of magnets

● The fundamental purpose of an electronic meter magnetizer is to furnish an entirely unidirectional current of a definite polarity. In addition, it should be capable of high speed operation from an alternating current source of power. The first electronic meter magnetizer designed to operate from an alternating current source employed a thyatron tube to control a small ignitron rectifier tube.

When producing magnets, a load current of considerable proportion is required since the units being magnetized are usually in a circuit that has a very low impedance, hence a load transformer is used to reduce the current through the ignitron tube. If the load transformer were not used, the voltage between the cathode and anode of the ignitron tube would be considerably below its ignition point.

The control circuit of the magnetizer is designed to control the firing of the ignitron tube during a half-cycle period. It is for this reason that a meter magnetizer of this design is often called a controlled half-cycle magnetizer.

Experience has indicated that the control must be especially designed to eliminate the possibility of the occurrence of current reversal in the secondary circuit of the load transformer. If the load impedance characteristics are such that it results in other than a unity power factor load on the magnetizer, and if the control circuit of the magnetizer is not designed to avoid the occurrence of current reversal, then the combination of these two shortcomings will ordinarily permit a small reverse current in the secondary circuit of the magnetizer for a comparatively long time.

The electronic magnetizer has the capacity to magnetize a wider variety of magnets than any previously used device. At the same time, it is compact enough to be taken into the field for service work should it be inconvenient to remove the meters and return them to a central repair station.

Basically, the latest type of meter magnetizer consists of a single phase, full wave rectifier utilizing two rectifier tubes which charge a

capacitor bank to the maximum rated voltage of the capacitors. Since the capacitor bank is charged through a magnetizing transformer, the circuit is arranged so it will completely reset the flux after each discharge. When the capacitor bank is fully charged, the unit to be magnetized is placed within the secondary loop of the magnetizing transformer and the energy from the capacitor is discharged by means of a thyatron tube.

Looking at the front of the magnetizer panel, utilizing the electronic capacitor discharge principle the following is to be seen: At the top left is a two-button push-button station marked "Charge" and "Discharge." To the right of

this are two lights: one red, marked "on"; and one green, marked "TD."

The function of the red "on" light is to indicate when the power is on the unit. The green light "TD" indicates that the time delay relay, used to protect the tubes against operation before they are sufficiently warm, has completed its function. It also indicates when the cover interlock is open. If the green light is on, the operator can magnetize; however, if the green light is off, the operator cannot operate the unit as it indicates there is no high voltage on the system.

In the center there are two sets of copper leaves which comprise the secondary of the magnetizing transformer. Shunting these leaves is an arrangement of copper blocks or leaves upon which the magnets are suspended. With a design incorporating a number of removable leaves, it is possible to handle a variety of magnets since either large or small meter magnets can be accommodated by simply adding additional leaves or subtracting the proper number of leaves from the bank.

On the unhinged end of the leaves is found a small hole in which a pin is inserted. The purpose of the pin and hole arrangement is to provide a faster means of returning all leaves to the closed loop position or to move the leaves to a position where they will not interfere with the operator while smaller meter magnets are being magnetized.

To insure that the resistance of the secondary or magnetizing loop circuit is reduced to a minimum, a special cone system of lever locks is provided. With this system, all the operator need do is to press a small lever (located at the left and right terminals as shown in the photograph), which forces the secondary leaves tightly against the switch blades. In the event that the tension is too low, it is possible to increase it by tightening the nuts at the top of the leaves.

To produce a magnet, the proper number of leaves are selected and a magnet suspended over them.

(Continued on page 190)

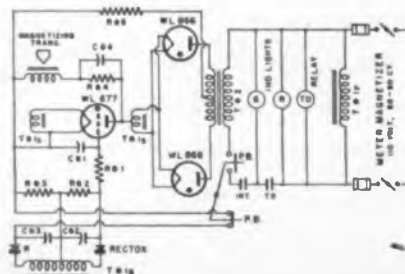

Fig. 1—Schematic drawing of meter magnetizer

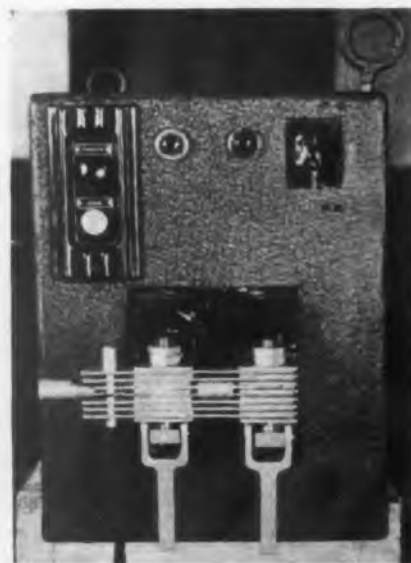

Fig. 2—Latest development, providing a satisfactory secondary circuit



How the new FM walkie-talkie (SCR-300) is used by invasion forces operating in France



During the invasion of France members of a shore fire control party set up shop in an old shell hole and immediately proceed to direct the fire of Naval guns against targets on the beachhead

COMMUNICATIONS IN COMBAT

Radio equipment in use under battle conditions in European and Pacific theaters

Below are five of the many men who go to make up a communications platoon carrying equipment in new packs lately developed for combat service. The men are carrying: (1) SCR-511 radio; (2) part of SCR-284 radio; (3) CE-11 telephone; (4) SCR-284 radio; (5) switchboard



X-RAY ADJUSTMENT

by DR. C. FRONDEL

Director of Research, Reeves Sound Laboratories, Brooklyn, N. Y.

Alteration of atomic structure of piezo crystals by irradiation accurately changes oscillating frequency

● One of the most unusual and interesting discoveries of fundamental importance in the piezoelectric crystal art is a new method of adjusting the frequency by altering the atomic properties of the quartz itself, without lapping or etching the oscillator-plate. The adjustment can be made, if so desired, while the plate is oscillating in a holder, and so can be followed visually on a meter. The precision that can be attained is limited only by the accuracy of the frequency measuring equipment.

When a BT quartz oscillator-plate is irradiated with X-rays, or by certain other radiations, it gradually becomes smoky in color and at the same time the oscillation frequency decreases. Similar effects are obtained with oscillator cuts other than the BT, and with substances other than quartz, but the present discussion will be limited to high frequency BT quartz plates.

The total frequency change that can be effected increases with increasing initial frequency of the plate, and can be roughly estimated for a given frequency on the basis of a decrease of approximately 0.02 per cent in the frequency-thickness constant of irradiated quartz. There is, however, a considerable varia-

tion in response among different crystals of the same frequency; in an unsensitized 8 megacycle plate the observed total response varies between 500 and 3,000 cycles, with an average change of about 1,400 cycles.

The rate of change of frequency is primarily determined by the intensity and wavelength of the X-radiation employed. The rate, like the total change, also increases with increasing initial frequency of the plate. Rates now achieved in production in the Reeves Sound Laboratories, Inc., plant average about 40 cycles change per minute in 8 megacycle plates. A considerable increase over this rate can be expected from North American Phillips X-Ray Corp. equipment designed for the purpose that shortly will be placed on the market. The change in frequency on irradiation is accompanied by little or no change in crystal activity.

The frequency change brought about by radiation can be reversed, and the plate restored to its original frequency, by baking at temperatures over about 175° Centigrade. The rate of reversal increases with increasing temperature and is practically instantaneous above 400° C. Irradiated

plates have been found to be entirely stable at temperatures below 175° C.

The fact that the frequency change is downwards from the original value permits the salvage of plates that have been overshot in frequency during manufacture, provided that the desired frequency change is within the range of the radiation technic. Similarly, plates that have gone over frequency due to aging, re-cleaning, or under-plating may be recovered.

At the present writing, roughly 1,000 over-frequency plates are being recovered per week by X-rays in the Reeves plant. Another advantage of the method is that the frequency of stabilized crystals can be adjusted without disturbing the surface condition of the quartz. Plates can also be finished to have a desired frequency at a specified temperature by irradiation to frequency while held at that temperature.

The greatest advantage of the method, however, is that the frequency adjustment can be brought under continuous, visual control by oscillating the crystal in the X-ray beam until it reaches the desired frequency and then stopping the treatment. This can be accom-

North American Phillips equipment for irradiation of quartz plates for reducing oscillation frequency of plates ground too thin

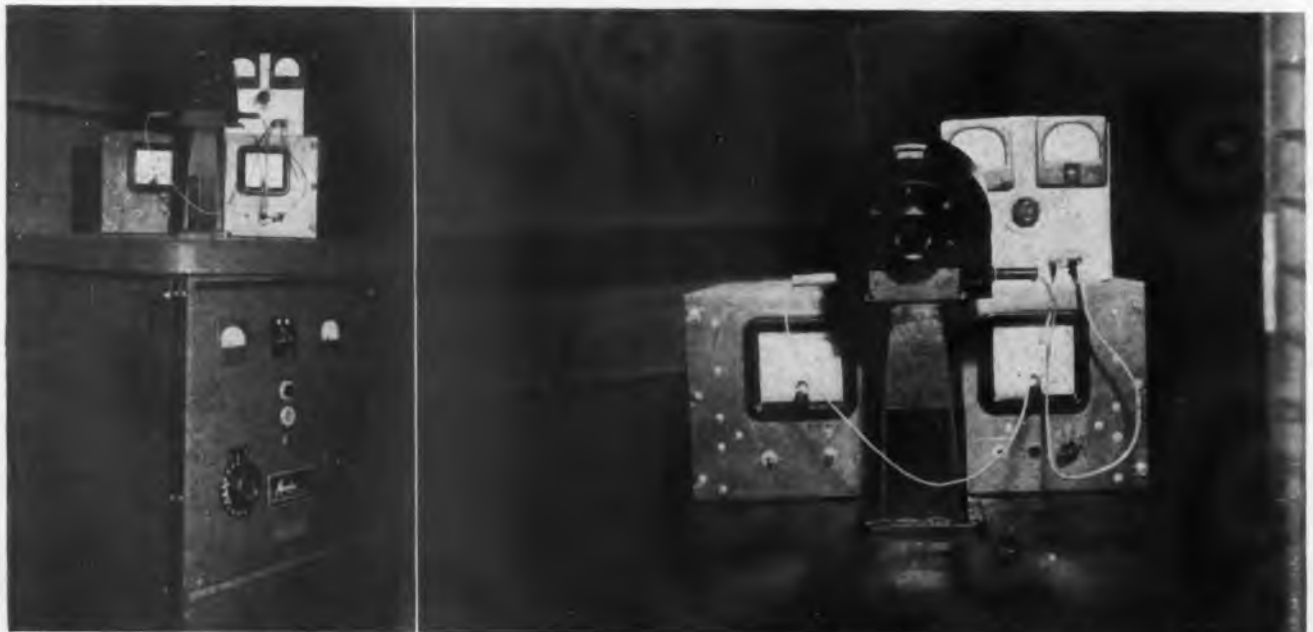

OF QUARTZ PLATES

plished while the crystal is mounted in its permanent holder, if the latter is suitably designed, or in a temporary holder so made as to permit entrance of the X-ray beam. Frequency adjustments of the highest precision can be attained in this way. The irradiation-to-frequency technic is of special advantage in the manufacture of ultra-high frequency plates, in the range over 15 megacycles, since the conventional methods of finishing crystals here become very difficult to control while the radiation technic, on the other hand, is at its maximum power.

Rate of change of frequency

The principal factors influencing the rate of change of frequency during irradiation are the intensity of the X-ray beam, the distance of the plate from the window and anode of the X-ray tube, and the initial frequency of the plate itself.

The rate of change of frequency is found to be directly proportional to the intensity of the X-ray beam. The beam intensity itself increases as the square of the voltage and directly as the current passed. It may be noted that the peak wavelength of the continuous radiation yielded by the tube decreases with increasing voltage so that there is an accompanying slight decrease in the percentage absorption of the beam.

Using copper radiation from a tube operated at 25 ma and 50 kv, with a crystal to window distance of approximately 1 mm., ordinary unsensitized 8 megacycle plates can be changed in frequency on the average about 40 cycles a minute. At 20 ma and 40 kv on a slightly different type of tube an average rate was obtained of roughly 18 cycles a minute; and at 4 ma and 20 kv on still another tube, a rate of about 5 cycles a minute. Changes of from 200 to 400 cycles have been obtained in one minute on tubes operated intermittently at 50 ma and 50 kv with the plate directly on the window. If the quartz has been sensitized before irradiation, or other steps taken to increase the response, these rates may be increased several-fold at the same beam intensities. The nature of the curves obtained when the frequency change is graphed against the time of irradiation is shown in Fig. 1. The rates cited here refer to the initial essentially linear parts of the curves.

If absorbing material is interposed between the window and the

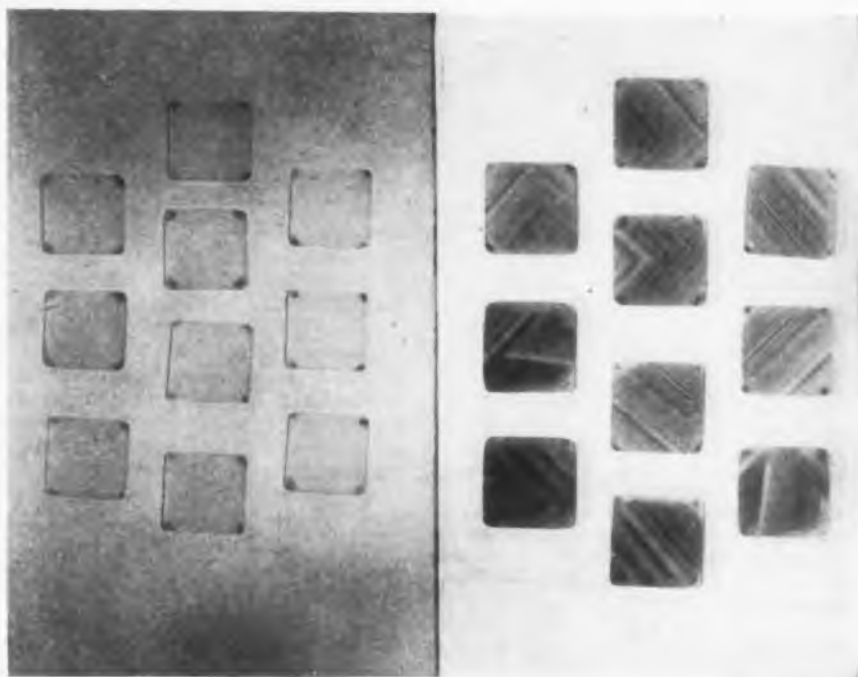

Marked examples of color banding developed in oscillator plates by X-rays. Left—Plates before irradiation. Right—Appearance of plates after exposure to X-rays. All of the plates were cut from the same rough quartz crystals

crystal the rate of change of frequency is reduced due to diminution in intensity of the beam. Wire suspension mounted crystals that are irradiated through their holders while oscillating change much more slowly than when irradiated at the same window distance and out of their holders. In such work every effort should be made to reduce the thickness of the holder wall to a minimum and to use holder materials that are relatively transparent to X-rays.

The distance of the plate from the window and anode of the X-ray tube is one of the most important single factors in irradiating oscillator-plates. Broadly speaking, a given frequency change produced in a few minutes when the plate is 0.5 millimeters from the window will require an exposure time of hours when the plate is 20 millimeters distant and an exposure of many days at a distance of a foot. Measurements that further illustrate the effect are given in Fig. 2.

These curves were all obtained on the same plate, which was irradiated successively at the various distances cited with the X-ray intensity kept constant. The plate was reversed in frequency by baking at 300° C. between each run. Although the intensity of radiation drops off inversely as the square of the distance from the source, it is

found in the present instance that the time needed to effect a given frequency change decreases much more rapidly than would be expected from this law as one closely approaches the window. This is in part due to the fact that the X-rays are proceeding from a relatively broad area on the target and not from a point source, and to the relatively high absorption of the longer, and more effective wavelengths in the beam during their passage in the air after emerging from the window.

It has already been pointed out that the average saturation value increases with increasing frequency of the plate. The average rate at which saturation is reached also is found to increase with increasing plate frequency (or decreasing plate thickness) at constant intensity of the X-ray beam. The exact relation is not known. The increase in rate with decreasing thickness appears to be much more pronounced than the accompanying increase in saturation value. This presumably is due to the relatively strongly absorbed but weakly penetrating long wavelength components of the incident beam, which, while they penetrate to the same depth in a thick plate, expose a larger percentage of the total mass of quartz as the plate thickness decreases. (Turn page)

X-RAY ADJUSTMENT

by DR. C. FRONDEL

Director of Research, Reeves Sound Laboratories, Brooklyn, N. Y.

Alteration of atomic structure of piezo crystals by irradiation accurately changes oscillating frequency

● One of the most unusual and interesting discoveries of fundamental importance in the piezoelectric crystal art is a new method of adjusting the frequency by altering the atomic properties of the quartz itself, without lapping or etching the oscillator-plate. The adjustment can be made, if so desired, while the plate is oscillating in a holder, and so can be followed visually on a meter. The precision that can be attained is limited only by the accuracy of the frequency measuring equipment.

When a BT quartz oscillator-plate is irradiated with X-rays, or by certain other radiations, it gradually becomes smoky in color and at the same time the oscillation frequency decreases. Similar effects are obtained with oscillator cuts other than the BT, and with substances other than quartz, but the present discussion will be limited to high frequency BT quartz plates.

The total frequency change that can be effected increases with increasing initial frequency of the plate, and can be roughly estimated for a given frequency on the basis of a decrease of approximately 0.02 per cent in the frequency-thickness constant of irradiated quartz. There is, however, a considerable varia-

tion in response among different crystals of the same frequency; in an unsensitized 8 megacycle plate the observed total response varies between 500 and 3,000 cycles, with an average change of about 1,400 cycles.

The rate of change of frequency is primarily determined by the intensity and wavelength of the X-radiation employed. The rate, like the total change, also increases with increasing initial frequency of the plate. Rates now achieved in production in the Reeves Sound Laboratories, Inc., plant average about 40 cycles change per minute in 8 megacycle plates. A considerable increase over this rate can be expected from North American Philips X-Ray Corp. equipment designed for the purpose that shortly will be placed on the market. The change in frequency on irradiation is accompanied by little or no change in crystal activity.

The frequency change brought about by radiation can be reversed, and the plate restored to its original frequency, by baking at temperatures over about 175° Centigrade. The rate of reversal increases with increasing temperature and is practically instantaneous above 400° C. Irradiated

plates have been found to be entirely stable at temperatures below 175° C.

The fact that the frequency change is downwards from the original value permits the salvage of plates that have been overshot in frequency during manufacture, provided that the desired frequency change is within the range of the radiation technic. Similarly, plates that have gone over frequency due to aging, re-cleaning, or under-plating may be recovered.

At the present writing, roughly 1,000 over-frequency plates are being recovered per week by X-rays in the Reeves plant. Another advantage of the method is that the frequency of stabilized crystals can be adjusted without disturbing the surface condition of the quartz. Plates can also be finished to have a desired frequency at a specified temperature by irradiation to frequency while held at that temperature.

The greatest advantage of the method, however, is that the frequency adjustment can be brought under continuous, visual control by oscillating the crystal in the X-ray beam until it reaches the desired frequency and then stopping the treatment. This can be accom-

North American Philips equipment for irradiation of quartz plates for reducing oscillation frequency of plates ground too thin

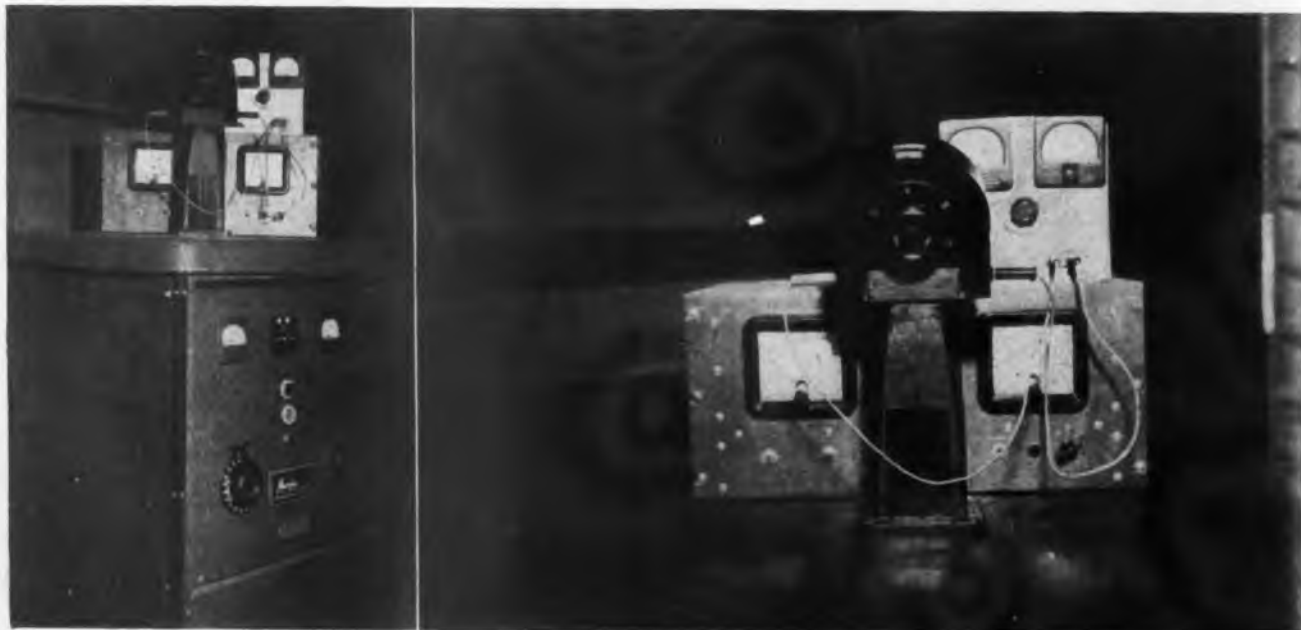

OF QUARTZ PLATES

plished while the crystal is mounted in its permanent holder, if the latter is suitably designed, or in a temporary holder so made as to permit entrance of the X-ray beam. Frequency adjustments of the highest precision can be attained in this way. The irradiation-to-frequency technic is of special advantage in the manufacture of ultra-high frequency plates, in the range over 15 megacycles, since the conventional methods of finishing crystals here become very difficult to control while the radiation technic, on the other hand, is at its maximum power.

Rate of change of frequency

The principal factors influencing the rate of change of frequency during irradiation are the intensity of the X-ray beam, the distance of the plate from the window and anode of the X-ray tube, and the initial frequency of the plate itself.

The rate of change of frequency is found to be directly proportional to the intensity of the X-ray beam. The beam intensity itself increases as the square of the voltage and directly as the current passed. It may be noted that the peak wavelength of the continuous radiation yielded by the tube decreases with increasing voltage so that there is an accompanying slight decrease in the percentage absorption of the beam.

Using copper radiation from a tube operated at 25 ma and 50 kv, with a crystal to window distance of approximately 1 mm., ordinary unsensitized 8 megacycle plates can be changed in frequency on the average about 40 cycles a minute. At 20 ma and 40 kv on a slightly different type of tube an average rate was obtained of roughly 18 cycles a minute; and at 4 ma and 20 kv on still another tube, a rate of about 5 cycles a minute. Changes of from 200 to 400 cycles have been obtained in one minute on tubes operated intermittently at 50 ma and 50 kv with the plate directly on the window. If the quartz has been sensitized before irradiation, or other steps taken to increase the response, these rates may be increased several-fold at the same beam intensities. The nature of the curves obtained when the frequency change is graphed against the time of irradiation is shown in Fig. 1. The rates cited here refer to the initial essentially linear parts of the curves.

If absorbing material is interposed between the window and the

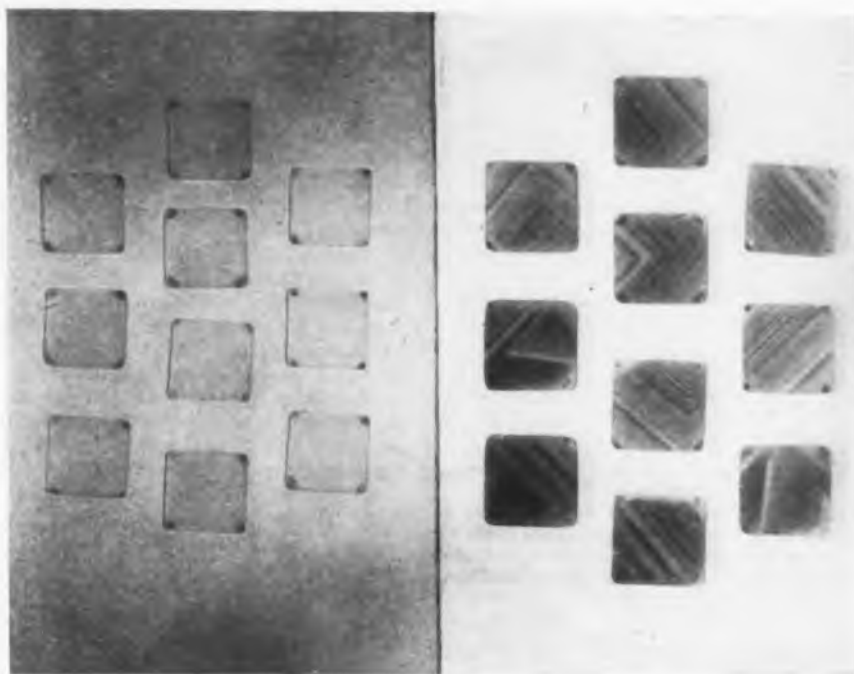

Marked examples of color banding developed in oscillator plates by X-rays. Left—Plates before irradiation. Right—Appearance of plates after exposure to X-rays. All of the plates were cut from the same rough quartz crystals

crystal the rate of change of frequency is reduced due to diminution in intensity of the beam. Wire suspension mounted crystals that are irradiated through their holders while oscillating change much more slowly than when irradiated at the same window distance and out of their holders. In such work every effort should be made to reduce the thickness of the holder wall to a minimum and to use holder materials that are relatively transparent to X-rays.

The distance of the plate from the window and anode of the X-ray tube is one of the most important single factors in irradiating oscillator-plates. Broadly speaking, a given frequency change produced in a few minutes when the plate is 0.5 millimeters from the window will require an exposure time of hours when the plate is 20 millimeters distant and an exposure of many days at a distance of a foot. Measurements that further illustrate the effect are given in Fig. 2.

These curves were all obtained on the same plate, which was irradiated successively at the various distances cited with the X-ray intensity kept constant. The plate was reversed in frequency by baking at 300° C. between each run. Although the intensity of radiation drops off inversely as the square of the distance from the source, it is

found in the present instance that the time needed to effect a given frequency change decreases much more rapidly than would be expected from this law as one closely approaches the window. This is in part due to the fact that the X-rays are proceeding from a relatively broad area on the target and not from a point source, and to the relatively high absorption of the longer, and more effective wavelengths in the beam during their passage in the air after emerging from the window.

It has already been pointed out that the average saturation value increases with increasing frequency of the plate. The average rate at which saturation is reached also is found to increase with increasing plate frequency (or decreasing plate thickness) at constant intensity of the X-ray beam. The exact relation is not known. The increase in rate with decreasing thickness appears to be much more pronounced than the accompanying increase in saturation value. This presumably is due to the relatively strongly absorbed but weakly penetrating long wavelength components of the incident beam, which, while they penetrate to the same depth in a thick plate, expose a larger percentage of the total mass of quartz as the plate thickness decreases. (Turn page)

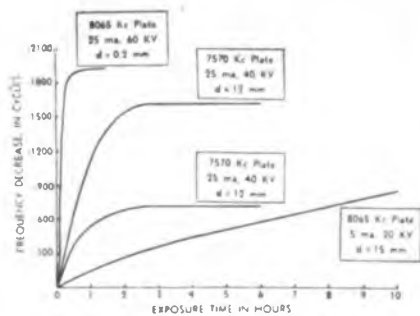

Fig. 1—Exposure time and frequency change relationships for various X-ray beam intensities and for two different crystal frequencies

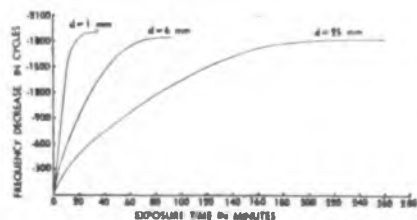

Fig. 2—Frequency shift of 8416 kc plates irradiated at 25 ma-60 kv with copper target for various distances (d), between crystal and X-ray tube window. Other experimental conditions constant

Irradiated quartz decolorizes and reverts back to the original frequency when heated to a sufficiently high temperature. The change is a time-temperature reaction and is similar in this to the decolorization of natural smoky quartz. No frequency changes have been observed in irradiated crystals stabilized by baking and deep etching before irradiation and kept on time test for periods over six months at room temperature and for periods of weeks at temperatures up to about 170° Centigrade.

Repeated cycling over the range of -50° to $+90^{\circ}$ has not been found to affect the stability. In the neighborhood of 170° to 180° C. a true reversal of frequency begins which is extremely slow and requires a period of weeks for completion. The rate of reversal increases rapidly with increasing temperature. In the range from 210° to 230° C. complete reversal requires a few hours, and at 350° to 400° C. a few minutes. Over 450° C. the change is almost instantaneous. The reversal in frequency is accompanied both by a discharge of the smoky color and by a pale bluish thermoluminescence.

The maximum temperature at which the color of natural smoky quartz is stable is about 225° C., and the rate of change, as with artificially colored crystals, increases rapidly with increasing temperature. The decolorization in this case is not accompanied by any change in frequency.

The increase in frequency brought about by baking is found to be exactly the same as the initial de-

crease brought about by irradiation. This is true, however, only if the plate has been stabilized before irradiation and does not undergo an added increase in frequency due to aging when it is later baked. Stabilized crystals can be cycled downwards by irradiation and upwards by baking indefinitely by the same amount of frequency if the conditions of irradiation and baking are exactly duplicated.

Variations in the conditions of reversal by baking, including the temperature at which the crystal is baked, and the rate of cooling, may markedly influence the behavior of the crystal on re-irradiation. This matter is of first importance if the oscillator plate is to be used as on X-ray dosimeter, as a standard in absorption measurements, or in other ways where the response of the crystal must be identical in successive tests.

A powerful beam of ultraviolet light from a quartz-mercury arc also is found to reverse the color and frequency of irradiated plates. The change takes place more rapidly if the plate is heated to 100° - 150° C. during the exposure. Exposure to ordinary sunlight is without effect.

The action of heat and of ultraviolet light in reversing the frequency change brought about by X-rays offers the possibility of adjusting the frequency of irradiated crystals on the upgrade. Thus, crystals overshot by X-rays on the downgrade could be recovered, or crystals could be deliberately overshot in bulk by a very powerful and relatively cheap source of radiation and then individually adjusted upwards to the desired frequency by heat in this way, but only if the holder did not contain plastic or soldered parts which would be affected by the degree of heat necessary. Adjustment by ultraviolet light requires that the crystal be directly exposed to the beam, since the ordinary holder materials are opaque to the ultraviolet wavelengths.

Sensitive area of plate

Only part of the total area of a BT crystal has to be irradiated in order to gain the maximum frequency shift. The exact percentage of this area apparently decreases with the gross edge dimensions of the crystal. In 6450 kc plates measuring 0.75×0.75 inch it was found that only about 40 per cent of the total area had to be irradiated for maximum results, as shown in Fig. 3. Frequency changes of 100 cycles or so can be obtained even when the irradiated area is less than 1 per cent of the whole. In these experiments the irradiated areas were circular and were cen-

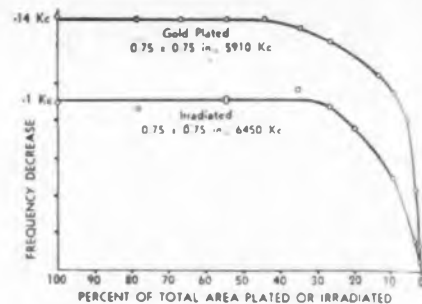

Fig. 3—Relation between frequency decrease and the area of crystal exposed to X-rays or gold-coated by cathodic sputtering. Note saturation at about 30% area for irradiation

trally located in the crystal. The observations tie in with the well known fact that the corners of shear mode rectangular plates are relatively inactive during oscillation.

A similar relation exists with plated crystals, whether rectangular or circular. Only a relatively small part of the central portion of the crystal has to be plated to gain maximum frequency decrease by loading, as shown in Fig. 3. The percentages of sensitive area is in general close to those found in irradiation by X-rays.

Special attention should be paid to the following general matters:

1. The crystal must be placed as close as possible to the window of the X-ray tube, preferably within a distance of one-half millimeter.

2. The X-ray beam should be made as intense as possible, since the photoelectric response of the quartz appears to be directly proportional thereto.

3. The wavelength of the X-rays employed should be so selected as to yield maximum absorption in the total thickness of the quartz plate being irradiated. For example, soft X-rays are strongly absorbed and are relatively efficient in producing ionization, but their penetrating power is low and hence they may not penetrate through a thick crystal. On the other hand, hard X-rays penetrate deeply but their absorption and ionizing power is relatively low and hence the greater part of the energy in the X-ray beam might be transmitted through a relatively thin crystal. Considering the various factors involved, including the practicalities of tube design and flexibility of application, copper radiation appears to be best for general use. Radiation of a longer wavelength, hence more easily absorbed, such as from Fe, Co, Cr, Mn, or Tl target, would be especially suited for very high frequency plates of a thickness of 0.008 inch or less. Thick low frequency plates may perhaps best be irradiated with a more penetrating radiation, such as from a tungsten tube

(Continued on page 166)

TUBES ON THE JOB

Oil Refining Temperatures

It is of vital importance in modern refinery methods that accurate boiling points of the various vapors to be separated in fractionation be predetermined in the laboratory. This is accomplished by an electronic measurement system in the Los Angeles plant of the Richfield Oil Corp.

The instrument, manufactured by the Brown Instrument Co., Philadelphia, is a continuous balance precision indicating potentiometer pyrometer, which uses tubes to magnify a small temperature gradient. It is mechanically connected to a conventional recording potentiometer built into the Hyd-Robot. A special high-sensitivity fine wire thermocouple, consisting of six individual couples spaced about one-half in. apart, is located in the reflux zone of the fractionating column. The electromotive forces of these thermocouples are magnified by the electron tubes and recorded continuously by pen on the time-temperature strip chart.

The instrument finds particular application in the rapid and accurate analyses of four and five carbon hydrocarbons. The special thermocouple covers all possible positions of a wandering condensation ring, which is known to vary

several inches up or down in the fractionating column. By this expedient the true boiling of a compound is accurately recorded no matter which couple is located in the coldest zone. This could never be accomplished by a single junction thermocouple. The electronic recorder and the special Podbielniak fractionating column makes possible rapid and accurate separation of compounds whose boiling points are only one and one-half degrees apart, a feat which cannot be accomplished by the older type of apparatus. This new development considerably reduces distilling time with increased accuracy and opens up a new field in fractional distillations.

"Handie Talkies" Used in Emergency

Production continued without delay, after fire had destroyed the Administration Building of the Douglas Aircraft Company plant and all telephone lines at Chicago, recently, through the use of Motorola "handie talkies" for emergency communications.

The "handie talkies" were strategically located throughout the plant at 8 stations and, though distances ranged from less than 100 ft. to well over a mile, messages



A new note in intra-plant communication. After fire had destroyed Administration building and all phone lines at Douglas Aircraft Co., Chicago, "handie talkies" served as telephones

were clearly and quickly received.

Replacing the hastily organized messenger service, the system—"really did the work, during the 2½ days, 24 hours a day."

More Walkie Talkie News

Two more "firsts" have been chalked up for Motorola's "handie talkies," at least one of them a success. The entire coordination job involved in presenting the Chicago Music Festival to an audience of some 90,000 persons was handled by this wireless telephone technic. Entrances and exits of the several thousand performers was reputedly handled with grace and smoothness previously unknown in such gigantic spectacles. Field officials also used "handie talkies" to exchange messages with control rooms and other vital points around the great Soldier Field.

The other experiment, an attempt to have a reporter of the Indianapolis "Times" radio in a news story, had two strikes against it from the beginning! It seems that the traditional privacy of the leg man is threatened. What self-respecting reporter wants to have the city editor putting the tab on him just at the moment when he's busily engaged in having a few shots, or perhaps taking his afternoon snooze? Moreover, how are you going to keep the rival rag from dialing in on your frequency to unscop you? However, the third strike was that the communication over the necessary distance was not established, probably due to the interference of city buildings and extensive overhead streetcar wires.



Electronic laboratory controls have been installed in the recently completed Richfield 100-plus octane refinery near Los Angeles. The unit pictured is a pilot fractionation tower that accurately determines the boiling point of any hydrocarbon fraction, enabling high efficiency separation

TELEVISION SERVICE

Shadows, multi-path and other disturbances exist at all frequencies, likely to be worse at 400 than 50 mc

● Shadows are most severe in metropolitan areas; they do not constitute a problem in residential areas, except in special cases, but are moderate to severe in hilly or mountainous regions. Tests made during the summer of 1934 in the Camden-Philadelphia area* showed a marked increase in shadows cast by individual buildings and groups of buildings at 100 megacycles as compared with 30 megacycles. Tests have not indicated any real difference in shadow phenomena for horizontal or vertical polarization. For practical conditions, the band width required for modulation is not a factor in these shadow effects.

It has been our experience, from many tests, that shadow effects become more serious with increasing carrier frequency and that, for the higher frequencies, they are definitely sharper, with less tendency to heal or fill-in back of the obstruction. Shadow phenomena may well present, at some frequency higher than any frequency tried to date in broadcast-type field tests,

*"An Urban Field Strength Survey at Thirty and One Hundred Megacycles", R. S. Holmes and A. H. Turner, Proceedings of The Institute of Radio Engineers, Vol. 24, page 755, May 1936.

one of the limits to the present method for obtaining broadcast coverage.

Increase in radiated power, obtained either by greater generated power or by transmitter antenna directivity, will aid in overcoming shadow effects, particularly at the frequencies above 40 megacycles; but one may reach a frequency above several hundred megacycles where increases in power which are practicable will do no real good. This is because, as just indicated, the shadows become sharper and do not heal or fill-in.

Multipath phenomena

Multipath phenomena undoubtedly constitute one of the most serious problems confronting television. Much experience has been obtained in the neighborhood of 50 megacycles, but the experience becomes less extensive as we go up in frequency. We have had some experience at frequencies as high as 400 megacycles, and there is indication that multipath exists at all frequencies considered for television broadcasting, and that it becomes gradually worse with increasing carrier frequency.

We chose, as the objective for the tests, to study the effects of multiple propagation paths encountered in an urban area using a frequency of 400 megacycles, and to compare these effects with those obtained at approximately 50 megacycles, in order to permit some estimate to be made of how multiple propagation paths would affect television broadcasting systems operating at 400 megacycles.

In order to do the work and do it quickly, we made use of apparatus which was already available. The transmitter was installed in the Empire State Building, New York City, with an antenna just outside a window at the 85th floor level, on the north side of the building. The antenna consisted of a dipole mounted in front of a metal-plate reflector. Horizontal polarization was used.

The transmitter was one which could emit short pulses of 400-megacycle signal. The peak power of these pulses was approximately 20 kw. Each pulse lasted for approximately two-millionths of a second and they occurred at a rate of 1,000 per second. At the receiving location, a similar antenna was used. The output of the receiver was fed

Comparison field strength surveys made at 30 mc (left) and 100 mc (right). Transmitter location was the same in both cases. Power, 1 kw, transmitter antenna 200 feet and receiving antenna 10 feet in both cases. In general, field is 2 to 5 times greater at 30 mc in outlying districts. Map scale is approximately 5 miles per inch



HINGES ON FREQUENCY

EXPERT OPINION

Statements in this article have been extracted from testimony given by Dr. E. W. Engstrom, Director of Research, RCA Laboratories, before the public hearing conducted by the Federal Communications Commission in Washington during October. Dr. Engstrom makes these points:

- 1—All factors considered, television broadcasting channels should start as near 145 mc as possible.
- 2—Shadow effects become more serious with increasing carrier frequency.
- 3—At higher frequencies shadows are sharper and there is less tendency for them to fill in back of obstructions.
- 4—Multipath exists at all frequencies, becomes gradually worse with increasing frequency.
- 5—Multipath sets a limit on fineness of detail.
- 6—Destructive effects of multipath increase as channel width is increased.
- 7—Man-made disturbances decrease as carrier frequency is increased above 40 megacycles.
- 8—In moving upward above 40 megacycles choice of transmitter location and antenna height becomes increasingly critical.

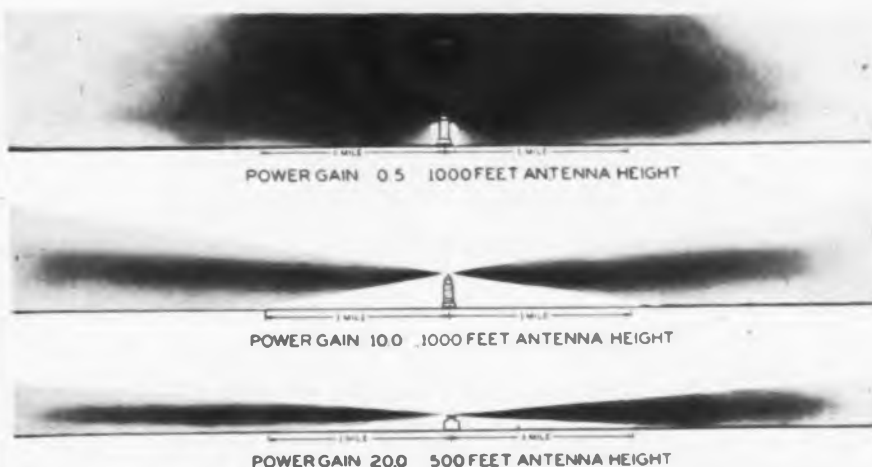

Increasing power gain of transmitting antenna by limiting radiation in vertical plane creates "dead area" around transmitter. Considering horizon distance, a power gain of 10 in antenna appears optimum



Television test pattern with no multi-path reflection



One multi-path reflection over 165 foot path and 50 per cent amplitude



Multipath No. 1, 2480 feet and 7 per cent amplitude and No. 2, 4500 feet and 7 per cent



Multipath No. 1, 3940 feet, 30 per cent and No. 2, 11,100 feet at 2 per cent amplitude

to a special cathode-ray oscilloscope.

The horizontal movement of the oscilloscope trace represented time, and the vertical movement the amplitude of the received signal. The horizontal movement or deflection of the trace was such that one sweep took place every one-thousandth of a second, in synchronism with the transmitted pulses. Thus, if the transmission path were an ideal one, the trace on the oscilloscope would show a single pulse, but, if multipath transmission occurred, there would be, in addition to the pulse representing the main signal, other pulses displaced in position by an amount depending upon the difference in distance traveled by these multipath signals. Thus, we were able to evaluate the number, magnitude and the time difference of pulses for each of the test locations and for a number of receiver orientations. Similar tests were made using the NBC television transmitter with a frequency of 51.25 megacycles.

The receiving locations varied from the top of the RCA Building

in Rockefeller Plaza, three-fourths of a mile from the Empire State Building, to detached private residences fifteen miles north of the transmitter. We realize that the tests were incomplete and inadequate to form the basis for general conclusions, particularly because the observations at 400 megacycles could not be interpreted directly as television pictures. But we did find, for regions having large buildings, where difficulty has been encountered in the past from multiple transmission paths at 51.25 megacycles, that these same multi-

path difficulties were in evidence at 400 megacycles. It seems that it was more difficult at some locations to find an antenna location at 400 megacycles reasonably free of multiple transmission effects than at 51.25 megacycles. In residential areas at some distance from the transmitter, where multipath transmission effects have not given difficulty at 51.25 megacycles, the same freedom from trouble was indicated at 400 megacycles.

In the frequency range above 400 megacycles, we know of no experience with television broadcasting

which can add information regarding the multipath problem. We predict that multipath phenomena will be present and that the magnitude of the problem will continue to increase with increasing frequency. We propose, just as soon as our war work program will permit, to make observations with frequencies near 1,000 megacycles, of the character just reported for 400 megacycles. Furthermore, we will be in a position, in about six months, to make field tests in New York City with actual television picture transmission at 288 megacycles and 5 kw output power. Multipath effects will be one of the first items to receive our attention.

In a metropolitan center such as New York, in the heavily congested areas, it has been our experience in many locations that multipath has set a real limit to the fineness of detail which can be reproduced in the television picture. This limitation gradually disappears as the receiving location is moved away from the congested area and into an area of detached residences.

The scanning spot naturally must travel faster to cover each frame in a television picture of approximately 800-1000 lines than in a 525-line picture. Thus, the multipath images, which remain fixed in time differences of transmission for a given radio carrier frequency, are displaced by a greater distance left to right on the television picture. Short differences in path length

which would just begin to reduce the picture detail at 525 lines would now be spread out more (approximately two times as far) at 800-1000 lines and might more than destroy the increase in detail expected from the greater number of lines. Generalizing, the destructive effects of multipath increase as the channel width is increased (to add picture lines or to transmit pictures in color).

Solely from the point of view of multipath phenomena and shadow phenomena, one should use as low a frequency as possible consistent with obtaining sufficient band width and a sufficient number of channels for a broadcast service. This means as near 45 megacycles as possible. Multipath and shadow difficulties both gradually become worse with increasing carrier frequency. This has been our experience from tests conducted over a period of several years, using carrier frequencies from 30 megacycles to 400 megacycles, under conditions pertinent to a broadcast type service.

Our experience indicates that the interfering level of ignition noise and most other man-made disturbances produced by sparks or electrical pulses decreases as the radio carrier frequency is increased above 40 megacycles. This opinion is based on general observations over the frequency spectrum rather than an extensive quantitative radio-noise measurements. We do not consider

natural static a factor in allocating frequencies above 40 megacycles.

At present, diathermy interference is less serious the higher the frequency assignment above 40 megacycles, but this is because most of the apparatus now available for the medical profession uses frequencies below 40 megacycles. Future needs on the part of the medical profession for the use of higher radio frequencies in treatment could easily change the situation unless future diathermy equipment is properly designed and used.

On several occasions earlier in this hearing, witnesses have been asked to comment upon K. A. Norton's curves showing the variation with frequency of the service and interference ranges of television broadcast stations. These data show that the field strength at receiver locations increases with frequency. This is true for the conditions assumed by Norton for the computations, i.e., unobstructed paths. These are conditions which hold for a normal point-to-point circuit at VHF or UHF, and for example, a radio relay system at UHF. For such tests as have been made, the data for average conditions in a broadcast type service area and for practical receiver antenna heights have shown lower field strengths than the Norton curves indicate.

L. F. Jones, in an article entitled,

(Continued on page 170)

Relative field strength over actual terrain using a frequency of 288 mc. Values on bar graph are in per cent of theoretical field strength calculated for plain earth and no obstructions. Note large effect of tree absorption

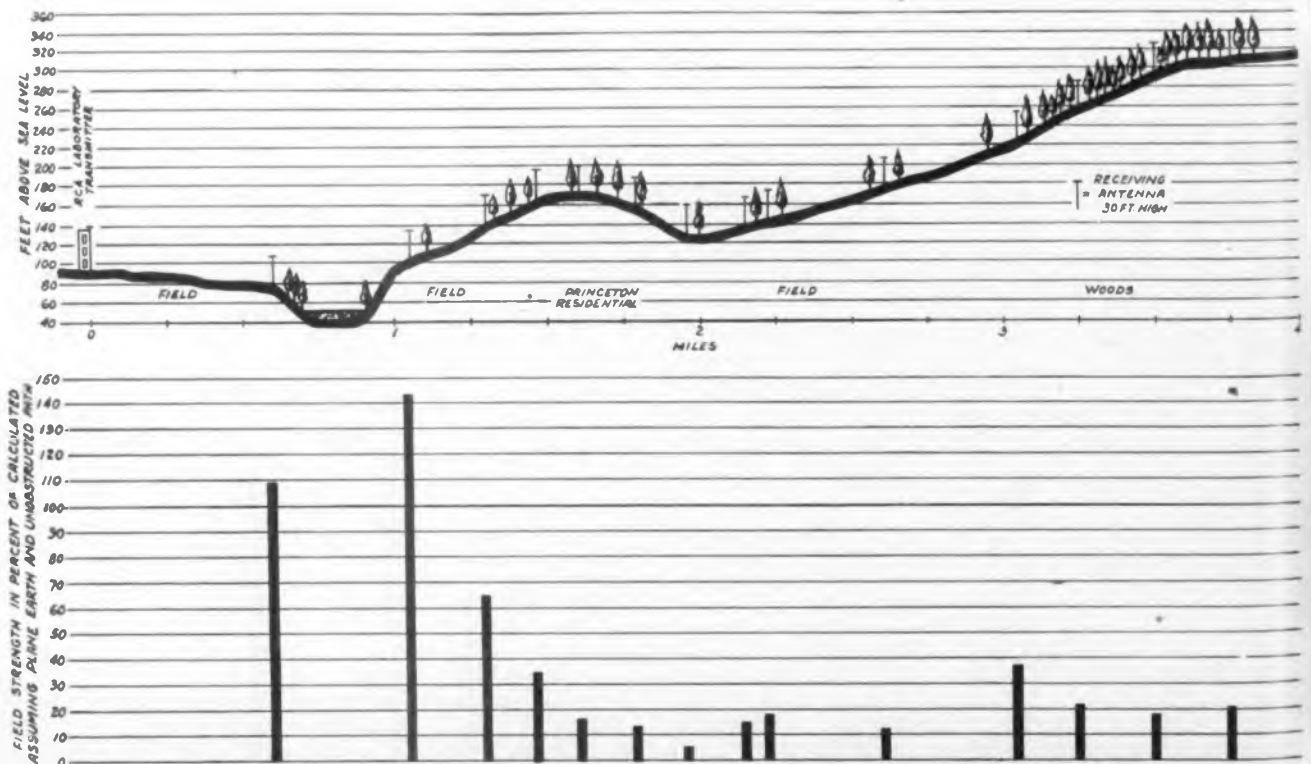



TORTURE CHAMBERS



As ground and airborne electronic equipment for the armed forces grows in complexity, and the difficulties under which it must operate without trouble or failure increase with every new invasion, quite as much ingenuity is needed in the design and building of test devices as was required in producing the equipment itself. These photos, made at Western Electric's great Hawthorne Works in Chicago, show some of the newer test equipment in use. Upper left is a giant stratosphere chamber for putting radio equipment through its paces under high altitude conditions. At the right of it is an apparatus that simulates the rolling and pitching of a war ship ploughing through rough seas; it is used to check the performance of ship-borne equipment, rocks and rolls for hours and days. Left are the controls and measuring equipment for a humidity chamber, and on oscillator in the company's type-test laboratory.

SURVEY of WIDE READING

Electronic news in the world's press. Review of engineering, scientific and industrial journals, here and abroad

Rectifier-Doubler

J. Menke (Funktechnische Monatshefte 1942, Nos. 11/12, summarized in Bulletin Schweizer Elektrotechnischer Verein, 1944, No. 9)

Diodes are used in this frequency doubler circuit because of the short transit time as compared with triodes. The particular type of diode shown has Lecher wire systems as leads to the plates and to the common cathode, they constitute the resonant output circuit. The rotor is provided for the tuning of capacitances C' and C'' , while the capacitance of C_1 is varied by moving the disk closer to or away from the diode structure.

A 300 megacycle input of 20 watts maximum is doubled by the circuit to give an output of 600 megacycles. The cathode diameter of the diode was 3.15 mm., its plate diameter 3.60 mm., the maximum output current 75 mA per system, and the transconductance 12 to 15 mA/volt.

In an alternative scheme, the Lecher wire systems are replaced by a "pot" circuit which is arranged in the envelope of the double

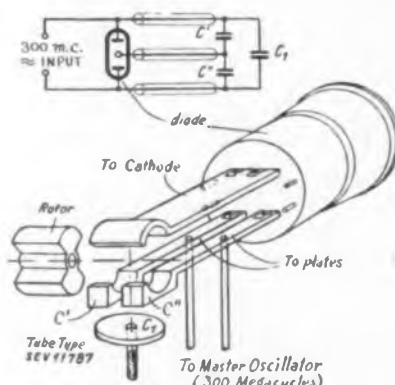

Double-diode frequency doubler

diode. The cathode surface of this structure was 1.15 cm², the cathode-plate distance 0.32 mm., the maximum plate current 90 mA, and the transconductance 12 to 13 mA/volt.

Counter Circuit

J. A. Simpson (Physical Review, August, 1944)

An insensitive time interval is associated with Geiger - Mueller counters because the positive ion

space charge produced by each ionizing particle in the immediate vicinity of the positive center wire reduces the electric field below the critical value for supporting a new avalanche. An ionizing particle traversing the counter during the insensitive interval will not cause discharge of the counter and, consequently, will not be registered. The insensitive time interval, which is of the order of 10⁻⁴ second, lasts until the positive ion sheath has moved about two-thirds of the distance toward the cathode cylinder surrounding the positive wire.

(Continued on page 191)

Evaluating Direct Current in Triodes

G. A. Gruenberg (Journal of Physics, Moscow, Vol. VII, No. 6)

A method is developed for the approximate calculation of the electron current through a cylindrical triode in the presence of a current-limiting space charge between cathode and grid. The computations are based on Langmuir's rela-

(Continued on page 192)

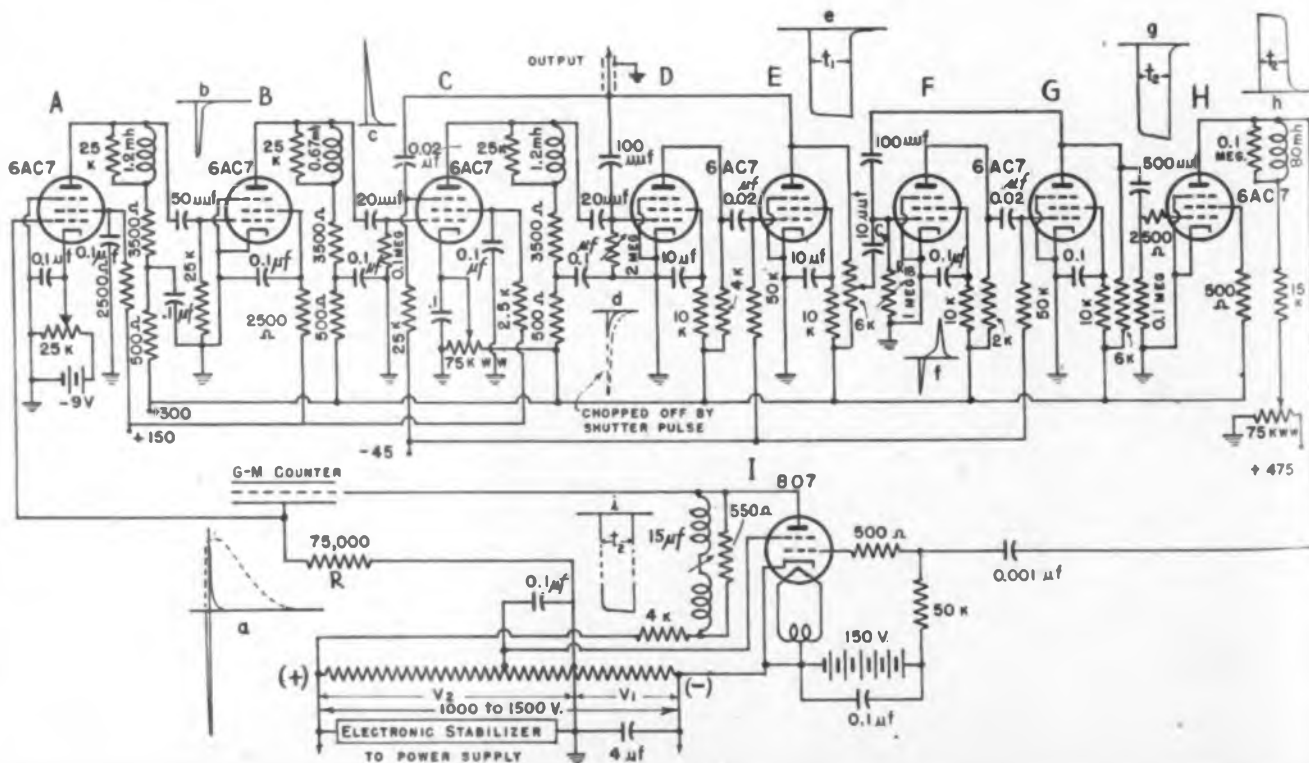

Circuit associated with G-M counter to amplify and shape pulses (tubes A, B and C), to block amplifier (feedback from tube E to tube C), and to reverse counter voltage after each ionizing event for a short period of time (tubes F, G, H and I)

HYTRON has made them all!



The march of Hytron receiving tube progress down through the years is fascinating. One looks back on tubes, tubes, and more tubes: battery, AC, AC/DC, diodes, triodes, pentodes, beam tetrodes, multiple purpose types, G's, MG's, BANTAM GT's—and now the miniatures. Price and size have been drastically cut; quality and performance, amazingly improved.

Hytron has made them all. Its long and varied experience is priceless in a complex industry where probably never will all the answers be known. In making radio tubes, painfully acquired practical

experience must supplement the formulae of science.

With an eye to present and future, Hytron is concentrating its production of receiving tubes on preferred BANTAM GT types needed for war—for today's civilian replacements—and ultimately for post-war. Its wartime activities are teaching Hytron new techniques of miniature production. Many potentially popular Hytron miniatures are in development. Typical American dissatisfaction with anything but perfection continues; the parade of Hytron receiving tubes marches on.

OLDEST EXCLUSIVE MANUFACTURER OF RADIO RECEIVING TUBES

HYTRON
CORPORATION



ELECTRONIC AND RADIO TUBES
SALEM AND NEWBURYPORT, MASS.

BUY ANOTHER WAR BOND

WHAT'S NEW

Devices, products and materials the manufacturers offer



Dual Attenuator

An improved type of dual unit attenuator has been developed by the Daven Co., 191 Central Ave., Newark, N. J. It comprises two units mounted tandem fashion; the shafts meet in a lap joint within a bushing permitting easy separation by loosening a knurled nut and releasing a snap-on fitting, without dismantling the front unit. The new model is electrically the same as previous models. In addition it has fungus and mildew resisting varnish on all bakelite parts and resistive windings. Contact and switch blades are of tarnish resistant, improved silver alloy.

New Microphones

Universal Microphone Co., Inglewood, Calif., has brought out its first new model since 1940 with the presentation to the trade of the new D-20 series. The new Universal dynamic microphone has a response of 50 to 8,000 cycles. Ultra-streamlined in appearance, the D-20 will be modeled in brush satin chrome finish case with Universal's new "micro adjust" swivel. Dust proof hood and twenty-five feet of cord will be included in the attractively packed unit. D-20 will be manufactured in four impedances. Universal will also resume production on some of its microphone models including the KD and 15 MM, both of which are dynamics; 200 series, a dynamic hand-mike model; and X-1 and XX, both carbons.

Clutch Head Screws

Clutch head screws, made by United Screw and Bolt Corp., Chicago, with any standard style of head, in many materials, ferrous and non-ferrous, and in practically



any size and thread including thread-cutting types, have a specially shaped slot with which any ordinary screwdriver may be used, or the screws may be driven with a specially formed bit. In either case, a slight reverse twist holds screw and driver together facilitating work in hard-to-get-at places. Dimensions of the slot, being liberal, prevent driver slippage and speed up work. The driving face is parallel with the axis of the screw, reducing required end pressure.

Welding Timer

A new type of electronic timing control for use in resistance welding operations has been produced by Electrical Industries, Inc., 42 Summer Ave., Newark, N. J. It may be applied to new or existing installations and a single knob gives control from one to 28 cycles in steps of one cycle. Welding current is electronically switched. The equipment will handle welding powers of from one-half to five kva.

Ratio Meter

New development of the Instrument Division of Thomas A. Edison, Inc., West Orange, N. J., is an electrical ratio meter. The principal use thus far of the instrument has been in connection with a temperature sensitive resistance bulb to indicate temperatures at various critical points about aircraft, but its application to a number of other uses is in process of development. The design of the meter movement inverts the conventional arrangement of such instru-

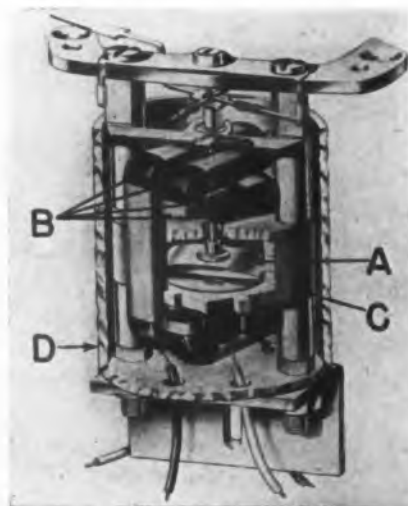

ments by using a small moving permanent magnet vane (A), the position of which is governed by the ratio of the currents in two sets of stationary actuating coils (B), placed at an angle with one another. (C) is a damping housing; (D) is a magnetic shield. This arrangement provides an exceptionally rugged construction and permits the elimination of all hair springs. The movement may be adapted to any service in which it is desired to indicate the ratio between the values of two currents or voltages, independently of their magnitude. Coil resistances up to 1000 ohms are feasible, and the instrument will operate dependably at currents down to 800 microamperes. The scale span ordinarily covers 120 circular degrees.



Vacuum Tube Voltmeter

This new vacuum tube volt-ohm-milliammeter instrument incorporates many features which simplify operation and save time in production testing. Of particular importance is the wide frequency range ac voltmeter which measures from 50 cps. to 50 megacycles; also the six dc voltage ranges, with input capacitance of less than 2 micromicrofarads and input resistance of 11 megohms all ranges; dc current ranges from 50 microamperes to 1 ampere in six ranges. Model 450 has a single zero adjust for all ac and dc ranges. Measures 100 ohms to 1,000 megohms without battery. The battery is used only for measurements below 100 ohms. Voltage regulated supply provides stable operation. Maker is Reiner Electronics Co., Inc., 152 W. 25th St., New York.

Special Finishes

The manufacture of "Hammer-tone" finishes, interrupted by the war, has been resumed by Maas & Waldstein Co., Newark, N. J. These finishes simulate hammered silver, copper, bronze, and other ornamental metals, and are for application on most metals or bakelite type (phenol formaldehyde) molded plastics. Recent refinements in manufacture have improved the working qualities of the finishes and simplified their application.

Improved Dial Light

Featuring new construction in which the shell, bracket and lugs are permanently secured by tab and notch devices, Dial Light Co. of America, 900 Broadway, New York, has improved pilot light assemblies which use miniature screw, miniature bayonet or candelabra type sockets. The new design is intended to eliminate the possibility of shorts.

(Continued on page 186)





**PRECISION Frequency Calibration up to
2000 Megacycles with the LAVOIE
HARMONIC FREQUENCY GENERATOR**

PROVIDES output voltages which are multiples of 10 megacycles or 40 megacycles with CRYSTAL-controlled accuracy.

SELECTS 10 megacycle series or 40 megacycle series by means of a switch located on the front panel.

IDENTIFIES any one of these harmonics by means of a Frequency Identifier. *The Frequency Identifier** consists of a filter which provides high attenuation of all voltages except that of the frequency to be identified.*

**** BE SURE** to specify FREQUENCY of Identifier wanted when ordering.

- The above methods can be used in the calibration of equipment requiring a voltage, such as receivers or wavemeters . . . or (by using the Beat Detector built into the Harmonic Frequency Generator) in the calibration of equipment producing a voltage, such as oscillators and signal generators.



Write for detailed information.

Lavoie Laboratories

RADIO ENGINEERS AND MANUFACTURERS
MORGANVILLE, N. J.

Specialists in the Development of UHF Equipment

ELECTRONIC INDUSTRIES • December, 1944

WASHINGTON

Latest Electronic News Developments Summarized
by Electronic Industries' Washington Bureau

FUTURE PROSPECTS—Procurement will keep up at present high levels until V-E Day; special emphasis now by Army and Navy is on batteries and tubes. Production of 9,100,000 miniature receiving tubes slated for first quarter of 1945 and current production of 2,600,000 tubes per month is termed short of military requirements; due to battle losses and development of new electronic equipment, the military demands for these tubes have increased instead of falling off.

CIVILIAN SUPPLY OF TUBES UP—Production of civilian radio home-receiver tubes increased in final 1944 quarter, together with a larger amount of surplus Signal Corps tubes. But danger exists, in the opinion of WPB officials, that many home sets may be silenced in near future for lack of tubes, as Army surplus tubes often do not fit civilian requirements. There is no pinch on transmitter tubes, except in a few types. Comparatively little revision of WPB limitation orders in sight for immediate future. Major change is to be cancellation of priorities rating floors in limitation orders under general WPB policy that the CMP plan and Priorities Regulation 23 take care of ratings for military orders.

SURPLUS ADMINISTRATOR'S REPORT—Confirming the trends previously published here, the report of Surplus War Property Administrator Clayton on that agency's progress since its creation last February brought out that actual sales of surplus communications equipment through declaration of such excess equipment by the Army have been comparatively small and that the big rush of surpluses will come with contract terminations after V-E Day. Surplus in communications-radio-electronic field up to date has been entirely from the Army. The Navy has been using one manufacturer for disassembling of components and parts of obsolete sets for the production of other equipment or for maintenance. Big portion of declared surplus up to Sept. 30 was some \$13,300,000 of vacuum tubes released by Army Signal Corps.

DISPOSAL POLICIES—Plan of government in surplus disposal through agreements with original manufacturers of apparatus and components to act as disposal agents, which was outlined in three early November meetings with radio-electronic equipment and component manufacturers, is designed to give manufacturers discretion on selling surpluses and at same time keep their plants in operation with own products. But Administrator Clayton's report contained this most significant admonition to the industry that "it is thought the manufacturers should sell the government (surplus) stock at least as fast as their own". The Clayton report warned that contracts will be followed by the governmental Surplus Property Board (appointed by President Roosevelt during late November) "to make sure the government's interest is being protected" and where manufacturers contend there is no possible sale for certain equipment other opinions will be obtained from independent sources.

OUTLOOK AND HANDLING—Planning for handling of surpluses has been done well. Universal military training, supported by President Roosevelt, will absorb substantial amounts of equipment for training. Large

accumulated demand from government departments, such as shipping, forestry, park services, and from state-municipal police and fire departments, and from railroads, truck, bus, taxi services, but, if as is anticipated, the large surpluses of this equipment will not come until Japanese V-Day, there then will be more difficulty in disposal as manufacturers will be on a part-time civilian basis and the Army-Navy apparatus will be more expensive and heavier.

OBSOLETE AND UNMARKETABLE APPARATUS—In the case of obsolete or unmarketable equipment, such as certain types of radar, Surplus Administration agrees should be scrapped where equipments stand. Navy may sell radio and radar on ships disposed of to allied nations; also Navy is likely to maintain its radio-electronic installations on Pacific islands. All these factors may substantially reduce amount of eventual surpluses.

SIGNAL CORPS TO HELP—Recent statements of the leading officers of the Army Signal Corps on the necessity of expeditious and wise handling of contract terminations after the defeat of Germany are most helpful signs for the radio-electronics industry. Major General Harry C. Ingles, Chief Signal Officer, in an address to five hundred student officers being trained to handle terminations at Ft. Monmouth, emphasized its wise handling will have direct bearing on bringing industrial plants back to a peacetime economy on a stable basis and he also praised the cooperation between industry and the Signal Corps. Brigadier General A. A. Farmer, Commanding General of the Philadelphia Signal Depot, stressed the necessity of speed in achieving quick and fair settlement of war contracts.

GENERAL HARRISON HEADS CONTRACT TERMINATIONS—The Signal Corps is deeply conscious of its responsibilities in planning for reconversion, Brigadier General J. V. Matejka, of the Signal Corps, stated in another address. A contract termination branch has been established in the Procurement and Distribution Service by Major General William H. Harrison and Lieutenant Colonel John S. G. Rottner has been designated Chief of the branch, which will exercise staff supervision over contract terminations and the formulation of uniform policies and procedures with the actual operations decentralized in the various Signal procurement districts.

MISCELLANY—Plan for single U. S. privately-owned international broadcasting company after the war slated to be approved by Washington government agencies. . . . Chief job in FCC allocations to be reconciliation of industry spectrum demands with those of government services. . . . Japanese war requirements will be 73½ per cent of November peak military production. . . . Electronic distributors urge WPB and SWPA to set up barriers against components falling into hands of speculators. . . . World aviation conference in Chicago indicates U. S. type of radio range favored by many countries.

National Press Building
Washington, D. C.

ROLAND C. DAVIES
Washington Editor

wherever a tube is used...

for example:

ELECTRONIC AIR CLEANING

Smoke, dust, and soot particles 100 times smaller than the eye can see are drawn out of the air electronically by an ingenious arrangement of positively and negatively charged plates. This device facilitates precision manufacturing of delicate instruments, guarantees purity and sanitation in food processing, promotes health and cleanliness in restaurants and hospitals.

POWER PACK



THERE'S A JOB FOR *Relays* BY GUARDIAN

Electronic air cleaners ionize dust particles and collect these particles on a series of positive and negative plates called "Collector Cells" which are arranged in a venetian blind fashion. Rectifier tubes in a power pack change the a-c secondary voltage into pulsating d-c voltage. This d-c voltage is smoothed out by a capacitor and charges the Ionizer and Collector cells.

Relays are built into the power pack to protect it against short circuits or other irregularities in circuit operation. Typical of such relays is the Guardian Series 40 a-c relay which has a laminated armature and field piece.

The Series 40 is well fitted for use in power packs such as illustrated, because it is designed to handle a maximum of control in minimum space. It has a switch capacity of double pole, double throw with $12\frac{1}{2}$ ampere contacts (rated at 110 volts, 60 cycles, non-inductive load). Coils are available for standard voltages up to 220 volts, 60 cycles. Normal power requirements are 9 V. A.

For details on this and other Relays by Guardian write for General Relay Bulletin.

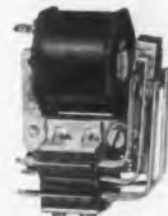

Series 40 A C Relay

Consult Guardian whenever a tube is used—however—Relays by Guardian are NOT limited to tube applications but are used wherever automatic control is desired for making, breaking, or changing the characteristics of electrical circuits.

GUARDIAN ELECTRIC

1622-P W. WALNUT STREET CHICAGO 12, ILLINOIS

A COMPLETE LINE OF RELAYS SERVING AMERICAN WAR INDUSTRY

ASSOCIATION NEWS

1,400 at Chicago Distributor Conference

The demand for radio sets and for replacement parts will be greater, postwar, than it has even been in the history of the business. The 1,400-odd manufacturers, executives, distributors and dealers who attended the Electronic Parts and Equipment Industry Conference which closed October 21 after a three-day session in Chicago believe that, and are preparing for it. But they also believe, with John Creutz, Chief of the Civilian Domestic and Foreign Branch of the WPB Radio and Radar Division, that there are going to be shortages of some critical components such as tubes, transformers, vibrators, resistors, electrolytics, switches and some other items.

The talk Creutz gave the gathering was one of the features that kept everybody who attended Chicago's second conference in a month, busy every minute of their time. A great deal of that time was spent in an exhibitless exhibit hall where "exhibitors" were permitted to talk to distributors and dealers, but not to exhibit

anything. Sponsors of the gathering were the Electronic Parts and Equipment Manufacturers, Sales Managers Club (Eastern Division), Radio Manufacturers Association
(Continued on page 128)

Conventions and Meetings

Institute of Radio Engineers (330 West 42nd Street, New York); December 6, 29 West 39th Street, New York; 1945 Winter Technical Meeting, January 24-27, Hotel Commodore, New York.

Television Broadcasters Association, Inc. (500 Fifth Avenue, Room 1038, New York); First Annual Conference, December 11-12, Hotel Commodore, New York.

American Physical Society (Dr. Karl K. Darrow, Secretary, Columbia University, New York); January 19-20, New York.

American Institute of Electrical Engineers (H. H. Henline, 29 West 39th Street, New York); Winter Technical Meeting, January 22-26, New York.

Electrochemical Society (Colin G. Fink, Columbia University, New York), April 12-14.

Open Electronic Parts and Equipment Industry Luncheon



Before H. W. Clough, vice-president of Belden Mfg. Co., Chicago, and Conference General Chairman, opened the "General Industry" Luncheon in Chicago. Along with Mr. Clough (second from left) are Brig. General J. V. Matejka, Chief of Personnel Training Service, Office of Chief Signal Officer, Washington, D. C.; Lt. Kay Snyder, WAC; Commander W. C. Eddy, USN (RET), Commanding Officer Radio Training Schools (Radio Chicago); and W. J. Halligan (Mallcrafters)



Dr. William L. Everitt, IRE's new president

IRE Elects Everitt

Dr. William L. Everitt, recently appointed professor and head of the department of electrical engineering at the University of Illinois and at present Chief of the Operational Research Branch, Office of the Chief Signal Officer, U.S. Army, has been elected president of the Institute of Radio Engineers. He succeeds Professor Hubert M. Turner of the Department of Electrical Engineering of Yale University. At the same time Dr. Hendrick J. Van der Bijl, Johannesburg, South Africa, was elected vice-president. Three new three-year directors are Stuart L. Bailey (Jansky and Bailey, Washington); Keith Henney; and Dr. Benjamin E. Shackelford, engineer in charge of RCA's Frequency Bureau.

Dr. Everitt, who is on leave from University of Illinois to continue his war work, was born in Baltimore on April 14, 1900, received the degree of EE from Cornell in 1922, the MS degree from Michigan University in 1926 and the degree of Ph.D. from Ohio State University in 1933. He was instructor at Cornell from 1920 to 1922 and at University of Michigan from 1924 to 1926 when he went to Ohio State University to take charge of instruction in communications. His research work has been concerned largely with high power radio amplifiers, impedance matching circuits, radio altimeters and antennas. He is the author of "Fundamentals of Radio" and was responsible for the section on "Wire Telephony and Telegraphy" in the
(Continued on page 126)

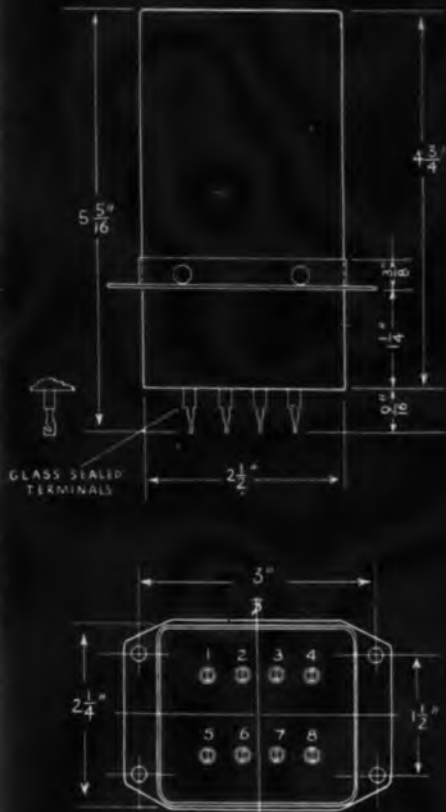

Another SOLA CONSTANT VOLTAGE TRANSFORMER that has an important future in *YOUR* postwar plans

There may be one vulnerable spot in the design of *your* equipment that this SOLA Constant Voltage Transformer will correct.

Your customers do not have the stable line voltage called for on your label. They will blame *your* equipment for inefficient operation, *not* the fluctuating voltages that really cause it.

Build this SOLA Constant Voltage Transformer into your product and you can be certain that the operating voltages will always be within $\pm 1\%$ of rated require-

ments regardless of line fluctuations as great as 30%.

This SOLA Constant Voltage Transformer is built to fit your equipment. (Note the small, compact dimensions.) Its low cost will fit your production budget. Its automatic operation will eliminate the need for other costly components, and relieve your customers of the responsibility of making manual voltage adjustments.

There's a powerful sales story behind a product equipped with a SOLA Constant Voltage Transformer.

Constant Voltage Transformers SOLA

To Manufacturers:

Built-in voltage control guarantees the voltage called for on your label. Consult our engineers on details of design specifications.

Ask for Bulletin 10CV-103

Transformers for Constant Voltage • Cold Cathode Lighting • Mercury Lamps • Series Lighting • Fluorescent Lighting • X-Ray Equipment • Luminescent Tube Signs • Oil Burner Ignition • Radio • Power • Controls • Signal Systems • Door Bells and Chimes • etc. SOLA ELECTRIC CO., 2525 Clybourn Ave., Chicago 14, Ill.

★ TELEVISION TODAY* ★

New Developments in the Video Field

Television For Raytheon

Raytheon Mfg. Co. is planning to enter the television field. News of the development came out at the recently finished FCC Allocations hearing at which Joseph Pierson, manager of the communications division of Raytheon and formerly president of Press Wireless, requested three groups of frequencies—1,900, 3,900 and 5,800 megacycles—which it is planned to use for a transcontinental micro-wave relay system. Raytheon will apply for television station licenses and also contemplates entering the FM broadcasting business. Frequencies requested would also be used to guide commercial and private airplanes, to expedite television relaying, to promote FM broadcasting and to offer relay channels for AM broadcasting. In addition the frequencies would be used for public telephone service and for facsimile and high speed telegraph service.

TBA Programs First Annual Conference

Television Broadcasters Association, which has attained to the stature of 31 members, has scheduled an ambitious program for its first Annual Conference, scheduled for Monday and Tuesday, December 11 and 12 at the Commodore in New York. A highlight of the gathering will be the presentation of Awards of Merit to those several who have contributed most to television progress in its various categories.

The plan is to keep the program as popular as possible and to this end technical discussions will be confined to the second day and will

be covered in a Round Table presided over by Dr. Alfred N. Goldsmith and participated in by such experts as O. B. Hanson (NBC), Dr. C. F. Jolliffe (RCA), F. J. Bingley (Philco), J. E. Keister (G-E), Harry Lubcke (Don Lee), Jack R. Poppele (WOR), who is Chairman of the conference, A. H. Brolly (Balaban & Katz) and Klaus Landsberg (Television Productions, Inc.).

Dr. W. R. G. Baker (G-E) will open the meetings with an address "New Horizons in Television." Others who will address the sessions are Dr. E. W. Engstrom (RCA), John F. Royal, vice-president in charge of television for NBC, Robert L. Gibson (G-E), Thomas H. Hutchinson (RKO Television Corp.), Harold S. Osborne (AT&T). Panel meetings will be conducted by:

C. A. Priest (G-E), Samuel H. Cuff (Du Mont), Thomas H. Hutchinson (RKO Television), William H. Weintraub, Clifford Denten, Paul Larsen (Society of Motion Picture Engineers), William Morris (Morris Agency).

More Tele Applications

Applications for commercial television stations continue to pour into FCC offices in Washington. Four applications were filed first week of November. The Yankee Network has applied for channel No. 9 in Hartford, Conn.; Filene's Television, Inc., of Boston, seeks channel No. 7; the Times-Herald of Washington, D. C., has applied for channel No. 8 and the Intermountain Broadcasting Co. of Salt Lake City, Utah, now wants channel No. 1 for a commercial station.

No Quick Decision On Spectrum Allocation

With the FCC Allocations hearing all done, though there remain many "resolving" intra-committee meetings to be held, it is judged likely that as predicted in "Electronic Industries" last month, both FM and television spots in the spectrum will undergo little change. At least RTPB has recommended little change and it is believed FCC will follow those recommendations pretty closely.

That any decision on the general spectrum allocation will be ready quickly is unlikely in view of the tremendous amount of work represented by the 5,000 pages of testimony and 528 exhibits that FCC must digest. However, it is expected that a preliminary report will be issued to IRAC soon after the first of this month.

There are considerable differences between the original allocation suggested by IRAC, which, for example, made no provision whatever for international short wave broadcasting, and the RTPB proposals. Beyond question there will be a compromise between the two. As most people know, IRAC has first call on frequencies for government use; FCC is concerned with non-government use of those parts of the spectrum not claimed by IRAC. Following are the RTPB recommendations as presented by C. B. Jolliffe, RCA Victor Division Chief Engineer and Chairman of Panel 2, though the region below 23.5 megacycles remains as "unfinished business."

(Continued on page 183)

For Higher Frequencies

With public hearings on spectrum allocation, initiated and wound up by FCC during October in Washington, interest settled on final action which may be forthcoming by the middle of the month. In the meantime, the pitched battle between television experts who string along with the RTPB recommendation to leave the video practically where it is, and those who advocate going upstairs well above 300 megacycles, goes merrily on.

Best regarded opinion of engineers opposed to the higher frequencies is contained in the testimony given by RCA's Dr. Engstrom, which is reported in considerable

(Continued on page 122)

* Title registered U. S. Patent Office.

Rectangular Flat Face Picture Tube



A cathode ray tube developed for CBS color television has flat viewing surface and screen same shape as image. Image is same size as conventional 7-in. round tube—5½ x 4¼ in. Magnifying lens is used.

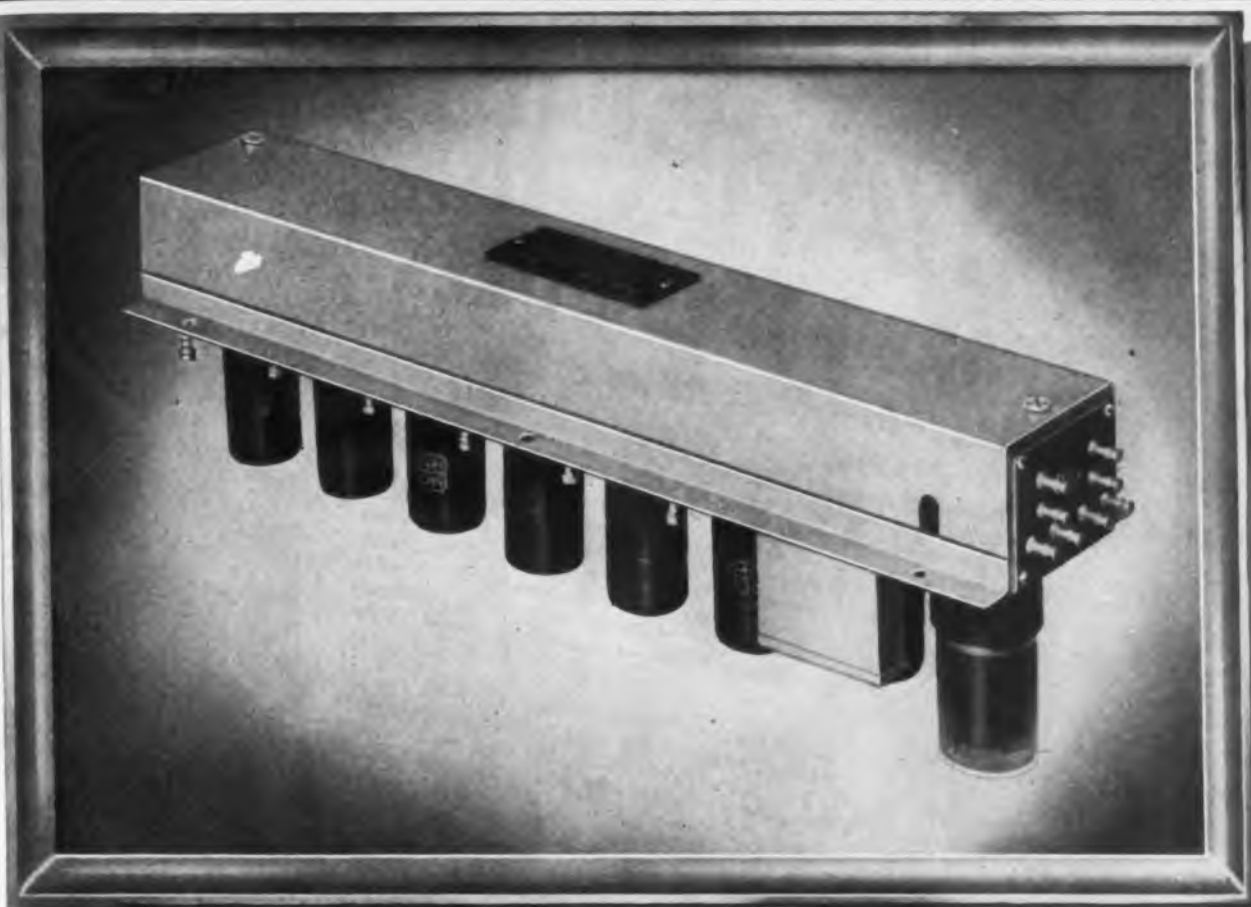

DOES THIS HARVEY "AMPLI-STRIP"
Fit Into Your Picture?

It does if you need thoroughly dependable I-F and AUDIO Amplification. The HARVEY "AMPLI-STRIP" was designed and developed to provide a compact, convenient and practical Audio and I-F Amplifier. Custom-made to meet *your* electrical characteristics. This tested and proved "AMPLI-STRIP" will meet your most exacting performance standards.

The "AMPLI-STRIP" provides an excel-

lent example of how the knowledge and experience gained by HARVEY through years of specialization in the radio-electronic field results in practical, efficient, reliable apparatus.

Why not let HARVEY of Cambridge help you to bring to a successful solution any of the present or projected radio-electronic problems that may be troubling you? Just get in touch with



HARVEY RADIO LABORATORIES, INC.
441 CONCORD AVENUE • CAMBRIDGE 38, MASS.



HARVEY
UHX-25

A 25-Watt
 General Purpose
 Radio Telephone
 Transmitter

Available for operation between 1.5 M.C. and 30 M.C.

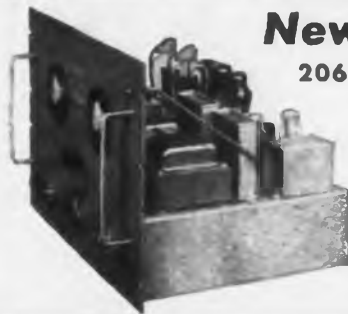

New HARVEY
206 PA REGULATED
POWER SUPPLY
 for Laboratory
 D. C. Source—
RANGE 500
to 1000 VOLTS

500 to 700 at 1/4 ampere
 700 to 1000 at .2 ampere

KARP

SPARE PARTS BOXES

Made-to-order at no extra cost

For the many years that sheet steel has been designated for spare parts boxes, Karp has been a major national supplier. Vast experiences, coupled with unusual production facilities, permit us to lay out and design boxes to *individual order* . . . at no extra cost. Each is built in accordance with U. S. Navy specifications. Tightly welded seams are vermin-proof. Special corrosion resisting paint is applied. Partitions, fittings, supports and trays are added as the case demands. Sizes range from 12" x 6" x 6" (and smaller where special existing conditions require) to boxes of sufficient length to house long motor shafts. *Rapid deliveries, too.*

Artisans in sheet metal, Karp craftsmen produce a varied line of products . . . from a chassis small enough to be handled by two fingers to a heavy rack which requires a crane to lift. We save you time, cost and manpower. A Karp engineer will gladly consult with you.



ARTISANS
IN
SHEET
METAL

KARP METAL PRODUCTS CO., INC.

126 30th STREET • BROOKLYN 32, N. Y.

CABINETS
CHASSIS
RACKS
PANELS

HELP SHORTEN THE WAR . . . BUY MORE WAR BONDS

HOW G-E CAPACITORS are being used on new jobs

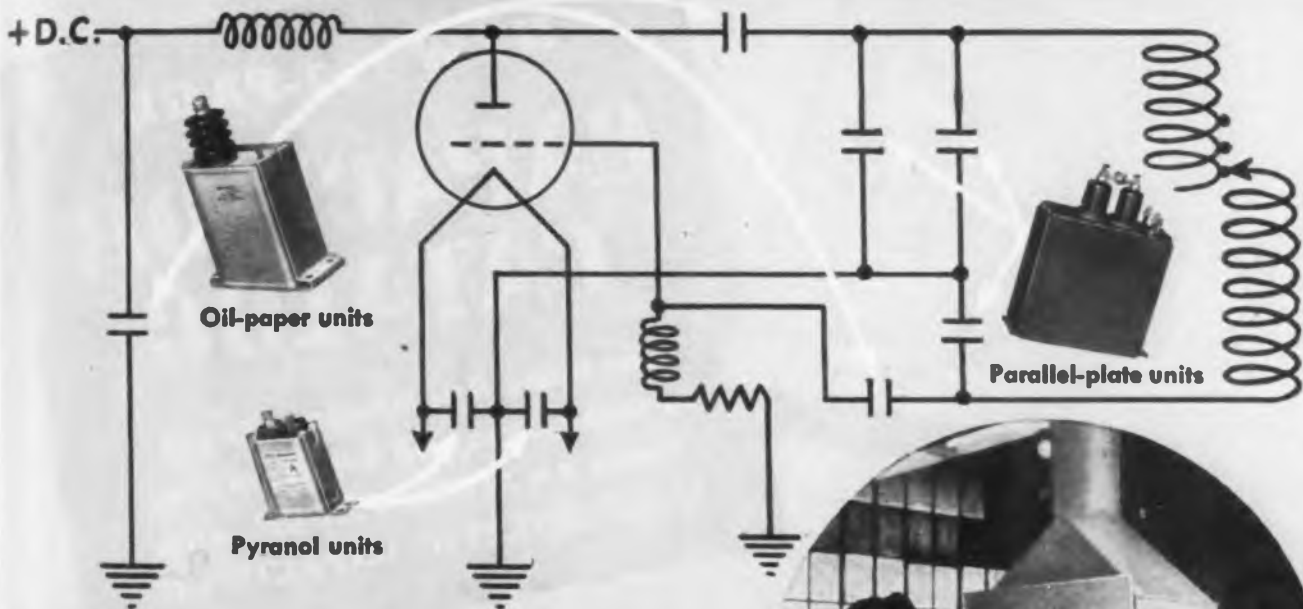

8 CAPACITORS NOW DO THE WORK OF 31 in this h-f oscillator circuit, and save space, weight, money

THE great number and wide diversity of capacitors required by today's electronic circuits make their selection an important factor in the design of the completed electronic device. Capacitors designed for the job can often appreciably reduce the over-all weight, size, and cost.

Take the simplified electronic heater circuit shown above: The original circuit called for 31 capacitors. By selecting G-E high-frequency capacitors designed for electronic-heater applications, this number was reduced to eight.

Four mica capacitors were replaced with three G-E oil-paper blocking capacitors. This change alone saved more than \$50.

In the resonant circuit, it originally took 25 mica units to do the job that three G-E high-frequency parallel-plate capacitors are now doing. These compact water-cooled units permitted an additional sav-



ing of more than \$200, as well as an appreciable reduction in the over-all dimensions of the electronic heater.

As a manufacturer of a wide variety of capacitors—including Pyranol*, oil-paper, high-frequency parallel-plate, and Lectro-



Electronic heater being used to solder on the covers of G-E capacitors. Four units are soldered simultaneously.

G-E capacitors designed for h-f oscillator circuits. Large unit: high-frequency, parallel-plate capacitor for the resonant circuit. The others: an oil-paper, high-frequency blocking capacitor, and (smallest) a Pyranol by-pass capacitor.

film units—G.E. is in a position to help you make savings like these in your electronic devices. Bulletins on our various lines are yours for the asking. See your nearest G-E representative, or write to General Electric Company, Schenectady 5, N. Y.

*Reg. U.S. Pat. Off.

Buy all the BONDS you can—and keep all you buy

GENERAL ELECTRIC

EV-85-5708

Here's an ESSENTIAL TOOL for Radio-Electronic Engineers, Designers, Equipment Builders, Manufacturers ...



**NEW 152-PAGE
CAPACITOR
CATALOG**

Contains Application Engineering Data and Separate Sections on MICA, PAPER, and ELECTROLYTIC CAPACITORS

● Why essential? That's a big statement. Let us qualify:

This new Aerovox Catalog contains that information which is essential to those who design and build radio-electronic equipment. Here is general and specific engineering data on capacitors and their applications; detailed specifications on various types; listings of recommended types and ratings; special notes covering special features and special types; color codes; etc.

For greater convenience, the catalog is divided into four sections, each with its tab-indexed cover. These sections comprise Mica Capacitors, Application Engineering Data, Paper Capacitors, Electrolytic Capacitors. The plastic binding permits pages to lie absolutely flat.

In preparation for a year and a half—involving widespread gathering of data and intensive compilation—this combination manual-catalog represents an outstanding contribution to the working library of the radio-electronic engineer and executive. It was prepared BY engineers FOR engineers; contains absolutely no advertising—just information on capacitance and capacitors. And because of cost, its circulation is strictly limited to engineers and executives.

● Write for Your Copy ...

If you are engaged in designing or building radio-electronic equipment of recognized standing, write on your business letterhead for your registered copy. Also submit your capacitor problems and requirements for our collaboration.



Capacitors

INDIVIDUALLY TESTED

AEROVOX CORPORATION, NEW BEDFORD, MASS., U. S. A.

SALES OFFICES IN ALL PRINCIPAL CITIES

Export: 13 E. 40 St. New York 16, N. Y. • Cable: 'ARLAB' • In Canada: AEROVOX CANADA LTD., HAMILTON, ONT.

Casting the International Meter Rods in Paris 1874. The degree of accuracy attained 1/10,000,000 of a quadrant of a terrestrial meridian.



WHO SETS THE

Quality Standard

FOR TRANSMITTING TUBES



371-B



BW-II



KU-23



813



905



949-A



CV-II



967



972-A

UNITED



**TRANSMITTING
TUBES**



In every art or craft, the work of some acknowledged master sets the standard.

Since 1934 UNITED has won recognition by specializing exclusively in the engineering, design and building of transmitting tubes which are unchallenged for excellence. UNITED tubes excel in every electronic application . . . including radio communication, physiotherapy, industrial control and electronic heating. In these and other applications, tubes by UNITED continue to win top honors for uniformly dependable performance.

In communication equipment for airlines, commercial broadcasting, police radio stations and other vital civilian services, UNITED transmitting tubes set the standard. Accept nothing less than UNITED quality tubes for your requirements.

Order direct or from your electronic parts jobber.

UNITED ELECTRONICS COMPANY

NEWARK, 2

New Jersey

Transmitting Tubes **EXCLUSIVELY** Since 1934

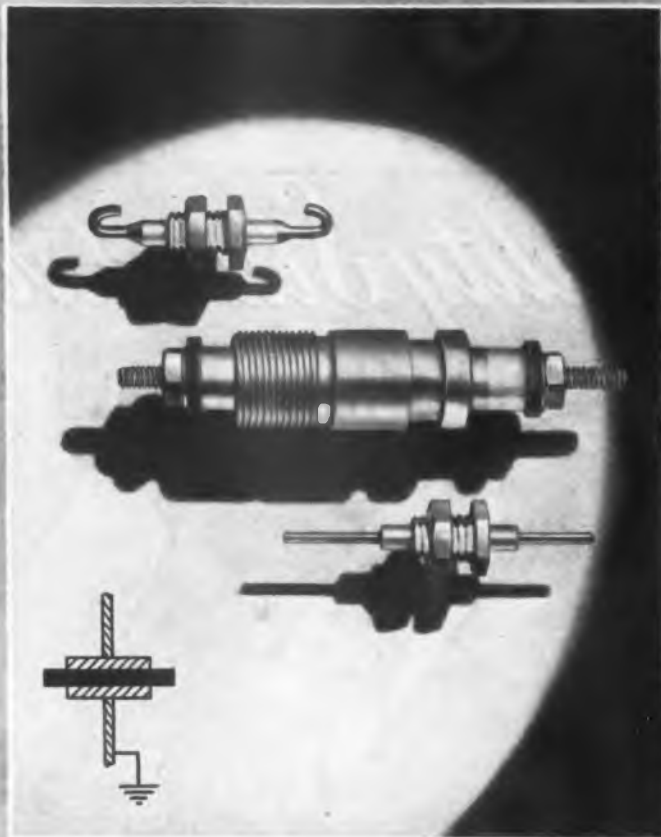

ERIE Feed-Thru CERAMICONS

REG. U. S. PAT. OFF.

For By-passing R. F. Currents to Ground

Erie Feed-Thru Ceramicons are sturdy, compact ceramic condensers of a rigid mounting type that perform the function of bypassing high frequency currents to ground through the shortest possible path. As shown in the illustration, lead inductance is practically eliminated, since the lead inductance is in series with the transmission line rather than in the path to ground.

Small sizes are made in capacities from 5 MMF through 75 MMF, and can be furnished with either straight or hooked wire leads, as shown in the photograph above. The

larger size, Erie Part No. SP-110 represents a special design for high voltage applications, and is available in capacities from 20 MMF through 250 MMF.

The Erie Resistor Engineering Department is working on several other developments for high voltage, high altitude, and pressurized feed-thru applications.

ERIE PART No.	MIN. CAP. MMF	MAX. CAP. MMF	WORKING VOLTAGE D. C.		OVERALL LENGTH
			SEA LEVEL	50,000 FT.	
357-000 (Hooked wire)	5	75	1,000	375	1-1/16"
SP-114 (Straight wire)	5	75	1,000	375	1-1/4"
SP-110	20	250	2,000	750	2-3/8"



Electronics Division

ERIE RESISTOR CORP., ERIE, PA.

LONDON, ENGLAND • • TORONTO, CANADA

NOW AVAILABLE

NEW CATALOG, DESCRIBING THE COMPLETE LINE OF

Electro-Voice

COMMUNICATIONS MICROPHONES



Electro-Voice Differential Microphone, Lip-Type Model 245 for applications where background noise elimination, free use of hands and high articulation are required.



Electro-Voice Differential Carbon Microphone, Hand-Held Model 205-S, an ideal microphone for aircraft, industrial, railroad, police and emergency services.



Electro-Voice Carbon Microphone, Model 210-S, a single button microphone which embodies all of the latest developments required for military use

Electro-Voice Dynamic Microphone, Hand-Held Model 600-D, designed for high fidelity speech pick-up in those locations where the ambient noise does not exceed 100 db.

ELECTRO-VOICE CORPORATION
1239 South Bend Ave., South Bend 24, Ind., Dept. _____
Please send us your new "Electro-Voice Communications Microphones Catalog."
NAME OF COMPANY _____
ADDRESS _____
CITY _____ STATE _____
ATTENTION OF _____

Electro-Voice MICROPHONES

ELECTRO-VOICE CORPORATION • 1239 SOUTH BEND AVENUE • SOUTH BEND 24, INDIANA
RADIO DIVISION, 22 EAST 40TH STREET, NEW YORK 18, N. Y., U. S. A. Cubiaci Arlok



SHEET METAL FABRICATION



"Cole Steel Equipment" specializes in tough sheet metal assignments as well as boxes, chassis, and instrument housings. Whether your blueprints call for extreme precision or gauge limits, we're geared to design, fabricate and finish exactly to specifications. Whatever your problem, let us help you.

COLE STEEL OFFICE EQUIPMENT

will again be available
after the war

COLE

STEEL EQUIPMENT COMPANY

349 Broadway, New York 13, New York • Factory: Brooklyn, New York

HIGHER FREQUENCIES

(Continued from page 114)

length on page 112 in this issue. On the other side of the fence T. A. M. Craven, ex-FCC Commissioner and now vice-president of Cowles Broadcasting Co., and Paul Kesten, CBS vice-president, strongly urged going above 400 mc and both have let it be known that they are readying transmitters to give such service.

In support of proponents who see great advantages in the higher frequencies, Dr. Kenneth A. Norton, propagation expert and scientist, offered as his opinion, based on data which heretofore was classified "restricted" but has since been released, that television should surely go above 400 megacycles. "The expected range for a transmitting antenna at 1,000 ft. would be a maximum in the band between 500 and 1,500 mc," he said, and added: "No experience which I have had within the past few years would lead me to change that prediction."

Video on 'Phone Wires

Although transmission of television signals requires a band many times wider than telephone engineers have found it possible to transmit on the usual wires, it may still be possible to utilize such facilities. Packard Mfg. Co., Indian-



The manufacturer who has an involved precision switching problem can depend on the speed, precision and dependability of Mu-Switch.

Mu-Switch gives you continuous operation without mechanical fatigue.

With the varied types of actuators and special housings industry will find a thousand uses for Mu-Switches in electrically controlled equipment.

Send for
FREE MU-HANDBOOK

• The ORIGINAL LEAP BEYOND PRECISION SWITCH •

MU-SWITCH CORP
CANTON, MASS.

ELECTRONIC INDUSTRIES • December, 1944

When you reveal
your post-war line

BE SURE IT'S
POWERED BY

RAY-O-VAC



»RAY-O-VAC

• • • If your V-Day products will require dry batteries, be sure to include Ray-O-Vac in your plans. The know-how that has solved so many portable power problems for the armed forces can be of great value to you. Ray-O-Vac engineers are at your service. Write Dept. I-A.

RAY-O-VAC COMPANY, MADISON, WISCONSIN
OTHER FACTORIES AT CLINTON, MASS., LANCASTER, O., SIOUX CITY, IA., FOND DU LAC, WIS., MILWAUKEE, WIS.

ELECTRONIC RESEARCH FOR INDUSTRY

FOR A SINGLE PROJECT OR A COMPLETE SERVICE . . . THE NATIONAL UNION LABORATORIES ARE AVAILABLE TO YOU



The *idea* that electronics may work to advantage in your peacetime products or processes—is only the start. Making it *work* by developing efficient, up-to-the-minute applications is where this task really begins.

Here, highly specialized experience and proved resourcefulness of National Union can save you time and money. How extensive or

limited your electronic research requirements may be is no problem. National Union has the top-flight scientists, the costly laboratory equipment and high-priority materials to take all or any part of the assignment.

May we discuss electronic research with you? Without obligation, of course. Please address Department A.

NATIONAL UNION RESEARCH LABORATORIES
National Union Radio Corporation Newark 2, New Jersey



The advertisement features several black and white photographs of different transformer models. In the top left, a transformer with two large, tiered bushings is shown. To its right are two smaller, box-like transformers with multiple terminals on top. Below the main title, there are three more transformers: one with several bushings on the left, one with many small terminals in the center, and one with a few larger bushings on the right. The background is a light, textured surface.

TRANSFORMERS *of Special Design*



A few of the many high quality transformers manufactured to critical specification. Rigid control of material and process—PLUS conservatism in design insure a dependable long-life product. We solicit your inquiries. Sizes to 5 KVA.

The Langevin Company

INCORPORATED

SOUND REINFORCEMENT AND REPRODUCTION ENGINEERING

NEW YORK

37 W. 63 St., 23

SAN FRANCISCO

1050 Howard St., 3

LOS ANGELES

1000 N. Seward St., 3B

Give Your Products Modern

WEBSTER ELECTRIC SOUND REPRODUCTION

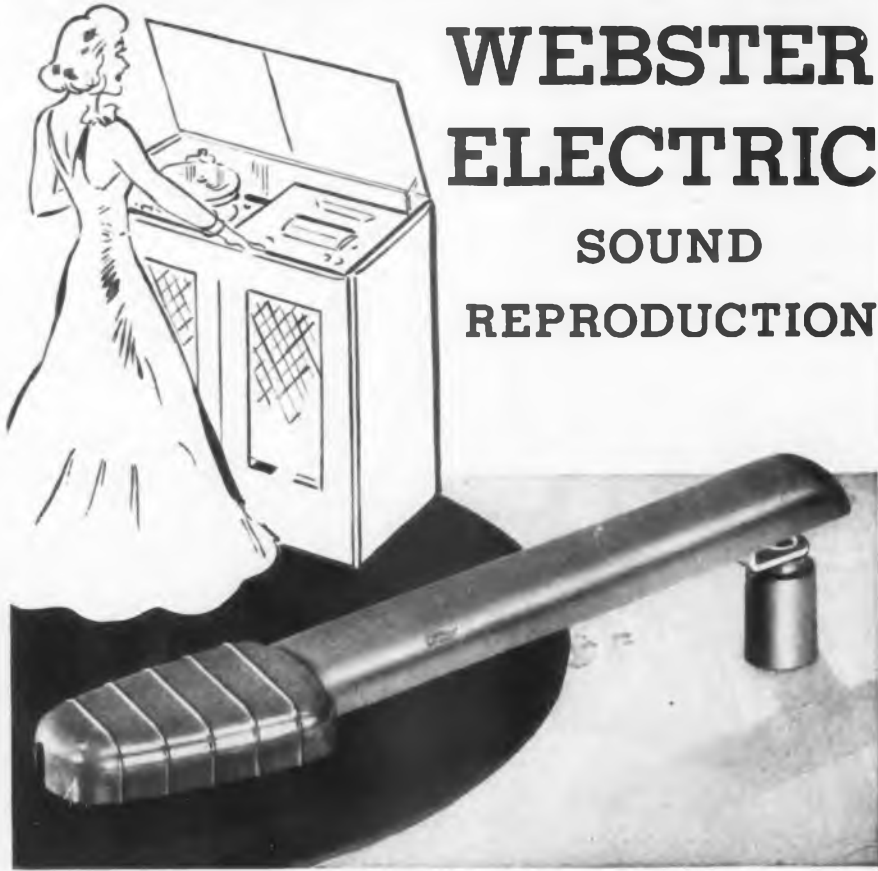

Silk purses don't come from sow's ears, we have been often told. It is equally true that clear, high quality tone reproduction only comes from use of the best in crystal pickups . . . and that means Webster Electric.

Remarkable tone range of Webster Electric Pickups is the result of a background of engineering experience in the design of modern sound equipment for faultless tone reproduction. Webster Electric Pickups have the *precise balance* to give exactly the right needle pressure . . . *light weight* to prolong record life . . . styling to harmonize with modern cabinets.

Tomorrow's radio-phonograph sets will be gauged more critically than ever by the clarity and wealth of detail with which they reproduce . . . the extraneous noises which they screen out. With Webster Electric Pickups every nuance and tone color is reproduced . . . details in the record track are brought out . . . overtones and harmonics are picked up that are lost with old style equipment.

Now is the time to be making sure that your products will contain the results of the very latest developments in sound reproducing equipment. That means the use of Webster Electric Pickups. Write Webster Electric today. Let us give you full information.



(Licensed under patents of the Brush Development Company)

WEBSTER ELECTRIC COMPANY, Racine, Wisconsin, U. S. A.
Established 1909. Export Dept.: 13 E. 40th St., New York 16, N. Y.
Cable Address: "ARLAB" New York City

WEBSTER ELECTRIC

"Where Quality is a Responsibility and Fair Dealing an Obligation"

LET'S ALL BACK THE ATTACK — BUY MORE WAR BONDS!

apolis, last month demonstrated transmission of images over a 12 mile loop of ordinary communication circuit, from the laboratory to a downtown radio station, and claims to have sent signals over 50 miles of wire strung within the laboratory. The idea is the work of Raymond Binney, formerly of the Video-Graph Corp., Detroit, and is built around a vacuum tube coupling circuit as yet unpatented and therefore kept under wraps. Also demonstrated was a method of recording simple black and white television signals on wax disks like phonograph records. Engineers are confident of their ability to so improve the process that fine detail, and half tones can be recorded.

ELECT EVERITT

(Continued from page 112)

Standard Handbook for Electrical Engineers. He has been employed by the North Electric Mfg. Co. on automatic telephone development and by AT&T's department of development and research on automatic telephones and inductive coordination. He initiated and directed the annual Broadcast Engineering Conference at Ohio State University, which was a focal point for the discussion of engineering problems in the broadcast field. Dr. Everitt is a fellow of the AIEE and of the IRE.

PLASTIC NAME PLATES

SCALES, GAUGES,
CALCULATORS,
CHARTS,
DIALS,
ETC.

- Impervious to moisture, grease, oils, acids, alkalis.
 - Printing guaranteed not to wash or rub off.
 - Non-inflammable, non-corrosive plastic.
 - Printed and laminated vinylite and cellulose acetate.
- SAMPLES AND ESTIMATES GLADLY SUPPLIED ON REQUEST
WRITE DEPARTMENT E. 1.

THE HOPP PRESS, INC.

460 W. 34th STREET, N. Y. C.

ESTABLISHED 1893

Here's The Precision Factor in Radio Frequency Control

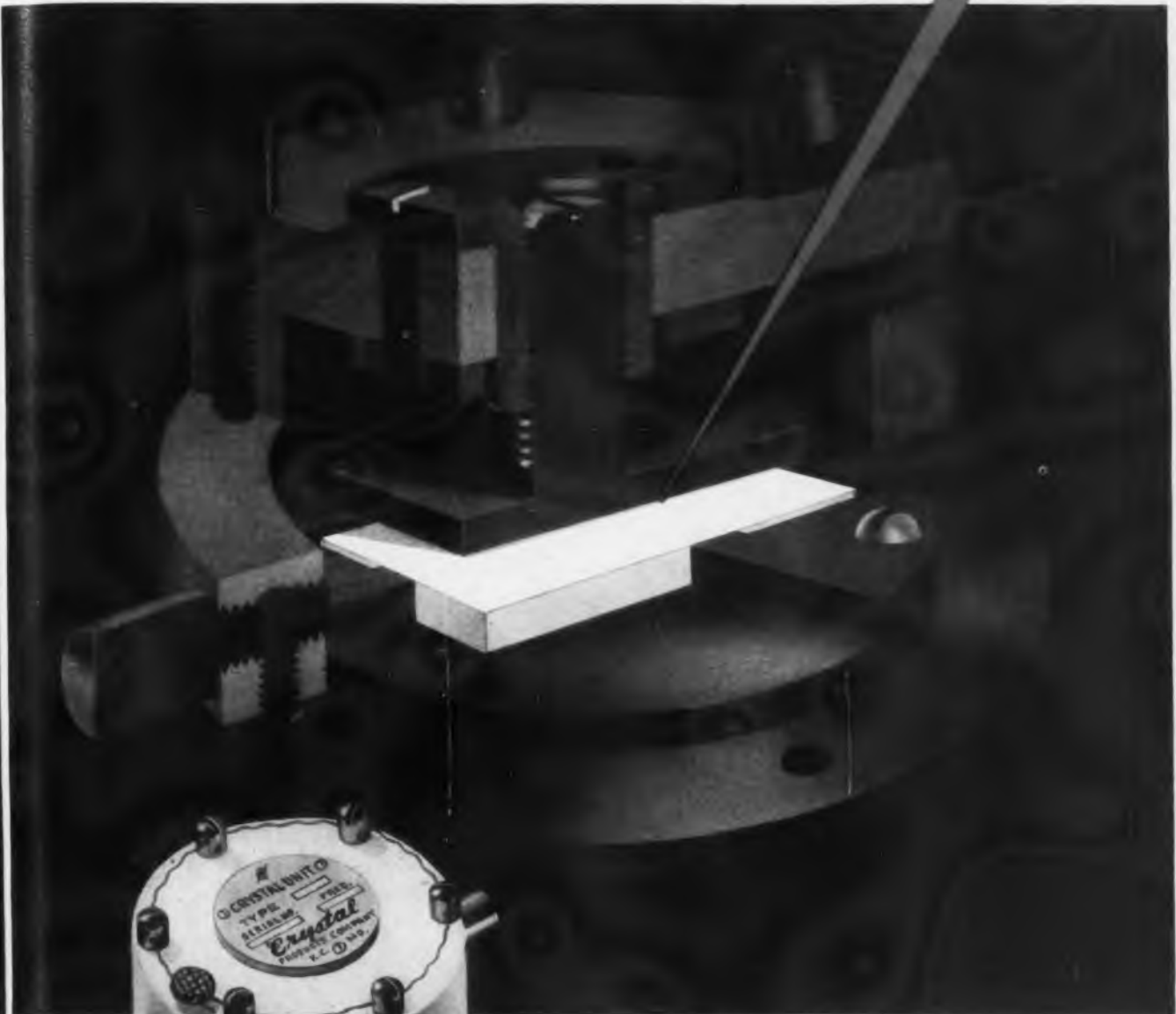

Crystal

PRODUCTS COMPANY

1519 McGee Street, Kansas City, Mo.

Producers of Approved Precision Crystals for Radio Frequency Control

For the inside facts about precise radio frequency control, look *inside* the holder!

Crystal Holder Units are made in many types, but each depends upon the quartz-crystal blank for its accuracy in final performance.

This is why more and more electronic engineers specify quartz oscillator plates made by Crystal Products Company. Here they get crystals made under the most exacting methods of control. Here, too, they find valuable cooperation in engineering the crystal and its holder for any specific circuits.

Our products and our services are available to you. Use them—and be sure of satisfaction.

The Answer
**TO YOUR
 PROCUREMENT PROBLEMS
 MAY LIE
 BETWEEN THESE COVERS!**

**WE OFFER
 FAST DELIVERY
 ON OVER
 10,000
 ITEMS**

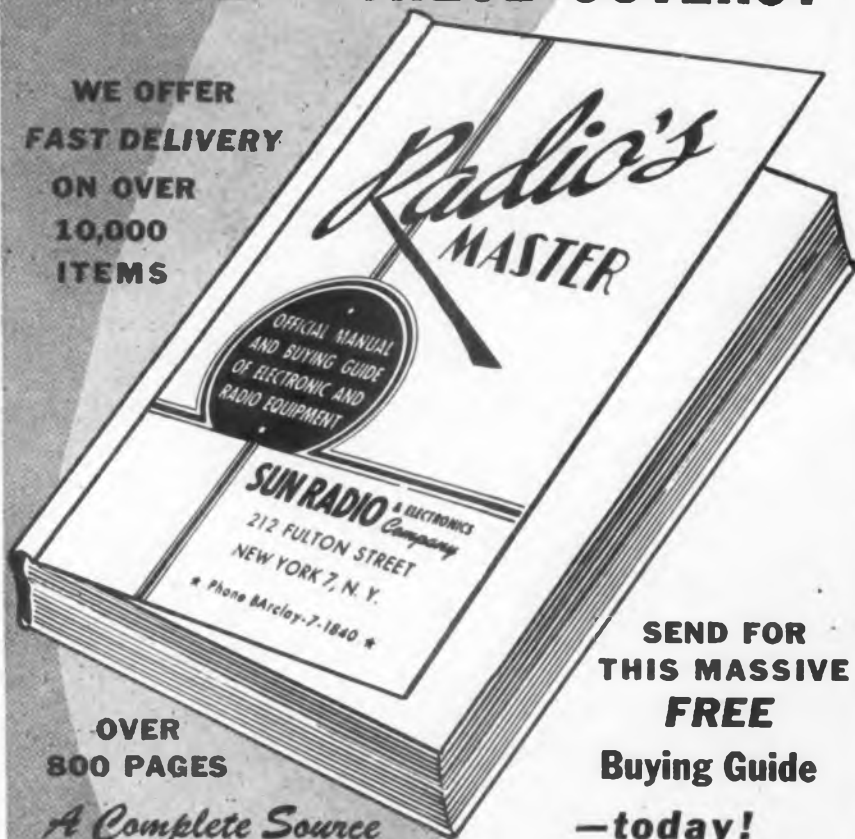

**OVER
 800 PAGES**

*A Complete Source
 for*

**RADIO PARTS
 RADIO TUBES
 and INDUSTRIAL
 ELECTRONIC EQUIPMENT**

For INSTANT SERVICE—Telephone BRclay 7-1840

**SUN RADIO
 & ELECTRONICS CO.**

212 Fulton Street, New York 7, N. Y.

**SEND FOR
 THIS MASSIVE
 FREE
 Buying Guide
 —today!**



Available without charge to authorized purchasing agents, engineers and expeditors, who write to us on Company stationery, stating their title.

Address Box ER

**DISTRIBUTOR
 CONFERENCE**

(Continued from page 112)

and the National Electronic Distributors Association. The latter elected new officers, making Wm. O. Schoning (Lukko Sales Co.) their president; A. D. Davis, vice-president; Aaron Lippman, secretary-treasurer. Former president George Barbey was appointed temporary executive secretary to function until a permanent incumbent can be chosen.

Creutz told the gathering, presided over by General Conference Chairman Herbert Clough (Belden Mfg. Co.) that scheduled deliveries of radio and radar equipment to the armed forces are still on the increase, and for the last quarter of this year require a 16 per cent increase over deliveries in any past quarter. Thus, he cited, the equipment manufacturers are working under the greatest load they have ever had.

Even though after V-E Day, most of the restrictions imposed by WPB will be removed, he cautioned hearers "not to expect an immediate large supply of all types of components." There will be, however, sufficient raw material for civilian production, but he pointed out that removal of limitations on the use of raw materials, especially for replacement components, will have

CORWICO

WIRES

MADE BY
*Engineers FOR
 Engineers*

VICTORY
 concentrating upon
 for the duration

cornish
 WIRE COMPANY, inc.
 15 Park Row, New York City, New York

CORWICO

MACHINERY and MANPOWER

... Yours on Contract—

"like adding a wing
to your plant"

Looking for new-unit production without crippling your own manufacturing facilities? Hesitant about calling outside help? Consider these facts:

Foote, Pierson is a 48 year old organization engaged in contract manufacture during a large part of its business life.

Foote, Pierson puts at your disposal a modern machine shop well equipped and laid out to accommodate quick change-overs.

At its machines—its drills, lathes, millers, presses—are loyal groups of workers with a surprisingly high proportion of skilled men and women.

In charge of this personnel is a group of trained technicians. Their varied work at Foote, Pierson insures resourcefulness and ingenuity . . . applied specialized knowledge to the fresh challenges of new problems . . . starts with planning . . . supervises the manufacture of product or component, whichever you need . . . controls operations in plating and finishing, assembly, inspection and checking, packing, warehousing and storage. The company's Newark plant is favorably located for rail, water and air freight.

Talk over your product ideas now with Foote, Pierson. Learn how this specialized manufacturing organization is qualified to make parts or articles for you and to deliver them to you or to your markets.

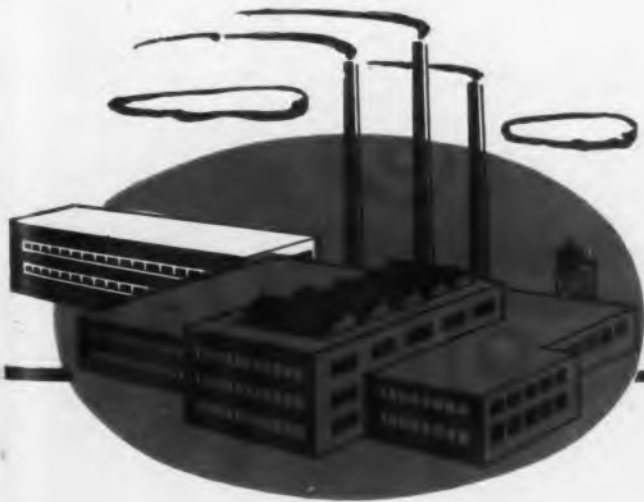

FOOTE · PIERSON & CO · INC

75 Hudson Street



Newark, 4, N. J.

Foote, Pierson helped pioneer instruments used in municipal fire and police alarm systems, stock tickers, X-ray apparatus, many components of telegraph equipment, instruments and aircraft radio communication apparatus.



**a new tool
speed**

**QUICK LOCAL SERVICE
ON INDUSTRIAL
ELECTRONIC TUBES**

Looking ahead to continued development of electronic equipment in industry, postwar, we now have a plan to make Westinghouse Electronic Tubes quickly and easily available. Stocks of the most widely used tubes are now available through Westinghouse Electronic Tube Distributors and Westinghouse District Warehouses. As rapidly as possible additional types will be added to local stocks to make a complete line of Quality Controlled Westinghouse Electronic Tubes available to everyone.

of incredible and versatility . . .

The electronic tube may easily prove to be one of your most useful tools when you are confronted with reconversion headaches. Electronic tubes have proved that they save money in innumerable operations by increased speed and accuracy.

Take welding for example. For years resistance welding was limited to steel fabrication, permitting a considerable tolerance for electrode marking, discoloration and warping. Today—with the introduction of Westinghouse Electronic Tubes in welding and timing circuits—spot, seam, butt and projection welding is accomplished accurately, efficiently and quickly. This modern welding technique can be applied to stainless steel, aluminum and a wide variety of alloys in varying sheet thicknesses.

But—the use of electronic tubes is not confined to welding. In countless other applications such as heat treating, speed control, current regulations, conversion and measuring, they help do a better job.

For electronic devices you now have in service, or for new equipment you are planning, *always* specify and insist on Westinghouse Electronic Tubes—the tubes of assured uniformity and dependable performance.

Westinghouse

PLANTS IN 25 CITIES OFFICES EVERYWHERE

Quality Controlled Electronic Tubes



WESTINGHOUSE PRESENTS: John Charles Thomas—Sunday 2:30 EWT—NBC. • Ted Malone—Monday, Wednesday, Friday—10:15 EWT—Blue Network.

We're Looking
"WAY AHEAD"

Yes, we're not only looking ahead to a great expansion in transformer needs, but we're accumulating advanced ideas from our war work which will be built into transformers, for many purposes, when commercial requirements return . . . Keep "Stancor" in mind—for improved design technique and exclusive technical developments in transformers.

STANDARD TRANSFORMER
CORPORATION

1500 N. HALSTED STREET · CHICAGO 22, ILLINOIS



little effect in radio and radar production.

Stressing that it is difficult to predict the exact situations that will arise, and how the ingenuity of the industry will solve the problems, he declared that there should be ample facilities for the assembly of equipment, including broadcast receivers. But, he warned, "it does not seem likely there will be enough of all types of components so that unlimited new set production will be possible."

Others who addressed the many meetings included Commander W. C. Eddy who heads up Radio Chicago, the Navy's great training establishment. He told briefly of the method by which a college course is compressed into about 10 months of study; Brigadier General J. V. Matejka, Chief of Personnel and Training Service, office of the Chief Signal Officer, told a little something about the communications equipment used by the Army.

NEMA Honors Leaders

Five of the nation's electrical manufacturing leaders were honored by award of the "NEMA Certificate of Recognition" at the annual meeting of the National Electrical Manufacturers Association in New York, late in October. Honored were J. B. Wantz, Chicago, vice-president of General Electric X-Ray Corp.; Arnold H. Friend, Chicago, treasurer of the M. B. Austin Co.; Godfrey H. Atkin, Chicago, special representative of the Electric Storage Battery Co.; W. I. Patterson, president of the Steel City Electric Co., Pittsburgh, and E. H. Hammond, vice-president and general sales manager of the Kennecott Wire and Cable Co., Phillipsdale, R. I.

Discuss Multivibrators

Controlled and uncontrolled multivibrators was the subject discussed at the last meeting of The Radio Club of America, Inc., held Nov. 9, in Havemeyer Hall, Columbia University. The paper was being presented by Eugene R. Shank, Research Engineer of the RCA Laboratories. In the course of the paper an equation relating the natural frequency of the multivibrator to the characteristics of the tubes and circuit components was developed on the basis of simple capacitor-resistor time constants. Information about the natural frequency stability was given, and the wave form of the synchronizing voltage considered. Equations and curves which relate the variations permissible in the time constants of the circuit to the order of division of the stage, were shown. The synchronizing of the multivibrators was considered in some detail.

Sherron
Electronics

TELEVISION

Studio and Transmitting Equipment

As a source of supply for television equipment manufacturers, we are prepared to design, develop and manufacture—to their specifications—the full range of units shown on these pages.

Notable for its quality-protecting dependability, Sherron equipment is serving many of America's most vital manufacturers in the fields of electronics and radionics.

We are an intensively specialized organization, expertly staffed in all departments—laboratory through manufacturing. All our equipment is custom built exclusively for manufacturers. Our laboratory and engineering staff are at your disposal for consultation.

- LABORATORY
- DESIGN
- DEVELOPMENT
- MANUFACTURING

SHERRON ELECTRONICS CO.

Subsidiary of Sherron Metals Corp.

1201 FLUSHING AVENUE

BROOKLYN 4, N. Y.

WHERE THE IFRAL IS THE STANDARD, SHERRON UNITS ARE STANDARD EQUIPMENT

DO YOU MAKE:

RADIO, SOUND AND COMMUNICATIONS EQUIPMENT?

Loud Speakers	Sound-powered	Vibration Pick-ups
Headsets	Telephones	Polarized Relays
Microphones	Telephone Ringers	Generators
Hearing Aids	Voltage Regulators	Meters
Electrical Musical Instruments	Phonograph Cutting Heads	Magnetron Fields
	Phonograph Pick-ups	

AUTOMOTIVE AND AVIATION EQUIPMENT?

Magnetos	Voltage Regulators	Generators
Tachometers	Motors	Magnetic Oil
Compasses	Speedometers	Filters

INSTRUMENTS?

Ammeters	Oscillographs	Light Meters
Voltmeters	Flux Meters	Cardiograph
Galvanometers	Watt-hour Meters	Recorders
Seismographs	Flow Meters	Vibration Pick-ups

MISCELLANEOUS PRODUCTS?

Magnetic Separators	Arc Blow-out Magnets	Clocks
Magnetic Chucks	Temperature and Pressure	Toys and Novelties
Magnetic Conveyors	Control Equipment	Coin Separators
Magnetic Clutches	Circuit Breakers	for Vending
Magnetic Damping	Limit Switches	Equipment
Devices	Holding Magnets	

IF YOU make any of the above products, it will pay you to find out how *better permanent magnets* can improve efficiency and reduce costs. Put your design, development or production problems up to The Arnold Engineering Company. Arnold engineers have been of great assistance to many manufacturers and are at your service to advise exactly what Alnico

permanent magnet will solve your particular problem.



THE ARNOLD ENGINEERING COMPANY

147 EAST ONTARIO STREET CHICAGO 11, ILLINOIS

Specialists in the manufacture of ALNICO PERMANENT MAGNETS



NEW! Get your copy of this valuable, up-to-the-minute manual on the design, production and application of modern Alnico permanent magnets. Write us, on your company letterhead, today.

Aaron Heads "Representatives"

At a meeting of "The Representatives" held at Chicago, Oct. 20, during the Electronic Parts and Equipment Conference, Irvin I. Aaron, 4028 North 16th St., Milwaukee 9, Wis., was elected president. He succeeds S. K. Macdonald of Philadelphia, who now becomes chairman of the Reps' board of governors. A new committee of the Reps has been assigned to industry relations, with Robert Breuer, 1674 Broadway, New York City, as chairman. Other members of the committee will represent principal geographical areas of the country. This Industry Relations committee will meet with the other important divisions of the radio industry.

Rochester Meeting Draws 650

The Rochester Fall Meeting, held in that New York City's Sheraton hotel during November 13 and 14, was the usual unqualified success. Nearly 650 engineers attended and listened to a long program of technical papers and there were the usual social gatherings sponsored by American Lava Corp., and Stackpole Carbon Co. to relieve any tedium that may have existed. In all there were 14 technical papers given before fully crowded sessions. The papers, to be reviewed in a later issue, included:

- The Reactance Theorem for a Resonator, by W. R. McLean, Polytechnic Institute of Brooklyn.
- Resonant Cavity Method for Measuring Dielectric Properties at High Frequencies, by C. N. Works, T. W. Dakin and F. G. Boggs, Westinghouse Electric & Mfg. Co.
- RCA Laboratories at Princeton, by Dr. E. W. Engstrom, RCA.
- Low Frequency Compensation of Multi-Stage Video Amplifiers, by M. J. Larson, Stromberg-Carlson Co.
- Trends in Receiving Tube Design and Application, by L. R. Martin, RCA.
- Standardization of Capacitors for Civilian Equipment, by J. I. Cornell, Solar Mfg. Co.
- Unpublicized Facts About Frequency Modulation, by Sarkes Tarzian, Bloomington, Ind.
- One Look Backwards—and Two Ahead, by K. W. Jarvis.
- Report of RMA Director of Engineering, by Dr. W. R. G. Baker, General Electric Co.
- Organization of Research in the Radio Industry After the War, by Dr. Rupert Maclairin, Massachusetts Institute of Technology.
- Electronic Tube Trends, by Roger M. Wise,sylvania Electric Products Co.
- Silicone Products of Interest in the Radio Industry, by Shailer L. Bass and T. A. Kauppi, Dow-Corning Co.
- Pulse Time Modulation, by E. Labin, Federal Telephone and Telegraph Laboratories.
- Designing Thoriated Tungsten Cathodes, by H. J. Dailey, Westinghouse Electric and Mfg. Co.

Packagers Organize

To further the application of good engineering practices in the industrial packaging field, Industrial Packaging Engineers Association has been formed with headquarters in the Tribune Tower, Chicago. R. F. Weber (International Harvester Co.), was elected president, other officers being: Vice-president M. H. Allen (Chrysler (Dodge Div.) Corp.); Treasurer D. H. Irwin (Sangamo Electric Co.); Executive secretary Irving J. Stoller.

**A
TELECHRON
PRE-SELECTOR
FOR
POST-WAR
RADIOS**



THE Telechron Pre-Selector shown here is an important development for post-war radios. It's low in cost—recommended for use with moderate-price receivers.

Buyers will like this easy-to-use Pre-Selector, with finger-tip control. Each of the 48 keys around the Telechron clock dial represents a 15-minute timing interval. Pulling out a key

automatically turns the receiver on, at the pre-selected station, for 15 minutes—and off at the end of the period, unless the next key is pulled out also. Keys are automatically reset to OFF position after timing periods are passed.

A flick of the finger sets the keys around the large and legible clock face. There are no knobs to turn, no complicated settings, no difficult calculating. Settings can be made as much as 10 hours in advance.

This Telechron Pre-Selector is only one of a full line of automatic timing and control devices which we can supply for post-war home appliances. All use the famous self-starting, synchronous Telechron motors and movements. For full information about Telechron timers, wire or write Automatic Control Division, Dept. N.



Telechron
REG. U. S. PAT. OFF.

WARREN TELECHRON COMPANY • ASHLAND, MASSACHUSETTS

... speaking of exhaustion

all the air in
1,500,000
TUBES

exhausted to 1/2 micron

would not fill

1
TUBE

to atmospheric pressure



KINNEY

Compound Vacuum Pumps
maintain low absolute pressures
of 1/2 MICRON or better

In the making of lamps, tubes and other electronic products, KINNEY Compound Dry Vacuum Pumps regularly maintain low pressures of 0.5 micron. On acceptance tests, prior to shipment, they must pump down to 0.2 micron!

The reliability of KINNEY Pumps in producing such extremely low pressures year after year makes them the choice of leading tube manufacturers.

Ask for Bulletin 18.

We also manufacture Single Stage Vacuum Pumps, Vacuum Tight Valves, Liquid Pumps, Clutches and Bituminous Distributors.



KINNEY MANUFACTURING CO.

NEW YORK CHICAGO PHILADELPHIA LOS ANGELES SAN FRANCISCO

Write to 3595 Washington St., Boston 30, Mass.

Streamer Heads NEMA

A. C. Streamer, vice-president of Westinghouse Electric & Mfg. Co., Pittsburgh, was elected president of the National Electrical Manufacturers Association at its annual meeting at the Waldorf-Astoria late in October. He succeeds Leonard Kebler, chairman of the board of the Ward Leonard Electric Co., Mt. Vernon, N. Y. Vice-presidents selected were C. W. Higbee, manager of the wire and cable department, U. S.



A. C. Streamer, new president of NEMA

Contact
Specialists
for the
Right Connector

Terminals - Lugs :-
Solder - Compression
- Solderless Types.

Standard Government
Electrical Parts.

ATLAS PRODUCTS
CORPORATION

30 ROCKEFELLER PLAZA
NEW YORK, U. S. A.



Exact Contour Hardening



in $\frac{2}{3}$ of a SECOND
with **-MEGATHERM-**

ELECTRONIC HEAT



Here's another difficult hardening job, done simply and quickly with Megatherm.

Exact contour hardening of the inner gear of these supercharger clutch discs was done in less than $\frac{2}{3}$ of a second each.

These gears were hardened to a depth of .050", with the hardening closely following the tooth and root contour of the gear surface, without affecting the strength or ductility of the remaining metal. The unretouched photograph above tells the story.

To do this contour hardening a jig was built to support the disc so that its inner surface sur-

rounded a two-turn induction coil, directly connected to the output terminals of the 25 kw Megatherm.

The Megatherm automatic timer limits the heat period to exactly $\frac{2}{3}$ of a second, then operates a solenoid which trips the disc into an oil-quench bath.

Here is another example of Megatherm's adaptability to many hardening problems involving irregular and "hard-to-get-at" surfaces.

If you have a surface hardening problem . . . whether for wartime or peacetime application . . . consult Federal's Megatherm engineers for the answer or write for complete data.



Federal Telephone and Radio Corporation

REG. AND PAT. TRADE MARK

INDUSTRIAL ELECTRONICS DIVISION



Newark 1, N. J.

A GIRL... A "BREAD BOARD" ...AND A CHALLENGE

Breadboards are nothing new to housewives...or to radio. But to teach one about the other has been one of the minor problems created by the war.

Ample proof that the housewives have learned their lesson well is to be found in the volume production of radio assemblies at Pacific Division.

To these girls also must go credit for the important part they play in maintaining the excellence of workmanship which has always been associated with Pacific Division products.

And so Pacific Division continues to offer this friendly challenge—in manufacture and assembly, as well as in engineering, there is no finer product than the one Pacific Division produces.

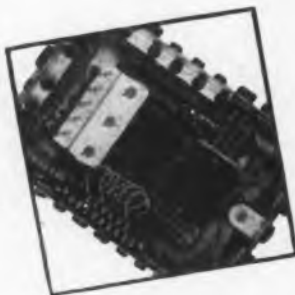

Rubber Co., New York; E. A. Williford, general sales manager of the carbon products division, National Carbon Co., New York; R. L. White, president of Landers, Frary, and Clark, New Britain, Conn.; R. W. Turnbull, president of Edison General Electric Appliance Co., Inc., Chicago, and W. C. Johnson, vice-president of the Allis-Chalmers Mfg. Co., Milwaukee. Elected treasurer for NEMA was R. S. Edwards, president of Edwards & Co., Inc., Norwalk, Conn.

NEMA Electronics Section Re-elects Its Chairman

National Electrical Manufacturers' International Electronics Exposition, proposed for the latter part of 1945, came up a step nearer with appointment of a permanent Exposition Operating Committee during the NEMA annual convention late in October. During the convention the Electronics Section of NEMA re-elected both its chairman, H. J. Hoffman (Machlett Laboratories, Inc.) and its vice-chairman, D. Y. Smith (RCA Victor Div. of Radio Corp. of America.)

A plan to develop joint RMA-NEMA standards for electronic tubes has been initiated through the appointment of a two-man policy committee and a four-man joint tube engineering committee with equal representation from both associations. Dr. W. R. G. Baker, vice-president of General Electric Co., will act for RMA and A. C. Streamer, vice-president of Westinghouse Elec. & Mfg. Co., will serve as the representative for NEMA. The Joint Tube Engineering Committee will consist of: D. D. Knowles—Westinghouse Elec. & Mfg. Co., A. Senauke—Amperex Electronic Corp. (representing NEMA), Wallace James—RCA Victor Div. of Radio Corp. of America, A. W. Pike—General Electric Co. (acting for RMA).

The function of the four-man joint committee will be to develop first, standards on type designation, and second, mechanical standards. This will be done through the operation of seven subcommittees, the chairmen of which will be appointed by the four-man committee, the first on pool type tubes, the second on thyratrons, the third on gas rectifiers, the fourth on miscellaneous electronic devices including phototubes, the fifth on cathode ray tubes, the sixth on large high vacuum tubes, and the seventh on small high vacuum tubes.

The preparation and publication of industry diagram charts showing the uses of electronic devices in various industries will be initiated in the near future by the Electronics Section in collaboration with the two leading trade magazines serving the electronics field.



LEAR AVIA, INC. RELY ON MICRO SWITCHES FOR INSTANT, PRECISE CONTROL OF ELECTRO-MECHANICAL ACTUATORS

Micro Switches are responsible for the accurate operation which has made Lear Actuators ideal components for use in military aircraft.

Lear Avia, Inc., Piqua, Ohio, who build these light, powerful electro-mechanical devices, find Micro Switches provide the precise, instant control required yet keep within the required limits of small space and light weight.

This small Lear Actuator shown here weighs but 3.3 pounds. Yet it is capable of moving 1200 pounds. Rotary type Lear Actuators are capable of operating torques from 400 inch-pounds to 6500 inch-pounds.

Lear Actuators must operate instantaneously. Micro Switches, used in pairs, cause the unit to start or stop at the exact point of predetermined setting in the control box. The

first Micro Switch limits the actuator travel in one direction, the second Micro Switch serves as the limit to travel in the other direction. Lear Actuators may be controlled by manual switches, thermostats, pressure switches, etc. Micro Switches were selected by Lear Avia, Inc. because a sensitive and precise limit switch was required to provide the accuracy of control necessary. The quick make-break action of Micro Switches was also found to assure long operation life on severe direct current loads. No unit failure due to faulty Micro Switches has ever been recorded.

Designers and production engineers who are letting pre-conceived ideas go by the boards . . . seeking a new way . . . will do well to investigate Micro Switch. This tiny, snap-action electric switch can be counted on for any application where a small, precise, sensitive switch is required that will respond accurately to actuating motion through millions of repeat operations.

Micro Switches provide over 2700 variations . . . combinations of housings, actuators and electrical characteristics. For complete information, send for Handbook-Catalog No. 60. If your application is for aircraft use, also send for Handbook-Catalog No. 70.

The basic Micro Switch is a thumb-size, feather-light, plastic enclosed, precision, snap-action switch, Underwriters' listed and rated at 1200 V.A., at 125 to 460 volts a-c. Capacity on d-c depends on load characteristics. Accurate repeat performance is experienced over millions of operations. Wide variety of basic switches and actuators meets requirements varying from high vibration resistance to sensitivity of operating force and motion as low as 2/1000 ounce-inches. Many types of metal housings are available.



"Uses Unlimited"—a dramatic talking motion picture of Micro Switches, in color, is available to industrial groups, training classes, schools and colleges, through Y.M.C.A. Motion Picture Bureau, New York, Chicago, San Francisco. Size: 16 mm. Length: 40 minutes. Write us for details.

© 1944



LET'S ALL
BACK THE
ATTACK—
BUY EXTRA
WAR BONDS

MICRO MARK MS SWITCH

A DIVISION OF FIRST INDUSTRIAL CORPORATION

FREEPORT, ILL., U.S.A., Sales Offices in New York, Chicago, Cleveland, Los Angeles, Boston, Dallas, Portland, (Ore)

**PEACE
TIME ...**



(Freight conductor, talking from caboose):—
"Charlie, we drop four cars from the rear at
Pikeville, and pick up three from the Saw
Hill siding to hook on in front."
(Engineer, replying):—"O. K., Joe. We'll
take on water; we're ahead of the card."

In the railroading of tomorrow, express freight trains will be one of the many public services that will depend on coordination and speed which in turn will depend on perfect communications — which will depend on perfect crystals.

Valpey Crystals, unseen, unobtrusive, will be the vital servants of this type of communication. Precision-ground by crystal craftsmen, they can be depended upon for perfect service whether in the arctic or the tropics.

**WAR
TIME ...**



In planning your peacetime products, be sure to consult Valpey. Our laboratory and our engineers are ready to help you with any problem of design or performance.

Write for information on "CRYSTIONICS."



CM-1
A design for normal
frequency control
applications.



NEW XLS
Special new low fre-
quency unit... vital
in the newer fields
of electronics.



CBC-0
Where utmost in
stability requires
constant tempera-
ture control in com-
mercial installations.

VALPEY
Crystal Corp.
CRAFTSMANSHIP IN CRYSTALS SINCE 1931
MOLLISTON, MASSACHUSETTS

NEW PATENTS ISSUED

Transducer-Frequency Modulator

The diaphragm 12 drives the magnet core 6 as well as electrode 7 of capacitor 5 to provide simultaneous variations of the inductance 4 and the capacitance 5 in the tuned plate circuit of oscillator tube 1. Variable capacitor 8 may be inserted to adjust the plate circuit of the tuned-plate tuned-grid oscillator to the resonance frequency of the grid circuit.

In the other embodiment shown, a conical diaphragm 22 in response to sound waves received thereon. The reactance of a magnetic circuit, including a U shaped core 23 and the windings 24, is varied by the magnetic diaphragm 22 as well as the capacitive reactance between magnetic diaphragm 22 and a capacitor electrode 25.

Preferably, the variations of inductive and capacitive reactance are of approximately the same magnitude. The simultaneous variation of both the inductive and capacitive reactance in response to the modulating sound waves provides a highly ef-

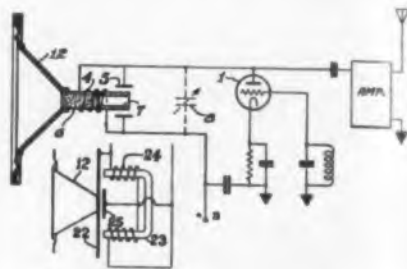

TEST INSULATION THE MODERN WAY



... WITH A
MODEL B-5

MEGOHMER NEW BATTERY-VIBRATOR TYPE

No more tiresome cranking of a hand-driven generator. Entirely self-contained. Steady test potential of 500 volts D.C. available at the touch of a switch. Direct reading in insulation resistance. Various new models and ranges.

Write or phone for Bulletin 430

HERMAN M.

Sticht

COMPANY, INC.

27 PARK PLACE

NEW YORK, N. Y.

When Victory is Won

Our Plant

Will Be Ready

The great capacity of the Jefferson Electric plant, made good use of in producing vast quantities of transformers required for military uses,— will be ready to serve you promptly when Victory is won.

Having full control of the manufacture of all parts in our own plant,—and the ability to give you laboratory accuracy and precision in mass production, assure you uniform, high-quality Transformers to meet still better your post-war needs.

The latch string will be out; awaiting your visit. JEFFERSON ELECTRIC COMPANY, Bellwood (Suburb of Chicago), Illinois. *In Canada:* Canadian Jefferson Electric Co., 384 Pape Avenue, Toronto, Ontario.



T R A N S F O R M E R S





Hermetically Sealed TRANSFORMERS of Proven Design . . . *In Full Production — Short Delivery*

We are in full production on Hermetically Sealed Transformers and ready to accept orders for short delivery.

CHICAGO TRANSFORMER



DIVISION OF ESSEX WIRE CORPORATION

3501 WEST ADDISON STREET

CHICAGO, ILL.



NEW PATENTS

efficient method of frequency modulation of the oscillator circuit. Conventional receivers may be used for the reception of these waves.

D. M. Kaltenbacher, RCA, (F) Mar. 29, 1942, (I) July 11, 1944, No. 2,353,162

Correcting Spherical Aberration of Electron Lenses

Electrons leaving a predetermined point O on the object travel at different angles θ' , θ'' with respect to the electron beam axis C , and therefore required different time intervals to reach the electron refracting field of the objective lens L . Further, electrons which enter the lens field at a distance from the lens axis are deflected more strongly than in proportion to this distance. Consequently the intersections of two electron paths e', e'' with the lens axis occur at different points O' and O'' ; and each zone of a conventional electron lens has a different effective focal length, causing spherical aberration. Both effects being in a first approximation proportional to the square of the angle θ between the electron path and the lens axis, the difference in travel time may be made use of to provide correction for the spherical aberration of the electron lens.

According to the invention, the object is irradiated either by a discontinuous electron stream,—i.e., electrons will leave the object for certain time intervals while there will be no electrons during other time intervals,—or by a continuous beam the velocity of which is varied; in both instances, the electrons pass through the lens field

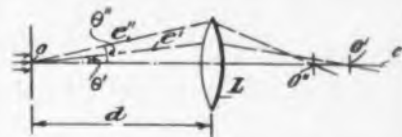

JONES BARRIER STRIPS

SOLVE MOST TERMINAL
PROBLEMS



No. 151

A compact, sturdy terminal strip with Bakelite Barriers that provide maximum metal to metal spacing and prevent direct shorts from frayed wires at terminals.

6 SIZES

cover every requirement. From $3/8$ " wide and $13/32$ " high with 5-40 screws to $2 1/2$ " wide and $1 1/8$ " high with $1/4$ "-28 screws.

Jones Barrier Strips will improve as well as simplify your electrical intra-connecting problems. Write today for catalog and prices.

HOWARD B. JONES COMPANY
2460 WEST GEORGE STREET
CHICAGO, ILL. 18

Franklin's 39

RADIO SOCKET

The favorite yesterday, the favorite for tomorrow

THE MANY MILLIONS INSTALLED IN 1941 IS

Positive Testimony to its
POSTWAR VALUE

The story of Franklin's series 39 Radio Socket, with patented "U" shaped bow spring action contacts, is most remarkable ... developed and patented early in 1938 it received immediate acceptance and approval by practically all the radio set manufacturers and became standard equipment with most.

Series 39 sockets should be riveted to the chassis to become a permanent part of the set ... no replacement will be necessary as the socket will outlive the set.

Series 39 sockets were the favorite yesterday and will be the favorite tomorrow for standard broadcast receivers.

For the details of the 39, Diheptal, Miniature, Lock-in, Battery and Sockets for other applications, moulded or ceramic, and a complete line of Radio Components... write for the New Franklin Catalog with which is included a complete Buyers Guide for the Electronic Industries.



This series 39 socket has a 39G Contact with a soldering tab which eliminates wiring to ground.

Bow spring action maintains resiliency even after installation of oversize pins

Direction of metal grain prevents breaking of soldering tail and permits rough handling in production



"U" shaped contact provides separate soldering tail which prevents solder from flowing into contact body



The 39G contact has a soldering tab to eliminate wiring to ground ... can be inserted in any position where grounding is desired.

A.W. FRANKLIN MANUFACTURING CORP.

SOCKETS • TERMINAL STRIPS • PLUGS • SWITCHES • PLASTIC FABRICATION • METAL STAMPINGS • ASSEMBLIES

175 VARICK ST., NEW YORK 14, N. Y.

Annealing costs reduced 50% with electronic heating



G-E electronic tubes supply the high-frequency power for this industrial heating application.



Electronic heating makes it possible to localize heat where you want it . . . both the heated area and the depth of the heat-affected zone can be controlled within close limits.

One large manufacturing company uses the feature of localized heating with a G-E electronic heater to anneal the 1/8-inch tip of small thumbscrews while the rest of the screw remains hardened to the far end of the thread. By

conventional heating methods, it was difficult to confine the heat to the tip. Costs were high. Now, with a single electronic heater, 100,000 thumbscrews are annealed per day—at one-half former cost and with exceptional uniformity of product.

Two G-E electronic tubes—the GL-851 power-oscillator triode and the FG-104 rectifier—supply the high-frequency waves for this heating application.

Electronic heating is divided into two broad classes. Induction heating can be used in the treatment of metals to harden, anneal, braze, and solder. Dielectric heating can be used for heating non-conductive materials such as plastics.

Electronic heating eliminates waste heat, cuts heating time-lag, minimizes scale, improves working conditions. It does many heat-treating jobs faster, better, and in most cases at lower cost.

To designers, manufacturers, and users of electronic-heating equipment, General Electric offers a complete line of electronic tubes for all applications. Through its nation-wide distributing system, General Electric is prepared to supply users of electronic devices with replacement tubes.

For information on electronic tubes for all applications, write *Electronics Department, General Electric, Schenectady 5, New York.*

Tune in General Electric's "The World Today" and hear the news from the men who see it happen, every evening except Sunday at 6:45 E.W.T. over CBS network. On Sunday evening listen to the G-E "All Girl Orchestra" at 10 E.W.T. over NBC.

G. E. HAS MADE MORE BASIC ELECTRONIC-TUBE DEVELOPMENTS THAN ANY OTHER MANUFACTURER

GENERAL  ELECTRIC

18E-CIS-886C

We've Done Away With Silver Soldering

P. R. MALLORY & CO. Inc.
MALLORY

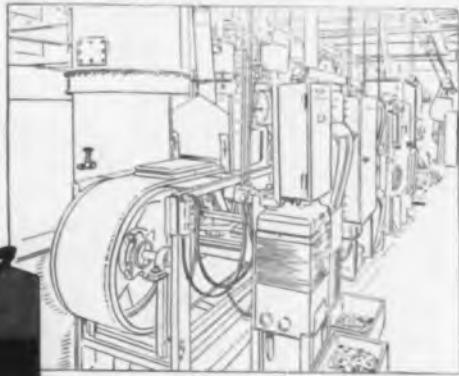

This giant electrical furnace, carefully regulated, permanently bonds the silver contact face directly to the base metal backing.

STANDARDIZED CONTACTS



TYPE SUF



TYPE SUR



TYPE SVF



TYPE SVR

You're assured of quick delivery, high efficiency and long life when you specify Mallory standardized, silver-faced, steel-backed contacts. Brazing is eliminated by a patented Mallory process and by the ingenious equipment pictured above. The silver face is bonded directly to the steel back, insuring completely even wear and at least 20% longer service than when the faces are attached with silver solder.

By eliminating the silver solder, high currents can be carried without overheating the contact. Safe operating temperatures are constant, and con-

tact drop and heat development are greatly reduced.

Mallory's specialized fabricating process produces silver-faced contacts of a hardness equivalent to cold headed rivets. To prevent any danger of corrosion, steel backs are *nickel-plated*. Standard sizes of Mallory silver-faced contacts can be furnished attached to arms, studs, brackets, or ready for your own assembly operations. Literature giving detailed dimensions and specifications is available upon request.



There's a Job for All to Do: Buy War Bonds!

P. R. MALLORY & CO., Inc., INDIANAPOLIS 6, INDIANA

*Elkonite is a registered trademark of P. R. Mallory & Co., Inc., for electric contacting elements.

P. R. MALLORY & CO. Inc.
MALLORY

MANUFACTURES CONTACTS OF TUNGSTEN, MOLYBDENUM, SILVER, PLATINUM, ELKONITE* AND SPECIAL ALLOYS FOR INDIVIDUAL REQUIREMENTS. SPECIAL DESIGNS TO SUIT YOUR APPLICATIONS



ELECTRICAL CONTACTS AND CONTACT ASSEMBLIES
 NON FERROUS ALLOYS AND POWDERED METAL PARTS



Conforming to Army-Navy requirements for critical field conditions

Transformers, condensers, relays, vibrators and various component parts can now be protected against heat and tropical humidity, salt spray, sand infiltration, fumes, fungus attack and other varied conditions that cause sensitive equipment to fail under critical conditions.

In the laboratories beyond Sperti, Inc., techniques have been discovered which permit volume production of improved Hermetic Seals at low cost, safeguarded by unique inspection methods.

Principal features of the improved Sperti Hermetic Seal are:

1. Small, occupies little space, one piece, no other hardware needed, simple and easy to attach. (Soldering temperature not critical.)
2. Vacuum tight hermetic bond, hydrogen pressure tested for leaks.
3. Resistant to corrosion.
4. High flash-over voltage. Does not carbonize.
5. Insulation resistance, 30,000 megohms. minimum, after Navy immersion test.
6. Thermal operating range—70° C. to 200° C. Will withstand sudden temperature changes as great as 140° C.

Wire or phone for information, today. Give as complete details as possible so that samples and recommendations may be sent promptly.



RESEARCH, DEVELOPMENT, MANUFACTURING, CINCINNATI, OHIO

NEW PATENTS

only during periodically recurring time intervals, passing through the lens center at the beginning of each interval and through the edges of the lens at the termination of each interval. Simultaneously, the strength of the objective lens field is varied in synchronism with the modulation of the beam, and to such an extent that the focal lengths of all zones are equal at the instants the electrons pass through the respective zone. It will be seen from the drawing that to obtain equal focal length for all zones, the electron stream and the strength of the electron lens must be varied so that the field is stronger for electrons reaching it in a path e' closer to the lens axis and weaker for electrons in a path e'' which arrive in the field slightly later at greater angles with the lens axis, i.e., the electrons must pass the lens during a decrease in field strength.

By this expedient, a lens of constant focal length throughout all zones is presented to electrons entering the lens field at all angles with respect to the lens axis from a given object point. The strength of the electron lens field may be varied by a suitable saw-tooth voltage or by a sinusoidal voltage.

V. Zworykin, J. Hillier, and E. G. Ramberg, RCA, (F) April 20, 1942, (I) July 25, 1944, No. 2,354,287.

Television System

The carrier frequency is shifted during transmission of the frame synchronizing signal. For this purpose, the transmitter includes two alternately operating oscillators generating two carrier waves of slightly different frequency. One oscillator operates during transmission of frame synchronizing signals, while the other oscillator operates the rest of the time. This alternate operation is obtained by suitably biasing the oscillator tubes, the bias being derived from the frame synchronizing sig-

EXPERIENCED ELECTRICAL ENGINEERS

• Graduate or non-graduate Electrical Engineers with at least three years of recent radio circuit or laboratory experience are needed for the development and design of pocket size radio and audio frequency equipment. The company is well established in the electronics field and offers the right man a salary dependent on his experience and also the opportunity to grow in a relatively new field. The company is located in the suburbs of a large New England city.

BOX A-40

ELECTRONIC INDUSTRIES

480 Lexington Avenue
New York 17, New York

making mountains
out of molehills



Dependability is a lot of little things that add up—it's the end result of paying due homage to all the molehills of production so that the finished product will give a mountain of service. Like paying strict attention to seemingly unimportant details of workmanship. Like emphasizing the work of skilled technicians who are experts in their special field of building finer capacitors.

That's the way we've been making capacitors since 1910. Many of our men and women have been working on C-D capacitors for nearly 34 years. Others have been with us for five—ten—twenty years of loyal, devoted service.

Dependability is a C-D tradition. Every C-D capacitor has built into it the dependability . . . the skill, experience and research . . . that belong only to the leader, Cornell-Dubilier Electric Corporation, South Plainfield, New Jersey.

TYPE YAT—A compact, low capacity Dykanol "G" bypass capacitor—hermetically sealed in specially-treated drawn metal container. Range at 600V.—.05 mfd. to 1 mfd. at 100V.—.05 mfd. to .5 mfd.



CORNELL-DUBILIER
CAPACITORS 1910  1944

MICA • DYKANOL • PAPER • WET AND DRY ELECTROLYTICS

ALSO AT NEW BEDFORD, BROOKLINE, WORCESTER, MASS.; PROVIDENCE, R. I.

LOOK TO CANNON 'DP' CONNECTORS IN 1945

HERE ARE A FEW OF
THE 'DP' CONNECTORS
AVAILABLE NOW—
AND MANY NEW
DESIGNS ARE COMING

NEW applications of the exclusive Cannon Electric "DP" series of connectors have recently been extended from rack equipment in radio assembly to such uses as special centralized aircraft control on through to signal relay equipment.

Several new "DP" connectors of strikingly new design will be released in 1945—testimony to the progressive engineering Cannon Electric incorporates into its products. Since Cannon Electric pioneered the aircraft electrical connector in 1932, this development process has gone steadily onward. Cannon is prepared to meet the demands of postwar electrical equipment.

Cannon Type DP Connectors cover a variety of rack, panel and bail-type fittings, carrying from eight to 135 circuits with amperage range from 10, 15, 30 and 40 in many varied arrangements, including coaxial contacts.

All these and many other high quality electrical connectors are Cannon designed and manufactured.

For detailed engineering data on Type DP Connectors refer to the Cannon DP Bulletin. Write to Department A-122, Cannon Electric Development Company, 3209 Humboldt Street, Los Angeles 31, California.



CANNON ELECTRIC

Cannon Electric Development Co., Los Angeles 31, Calif.

Canadian Factory and Engineering Office:
Cannon Electric Company, Limited, Toronto



REPRESENTATIVES IN PRINCIPAL CITIES—CONSULT YOUR LOCAL TELEPHONE BOOK

NEW PATENTS

nal generator by means of a tube circuit.
H. de France, Alien Property Custodian,
(F) February 4, 1942, (I) August 22, 1944,
No. 2,356,568.

Selective Receiver

The selective receiver may be used for radio telephony or telegraphy. A substantially rectangular pass band is provided, the width of which may be continuously varied from zero up to 10,000 cycles and more; the variation may be made at an audible rate.

It will be seen from the diagram, that two infinite rejection circuits determine the highest intermediate frequency passed before mixing with the output of the second conversion oscillator. The lower frequency limit is then established by the two following infinite rejection circuits. By changing the frequency of the wave generated by the

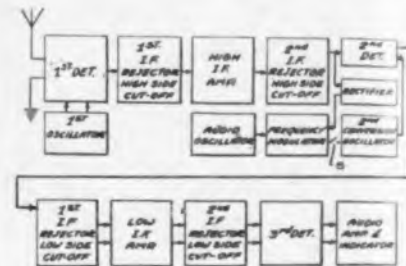

second conversion oscillator the width of the frequency band passed may be varied; actually the low-frequency cut-off is moved away or toward the high-frequency cut-off.

For the reception of continuous wave signals, the frequency of the second conversion oscillator is varied at audio rate; the audio frequency will be the tone frequency of the output. By varying the frequency to such an extent that signal is passed and not passed at alternate time intervals, amplitude modulation at an audio frequency rate is achieved.

D. A. Griffin, Communication Measurements Laboratory, (F) March 11, 1941, (I) August 1, 1944, No. 2,854,749.

Telegraph System

A certain degree of secrecy is provided by the use of circular polarized waves. Polarized waves having one direction of rotation correspond to either mark or space signals, and polarized waves having the other direction of rotation correspond to the other signal. The polarized waves are each produced by two push-pull amplifiers each connected to a dipole antenna; the two dipole antennas are at right angles to one another. To change the direction of rotation, one antenna is fed a 180-degree phase-shifted wave by replacing the connected push-pull amplifier by another one. The switching means are described in detail. At the receiver, two dipole antennas arranged at right angles feed two separate amplifier channels, one including a 90-degree phase-shifting network, so that eventually the outputs add up for one direction of rotation and cancel out for the other direction of rotation. H. Salinger, Farnsworth Television and Radio Corp., (F) Oct. 25, 1941, (I) June 6, 1944, No. 2,350,331.

Discriminator Circuit

The frequency of the local oscillator is controlled that a constant intermediate frequency is generated in duo-diode B and applied to the following amplifier. For this purpose a voltage varying with the frequency of the received wave—i.e., a detected audio voltage—is produced in the phase bridge across resistors R₁, R₂; this voltage controls the local oscillator and simultaneously, provides the input to the audio amplifier.

The standard oscillator generates a constant frequency wave, the phase of which is

An Important Statement

BY MYCALEX CORPORATION OF AMERICA

Issued in an Effort to Clear Up and to
Avoid Continued Confusion in the Trade

It has come to our attention that in some quarters electronic engineers and purchasing executives are under the erroneous impression that the MYCALEX CORPORATION OF AMERICA is connected or affiliated with others manufacturing glass-bonded mica insulation, and that genuine "MYCALEX" and products bearing similar names are all "the same thing" . . . are "put out by the same people" . . . and "come from the same plant."

These are the FACTS:

- 1** The MYCALEX CORPORATION OF AMERICA is not connected or affiliated with any other firm or corporation manufacturing glass-bonded mica insulating materials. It is 100% American in ownership and operation.
- 2** The word "MYCALEX" is a registered trade-mark owned by the MYCALEX CORPORATION OF AMERICA, and identifies glass-bonded mica insulating materials manufactured by MYCALEX CORPORATION OF AMERICA.
- 3** The General Electric Company, by virtue of a non-exclusive license it had under a MYCALEX patent through the MYCALEX (PARENT) COMPANY, LTD., has been permitted use of the trade-mark "MYCALEX" on its glass-bonded mica insulating materials.
- 4** The MYCALEX CORPORATION OF AMERICA has behind it over 20 years of research leadership, dating back to work done by the original MYCALEX (PARENT) COMPANY, LTD., of Great Britain, from which it obtained its American patents.
- 5** MYCALEX CORPORATION OF AMERICA owns U. S. patents and patent applications on improved glass-bonded mica insulation marketed under the trade-mark "MYCALEX."
- 5** The products of MYCALEX CORPORATION OF AMERICA are: (a) "MYCALEX 400"—the most highly perfected form of MYCALEX, approved by the Army and Navy as Grade L-4 insulation. MYCALEX 400 is sold in sheets, rods and fabricated form. (b) "MYCALEX K"—an advanced capacitor dielectric with a dielectric constant of 10 to 15, which can be fabricated to specifications. (c) MOLDED MYCALEX available to specifications in irregular shapes and into which metal inserts may be incorporated
- 6** "MYCALEX" in the forms described above is made by exclusive formulae and exclusive patented processes. It is utterly impossible for any one other than the MYCALEX CORPORATION OF AMERICA to offer any product, similar in appearance, as "the very same thing."



MYCALEX CORPORATION OF AMERICA

"Owners of 'MYCALEX' Patents"

Plant & General Offices: CLIFTON, N. J. Executive Offices: 30 ROCKEFELLER PLAZA
NEW YORK 20, N. Y.

MOTOR DATA

No. 126



2300 FRAME MOTOR

1/5 HP at 3800 RPM

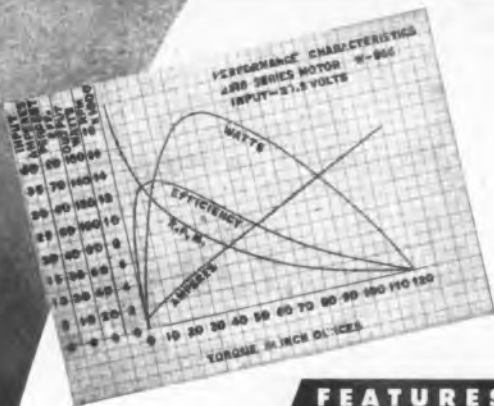

The basic design of the 2300 Frame Motor has been used in scores of individual modifications. Many of these designs are complete and available—others for new equipment can readily be developed.

FEATURES

ELECTRICAL

- Series or shunt wound
- High starting torque
- Low starting current
- High efficiency
- Low RF interference
- Unidirectional or reversible
- Armature and field windings varnish impregnated and baked

MECHANICAL

- Low weight factor
- Unusual compactness
- Completely enclosed
- Base or flange mounting
- Laminated field poles
- Precision ball bearings
- Segment-built commutator
- Permanent end play adjustment

2300 FRAME MOTORS		2318 Series	2310 Shunt
Watts Output, Int.	(max.)	160	50
Torque at 6000 RPM	(in. oz.)	40	10
Torque at 3800 RPM	(in. oz.)	57	—
Lock Torque	(in. oz.)	120	14
Volts Input	(min.)	5	5
Volts Input	(max.)	110	28
Temperature Rise	(int.)	50°C	50°C
Diameter		2 ⁵ / ₁₆ "	2 ⁵ / ₁₆ "
Length less shaft		4 ⁵ / ₃₂ "	2 ³ / ₄ "
Shaft Dia.	(max.)	.312"	.312"
Weight	(lbs.)	2.4	1.5

EICOR INC. 1501 W. Congress St., Chicago, U. S. A.

DYNAMOTORS • D. C. MOTORS • POWER PLANTS • CONVERTERS

Export: Ad Auriema, 89 Broad St., New York, U. S. A. Cable: Auriema, New York

NEW PATENTS

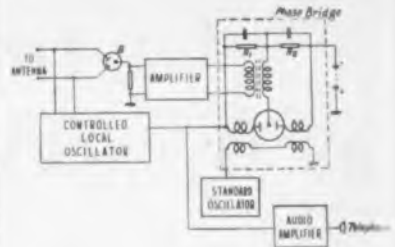

compared in the phase bridge with the phase of the modulated intermediate frequency wave to produce the desired control voltage.

O. Irslinger, Alien Property Custodian, (F) July 17, 1941, (I) May 30, 1944, No. 2,349,966.

Quenched Oscillator

The high frequency oscillations generated by the oscillator are regularly quenched by a lower frequency also generated by the circuit. A cycle of operations consists of a period of time during which the capacitor C is charged through the grid resistor GR

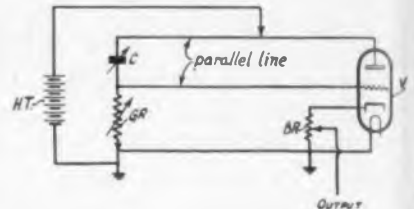

(the length of this time interval depends mainly upon the product of the capacitance of C and the resistance of GR) and of a period of time during which the circuit generates high frequencies (the length of this time interval is inversely proportional to the value of GR).

T. D. Parkin, RCA, (F) October 28, 1942, (I) July 11, 1944, No. 2,353,493.

Measuring Cross Talk

Cross-talk measurements are made at the frequencies of individual pilot waves while normal signal transmission is being effected on the two parallel conductor pairs 10,13. The pilot frequencies f_1 regulate the gain characteristic of the individual repeaters 11,12 and 14,15.

The output of modulator 26 includes frequency f_1 and the side-bands of this frequency due to the audible modulating wave f_2 . Portions of the upper and lower side bands transmitted on the disturbing conductor pair 10 are also transmitted as cross-talk to the disturbed conductor pair 18. These side bands and the frequency wave f_1 generated by pilot source 25 are demodulated in demodulator 28 producing a wave of frequency f_2 . This component is selected by selective amplifier-detector 29 and indicated by meter 30. It is a measure for the cross-talk at the frequency f_1 . This procedure is repeated for the other individual frequencies of the pilot waves.

H. H. Benning, Bell Telephone Laboratories, (F) July 4, 1942, (I) August 15, 1944, No. 2,355,776.

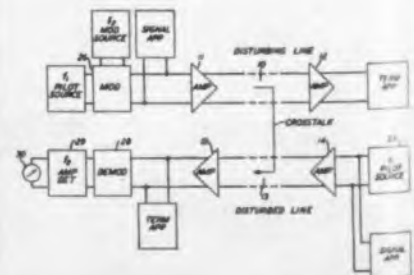

AMPHENOL offers you a COMPLETE INSERT REFERENCE CHART

For "AN" Series
Electrical Connectors

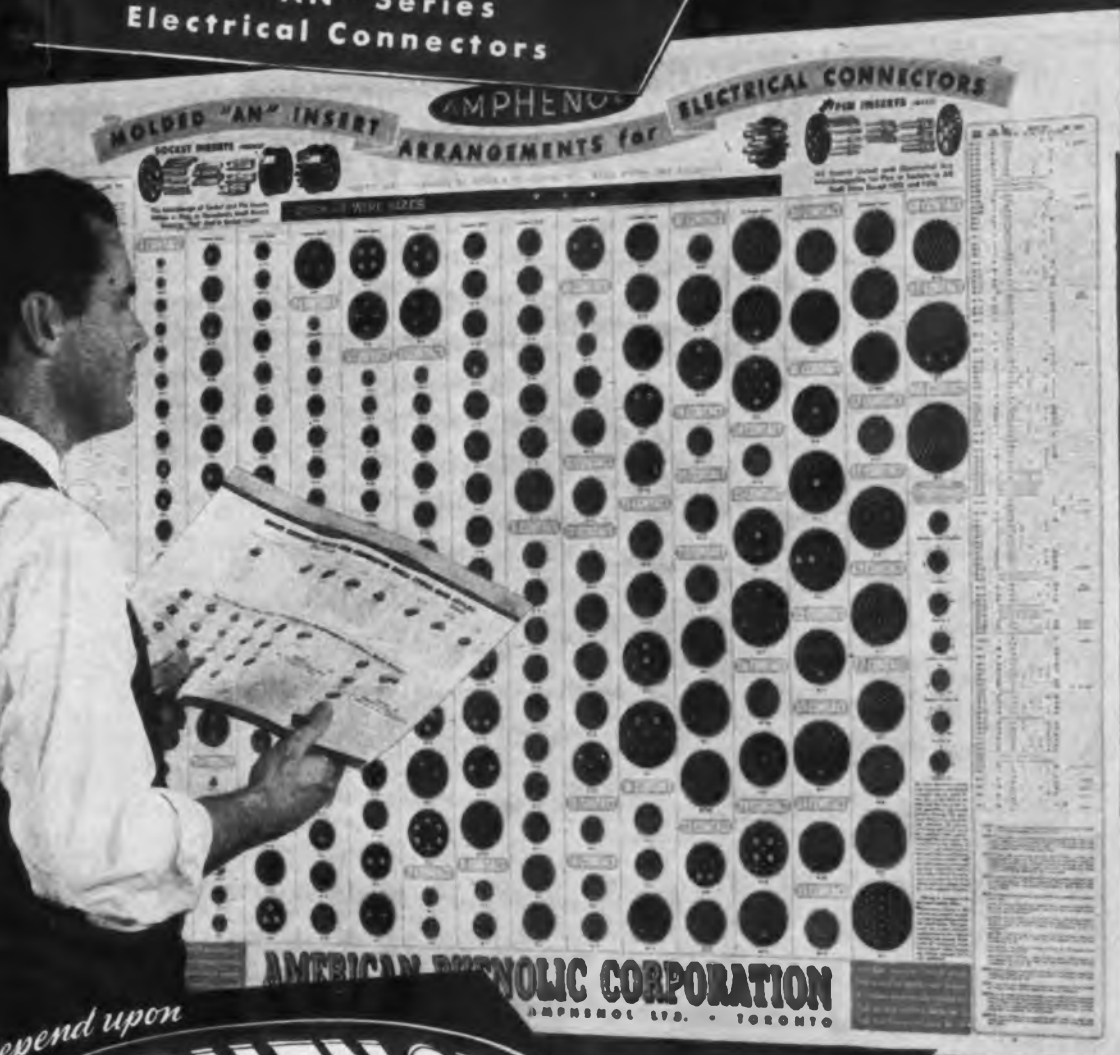

Depend upon
AMPHENOL
Quality

You may have this helpful chart. You can in an instant find the correct insert that fits your particular combination of conductors, voltage and current requirements.

First advantage—this chart organizes for the

Also included are two ringbook charts. One shows all connector shell types and styles including the special purpose shells—pressure-tight, moisture-seal, explosion-proof, light-proof. The other clearly explains the numbering system for connectors.

eye the most complete line of AN inserts made by any one company—arranged and divided according to number of contacts—readable from top to bottom and left to right. Each insert is illustrated full size on this 38" x 50" chart. A table gives the mechanical spacing of contacts and other valuable information.

All it takes to get this chart is a request on your company's letterhead.

A M E R I C A N P H E N O L I C C O R P O R A T I O N
Chicago 50, Illinois

IN CANADA • AMPHENOL LIMITED • TORONTO

Connectors (AN; British, U. N. F.) • Fittings • Conduits • Cable Assemblies • U. N. F. Cable • Radio Parts • Plastics for Industry

12 REASONS WHY YOU

Do You Want Faster, Cleaner, More Uniform Heating?

CHECK THESE FEATURES

✓	1. INSTANT AVAILABILITY	With Westinghouse Radio Frequency Generators, power is turned on or off by pressing a button—no waiting for the furnace to heat up or cool off.
✓	2. COMPLETE CONTROLLABILITY	Power is increased or decreased <i>with the speed of electrons</i> by turning a knob—apparatus especially adaptable to automatic control devices.
✓	3. RAPIDITY	Heat is generated within the material itself—no "soaking" time required. Automatic operation further speeds production.
✓	4. FLEXIBILITY	Heat generating apparatus often can be brought right beside the work. Heat is confined to the work area desired—ideal for changing production schedules.
✓	5. REPRODUCTIVITY	Heat after heat can be repeated automatically without interruption—or can be duplicated at any time in the future, with absolute accuracy.
✓	6. UNIFORMITY	All desired parts of the material are heated <i>simultaneously</i> —not by conduction from one area to another—thus minimizing radiation losses.
✓	7. CLEANLINESS	When you use radio frequency heating you get no residue, negligible scale, no products of combustion and no open flames.
✓	8. COMPACTNESS	No fuel to store—no bulky pipes and valves. The Westinghouse Radio Frequency Generator is <i>self-contained</i> —and in many cases, portable.
✓	9. ECONOMY	Power consumption is limited to that required for the operation. Otherwise, the unit draws only enough to light the tube filaments and operate the auxiliaries.
✓	10. LOW MAINTENANCE	There are a minimum of moving parts to wear out. Tube life is guaranteed. Lengthy shut-downs for repair are eliminated.
✓	11. SIMPLICITY	Once the Westinghouse heating unit is adjusted to a process, operation merely requires pushing buttons and setting dials to calibration data.
✓	12. SAFETY	Adequate safeguards are provided to protect operator and apparatus from dangerous electrical forces.

Westinghouse RADIO FREQUENCY HEATING
PLANTS IN ALL CITIES • OFFICES EVERYWHERE

SAVE WITH WESTINGHOUSE RADIO FREQUENCY HEATING

- For Dielectric Heating of Nonconducting Materials
- For Induction Heating of Ferrous and Nonferrous Metals

Speed — cleanliness — uniformity — these are the characteristics of Westinghouse Radio Frequency Heating. By this electronic method, jobs are reduced from hours to minutes. Heat is created within the material itself—instantly—uniformly—and under precise control. There's no waiting for heat to "soak" in; no rejects due to heat-damaged surfaces.

Applications include metals, wood, chemicals, plastics, paper, rubber, textiles and foodstuffs.

Westinghouse single unit design "packages" all the radio frequency generating and control equipment into a safe, compact sturdy metal cabinet. These generators are built in 1, 2, 5, 10, 20, 50, 100 and 200 kw sizes—at a range of frequencies wide enough to meet all probable dielectric and induction heating needs. For more information ask for Descriptive Data 85-800; for aid on your specific problem call your nearest Westinghouse representative. Westinghouse Electric & Mfg. Co., Box 868, Pittsburgh 30, Pa.

J-08083

20 KW RADIO FREQUENCY GENERATOR. This unit is designed for permanent installation to handle a wide range of induction and dielectric heating applications. Controls and meters are conveniently located on the front panel. Dead-front construction safeguards operating personnel.

2 KW RADIO FREQUENCY GENERATOR. This mobile unit is ideal for small work—it requires a minimum of floor space. The "table top" work surface eliminates the need for special worktables; all controls are conveniently located on the protected sloping panel.



Electronics at Work



Dependable Power..



Probably the most important single factor in modern warfare is complete, dependable communications. Dependable communications require a dependable power supply. Pincor is proud of its part in furnishing portable gasoline-driven and other electrical power supply units to the fighting front as well as to the home front.

Look to Pincor for your postwar needs in power plants, motors, converters and battery chargers.

DYNAMOTORS . . . CONVERTERS
GENERATORS . . . D C MOTORS
POWER PLANTS...GEN-E-MOTORS

BUY WAR BONDS!

PINCOR
Products

**PIONEER
GEN-E-MOTOR**

CORPORATION
5841-49 DICKENS AVENUE
CHICAGO 39, ILLINOIS

EXPORT ADDRESS: 25 WARREN STREET, NEW YORK 7, U. S. A. • CABLE ADDRESS: SIMONTRICE, NEW YORK



IRC Sales-Planning Conference

At a three-day conference attended by IRC sales representatives and company executives, early in November, at the Bellevue-Stratford, Philadelphia, Ernest Searing, president of International Resistance Co., pointed out that war's increasing demand for resistance devices has resulted in a personnel expansion of nearly 800 per cent and a plant and facilities expansion of upwards of 500 per cent. This has meant the development of a well-knit, hard-hitting team, taking its signals from top management and carrying through on its own initiative.

During the first morning of the conference a trip was made to IRC's new Logan, Pa., plant. Among the guest speakers who addressed sessions were George Barbey, past-president of the National Electronic Distributors Association, who presented his views on the place of the jobber in the postwar electronic picture. Another highlight of the meeting was a review and preview of IRC products by vice-president Jesse Marsten, chief engineer.

A unique feature of the gathering was the adoption of the letters "PB" as a theme for the series of meetings. The meaning of these mysterious letters became the \$64 question at which all sales agents tried their hands without success. At the finale of the convention it was disclosed that PB stood for Preferred Business and that sales of IRC products were in this category.

NEW BOOKS

Luminescence of Liquids and Solids

By Peter Pringsheim and Marcel Vogel, published by Interscience Publishers, Inc., 215 Fourth Ave., New York, N. Y., 201 pages, \$4.00.

This book is a general reference on luminescence and its applications in the fast growing fields that make use of fluorescent and phosphorescent materials: chemistry, television, black-out lighting, physiology, crime detection, mining and numerous others.

Part I gives an historical introduction, theory of luminescence and its experimental technics, and surveys the important materials used, both organic and inorganic. Part II is devoted to applications, including analysis technics, uses involving luminescent materials as light sources and a list of important materials found to have such properties. Each part is well supplied with foot note references. Its contents and style are of impor-

Announcing
SONOTONE
"Specification-Engineered"
ACORN TUBES
 with a new **LONG LIFE** and **STABILITY**
 exceeding service specifications!

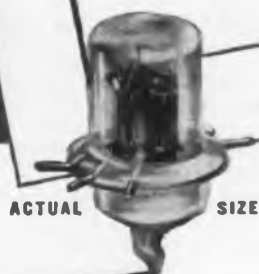

★ now mass-produced!

For the first time, engineers can plan quantity peacetime production using acorn tubes whose life and stability exceed government service specifications. These improved acorn tubes are now being produced on mass-production schedule for widespread military uses, by revolutionary automatic technics and controls devised by the Sonotone Corporation.

In the important channels between 30 and 1,000 megacycles, in the fields of UHF broadcasting, television, communication, and in many commercial installations, Sonotone believes the new acorn tube will find

many uses not previously anticipated. Long life, dependability, stability and uniformity, unobtainable before the war, now achieved by Sonotone methods, allow circuit engineers to specify these tubes for their sockets with full confidence of trouble-free performance.

If you have a problem where tubes of this character can be successfully applied, Sonotone's engineers will be glad to assist you in every way.

Technical Handbook No. 1 on Sonotone Acorn Tubes is on the press. Send for your copy.

**WRITE NOW
 FOR THIS
 BOOKLET!**

SONOTONE CORPORATION
 Elmsford, New York

HEARING AIDS • HEADSETS • THROAT MICROPHONES
 "SPECIFICATION-ENGINEERED" ACORN TUBES

HOWARD *Crystal* HOLDERS

Built to Your
SPECIFICATIONS

Tested, used, and proved by the armed forces of our country, Howard Crystal Holders are ready to serve you in peacetime. Dependability, accuracy, and assured performance are the results of precision work by HOWARD'S skilled personnel. Send your specifications to HOWARD.

★ BUY WAR BONDS ★

HOWARD MANUFACTURING CORPORATION

COUNCIL BLUFFS, IOWA



NEW BOOKS

tance to practical workers, and the book should be of value to anyone working with fluorescent effects.

Sampling Inspection Tables

By Harold F. Dodge and Harry G. Romig (Bell Tel. Labs.). Published 1944 by John Wiley & Sons, Inc., New York, N. Y. 106 pages with numerous tables and charts, \$1.50.

The sampling inspection tables presented in this book were developed for use in checking communication equipment for the Bell Telephone System, and have been adopted by several other companies. Chapter I outlines some of the factors to be considered in setting up of inspection plans and develops a basis for minimizing the amount of inspection. Chapter II compares single and double sampling methods, and brings out the "average outgoing quality limit"—the AOQL concept, and the mathematical background of the tables. Chapter III outlines the shop procedures for applying the tables.

This system creates a workable solution to the problem of quality control, and simplifies inspection to a marked degree, while minimizing the risk to both consumer and producer of having sub-level items getting passed.

Radio's 100 Men of Science

By Orrin E. Dunlap, Jr., published by Harper & Bros., New York, 294 pages, \$3.50.

You may have never heard of Thales of Miletus, of von Guericke, Pieter Van Musschenbroek or Charles Francis Du Fay. Yet all four of these men had an important part in the birth of the electronic sciences. All of them, of course, came before Benjamin Franklin who found the key to static.

Thales of Miletus lived and died in that BC period represented by the stretch of years between 640 and 548. During his lifetime he won the title to "The Patriarch of Electricians" through his observations of the phenomena of frictional electricity and magnetism. Since his time there unquestionably have been more than 100 men with just claims on electronic fame but few, if any, are better entitled to be named with the group Mr. Dunlap so entertainingly writes about.

Of the 100 whose stories go to make up this narrative, 45 are still living and the author has had a unique opportunity to know personally the work and achievements of most. To each of the 100 a chapter has been allotted outlining the personality and tracing each scientist's contribution to the steady progress of electronics in every field of endeavor.



BERYLLIUM, *Flake and Cast Bar*
BERYLLIUM OXIDE, *Metal Grade*
BERYLLIUM OXIDE, *Fluorescent*
BERYLLIUM ALLOYS

Manufactured by

CLIFTON PRODUCTS, INC.
PAINESVILLE OHIO

FASTER WINDING

Fewer Rejects

... WHEN YOU USE **FORMEX** MAGNET WIRE



TOUGHNESS ... In terms of abrasion resistance

Type of wire	Number of scrapes per mil of insulation before failure
Conventional heavy-enamelled wire	0.9
Synthetic A	10.0
Synthetic B	9.0
Formex wire	28.0

Abrasion or wear resistance, as determined by the repeated-scrape tester, provides the best single measure of film toughness.

FLEXIBILITY ... measured by tapered-mandrel test



Formex wire (bottom) compared with enameled wire (top). The outer surfaces of the films have been elongated by stretching around a tapered mandrel and heating the samples to 150 C. Note the cracks on the enameled wire.

Its tough, flexible insulation enables you to produce tighter coils in less time

● When you're using Formex® magnet wire, you can literally "go the limit" in speed of coil winding and in tension. Its insulation film is so flexible that it can be wound around its own diameter without cracking.

It is so tough that it has thirty times the abrasion resistance of conventional enameled wire; so tough that, even in the ultrafine sizes, the tension limit is determined by the strength of the copper conductor, not by the insulation.

Formex wire is smoother and more flexible than either enameled or fabric-covered wire. It pulls into place readily without forcing or jamming.

Because of this extra strength and flexibility, you can wind coils tighter and faster—and these same qualities will insure more coils passing final inspection.

For more information on Formex magnet wire, get in touch with the nearest G-E apparatus office. *General Electric Company, Schenectady 5, N. Y.*

*Reg. U.S. Pat. Off.

BUY
WAR
BONDS

GENERAL  ELECTRIC

603-18-1200





Presto MODEL "K" RECORDER

The Presto Model "K" is an unusual electronic device! It is a portable sound recorder, record player, and public address system complete in one carrying case.

Exceptionally light and compact, it is ideally suited to the needs of sales training and industrial schools, teachers of speech, music and dramatics, as well as professionals who require an instrument that can be carried easily and set up for operation in a few minutes' time.

TURNER Microphones are standard equipment with Presto Model "K" Recorders

TURNER Applications in electronic communications give outstanding performance on every front. On land, on sea and in the air. In war and in peace, Turner Microphones deliver crystal clear reproduction under all climatic and acoustic conditions.

All crystals licensed under patents of the Brush Development Co.



The **TURNER** Company

CEDAR RAPIDS, IOWA

Pioneers in the Communicative Field.

41 Million Sets Short

Office of Price Administration, which has compiled statistics on the matter, states that on the basis of 1941 production, radio set manufacturers have foregone production of some 41,100,000 units during '42, '43 and '44.

AUTOMATIC RECORDING

(Continued from page 78)

e. Power supply circuits to provide dc for discharge and amplifier circuit, and power for drum drive, disk advance and heating circuits for the test chamber.

The circuits listed under a and b are more or less conventional and need not be shown here. Fig. 6 shows the arrangement of the circuits serving functions c, d, and e.

At the left is shown the temperature-measuring 60-cycle bridge whose output is fed into the input of a 3-stage amplifier. The amplifier output, in turn, feeds the shading winding of a reversible induction motor, the main winding of which is connected to the same 60-cycle source which feeds the bridge. The phase relation between the two motor windings is adjusted for maximum torque by means of coupling condensers inside the amplifier.

Motor control

It will be seen that reversing this phase relation will reverse the rotation of the motor, while the amplitude of the amplifier output, within certain limits, governs the speed. The required amplifier gain was arrived at by the requirement that a bridge unbalance corresponding to, for instance, 1 deg. C. temperature change should supply the full power output of approximately 3 watts, enough to start the motor and move the stylus to its new position 1 deg. C. away from its former balance point. As sudden large temperature changes produce considerable input voltage into the amplifier, an amplitude limiting device, shown as a delayed-action rectifier, furnishes the bias for the first tube. The filter circuit causes no particular difficulties due to the slow speed which also eliminates hunting.

The arrangement described makes the abscissa of the diagrams follow temperatures irrespective of the time at which these occur and thus makes this device a genuine X-Y recorder, in which none of the coordinates represent time. In addition, however, a record of the temperature rate of rise can be made by scribing vertical lines at even time intervals, for instance, every 10 minutes. To this end the switch marked "Time Contact" (Fig. 6) may be operated periodically by a small clock motor. A number of

LISTEN!

to John W. Vandercook!

SATURDAYS

5:30 to
5:45 p. m.
E. W. T.



OVER THE
COMPLETE
FACILITIES
OF N. B. C.

Sentinel Radio

Starting Saturday, October 21st and every Saturday afternoon thereafter, Sentinel Radio Corporation is bringing you and all your prospective customers John W. Vandercook, eminent news analyst. Mr. Vandercook will help you keep abreast of the times with his thoroughly informed comment on the stirring events of these times.

This series of broadcasts, over NBC's entire nation-wide chain of 142 stations will keep Sentinel Radio before the public—will make the Sentinel name known as radio that makes good programs sound better! This public acceptance will result in even greater sales for post-war Sentinel Radios . . . more profits to Sentinel dealers!

LISTEN to John W. Vandercook as he talks to "your customers" for Sentinel Radio.

SENTINEL RADIO CORPORATION, 2020 Ridge Ave., Evanston, Ill.



FIND YOUR LOCAL STATION HERE:

The following stations have been ordered:

Albuquerque KOB	Butte *KGIP	Eau Claire *WEAU	Houston KPRC	Los Angeles *KFI	Norfolk WTAR	Rochester, Minn. BRBC	Tampa WFLA
Albany WISN	Charleston, S. C. WTMA	Elmira WENY	Hutchinson KWBW	Louisville WAVE	Os Platte, Neb. KODY	Safford *KGLU	Terre Haute WBOW
Albany WFBG	Charleston, W. Va. WGRV	El Paso *KISM	Indianapolis WIRE	Madison *WIBA	Oklahoma City WKY	Saginaw *WSAM	Toledo WSPD
Amarillo *KNC	Charlotte WSDC	Evansville WGBF	Jackson *WJDX	Manchester WFEA	Omaha WOW	St. Cloud *KFAM	Trenton WTTM
Astoria WISE	Chattanooga WAPC	Fargo WDAY	Jacksonville WJAX	Manhato KYSM	Pensacola WCOA	St. Louis KST	Tucson *KVDA
Atlanta WSB	Chicago WMAQ	Fort Wayne WGL	Johnstown WJAC	Martinsville WMYA	Philadelphia KYW	Salt Lake City *KDYL	Tulsa WDDO
Aurora WRDD	Cincinnati WLV	Fort Worth WDFW	Kansas City WDAF	Medford *KMEC	Phoenix *KTAR	San Antonio WOA1	Twin Falls *KTFI
Baltimore WBAL	Cleveland WTKM	Fresno *KMJ	Knoxport WKPT	Memphis WMC	Pittsburg, Kan. KOAM	San Diego *KFSD	Virginia *WLB
Birmingham WLBZ	Columbia WIS	Des Moines *KXJB	Knoxville WRDL	Miami WIOD	Pittsburgh, Pa. KDKA	San Francisco *SFZ	Washington WRC
Bismarck *KFYR	Corpus Christi *KRIS	Grand Rapids WOOD	La Crosse WKBH	Milwaukee WTNJ	Pocahontas KSEI	Savannah *WSAV	Wichita *KRGV
Boston WBZ	Denver *KRE	Greenwood WFCB	Lafayette, La. *KVOL	Minneapolis WMIN	Portland, Me. WCMH	Schenectady WGY	Wichita *KANS
Buffalo WBRB	Dayton WDAZ	Harrisburg WCRS	Lake Charles, La. *KPLC	St. Paul *KSTP	Portland, Ore. KGW	Seattle *KOMO	Wichita WBRB
Butte WHIS	Dayton *KOA	Harrisburg WRBO	Lakeland WFLA	Mobile WALA	Prescott *KYCA	Shreveport KTVS	Wilmington WRAK
Butte *KIDQ	Des Moines WHO	Harrisburg WFTC	Lancaster WGL	Monroe, La. KNOE	Providence WJAR	Sioux Falls KSDO	Wilmington WDEL
Butte *KRBM	Detroit WWJ	Harrisburg WFOR	Laurel WML	Montgomery WSFA	Raleigh WPTF	Spokane *KHQ	Winston-Salem WSJS
Butte *WOP1	Duluth-Superior WDCB	Harrisburg WAZL	Lewistown WMBF	Nashville WSM	Reading, WEEU-WRAW	Springfield, Mass. WELZ	York *WOKX
Butte WBN	Easton WEST	Helena *KPFA	Lima WLOK	Nashville WSM	Richmond WMBG	Springfield, Mo. *KCB	Yuma *KYUM
		Hibbing *WMFG	Little Rock KARK	New Orleans WSMB	Richmond, N. Y. WMBG	Syracuse WSYR	Zanesville *WHIZ

* See your newspaper for the rebroadcast time of this program.



Centralab

CERAMIC CAPACITORS for HIGH VOLTAGE

Three new double cup style ceramic capacitors engineered by Centralab for transmitter applications where high working voltages and loads are required.

Type 850 currently available with two terminal styles — axial screw type and lug style . . . or one of each. Capacities ranging from 25MMF NPO to 100MMF N750. Working voltage to 10,000 D.C. Type 851 available with two terminal styles as illustrated. Capacities ranging from 25MMF NPO to 200 MMF N750. Working voltage to 20,000 D.C.

Type 852 designed to withstand shock of 100 to 200 G. Axial screw style terminal. Capacities range from 10MMF NPO to 25MMF N750. Working voltages to 10,000 D.C. Ask for Bulletin 721 and 814.

Producers of Variable Resistors • Selector Switches
• Ceramic Capacitors,
Fixed and Variable •
Steatite Insulators

Centralab

Division of GLOBE-UNION INC., Milwaukee

pioneer for tomorrow

The world of tomorrow will be one of electronics. Pioneer for that world is the electronic engineer. His vitally important effort during this wartime period in devising electronic equipment is helping to defeat the enemy. Tomorrow, he devotes his specialized scientific knowledge to aid peacetime industries.

Raytheon is applying its efforts to the development of advanced electronic tubes and equipment for the war effort. When that job is done, the knowledge that has been gained will be used to guarantee that post-war radio, industrial and electronic equipment manufacturers will receive Raytheon tubes and equipment with even greater "Plus-Extra" quality.



ARMY-NAVY "E" WITH STARS

Awarded All Four Divisions of Raytheon for Continued Excellence in Production

RAYTHEON

Raytheon Manufacturing Company

ELECTRICAL EQUIPMENT DIVISION

Waltham and Newton, Massachusetts

DEVOTED TO RESEARCH AND THE MANUFACTURE OF TUBES AND EQUIPMENT FOR THE NEW ERA OF ELECTRONICS

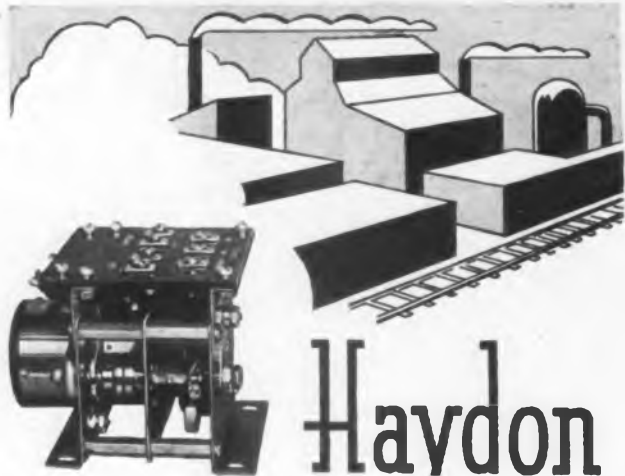

Haydon

"Electroneered" timing WILL BE THE HEART-BEAT OF TOMORROW'S INDUSTRY

New electronic-engineered timing devices by Haydon, now measuring and motivating thousands of mechanical functions in war-time industry, will find wider scope in uncounted duties after the war.



AC MOTORS
Available 450 RPM to one Revolution per month; manufactured to your specific voltage, frequency and speed requirements. Special lubricants for $-60^{\circ}\text{C}.$ to $+100^{\circ}\text{C}.$



DC MOTORS
Reversible—Compact—light in weight—with seven segment commutator—low reactance rotor winding—alnico magnet field—totally enclosed. Virtually any speed or voltage.

They are engineered into new applications for homes, factories, laboratories; in transportation and communication—in short, Haydon timing devices will regulate and govern the energy of tomorrow, for greater economy and efficiency.

Write today for your copy of this catalogue.



Haydon

MANUFACTURING COMPANY
INCORPORATED

Forestville, Connecticut

©1944

such time marking lines are visible on the diagram Fig. 1.

The stylus discharge circuit provides for printing three curves (activity, frequency, zero) through the same stylus and therefore contains three condensers of different capacity to distinguish between them. In the normal position of their associated "oscillating relay" switches the condensers are charged from the B-supply. Whenever these switches are actuated by their respective mechanisms (shown as M1, M2 and the 5-pointed cam S1), a spot is "printed" on the paper as each condenser discharges, the spot being the "fatter" the larger the condenser.

Where the frequency and activity come close, the switch of M1, for instance, may close shortly after M2 closed. In that case the charge of one condenser would distribute itself on two condensers with a resultant drop in voltage, and the particular curve point would not be printed clearly but inserting rectifier elements as shown in Fig. 6 prevents this interference. Since continuity of the zero line is less important, no rectifier is used in that branch.

Fig. 6 shows further the circuit of the solenoid which advances the loading disk in the test chamber, and also the auxiliary circuits for heating and air circulation. The test chamber of the actual recorder contains a loading disk for 71 crystals.

In order to eliminate changing the recording paper after each run, the design of the recorder was based on the use of standard Teledeltos paper 10 in. wide. This width accommodates four rows of diagrams. After each run the stylus is shifted into a notch $2\frac{1}{2}$ in. to the right, the full chart appearing on Fig. 7.

A free-wheeling arrangement allows the individually numbered diagrams to be transported underneath an acetate mask (see Fig. 8) bearing the measuring limits to allow a quick acceptance inspection of the entire lot tested.

In addition, the diagrams reveal a wealth of information of value to production and quality control. Since the maximum of the frequency temp. curve is largely a result of BT-angle orientation, its location indicates the care with which slabs were cut. Depending on the kind of use, the turning point in the frequency curve should be either around the most frequent temperature (say $+20$ deg. C.) to insure minimum change in that neighborhood, or in the center of the range ($+10$ deg. C.), to obtain minimum deviation at both end temperatures. The consistency of production with regard to these points shows at a glance from the record. (Continued on page 164)

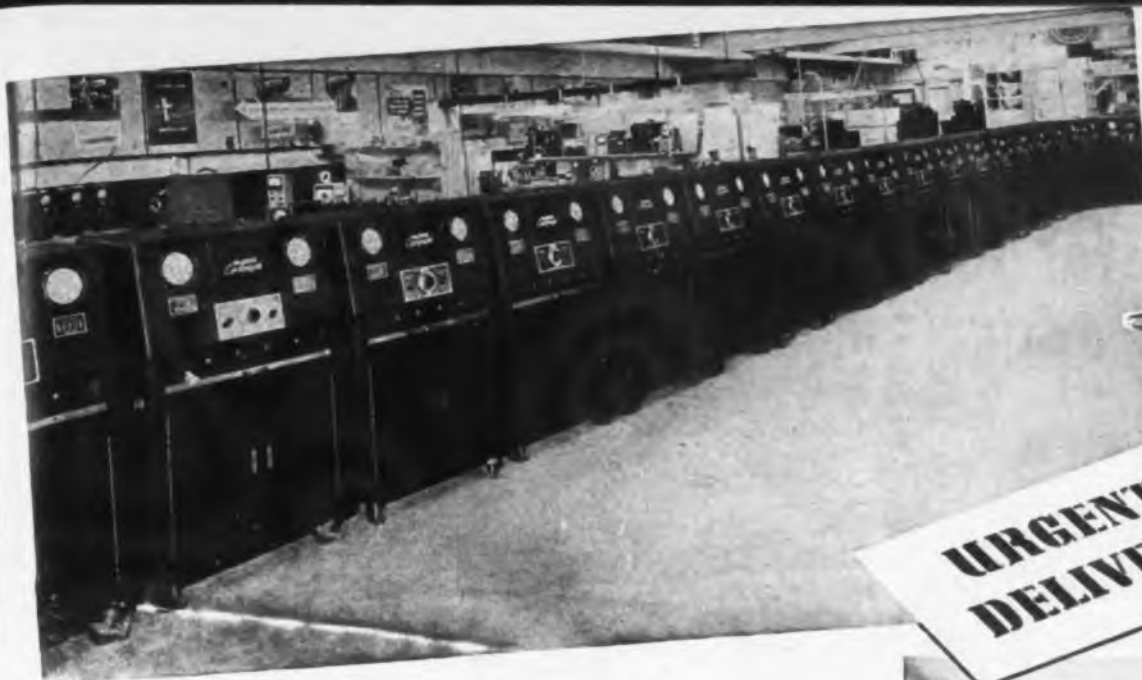

When you have urgent need for this 100% quality inspection, present production of instruments now assures early delivery and installation of your

DuMONT

Cyclograph



◆ DuMont Cyclographs are rolling off the production line. With details and circuits refined and set, the building of these instruments has now passed to our manufacturing plant. Early delivery and installation is now assured for those who have real need for this 100% quality inspection means.

Meanwhile, the Cyclograph is proving indispensable in one plant after the other. This technique is

making a notable contribution to the war effort in manpower and material savings, in product uniformity, and in production speedup. Likewise in the postwar industrial situation, the Cyclograph promises to be a vital factor in reducing production costs and increasing product uniformity.

From now on it's PROMPT delivery and installation — when you need 100% quality testing.

➔ Write for Literature . . .

**TYPICAL CYCLOGRAPH
100% QUALITY TESTING . . .**

- ✓ Non-destructive testing for machinability of metal stock to be machined in automatic high-speed equipment.
- ✓ Pre-checking iron castings for machinability.
- ✓ Sorting of mixed lots of forged steel.
- ✓ Inspecting 150,000 pounds of packaged welding electrodes for critical magnetic properties, without opening packages.
- ✓ Automatically sorting six and a half million copper-clad steel cups to discard those accidentally reversed in the stamp.
- ✓ Sorting large quantities of mixed bolts according to their SAE analyses.
- ✓ Checking gears for case hardening.
- ✓ 100% quality inspection and control of incoming materials and outgoing products, according to metallurgical analyses, case depth, depth of decarburization, amount of cold working, brittleness (stress gradients), structure, etc., on either non-ferrous or ferrous metals.

© ALLEN B. DUMONT LABORATORIES, INC.

DUMONT

Precision Electronics & Television

ALLEN B. DUMONT LABORATORIES, INC., PASSAIC, NEW JERSEY • CABLE ADDRESS: WESPXLIN, NEW YORK

Does Your Postwar Design Problem Call for Better Acoustical Reproduction?



● Permoflux Acoustical Devices have brought vital improvement to numerous wartime communication projects. Many of these developments will soon be available for the betterment of designs now on your own planning boards. Our engineers will be pleased to confer with you at any time.

BUY WAR BONDS FOR VICTORY!

TRADE MARK
PERMOFLUX
 PERMOFLUX CORPORATION
 4916-22 W. Grand Ave., Chicago 39, Ill.

PIONEER MANUFACTURERS OF PERMANENT MAGNET DYNAMIC TRANSDUCERS

"Spurious frequencies," which are interpreted as a coupling effect between two modes of vibration can be detected in the form of dips. Such conditions often can be corrected by refinishing the contour of crystals. General dropping of activity toward the higher or lower temperatures and sudden drops around the freezing point have been traced to definite causes.

A large number of the finer points in crystal production can thus be made visible while at the same time the human element is entirely eliminated from the inspection process.

The application of multiple recorders like the one described is naturally not limited to the testing of radio crystals. Generally they offer advantages for production testing and inspection of many products the properties of which can be described in an X-Y diagram. Voltage-current curves of dry disk rectifiers, angle-resistance curves of volume controls, regulation curves of non-linear resistances such as current limiter tubes, voltage stabilizing devices, etc., can readily be traced. Frequently units can be compared with "master" units whose characteristics are selected or made to approach the ideal state very closely. In this case, the error or deviation curve often reveals all essential data and permits quality control at a glance.



Available from local dealers or by writing factory direct.

UNIVERSAL STROBOSCOPE

This handy photograph turntable speed indicator, complete with instructive folder, is now available gratis to all phonograph and recorder owners through their local dealers and jobbers. As a recorder aid the Universal Stroboscope will assist in maintaining pre-war quality of recording and reproducing equipment in true pitch and tempo. Universal Microphone Co., pioneer manufacturers of microphones and home recording components as well as Professional Recording Studio Equipment, takes this means of rendering a service to the owners of phonograph and recording equipment. After victory is ours—dealer shelves will again stock the many new Universal recording components you have been waiting for.

UNIVERSAL MICROPHONE CO.
 INGLEWOOD, CALIFORNIA

ELECTRONIC INDUSTRIES ■ December, 1944

STUPAKOFF METAL-GLASS TERMINALS

Engineered for

**IMPROVED PRODUCTION
AND PERFORMANCE . . .**



**TEMPERATURE COMPENSATED
TUNING FORK**

Courtesy American Time Products Inc.

Use KOVAR* for sealing

**ELECTRONIC TUBES
TRANSFORMERS
RESISTORS
CAPACITORS
CONDENSERS
VIBRATORS
SWITCHES
RELAYS
INSTRUMENTS
GAUGES
METERS
RECEIVERS
TRANSMITTERS**

BUILT into an evacuated container (illustrated on the left) is a temperature compensated tuning fork, component of a multi-frequency generator, accurate to 10 parts in 1,000,000 per degree C.

Kovar-glass terminals contribute to the maintenance of the vacuum required. They enable the manufacturer to effectively reduce the size and weight of the cylinder, and facilitate quicker, easier, more dependable and more economical assembly of the unit.

Kovar, a cobalt, nickel iron alloy, forms a chemical bond with hard glass through a heating process, in which the oxide of Kovar is dissolved into the glass. The result is a permanent vacuum and pressure tight seal, effective under the most extreme climatic conditions.

Stupakoff manufactures Kovar-glass seals with single or multiple, solid, or tubular electrodes. For those equipped to do their own glass working, Stupakoff supplies Kovar as sheet, rod, wire or tubing or fabricated into cups, eyelets, etc.

Write Stupakoff today for more information on the advantages of Kovar-glass seals for electronic components.



**Do More Than Before—
Buy EXTRA War Bonds**

*TRADE MARK 337962 REGISTERED IN U. S. PATENT OFFICE

STUPAKOFF CERAMIC AND MANUFACTURING CO., LATROBE, PA.



SIGMA RELAYS

ARE GOOD MIXERS

Designed for great sensitivity and high speed, Sigma Relays are capable of more precise adjustment than most commercial relays.

When the job at hand requires large current capacity and precise pick-up adjustment it's a good idea to combine the Sigma Relay with another type to obtain these characteristics.



This circuit breaker designed by *Hatton of Hartford* provides instantaneous cut-off when current exceeds a pre-set value.

Our engineering staff will gladly advise you of the best combination to meet your requirements.

SIGMA
Sigma Instruments, inc.
Sensitive RELAYS

70 CEYLON ST., BOSTON 21, MASS.

X-RAY ADJUSTMENT

(Continued from page 100)

operated at from 40 to 80 kv, but sufficient experimental data is not yet at hand to decide this matter.

4. Foreign material such as metal, glass, or plastic sheets should not be placed in front of the crystal during irradiation since they absorb part of the incident radiation, especially the relatively effective soft components, and thereby slow down the change in the quartz.

X-rays used in irradiating oscillator-plates should not be filtered. If the crystal is irradiated while in a bakelite or other holder or if it is oscillated in a special holder on the tube during irradiation, every effort must be made to keep the shielding material as transparent to X-rays as possible, both by controlling the thickness and the composition of the material. Plastics, thin Al or Be foil, and very thin Cu foil are relatively transparent to copper X-rays. Metals such as iron or lead are relatively opaque to X-rays, even in thin sheets, and X-ray beams of the intensity described here cannot penetrate through the steel electrodes used in clamp type holders.

5. Advantage should be taken of the fact that quartz crystals can be markedly sensitized to the effect of X-rays by prior baking to 300° C. to 570° C. Baking also is advantageous because of the stabilizing effect it has on the crystal. Note that one former objection to the baking of crystals, that of an erratic increase in frequency which often brought the plate out of tolerance, is readily overcome by the irradiation method without destroying the stability of the plate. Attention should also be given to methods of increasing the efficiency of the radiation by coating or backing up the crystal with a highly scattering metal or substance. The plate that immediately supports the crystals in the irradiation jig should be made of nickel, since this metal will give the maximum amount of back-scattering in copper radiation.

6. X-rays are dangerous and every care must be taken to shield the operator both from direct and scattered radiation. Irradiation jigs should be completely shielded by lead sheets not less than 1 mm. in thickness.

7. Quartz crystals may acquire a static electric charge during irradiation, especially if they are placed directly in contact with the window, and thereby may attract particles of dust to their surface. This dust can be blown off with compressed air—a much easier procedure than trying to remove the static charge. Under certain conditions the metal parts of water cooled tubes may sweat and moisture may deposit on the surface of



An Electronic Part ... ENGINEERED TO A SPECIFIC NEED

This is a special-purpose electronic part. It is a plug-receptacle assembly for use with rack-panel type of mounting. Twenty-four silver-plated phosphor-bronze contacts are provided, each male and female contact full floating between steatite plates. Heavy guide pins and matching holes in the frame assure perfect alignment.

We don't know that your product has any need for such a part as this. We do know, however, that this part is most exactly suited to its special requirement, just as are hundreds upon hundreds of other parts which have been created through Lapp engineering and Lapp production facilities directed to the solution of specific problems.

With a broad basic knowledge of ceramics—their capabilities and their limitations—Lapp has been able to simplify and to improve many types of elec-

tronic equipment through engineering and production of sub-assemblies that make most efficient use of porcelain or steatite and associated metal parts.

There may be a way you can improve performance, cut costs and cut production time through use of Lapp-designed and Lapp-built sub-assemblies. We'd like to discuss your specific requirements with you. *Lapp Insulator Co., Inc., LeRoy, N. Y.*

Lapp



New in conception and application

GREEN MULTI-RECTIFIER MRI

. . . providing flexible DC power for laboratory work

New in conception and application, the Green Multi-Rectifier MRI fulfills a definite need in the laboratory. By providing in one compact unit a flexible DC power supply, the Multi-Rectifier MRI lifts the restrictions which orthodox rectifiers, generators or batteries impose upon engineers and technicians. By the simple shifting of a few external links a choice of four different voltage ranges is available, with control from zero to maximum on each range.



Unlike present rectifiers, the MRI, designed and developed by Green engineers, incorporates six individual selenium rectifier sections. These may be quickly interconnected by external links to provide four different ranges of DC power:



- 0-8 volts, max. cap., 100 amps.
- 0-16 volts, max. cap., 50 amps.
- 0-24 volts, max. cap., 35 amps.
- 0-48 volts, max. cap., 18 amps.

On any range, the two panel-mounted voltage control switches offer a range of control in 49 steps from zero to maximum. Maximum current limitations are indicated on each range. For convenience in connecting to loads, output terminals are located on each side of the cabinet. On-Off push buttons control the 3-phase magnetic contactor in the main power supply circuit. Overload warnings are given by supervisory Monitor buzzer and lamp located between the voltmeter and ammeter. The Automatic Watchman furnishes automatic current interruption in case of prolonged overload. Cabinet size: 22" wide x 15" deep x 36 1/2" high.

For additional information about this new Green development, write for our explanatory brochure, or talk to a Green representative.

W. GREEN ELECTRIC COMPANY, INC.

SELECTED PLATEPS AND ALL TYPES OF RECTIFIER EQUIPMENT

GREEN EXCHANGE BUILDING 130 CEDAR STREET NEW YORK 6, N. Y.

RECTIFIER  ENGINEERS

the crystals. This can be overcome by proper design of the irradiation jig and the tube housing.

8. Silver plated crystals may darken during irradiation if ozone is developed in the X-ray tube housing. The ozone can be eliminated by proper insulation and shielding of the high tension thereby preventing corona and flashovers. Gold, nickel and aluminum plated crystals have not been observed to be affected in this way.

9. The X-ray beam where it hits the crystal should be large enough in cross section to cover the critical area completely. In most types of shear mode plates, as has been pointed out, less than 50 per cent of the total area of the crystals has to be irradiated to gain maximum effect.

In one method the crystal is not oscillated during the exposure to the X-rays. The method is primarily applicable to crystals in which the frequency has merely to be reduced below a certain tolerance and a precise adjustment is not desired. This situation is commonly met with in the case of crystals: (a) that have been overshoot in frequency during the final finishing, or that have been underplated; (b) that have increased in frequency over tolerance due to aging; (c) or that have gone over tolerance after cleaning, baking, or other treat-

Rugged!



PAPER and ELECTROLYTIC

Capacitors

Dependability is a MUST. The rugged, durable Illinois Capacitors give you maximum satisfaction under the severest of operating conditions. When looking for "tough" condensers that can be relied upon, choose "ILLINOIS."

ILLINOIS CONDENSER COMPANY

1160 NORTH HOWE STREET CHICAGO 10, ILLINOIS

known

Performance



for destinations known or unknown

Today, our electrical equipment encircles the globe; some serving at Greenland's ice cap or in Kiska's fogs . . . others stewing in the swamps of a Pacific atoll.

With the destinations of war-products totally unknown, manufacturers logically have preferred "building-in" WESTONS on their control panels. They know that a WESTON will perform dependably *anywhere* . . . that there is sound reason behind WESTONS acceptance as the *international standard*.

And tomorrow, with equipment reaching known markets, instrument preferences will remain unchanged. For while human life no longer will be at stake, *reputations will*. So manufacturers will continue to "build-in" the instruments which consistently tell-the-truth . . . to build broader market acceptance and customer good-will, and assure highest efficiency from the machines which bear their name.

- Laboratory Standards
- Precision DC and AC Portables
- Instrument Transformers
- Sensitive Relays
- DC, AC, and Thermo Switchboards and Panel Instruments
- Specialized Test Equipment
- Light Measurement and Control Devices
- Exposure Meters
- Aircraft Instruments
- Electric Tachometers
- Dial Thermometers

Weston

WESTON ELECTRICAL INSTRUMENT CORPORATION
666 FRELINGHUYSEN AVENUE, NEWARK 5, NEW JERSEY

FOR OVER 55 YEARS LEADERS IN ELECTRICAL MEASURING EQUIPMENT

Shock-Proof FREQUENCY METERS

Model 33-F for 400 cycles Accuracy $\pm 0.3\%$

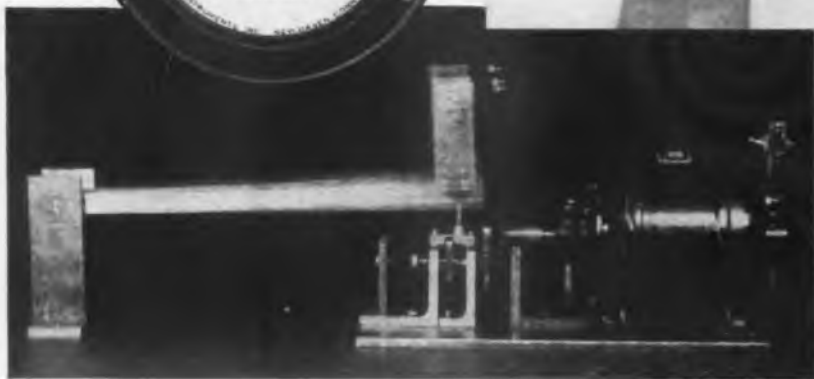

Mechanical shaking — one hundred and twenty times a minute through a one inch stroke for a full hour—on this Government bronco

...a rough ride for any instrument—but J-B-T Vibrating Reed Frequency Meters take this slamming in stride—with accuracy unaffected. They're rugged.

During the run, meters are rotated in the clamp to subject the reeds to stress and shock not only in their normal plane of operation but also in cross planes. They also undergo 24 hour vibration tests and single impact shocks of 50 G's and above—through all planes.

Here's where the designer's specifications of base inserts, lock washers at every critical point, polymerized finish, and similar precautions prove their worth.



For technical data on the complete line of J-B-T Vibrating Reed Frequency Meters, send for VF-43 with supplements.



(Manufactured under Triplet Patents and/or Patents Pending)

J-B-T INSTRUMENTS, INC.

433 CHAPEL STREET • NEW HAVEN 8, CONNECTICUT

ment to effect stabilization.

A number of different kinds of radiation have been found that cause color and frequency changes in quartz. These include both radiations of the wave type, more particularly X-rays and gamma rays, and streams of material particles, including alpha-particles, electrons (both cathode rays and beta-radiation from radioactive decay) and deuterons. Neutrons and radiations in the wave spectrum of wavelength longer than X-rays have not been found to pigment or reduce the frequency of previously untreated quartz oscillator-plates.

Some of the effective radiations, especially the alpha, beta, and gamma radiations afforded by radioactive decay, and cathode rays, have long been known to effect color changes in quartz and many other substances, but the accompanying change in the elastic constants hitherto has gone unnoticed. Of the effective radiations, X-rays are the only practical choice for manufacturing operations.

TELEVISION

(Continued from page 104)

"A Study of the Propagation of Wave Lengths Between Three and Eight Meters," published in 1933,* includes data drawn from field tests in metropolitan New York indicating that substantially more power would be required to provide the same field strength at average broadcast receiver locations for three meters (100 megacycles) than for eight meters (approximately 38 megacycles). I made reference earlier to a propagation study in the Camden-Philadelphia area conducted during 1934 by R. S. Holmes and A. H. Turner.** These tests gave measured values of the powers required, for the conditions of test (low receiving antenna heights), at frequencies of 30 and 100 megacycles. The power needed at the higher frequency was very substantially greater than that at 30 megacycles required to produce the same field strength at average receiver locations. A paper by H. H. Beverage,*** published in 1937, also gives information on this subject and shows the distinction between signals received under communications conditions and for antennas near the ground on radials from the transmitter.

C. R. Burrows, L. E. Hunt, and A. Decino† show in a paper published

*"A Study of the Propagation of Wave Lengths Between Three and Eight Meters", Proc. I.R.E., Vol. 21, p. 349, March, 1933.

**Loc. cit.

***"Some Notes on Ultra High Frequency Propagation", RCA Review, Vol. 1, pp. 76-87, January, 1937.

†"Ultra-Short-Wave Propagation: Mobile Urban Transmission Characteristics", C. R. Burrows, L. E. Hunt, A. Decino, Bell Systems Technical Journal, Vol. 14, pp. 253-272, April, 1935.



... *in Hearing Aids*

A vital component of the Hearing Aid is the Microphone which must be small, light, moisture-proof and possess the frequency response adapted to the Hearing Aid Device. Often the Microphone must be chosen to fit the threshold of hearing of the patient. Shure Research has succeeded so well in controlling the frequency response and output level of small size Hearing Aid Microphones that, today, Shure Brothers produces microphones for practically every major manufacturer of Hearing Aids.

SHURE BROTHERS, 225 West Huron Street, Chicago
Designers and Manufacturers of Microphones and Acoustic Devices.



At Home in Water



Danger Lurks Here

The fish and the seaweed are incidental. They're strictly at home in water and they thrive in it. But our armed forces, on sea or land, find water and moisture deadly enemies of electrical and electronic equipment.

If electrical coil windings that are dependably waterproofed and exempt from moisture damage are required in your products, Coto-Coil's 27 years of experience can help you with proper coil design and construction.

COIL SPECIALISTS SINCE 1917

COTO-COIL CO., INC.
65 Pavilion Ave. Providence 5, R. I.

during 1935 that the field strengths measured for low antenna heights in the urban Boston area are lower than those predicted for unobstructed paths. These measurements were at 34.6 megacycles.

The reason for the discrepancy between the theoretical values and the measured values for broadcast conditions is that the transmission path is not an unobstructed one. For much of the area the waves must pass through and around buildings and roof-tops and through trees, grazing over miscellaneous structures and vegetation to reach the receiver antenna. The attenuation for these conditions departs somewhat at 40 megacycles from theory for an unobstructed path; this attenuation increases with frequency and becomes really serious at 300 megacycles. We are, therefore, confronted with the need for more power at the higher frequencies and not less. This attenuation situation is probably a special form of shadow effect.

This condition was pointed out in an article published during January, 1937, entitled, "Frequency Assignments for Television."* In this paper Mr. Burrill and I made a correlation on synthesis of the information then available. It is interesting that in this article we

*"Frequency Assignments for Television", E. W. Engstrom and C. M. Burrill, RCA Review, Vol. 1, p. 88, January, 1937.



ELECTROX RECTIFIERS

• All kinds of rectifiers for all purposes . . . any capacity. Suppliers of ElectroX Rectifiers to leading instrument and test-set makers since 1930.

Write for Illustrated Bulletin 446.

SCHAUER MACHINE COMPANY

2057 READING RD., CINCINNATI 2, OHIO

AGAIN!



*For the 5th time
Hallicrafters
employees
win Army-Navy
"E" Award!*

First exclusive manufacturer of short wave radio equipment to receive the coveted Army-Navy "E" Award for the fifth time... the result of the continued and untiring devotion to duty of the company's 1,500 employees.

hallicrafters

THE HALLICRAFTERS COMPANY • MANUFACTURERS OF RADIO AND ELECTRONIC EQUIPMENT • CHICAGO 16, U. S. A.



Builders of the famous SCR-299



There's a Lot in a Transformer That You Can't See . . .

Of course we are proud of the appearance of ADC Transformers. One of our greatest satisfactions however, is in the way they are designed and built—for it is upon these qualities that ADC performance has been achieved and maintained.

It might be easier to make transformers some other way, but we enjoy doing our work the right way—and that means a lot to all of us here at ADC.

SEND FOR LATEST CATALOG!



Audio Development Co.
2833 13th Ave. S., Minneapolis, Minn.

treated essentially all of the factors considered as affecting television broadcast allocations now under review.

In any service area there will be locations having unobstructed paths and at such locations the field strengths will be higher than in adjacent regions having attenuation because of obstructions. Such high-signal locations will be where there is line of sight between receiving and transmitting antennas. For those situations the field strengths will conform approximately to the Norton curves. However, these are not the average conditions for the areas to be covered in a broadcast service.

In moving upward in carrier frequency above 40 megacycles the choice of transmitter location and antenna height becomes increasingly critical. In particular, one must choose just as high a location as possible to obtain unobstructed paths and freedom from shadows for as much of the service area as possible. At the receiver location the antenna must be elevated to assure being immersed in a useful field from the transmitter. For much of the service area this indicates a well placed outdoor receiving antenna.

Power gain by vertical directivity of the transmitter antenna can be used to increase the effective radiated power for all frequencies considered for television broadcasting. At 50 megacycles a practical power gain is five times. From the point of view of antenna structure, the power gain may be increased as the frequency increases, but only up to the point at which the vertical directivity still permits coverage of the areas near the transmitter. We do not have any operating experience on this point, but calculations have indicated that a power gain of ten times of view of coverage, for an antenna elevation of 1000 ft. As the transmitter antenna elevation is lowered the power gain may be proportionately increased and still cover equally well the nearby area.

A single half wave dipole antenna collects, for a constant field strength at the receiving antenna location, less and less signal as the frequency is increased. This is because its size decreases with frequency. Some gain can be obtained by designing a receiving antenna with directivity characteristics. If such an antenna is to cover a broad frequency band (several or many television channels) then it becomes relatively complex and costly. Gains in pick-up voltage from directive receiving antennas will be limited in practice and may approach but surely may not, as the frequency is increased, exceed the loss due to the decreasing size of practical antennas for the higher frequencies.

At the present time it would be

GLASS-TO-METAL SEALS

by the Thousand!

HUMIDITY-PROOF
SHOCK-PROOF
LEAK-PROOF



**Another modern electrical development
pioneered and perfected by Sprague**



Pioneered many months ago by Sprague, glass-to-metal seals for Sprague Capacitors and hermetically-sealed "Koolohm Resistors" have progressed far beyond any "laboratory curiosity" stage. Not only are they being produced commercially at better than 10,000 seals per day, but they have proved highly efficient both electrically and mechanically. Seal sizes range from very small up to 3" diameter. They work equally well with practically any metal including steel, brass, and monel metal, and do not require the use of glass bushings and adjacent metal rings with "matched" temperature coefficients of expansion.

There are, of course, plenty of "scientific" reasons why glass-to-metal seals of this type are not feasible.

Here again, however, the allegedly impossible has simply provided the incentive for another outstanding Sprague engineering achievement. Actually, the only disadvantage to the seals so far uncovered is the fact that corona voltages are a little lower than we'd like them to be—yet this limitation only becomes a factor at voltages upwards of 25 KV. In all respects, the Sprague glass-to-metal seal answers the old problem of guarding Capacitors and Resistors adequately against leaks and moisture—and without organic bushings or other materials which might be attacked by fungus.

Today, glass-to-metal sealed Sprague Capacitors and "Koolohm Resistors" are available in 8,000 electrical characteristic combinations—which is another way of saying that there is a sealed unit for every application that needs one. Details gladly sent on request.

SPRAGUE ELECTRIC COMPANY, NORTH ADAMS, MASS.
(Formerly Sprague Specialties Co.)



* T. M. REG. U. S. PAT. OFFICE

SPRAGUE

PIONEERS OF ELECTRICAL-ELECTRONIC PROGRESS

ONE CENTRAL SOURCE FOR
All Types of Industrial
ELECTRONIC TUBES



STOCKS ON HAND FOR
Immediate Delivery

**RECTIFIER
 POWER
 CONTROL
 PHOTO-ELECTRIC
 TRANSMITTING
 RECEIVING**

Here you have the advantage of a complete, centralized service on all types of industrial electronic tubes. Many are "on-hand" for rush delivery! This enables you to obtain the exact type you require, in the shortest possible time. Rectifier, power, control, photo-electric, cathode ray, transmitting, or receiving . . . in RCA, G.E., Raytheon, Amperex, Eimac, Taylor, and other well known makes.

**EVERYTHING IN
 ELECTRONICS & RADIO**

It's faster, simpler to get all your electronic and radio supplies from this one central source. We carry the largest and most complete stocks of parts and equipment under one roof . . . ready for immediate shipment. Besides, our procurement experts are in constant contact with all leading manufacturers. This complete service simplifies and speeds supply of diversified needs.

**Helpful
 BUYING
 GUIDE**

Available
 on Request
 Write for it!

*Save time and work—Call Allied First!
 Write, Wire or Phone Haymarket 6800*

Engineering Service Available

ALLIED RADIO

C O R P O R A T I O N

833 W. Jackson Blvd. Dept. 32-M-4 Chicago 7, Illinois

SUPPLIERS OF ELECTRONIC PARTS AND EQUIPMENT TO INDUSTRIAL AMERICA

Electronic Tubes, Rectifiers, Power Supplies, Intercommunicating Systems, Sound Systems, Photo-Cell Equipment, Batteries, Chargers, Converters, Generators, Supplies for Resistance Welders, Fuses, Test Instruments, Meters, Broadcast Station Equipment, Relays, Condensers, Capacitors, Resistors, Rheostats, Transformers, Switches, Coaxial Cable, Wire, Soldering Irons, Microphones, Speakers, Technical Books, etc.

more difficult to build a receiver to operate in the region from 500 to 1000 megacycles having the same efficiency of use of the received signal as at 50 megacycles. Progress in tube and circuit research will change this, so that at some time in the future there may be little or no difference in efficiency. This is not believed to be a fundamental factor in the allocation of frequencies below 1000 megacycles.

We need field test information under conditions which are true equivalents for the service to be rendered. Naturally, television transmission at the higher frequencies, under broadcast conditions would be ideal.

RCA is preparing to do this in New York at 288 megacycles and expects to have these tests started in the early spring. But this is only a beginning as tests are needed in the 300 to 1000 megacycles region. Therefore, I endorse the RTPB recommendation that commercial television be assigned channels not to exceed 300 megacycles top frequency.

Transmitter developments

Following the report of the National Television System Committee to the Commission during 1941, we took stock of our ability in RCA to produce tubes and transmitters for television, first, in the region

SKILL
 that saves you
TIME • MONEY
WORRY!



**FABRICATING
 GLASS BONDED MICA**

**COLONIAL
 KOLONITE COMPANY**
 2212 W. ARMITAGE AVE., CHICAGO, ILL.

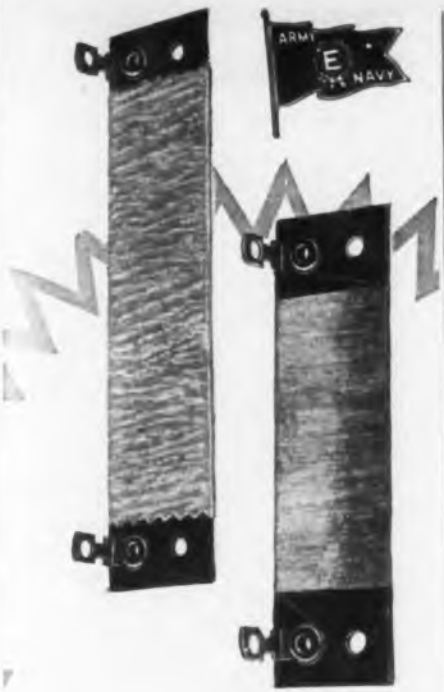

Tight-Tolerance RESISTORS

★ Just turn those tight-tolerance resistor requirements of yours over to CLAROSTAT, just as other electronic equipment and instrument builders have been doing for years past.

Remember, Clarostat specialists offer over two decades of winding experience, outstanding skill, and exclusive winding facilities. They wind all wire sizes even down to .0009" dia. Windings as fine as 600 to 700 turns per inch, on bakelite, ceramic or other material, flat or round. Also string windings in fibre glass, asbestos and cord.

★ Submit your problem . . .

Solving your resistance and control problems is our business. Call on us for engineering collaboration, specifications, quotations.



CLAROSTAT MFG. CO., Inc. • 285-7 N. 6th St., Brooklyn, N. Y.

of 50 to 180 megacycles, and second, in the region of 108 to 300 megacycles. That stock-taking indicated the need for active research and development if we were to be in a position to adequately supply the need of broadcasters for all of the channels assigned by the Commission to television broadcasting. The objectives we established for research and development, particularly output power levels, were weighted by practical matters, but at the same time they looked toward useful results. These objectives were:

- 50 to 108 megacycles — output power of 40-50 kilowatts
- 50 to 300 megacycles — output power of 5 kilowatts

Work on this program has gone along much slower than normal because of war work requirements. Today we have research tubes of the 40-50 kw type which have been tested to give the planned output under test conditions simulating television requirements over a part of the planned frequency range. We are sure of the fundamentals and when conditions permit, expect to bring the work rapidly to the engineering design stage.

Today we have a research-built television transmitter using the 5 kw type tube, operating at planned output and at 288 megacycles. This transmitter is now connected to an antenna above our laboratory in Princeton, N. J., and we are just starting our first transmission tests. The quality of the picture on the transmitter monitor is excellent. Reception tests at some distance from the laboratory are just beginning. We have planned several months of research work on tube, circuits and reception tests. Then we will move the transmitter to the Empire State Building in New York City for field tests under metropolitan area conditions. Our next objective in the 108 to 300 megacycles frequency band is to work on tubes for output powers up to 50 kw.

We are also working on tubes suitable for carrier frequencies above 300 megacycles and for modulation with television signals. Here we are less sure about what we can do because we have yet to obtain results under television conditions with output power of significance. Our next objective is to see what we can do at 600 megacycles. Two years from now we may expect to be as far along at this frequency as we are now for the 288 megacycle transmitter, i.e., just starting tests with power radiated from a research setup. Then we can begin to obtain directly applicable data and propagation conditions (multipath, shadow and signal attenuation) affecting television at this frequency.

This is IMPORTANT to 5 MANUFACTURERS

WE will purchase one or more equipment or component manufacturing businesses in these fields

RADIO
TELEPHONE
TELEGRAPH
TELEVISION
WIRE PHOTO
SOUND on FILM

OR we will purchase only a particular Department. In either case we will assume responsibility for servicing equipment now in use.

All answers will be held confidential.

Please Reply to BOX A-27

ELECTRONIC INDUSTRIES
400 Lexington Avenue, New York 17, N. Y.

(The publisher is authorized to furnish our name if written request is made on your company letterhead.)

B & W *Miniature* R-F INDUCTORS



**SAMPLE
FREE**

Write for
sample card
containing ac-
tual unit. Also
ask for Bulletin
78C describing
B & W Miniduc-
tors in detail.

B & W

New Standards of Efficiency for Many Types of Radio Equipment

THINK of all of the places where you can use exceptionally rugged, finely made, light-weight little coils like this! Many types of mountings, pitches from 4 to 44 t.p.i., and any diameter from $\frac{1}{8}$ " to $1\frac{1}{4}$ " can be supplied. Q is amazingly high, due to the small amount of insulating material in the electrical field.

These B & W Miniductors can be

equipped with either fixed or variable, internal or external coupling links, and many other special features. They are adaptable to every need from complicated band-switching assemblies and "tailor-made" coupling link units, to sturdy, easy-to-mount coils for any tuned r-f circuit. Send us your specifications. We'll match them!



BARKER & WILLIAMSON

DEPT. EL-124, 235 FAIRFIELD AVE. UPPER DARBY, PA.
Export: LINDETEVES, INC., 10 Rockefeller Plaza, New York, N. Y., U. S. A.

NEW BULLETINS

Measuring Instruments

The General Catalog issue "Modern Precision," published by Leeds & Northrup, may be of interest to any industrial man who has a problem which must be solved through the use of measuring instruments and controls. It briefly describes all L & N products for regulating plant processes. It includes details concerning four pyrometric methods: Thermocouple, Rayotube, Thermohm and Optical, and equipments which measure such quantities as pH, speed, gas analysis, etc. A large chart shows the particular instrument model which is available in each case... installation photographs show the equipments in service. Those interested may receive a copy from Leeds & Northrup Co., 4934 Stenton Ave., Philadelphia 44, Pa., by specifying Folder ENT(7a).

Solenoid Bulletin

A complete new bulletin on dc solenoids has been issued by Cannon Electric. This 32-page bulletin contains photographs of their full line of direct current solenoids, together with tabular data, dimensional drawings, wiring diagrams and response characteristic charts. The introduction which lists the aircraft applications of the dc solenoid includes general means of operating mechanisms such as retarding magnetoes for starting engines, operating hydraulic valves and mechanical clutches, firing machine guns, arming and releasing bombs, releasing auxiliary fuel tanks and locking aircraft retracting gear. In other industries dc solenoids are adaptable for film winding mechanics and cameras. The bulletin is distributed by Cannon Electric Development Co., 3209 Humboldt St., Los Angeles 31, Calif.

Postwar Explosive Rivets

Uses of explosive rivets in peacetime production jobs are discussed fully in a new manual published by E. I. du Pont de Nemours & Co., Wilmington, Delaware.

The explosive rivet was developed to meet the need for a quick, sure "blind" fastening in the hard-to-get-at places in aircraft. First a rivet was made with a small explosive charge in the end of the shank. Exploded by a high frequency heating coil or by an electric riveting iron, the charge formed a barrel-shaped closing head.

Du Pont has developed an improved rivet with the charge running the full length of the shank. When the charge is fired, not only does the blind end form the same

MODEL 201



The Time-Tested, Reliable **VIBROTEST**

Insulation Resistance Tester

Since 1938 VIBROTESTS have proven the soundness of this modern method of testing insulation resistance. Superbly engineered, ruggedly built, this pioneer instrument in CRANKLESS INSULATION TESTING offers the utmost in usefulness and value.

VIBROTEST

Is Thoroughly Modern —

No handcranking, no leveling, no shocks to the operator. Wide range of 0-200 megohms covering values usually encountered in general testing are instantly available from a self-contained power service providing a constant potential of 500 volts DC.

Available in this one compact instrument are a convenient ohmmeter scale, as well as AC and DC voltage ranges of 150-300-600 volts full scale, which covers all testing problems usually encountered in industry.

Many Other VIBROTESTS

are designed for specific uses involving unusual ranges of operating conditions. WRITE for full information at your earliest opportunity.

ASSOCIATED 
RESEARCH,
Incorporated

221-B So. Green Street • Chicago 7, Ill.

NEW BULLETINS

barrel-shaped head as before but, in addition, the shank fills the hole through which it passes. Thus the rivet holes need not be drilled to such close tolerances.

The Du Pont booklet cites numerous possibilities for postwar uses of explosive rivets; among them are:

Refrigeration—in the construction of cabinets for the home, the locker plant and the farm.

Radio Manufacture—in sealing radio units and the production of cabinets.

Household Appliances—in the manufacture of washing machines and other household aids—even to attaching name plates.

Relays and Solenoids

A four page illustrated bulletin giving details and operating characteristics on eight relays and eight solenoids has been issued by Guardian Electric, 1404 W. Washington Blvd., Chicago. Relay charts show standard voltages, maximum contact capacity, coil resistance, and operating current. Solenoid charts give resistance and operating current at standard voltages and show stroke and lifting capacity of small solenoids.

Mike Information

An informative six page booklet dealing with and illustrating several types of communications microphones, has been issued by the Electro-Voice Corp., 1239 South Bend Ave., South Bend 24, Ind. Complete with illustrations of the various communications microphones, the booklet includes specifications and price listings. The lip-type, Model 245, or differential microphone, which allows the free use of the hands, the hand-held model 205-S, the noise-cancelling microphone, and the dynamic Model 600-D, are among those listed in the booklet.

Non-Metallic Materials

Six products which find wide uses in the electronic field have been technically described in a new 12-page booklet just issued by Continental-Diamond Fiber Co., Newark 50, Delaware. The products are: Diamond vulcanized fiber, which comes in rolls, sheets, tubes and rods; Dilecto, which is a laminated phenolic plastic; Dilectene, a pure synthetic resin; Celoron, a phenolic impregnated fabric material; Micabond, available in plates, sheets and also as round, square, oval or hexagonal tubing; Vulcoid, an insulation material in sheets, rods and fabricated parts. Quite complete specifications and much engineering data are given on all products.



Broadcast Station Directional Equipment

Have you investigated the possibilities of increasing power by installing directional antenna equipment to "protect" other near-by stations on your frequency? If not, this should definitely be a part of your Post-War plans.

Johnson Engineers are pioneers in the directional antenna equipment field. They have completed and delivered 39 such units (probably more than any other manufacturer) and it is not too soon to place your order for Post-War delivery.

Johnson service includes working in cooperation with your consulting engineer in design of the equipment, building the phasing unit with cabinet to match your other equipment, furnishing tower coupling units, and furnishing concentric line, gas equipment and other accessories.

Write to Johnson today for further information and estimates.

JOHNSON
a famous name in Radio

E. F. Johnson Co. Waseca, Minn

CONCORD Service!

NONE BETTER IN AMERICA FOR RADIO AND ELECTRONIC PARTS AND EQUIPMENT



Sure! Swift! Satisfactory! That's the story of Concord Radio Corporation's service. Twenty-two years of "delivering the goods" have made us a top supplier of radio and electronic merchandise to industry, government and the trade. Two strategically located "supply bases"—CHICAGO and ATLANTA—are as close to you as a letter, a telephone call, a telegram, or a message on the teletype. Here is what Concord can offer you:

- The finest merchandise from the best manufacturers
- Large and complete stocks of components and equipment
- A seasoned selling staff of radio and electronic experts
- Consultant radio technicians and engineers
- Same-day shipment, wherever humanly possible
- Super-speed "special service" for military and industrial needs
- Special radio training kits for radio schools

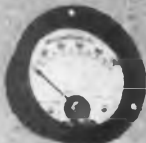

Weston
2 1/2" Model
505 Milliammeter
D.C. 0-100
Weston
2 1/2" Model
505 Milliammeter
D.C. 0-200

Your Cost, other type, \$4.05



IRC Dual
Potentiometer
1 1/2" diameter
1 1/2" deep
1/4" shaft—3/8" long
Your Cost, 85c

Micro-Switch, Type
Z, S.P.S.T. Normally
closed. Aero-Switch,
similar to above but
normally open.

Your Cost,
either type, 70c



25 mfd. 25 volt
condenser in alu-
minum can.
Your Cost, 25c

FREE! Special Supplement! "Hard-to-Find Radio and Electronic Parts and Equipment"

Sixteen pages, jammed to the margins with such items as condensers, wire, switches, volume controls, relays, resistors, test accessories, speakers, etc. There's not another listing like it anywhere else in the country today! All items are on the "high requirement" list . . . all first quality . . . all exceptional values and all available for immediate shipment!

MAIL THIS COUPON FOR RUSH SERVICE

CONCORD RADIO CORPORATION
901 W. Jackson Blvd., Chicago 7, Ill., Dept. No. J-12

Please rush me the new 16-page "Special Supplement" by Concord Radio Corporation.

NAME _____

ADDRESS _____

CITY _____

STATE _____



CONCORD RADIO CORPORATION
Lafayette Radio Corporation

901 W. Jackson Blvd., CHICAGO 7, ILL. ★ 245 Peachtree St., ATLANTA 3, GA.

MEASURING POTENTIALS IN GROWING THINGS

(Continued from page 85)

cal phenomena long regarded as pure superstition. If findings of an electrical field accompanying organic growth points to the hypothesis that the exterior electrical fields may influence the behavior pattern of growth, then experiments may well be directed toward this end.

Some time ago certain experiments were tried at the Cosmic Terrestrial Laboratory at Needham, Massachusetts, to detect any effect which an imposed direct current field might have on plant growth. These experiments were a corollary to the routine measurements of changes in atmospheric electrical potential near the earth's surface. To guard against inequalities in the supply of moisture and nourishment tomato seeds were planted in sterile sand, fed hydroponically, with a nutrient solution compounded in accordance with the Smithsonian Institution formula. Fig. 10 is a photograph of the plants thirty-three days from seed. Above each receptacle was a fine mesh copper screen, the one on the left being maintained at a negative potential of ninety volts with respect to the root system. The right hand specimen, being the control, was set up in a precisely similar

Wanted ENGINEERS

Radio

Chemical

*Electrical

Electronic

*Mechanical

Metallurgical

*Factory Planning

Materials Handling

Manufacturing Planning

Work in connection with the manufacture of a wide variety of new and advanced types of communications equipment and special electronic products.

Apply (or write), giving full qualifications, to:

R.L.D., EMPLOYMENT DEPT.

Western Electric Co.

100 CENTRAL AV., KEARNY, N. J.

*Also: C.A.L.

Locust St., Haverhill, Mass.

Applicants must comply with WMC regulations

STANDARD



Air Tuned I.F. Transformer

INGENUITY

When a really difficult coil problem confronts you, let us demonstrate how our specialized research, engineering and production skill can solve it — just as it has so many other complex assignments. Our engineering staff is available for consultation without obligation.

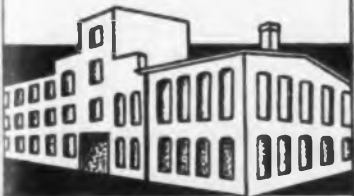

WE INVITE YOUR INQUIRIES

STANDARD WINDING CO.

44-62 Johnes Street
NEWBURGH, NEW YORK
NEW YORK OFFICE 53 PARK PLACE
REctor 2-5334

manner except that the over-suspending screen had no applied potential. While care was taken to see that both specimens received the same illumination, a second planting was made with the experimental specimen at the left and the control specimen at the right. Again the result showed an accelerated growth in the specimen subjected to negative potential.

Similar experiments were conducted with mustard seeds and the result photographed thirty-eight days from seed, are shown in Fig. 11. In these instances, the voltage was arbitrarily chosen. In order to attempt to discover the optimum potential gradient for greatest growth, a hydroponic trough was constructed in which plants were grown under a sloping screen to which was applied 190 negative volts with respect to the roots. The photograph (Fig. 12) is a silhouette of the growth resulting forty-three days after germination.

It will be observed that at the extreme left where the potential gradient was high, the growth was markedly stunted. At the extreme right where the potential gradient was relatively low, the growth was not far from normal expectancy. A little to the right of the center of the trough, the maximum growth was obtained. A measure of the distance from root level to the charged screen in a vertical direction at this point revealed a potential gradient of approximately four volts per centimeter, which is apparently the optimum value of the potential gradient for greatest growth.

Other experiments have since been tried in the open without significant results. Perhaps, however, it should be noted that in the laboratory experiments here recorded, the receptacles were not placed at ground potential. Whether or not this is significant or whether other conditions peculiar to the laboratory existed, not common to natural growth in the ground is not yet a matter of knowledge.

Army-Navy "E" Awards

Amperez Electronic Corp., 79 Washington St., Brooklyn, N. Y. (second star added).

DeJur-Amsco Corp., Shelton, Conn. (white star added).

Canfield Mfg. Co., 718 North 7 St., Grand Haven, Mich.

The Electro Motive Mfg. Co., Willimantic, Conn. (second star added).

Galvin Mfg. Corp., 4545 Augusta Blvd., Chicago, Ill. (4th star added).

The General Industries Co., Elyria, Ohio (white star added).

Rola Company, Inc., 2530 Superior Ave., Cleveland, Ohio (second star added).



**cuts a
Purchasing Agent's
time to minimum**



- Tubes
- Relays
- Meters
- Resistors
- Capacitors
- Transformers
- Test Equipment

Hard-to-find Radio and Electronic Components from famous makers!

On our shelves, we've got the merchandise you need. At our fingertips, we have the answers to questions you ask . . . about priorities, about technical problems, about the effectiveness of substitutes. And we DELIVER! Trained expeditors ship your orders by the fastest possible methods. And there's guaranteed satisfaction on every purchase. HARVEY is a "find" for harassed purchasing agents . . . try us, and you'll know the reason why!

P. S. HARVEY now distributes AUDAX, the "royal family" of Pickups, Cutters and Jewel Points.

Telephone Orders to LOagacre 3-1800



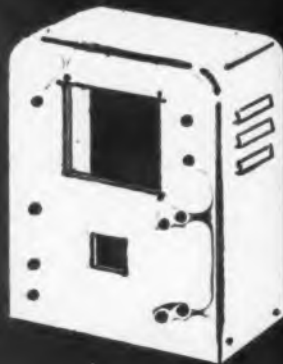
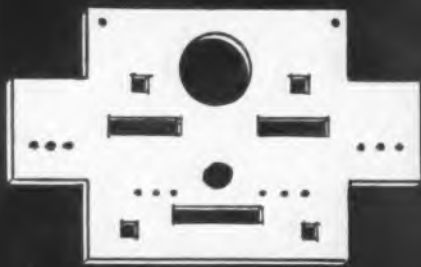

What are Your

PRECISION METAL WORKING REQUIREMENTS?

Do you require versatility—the ABILITY to do sheet metal work, stamping and fabricating—the ABILITY to build metal boxes and cases in a wide variety of sizes—to build cabinets, chassis, odd shaped flat pieces, strips, panels, housing, etc.? Do you require the ABILITY to do precision work to extremely close tolerance? What about the ABILITY of helping work out a design or design change that can save up to thousands of dollars and speed delivery of many weeks?

If the answer to any of the above questions is YES, write us for further information or consultation on specific jobs.

PORTER

METAL PRODUCTS COMPANY

121 INGRAHAM ST., BROOKLYN, N. Y.

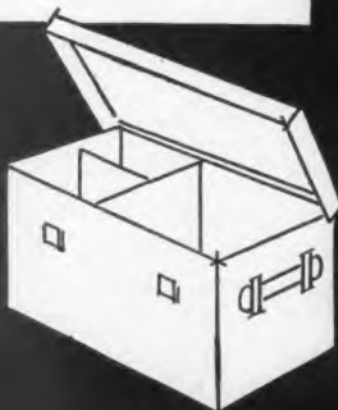
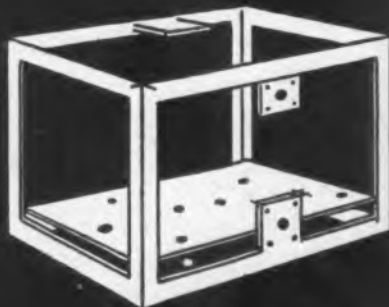

FCC Fly Flies

By now most everyone knows that James Lawrence Fly is through as Chairman of the Federal Communications Commission, a job he has held through many a storm since 1939. But nobody knows yet who his successor will be. Paul Porter, publicity director of the Democratic National Committee, is a possible appointee, perhaps probable; so is J. Leonard Reinsch, radio chief of the Democratic Committee. Maybe both will be appointed to FCC, now that it is still to be President Roosevelt, for the resignation of T. A. M. Craven last June leaves two vacancies to be filled. Porter is a former attorney for CBS, was OPA rent control chief until last July. Reinsch is on leave as managing director of several radio stations owned by James E. Cox, Roosevelt's running mate back in 1920.

Fly has announced his intention of returning to the practice of law. He was a private lawyer in New York when he joined the anti-trust department of the government under President Hoover, soon became prominent by defeating the late Wendell Willkie in the historic battle of the Tennessee Valley Authority. During his tenure of office, Fly has been often criticized, frequently damned as a despot, investigated by Congress. Consensus is that he has done a good job.

IBM—G-E Radio Relay System

The first major decision of the FCC after its Allocations Hearings was the authorization of the applications of the International Business Machines Corp. and the General Electric Co. to operate a chain of experimental radio relay stations from Washington to New York and from New York to Schenectady and New Scotland, N. Y.

Pulse transmissions

The two companies propose to develop a new system of point-to-point communications, employing high-speed pulse transmissions in connection with the operation of business machines, as well as standard emissions for the relaying of television and FM programs. The system will utilize wide band ultra-high frequencies experimentally and will particularly engage in relaying the television programs of General Electric stations W2XI (New Scotland) and W2XGE (Schenectady). The frequencies to be employed will be 1,900-1,960; 1,960-2,020; 2,020-2,080; 2,120-2,180; 2,180-2,240, and 2,240-2,300 megacycles, with 15 watts power.

NO QUICK DECISION ON SPECTRUM ALLOCATION

(Continued from page 114)

Following are RTPB recommendations as presented by Panel 2 to FCC:

Megacycles	Service	Notes
25.5—27	INDUSTRIAL APPLICATIONS	
27—29	AMATEUR	
29—48	NON-GOVERNMENT EMERGENCY AND MISCELLANEOUS† and GOVERNMENT MISCELLANEOUS SERVICES, FIXED (3 Channels), MOBILE (5 Channels), INDUSTRIAL APPLICATIONS (1 Channel at 40 mc)	
48—58	FM BROADCASTING	
58—60	AMATEUR	
60—218	To be assigned to Areas A and B as shown below:	
	A Areas (1)	B Areas (2)
60—66	TELEVISION	TELEVISION
66—72	NON-GOVERNMENT EMERGENCY SERVICES	TELEVISION
72—78	TELEVISION	TELEVISION
78—84	NON-GOVERNMENT EMERGENCY SERVICES	TELEVISION
84—90	TELEVISION	NON-GOVERNMENT EMERGENCY SERVICES
90—96	NON-GOVERNMENT EMERGENCY SERVICES	TELEVISION
96—102	TELEVISION	NON-GOVERNMENT EMERGENCY SERVICES
102—108	NON-GOVERNMENT EMERGENCY and MISCELLANEOUS SERVICES*	NON-GOVERNMENT EMERGENCY and MISCELLANEOUS SERVICES
108—132	AIR NAVIGATION and AIR MOBILE for use immediately following the war and until such time thereafter as may be required (3)	AIR NAVIGATION and AIR MOBILE for use immediately following the war and until such time thereafter as may be required (3)
132—144	GOVERNMENT	GOVERNMENT
144—148	AMATEUR	AMATEUR
148—152	GOVERNMENT MISCELLANEOUS SERVICES	GOVERNMENT MISCELLANEOUS SERVICES
152—158	TELEVISION (4)	NON-GOVERNMENT EMERGENCY and MISCELLANEOUS SERVICES (4)
158—164	NON-GOVERNMENT EMERGENCY and MISCELLANEOUS SERVICES	TELEVISION
164—170	TELEVISION	GOVERNMENT EMERGENCY and MISCELLANEOUS SERVICES
170—176	NON-GOVERNMENT EMERGENCY and MISCELLANEOUS SERVICES (5)	TELEVISION (5)
176—182	TELEVISION (5)	NON-GOVERNMENT EMERGENCY and MISCELLANEOUS SERVICES (5)
182—188	NON-GOVERNMENT EMERGENCY and MISCELLANEOUS SERVICES	TELEVISION
188—194	TELEVISION	NON-GOVERNMENT EMERGENCY and MISCELLANEOUS SERVICES
194—200	NON-GOVERNMENT EMERGENCY and MISCELLANEOUS SERVICES	TELEVISION
200—206	TELEVISION	NON-GOVERNMENT EMERGENCY and MISCELLANEOUS SERVICES
206—212	NON-GOVERNMENT EMERGENCY and MISCELLANEOUS SERVICES	TELEVISION
212—218	TELEVISION	TELEVISION
218—225	AMATEUR	AMATEUR
225—400	GOVERNMENT	GOVERNMENT
400—429	GOVERNMENT MISCELLANEOUS SERVICES, STUDIO TRANSMITTER LINK (Broadcasting) POINT-TO-POINT TRANSMITTER CONTROL CIRCUITS (12 mc)	GOVERNMENT MISCELLANEOUS SERVICES, STUDIO TRANSMITTER LINK (Broadcasting) POINT-TO-POINT TRANSMITTER CONTROL CIRCUITS (12 mc)
420—450	AIR NAVIGATION AIDS, AMATEUR (to be discontinued as soon as possible after the war)	AIR NAVIGATION AIDS, AMATEUR (to be discontinued as soon as possible after the war)
450—460	AIR NAVIGATION AIDS, FACSIMILE BROADCASTING (to be discontinued as soon as possible after the war)	AIR NAVIGATION AIDS, FACSIMILE BROADCASTING (to be discontinued as soon as possible after the war)
460—956	TELEVISION BROADCASTING (Experimental) and TELEVISION RELAY (700-900 mc only, to be abandoned when space is needed for commercial television broadcasting)	TELEVISION BROADCASTING (Experimental) and TELEVISION RELAY (700-900 mc only, to be abandoned when space is needed for commercial television broadcasting)
508—524	AIR NAVIGATION AIDS (to be discontinued as soon as possible after the war) 12 mc between 480 and 500 mc for point-to-point transmitter control, final allocation to be determined after channel allocations have been made.	AIR NAVIGATION AIDS (to be discontinued as soon as possible after the war) 12 mc between 480 and 500 mc for point-to-point transmitter control, final allocation to be determined after channel allocations have been made.
956—1,125	NAVIGATION AIDS	NAVIGATION AIDS
1,125—1,225	AMATEUR	AMATEUR
1,225—1,325	PORTABLE AND MOBILE RELAY	AMATEUR
1,325—1,450	GOVERNMENT including AIR NAVIGATION AIDS	GOVERNMENT
1,450—1,500	METEOROLOGICAL and AIR NAVIGATION	GOVERNMENT
1,500—1,600	AERONAUTICAL EXPERIMENTAL	GOVERNMENT
1,600—1,900	GOVERNMENT RELAY AND STUDIO TRANSMITTER LINK (Broadcasting) 2,200-2,800 mc only	GOVERNMENT RELAY AND STUDIO TRANSMITTER LINK (Broadcasting) 2,200-2,800 mc only
2,300—2,500	AIR NAVIGATION	GOVERNMENT
2,500—2,700	AMATEUR	AMATEUR
2,700—3,900	NAVIGATION AIDS	AMATEUR
3,900—4,450	RELAY	AMATEUR
4,450—4,550	INTRA-CITY RELAY (Television)	AMATEUR
4,550—5,200	GOVERNMENT	AMATEUR
5,200—5,750	AMATEUR	AMATEUR
5,750—6,800	EXPERIMENTAL RELAY and OTHER EXPERIMENTAL	AMATEUR
6,800—7,200	EXPERIMENTAL INTRA-CITY RELAY (Television), EXPERIMENTAL STUDIO TRANSMITTER LINK and OTHER EXPERIMENTAL	AMATEUR
7,200—10,000	GOVERNMENT	AMATEUR
10,000—10,500	AMATEUR	AMATEUR
10,500—13,000	EXPERIMENTAL RELAY and OTHER EXPERIMENTAL	AMATEUR
13,000—16,000	GOVERNMENT	AMATEUR
16,000—18,000	EXPERIMENTAL RELAY and OTHER EXPERIMENTAL	AMATEUR

Above 30,000... EXPERIMENTAL

- The services under this column are allocated the bands of frequencies indicated to be used in certain areas (television predominantly metropolitan) to be designated by the FCC.
- The services under this column are allocated the bands of frequencies indicated to be used outside A Areas (C Areas, D Areas, East Coast and North Central U.S.).
- These frequencies to be allocated to Television and Other Services when and if use by Air Services no longer necessary.
- Government Military Aviation 152-156 (to be discontinued as soon as possible after the war).
- Air Navigation 170-180 mc (to be discontinued as soon as possible after the war).

*With first priority for non-government emergency services and second priority for miscellaneous ground mobile services requiring the use of the same channel in more than one class of area.

†Non-Government Emergency Services include: Police, Fire, Forest and Conservation, Emergency Power and Utilities. Non-Government Miscellaneous Services include: Common Carrier—Highway, Common Carrier—Urban, Common Carrier Circuits, short haul toll and rural subscribers, Coastal Harbor, Transmitter Control, Railroads, Broadcast Relay, Taxi, Bus, Petroleum, Highway Operation, Power and Utilities Communications, Special Experimental for low power mobile and low power point-to-point services.

Global BRAND SEMI-INSULATED CERAMIC RESISTORS

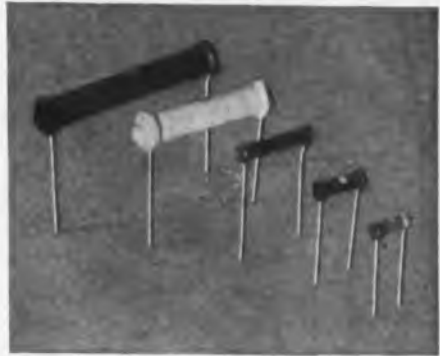

● Low ohmic values are made in body type "CX" only whereas type "A" body is offered in a wide range of resistance values.

Global Brand Resistors are unusually rugged as your tests will prove. Those illustrated are standardized sizes and resistance values. In case you require resistors having special characteristics we can furnish them. Larger units or special sizes can be provided.

Write us outlining your resistor problem, it will receive prompt and careful consideration.

PHYSICAL AND ELECTRICAL SPECIFICATIONS
TYPE "A" RESISTORS

PART NUMBER	WATT RATING	RESISTANCE RANGE	OVERALL LENGTH	OVERALL DIAMETER
997-A	1/8	150 Ohms to 4.7 Megohms	2 1/4"	3/16"
763-A	1/4	47 Ohms to 15 Megohms	3/4"	1/8"
759-A	1/2	33 Ohms to 15 Megohms	3/4"	1/8"
766-A	1	47 Ohms to 15 Megohms	1 1/8"	1/8"
792-A	3	33 Ohms to 150,000 Ohms	1 7/8"	1 1/32"
774-A	5	33 Ohms to 220,000 Ohms	2 3/8"	1 1/32"

TYPE "CX" RESISTORS

PART NUMBER	WATT RATING	RESISTANCE RANGE	OVERALL LENGTH	OVERALL DIAMETER
997-CX	1/8	1 to 150 Ohms	2 1/4"	3/16"
763-CX	1/4	1 to 47 Ohms	3/4"	1/8"
759-CX	1	1 to 33 Ohms	3/4"	1/8"
766-CX	2	1 to 47 Ohms	1 1/8"	1/8"
792-CX	4	1 to 22 Ohms	1 7/8"	1 1/32"
774-CX	6	1 to 33 Ohms	2 3/8"	1 1/32"

STANDARD RESISTANCE (Tolerances 5% - 10% - 20%)

ALL RESISTORS COLORED ACCORDING TO E. I. A. STANDARDS.

ORDER BY PART NUMBER, RESISTANCE VALUE AND TOLERANCE.

Global Division
THE CARBORUNDUM COMPANY
TRADE MARK
NIAGARA FALLS, N. Y.

{Carborundum and Global are registered trade marks of (and indicate manufacture by The Carborundum Co.)

Ingenious New Technical Methods

Presented in the hope that they will prove interesting and useful to you.



New 9000° Arc Torch Can Be Used for Welding and Brazing All Ferrous and Non-Ferrous Metals and Alloys

Now an arc torch that makes it possible to do most jobs *electrically* that previously were thought possible only with gas. This attachment for arc welders provides an independent source of heat by means of two carbons. It is capable of producing intense heat, approximately 9000° F., over 2000° hotter than an oxyacetylene flame. Pure heat, no oxygen or gas to contaminate the weld. No pressure to force the molten metal away or blow holes in light sections.

Developed to capitalize to the fullest on the time-saving advantages of electric welding, the new Mid-States 9000° arc torch can be used with any AC or DC electric welder. It opens up new horizons of service in this field, never before possible with an electrically operated instrument.

New uses are being found every day for products that have been familiar to us for years. Wrigley's Spearmint Gum, always enjoyed for its chewing satisfaction, is now proving with the fighting men overseas many benefits which will be useful to you in peacetime. One of the big factors in mass production is the alertness and efficiency of the man on the job. The chewing of Wrigley's Spearmint will help keep you alert and wide-awake during those work periods that, while seemingly dull and monotonous, call for watchfulness in order to get perfection in the final assembly.

You can get complete information from Mid-States Equipment Co., 2137 S. Wabash Avenue, Chicago 16, Illinois.



For BRAZING Steel, Cast Iron, Malleable Iron, Copper, Brass, Bronze, and other ferrous and non-ferrous metals.



For HEATING to Straighten or Bend, etc.

Y-168

G-E Safety Door Interlock Switch

OPEN the door and the power's off! Prevents accidents, protects equipment. Will not fail mechanically. For complete details, write:

GENERAL ELECTRIC
ELECTRONICS DEPARTMENT SCHEMECTADY, N.Y.



Postwar Set Prices

Prices at which postwar radio sets are to be sold to an avidly waiting public are far from being settled. As it stands at present OPA won't have the last say. Any increases above the 1942 level, where OPA Administrator Bowles would peg them, must be okayed first by OPA and then by Economic Administrator Director Vinson. RMA states that if a uniform formula can be adopted by Vinson, it will not be necessary for him to pass on price ceilings for individual companies provided they fit within the formula. The trade looks for increases somewhere between 12½ and 25 per cent.

SMPE CONFERENCE

(Continued from page 93)

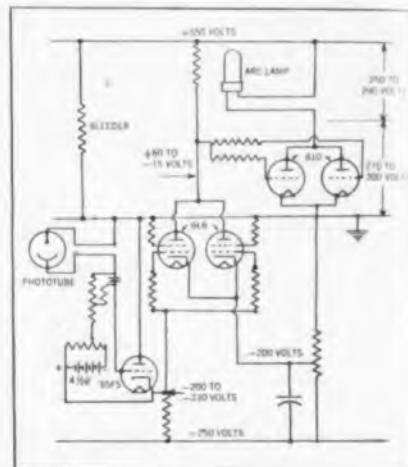

Fig. 9—Inverse light-feedback control circuit for modulated mercury vapor arc

pair of 6L6 beam tetrodes excited by a single 6SF5 high mu triode. A change in light output of the arc falling on the phototube results in a signal to the grids of the 810's opposing this change, maintaining a linear relationship between light output and audio signal input. The audio is introduced into the circuit in such a way as to have the same effect upon the arc as if it had originated in the phototube.

Aircraft Vibration Studies

"Application of Sound Recording Techniques to Airplane Vibration Analysis," by J. C. Davidson and J. G. Frayno, Electrical Research Products Division, Western Electric Co.: This paper described methods which have been developed for analysis of the various vibration components present in airplane structures. The complex wave forms are recorded on standard motion picture sound negatives during flight. These films later, after proper development, are analyzed

**NEW
IMPROVED**

**"T"-PAD
ATTENUATORS
BY TECH LAB**



- Stainless Silver Alloy contacts and wiper arms.
- Rotor hub pinned to shaft prevents unauthorized tampering and keeps wiper arms in perfect adjustment.
- Can be furnished in any practical impedance and db. loss per step upon request.
- Write for our Bulletin No. 431.

**TECH
LAB MICROHMMETER**



Direct and instantaneous resistance readings down to 5 microhms and up to 1,000,000 megohms. Write for Bulletin No. 432.

**TECH
LABORATORIES**

11 LINCOLN STREET
JERSEY CITY 7, N. J.

electrically, making possible a complete analysis on the ground and thereby reducing materially the time devoted to flight test and also simplifying the process of analysis of complex wave forms. The technique described makes possible a permanent record of the conditions obtained during the particular flight under examination which may be subjected to review at any future date.

"Airplane Vibration Recorder," by J. C. Davidson and G. R. Crane, Electrical Research Products Division, Western Electric Co.: This paper described a portable film recorder capable of simultaneously recording 13 variable area tracks on 35 mm. film. It is intended for use in the analysis of airplane vibration or similar studies in which it is desirable to record disturbances (mechanical, acoustical or electrical) from a number of sources in such a manner that the resultant record can be analyzed for frequency, amplitude and phase relation. Film speeds of 12, 6 or 3 inches per second are available.

"An Airplane Vibration Reproducer," by G. R. Crane, Electrical Research Products Division, Western Electric Co.: This paper described a reproducer set designed for use in the reproduction for analysis of multiple track film recordings. It is capable of reproducing simultaneously 13 variable area tracks recorded side by side on standard 35 mm. film. Recorded signals between 5 and 3,000 cps are accurately reproduced and may be analyzed for frequency components, amplitude and phase relation.

New Sound Film Stock

"Comparison of Variable Area Sound Recording Films," by Dorothy O'Dea, RCA Victor Division, Radio Corp. of America: This paper described the test results obtained by comparing the new Eastman 1372 film with others in current use. Tests indicate that this film has characteristics superior to the Eastman films now in use for variable area sound recording, particularly with respect to density speed, processing tolerances, and requirements for direct positive.

Television Cables

"Coaxial Cable and other Facilities for Television Networks," by H. S. Osborne, Chief Engineer, American Telephone and Telegraph Co.: The telephone companies of the country provide many services which contribute to the entertainment industry. The part they may play in the introduction of television as a new means for the nationwide distribution of information, news and entertainment is related to the Bell System plans for ex-

University

**REFLEX
SPEAKERS**



**DESIGNED
for
WAR
USE**



★ **HIGH
EFFICIENCY** ★



★ **RUGGED
CONSTRUCTION** ★



★ **HIGH
POWER** ★

★ **UNIFORM
RESPONSE** ★



★ **HIGH
INTELLIGIBILITY** ★

★ **WEATHER
PROOF** ★

★ **REFLEX
SPEAKERS
ARE THE
ACCEPTED
STANDARD
FOR ALL
WAR
USE** ★



Every high efficiency speaker in University's extensive line of speech power reproducers has a vital part in the WAR program.



Submit your special loudspeaker problem direct to our engineering department.



UNIVERSITY
327 VARICK STREET N. Y. C.

Radiart

Wishes You A



Latest W P B Information is . . . No permission to make auto antennas until Germany surrenders.

THE RADIART CORPORATION

3571 W. 62nd Street

Cleveland 2, Ohio



GROVES

wire wound

RESISTORS

EFFICIENT UNDER TROPICAL HEAT

Engineered and constructed to meet the severest service conditions. Stand the gauntlet of shock, vibration; heat and humidity. Prevent failures caused by long exposure to high humidity with resultant electrolysis. Also available with low temperature coatings. Wide range of types and sizes. . . . Catalog sent on request.

GROVES

CORPORATION

CAPE GIRARDEAU

MISSOURI

tending coaxial cable networks. The general features of the coaxial cable system as designed for both telephone and television use were reviewed and the past and possible future use of coaxial cable in television networks discussed. The possible future development of new types of systems, including repeated radio was also considered.

WHAT'S NEW

(Continued from page 108)

Band-Pass Filter

Interstage band-pass filters having a primary impedance of 10,000 ohms, designed to operate from the plate of a triode to a succeeding grid, and having a gain of approximately 2 to 1 are being produced by United Transformer Co., 150 Varick St., New York. The unit has a dual alloy mag-



netic shield which reduces inductive pickup and is hermetically sealed. Filters of this type can be supplied for any band-pass frequency from 200 to 10,000 cycles.

Self-Locking Nut

A recently developed radically new self-locking nut is all-metal, thus eliminating plastic or rubber insertions. It does not jam the threads to fasten and has full and undisturbed threads throughout the entire length of the nut. Tests indicate that the new nut is stronger and that it will withstand higher heat temperatures, oil, or any other disturbing element that might affect proper functioning. It will maintain its locking features regardless of the number of times it is screwed on and off, and the self-locking principle will not injure the thread of either the bolt or the nut. Manufacturer is Dzus Fastener Co., Babylon, N. Y.

Impregnating Varnish

This new impregnating insulating varnish (PG-4-FC) for all types of electrical windings, unlike the conventional surface protective coating, is designed to protect each layer of wire. Therefore, if the surface of the winding is damaged in rough handling, the fungicidal protection of Synthite clear baking varnish is still retained. Curing of the varnish takes place through heat induced chemical polymerization which brings about complete solidification of the entire mass. This type of curing eliminates the possibility of wet spots in the interiors of windings. The degree of hardness can be controlled by altering the baking time and temperature. Although this varnish solidifies completely in a relatively short period of time, a longer bake will produce a finish

WHAT'S NEW

which is extremely hard. The varnish is adaptable for use on modern types of polyvinyl acetal coatings of magnet wire, glass insulation and Class "B" insulation as well as textile tapes. Manufacturer is John C. Dolph Co., 168 Emmet St., Newark, N. J.

Andrew Antenna Tuner

The primary purpose of the new Andrew Type 48 antenna tuning unit is to efficiently couple a vertical tower antenna to a coaxial transmission line. It does this by means of an I network, the elements of which are variable to permit adjustment for optimum performance. The unit, manufactured by The Andrew Co., 368 E. 75th St., Chicago, has a built-in isolation filter, to permit connecting a coaxial transmission line to an ultra high frequency antenna on top of tower. This permits operation of a high frequency "talk-back" antenna on top of a low frequency tower. It is enclosed



in a substantial steel weatherproof cabinet, and has a built-in tower lighting filter, to facilitate feeding aircraft warning lights on top of tower. Steatite insulation is used throughout. Plug-in meter positions, to facilitate temporary metering in all branches of the circuit during adjustment are provided. There is a convenient outlet box, for soldering iron, extension light, etc.

"TH" Carbonyl Iron Powder

Type "TH" carbonyl iron powder, which was first made in this country in 1941 and which then cost \$3 a pound, has been reduced in price from \$1.75 to \$1.20 a pound by the General Aniline Works division of General Aniline and Film Corp. Type "TH" carbonyl iron powder heretofore has been used exclusively for military electronic and communications equipment, and was especially developed for high frequency application in the range above three megacycles. It is characterized by the highest Q value obtainable in this frequency range, combined with good permeability. There is extremely low eddy current loss in cores made from this powder because of its small particle size.

Stripping Liquid

A non-creeping liquid that quickly strips finishes from metal has been developed by Fidelity Chemical Products Corp., Newark, N. J. The liquid, marketed as Fidelity Stripper No. 306, was developed especially for rapid removal of insulating coatings from wires, and baked enamels from objects which cannot or should not be submerged. The stripper is applied by brush at room temperature, and, usually in less than a minute, causes the finish to puff and leave the metal. The metal is then wiped clean, and since there is no residue or corrosive action, the stripped part may be soldered or refinished without any after treatment. The

Littelfuse FUSE MOUNTINGS

for 3 AG FUSES



Single, double and multiple pole mountings.



OPEN TYPE SINGLE POLE MOUNTING No. 351001 (old No. 1060). Black bakelite base. Overall length, 2 1/4". Shakeproof terminals. One mounting hole.



OPEN TYPE DOUBLE POLE MOUNTING No. 351006 (old No. 1068). Same as above but double pole.



LIGHT WEIGHT SINGLE POLE MOUNTING No. 351003 (old No. 1128). 1 1/2" x 9/16" x 9/16". Bakelite mounting strip, fibre insulator bottom for metal panel mounting. One mounting hole.



UNIVERSAL FUSE PANEL, NO. 1505 SERIES Standardized units for 10 fuse sizes, any practicable number of poles. Send for blueprints.



COVERED TYPE DOUBLE POLE MOUNTINGS Double Pole No. 351009 (old No. 1237-B). Underwriters' Approved. Fibre-lined, metal-shielded cover hinged to bakelite base.

Littelfuse Mountings made for all fuse sizes. Ask for details.

LITTELFUSE INCORPORATED

4757 RAVENSWOOD AVENUE, CHICAGO 40, ILLINOIS
200 ONG STREET, EL MONTE, CALIF.

GET THIS SAMPLE
OF
E-Z Code WIRE
MARKERS

ILLUSTRATION
APPROX. 1/2 SIZE



SEE FOR YOURSELF
HOW QUICK AND EASY IT IS TO
CODE WIRES

Cuts Time, Saves Money...on Assemblies
...Installations and Maintenance Work

E-Z CODE is the quickest known method of coding electrical wires. Made on handy cards, ready to use, they stick quickly — no moistening — stay on — stand abuse. Styles in stock fit most coding requirements. Special sizes or codes can be made to order. Mail requests to:

WESTERN LITHOGRAPH COMPANY
Dept. D3, 600 East 2nd St., Los Angeles 54, California

E-Z Code WIRE MARKERS



PEEL OFF STRIP



WRAP AROUND WIRE



EACH WIRE CODED

Take a **TURRET TERMINAL LUG**
LIKE THIS...



Swage it to the Board
LIKE THIS...



And in a jiffy you have
a good, firm Turret Terminal



It's as simple as that with these heavily silver plated C. T. C. Turret Terminal Lugs. Quick soldering, too. Sufficient metal is used to give them strength but there's no surplus metal to draw heat and increase soldering time.

C. T. C. Turret Terminal Lugs are stocked to meet a wide range of board thicknesses. Order them from

CAMBRIDGE Thermionic CORPORATION

441 CONCORD AVENUE

CAMBRIDGE 38, MASSACHUSETTS

WOMAR

Manufacturers of
RADIO, ELECTRICAL AND
ELECTRONIC COMPONENTS

ELECTRONIC PRODUCTS MFG. CORP.
DEXTER, MICHIGAN

WHAT'S NEW

liquid does not run, so that stripping may be limited to a specific section of coated surface.

Induction Generators

Electric Indicator Co., Stamford, Conn., has developed new drag cup induction generators, in both base- and frame-mounted models. Housings are die-cast aluminum alloy anodized in accordance with Army and Navy specifications, and finished with baked black synthetic enamel. The generators consist of laminator stator wound two phase, stationary steel pole, with an aluminum cup on shaft rotating between stator and pole. With voltage applied to one of two stator phase terminals, rotation of shaft and cup induces voltage at other terminal, the voltage



being linear with speed. Torque required for rotation approximately 25 grains at 1 in. radius. For increased voltage where linearity is not important, copper cup may be used. Applied voltage 115 v 60 cycles. Output of type 68 (with resistive load 100,000 ohms) varies from 0.15 v max. with cup stationary, to 1.20 v min. at 1,000 rpm, increasing at uniform rate up to 6,000 rpm. Type 101 generates from 0.15 v max. with cup stationary to 20.0 v at 5,600 rpm.

Blackening Process

Ferrotone, a new simpler chemical blackening finish for ferrous parts, has been developed by Turco Products, Inc., 6135 South Central Ave., Los Angeles. The process utilizes immersion equipment which can be set up quickly. The bath operates at a temperature considerably below that required by oxide finishing baths. Ferrotone provides a gleaming black or rich matte finish which is integral with the metal itself and is durable. It does not chip, flake or peel off even under repeated flexing. It will not blister and cannot be removed under routine cleaning operations by the action of solvents or degreasing agents.

LOW VOLTAGE RECEIVER

(Continued from page 87)

to the control grids of the driver, consisting of the two pentode systems of a 28D7 tube connected in parallel. The plate circuit of the driver works into an interstage transformer which in turn feeds another 28D7 tube operating in push-pull. The primary to $\frac{1}{2}$ secondary impedance ratio of the interstage transformer is 6 to 1 for optimum working conditions, the load impedance of the driver being 2000 ohms. The plate-to-plate load impedance of the output stage is 1500 ohms. This arrangement will provide a maximum power output of approximately 600 milliwatts.

While this discussion has thus far only concerned itself with supply voltages around 28 volts it is worth mentioning that equipment

DOLPH'S INSULATING VARNISHES



FOR EXTRA PROTECTION TO WINDINGS

Today it is most essential that transformers are built to withstand temporary power surges and deliver uninterrupted service. It is a known fact that these power surges can prove to be very detrimental to the varnish insulation on coil windings and will tend to lessen the useful service of your equipment.

No matter what type of electrical units you manufacture, you will find a DOLPH Insulating Varnish formulated to do a better job by providing the extra protection under severe operating conditions. Why not let us help you with your insulating varnish problems.

The above cut-away photo is a 50 K.V.A. Air Cooled Transformer manufactured by Jeffries Transformer Company.



JOHN C. DOLPH COMPANY

Insulating Varnish Specialists

173-C Emmet St., Newark, New Jersey

operating from 14 volt supplies is entirely feasible. The performance, especially the power output obtainable, is naturally somewhat lower than for 28 volts supplies. Since at this writing no special output tubes for 14 volts operation are commercially available as yet it is necessary to use power output tubes designed for higher voltages.

The 6U6GT has been found to be most useful in this application. However, in order to obtain sufficient power output it is necessary to use two tubes of this type connected in parallel. The sensitivity of a receiver equivalent to the one shown in Fig. 1, but using six tubes including two 6U6GT output tubes, is better than 10 microvolts for 6 milliwatts output and the maximum power output obtainable is approximately 35 milliwatts and 80 milliwatts for Class "A1" and Class "A2" operation respectively, at reasonably low harmonic distortion. While a power output of this order is no longer recommended for satisfactory loud speaker reception it is still very usable for phone operation and even several headsets may be used simultaneously.

While low voltage radio equipment is still in its early stages of development it is already causing a considerable amount of interest. It would be given an even greater impetus should the radio tube industry succeed in designing output tubes capable of delivering larger amounts of power than now obtainable.

Metallurgy Demonstration

How electronic technic facilitates the testing and checking of materials or finished pieces in accordance with various metallurgical factors, was demonstrated at the Franklin Institute in Philadelphia November 1-3, by technicians of the Allen B. DuMont Laboratories, Inc., Passaic, N. J. Among the electronic industrial equipment shown was the latest Du Mont development, the Ferrograph, which provides simple and instantaneous comparisons of ferrous materials as to analysis and heat-treatment; the Cyclograph for checking both non-ferrous and ferrous materials also was shown. The occasion for the display and demonstration was the appointment of the Electronic Tube Corp., 1200 East Mermaid Avenue, Philadelphia, as exclusive distributors of Du Mont instruments in Eastern Pennsylvania, Delaware and Southern New Jersey.

More M'frs Add Home-Radio Lines

Add to the list of makers of home radios who will be ready postwar (appearing on page 250 and 252 of the November issue of "Electronic

TECHNICAL NOTES

Excerpts from New Home Study Lessons Being Prepared under the Direction of the CREI Director of Engineering Texts

Circuit Equivalents

The CREI NEWS, monthly house organ published by the Capitol Radio Engineering Institute, is now presenting an interesting series of technical articles on the subject of Circuit Equivalents.

The current article takes up actual circuit equivalents. These include such elements as speaker dividing networks, high-frequency resistors of large power dissipation for use in high-level video amplifiers, rhombic antenna termination, and finally, an example from the acoustic field, that of the rubber transmission line used in a disc recorder.

We believe you will be interested in this material and in the further examples that are to follow in succeeding issues. If so, we will be glad to place your name on our mailing list to receive copies of the CREI NEWS, free of charge. Merely write to Capitol Radio Engineering Institute and ask for your copy of the December CREI NEWS, plus other issues discussing Circuit Equivalents.

The subject of "Circuit Equivalents" is but one of many that are being constantly revised and added to CREI lessons by A. Preisman, Director of Engineering Texts, under the personal supervision of CREI President, E. H. Rietzke. CREI home study courses are of college calibre for the professional engineer and technician who recognizes CREI training as a proved program for personal advancement in the field of Radio-Electronics. Complete details of the home study courses sent on request. . . . Ask for 36-page booklet.

CAPITOL RADIO Engineering Institute

E. H. RIETZKE, President

Home Study Courses in Practical Radio-Electronics Engineering for Professional Self-Improvement

Dept. EI-12, 3224 — 16th St., N.W.
WASHINGTON 10, D. C.

Contractors to the U. S. Navy—U. S. Coast Guard — Canadian Broadcasting Corp. — Producers of Well-trained Technical Radiomen for Industry.

Specialists

... in Assembly and sub-assembly
of Precision Electronic Products

- Complete Facilities for Production and Testing of Audio Equipment
- Consult us with your Production Assembling Problems

RADELL

C O R P O R A T I O N

6323-27 GUILFORD AVENUE, INDIANAPOLIS 5, INDIANA

PLASTIC PARTS

Large or small quantities. Produced to your specifications. Precision machining, stamping and forming all plastics. No molds required. Send your blueprint, or write for bulletin.

PRINTLOID, Inc.

93 Mercer Street

New York 12, N. Y.



Industries") the following: Globe Electronics, Inc., 295 Madison Ave., New York; Jefferson-Travis Mfg. Corp., 245 E. 23rd St., New York; U. S. Television Mfg. Co., 106 7th Ave., New York; V-Lectrical Engineering Co., 828 N. Highland Ave., Los Angeles. Note also that the correct address of Freed Radio Corp is 200 Hudson St., New York.

DuMont Canadian Distributor

The appointment of Cyclograph Services, Ltd., of 12 Gordon St., Toronto, Ontario, as distributors for DuMont cathode-ray tubes, oscillographs and cyclographs in Canada, has been made by Allen B. DuMont Laboratories, Inc., Passaic, N. J. The Canadian appointee will function not only as sales and field engineering organization, but also in the maintenance and repairs of DuMont equipment in the Dominion, succeeding Burlec, Ltd.

New Hercules Plant

The Hercules Electric & Mfg. Corp., manufacturers of dc and ac welders, transformers, coils, magnetic clamps, solenoids, rivet heaters, spot welders, fluorescent ballasts and special controls, is now located in the new plant and offices at 2500 Atlantic Ave., Brooklyn 7, N. Y. Expanded facilities will enable them to better serve the requirements of their trade.

MAGNETIZER UNIT

(Continued from page 96)

Next, the button marked "charge" is depressed and the capacitor bank is allowed to charge for a few seconds. The discharge button is then pressed and the capacitor discharges through a tube and transformer. This takes place only once per charge and requires but approximately 1/120 second.

The electronic capacitor discharge meter magnetizer is designed for operation from a 110 volt, 50/60 cycle, single phase, ac power supply. The power requirement while the capacitor bank is not being charged is approximately 250 volt amps., and when the capacitor bank is being charged the instantaneous demand does not exceed 1/2 to 2 kva. It should be noted, however, that this demand will drop rapidly in a few cycles.

The instantaneous demand as given is for the worst condition that would be encountered. This is very low when compared with the maximum instantaneous demand of 50 to 100 kva required by the controlled half cycle design of meter magnetizers.

When all of the adjusting leaves are clamped into the transformer secondary, the output will provide a minimum of approximately 50,000 amps. crest current in the secondary throat. In addition to having a lower kva instantaneous

demand with a high output current, the capacitor discharge scheme of operation also has the advantage of reasonable current constancy due to a drop in the frequency of oscillation when the secondary loop of the magnetizer is increased. On the other hand, with the controlled half cycle type of meter magnetizer, the current drops off much faster since the frequency remains constant.

To provide maximum protection for the operator, a number of safety features have been included in the electronic capacitor discharge type of meter magnetizer:

1. Primary fuses are supplied to protect the power supply and component parts.
2. A fixed five-minute time delay relay is incorporated in the circuit to protect the thyatron tubes from being operated before they have reached their proper operating condition.
3. The cover is equipped with an electrical interlock to discharge the capacitor and to remove the high voltage from the unit when removed.
4. The capacitor bank is automatically discharged when the power is shut off.
5. Only three low cost tubes are used, thus tube replacement cost is kept at a minimum.

WIDE READING

(Continued from page 106)

Counter Circuit

To reduce the insensitive time of these counters, it is proposed to reverse the voltage between center wire and cylinder after each ionizing event for a long enough period of time, approximately 10^{-5} second, to insure collection of the positive ions by the temporarily negative wire. As soon as all ions are collected, the counter should be immediately returned to its normal operating voltage, i.e., the center wire will again be positive with respect to the outer cylinder. An electronic circuit was designed to amplify and shape the counter discharge pulses, to provide the reversing voltage for the counter, and to block the amplifier during a period of time following each ionizing event so that the amplifier does not pass the field reversal pulse. The circuit must respond to frequencies up to two megacycles and still possess fairly high gain; no residual voltage exceeding three or four volts can be tolerated on the center wire after the collection period is over.

In the initial condition, the type 807 tube is non-conducting, and positive potential V_2 is applied to the center wire of the counter and to the plate of the type 807 tube. When the counter passes current

STAMINA



The inherent stamina of Cinaudagraph Speakers is due to experience in design and manufacturing plus highest inspection standards. In all types of Cinaudagraph Speakers, from small watch-like Handie-Talkie units to large auditorium speakers, you'll find the same precision, the same painstaking workmanship and the same long-lived faithful reproduction.

Watch Cinaudagraph Speakers after Victory!



Cinaudagraph Speakers, Inc.

3911 S. Michigan Ave., Chicago

Export Div., 13 E. 40th St., New York 16, N. Y.

"No Finer Speaker Made in all the World"

Elinco
A.C.

DRAG-CUP INDUCTION GENERATORS



BOTH BASE AND FRAME MOUNTED MODELS

New "Elinco" Drag-Cup Induction Generators are of die-cast aluminum alloy housing anodized in accordance with Army and Navy specifications, and furnished with baked black synthetic enamel.

OPERATION:

Generators consist of laminated stator wound two phase, stationary steel pole, and aluminum cup on shaft rotating between stator and pole. With voltage applied to one of two stator phase terminals, rotation of shaft and cup induces voltage at other terminal, voltage lineal with speed. Torque required for rotation approx. 25 grains at 1" radius. For increased voltage where linearity is not important, copper cup may be used.

SPECIFICATIONS:

Type 68: Applied voltage 115 v. 60 c. AC, generated voltage with resistive load 100,000 ohms varies from 0.15 v. max. with cup stationary, to 1.20 v. min. at 1,000 RPM, and to increase at uniform rate up to 6,000 RPM.

Type 101: Generates from 0.15 v. max. with cup stationary to 3.65 v. min. at 980 RPM, and 20.0 v. at 5,600 RPM.

MODELS CAN BE VARIED TO MEET SPECIAL REQUIREMENTS

Electric Indicator Co. **112 PARKER AVE.
STAMFORD, CONNECTICUT**

RADIO HOOK-UP WIRES

for

Radio Set Manufacturers

Satisfactory performance of Hook-up Wire depends on the wire manufacturer's standard of material plus quality control in fabrication.

Consult us on the type wires your postwar plans include. We will suggest those that are adequate and dependable.

*A Complete Plant from Copper Drawing
to Final Testing and Inspection!*



**DIAMOND
WIRE & CABLE CO.**

Chicago Heights, Illinois

G-E INDICATOR LAMPS

Vibration-proof Lock-on Cap • With or without adjustable Dimmer feature
• Choice of five colors • Well-insulated plastic body • Rugged construction • Easy to mount • Light weight.

For complete details, write to

GENERAL ELECTRIC ELECTRONICS DEPARTMENT
SCHENECTADY, NEW YORK



WIDE READING

after an ionizing event, a positive pulse, which is several volts high within one or two microseconds, appears across the resistor R, producing the pulses b,c and d at the inputs to tubes, B,C and D, respectively. Negative pulse e formed by the trigger pair D,E is fed back to the suppressor grid of tube C to block the amplifier for a time interval t_1 . Pulse e is differentiated by the circuit R_{18}, C_9 and the resulting pulse f applied to the second trigger pair F,G which in turn produces a rectangular pulse g lasting for a time interval t_2 . This pulse is amplified and inverted by tube H giving pulse h which drives the grid of the type 807 tube positive, the tube will conduct and pulse i of approximately $V_1 + V_2$ volts will make the center wire potential drop to approximately V_1 volts below ground potential. The differentiated rectangular wave will appear at the input of the amplifier tube A, but a time t_1 longer than t_2 must elapse before the amplifier passes any pulses through tube C, and so this voltage reversal pulse will not be recorded.

Circuit tests and performance are described. The time delay in making the center wire V_1 volts negative with respect to ground is about 1.5×10^{-6} second for a 1000 volt pulse. Preliminary experiments indicate that the new insensitive times lie around 2×10^{-5} second as compared with 10^{-4} second with conventionally operated counters of the same type. This is nowhere the limit to be expected in future trials. The movements of ions and electrons in the counter under the influence of the applied voltages are studied and the observed phenomena explained.

Evaluating DC in Triodes

(Continued from page 106)

tion for a cylindrical, space-charge limited diode

$$I = 14.68 \times 10^{-6} E^{3/2} / r_p B^2 \text{ amperes,}$$

where I is the current through the diode, E the voltage across it, l its length, and r, its plate radius. B is in most instances close to unity; it is a function of r_p/r , where r, is the cathode radius. (See Terman's Radio Engineers' Handbook, page 288.)

In the article an expression for an equivalent voltage E' is derived which, when inserted in the above formula, gives the direct current in a space-charge limited triode. Equivalent voltage E' is given as a function of the dc grid voltage E_g , the dc plate voltage E_p , and the ratio between the cathode-plate capacitance C_{cp} and the cathode-grid capacitance C_{cg} .

In the derivation the radius r_1 of

OHMITE Control UNITS

GIVE ACCURATE, TROUBLE-FREE SERVICE

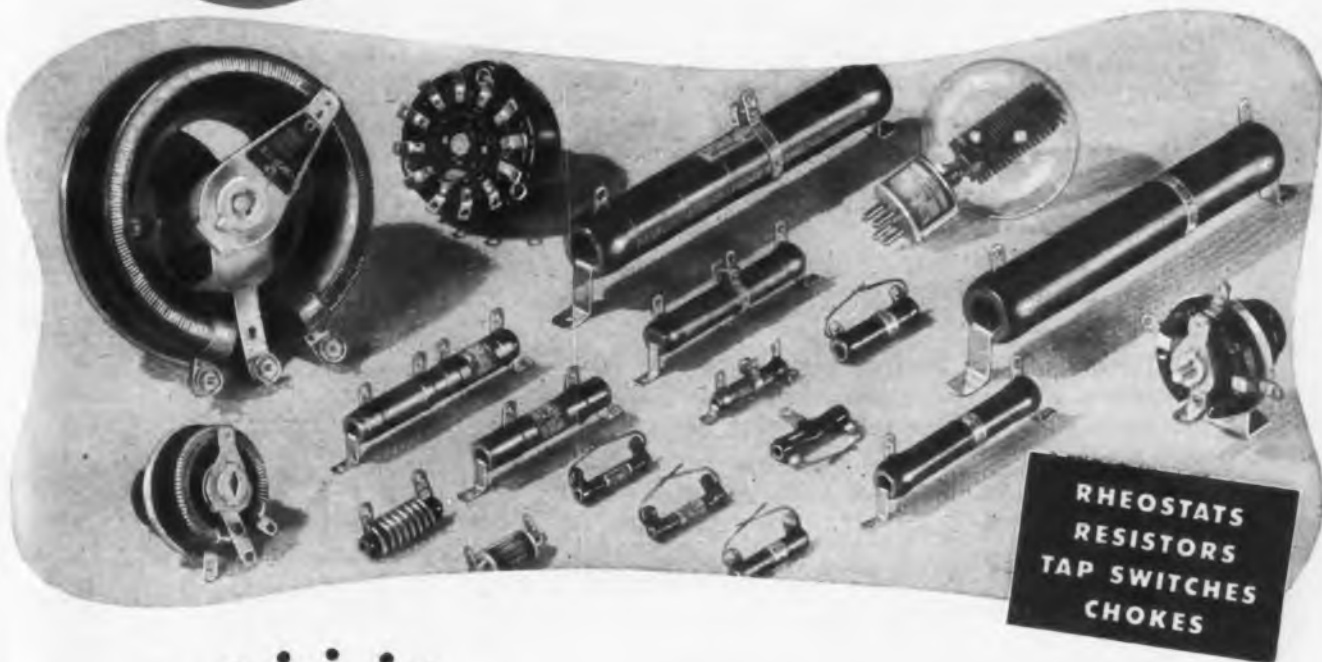

Designed and Built
to Withstand

SHOCK
VIBRATION
TEMPERATURE EXTREMES
HUMIDITY
ALTITUDE

● Because they are so consistently reliable in actual service . . . Ohmite Rheostats, Resistors, Chokes and Tap Switches have become "the control engineer's control units."

Shown here are a few of the many types extensively used in military and industrial equipment. The wide variety of types and sizes in stock or special units provides a ready and exact answer to most applications.

In designing for war or postwar, let Ohmite experience help you.

OHMITE MANUFACTURING COMPANY
4984 Flournoy Street Chicago 44, U.S.A.



For helpful data and information, write on company letterhead for Industrial Catalog and Engineering Manual No. 40. Address Ohmite Manufacturing Co., 4984 Flournoy Street Chicago 44, Ill.

Be Right with **OHMITE**

RHEOSTATS · RESISTORS · TAP SWITCHES

SUB-ZERO Temperatures "LICKED" THE NAZIS IN RUSSIA



One of the fatal mistakes the Nazis made in developing their army equipment was to underestimate the intense cold of the Russian winter. Motor lubricants, hose lines for fuel and hydraulic connections, and other armament components had not been designed for that type of service. Likewise, our aircraft before we entered the war was not equal to the very high altitudes at which many aerial battles have been fought.

There is only one sure way to determine the effects of extremes in temperature, pressure and humidity—a properly engineered test chamber in which any kind of weather from that of the tropics at sea level to the stratosphere may be duplicated at will and in accordance with close timing.

KOLD-HOLD MANUFACTURING COMPANY
454 NORTH GRAND AVENUE, LANSING 4, MICH.

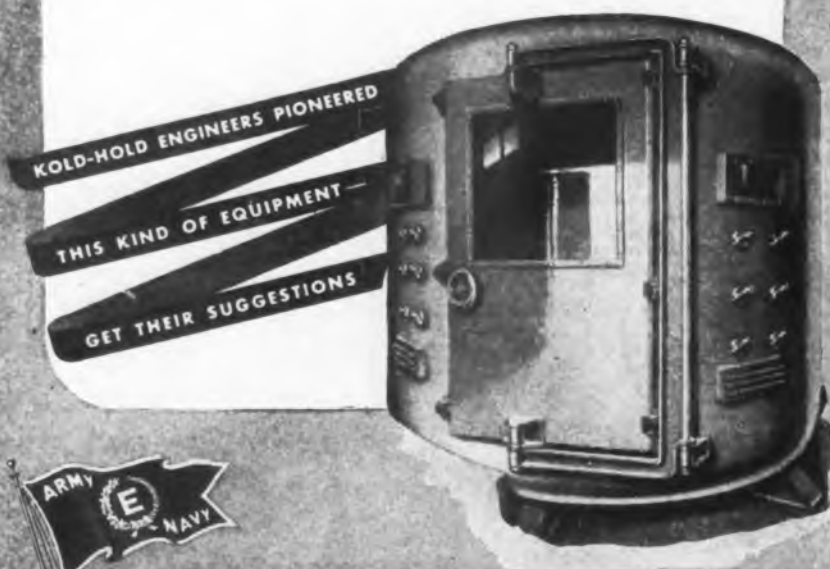

KOLD-HOLD ENGINEERS PIONEERED
THIS KIND OF EQUIPMENT—
GET THEIR SUGGESTIONS



KOLD-HOLD

WIDE READING

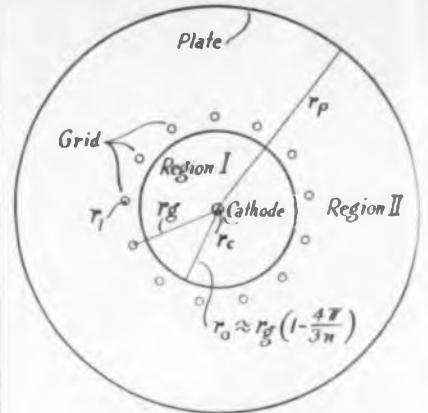

Cross-section of cylindrical triode

the grid wires is assumed to be small compared to the distance $2\pi r_g/n$ between neighboring wires. A cylindrical surface, separating regions I and II, and having a radius r_0 approximately equal to $r_g(1-4V/3n)$, is introduced for computation purposes. The effect of the space charge within region I on the electron current is taken into account, while the effect of the space charge in region II is neglected and later shown to be of minor importance. Further, the field of the grid in region I is assumed to be zero, while the field of the grid in region II is effective in

El-Menco

MOLDED
MICA
CAPACITORS



IMMEDIATE DELIVERY—
ALL SIGNAL CORP ORDERS BEARING
INSPECTION AT SOURCE; INSPECTED
ON PREMISES & SHIPPED IMMEDIATELY

All R.M.A. or A.S.A. color coded
A complete stock is ready for immediate
shipment of quantities, ranging from 500
to 5,000 of each capacity in regular MICA
CAPACITORS in 5%, 10% and 20% tol-
erance and silvered MICA CAPACITORS
in 2%, 5% and 10% tolerances.
Write for
price sheets and complete information

Territory
open for
JOBBERS

SEND FOR OUR
SPECIAL INITIAL
ORDER OFFER

ALBERT ROTHENSTEIN
National Distributor
135 LIBERTY ST. New York 6, N.Y.

WIDE READING

controlling the electron stream.

Under these assumptions and by making use of the boundary conditions at the cylindrical surface of radius r , and at the grid, the equivalent voltage E' is found to be approximately equal to

$$E' = (E_g + DE_p) / (1 + D r_p^{2/3} / r_g^{2/3}),$$

where

$$D = (\log r_g / n r_1) / (n \log r_p / r_g) = C_{cp} / C_{cg}.$$

In the case of a plane, space-charge limited triode, the equivalent voltage is given by the expression:

$$E'_{plane} = (E_g + DE_p) / (1 + D a^{1/3} / g^{1/3}),$$

where a is the distance between cathode and plate and g the distance between cathode and grid. The current per unit area will be equal to

$$I = 2.331 \times 10^{-6} E'_{plane}^{3/2} / a^2 \text{ amperes per sq. cm.}$$

Two Methods of Measuring UHF Electric Fields

K. R. Makinson and H. D. Fuser (Philosophical Magazine, London, June, 1944)

Both methods were developed for the measurement and the comparison of electric field strengths of the order of 10 volts/cm. at frequencies up to 500 megacycles. The field was generated by a coupled pair of magnetrons and existed between two parallel copper plates 4 cm. square and 4.6 cm. apart.

Induced dipole method

If a conducting strip of length L is placed in a uniform electric field, it experiences a torque due to the redistribution of its charges. The mean torque produced by an alternating field of wavelength λ is independent of the frequency if $\lambda \ll L$, acts in the plane of L and the direction of the field, and is proportional to L and to the mean square of the electric field intensity, E^2 ; it is zero when the field and the conducting strip are either parallel or at right angles to one another, and it is a maximum when they are at an angle of 45 deg.

To adjust the instrument (see figure), for use, it was placed in the field with the axis of the strip approximately parallel to the direction of the electric field and a light beam incident through the window on the mirror 1 was reflected on to a scale. The strip was rotated slightly by means of the torsion head until the light spot on the scale was not deflected when the field was switched off and on. The strip was then known to be exactly parallel to the field. The position of the torsion head was noted, the



Model DR-12

Versatile is the word for Atlas Sound's latest creation, the DR-12 Little Giant (Bell diameter 7 in. Overall length 7 1/2 in.) Its construction gives equally gratifying service when used for marine application, factory, police and other communications . . . a design that has proven itself more than equal to War's rigorous demands.

Write for detailed description

Complete Atlas Sound Catalog on request.



ATLAS SOUND
CORPORATION

1445 39th Street

Brooklyn, N. Y.

NORTON N INSTRUMENTS

PORTABLE AMMETERS-VOLTMETERS



Reliable, sturdy, portable Ammeters and Voltmeters for testing purposes. These instruments are built to maintain accuracy under hard usage in electronic, marine, and industrial service, power plants and electrical repair work.

Hand calibrated, hand drawn dials assure accuracy at every part of the scale. Supplied with knife-edge pointer and mirror reflector for quick, accurate reading.

Send for latest Catalog

NORTON Electrical Instrument Co.
85 HILLIARD ST., MANCHESTER, CONNECTICUT

WIDE READING

strip was rotated through approximately 90 deg., and the same procedure was repeated, using mirror 3, to set the strip at 90 deg. to the field. The position of the torsion head was again noted, and it was then set midway between these positions. If the field was very small, the copper strip was then known to lie at 45 deg. to it. The light beam was then reflected to the scale by mirror 2.

The instrument was calibrated in a uniform field of 10 to 30 volts/cm. at 1.2 megacycles. The calibration is independent of frequency up to

higher than 500 megacycles. The rms field strength E is given by the equation $E^2 = 74.0 a$ to within 4 per cent, where a degrees is the rotation of the torsion head necessary to maintain the dipole at 45 deg. to the field. The displacement of the light spot on the scale obtained when the field is applied, may be taken, when small, as proportional to the rotation a .

Dielectric thermometer method

The rate of expansion of a dielectric liquid (n-propyl alcohol)

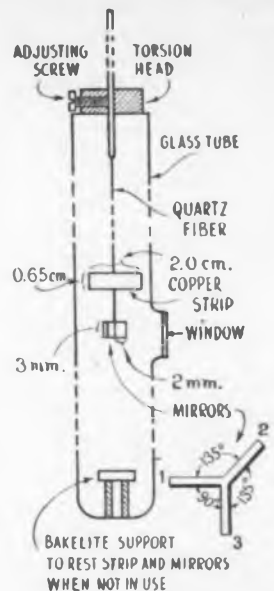

Torque on copper strip measures uhf field intensity

heated by the field is determined. The dielectric liquid is contained in a thin walled, approximately spherical glass bulb about 0.02 cm. thick and having a radius of about 0.73 cm. with an attached capillary tube about 0.01 cm. in diameter for observation of the rate of expansion.

The thermometer was calibrated against the induced dipole. The calibration factor was evaluated as $K = 27.0 \pm 1.7$ volts $\text{min.}^{\frac{1}{2}} \text{cm.}^{-\frac{1}{2}}$ at 136 megacycles and $K = 10.3 \pm 0.9$ volts $\text{min.}^{\frac{1}{2}} \text{cm.}^{-\frac{1}{2}}$ at 510 megacycles; E is equal to Kr^2 , where r is the rate of rise of the alcohol in the capillary tube. Calibration procedure and performance of the instrument are described in detail, the calibration factor computed from the values of the dielectric constants available in the literature, the probable error estimated, and theoretical and experimental results compared.

DC Galvanometer Amplifier

D. I. Lawson (Electronic Engineering, London, August, 1944)

The small voltage to be measured

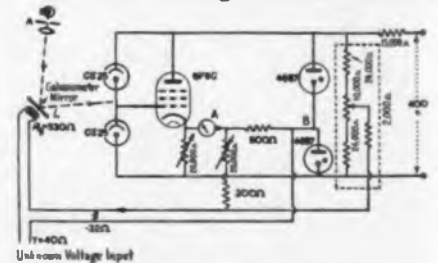

is applied to the terminal T. The resulting current through the galvanometer will cause a deflection of the light beam L so that the resistances of the two photocells G825 are no longer equal. Due



Interested in Beryllium Copper Springs?

If you are, you'll find at Accurate, a specialized knowledge of this unusual spring material . . . a knowledge that is based upon research and experience in the material and its use and advantages in spring manufacture. Accurate has produced many types of beryllium copper springs with close control of tolerances and physical properties—the torsion and compression brush springs and the aircraft carburetor idle valve flat spring shown here are examples. When your "specs" or plans call for beryllium copper springs, Accurate "know-how" in precision spring manufacture and experience with beryllium copper are at your service.

If you have a spring problem, whatever it may be, Accurate engineers will be glad to help you work it out.

Send for your copy of the new Accurate Spring Handbook. It's full of data and formulae which you will find useful. No obligation of course.

ACCURATE SPRING MANUFACTURING CO.
3808 West Lake Street • Chicago 24, Illinois
SPRINGS • WIREFORMS • STAMPINGS





A VERSATILE LINE TRANSMITTERS and RECEIVERS

A line of transmitters and receivers . . . each engineered for its specific application. Dependable performance assured through laboratory testing and modern production methods. Our facilities are at your service whether you need transmitters, receivers or an electronic component which we can design and manufacture for you. Write for complete details.

Aeronautical Ground Stations

Since the early days of airlines, Comco engineers have had actual field experience designing aeronautical ground station equipment. Transmitters available for operation on frequencies of 2 to 150 Mc. Receivers, 2 to 8 Mc. and 100 to 150 Mc.

Airport Traffic Control Towers

Pioneers, too, in producing airport control equipment. Transmitters for operation on 200 to 550 kc. and 100 to 150 Mc. Receivers from 200 to 550 kc., 2 to 8 Mc. and 100 to 150 Mc.

Commercial and Private Aircraft

Dependable compact equipment for all aircraft requirements. Transmitters for operation on frequencies of 2 to 8 Mc. and 100 to 150 Mc. Receivers from 200 to 1600 kc., 2 to 8 Mc. and 74 to 150 Mc.

Police, Fire and Public Safety

Reliable equipment for all applications in these fields. Transmitters and Receivers to cover the ranges of 1.5 to 8 Mc., 30 to 40 Mc. and 100 to 150 Mc.

Marine Communications

Ship-to-shore and inter-ship communications. Transmitters and Receivers for operation on frequencies of 2 to 3 Mc.

COMMUNICATIONS COMPANY, Inc.

Manufacturers of Radio and Electronic Equipment

CORAL GABLES  34, FLORIDA



Gas Filled Pressure Condensers

Johnson Engineers were among the first to design and build Gas Filled Pressure Condensers in fixed, variable, and combination fixed and variable types.

Gas Filled Condensers offer a decided advantage in size where large capacities or high voltage ratings are necessary. In some cases Gas Filled Condensers make possible an instrument that would be a mechanical impossibility in an air type.

Johnson Gas Filled Pressure Condensers are available in several sizes of housings depending on the rating specifications. Prices are low, efficiency is high, gas leakage is nil over long periods of time.

Write today for more information and prices.

JOHNSON
a famous name in Radio

E. F. Johnson Co. Waseca, Minn.

WIDE READING

to the consequent change in grid voltage of the 6V6G tube, the current through the cathode resistor and, since point B is at constant potential with respect to ground, the current through the ammeter A will change.

A fraction of the output current is fed back to the galvanometer. If the feedback is negative, the response time of the galvanometer is decreased, although the sensitivity of the apparatus is reduced. The sensitivity may be increased by positive feedback at the cost of increasing the response time.

The network shown inside the dotted lines is used to feed a small steady current into the galvanometer circuit in order to facilitate centering the beam of light between the photocells. A detailed analysis of the circuit is given.

Supersonic Methods for Measuring Properties of Solids

S. Siegel (*Journal of the Acoustical Society of America*, July, 1944)

Dynamical methods for measuring elasticity and damping of solids



The largest, metal plate type, power supply units ever built for the charging and floating of batteries for telephone and telegraph services, constructed by Federal Telephone and Radio Corp., Newark, N. J., associate of International Telephone and Telegraph Corp., are playing a major role in the restoration of communications in areas now being reconquered from the Axis. Each is used to supply a total of 14,410 watts of direct current from alternating current sources. The unit contains, besides transformers and control equipment, two selenium rectifiers of 24-volt, 250-ampere capacity connected to two 24-volt 440-ampere-hour storage batteries; two 130-volt, 19-ampere selenium rectifiers connected to two 130-volt, 24 ampere-hour batteries and two 220-volt, 27 ampere selenium rectifiers connected to two 220-volt, 36 ampere-hour batteries



Permanent Magnets

All Shapes, Sizes and Alloys. Alnico magnets cast or sintered under G. E. license. Chrome, Tungsten and Cobalt magnets stamped, formed or cast.

THOMAS & SKINNER

STEEL PRODUCTS CO. • INDIANAPOLIS, IND.

42 YEARS' EXPERIENCE



"The radio that told it to the Marines"

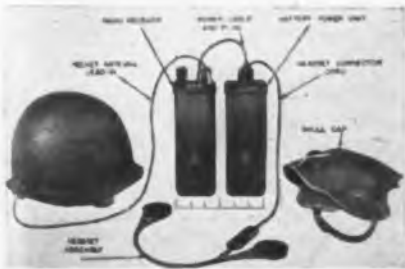

When the U. S. Marines stormed ashore in the South Pacific to get a situation well in hand, they received their orders by portable radio.

You can imagine the apparently impossible conditions under which such a radio receiver must operate: immersion, shock, heat, cold, storm — and Noise, with a capital N.

Emerson Radio and Phonograph Corporation designed the Marine "Raider" Receiver to withstand just such conditions. It is so compact that it leaves the operator's hands

and arms free for action, and does not distinguish him from his companions as an especially inviting target.

The earphones are built into a fabric cap which fits into the metal helmet. The helmet is the antenna.

The pride which the Emerson people feel in this unique receiver is shared by the Wheeler Insulated Wire Company, Inc.

For we at Wheeler supply the wire

for certain parts of this rugged little apparatus.

In our 35 years of wire-making experience, Wheeler Insulated Wire Company, Inc. has sold its entire output of quality products to comparatively few customers. *But they have been mighty good customers!*

We hope to introduce Wheeler products to many other companies in the electrical industries when war-time demand permits.

The Wheeler Insulated Wire Co., Inc.

BRIDGEPORT 4, CONN.

*Manufacturers of Magnet Wire ... Litz Wire
Coil Windings ... Transformers*



BACK THE INVASION — BUY MORE WAR BONDS NOW!

ORIGINATORS
OF THE
**FINEST-MADE
AND MOST-WIDELY IMITATED
PILOT LIGHT ASSEMBLIES**

Dialco creative Engineering has originated numerous types of Pilot Lights which set the standard for the industry. COMPLETE WITH LAMPS: To speed production we offer a vast line of Pilot Lights completely assembled with proper G.E. or Westinghouse Lamps. SPECIALISTS IN NEON APPLICATIONS . . . Send specifications for immediate solution of your problem. Write for complete Catalogue.

**YOU CAN DEPEND ON DELIVERIES
WHEN YOU DEAL WITH THE**

World's Largest Manufacturer of Pilot Lights

DIALCO

DIAL LIGHT CO. of America, Inc.
200 BROADWAY · NEW YORK 3, N. Y.
Telephone: ALganquin 4-5180-1-2-3

BACK THE INVASION — BUY MORE WAR BONDS NOW!

usually involve the excitation of longitudinal or torsional oscillations in the specimen and determination of resonant frequency and width of resonant curve. The article gives a review of various methods for the excitation of ultrasonic oscillations in the material and for finding the oscillation intensity as a function of frequency. A variety of problems in fields related to magnetism, plasticity, metallurgy, thermal properties of solids, etc., has been studied by these methods and several examples are reported.

Porter Heads FCC

The probability, reported on another page in this issue, that Paul Porter might be appointed Chairman of the Federal Communications Commission, has become an actuality. On November 16 Porter was formally appointed to the job by President Roosevelt and his name sent to the Senate for approval, which, it was expected would come through quite promptly. In the meantime President Roosevelt named Commissioner Jett to be interim chairman.

James Lawrence Fly's resignation became effective November 15 and he has let it be known that he will return to the private practice of law. Rumors have connected him with the Musak interests.

Paul Porter, at present publicity chief for the Democratic National Committee and a former CBS attorney, has had considerable government service experience, having been rent control chief for the Office of Price Administration. He plans a brief vacation before formally taking over the current difficult task of FCC in untangling allocation of the radio spectrum.

Four Will Make Wire Recorders

Armour Research Foundation, which did the original development work on the wire recorder, has set up a company to carry on further development. Wire Recorder Development Corp., which is capitalized at \$100,000, has granted non-exclusive manufacturing licenses to Stromberg-Carlson Co., Rochester; General Electric Co.; C. G. Conn Ltd., Elkhart, Ind.; Utah Radio Products Co., Chicago and WiRecorder Corp., Detroit. Stromberg and General Electric plan to use the device in home radio sets; Conn will invade the technical field; WiRecorder plans a unit for automobile use; Utah will invade four fields: a stationary recorder for radio stations, two portable models for street interviews, etc., and battery operated recorder for field surveys in rural use and a home recorder.

Laboratory Standards

MODEL 62

VACUUM TUBE VOLTMETER

SPECIFICATIONS:
RANGE: Push button selection of five ranges—1, 3, 10, 30 and 100 volts a. c. or d. c.
ACCURACY: 2% of full scale. Useable from 50 cycles to 150 megacycles.
INDICATION: Linear for d. c. and calibrated to indicate r.m.s. values of a sine-wave or 71% of the peak value of a complex wave on a c.
POWER SUPPLY: 115 volts, 40-60 cycles—no batteries.
DIMENSIONS: 4¾" wide, 6" high, and 8½" deep.
WEIGHT: Approximately six pounds. **PRICE:** \$135.00 f.o.b. Boonton, N. J.

MEASUREMENTS CORPORATION
BOONTON, NEW JERSEY



BOSTON OFFICES

ARE YOU INTERESTED IN
Aggressive Representation

THROUGHOUT NEW ENGLAND?

The Electrical Apparatus Company is interested in representing manufacturers having products of advanced design and of an engineering nature for postwar applications.

We have unusually fine facilities, a specially trained personnel of many years experience, and are thoroughly capable of producing outstanding results.

In our opinion, the postwar era will require concerted and well organized sales effort. We are enthusiastic about obtaining the greatest amount of business possible for the manufacturers we represent.

An interesting brochure of a really unique sales organization will be sent gladly upon request.

W. J. Kelleigh



APPLICATION



ENGINEERS

DEMONSTRATION LABORATORY

ASSEMBLY HALL

HARTFORD OFFICE



- RELAYS • RHEOSTATS • FOOT SWITCHES • CAM LEVER SWITCHES • LIMIT SWITCHES • SNAP ACTION SWITCHES • TRANSFER SWITCHES • RESET TIMERS
 REMOTE CONTROL SWITCHES • PROCESS CONTROL TIMERS • SOLENOID VALVES • ELECTRONIC DEVICES • TEMPERATURE CONTROLS • PRESSURE CONTROLS
 ELECTRONIC CONTROLS • AUTOMATIC PRODUCTION GAUGES

ELECTRICAL APPARATUS COMPANY
 1200 SOLDIERS FIELD ROAD, BOSTON 34, MASSACHUSETTS

ENGINEERS: Here's
the **BIG POINT** about
**AMPERITE
REGULATORS**

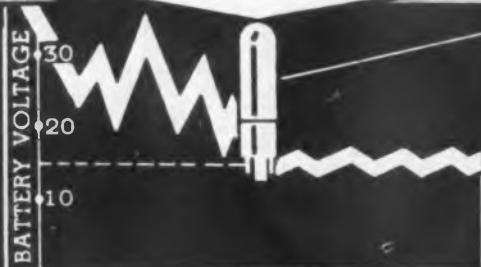

VOLTAGE OF 24V
BATTERY & CHARGER
VARIES APPROX

50%

WITH **AMPERITE**
VOLTAGE VARIES
ONLY

2%



Features:

1. Amperites cut battery voltage fluctuation from approximately 50% to 2%.
 2. Hermetically sealed — not affected by altitude, ambient temperature, humidity.
 3. Compact . . . light . . . and inexpensive.
- Used by U.S. Army, Navy, and Air Corps.

DELAY RELAYS: For delays from 1 to 100 seconds.
Hermetically sealed. Unaffected by altitude. . . . Send for catalogue sheet.

NEW! 4-page folder will help you solve Current and Voltage Problems; contains much valuable data in practical form—Write for your copy now.

AMPERITE CO., 561 Broadway, New York (12), N. Y.
In Canada: Atlas Radio Corp., Ltd., 560 King St., W. Toronto

Q METER

MODEL 160-A

*Direct
Reading*



A dependable direct-reading instrument for determining the Q or the ratio of reactance to resistance, of coils. Used in design and production engineering of Radio and Electronic equipment. Condensers and other components readily measurable.

*Determines effective
inductance or
capacitance*



BOONTON RADIO

BOONTON, N. J.

Corporation



DESIGNERS AND MANUFACTURERS OF THE "Q" METER Q CHECKER FREQUENCY MODULATED SIGNAL GENERATOR BEAT FREQUENCY GENERATOR AND OTHER DIRECT READING TEST INSTRUMENTS

**Will Exhibit New
Precision Instruments**

An electronic precision industrial instruments demonstration will be held December 8 by the Brown Instrument Co. at the Hotel Coronado, St. Louis, climaxing an eight weeks course in fundamental theories of electronics which has been given in St. Louis and Alton, Ill. Between 150 and 200 students have been attending the classes. The display will include latest circular and strip chart electronic potentiometers. These are being shown for the first time by the Brown company throughout various industrial areas. Other recent models of industrial instruments will be included.

Nylon Insulation

A new nylon plastic compound that permits coating of electrical wire at rates of more than 1,000 ft. per minute has been developed by E. I. du Pont de Nemours & Co. On a commercial machine having a two-inch screw, laboratories have extruded nylon jackets seven mils in thickness (overall diameter 40 mils) at rates of speed over 1,000 ft. per minute. The die used is a modified, self-centering tubing design which allows for the free flowing of the nylon. A tube of nylon is extruded and is laid snugly over the wire, the wall thickness being controlled primarily by the wire speed. Coatings of less than one mil in thickness have been applied by this method.

**Bendix Transport Group
For Railroad Radio**

Establishment of a new engineering, sales and service organization to coordinate the company's expanding activities in the field of railroad radio communications has been completed by Bendix Radio Division of Bendix Aviation Corp., Baltimore. R. B. Edwards, who has been responsible for many Bendix developments in the radio transmitter field during his eight-year association with the company, has been named engineering coordinator for the new group, which will be under the general direction of W. L. Webb and John W. Hammond, chief engineer and sales manager, respectively, of the Radio Division.

JBT Men Study

When J-B-T Instruments, Inc., New Haven, Conn., held its first sales engineering conference, middle of October, fifteen representatives, handling the company's instruments throughout the United States, Canada and South America, spent four days at technical sessions, under the leadership of Chief Engineer Donald E. Andersen. The

SYLVANIA NEWS

ELECTRONIC EQUIPMENT EDITION

DECEMBER

Published in the Interests of Better Sight and Sound

1944

Type EF-50 Pentode Found Useful at High Frequencies



Sylvania's Type EF-50 Amplifier Pentode, originally produced primarily for military purposes, has a number of unusual features that suggest many applications in postwar design.

The outstanding characteristic of the EF-50 is that it is designed to operate at 250 volts on both screen and plate, permitting operation at higher frequencies because of the resulting reduction in input loading.

Tube is provided with its own external shield, grounded through center lug, as well as internal shielding brought out on two terminals. Since suppressor and cathode are brought out separately, 9 pins are needed.

Full technical data on the EF-50 can be obtained from Sylvania.



"Next time you go bailing out, for heaven's sake grab a set with Sylvania Tubes!"

Sylvania Equipment Helps B-29s Report "Mission Accomplished"

*Company's Tubes, Electronic Devices
Extensively Used on Superfortresses*

Radio communications equipment and electronic navigational aids have been developed to a new pitch of perfection aboard the giant Boeing Superfortresses, which have so convincingly demonstrated their ability to strike hard and effectively, deep within the enemy's territory, after flying from far-distant



Exterior view shows the B-29 bristling with 50-calibre machine guns and 20 mm. cannon. The Superfortress is powered by four 2200-hp. engines, rolls on double-wheeled landing gear, carries electronic equipment such as is manufactured by Sylvania and others. (Boeing Photo)

DID YOU KNOW...

That many industries use Sylvania Pirani tubes to measure pressures ranging from 1/10 to 1/10,000 mm?

★ ★ ★

That newly defined life ratings for Sylvania Fluorescent lamps show that, in many applications, life expectancy is greater than previously indicated, when lamps are burned on long time-on cycles?

bases. The long operating range of the Superfortresses necessitates a complex electronic nerve system to assure close contact in flight, accuracy in reaching target, and safe return to base. Radio and electronic equipment — estimated to total approximately one ton for each Superfortress — includes the most modern navigational devices, in addition, of course, to the transmitters, receivers and other apparatus necessary for communication between crew members, between aircraft in flight, and between planes and their distant bases.

Sylvania has made important contributions to the electronic equipment that helps make possible—and ultimately transmits—the terse, stirring message, "Mission Accomplished." Not only are many Sylvania tubes utilized in the various radio sets and control devices carried by the Superfortresses, but Sylvania is among the manufacturers supplying electronic equipment for the B-29s.

SYLVANIA ELECTRIC

PRODUCTS INC.

Radio Division • Emporium, Pa.

MAKERS OF FLUORESCENT LAMPS, FIXTURES, ACCESSORIES, INCANDESCENT LAMPS, RADIO TUBES, CATHODE RAY TUBES, ELECTRONIC DEVICES
ELECTRONIC INDUSTRIES • December, 1944



HAVE YOU INVESTIGATED MYCALEX?

mycalex has many physical and electrical characteristics which make it outstandingly superior to any other electrical insulation for many purposes. It is particularly effective at ultra-high frequencies.

Mycalex can be sawed, drilled, tapped, ground, polished, turned or milled and dimensions can be held to very close tolerances. It is an ideal material where only a few pieces are required and die cost necessary for other materials would not be justified.

Mycalex is available in sheets, rods, bars, tubes and strips which can be fabricated into almost any shape or size required.

Mycalex is just one trade name for glass-bonded mica insulation also available under several other trade names. Johnson has used and is prepared to furnish any such material.

Johnson as a fabricator is approved and recommended by the manufacturers of this material. Johnson is one of the pioneer fabricators of Mycalex, probably has more complete equipment, and certainly has had more experience than other manufacturers.

Johnson's recommendations will be unbiased. Johnson regularly uses steatite, porcelain, bakelite, hard rubber and all makes of glass bonded mica. If you have an insulation problem, Johnson Engineers will be glad to make recommendations, submit samples or quote prices. Write Johnson today or contact the Johnson Representative in your territory.

JOHNSON
a famous name in Radio

E. F. Johnson Co. Waseca, Minn.

204

sessions were held at Dunham electrical laboratories of Yale University.

PERSONNEL

Golden Heads Speaker Division of General

Richard E. Laux, executive vice-president of General Instrument Corp., Elizabeth, N. J., has announced the appointment of Leon Golder as manager of its new speaker division, for which plans are now being made for large scale manufacture after the war. Lee Golder is a veteran of the radio components field, having started his career with the original Sonora Phonograph Co., advancing to the position of Chicago District Manager. In 1924 he became Eastern District Manager of Magnavox Co., where he remained until 1927 when



Lee Golder, newly appointed manager of speaker division, General Instrument Co.

he resigned to assist in the organization of Rola's Cleveland operations.

The speaker business will be conducted by the General Electronic Apparatus Corp., a subsidiary of General Instrument Corp. This new subsidiary will have the capacity to supply a complete line of speakers for a substantial percentage of the demand.

Kobak Heads Mutual

Edgar Kobak, formerly executive vice-president of the Blue network and before that vice-president of the National Broadcasting Co., has been elected president of the Mutual Broadcasting System. Mr. Kobak's career started as a member of the electrical engineering department of the Georgia Railway & Power Co., Atlanta, following his studies at Georgia Tech. In 1934 he joined NBC as vice-presi-

BIRD & CO. GLASS INSTRUMENT BEARINGS

GLASS "V" BEARINGS
made to your specifications



We welcome your inquiries

RICHARD H. BIRD

*Manufacturers of Jewel Bearings
for thirty years*

23 MOODY STREET
WALTHAM, MASS.



ELECTRONIC EQUIPMENT
QUARTZ CRYSTALS

MANUFACTURING
ENGINEERING
DESIGNING
TO ORDER

REX BASSETT
INCORPORATED

FORT LAUDERDALE,
FLORIDA

ELECTRONIC INDUSTRIES • December, 1944



FAST

can build that "Out of the Ordinary" Capacitor

Pictured above are a few Capacitors designed for unusual operation . . . or for some particular application which requires not only a special container and terminals, but a departure from standard internal construction.

Whether it be the tubular wax paper Capacitor . . . the wax filled metal cased type . . . the hermetically-sealed oil impregnated and filled type . . . or the polystyrene types . . . the FAST organization can best meet your requirements.

Instrument Designers, Physicists, Scientists, Researchers, Experimenters—as well as Commercial Organizations planning to build that Electronic Device for tomorrow's market—are invited to avail themselves of our wide experience in the design and production of fine Capacitors. Feel free to consult us the next time you have a particularly vexing Capacitor problem.

"When You Think of Capacitors . . . Think FAST"



CERTIFICATE OF ACHIEVEMENT

It may be of interest to note this is the first time in the history of the United States Navy that any industry has been selected for a citation of honor and achievement. The John E. Fast organization is a member of this group.

JOHN E. FAST & CO.

Capacitor Specialists for a Quarter-Century
3129 North Crawford Avenue, Chicago 41

Canadian Representative: Beacore Engineering Works Reg'd.
2101 Bennett Avenue, Montreal, for Power Factor Correction
J. R. Longstaffe, Ltd., 11 King Street, W., Toronto 1, for Special Applications

DUMONT
ELECTROLYTIC
CAP. 20 MFD.

DUMONT
CAPACITORS

FOR DEPENDABLE RADIO REPAIRS

SOLD ONLY THROUGH
EXCLUSIVE JOBBER
TERRITORIES

DUMONT ELECTRIC CO.
34 HUBERT ST. NEW YORK, N. Y.

DUMONT
600V
TYPE P3

DUMONT
600V

DUMONT
05



Edgar Kobak, leaves the Blue for Mutual

dent in charge of sales. Then followed four years as vice-president of the advertising agency, Lord & Thomas. He was called back to NBC to assist in setting up the Blue network as a separate division of RCA, early in 1942 becoming its executive vice-president and general manager. Mr. Kobak has been active in association and charitable work. He is a past president and Board Chairman of the Advertising Federation of America and a former Board member of the American Management Association. He was recently elected President of the Marketing Executives Society, is a Trustee of the United Seaman's Service as well as a Trustee of the Engineers Club of New York. For four years he was a vice-chairman of the Greater New York Fund drives.

Frank A. Turnquist, widely known in the radio-electronic tube industry for his contributions to production technic in that field, has joined the National Union Radio Corp. as production manager.

Dr. Wallace E. Richmond has been elected vice-president in charge of operations of the Standard Piezo Co., Carlisle, Pa. He was formerly technologist for the Quartz Crystal Section of the U. S. Army Signal Corps.

Robert N. Baggs has been made manager of the merchandising division of International Resistance Co. Prior to assuming his new duties he was advertising and sales promotion manager of the Tube Division of the Radio Corp. of America.

Henry J. Dostal, purchasing agent of Emerson Radio and Phonograph Corp. for the last three years, has been appointed contract manager of the company. He will handle all Government contracts for Emerson.

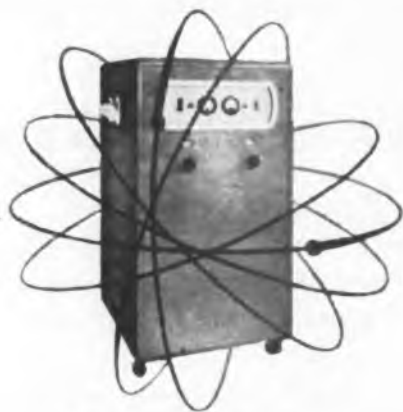

Thermatron

ELECTRONIC HIGH FREQUENCY HEATERS

In heating preforms, joining thermoplastics, and in many other applications, THERMATRON equipment makes possible better, quicker and, in many cases, cheaper processing than by any other known method. The THERMATRON method of accurately controlled internal heat generation in plastic materials is setting new records for low costs and high production. A wealth of practical knowledge on electronic high frequency heating applications, in plastics and other fields, is yours for the asking. Describe your problem to us today—let's plan for tomorrow.

Standard sizes from 500 watts to 30 kilowatts output
Units of special sizes and frequencies built to order

Thermatron Division

RADIO RECEPTOR COMPANY, Inc.

231 WEST 19th STREET

NEW YORK, N. Y.

SINCE 1922 IN RADIO AND ELECTRONICS

You are looking at
the first and only
Floating LAMP

MOVES FREELY IN ANY DIRECTION



CHOICE OF 4 BASES



UNIVERSAL BRACKET PORTABLE BENCH PEDESTAL



MACHINE TOOLS



ASSEMBLY LINES



INSPECTION BENCHES



DRAFTING BOARDS
ELECTRONIC INDUSTRIES • December, 1944

FLOATING is the only word to describe the effortless action of the Dazor Lamp. For a slight touch will *float* this light exactly where it's needed, as easily as a man can move his arm. And it stays put without locking. Raise, lower, push, pull or turn the Dazor *Floating Lamp* — it remains firmly and automatically held in position. Thus *localized* lighting acquires new efficiency . . . increasing production, improving accuracy and safety, lowering costs.

Each job presents a separate problem of illuminating the working area. With the Dazor *Floating Lamp* an employee gets lighting *flexibility* at the point of work. He can control intensity . . . avoid reflected glare . . . curtail eye-strain, fatigue and error. A single spring force acting through an ingenious linkage and arm parallelogram balances the lamp arm in any desired position. Both Fluorescent and Incandescent Dazor Lamps are available; 4 bases cover every type of machine fastening and portable plant use.

In thousands of industrial and governmental operations, economical Dazor *Floating Lamps* are contributing to high productive capacity. They are distributed by electrical wholesalers, selected for ability to serve. Call your electrical wholesale supplier or write us for the names of our distributors in your locality. Upon request for Booklet "E" we will also send a 16-page Illustrated Catalog describing Dazor models, features, applications.



Dazor Manufacturing Co. • 4463 Duncan Ave., St. Louis 10, Mo.

DAZOR *Floating* **LAMPS**

FLUORESCENT and INCANDESCENT

LUXTRON PHOTOCELLS

Give Simple
Means of
Precision Control



This pigtail-contact model is only one of a series of mountings and indicates only one of the complete range of Luxtron® cell shapes and sizes available.

Circuit simplicity contributes to a constant flow of power. The ability of Luxtron Photocells to operate instruments and instrument relays, without amplification, removes the hazards of complex circuits.

This fact alone recommends their application to precision control problems. Another quality is their exceptional resistance to vibration, shock and general mechanical violence. These factors assure long service and unusual adherence to calibrated accuracy.

Engineering inquiries are always welcome.
Illustrated data sent on request.
*Reg. U. S. Pat. Off.

BRADLEY LABORATORIES, INC.

82 Meadow Street, New Haven 10, Conn.

D. Martin has been appointed chief engineer of the Wilcox-Gay Corp., Charlotte, Mich. Schooled at Massachusetts School of Technology, Martin brings to his new post a background of fifteen years' experience in the design and research



D. Martin

division of the engineering field. Prior associations include Westinghouse Aircraft Division, De Forest Radio Co., Federal Telephone and Radio Mfg. Co., Radio Receptor Co. and the J. H. Bunnell Co.

Charles H. Kinzel, Jr. has been appointed sales promotion manager of the John C. Dolph Co., Newark, N. J. He was formerly associated with the advertising department of the Eclipse-Pioneer Division, Bendix Aviation Corp., Teterboro, N. J.

Dr. Alexander J. Allen has been appointed Westinghouse graduate professor of engineering at the University of Pittsburgh. Formerly associate professor of physics at Pitt from 1939 to 1940, Dr. Allen returns to the University from the Bio-Chemical Foundation of Franklin Institute, Newark, Del., where he has served for the past year as assistant director.

Dr. Peter C. Goldmark has been appointed Director of Engineering and Research, a new department created by Columbia Broadcasting System. At the same time William B. Lodge has been named Director of General Engineering. Technical operations in the field of standard broadcasting, FM and short-wave broadcasting, continue under the direction of Henry Grossman.

Fred E. Walters has been appointed plant manager of John Meck Industries, Plymouth, Ind. Mr. Walters goes to Meck from the International Detrola Corp., where he was production manager for the past 2½ years. Prior to that, he was connected with RCA and General Electric in various production capacities.

COPROX RECTIFIERS

Include Many
Extras for
Longer Life

New!



"Coprox" Model CX-4D4F23, a full wave rectifier with high conversion efficiency, for electronic control work. Rated at 5 volts A.C., 40 milliamperes D.C. continuous. Fully enclosed. Mounts on a single screw.

Special terminals, or pre-soldered lead wires, prevent overheating during assembly. Standard units sealed with waterproof lacquers. critical-application units potted in wax. Standard "pellets" gold coated on front surface, forming positive contact, for critical applications, gold used on both sides. High leakage, but very low forward resistance. Highly adaptable mountings.

To these extras, add Bradley's ability to produce "Coprox" rectifiers for special applications, then:

Ask for samples and full technical data.

BRADLEY LABORATORIES, INC.

82 Meadow Street, New Haven 10, Conn.

May, Bond & Rothrock Form Consulting Firm

Organization of the firm of May, Bond & Rothrock to function as consulting radio engineers has been completed, and offices have been opened in Washington. Temporary quarters are at 1040 National Press Building. The partners are Russell P. May, with RCA at Camden, N. J., and Washington for 19 years; Clyde H. Bond, former Washington engineering consultant, now serving overseas with the Army Air Forces; and Harold B. Rothrock, who served as engineering counsel for the Clear Channel Group until 1941, and later with Bell Telephone Labs.

DSC Surplus Disposal Plan

The pattern for the disposal of surplus electronic equipment has been well established and already nearly 50 radio component manufacturing companies have signed contracts as disposal agents for the Defense Supplies Corporation. Under this plan the manufacturer enters into an agreement with Defense Supplies Corporation to act as agent of the latter in the disposal of government surplus. This plan permits the manufacturer to sell his own product for DSC, without making any capital outlay. All expenses incurred by the agent-manufacturer are for DSC account and a commission on all sales, representing a net profit to the agent-manufacturer, is provided.

In order to promote better understanding of the DSC plan, and by way of eliminating confusion which may exist, Radio Manufacturers Association, through its Industry Reconversion Subcommittee and its Parts Division Subcommittee on Reconversion has approved a report completely outlining procedure and clearing up obscure points. Salient features of the report follow:

(1) The same contract is available to all companies in any given industrial group. This means that no one manufacturer will receive a more favorable contract than any other manufacturer unless the same provisions are extended to the other manufacturers if the change is one of substance. DSC has every intention to provide a uniform contract. Pursuant to each contract, however, there will be submitted a plan of operation which will reflect the agent's tentative judgment as to how he will perform his functions and duties under the contract.

(2) The so-called plan of operation mentioned above is provided in the DSC contract for the purpose of settling preliminarily, at least, the details of operation between the DSC and the individual company, and also for the purpose of removing all possible misunderstandings and possible objections.

(3) In considering this whole matter it must be remembered that many plans have

SMART IDEA:

Though we're all absorbed in vital war work, let's give some thought to the future. Do a smart thing now — get thoroughly

acquainted with Insuline's vast line of Radio-Electronic Products and the Insuline Manufacturing Facilities . . .

These 2 books tell the story. Write for them now.

48-page Catalogue describes Insuline's vast line of Radio-Electronic Products.

8-page Brochure presents Insuline's organization and manufacturing facilities.

What are your requirements? Send data for immediate assistance.

INSULINE
CORPORATION OF AMERICA
INSULINE BUILDING · LONG ISLAND CITY, N.Y.

BLOWERS for Electronic Equipment



Easy-to-install . . . compact . . . quiet-running . . . economical . . . these are the features which make Pilot Blowers ideal for the important job of air circulation and ventilation in Radio Equipment. Available in standard models to move from 15 to 100 C.F.M. Write for Bulletin 507.



"SHADED POLE" F. H. P. MOTORS

Tell us what your requirements are and we will send you "fact sheets" giving complete specifications on these dependable, efficient, low-cost Motors. For continuous or intermittent duty with H.P. ratings ranging from 1/15 to 1/500 H.P. and from 1550 to 3400 R.P.M. Plain round or with base or resilient mounting . . . open or enclosed cases.

F. A. SMITH MANUFACTURING CO., INC.

901 DAVIS ST.

FASCO

ROCHESTER 2, N. Y.

SHADED POLE **Pilot** CENTRIFUGAL
MOTORS BLOWERS

Prompt Delivery

Cramer

Running Time Meters



Type RT2

FUNCTION

Designed for use on alternating current circuits to automatically and cumulatively register the total operating time or idle time on any circuit, machine or system to which they are connected.

USES

To record operating time of vacuum tubes so replacements can be made prior to failure occurring. To indicate total number of hours of pump or machining operation. For testing work in laboratories.



Type RT3

Send for Bulletin 3500



been considered by the DSC to handle surplus war materials, and none but the instant plan is considered workable.

(4) It is to be borne in mind that the so-called plan of operation called for by the contract has to do with the proposed routine of carrying out the plan from day to day in the future. In addition to this, however, there will be reports by the agent companies to DSC which will refer to the operations of the immediate past.

(5) Because of the facts as stated in paragraph 1 it must not be expected by the individual companies that the contract itself may be changed to suit some particular idea of language held by any individual company, but at the same time it is to be understood that it is the DSC's intention that where questions of interpretation are involved in connection with the contract, there will be no hesitancy on the part of DSC to acknowledge the correctness of such interpretations if DSC agrees with the given company's interpretation.

(6) All companies should be advised that it is the intention of DSC to pay promptly on monthly invoices.

(7) It is part of the plan of DSC that there shall be a general audit after a given period of time for each company, but DSC will endeavor to advise all agents of the industry in the immediate future as to the general principles under which DSC will approve or disapprove allocations of certain general expenses.

Antenna Towers

A dozen or more types of antenna towers are illustrated and described in a 24-page booklet being circulated by Harco Steel Construction Co., Elizabeth, N. J. The booklet gives constructional details and erection plans for tubular masts of from 20 to 200 ft. height, and of straight and tapered triangular and square towers of from 20 to 500 ft. in height. Portable types and mobile types of masts also are described.

Broad Band Circuits Available Now for FM

"If the radio industry wants FM radio program networks that employ frequency bands two, three, or even more times the width of today's standard broadcast bands, facilities to do the job can be supplied," Ernest W. Baker, American Telephone and Telegraph Co. engineer, told a joint meeting of the American Institute of Electrical Engineers and the Institute of Radio Engineers in New York.

Telephone broad-band carrier systems employed at present in the Bell System form a nationwide network which can readily be adapted for use as program circuits to interconnect FM broadcasting stations, Mr. Baker declared. He cited a trend in recent years toward broad-band carrier systems in the telephone plant, including cable and open wire carrier systems carrying frequencies extending up to 60,000 cycles and beyond; and the new coaxial cable system which is capable of accommodating a fre-

BROADCAST ENGINEERS — POLICE RADIOMEN

Write Now!

—on your phasing and tuning gear problems

• Let us know *now* your requirements and specifications for *phasing and tuning gear* for your directional antenna. Andrew custom built equipment will again become available as soon as Uncle Sam releases our engineering and manufacturing facilities from production for war.

This release may come at any moment. Be sure that your needs are listed at the top of our peace-time back-log. The planning you do now will speed your own reconversion to the new high standards of the future.

Andrew engineers will gladly apply their years of skilled experience to the

solution of your special problems in the field of directional antenna equipment:

- Phasing networks and equipment
- Antenna tuning units
- Remote reading antenna ammeters
- Phase monitors
- Coaxial transmission lines and accessories

ANDREW CO.

363 East 75th Street
Chicago 19, Illinois

Forward

WITH THE 6TH WAR LOAN!



Official U. S. Marine Corps Photo

Keep Your Plant's Quota "OUT FRONT!"

Victory depends upon materials—as well as men! To keep our American forces "closing in" overseas, you and every other manufacturer here at home must keep on making "Out Front" War Bond Quotas!

This means *action now* on every point in the fighting 8-Point Plan to step up Payroll Deductions. For instance, have you a 6th War Loan Bond Committee, representing labor, management and other important groups in your company? Selected Team Captains yet—preferably returned veterans? If so, have you instructed them in sales procedure—and given each the Treasury Booklet, *Getting the Order?*

How about War Bond quotas? Each department—

and individual—should have one! Assigning responsibilities is vital, too! Have you appointed enough "self-starters" to arrange rallies, competitive progress boards and meeting schedules? Are personal pledge, order or authorization cards printed, and made out in the name of each worker? Planning for resolicitation near the end of the drive? Your State Payroll Chairman is ready now with a detailed Resolicitation Plan. And, have you contracted for space in *all* your regular advertising media to tell the War Bond story?

Your positive Yes to *all* points in this forward-to-victory 8-Point Plan assures your plant meeting an "Out Front" Quota in the 6th War Loan—and speeds the day of unconditional surrender!

The Treasury Department acknowledges with appreciation the publication of this message by

ELECTRONIC INDUSTRIES

This is an official U. S. Treasury advertisement — prepared under the auspices of Treasury Department and War Advertising Council.





**AN AMERICAN SOLUTION TO
YOUR CAPACITOR PROBLEMS**

ALL TYPES • BY PASS
AND ELECTROLYTIC

DATA SHEETS
ON REQUEST

AMERICAN CONDENSER CO.
4410 No. Ravenswood Ave. • Chicago 40, Ill.

NO SHORTS

when you use

Gothard

PILOT LIGHTS and DIAL LIGHT BRACKET ASSEMBLIES

Gothard has developed and standardized an important terminal improvement in all Gothard Lights. Specially embossed octagon washers, blanked from linen base laminated bakelite 3/32" in thickness, permanently lock the terminals in position—no turning—no shorting—above average insulation. This and other Gothard pioneered features will greatly aid you in establishing a higher standard of performance in your precision products. Ask for complete information.

Gothard MANUFACTURING COMPANY
1315 NORTH NINTH STREET SPRINGFIELD, ILLINOIS
EXPORT DIVISION—25 Warren Street, New York 7, N. Y.
CABLES—Simostrice, New York



Have you sent
for the
New Gothard
Catalog?

quency band several million cycles wide with present equipment.

"All these broad-band carrier systems," Mr. Baker said, "employ in common the principle that a broad band of frequencies is subdivided to obtain a number of telephone circuits. For use with such carrier systems, special carrier program terminal equipment arrangements have been developed which enable a program circuit to be obtained by using the frequency space normally occupied by one or more message telephone circuits. Changes are not required in the line conductors and equipment."

It is uncertain at the moment, Mr. Baker stated, just what the design objective for intercity program circuits should be to meet the broadcasters' requirements for connecting FM stations together.

"The present extensive program networks are made up largely of facilities equalized to 5,000 cycles," he said. "However, if the broadcasters decide that they want circuits wider than 5,000 cycles, the telephone companies will be able to supply them whether the demand be for 8,000 cycles, 10,000 cycles, 15,000 cycles, or even higher."

Mr. Baker pointed out that practically all the FM stations built thus far, or for which application has been made, are in or near cities on existing intercity program routes. Over these and other routes the telephone companies are prepared to furnish the types of circuits FM broadcasters may require.

Some of the present FM stations are now being supplied with distant programs over existing networks, the speaker said, and it is entirely practical to continue this arrangement or to provide separate networks for FM stations if the broadcasting industry desires them.

830 BC stations "on wire"

"There are today," he said, "about 830 radio broadcasting stations in some 550 cities served on a full-time or occasional basis by intercity telephone wire lines. This requires about 90,000 miles of telephone company circuits for the regular full-time broadcasting period. In addition, about 45,000 miles of circuits are provided on these and paralleling routes, to handle part-time services and to make possible quick restoration of the program in the event of a failure of the regular layout."

Mr. Baker said that program circuits are being provided on the same open wire lines and in the same cables with message telephone circuits and other communication channels. In addition to the several types of wire systems, Mr. Baker stated that development work is in progress to make use of radio.



What the strain gage is quick to see

FOR THE RAPID determination of static or dynamic strains on large or complex structures, Waugh offers a range of instruments of extraordinary value. There is the 12-channel strain gage control unit which, together with recording equipment, permits 12 simultaneous measurements of strain and vibration. With this equipment, strain frequencies from 0 to 1500 cycles can be recorded.

Then there is the vector computer . . . a robot brain for the evaluation of linear strain measurements on the sur-

face of a structural element when rosette gages are used. The output of the instrument furnishes directly the principal stresses as well as the stresses or strains at any angle to the axes of the rosette.

These instruments are indicative of the range of modern instruments available through Waugh Laboratories. Write for details—Strain Gage Control Unit Type MRC10 and Vector Computer Type 30-101.



Vector Computer Type 30-101.



Write for Rental
List and Service
Manual on busi-
ness letterhead.



**AN AMERICAN SOLUTION TO
YOUR CAPACITOR PROBLEMS**

ALL TYPES - BY-PASS
AND ELECTROLYTIC

DATA SHEETS
ON REQUEST

AMERICAN CONDENSER CO.

4410 No. Ravenswood Ave. • Chicago 40, Ill.

NO SHORTS

when you use

Gothard

PILOT LIGHTS and DIAL LIGHT BRACKET ASSEMBLIES

Gothard has developed and standardized an important terminal improvement in all Gothard Lights. Specially embossed octagon washers, blanked from linen base laminated bakelite 3/32" in thickness, permanently lock the terminals in position—no turning—no shorting—above average insulation. This and other Gothard pioneered features will greatly aid you in establishing a higher standard of performance in your precision products. Ask for complete information.

Gothard MANUFACTURING COMPANY

1315 NORTH NINTH STREET SPRINGFIELD, ILLINOIS
EXPORT DIVISION—25 Warren Street, New York 7, N. Y.
CABLES—Simostrico, New York



Have you sent
for the
New Gothard
Catalog?

quency band several million cycles wide with present equipment.

"All these broad-band carrier systems," Mr. Baker said, "employ in common the principle that a broad band of frequencies is subdivided to obtain a number of telephone circuits. For use with such carrier systems, special carrier program terminal equipment arrangements have been developed which enable a program circuit to be obtained by using the frequency space normally occupied by one or more message telephone circuits. Changes are not required in the line conductors and equipment."

It is uncertain at the moment, Mr. Baker stated, just what the design objective for intercity program circuits should be to meet the broadcasters' requirements for connecting FM stations together.

"The present extensive program networks are made up largely of facilities equalized to 5,000 cycles," he said. "However, if the broadcasters decide that they want circuits wider than 5,000 cycles, the telephone companies will be able to supply them whether the demand be for 8,000 cycles, 10,000 cycles, 15,000 cycles, or even higher."

Mr. Baker pointed out that practically all the FM stations built thus far, or for which application has been made, are in or near cities on existing intercity program routes. Over these and other routes the telephone companies are prepared to furnish the types of circuits FM broadcasters may require.

Some of the present FM stations are now being supplied with distant programs over existing networks, the speaker said, and it is entirely practical to continue this arrangement or to provide separate networks for FM stations if the broadcasting industry desires them.

830 BC stations "on wire"

"There are today," he said, "about 830 radio broadcasting stations in some 550 cities served on a full-time or occasional basis by intercity telephone wire lines. This requires about 90,000 miles of telephone company circuits for the regular full-time broadcasting period. In addition, about 45,000 miles of circuits are provided on these and paralleling routes, to handle part-time services and to make possible quick restoration of the program in the event of a failure of the regular layout."

Mr. Baker said that program circuits are being provided on the same open wire lines and in the same cables with message telephone circuits and other communication channels. In addition to the several types of wire systems, Mr. Baker stated that development work is in progress to make use of radio.



What the strain gage is quick to see

FOR THE RAPID determination of static or dynamic strains on large or complex structures, Waugh offers a range of instruments of extraordinary value. There is the 12-channel strain gage control unit which, together with recording equipment, permits 12 simultaneous measurements of strain and vibration. With this equipment, strain frequencies from 0 to 1500 cycles can be recorded.

Then there is the vector computer . . . a robot brain for the evaluation of linear strain measurements on the sur-

face of a structural element when rosette gages are used. The output of the instrument furnishes directly the principal stresses as well as the stresses or strains at any angle to the axes of the rosette.

These instruments are indicative of the range of modern instruments available through Waugh Laboratories. Write for details—Strain Gage Control Unit Type MRC10 and Vector Computer Type 30-101.



Vector Computer Type 30-101.



Write for Rental List and Service Manual on business letterhead.

Pacific Coast Branch: 180 East California St., Pasadena 5, California

♦ 420 LEXINGTON AVE., NEW YORK 17, N. Y.

Wet Cell Developed For Radio Sonde Sets

For quite a while the Navy has been sending miniature battery-powered transmitters up into the stratosphere—radio sondes, they are called—as a means of collecting weather data. Heretofore these transmitters have been powered with dry cells. Now, however, a new type of storage wet cell has been developed. It is a battery measuring approximately $2\frac{1}{2} \times 2\frac{1}{2} \times 2$ in., weighing a pound when charged and providing A and B voltages of 3 and 90, respectively. Whereas the life of the previously used dry battery has been about six months, shelf life of the new unit is indefinite inasmuch as batteries are stored dry and charged just before being used.

Operate at 72.2 mc

The little transmitters are carried oftentimes to an altitude of 60,000 ft. and operate normally on a frequency of 72.2 megacycles. The component parts are a temperature instrument, a humidity instrument, a pressure capsule, a one-tube transmitter and a power supply. Transmissions are controlled by the pressure element which at

periodic intervals places the temperature and the humidity in the transmitter circuit. Each radio set transmits a series of 80 pulsations. Alteration of these factors change the resistance in the circuit which in turn changes the frequency of the transmission. This is recorded automatically by the ground receiver.

At certain points in the ascent circuits of known resistance and frequency are cut into the transmitter for reference purposes. These have been previously calibrated and can be computed in altitude terminology. Likewise, the frequency of the temperature and humidity transmission may be made to read in terms of temperature and humidity. Thus valuable information at known elevations above the earth's surface may be obtained.

There is little salvage on the radio sending apparatus, for the majority of the balloons are launched over the Pacific ocean and the radio sets are parachuted into water, but occasionally the set is recovered when launched in the continental U.S. Such radio sets are being used once or twice daily and are launched from shipboard, advance bases and forward areas, as well as from standard stations in the continental United States.

Crystal Type Frequency Converter

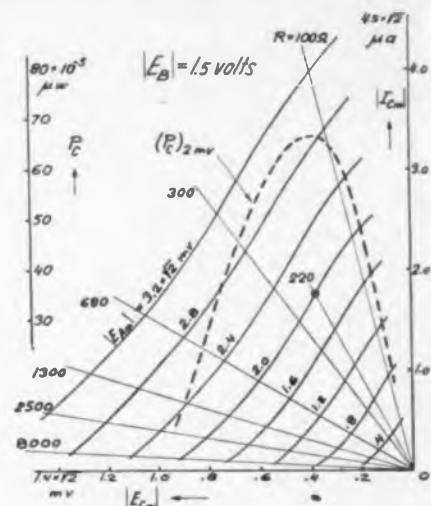

The non-linear E-I characteristics of certain crystals have long been used for modulation and de-modulation. The accompanying graph serves as a convenient calculator for operation of these crystals as a frequency converter. The chart gives IF voltage (E_{cm}) and IF current (I_{cm}) for various signal amplitudes (E_m) with the local oscillator delivering 1.5 volts. The load impedance presented by the IF transformer is represented by R with values of 100 ohms to 8000 ohms. As an example, a signal of 2.0 volts will give about 0.6 volts IF with a 680 ohm load.



Compare!

SIGNAL

PILOT LIGHT ASSEMBLIES

GIVE YOU THESE 5 ADVANTAGES:

- 1) Extensive line covers every known application...
- 2) Assemblies complete with Lamps...
- 3) Top-flight engineering...
- 4) Personalized service...
- 5) Rapid-fire deliveries.

Write for Catalog.

SIGNAL INDICATOR Corporation

894 BROADWAY... NEW YORK 3, N. Y.

Telephone: ALgonquin 4-4770

...on our mark

... and set to go on Civilian production of Radio and Automotive Products—soon. Set your sights on Snyder.

SNYDER MFG. CO.
RADIO & AUTOMOTIVE PRODUCTS - PHILA. 40 PA.

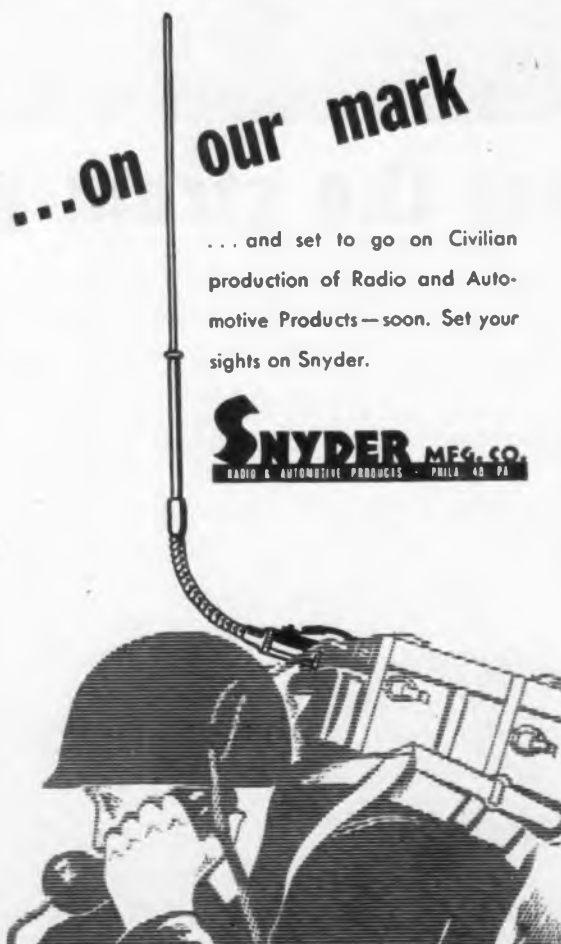

STAINLESS STEEL FASTENING DEVICES

IN STOCK!

**Prompt Delivery
of both Specials
and Standard Items**

We Stock:

Cap Screws
Machine Screws
Bolts
Washers
Nuts
Wood Screws
Taper Pins
Pipe Fittings
Rivets
Cotter Pins
Wing Nuts
Etc.

When you need non-corrosive fastening devices, write or phone Allmetal first. Chances are we have them **IN STOCK** ready for shipment. We can take care of your special work, too, as we have equipment for tapping, drilling, reaming, turning, slotting, etc. We also have complete centerless grinding facilities. Let us estimate on your requirements. Write us today.

Send for FREE CATALOG



This new, 83-page catalog helps you pick the correct size and type of non-corrosive fastening device for any particular job. Includes stock sizes, typical specials, engineering data, etc. Make request on company letterhead, please.

Write to
DEPARTMENT D

ALLMETAL SCREW PRODUCTS CO.
80 Grand Street New York 13, N. Y.

RELAYS by KURMAN

Twenty-five years' experience in solving all types of Relay Problems. Complete facilities for Design, Engineering, Manufacturing. Specialists in producing Relays of exceptional power and sensitivity for Aircraft, Intercommunications Systems, Electronic Devices. Exclusive Kurman features provide greater dependability, longer life, more precise performance.



Send data for quotations.

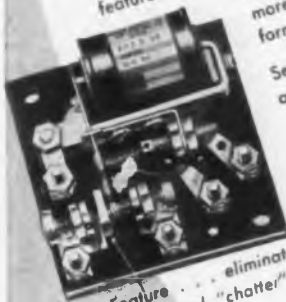

KURMAN ELECTRIC CO.



35-18 37th STREET • LONG ISLAND CITY 1, N. Y.

ENGINEERS FOR DESIGN and DEVELOPMENT RADIO-TELEVISION

Degree in communications engineering or equivalent in radio design essential. Post war permanence assured right men.

Write full qualifications — education, experience and status of availability.

ANDREA RADIO CORP.
43-20 34TH STREET LONG ISLAND 1, N. Y.

TERMINALS for ELECTRIC WIRES

SMALL METAL STAMPINGS
in accordance with your blueprints

PRECISION PARTS
from Modern Equipment

PATTON-MacGUYER CO.
17 VIRGINIA AVENUE
PROVIDENCE 5, R. I.

Need Wire Now?

COLUMBIA is reliable!

Immediate Delivery!



- **WIRE**
#22 to #12 Gauge
- **CABLES**
All Types
- **CORD SETS**
Ready-to-attach Assemblies

We Serve the

RADIO & ELECTRONIC INDUSTRY

We cut, strip, and tin wire; attach lugs and eyelets to meet your requirements.

INQUIRIES ARE WELCOME

Columbia 

COLUMBIA WIRE AND SUPPLY COMPANY
4108 N. PULASKI RD. CHICAGO 41, ILL.

ANNUAL INDEX

To Electronic Industries for 1944

The Annual Index has been arranged by Subjects for easy reference to related topics. The first figure indicates the Month in which the article appeared; the second figure indicates the page.

I CIRCUITS and THEORY

AMPLIFICATION and AMPLIFIERS

Cathode Follower Circuit...Moulic	10-90
Engineering Details of Magnetic Wire Recorder...Pugaley	1-116
Features of Inverse Feedback Amplifiers...Erhorn	2-86
Modulated Carrier for DC Amplifiers...Javna	1-102
Signal Mixing Amplifier	11-122
Transient Response of Wide Band Amplifiers...Hansen	11-80
UHF Amplifier	1-136
Using Cathode Coupling...Muller	8-106
Using Series Tubes as Control Impedances...Moulic	1-88
Variable Gain-Constant DC Circuit	3-176

CATHODE RAYS

CR Tube Voltmeter	1-124
Deflection Beam Tube...Glass	8-90
Electron Lenses	8-124

DETECTOR, DISCRIMINATOR

FM Detector Circuit of Wide Adaptability...Gelzer	7-92
---	------

ELECTRON PHYSICS

Cyclotron-Atomic Research Instrument	10-86
Exploration of Cosmic Rays...Stetson	1-94
On Ehrenhaft's Magnetic Current	5-232
Similar Electromagnetic Fields in Tubes	1-123

FILTERS

Filter Networks for UHF Amplifiers...Reber	4-86
Reducing Radio Noise...Wasmandorff	7-80

IMPULSE GENERATORS

Amplification of Voltage Impulses	8-124
Clipper and Limiter Circuit Action...Batcher, Moulic	5-100
Saw-Tooth Generator for HF Oscilloscopes...Muller	5-120
Simplified Pulse Generator...Moulic	9-84

MODULATION and MODULATORS

Modulator Load Reactance Correction...Hanson	2-108
--	-------

NETWORK ANALYSIS

Cathode Follower Circuit...Moulic	10-90
Filter Networks for UHF Amplifiers...Reber	4-86
Filters Terminated in Negative Impedances	1-123
Transient Response of Wide Band Amplifiers...Hansen	11-80

OSCILLATION and OSCILLATORS

Acorn Tube Technics...Pacent	9-94
Bridge-Controlled Oscillator Design...Bussey	8-114
High Speed Time Bases...Stewart	8-112
Klystron Characteristics...Moulic	6-90
Modulated Carrier for DC Amplifiers...Javna	1-102
Oscillator Fundamentals...Jordan	4-105
Saw-Tooth Generator for HF Oscilloscopes...Muller	5-120
Stabilization at UHF...Schmeling	9-102

RECTIFIERS and INVERTERS

Practical Applications of Selenium Rectifiers...Reinken	1-110
Rectification With Imperfect Rectifiers	3-176
Response of Rectifier to Signal and Noise	4-122
Voltage Regulator	11-122

TRANSMISSION LINES

Discontinuities in UHF Lines	5-124
Equivalent Circuits of the Electromagnetic Field	5-131
Feeder Wire Losses...Rettinger	7-89
Impedance Concept in Wave Guides	8-124
Intercoupled Transmission Lines	5-130
Klystron Characteristics...Moulic	6-90
Line Characteristics...Greenfield	10-108
Lossless Transmission Lines	7-122
Reflector Efficiency...Reber	7-101
Transmission Line Coupling in UHF Amplifiers	8-124

WAVE FORM ANALYSIS

Clipper and Limiter Circuit Action...Batcher, Moulic	5-100
Harmonic Analysis by Photographic Method	1-124
Square Wave Measurements	1-107

WAVE PROPAGATION

Discontinuities in UHF Lines	5-124
Equivalent Circuits of the Electromagnetic Field	5-131
FM "Bursts" Should Diminish...Stetson	11-83
Reflector Efficiency...Reber	7-101
VHF Ignition Noise...Sonbergh	11-94

II COMMUNICATION SYSTEMS and EQUIPMENT

AERONAUTICAL RADIO

Automatic Devices Aid Airway Safety	1-120
CAA-RTCA Instrument Landing Installation	5-92
Enemy Radio Equipment (Signal Corps Photos)	2-78
Panoramic Principles...Moulic	7-86
Radio Equipment on B-29 Superfortress	9-92
Radio on Bombers	6-113
Servicing Airborne Radio...Sonbergh	10-76
VHF Ignition Noise...Sonbergh	11-94

ANTENNAS

Chart for Rhombic Antenna Design	10-112
----------------------------------	--------

BROADCAST

Broadcasting Network Engineering Technic	4-90
Flexible Studio Console...Erhorn	8-108
Pioneer West Coast Network	6-116
United Nations North Africa Installation...Sonbergh	2-100

CARRIER CURRENT

Carrier Current System Helps Run "Penny" R.R.	4-96
Carrier Systems for Radio & Wire Lines...Erickson, Lynch	6-96
Induction Radio	11-132
Industry Uses of Carrier Current...Langdon	1-82
Railroad Traffic Control With Carrier Current...Richards	2-114

FREQUENCY MODULATION

Direction or Polarization Modulation	2-132
Engineers Discuss FM	8-110
FM "Bursts" Should Diminish...Stetson	11-83
FM Communications Highly Successful During Landings	5-160
FM Detector Circuit of Wide Adaptability...Gelzer	7-92
FM for War Workers	4-115
Invasion Radio Hazards...Davies	6-120
Measuring FM Wave Characteristics	9-118
Michigan's FM State Police System...Scavarda	2-90
Pioneer West Coast Network	6-116
RCA Super FM Uses Locked-In Oscillator...Beers	11-76
Should FM Sets Be Rated?	10-97
Television and FM Plans of Receiver Manufacturers	9-90
Transient Response in FM Systems	10-112

GENERAL

AACS—World's Greatest System	4-106
Army Radio Production...Harrison	4-100
Broadcasting Network Engineering Technic	4-90
Communications in Combat	12-97
"Conveyor-Belt" Plan for Radio Communications	1-192, 5-164
Flexible Studio Console...Erhorn	8-108
Navy Radio at War	3-100
Spiral-Four System...Johnson	5-104

INDUSTRIAL COMMUNICATION

Carrier Current System Helps Run "Penny" R.R.	4-96
Carrier Systems for Radio and Wire Lines...Erickson, Lynch	6-96
Industry Uses of Carrier Current...Langdon	1-82
Postwar Fire Radio Service	9-98
Railroad Traffic Control With Carrier Current...Richards	2-114
Senate Studies Radio Train Control	5-288
VHF R. R. Radio	9-110

INTERNATIONAL SHORT WAVE

AACS—World's Greatest System	4-106
"Conveyor-Belt" Plan for Communications	1-192
OWI's New York Master Control	8-94
OWI 300 KW International BC Set-up	9-76

RADIO RELAY SYSTEMS and EQUIPMENT

AT&T to Try UHF Repeater Links	5-166
Radio Relay Links in Police Work...Kridler	6-128
Remote Control Circuit	9-118

RECEIVERS

Brief Case Transmitter...Duncan	10-83
Captured Enemy Radio Equipment (Japanese and Italian)	2-106
Enemy Radio (captured German Radio Equipment)	5-122
Enemy Radio Equipment (Signal Corps photos)	2-78
Low Voltage Receiver...Lorch	12-86
Marine Console Radio Unit...McDonald, Hopkins	1-108
Michigan's FM State Police System...Scavarda	2-90
Panoramic Principles...Moulic	7-86
Postwar Home Receivers	9-83
RCA Super-FM Uses Locked-In Oscillator...Beers	11-76
Reducing Radio Noise...Wasmandorff	7-80
Signal Corps Analyzes Enemy Radio...Colton	3-114

RECORDING and TRANSCRIBING

Deflection Beam Tube...Glass	8-90
Earthquake Recorder	10-98
Engineering Details of Magnetic Wire Recorder...Pugaley	1-116
Engineering Problems of Picture Engineers	12-90
Recording Sound on Film...Sonbergh	8-98
Recording Two Variables...Hellman	12-76
Scoring Stage Design...Livardy, Rettinger	4-116

SOUND and PUBLIC ADDRESS SYSTEMS

Enemy Radio	5-122
Power-VU-db Relations	7-83
Recording Sound on Film...Sonbergh	8-98
Reflection of Sound...Nachod	5-107
Scoring Stage Design...Livardy, Rettinger	4-116
Sound Amplification by Air Modulation	11-84

TELEVISION

AT&T to Try UHF Repeater Links	5-166
Columbia Urges Immediate Television Improvement	8-148
Communications in Combat	12-97
Electronic Color Television	11-101

NO. 51N

NO. 50N

NEWEST DRAKE **NEON** LIGHT ASSEMBLIES

DEPENDABLE SERVICE



LONGER LIFE



SOCKET AND JEWEL LIGHT ASSEMBLIES

Drake No. 50N NEON Jewel Min. Bayonet Assembly is ideal where a distinct signal is required and observer is directly in front of instrument panel. Its 1/2" smooth clear jewel magnifies and intensifies the illumination from the Neon lamp. Red glass jewel can also be supplied. The No. 51N (without jewel) is applicable where 180° visibility is desirable. Both units have built-in resistors for NE51 Neon Lamps operating on standard 105 to 125 volt circuits. These rugged units offer BIG savings in power (1/25 watt), long life (3000 hours), wide voltage range, and great reliability.

DRAKE MANUFACTURING CO.

1713 W. HUBBARD ST. • CHICAGO, U. S. A.

Kahle

**ENGINEERING COMPANY
ELECTRON TUBE MACHINERY**

All types, standard and special design.

Specialists in equipment and methods in the manufacture of

RADIO TUBES	NEON TUBES
CATHODE RAY TUBES	PHOTO CELLS
FLUORESCENT LAMPS	X-RAY TUBES
INCANDESCENT LAMPS	GLASS PRODUCTS

On Production or Laboratory basis.

1307-1315 SEVENTH ST., NORTH BERGEN, N. J., U. S. A.

CORNELL M. E. GRADUATE

Now in Navy Research, expecting release from project early '45, seeks connection with Manufacturer of Electronic Equipment. . . . Ambitious, willing to work hard and long. Opportunity for advancement principal consideration.

Box W24
ELECTRONIC INDUSTRIES
480 Lexington Ave., New York 17, N. Y.



INDUSTRIAL X-RAY MACHINES

We're Prepared to Ship in a HURRY!



CONSTANT VOLTAGE TRANSFORMERS



PRODUCTION DRILLS



STEEL SHOP BOXES

Radio Group's National Emergency Service extends far beyond the usual items of Radio and Electronic Supplies. Our first consideration is SPEEDY DELIVERY. Vital war research or production lines must continue unchecked by sluggish procurement and deliveries.

The few products pictured here merely suggest the "unusual" items found in OUR huge well diversified stocks. So, if the things you need in a hurry don't appear in our Reference Book, include them in your order anyway. Our specially trained technicians will know all the procurement short-cuts. National Industrial Emergency Service lends valuable aid to thousands of antited buyers from coast to coast. Mail or phone your orders to the nearest distributor listed. Or write today for his free reference book and buyers guide. You'll get a degree of delivery-speed unapproached in the history of Radio Supplies distribution.

Radio and Electronic Supplies

WRITE OR PHONE YOUR NEAREST DISTRIBUTOR

TERMINAL RADIO CORP.
85 Cortlandt St., Phone WOrth 2-4416 NEW YORK 7
WALKER-JIMIESON, INC.
311 S. Western Ave., Phone CAnal 2525 CHICAGO 12
RADIO SPECIALTIES CO.
20th & Figueroa, Phone Prospect 7271 LOS ANGELES 7

NATIONAL INDUSTRIAL EMERGENCY SERVICE

Industrial Applications for Television...	Beal	7-116
NBC Plans Nationwide Television System		5-224
7000 Hours Experience in Television Service	Lubeke	7-110
Television		9-120
Television and FM Plans of Receiver Manufacturers		9-90
Television Studio Lighting		11-166
Television Today		5-314
Television Today		7-124
Television Today		8-180
Television Today		10-120
Television Today		11-120
Television Today		12-114
Television Service Hinges on Frequency		12-102
Television Without Scanning		1-122
Transient Response of Wide Band Amplifiers	Hansen	11-80

TRANSCEIVERS

Carrier Systems for Radio and Wire Lines	Erickson, Lynch	6-96
Postwar Handie-Talkie Uses		9-110

TRANSMITTERS

Brief Case Transmitter	Duncan	10-83
Captured Enemy Radio Equipment (Japanese and Italian)		2-106
Enemy Radio Equipment (Signal Corps photos)		2-78
Low Frequency Unit		9-97
Marine Console Radio Unit	McDonald, Hopkins	1-108
Michigan's FM State Police System	Scavarda	2-90
200 KW HF Transmitter		7-90
United Nations North Africa Installation	Sonbergh	2-100

UHF COMMUNICATION and EQUIPMENT

AT&T to Try UHF Repeater Links		5-166
CAA-RTCA Instrument Landing Installation		5-92
Filter Networks for UHF Amplifiers	Reber	4-86
Klystron Characteristics	Moulic	6-90
Postwar Fire Radio Service		9-98
Radio Relay Links in Police Work	Kridler	6-128

III COMPONENTS, MEASUREMENT and TEST APPARATUS

CAPACITORS

Dielectric Constants and Power Factors at Centimeter Wave Lengths		6-140
Dielectric Constant of Ionized Air in a Tube		6-140
Winding Industrial Capacitors		2-118

COILS

On Powder-Cored Coils		2-120
-----------------------	--	-------

CONTROL MOTORS

Multiwinding Motors for Electronic Uses, I	Glaser	3-104
Multiwinding Motors for Electronic Uses, II	Glaser	4-102

FREQUENCY METERS

Direct Reading Frequency Meter	Hickok	8-120
Frequency Range Extension		8-117

INSULATION MATERIALS

Blind Aid Mica Output		3-121
Electric Properties of Ceramic Materials		10-114
On Organic Insulators		2-120
Power Factor of Indian Mica		2-121
Processing of Glass for Tubes		4-120

MISCELLANEOUS

Beryllium-Copper Springs	Klock	5-108
Tropicalizing Problems		7-113

OSCILLOGRAPHS

Circular and Polar Sweeps, I	Batcher	9-80
Circular and Polar Sweeps, II	Batcher	10-80
CR Tube Voltmeter		1-124
High Speed Time Bases	Stewart	8-112
Saw-Tooth Generator for HF Oscilloscopes	Muller	6-120

QUARTZ and OTHER PIEZO-CRYSTALS

Process Control Methods for Industrial Uses, IV	Batcher	5-112
X-Ray Adjustment of Quartz Plates	Fronzel	12-98

RELAYS and SWITCHES

Beryllium-Copper Springs	Klock	5-108
Relay Testing		8-124

RESISTORS

Behavior of Resistors at Radio Frequencies	Anthes	9-86
--	--------	------

SIGNAL GENERATORS

Design of Frequency Meter		2-120
---------------------------	--	-------

TRANSFORMERS

Small Power Transformer Design Factors	Thomson	2-99
Wound-Core Transformer Design	Lee	1-114

TUBES

Acorn Tube Technics	Pacent	9-94
Continuous Production of Large Power Tubes		8-88
Deflection Beam Tube... Glass		8-90
Deflection-Modulated CR Tube		11-112
Electron Tube Development		12-81
Evolution of Tantalum Tubes	Wagener	6-108
FM-Tele Shift Slight		11-108
Klystron Characteristics	Moulic	6-90
Measuring Color Response of Photocells		4-120
On Tube Circuits		2-121
On The Virtual Cathode		7-122
Production of Cathode Ray Tubes		8-110

Rating Tube Performance		5-103
Similar Electromagnetic Fields in Tubes		1-123
Space Charge Theory		10-112
Standard Tele Tube		11-120
Tube Performance at Ultra High Frequency	Llewellyn, Peterson	11-88

VACUUM TUBE VOLTMETERS

Cathode Ray Tube VM		1-124
Low Frequency VTVM	Van Rensselaer	6-110

IV ELECTRONIC APPLICATIONS

CONTROL SYSTEMS and EQUIPMENT

General Problems

Deflection Beam Tube... Glass		8-90
Electronic Fire Control		1-106
Process Control Methods for Industrial Uses, I	Batcher	2-110
Process Control Methods for Industrial Uses, II	Batcher	3-118
Process Control Methods for Industrial Uses, III	Batcher	4-94
Process Control Methods for Industrial Uses, IV	Batcher	5-112
Railroad Traffic Control with Carrier Current	Richards	2-114
Vacuum-Tube Thyatron Phase Control Circuit		2-121

Photoelectric

Electronic Controls in Paper Industry		9-111
Photoelectric Dimension Gage	Edelman	5-96
Photoelectric Flash-Camera		7-95
Phototube Follows Cutting Pattern		6-127
Phototubes Revolve Doors		6-131

Speed Control

Industry Uses of Carrier Current	Langdon	1-82
Machine Tool Load Control		10-111
Synchronizer for Motors		2-121
Winding Industrial Capacitors		2-113

Time Control

Cold Cathode Timing Devices	Myles	7-98
Rapid Timing Switch		8-184

Welding Control

Dual Pressure Resistance Welding	Humphrey	1-98
----------------------------------	----------	------

GENERAL—INDUSTRY APPLICATIONS

Aircraft

Precision Leveling	Bennett	10-92
Torture Chambers		12-105

Automotive—Heavy Metal

Measurement of Static and Dynamic Pressures, I	Schultz, Grinstead, Frawley, Chapman	8-84
Measurement of Static and Dynamic Pressures, II	Schultz, Grinstead, Frawley, Chapman	9-104
Tubes in Metallurgical Research, I	Potter	4-112
Tubes in Metallurgy, II	Potter	5-115

Chemical

Chemical Research	Eddison	11-98
Tubes in Metallurgical Research, I	Potter	4-112
Tubes in Metallurgy, II	Potter	5-115
Tubes on the Job		12-101

HIGH FREQUENCY HEATING

Annealing, Hardening, Tempering

Case-studies of Typical Induction Heating Jobs		5-110
Continuous Heat Treating		10-111
HF Induction Heating for Thin Cases		10-112
Operating Experience with HF Heating	Gillespie	2-80

Bonding

Operating Experience with HF Heating	Gillespie	2-80
--------------------------------------	-----------	------

Brazing

Case-studies of Typical Induction Heating Jobs		5-110
Operating Experience with HF Heating	Gillespie	2-80

Drying

HF Heating Speeds Penicillin		8-118
Operating Experience with HF Heating	Gillespie	2-80

General Applications and Equipment

Case-studies of Typical Induction Heating Jobs		5-110
Coupling Methods for Induction Heating	Roberds	4-80
HF Heating Oscillators	W. C. Rudd	7-96
Maintaining Electronic Heat Equipment		5-154
Operating Experience with HF Heating	Gillespie	2-80

Molding

Electronic Tire Repairs		8-118
Operating Experience with HF Heating	Gillespie	2-80

Sterilizing and Irradiation

High Frequency Bug Eliminator		3-122
-------------------------------	--	-------

MANUFACTURING PROCESSES

Miscellaneous

Electronic Magnetizer	Hague	12-96
Torture Chambers		12-105
Tubes in Metallurgy, II	Potter	5-115

MEASUREMENTS, TESTING and TEST PROCESSES

Cosmic Rays

Exploration of Cosmic Rays	Stetson	1-94
Reflector Efficiency	Reber	7-101

Electron Microscopes

Chemical Analysis by Electron Microscopy		4-110
Electron Microscopes		6-130

METAL Stampings

DUPLICATED WITHOUT DIES

If you desire to save time and critical materials on production of metal stampings or other small parts, then the DI-ACRO System of "Metal Duplicating Without Dies" merits your consideration. It is based on the rapid and accurate production of formed parts with DI-ACRO Shears, Brakes and Benders. All duplicated work is accurate to .001". These precision machines are adaptable to an endless variety of work, and ideally suited for use by girl operators. For short runs your parts are processed in a matter of hours instead of waiting weeks for dies.



SHEARS

BRAKES

BENDERS



Send for This Catalog "DIE-LESS DUPLICATING"

It illustrates many stampings or parts made without dies, gives full details on DI-ACRO machines and shows how they may readily be adapted for various applications. Request your copy now.



← Pronounced "DIE-ACK-RO"

O'NEIL-IRWIN MFG. CO.

348 EIGHTH AVE. SO., MINNEAPOLIS 15, MINN.

Radio AND ELECTRONIC DEVICES



BURSTEIN-APPLEBEE CO.

1012-1014 McGee St. • Kansas City 6, Missouri

An established Connecticut manufacturer of small precision parts and assemblies, chiefly on contract basis, desires man familiar with such production to handle sales contacts and correspondence. Should be able to discuss design of customer's product for commercial production, quality requirements, etc.

Write Box No. E-68
ELECTRONIC INDUSTRIES
 480 Lexington Ave. New York 17, N. Y.

SOLDER POTS

1 3/4 and 2 pound capacities



for continuous 110 volt AC-DC operation

The most versatile solder pot on the market for tinning small wires, terminals, radio tube prongs, leads, etc., with maximum efficiency and minimum cost. Particularly adapted to radio, motor and electrical equipment plants where individual solder pots are desired for each operator. A single-heat, porcelain nickel-chrome heating element, which can be quickly and inexpensively replaced when necessary, heats the pot. 220 v. available. Ruggedly constructed for long, dependable service.



5139 West 25th Street, Cicero 50, Illinois
 Division of
 The National Lock Washer Company, Newark, N. J.

EISLER'S

General Glass Working Equipment



manufacturing RADIO, CATHODE RAY, ELECTRONIC and FLUORESCENT TUBES, ELECTRONICS LABORATORY UNITS.

WELDERS, TRANSFORMERS FROM 1/4 TO 500 KVA.



Glass Cutter



Ampule Machine



Tipless Stem Mosh.



Sealing Machine



Electronics Laboratory Unit



Flare Machine

CHAS. EISLER
EISLER ENGINEERING CO.
 778-SO. 11th ST. NEAR AVON AVE NEWARK, 3 N. J.

Foreign Object Detectors	
Electronic Divining Rods	4-118
Electronic Indicator for Liquid Separation	10-112
Fishing via Ultrasonics	6-131
Polarographic Analysis	Walker

General Measurements—Electrical Quantities	
Automatic Calibration	4-93
Frequency Range Extension	8-117
Measuring Potentials in Growing Things	Stetson
Measuring Small Inductances	4-122
Recording Frequency Drift	2-116
Recording Two Variables	Hellman
Square Wave Measurements	1-107
Wavemeter for 14 cm. Waves	11-112

General Measurements—Physical Quantities	
Baling Press Recorder	Killever
Measurement of Static and Dynamic Pressures, I	Grinstead
Measurement of Static and Dynamic Pressures, II	Grinstead
Measuring Projectile Velocities	10-110
Measuring Short Time Intervals	11-112
PE Tube Gas Detection	3-108
Photoelectric Dimension Gage	Edelman
Polarographic Analysis	Walker
Precision Leveling	Bennett
Process Control Methods for Industrial Uses, I	Batcher
Process Control Methods for Industrial Uses, II	Batcher
Process Control Methods for Industrial Uses, III	Batcher
Process Control Methods for Industrial Uses, IV	Batcher
Recording Two Variables	Hellman
Spectrophotometer Camouflage Technic	1-121
Tubes in Metallurgical Research, I	Potter
Tubes in Metallurgy, II	Potter

Maintenance and Testing	
Automatic Calibration	4-93
Continuous Production of Large Power Tubes	8-88
Precision Leveling	Bennett
Production of Cathode Ray Tubes	8-110
Recording Frequency Drift	2-116
Recording Two Variables	Hellman
Torture Chambers	12-105

Oscillographic Measurement and Testing	
Circular and Polar Sweeps, I	Batcher
Circular and Polar Sweeps, II	Batcher
Panoramic Principles	Moulic
Square Wave Measurements	1-107
Tubes in Metallurgical Research	Potter

Photoelectric	
Engineering Problems of Picture Engineers	12-90
Partly-Filled Tin Cans Detected by PE-Tube	7-116
PE Tube Gas Detection	3-108
Photoelectric Dimension Gage	Edelman
Slow Action Recording	Remnick
Tubes in Metallurgical Research	Potter

Piezoelectric	
Process Control Methods for Industrial Uses, IV	Batcher
Tubes on the Job	Piezoelectric Probe

Seismic and Geophysical Prospecting	
Earthquake Recorder	10-98

Spectrographic	
Light Spectra Analysis	Valle
Mass Spectrometer—New Industrial Tool	Berry
Tubes on the Job	Mass Spectrometer in Chemistry

Vibration	
An Automatic Vibration Analyzer	6-140
Earthquake Recorder	10-98
Process Control Methods for Industrial Uses, IV	Batcher
Torsional Vibration Study	7-84

MEDICAL	
Measuring Potentials in Growing Things	Stetson

MOTION PICTURES	
Engineering Problems of Picture Engineers	12-90

RECTIFIERS	
Coal Mine Installs Portable Ignitron	9-110
Practical Applications of Selenium Rectifiers	Reinken

WELDING SYSTEMS and EQUIPMENT	
Dual Pressure Resistance Welding	Humphrey

X-RAY EQUIPMENT and APPLICATIONS (Industrial Radiology, Medical Applications, General Scientific)	
High Speed X-Rays by Field Emission Arc	11-104
Million Volt X-Rays	Mermagen
Secret X-Ray Ink Detects Marked Documents	9-111
Tubes on the Job	X-Ray for Ballistics Research
2-Million Volt X-Ray Tube	11-79
X-Ray Adjustment of Quartz Plates	Frondel

V GENERAL ENGINEERING

ALLOCATIONS	
FM-Tele Shift Slight	11-108

Immediacy vs Long Term Looms as RTPB Problem	McMinn
Spectrum Division	6-112
Television Service Hinges on Frequency	12-102

ENGINEERS

Chief Engineer Jett Appointed Member of FCC by Roosevelt	2-124
Elihu Thomson's Wireless Experiments of 1871-5	Woodbury
Engineer as Executive	Clement
Engineer as Executive	Kettering
Engineer as Executive	Kaar
First Milestone of the Electronic Era	Butler
Goldsmith V-Chairman RTPB	1-97
Hubert Michael Turner, Pres. IRE	1-93
6 Keys to Engineering Success	DuMont
The Engineer as Executive	Wilimotte

GENERAL

Army Radio Production	Harrison
Behind the Development Scenes	4-84
California—Pacific Gateway	Code
California Plans Her Electronic Future	McMinn
California Sees Bright Export Future	Hansen
Cut-Backs to Bring Production	6-107
Desert Laboratory	9-124
Engineer as Executive	6-119
Engineering Laboratory	5-129
Hollywood on Wheels	1-112
Instrument Development Labs	6-126
Radio in Russia	Ellis
Research Laboratories	5-90
WPB Moves to Ease Industry Reconversion	Davies

MAINTENANCE and REPAIR PROBLEMS and PRODUCTION

Balancing Production Loads	10-106
Factory Short Cuts	1-104
Factory Short-Cuts	12-88
Ideas to Speed Production	6-124
Ideas to Speed Production	11-102
Ideas and Methods for Radio-Electronic Plants	10-104
Maintaining Electronic Heat Equipment	5-154
Maintaining Military Radio Communications	Davies
Military Radio Production Technics	9-108
Production Ideas and Technics	4-108
Production Must Increase	2-112
Production Short Cuts	7-104
Production Short Cuts	8-104
Production Speed-Up	3-116
Radio Electronic Production	McIntosh
Short Cuts in Production	3-408
Servicing Airborne Radio	Sonbergh
Six Radio-Electronic War Production Ideas	10-76
	5-118

MARKET PLANNING and SELLING

California Plans Her Electronic Future	McMinn
Finding the Answer to Postwar Products	6-100
Latin-American Markets for Home Radio	3-106
Planning for Postwar Product Development	10-94
Planning New Products for Postwar Markets	2-88
Postwar Horizons	Davies
	1-86
	12-79

PROFESSION REVIEW

Engineers Talk Shop	11-91
---------------------	-------

RADIO-ELECTRONIC STATISTICS

1944 Statistical Picture	1-91
Radio Electronic Production	McIntosh
Statistical Picture of the West	3-408
	6-103

SOCIETIES and ORGANIZATIONS

Association News	5-142
Association News	7-126
Definite Postwar Plan Urged at RMA Conference	7-114
Engineers Attend IRE-AIEE Technical Meeting	2-122
Engineers Discuss FM	8-110
Goldsmith V-Chairman RTPB	1-97
Immediacy vs Long Term Looms as RTPB Problem	McMinn
IRE-AIEE Winter Meeting	2-84
Postwar Studies Engage IRE	1-92
	8-113

STANDARDIZATION

Circuit Diagram Symbols Are Standardized	8-200
Graphical Symbols for Vacuum Tubes	7-264
Immediacy vs Long Term Looms as RTPB Problem	McMinn
Military Radio Should Be Simplified and Standardized	1-100
Wolf, Hull	8-115
Propose Standard Symbols	3-115
Goldsmith V-Chairman RTPB	1-97

VI DEPARTMENTS and FEATURES

SUPPLEMENTS

Broadcast Network Engineering Technique—April	
---	--

ELECTRONIC APPLICATION BIBLIOGRAPHY

Where to Find Special Information on Electronic Uses in Industry	White
	2-96

TRADE DIRECTORY

California's Electronic Industries	6-132
Electronic Engineering Directory	3-123

AUTHOR INDEX ON FOLLOWING PAGE

WANTED

By RBM Manufacturing Co.
Division of Essex Wire Corp.
Logansport, Ind.

**DESIGN LAYOUT DRAFTSMAN
PRODUCT DESIGNERS
ELECTRICAL ENGINEERS**

These positions offer real opportunities for advancement now and in the post-war era to those men who can design:

**RELAYS
SOLENOIDS
VOLTAGE REGULATORS
SWITCHES
REMOTE CONTROL MECHANISMS
OVERLOAD CIRCUIT BREAKERS
ELECTRONIC DEVICES**

Let us hear from you

ESICO

REG. U. S. PAT. OFF.



SPOT SOLDERING MACHINE
designed for treadle operation for advancement of iron and solder, leaving operator's hands free for handling of product.

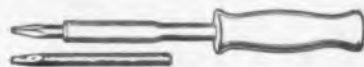

SOLDERING IRONS

are widely used in industrial plants throughout the country. They are designed to withstand the strain of continuous service required of factory tools.



SOLDERING IRON TEMPERATURE CONTROLS
prevent overheating of soldering irons between soldering operations. Irons do not deteriorate when being used. The idle period causes oxidation and shortens life.



SOLDER POTS
ruggedly constructed pots of various sizes designed for continuous operation and so constructed that they are easily and quickly serviced, should elements have to be replaced.

Write for Catalog

ELECTRIC SOLDERING IRON CO., INC.
2144 WEST ELM STREET, DEEP RIVER, CONN.

*Continuously
Since 1930*

PRECISION GROUND

Crystals
BY
HIPOWER

AIRCRAFT
MARINE • BROADCAST
POLICE • COMMERCIAL • AMATEUR

HIPOWER CRYSTAL COMPANY
Sales Division — 205 W. Wacker Drive, Chicago 6
Factory — 2033 Charleston St., Chicago 47, Ill.

ELECTRONIC ENGINEERS MECHANICAL DESIGNERS

Manufacturer of Electronic equipment seeks the services of qualified Electronic Engineers and Mechanical Designers for development and research work on high quality AM-FM Radio-phonographs. Extensive experience required in Design Engineering of Electronic equipment, including receiver, radio chassis and dial mechanisms. Engineering degree desirable but not essential. Excellent opportunities. Please submit resume.

PHILHARMONIC RADIO CORPORATION
528 East 72nd Street
New York 21, N. Y.

METAL STAMPINGS

IN SMALL LOTS

There is no other method of producing metal stampings in small lots that can equal the process originated by Dayton Rogers Mfg. Co. No matter how intricate the design or how small the quantity requirements, we can show you a substantial saving.

Write for illustrated booklet No. 176-5

**DAYTON ROGERS
MANUFACTURING COMPANY**
2841 12th Avenue South
MINNEAPOLIS 7, MINNESOTA

AUTHOR INDEX

- ANTHES, R. G.**
Behavior of Resistors at RF.....9-86
- BATCHER, RALPH R.**
Circular and Polar Sweeps, (I).....9-80
Circular and Polar Sweeps, (II).....10-80
Clipper and Limiter Circuit Action.....5-100
Control Methods for Industrial
Uses (I).....2-110
Control Methods for Industrial
Uses (II).....3-118
Control Methods for Industrial
Uses (III).....4-94
Control Methods for Industrial
Uses (IV).....5-112
- BEERS, G. L.**
RCA Super-FM Uses Locked-In
Oscillator.....11-76
- BENNETT, PAUL**
Precision Leveling.....10-92
- BERRY, CLIFFORD E.**
Mass Spectrometer—New Industrial
Tool.....6-94
- BUSSEY, WILLIAM H.**
Bridge—Controlled Oscillator Design.....8-114
- CHAPMAN, F. W.**
Measurement of Static and Dynamic
Pressures (I).....8-84
Measurement of Static and Dynamic
Pressures (II).....9-104
- CLEMENT, LEWIS M.**
Engineer as Executive.....1-119
- CODE, MAJOR GENERAL JAMES A., JR.**
California—Pacific Gateway.....6-99
- COLTON, MAJOR GENERAL R. B.**
Signal Corps Analyzes Enemy Radio.....3-114
- DAVIES, ROLAND C.**
Invasion Radio Hazards.....6-120
Maintaining Military Radio Com-
munications.....8-102
Postwar Horizons.....12-79
WPB Moves to Ease Industry Re-
conversion.....3-102
- DUMONT, ALLEN B., DR.**
6 Keys to Engineering Success.....11-111
- DUNCAN, J. R.**
Brief Case Transmitter.....10-83
- EDDISON, CLIFFORD**
Chemical Research.....11-98
- EDELMAN, A.**
Photoelectric Dimension Gage.....5-96
- ELLIS, RAY C.**
Radio in Russia.....7-76
- ERHORN, PHILIP C.**
Flexible Studio Console.....8-108
Inverse Feedback Amplifiers.....2-86
- ERICKSON, L. G.**
Carrier for Radio and Wire Lines.....6-96
- FRAWLEY, R. N.**
Measurement of Static and Dynamic
Pressures (I).....8-84
Measurement of Static and Dynamic
Pressures (II).....9-104
- FRONDEL, DR. C.**
X-Ray Adjustment of Quartz Plates.....12-98
- GELZER, JOHN**
FM Detector Circuit.....7-92
- GILLESPIE, HENDERSON C.**
Experience With HF Heating.....2-80
- GLASER, EDWARD M.**
Multiwinding Motors (I).....3-104
Multiwinding Motors (II).....4-102
- GLASS, PAUL**
Deflection Beam Tube.....8-90
- GREENFIELD, E. W.**
Line Characteristics.....10-108
- GRINSTEAD, C. E.**
Measurement of Static and Dynamic
Pressures (I).....8-84
Measurement of Static and Dynamic
Pressures (II).....9-104
- HAGUE, H. J.**
Electronic Magnetizer.....12-96
- HANSEN, O. C.**
California Sees Bright Export
Future.....6-107
- HANSEN, W. W., DR.**
Transient Response of Wide Band
Amplifiers.....11-80
- HANSON, ROBERT M.**
Modulator Load Reactance
Correction.....2-108
- HARRISON, MAJOR GENERAL W. H.**
Army Radio Production.....4-100
- HELLMAN, R. K.**
Recording Two Variables.....12-76
- HICKOK, JR., R. D.**
Direct Reading Frequency Meter.....8-120
- HOPKINS, GORDON C.**
Marine Console Radio Unit.....1-108
- HULL, COMMANDER D. R.**
Military Radio Should Be
Standardized.....1-101
- HUMPHREY, S. M.**
Dual Pressure Resistance Welding...1-98
- JAYNA, STEPHEN L.**
Modulated Carrier for DC Amplifiers.....1-102
- JOHNSON, CLIFFORD J.**
Spiral-Four System.....5-104
- JORDAN, J. P.**
Oscillator Fundamentals.....4-105
- KAAR, JOHN M.**
Engineer as Executive.....6-123
- KLIEVER, WALDO H.**
Baling Press Recorder.....7-106
- KLOCK, SHELDON C.**
Beryllium-Copper Springs.....5-108
- KRIDLER, R. A.**
Radio Relay Links in Police Work...6-128
- LANGDON, G. G.**
Industry Uses of Carrier Current...1-82
- LEE, REUBEN**
Wound-Core Transformer Design...1-114
- LIVARDY, JOHN P.**
Scoring Stage Design.....4-116
- LLEWELLYN, F. B.**
Tube Performance at Ultra High
Frequency.....11-88
- LORCH, JOSEPH**
Low Voltage Receiver.....12-86
- LUBCKE, HARRY R.**
7000 Hours Television Service....7-110
- LYNCH, F. W.**
Carrier for Radio and Wire Lines...6-96
- MCDONALD, JOSEPH M.**
Marine Console Radio Unit.....1-108
- McMINN, STANLEY P.**
California Plans Her Electronic
Future.....6-100
Immediacy vs. Long Term RTPB
Problem.....2-84
- MERMAGEN, HERBERT**
Million Volt X-Rays.....10-100
- MOULIC, WILLIAM**
Cathode Follower Circuit.....10-90
Clipper and Limiter Circuit Action...5-100
Klystron Characteristics.....6-90
Panoramic Principles.....7-86
Series Tubes as Control Impedances...1-88
Simplified Pulse Generator.....9-84
- MULLER, W.**
Saw-Tooth Generator for HF
Oscilloscopes.....5-120
Using Cathode Coupling.....8-106
- MYLES, ASA H.**
Cold Cathode Timing Devices.....7-98
- NACHOD, CARL P.**
Reflection of Sound.....5-107
- PACENT, LOUIS GERARD**
Acorn Tube Technics.....9-94
- PETERSON, L. C.**
Tube Performance at Ultra High
Frequency.....11-88
- POTTER, E. V.**
Tubes in Metallurgical Research (I) 4-112
Tubes in Metallurgy (II).....5-115
- PUGSLEY, D. W.**
Details of Magnetic Wire Recorder..1-116
- REBER, GROTE**
Filter Networks for UHF Amplifiers..4-86
Reflector Efficiency.....7-101
- REINKEN, L. W.**
Applications of Selenium Rectifiers..1-110
- REMNICK, HERBERT S.**
Slow Action Recording.....7-102
- RETTINGER, M.**
Feeder Wire Losses.....7-89
Scoring Stage Design.....4-116
- RICHARDS, HARRY W.**
Railroad Control With Carrier....2-114
- ROBERDS, WESLEY M.**
Coupling Methods for Induction
Heating.....4-80
- RUDD, W. C.**
HF Heating Oscillators.....7-96
- SCAVARDA, CAPTAIN C. J.**
Michigan's FM State Police System..2-90
- SCHMELING, AUGUST M.**
Stabilization at UHF.....9-102
- SCHULTZ, H. F.**
Measurement of Static and Dynamic
Pressures (I).....8-84
Measurement of Static and Dynamic
Pressures (II).....9-104
- SLACK, CHARLES M.**
High Speed X-Rays by Field
Emission Arc.....11-104
- SONBERGH, GILBERT**
Carrier System Helps Run "Pennay"
R. R.....4-96
Recording Sound on Film.....8-98
Servicing Airborne Radio.....10-76
United Nations North Africa
Installation.....2-100
VHF Ignition Noise.....11-94
- STETSON, DR. HARLAN T.**
Exploration of Cosmic Rays.....1-94
FM "Bursts" Should Diminish.....11-83
Measuring Potentials in Growing
Things.....12-82
- STEWART, WILLIAM A.**
High Speed Time Bases.....8-112
- THOMSON, J. M.**
Power Transformer Design Factors..2-90
- THILO, EDWARD R.**
High Speed X-Rays by Field
Emission Arc.....11-104
- VAILE, C. A.**
Light Spectra Analysis.....6-114
- VAN RENSSELAER, CORTLANDT**
Low Frequency VTVM.....6-110
- WAGENER, DR. WINFIELD G.**
Evolution of Tantalum Tubes.....6-108
- WALKER, A. C.**
Polarographic Analysis.....3-120
- WASMANSDORFF, CARLTON**
Reducing Radio Noise.....7-80
- WHITE, W. C.**
Electronic Uses in Industry.....2-96
- WILMOTTE, RAYMOND M.**
The Engineer As Executive.....8-116
- WOLF, SIDNEY K.**
Military Radio Should Be
Standardized.....1-100
- ZAVALLAS, CHARLES T.**
High Speed X-Rays by Field
Emission Arc.....11-104

ELECTRONIC INDUSTRIES

Advertisers — December, 1944

Page	Page	Page
Accurate Spring Mfg. Co. 196	Eisler Engineering Co. 219	Patton-MacGuyer Co. 215
Aerovox Corp. 118	Eitel-McCullough, Inc. 50	Permoflux Corp. 164
Aircraft Accessories Corp. 6, 7	Electrical Apparatus Co. 201	Philco Corp. 45
Aircraft-Marine Products, Inc. 55	Electric Indicator Co. 191	Philharmonic Radio Corp. 221
Albion Coil Co. 65	Electric Soldering Iron Co., Inc. 221	Pioneer Gen-E-Motor 154
Allied Radio Corp. 176	Electronic Laboratories, Inc. 10	Porter Metal Products Co. 182
Allmetal Screw Products Co. 215	Electronic Products Mfg. Corp. 188	Presto Recording Corp. 38
American Condenser Co. 212	Electro-Voice Corp. 121	Printloid, Inc. 190
American Lava Corp. 36	Erie Resistor Corp. 120	Radell Corp. 190
American Phenolic Corp. 151	Fast & Co., John E. 205	Radiart Corp. 186
Amperex Electronic Corp. 2	Federal Telephone & Radio Corp. 66, 137	Radio Corporation of America: RCA Victor Division 21
Amperite Co. 202	Foote Pierson & Co., Inc. 129	Cover 4
Andrea Radio Corp. 215	Formica Insulation Co. 11	Radio Receptor Co., Inc. 206
Andrew Co. 210	Franklin Mfg. Corp., A. W. 143	Radio Specialties Co. 217
Ansonia Electrical Co. 17	General Ceramics & Steatite Corp. 49	Ray-O-Vac Co. 123
Arnold Engineering Co. 134	General Electric Co., 5, 22, 23, 117, 144, 157, 184, 192	Raytheon Mfg. Co. 161
Associated Research, Inc. 179	General Electronics, Inc. 47	RBM Mfg. Co. 221
Atlas Products Corp. 136	General Instrument Corp. 44	Remler Co., Ltd. 24
Atlas Sound Corp. 195	General Industries Co. 41	Rogers Mfg. Co., Dayton 221
Audio Development Co. 174	General Radio Co. 64	Rothenstein, Albert 194
Automatic Electric Sales Corp. 52	Gothard Mfg. Co. 212	Sangamo Electric Co. 70, 71
Barker & Williamson 178	Green Electric Co., Inc., W. 168	Schauer Machine Co. 172
Bassett, Inc., Rex 204	Groves Corp. 186	"S" Corrugated Quenched Gap Co. 59
Bendix Aviation Corp.: Pacific Division 138	Guardian Electric Mfg. Co. 111	Sentinel Radio Corp. 159
Radio Division 73	Hallicrafters Co. 173	Sherron Electronics Co. 133
Bentley, Harris Mfg. Co. 63	Hammarlund Mfg. Co., Inc. 25	Shure Brothers 171
Benwood Linze Co. 68	Harvey Radio Co. 115	Sigma Instruments, Inc. 166
Bird, Richard H. 204	Harvey Radio Laboratories, Inc. 181	Signal Indicator Corp. 214
Bliley Electric Co. 39	Haydon Mfg. Co., Inc. 162	Simpson Electric Co. 48
Boes Co., W. W. 26	Hipower Crystal Co. 221	Smith Mfg., F. A. 209
Boonton Radio Corp. 202	Hopp Press, Inc. 126	Snyder Mfg. Co. 214
Bradley Labs. 208	Howard Mfg. Corp. 156	Sola Electric Co. 113
Bridgeport Mfg. Co. 40	Hyttron Corp. 107	Sonotone Corp. 155
Burndy Engineering Co. 35	Illinois Condenser Co. 168	Sperry Gyroscope Co. 19
Burstein-Applebee Co. 219	Indiana Steel Products Co. 31	Sperli, Inc. 146
Cambridge Thermionic Corp. 188	Insuline Corp. of America 209	Sprague Electric Co. 175
Cannon Electric Development Co. 148	J-B-T Instruments, Inc. 170	Stackpole Carbon Co. 54
Capacitron Co. 60	Jefferson Electric Co. 141	Standard Transformer Corp. 132
Carborundum Co. 183	Jennings Radio Mfg. Co. 37	Standard Winding Co. 181
Capitol Radio Engineering Institute 189	Johnson Co., E. F. 179, 198, 204	Sticht Co., Inc., Herman H. 140
Celanese Corp. of America 69	Jones Co., Howard B. 142	Struthers-Dunn, Inc. 61
Centralab 43, 160	Kaar Engineering Co. 20	Stupakoff Ceramic & Mfg. Co. 33, 165
Chicago Telephone Supply Co. 32	Kahle Engineering Co. 217	Sun Radio & Electronics Co. 128
Chicago Transformer Corp. 142	Karp Metal Products Co., Inc. 116	Sylvania Electric Products, Inc. 203
Cinaudagraph Speakers, Inc. 191	Kinney Mfg. Co. 136	Synthane Corp. 56, 57
Clarostat Mfg. Co., Inc. 177	Kold-Hold Mfg. Co. 194	Tech Laboratories 185
Clifton Products, Inc. 156	Kurman Electric Co. 215	Telicon Corp. 27
Cole Steel Equipment Co. 18, 122	Langevin Co. 125	Terminal Radio Corp. 217
Collins Radio Co. 58	Lapp Insulator Co., Inc. 167	Thomas & Skinner Steel Products Co. 198
Colonial Kolonite Co. 176	Lavoie Laboratories 109	Triplet Electrical Instrument Co. 16
Columbia Wire & Supply Co. 215	Lectrohm, Inc. 219	Tung-Sol Lamp Works, Inc. 12
Communications Co., Inc. 197	Littelfuse, Inc. 187	Turner Co. 158
Concord Radio Corp. 180	Machlett Laboratories, Inc. 67	United Electronics Co. 119
Connecticut Telephone & Electric 42	Mallory & Co., Inc., P. R. 145	United Screw & Bolt Corp. 46
Connector Division of International Resistance Co. 9	Measurements Corp. 200	United Transformer Co. 74
Cornell-Dubilier Electric Co. 147	Mec-Rad Division—Black Industries 14	Universal Microphone Co. 29, 164
Corning Glass Works 13	Merit Coil & Transformer Corp. 4	University Laboratories 185
Cornish Wire Co., Inc. 128	Micro Switch Corp. 139	U. S. Treasury 211
Corry-Jamestown Mfg. Corp. 15	Millen Mfg. Co., Inc. 224	Utah Radio Products Co. 34
Coto-Coil Co., Inc. 172	Mu-Switch Corp. 122	Valpey Crystal Corp. 140
Cramer Co., R. W. 210	Mycalex Corp. of America 149	Walker-Jimieson, Inc. 217
Crystal Products Co. 127	National Union Research Laboratories 124	Warren Telechron Co. 135
Dalis, Inc., H. L. 224	New York Transformer Co. 28	Webster Electric Co. 126
Daven Co. Cover 3	Norton Electrical Instrument Co. 195	Weltronic Co. 223
Dazor Mfg. Co. 207	Ohmite Mfg. Co. 193	Waugh Laboratories 213
De Jur-Amsco Corp. 72	O'Neil-Irwin Mfg. Co. 219	Western Electric Co. 180
Deutschmann Corp., Tope. 3		Western Felt Works 8
Dial Light Co. of America, Inc. 200		Western Lithograph Co. 187
Diamond Wire & Cable Co. 192		Westinghouse Electric Mfg. Co. 30, 53, 130, 131, 152, 153
Dolph Co., John C. 189		Weston Electrical Instrument Corp. 169
Drake Mfg. Co. 217		Wheeler Insulated Wire Co., Inc. 199
Dumont Electric Co. 206		Wiedemann Machine Co. 62
DuMont Laboratories, Inc., Allen B. 163		Wrigley Co., Wm. 184
Eastern Air Devices, Inc. 51		
Ecor, Inc. 150		

While every precaution is taken to insure accuracy, we cannot guarantee against the possibility of an occasional change or omission in the preparation of this index.



RUNS D-C MOTORS FROM A-C AT FULL TORQUE

Any standard D-C shunt motor can now be operated from A-C power at full-load torque at all speeds from a few rpm to basic motor speed by using the Weltronic Motor Control. Speed reducers, gear motors, motor generators, transmissions or special motors are no longer needed when this control is used—and constant torque can be maintained as the speed is varied.

The control is a complete 'packaged' unit—it starts motors at an adjustable constant line current, brings them up to a selected speed and holds this speed under varying loads. In addition, it stops motors and if required can be designed to apply dynamic braking, reversing and 'inching' of motors—all from a single push button and dial control station located handy to the operator. Models are available up to 20 HP capacity.

Ask for Bulletin No. WTM-44

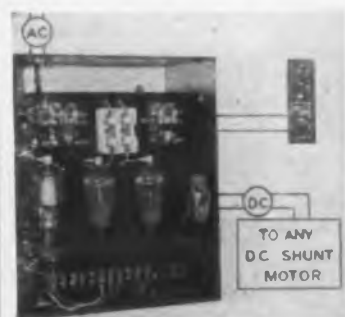

Weltronic
COMPANY
DETROIT 19, MICH.

Designed for



Application



**The No. 37105
Steatite Terminal Strip**

• Another exclusive Millen "Designed for Application" product is the No. 37105 Steatite five-terminal strip. Lugs soldered as well as mechanically attached to floating screw machine units. Easy to mount with series of round holes for integral chassis bushings. Ideal answer to the "tropicalization" problem.

**JAMES MILLEN
MFG. CO., INC.**

MAIN OFFICE AND FACTORY
**MALDEN
MASSACHUSETTS**



**Train Telephones
Feasible**

Telephone communication with moving trains, using existing public exchange systems is quite feasible according to AT&T. Bell System engineers submitted a statement to the FCC during the course of the recent public hearings in Washington in which an offer to work with the railroads was included. In addition Western Electric plans, postwar, to produce radio telephone and carrier equipment suitable for any railroad use.

**Curved Electrodes
Improve Plastics
Preheating**

A special output electrode arrangement for effective preheating of domed plastic preforms has been developed by Airtronics Mfg. Co., Los Angeles. Comprising dual curved lower electrodes in combination with a standard flat upper electrode, the new arrangement effects uniform heating of the domed preforms by placing them on edge in the lower electrodes which are curved to insure uniform heating throughout the preforms. These new electrodes also preheat conventional cylindrical preforms very effectively and heating irregularities due to variations in preform thickness are markedly reduced. The lower electrode assembly is readily removable to facilitate transfer of the preheated material to the molding press.

An air-gap adjustment on the upper electrode assembly regulates the distance between upper platen and preform charge. In many instances, the utilization of an air gap facilitates evaporation of volatiles and minimizes irregularities in heating.



BUY BONDS

RESISTORS
CONDENSERS
CONTROLS • WIRE
TRANSFORMERS • CABLE
HEADPHONES
RELAYS • SWITCHES
SOLDERING IRONS
BATTERIES • TUBES
TOOLS

**WAR-ORDER
NEEDS**

• Your priority orders for radio-electronic materials get whirlwind action here because:

Dalis always has on hand exceptionally large and complete stocks. Most orders are filled immediately from stock.

Since 1925, Dalis has specialized in the distribution of radio materials. Long-established factory connections assure deliveries of needed items in quickest possible time.

Dalis has it — or Dalis can get it. If you're in a terrific rush for those priority needs, just

**'Phone, wire
or write . . .**

H. L. DALIS, INC.

Wholesale Distributors
RADIO-ELECTRONIC SUPPLIES & PARTS
17 Union Square
NEW YORK 3, N. Y.

Phones: ALgonquin 4-8112 3-4-5-6-7

DAVEN

POWER OUTPUT METERS

DESIGNED TO MEASURE POWER OUTPUT

- at fixed impedance and fixed frequency
- at fixed frequency and variable load
- at fixed load and variable frequency



ALSO

- to determine internal impedance or optimum load
- to measure insertion loss of a network
- to measure noise pick-up level
- to test band width, selectivity, fidelity, sensitivity

OP-193-A—OP-193-B
 Power range: 0.1mw to 5 watts.
 Impedance:
 OP-193-A—12 values, 400 to 20,000 Ω
 OP-193-B—40 values, 2.5 to 20,000 Ω
 Accuracy: $\pm 5\%$.
 Special Feature: Provision for use of headphones and/or meter.

The DAVEN OP Series Power Output Meters offer a selection of four models for measuring the effect of power and load on audio amplifiers, filters, oscillators and similar equipment, as well as for standard radio receiver tests. Types OP-182 and OP-961 are widely accepted for their wide flexibility, accuracy and durability. Types OP-193-A and OP-193-B are especially adapted for noise pick-up level work in testing radio receivers, where the use of headphones is desired. A special three-position switch enables use of headphones circuit, meter circuit or both simultaneously.

OTHER SPECIFICATIONS

INDICATING METER

Rectifier type AC, calibrated 1 to 50mw and 0 to 17 DB. Reference level 0 DB = 1mw.

METER MULTIPLIER

OP-182, OP-193-A, OP-193-B—Extends meter power reading, 0.1 to 100 X scale; DB reading, -10 to +20 DB, in 10 DB steps.
 OP-961—Extends meter power reading, 0.1 to 1000 X scale; DB reading, -10 to +30 DB, in 2 DB steps.

MOUNTING

OP-182—Black metal panel, hand rubbed walnut cabinet, 12"x6"x6"
 OP-961—Black metal panel, ventilated metal case, 12"x7"x6 1/2"
 OP-193-A, OP-193-B—Black bakelite panel, portable cabinet with removable cover, 13 3/4"x7 3/4"x5 1/4"

BUY, HOLD, GIVE—WAR BONDS!

THE **DAVEN** COMPANY
 191 CENTRAL AVENUE
 NEWARK 4, NEW JERSEY



OP-182

Power Range: 0.1mw to 5 watts.
 Impedance: 40 values,
 2.5 to 20,000 Ω
 Accuracy: $\pm 5\%$.



OP-961

Power Range: 0.1 to 50 watts.
 Impedance: 40 values,
 2.5 to 20,000 Ω
 Accuracy: $\pm 5\%$.

REVOLUTIONARY TUBE DESIGN



1. Filament Posts
2. Exhaust-tube Protective Cap
3. Metal Exhaust Tube
4. Filament Lead Seal (metal-to-glass)
5. Low-inductance Grid Terminal
6. Entrant Metal Header
7. Grid Seal (metal-to-glass)
8. Corona Ring
9. Filament Terminal Blocks
10. Filament Support Rods
11. Hard-glass Bulb
12. Grid Support Rods
13. Anode Seal (metal-to-glass)
14. Filament Heat Shield and Rod Reinforcement
15. Electrostatic Shield
16. Anode Flange
17. Anode (1/4-inch thick copper)
18. Grid Welded to Supports
19. Tie Wires for Self-Supporting Filament Assembly
20. Filament Strands
21. Common Tie of Self-Supporting Filament Assembly



RCA 9C22, air-cooled twin of 9C21, also offers high performance in industrial and radio broadcast service

This is the story of a new tube design that "rewrites the rule book."

The tube is the new RCA 9C21, a high-power, water-cooled triode . . . which, together with its air-cooled twin, the 9C22, offers important advantages in high-power, high-frequency equipment. In designing these tubes, RCA engineers have established new concepts of tube design for such service.

Their goal was higher frequency performance for tubes of high-power design. Drawing upon their years of experience in designing and building tubes, they worked out unique innovations that produced the results they sought.

For example, one of these innovations is an *entrant metal header* which allows short, internal filament leads, and a short, low-inductance path to the grid . . . highly important factors in improving high-frequency performance.

For industrial oscillator service these new design features, shown here in an "X-ray" view, give the 9C21 a 50-kw output at a maximum frequency of 25 mc, and a 100-kw output at 5 mc or below. In high-level modulated service (at 5 mc or below) the 9C22 provides 38-kw maximum output. Thus a pair of 9C22 tubes may be used conservatively as a tube complement for the output stage of a 50-kw transmitter.

A better tube, for better performance . . . and another example of the engineering leadership that makes RCA tubes the standard of comparison in the electronic industry.

Remember, *the Magic Brain of all electronic equipment is a Tube . . . and the fountain-head of modern Tube development is RCA.*



RADIO CORPORATION OF AMERICA

RCA VICTOR DIVISION • CAMDEN, N. J.

Listen to "THE MUSIC AMERICA LOVES BEST"
Sundays, 4:30 p.m., E. W. T., NBC Network

