

*Win a FREE Trip to the World's Fair*

# RADIO WORLD

*New*

*In This Issue:*

**Television Awaits the Broadcasters . . . .**

**Modulators without Headaches . . . .**

**A Push Button All Band Exciter Unit . . . .**

**JANUARY 1939**

25c

Discover America's  
No. 1 Capacitor  
Value



## TYPE BR

Cornell-Dubilier's new capacitor catalog is yours for the asking. It's crammed full of important information—news of what's happening in the capacitor world; tips on what to look for in the capacitor world; plus a page-by-page description of Cornell-Dubilier's complete line of experience-built, service-proved capacitors. Mail coupon today for your FREE copy.



**CORNELL-DUBILIER  
ELECTRIC CORPORATION**  
South Plainfield, New Jersey

Cable Address: "CORDU"

### FEATURES:

- 1—Exclusive Electro-Chemical Etching—Eliminates corrosion.
- 2—Hi-Formation Process—Affords higher voltage breakdown.
- 3—Hi-Pressure Centrifuge—Better impregnation; lower power-factor.
- 4—Hi-Purity Aluminum Foil—Better direct current leakage recovery.
- 5—Special C-D Super-Purity Cellulose Separator—Extra long life.
- 6—Rigid Chemical Purity Control—Uniform performance.
- 7—Double Ageing—Stable characteristics.
- 8—All Aluminum Tube and Accessories—Uniform results in all weather.
- 9—Special Vent—Safety under all operating conditions.
- 10—Tubular, Compact Construction—Allows ease of wiring into circuit.

**FREE**  
Catalog

**CORNELL-DUBILIER  
ELECTRIC CORP.**

1024 HAMILTON BLVD.  
SO. PLAINFIELD, N. J.

Rush to me copy of Catalog 161   
Put my name on list for house organ

Name \_\_\_\_\_

Address \_\_\_\_\_

City \_\_\_\_\_

State \_\_\_\_\_

RW139

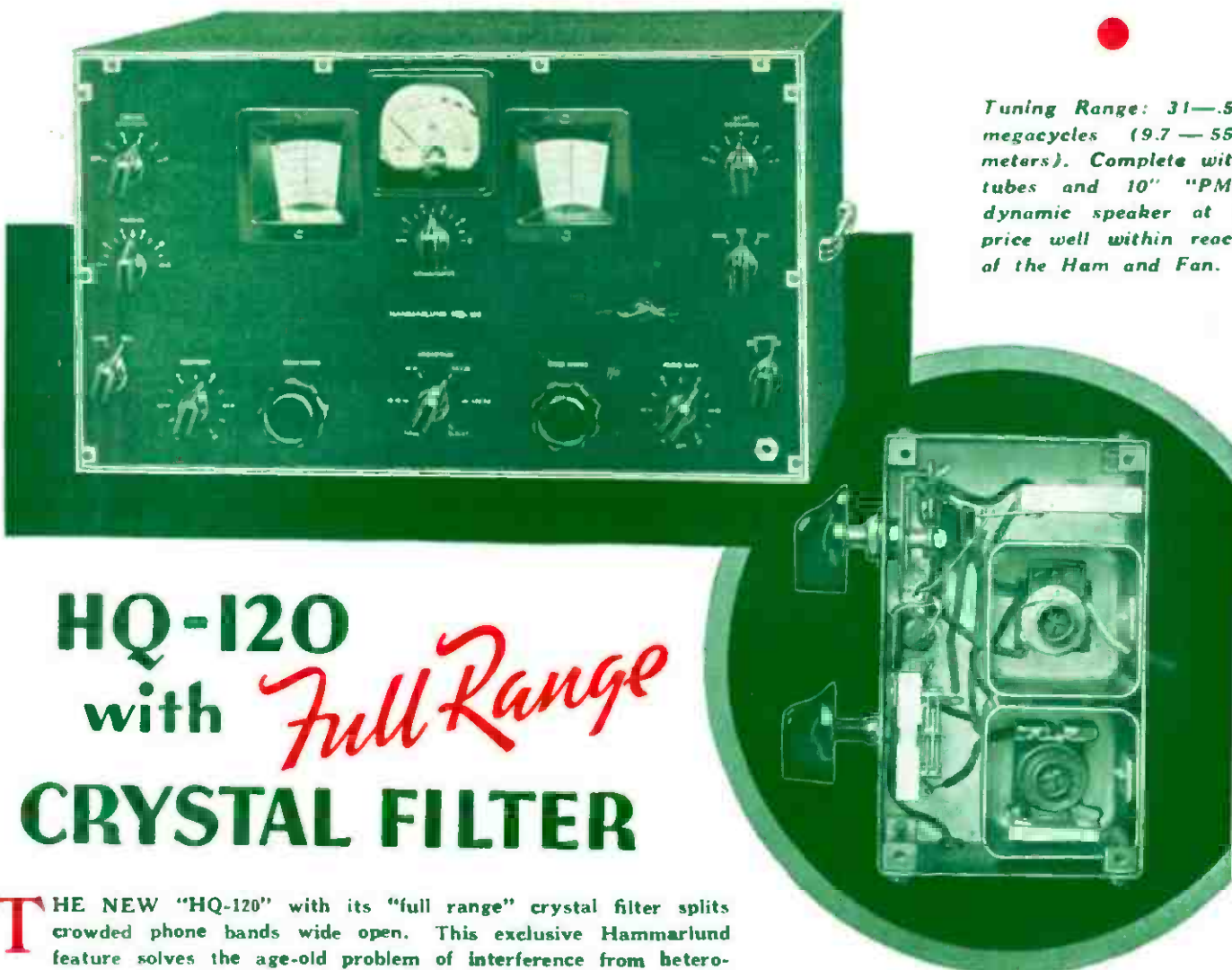

*Tuning Range: 31—54 megacycles (9.7 — 555 meters). Complete with tubes and 10" "PM" dynamic speaker at a price well within reach of the Ham and Fan.*

# HQ-120 with *Full Range* CRYSTAL FILTER

**T**HE NEW "HQ-120" with its "full range" crystal filter splits crowded phone bands wide open. This exclusive Hammarlund feature solves the age-old problem of interference from heterodynes and side-band splashover. The selectivity curves shown in the drawing were taken on a production model receiver. Labeling of these curves corresponds to the markings of the selectivity switch on the panel. In practice, curve No. 1 is not only wide enough to permit excellent voice reception, but fairly good quality music as well. Curve No. 2 is intended for voice reception where quality is a consideration even though interference may be very heavy. Number 3 is for extreme conditions of interference where "getting the message through" is more important than quality. Positions No. 4 and No. 5 are for CW code reception. Unlike most crystal filters, the output of this one is uniform throughout its selectivity range, and there is no interlocking of controls.

Special consideration has been given to the R.F. gain of the receiver in order that it will not require a stronger signal on 20 meters than on 80, for example, to read "S-9" on the meter. The "HQ-120" is also equipped with a noise limiter which follows the strength of the incoming signal and takes out automobile ignition interference and similar disturbances. In order to maintain high efficiency with various types of antennas, the "HQ-120" has an antenna compensating control which assures maximum image rejection, maximum signal-to-noise ratio, and perfect circuit alignment at all times. There is a spread of 310 degrees for each amateur band from 80 to 10 meters, and the dial is calibrated in megacycles for these amateur bands. The main tuning dial is also calibrated in megacycles for the entire range of the receiver.

*Write Dept. RW-1 for 16-page booklet.*

*Selectivity Curves*

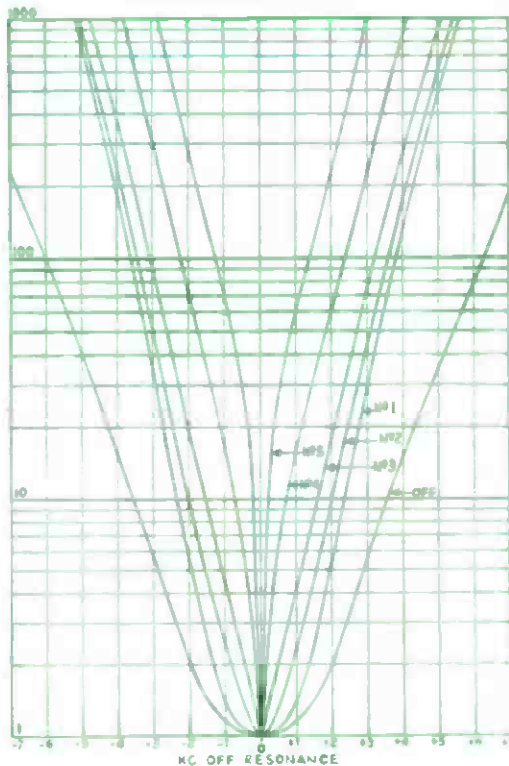

**HAMMARLUND MFG. CO., INC.**  
424-438 WEST 33rd ST., NEW YORK  
CANADIAN OFFICE: 41 WEST AVE. NO. HAMILTON, ONT.

# THE HANDIEST TESTER OF ALL.....

**Model 666**



**POCKET  
VOLT-OHM-  
MILLIAMMETER**

For laboratory,  
shop or field use.  
Handy pocket size,  
yet sturdy and pre-  
cision-built.

**Dealer Price . . . \$15.00**

**Size: 3 1/16" x 5 7/8" x 2 1/8"**

## MODEL 327-A DECIBEL METER

3" Instrument in New Style Molded Case



**Dealer Price . . \$12.00**

Standard range  
reads up 6 and  
down 10 decibels,  
zero decibel at 1.73  
volts, 500-ohm line,  
6 milliwatts, stand-  
ard damping fur-  
nished unless highly  
damped is specified.  
Economically priced.

Has 3" Sq. Triplet Improved Rectifier Type  
Instrument. AC-DC Voltage Scales Read:  
0-10-50-250-500-1,000 at 1,000 Ohms per  
Volt. DC Milliampere Scales Read: 0-1-  
10-50-250. Ohms Scales Read: Low, 1/2-  
300; High, 250,000. Black Molded Case and  
Panel. Low Loss Selector Switch. Complete  
with Alligator Clips, Battery and Test Leads.  
Dealer Price \$15.00.

A complete instrument for all servicing and  
other needs. Can be used for all AC-DC  
voltage, current and resistance analyses.

Attractive Heavy Black Leather Carrying  
Case with Finished Edges and Strap. Model  
369, supplied extra—Dealer Price \$3.67

**SEE YOUR JOBBER**

**WRITE FOR CATALOG**

**TRIPLET**  
*Precision*  
**ELECTRICAL INSTRUMENTS**

The Triplet Electrical Instrument Co.  
271 Harmon Ave., Bluffton, Ohio

Please send me more information on  
..... Model 666; ..... Model 327-A.

NAME .....

ADDRESS .....

CITY..... STATE.....

750



**I jumped from \$18 a week to \$50**  
**-- a Free Book started me toward this**  
**GOOD PAY IN RADIO**

**HERE'S**  
*How it Happened*  
by **S. J. E.**  
(NAME AND ADDRESS SENT UPON REQUEST)



"I had an \$18 a week job in a shoe factory. I'd probably be at it today if I hadn't read about the opportunities in Radio and started training at home for them."



"The training National Radio Institute gave me was so practical I was soon ready to make \$5, \$10, \$15 a week in spare time servicing Radio sets."

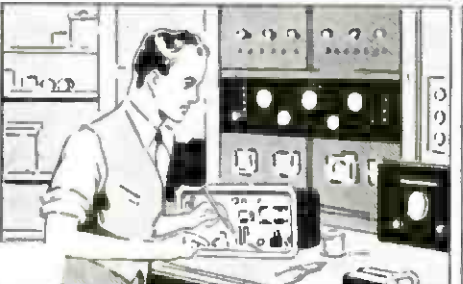

"When I finished training I accepted a job as serviceman with a Radio store. In three weeks I was made service manager at more than twice what I earned in the shoe factory."

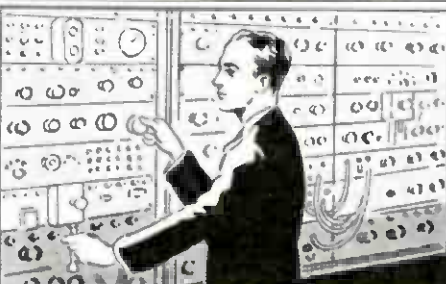

"Eight months later N.R.I. Employment Department sent me to Station KWCR as a Radio operator. Now I am Radio Engineer at Station WSUI. I am also connected with Television Station W9XK."



"N.R.I. Training took me out of a low-pay shoe factory job and put me into Radio at good pay. Radio is growing fast. The field is wide open to properly trained men."



*Find out today* how I Train You at Home  
**to BE A RADIO EXPERT**

**J. E. SMITH,**  
President  
National Radio Institute  
Established 1914

**Many Radio Experts Make \$30, \$50, \$75 a Week**

Radio broadcasting stations employ engineers, operators, station managers and pay up to \$5,000 a year. Fixing Radio sets in spare time pays many \$200 to \$500 a year—full time jobs with Radio jobbers, manufacturers and dealers as much as \$30, \$50, \$75 a week. Many Radio Experts open full or part time Radio sales and repair businesses. Radio manufacturers and jobbers employ testers, inspectors, foremen, engineers, servicemen, and pay up to \$6,000 a year. Automobile, police, aviation, commercial Radio, loudspeaker systems are newer fields offering good opportunities now and for the future. Television promises to open many good jobs soon. Men I trained have good jobs in these branches of radio. Read how they got their jobs. Mail coupon.

**Many Make \$5, \$10, \$15 a Week Extra in Spare Time While Learning**

The day you enroll I start sending Extra Money Job Sheets; show you how to do Radio repair jobs. Throughout your training I send plans and directions that made good spare time money—\$200 to \$500—for hundreds while learning.

I send you special Radio equipment to conduct experiments and build circuits. This 50-50 method of training makes learning at home interesting, fascinating, practical. I **ALSO GIVE YOU A MODERN PROFESSIONAL ALL-WAVE, ALL-PURPOSE RADIO SET SERVICING INSTRUMENT** to help you make good money fixing Radios while learning and equip you for full time jobs after graduation.

**Find Out What Radio Offers You** Act Today. Mail the coupon now for "Rich Rewards in Radio." It's free to any fellow over 16 years old. It points out Radio's spare time and full time opportunities and those

coming in Television; tells about my training in Radio and Television, shows you letters from men I trained, telling what they are doing and earning. Find out what Radio offers YOU! MAIL COUPON in an envelope, or Paste on a postcard—NOW!

**J. E. SMITH,**  
President,  
Dept. 9AM4,  
National Radio Institute,  
Washington,  
D. C.



**J. E. SMITH, President, Dept. 9AM4**  
National Radio Institute, Washington, D. C.

Dear Mr. Smith: Without obligating me, send "Rich Rewards in Radio," which points out spare time and full time opportunities in Radio and explains your practical method of training at home in spare time to become a Radio expert. (Please write plainly.)

Name..... Age.....  
Address.....  
City..... State.....

# A Fully-Protected BERNARD Pocket Meter

EVERYTHING valuable deserves fullest protection. The BERNARD FULL-METER is extremely valuable because it provides seventeen ranges for measuring DC volts and currents, resistance and AC volts.

The 3" square Bakelite meter, with 2% accurate d'Arsonval movement and knife-edge pointer, has extended, easy-reading scale. There are only two controls on the No. 14 gauge lithographed aluminum panel. These are the selector switch and the ohms adjuster. There is no AC-DC switch because the BERNARD system automatically puts the copper-oxide rectifier in circuit at the a-c voltage positions, so there is better accuracy and no possibility of confusion or error due to an AC-DC switch being on when it should be off, or off when it should be on. The DC scale is linear. The AC scale is nearly linear.

There are only three pin jacks. The one at left is common negative. The center one is for all voltages and currents. The right-hand one is for ohms. Only one ohms scale is on the meter, 0-2500 ohms, with 30-ohm center. The first bar represents one ohm, with wide space between it and zero. Resistance to .2 ohm can be closely estimated. Then for the next range the base resistance scale is multiplied by 10 and on the third range by 100, enabling readings to 250,000 ohms, with self-contained 3-v flashlight battery (renewal cost 10 cents).

High protection against meter burnout is provided by a limiting circuit.

All-around protection against breakage is offered by the attractive, solid instrument-wood cabinet, with removable hinged cover, with snap lock. There is a compartment for test leads.

## SPECIFICATIONS

0-2.5-10-50-250-500-2500 volts d.c., all at 1000 ohms per volt. 0-1-10-100 ma, 0-1 ampere d.c. 0-2500-25000-250000 ohms. 0-15-150-1500 volts a.c. Output meter range.



**1000 OHMS  
PER VOLT**

Three of the FULLMETER ranges have wire-wound resistors. FULLMETER cabinet is 6¼" x 3¼" x 4½". Test leads included. **\$11.90**  
Shipping weight 3 lbs. Net price.....

## THE OUTSTANDING BERNARD ANALYZER

**5000 OHMS PER VOLT**



**\$29.90**

OUTSTANDING in the test equipment field because it makes all basic measurements in electricity, because it is a complete outfit for radio servicing, expertly engineered and manufactured; and because of entrancing appearance. MAXIMETER provides big service at moderate cost.

Imagine having six resistance ranges, from a small fraction of an ohm to 300,000,000 ohms; imagine having two capacity ranges from .001 to 100 mfd. and two inductance ranges! All these are besides the AC-DC voltage, decibel and direct-current ranges, themselves unusual, e.g., direct current from microamperes to 10 amperes. And all DC volts are at 5,000 ohms per volt; AC at 1200 ohms per volt! All 28 services on a 4½" square meter, with 2% accurate d'Arsonval movement, in molded Bakelite case. The pointer is knife-edged.

Handsomely housed in a sturdy cabinet of finest instrument wood, with tool compartment and test leads. BERNARD offers attractiveness of appearance, price and performance. MAXIMETER is sold ready to use—complete with batteries to read up to 3 meg.

All 28 services are obtained from only two input posts and with only two controls. The AC automatic feature is included. Only MAXIMETER, of all test instruments made, offers this convenience and protection. Wire-wound resistors are used on seven ranges.

## SPECIFICATIONS

DC VOLTS: 0-100 millivolts; 0-10-50-250-500-2500 v., all at 5000 ohms per volt.  
DC CURRENTS: 1-10-100 MA, 1-10 amps.  
RESISTANCE: 0-3000 ohms (20 ohm center); base times 10-100-1000-10000-100000, to 300 meg.  
AC VOLTS: 0-15-150-1500 v.  
DECIBELS: Minus 10 to Plus 58 DB in three ranges.  
OUTPUT METER: Indicates before AVC starts.  
CAPACITY: .001 to 100 mfd. in two ranges.  
INDUCTANCE: 1-7000 Henries in two ranges.

Send for Catalogue  
M and Name of  
Nearest Distributor  
or Jobber.

# BERNARD

All Voltage  
Multipliers on  
Bernard Equipment  
Are Insulated.

**H. J. BERNARD, 319-M Third Avenue, BROOKLYN, N. Y.**

Export Representative: Pan-Mar Corp., 1270 Broadway, New York, N. Y.

# Attention:

We purchased the entire quantity of coil winding machines of the world famous Atwater Kent Manufacturing Company and offer same subject to prior sale.

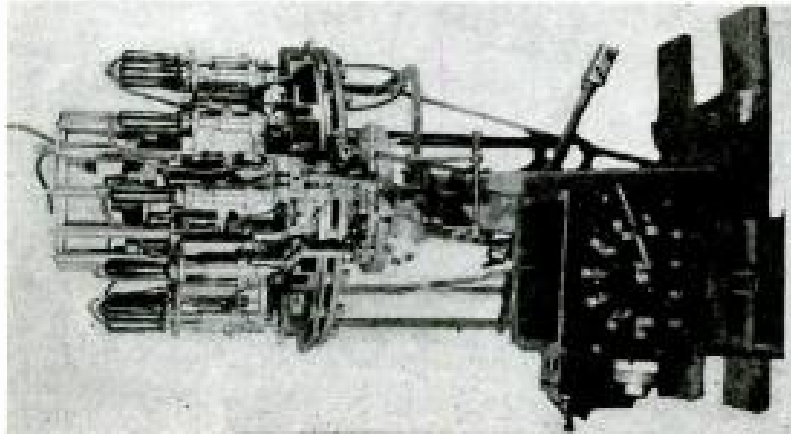

One only Charles Eisler Automatic Rotary Soldering Machine with twelve 200 watt American Beauty Soldering Irons, rotated by 1/4 h.p. motor, 110 volts A.C. Solder fed by automatic roll feed illustrated above. Price \$465.



7 Roll feeds for L&J and Bliss Nos. 20 & 21. Power Presses for lamination stamping—\$40 to \$75 each.

- 109 Resistor Coil Winding Machines. Price \$10.50 EACH
- 62 Filament Coil Winding Machines. Price \$ 9.50
- 50 Hand Coil Winding Machines. Price \$ 6.50

One 24" Squaring Shear with 18" hand roll feed and steel racks for holding 3 rolls paper.....Price \$ 85.00

One 18" paper tube rolling machine with motor drive and speed reducer...Price \$125.00

Miscellaneous—Large quantity of spare parts including change gears for all coil winding machines.

100 Logen Air Cylinders used by Atwater Kent punch presses for knock-outs, also on screw machines. Prices ranging from.....\$3 to \$15 each.

NOTE: All machines listed are guaranteed to be in perfect working order. 30 days—*Money back if not satisfactory* within 30 days. Terms: 1/3 cash with order. Balance Sight Draft against B. of L., or C. O. D.



7 Gas operated baking ovens for Japan finish or crinkle lacquer, etc. Price \$25 each.

**SAVE MONEY  
HERE ON  
EQUIPMENT**

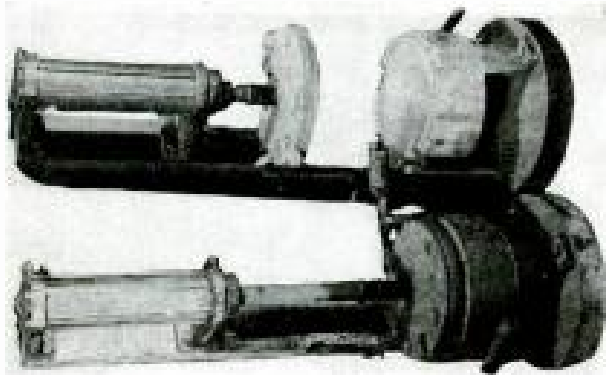

11 Logen Presses with air cylinders applying silk on paper for grills, for forming paper diaphragms and applying silk on paper for grills. Complete with Hand Control, automatic lock and releasing attachment. Aluminum forms, dies and aluminum plates complete. Price \$95.00 each.



169 I.F. & R.F. 300 Field Coil Winding Machines. Price \$11.50 each



240 Power Transformer Coil Winding Machines complete at \$25 each.

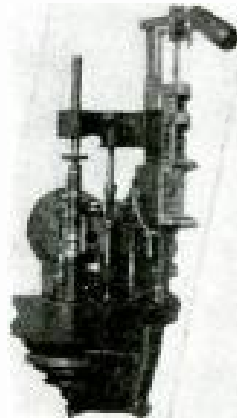

5 Coto Coil Winding Machines. Price \$45.00 each.

**ACTIVE STEEL AND TOOL CO.**  
84 Warren Street  
New York City

Phone WOrth 2-8655

# MYSTERIOUS WIRELESS PHONOGRAPH

**SENSATIONAL  
NEW 1939  
MAY ELECTRIC  
MYSTERY RECORD PLAYER**

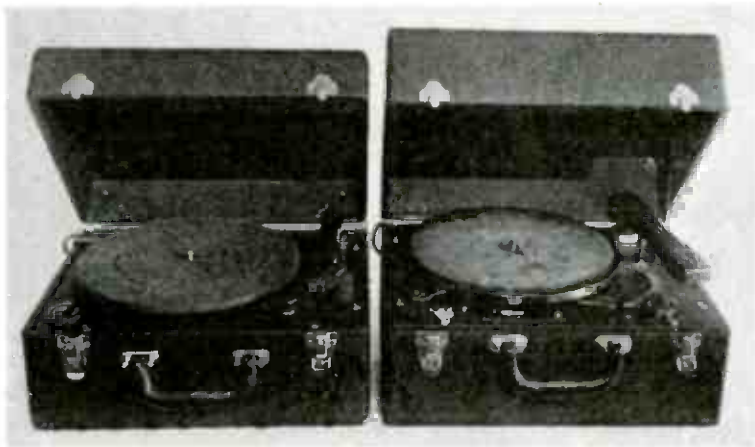

**NO WIRES. NO CONNECTIONS TO YOUR RADIO. PLUG IN SOCKET.  
MAKES EVERY SET A PHONOGRAPH COMBINATION**

Plays all records. Transmits recorded music through air at 540 to 740 K.C. Adjustable tuning condenser. Your radio receives it like any other broadcast station. Uses Webster A.C. self-starting motor. Astatic pickup, leather portable carrying case. Volume control and switch. Transmitter uses 25Z5 and 6A7 tubes. Plays 10 or 12 inch records through any radio with superb richness of tone and volume.

IF DESIRED  
A CABINET OF GENUINE WALNUT  
\$1.50 EXTRA

**YOUR COST \$10<sup>95</sup>**

IN QUANTITIES OF 6, SAMPLE \$12.95  
(WEIGHT 15 LBS.)

May Electric Phonograph with built-in amplifier. Plays 10" or 12" records. Entirely self-contained. Attach it anywhere. No radio connection necessary. Just the entertainment unit you've been waiting for. Here is a popular, complete record player with built-in 3 tube, 2 watt amplifier and full dynamic speaker to amplify your favorite records with ample volume and superb tone quality. Sound is well distributed through grille opening on top of cabinet, supplied with crystal or magnetic pickup (specify). Has Webster A.C. self-starting motor, volume control, Arcturus 6J7-25L6-25Z5 tubes. Handsome leatherette cabinet.

IF DESIRED  
A CABINET OF GENUINE WALNUT  
\$1.50 EXTRA

**YOUR COST \$16<sup>95</sup>**

(WEIGHT 22 LBS.)

## MAY ELECTRIC RECORD PLAYER

- ★ GENUINE WALNUT CABINET
- ★ ASTATIC CRYSTAL PICKUP
- ★ PLAYS 10 OR 12 INCH RECORDS
- ★ HAS OWN VOLUME CONTROL
- ★ MOTOR SWITCH AND NEEDLE CUP
- ★ WEBSTER A.C. MOTOR, SELF-STARTING
- ★ IDEAL FOR HOME RADIO
- ★ FOR USE WITH AMPLIFIERS, ETC.
- ★ WEIGHT (10 LBS.)

YOUR COST **\$11<sup>95</sup>**

IN LEATHERETTE \$10.45

ALL EQUIPMENT CAN BE SUPPLIED IN  
110-120 V. A.C.-D.C., AT THE ADDITIONAL  
COST PER UNIT OF

**\$6<sup>50</sup>**



10% Deposit Must Accompany All C.O.D. Orders  
We Can Supply Any Phono Material Not Listed,  
At Money Saving Prices

## SPECIALS ON PHONO PARTS

Webster Phono-Motors A.C. Self-Starting, Lots of 6	\$3.25	Sample	\$3.95
Dynamic Pickup, Offset Arm, Lots of 6	2.65	Sample	3.25
Discaphone Magnetic 10,000 Ohm Impedance, Lots of 6	2.75	Sample	3.35
Discaphone 110-120 Volt A.C.-D.C. Phono-Motor, Lots of 6	9.00	Sample	9.75
Walnut Cabinet 15 1/2" x 14" x 7" With Motor Board, Lots of 6	3.25	Sample	3.95
Leatherette Cabinet 14 1/2" x 13 1/2" x 7" With Motor Board, Lots of 6	2.50	Sample	3.20
TRANSMITTER ALONE (One used in above player with two tubes, converts any record player into a wireless machine)			\$5.95

# DISCAPHONE MFG. COMPANY

396 BROADWAY

NEW YORK CITY



# RADIO WORLD

*The Magazine of Advanced Radio Ideas*

SEVENTEENTH YEAR

## CONTENTS • JANUARY • 1939

COVER By H. Hohnhorst	A COMPLETE ANALYZER . . . . . 24 By Herbert E. Hayden
AFTER RADIO . . . WHAT? . . . . . 8 By Austin C. Lescarbours	TUNING BY EAR DESPITE AVC . . . . . 27 By Lewis Winner and Kenneth V. Thompson
WHAT TO EXPECT OF TELEVISION 10 By I. J. Kaar	DIVERSITY RECEPTION REDUCES FADING . . . . . 29 By Gordon Fraser
TELEVISION AWAITS BROADCASTERS . . . . . 15	EDITORIAL . . . . . 34
AN OPTICAL SCANNING SYSTEM 18 By H. J. Bernard	A PUSH-BUTTON EXCITER . . . . . 35 By William Filler, W2AOQ
MODULATORS WITHOUT HEADACHES . . . . . 20 By S. Gordon Taylor	OSCILLATOR CHARACTERISTICS . . . . . 46 By Martin Posner



*... and in Next Month's Issue*

Television Goes Hollywood  
Better Radio . . . and How!  
Diversity for Experimenters  
Building a Tube Voltmeter

Vol. XXXII, January, 1939. No. 1. Whole No. 719. RADIO WORLD, published monthly by Hennessy Radio Publications Corporation, 145 West 45th Street, New York, N. Y. Editorial and executive offices, 145 West 45th Street, New York, N. Y. Executives of RADIO WORLD: Edward L. Moore, Editor and Publisher; Herbert E. Hayden, Advertising Manager. Officers of Corporation: James E. Bryan, President and Treasurer; Edward L. Moore, Vice-President and Secretary. Entered as second-class matter March, 1922, at the Post Office at New York, N. Y., under the Act of March 3rd, 1879.

SUBSCRIPTION RATE: Price 25c per copy. Subscription, \$2.50 per year, postpaid, in the United States and Possessions; \$3.00 per year, postpaid in all other countries. Foreign remittances should be by International postal or express money order or bank draft negotiable in the U. S. and for an equivalent amount in U. S. funds.

MANUSCRIPTS: These are always welcomed and readers are invited to submit manuscripts for consideration. However, all manuscripts, except those definitely contracted for, are submitted at the author's risk and cannot be returned unless accompanied by sufficient postage. Address: Martin Posner, Technical Editor.

# WIN A FREE TRIP



RCA EXHIBIT BUILDING AT THE NEW YORK WORLD'S FAIR WHERE TELEVISION PROGRAMS WILL BE FEATURED

## TO THE 1939 NEW YORK WORLD'S FAIR

- Have the time of your life for seven days
- Five days of sight-seeing at the World's Fair
- Five nights of New York's gay and glamorous night life

EVERY minute of this free trip will be packed with thrills and excitement.

Winners will be flown from an airport nearest to their homes in mammoth air liners of an American airways system . . . will stay at one of New York's finest hotels . . . motor cars will convey them to and from their hotel to the Fair grounds . . . everything will be done for their pleasure.

To enter this contest, write a letter of not more than 100 words, telling us in your own words what type of articles and subjects you would like best to see in forthcoming issues of the NEW Radio World. Then mail your letter with three subscriptions to Radio World Contest Editor. Read these easy rules carefully. It's no trick to obtain three subscriptions to this different and interesting radio publication. Show copies to your associates, friends and radio fans. They'll be glad to subscribe. The contest is easy. It's fun. Get in today and WIN!

### FOLLOW THESE EASY RULES

The Radio World subscription contest starts November 15th, 1938, and closes February 1st, 1939. It is open only to residents of the United States and Canada.

To qualify, each contestant is required to write a letter of not more than 100 words, telling us in his, or her, own way the type of articles and subjects he, or she, would like best to see in forthcoming issues of the NEW Radio World.

A free trip to the New York World's Fair and return, with all expenses paid, will be awarded to the writers of the two winning letters.

Enclose with each entry, three prepaid yearly subscriptions to Radio World together with check, or money order, in the amount of \$7.50 for such domestic subscriptions, or \$9.00 for three Canadian subscriptions. The free trip prize will be awarded to each of the writers of the two letters which, in the opinion of the judges, are deemed most original and contain the most constructive suggestions for improvement of the editorial contents of Radio World.

The judges of the contest will be Mr. Berry Rockwell, Advertising Director of Judge magazine; Mr. Sam Nelson, Vice-President of Ideal Publications, and Mr. Otto Luther, Fairfax Advertising Agency, all of New York City. The decision of the judges will be final and binding.

Send in as many entries as you wish, provided that each entry is accompanied by 3 subscriptions to Radio World and the required amount of money to cover them.

Mail entries to Contest Editor, Radio World, 145 West 45th Street, New York City. Be sure to attach sufficient postage. Entries lacking sufficient postage will not be accepted. All entries must be postmarked not later than midnight February 1st, 1939. Winners' names will be published in the March, 1939, issue of Radio World. Entrance in the contest constitutes permission to publish the winner's name.

Persons entering this contest agree that in the event of winning, they, or their parents or guardians, will sign waivers of liability while en route to the World's Fair and return to his, or her, residence and during stay in New York City.

All letters become the property of Radio World and cannot be returned. In case of tie, duplicate trips will be awarded to each of the tying contestants.

No person connected with Radio World, or their families, is eligible for an award.

**THE NEW RADIO WORLD**  
145 W. 45th St., New York City

### USE THIS ENTRY BLANK

#### CONTEST EDITOR

Radio World  
145 West 45th St., New York City

#### SUBSCRIPTION RATES

\$2.50 per annum in the U. S.  
\$3.00 per annum in Canada

Enclosed find my letter and three annual subscriptions, together with money order for \$7.50 (\$9.00 for three Canadian subscriptions).

Name of sender.....

Street address .....

City .....

State .....

Print Name and Address Plainly

**RADIO WORLD** 145 West 45th St.  
New York City

# ANNOUNCEMENT

---

TO OUR READERS AND OTHER FRIENDS:

**W**E are happy to announce that with this issue regular publication of RADIO WORLD is resumed once more. It had been discontinued temporarily due to the serious illness of its former editor and publisher, Mr. Roland Burke Hennessy, who has since retired.

We regret the disappointment and inconvenience caused readers by reason of missed issues. However, the lapse has served to emphasize one fact, that is the high esteem in which RADIO WORLD is held by those same readers.

It has done our hearts good to read, during recent months, the hundreds of letters of appreciation of the magazine received from loyal readers in all quarters of the globe and their expressed hope of being able to read it regularly again at an early date. We want you to know that we prize and appreciate highly those many kind expressions and good wishes so heartily voiced.

But we are certain you'll agree that our time has been well spent and that any disappointment or inconvenience has been more than offset by the improved appearance and general make-up of this, the NEW RADIO WORLD. Undoubtedly, you have noted already the larger page size, the new type dress and the more comprehensive editorial policy to include the serviceman, engineer, experimenter and amateur.

In making these changes, we have been careful to retain those features which for 16 years have contributed so effectively in making RADIO WORLD an authority and top favorite with radio enthusiasts throughout the world. At the same time, the new editorial policy takes into account the fact that radio today offers greater possibilities and more thrills than ever before.

We shall explore and develop those possibilities towards restoring once more thrills comparable to those of old-time radio set building days, featuring television and the practical application of electronics in various fields.

In other words, the new RADIO WORLD as "The Magazine of Advanced Radio Ideas" will bring to you the radio of tomorrow today in distinctive RADIO WORLD *style*, such as you'll enjoy and appreciate.

*To further offset the missing of issues, all unexpired subscriptions will be extended, so that subscribers will receive the full number of issues called for by their subscriptions.*

We're sure you'll like the new RADIO WORLD and tell your friends about it. We want to make it just YOUR kind of magazine and invite you to feel free to write and tell us from time to time just what you would like to see in its columns.



EDITOR AND PUBLISHER

# After Radio . . . *What?*

With Old-Time Set Building Past, New Fields Now Welcome Thrill-Seekers

By AUSTIN C. LESCARBOURA\*

FOR many, the thrill of yesteryear, when one played with coils and condensers and other components in the quest for still better results, is admittedly gone so far as broadcast and short-wave routine reception is concerned. And yet . . .



The very nature of mass-production radio has brought about possibilities for experimentation on a stupendous scale. The more adventuresome have almost countless new and unexpected fields of endeavor now thrown open to them. Simply because our radio industry has brought into existence the most accurate electrical components at virtually five-and-ten cent price levels. Proof? Take the garden variety of carbon resistor. Accurate within 10% plus or minus of stated resistance. Yet it sells for a dime or less. Take an ordinary volume control. 500,000 ohms, for instance. Accurate within 10%. Practically "noiseless." Stays that way for months and years. Sells for half a buck.

## Dollars to Dimes

Take a dwarf electrolytic condenser. Provides 8 microfarads of capacity. Formerly you would have spent several dollars for that much capacity at say 500 volts. Today you buy it for a few dimes. And so on and on.

And with such precision parts, you are now in position to invade many new fields

which, heretofore, were barred to the experimenter because of the cost.

But, now that we have the parts, what shall we do with them? Well, let's take inventory of what radio technique has to offer. For example, the vacuum tube with proper inductance and capacity combinations is capable of oscillating or generating frequencies over a tremendous range. Only a relatively limited sector of these frequencies is employed in present-day radio. True, there is still much experimentation to be done in the ultra-high-frequency end, say below 1 meter. That assignment alone can keep radio experimenters and amateurs at work and happy for several years to come.

## Bloodless Surgery

High frequencies can be used for creating synthetic fever. Elaborate fever machines are already in use in our well-equipped hospitals. Any degree of fever can be developed in any portion of the patient. It starts or stops at the flipping of a switch.

Again there is the high-frequency surgeon's knife which sears its way bloodlessly through flesh, cauterizing as it goes. Here alone, oscillating tubes supply the energy for the localized burning action. A further variation is found in the heating of metallic bodies by so-called bombardment, in which a coil carrying the high-frequency energy is placed over or around the metallic mass to be heated. In the production of pure alloys or the melting of metals without atmospheric contamination, the high-frequency induction furnace is widely used.

## Sounding Sea's Depths

Another sector of the wide range of frequencies produced by oscillating tubes may be put to work in sounding operations. Supersonic equipment on board ship permits of ex-

\*Well-known radio pioneer, editor, author. Former Editor *Popular Science Monthly*; former Managing Editor, *Scientific American*. Author of "This Thing Called Broadcasting," "Radio for Everybody," etc.

ploring the ocean bottom. The supersonic waves are batted out and picked up on the rebound, so to speak, disclosing fathoms, nature of bottom and other facts. Similar technique locates oil and mineral deposits beneath the earth's surface.

Getting down to the musical frequencies, a world of possibilities opens up. Those of us who have read those electric organ advertisements with green envy, might well turn to the building of an inexpensive counterpart, starting with a discarded piano for the keyboard or console, and the radio junk box for condensers, coils, resistors, and other components. Likewise with those body-capacity operated musical instruments, following in the footsteps of the Theremin.

#### **More Sensitive Microscopes**

And what about new carrier-current communication possibilities over existing water and gas pipes in great cities, using new frequencies? Or over electric light wires? Of course the Federal Communications Commission's rulings would have to be consulted in any of these extra-radio activities, but what a world of fun one could open up in contacting a host of amateurs neraby!

Let's turn to the amplifying potentialities of the vacuum tube. Here is a veritable electrical microscope, capable of magnifying the faintest electrical impulse to any desired degree. Or call it a super-hair-trigger, if you prefer.

No end of experimental possibilities here. Starting with a microphone pickup, we can study sounds never before listened to. Imagine placing a microphone close to a bird's nest. Listen to the intimate chatter of parent birds and young. Make records if you wish, using the simple metal or acetone records. Likewise pick up sounds of other animals. Or listen in on conspirators by placing the microphone at the focal point of a huge parabolic reflector that can be readily "aimed."

Substitute a photo-electric cell for the microphone. Now you are dealing with light impulses. Use infra-red rays, and you can throw an invisible beam across a window or door which cannot be broken without detection. There is no better burglar or kidnap alarm.

#### **Counts, Opens and Checks**

When the beam is used with an electromagnetic counter, you can count objects passing by. Open your garage doors by flashing a beam of light on the cell. Or instead of simply a make-and-break action, you can work on the degree of interference with the light beam. Use that idea to detect the amount of smoke going up the

chimney, as a check on stoking and fuel waste. Use it to check the transparency of a liquid or other material flowing by. More elaborate arrangements permit sorting out objects of varying size or color or finish. Also the comparing of shades of given colors.

You can speak over a beam cast by a flickering diaphragm mirror and intercepted by a remote photo-electric cell.

Concealed pipes and electric wiring may be traced in an existing building.

Minute changes can be checked with suitable vacuum-tube equipment. The bending of a half-inch diameter bar of tool steel, under the strain of a fly alighting on same, can be measured. The vibration of machinery can be checked by the trembling of tube elements. Especially significant are such studies if a cathode-ray oscillograph is the indicating means. Which opens up many more possibilities . . .

As a visual indicator, the cathode-ray tube provides untold advantages over any meter heretofore available. The extreme sensitivity and ready response of this indicator makes for a brand new field of study. All sorts of electrical phenomena can be investigated. Minute differences can be studied. As an example, an automobile manufacturer recently got two lots of steel crankshafts hopelessly mixed. Nothing short of a costly chemical test could serve to separate them. But along came an ingenious mind with a cathode-ray oscillograph and a simple set of magnetic coils. The slight magnetic difference between the two alloys immediately showed up in an unmistakable variation in cathode-ray screen pattern. The mixed lots were readily and positively separated.

#### **Action at Standstill**

The cathode-ray oscillograph studies action that is slowed down to any desired speed, making the image stationary when required. Some very rapid and transient phenomenon, such as an explosion, can be captured and retained on a slow-decay screen for a minute or more—sufficient time to make permanent photographs, for that matter. By means of the electronic switch which throws one phenomenon and then another on the cathode-ray screen, at any frequency, two phenomena can be seen at a time and studied with relation to each other. Their wave forms can be superimposed or separated, to facilitate comparisons.

One step beyond the cathode-ray oscillograph and we are in the domain of television. What a field for experimentation! Although developments are almost certain to favor the factory-produced television re-

*(Continued on page 59)*

# WHAT TO EXPECT FROM TELEVISION

Quality and Size of Pictures Discussed by I. J. Karr

THE quality of television pictures achieved in the past few years has certainly been good enough to interest an increasingly large proportion of the population, but there are still two major questions to be answered, I. J. Karr, design engineer of the General Electric Company's radio division, pointed out in a paper delivered in Detroit, before the Fall convention of the Society of Motion Picture Engineers. The first of these—fixing satisfactory television standards—has practically been settled now, he added. The second is a method of paying for the programs.

"Television differs from sound broadcasting very markedly in the importance of standards," said Mr. Karr. "In sound broadcasting the technical quality of transmitted programs can be improved year by year, and while this happens a receiver once purchased is always usable, even though it may become outmoded. The situation in television is quite different.

## Where Change Is Serious

"Because of the use of scanning and the necessity of synchronization between receiver and transmitter, if transmission standards are changed, receivers designed for the old standards become useless. Hence, no responsible manufacturer would sell re-

## Will It Come to This?

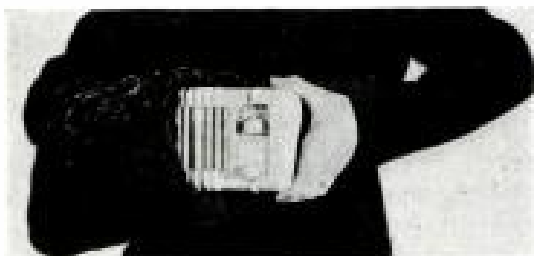

When tube radio receivers first came out they were three feet or more in length. Now some are so small they fit in a woman's muff. Will the massive television receivers ever shrink as much?

ceivers to the public until standards were fixed by the industry and sponsored by the Federal Communications Commission.

"It required considerable technical perfection to justify our high standards, but this has now been attained and the essential standards agreed upon. It may be said with some assurance that the last technical obstacle in the path of commercial television, as least so far as the excellence of the picture under proper conditions is concerned, has been removed."

## The Non-Existent "Audience"

The question of who shall pay for television programs has not been answered, Mr. Karr said, pointing out that the present broadcasting system, with its commercial sponsors who pay the bill, requires the existence of tens of millions of receivers, with listeners who may be induced to buy the advertised products.

"Such an audience does not exist in television," he said, "and cannot be expected for several years. Of course, no such audience existed in the early days of sound broadcasting, either, and the receiver manufacturers, along with a few others, operated the stations. In those days, however, the thought of something coming through the air, receivable at no cost, was an entirely new one. People were quite satisfied with the new toy as such and program excellence was a secondary consideration. This meant that the cost of broadcasting, as compared to the present, was low.

## Public Expects Excellence

"Now the public has been educated to expect a high degree of excellence in program material. In other words, when television is born, it must be born full-fledged as far as program material is concerned. This means great expense, which undoubtedly will have to be borne by the pioneers."

In television, it was pointed out in a discussion of the standards which have been

adopted in this country, the picture is scanned at both camera tube and picture tube by an electronic spot in a series of adjacent horizontal lines. The number of lines into which the picture is divided in the scanning process determines the fineness of vertical detail which is reproducible. After scanning the whole picture, the electronic spot then repeats the process at a sufficiently rapid rate so that no apparent flicker exists.

### What Interlacing Means

The frequency of repetition of scanning the whole picture is known as frame frequency. In order to conserve either space, it is desirable to keep the frame frequency as low as possible, and an artifice, "interlacing," is employed to increase the apparent frequency of repetition. It consists of scanning every other line, then scanning those in between which were missed the first time. This gives the physiological effect of scanning the picture twice, as far as flicker is concerned, even though all details of the picture have been scanned only once. The apparent flicker frequency under these conditions, which is twice the frame frequency, is known as field frequency. In America the number of lines per frame has been standardized at 441, the number of frames per second at 30, and the number of fields per second, interlaced, at 60.

Among other matters requiring standardization are the synchronizing operations at both transmitter and receiver. To keep the error small, synchronizing signals are always transmitted with the picture signals, Mr. Kaar said. The purpose of these synchronizing signals is to start the scanning of both lines and frames at exactly the right time.

### Tubes from 5 to 12 Inches

Answering the questions as to how good television will be and how much it will cost means discussing how large and bright the picture will be and how much it will show, said Mr. Kaar.

"The standard high-quality television system which will possibly be commercialized shortly will have a 12-inch tube with a picture  $7\frac{1}{2}$  by 10 inches. Three, five, seven, and nine-inch tubes will probably also be standard commercial sizes. Compared with the size of a motion picture or even a home movie, these dimensions seem small. However, considering the fact that an audience viewing a television picture will ordinarily not be more than four feet from the screen—and in the case of the small tubes, even one foot from the screen—these sizes do have considerable entertainment value. Neverthe-

less it is reasonable to expect larger pictures in the best systems of the future.

"The matter of increasing the size of a cathode ray picture presents serious obstacles," Mr. Kaar declared. "As tubes become larger they also become longer, and their overall size becomes such that it is difficult to find suitable cabinets for them which at the same time lend themselves to attractive styling.

### Mirror Called Undesirable

"When the 12-inch tube is used it is invariably mounted vertically in a cabinet, and the picture is seen as a mirror image by the observer. Since a mirror causes loss of light, and possible double images and distortion, it is an undesirable adjunct at best. As a further difficulty, as cathode-ray tubes are increased in size, they require more driving power, which is expensive, and higher anode voltages, which cost more and offer shock hazards."

Mr. Kaar suggested as an alternate method of increasing the picture size the projection picture tube. In this case a very brilliant picture on the screen of a four-inch cathode ray tube is enlarged by an external optical system and projected on a screen three or four feet wide. This system requires an exceedingly bright tube with a very fine spot.

The ultimate size of projection tube pictures is limited on one hand by the brightness obtainable from a fluorescent screen without causing its rapid deterioration, and on the other hand by the detail which can be obtained. Projection tube apparatus is probably too large and costly for home use,



Meet Dr. H. E. Mendelkall of the Bell Telephone Laboratories. What's he doing? According to KVOO, Tulsa, he's studying the Oklahoma version of an electronic television camera constructed by its staff as an aid in television research.

he said, but undoubtedly has a future for public performances.

### Limitation on Distance

In discussing picture size, Mr. Kaar reminded his listeners that vertical detail depends on the number of scanning lines and horizontal detail upon the ability of the electrical system to pass extremely high frequencies. A large television picture of high quality would require, at conservative estimate, a band width of 80 megacycles per program for its transmission, or 80 times as wide as the whole spectrum allocated to broadcasting in the United States.

"The problem of signal propagation in television is far more serious than that in sound broadcasting," Mr. Kaar said. "The exceedingly wide frequency channels required in television make it necessary that signals be transmitted in the ultra-short wave bands. At these frequencies there exists reliably only line-of-sight transmission, since there is no longer reflection from the Heaviside layer. Nevertheless, because of the very short waves employed, such objects as steel buildings and overhead wires

provide efficient reflectors and give rise to 'ghost' images. The severity of this problem will be realized more fully when the public begins erection of receiving antenna on a large scale.

### Relay Hinges on Cost

"It is not surprising that the great problem in the relaying of television signals is cost," Mr. Kaar said in conclusion. "The cost per mile of a coaxial cable is many times the cost of corresponding networks used in sound broadcasting, both as regards initial cost and maintenance. If radio relaying is used, the cost of the relay transmitters is very great. However the coming years are likely to bring great reductions in the cost of both methods, particularly the coaxial cable.

"It is not to be construed, from a survey of these problems, that commercial introduction of television will await their solution. Undoubtedly it will be commercialized in the near future. One fact is very clear—that further development must come largely through findings in the field, by actual trial."

---

## I KW Television Transmitter Announced by RCA

The RCA Manufacturing Company has recently announced that it will make available television transmitting equipment for sale to stations desiring to enter this field of service. This apparatus includes studio equipment, transmitters and television test equipment.

The RCA 1 kw television transmitter is the first medium-powered television transmitter to be made available by RCA. It is believed that the power of this transmitter is sufficient to enable experimental stations to render a satisfactory service over a reasonable area without too great an initial expense in starting television service. The transmitter conforms fully with the recently established Radio Manufacturers Association standards and is designed for DC transmission with negative modulation. The video response of the transmitter extends well beyond the range required for present day 441 line pictures with equal horizontal and vertical detail, thus providing for future requirements as to frequency response. The transmitter includes many circuits specially developed by RCA engineers to provide for good quality picture transmission.

The transmitter employs a long line controlled oscillator using an invar rod (which is unaffected by changes in temperature) to

maintain the carrier frequency at a stable value. Because of the relatively high power output from the oscillator, only two buffer amplifier stages are necessary in order to drive the final power amplifier stage. Lines are employed instead of conventional tank circuits in the radio frequency amplifiers. A special modulator circuit is employed with the plates of the modulators directly connected to the grids of the power amplifier tubes in order to provide for carrier control during picture transmission. Rectifier and filter circuits have been specially designed to avoid reaction and to provide an extremely low impedance at all video frequencies. The transmitter includes provision for inserting the DC component during the picture transmission which provides for variable carrier output in accordance with the light and shade tones of the picture.

The transmitter is arranged for disassembly if necessary in transporting it into buildings since in some cases the transmitter may be located near the roof to be adjacent to the antenna system.

---

### HEADLINE LONGER THAN THE TEXT

RADIO WORLD is "tops."

DAVID H. GLASS,  
Detroit, Mich.



# Waves Shot from 'Torpedoes'

## In New Television Antenna Atop Empire State Building

**A** NEW television antenna is installed on top of the Empire State Building. Waves will be launched into space from torpedo-shaped radiators.

RCA engineers said that the device overcomes a technical bottle-neck in the transmission of television signals by departing from the use of wires or their equivalent in pipes or masts in various arrays. The new device is unique in its capacity to communicate television waves to the ether over a band width of 30,000,000 cycles a second without accentuating or "peaking" the energy contained in any segment of the band, i. e., the transmission characteristics of the antenna is "flat" over a 30 megacycle band.

RCA engineers explained that the necessity for a new antenna capable of perfectly transmitting a wide band of frequencies has arisen through the development of television and other new radio communication arts.

### Wide Band Width Needed

As the radio "intelligence" to be communicated became more detailed and elaborate, the band width necessary to carry it had to be correspondingly enlarged. In radio telegraphy, they explained, a simple word may be transmitted in a second's time or less on a band width of a few hundred cycles. In radiotelephony, the additional intelligence conveyed in the voice intonation demands a band width of several thousand cycles. Television, with its demand for almost simultaneous transmission of the vast amount of information contained in a moving picture, has made necessary band widths of many millions of cycles. Thus, as the radio communication arts become more elaborate and detailed in the intelligence which they convey, wide band transmission becomes an increasingly important factor.

The desirability of creating such an antenna, which is still so new that it has not yet been named, was realized in the first field tests conducted on the present experimental standard of 441 lines to the picture. Antenna designs existing at that time were found insufficient to handle the desired band width. The new device, in contrast, will

accommodate six times the band width they wanted.

### Energizing the Antennas

In appearance the structure which will be

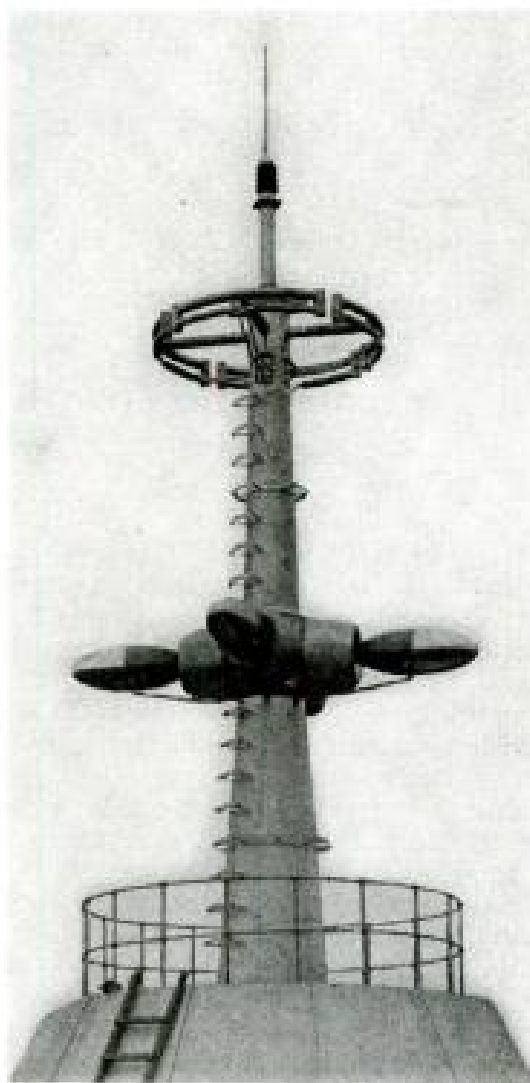

A new television transmitting antenna, representing a radical departure, atop the Empire State Building, has torpedo-shaped radiators to overcome the conventional bottleneck.

placed in service in the National Broadcasting Company's experimental field tests, is simple and decorative. Its radiation components will consist of two "doublets" for the picture signal and four "doublets" for ac-

companying sound. Both antennas are energized through concentric feeders in a common vertical shaft. Interference between sight and sound signals is eliminated by calculated arrangement of the two antennas and by using the equivalent of a closed loop for the sound channel and open radiators for picture signals.

The electrical measurements involved in the new structure are as precise as the specifications for a watch, yet in service it must withstand the rigors of the elements at its precarious perch. The antenna includes electrical heating units to prevent the formation of ice, which would enlarge its effective physical dimensions and detract from the perfection of its performance. The entire structure is topped by a lightning rod.

The radiating units nearest the top are for sound signals, and consist of a unique type of doublet, which doubles back on itself. The four together form a complete loop. The four torpedo-like shapes comprise the two doublets for the transmission of the picture signals. Both their elliptical shape, and the contour of the metal "collars" into which they nest, are the result of radical experimental approach.

---

## Test Equipment for Television Appears

---

RCA has developed a number of pieces of television test equipment which it is making available to laboratories, experimental television stations and to the industry in general for carrying forward a program of television service. This equipment was originally developed for use in RCA's own television research program.

In ordinary broadcasting, for the development of sound apparatus, it is often necessary to check the frequency response over the band of 30 to 10,000 cycles. It is also desirable to check the distortion introduced in amplifiers and for this reason apparatus of this sort has been in general use. However, for television purposes, the video frequency response of circuits extends over the range of 30 cycles to 2,000,000 cycles at the minimum and because this band is two hundred times as wide as that required for present-day broadcasting, very special test equipment is necessary to check the operation of apparatus.

### Wide-Band 'Scope

One of the first items which RCA has offered for sale is a special cathode-ray oscillograph, Model 136-B, provided with amplifiers extending over the video band. Thus

it is possible to examine the wave form of minute impulses and to produce a large image on the cathode ray oscillograph tube for photographic purposes. Many cathode-ray oscillographs have been manufactured previously but few, if any, have been able to amplify over such a wide band. Oscillographs of this type have been used by RCA in the Empire State installation and by the Columbia Broadcasting System for experimental television work. Another piece of test equipment is the Video Sweep Oscillator which enables engineers to adjust amplifiers to provide the necessary wide band response. By the use of this equipment and the cathode ray oscillograph, it is possible to observe the frequency response curve of the equipment under test and to make necessary adjustments to produce the desired response. Such equipment saves many hours of time over the conventional method of using a beat frequency oscillator and plotting out response curves point by point.

Perhaps the most unusual piece of equipment is the RCA Square Wave Generator. Early in the program of RCA's television research, it was discovered that by transmitting a square wave through the apparatus instead of the conventional sine wave, engineers could observe the wave shape of the impulse at the output of the equipment and could tell the deficiencies in the equipment by the difference in the two forms.

For example, if the amplifier being tested lacks high-frequency response, the wave would not be reproduced with square corners but would be rounded. If phase shift occurs in the amplifier, other distortions would take place which would be readily recognized. The RCA instrument produces square waves having exceedingly straight sides, at several convenient frequencies over the video band. It also possesses the property of making square waves out of sine waves which are fed into it.

### What Change Means

RCA has also developed an ultra-high-frequency field intensity meter, the first to be offered commercially for checking the range of television stations and other ultra high frequency transmitters. In this way the effectiveness of antennas and the service area of the station can be determined. The instrument also is provided with an attachment for measuring the noise produced by electrical appliances throughout the ultra high frequency band.

Several other RCA test instruments have also been developed, including an RF signal generator, and an RF and IF sweep oscillator, which are useful to television receiver manufacturers.

# TELEVISION AWAITS BROADCASTERS

---

## Sets Are Selling—The Audience Is Ready—It's Up to Studios to Start the Show

By PERRY WARNER

AS with so many new arts on the threshold of commercialization, television presents still another version of the chicken-and-the-egg controversy. Which comes first? Shall it be a serious attempt at producing television sets down to a reasonable price, even in the absence of dependable television programs? Or shall it be television programs scattered to the four winds and not much else in the absence of television sets?

At the moment, set-producing seems to be the prevailing situation, brought about by one willing pioneer endowed with sufficient enthusiasm as to the early possibilities of television, Allen B. Dumont, President of the electrical laboratories bearing his name. Originally interested in the development and

production of cathode-ray tubes and working with Cossar in England, the Dumont organization is now in production of television receivers on a commercial basis. At present, this represents several dozen sets per month with facilities for stepping-up that figure without delay.

### Television Sets Being Made

Apart from details of the product, the outstanding factor is that television sets are now available and being sold. The public has evidenced practical interest in television even in the absence of television programs, so that the audience for television programs is here, now. It will be increased exceedingly as soon as regular programs are available. Therefore, the next move is up to the

### Tubes and Voltages Grow With Television

Side view of a 12-inch television tube affords a striking comparison with the size of usual type tubes found in a sound receiver. The supply voltage for the television tube bears about the same relationship to that of the more familiar tubes as does the physical size.

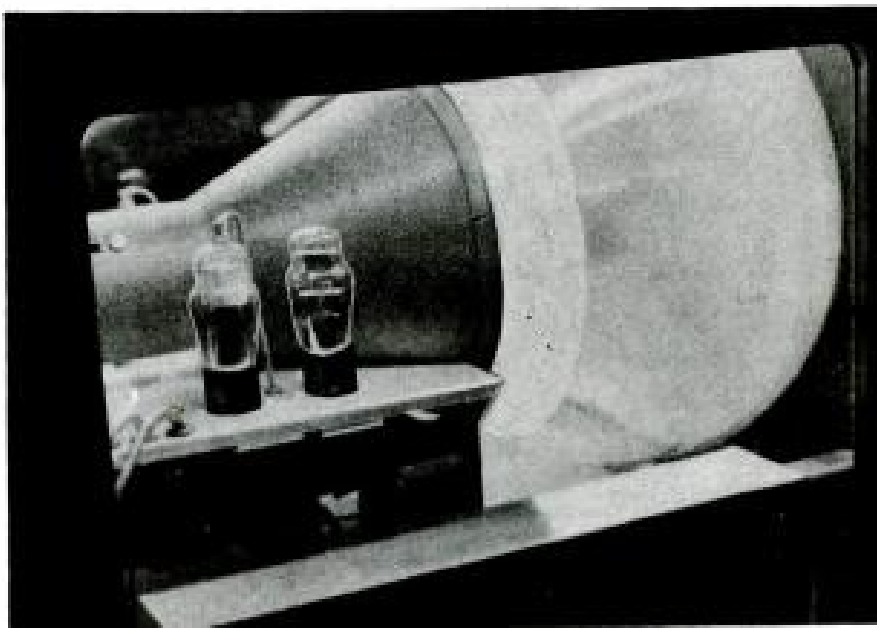

broadcasters. It is for them to raise the curtain and the television show will be on in earnest.

As to the actual progress being made in this direction, information on the subject will be included in a special article on television program-making scheduled for the next issue of **RADIO WORLD**.

With a 14-inch size tube as the foundation, the Dumont company has evolved a simple, practical television and synchronized sound receiver in both table and console cabinets. The set includes 21 tubes in all, counting the electrostatically-controlled cathode-ray tube. Components and tubes are compactly arranged in several decks for convenience in assembly and servicing.

#### **Pictures 8"x10"—Black and White**

A dozen persons can comfortably follow the visual program. Another dozen sitters can be squeezed in. As many as 50 persons have followed the demonstration programs. The black-and-white screen image measures

a full 8x10 inches, and is quite comparable in brilliancy, detail and absence of flicker with typical home movies.

The set operates in conjunction with a special dipole antenna comprising two 3-foot brass rods or arms, connected with the receiver by a two-wire transmission line. When operating close to the television transmitter, a quarter wave length dipole is employed. For greater distances, a half wave length dipole is used, while a dipole with a reflector serves for maximum distances. These dipole antennas are quite critical as to directional effect and precise location, and should therefore be adjusted for maximum signal pickup.

All of which means that satisfactory television sets are already available, with others scheduled for Spring. They are being sold. Dealers have capitalized on public interest in television, as evidenced by reaction to the display of sets in windows and stores. So that all is needed to turn it into sales are real programs.

---

## **Scenes at Fair to Be Televised**

---

Installation of the television equipment at the New York World's Fair grounds will soon be under way.

With the opening of the Fair in April, regular television programs will be available regularly thereafter in the New York metropolitan area. An ultra-modern Hall of Communications will house the equipment. A complete exhibition of all branches of the radio art and its developments will be included.

The building will be linked directly with the television transmitter in the Empire State Building. From the Hall and television field trucks will be televised outstanding World's Fair events, bringing to visitors for the first time in history joint demonstrations of the marvels of sound and sight broadcasting of a World's Fair.

There will be shown details of the vast network of radio safeguards for ships at sea and ships and 'planes in the air. A radio communications center will be provided, so

that visitors may send from the Fair radio-grams to all parts of the world and to ships at sea. Demonstrations will include how photographs are transmitted across the ocean by radio.

The exhibit will have the most modern equipment for recording sound in motion picture studios and reproducing it in theatres. There will be demonstrated, also, how the music of the world's great artists is recorded and reproduced on records.

In addition, visitors to the Fair will be given opportunity to study the latest models of radio instruments of all kinds, as well as

see what goes on behind the scenes in the world of broadcasting in putting programs on the air and broadcasting them to all corners of the globe.

Full direction of his company's participation in the Fair will be in charge of Lenox R. Lohr, president of the National Broadcasting Company. It was he who headed the Chicago Century of Progress Exposition, which was very successful.

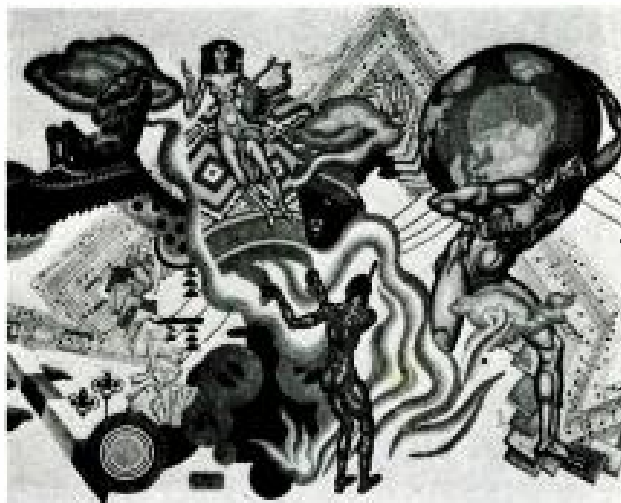

Mural main entrance facade, Hall of Communications, at the World's Fair in New York.

# OFFERS TWO HOME VISION SETS

ONE USES 5" TUBE, HAS PUSH-BUTTON TUNING; OTHER IS DELUXE, WITH 12" TUBE AND SOUND RECEIVER

By GUY BARTLETT

TELEVISION has probably captured popular fancy more completely than has any other scientific development since the x-ray. With certain limitations it seems capable now of providing an acceptable level of visual entertainment to supplement the highly developed practice of sound broadcasting.

It is easy to recall how limited the "silent" motion pictures were, in comparison with present ones appealing to hearing as well as sight, and it may well be that, perhaps in 10 or 20 years, sound broadcasting alone will appear equally limited. There are, however, several important distinctions between the problem of adding sound to pictures and the problem of adding sight to broadcasting. It is perhaps sufficient to mention that the frequency band required to broadcast a moving picture in a reasonably good manner is about 1,000 times as wide as is the frequency band necessary to broadcast the accompanying sound; and it is also approximately correct to say that the present difficulties and costs of broadcasting sight bear a somewhat similar ratio to present difficulties and costs of broadcasting sound.

## Television Transmission

The General Electric Company has been active in the laboratory development of television for more than 10 years. Feeling that the time has come for a public demonstration of the possibilities of television on a relatively large scale, application for the necessary experimental authorizations have been made to the Federal Communications Commission, and development work on the necessary equipment has been going forward rapidly.

A studio is being equipped in Schenectady, N. Y., to permit the televising of staged

shows and motion pictures. A television broadcast station has been built high in the Helderberg hills, south of Schenectady, capable of giving excellent coverage of Schenectady, Albany and Troy. The location gives an equivalent antenna height somewhat better than is offered in New York City by any skyscraper, and with short waves as used for television coverage is directly proportional to antenna height. Programs originating in the Schenectady studio will be relayed to the Helderberg station by a "line of sight" radio circuit operating on 1.9 m wavelength, with sharply directional antennas at both ends of the circuit.

## Television Receivers

Two types of receivers representing typical home units in the upper and lower price brackets were developed for use in connection with the television field tests already mentioned. The first, and more simple, is a table-model receiver with a cathode-ray picture tube of 5" diameter and including the sound accompaniment to the picture. There are seven push buttons for selecting any one of the first seven channels assigned by the FCC for television broadcasting. The second is a deluxe receiver, employing a cathode-ray picture tube of 12" diameter and likewise including the sound accompaniment. It, too, has a seven-push-button station selector. The picture is viewed in a mirror on the under surface of the lid, which is raised at an angle when viewing. These receivers are to be placed throughout the Schenectady-Albany-Troy area so as to obtain the most useful information in regard to their performance in actual service.

At the General Electric exhibit at the World's Fair, New York, equipment like that described will be shown in operation.

LARGE-SCALE PUBLIC TELEVISION DEMONSTRATION EARLY GOAL

# Optical Scanning in Race

## British Firm Exploring American Market for Its Mechanical System of Transmission and Reception

By H. J. BERNARD

THE advance of television in the United States is exclusively along electronic lines, "no moving parts." If there is any mention of a mechanical system it is with ill-concealed contempt. However, mechanical



and electronic techniques grew together in this country, in unfriendly companionship, only the electronic methods grew faster. The outgrowth of the Nipkow disc was outstripped.

Television as it will be realized at the World's Fair in New York City this spring will be entirely according to the electronic American plan.

The receivers for the American market will be electronic, of course.

Recently there have been indications of a British firm considering the possibilities of the American market for their mechanical system. The firm is Scophony Limited, Thornwood Lodge, Campden Hill, London, W8. "Two-foot Pictures for the Home" is the slogan.

### American Plan Accepted

One fact in favor of the optical method of scanning, as contrasted with the electronic method, is that there is an abundance of light cheaply at hand, obtained at low voltage. Scophony, using a 300-watt mercury tube, 80 volts,  $3\frac{1}{2}$  amperes, stresses the high illumination and points to the plausibility of large screen television exhibitions, e. g., in theatres. America has a large-screen method, by the way, but it is a laboratory feat, not a commercial possibility yet, since \$5000 would be a cut price for such a receiver.

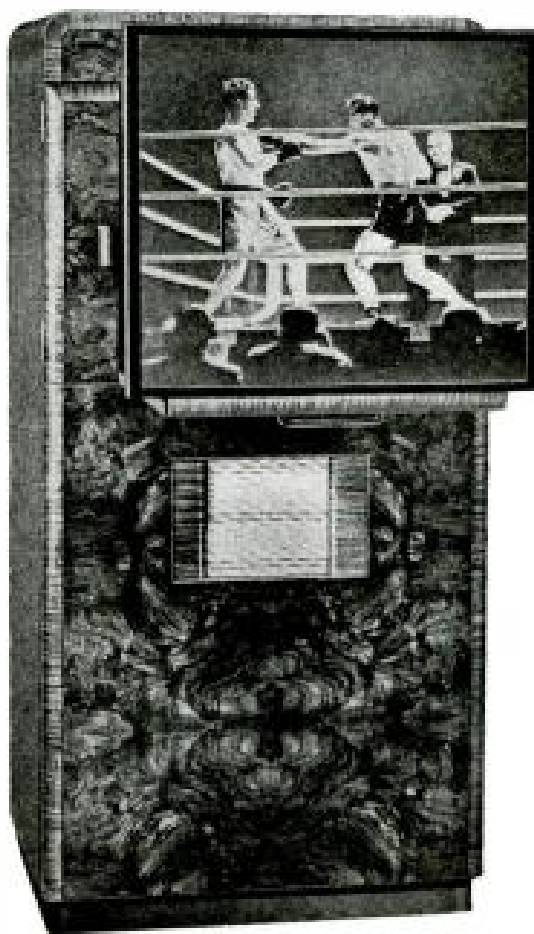

The home television receiver, with 2-foot screen, using an optical scanning system.

The preference for the electrical system is not only American, it is practically world-wide.

Scophony may be a British company, but England has gone over to electronic methods, merely by adopting an American system under a patent arrangement. Germany is electronically-minded in its television activities, which, like those in England, are government-backed. Japan, too, with a governmental status, also adopts the American method for its emissions from JOAK, at

Mchisaiwaicho. Regular programs are to start in the Spring, as if intentionally keeping step with the American decision.

How well established is the idea that the electronic method is the only one worth while may be gleaned from a report of the Electrical Division, United States Department of Commerce, based on findings of the American Commercial Attache at Tokyo.

"A committee of experts," says the report, referring to Japanese, "approved use of the Iconoscope, employing a cathode tube, instead of the outmoded mechanical scanning disc, and settled upon a standard of 441 scanning lines per unit, the same as in the United States experiments with television."

By foreign acts, if not words, the American superiority in television is acknowledged, and it is an electronic leadership, but it does not follow that mechanical systems are "outmoded" simply because they have not been so fully developed. In the formative stages of an art no avenues should be considered closed.

#### Picture Storage in Receiver

Scophony presents an argument in favor of its own particular optical system, though

it now stands alone in the world in using entirely optical methods, a fact in which it takes pride.

Discussing electronic scanning—the method of its competitors—Scophony says:

"It was found, at least at the transmitting end, that electrical storage is possible (without auxiliary apparatus as in picture telegraphy or in the intermediate film recording method) with a suitable design of light sensitive layer.

"The employment of the principle of electrical storage has made possible the remarkable technical achievements on the transmission side known today.

"On the reception side, however, it has not yet been found possible to employ a practical form of signal storage in the electronic type of receiver. In spite of the fact that the biggest laboratories in the world have concentrated in recent years on the development of cathode ray tubes for reception purposes, the results achieved in demonstrable commercial apparatus are still a compromise between either a small size picture with adequate brightness or a large enough picture with insufficient brilliance."

(Continued on page 45)

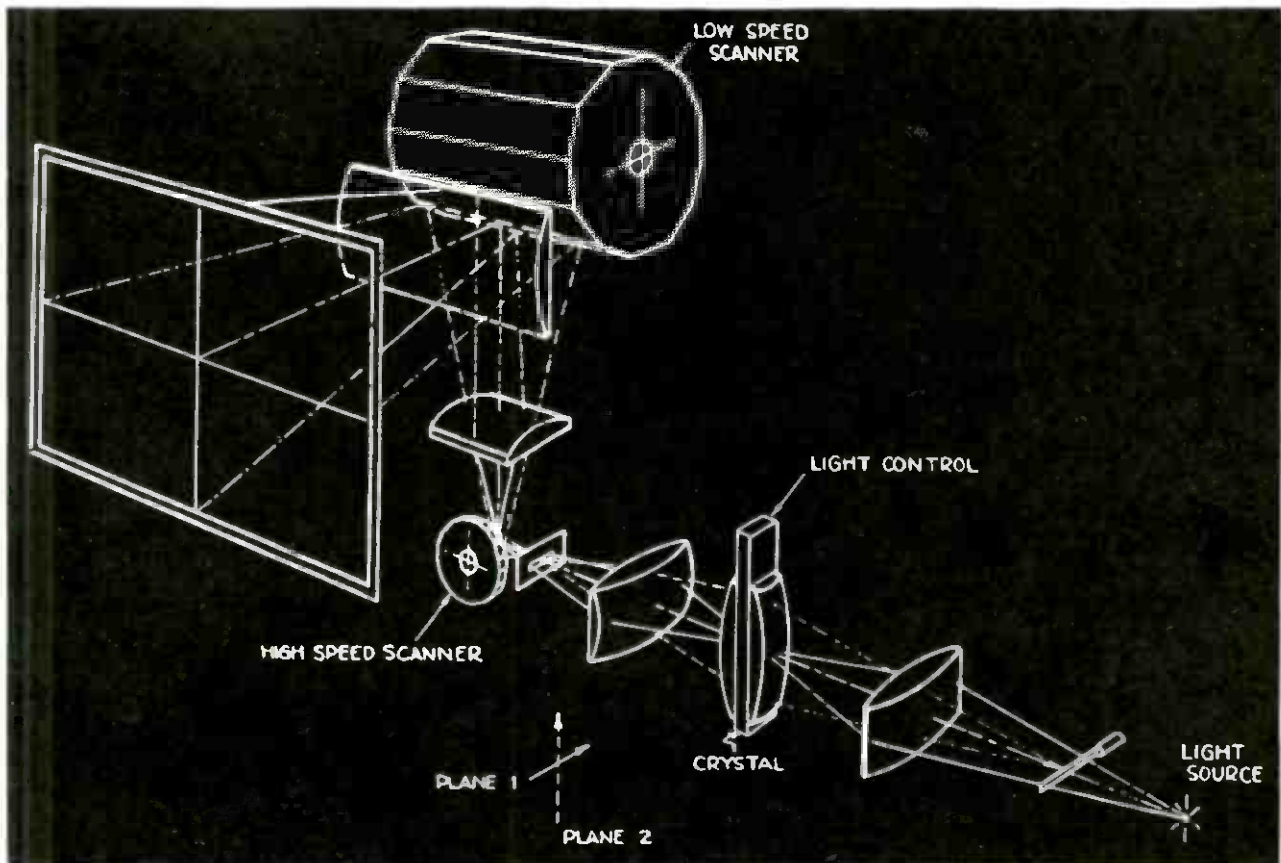

A British optical system for a television receiver uses two scanners, a high-speed motor to rotate a small mirror paragon which produces the line scanning, and a low-speed scanner to produce the frames, using a 12-mirror drum. A crystal and liquid constitute the light control.

# MODULATORS WITHOUT HEADACHES

## TRANSMITTER TROUBLES FLEE WHILE HAMS REPORT, "SWELL"

By S. GORDON TAYLOR\*

IN the design of modulator equipment for amateur transmitters the amateur finds extremely wide latitude. With the coming of the inexpensive, high-output 6L6 beam-power tube the choice was still further extended. There came an immediate attempt to drag 50 to 60 watts of audio out of a pair of these tubes, sometimes with a fair degree of success and sometimes with nothing less than a load of grief.

Assuming a transmitter with an input to the RF final in the vicinity of 100 watts



or less, 6L6's can do a mighty nice job of modulation. A pair of them, operated Class AB<sub>1</sub>, will provide up to 30 watts audio output and is therefore capable of modulating RF inputs up to 50 or 60 watts. From 60 to about 110 watts RF input, four 6L6's in push-pull parallel, Class AB<sub>1</sub>, will do an excellent job,

providing a good 50 to 60 watts of audio.

These 6L6 modulators offer a number of worth-while advantages. This is especially true in the case of transmitters running around 100 watts input to the final RF stage, and it is this type that is to be considered here.

### Tubes Inexpensive

First of all, the tubes are inexpensive, costing less than \$5 for four of them. Second, no grid current is drawn and the input transformer is therefore relatively inexpensive. Third, voltage regulation of the

power supply is less of a problem, as the surges of power required in either B or AB<sub>2</sub> operation are not present to anything like the same marked degree, nor are many of the other headaches of these types of operation.

### Free of Troubles

Fourth, but by no means least, is the high voltage sensitivity of the 6L6's. Requiring only voltage drive, and relatively little of that, the speech amplifier requirements are unusually modest.

Fig. 1 shows a complete speech amplifier-modulator unit which is just about as simple as anything could be. Using a total of only five tubes, four of which are the push-pull-parallel 6L6's, and operating from a D104 crystal mike, this unit provides enough audio to over-modulate a pair of T20's in the final RF stage running at their rated input of 112 watts. Not only does this spell tube and space economy but the unusual compactness of the speech amplifier from the viewpoint of concentration of wiring, etc., results in reduced likelihood of trouble from RF feedback.

Although this outfit has been in operation for more than a year there has never been the least evidence of trouble from hum, RF feedback nor the other ills to which ham transmitters are heir, and quality reports have in many cases included such adjectives as "swell," "excellent," "unusually good," "broadcast," etc.

### Bias Cells Prevent Motorboating

This was a bit surprising because the modulator unit was built up in the first place with the expectation that additional filtering would be needed in some of the plate and grid leads, and that other minor changes would be needed to provide complete and foolproof dependability.

It developed, however, that not a single

\*Member, Radio Institute of Engineers. Former Assistant Technical Editor, Popular Radio and Managing Editor, Radio News. A Ham since 1909; former call letters 20F; present call letters W2JCR.



alteration or addition had to be made except to substitute bias cells for the cathode bias resistor originally used in the 6N7 circuit. The only other time the unit has been out of the rack was when one of the 6L6 tubes developed a peculiar quirk which did not show up in a tube tester. It was only after everything else had been checked that the trouble was found to be in the tube after all.

Perhaps the statement that only five tubes are used is an open one, as the speech amplifier consists of the equivalent of two tubes—the two sections of the 6N7 dual-triode.

and 700 and therefore provides ample voltage to drive the four 6L6's to full output from a crystal microphone. With a single-button carbon microphone such as the 625A a single triode would serve this purpose more than adequately.

The transformer T1 is a standard "single plate to push-pull grid" inter-stage type. This is a Class A transformer with a turns ratio of 1-to-4.

The 6L6's are self-biased by means of an adjustable resistor. The biasing resistor need be only 100 ohms or less but in this

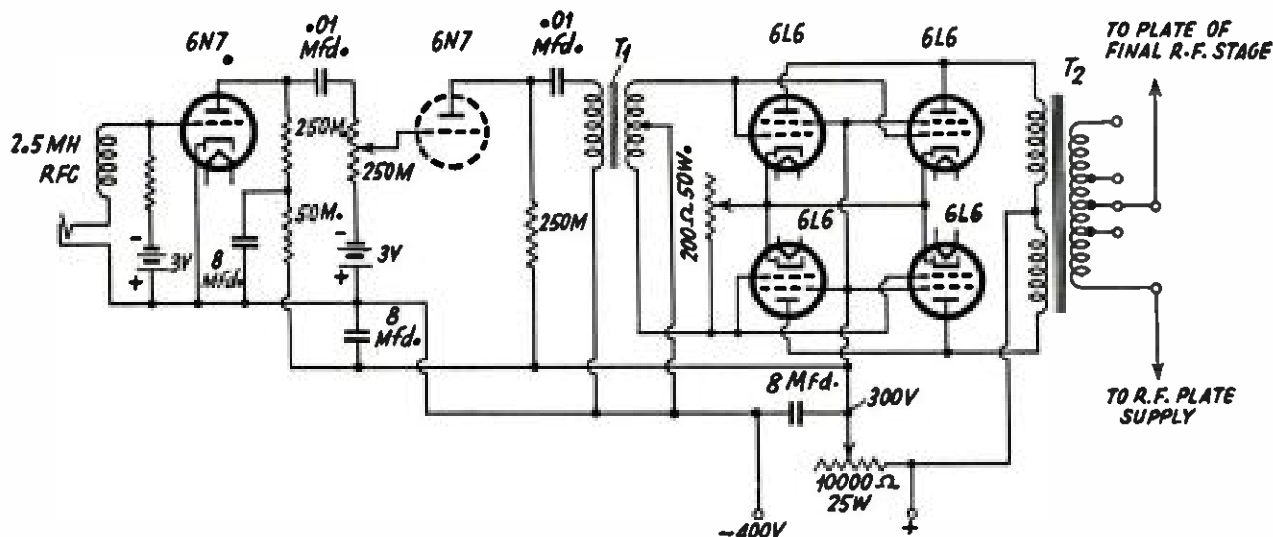

FIG. 1.

A simple speech amplifier, for coupling to plate of the "final."

These are employed in cascade and in the circuit diagram have been shown as two separate tubes for convenience.

About the only unusual feature of this part of the circuit is the use of bias cells separately to bias each section. This is made necessary by the fact that the two sections of this tube (like the 53 and the 6A6) have a common cathode. If an attempt is made to obtain bias by means of a cathode resistor motorboating results at the higher gain levels, due to common coupling in this resistor. First the attempt was made to overcome this by high-capacity bypassing but when even 75 mfd. failed to do the trick the bias cell idea was adopted.

The new 6C8G tube would undoubtedly solve this problem as it is a double diode with much the same characteristics as the 6N7 but with even higher gain and with separate cathodes for each section. Thus cathode resistors may be employed without causing undesirable coupling.

#### Four 6L6's Fully Driven

The cascade operated 6N7 provides an overall gain in this circuit of between 600

case a 200-ohm unit was employed as it is sometimes difficult to obtain a full 100 ohms resistance in a 100-ohm unit having an adjustable tap. A 25-watt resistor would have served the purpose but the 50 provides just that much greater safety factor.

The screens are fed through another adjustable resistor which drops the high voltage to 300 for all the screens and the two triode plates. An 8 mfd. electrolytic condenser provides adequate filtering here without the necessity for individual filters in any circuits but the plate of the first section of the 6N7; here a 50,000-ohm resistor is used with an 8 mfd. condenser each side of it.

#### Plate Compensating Resistors

The modulation transformer is tapped to provide a suitable match for a variety of RF tubes and is rated at 75 watts audio and 150 watts RF.

It is usually considered good practice in push-pull-parallel 6L6 amplifiers to insert 50-ohm resistors in each of the four plate leads. This helps to compensate for slight differences in tube characteristics and is probably a worth-while addition although in

the amplifier under discussion the need for them has not been evident to date.

From the viewpoints of economy, quality and simplicity this modulator and speech combination offers most for the least.

The merit of this type of modulator stage is being recognized in commercial transmitter design. Hallicrafters have adopted it, Their commercial marine circuit is identical with that of Fig. 1 except that the 6L6 bias is semi-fixed and 50-ohm suppressors are included in each plate lead. In the modu-

Plate current for the system is obtained from a dual power-supply utilizing a 5Z3 and an 80, the exclusive function of the 80 being to provide fixed voltage for the 6L6 screens. Grid bias is obtained from a 22.5-volt B battery, with the 6L6 cathodes grounded.

This circuit will interest the ham who would like to go a step further than the simple circuit of Fig. 1. It will provide somewhat greater output before the distortion region is reached. At 50 watts output

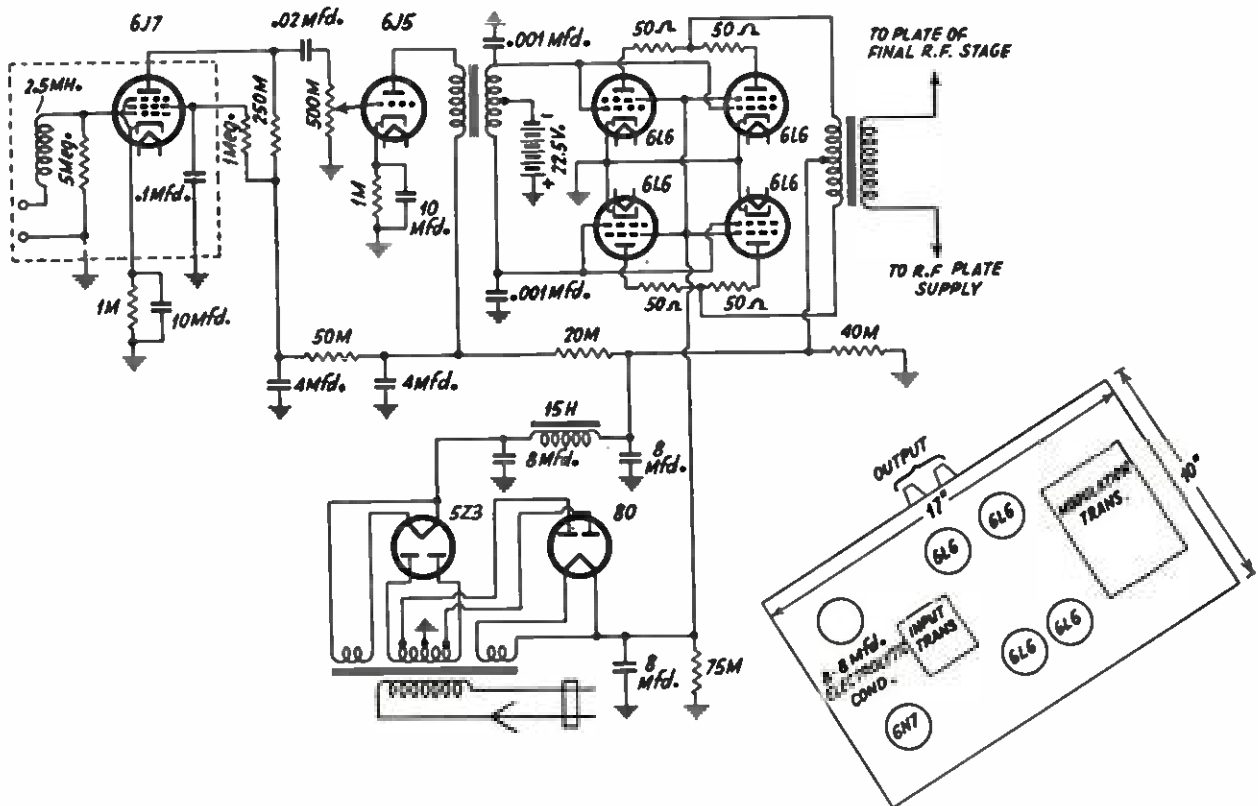

FIG. 2.

More speech amplification and greater undistorted output are provided by this circuit. Layout is at right.

lator stage of their HT-1 ham transmitter a number of refinements is incorporated, including a separate source of screen voltage, and battery grid bias, both of which permit somewhat higher undistorted output than would otherwise be obtainable.

### More Speech Amplification

For those who may be interested in the details of these refinements, the circuit of the audio system of this rig is shown in Fig. 2.

Here it will be noted that more speech amplification is provided, perhaps made desirable through the use of a low-ratio input transformer, or to provide ample reserve to meet any contingency. But even at that only two tubes are employed as compared with the more conventional three or four normally employed ahead of a 50-60 watt modulator.

for instance, it shows a response flat within 2 db from 80 to 8,000 cycles. It includes extensive filtering and shielding (the entire first stage being completely inclosed in a metal can), which is undoubtedly a good idea where the audio and RF sections are inclosed within one compartment as they are in this transmitter.

### All Wiring Below Deck

The complete audio and modulator equipment may be seen in the front left-hand corner of the top view of this transmitter.

Both circuits provide complete details as to values.

The simpler unit of Fig. 1 is built up on a single standard chassis (the power supply unit is separate) laid out as shown in Fig. 2. The gain control is centrally located on the front panel with the microphone jack

## Refinements Feature Ham Transmitter

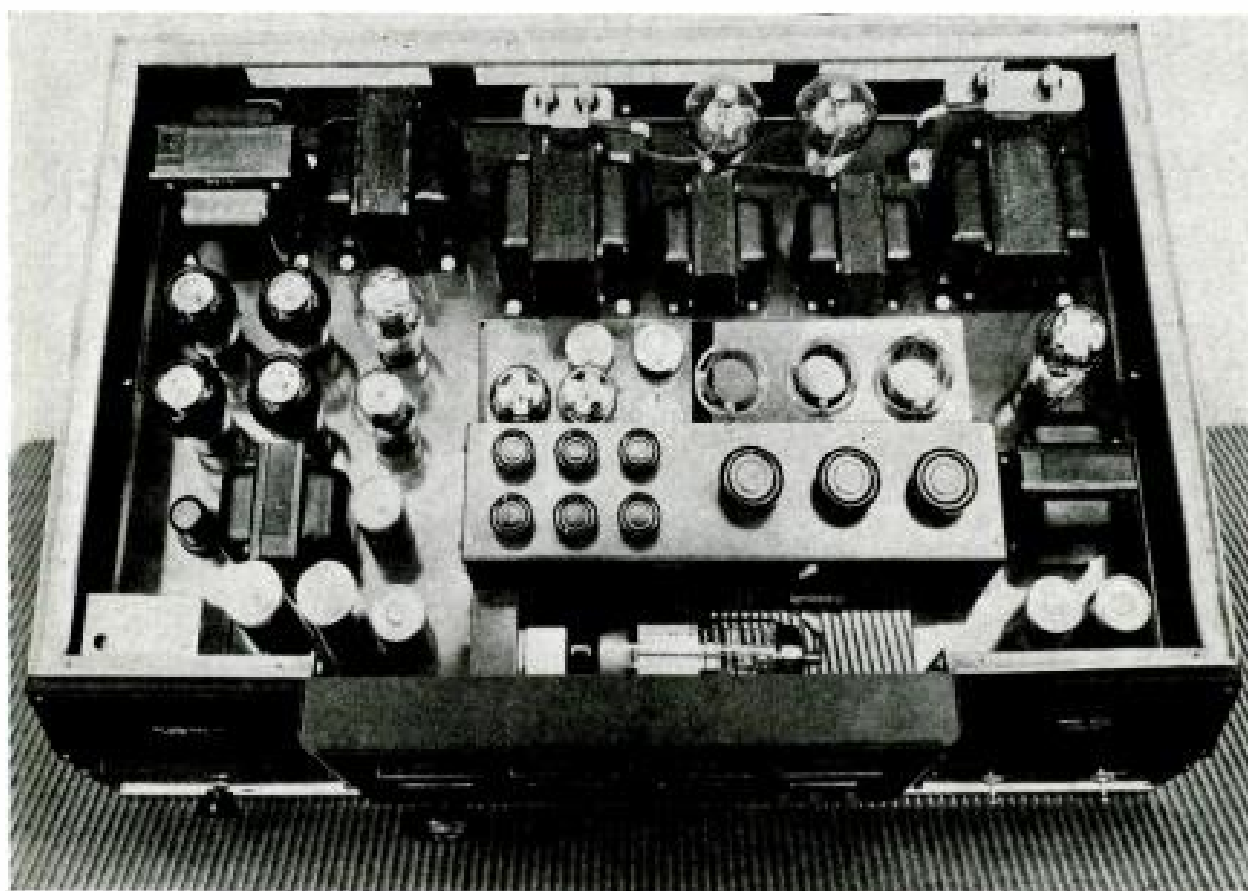

FIG. 3.

Top view of the more elaborate device as found in a commercial unit.

and a pilot light at the left and right. The only shielded leads are the one from the mike jack to the first grid of the 6N7, and the

two "hot" leads to the gain control. No wiring whatsoever is visible from the top of the chassis, all being confined below deck.

## New Glow Lamps in Two Colors for Testing

A new  $\frac{1}{4}$ -watt glow lamp, equipped with single contact bayonet base, has just been announced by the General Electric Vapor Lamp Company, Hoboken, N. J. The lamp is adaptable to many radio test and instrument uses, electrical instruments, pilot lights and indicators where space is a serious consideration. Small physical size also indicates its use in aviation, submarine and similar instruments where the space factor is important.

This lamp is electrically identical to the double-contact bayonet T 4 $\frac{1}{2}$  lamp, widely used for radio test applications. The new lamp may be interchanged with only a change in socket. Fitting the sockets now supplied to the radio and automotive industries by many manufacturers, the new base is the same as that being extensively used on radio panel lamps.

Like the double bayonet base lamp, the new lamp has no resistance built into the base; therefore, external resistance must be of such value as to limit the current to 2 milliamperes. Currents greatly in excess of this will shorten the useful life of the lamp, and may possibly change its electrical characteristics. The electrode shape is hemispherical, and on d.c. only the negative electrode glows.

The candle power is the same, however, as that produced on a.c. when both electrodes glow. Made in two types, one neon filled, the other argon filled, the lamps are 1 $\frac{1}{2}$  inches in overall length. The neon lamp may be used on either a.c. or d.c., and the argon lamp on a.c. only. Further information about these lamps may be obtained by writing the General Electric Vapor Lamp Company, Hoboken, N. J.

# YOUR STANDOUT: AN ANALYZER

## Simple Way to Obtain Wide-Range Measurements While Using Only Two Controls

By HERBERT E. HAYDEN

**A** FLEXIBLE circuit for the construction of an analyzer is shown in Fig. 1. There are so many d-c voltage ranges that omissions may be made, to accommodate the circuit to a two-deck switch of fewer than the twenty-three positions shown. However, it is worth-while to have multiple ranges for the important purpose of d-c volts, so that readings will obtain largely at the upper end of the scale, where accuracy is better. Shown are nine d-c voltage ranges, 0-2.5-10-25-50-100-250-500-1000-2500 volts. If reduced to five these might be 0-10-50-250-500-2500, or, make the last range 1,000. In any event a triple numbering system for the dial scale suffices for any of these requirements, since the appearing numbers for all the ranges are 0-10-50-250, and higher than base ranges are read as decimal multiples.

The analyzer is the outstanding instrument in radio servicing, but it also is of extreme value to students, experimenters, garage mechanics, photo-electric workers and others. It is characterized by a large meter, at least 4", usually square; multiple ranges, and a portable cabinet.

### The Multiplier Resistors

As all the d-c voltage ranges are at 1000 ohms per volt, the required resistance for any such range is 1000 times the full-scale voltage. Since the meter has some resistance, that value must be subtracted from any small computed total, to give the resistance value required for the separate multiplier. Thus, for the 2.5-volt range, needing 2,500 ohms, since the meter has 100 ohms, the multiplier resistance introduced should have 2500 less 100 ohms, or 2400 ohms. On the second range, 10 volts, the meter resistance may be taken in consideration also, hence the tubular resistor introduced has a value of 9,900 ohms, the meter accounting for the difference.

If the meter has lower or higher resistance than the specified 100-ohm value,

make the corresponding deduction in determining the value of the added resistance. After the second range the meter resistance becomes negligible compared to the total required resistance, hence 1000 times the full-scale deflection voltage gives a satisfactorily correct value for the limiting resistance to be added to the circuit.

### Checking Resistors

If wire-wound precision resistors are used as voltage multipliers the values as computed should be the ones included.

If, however, carbon resistors, including metallized types, are to be wired in, then it is preferable to have two resistors in series for each range, each about half the required value. Hence from an assortment of resistors it is possible to get the right combinations.

There are several ways of doing this, one being by using an accurate ohmmeter, preferably one that draws the same current as the meter in the analyzer. This method does not always yield the best practical value of resistance, due to the voltage coefficient of the carbon resistor. Hence it is advisable to measure the resistor not only at the current to be flowing at full-scale in the analyzer but also at or near the full-scale voltage. This combined requirement is difficult to fulfill in an ohmmeter, where the voltages are what they are, but the same combination effect can be obtained by selecting the paired resistors in connection with known voltages as the analyzer is being built.

### Use of Dry Cells

For the 2.5-volt range it would be satisfactory to take a new dry cell and adjust the resistor for meter reading of 1.55 volts, by proper combination of resistors. For the next range, 10 volts, a fresh 7.5-volt battery may be used, and the adjustment made for 7.7 volts. A 22.5-volt battery serves for the 25-volt range, adjustment to 23.5

volts, while a 45-volt battery is used for the next range, adjustment at 47 volts. When the batteries are fresh these slightly higher than rated voltages are almost un-failingly present, within the accuracy re-quired.

### Current Ranges

In any event, the use of another meter with which to compare the present one is

These values may be measured on a bridge, or may be selected on the basis of passing a known current through the meter when it is shunted; however, there must be some previous knowledge that the shunt is low enough in resistance, even if too low, and is securely in place, since if by accident the shunt is absent, the meter may be ruined by the large overdose of current passed through it. The purpose of the shunt is to

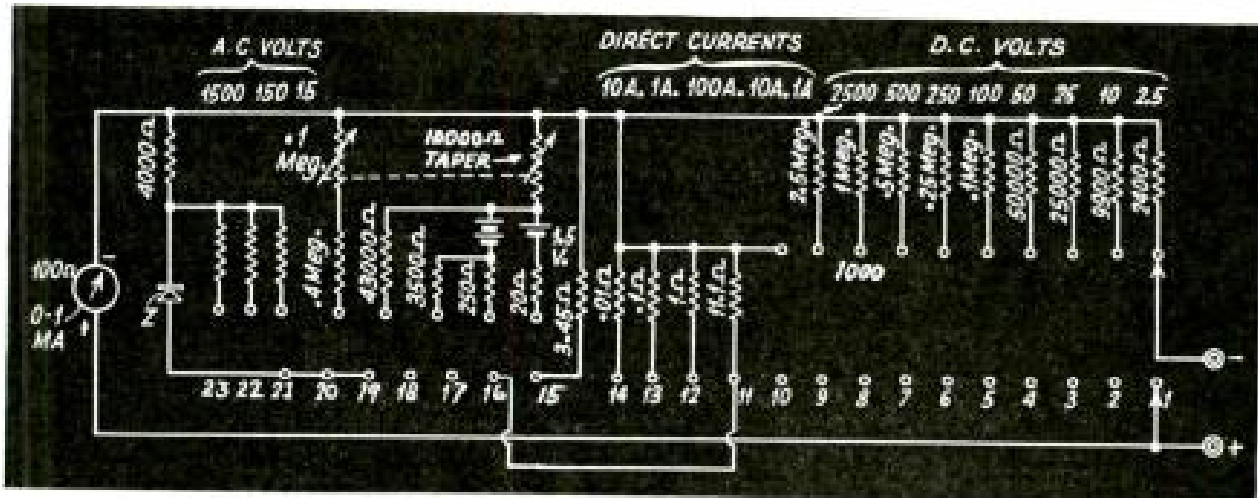

The switch positions are numbered on the diagram, starting with No. 1 at right, representing 2.5-volts. The lowest resistance range has a 30-ohm center (position 15 on diagram). A meter shunt of 3.45 ohms is needed, for a 100-ohm meter. The 300-ohm-center range picks up the 10 ma shunt, used also for the d-c range. The rest of the resistance ranges require no shunt. The lower deck of the switch idles for resistance ranges, being cut in only for inclusion of the rectifier in the circuit, dispensing with separate AC-DC switch.

always advisable, especially if that other meter, really used as standard, is of high caliber. If there is high resistance in the voltage supply circuit, it is advisable always to have both meters across the voltage supply at the same time.

In this way the d-c voltage ranges are satisfactorily established.

The direct-current ranges are 0-1-10-100 milliamperes and 0-1-10 amperes. For each such range, except the base range of 0-1 ma, a shunt is placed across the meter. Its value equals the meter resistance divided by a number one less than the current multiplying factor. Thus, if a 0-1 millimeter is of 100 ohms internal resistance is to be made into 0-10 millimeter, the multiplying factor is 10, hence the number by which to divide the meter resistance being one less, or 9, the required value of shunt in this instance is  $100 \div 9 = 11.1$  ohms. For 100 milliamperes the meter resistance simply may be divided by 100, as there is no appreciable difference between dividing by 100 or by 99. So a shunt of one ohm suffices. For one ampere the required shunt is .1 ohm.

take up the current in excess of the meter current.

### Wire for Shunts

Another precaution is that copper wire should not be used for shunts. Wire, like manganin, having a more nearly constant resistance with change in temperature gives better results. Since all the shunts are in the low resistance classifications, it is convenient to have them wire-wound, besides being practically necessary. The 10 ampere shunt should be of No. 14 wire at least and may be cut to length on the basis of fractional ohms per inch, then checked.

The resistance ranges start with 0-2500 or 0-3000 ohms, depending on where the designer prefers to stop, since the two values are very close together on a necessarily crowded part of the scale. At all hazards, the center of the base scale is 30 ohms, and values well below one ohm may be estimated, e.g. to about a quarter of an ohm. Actually the first bar is one ohm. Since the spread-out is best from center to zero ohms, all resistance values should be read to right of

center, except for the highest resistance range, where there is no choice for readings from 300,000 ohms to 25 or 30 megohms.

### Battery Ranges

It is convenient to build into the analyzer the batteries for ranges up to 100 times R, or the 250,000 or 300,000-ohm range. This requires only 3 volts. With the limiting resistor built into the analyzer, all you need do is introduce about 30 volts externally, adjusting for full scale with test leads touching, and for the highest range, introduce externally the required 300 volts, or a bit more, from a B supply, and adjust for full-scale with a larger rheostat (.1 meg.) ganged to the other (10,000 ohms). It is usual to introduce the tapered type rheostat. Clarostat's M taper works nicely in such service. The taper particularly permits the smaller value rheostat to serve on four ranges, although the adjustment is to about 10 ohms on the base resistance range, 50 ohms on the next range and 1,000 ohms on the next, and finally 2,000 ohms, which completes the adjustments for internal batteries and the external 45-volt battery.

For the 450-volt requirement, to obtain satisfactory adjustment, a higher resistance control is preferred. This is shown as .1 meg. and, as stated, may be ganged to the other, for unification of ohms control.

There is no need for a separate a-c/d-c switch in the circuit, as the selector switch is used for bringing the copper-oxide rectifier into service. If this is a high-grade rectifier, well able to stand a sizeable inverse voltage, the resistor between the rectifier and the meter, whereby the meter is constituted a d-c voltmeter to measure the pulsating d.c. across the rectifier, may be of relatively high value, e.g., 4000 ohms. In this way the curvature of the a-c scale is greatly reduced; indeed, the a-c volts scale is nearly linear. Also a single scale, reading, say, 0-15, may be decimally multiplied, and the accuracy is well maintained on the two ranges other than the one for which calibration was made, the calibrated range of course being the most accurate.

### A-C Resistors

The multiplier resistors depend a great deal on the make and type of rectifier, and even rectifiers of the same make may require somewhat different limiting resistors, so it is well to have an accurate a-c voltmeter and the supply voltages for comparison purposes, choosing the a-c resistors by test, the same way as the d-c resistors.

The independence of the resistors for a.c. and d.c. improves possibilities of accuracy in such a circuit. Approximate values for

the a-c limiting resistors are given on the diagram.

The circuit may be built for 22 positions with generally-obtainable two-deck switches. After the ohms (Pos. 19) (left to right in diagram) simply bring the rectifier Z to three bottom positions of the switch and insert the proper limiting resistors on the other decks. Their values are not given because they are not always repeatable.

## Priestly's Comedy Vivid in Telecast

London claims credit for "giving another television lead to the world" by its recent telecasting of J. B. Priestly's Yorkshire comedy, "When We Are Married," direct from the stage of St. Martin's Theater in London.

According to a description of the event, special lights resembling anti-aircraft searchlights, installed around the stage and in the boxes, blazed on the actors, whose make-up seemed unusually pallid. Three electric cameras were focussed on the stage; two were on platforms at each end of the front row, while the third was located in the center of the dress circle.

The broadcast began with a film giving the impression of a taxi ride through the city's lighted streets and ending at the theater. Extras sat in rows of seats in front of the stage to create the illusion of an audience in front of the viewers.

A thrill followed the sudden closing of the curtain, as a burst of applause was supplied by the extras as each act ended, thus bringing the "feel" of the theater into an estimated 25,000 homes.

Based upon press reports, the event was surprisingly successful, although the limitations of the cameras caused only one-half of a party group to appear at a time, with moving individuals disappearing completely at times, only to reappear again in unexpected places.

### FREE INFORMATION ON PARTS

Constructional articles appearing in RADIO WORLD use parts and equipment commercially obtainable. Readers desiring particular information, including parts lists, should address Trade Editor, RADIO WORLD, 145 West 45th Street, New York, N. Y.

# TUNING BY EAR DESPITE AVC

## Separate Channel Produces Greatest Volume at Resonance

By LEWIS WINNER and KENNETH V. THOMPSON

THE addition of a separate channel for automatic volume control will provide easier tuning and far superior volume regulation than those found in current radio receivers. The cost of the auxiliary unit, which can be added to almost any superhet, whether or not the set now employs AVC, is rather small.

In the usual superhet the selectivity of the AVC system is the same as that of the signal circuits, since both employ the same circuits. The resulting AVC characteristic is such that stations come in at the same volume for a region of plus or minus five kilocycles. This means that distortion and hissing are present unless the station is tuned in very carefully or a visual tuning indicator employed.

The reason for this characteristic is that, when the signal strength tends to drop at off-resonance tuning, the AVC voltage has decreased to such an extent as to build up the gain, hence the volume of the set remains substantially constant for mistuning up to 5 kc or more.

### Unusual Performance

Another disadvantage of the usual AVC is that the IF and AVC amplifiers are biased by the voltage produced by the AVC rectifier. Thus, on strong signals the IF and AVC voltage available is decreased since the IF amplifiers are not running at full gain. In the unit to be described the AVC amplifier tube works just the opposite of the tubes in the usual IF amplifier. When the signal is strong and a large amount of bias is needed to hold down the signal, the AVC amplifier is working at full gain. With a weak signal, when little AVC voltage is required, the AVC amplifier is working at low gain.

The unit used to provide a separate AVC channel is a two-stage IF amplifier using one overcoupled tuned IF amplifier and a stage of untuned IF which is fed to the AVC diode. The overcoupled stage uses one of the Hammarlund variable coupling transformers adjusted so that there is a pronounced dip in the curve at resonance. Since the grid for this amplifier is connected to either the primary or secondary of the first IF transformer in the receiver, the overall selectivity of the two transformers is such that a slight dip occurs at resonance, and peaks appear at about 5 or 8 kc on either side of resonance.

### Highest Gain at Resonance

This means that the gain of the receiver is somewhat greater at resonance than at either side, since the AVC bias voltage drops slightly at resonance due to the dip in the resonance curve. (See diagram.) Consequently, the signal supplied by the set is greatest at resonance. At either side of resonance, the AVC voltage is slightly greater than at resonance, resulting in a decreased gain. Thus, due to the AVC alone, the signal will drop at either side of resonance. When the selectivity characteristic of the set's IF channel is considered, one will realize that at a few kilocycles off resonance the signal has been attenuated considerably. The effect of the AVC channel and the natural selectivity of the set's IF channel is to provide a marked drop in signal level at either side of exact resonance. In fact, the effect is more noticeable than in a set not using AVC. This means that all one has to do is tune for maximum volume as in the old days before AVC.

When the device was attached to a low-priced midget which was tuning rather broadly, the broadness disappeared at once

SEPARATE CONTROL CHANNEL IMPROVES SET PERFORMANCE

and the stations seemed to come in at but one point on the dial—and that was the point for perfect tuning.

The more constant output for a given range of signal strengths is obtained by the

built and wired is important now that the reader knows why the unit should be added to his present receiver.

All the parts are mounted on a chassis measuring  $3\frac{1}{2} \times 8 \times 2''$ . The wiring is

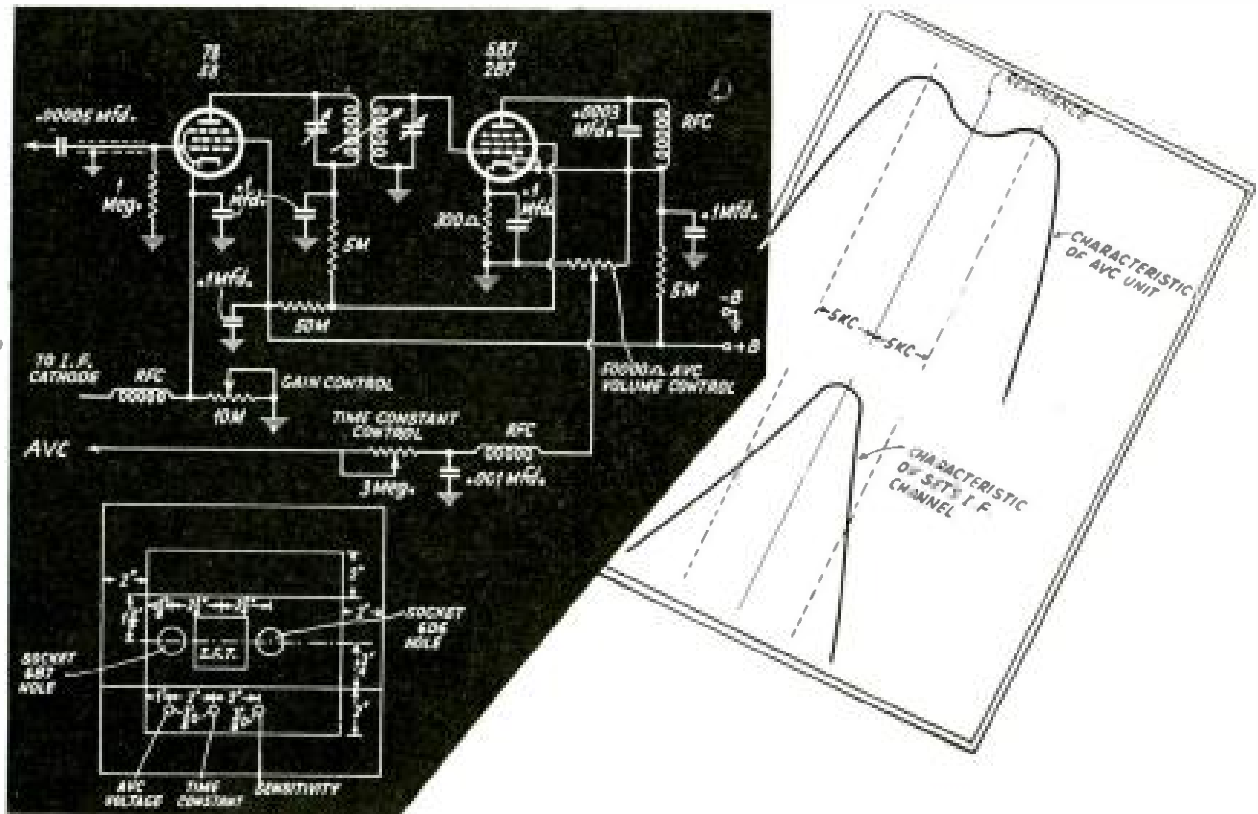

The diagram of the separate AVC channel is shown, with plan for layout, and response curves.

use of a "reversed bias" on the AVC amplifier. The AVC amplifier and the IF amplifier in the set are cathode-biased through a common resistor. The AVC amplifier grid goes directly to ground. When a strong signal is picked up, the AVC reduces the gain by putting an increased bias on the IF amplifier of the set.

### Better Control Action

With this increased bias the plate current drops, consequently the voltage drop through its bias resistor is less. And since the AVC amplifier tube is connected across this resistor too, its cathode-to-ground voltage decreases. Since the AVC amplifier grid is grounded, the effective grid-to-cathode voltage has decreased, with a resulting increase in the amplification from the tube. Consequently the AVC amplifier is capable of holding down the signal strength of strong stations. In other words, the automatic volume control provides a better controlling action.

Up to the present what the unit will do has been the main discussion. How it is

kept below the chassis in the  $2''$  cavity with the exception of the grid lead of the 78 amplifier tube. The accompanying drawing shows the layout of the chassis and the parts. Since there is plenty of space available, placement of the parts is not critical. The RF choke for the plate load of the 6B7 tube is mounted next to the tube socket.

So that the unit can be used with any set, a variable resistor is employed to give any desired amount of AVC voltage. With this control the signal level at the second detector of the set can be varied.

A second control is used to determine the maximum gain of the set. It is really nothing more than a sensitivity control located in the cathode circuits of the IF amplifier and AVC amplifier tubes.

### Adjustable Time Constant

Since there is a number of different circuit values used in the AVC line, all affecting the time constant, it was decided to employ a variable resistor to provide a means of varying the time constant of the AVC unit. The time constant will be greatest



when the full resistance value if the 3 meg. resistor is employed. If a smaller time constant is desired, as is most likely, the resistor can be set at any value of resistance.

A few minutes experimenting will show what values of AVC voltage, time constant, and maximum sensitivity will give most satisfactory results. A fourth variable is the coupling in the IF transformer. Experience to date show that maximum coupling is satisfactory. Also it is well to try connecting the grid of the 78 tube to both the primary and secondary of the first IF transformer. Leave it connected to the side which gives most satisfactory results. Remember, however, that the first IF transformer in the set must be retuned to resonance when the grid of the 78 is connected.

The IF transformer in the AVC unit should also be tuned to the IF of the set. This should be done in the sharp selectivity or loose coupling position. If the set has a tuning ray tube, the grid of the tube can be disconnected from the set and connected to the diode circuit of the AVC unit to indicate resonance. It should then be connected back to the diode circuit in the set where it will function normally.

#### How to Connect Up

In connecting the unit to the set, the AVC line is disconnected from the circuit at the point where the filtering resistor connects to

the diode load resistor. The filtering resistor is removed from the circuit and the AVC line is run to the AVC unit. Secondly, the cathode of the AVC controlled IF amplifier is run to the unit, after removing the cathode bias resistor. Other connections are the B plus, which is made to the high-voltage bus in the set, and grounding of the unit to the chassis. Filament connections must also be made.

Either the 6-volt or 2½-volt series of tubes may be employed in the unit. The additional load in most well-designed sets will have no effect upon the power transformer. If the set is an AC-DC unit, the heaters should be wired in a series and 6-volt tubes employed. Naturally the value of the voltage dropping resistor must be reduced.

When space permits, the AVC unit is bolted to the chassis of the set as near the first IF transformer as possible.

#### EASILY SATISFIED?

I have bought nearly all radio publications in past years, but these last few years nothing but RADIO WORLD satisfies me. I consider it the very best.

E. E. STARR,  
Lodi, Calif.

### "Machine-Gun" Mike Very Directional

Thousands of questioning eyes were directed toward a figure operating a strange contraption atop the Stadium press box at the recent Michigan-Ohio State football game at Ann Arbor, Mich. That figure was Walter Hoffman, Chief Engineer of WWJ in Detroit, and his "weapon" was one of Western Electric's new ultra-directional "Machine Gun" microphones. From his commanding position, Hoffman drew a bead on the field all afternoon, picking up those sounds that are necessary to make a football contest real and exciting to a radio listener. The impact of the punting foot against the ball, the shrill of a referee's whistle, the blare of the bands and the yells of the cheerleaders, all fell before his unerring fire.

Like the popular "Eight Ball" and "Salt Shaker," the "Machine Gun" mike acquired its name almost at birth. Gunlike in ap-

pearance, it consists of a standard 618A microphone, close coupled to a bundle of 50 aluminum alloy tubes whose lengths vary from one and one-quarter inches to five feet. Weighing only seven pounds, the entire assembly is easily aimed and manipulated from the top of any standard motion picture tripod



The "Machine Gun" Mike in Action

# DIVERSITY NOT MERE DIVERSION

## Multiple Antennas for Reception to Throttle Fading

By GORDON FRASER

**D**IVERSITY reception reduces fading, inherent in all short-wave reception, and starts improving the signal-to-noise ratio where the benefits of automatic volume control leave off.

Fading may logically be considered as the effect of a signal arriving at the receiving antenna simultaneously over several different paths of different lengths.

The fading cycle of a given signal as received on one antenna will be invariably different from that of the same signal received on another antenna a moderate distance away, or even another one close by if it runs a different direction from the first. Thus the signal may fade 'way down on one antenna and yet be strong at the same instant on another antenna only a few feet distant. This peculiarity can be proven by a simple test employing an ordinary receiver and two antennas.

Arrange the two antennas with a knife switch so that either may be switched onto the receiver. The antennas may be of any ordinary types.

### The Switch Test

With one of the antennas connected to the receiver through the switch, tune in a short-wave signal that is subject to troublesome fading. Then, at the instant that the signal has faded to a low level quickly throw the switch to the other antenna. Repeat this operation several times and on several signals. *At any given instant the signal will be better on one or the other antennas.*

This constitutes the simplest form of diversity reception. Its drawback, from a practical viewpoint, is that switch-throwing is cumbersome and slow. The test does provide convincing evidence that if an arrangement could be worked out that would permit reception of a signal on two or more an-

tennas at one time, the effects of fading would be greatly reduced.

Another test, and one which does constitute a practical application of the diversity principle for those who have the necessary receiving equipment, is to utilize two different receivers connected to the two antennas, with a headphone in the output of each, one headphone being placed on each ear. For this use it is essential that the receivers employ different intermediate frequencies, otherwise their oscillators will interact and cause heterodyne beats.

### Results Demonstrated

But given such equipment, fading of ham signals (or any other SW signals) can be smoothed out to an almost unbelievable degree. Listening to GM6RG a few minutes ago on 10 meters, with this arrangement the author held his signal constant at better than an  $R_6$  level (as judged by ear) although on the "R" meter on one receiver his signal was dipping to  $R^3$  on fades and on the other to  $R_6$ . On the first receiver alone the reception could not be classed better than "poor" and on the other "fair." Yet on the combination the report could be nothing less than "excellent, a solid  $R_6$ -plus."

It is interesting to note in this case that the antennas employed were a horizontal, 10-meter "Q" and a vertical 5-meter dipole, the bottom of the dipole not more than 8 feet from the nearest end of the "Q." This same advantage was obtained on many other signals and this antenna arrangement seems definitely to disprove the belief that effective diversity reception is possible only with widely-spaced antennas.

The question arises as to coupling two antennas to the input of a single receiver. Unfortunately, this scheme does not work out because additional bucking and adding

FADING REDUCTION TESTED ON SIMPLE SWITCH

will take place between the two antenna inputs in the coupling coil of the receiver. The two signals will add or cancel exactly as do the components of one signal arriving over different paths. This is likewise true of any attempt to feed the two antennas into one receiver through individual RF amplifiers.

### Rectified Current Mixed

The only way that has been found to obtain an additive action without likewise suffering cancellation is by feeding the two antennas into separate receivers and mixing the audio signals after rectification, or detection. The rectified outputs of two superheterodyne receivers, for instance, can be fed into a common load resistor connected to the two second detector plate circuits. There the audio voltages will be entirely additive. This, in effect, is the same as the test mentioned above in which two receivers were used, each feeding a different headphone; the mixing in that case taking place within the ears instead of in a common load circuit.

The disadvantage in the double-headphone system lies in the fact that when the signal fades down or out on one receiver the noise level in that receiver rises (assuming that the set has AVC) so even though the signal is strong and free from noise in the other headphone, the noise from the first will still be present.

Where the outputs are mixed in the audio amplifier this objection can be eliminated through a common AVC system actuated by the combined outputs and which applies equal control to both receivers. This when the signal from one antenna is strong the overall output will likewise be strong even though the signal at the other antenna may have faded out.

### Selects Stronger Signal

The AVC action resulting from the strong output will be considerable. As the AVC is applied equally to the two receivers the gain of both will be throttled to a point where the noise contribution of the receiver in which the signal is weak will be negligible.

This means, in effect, that when the signal is stronger in one receiver channel than in the other, the system automatically selects the stronger one and suppresses the weaker.

Much experimental work has been done on other schemes, but all such systems have been found incapable of following fast fading, or have had other disadvantages. The result is that the multiple-receiver system described above is in general use in commercial long-distance stations wherever diversity reception is practiced.

One such system is used at the RCA receiving station at Riverhead, Long Island (N. Y.) Here it is the practice to use three receivers and antennas in each circuit.

---

## Sets Face Severe Requirements in Tropics

---

Severe demands are placed on receivers in tropical and sub-tropical countries, and manufacturers are constantly endeavoring to bring their products up to the full requirements of these markets. The situation in India is expressed by Debendra Nath Ganguli, of Calcutta, who says:

"In tropical and sub-tropical countries, the rainy season has a very damaging influence on radio sets and components. For example, from one end of India to the other, the maximum temperature varies from 100° F to 120° F during the months of May, June and July.

"Rains begin from the middle of June and last until the end of September. During the rainy season, the temperature varies from 80° F to 100° F and the humidity varies from 80% to 100%.

"During and after the rainy season, most of the paper condensers become leaky and the resistors noisy. These have to be changed. Fungus grows on cotton-lapped

wiring and components, due to continuous dampness. To crown it all, reception becomes very poor and noisy."

Similar complaints prevail in Central and South America, according to a report of the American Consulate General at Panama to the U. S. Bureau of Foreign and Domestic Commerce.

Some of the faults of American-built receivers found in those countries are due, according to the report, to small capacity bypass condensers which are made of paper instead of mica; filter condensers with electrolyte which evaporates too rapidly, as also resistors of insufficient current-carrying capacity. An objection to metal tubes was also listed, because the metal envelopes "retard the heat dissipation, thereby increasing the internal temperature of the tube to an excessive degree."

The replacement of wood cabinets with metal housing, to prevent swelling and warping of the veneer, was also recommended.

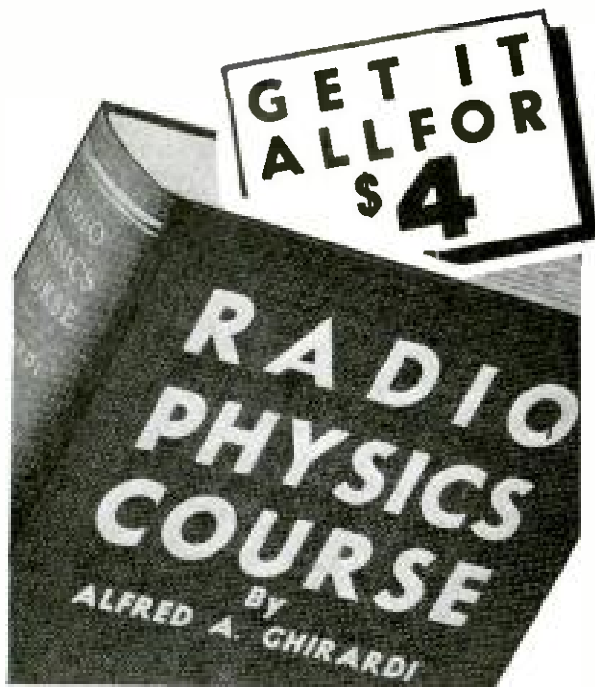

**Here's what you learn:**

- Sound, Speech and Music —
- Electric —
- Electric Current —
- Electric Units and Circuits —
- Resistance —
- Ohm's Law —
- Batteries —
- MAGNET —
- Electromagnetism —
- Transformers —
- Inductance —
- Condensers —
- Alternating Current Circuits —
- Filters —
- Electrical Measuring Instruments —
- Radio Waves; Radiations —
- Broadcast Stations —
- Receiving Equipment —
- Vacuum Tubes —
- Radio and Audio Frequency Amplification —
- Superheterodynes —
- Loud Speakers —
- Battery Operated Receivers —
- Power Supply Units —
- Electric Receivers —
- Automobile and Aircraft Receivers —
- Phonoc-

**36 RADIO BOOKS IN ONE**

Think of it! A complete radio education for only \$4! In this big training book you will quickly learn Radio, Electricity, Sound, Television, etc. In 36 sections, each the equivalent of an ordinary book, you will pick up step by step all essential knowledge required for a thorough grounding in RADIO.

**SO EASY IT'S AMAZING!**

You will be surprised and delighted at your rapid progress once you start reading Ghirardi. No previous training is necessary. Ghirardi has an uncanny knack for making everything crystal-clear. Intricate problems seem ridiculously simple the way he explains them. That's why this book is used by more radio schools and students than any other radio text.

**10-DAY TRIAL**

Fit yourself at home for a good-paying radio job this quick, inexpensive, most popular way. Send the coupon for your copy at once. You risk nothing; your money is automatically refunded if you return the book within 10 days. The whole fascinating field of Radio lies ahead of you—get into it NOW!

**TEAR OUT - MAIL NOW!**

- Graph Pickups —
- I A Systems —
- Short - Wave Receivers —
- Photoclectric Cells —
- Tele. vision —
- Antenna —
- Grounds —
- Testing and Servicing Receivers —
- Sound Motion Pictures —
- Appendixes —
- 856 Review Questions for Self-Study —
- AND DOZENS OF OTHER SUBJECTS!

972 pp. 500 illus. **\$4**

**RADIO & TECHNICAL PUBLISHING CO.,**  
45 Astor Place, New York Dept. RW-19

Here is \$4. (8-50 foreign) for my copy of RADIO PHYSICS COURSE. Ship postpaid at once with 10-day money-back guarantee.

NAME .....

ADDRESS .....

CITY ..... STATE .....

Send free descriptive literature.

**LEARN RADIO THE EASY WAY**

Ghirardi's "Radio Physics Course" is the biggest-selling text on radio principles in the world. It is used as a basic text in radio schools in every state in the Union and in 82 different foreign countries



This is without doubt the handiest, simplest, most Practical LIGHTNING WORLD-TIME INDICATOR that has ever been thought up! It's absolutely unique and novel. You'll marvel at its simplicity—all you do is turn the rotating clock dial in the center—and there before your eyes is the information you want.

**AT A GLANCE**—it will show you the exact Greenwich Mean Time, Standard, or Daylight-Saving Time in any city and country in the world, no matter where you live, nor what time of day or night. Also, it shows you exactly WHEN and WHERE to tune in your radio set for any foreign or domestic radio program or event; the number of hours difference between the time in any two cities; the difference between your local time and G.M.T.; etc. with a complete S.W. Station List on the back. No fussing! No fumbling! No guessing! No calculating! This little wonder-worker saves you all that—figures it all out for you—shows it concisely, accurately **IN A FLASH!**

Risk nothing! Your money back if not satisfied after 10 days' trial. Just write your name and address on this ad mail it at once with 50 cents (60 cents foreign). We ship postpaid anywhere.

**50c postpaid**

**A Turn of the Disc and there's the Time!**

**RADIO & TECHNICAL PUBL. CO.**  
45 Astor Pl., New York, Dept. RW-19

**Amazing New Gadgets**  
**Speed up YOUR SERVICE WORK**

**Ghirardi's New Pocket Trouble-Shooters**  
**Save Time • Save Labor • Save Money**



These wonder-working "Twin Gadgets" get straight to the bottom of your service jobs—quickly. Instead of servicing by trying out all sorts of experimental tests and remedies, now you can tell—with just a glance at Ghirardi's "Gadgets"—exactly what TESTS to make and what REMEDIES to use for

any trouble symptoms you find. Most useful and ingenious time-savers you ever saw.

**HERE'S HOW THEY WORK:**

There's nothing to it! Just pick out the card marked with the Trouble Symptom you find in the "sick" receiver; flip the card around and there you'll see complete instructions for locating and Repairing the trouble. Use these streamlined servicing short-cuts and stop wasting valuable time "checking" and "fussing." Together, they spot OVER 800 DIFFERENT SET TROUBLES! One for HOME RADIOS, another for AUTO RADIOS—the pair costs only \$1 (\$1.20 foreign), so you can't afford not to have them. Every day without them means money thrown away. Order them the EASY way! Write your name and address on this ad and send it in with a dollar today.

**RADIO & TECHNICAL PUBLISHING CO.**  
45 ASTOR PLACE, NEW YORK Dept. RW-19

These gadgets sent postpaid anywhere on 5-day Trial basis.  
**50c EACH ORDER THEM NOW! \$1 FOR THE PAIR**



# THE THEORY

OF  
RADIO  
SERVICE  
WORK



Priceless Knowledge  
at your Command

## Here's the BRAINS

### ALL IN 1 BOOK

Everything you need to know about the theory of radio service work is explained to you in this big Ghirardi book. It teaches you exactly HOW to do every step of it—and WHY. Learn up-to-date factory servicing methods from the experience of leading service organizations—condensed and simplified for you in this convenient source-book.

### BASIC FUNDAMENTALS

Here in compact form is your complete background in test instruments—how they work—how to use them; trouble-shooting; repair methods; and everything else essential for a thorough knowledge of modern radio servicing. Ghirardi makes it all wonderfully clear and easy to understand. With this solid foundation you will be prepared to tackle and solve the most difficult servicing problems you'll ever meet. Make yourself a better, more successful service man. Get your copy at once—with an absolute MONEY-BACK GUARANTEE. Mail coupon today!

#### ● Test Equipment

A 420-page section, giving you the whole theory and construction of every type of test and servicing equipment. Diagrams, construction data, etc., etc.

#### ● Repairing

184 pages of time-saving repair methods, superhet alignment, interference elimination; etc., etc.

#### ● Trouble-Shooting

254 pages of latest shortcuts in tracking down all kinds of difficult receiver troubles.

#### ● Special Problems

442 pages on Auto-Radio installation and servicing; All-Wave sets; High-Fidelity sets; AVC and QAV Circuits; Selling and Advertising; etc., etc.

## Ghirardi's MODERN RADIO SERVICING

1300 pp.  
706 illus.

Radio & Technical Publ. Co., RW-19  
45 Astor Pl., New York, Dept.

- Here is \$4 (\$4.50 foreign) for my copy of MODERN RADIO SERVICING.
- Here is \$6.50 (\$7 foreign), the "Special Combination Price" for the above book together with Ghirardi's TROUBLE-SHOOTER'S HANDBOOK (see opposite ad).

NAME.....  
ADDRESS.....  
CITY.....  
STATE.....

Please send free literature describing detailed contents of MODERN RADIO SERVICING. \$4

**MAIL  
NOW!**



# THE PRACTICE

OF  
RADIO  
SERVICE  
WORK



Brand  
NEW—  
and it's a  
KNOCKOUT!

## Here's the DATA

### READY FOR ACTION

New as tomorrow's radio sets is this latest Ghirardi service-man's Handbook—a Handbook that IS a Handbook! Data—any, it's packed jam full of just the kind of practical, time-saving servicing dope you really want in your shop—loads of indispensable, factory-checked servicing data boiled down to the real essentials—tabulated and organized for split-second reference. And right up to the minute—even for the 1939 models!

### 1st Aid for Set Troubles

Here, right at your finger tips are the answers to all the "tough ones." A matter of seconds to save hours of fiddling and fussing in hard service jobs. You've just got to see this new book! And you won't have to take a single chance, because with our MONEY-BACK GUARANTEE you can return it within 10 days and get your money refunded. Don't fall behind. Don't let it slide. ORDER YOUR COPY TODAY!

#### ● Case Histories

Trouble Symptoms and remedies for over 2,000 sets, compiled from actual service records.

#### ● I-F Peaks

Over 12,000 listings for alignment of all superhets, old and new, including 1939 models and "orphans."

#### ● Auto-Radio

Interference Elimination for over 80 car models; Installation and Car Ignition System Data Chart; Electrical Wiring Diagrams; Gear Ratios and Dial Directions of Tuning Controls.

#### ● Other Data

Trouble-Shooting Charts; Servicing Records; Intercommunicating Systems; P.A. Systems; Trade Directories; and over 30 other charts and tables on Tubes, Wire, Grid-Bias Resistors, RMA Color Codes, etc. Standard Manual Size (6 1/2 x 11).

## IT'S NEW! RADIO Trouble- Shooter's HANDBOOK

OVER  
500  
pages

Radio & Technical Publ. Co., RW-19  
45 Astor Pl., New York, Dept.

- Here is \$3 (\$3.50 foreign) for my copy of RADIO TROUBLE-SHOOTER'S HANDBOOK.
- Here is \$6.50 (\$7 foreign), the "Special Combination Price" for the above book, together with MODERN RADIO SERVICING (see opposite ad).

NAME.....  
ADDRESS.....  
CITY.....  
STATE.....

Please send free literature describing detailed contents of RADIO TROUBLE-SHOOTER'S HANDBOOK. \$3

**MAIL  
NOW!**

Save Money with this  
SPECIAL Limited-Time COMBINATION OFFER

Both Ghirardi Servicing Books \$6.50

(if purchased together)

# In Our Opinion

---



## Television with Courage

WITH commerical television impending, we have an example of manufacturers and broadcasters entering a field full of enormous difficulties. They show their courage. Manufacturers assume, no doubt, rightly, that production of television receivers will solve problems so much faster than experimental work alone, that more progress will be achieved in a year of production than in five years of laboratory work.

In fact, there is a whole group of problems. Experience alone will reveal how the costly television programs are to be produced with live talent, to be viewed in the beginning by what must be a meagre percentage of the population. Even if commercial television programs were permitted by the Federal Communications Commission, little except prestige could be gained at first by the advertiser. Television receivers being much more complicated and delicate than anything heretofore known in sound broadcasting, there will be plenty of servicing to be done, and yet there is as yet no body of men equipped to do this field work. Nothing has been said about the transmitter, but not because this lacks problems.

What may interest the prospective television receiver owner is the fact that the voltages required for operation are very high, running into a few thousand volts, hence if a way could be found to attain satisfactory results at lower voltages, or to introduce the high voltages in connection with some safeguarding device, there would be less danger to the over-inquisitive.

## The Pistol Wavelengths

WHEN short waves were pioneered by the amateurs it was not in anybody's mind that these waves would be abused as they are to-day by certain nations using them for propaganda. What was stressed then was the opportunity by use of the penetrating waves to send messages of good will, to promote international friendships, and serve the causes of peace and civilization. With so much bitterness and hatred now stirred up by broadcasts officially sent out by rampant nations, these wavelengths acquire

the status of pistols, aiding law and order when in the hands of a benevolent police power, but constituting a menace in the hands of dangerous nations.

## Room for Improvement

EVER since the beginning of radio there has been talk of monopoly, whether of wavelengths, patents or music rights, with alert public attention given to the peril of censorship. An odium attaches to the word monopoly, and yet monopolies abound, and our economic progress has been built up very considerably on their presence and sanction. How many railroads would have criss-crossed the country had they not a monopoly of their right of way? What is a trade mark or a patent if not a monopoly? It is therefore only the "harmful" monopoly that causes concern.

The Federal Communications Commission is conducting an investigation, broad in scope, months in duration, to determine whether any harmful influences of a monopolistic or duplicative nature exist in radio. The broadcasters feel that they will be able to show complete innocence of any illegal acts, but it is too much to expect that an industry that has mushroomed will be found entirely free of possibilities of improvement by legislation. It is only reasonable to expect that the report to be submitted to Congress by the Commission will contain many recommendations for legislation to improve the broadcasting and manufacturing structure.

## Radio's 1939 Promise

RADIO and the general electronic science are spreading more and more, so that almost no branch of human endeavor escapes. This beneficial growth promises to be biggest in 1939. One of the possibilities is that the electronic microscope will reveal to pathological science the hitherto unseen viruses, for instance of poliomyelitis (infantile paralysis) and indicate the road to a cure. Industry will benefit largely from the wider applications, too. Hence better for less money, and more jobs to boot, is radio's 1939 promise.

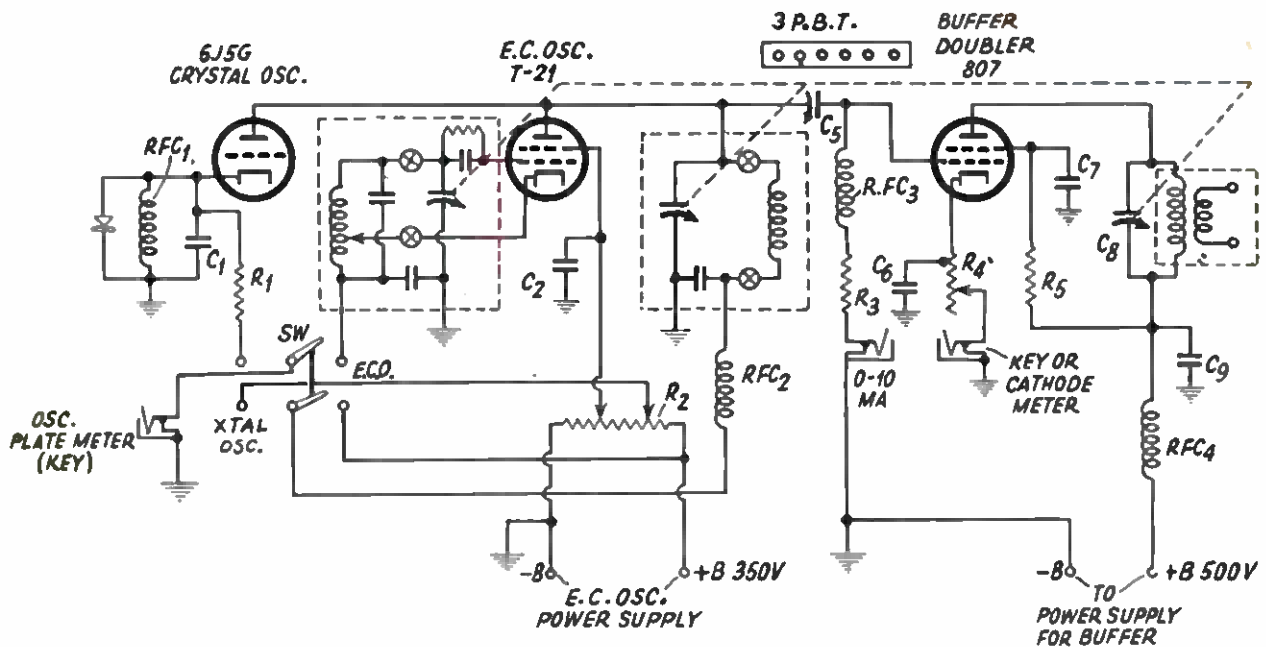

FIG. 1.  
The all-band exciter, using three push-button tuners.

# Push Buttons on Exciter

UNIT "FLIES" THROUGH BANDS WITH GREATEST OF EASE  
AND AVOIDS GETTING OUT OF BAND LIMITS

By William Filler,\* W2AOQ

THE interesting possibilities of applying some of the push-button tuners, used for broadcast receivers, to a universal exciter has occurred to many. Applying such a tuner to an amateur band exciter of tried and tested capabilities has resulted in the layout shown in the photographs. Although, taken before the final wiring, the pictures show the location of parts quite clearly.

The choice of a most adaptable circuit for push-button control, and of the parts used, is the result of considerable thought and research. First, the tube line-up and general circuit arrangement were decided upon. A pair of commercially-made electron-coupled oscillator band-switching turrets was obtained to include coverage of all amateur bands from 10 to 160 meters, with complete

LC combinations for the grid and plate circuits respectively.

The major difference between this circuit and one described by Glenn Browning is the substitution of a Taylor T-21 (glass 6L6 equivalent with standard 6-prong Isolantite base) for the 802 used by Mr. Browning.

## Push-Button Mechanism

The exciter proper, with three sets of six push buttons for controlling each of the three tuning condensers, makes possible, for example, push-button selection of any two pre-set frequencies in any three bands, with complete manual coverage of these three bands by the control dials shown.

Several types of push-button tuners are denser to any of six pre-set positions, se-

\*Terminal Radio Corporation

lected at random from the full 180 degrees of possible condenser shaft rotation.

The model, of which three were used, has six cams, one for each button, capable of being set so that when a button is pushed in, the condenser, operated by a bell crank mechanism, revolves until the cam stops a

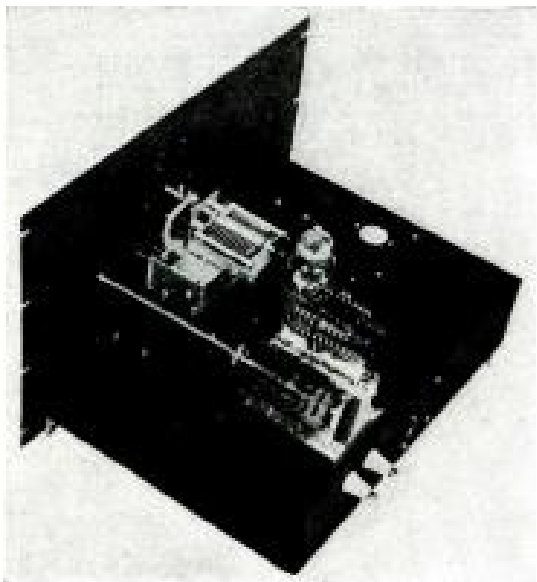

**FIG. 2.**  
The chassis arrangement.

movable cross-bar also operated by the bell crank.

Having manually tuned up the exciter by the control dials, say, to the low end of the 10-meter band, we give the first push button on each of the three tuned circuits a couple of revolutions to the left, thus releasing the cams. The first button on each tuner is then held in as far as it will go and given right turn twists until tight, thus locking in position the cam on each tuner.

### Buttons Independent

Then no matter at what position the manual control dials on the variable condensers are set, pushing in button No. 1 in one each of the three tank circuits will automatically bring the condensers back to the previously determined settings for the set frequency at the low end of the 10-meter band.

The next step would obviously be to set button No. 2 on each circuit for resonance to some other frequency, near the high-frequency end of the 10-meter band.

Any two frequencies can then be set up on buttons Nos. 3 and 4 for the 20-meter band any two frequencies on the 80-meter band on buttons 5 and 6. It is apparent, of course, that since 160 and 40 meters are available, as well as the possibility of doubling to 5 meters (with reduced output) in

the 807 stage, that the necessary coils for these bands may be obtained.

Since the drive to the 807 grid is capable of being nicely adjusted to optimum operating condition with the plate circuit control of the ECO (electron-coupled oscillator), we decided to "push-button" it, also, because it had been decided to tune no variables for the spot frequency operation desired, reliance being placed on buttons. The reason for such determination was akin to that which keeps some of us honest—i.e., we are afraid of the police.

### Separate Crystal Oscillator

It was our intention carefully to spot a frequency as near the high end of a band as appeared safe, and another likewise near the opposite end of the band, and with the marker points established by these two push-button dial settings (push a button to see where they are—no calibration required) it would then be possible to slide around the band between the limit points thus set up, using manual control as desired.

The extreme flexibility of such an arrangement with an ECO which really has Xtal stability, and with five bands capable of being instantly switched in, on the ECO, as well as the grand way the thing doubles and quadruples frequency with a good 35 watts output from the 807 tank, makes the push-button exciter a pleasing device to operate.

After you get it going you can easily spend a couple of evenings just fiddling with it and a calibrated receiver to check audibly what you are doing.

### Crystal Oscillator

For those who wish to use a crystal oscillator, a separate one was built in, as shown in the circuit diagram, a toggle switch providing quick selection of either ECO or Xtal. Probably some may prefer to leave out the crystal stage entirely, although some thought was given to switching the T-21 connections from ECO to Xtal. This was finally thrown out as adding unnecessary complications. The 6J5G Xtal tube, socket, choke and wire add little to the cost, so were included.

The electron-coupled oscillator is not to be considered as a cheap substitute for crystal control. Its flexibility and capability of frequency shifting to any calibrated or predetermined band of frequencies with comparable stability (you can't tell the difference by listening) to Xtal control, makes the ECO, and any refinements you can hang on it, well worth the cost and trouble.

One word of caution. Under a rule recently effective, a really stable and accurate



FIG. 3.

Top view, showing workmanlike layout of the all-band push-button exciter unit.

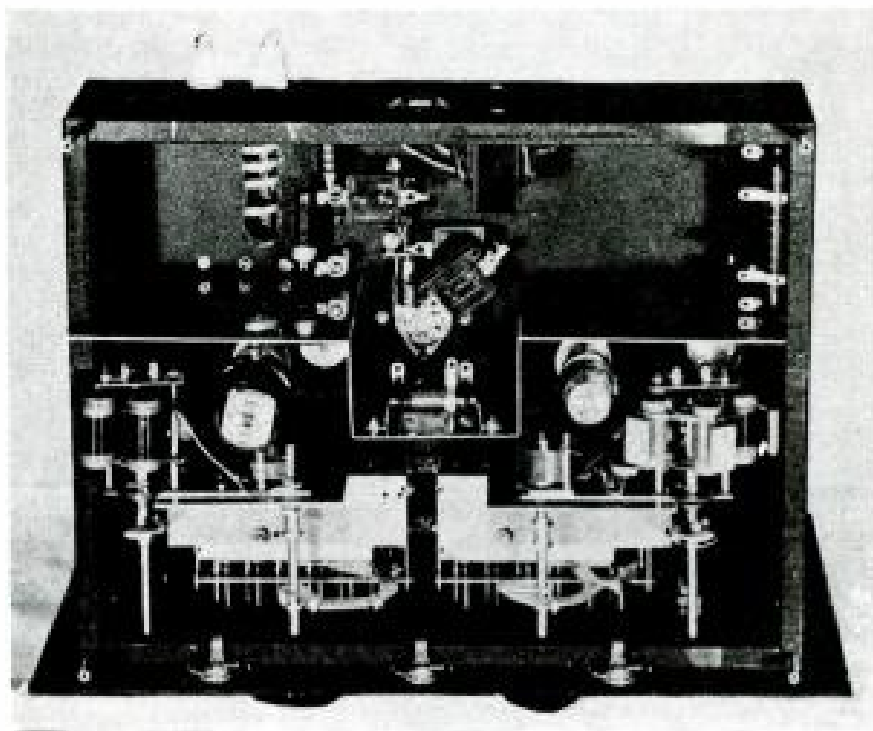

frequency meter-monitor is a legal necessity and it will be found a mighty handy gadget for pre-setting the PBT.

### Mechanical Information

Applying the push-button tuners to a normal layout was not found to be as simple as hoped.

Although considerable extra space is apparent in the photographs, the upper right-hand corner of the set is reserved for the separate power supply for the ECO, desirable for highest stability.

A standard 12" x 19" x 1/8" steel panel and 13" x 17" x 4" chassis were used.

Looking at the bottom view, the turret found on the right is the grid circuit of the ECO, and another is shown at the left with the T-21 close beside it. While a number of preferable layouts may occur to the reader, it was found that no ideal layout could be arrived at for mechanical reasons. Therefore compromises were made, such as placing the ECO, tube (T-21) beside the plate circuit instead of midway between the plate and grid circuits, as would appear more logical.

In constructing such a device the reader can drop the socket for the 807 half an inch toward the rear and make it possible to place the T-21 centrally between the two coils.

Another improvement in mechanical layout would be to move the Xtal stage (if used) from its present location beside the coil (ECO) grid turret) to the left front corner, looking at the bottom view. The top

view indicates the space available between the drive shaft of the turret and the edge of the chassis. The Xtal tube can "come out of the cellar" and stand in the corner, out of the way, as also can the socket for the Xtal holder.

### Shielding Considerations

Shielding between the plate and grid circuits of the ECO was unnecessary, due to the wide space between turrets. The shielding between the ECO and the injection side of the 807 was a precaution which probably could be eliminated due to the layout, the 807 plate tank being entirely on the top deck. Here again the push-button tuners make for some awkwardness in the layout. The connection from the plate cap of the 807, running to the stator of the variable condenser, and to the front coil switch terminal of the turret, adds appreciable inductance to the tank circuit at 10 meters.

Hardly visible in the bottom or top view is the condenser which couples the output of the ECO to the grid circuit of the 807. It is mounted on two posts, in the corner between the T-21 and the first bend of the shielding wall. A small hole was drilled in the shield wall, grommited for insulation, for the lead from the stator of this coupling condenser to the grid of the 807.

Three .006 mfd. bypass condensers for screen, cathode and grid return are stacked beside the 807 socket and, with the center tap of the filament transformer, are grounded to the chassis. The aluminum shield was used as a common ground point for the ECO or alternate Xtal oscillator circuits

with no apparent ill effects and is useful as a ground bus.

### An Unconventional Panel

At rear center of the back side of the chassis a 5-prong socket carries the 110-volt a.c., the B negative and two B plus terminals. The two porcelain feed-through insulators bring out the link terminals which would connect the exciter to any final up to the 200 or more watts that the exciter's 35-watt output will readily drive.



FIG. 4.  
Front panel view. Note the three sections of buttons.

The achievement of anything comparable to a conventional-appearing front panel was given up in the beginning as hopeless, but, as the front view indicates, aside from being shoved slightly left, the general appearance is fairly well balanced.

So far, the market does not appear to offer

a 270° dial plate divided to 5 points. You can get a 10-point 270°, and use every other one. The writer suggests proper designations be engraved on the panel for these two switch controls, lacking proper commercial dials.

At the left the 5-point switch connects in the various coils of the turret used for the ECO grid circuit. The 5-position switch on the right side is the coil selector for the ECO plate circuit. Above is an "off-on" switch for later use when the ECO power supply is built in. It is not used at present. The toggle at the left selects Xtal or ECO control at will. The two knob and pointer lower control dials are the manual controls for the ECO grid and plate circuits. Their corresponding push button groups are directly above them.

### Locations on Panel

Higher up the push-button group for the 807 plate tank is seen, while just above the buttons is located the manual control knob and dial associated with them. To the right is a 3-position switch control indicator. Again we find no commercial dial plate that serves the bill. The 3-positions of the turret tuner switch control are not as shown but span 270 degrees. These points may also be panel engraved as "10 M," "20 M," "80 M."

Along the lower edge of front panel are located respectively, from left to right, the closed circuit jacks for oscillator plate current, 807 first buffer grid and 807 first buffer plate current.

## Voice Alone Powers New Industrial 'Phone

A portable telephone which gets its power solely from the speaker's voice and requires no external source of power was announced by the Western Electric Company. The new instrument will, with an efficient telephone line, transmit speech over distances in excess of 200 miles.

The "magnetic" telephone, as the device is known, was designed by Bell Telephone Laboratories primarily for use in such places as railroad yards, ships, coal mines, construction camps and similar locations where the need exists for simple, highly reliable and portable communication facilities.

In size and shape the instrument resembles a child's building block and its secret of operation rests in a small though powerful magnet. "Voice currents" are generated when the flux from this magnet is influenced by the motions of a metal diaphragm assembly vibrating under the impact of sound

waves. An identical instrument at the receiving end acts in reverse order to reconvert the voice currents into intelligible speech sounds. Each telephone is fitted with a small hand crank for generating signalling tone. The "called party" hears a shrill, distinctive note, similar to that emitted by a fire siren, which is especially capable of penetrating through noise.

### LONG AND SHORT AERIALS

Sets are often equipped with three wires, two for aerial, one for ground. One of the aerial wires is for a long antenna, the other for a short antenna. For standard broadcasts the long antenna is generally preferable; for short waves, the short antenna. The short aerial always improves selectivity. On broadcasts it may not always provide sufficient volume.

# Car Set May Be Used in Home

B Eliminator Aids Conversion; AC May Run Heaters  
Or Battery May Be Trickle-Charged

By EDWARD LINDBERG

If you wish to use your car radio in the house during the winter, connect a B eliminator to it to reduce the current drain on the A battery. The filaments require only 2 amps, or even less, so the battery can be kept up with only a trickle charger. The heaters could be rewired for AC, but this is a tedious job and if the battery is available it will easily furnish heater current.

The receiver shown is a Majestic 66 and the pack is an AK 53. The socket in the foreground is for the external vibrator shown second from the left. This was used as a temporary replacement for the original defective unit.

It is also interesting to compare the two

types of power. At the left is the 6Y5Y rectifier tube which was removed from its socket and replaced with a 6 prong plug with a lead to the cathode terminal. This wire, shown coming from the receiver at the right front, leads through a dropping resistor of a few thousand ohms to the B+ lead of the pack. The pack's B- is clipped to ground.

The ammeter at rear is a 5-0-5 instrument. It reads about 2 amps. With this arrangement the receiver works even better than in a car. It may be changed back in a jiffy. Of course each receiver will represent a separate problem, but most of them can be adapted to external B power.

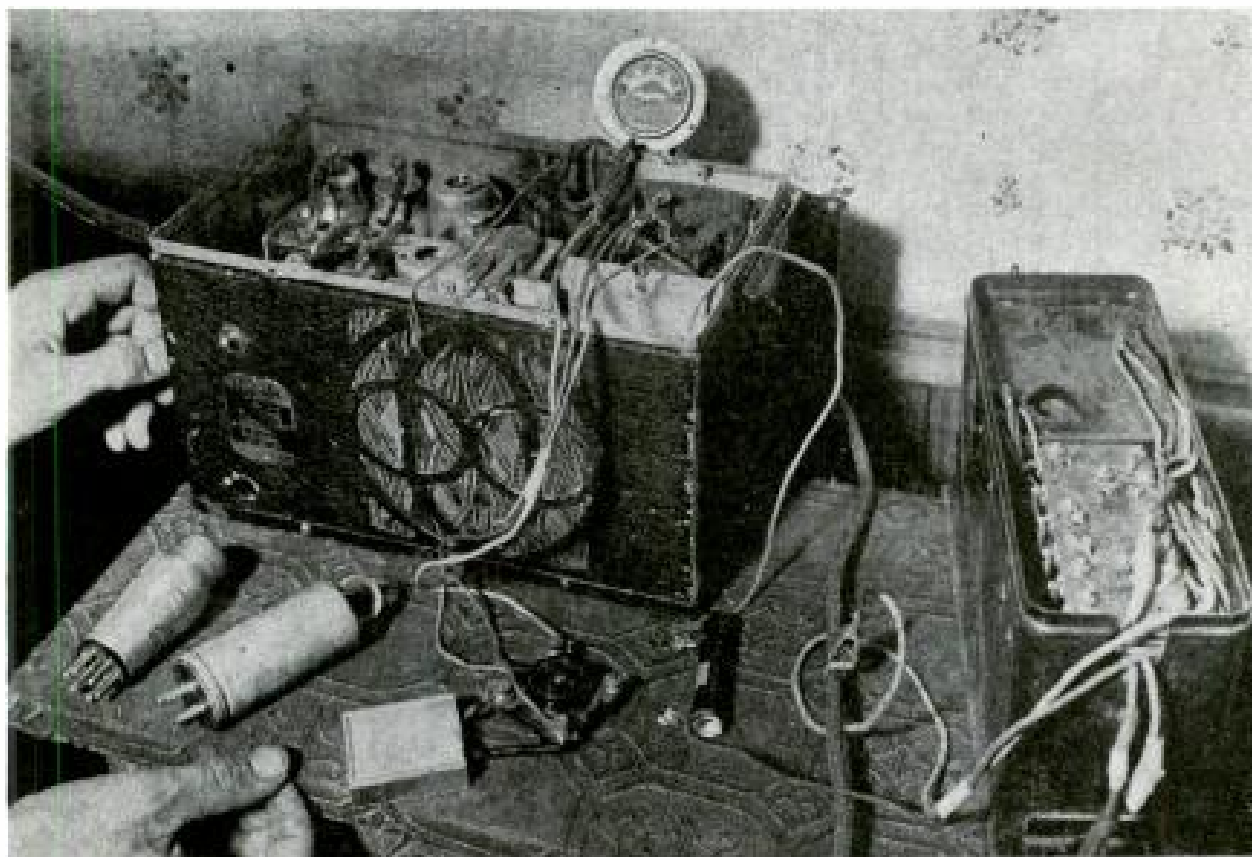

Auto receiver converted to home use by connecting a B eliminator. Rewiring would also permit AC operation of the heaters.

## Blind Flyer Unit Denotes Beacon Underneath

Another "blind flying" instrument, which in effect creates a trail of fixed radio landmarks enabling airplane pilots to check their progress along the airways and to spot airport approaches, and which give the pilot a positive indication when the ship is flying above so-called "beacon" stations, has been announced by the Western Electric Company.

Known as a "marker receiver," the new device operates in conjunction with recently installed radio transmitters of the Civil Aeronautics Authority. These transmitters send out "marker" signals on a frequency of 75 million cycles per second. They are low-power ground transmitters using special antennas which project, directly above each station, either a fan or a cone-shaped signal pattern. Entering the field of this pattern, the marker receiver delivers a characteristic tone, thus enabling the pilot to identify the station over which he is flying.

The receiver is also equipped to operate a set of signal lamps automatically for visual indication. With this arrangement a colored lamp, corresponding with each type of marker transmitter, flashes as the ship passes through the radio pattern. Fan markers are used as radio landmarks along airways between beacon stations and also as aids to instrument landing in the form of approach signals in the vicinity of airports. The cone marker transmitters are used at the sites of present low frequency radio range beacon stations to replace the "cone-of-silence" and thereby give a positive indication when the airplane is directly above.

## Shield Inside a Shield Improves Isolation

It has been found that the thick iron or permalloy boxes which have been commonly used where very good magnetic shielding was required are not as effective as they might be. A much higher degree of shielding is obtained by the use of several relatively thick shields, one inside the other and separated by an air space.

These multiple shields are better because they absorb more lines of force.

### Whaddya Mean, "Don't Miss"?

RADIO WORLD prints a lot of valuable information for the serviceman and I don't miss any of the issues.

W. J. WIRTEL,  
909A Carroll St., St. Louis, Mo.

## READERS' OWN FORUM

### Transformer Cushion Stops Hum

EDITOR, RADIO WORLD:

I have a 6-tube super, which I built from a kit. From the beginning the set had quite a bad AC hum. As the only power filtering was the speaker field and two 8 mfd. electrolytics, I added a 30-henry choke and another condenser and was rewarded by—exactly the same hum as before.

In handling the controls quite a strong noticeable mechanical vibration was apparent and I came to the conclusion that it was settling up a microphonic disturbance between the tube elements. The tuning condenser was mounted on live rubber and as no vibration could be detected when touching the condenser knob, it was assumed that the hum in the speaker did not come through the tuning condenser.

As there seemed to be no doubt that the power transformer vibration was the real source of the trouble, I raised it slightly above the chassis and mounted it on live rubber cushions, which did the trick. The set now is nearly as hum free as a battery set.

D. M. DUNSMORE  
Estate Consuelo,  
San Pedro Macoris,  
Dominican Republic,

## New Needle Developed for Coin Phonographs

A new needle especially developed for coin phonographs, has been announced by RCA Victor. It was designed to assure longer record life, higher fidelity performance, lower surface noise and longer needle life.

The new needle is manufactured with a special welding process which gives it extra strength where the special-alloy shank joins the tip. The necessity for a point that would withstand the shock of impact when the needle first hits the record and, in turn, wear the record less, led to the selection of a precious metal for use in making the tip. In addition, the angle of the tip is projected to give maximum strength and minimum wear.

The shank has been impressed with a prominent "V" to identify the needle, which is individually packed on cellophane wrapped cards.

# LINE-VOLTAGE REGULATOR

Transformer, Switch and Rheostat Main Parts

By WILLIAM NAKEN

MANY servicemen and experimenters have wished that either their line voltage would not fluctuate, or, as the next best solution, an inexpensive device to regulate the line voltage. Frequently the need

across the primary winding. (Lenz's Law). We can use this fact to regulate the voltage applied to a tube tester.

Since the secondary voltage is out of phase it will either add to or subtract from

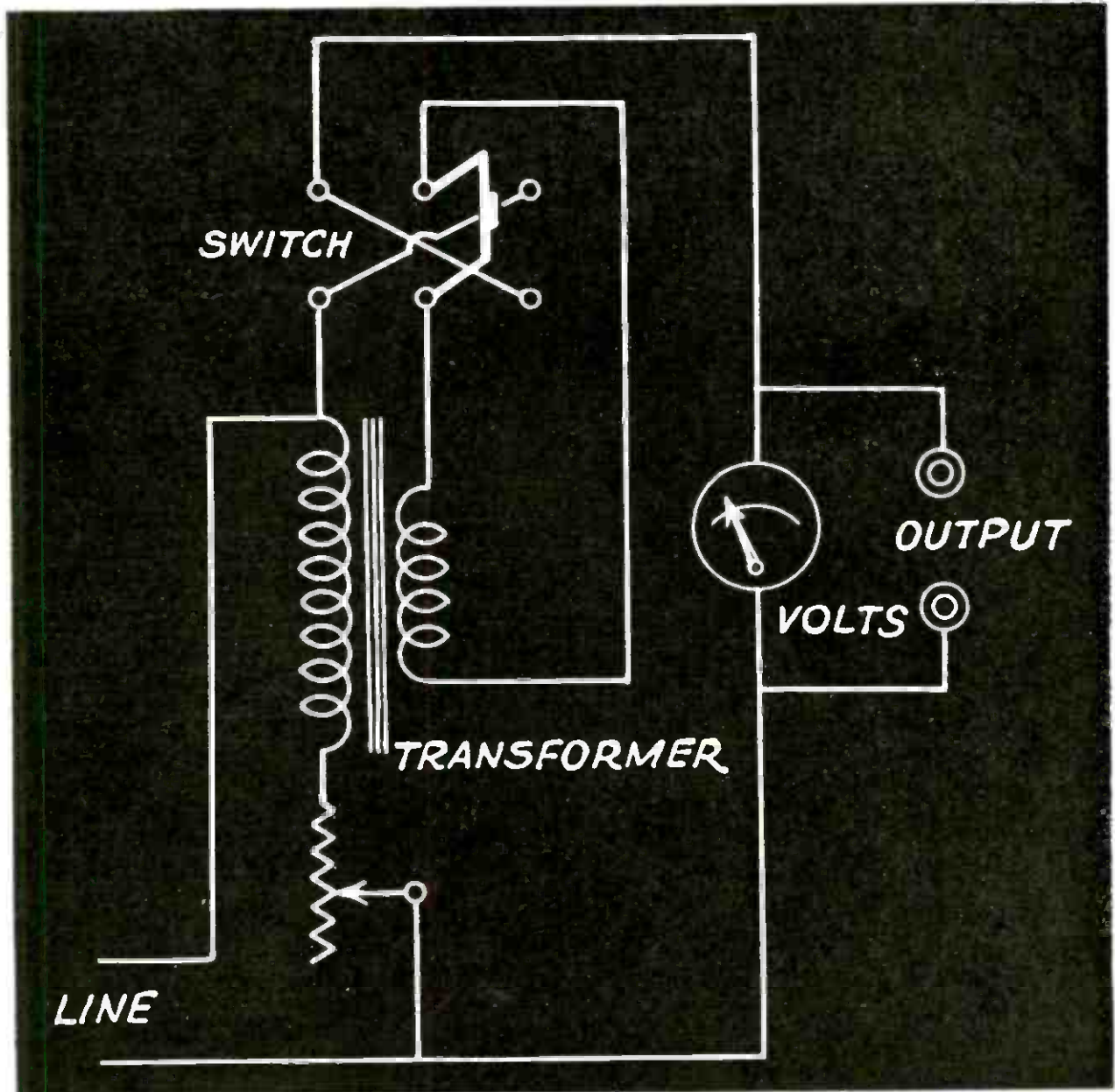

Method of utilizing a transformer as a voltage-regulating device.

of such a regulator is felt when using test equipment calibrated for a particular line voltage.

One of the fundamental laws of electricity may be employed to solve the problem. In a transformer the voltage across the secondary is exactly out of phase with the voltage

the voltage across the primary winding, depending upon series aiding or series opposing connection.

We connect the transformer into the circuit as shown in the diagram, to a double-pole, double-throw switch, to place the secondary either aiding or opposing the

primary, thereby raising or lowering the voltage across the combination. A variable resistance (R) is placed in series with the AC line and the transformer, to provide fine adjustment of the voltage. An AC voltmeter is connected across the output, which is connected to an outlet.

It is necessary that the voltage of the secondary be equal to or greater than the departure from normal line voltage. Thus if the voltage of the secondary were 25 volts (an old tube-testing transformer) the device would regulate the line voltage from 25 volts under to 25 volts above normal. Let us say the normal voltage is 110 volts. The device would take care of fluctuations from 135 volts to 85 volts.

### How It Works Out

An old transformer having several filament windings may be connected in series or three 5-volt windings would total 15 volts.

It should be understood that when connecting together the three 5-volt windings on the same transformer that the voltage will be measured first to ascertain that the three windings are connected series aiding (total voltage 15 volt) and not opposing (total voltage less than 15, possible 10.)

The variable resistance (R), used for fine adjustment, may be any make of variable resistance that is wire-wound and does not heat too much while working. The value should be approximately 1,000 ohms.

If the line voltage is 100 volts and a 15-volt secondary is used, the voltage across the combination (primary and secondary) would be 115, or 5 volts too high for a normal of 110. In this case resistance is added to the circuit by the variable resistance until the voltage decreases to 110 volts. In this case the primary and secondary are connected series aiding.

### Not for Large Power

In the case where the line voltage is 120 volts, which is 10 volts above 110, the primary and secondary would be connected series opposing and the resultant voltage would be 120 volts less 15 volts, or 105 volts, which is below the value of 110.

Increasing the value of the variable resistance (R) has the effect of lowering the voltage across the secondary, which increases the voltage across the combination. Thus resistance is added until the voltage across the combination equals 110 volts.

The device will work only on AC and the voltmeter may be a 0-150-volt AC meter. The 110-volt position may be marked on the

scale of the voltmeter by a heavy black line. Thus one can tell at a glance whether the line voltage is normal.

The device may be incorporated into the design of test equipment, or it may be constructed as an accessory.

The device is not intended for use with a receiver or large transmitters which use a high wattage. It is essentially a low-wattage device.

To find which is series-aiding and which is series-opposing position of the switch, note the reading of the voltmeter with the series resistance set at no resistance. The position of the switch resulting in the high deflection of the voltmeter is series aiding, while a low reading indicates series-opposing.

### LIST OF PARTS

- One Transformer, having secondary voltage of approximately 20 volts.
- One AC voltmeter, 0-150 volts.
- One wire-wound rheostat (R), about 1,000 ohms.
- One double-pole, double throw switch.
- One outlet.
- One panel (if constructed as a separate unit).

### THANKS

I consider your publication the best obtainable and would accept no substitute.

HERBERT CHEESMAN,  
Freeland, Pa.

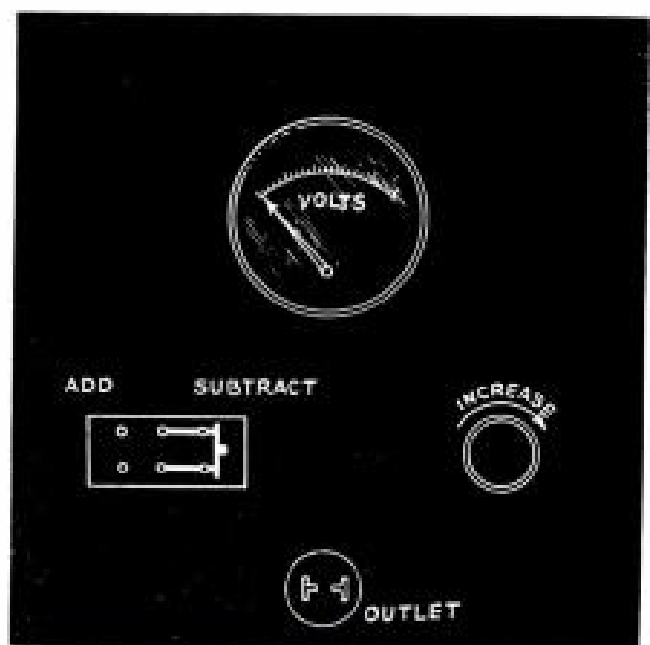

The arrangements of the parts on a panel, for utilizing the voltage regulator.

# ANSWERS

## Millivolt Drop Explained

**W**HAT is the millivolt drop across a meter and how is it computed? Has it any significance on measurements made?—I. F. B.

The millivolt drop is simply a statement of the total potential across the meter, usually across only the resistance of the magnet coil, when full-scale deflection current is flowing, and is computed the same way as any other voltage from the known current and resistance, i.e., voltage in volts equals current in the amperes multiplied by resistance in ohms. In meters used in servicing and experimental work, the current is in microamperes usually, and the resistance may run from 27 ohms to 100 ohms for a 0-1 milliammeter, and higher for meters of higher sensitivity, because more turns and finer wire are used. Thus the voltage drop is always less than one volt and is conveniently expressed in thousandths of a volt, e.g., millivolts. For a meter of 100 ohms resistance and current of one milliampere the full drop is 100 millivolts or one-tenth volt. The millivolt drop is significant in determining the limiting resistor for low voltage ranges (see Mr. Hayden's article in this issue). In current measurements small drop is desired, so that the circuit current is not reduced appreciably when the meter is introduced. If the millivolt drop corresponds to a voltage scale on the meter face, small fractions of a volt may be read directly, which is useful in special applications.

\* \* \*

## Voltage Specifications in Manuals

**M**OST of the manuals state what the voltage readings on DC should be for commercial receivers, when the meter used has a sensitivity of 1,000 ohms per volt. As I have an instrument that has a sensitivity of 20,000 ohms per volt, how may these two conflicting factors be made to correspond?—I. O.

Where low resistance circuits are being measured, such as the potential difference across a few hundred ohms or so, where normally considerable current is flowing compared to full-scale meter current, no distinction need be made, as the readings will be approximately the same on the two instruments. When measurement is attempted across high-resistance circuits, then the higher sensitivity instrument will read

higher voltages than the specification on the basis of 1,000-ohms-per-volt measurement. With the resistance in the measured circuit known, and the meter resistance known normally (the multiplier resistance) what the reading should be for the higher sensitivity instrument can be computed, but of course this is no quick solution. The set manufacturers should give voltage specifications for both types of instruments, and the manual publishers will then use reprint the same data. Also, manual publishers could make the computations mentioned above, and insert the data.

\* \* \*

## Voice Coil Output Measurement

**I**S it practical to connect the output meter across the voice coil, instead of from plate to ground?—K. D.

Yes, if the output meter has a low-voltage scale. Usually it hasn't, unless it is a special output meter. Not more than 3 volts full-scale deflection would be justifiable. The range normally on test instruments for output measurement, plate to ground, is 15 volts. If you want to convert such an instrument to voice-coil measurements, much less than 3 volts full scale can be attained by connecting an output transformer backwards, so to speak, with low resistance winding to the voice coil and higher resistance winding to the input jacks of the analyzer or other meter, on the lowest AC voltage range.

\* \* \*

## Tube Voltmeter Sensitivity

**I**S it vital that a vacuum-tube voltmeter should draw no current whatever, or would a small current be permissible?—W. C.

It is not vital that current draw should be absolutely zero. On DC it may be made zero in practice by the slideback method. On AC, when frequencies become high, nominal zero draw becomes less than a fact, because of the loading effect by the input capacity of the instrument. A small draw is permissible. For instance, an input resistance of 5 meg. would be satisfactory for most purposes.

\* \* \*

## Accuracy of Bridge

**I**S the accuracy constant on a bridge? I have been told that the resistance depends on the current flowing through it.—W. S.

Usually the accuracy is not constant, on  
(Continued on following page)

## Electronic Chair Preserves Human Life

A machine called Electronic Bi-Normalizer, when plugged into an electric appliance socket and connected to ground will develop radio frequencies necessary to kill germs.

Its operation is painless to the patient. All matter, whether organic or inorganic, vegetable or animal, generates radio frequencies which are constant and measurable. Germ life, when placed in the field of a radio frequency of the same magnitude as it produces itself, is quickly killed. This fact makes it possible to treat a number of diseases with the same machine because the frequency not needed will have no effect on the patient. There is another type machine which can be adjusted to produce any frequency desired. With these two machines diseases common to man and beast can be treated successfully.

For detection of disease, a very delicate instrument has been developed which is in reality a radio receiver, constructed so that reception is effected through touch rather than sound. As the electronic physician tunes in his patient with the usual radio dials, he also obtains data on disease with which the patient may be afflicted.

Before using one of these machines, the patient is given a complete electronic analysis.

Treatment is accomplished generally by the patient sitting on a chair, with the back to the machine. Treatment is continued for from three to five minutes, two or three times a day. In this length of time there will be destroyed in the system as many germs as the eliminating faculties of the patient can handle.

### NEW BOOKS

#### The Radio Manual

(D. Van Nostrand Co., Inc., 250 Fourth Ave., New York, N. Y. \$6.)

A new and completely revised edition of this popular manual by George E. Sterling, is now off the press. It represents an up-to-date and complete compendium on the radio field. It aims to give expert information on all phases of the subject, including facts needed to learn the fundamentals, to obtain licenses, to pass examinations for Government and commercial positions; also how to apply the newest methods and instruments.

The author is Assistant Chief, Field Section, Engineering Department of the Fed-

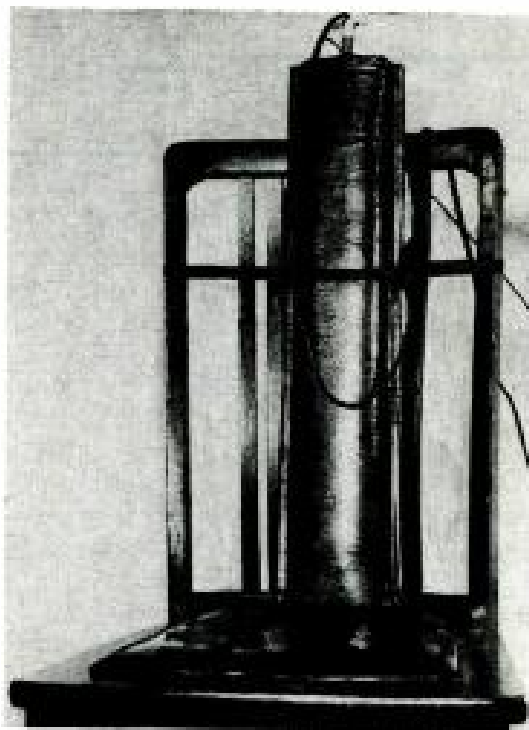

A patient sitting in the chair is subjected to high-frequency radio waves as an aid to treatment of disease.

eral Communications Commission. He has had a total of 29 years direct association with radio, including 15 years in radio law enforcement with the Federal Government.

\* \* \*

#### The Radio Amateur's Handbook

(American Radio Relay League, W. Hartford, Conn., \$1 in U. S. A.)

The sixteenth edition of the Radio Amateur's Handbook, like its predecessors, is voluminous and complete, containing 560 pages with illustrations, charts, equations and formulas.

Included are a new approach to the subject of fundamentals, chapters on receivers, transmitters and radiotelephony, a wider treatment of antenna systems, and also reviews of new construction material.

The new edition is dedicated to the late Ross A. Hull, for ten years editor of the volume, who was accidentally electrocuted while experimenting with a method of insuring safety to life, despite the high voltages, in using television apparatus.

(Continued from preceding page)

account of multipliers, but it is very high at worst. The instrument maker discloses the percentage accuracy, also usually the limits within specified lesser accuracies obtain. As for the resistance actually being different when measured on a bridge than on some other circuit, this has nothing to do directly with the instruments, but refers rather to the temperature coefficient.



## T-R-F Sets Used for Sound and Vision

(Continued from page 19)

Picture signal storage is accomplished by Scophony in their receiver by using a special supersonic light control, so that a series of picture elements is projected simultaneously. Scophony continues:

"Scophony were the first to tackle seriously the possibilities of *optical scanning* for modern television. It has been found that the early difficulties were not inherent in the principle, but only in the orthodox components, such as the scanners and the light relays available at the time.

"*Novel optical principles* were evolved in the Scophony laboratories which resulted in simpler and smaller apparatus with a higher optical aperture than before."

### Uses T-R-F Sets

Moreover, Scophony goes the whole way in opposing the leading American approaches to solution of the television problem. Where American firms use the superheterodyne circuit, Scophony uses tuned-radio-frequency sets, one for sound, one for vision. Scophony also has a pickup and transmitting system, for direct and movie-film application.

### Table Vision Set Appears

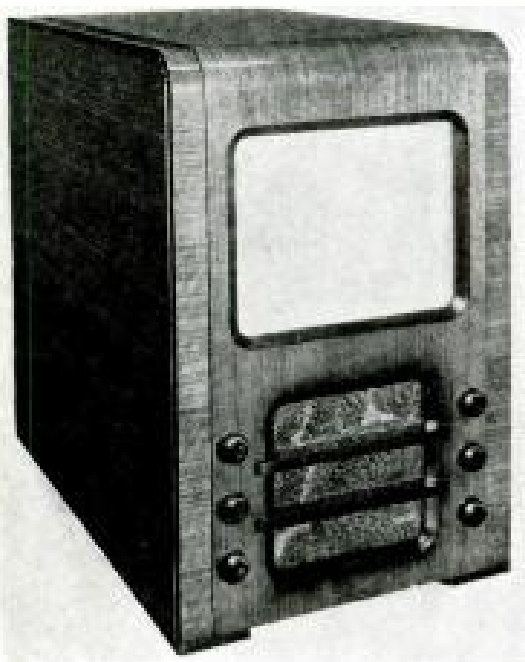

Table model television receiver, made by Dumont, is the first electronic type offered to the American public.

## LITERATURE WANTED

Readers desiring to receive literature on radio parts, accessories, test equipment, transmitters and receivers may send in names and addresses for publication in this column. Address Trade Editor, Radio World, 145 West 45th Street, New York, N. Y.

L. D. Pfeiffer, 126 Irving Ave., Brooklyn, N. Y.  
Gordon Weeks, Weeks Radio Serv., Brooksville, Fla.  
W8RYK, P. O. Box 546, Alliance, Ohio.  
Wesley Murray, Fredericton, Prince Edward Island.  
J. S. Jackson, Jr., Rd. 3, Box 76, Bowling Green, Ky.  
Bob Thompson, 146 W. Main, Shelby, Ohio.  
Wm. O'Shaughnessy, c/o Radiograph Co., 330 W. 47th St., New York City.  
Harry T. Keene, 1128½ So. Gage Ave., Los Angeles, Calif.  
Stanley Gaciach, 721 Tracy St., Utica, N. Y.  
B. V. Swami, 5, Sirsi Road, Chamarajpt, Bangalore City, India.  
Donnelly Radio Repair Shop, 345 Willard St., Berlin, N. H.  
Powell Radio, 745 47th Ave., San Francisco, Calif.  
Richard Houghton, Quoddy Village, Eastport, Maine.  
William Jones, 27 Park Ave., Greer, S. C.  
H. F. Zane, Box 212, Farmington, Iowa.  
M. J. Bauer, 600 W. 175th St., New York City.  
W. C. De Long, Sergeant Bluff, Iowa.  
Allen's Radio Service, Arbyrd, Mo.  
Nathan Williams, 1144 Calumet Ave., Calumet, Mich.  
Raymond Foltz, 99 Lenox St., Uniontown, Penn.  
O. K. Radio Service, 2235 N. 39th St., Milwaukee, Wisc.  
Frank's Radio Service, 1814 W. 18th St., Chicago, Ill.  
Kon's Radio Service, Forest Grove, Ore.  
G. Vallis, 406 Park Place, Brooklyn, N. Y.  
Aaron Baumgarten, 335 Chester St., Brooklyn, N. Y.  
Walter Romberg, 90 West Broadway, New York City.  
L. Tamcred, 490 E. 181st St., Bronx, New York City.  
H. E. Clark, Clark's Radio Service, 930 South Main Ave., Scranton, Penn.  
Campbell Radio Specialties, 2781-6 Packard Rd., Ann Arbor, Mich.  
John Zsembik, Jr., 1574 Lakewood Ave., Lakewood, Ohio.  
Mike Philip, Perryopolis, Penn.  
Fred N. Ayer, 84 Wenham St., Jamaica Plain, Mass.  
Philip C. Hopkins, Medina, Ohio.  
Floyd Brackee, R. 2, Box 42, Clayton, Wisc.  
E. C. Malton, 406 Park Pl., Brooklyn, N. Y.

### Covered Cylinders Give Better Shielding

It is possible to attain a magnetic shielding efficiency of nearly 100 db over a range of 50 to 5,000 cycles, by the use of three concentric permalloy tubings with copper cylinders placed between them. The cylinders should have top and bottom covers for maximum effectiveness. The copper, while not much value for magnetic shielding at low frequencies, becomes increasingly effective as the frequency rises and serves to maintain the same high shielding efficiency that the permalloy provides at the lower frequencies.

### So Say Many

RADIO WORLD is a fine magazine. It presents some of the best servicing theory and instrument construction in print.

ROY E. PETERSON,  
3933 North Oak Park Ave., Chicago, Ill.

# OSCILLATORS SEEN FROM THE INSIDE

By MARTIN POSNER

**I**N attempting to extend the frequency range to be covered by an all-wave oscillator, or to increase the frequency ratio of any given band in the range while maintaining a stable and uniform output, it is not unusual to encounter a variety of peculiar and unexpected effects which must be disposed of before further progress is possible. These effects are generally undesirable, and appear to be endowed with a most obstinate persistence. They are at first difficult to explain, and they have the property of being able to in-

duce apoplectic effects in the designer, which, however, are very much less difficult to understand.

duce apoplectic effects in the designer, which, however, are very much less difficult to understand. We can exemplify this point by discussing a few of the various aspects of one oscillator circuit as exhibited in the drawings and redrawings herewith.

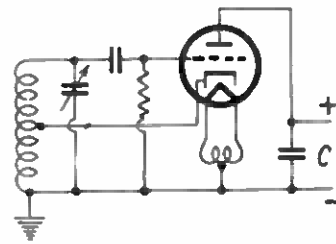

Fig. 1.

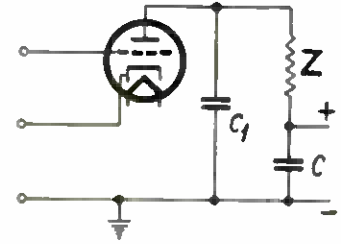

Fig. 2.

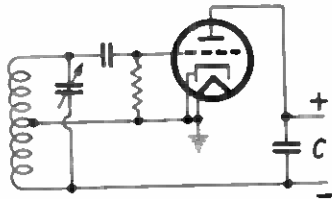

Fig. 3A.

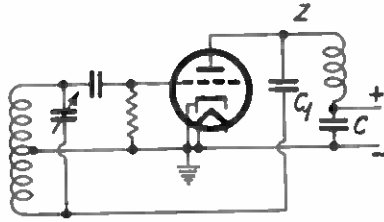

Fig. 3B.

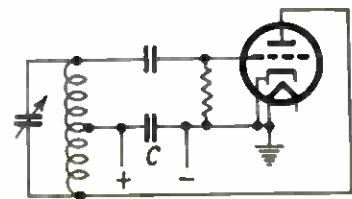
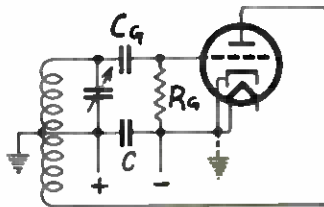
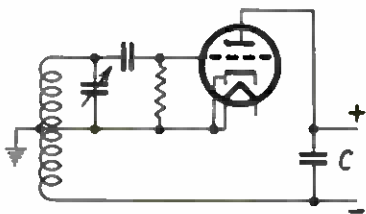

Fig. 3C.

duce apoplectic effects in the designer, which, however, are very much less difficult to understand.

These skulking effects (the electrical ones) are due to latent characteristics of the circuit and the components involved, and they only come to the fore when the frequency and the circuit constants are favorable. It thus becomes necessary to consider closely many more or less obscure aspects of the circuit in hand that are not always obvious from a customary inspection of the

In Fig. 1 we have a modified Hartley oscillator, with series plate feed so arranged that both the plate and the tuning condenser are at ground RF potential. At high frequencies it is sometimes necessary to improve the RF groundings of the plate, as well as the RF isolation of the plate from the power supply, by a separate RF filter impedance  $Z$  (which may be RF choke or a resistor), aided by the condenser  $C_1$  (Fig. *(Continued on page 56)*)



Figs. 4 and 5.

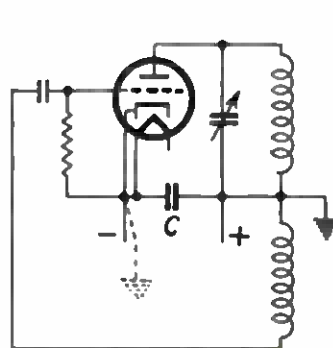
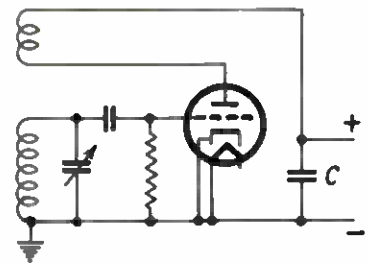

Figs. 6 and 7.

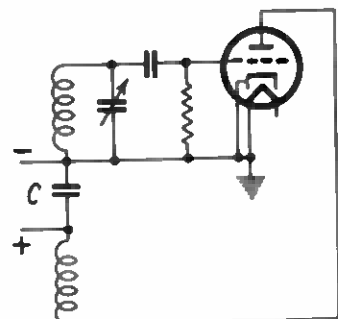

Figs. 8 and 9.

# A ONE-TUBER FOR LEARNING

Regenerative Set Permits Many Experiments

By M. N. BEITMAN

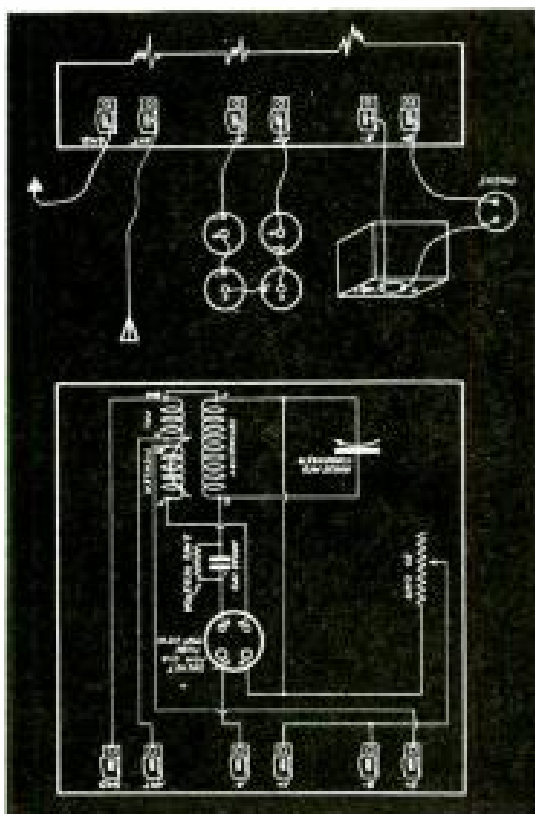

Circuit and terminal strip for experimental regenerator.

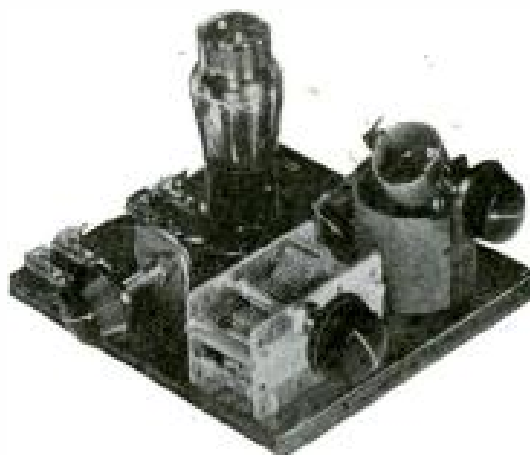

The built-up device, with the three controls handily placed.

## Fundamental Facts on Theory and Construction Made Obvious to Beginners

THE experimenter's one-tube kit will help radio beginners and students to acquire the needed fundamentals in radio construction, theory, and trouble shooting. Essentially a regenerative receiver, this set permits numerous instructive tests to be performed with the aid of a 0-15 milliammeter and 0-25 DC voltmeter.

The parts are mounted on a 7x7" ply-wood board. The layout of parts as shown in the illustration should be followed. Regular No. 18 hook-up wire is used for all external connections and for wiring the set. A type 01-A battery-operated triode is used. After the parts are correctly mounted and the tube

is placed into the socket, you are ready to start.

The 22½-volt battery is marked plus, —3, —4½, —16½ and —22½ volts. Connect one terminal of the voltmeter to the plus connection and the other to —3. A 3-volt reading should be obtained. If the needle moves backwards, the meter is connected in reverse and the connection should be changed. Follow through and measure the other voltages.

### Rheostat Adjustment

Each of the dry cells has 1½ volts. The center connection is positive and the outside connection to the zinc can is negative. In order to obtain six volts, the four cells are connected in series as shown in the diagram. The voltage of individual batteries should be measured, as well as the voltage of the four cells after the connections are made. These cells serve as the A battery.

Examine the schematic diagram and learn to recognize the symbols used. The layout of the schematic diagram follows the photograph view. The first wires should be connected from A— to one F connection of the tube socket. The other F connection of the socket should be connected to the stationary element lug of the rheostat. The moving arm lug of the rheostat is connected to the other F (filament) prong of the socket. The A battery is now connected according to the markings on the Fahnestock clips. The

*(Continued on page 55)*

# Selectivity in Steps

## Marks Crystal Filter, Useful for Broadcasts, Too

ANY receiver intended for short-wave use, whether for commercial, amateur or program listening, requires a crystal filter to make it complete. However, the

The selectivity curves for the receiver remain unchanged regardless of the position of the phasing control. There is no interlocking. Also, the output of the crystal

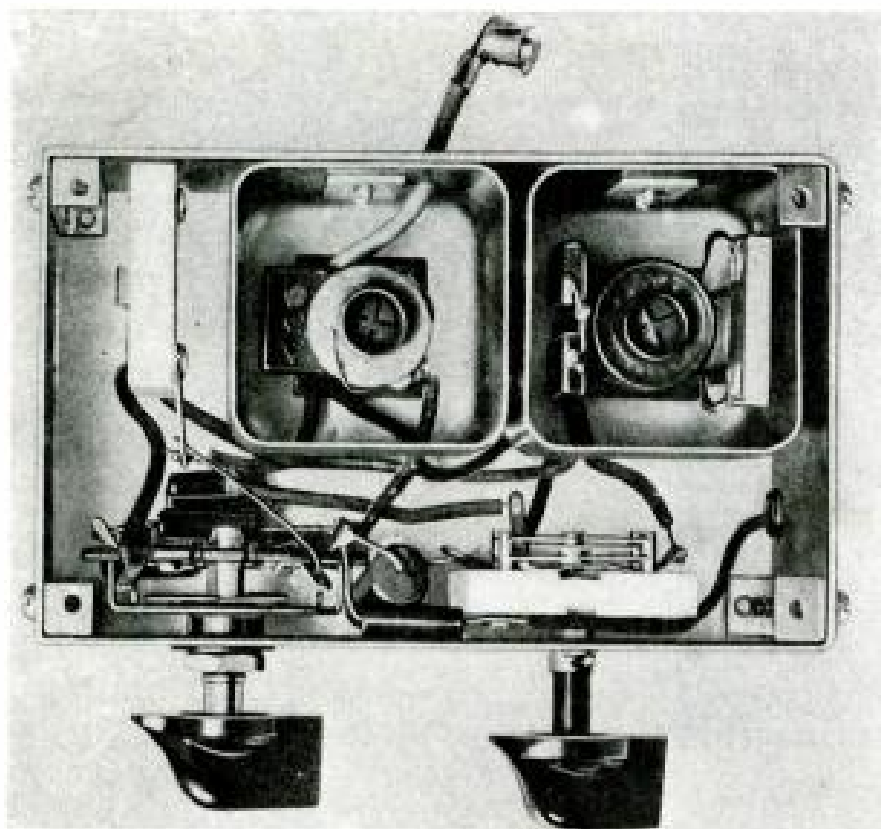

Top view of the crystal filter in the new Hammarlund communications receiver.

conventional crystal filter, while it serves excellently for "single-signal" CW reception, in crowded amateur bands, does not help the short-wave program listener or 'phone man to any great extent.

### Uniform Output

Hammarlund's crystal filter in the new HQ-120-X receiver has a complete range—that is, selectivity is variable from the maximum band width of the receiver to the usual razor-edge selectivity of ordinary crystal filters. The range of this crystal filter is divided into six steps, including the "off" position. The first two or three ranges of the crystal filter are suitable for 'phone use. Position No. 1 permits broad enough band width to admit fair quality musical programs. In other words, the short-wave listener can now enjoy the same benefits of the crystal filter that amateurs have enjoyed. The other positions afford successively sharper selectivity.

filter is relatively uniform over the entire selectivity range. Attenuation is not apparent when switching from the "off" position to any other point. In other words, the crystal has no effect on the output level of the signal.

By using sectionalized tuning condenser units inclusion of the standard broadcast band in no way affects the efficiency of the receiver at higher frequencies because each wave range (and there are six ranges in this receiver) employs the proper size tuning condenser for maximum efficiency. The result is like having a special receiver for each wave range.

Another great problem in designing a communications type short wave receiver is in maintaining accuracy of the signal strength meter throughout the range of the receiver. Hammarlund engineers have treated the RF portion of the receiver in such a manner as to maintain constant gain in all of the amateur bands. This means that it will not re-

quire a stronger signal in the 20-meter band to read "S-9" than is required in the 80-meter band.

### Interference Reduced

Then, too, the constant output level of the crystal filter further maintains the accuracy of the signal strength ("S") meter. This meter is calibrated in units from 1 to 9 and also up to 40 db above "S-9." A very flexible vacuum tube voltmeter circuit is employed with the "S" meter. This circuit has adjustments on the rear of the chassis so that corrections can be made to compensate for various line voltages which definitely would make the meter read in error in ordinary arrangements.

Automobile ignition interference and similar crackling disturbances which usually mar short-wave reception are taken care of in the "HQ-120-X. The noise limiter, provided for the removal of these disturbances, is an automatic device which follows the level of the incoming signal. It has no delicate controls on the panel, being worked simply by an on-off switch. Its use during reception in no way affects the quality of the incoming signal.

*[The above data were supplied by Hammarlund Manufacturing Company, Inc.]*

### TELEVISION SET ATTRACTS CROWDS

With glass-sided case and interior illumination, the DuMont so-called "aquarium" television sets attracted crowds in the metropolitan New York area where they are on display. To acquaint the public with the intricacies of a television receiver, the Allen B. DuMont Laboratories, Inc., of Passaic, N. J., made up several of their standard table-model sight-and-sound receivers with glass sides, back and top, instead of the solid-wood cabinets. The interior of these aquarium sets is illuminated by means of concealed mercury-vapor tube lights, producing a bluish glow from the huge 14-inch cathode-ray tube and the aluminum chassis with closely packed tubes and components.

### SHIP ALMOST NON-MAGNETIC

Construction is reported of an almost non-magnetic ship in England, the Research. Stoves of bronze, aluminum bronze anchors and bathtubs made of teakwood are being used in an effort to make the vessel as free from magnetic influence as possible. The ship will be employed in magnetic survey work and is expected to enter service in the Spring.

## Static-Free Phones for 'Planes on 2.4 M.

Static-free radio telephone transmission between airplane pilots and landing field attendants may soon be a practical reality. Despite thunder-storms and other atmospheric disturbances, flight tests of a new ultra-high frequency apparatus show the system to be substantially impervious to adverse weather.

The system was designed for the Western Electric Company by Bell Telephone Laboratories and has been tested in cooperation with Transcontinental and Western Air, Inc., under actual flying conditions over its New York-Pittsburgh route. Should continuing tests, now being carried forward to explore the new system's behavior on other typical airways verify the initial findings, ultra-high frequency radio telephone at 125,000 kilocycles or 2.4 meters may soon find universal adoption.

The tests gave additional verification to the fact that ultra-high frequency transmission will not carry for any considerable distance beyond the horizon. Like light waves, the signals travel only in straight lines and will not pass around the curvature of the earth.

Although this characteristic represents a real handicap to the general application of such short waves, it is less important to aircraft communication because the airplane's horizon is continuously expanded as it gains altitude. It does mean, however, that for airline operation, a greater number of ground stations will be required along the line of flight than with present lower frequency equipment operating between 3,000 and 6,000 kilocycles. Conclusive tests have not yet been completed in mountainous terrain but fewer transmission points will likely be required in these areas as advantage can be taken of high peaks and the greater elevations on mountain ridges for equipment installation points.

### Thank You, Professor

I consider RADIO WORLD the best technical review of its kind. The technical parts of radio engineering is profusely and skillfully developed. Each diagram presented offers a real improvement. The ambitious serviceman whose ideal lies beyond repairing a few sets has ample harvest to gather in.

GASTON MICHEL

*Member, R. T. A. of Chicago.  
Member, Lincoln Engineering School,  
Professor of Sciences at Lyceum, Jacmel, Haiti.*



# The Trade Parade

---

E. H. Vogel, manager of the radio division of the General Electric Company, Schenectady, N. Y., is studying television facilities, developments, and experience abroad, particularly in England, France and Germany. He will discuss commercial television experience and plans with various European agencies and G-E affiliated companies.

"We want to know how British audiences react, for instance, and how television is set up economically, both for transmitting and for receiving equipment, also what are its effects on radio and motion pictures," he said.

Solar Mfg. Corp., of New York City and Bayonne, N. J., appointed J. I. Cornell as Chief Engineer. Mr. Cornell joined Solar as Consulting and Field Engineer a year ago, having previously been Chief Engineer and Director of the Magnovox Company. Prior to that he had been with RCA as section engineer on components, and with General Electric Company. He is a graduate of Worcester Polytechnic Institute.

Arthur Levesque announced that Fred J. Wessner has joined him as a partner in the ownership of Radio Service Laboratory of New Hampshire. The continued growth and expansion of the organization—which now operates branches in Manchester, N. H., Portland and Bangor, Me., and Barre, Vt.—has made it one of the largest firms of its kind in New England.

Frederick R. Lack, formerly director of vacuum tube development at Bell Telephone Laboratories, was appointed General Commercial Engineer of the Western Electric Company. He will have charge of the sale, through the company's distributors, of Western Electric products outside of the Bell System, including the by-products of telephone research such as broadcasting equipment; aviation, police and marine radio; public address systems; hearing aids; train dispatching systems, etc.

A new name with an old background has been added to the radio schools in New York.

The New York Wireless School of New York and the American Radio Institute of Chicago have been merged under the latter's name and have established headquarters at 1123 Broadway, New York City.

The school is under the guidance of John G. Hart, who, during his connection with the New York Wireless School, was responsible for the swelling of the amateur ranks by hundreds of individuals. In the New York area alone, Mr. Hart has put a great number of doctors, lawyers, CPA's, housewives, etc. on the air, all this, as one of his students expressed it "through friendly, competent and thorough instruction in the field of radio."

Catalog No. 165A has been released by the Cornell-Dubilier Electric Corporation. This catalog consolidates the capacitor listings and descriptions appearing in Catalog No. 161.

Consisting of twelve pages, this flyer is complete with concise information on all the popular items in the entire C-D line. Ideal as a quick reference for required capacitors, for servicemen and engineers. Copy available free on request at main office of plant at South Plainfield, N. J.

The 1939 Radolek Profit Guide brings out several thousand new items. All in all, there are 12,000 items for dealers, servicemen, amateurs, institutions and firms interested in radio service work and public address. It contains a large auto radio vibrator section, a P. A. Section, and features electric appliances such as clocks, shavers, and electric fences. The Radolek Company, 601 West Randolph Street, Chicago, sends the Guide on request.

The Supreme Instruments Corporation announced the promotion of E. G. Perkins to Chief Engineer. After receiving his B. S. degree in electrical engineering, he entered the field of radio engineering. After several years of radio engineering work, he joined the Supreme Engineering staff three years ago.

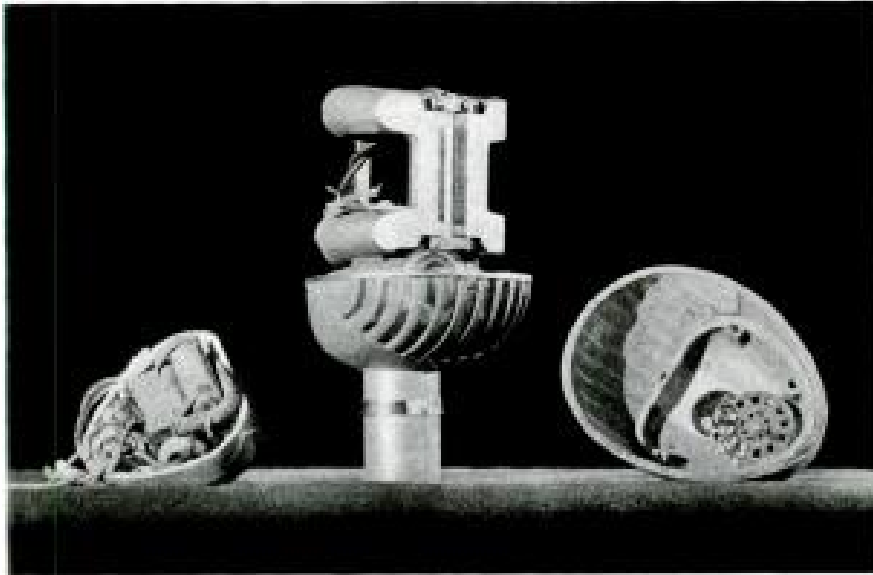

A glimpse inside the 639A cardioid directional microphone, revealing the construction and relative positions of the microphone elements. The case on the left contains the dynamic element, the ribbon transformer and electrical equalizer and fits together with the lower case on the right to form the basic frame for the instrument.

### Cardioid Microphone Solves Many Problems

A new microphone that picks up equally all sounds reaching it from the front but which loses its sensitivity as the source of sound moves to a position behind it has been announced by the Western Electric Company. If a person talking comes closer to the microphone to compensate for this loss in sensitivity, as he walks around from front to back his path will be a heart-shaped curve or cardioid. Because of this unique pickup characteristic, the device is known as a "cardioid directional" microphone.

In the new instrument Bell Telephone Laboratories has found a practical solution to many problems in sound pickup that have long baffled radio engineers. The directional properties are equally good for the lowest bass and the highest overtones. With the cardioid microphone, each group in a symphonic orchestra—brasses, woodwinds, and strings—stands out clearly. In addition to this increased definition, the bass reproduction comes through without "boominess" and the treble is crisp. The new instrument achieves this by giving more prominence to the direct sound and less to reflections for all ranges of the musical scale.

Because of the "dead" zone existing behind the microphone, it may be placed near a wall leaving the center of the studio free for use. Reflections from this wall are suppressed and, because of the wide angle of pick-up in front, vertical as well as horizontal, no tilting of the device is necessary.

### AC Electrolytics by C-D Serve Wide Uses

Cornell-Dubilier Type JDF electrolytic capacitors for motors and other AC applications are hermetically sealed in lock-seamed aluminum containers. They are equipped with a special bakelite terminal block having two dummy screw terminals. Terminals are arranged for convenient wiring to motor, line and thermostat, in refrigerator applications.

The high capacity dry electrolytic AC capacitors are designed for the many AC applications, such as motor starting during the starting cycle of the motor, where high capacity is necessary for intermittent use, and for operation involving a maximum of 20 starts per hour, each start of 3 seconds duration. C-D type JDF electrolytics are recommended for use with fractional horsepower motors of the type used in refrigerators, oil-burners and similar appliances. Catalog No. 160 just off the press describes these capacitors in detail.

An ever increasing trend toward action in advertising by means of commercial motion pictures of products and manufacturing processes has been noted with the pronounced improvement in projectors, according to Drayton E. Church of Advertising Projectors, Inc., 10 West 33rd street, New York. This will be reflected in The World of Tomorrow, a feature planned for the New York World's Fair. The feature, according to Mr. Church, will set a new high for motion picture industrial exhibits.

---

## THE TRADE PARADE

---

The newest radio gadget issued by Alfred A. Ghirardi is his "Radio World-Time Indicator Gadget."

The object of this device is to show at a quick glance the exact time of any radio program or news event in any part of the world. Readings are given for Standard, Daylight Saving, or Greenwich Mean Time. Just a turn of the simple dial and the short-wave listener can tell just when and where to tune in for any foreign or domestic radio program or event. The Gadget also indicates the number of hours difference between any two given cities, and between local time and Greenwich Mean Time. It also contains a complete list of short-wave stations, their locations, call letters and frequencies; International Date Line data; and information about when to send or receive foreign telephone calls or cablegrams.

This new World-Time Indicator is extremely simple in construction and operation, being a compact, pocket-size unit 5 x 7 inches. It is attractively printed in two colors on light yellow stock and is punched for hanging alongside the radio. All readings are perfectly clear; no calculations are necessary. Full instructions are printed on the Gadget.

The publishers are the Radio & Technical Publishing Co., 45 Astor Place, New York, N. Y. An attractive, illustrated mailing piece describing this new Gadget will be mailed free to you upon request. Other Ghirardi Gadgets previously issued are the Home-Radio Trouble Shooter and the Auto-Radio Trouble Shooter Gadgets.



L. L. ADELMAN

Leon L. Adelman, W2AFS, is an old-timer in a amateur radio. During the day, he is Cornell-Dubilier's sales manager. He is a charter member of the Bronx Radio Club, organized early in 1922 and which has met almost without interruption each Friday during the 16 years of its existence. Mr. Adelman was also a distinguished radio magazine contributor and editor.

## 12 Square Blocks Size of New Aerovox Plant

The Aerovox Corporation announces the moving of its plant and general offices to larger quarters at New Bedford, Mass. The group of buildings to be occupied is approximately six city blocks long by two wide, totaling 433,000 square feet or about four times the area of the vacated Brooklyn plant.

It is expected the new plant will be in full operation by February 1st. The moving job is estimated to require 150 loads on 24-foot-long trailer trucks. In addition, much new equipment is being installed.

The New Bedford plant comprises an office building, a large single-story building with saw-toothed skylight roof, a three-story building, and the power plant and scattered buildings.

A training school has been in operation for some time, and just as rapidly as each department is installed, workers are available for production, under the guidance and supervision of key workers and foremen from the former plant.

## "S" Tubes Single-Ended

Four new types of radio receiving tubes which are being used as initial equipment in many new radio instruments have been made available to RCA tube dealers and service men for replacement sales.

All of the types are single-ended metal tubes with interlead shielding. A single-ended tube is one in which all electrodes, including the control grid, terminate at base pins.

One of the new types is the 6SF5, a high-mu Triode tube. Others are the 6SJ7, a triple-grid detector amplifier; the 6SK7, a triple-grid super-control amplifier, and the 6SQ7, a duplex diode high-mu triode type.

## NEW "LITTLE NIPPERS" ANNOUNCED

A series of five new "Little Nipper" miniature radios, housed in attractively-styled moulded plastic and wooden cabinets and providing remarkable performance, has been announced by RCA Manufacturing Co., Inc., Camden, N. J. The new models replace the original "Little Nipper" receivers.



---

## THE TRADE PARADE

---

To provide the fullest protection against extreme heat, humidity, salt air, sulphur fumes and other severe atmospheric conditions in industrial, coastal, marine and tropical locations—and to insure sustained accuracy noise-free performance, trouble-free life in the most exacting applications—Ohmite Manufacturing Company of Chicago has made available a series of hermetically glass sealed precision resistors.

The new Ohmite precision units are non-inductively pie-wound on procelain in 2, 4, 6 or 8 sections and have terminals emerging through vacuum-type glass seals. The rating is 1 watt, accuracy 1% (or closer tolerance when required.) Resistances range from 0.1 ohm to 2 megohms.

---

A Pick-Me-Up portable radio that is completely self-powered and requires no external connections for efficient operation, has been announced by RCA Manufacturing Co., Inc., Camden, N. J.

The instrument employs the newly-developed low-drain tubes for long battery life. It has a permanent magnet dynamic loud-speaker. Its powerful superheterodyne circuit utilizes magnetic core coils to insure permanent alignment of the radio circuits, regardless of weather conditions. A loop antenna has been built into the cabinet, which is also equipped with terminals for connection to external antenna and ground if desired. Its tuning range covers the entire domestic broadcast band.

---

Three new types recently added to the list of IRC precision wire-wound resistors in accuracies up to 1/10 of 1% employ an ingenious method for bringing both terminals out at one end. This method eliminates the problems of shorting and breakage at terminals frequently caused by exposed resistance wire.

The resistance wire is returned internally through the ceramic, yet completely insulated and protected from windings or mounting bolts. End leads of the resistance wire are not exposed. The new method has been adapted for all three of the new designs, Types WW-12, WW-13 and WW-14.

---

A handy and positive means of testing resistor tubes and line-cord resistors is presented in the Model 160 tester just introduced by Clarostat Mfg. Co., Inc., 285-7 N. Sixth St., Brooklyn, N. Y. Enclosed in a

sturdy steel case, the tester has an attractive panel carrying the meter or indicator, the prong-selector switch, an octal socket and a UX socket, for testing resistor tubes with any type of base. There is also an AC outlet receptacle for plugging in a resistor line cord, as well as a pin jack for testing the different cord leads.

The selector switch has eight positions lettered from A to H, permitting the meter to be cut in on any prong of a resistor tube being tested. The power cord of the tester plugs into the nearest outlet. The meter indicates whether the tube or cord is good or bad. Physical dimensions are  $5\frac{3}{4}$  x  $5\frac{3}{4}$  x 2" high. The steel case is finished in wrinkled gray. A resistor tube characteristic chart is supplied with the instrument.

---

Phonograph records can now be reproduced through any radio set by remote control with the new Knight "Magic Wireless" Record Player. No connections to the radio set are required; the Record Player will function over any distance up to twenty feet from the radio set; and recordings are reproduced with the regular tone ordinarily obtained from the radio receiver.

The Knight "Magic Wireless" Record Player can be used in conjunction with any radio set, no matter what its make or age. For operation, it is necessary only to plug the record player into an electric outlet (110 volts, 60 cycles) to obtain power for operating the phonograph motor; the radio set is then turned on, and the dial adjusted to a neutral point. Then the recording is reproduced through the radio amplifying system and loudspeaker.

---

Ceramic-jacketed, fully-sealed precision non-inductive wirewound resistors in the widest range of resistance values up to 3 megohms, and in  $\frac{1}{2}$ , 1,  $1\frac{1}{2}$ , and 2 watt ratings, are now offered by Clarostat Mfg. Co., Inc., 285-7 North Sixth St., Brooklyn, N. Y.

---

For the safety and convenience of those thousands of yachtsmen who put out to sea in small boats, the Western Electric Company is introducing a low priced, midget marine radio telephone comparable with the familiar telephone ashore.

The instrument links those aboard the craft with the telephone system on land and with other radio-equipped boats.

# Everything in RADIO at LOWEST PRICES!

Sets • Parts • Kits  
P.A. • Ham Gear • Testers  
FREE! 180 Page Catalog

## 1939 KNIGHT SETS at New Low Prices!

See the amazing new 1939 Knight Radios in your ALLIED CATALOG! New features—Push-Button Tuning, "Low-Boy" cabinets, 1½ volt tubes, etc.—at new low prices. 62 models, some as low as \$6.95, 4 to 16 tubes. In AC, AC-DC, 1½ Volt, 6 Volt and 32 Volt models. Also new "Tiny Knights," phonographs, phonoradio combinations, record players, etc. They're all in ALLIED's 1939 Catalog—the Buying Guide of Radio Buyers!



Choose  
from  
62 MODELS

## KITS! Complete-Ready to Build! Send for FREE Parts Lists!

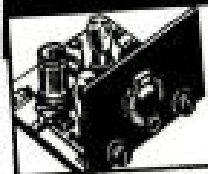

**2 Tube DX'er Kit**  
The favorite receivers of thousands! Low in cost, efficient, easy to build. Less coils.... \$3.98

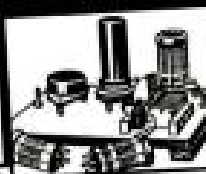

**20 Watt X'mitter**  
Advanced type 6L6 Beam-power transmitter for C. W. Tunes all bands. Complete less tube, crystal and key. \$3.60



**Photo Cell Kit**  
Ideal for burglar alarms, controlling lights, starting and stopping motors, etc. Complete \$5.85



### BEGINNERS! SEND FOR *Allied* RADIO BUILDER'S HANDBOOK

A new and different type of book, planned especially for radio beginners. Tells how to select circuits, read diagrams, make chassis, solder, wind coils, etc. Packed with valuable data. Send coupon with 10c for your copy today. Only 10c.

**FREE PARTS LISTS.** We can supply Free Parts Lists covering hundreds of kits, including those above. Write!

### SAVE MONEY ON ALL YOUR RADIO NEEDS

The new ALLIED Catalog also shows 14,000 radio parts, new P. A. Systems from 8-65 watts, Amateur Gear, Test Equipment, books, tools, etc. Write for your Free copy today—you'll save and profit on every order!



SEND  
FOR FREE  
CATALOG

ALLIED Radio Corp.  
Dept. 16-A-9  
833 W. Jackson Blvd.  
Chicago, Ill.

- Send me your Free 1939 Catalog.
- Enclosed find 10c plus postage for Radio Builder's Book.
- Send me parts list.....

Name .....

Address .....

## Record Station to Rise at San Francisco World Fair

The first short-wave radio transmitter in the United States west of the Mississippi river will be erected on Treasure Island, site of San Francisco's world's fair, and will be in readiness for operation with the opening of the fair the middle of February. The Federal Communications Commission approved the building of this station at the fair instead of at Belmont, as asked in the original application.

The General Electric station will operate on two frequencies, 9530 kc (31.48 meters) and 15,330 kc (19.56 meters), duplicates of the wavelengths used for many years in short-wave broadcasting over W2XAF and W2XAD from Schenectady, N. Y.

### 24-Hour Service

However, because of the difference in time, it will be possible for this new Pacific coast station to operate without interference and provide more or less a 24-hour short-wave service on those two wavelengths from America.

The station, operating on 20 kilowatts, will be equipped with directional antennas of the latest type with beams directed to the Far East and South America. These beams, concentrating the transmitter output within an angle of about 30 degrees, will increase the effective carrier power 10 times.

In order to serve the Far East, at present radio signals following a great circle path from the existing international broadcast stations located only in the eastern part of the United States must pass directly over the north polar regions. The magnetic field of the earth and the daylight-darkness distribution over this path are subject to extreme variations, and their effects on radio signals is believed to be the cause of the failure of radio transmissions to the Orient and has prevented reliable broadcast service from the United States.

### Variations Reduced

Such service as can now be rendered from Schenectady to the Far East is "spotty," varies from season to season and from hour to hour, and to a large extent is unavailable during the evening hours of the Orient.

On the other hand, the great circle path from the proposed location in California does not pass over the north polar regions, is a more east-west path, and therefore should not be subject to the extreme variations found in the signals transmitted from Schenectady, New York. It should be possible to render a satisfactory and reliable broadcast service to the Far East from Treasure Island throughout the greater part of the year.

(Continued from page 47)

movement of the rheostat control should vary the intensity of the light emitted by the filament of the tube. Connecting the ohmmeter to the F prongs of the tube socket will indicate a changing voltage as the rheostat control is moved. In operation the rheostat should be adjusted to 5 volts since this is the required filament voltage for a type 01-A tube.

### Enables Experimenting

The rest of the set is now wired. Care must be exercised in this work, connections must be made correctly, and carefully soldered. A good antenna, fifty to one hundred feet long, should be employed. A water pipe will serve as ground.

The plug terminal of the "B" battery is connected to one side of the milliammeter, the other binding post of the meter is connected to B+ Fahnestock clip. The  $-22\frac{1}{2}$  volt connection is brought to B-. A small current reading of one or two m.a. will be obtained. If the tickler coil is now revolved the current will increase and decrease as the set goes in and out of oscillation. Leaving the tickler in one position, vary the rheostat setting and again you will note a change in plate current as shown on the meter.

Now reset the rheostat to obtain 5 volts on the filament of the tube and connect headphones in place of the meter. You should be able to tune in a number of local stations by varying the condenser setting. You will notice that signals are loudest when the tickler is set below the point where oscillation (whistling) starts.

### Change in Current

Hundreds of other experiments will suggest themselves to the versatile individual. For example you may try to use the plate of the tube as the grid and grid as the plate. When the set is wired with this change notice the difference in the current reading. Or you may connect the antenna wire to the grid connection of the '01 tube and note the lack of selectivity and increase in volume.

A kit is marketed by Allied Radio Corporation, 833 West Jackson Boulevard, Chicago, Ill., under their trade name, Knight, and includes the two meters and other apparatus.

## COIL KITS

**FOR T. R. F. AND SUPERHET. CIRCUITS**  
456-465 k.c. Shielded Wave-traps,  $1\frac{1}{2} \times 2$ , adjustable, \$1.00  
WE CAN SUPPLY HARD-TO-GET RADIO PARTS QUICKLY  
Enclose 3c Stamp for Free Circuit Diagrams of T. R. F. and Superhet. Sets.

**ALL PARTS FOR "RADIO WORLD" CIRCUITS**  
**RADIO DESIGN CO.**  
1353 STERLING PLACE, BROOKLYN, N. Y.

### Wanted—Miscellaneous

**WANTED—DIAL FOR PHILCO, Model 16-122. Must be old type (scale on back). KINSMAN, 4625 No. Hermitage, Chicago.**

## RADIO BOOKS

### Mathematics of Radio Servicing

Complete home-study training in useful radio mathematics. Explains and interconnects simplified arithmetic and algebra with everyday radio problems.

### Public Address Systems

A practical handbook, full of useful information, well illustrated. Considers in detail various microphones, radio and phono inputs, feed-back, mixing and volume controls, use of vacuum tubes, coupling, loudspeaker placement, DB, and hundreds of other points. Many actual circuit diagrams. Everything about P. A. Size:  $8\frac{1}{2} \times 11$  inches.

### Radio Servicing Short-Cuts and Money-Making Ideas

A new and different book that tells how radios can be repaired quickly with the absolute minimum of test equipment. Proves that by actual test 9 out of 10 sets can be repaired with simple tools and ohmmeter. The author, M. N. Bellman, has been in the service work for years and kept data on these important helpful facts. Page after page of practical and money-making ideas applicable to all sets.

Special price, 50¢ each book, postpaid.

**SUPREME PUBLICATIONS** 5729 W. 13th St.  
Chicago, Ill.

## Wind Electric Plant

**Build Your Own — We Show You How.**  
Easily made from old auto generator. Dime brings complete plans and Big N.E.W. catalog of 500 electrical items. 100 other generator changes to 6, 12, 32, 110 volt Plants, Motors, Welders, Electrical Fencer. Write today.  
**LEJAY MFG., 1404 LeJay Bldg., Minneapolis, Minn.**

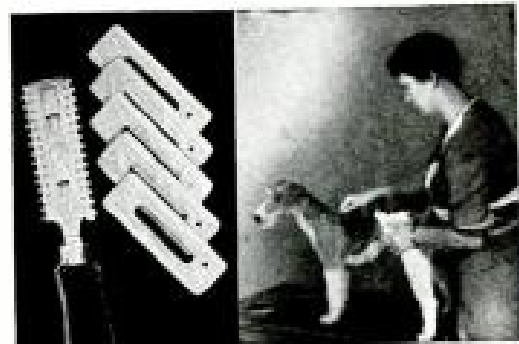

### IT makes STRIPPING FUN

It's simple as A. B. C. and the chart makes professional success a certainty.

### DUPLEX DOG DRESSER

Mystic, Conn., Dept. R.W.

Enclosed find \$..... for which please send me the articles as checked. Send check, money order or C.O.D.

- Duplex Dog Dresser.....\$1.00
- Additional Blades, 5 for..... .50
- 161 Individual Charts.....Each .25  
(Name Breed)
- Nail Nip..... 2.00
- Dog Library, 4 vols: the set..... .25

Name .....

Address .....

Town..... State.....

Money Back if Not Satisfied  
Div. Durham Duplex Razor Co.

(Continued from page 46)

2). If the ripple current flowing through the tube must be reduced,  $Z$  may be a resistor.

In Fig. 1 the heater is shown grounded. Note that this puts the heater-to-cathode space across the oscillator plate winding. Thus RF flows in the H-K space and conversely the admittance of the H-K space, with its hum and noise voltages, appears across the plate coil.

With the grid leak in the position shown, a portion of these voltages is fed into the grid circuit, for grid leak, grid condenser and grid coil in series form an AC voltage divided across H-K. For the same reason a portion of the RF voltage in the plate coil will appear in the grid circuit, but this component will not have the same phase as the desired induced component.

Fig. 3A attempts to eliminate these conditions by joining the heater and cathode together, while the grid leak is returned to the grounded cathode.

Fig. 3B shows the same arrangement applied to the shunt-fed Hartley.

### Circuits Compared

Comparing Fig. 3C with Fig. 3A, it will be seen that they are both plate series fed, with the difference that the power supply is inserted in between the cathode tap on the coil and the cathode, in Fig. 3C.

The remaining figures are in pairs, in which the circuit bearing the lower numeral is on top and the one bearing the higher numeral on the bottom.

In the series covered by Fig. 3 it has not been possible to ground the tuning condenser. Fig. 4 and the figures which follow incorporate this desirable grounding feature, but it will be noticed that this involves a change in the manner in which the oscillator functions. However, coil center tap, condenser return, grid leak, cathode and heater are all at one ground potential.

Fig. 5 retains this advantage, but in addition makes possible grounding of B minus as well. Here the plate winding is shown tuned, instead of the grid, which is a desirable feature from the viewpoint of plate circuit linearity and ability to hold down harmonic content by a high C-L ratio. An impedance  $Z$  may be inserted so that, aided by the condenser for completing the tuned circuit, isolation of the power supply from the tank circuit is accomplished.

### Two That Are Same

In Fig. 6 the plate potential is supplied in series with the coil's cathode tap, as in Fig. 3C, with the exception that the tuning con-

denser is grounded. To accomplish this, B plus is grounded.

In Fig. 7 the circuit is essentially the same as Fig. 5, being plate tuned, with the advantage that by grounding B plus, as in Fig. 6, the tuned circuit may be closed without the use of any isolating condenser such as Fig. 5 required.

Fig. 8 is readily recognizable as the standard Armstrong feedback oscillator, and its functional similarity with Figs. 4 and 6 is apparent. The same is true of Fig. 9, which, while not instantly recognizable as the Armstrong circuit, is such nevertheless, being merely a redrawing to emphasize its relationship to the Hartley type of diagram. Actually, in the Hartley, where the tuning condenser return goes to the plate end, the grid and plate windings are not required to be coupled together for oscillation.

## Right or Wrong?

### Propositions

1. Frequency-modulated broadcasts can not be received on a receiver adapted for the present amplitude-modulated signal.
2. To provide a higher current range, say ten times, with a one millimeter, it should be shunted down until the full-scale current of one mill reads 0.1 mill.
3. The rectified output of a rectifier is independent of the wave shape of the input AC voltage.

### Answers

1. Wrong. In frequency modulation the carrier frequency is varied symmetrically above and below the nominal carrier, at the frequency of the modulating signal. This type of broadcasting can be received on an ordinary receiver if the receiver is tuned so that the nominal carrier falls well down on one side of the resonance curve, whereby the constant-amplitude carrier frequency variations are converted in the receiver into amplitude variations of modulation frequency.
2. Right. This is not strictly correct, but it is generally satisfactory, providing the original meter resistance is a negligible portion of the resistance of the circuit in which the current is being measured. Note that there must be resistance in the circuit or in the generator supplying the current. Otherwise there will be no difference in the meter indication, whether shunted or not.
3. Wrong. While with a square-law rectifier the proposition is substantially true, with linear and similar rectifiers the output will depend on the harmonic content.

## Dumont Gets Television Xmitter Permit

An experimental television transmitter construction permit has just been granted by the Federal Communications Commission to the Allen B. DuMont Labs., Inc., of Passaic, N. J. The permit covers a power rating of 50 watts, and a frequency range of 42,000-56,000 kc. at this time.

This application was made for the purpose of establishing an experimental television transmitter to aid in the practical development of visual broadcasting and reception. Allen B. DuMont, active head of the organization, has had previous experience in television broadcasting, having directed the activities of W2XCD in Passaic, seven years ago, when he was Chief Engineer of the DeForest Radio Company.

## OVERLOOKING CENTRAL PARK

*in New York*

ESSEX HOUSE with its convenient location, luxurious rooms and excellent service is the ideal stopping place. Single rooms from \$4.50, Suites from \$9. Wire reservations collect.



## ESSEX HOUSE

OSCAR WINTRAB, Managing Director

160 CENTRAL PARK SOUTH, NEW YORK

# Save Money



Typical of AEROVOX condensers are these HYVOL high-voltage condensers.

Selected paper sections. Oil-filled (heavy-duty) or wax-filled (normal-duty).

Sturdy welded steel cans. High-tension pillar terminals. Adjustable mounting bracket.

● In building the many fascinating "rigs" described in RADIO WORLD, you'll want components that are inexpensive — *first* and *last* cost considered.

That's precisely where AEROVOX condensers and resistors come to the rescue. These components have long been renowned for that *extra safety factor* and *service* that enables them to stand the gaff and to continue in use long after associated equipment is worn out. So build with AEROVOX and you'll be building economically, satisfactorily, permanently.

## Ask for AEROVOX...

See your local supplier about AEROVOX condensers and resistors. Compare quality, prices, selection. Get our catalog — from local jobber or from us direct.



# AEROVOX

CORPORATION

70 Washington St. : : Brooklyn, N. Y.

IN CANADA: AEROVOX CANADA, Limited Hamilton, Ont.

## AMATEUR RADIO LICENSES

Day and evening classes in code and theory.

*Home Study Courses*

**THERE IS NO QRM IN THE INSPECTOR'S PHONES!**

When you go up for your exam you will hear a clean, clear note without any interference, from a punched tape prepared by an expert. Study for your license the same way; by listening to a clean, clear note either in our classrooms or through code machines with tapes prepared by an expert. Hundreds of licensed students now on the air. Results guaranteed.

**AMERICAN RADIO INSTITUTE**  
1123 Broadway, Dept. 1 W, New York, N. Y.

## CHASSIS-CABINETS PANELS & CANS

STANDARD SIZES ON HAND  
SPECIAL SIZES MADE TO ORDER

**KORROL RADIO PRODUCTS CO.**  
350-354 Greenwich St. RW-139 New York City

Everything in Radio in this Big New 1939 Radolek Radio Profit Guide. Over 12,000 repair parts to repair any radio made. Radolek's immense stock plus Radolek's efficient organization insures you the fastest service. Radolek's prices are lowest—you get Better Quality. Bigger Selection and Faster Service at Radolek. 3000 New items over previous edition—items to increase the profits of every serviceman and dealer. Includes new Test Equipment—New Radios—New P. A. Equipment—Electrical Appliances—Clocks—Power Tools—Electric Shavers and many other items to give you new ideas in conducting your business on a more profitable basis. Send for your FREE copy of the Radolek Radio Profit Guide NOW!

**The RADOLEK Co.** 601 West Randolph St.  
Chicago, Ill. Dept. G-26

Send me the Radolek Radio Profit Guide FREE.

Name .....

Address .....

Serviceman?..... Dealer?..... Experimenter?.....

## Throckmorton Answers Laymen's Questions

George K. Throckmorton, President of the RCA Manufacturing Company, has answered some questions on television as follows:

**Question:** How will Television affect sound broadcasting?

**Answer:** Television will not supplant sound broadcasting. Sound broadcasting, with its highly developed entertainment and informational services, has established itself firmly in our daily lives. It will continue to provide these services in a way which no other medium can supplant. Television, when it becomes available on a national basis (and no one can predict how many years off this may be), will provide another public service which will not conflict, but rather supplement existing services. In a sense, television will for a long time be merely an adjunct to sound broadcasting as we know it.

**Question:** When can I expect television in my territory?

**Answer:** To have television in your territory, you must wait until at least one station in your area is willing to undertake the heavy financial and other responsibilities attendant upon the establishment of a regular program service to the public. These include, besides the purchase of the necessary transmitting equipment, changes in studios and the establishment of an organization capable of providing and staging a flow of programs on a reliable basis.

**Question:** When television comes, how will it affect the sale of broadcast receivers?

**Answer:** There is not the slightest reason why anyone should hesitate to purchase a sound broadcast receiver, because of the advent of Television. When television does come, there will still be a big demand for sound broadcasting receivers, not only for the complete hour-to-hour services that they offer, but because receivers purchased now may be used to provide the sound part of television, with an extra accessory providing the image reception.

### A YEAR'S GIFT FOR HIM

Is your husband, son or nephew interested in radio? Why not send him Radio World for a year?

We will send him, at your request, a gift card notice telling him of your thoughtfulness in sending a gift that lasts all year!

For \$2.50 a year in the United States, \$3.00 in Canada, he will be reminded of your generosity every time the magazine arrives.

**RADIO WORLD, 145 WEST 45th ST., NEW YORK CITY**

(Continued from page 9)

ceiver as against the home-made or kit set, many an adventuresome worker will prefer to assemble his own version, using many spare parts. And while playing around with television, the experimenter will find a world of fun in weaving all sorts of fantastic patterns on the cathode-ray screen, some of which will perhaps find a place in next season's silks for Milady's dress or in the latest wall papers.

Recent disclosures of a cathode-ray microscope simply intrigue those of us who want to push out into that universe that lies beyond the resolving power of even the finest high-power optical microscopes.

Using electronic beams instead of light beams, we may be able to see and study things heretofore barred from human beings. Of course a cathode-ray microscope is not going to be an easy thing to build. But the same thing was once said of a 1-meter radio communication rig.

There is, indeed, no limit to the many fields which radio technique and radio components now make available to us. The only thing needed is guidance—the basic idea—a general blueprint for procedure.

*P. S. Since writing the above, I have had a long talk with the new publisher of RADIO WORLD. He agrees to the opportunities for development of the possibilities I have outlined above, as well as to the value of this magazine sponsoring such development. As a result, these possibilities and their development will be a feature of the editorial policy of the NEW RADIO WORLD, with articles by leading experts and authorities appearing in ensuing months and years. Readers, too, can help in the work through an interchange of ideas in these columns as a matter of mutual benefit.*

### "One Up" on Circulation

I did not know how valuable RADIO WORLD was until I bought my first copy.

SAM COSTELE,  
4607 Boudinot Street, Philadelphia, Pa.

\* \* \*

### Makes Pleasure of Study

I find many hours of pleasure studying RADIO WORLD.

HARRY T. KEENE,  
1128½ South Gage Ave.,  
Los Angeles, Calif.

\* \* \*

### They Know a Good Thing

For us it's RADIO WORLD or nothing.

BREMER & HELFER,  
River Grove, Ill.

RECEIVERS • TRANSMITTERS • TUBES  
• TRANSFORMERS • CHOKES • CON-  
DENSERS • RESISTORS • METERS • TEST  
EQUIPMENT • RACKS AND PANELS •  
DIALS • PHONES • MICROPHONES •  
TRANSMITTING ACCESSORIES

You can't afford to  
pass up these typical  
**TERMINAL VALUES!**

**TRANSFORMERS!** Made by one of the largest and most well-known transformer manufacturers! Guaranteed to deliver voltages and currents as rated! At both stores!

#### Plate Transformers

Rated in D.C. voltages out of full-wave rectifier; A.C. voltages are approximately 20% higher, each side of center tap.

P-1—650 or 500 volts @ 200 ma.	\$3.10
P-2—1250 or 1000 v. @ 500 ma.	9.95
P-3—1800 or 1450 v. @ 300 ma.	8.95
P-4—2500 or 2000 v. @ 300 ma.	11.25
P-5—1000 v. @ 200 ma.	750 v.
@ 150 ma.	5.95

#### Filament Transformers

F-1—2.5 v. CT @ 10 amps.	7500
volts insulation	\$1.30
F-2—5.25 v. CT @ 18 amps.	1.65
F-3—6.3 v. CT @ 3 amps.	.85
F-4—7.5 v. CT @ 8 amps.	1.25

"Terminal Radiogram!"  
Send for new bulletin,

VISIT THE  
TERMINAL STORE  
NEAREST YOU!

**TERMINAL**  
*Radio Corporation*

2 STORES IN NEW YORK CITY

80 CORTLANDT ST. • 68 WEST 45th ST.

Cable Address: TERMRADIO

# Inflation or Reflation?

*What Is the Difference?*

**D**EPRESSION or recession? Ideology or idealism? Neurosis or psychosis? You'll find every difference of meaning clearly explained, with examples of use, in

## THE NEW MERRIAM-WEBSTER

To talk and read intelligently about current events—to win a reputation for being well-informed—look up unfamiliar word-meanings in the Merriam-Webster. This new Second Edition of Webster's New International Dictionary (unabridged) also contains thousands of encyclopedic articles, written by 207 leading authorities, which supply comprehensive information on all the topics talked and written about today. 600,000 entries; 3,350 pages. See it at your bookdealer's, or write for free illustrated booklet to G. & C. MERRIAM COMPANY, 26 Bdwy., Springfield, Mass.

Look for the Circular Trade-Mark



It identifies the "Supreme Authority"

**WEBSTER'S NEW INTERNATIONAL DICTIONARY • Second Edition**

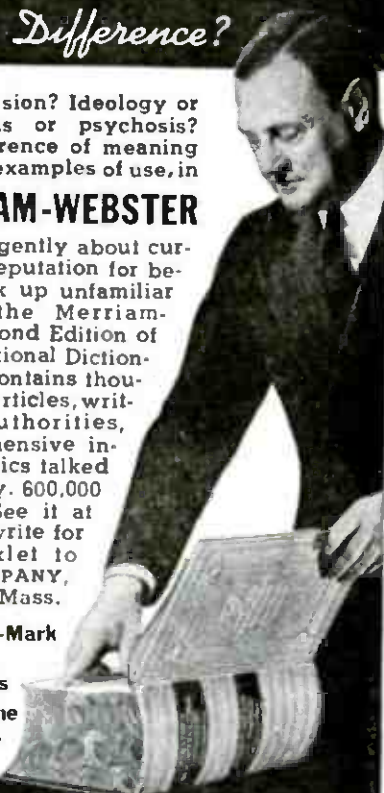

## Thorne's Radio Coil Winder

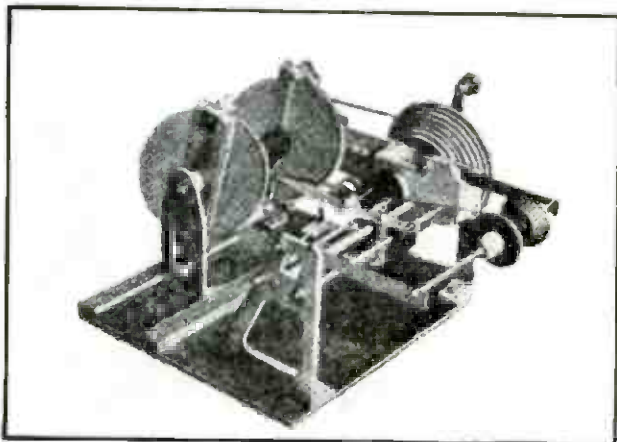

Patented

Will wind transformers, straight or honeycomb coils and car phone armature, revolution recorder. 14 speed changes.

Write for illustrated circular RW38 and prices. Designed for the amateur and radio repair shop.

**MIAMI LABORATORIES, INC.**

951 N. W. THIRD STREET, MIAMI, FLORIDA



## BIG PROFITS

for Radio Hams selling short-wave diathermy apparatus and other electro-medical equipment to physicians. Old established firm. Exclusive territory. Intensive instruction course.

**McINTOSH ELECTRICAL CORPORATION**  
223 North California Avenue Chicago

## CELEBRATING OUR THIRD ANNIVERSARY

### WE ARE NOT BIG ENOUGH

To snub your inquiries on how to build various circuits and how to make tests. Whether you are a beginner, novice, amateur, serviceman, or veteran experimenter, you'll be accorded the same careful, courteous attention. Come in or write us about your problems. We'll cheerfully advise you. Give us a trial.

### IN REFERENCE TO TESTS

WE SUGGEST 2 NEW INSTRUMENTS

## RADIO CITY No. 432

POCKET SIZE \$5.95

DC Volts—0-5, 50, 500, 1000

DC Mills—0-1, 0-10

Ohms—0-500, 50M, 500M



## No. 444

### AC-DC

AC-DC Volts—0-5, 50, 500, 1000

DC Mills—0-1, 10, 100

Ohms—0-500, 50M, 500M



Free—One Pair Birnback Test Prods with purchases of \$8.50 or more. \$9.95

**ADSON RADIO CO.**

201 GREENWICH ST., N. Y. C.

## Correspondence Courses in

# Radio and Electrical Engineering

### ELECTRICAL ENGINEERING.

Get good grasp of wide electrical field. Modern. Very understandable. Theory made easy.

Low as  
**\$25**

**RADIO ENGINEERING.** Extra fine course in radio, public address, photo-electric work. Trains you to be super-service man, real vacuum tube technician. Tuition ONLY \$25, either course. Deferred payment plan. Experiment kits furnished.

**FREE** Write for free copies of school catalog, student magazines, etc.

## LINCOLN ENGINEERING SCHOOL

Box 931-W1, Lincoln, Nebr.

## TREASURE-HUNTING CIRCUITS

By J. E. ANDERSON

Radio devices for locating buried treasure, deposits of ore bodies, etc., open a vast field for potential riches. A detailed discussion by J. E. Anderson appeared in the January, 1938, issue. Send 25c for a copy

RADIO WORLD

145 West 45th St., N. Y. City



## Profit Sources Outside the Routine

The success of many an individual and many a business, both large and small, may be traced readily to a single fact: taking advantage of opportunities. Frequently such opportunities have been in practically new fields of endeavor and it is just such opportunities that have changed many a small business into a large one, often in a comparatively brief period.

It was due to recognition of the opportunities in radio in its early days that accounts for the position of many of the leaders in the field today. Despite the opportunities that still exist in radio, many in it wish to explore new fields; while others already successful are anxious to improve their position by branching out by adding new services or departments to their present businesses.

### They Branch Out

For instance, many radio servicemen do a large business also in vacuum cleaner repairing.

Modernization and development are responsible for many opportunities. Sales ability, technical knowledge, or both, as gained in radio, may be applied readily and profitably.

In singling out an individual example that of the frozen food industry comes to mind and, strange as it may seem, it offers opportunities for the man or concern in radio. Today there are approximately 200 con-

cerns freezing foodstuffs and the success of their business is predicated largely upon special equipment in retail stores throughout the country for the preservation and handling of such foods.

Now, while not really difficult, the installation and servicing of such equipment required a certain amount of technical knowledge.

### Service and Sales

The radio man can readily acquire and thus create an added source of profit for possible spare time, or as an added service to his regular business. Such servicing may mean even the occasional sale of equipment itself as a further source of profit without in any way interfering with the regular run of radio business.

There are a number of sources from which information on the subject may be obtained and any who are interested may write for particulars to Trade Editor, Radio World, 145 West 45th Street, New York, N. Y.

---

### Patent Attorneys

---

**INVENTORS—WRITE FOR NEW FREE BOOK,** "Patent Guide for the Inventor" and "Record of Invention" form. No charge for preliminary information. **CLARENCE A. O'BRIEN & HYMAN BERMAN,** Registered Patent Attorneys, 711-A, Adams Building, Washington, D. C.

---

## RADIO GIMBAL

### A New Chassis Cradle for Speed and Profit in SERVICING

FOR testing and repairing receivers or amplifiers, every radio service shop needs the RADIO GIMBAL. It can be adjusted to any desired angle and permits top, underside and left- or right-side examination, as well as inspection of any intermediate arrangements. Conveniently accommodates any chassis up to 13" x 12" by 23".

Senior Radio Gimbal net.....\$6.00  
Junior model chassis cradle net.....\$3.50

*Senior Model (illustrated) has two frames. Junior Model has one frame.*

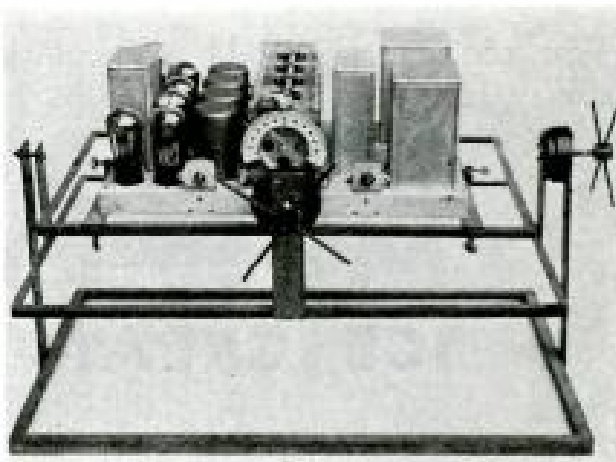

*Write for illustrated circular RW-9-38*

**THE W. A. THOMAS COMPANY, 321 Caroline St., Neenah, Wisc.**

*Another Source of  
PROFITS for  
Servicemen!*



Hundreds of Radio Servicemen everywhere are capitalizing on the growing popularity of commercial refrigeration as a source of added profits.

You, too, can turn odd moments into dollars by realizing on your ability and local acquaintance by installing, servicing . . . and even selling . . .

**MOSS EVACOLD  
ICE CREAM CABINETS**

*Write for booklet and full information.*

**J. MOSS EQUIPMENT CO., INC.**

**400 WITHERS STREET**

**BROOKLYN, N. Y.**



**BUSINESS IS BOOMING  
IN "FROSTED FOODS"**

Frosted Foods is perhaps the fastest growing industry in this country. Within ten years sales have reached a volume in excess of 250 Million pounds a year . . . and increasing daily.

This booming business has developed a steady demand for Polarbox . . . the low priced, low temperature mechanical Frosted Food dispensing cabinet. We have hundreds of inquiries from retail food outlets everywhere which can be easily converted into sales and profits. That's why we say, if you are servicing electrical equipment

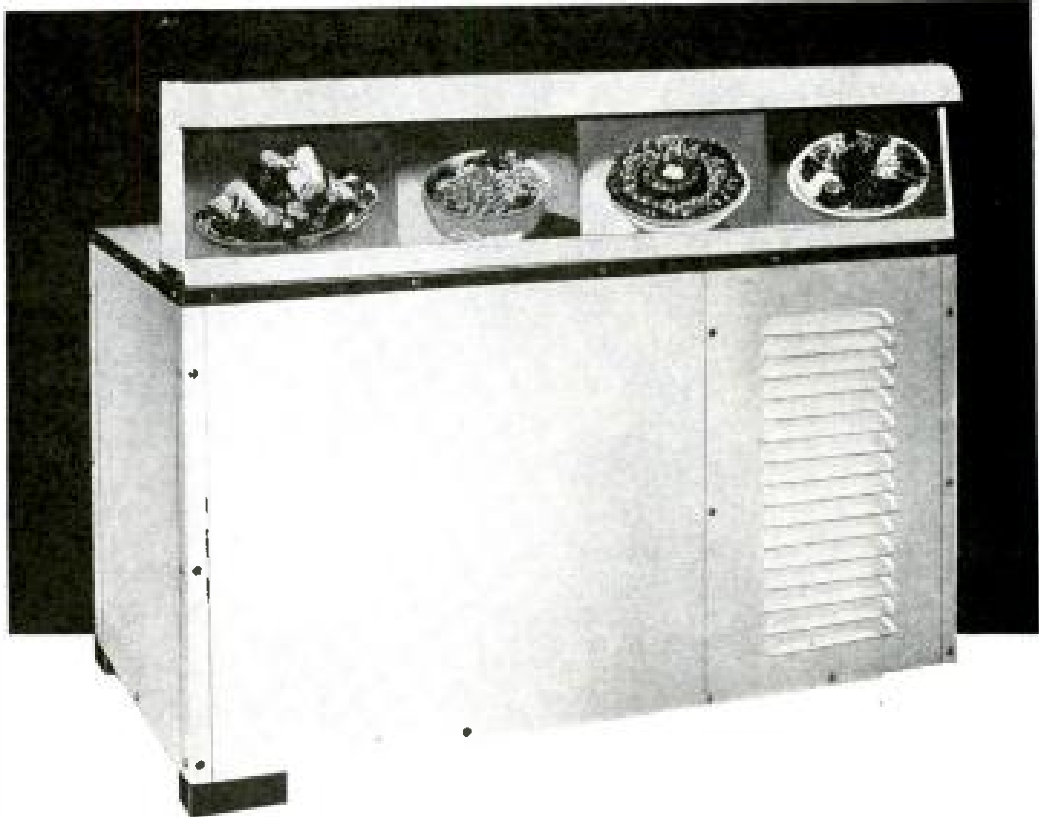

**YOU CAN MAKE GOOD MONEY  
SELLING, INSTALLING & SERVICING**

**POLARBOX**

**LOW PRICED FROSTED FOOD CABINETS**

The quickest way to get into action is to send for a copy of The Two-Profit Polarbox Sales Plan, which gives complete information. Then order in a Polarbox floor sample. With it you can start to close sales immediately. Write today.

**FROSTED FOODS PRODUCTS CO.**  
19 East 47th Street, New York City

**FROSTED FOOD PRODUCTS CO.,**  
19 East 47th Street, New York City

Please send a copy of the "Two-Profit Polarbox Sales Plan" by return mail.

NAME .....

ADDRESS .....

CITY..... STATE.....

POLICE CALLS  
PRIVATE UR CALLS  
AIRPLANES

AIR SCOUT

JUNIOR ALL  
ONLY KIT OF ITS KIND IN THE WORLD

SHIP-TO-SHORE  
10 to 550 METERS

WAVE KIT

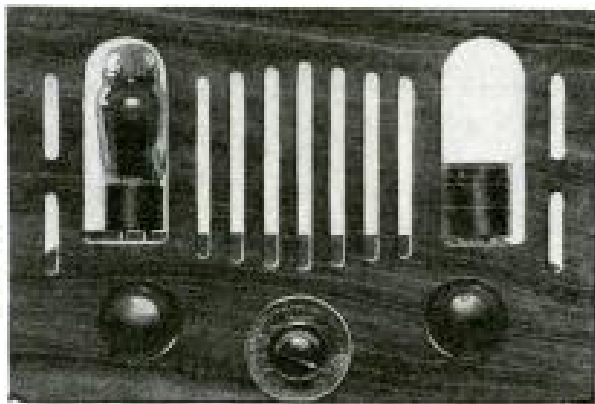

AT LAST! AN ALL WAVE KIT INCLUDING TUBE & ONLY \$2.

COMPLETE WITH ALL  
PARTS - TUBE  
AND 2 COILS COVERING  
BAND 70 to 550 METERS

THRILLING SHORT WAVE & BROADCAST ENTERTAINMENT  
A REAL ALL WAVE RADIO - NOT A TOY

USES 2 FLASHLIGHT  
CELLS AND SMALL  
22KV "B" BATTERY  
SHIPPING WT--1 LB

FOREIGN <sup>15-80 METERS</sup> RECEPTION  
STANDARD BROADCAST RECEPTION

COMPLETE KIT CONSISTS OF THESE PARTS

- 1 WOOD PANEL, WALNUT FINISH
- 1 BLACK & GOLD FINISH CALIBRATED DIAL
- 1 VARIABLE TUNING CONDENSER
- 1 REGENERATION CONTROL-POTENTIOMETER
- 1 FILAMENT RHEOSTAT
- 1 GRID LEAK RESISTOR
- 1 MICA GRID CONDENSER
- 1 ROLL & HOOK UP WIRE
- 1 ANTENNA TRIMMER CONDENSER
- 1 MICA BY-PASS CONDENSER
- 1 ANTENNA CONNECTION CLIP
- 1 "A" PLUS-GROUND CONNECTION CLIP
- 1 "A" MINUS-"B" MINUS CONNECTION CLIP
- 1 "B" PLUS CONNECTION CLIP
- 2 EARPHONE CONNECTION CLIPS
- 1 COIL COVERING BROADCAST BAND to 550 METERS
- 1 COIL COVERING SHORT WAVE BAND -  
70-200 METERS  
3 KNOBS

- 1 TUBE SOCKET
- 1 COIL SOCKET
- PICTURE WIRING DIAGRAM-DETAILED INSTRUCTIONS
- ... 1-30 TYPE TUBE ...

AUXILIARY PARTS SOLD ONLY WITH KIT

- SINGLE EARPHONE ..... \$ .65
  - DOUBLE EARPHONES ..... 1.40
  - COMPLETE ANTENNA KIT ..... .50
  - 2 "A" BATTERIES (FLASHLIGHT) ... EA. .10
  - 22KV VOLT "B" BATTERY ..... .75
  - 10-20 METER COIL ..... .25
  - 15-45 METER COIL FOR FOREIGN ... .25
  - 40-80 METER COIL RECEPTION ... .25
  - WOOD SCREW KIT ..... .10
  - WOOD CHASSIS KIT ..... .45
- ENCLOSE \$1 DEPOSIT WITH C.O.D. ORDERS  
NO CIRCULARS AVAILABLE • ORDERS FILLED IN ROTATION

CLIP COUPON

Gentlemen:-  
Enclosed find \$2 for complete  
Air Scout Junior All Wave Kit  
Name: \_\_\_\_\_  
Address: \_\_\_\_\_

H.G. CISIN, CHIEF ENG. ALLIED ENGINEERING INSTITUTE -  
DEPT. RW1-98 PARK PL. NEW YORK, N.Y.