

7 STATIONS SEND HOME FACSIMILE

# RADIO WORLD

REG. U.S. PAT. OFF.

31-INCH TELEVISION TUBE

[SEE PAGE 10]

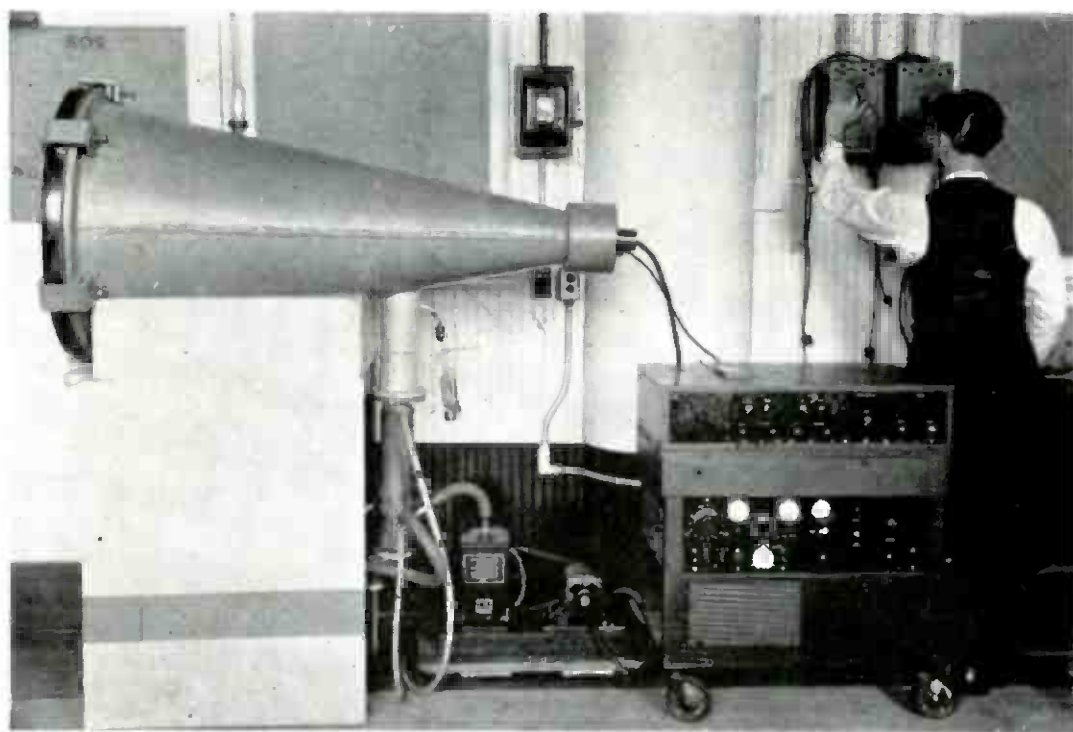

Side View of 31" Demountable TCR Tube

*New Development in Coaxial Cables*

**ELIMINATION OF INTERFERENCE**

**MARCH**

1938

**25c** Per Copy

# CORNELL- DUBILIER Capacitors

for broadcast transmission

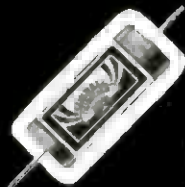

When the layman thinks of radio, he thinks of personalities — famous names. But ask the broadcast engineer, who the REAL performers are.

He'll give you great names, but not of entertainers. He'll mention names like Cornell-Dubilier. He'll talk of the solid, in-built dependability of C-D's. And should you ask him, "Why always Cornell-Dubilier condensers?", he'll tell you that in radio there is no substitute for a reputation built on engineering experience.

When radio men specify C-D's you know they are thinking of the twenty-eight years Cornell-Dubilier has devoted exclusively to the building of condensers and of the world-wide reputation those years have won for the product behind the C-D emblem.

... take Dykanol Transmitting Capacitors for instance: impregnated and filled with non-inflammable Dykanol, these capacitors are available in a complete capacity range from 600 to 100,000 volts. ... C-D heavy duty mica capacitors are scientifically designed to operate under conditions of full load duty, abnormal temperatures and high voltages. For complete listing of C-D Capacitors, send for catalog No. 150.

WORLD'S LARGEST & OLDEST EXCLUSIVE MANUFACTURER OF CAPACITORS  
DYKANOL • PAPER • MICA • WET & DRY ELECTROLYTICS

**CORNELL-DUBILIER**  
**ELECTRIC CORPORATION**



1004 Hamilton Boulevard, South Plainfield, New Jersey

# I WILL SEND MY FIRST LESSON FREE

*It Shows How I Train You  
at Home in Your Spare Time for a*

## GOOD JOB IN RADIO



**J. E. Smith, President  
National Radio Institute  
Established 1914**

*Here's  
Proof*



**Service  
Manager for Four  
Stores**

"I was working in a garage when I enrolled with N. R. I. In a few months I made enough to pay for the course three or four times. I am now Radio service manager for the M— Furniture Co., for their four stores."  
**JAMES E. RYAN, 1535  
Slade St., Fall River, Mass.  
\$40 a Month**



**Spare Time**  
"I have a very good spare time trade. At times it is more than I can handle. I make on an average of \$40 per month profit, and that is spare time working week ends and some evenings."  
**IRA BIVANS, 102 Diagonal St.,  
Savanna, Ill.**

**Free Sample Lesson**  
I will send you my 38-page Lesson "Broadcast, All-Wave and Television Superheterodyne Receiver Principles" absolutely FREE, to prove to you that my Course is practical, helpful, complete. This fascinating lesson contains an analysis of the superiority of the superheterodyne over other circuits; separate sections which cover the action of preselectors, oscillators, mixer and detector circuits, pentagrid converter circuits, tracking, shielding, padding, all-wave receivers, I.F. amplifiers, special broad-band I.F. channels for Television reception, etc. You can get this Lesson absolutely free simply by mailing the coupon now.

Clip the coupon and mail it. I will prove I can train you at home in your spare time to be a **RADIO EXPERT**. I will send you my first lesson **FREE**. Examine it, read it, see how clear and easy it is to understand—how practical I make learning Radio at home. Men without Radio or electrical experience become Radio Experts, earn more money than ever as a result of my Training.

### Many Radio Experts Make \$30, \$50, \$75 a Week

Radio broadcasting stations employ engineers, operators, station managers and pay up to \$5,000 a year. Spare time Radio set servicing pays as much as \$200 to \$500 a year—full time jobs with Radio jobbers, manufacturers, dealers as much as \$30, \$50, \$75 a week. Many Radio Experts operate their own full time or part time Radio sales and service businesses. Radio manufacturers and jobbers employ testers, inspectors, foremen, engineers, servicemen, paying up to \$8,000 a year. Radio operators on ships get good pay, see the world besides. Automobile, police, aviation, commercial Radio, loud speaker systems are newer fields offering good opportunities now and for the future. Television promises to open many good jobs soon. Men I have trained have good jobs in these branches of Radio. Read their statements. Mail the coupon.

### There's a Real Future in Radio for Well Trained Men

Radio already gives good jobs to more than 300,000 people. And in 1938, Radio enjoyed one of its most prosperous years. More than \$500,000,000 worth of sets, tubes and parts were sold—an increase of more than 60% over 1935. Over a million Auto Radios were sold, a big increase over 1935. 24,000,000 homes now have one or more Radio sets, and more than 4,000,000 autos are Radio equipped. Every year millions of these sets go out of date and are replaced with newer models. More millions need servicing, new tubes, repairs, etc. A few hundred \$30, \$50, \$75 a week jobs have grown to thousands in 20 years. And Radio is still a new industry—growing fast!

### I Give You a Professional Servicing Instrument

Here is the instrument every Radio expert needs and wants—an All-Wave, All-Purpose, Set Servicing Instrument. It contains everything necessary to measure A.C. and D.C. voltages and current; test tubes, resistance; adjust and align any set, old or new. It satisfies your needs for professional servicing after you graduate—can help you make extra money servicing sets while training.



### Many Make \$5, \$10, \$15 a Week Extra In Spare Time While Learning

Almost every neighborhood needs a good spare time serviceman. The day you enroll I start sending you Extra Money Job Sheets. They show you how to do Radio repair jobs, how to cash in quickly. Throughout your training I send you plans and ideas that have made good spare time money—from \$200 to \$500 a year—for hundreds of fellows. I send you special Radio equipment and show you how to conduct experiments and build circuits which illustrate important Radio principles. My training gives you **PRACTICAL EXPERIENCE** while learning.

### Find Out What Radio Offers You

Mail coupon for sample lesson and 64-page book. Both are free to anyone over 16 years old. My book points out Radio's spare time and full time opportunities and those coming in Television; tells about my training in Radio and Television; shows you letters from men I trained, telling what they are doing, earning. Find out what Radio offers YOU! **MAIL COUPON** in an envelope, or paste it on a penny post card—NOW!

**J. E. SMITH, President, Dept. 8CM4  
National Radio Institute, Washington, D.C.**

**MAIL  
COUPON  
NOW!**



## GOOD FOR BOTH 64 PAGE BOOK SAMPLE LESSON FREE

**J. E. SMITH, President, Dept. 8CM4  
National Radio Institute, Washington, D.C.**

Dear Mr. Smith: Without obligating me, send the sample lesson and your book which tells about the spare time and full time opportunities in Radio and explains your 50-50 method of training men at home in spare time to become Radio Experts. (Please write plainly.)

NAME..... AGE.....  
ADDRESS.....  
CITY..... STATE.....

**The Tested WAY  
to BETTER PAY**

# Quality Cannot Be Duplicated . . .

Months of painstaking research and design cannot be replaced with a carbon copy of an instrument. ELGIN radio test instruments are designed by engineers who have spent many years in the design of equipment that has met with spontaneous approval by leading servicemen.

## Model 950 TUBE AND UNI-TESTER

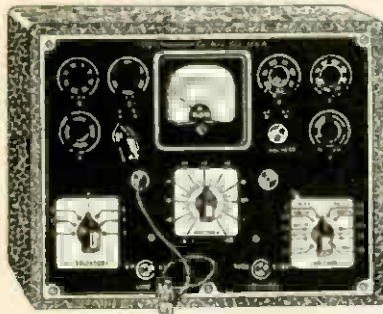

Complete **\$18.95**  
in portable case with Test Prods

## The Greatest Value Ever Offered

### HERE'S WHAT IT DOES . . .

- 0/5/50/500/1000 Volt A.C. Tests
- 0/5/50/500/1000 Volt D.C. Tests
- 0/500/500000 Ohm Resistance Tests
- 0/10/100 D.C. Milliamperere Tests
- Complete Tube Emission Test
- Neon Short Indicator
- Tests All Tubes Released To Date
- Output Indicator

When we say the greatest value ever offered we honestly believe that. Servicemen and experimenters have complimented us on its ability to provide all-around accurate tests. Its simplicity of design and entirely fool-proof construction makes it impossible to burn the foundation meter out.

Accuracy for tests is assured by the use of a 1000 ohm per volt large 3" meter. All readings are calibrated on the scale with shaded areas for "Good" "P" and "Bad" tests.

### 950A DELUXE MODEL

It is identical in every respect to the unit described above except that it is set up in an attractive canvas covered portable case with striped streamline design. Entirely weather proof and can be taken out in all sorts of weather. Detachable cover makes it adaptable for counter purposes.

Complete in Portable case with compartment for **\$19.95** tools, etc. Net to Dealers.....

## Model 801 POCKET VOLT-OHMETER



Servicemen, "hams," experimenters, in fact anyone associated with radio cannot afford to pass up this opportunity to purchase one of these instruments. Appearance and accuracy have not been sacrificed to attain this low price

that we have quoted. Used by thousands, and going like "hotcakes" every day. The 2" D'Arsonval type meter is calibrated in two colors for high and low resistance measurements. 1000 ohm per volt movement assures accuracy of plus or minus 2%.  
Readings available: 0-5-50-500 and 1000 volts D.C.; 0-500-500,000 ohms resistance; 0-1 Millamp.  
Shunts can be easily added to obtain milliamperere tests.  
Complete with Test Prods **\$5.75** and battery .....

## Model 808 UNI-TESTER

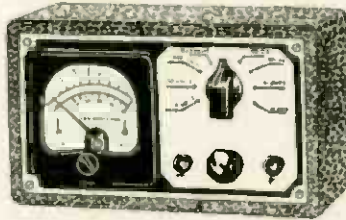

One of the most compact and most accurate instruments ever designed. Simplicity of operation plus the ability of the instrument to determine readings within 2% makes it especially desirable for all.

The large 3" clearly calibrated meter is simple to read, with all ranges available from one set of jacks. The rotary switch employed for the various readings makes use of well constructed contact points to minimize resistance losses that are usually encountered in instruments of inferior design.

Readings available: 0-5-50-500-1000 volts D.C.; 0-5-50-500 D.C. Milliamperes; 0-500-500,000 ohms resistance. Set up in an attractive leatherette covered case.  
Complete with battery and **\$8.95** test Prods .....

## Model 801A AC-DC UNI-TESTER



Reduced from its former price of \$11.95 to the present level. Hundreds were sold at the former price to satisfied customers. It is the answer to the serviceman's demand for a reliable compact unit that will provide accurate tests. Every range and scale available from one selector switch. Battery life about equal to shelf life. Confusing terminals entirely eliminated. D'Arsonval type meter—sturdy and dependable. Low resistance values spread for easy reading. Will read audio output on signal generator tests. Will measure A.C. and D.C. voltage to 1000 volts. Has an easy reading lance type pointer. It reads resistance from 1 to 500,000 ohms with internal battery.

Reading available: 0-5-50-500 and 1000 volts D.C.; 0-5-50-500 and 1000 volts A.C.; 0-500-500,000 ohms; 5-50-500 and 1000 mills. D.C.  
Complete with battery and **\$9.95** Test Prods .....

## Elgin Model 800 Tube Tester "The Hit of the Year"

Tests all types of tubes including the new metal tubes. Direct reading scale is colored "Good" and "Bad." Tests individual sections of diode and triode tubes. Makes separate test of plates of rectifier tubes. It is easy to use—with a new and simple circuit approved by leading engineers. There are no confusing calculations or complicated switch settings to put the unit into operation. Employs a new improved type emission circuit. It is positively the finest, most accurate low priced tube tester ever offered to the serviceman up to the present date.

Provided with two selector controls. One provides proper filament operating voltages and the other proper settings for individual tube tests. Separate diode, triode and plate tests are provided for by means of a novel toggle switch arrangement. The panel is clearly etched to facilitate testing. Supplied complete with combination screen grid cap which accommodates either the large or small caps. A complete set of instructions are forwarded with the unit.

Dealer's and Serviceman's Net Price ..... **\$11.50**

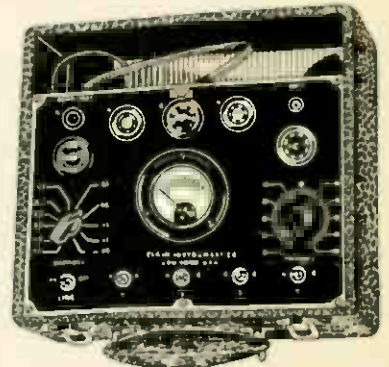

Complete **\$11.50**

## TRY-MO RADIO CO., Inc.

Dept. RW—85 Cortlandt St., New York City  
Send for New 1938 Catalog

# Complete RADIO TRAINING for \$5

## Regular \$39.00 RADIO TECHNICAL INSTITUTE Course



### AN UNUSUAL OFFER

We have obtained a limited number of R.T.I. radio servicing courses, that have regularly sold for \$39.00, and offer them to you for only \$5.00. These are the latest radio courses, complete in every detail, with all supplementary material.

Radio is the present-day opportunity field. Hundreds of men with no special talents have studied Radio Servicing for a short time and are now making twice and three times as much money as before. R.T.I. unique radio training brings rich rewards; you can get ready quickly, inexpensively, easily, and in your spare time for a good job.

### ACCEPTED BY INDUSTRY

Forty large radio concerns have helped to prepare the R.T.I. course. Just think what this backing by the radio industry means to you.

R.T.I. training gives you the practical information you will need when you are on the job. Hundreds of diagrams and illustrations help you to clearly understand important facts. You will pass quickly from lesson to lesson and in a surprisingly short time you will be ready to do real radio servicing. This is your chance to obtain this excellent course for only \$5.00.

### COMPLETE IN ALL DETAILS

No special previous education or experience is needed. R.T.I. course will give you all the training you need. The lessons are clear, interesting, easy to master and use. Fellows who knew nothing about radio before taking the R.T.I. courses are now the leading servicemen in their communities. And you can now obtain this training at the special price of \$5.00.

### YOUR GUARANTEE

You are completely protected. We guarantee these courses to be the identical courses sold and advertised by the Radio Technical Institute at \$39.00. References: Liberty National Bank, Chicago.

### THREE COURSES IN ONE

R.T.I. course is really three essential courses in one. You get training in (1) Practical and Applied Radio; (2) Fundamentals of Radio Principles, and (3) Advanced Specialized Training. This is the training that will place you above the average radio servicemen—and you can obtain this training now for only \$5.00.

### COMPLETE SERVICING COURSE



The R.T.I. has gone out of business and we obtained a quantity of their latest 1937 courses. We offer to you (while 160 courses last) the complete course with all supplementary materials for only \$5.00. We further guarantee the courses to be identical in every respect to the ones sold and advertised by the Radio Technical Institute for \$39.00. This is the best buy in a radio education. Take advantage of our special offer today. Get into Radio to make more money.

## YOUR LAST CHANCE FOR A BARGAIN

There are over 28,000,000 radio sets in use. Over 4,000,000 auto radios alone. You should cash in on this gigantic money market. Well trained men are badly lacking. The R. T. I. easy practical course will pave the way to your success in Radio Servicing. There are but a limited number of these courses left; regularly selling for \$39.00, the course is available to you for only \$5.00.

### OVER 750 ILLUSTRATIONS

Every important fact, part, and circuit is illustrated and explained from a practical point of view. With the R.T.I. advanced training you will understand complex modern radio circuits. You will also get training in Public Address work, photo-cell, and other branches. Order the course today at the bargain price.

### TELLS HOW TO USE INSTRUMENTS

From the very start, you are introduced to practical servicing equipment and practices. You are told how to open your own service shop or radio store. Lesson 15, "The Radio Servicing Business," will give you many practical ideas and hints. The course is so planned that you will be able to earn spare-time money before you have reached your tenth lesson. The special \$5.00 price of the course may be earned in a single evening's work.

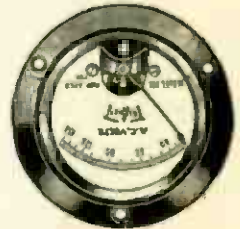

The training is complete. Many servicemen have found that R.T.I. training is excellent for brush up and study of modern servicing methods. You receive training from the simplest radio facts to the most complex set alignment.

### LATEST DATA



Yes, in the R.T.I. course you will find complete explanation of A.V.C., A.F.C., 20,000 ohm per volt meters, sound feed-back . . . every possible fact you must know to be the best servicemen. You will get a real radio training. One of the BEST radio courses is yours for only \$5.00.

### LIMITED QUANTITY

Hurry your order to us today. There are but 160 courses left at the special bargain price. You are completely protected with our guarantee. Send total remittance with order, or just one dollar for deposit. Postal money orders, checks, currency, unused stamps accepted.

**SUPREME PUBLICATIONS, Agents**  
3729 W. 13th Street, Chicago, Ill.

Please send the complete R.T.I. radio course at the special \$5.00 price.

- I am enclosing \$5.00, send prepaid.
- Send C.O.D., I am enclosing \$1.00 deposit.

NAME .....

ADDRESS .....

# Celebrate...

## 50 YEARS OF RADIO PROGRESS

**1938** brings Radio's Golden Anniversary—just once in a lifetime to celebrate such a commanding event. Under the leadership of Hugo Gernsback, pioneer editor of Radio magazines, RADIO-CRAFT for March, depicts 50 YEARS OF RADIO in a style of editorial and advertising make-up vastly different than anything you've ever seen in a Radio magazine. RADIO-CRAFT, once read, stands to be remembered by old-timers as well as newcomers to Radio. If you miss March RADIO-CRAFT (with the gold cover), you miss a revelation in Radio history.

### Here Are the Many Highlights:

- Story of Amateur Radio ● Progress of Radio Receivers—Radio Parts of Yesteryear ● Forecasts and Fulfillments ● Chronological History of Radio ● Reminiscences of Old-Timers ● Fleming's Valve and Up ● Early Radio Circuits ● Old Radio Stations ● Feature Radio Articles ● plus many more sensational articles to bring fond memories ● Cover Attractively Printed in Four Colors and Gold ● Special, New Cover and Body Paper ● Hundreds of Old Time Illustrations, Diagrams and Photographs ● Every New Advertisement Accompanied by an Old—Greatest Thing You Ever Saw! ● Different from Anything Ever Published in a Radio Magazine!

**HISTORY REPEATS ITSELF IN MARCH RADIO-CRAFT!**

144 PAGES



Look for the **GOLD COVER** on the **JUBILEE SOUVENIR NUMBER** MARCH 1938 RADIO-CRAFT -- ON ALL NEWSSTANDS

# RADIO-CRAFT

## Now—a high powered

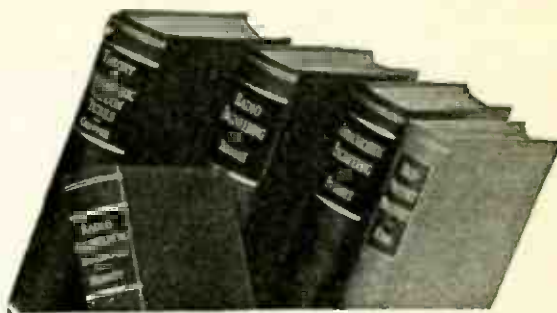

## Radio Engineering Library

—especially selected by radio specialists of McGraw-Hill publications

—to give most complete, dependable coverage of facts needed by all whose fields are grounded on radio fundamentals

—available at a special price and terms.

These books cover circuit phenomena, tube theory, networks, measurements, and other subjects—give specialized treatment of all fields of practical design and application. They are books of recognized position in the literature—books you will refer to and be referred to often. If you are practical designer, researcher or engineer in any field based on radio, you want these books for the help they give in hundreds of problems throughout the whole field of radio engineering.

5 volumes, 2891 pages, 2000 illustrations

1. Everitt's COMMUNICATION ENGINEERING
2. Terman's RADIO ENGINEERING
3. Chaffee's THEORY OF THERMIONIC VACUUM TUBES
4. Hund's HIGH-FREQUENCY MEASUREMENTS
6. Henney's RADIO ENGINEERING HANDBOOK

10 days' examination. Special price. Monthly payments \$26.00 worth of books cost you only \$23.50 under this offer. Add these standard works to your library now; pay small monthly installments, while you use the books.

### SEND THIS ON-APPROVAL COUPON

RADIO WORLD,  
143 West 45th St., N. Y. City.

Send me Radio Engineering library, 5 vols., for 10 days' examination on approval. In 10 days I will send \$2.50, plus few cents postage, and \$3.00 monthly till \$23.50 is paid, or return books postpaid. (We pay postage on orders accompanied by remittance of first installment.)

Name .....

Address .....

City and State .....

Position .....

Company ..... R.W. 1-38

# Make Your Own Last Will and Testament



Our booklet giving samples of Standard Last Wills and Testaments, with many separate clauses, enables one to make just the kind of Will desired by simply copying the wording and filling in your names.

With our booklet comes a legal form Will blank with full instructions how to sign and have it legally witnessed so as to make in SECRET, without other legal advice, a non-breakable Will.

Mail One Dollar for booklet and legal form Will blank.

*Satisfaction or Money Back.*

Address Dept. FC-38—Radio World, 145 West 45th St., New York City

For HOME Radios

HOME RADIO  
POCKET  
TROUBLE  
SHOOTER  
Gadget  
PRICE \$1

For AUTO Radios

AUTO RADIO  
POCKET  
TROUBLE  
SHOOTER  
Gadget  
PRICE \$1

## Servicing!

**IS 10 TIMES FASTER.**

WHEN YOU USE THE "Twin-Gadgets"

**SPEED UP YOUR SERVICE WORK** with these new fast-working Gadgets. How do they work? Easy as pie—you take up your Gadget; pick out the card marked for the Trouble Symptom you find in the sick receiver; flip the card around—and there you'll see all the tests to make and all the remedies, set down next to all the possible trouble sources. It works quicker than it can be described. A half second's time and you have all the dope you want right before your eyes. The most ingenious servicing aid ever invented. **OVER 400 DIFFERENT SET TROUBLES** are spotted on each of the Gadgets. You need both of them to cover all jobs—one for HOME RADIO sets and one for AUTO RADIO sets. And all they cost is \$1 A PAIR (\$1.20 foreign)—only \$1 to save you hours and hours of headaches, worry and wasted time. Don't delay—get your Gadgets today and let them coin money for you. Write your name and address on this ad and send it in with a dollar today! Sent postpaid anywhere on 5-day trial!

GHIRARDI'S POCKET TROUBLE SHOOTERS  
Radio & Tech. Pub. Co., Dept. RW-38, 45 Astor Pl., N. Y.

**MAIL \$1 NOW!**

**MONEY-BACK  
GUARANTEE!**

## MIND POWER

### A FREE BOOK

Develop your personal, creative power! Awaken the silent, sleeping forces in your own consciousness. Become Master of your own life. Push aside all obstacles with a new energy you have overlooked. The Rosicrucians know how, and will help you apply the greatest of all powers in man's control. Create health and abundance for yourself. Write for Free book, "The Secret Heritage." It tells how you may receive these teachings for study and use. It means the dawn of a new day for you. Address: Scribe, C.N.G.

## The Rosicrucians

SAN JOSE —AMORC— CALIFORNIA

"The Rosicrucians are NOT a religious organization"

## CHASSIS—CABINETS PANELS & CANS

STANDARD SIZES ON HAND  
SPECIAL SIZES MADE TO ORDER

KORROL RADIO PRODUCTS CO.

232 Greenwich St. RW 338 New York City

## Make Your Present 'Phones FIDELITY



A NEW earcap, suitable for all popular earphones, when replacing present caps, gives sweeter, clearer, better response. Speech intelligibility is made far higher, and the enjoyment of symphonic orchestras becomes a reality. You enjoy real fidelity.

Cross-section shows where the acoustical labyrinth is located. Upper illustration shows the channels in the mould that comprise half the labyrinth. Approved by Radio World Laboratories.

The invention consists of an acoustical labyrinth in the moulded Bakelite caps. This also prevents mechanical vibration, thus sparing the ears. There is no diaphragm rattle even on loudest signals.

In 'phones with ordinary caps there is strong artificial high audio frequency response due to this diaphragm rattle.

Artificial response is eliminated by the new caps. All response is due only to what is in the wave and not to spurious conditions in the 'phones. Background noise is greatly diminished.

Because of these corrections, the usual low-frequency limit of 'phones, which is around 600 to 800 cycles, is extended to 60 cycles, while there is no attenuation of natural response in the high audio-frequency region. The response is flattened by bringing it up where it is down. All is gain.

Immediate delivery is obtainable of these caps for the following makes of 'phones: Baldwin, Ambassador, Brandes, Cannonball, Globe, Kellogg, Murdock, Radiocar, Solid, Trimm Featherweight, Trimm Professional and Western Electric. Two caps required for each pair of 'phones are pre-threaded to screw on in place of ordinary caps.

Send for Illustrated Circular

## POUL JARNAK

Inventor and Manufacturer  
Dept. RW-3 69 W. 83rd St.—New York, N. Y.

# RADIO WORLD

Sixteenth Year

ROLAND BURKE HENNESSY  
Editor

H. J. BERNARD  
Publisher

HERBERT E. HAYDEN  
Advertising Manager

## Table of Contents for MARCH, 1938

<b>TELEVISION</b>	
<b>Large Images in a Direct-Viewing Cathode-Ray Tube</b> . . . . .	10
By I. G. Maloff <i>Research Division, RCA Manufacturing Company</i>	
<b>Tubes for Amateurs</b> . . . . .	13
By R. S. Burnap <i>Research &amp; Engineering Dept., RCA Manufacturing Co.</i>	
<b>Coaxial Cable for Wide Band</b> . . . . .	18
By M. E. Strieby <i>Transmission Development, Bell Telephone Laboratories</i>	
<b>Transmission Characteristics of the Coaxial Structure</b> . . . . .	24
By J. F. Wentz <i>Transmission Development, Bell Telephone Laboratories</i> * * *	
<b>Low-Cost Design for A.C.</b> . . . . .	28
<i>The 6Y6-G Attains Goal, 3.3 Watts Single, 6 Watts Push-Pull</i>	
<b>Low Drain, High Output</b> . . . . .	31
<i>In a Battery-Operated Audio Amplifier, with 6AC5-G</i>	
<b>New Metal Converter Tube, 6K8</b> . . . . .	33
<i>Better Frequency Stability, Independent of AVC Unbalancing Effect, Important at Short Waves</i>	
<b>New Home Facsimile Shown</b>	35
<i>System That Seven Stations Are Using Explained</i>	
<b>Elimination of Interference</b>	38
<i>Exhaustive Exposition of Causes and Cures</i>	
By Alfred A. Ghirardi <i>Radio &amp; Technical Publishing Company</i>	
<b>Right or Wrong?</b> . . . . .	49
<i>Propositions That Test Your Knowledge, with Answers</i>	
<b>Use of Contact Rectifiers in Instruments</b> . . . . .	50
<i>Half-Wave Circuits, Which Are Most Troublesome, Considered</i>	
By H. J. Bernard	
<b>Going to Town</b> . . . . .	56
<i>With a Volt-Ohm-Milliammeter in Service Work</i>	
By M. N. Beitman <i>Wholesale Radio Service Company</i>	
<b>Radio University</b> . . . . .	60
<i>Readers' Technical Questions Answered</i>	
<b>Electrolytic Condensers</b> . . . . .	62
<i>Part II of a Four-Part Article</i>	
By Paul McKnight Deeley <i>Chief Engineer, Electrolytic Division, Cornell-Dubilier Electric Corporation</i>	

Vol. XXX, March, 1938. No. 12. Whole No. 714. RADIO WORLD, published monthly by Hennessy Radio Publications Corporation, 145 West 45th Street, New York, N. Y. Editorial and executive offices, 145 West 45th Street, New York, N. Y. Executives of RADIO WORLD: Roland Burke Hennessy, editor and business manager; H. J. Bernard, publisher; Herbert E. Hayden, advertising manager. Officers of corporation: Roland Burke Hennessy, president-treasurer; Roland Burke Hennessy, Jr., vice-president, H. J. Bernard, secretary. Entered as second-class matter March, 1922, at the Post Office at New York, N. Y., under Act of March 3rd, 1879.

### SUBSCRIPTION RATE

Price 25 cents per copy. Subscription \$2.50 per year (12 issues); \$1.25 per six months (6 issues); postpaid in the United States and Possessions; \$3.00 per year, \$1.50 per six months, postpaid in all other countries. Remittance for foreign subscriptions should be by International money-order (postal or express) or draft against or discountable at New York bank.

RADIO WORLD is distributed by the American News Company and its Branches



# 417 THINGS EVERY RADIO SERVICE MAN *Must Know!*



**Ghirardi gives you instant command of servicing essentials in 2 HANDY BOOKS**



You've got to know a lot to even "just 'old-your-own" in the radio servicing game today. But you won't need to worry if you have **MODERN RADIO SERVICING & RADIO FIELD SERVICE DATA** at your elbow. These two great Ghirardi servicing books explain every phase of radio service work and will tell you exactly how to handle every servicing problem you'll ever run up against. The first book tells you **HOW** and **WHAT**—the other supplies instantly all the necessary receiver and servicing reference data right **WHEN** and **WHERE** you need it on a servicing job—with a regular Supplement Sheet service to keep it up to date at all times.

This "double-barrelled combination" will give you both servicing "background" and "theory"—the "417 Essentials" of successful servicing—all clearly explained in easy-to-understand language. You need both of these books on your service bench right away. Together, they give you a total of 1800 pages of priceless servicing dope with 813 diagrams and illustrations to make everything perfectly clear—all for only \$6. You can't pass up this big Combination Offer. **Grab It Now!** Fill out the coupon below, and Mail It Today! **Money-Back Guarantee. Sent Postpaid Anywhere!**

### These Men Were Smart!

They bought these two Ghirardi servicing books. Read what they say about them now:

"More data and information in these 2 volumes than a 4-year engineering course and always at your finger tips."  
—D. E. B., Marcellus, Mich.

"The tops in radio service information."  
—F. M. S., Crawfordsville, Ind.

"Like 1,000 hours additional experience."  
—J. M. H., Bad Axe, Mich.

"The best books in my collection. None better."  
—J. H. M., Lancaster, Pa.

"Had I purchased MODERN RADIO SERVICING before this time, I would not have had to invest all the money I did in other radio books with just half the information this 1 volume has."  
—R. C. P., Minneapolis, Minn.

#### 1 TEST INSTRUMENTS

A 420-page section which gives you the whole theory and construction of every type of test and servicing equipment, with diagrams, construction data, "How-They-Work" descriptions of commercial models, etc., etc. Here's basic test-instrument knowledge for every service man.

#### 2 TROUBLE-SHOOTING

254 pages of latest short-cut methods to use in analyzing all kinds of receiver troubles. AVC and QAVC circuits, tuning indicators, how to service circuits.

#### 3 REPAIR METHODS

184 pages of time-saving instructions for making the actual repairs in all types of receivers and individual components. How to align superhets by C-R Oscilloscope method. How to get rid of noise, electrical interference, intermittent reception, hum, distortion, etc.

#### 4 SPECIALIZED SERVICING

442 pages of specialized servicing information covering Auto-Radio installation and servicing, All-Wave, High Fidelity, and Marine set servicing, Selling Service, etc.

#### 5 CASE HISTORIES, etc.

The world's greatest collection of "Case Histories"—for over 1800 different receivers—in the Data Book. Also—the J. F.'s for over 6,000 superhets. Auto-Radio installation instructions for all cars, tube data, and 25 other invaluable charts and tables for instant reference in the shop or out on the job.



Don't Risk A Penny — Money-Back Guarantee Protects You! MAIL COUPON NOW!

**MODERN RADIO**  
*Servicing*  
**and RADIO FIELD**  
**SERVICE DATA BOOK**  
**BOTH BOOKS—Only \$6**

To: Radio & Technical Publ. Co.  
Dept. RW-38, 45 Astor Place, New York

Here's \$6 for my copies of MODERN RADIO SERVICING and RADIO FIELD SERVICE DATA (with the Jan. and June '37 Supplements to Data Book) Postpaid. (\$6.50 foreign)

Please send me free descriptive literature about these 2 servicing books.

NAME.....  
STREET.....  
CITY..... STATE.....

# LARGE IMAGES

## In a Direct-Viewing Type Cathode-Ray Tube for Television

By I. G. Maloff

Research Division, RCA Manufacturing Company, Inc., Camden, N. J.

**SUMMARY**—A new device for obtaining large bright television images of high contrast and high definition has been developed at the Camden Laboratories of the RCA Manufacturing Company. It is a direct-viewing cathode-ray tube  $4\frac{1}{2}$  feet long and 31 inches in diameter. It is of the continuously evacuated type and gives a picture 18 by 24 inches in size. The paper describes the design and construction of the new tube, the reasons for the development, the difficulties which were overcome, and the results obtained.

**E**VER since high-definition television pictures were first demonstrated, newspaper writers and laymen have commented on the small size of the picture. Seemingly it has been of little interest that the size of the picture has had little to do with the amount of information communicated. In early work on high-definition systems a 9-inch diameter cathode-ray tube was used to produce a picture approximately 6 by 8 inches. Most of the present direct-viewing cathode-ray tubes are 12 inches in diameter and produce pictures approximately  $7\frac{1}{2}$  by 10 inches. Even so,

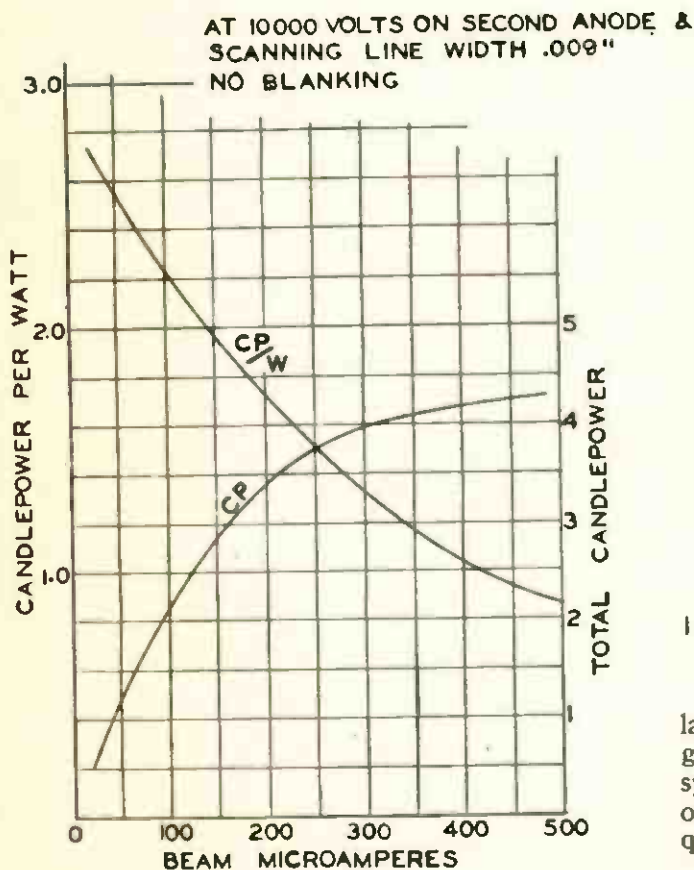

CURRENT SATURATION OF YELLOW WILLEMITTE IN 3-INCH KINESCOPE

FIG. 1

Current-saturation of a willemite screen.



FIG. 2

12-inch direct-viewing television cathode-ray tube for large light output at high contrast.

larger pictures are wanted. Consequently, a great amount of effort and money have been spent here and abroad in the quest for methods of producing large television images having adequate brightness, contrast and definition.

Many solutions to the problem of obtaining large television images have been proposed and several methods have been extensively explored. Interesting demonstrations have been given here and abroad. Frequent mentions of the projection cathode-ray tube method and also of the

supersonic light-valve method are made in the current technical news.

The purpose of this paper is to describe another method of obtaining large television pictures, namely, the method of large direct-viewing cathode-ray tube development. This tube was built with the primary purpose of studying television pictures of large size (18 by 24 inches) under conditions where brightness, contrast and definition were adequate and where the method of reproduction did not limit the performance of the system.

### LIGHT BASED ON AREA

The most important consideration in favor of the large direct-viewing cathode-ray tube is that the total amount of light obtainable from a luminescent screen is directly proportional to the area of the screen. This point will be clarified further.

At present the most widely used luminescent materials for screens in cathode-ray tubes are: the zinc orthosilicate (willemite) and the zinc sulphide. Both materials exhibit the property known as "current saturation." A current-saturation curve of a yellow willemite screen, bombarded by 10,000-volt electrons in a developmental projection tube, is shown in Fig. 1.

Measurements show that under the conditions of normal television scanning this saturation is a function of the area of the scanning spot and not of the total scanned area. But the area of the scanning spot is necessarily a function of the total area, if the detail of the picture is to be preserved; i.e., it cannot be larger than a certain fraction of the total area scanned. In actual practice, since the luminous spot is round, a certain overlap of the scanning lines is permissible. As a limit, after which a serious loss of detail takes place, 50 per cent overlap may be taken. The present tentative standard calls for 441 lines per frame, about 10 per cent of which are blanked out during vertical synchronizing time. The observed picture, therefore, consists of 400 horizontal lines. Allowing 50 per cent overlap this calls for the line width of one-half of one per cent of the height of the reproduced picture as the limiting maximum line width.

It may be deduced from the curves of Figure 1 that at 10,000 volts the maximum useful brightness of this particular type of luminescent screen is 0.7 candlepower per square inch or 100 candles per square foot. The maximum useful beam current (while it is on) is 58  $\mu$ a per square inch, but when the average power over a period of one complete white frame is considered, it is only 0.80 of the product of volts and amperes (max.).

The factor of 0.80 is introduced because in actual operation the electron beam scans a given picture area for only 80 per cent of the time since 20 per cent of the time it is extinguished for the line and frame returns or fly-backs.

### DISPUTE ON LIGHT NEED

As to the minimum required brightness of the screen, opinions vary greatly. As a yardstick, the brightness of a motion-picture screen is often used. A committee of the Society of Motion-Picture Engineers concludes that the

high-lights of the picture should have at least 11-foot lamberts or 3.5 candles per square foot if eye fatigue is to be completely avoided.\* The recommendation, however, is that 0.86 to 1.65 candles per square foot be adopted as a temporary standard. There is very good reason to believe that a television picture should have more light than that. The author's experience indicates that at no time has he seen a television image that was too bright in a normally lighted room. With the tube shown in Fig. 2, with 1.1 ma in the beam at 10,000 volts on the second anode, high-lights of 40 candles per square foot were obtained. The picture was bright and permitted demonstrations in a brightly illuminated room, but no observer pronounced the picture as being too bright. In a dark room such a picture is definitely too bright.

The reason for low screen brightness being satisfactory for motion-picture theatres is that there is practically no stray light and the size of the image is very large. The theatre hall is devoted to the showing of pictures and everybody there is looking at the picture. The television receiver is placed in a room which is used for other purposes. It may be the living room of a residence, a hotel lobby, or a restaurant. To be of maximum usefulness, a television receiver should not interfere with any other functions of the room. The willemite screen by itself, at 10,000 volts, is capable of giving a surface brightness as high as 100 candles per square foot or 314 foot-lamberts or apparent foot-candles. For a screen 18 by 24 inches it would require 25 ma at 10,000 volts. For the previously mentioned figure of 40 cp per square foot, only 6 ma at 10,000 volts are required. The lower the current density of the luminous spot, the higher is the screen efficiency. At 2 ma and 10,000 volts a directly bombarded luminescent willemite screen of the type described will have brilliancy of 14.6 cp per square foot or 46-foot lamberts which is nine times the upper brightness limit of the tentative SMPE standard.

### TUBE COMPLETED

During the first quarter of the present year the construction of a direct-viewing TCR tube with screen 18 inches by 24 inches was completed at the Camden Laboratory of the RCA Manufacturing Company, Inc. The tube is of the demountable, continuously-evacuated type and has a metal envelope with a Pyrex sight glass. Fig. 3 (front cover) shows a side view. The envelope is made of good grade steel  $\frac{1}{4}$ -inch thick with arc-welded seams and flanges.

It has the shape of a cone, and is 4.5 feet in length. The outside diameter of the larger flange is 31 inches. A three-stage oil-diffusion pump is directly connected to the tube through a special outlet. For fore-vacuum, a mechanical vacuum pump is connected to the diffusion pump by means of a length of rubber hose. The glass cover is convex outward, 31 inches in diameter and 2 inches thick. This thickness is re-

\**Jour. SMPE*, Vol. 26 (May 1936) and Vol. 27 (Aug. 1936).

(Continued on next page)

(Continued from preceding page)

quired because the total atmospheric pressure on the glass is approximately  $5\frac{1}{2}$  tons. A special machine was constructed in the laboratory for grinding and polishing both surfaces of the glass. The technique used was that of grinding telescope lenses. A layout of the grinding machine is shown in Fig. 4.

For vacuum-tight joints between the glass and metal as well as between metal flanges, pure gum rubber gaskets proved very satisfactory. The performance of the tube is quite satisfactory when vacuum of the order of  $10^{-6}$  mm Hg is reached. Normally such a vacuum is reached after 48 hours of operation. The vacuum meas-

to pass low video frequency currents. All the meters and controls on the last stages of the amplifier had to be insulated for 10,000 volts. A view of the portable outfit containing the video amplifier, synchronizing and deflecting circuits, and high and low-voltage supply, is shown on the right-hand side of Fig. 3 (front cover).

### NO BULGING

It will be noted from the photograph that the sides of the image are straight and there is no apparent bulging of the image. The reason for this effect is that the 2-inch thick glass disc

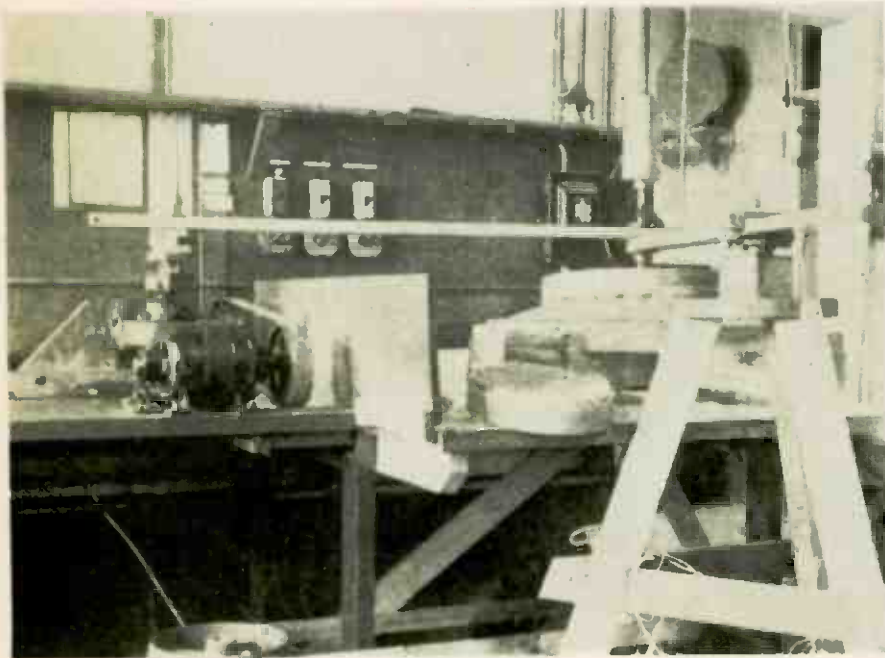

FIG. 4

Machine for grinding and polishing glass covers for 31-inch TCR tube.

urements are made by means of thermocouple and ionization gauges attached to the sleeve connecting the vessel and the diffusion pump.

The tube was designed for 10,000 volts on the second anode. For safety reasons, instead of operating the metal envelope at 10,000 volts positive, it is grounded and the cathode is raised to the same voltage, but negative. This arrangement greatly facilitates the construction of the electron gun. The electron gun used in this tube is shown in Fig. 5. It gave beam currents as high as 8 ma at 10,000 volts with corresponding brilliancy of the high-lights. However, the best overall performance was obtained with a gun giving 2 ma in a narrow beam with negligible defocusing and with — 150 volts cut-off grid voltage.

The design of the power supply and video amplifier for the demountable tube offered many difficulties. The cathodes in the last stages of the video amplifier had to be operated at minus 10,000 volts and, of course, had to be capacity-coupled somewhere along the chain to the low-voltage stages. The two coupling condensers during the operation are charged to 10,000 volts and at the same time are required

At right is electron gun for the big tube.



FIG. 5

is used only as vacuum cover or a sight glass while the luminescent material is deposited on a flat glass sheet  $\frac{3}{4}$ -mm thick, which is fastened to the walls of the tube. The flat appearance of this type of luminescent screen is not its only advantage. The fact that it is flat greatly improves the overall contrast of the reproduced picture. On a concave screen, illuminated parts throw light directly on the blacks of the image, thereby reducing the contrast. The fact that the screen glass is thin improves the contrast in details by reducing the well-known "halation" or "the spurious ring" effect.

The author acknowledges the valuable help and cooperation of his associates in carrying out the developments described, especially Dr. D. W. Epstein and Mr. K. R. Wendt, both of the General Research Division of the RCA Manufacturing Company, Inc., at Camden, N. J. The 31-inch glass disc was ground and polished with the assistance of Mr. D. D. Landis of the Telephone Division of the same company.

# TUBES FOR AMATEURS

## For Experimenting with Cathode-Ray Television

By R. S. Burnap

*Research and Engineering Dept., RCA Manufacturing Company, Inc., Harrison, N. J.*

THE work of amateurs and experimenters has always been important to radio progress. This is largely because many amateurs are highly endowed with a Missourian point of view and a driving curiosity which leads them to prefer the by ways and unknown regions of their hobby rather than the beaten paths. Even though the individual findings of many in this group may be small, the total contributions and accumulated experience of all the radio amateurs and experimenters in the United States have been impressive.

That the radio amateur group has perhaps not yet contributed much to modern television progress is in no way due to lack of ability or resourcefulness on its part, but rather to the fact that this field of investigation requires devices outside the scope of the home workshop.

Of these devices, cathode-ray tubes suitable for television reception are perhaps the most important. Now that such tubes are available to the amateur, one of the major obstacles to his participation in experimental television activities is removed. The fact that the way of the amateur television experimenter is not easy should

not be minimized. Even the hardy amateur who likes to pioneer, to build complex apparatus, to tear down and build anew, and who lives in one of the few favored areas which have television transmitters, should recognize that the transmissions in these areas do not as yet have a common standard and that transmitters are often off the air for long periods while changes are being made.

### BOTH TUBES ELECTROMAGNETIC

A photograph of two new cathode-ray tubes suitable for television, and known as Kinescopes, is shown in Fig. 1. Both of these tubes are of the electromagnetic-deflection type and utilize a screen material which fluoresces brightly with a yellowish hue. The larger tube, RCA-1800, has a bulb-end 9 inches in diameter and accommodates a picture 5½ inches by 7¾ inches in size, while the smaller tube, RCA-1801, has a bulb-end 5 inches in diameter and can show a picture 3 inches by 4 inches.

The electron gun in each of these tubes has been especially designed to give the small spot  
(Continued on next page)

[Reprinted from the January, 1938, issue of "RCA Review." Copyright, 1938, by RCA Institutes, Inc.]

## Duplex Set Announced for the Private Flier

For the private flier, the Western Electric Company introduced a midget aviation radio transmitter, the 25A, weight only 22 lbs. complete. It delivers more than 15 watts carrier power to a suitable antenna.

Arranged for multi-frequency transmission on 3,105, 3,120 and 6,210 kilocycles, it will also transmit on any of the 42 air-line frequencies for which the plane is licensed.

A built-in relay permits the same antenna to be used for both transmitting and receiving. A push-button on the microphone controls two-way communication, being pressed while the user is talking and released while he is listening. Either telegraph or telephone transmission may be employed on any of the frequencies between 2,800 and 6,400 kilocycles. Size is 7½" wide by 5" high by 4¾" deep.

## How to Tell Accuracy of Your Slide Rule

It is said that the percentage of accuracy of a slide rule is approximately proportional to the length of the scales, a slide rule having 10" scale, giving a result accurate to approximately 1/10 of 1%. Total scale length of the National Union Radio Slide Rule is 10" with this length divided into six cycles or decades, thus giving an effective scale length of slightly over 1½", with a resulting accuracy of approximately three-fourths of one percent. This degree of accuracy is adequate, in view of the fact that knowledge of circuit constants is infrequently better than to an accuracy of one percent. In the infrequent cases, where a very high degree of accuracy is required, this rule will be found extremely helpful as a check on the figures obtained by more laborious means.—National Union Radio Corp.

(Continued from preceding page)

size required for high-definition television reception. The conical portion of the bulb of each tube is coated on the inner surface with a conducting material to prevent distortion of the beam and spot at the outer edges of the picture area. The maximum anode No. 2 voltage for the 1800 is 7000 volts and for the 1801, 3000 volts. Lower voltages can be used where it is desired to economize on power-pack cost, but at some sacrifice in either picture definition or brightness.

A diagram of a voltage-supply circuit for the 1800 is shown in Fig. 2. This diagram gives suitable circuit constants. A bleeder current of two to five milliamperes is adequate. Adjustment of electrode voltages is provided by potentiometers in the bleeder circuit. The video

crease in d-c plate current, the plate voltage drops abruptly because of the loss of voltage in resistors  $R_4$  and  $R_5$ . During the period that the d-c plate current is zero, the plate voltage increases at a relatively slow rate, the rate being limited chiefly by the time constant of  $C_3$ , together with  $R_4$  and  $R_5$ . Because the plate voltage thus goes through an abrupt decrease followed by a relatively slow increase, its variation has a saw-tooth form. This voltage applied to the grid of the 6C5 through  $C_4$  and  $R_7$  produces a saw-tooth current in the plate circuit of the 6C5. In this manner, saw-tooth current is caused to flow in the vertical-deflecting coils.

In television circuits, it is essential that this saw-tooth wave be synchronized with that generated in the vertical scanning circuit of the

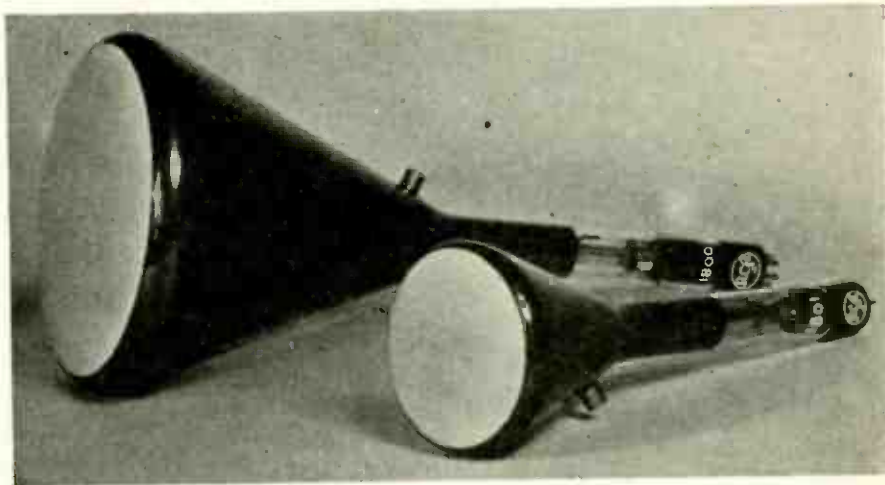

FIG. 1.  
Photograph of Kinescopes RCA-1800 and RCA-1801

signal and background-control bias are introduced between grid No. 1 and the cathode of the cathode-ray tube.

A typical vertical-deflecting circuit for television reception is shown in Fig. 3. This circuit generates a saw-tooth deflecting current in the following manner. In the 6N7 tube, the triode unit shown on the left operates as a blocking oscillator. Oscillations are started in the circuit by the feedback action of transformer  $T$ . The flow of grid current which accompanies these oscillations causes a negative bias voltage to build up across the condenser  $C_1$  and the grid leak consisting of resistors  $R_1$  and  $R_2$ . After a very few oscillations, this bias voltage becomes sufficiently large to cause the plate current of the triode unit to cut off and, by so doing, to stop oscillations. When the oscillations cease, the charge on  $C_1$  leaks off through  $R_1$  and  $R_2$  to a value such that the circuit can resume oscillation. The tube then blocks again, and the cycle repeats.

Because the grid of the right-hand triode unit is connected to the grid of the first triode unit, the d-c plate current of the former unit rises suddenly to a large value during the period of oscillations. When oscillations stop, the d-c plate current becomes zero and remains zero until a new cycle starts. With the sudden in-

crease in d-c plate current, the plate voltage drops abruptly because of the loss of voltage in resistors  $R_4$  and  $R_5$ . During the period that the d-c plate current is zero, the plate voltage increases at a relatively slow rate, the rate being limited chiefly by the time constant of  $C_3$ , together with  $R_4$  and  $R_5$ . Because the plate voltage thus goes through an abrupt decrease followed by a relatively slow increase, its variation has a saw-tooth form. This voltage applied to the grid of the 6C5 through  $C_4$  and  $R_7$  produces a saw-tooth current in the plate circuit of the 6C5. In this manner, saw-tooth current is caused to flow in the vertical-deflecting coils.

In television circuits, it is essential that this saw-tooth wave be synchronized with that generated in the vertical scanning circuit of the

### Constants for Fig. 3

[Diagram is on page 15.]

- $C_1, C_3 = 0.1$  mfd.
- $C_2, C_4 = 0.25$  mfd.
- $C_5, C_6 = 10$  mfd.
- $R_1 = 200,000$  Ohms } Vertical-Speed
- $R_2 = 10,000$  Ohms } Controls
- $R_3 = 100,000$  Ohms
- $R_4 = 2$  Megohms
- $R_5 = 2$  Megohms, Vertical-Size Control
- $R_6 = 100,000$  Ohms, Vertical-Peaking Control
- $R_7 = 1$  Megohm
- $R_8 = 100,000$  Ohms, Vertical-Distribution Control
- $R_9 = 10,000$  Ohms
- $R_{10} = 50,000$  Ohms, Vertical-Centering Control
- $R_{11} = 50,000$  Ohms
- $L_1 =$  Coupling Choke, 100 Henries
- $L_2 =$  Vertical-Deflecting Coils
- $T =$  Feedback Transformer

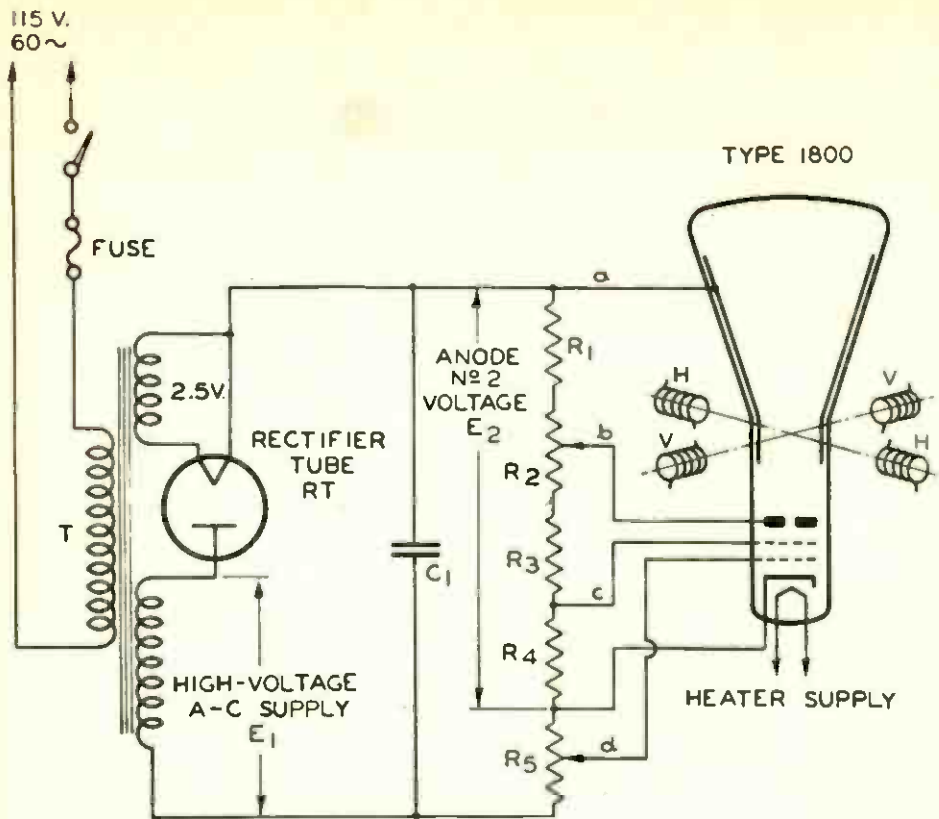

FIG. 2.  
Voltage-supply circuit for RCA-1800.

Circuit Component	Specifications	Specifications	Specifications
$E_2$ .....	3,000 Volts	4,500 Volts	6,000 Volts
$C_1$ .....	2 mfd., 3,000 Volts	2mfd., 4,500 V.	2 mfd., 6,000 V.
$R_2$ .....	1 Megohm, 6 Watts	1 Megohm, 12 Watts	1 Megohm, 25 Watts
$R_3$ .....	100,000 Ohms, 1 Watt	100,000 Ohms, 2 Watts	100,000 Ohms, 3 Watts
$R_4$ .....	135,000 Ohms, 1 Watt	150,000 Ohms, 2 Watts	165,000 Ohms, 4 Watts
$R_5$ .....	85,000 Ohms, 1 Watt	70,000 Ohms, 1 Watt	55,000 Ohms, 2 Watts
$R_6$ .....	12,000 Ohms, 0.5 Watt	10,000 Ohms, 0.5 Watt	10,000 Ohms, 0.5 Watt
$E_1$ .....	2,300 Volts RMS	3,400 Volts RMS	4,600 Volts RMS
RT .....	Type 879	Type 878	Type 878

a = Anode No. 2  
 b = Anode No. 1  
 c = Grid No. 2  
 d = Grid No. 1

H = Horizontal-Deflecting Coils  
 V = Vertical-Deflecting Coils  
 T = Power Transformer

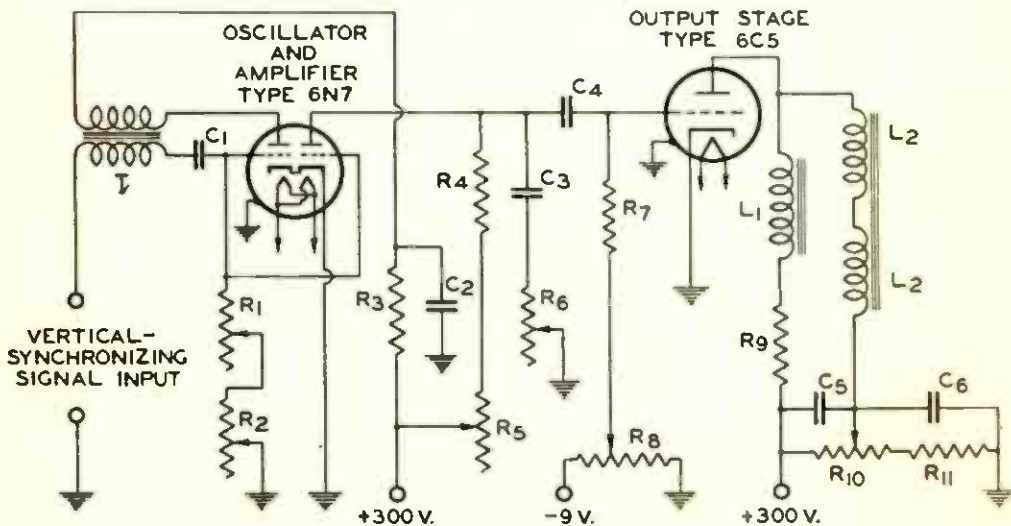

FIG. 3.  
Vertical-deflecting circuit for RCA-1800 or RCA-1801. [See table, p. 14]

(Continued from preceding page)  
 ode into oscillation. In practice, the circuit of the left-hand triode unit is adjusted to function at a rate slightly slower than the rate of the incoming synchronizing pulses. Hence, when

the pulses are applied, the action of the blocking oscillator is speeded up to the proper rate for synchronization. Controls are provided so that the circuit can be adjusted for optimum operation. (Continued on next page)

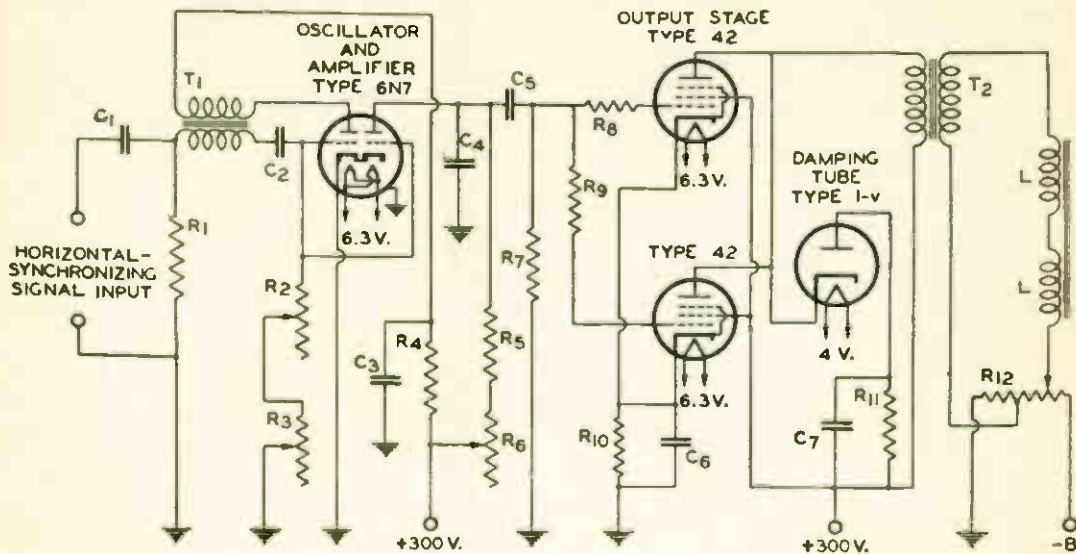

FIG. 4  
 Horizontal-deflecting circuit for RCA-1800.

- C<sub>1</sub> = 0.005 mfd.
- C<sub>2</sub>, C<sub>4</sub> = 0.001 mfd.
- C<sub>3</sub>, C<sub>5</sub>, C<sub>7</sub> = 0.05 mfd.
- C<sub>6</sub> = 0.5 mfd.
- R<sub>1</sub> = 500 Ohms
- R<sub>2</sub> = 100,000 Ohms } Horizontal-Speed
- R<sub>3</sub> = 10,000 Ohms } Controls
- R<sub>4</sub> = 100,000 Ohms
- R<sub>5</sub> = 50,000 Ohms

- R<sub>6</sub> = 0.25 Megohm, Horizontal-Size Control
- R<sub>7</sub> = 0.5 Megohm
- R<sub>8</sub>, R<sub>9</sub> = 100 Ohms, Non-inductive
- R<sub>10</sub> = 200 Ohms
- R<sub>11</sub> = 8000 Ohms, 5 Watts
- R<sub>12</sub> = 5 Ohms, Horizontal-Centering Control
- L = Horizontal-Deflecting Coils
- T<sub>1</sub> = Feedback Transformer
- T<sub>2</sub> = Output Transformer

## College Grads Start An Engineering Firm

Radio Development and Research Corporation, 145 West 45th Street, N. Y. City, was formed recently to supply engineering advice to amateurs, manufacturers and laboratories. In addition, special apparatus will be manufactured on custom order and particular attention will be paid to the development of specialized devices. In general the efforts of the organization will be directed towards recording amplifiers, transmitter design and production, theatre sound work, amateur transmitter devices and diathermy devices.

The personnel includes Irving Weiss, president, a Columbia University graduate, who is senior sound engineer for Loews, Inc.; Henry M. Bach, Jr., a Princeton graduate, formerly with Harvey Radio Co., and Joseph Star, a University of North Carolina graduate, formerly with Solar Manufacturing Co. The organization is equipped to handle engineering and manufacturing problems of all kinds, and has laboratory facilities for development work.

## Amateur 2,000 Miles off Picks up 7-Meter Wave

General Electric's new ultra-shore-wave radio transmitter erected on top of the state office building in Albany, N. Y., recently began its broadcast schedule. This station, call W2XOY, operates on 41 mc (7.31 m) with a power output of 150 watts. It will be on the air Mondays, Wednesdays and Fridays from 8 to 9 p.m., and on Saturday from 3 to 5 p.m. All programs will originate in General Electric's short-wave studios in Schenectady and will be carried by a special wire line to the Albany transmitter.

Signals on this ultra band are supposed to travel in straight lines, the same as light waves, to be heard within a distance of 20 or 25 miles from the point of origin. However, in one of the early tests a report was received from an amateur in Phoenix, Arizona, more than 2,000 miles distant, telling of receiving the station.

Such distant reception is interesting but not reliable, especially as the signal thus received is usually distorted.



(Continued from preceding page)

A typical horizontal-deflecting circuit for the 1800 is shown in Fig. 4. In this circuit, a 6N7 and an output stage generate a synchronized, saw-tooth current in a manner similar to that described for the vertical-deflecting circuit. However, the horizontal-deflecting circuit operates at a much higher frequency than the vertical-deflecting circuit. Because the horizontal-deflecting frequency is high, the deflecting current decreases very rapidly on the return portion of the deflecting cycle. This rapid decrease in current causes shock-excited oscillations in the plate circuit of the output stage. To damp out these oscillations, a Type 1-v tube is connected across the primary of the output transformer  $T_2$ . When oscillation starts, the primary first applies a high positive voltage to the cathode of the 1-v and then applies a negative voltage. As soon as the cathode becomes negative with respect to the plate of the 1-v, the 1-v conducts current. Thus, the flow of current through the 1-v quickly damps out the oscillations caused by shock excitation.

**CUTS DISTORTION**

A deflection yoke is shown in perspective in Fig. 5. This yoke is designed to minimize pin-cushion distortion and defocusing of the spot at the edges of the picture.

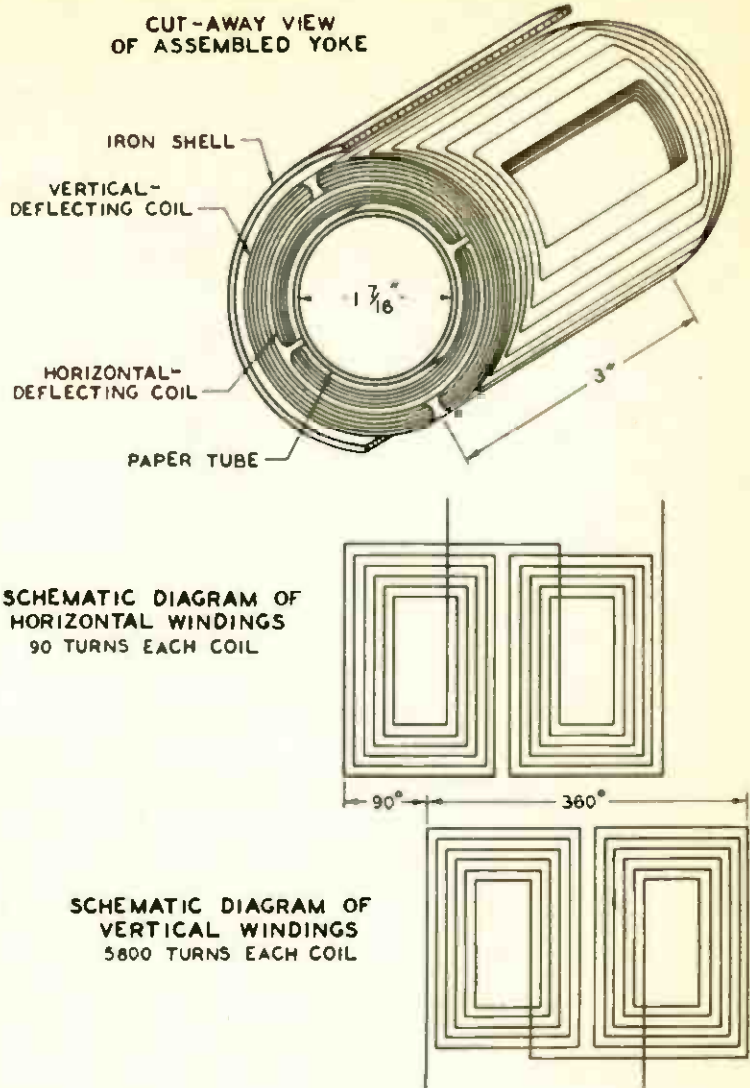

FIG. 5. Perspective view of a deflection yoke.

**RCA Net Up \$2,844,000; \$9,000,000 Year's Profit**

An estimated profit for 1937 of \$9,000,000 was reported to the stockholders of the Radio Corporation of America by David Sarnoff, President. While the final audit was not yet completed, this preliminary estimate indicated an increase of approximately \$2,844,100 over the net profit of the previous year.

Gross income of RCA for the year was estimated at \$112,650,000, compared to \$101,186,300 in 1936. After cost of operations, net income before deductions was estimated to be \$15,400,000, compared to \$11,464,100 the previous year. Deductions for taxes, interest, depreciation and amortization of patents and goodwill, were estimated at \$6,400,000, leaving a net profit of \$9,000,000. After allowing \$3,230,000 to cover the year's dividends on preferred stocks the earnings applicable to the common stock are equal to 4½ cents a share.

In comparison with the previous year, 1936, the Radio Corporation's operations for 1937 showed an increase of 11% in gross income,

while net profit increased 46% over the net profit in 1936 of 6,155,900.

During the year the holders of first preferred stock received their regular dividends, the dividend arrears on the few remaining shares of "B" preferred stock were paid in full and the holders of common stock received a dividend of 20c a share. The total dividends paid by the corporation during the year amounted to \$6,409,226. This amount was paid to 11,790 holders of 916,142 shares of preferred stock and 230,659 holders of 13,853,415 shares of common stock.

**RCA LICENSES H & K**

RCA announced that it has granted a non-exclusive license to Heintz & Kaufman, Ltd., of San Francisco, Calif. The license extends to various commercial radio apparatus for use on ships and aircraft, and by governments. The agreement terminates patent litigation.

# TELEVISION COAXIAL CABLE

By M. E. Strieby

*Transmission Development Department, Bell Telephone Laboratories*

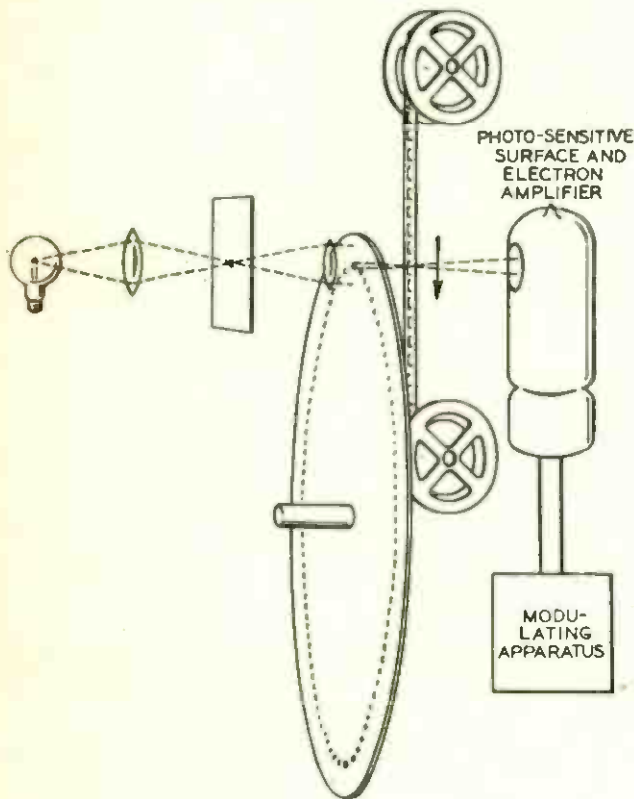

FIG. 1

Schematic representation of the scanning arrangement at the sending end of the television system.

**S**ATISFACTORY television transmission requires a very wide band of frequencies. According to present indications a width of several million cycles will be employed for ordinary commercial broadcasts and such a great spread of radio frequencies—wider than the total band now set aside for broadcasting sound programs—can be made available only in the ultra-high frequency part of the radio spectrum. The area of satisfactory reception from an ultra-high frequency broadcast transmitter is comparatively small. In order to reach a large audience simultaneously the same program therefore would have to be broadcast from a number of stations all connected together. A similar scheme is employed in the broadcasting of sound programs at the present time, but with television a greater number of stations than is now used in the sound programs would probably be involved.

As part of the general program of developing

the broad-band systems for wire-line communication service, the Laboratories have accordingly been studying the problem of transmitting television signals. Such transmission over wire lines was first demonstrated in 1927\* but the frequency employed at that time was only a little over 20 kc wide, which was narrow enough to permit the use of existing types of circuits and methods. With bands several thousands of kilocycles wide as now proposed for commercial television a radically different system is required.

## NEED OF SHIELDED CIRCUIT

Because of the necessity of reducing outside disturbances to a minimum, a shielded circuit seemed desirable, such as the coaxial conductor now installed† between New York and Philadelphia. The original equipment of this cable provided for the transmission of a band about a million cycles wide, and although this was somewhat narrower than the band that would be required to transmit the type of television images now proposed, it seemed desirable to provide the necessary terminal apparatus and circuits for television transmission over this line as a first step in an orderly process of development aimed at higher quality lines for commercial television networks.

Although television implies the transmission of an actual scene, it is much more satisfactory for engineering studies to transmit a motion picture, since exactly the same picture can then be transmitted over and over again as the circuit elements are changed or adjusted. Moreover, it was decided to use mechanical scanning to obtain the most nearly perfect signal possible, and with this form of scanning a film rather than an actual scene gives much better results. Because of these various factors a motion picture film was employed as the material for the recent experiments.

## HOW SCANNING IS DONE

The film is "scanned" by passing a beam of light across it in successive rows one below the other. The smaller this pencil of light and thus the greater the number of lines required to cover the picture, the finer will be the detail that can be transmitted and the higher will be the upper frequency required. Besides this very

\* Bell Laboratories Record, May, 1927, p. 297.

† Bell Laboratories Record, May, 1937, p. 274.

high frequency, determined by the finest detail to be transmitted, other components over the whole frequency range down to zero will be required to reproduce the larger areas of light and shade in the picture. The direct-current, or zero-frequency, component controls the general level of brightness of the picture, and where this changes slowly, it results in a component of very low frequency. The scanning arrangement used for the recent demonstration provided for a picture of 240 lines, which for the shape of picture used, a square scanning beam, and twenty-four frames per second results in an upper frequency of 806 kc, and other components over the entire frequency band from 0 to 806 kc.

For scanning the picture a six-foot disk was employed with a circle of 240 holes near its outer edge. The arrangement is indicated schematically in Fig. 1, and a photograph of the scanning apparatus is shown in Fig. 2. Each hole has a lens mounted in it, and light from a powerful incandescent lamp behind the disk, passing through one hole at a time, is focussed by the lens to form on the film a small dot of light about three thousandths of an inch square.

### SPACING OF LENSES

The lenses in the disk are spaced by a distance equal to the width of the picture, or a little less than an inch, and as the disk rotates, each spot is moved rapidly across the picture. The film is carried at a uniform rate downward behind the disk at such a speed that the successive holes throw their light in suc-

cessive rows across the picture one below another. A photosensitive surface mounted behind the film picks up the light transmitted through it, and produces a complex electric current corresponding to the variations of light which appear in the picture.

No small factor in the success of the recent demonstration was the cathode-ray tube, designed by C. J. Davisson and used at the receiving end to display the transmitted picture. Some of the features of this tube are indicated schematically in Fig. 4, and the tube itself is shown in Fig. 3. A stream of electrons from the cathode of this tube passes through a series of electron lenses which focus a narrow beam on a square aperture. Between the lenses and the aperture, however, are two modulating plates connected to the incoming circuit in such a way that there appear on these plates potentials proportional to the voltage of the incoming signals. The effect of potentials on these plates is to deflect the electron beam, and the conditions are such that at maximum strength of signal practically the entire stream of electrons passes through the hole and forms a brilliant spot of light on the front of the tube. As the signal decreases in strength, the electron stream is more and more deflected; so that fewer electrons pass through the aperture, and the illumination on the sensitized end of the tube decreases.

### CONTROLLED POTENTIAL

In addition to these modulating plates, and placed between the aperture and the front of  
(Continued on next page)

**FIG. 2**  
The scanning apparatus used for the recent television demonstration was developed under the direction of H. E. Ives

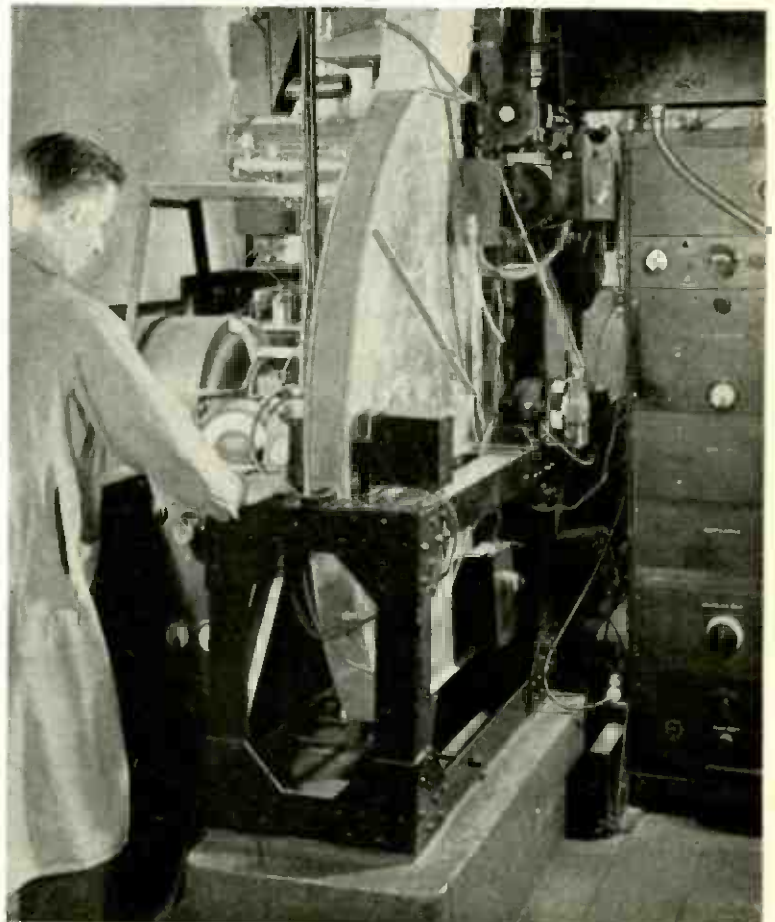

(Continued from preceding page)

the tube, are two other pairs of plates mounted in planes at right angles to each other. The potential on one of these sets of plates, controlled by a frequency of 5760 cycles, which is the frequency at which successive lines are scanned, varies in such a way that the beam of electrons passing through the aperture is swept across the front of the tube from left to right, exactly in synchronism with the scanning beam at the sending end. After the beam reaches the farther side of the picture, the potential on the plates is suddenly changed, and the beam is rapidly moved back to begin the next line.

Due to a black mask down the far side of the film being scanned, there is no signal during this very short period while the voltage on the plates is changed, and thus the electron beam is deflected from the aperture and is not visible on the front of the tube during its return.

The potential on the other pair of plates is controlled at a frequency of twenty-four cycles per second, which is the rate of scanning successive frames. The effect of the potential on these plates is to deflect the electron beam downward in synchronism with the motion of the film at the sending end. This results in the passage of the electron beam across the front of the tube in successive rows, one below another.

### VOLTAGE CHANGED

After the last row has been scanned, the voltage on the plates is changed and returns to the value that causes the beam to appear at the top line of the tube. A properly synchronized blanking out pulse is introduced between successive frames of the film, so that no signal is received during this interval, and thus the passage of the electron beam from the bottom to the top of the frame is not visible.

The sharpness of the image over the entire field and the wide range of brightness secured is due to the superior design of this cathode-ray tube. The chief factors are the sharp focusing by the electron lenses, the linear deflection of the beam at the aperture, and the great length of the tube, which makes it necessary to deflect the electron beam over only a narrow angle to cover the seven by eight inch field. Since this trial was a test to determine the capabilities of the coaxial system, such matters as size and cost, which would be important with commercial receivers, were not controlling.

The coaxial cable system used could not transmit the frequency band from 0 to 806 kc, because repeaters were not designed to pass frequencies below about 60 kc. This limitation was incorporated in the original design because the cable offers insufficient shielding to various disturbances at low frequencies. It was necessary, therefore, to raise the television band to a higher frequency position for transmission over the line. A number of considerations led to the decision to raise the upper frequency to 950 kc for transmission over the coaxial cable, which required raising the entire frequency band 144 kc.

Where such a frequency band is to be raised

by an amount less than the width of the band itself, a single modulation is not generally satisfactory. The products of modulation include the original frequency band as well as the upper and lower sidebands, so that there will always be a confusing jumble of frequencies in the modulator output unless the modulating carrier is greater than the highest frequency of the



FIG. 3.

The cathode-ray receiving tube used for the recent television demonstration held by C. F. Calbick who took an active part in its design.

band. For this reason a system of double modulation was used for the recent experiments.

### THE TWO MODULATING STEPS

The modulating scheme employed can be followed with the help of Fig. 5, which shows the two modulating steps at the sending end and the two demodulating steps at the receiving end in four lines beginning at the top. A carrier of 2376 kc is used for the first modulation, which results in a lower sideband from

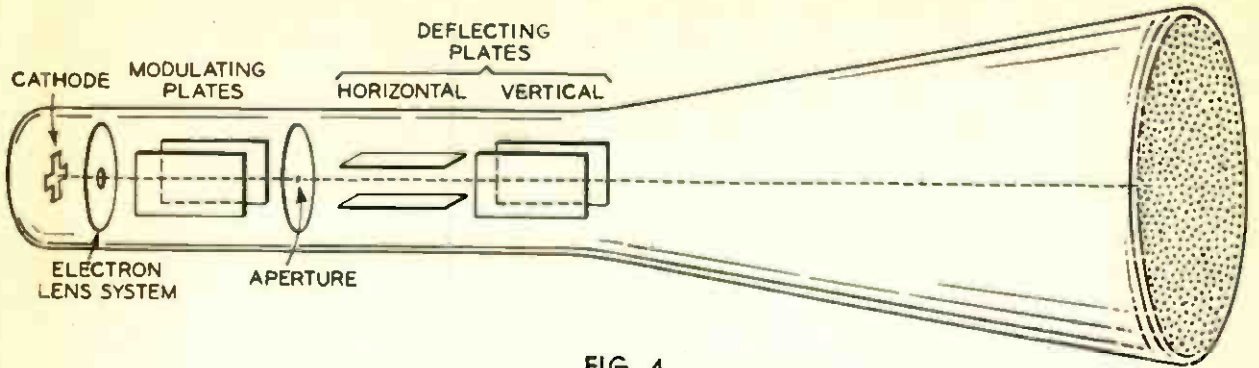

FIG. 4  
Schematic representation of the cathode-ray equipment at the receiving end.

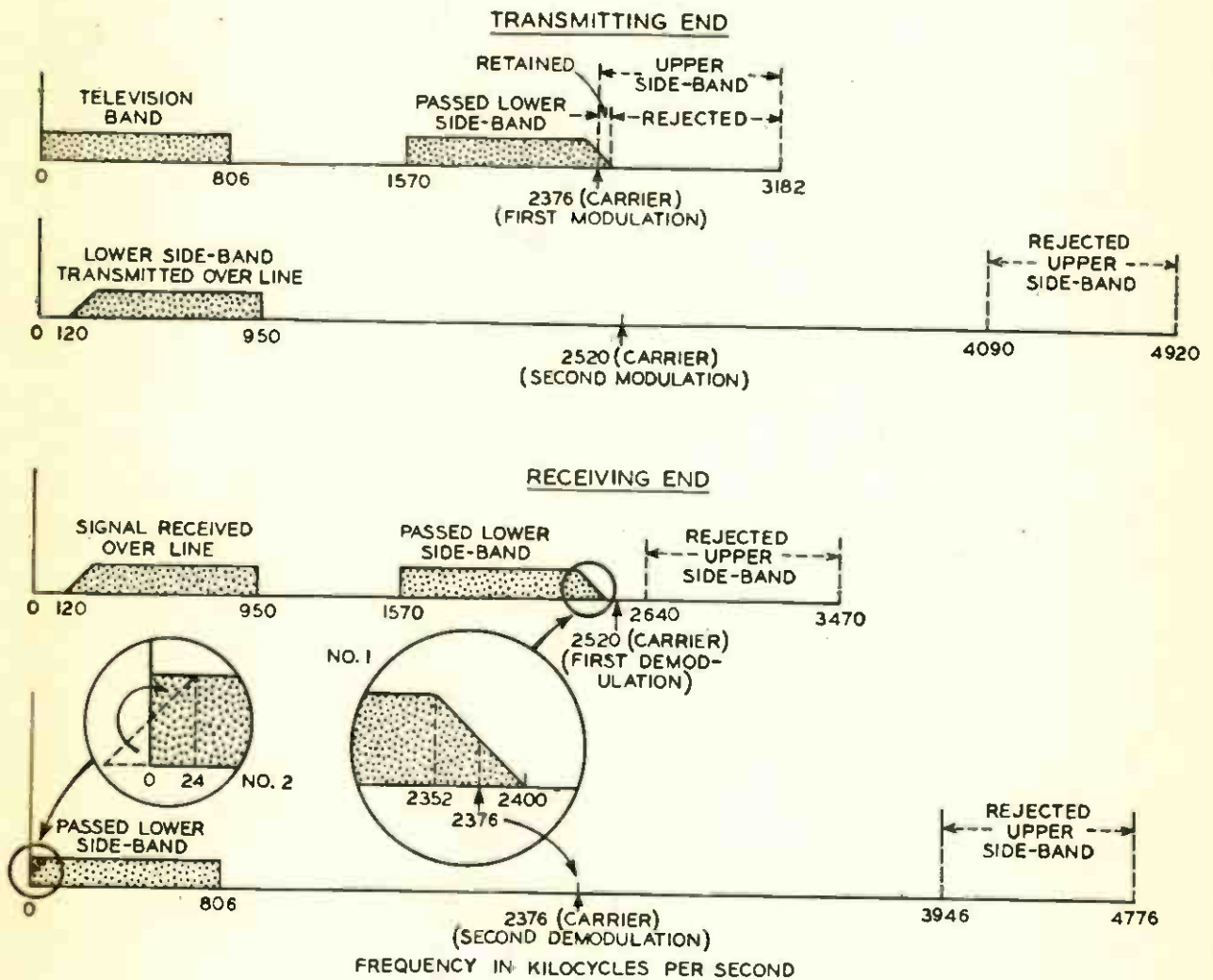

FIG. 5

Modulating and demodulating scheme for the recent television transmission, beginning with the first modulation at New York, above, and ending with the second demodulation at Philadelphia, below.

1570 to 2376 kc and an upper sideband from 2376 to 3182.

The carrier itself is eliminated in the balanced modulator. The output of this modulation is passed through a filter, but because the two sidebands touch each other at 2376 kc, the filter cannot cut off all the upper sideband. At the output of the filter there is thus the lower sideband plus a small amount of the lower part of the upper sideband. The upper sidebands from all subsequent modulations are

readily eliminated by the following filters because of the wide separation.

The carrier for the second modulation is 2520 kc, and the lower sideband extends from 950 down to 144 kc plus the vestigial upper sideband remaining from the first modulation which extends below 144 kc.

The lower edge of the filter following this modulation is accurately designed to attenuate slightly a group of frequencies just above 144  
(Continued on next page)

(Continued from preceding page)

kc and to pass with controlled attenuation the vestigial upper sideband, which then extends from 144 to about 120 kc. The resulting single sideband, extending from 120 to 950 kc, is then passed over the coaxial cable to Philadelphia.

### EQUALIZERS INTRODUCED

Here the transmitted band, together with a carrier of 2520 kc, is applied to the first demodulator, and the lower sideband, from 2400 down to 1570, is passed to the second demodulator where a carrier of 2376 kc is applied. The lowest frequency of the lower sideband, 1570

but consideration of certain factors led to the decision to hold frequencies between 806,000 and 5760 cycles to a delay of about 0.3 micro-second, and frequencies below 5700 cycles to a delay of about forty micro-seconds. The actual circuit roughly met these requirements as indicated by Fig. 8, which shows the phase delay characteristics of the line, repeaters and equalizers, and of the overall circuit including the phase equalizers.

Noise or interference is very annoying in television transmission; and pattern, or single-frequency interference, is particularly objectionable. The permissible noise or interference depends

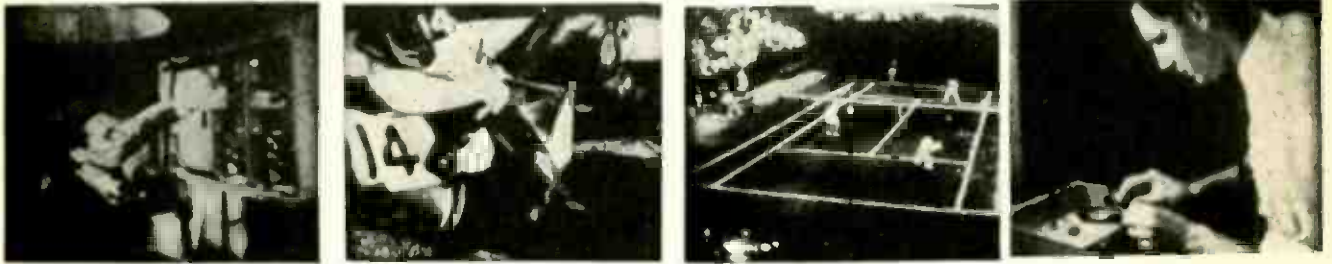

FIG. 6

Photographs of the receiving tube during transmission. In the tennis match the ball itself shows and its movement could be followed. The race horse is interesting because of the way the half-tones were reproduced.

kc, is converted to 806 kc, becoming the highest frequency of the final demodulated band. The frequencies from 2352 to 2400 kc of the sideband before the second demodulation are somewhat attenuated as a result of the filter following the second demodulator, and the second demodulating carrier, 2376 kc, falls in the middle of this attenuated band as shown in inset No. 1. Frequencies extending about 24 kc above the carrier are inverted by the demodulation, and superimposed upon the corresponding frequencies just below the carrier. The magnitude and phase of these components are proportioned by the filter and equalized so that the overall result, when they are superimposed, is an essentially flat transmission band from 0 to 806 kc.

Besides this carefully planned modulating and demodulating arrangement at the terminals, it was necessary also to provide networks and equalizers to insure that the coaxial line did not distort the ultimate image due to unequal attenuation, resulting in amplitude distortion, or to unequal time of transmission, causing phase distortion. The actual attenuation characteristics of the line, the line plus repeaters, and the overall result are shown in Fig. 7.

### REGISTERING THE DETAILS

The attenuation requirements are not particularly severe, but those for phase distortion are difficult to meet. The details in the scanned picture result in the various frequencies of the electrical signal, and if these details are to appear in the reproduced picture in the same relative position as in the scanned picture, it is essential that all frequencies be received in very closely the same relative time relationship as they were generated. Theoretical analysis

does not lead to any well defined requirements, on the amplitude range of the reproduced picture. During these experiments, it was found that a substantially linear response could be obtained over a current range of 30 db—corresponding to a brightness range of 15 db. The actual

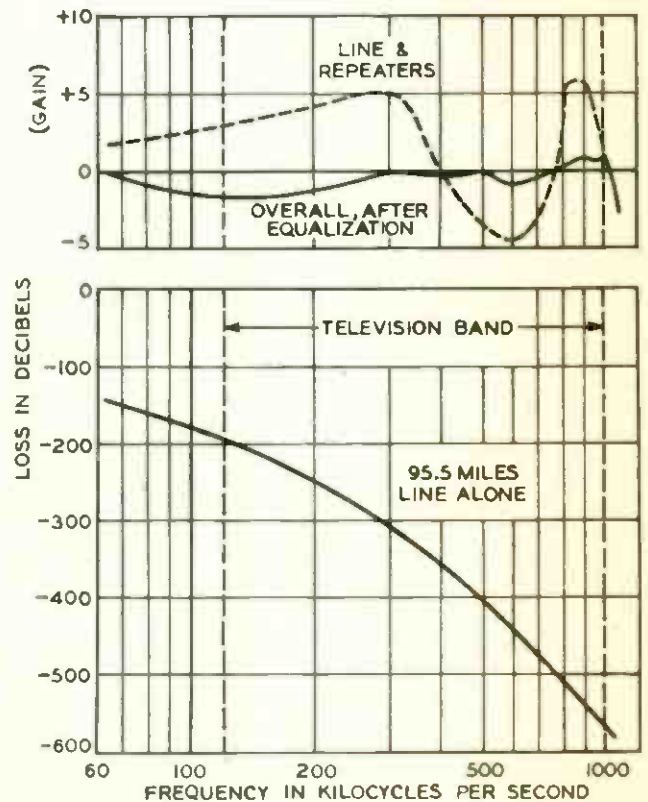

FIG. 7

Attenuation of the coaxial circuit between New York and Philadelphia as arranged for the television experiments.

range of the reproduced pictures extended somewhat beyond the range of linear response. It

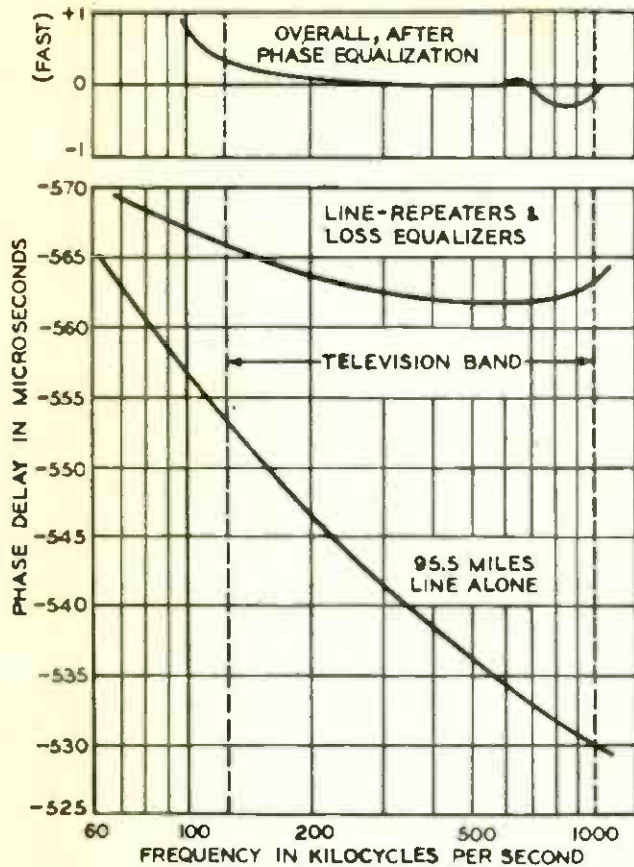

FIG. 8

Phase delay of the coaxial circuit during the recent experiments.

was found desirable to hold random interference down about 40 db below the maximum signal, and pattern interference down at least 15 db more.

The terminal equipment besides providing modulators, amplifiers, filters, and equalizers, New York, thus showing that the cable system itself introduced no appreciable distortion. must also provide for the generation of the two modulating carriers accurately spaced. This is accomplished by deriving all carriers from a 4000-cycle reference frequency at the transmitting end. From this source a 72 kc frequency is first obtained, and is then used for deriving the modulating carriers of 2376 and 2520 kc through harmonic generators. The same 72-kc frequency is also transmitted over the coaxial line to Philadelphia, where exactly synchronous carriers are derived from it for demodulating. These are adjusted for phase manually by observing the picture. To synchronize the scanning arrangements at the sending and receiving terminals, a frequency corresponding to the speed of the scanning disk is also transmitted. The appearance and arrangement of the terminal apparatus are shown in Fig. 9.

Many of the engineers who worked on the system, and outside experts who observed it, expressed the opinion that the reproduced pictures in Philadelphia were substantially the same as those seen on a similar receiving device in

### CAN MEET REQUIREMENTS

The opinion was also expressed that in spite of the use of only 240 lines, the pictures were remarkably clear and distinct. The photograph at the head of this article shows the end of the reproducing cathode-ray tube at Philadelphia, with C. L. Weis monitoring. The actual illumination on the tube was of such low intensity that it was difficult to secure photographs in the time interval of one frame. The tennis match scene shown here, however, is an actual

*(Continued on following page)*

FIG. 9  
Modulating terminal equipment at the New York end of the coaxial circuit.



# TRANSMISSION

## Characteristics of the Coaxial Structure

By J. F. Wentz

Transmission Development, Bell Telephone Laboratories

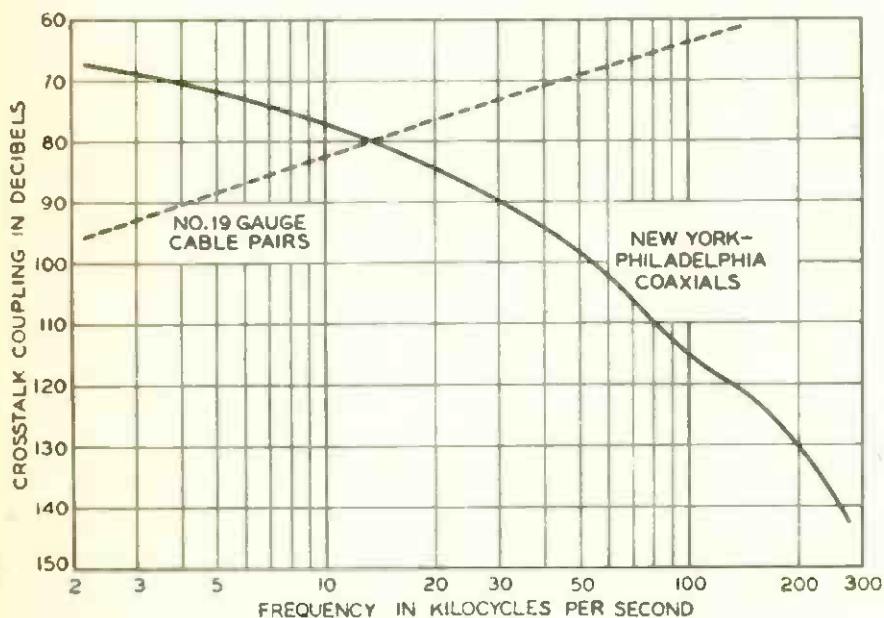

FIG. 1  
Typical crosstalk values for ten miles of nineteen-gauge cable pair and the coaxial structure.

THE very earliest telephone lines consisted of only one wire with the earth as a ground return. It was soon discovered, however, that not many such lines could be operated simultaneously in the same neighborhood. The large separation between the wire on a pole and its ground return formed a large loop which was ideal for transferring energy to other similar loops by induction. In addition the voice currents from all such grounded circuits flowed in the common ground which also tended to increase the crosstalk between them. By using another nearby wire for the return path of each circuit, most of this trouble disappeared. Since then ungrounded or metallic-return circuits have been employed almost exclusively, either as open-wire lines on poles or as paper insulated pairs in cables. With the coaxial structure,

however, which has been tried out experimentally, between New York and Philadelphia, the outer conductor is grounded; and thus on a circuit carrying a far wider range than the early voice-frequency circuits there is a reversion to the grounded circuit that proved so impracticable.\*

This anomalous situation is explained by the peculiar nature of the coaxial structure. The fact that the outer conductor is grounded does not mean that the return current of the circuit passes through the ground, and thus over the same path as the return of adjacent circuits. The reason for this is the phenomenon commonly known as "skin effect," which has more

(Continued on following page)

\* Bell Laboratories Record, June, 1937, p. 325.

## Wide Band Is Transmitted Well

(Continued from preceding page)

photograph of the end of the tube, although not taken under the conditions shown.

These experiments have proved that a wide-band signal of the type required for television

can be satisfactorily transmitted over a coaxial system. Work is already under way on repeaters and terminal apparatus for transmitting wider bands of frequency to meet the standards now envisioned by the television industry.



(Continued from preceding page)  
 and more influence as the frequency becomes higher. Skin effect is an inductive reaction that—as the name implies—causes the current to flow in the skin or near the surface of a

rents are physically in the same conductor as the return currents of the coaxial circuit but are electrically separated from them by the intermediate metal of the outer conductor. The higher the frequency the greater will be the

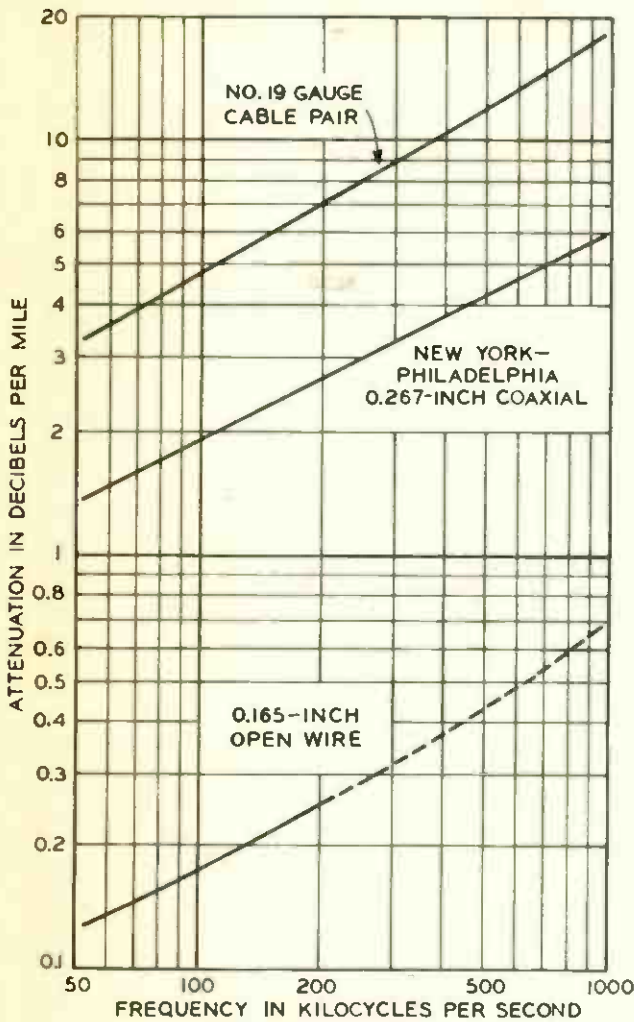

FIG. 2

Typical attenuation values per mile for nineteen-gauge cable pair, open-wire lines, and the coaxial structure.

conductor. With an ordinary circuit consisting of round wires, this means that the current tends to avoid the center of the wire and flows mostly in the outer layers. At very high frequencies it flows in a very thin surface layer or skin of the conductor.

**CURRENT IN OUTER SKIN**

In the coaxial circuit, the current flows largely in the outer skin of the central conductor and along the inner surface of the outer conductor. Even though the outer conductor is grounded, therefore, there is no appreciable mingling of the return currents of two adjacent conductors if the frequency is sufficiently high, because the return current of each structure is held to the inner surface of its own outer conductor, and is thus separated from the return currents of adjacent structures. Furthermore, in the case of lightning and power line interference, the currents induced are, by the same skin effect, forced to flow on the outside surface of the outer conductor. These induced cur-

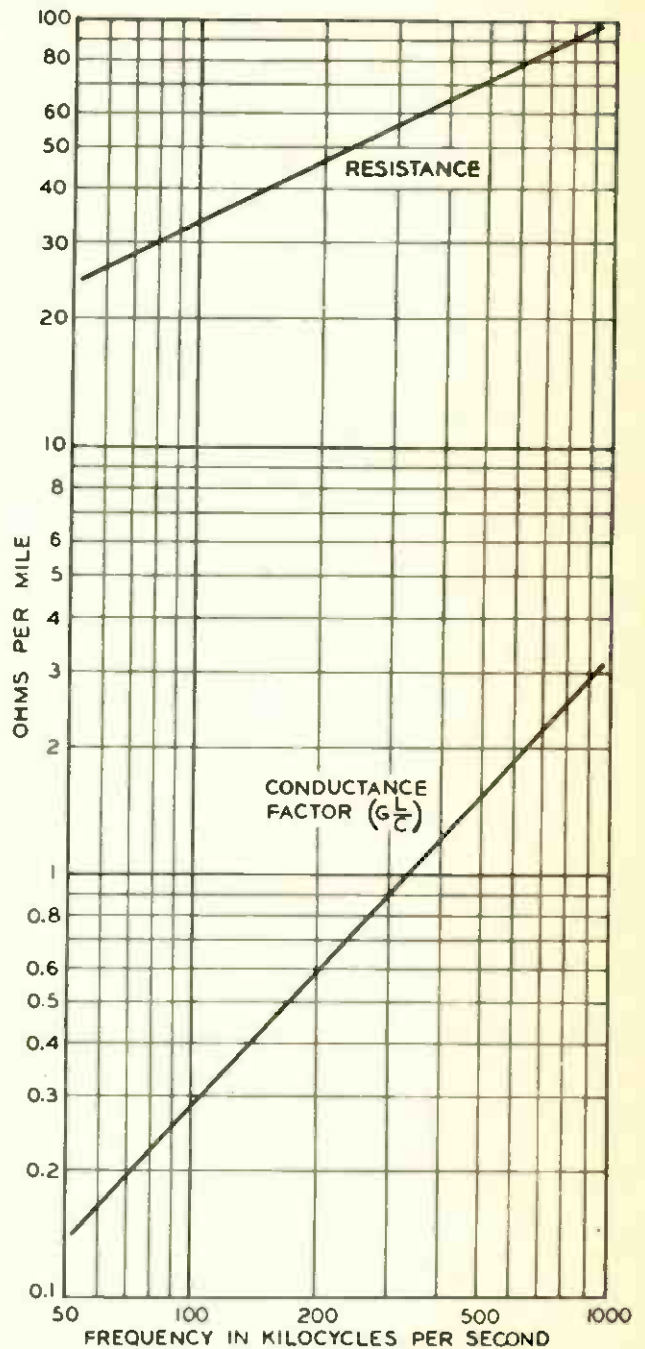

FIG. 3

Resistance and conductance factors for the coaxial structure.

separation between the signal and the disturbing currents. At very high frequencies, as a result, the signal currents of the coaxial structure are almost completely isolated from the disturbing currents.

The interference in a telephone circuit from other similar circuits is known as crosstalk, and the effectiveness of the coaxial circuit in eliminating it at high frequencies is indicated by Fig. 1, which shows the relative crosstalk coupling between ordinary cable pairs not individually shielded, and between two coaxial struc-

(Continued on following page)

(Continued from preceding page)  
 tures in the same sheath. It represents the ratio of the output of a disturbing circuit to the output of a disturbed one of the same type when the former and the latter are measured at the same end. With a rising cross-talk characteristic, as in existing cable, a frequency would be reached sooner or later where the disturbances become so great as to cause impairment of secrecy; but with a falling characteristic, as exists with the coaxial structure, the higher the frequency, the smaller becomes the chance of secrecy impairment.

**ATTENUATION PER DB MILE**

This shielding effect of the outer conductor makes the coaxial structure particularly suitable for the transmission of very high frequencies. Long before the top frequency of the present frequency band is reached, the crosstalk volume drops below the level of the thermal noise from the cable itself, and is thus always below the requirements for very quiet circuits.

The other transmission characteristics of the coaxial structure are not so unusual as the shielding, and depend primarily on the size and relative spacing of the conducting elements.

The attenuation for the coaxial structure in db of the conductor resistance. Values for both, per mile is shown in comparison with the equivalent values for typical cable and open-wire circuits in Fig. 2. The values are roughly proportional to the size of the conductor employed, which for the cable pair is 0.036 inch, for the coaxial is 0.072 inch, and for the open-wire line is 0.165 inch. This attenuation in terms of the four primary constants of the circuit is given very closely by the expression.

$$a = 4.343 \left( R + \frac{L}{C} \right) \sqrt{\frac{C}{L}}$$

in db per mile,

which is a part of the solution of the differential equation of transmission.

The largest contribution to the attenuation is the resistance, R. Due to the skin effect it increases with frequency, and at 1,000 kc is many times the d-c value. The conductance, G, sometimes called the leakance, acts as though the insulators were resistance shunts across the line. In the equation above, the conductance factor that causes attenuation is  $G(L/C)$  and is equivalent to a resistance that absorbs the

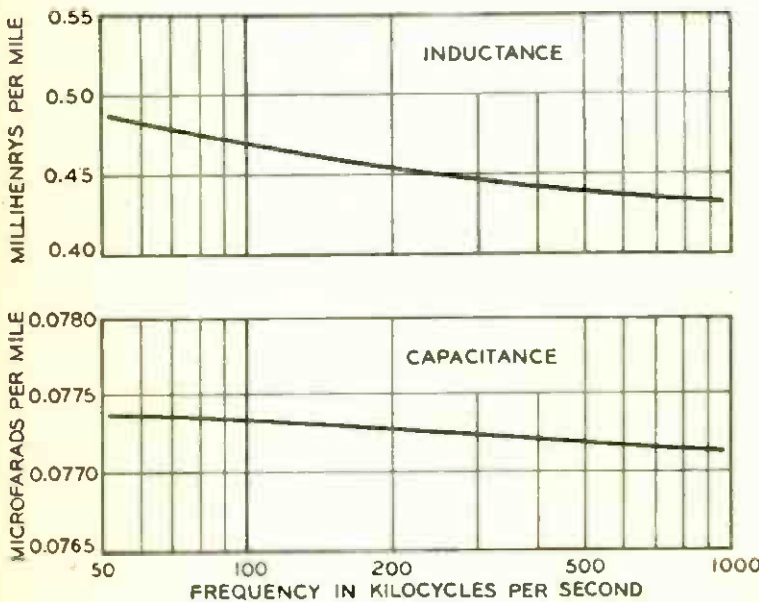
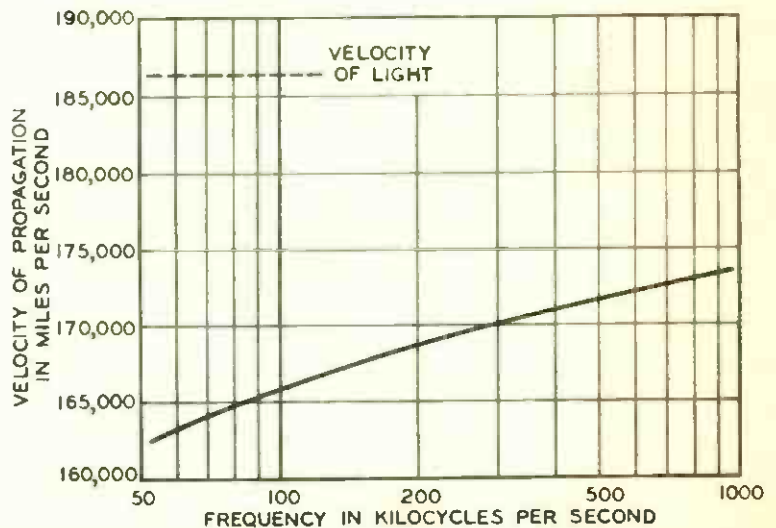

FIG. 4 (left)

Inductance and capacity characteristics for the coaxial structure. It is the ratio of these two factors, rather than their absolute values, that is of importance so far as attenuation is concerned.

FIG. 5 (right)

Velocity-frequency characteristic for the coaxial structure. The velocity of propagation is calculated from the transmission equation. Insulators used add about 13 per cent. to capacity and 2 to 14 per cent. to the inductance.



same amount of power as the insulators. In the coaxial structure it is only a few per cent over the frequency range involved, are shown in Fig. 3.

### CHARACTERISTIC IMPEDANCE

Values of the capacitance,  $c$ , and inductance,  $L$ , are given in Fig. 4 for the same range of frequencies, but as is evident from the formula, it is the ratio of these two factors rather than their absolute values that is of importance so far as attenuation is concerned. It is the ratio of these two factors that also determines the characteristic impedance of a long cable, which is the impedance it offers to a steady frequency applied at one end. The expression for the characteristic impedance is also obtained from the transmission equation, and is found to be

$$Z_0 = \sqrt{\frac{L}{c}} \text{ ohms.} \quad \text{It is practically a pure}$$

resistance, although actually there is a slight capacitance component at the lowest frequencies we use.

The velocity of propagation over the coaxial cable may also be calculated from the transmission equation, and turns out to be

### SHIELD AROUND METAL TUBES

IS there anything to be gained in putting a shield around a metal tube, which is already shielded?

There is no necessity for the extra shield, as the tube envelope is sufficient shield. A rare exception is when a metal tube is used as a power oscillator, when some extra shielding may be introduced, as there may be radiation from the metal casing of the tube at high frequencies. However, due to heat consideration, the extra shield then would have to be perforated or consist of copper screen.

$$v = \frac{1}{\sqrt{LC}} \quad \text{Again } L \text{ and } c \text{ are the im-}$$

portant factors, but this time as a product. If the capacitance were air alone, without any insulators, and if the conductors were very thin cylinders, the velocity for all frequencies would be equal to that of light, or about 186,000 miles per second. Actually the insulators used add about thirteen per cent to the capacitance, and the conductors are so thick that they add from two to fourteen per cent to the inductance. Thus, the velocity varies from 163,000 to 173,000 miles per second as shown in Fig. 5.

### DELAY DISTORTION

The difference in the time of transmission of different frequencies is called delay distortion. It is not very large over one of the 4,000-cycle bands used as a voice channel, and causes no distortion in speech that the ear can detect. Over a very wide band, however, such as was used for the transmission of television, the delay distortion amounts to a fraction of a microsecond in every mile, and if not corrected produces a distortion that the eye can detect. For our television demonstration special apparatus was constructed to measure this distortion so that equalizers could be built to correct it.

All of these characteristics were calculated before the cable was actually manufactured, but measurements of the primary constants were also made during manufacture, in the laboratory, and in the field after the cable was laid. A laboratory test is pictured in the photograph at the head of this article, and a field test, using a special truck equipped for the purpose, is shown in Fig. 6. Measurements made after installation check the calculated values closely.



FIG. 6

A field test being made of the coaxial cable after it was installed.

# Low Cost Design for A.C.

## The 6Y6-G Affords 3.3 Watts, Push-Pull 6 Watts at Low D-C Voltages

CIRCUIT OF POWER SUPPLY AND A-F PORTION OF TYPICAL RECEIVER

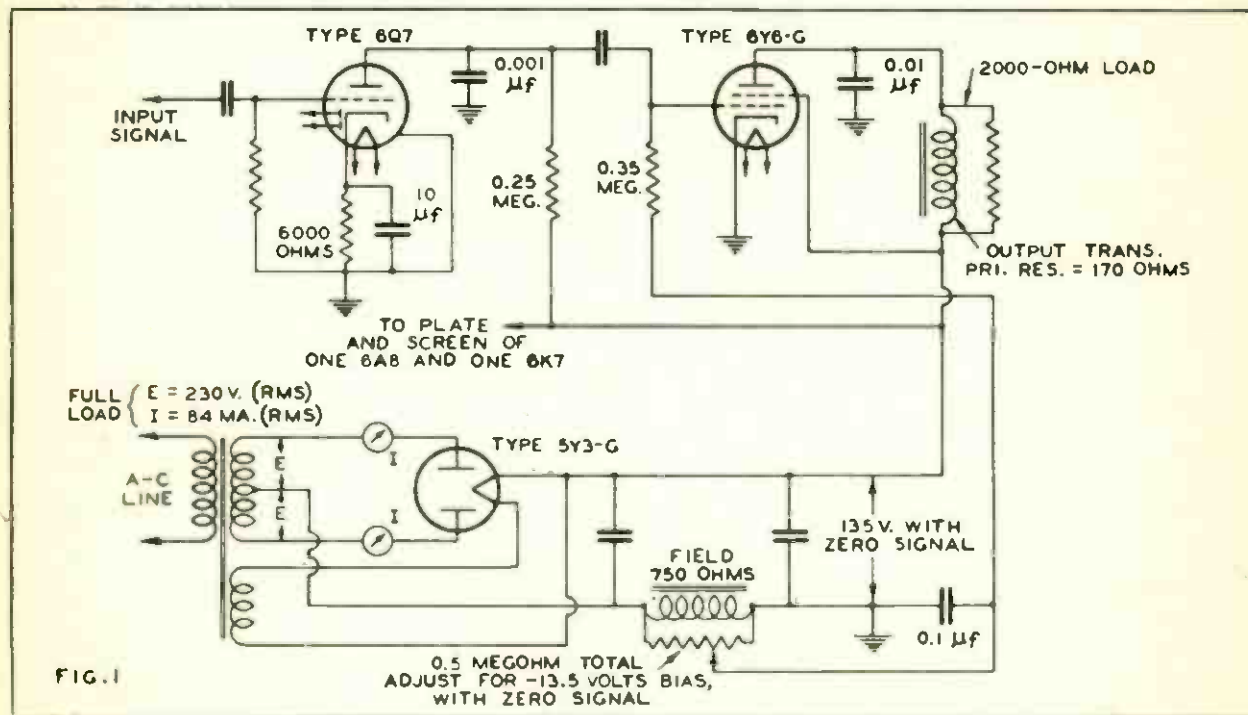

THE problem of producing a low-cost a-c operated receiver can be solved satisfactorily by employing a power output tube designed for operation at low voltages. The use of such an output tube effects substantial savings in receiver cost because a low-voltage power transformer, low-voltage filter condensers, and a low cost rectifier tube are used.

The 6Y6-G, a 6.3-volt, 1.25-ampere beam power amplifier, is intended for use in such an a-c operated receiver. Its characteristic features are high power sensitivity and high plate-circuit efficiency. Under ideal conditions of zero power-supply regulation, a single 6Y6-G can furnish 3.6 watts with reasonable distortion; under practical operating conditions, approximately 3.3 watts can be obtained at the grid-current point. Two type 6Y6-G's connected in push-pull can furnish nearly 6 watts at the grid-current point in a receiver of average design.

This Note describes operation of the 6Y6-G in single-ended and in push-pull circuits. All the data reported in this Note were taken in a radio receiver of average design in order that the information would be of practical value. The rms rectifier current and rms rectifier voltage are also given to facilitate the design of the power transformer. The type 5Y3-G was

used as a rectifier in both single-ended and push-pull tests. (The 5Y3-G is similar electrically to the type 80.)

### SINGLE-TUBE TESTS

Single-tube tests were conducted in a receiver using a 6A8, 6K7, 6Q7, 6Y6-G, and 5Y3-G. An a-f signal was fed to the input of the triode section of the 6Q7 and the power furnished by the 6Y6-G to the primary of the output transformer was measured. The circuit of the power supply and of the a-f portion of the receiver is shown in Fig. 1. In these tests, bias on the 6Y6-G was adjusted to  $-13.5$  volts and the screen voltage was adjusted to 135 volts with no signal.

Curves of power output, distortion, and screen dissipation vs load resistance are shown in Fig. 2. The recommended load of 2,000 ohms was selected on the basis of good power output, reasonable distortion, and reasonable screen dissipation at the grid-current point. It should be noted that screen dissipation rises rapidly with load impedance. Hence, a high value of load may contribute to poor tube life because of excessive screen dissipation.

The value of load shown in these tests is the parallel combination of the output trans-

former's primary impedance at 420 cycles and a fixed resistor. Bias for the 6Y6-G was obtained from the voltage drop across the speaker field. This arrangement is preferred by some engineers because the voltage output of the filter (Fig. 1) is less than that required for self-biased 6Y6-G's by an amount equal to the bias voltage.

Curves of distortion and peak input signal vs power output for a load of 2,000 ohms are shown in Fig. 3. The grid-current point of the 6Y6-G was reached at 3.3 watts output; the grid-current point of the 6Q7 was reached at 4.75 watts output. The power delivered from the secondary of the output transformer to the speaker is obtained by multiplying the power delivered to the primary by the efficiency of the output transformer. The efficiency of the usual single-tube output transformer is about 70 per cent.

### CURRENTS COMPARED

The cathode current of the 6Y6-G remained substantially constant at 65 milliamperes and the total rectifier current remained substantially constant at 85 milliamperes. The total rectifier current included the current drain of the 6A8 and 6K7; the avc system was not acting on these tubes during the tests. When the converter and i-f tubes are under the control of

the avc system, the values of total rectifier current and 6Y6-G cathode current are somewhat different from the values given.

When the rectifier is furnishing maximum current, the voltage per plate of the 5Y3-G is 230 volts (rms) and the rectifier current per plate is 84 milliamperes (rms). Under these conditions, the screen voltage is approximately 130 volts. The decrease from 135 volts is due to the internal resistance of the power-supply unit.

The receiver used in the previous tests was redesigned to accommodate two 6Y6-G's connected in push-pull and a two-tube phase inverter. The circuit of this arrangement is shown in Fig. 4. Two 6Q7's were used in the phase inverter circuit in order that a single cathode resistor and by-pass condenser could serve for both tubes. The diode plates in the second 6Q7 were connected to cathode, as shown, but may be grounded.

### FILTER FOR REDUCING HUM

The output tubes were self-biased by a cathode resistor. When the bias is obtained from the voltage drop across the speaker field in a manner similar to that shown in Fig. 1, a large amount of hum is introduced into the grid circuit of 6Q7 (II). This hum voltage can be  
(Continued on page 31)

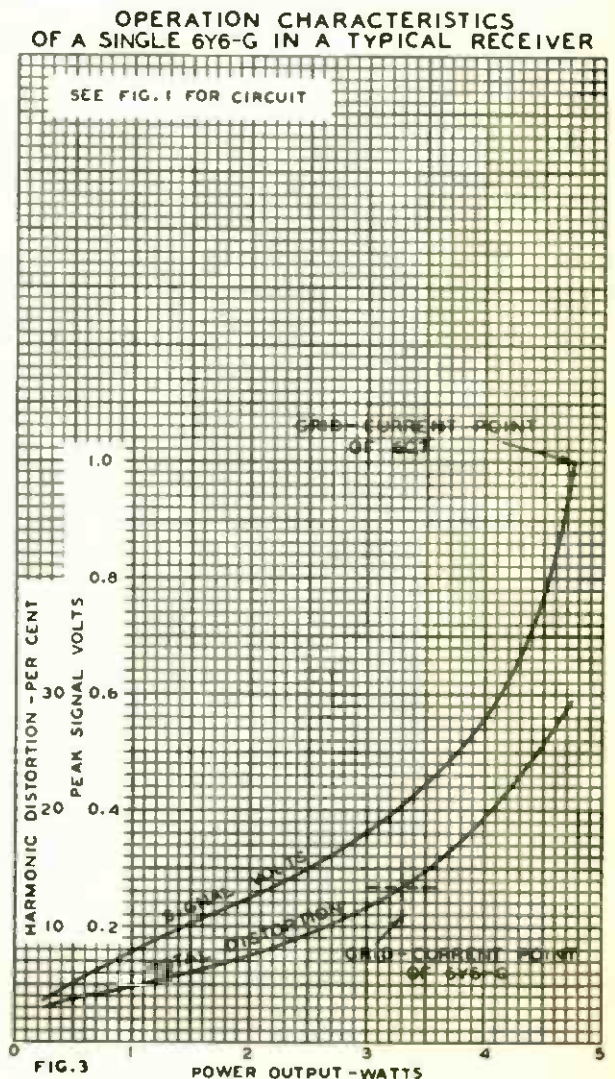
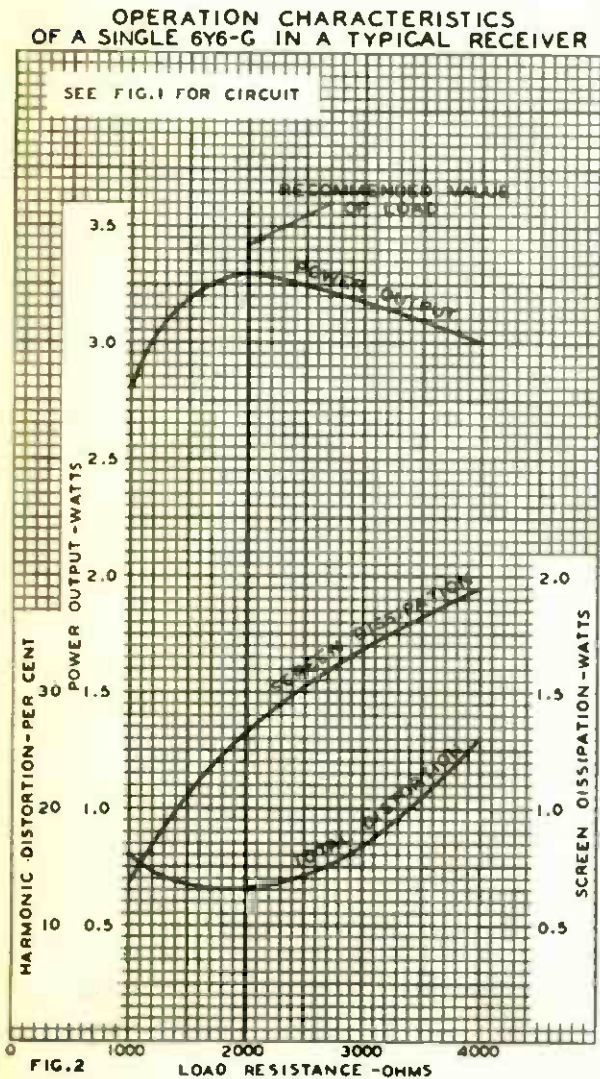

CIRCUIT OF POWER SUPPLY AND A-F PORTION  
(WITH TWO-TUBE PHASE INVERTER) OF TYPICAL RECEIVER

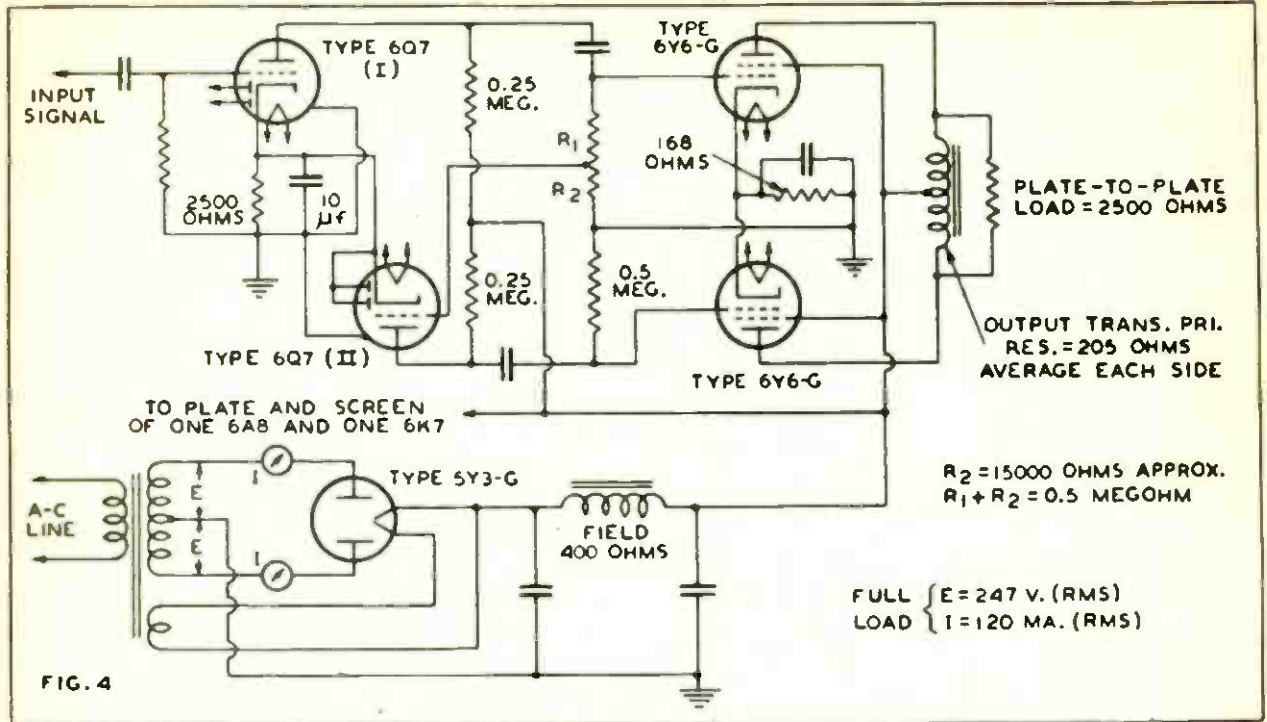

Values of constants not given in above diagram will be found in the text.

OPERATION CHARACTERISTICS  
OF PUSH-PULL 6Y6-G'S IN A TYPICAL RECEIVER

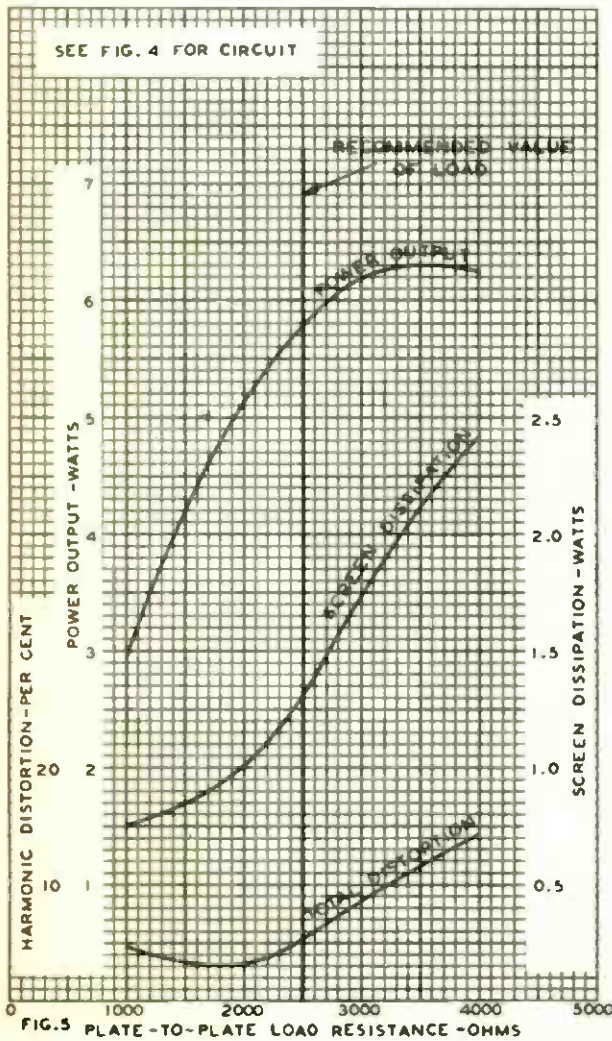

OPERATION CHARACTERISTICS  
OF PUSH-PULL 6Y6-G'S IN A TYPICAL RECEIVER

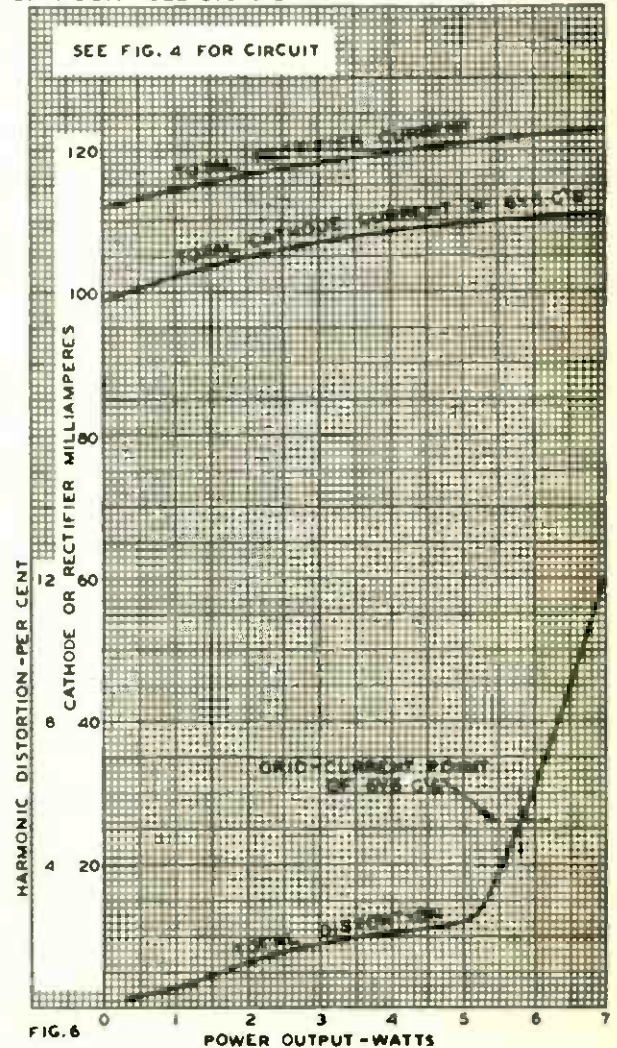

# Low Drain, High Output in Battery-Operated Audio Amplifier

OPERATION CHARACTERISTICS OF 6AC5-G.

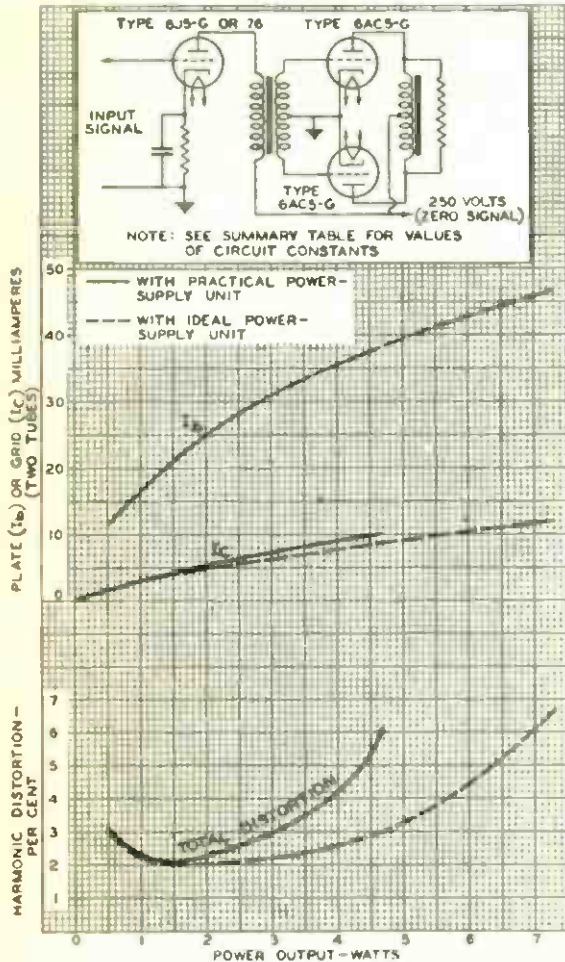

The power output, in watts, of the 6AC5-G, given on the base line, is compared to distortion and grid or plate currents, given on the perpendicular.

(Continued from page 29)

reduced to a satisfactory level by employing a suitable resistance-capacitance filter in the grid circuit of this tube. When such a filter is used, the plate-supply voltage of both 6Q7's is the zero-signal output voltage of the rectifier, or 135 volts. With 135 volts available from the filter, the output voltage of the 6Q7's at their grid-current point is not enough to drive the output tubes to full output (grid-current point of 6Y6-G's) when the output tubes are biased for class A<sub>1</sub> operation. Moreover, with class A<sub>1</sub> operation of the output tubes, the total rectifier current is high. However, when the output tubes are biased by a self-bias resistor, the output voltage of the filter is approximately 150 volts, which is the plate-supply voltage of the 6Q7's. With this value of supply voltage, the output of the 6Q7's is more than sufficient to drive the 6Y6-G's output. Hence, the 6Y6-G's can be overbiased to reduce the total

AN important requirement of an audio-radio receiver or mobile power-amplifier is low A-battery drain. As an aid in satisfying this requirement without sacrificing power output it is customary to employ a Class B output stage having low zero-signal plate current. Of course, plate current increases with power output in a Class B amplifier, but the plate-circuit efficiency is quite high compared to that of a Class A amplifier.

The 6AC5-G is a single high-mu triode suitable for use in a Class B amplifier. With 250 volts applied to the plates of two 6AC5-G's connected in push-pull, nearly 7.5 watts can be obtained with the voltage taken from an ideal power-supply unit and 4.6 watts with the voltage taken from a practical power-supply unit.

## 1,000 OHMS A GOOD AVERAGE

Under these conditions, the zero-signal plate current of two tubes is only 5 milliamperes. An ideal power-supply unit is defined as one which has zero internal resistance; a good value of internal resistance for a practical power-supply unit is 1,000 ohms.

Data on the operation of two 6AC5-G's connected as a zero-bias Class B amplifier are presented in this Note. This information is summarized in the accompanying chart; detailed operating data are given by the curves. Data showing the performance of the tubes with a nearly perfect interstage transformer and an ideal power-supply unit are included to show what can be obtained under the most favorable conditions in comparison with what can be expected under typical operating conditions.

The types 6J5 and 76 were selected as drivers  
(Continued on following page)

rectifier current to approximately 125 milliamperes.

Curves of power output, distortion, and screen dissipation vs plate-to-plate load are shown in Fig. 5. A recommended plate-to-plate load of 2500 ohms was selected from these data. Curves of distortion, total rectifier current, and output-stage cathode current vs power output are shown in Fig. 6. A power output of nearly 6 watts with 5 per cent distortion is obtained at the grid-current point of the 6Q7's.

When the rectifier is furnishing maximum current, the voltage per plate of the 5Y3-G is 247 volts (rms) and the rectifier current per plate is 120 milliamperes (rms). Under these conditions, the screen voltage of the 6Y6-G's is 117 volts. The internal resistance of the power-supply unit, as calculated from zero-signal and full signal data, is approximately 1600 ohms.

Copyright 1938 by R.C.A. Manufacturing Co., Inc.

**SUMMARY TABLE Class B Operation of Type 6AC5-G Tubes**

Tube Type	Driver Stage				Interstage Transformer				Output Stage				Total Harmonic Distortion (Per cent)			
	Input Signal (Peak Volts)	Zero-Signal D-C Plate Current (Milliamperes)	Max.-Signal D-C Plate Current (Milliamperes)	Grid-Bias Resistor (Ohms)	Primary	Secondary	Resistance of Power-Supply Unit (Ohms)	Grid Input Peak Voltage (Volts, Grid-to-Grid)	D-C Grid Current (Milliamperes, 2 Tubes)	Zero-Signal D-C Plate Current (Milliamperes, 2 Tubes)	Max.-Signal D-C Plate Current (Milliamperes, 2 Tubes)	Max.-Signal Plate Voltage (Volts)		Zero-Signal Plate Voltage (Volts)	Max.-Signal Plate Voltage (Volts)	Plate-to-Plate Load (Ohms)
6J5-G	7.2	8.6	8.82	930	3.25	1 <sup>1</sup>	0	57.3	12.1	5.0	47.0	250	250	11000	7.30	6.7
6J5-G	5.9	8.4	7.45	930	3.0	1 <sup>2</sup>	1000	52.1	10.0	5.0	38.0	250	250	11000	4.65	6.1
76	13.4	4.9	5.05	2750	4.0	1 <sup>1</sup>	0	58.0	12.1	5.0	47.5	250	250	11000	7.40	7.5
76	11.2	4.8	4.20	2750	4.0	1 <sup>2</sup>	1000	50.5	9.6	5.0	37.9	250	250	11000	4.65	6.3

<sup>1</sup>Resistance of primary of a nearly ideal transformer is 320 ohms; average resistance of total secondary is 255 ohms.  
<sup>2</sup>Resistance of primary of practical transformer is 680 ohms; average resistance of total secondary is 325 ohms.

**Cornell-Dubilier Reduces Size in New Electrolytics**



New compact electrolytic condenser.

A startling reduction in size of electrolytic capacitors is clearly shown in the above exact-size illustration. Cornell-Dubilier engineers have succeeded admirably in designing the new C-D type BR etched-foil electrolytics to a physical size one-fifth that of corresponding types, and retaining the excellent and dependable characteristics outstanding in all Cornell-Dubilier capacitors.

Constructional and servicing advantages are readily seen. The C-D type BR's fit conveniently into the most confined spaces; their high quality characteristics make them ideal for servicing jobs, especially a.c.-d.c. midgets. Both terminals are insulated, protective cardboard sleeve is supplied to insulate container, the compact unit being hermetically sealed. Installation, therefore, is made as simple as mounting a tubular paper condenser.

Cornell-Dubilier type BR dry electrolytics are available in single sections only, in capacities of 4, 8, 12, 16, 20 and 40 mfd. at 150 volts d.c. and up to 8 mfd. 450 volts d.c. Full details will be sent upon your request. Address Cornell-Dubilier Electric Corporation, South Plainfield, New Jersey.

**High Output, Low Drain for Battery Operation**

*(Continued from preceding page)*

because their plate-current drain is low and because they can furnish the power required by the grids of the output tubes with reasonable distortion.

In all tests, the input signal was applied to the driver; full output is defined as that obtained at the grid-current point of the driver. The operating data shown by the curves apply to both the 6J5 and 76 drivers, provided the proper interstage-transformer ratio is used with each type of driver.

Copyright 1938 by R.C.A. Manufacturing Co., Inc.

**WARNING BY CRAVEN**

Commissioner Craven submitted a report to the Federal Communications Commission praising free speech in radio but warning of censorship possibility if the privilege is abused.



# New Metal Converter Tube

## 6K8 Improves High-Frequency Response and Maintains Stability Despite A.V.C.

A NEW triode-hexode converter tube was recently announced.

The 6K8 is a multi-unit type of all-metal vacuum tube incorporating a triode unit and a hexode unit. It is intended primarily for use as a converter in superheterodyne receivers, especially those of the all-wave type. In such receivers, performance of the 6K8 is characterized by improved frequency stability in the high-frequency band.

The design of the 6K8 incorporates a triode unit and a hexode unit in one metal shell. G3, or signal input of the hexode, is a cap.

The action of the 6K8 in converting a radio frequency to an intermediate frequency depends on (1) the generation of a local frequency by the triode unit, (2) the transferring of this frequency to the hexode grid No. 1, and (3) the mixing in the hexode unit of this frequency with that of the r-f signal frequency applied to the hexode grid No. 3.

Because of its design, the 6K8 offers distinctive features of practical interest to the set engineer as follows: (1) in a-c/d-c receivers, the same voltage can be used for the screen and plate of the hexode unit. Such operation is made possible because shield plates serve as a suppressor to raise the plate resistance of the hexode unit at low plate voltages. (2) The triode plate voltage can be the same as the hexode screen voltage and provide adequate oscillation, because the latter is substantially independent of the hexode screen voltage. (3) For adequate conversion transconductance and high plate resistance (hexode unit), only a low triode grid current is required. (4) There is small variation in transconductance of the triode unit with changes in bias on hexode control-grid No. 3. As a result, the oscillator frequency is not appreciably influenced by avc voltage.

This is an advantage of considerable importance on short waves particularly.

### 6K8 Triode-Hexode Converter (Tentative Data)

HEATER VOLTAGE (A.C. or D.C.)	6.3	Volts
HEATER CURRENT	0.3	Ampere
DIRECT INTERELECTRODE CAPACITANCES (Approx.):*		
Hexode Grid No. 3 to Hexode Plate	0.03	Mmfd.
Hexode Grid No. 3 to Triode Plate	0.01	Mmfd.
Hexode Grid No. 3 to Triode Grid	0.1	Mmfd.
Triode Grid to Triode Plate	1.1	Mmfd.
Triode Grid and Hexode Grid No. 1 to Hexode Plate	0.05	Mmfd.
Hexode Grid No. 3 to All Other Electrodes = R-F Input	6.6	Mmfd.
Triode Plate to All Other Electrodes (except Triode Grid and Hexode Grid No. 1 = Osc. Output)	3.2	Mmfd.
Triode Grid and Hexode Grid No. 1 to All Other Electrodes (except Triode Plate) = Osc. Input	6.0	Mmfd.
Hexode Plate to All Other Electrodes = Mixer Output	3.5	Mmfd.
MAXIMUM OVERALL LENGTH	3 1/8 inches	
MAXIMUM DIAMETER	1 5/16 inches	
CAP.	Skirted Miniature—Style B	
BASE	Small Wafer Octal 8-Pin	Volts

Hexode Screen Voltage	100	100
Hexode Control-Grid Voltage	-3	-3
Triode Plate Voltage	100	100
Triode Grid Resistor	5000	50000 o. Megohms
Hexode Plate Resistance (Approx.)	0.3	0.6 meg.
Conversion Transconductance	360	400 mi. Volts

Hexode Control-Grid Bias (Approx.) for Conversion Transconductance =		
2 micromhos	-30	-30 v.
Hexode Plate Current	2.3	2.7
Hexode Screen Current	6.9	6.5
Triode Plate Current	3.5	3.5
Triode Grid Current	0.15	0.15

The transconductance of the oscillator portion (not oscillating) of the 6K8 is approximately 2400 micromhos when the Triode Plate Voltage is 100 volts, and the Triode Grid Voltage is 0 volts.

\* With shell connected to cathode.

\*\* In circuits where the cathode is not directly connected to the heater, the potential difference between heater and cathode should be kept as low as possible.

#### Converter Service

HEXODE PLATE VOLTAGE	250 max. V.
HEXODE SCREEN (Grids No. 2 & 4) VOLTAGE	100 max. V.
HEXODE CONTROL-Grid (Grid No. 3) VOLTAGE	-3 min. V.
TRIODE PLATE VOLTAGE	200 max. V.
TOTAL CATHODE CURRENT	Milliamperes
TYPICAL OPERATION:	16 max. Ma. Volts
Heater Voltage **	6.3 6.3
Hexode Plate Voltage	100 250

#### Pin Connections

- Pin 1—Shell
- Pin 2—Heater
- Pin 3—Hexode Plate
- Pin 4—Hexode Grids No. 2 & 4
- Pin 5—Hexode Grid No. 1 & Triode Grid
- Pin 6—Triode Plate
- Pin 7—Heater
- Pin 8—Cathode
- Cap —Hexode Grid No. 3

Data supplied by RCA Radiotron

# NEW HOME FAC

**A**FTER ten years of laboratory research, RCA Victor has made available to radio broadcasters a simplified radio facsimile system to flash pictures, news bulletins and other text through the air and into the home.

The first demonstration of the newly-developed facsimile apparatus was given recently for the benefit of the radio broadcasting executives and engineers attending the annual convention of the National Association of Broadcasters, at the Willard Hotel, in Washington, D. C.

Already, seven large radio stations in different sections of the country,

most of them (tus, preparator ices. These st both owned by ramento "Bee" falo "Evening owned by th WOR, of the ark, N. J.

Radio facsim considered by br ment existing planned to bro arad broadcast, morning hour that a complet user when he a has also set asi lengths for day

The new i Charles J. Yo neer, and his a paper, or news paper, at the r paper roll on printed is 8½ each page is Printing speed record per ho at the printer- apparatus on a determined tra

TWC

The facsimil simple wood ca in. by 12 in. Al inside so that once they hav paper rolls out cabinet.

Two design have been devel automatically c and deposits th is much simpler strips. It is fo the home appa expensive as is tion.

The new, si- veloped in the experimentation facsimile appar for commercial and informatio transmission of across the Atl developed as th because of its e

(Co

## EXPERIMENTAL FACSIMILE

NEW YORK N. Y.

FRIDAY

SEPT 10, 1937



MAJOR GENERAL FRANK R. MCCOY

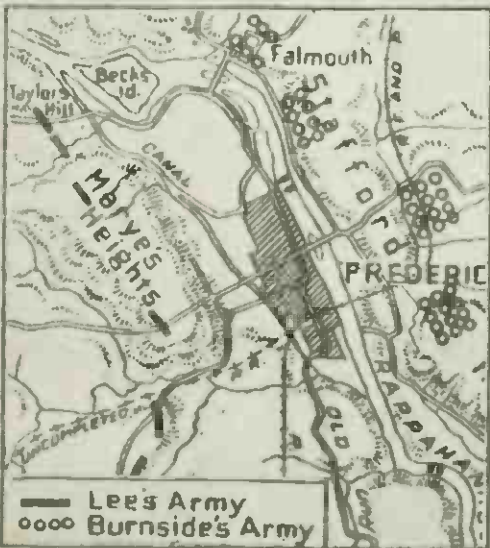
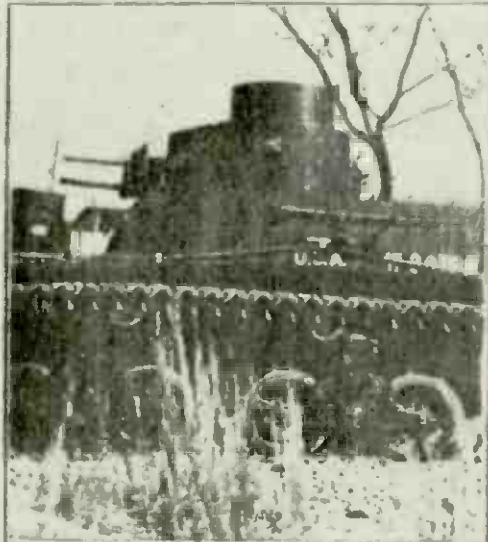

cost plant in by the opar a to existing lines, minimum cost. yet the ation to plant costs. Altho- it be fully considered as cost elen- and in every other way seemingly dis- it is uneconomic by reason of excessive trans- sion and the in cost. Conversely certain other tances to load centers. Nearness of existing high- voltage lines, and advantageous location of step- down stations in respect to city distribution systems may become a credit rather than a charge. If, for example, a large power consuming industry is sit- uated close to the power site that it can be served eco- nomically by transmission with voltage saving in transmission cost compared with a more distant source, or if nearby railroad lines are electrified there may be a distinct saving in the in expense- only because of the presence of the electrified tr- ansporting equipment. In the in expense- ing power to that industry from a more distant source, or if nearby railroad lines are electrified with single-phase system rather than aver- age converting equipment with three-phase system, there will be a saving in transmission charge rate. Espe-

Here is a sample of what came over the air in a demonstration of a new facsimile system that uses the regular home broadcast receiver, where a still picture re- producer supplants the loudspeaker. The illustration is half the actual size of the received facsimile.

# SIMILE SHOWN

owned by newspapers, have placed orders for the new apparatus to launching their experimental facsimile transmission operations are KMJ, Fresno, and KFBK, Sacramento, California, the McClatchy Properties, publishers of the Fresno and Sacramento; KHQ, Spokane, Washington; WBEN, owned by the Buffalo News; WTMJ, owned by the Milwaukee "Journal"; KGW, the Portland "Oregonian"; and L. Bamberger Company of New-

*The FCC requires each station to install at least fifty receiver-printers for each facsimile-scanner transmitter.*

facsimile service, as it is being conducted by radio broadcasters, will probably supplement sound broadcast programs. It is used to broadcast pictures and text on standard radio wavelengths during the early hours of the day, between midnight and dawn, so that the morning bulletin will be ready for the news broadcasts in the morning. The FCC has authorized a number of ultra-short wavelength radio stations for day and night facsimile service.

The facsimile system, developed by RCA Victor research engineers, utilizes ordinary white paper, and ordinary carbon receiving end. The width of the paper is 12 inches. The proposed length of the roll is at the rate of three feet of paper per hour. A time clock arrangement on the receiver automatically turns the power on and off in accordance with a pre-arranged transmission schedule.

## MODELS OFFERED

The receiver-printer is encased in a cabinet measuring only 18 in. by 18 in. The mechanism and controls are so arranged that they may not be tampered with unless they have been properly adjusted. The paper is fed through a slit in the front of the cabinet.

Two models of facsimile receiver-printers are being developed. One is fairly elaborate and cuts the paper into 12-inch pages which are collected neatly in a tray. The other model is simpler, and does not cut the paper into pages. It is intended that for experimental purposes the receiver should be as simple and inexpensive as possible, consistent with good reproduction.

The simplified facsimile system was developed by RCA laboratories after years of experimentation with many different types of apparatus, some of which were employed for the transmission of weather maps and news to ships at sea, and for the transmission of photographs and other material. The new equipment was designed to be the most practicable for home use, with extreme simplicity.

*(Continued on page 37)*



Charles J. Young, RCA Victor research engineer, with the simplified radio facsimile receiver-printer he developed for home use (with the lid-cover removed).

# Seven Large Stations to Send Still Pictures and News Bulletins



The young lady is reading a facsimile sheet torn from the model that delivers a continuous roll. All the controls are within the cabinet so that they may not get out of adjustment. Page size is  $8\frac{1}{2} \times 12$  inches on a continuous roll, printed at the rate of three feet an hour. An automatic time clock arrangement turns the device on and off in accordance with the pre-determined transmission schedule.

## Compact Transmitter-Scanner

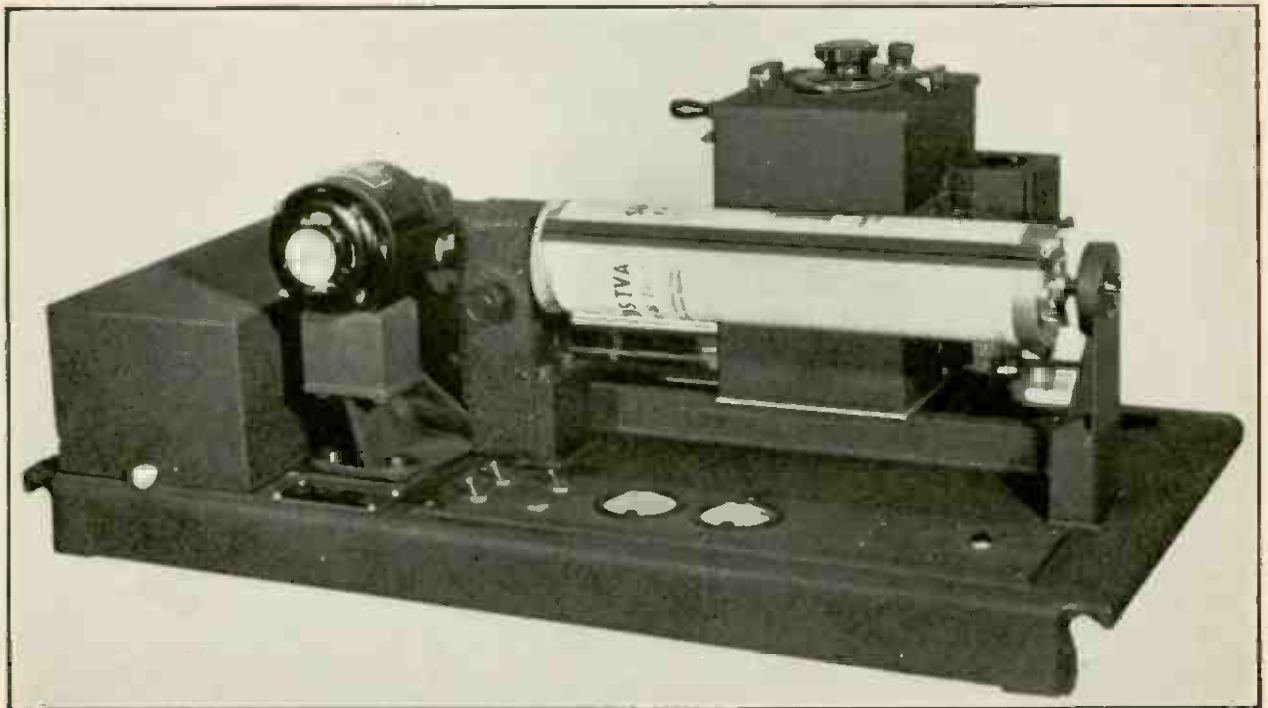

The facsimile transmitter scanner, for use by broadcasting stations. Pictures, text or drawings are placed directly on the roller drum, the speed of which is synchronized with the receiver-printer in the home. Speed of transmission is at the rate of  $8\frac{1}{2} \times 12$  inch page every eighteen minutes. About two minutes is required to fit each page on the drum.

# HOUSE GROUP HEARS PLEAS TO REPEAL TAX

Washington

The campaign of Radio Manufacturers Association in Congress to repeal or substantially reduce the Federal radio 5 per cent. excise tax received a hearing by the House Ways and Means Committee.

President Muter and O. Fred Rost, editor of "Radio Retailing," made some brief statements. Other radio industry leaders present included two directors of RMA, Ben Abrams, of New York, Peter L. Jensen, of Chicago, and John R. Howland, of Philadelphia.

## ARGUMENTS SET FORTH

RMA contended that the radio tax was a special burden on the greatest agency of mass communication; that its repeal or reduction would increase sales, employment, and spread the utility of radio to many millions more American homes; that radio is no longer a luxury; and that the price had been greatly reduced, and it was now in universal use.

That an entirely different condition exists today than when Congress enacted the tax in 1932 was stressed by Mr. Geddes. Pointing out that repeal was proposed of similar excise taxes on furs, sporting goods, cameras, and other luxury articles, Mr. Geddes urged that radio was entitled to prior consideration as a great agency of public use and service. He pointed out that Congress could at least reduce the radio tax to 2½ or 3 per cent, on the same basis as the automobile tax.

Also asked by the RMA was exemption of police, aircraft, marine, public address, and all other commercial radio, together with administrative changes to relieve manufacturers, espe-

## Westminster Abbey Wired for Sound With 70 Amplifiers

Westminster Abbey, historic shrine of the British Commonwealth, resting place of her kings and heroes, is being wired for sound. The impression made by the extensive public address system which was installed for the Coronation ceremony in May was so favorable that work is now progressing on a permanent installation. The system for the Coronation and for permanent installation is supplied and installed by Standard Telephone & Cables, Ltd., manufacturing subsidiary in London of the International Telephone and Telegraph Corporation.

Six microphones and 70 amplifiers are involved. The system is regarded as one of the most complete and most modern in use anywhere. Special installation problems are being met in the placing of the loud speakers. It has been possible to locate most of them so that they are invisible to the audience, but where this might impair the performance of the equipment, the speakers have been finished to match exactly their surroundings.

Without amplification, services are almost entirely inaudible in some parts of the Abbey.

cially of parts and accessories, not only of the tax but of accounting and collection difficulties.

## RADIO FOR MORE HOMES

President Muter reinforced the RMA position by similar arguments that repeal or reduction of the tax would permit radio to go into 4,000,000 homes now without it. Mr. Muter urged that radio prices would be reduced and greater public service provided if the tax were repealed. He pointed out that by radio, public men could reach the public direct, without any "interpretation," as in the press.

## Home Sets Adaptable to Facsimile

(Continued from page 35)

The picture, drawing or text to be transmitted is placed on the roller drum of the "scanner" at the station. A beam of light travels horizontally across the page as the drum revolves. The light is reflected and focussed on a sensitive photo-electric cell in the various degrees of shading corresponding to the picture. The photo-electric cell transforms the light into electrical impulses which are flashed through the air.

The receiver is synchronized to the transmitter-scanner. The signals are picked up on a broadcast or other receiver, exactly as in sound broadcasting, but instead of passing through the

loudspeaker, they are made to actuate the printer mechanism. Continuously-fed rolls of ordinary white paper and ordinary carbon paper are led past a metal cylinder drum, on which a single spiral of wire projects a fraction of an inch above the surface. The fluctuations in the intensity of the incoming signals press the paper and carbon together against the spiral to make marks corresponding to the light and shade of the original at the scanner.

The facsimile signals may be heard on the loudspeakers of ordinary radios, when broadcast wavelengths are used, as high-pitched tones of varying intensity.

They resemble television's clatter.

# KILLING OFF INTERFERENCE

## Sources of Trouble Fully Analyzed and Remedies Expertly Recommended

By Alfred A. Ghirardi

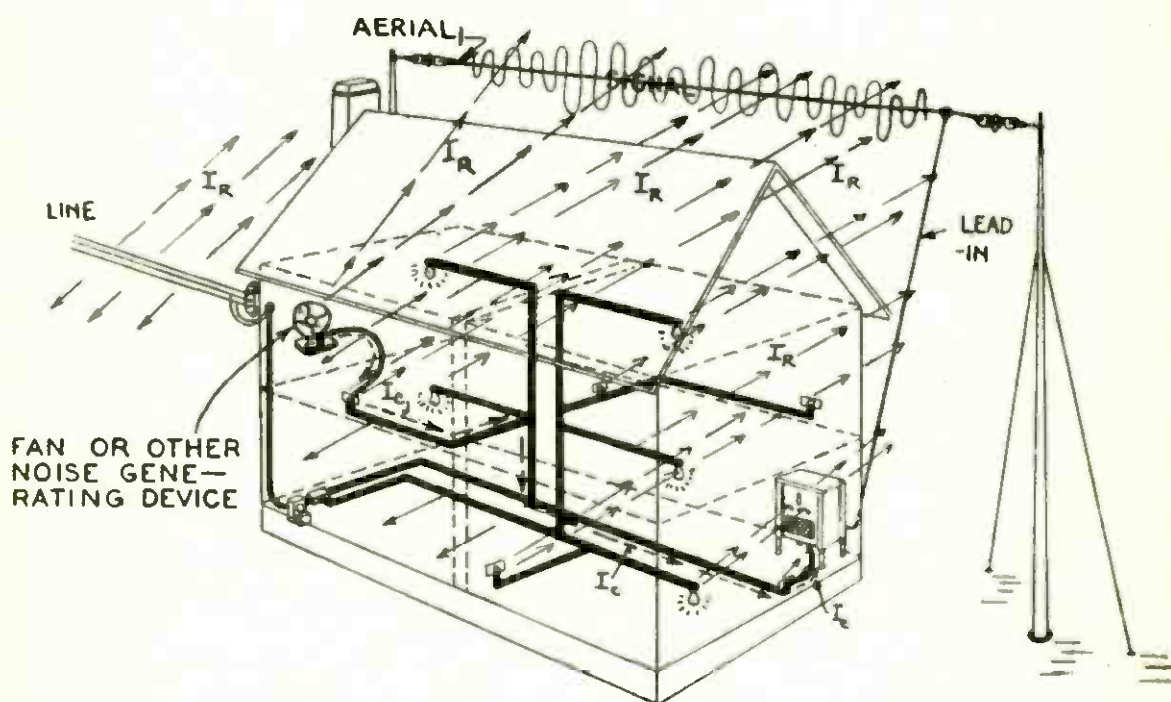

FIG. 1.

How the electromagnetic fields produced by lightning discharges (or other atmospheric discharges) between charged clouds (and between charged clouds and the earth) are radiated out into space, where they may induce interference potentials in the antenna systems of radio receivers located even many miles away. If these radiations reach the antennas with sufficient strength, interference known as natural "static" results.

[The following discussion of interference is reprinted from "Modern Radio Servicing," by Alfred A. Ghirardi, E. E., by special permission of the author and his publisher, and copyright owner, Radio & Technical Publishing Company—EDITOR.]

THE problem of minimizing or entirely eliminating man-made electrical interference which appears as disturbing crackles, clicks, buzzes, crashes, etc., along with the programs heard from radio receivers is one with which radio service men are now being faced squarely, and with greater frequency, than ever before. The term "interference" is commonly applied to include under one heading all of the various

classes of disturbing noises of this kind. Noisy reception occurring in radio receivers is one of the most serious and troublesome problems which the radio technician is called upon to solve. The problem of eliminating man-made interference to radio broadcast reception has become so serious, that several European countries have already taken definite steps to relieve the situation by law if possible.

For instance, in France, under date of April 1, 1934, a ministerial decree (a law) which defines radio interference, lists all the common sources of interference and makes it obligatory for the owner of the interfering equipment to eliminate the interference (under penalty of the law) was put into effect. Should an interfering

electrical device used in an apartment tend to create disturbances in radio receivers in the surrounding vicinity, for instance, the owners of the receivers in which the interference is being received have the right to complain to the Ministry of Posts, Telegraphs, and Telephones. The owner is notified immediately by the latter and given a period of one week in which to eliminate all electrical disturbances caused by his device—at his own expense. In fact, since the early part of 1935, the installer of a new device, as well as the manufacturer who provides it, is held responsible for the elimination of any interference which it creates.

### ABROAD AND AT HOME

In Germany, England and Canada, official government recognition and assistance has also been given in this problem.

In the United States, no such general laws exist (except in a few local communities, particularly in the middle west and on the Pacific coast) and the government has not interested itself in the problem. The Radio Manufacturers Association has formed a Committee on Interference which will work in cooperation with others interested in electrical and radio organizations to study and classify the various general sources of this interference, investigate the efficacy of the various methods of eliminating it and endeavor to enlist the help of all concerned in eliminating such sources of interference.

Just how much success the last mentioned step will meet with in the absence of any compelling laws remains to be seen, for anyone who has had considerable experience in attempting to persuade owners of interfering devices to equip them with effective interference-suppression devices (which cost money) knows that a good majority of such attempts are met with the proverbial "cold shoulder."

People are not generally willing to comply with such requests when it is going to cost them money, in fact, it is often exceedingly difficult to convince them at all that common electrical appliances in their homes are causing interference in the radio sets of strangers living in the same apartment house—much less a few blocks away.

### SERVICEMAN'S POSITION

In the United States at least, when a dealer sells a radio set and installs it, it is up to him to provide noise-free reception. The customer usually expects it, and the sale of the receiver often depends on it. When a service man is called in on a complaint of noisy reception due to interference, it is up to him to hunt down the cause of the interference and apply the proper remedy to eliminate it. The remedy must be as effective and inexpensive as possible, for his customer must pay the bill—even though an electrical device belonging to a neighbor is causing the trouble.

In order that service men may eliminate man-made interference as effectively, directly and inexpensively as possible, they must be thoroughly acquainted with the various causes of interference, the common devices which produce it, the various ways in which it may reach the receiver, the methods of testing to find out

definitely how it is reaching the receiver and the most effective remedies to apply to minimize or eliminate it under any installation conditions which may be encountered.

It must be realized at the start that interference elimination often is a very difficult task. It is a problem that cannot be solved by the wave of a magician's wand, the rubbing of an Aladdin's lamp, or the indiscriminate purchase and installation of all sorts of "gadgets" which are advertised as cure-alls for interference and which are applied to filter "this and that." In other words, as is the case with so many other problems in radio servicing, the service man must possess a thorough knowledge of the entire subject, use good sense in applying it, and be level headed throughout the job when tackling interference problems.

The set analyzer is almost useless for this sore of work, excepting in some cases where the interference is caused by one of the parts in the receiver itself, in which case, the set analyzer may help to locate the offending part. As a result of considerable experimental work on this problem, it is now possible to follow definite plans of attack in order to minimize interference, and in most cases, to actually identify the type of device which is producing the interference simply by listening to the character of the interference noise as evidenced in the loud speaker of the radio receiver. The service man should be thoroughly acquainted with the various methods which have been developed to accomplish this quickly and effectively.

### SETS IMPROVE, INTERFERENCE RISES

One very interesting fact concerning the entire noise problem, though it may seem ambiguous at first thought, is that the increasing importance and seriousness of the noise problem is due fundamentally to the many improvements which have been made in receivers during the past few years. Even simple sets of today are many times more sensitive than the most pretentious "super-blooperdynes" of a few years ago. They are so sensitive, that thousands of them will be found installed without benefit of any honest-to-goodness aerial. The owners, usually at the short-sighted advice of the dealers who sold them the sets and stressed the fact that they were so "good" and so sensitive that they would work "without an aerial" (thus making the sales easier for themselves and eliminating the need for installing aerials free with the set installations) simply took the sets home and installed them by plugging into the power line and throwing a short piece of wire out of the window, placing it behind the picture moulding, under a rug, or in some other easily accessible location. Since such locations are low and usually within the strong field of man-made electrical interferences, these installations are often found to be extremely noisy. Also, since the signal pickup with such aerials is small, the receiver must be operated at almost full sensitivity most of the time, thereby greatly amplifying the interference impulses as well as the signal.

The widespread popularization of short-wave  
(Continued on following page)

(Continued from preceding page)

and all-wave receivers has also had its effect. Since short-wave programs usually originate at distant points and the short-wave signals reach the listeners in greatly weakened condition, short-wave and all-wave receivers are built more sensitive than the standard broadcast band sets.

### MOSTLY DUE TO SENSITIVITY

The greater sensitivity at which they must be operated in order to pick up these weak signals is the main reason why more interference is experienced on the short wave bands than on the standard broadcast band. Also, the interference created by most electrical appliances and automobile ignition systems is stronger in the short-wave region and therefore is more troublesome in short-wave receivers. Since the sale of short-wave receivers is often impeded by noisy receiving conditions, the problem of interference elimination becomes a matter of dollars and cents to both the radio set manufacturer and the dealer.

Finally, the improvement in the high-frequency audio response of receivers has had its effect. It is generally well known that a great deal of the noise (both "static" and man-made electrical interference) produces audio disturbances in the neighborhood of 4,000 cycles and higher in the loud speaker. Consequently, receivers with good high-frequency response reproduce these noises with greater intensity than do those having poorer high-frequency response. Of course, the usual "tone control" may be used to suppress the high-frequency response of the receiver and thus reduce the noise, but the quality of reproduction also suffers if this is done.

### HOW INTERFERENCE ARISES

The fundamental principles of radio transmission involve the setting up of electric waves at the antenna of the broadcast station. These are radiated through space to the antenna of the receiving sets in which they induce modulated high-frequency currents which are amplified and rectified (detected) by the radio receiver so that a more or less faithful reproduction of the original voice-frequency sound waves are delivered from the loud speaker.

Now any electrical circuit which involves a spark or arc also sets up radio-frequency waves or radiations which are propagated into space; in fact, this is the principle upon which the operation of the now outmoded spark transmitters operated. How far they travel, and how strong they are depends upon the energy involved in the sparking circuit and to a large extent, upon the circuit itself. Most of these disturbances which cause noise in radio receivers are of relatively small power at their source, compared to the power radiated from a broadcast station. However, since their sources are very much nearer to the receiver than the broadcast station is, they often reach the receiving equipment with an intensity comparable to that of the broadcast signals and cause annoying interference.

The one main exception to this lies in the case

of disturbances due to lightning flashes. A single lightning flash puts out far more radiated power than all the broadcast stations in the world combined, so even though it takes place a great many miles away from the radio receiver, its disturbance may reach the receiver with sufficient intensity to cause interference—especially in sensitive receivers.

### VARIOUS CAUSES

Disturbing radiations, then, may be set up by practically any electrical circuit which involves a make and break of contact. Lightning discharges, atmospheric discharges not quite of lightning intensity, all switches, thermostat controls, motor commutators, automobile and oil burner ignition systems, X-ray, violet-ray and diathermy apparatus, and any other devices which involve the making or breaking of an electric circuit (even if the making and breaking is regular and continuous) are potential sources of radio interference, *provided the amplification of the radio receiver is sufficient to make these disturbances heard at an annoying noise level along with the desired program.* Also, any disturbances may be carried along wires or other conductors and re-radiated by them for some distance. Finally, if the radiating circuit is untuned (as it usually is), the radiations will cover a wide frequency range as contrasted to a broadcasting station, which radiates its signal energy on practically a single frequency (or at least a very narrow band of frequencies).

We will now study these various sources of interference systematically and in detail so that we may be thoroughly acquainted with the exact types of interference they set up and how it is likely to be propagated to the radio receiving equipment. When this is known, the problem of eliminating their interference can be attacked more directly and intelligently.

### THE FOUR TYPES

Generally speaking, *interference* (so far as it relates to broadcast reception) includes any sound emitted from the loud speaker, that does not originate at the transmitter but detracts from the full enjoyment of the broadcast program. Interference may be classified broadly into four types, according to the origin of the electrical disturbances which cause it. They are:

- (1) Interference caused by natural "static" (atmospheric disturbances).
- (2) Inter-station interference.
- (3) Interference caused by some part in the receiving equipment.
- (4) Interference caused by external electrical devices controlled by man (commonly termed *man-made* interference).

The nature of these types of interference will now be considered in the foregoing order.

### NATURAL STATIC

Clouds become electrically charged by the friction set up between the droplets of their water vapor and the surrounding air. Considerable electric potentials may thus be built up. When the potential difference between two such



banks of charged clouds or between one cloud bank and the earth becomes sufficiently high, it breaks down the insulating qualities of the intervening air an electric discharge takes place in the form of the familiar zig-zag "lightning" flash or spark. This action is illustrated in Fig. 1. Since the two cloud banks, or the one cloud bank and the earth, really form two plates of a large condenser with the intervening air as the dielectric, the discharge is really that of a condenser and is of the usual oscillating form associated with discharges of this nature. Since these lightning discharges really constitute the flow of powerful electric currents, they produce electromagnetic radiations,  $F_1$  and  $F_2$ , which are exactly of the same nature as those of radio signals from broadcast stations and spread out in practically all directions. It is not necessary than an actual lightning flash or discharge take place. Intermittent leakage currents which flow between charged clouds or between clouds and the earth also cause "static" disturbances. In general, lightning storms, "northern lights," heat-lightning, dust storms, rain storms, etc., may be the cause of particularly annoying electrical interference, even at considerable distances.

### CAN'T TUNE OUT NATURAL STATIC

A receiving aerial located in the path of these radiations will have corresponding voltages induced in it, and the discharges will be heard as a series of crashes and individual impulses. The intensity of the disturbance which reaches the receiving antennas on any particular locality depends on whether the nearest flash of lightning is taking place near the aerial, a few hundred miles away, or a few thousand miles away.

It is reasonable to suppose that thunderstorms and atmospheric electrical discharges are occurring somewhere in the world at all times, and even though a single flash radiates far more power than all the broadcasting stations in the world combined, the extreme distance reduces their intensity so that they are not all disturbing in the average radio receiver. It is only when the disturbances are particularly severe, or within a reasonable distance from the receiving equipment, that they are annoying.

The important point about natural static is, that since it is caused by disturbances which cover a broad frequency range and are of exactly the same nature as the broadcast radio signals, it cannot be tuned out or suppressed without reducing the strength of the desired signals also.

Regardless of the fact that many so-called "static eliminators" or "suppressors" are offered for sale for the elimination or reduction of atmospheric static, the truth is that all of them reduce the static effects simply by reducing the sensitivity of the receiver, so that both the desired signals and static are heard more weakly. Practically the same result could be obtained at no cost by simply turning down the volume control of the receiver. It is the opinion of responsible investigators that natural atmospheric disturbances cannot be *eliminated* successfully, although under some circumstances they can be *reduced* somewhat in intensity. A few

static eliminators which do *reduce* the effect of atmospheric static have been designed, but these devices are so intricate, elaborate and costly as to prohibit their general use in home receivers.

### ANNOYING THROUGHOUT

Although the intensity of static is much less on the shorter waves (higher frequencies) than it is on the longer waves, it is often a source of very annoying noises on the standard broadcast bands. Since this class of interference may be said to be beyond man's immediate control there is little that the radio service man can do about it. Fortunately it is not really troublesome everywhere, or at all times. In locations where it is very strong, it is best to educate the owners of radio receivers to reduce the sensitivity of their receivers by operating them with the volume control down as much as is consistent with audible reception; to place the tone control in the "bass" position when static is severe, so as to reduce the high-note response of the receiver; to have all interference other than natural static cleared up if possible, so that the total noise level will be reduced, and to maintain all antenna and receiver connections electrically and mechanically secure to prevent them from causing additional noises.

### INTERSTATION INTERFERENCE

Interstation interference is usually evidenced by high-pitched "peanut-stand" heterodyne whistles which may be either steady or slightly varying in pitch. It is caused by heterodyning of the carrier waves of stations occupying adjacent frequency channels, and sometimes by the *harmonics* of stations which broadcast at fundamental carrier frequencies which are quite widely separated. In superheterodynes, "image interference" caused by the simultaneous reception of two stations whose carrier frequencies differ by approximately twice the i-f of the receiver may be heard if the pre-selector is not able to eliminate the image-frequency signal, and if the resultant beat note between the two signals falls within the range of the audio amplifying and reproducing equipment in the receiver.

By suitable pre-selector design, this trouble has been largely eliminated in modern receivers, though it is often encountered in many of the older sets. In such receivers, the service man can eliminate the whistle effectively by image-interference elimination or by connecting to the receiver a suitable low-pass filter adjusted to have a cut-off point just below the heterodyne (whistle) frequency. An ordinary "tone-control" arrangement connected in the audio amplifier and adjusted to the proper point is satisfactory. This, of course impairs the reproduction of all the frequencies above this cut-off point of the receiver, but, since half a loaf is better than none, the owner of the receiver will undoubtedly be satisfied to forego the pleasure of hearing a few high notes if the annoying heterodyne whistle can be eliminated simply and inexpensively.

### INTERNAL INTERFERENCE

Interference may be due to causes within the  
(Continued on following page)

(Continued from preceding page)

receiver itself. Loose connections, leaky condensers, noisy resistors, noisy a-f transformer windings, high-voltage "sparkover" in condensers of transformer windings, dirty or peeling tuning condenser plates, dirty or corroded gang tuning condenser rotor wiping contacts, scraping speaker voice coil, broken speaker spider, loose cone apex, faulty or loose line fuses, a defective B battery, run-down batteries, etc., may produce scratches, rattles, buzzes, etc., in the receiver. Naturally, interference due to any of these causes can be eliminated by the service man—even though it is often a very tedious job to track the trouble to its source.

If the preliminary tests which will be out-

tinuity or ohmmeter test is applied, they may break down and become leaky when the high voltage is applied to them in the circuit. In receivers employing power or grid-bias detection, the cathode by-pass condenser may often be found to be at fault. A leaky condition of this unit will produce a puzzling and annoying irregular frying or sizzling noise. In some of the older receivers, where glass tubular grid leaks are used in grid leak-condenser detection, this unit has been found to be a frequent source of noisy reception.

The most common cause for noisy reception in an audio amplifier lies in the primary of one of the audio transformers. The best test for a noisy primary winding is that of substituting

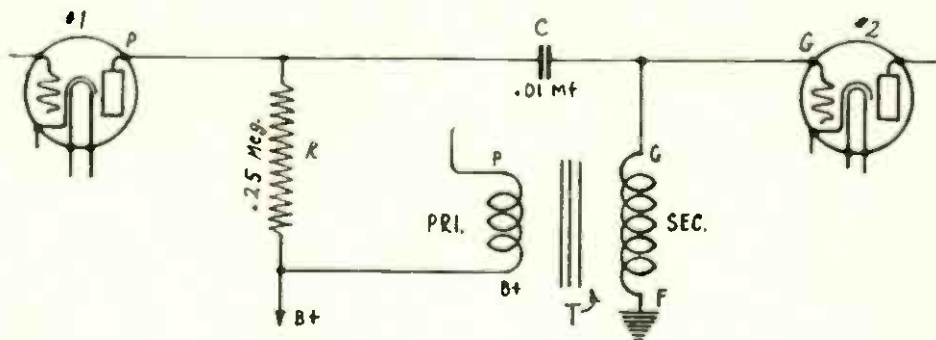

FIG. 2.

Testing an audio transformer primary for noise by substituting resistance plate coupling for its primary winding.

lined indicate definitely that the noise is originating in some part of the receiver itself, the following possibilities (as well as those mentioned in the previous paragraph) should be checked, and the proper steps taken to eliminate any of the troubles which may be found. Generally, tubes are the most frequent offenders! Each one should be tapped lightly on the top with the finger while the receiver is operating. If the tube contains loose elements, a loud noise will be heard in the loud speaker at once, and the tube should be replaced. A quick visual inspection and jarring the set may reveal a loose connection and will not be amiss. Should this procedure fail to disclose the cause, the following systematic mechanical tests should be made.

The first r-f tube should be removed after the set has been placed in operating condition. Should the noise cease, then the trouble is caused by some defect in that stage and an inspection of all parts, circuits, and connections of the first stage should be made immediately. If the noise is heard with the tube removed, the second r-f or the "mixer" tube should be withdrawn and the same tests carried out in that stage. In this way, employing the same procedure, the faulty stage may often be localized and the cause of the trouble ascertained and eliminated.

### A SUSPECTED CONDENSER

The detector plate by-pass condenser is a frequent cause of noise. This may be checked easily by disconnecting the unit from the circuit while the set is operating. Although these condensers may check satisfactorily when a con-

tinuity or ohmmeter test is applied, they may break down and become leaky when the high voltage is applied to them in the circuit. In receivers employing power or grid-bias detection, the cathode by-pass condenser may often be found to be at fault. A leaky condition of this unit will produce a puzzling and annoying irregular frying or sizzling noise. In some of the older receivers, where glass tubular grid leaks are used in grid leak-condenser detection, this unit has been found to be a frequent source of noisy reception.

The most common cause for noisy reception in an audio amplifier lies in the primary of one of the audio transformers. The best test for a noisy primary winding is that of substituting another transformer for the one in use, or to disconnect the "plate" terminal of the primary of the suspected one from the circuit entirely and substitute a plate resistance,  $R$ , and a blocking condenser,  $C$ , in its place, connected as shown in Fig. 2. This condition will some times evidence itself even when the detector or first audio tube is removed from its socket. Noisy plate circuit resistors (where resistance-capacity coupling is used) are also common, and may be found by the substitution test.

In cases where the noisy condition continues after all tubes but the last audio have been withdrawn, it is probable that the power pack or the reproducer is at fault. In the power pack there are several units which may be responsible for noisy reception. Most common is a voltage-divided resistor which "sparks" across. These resistors are usually covered with an enamel coating to make them moisture proof. Imperfections in the enamel, or impurities of a metallic nature, will produce sparking at that point. This condition may be noted by a visual examination (preferably in a darkened room), and the remedy is replacement. At times, a power transformer will be the source of interference.

### THE ELECTROSTATIC SHIELD

Many good power transformers employ an electro-static shield between the primary and the secondary windings to prevent the transfer of any electrical disturbances that might be carried in by the line. It has been found that arcing takes place in some cases between the primary and the shield due to breakdown of the insula-

tion. This will produce an annoying interference that is exceedingly difficult to trace. When this condition is found to exist, a new transformer must be installed.

A number of dynamic speakers used on some of the older broadcast receivers employed copper tinsel cord to make connection to the voice coil. This wire or cord, similar to that on ear-phones and magnetic reproducers, has great flexibility, but after some time becomes worn and frayed, resulting in noise. The complaint of intermittent reception may often accompany noise of this nature. A repair may be effected easily only by replacing the tinsel cord.

### FOREIGN MATTER HARMFUL

The "Off-On" switch and fuse mounting block in radio receivers are frequent offenders. Contacts become worn or corroded and will upon vibration set up a disturbing "crackle." If the switch or fuse block is at fault, a flickering or lowering of the pilot lights will often be noticed.

The presence of dust, peelings of the plating, burrs, or small foreign particles between the plates of the variable tuning condensers will also set up noise (especially when the station selector is rotated through its range), since they produce high-resistance intermittent contacts between the rotor and stator plates. An ordinary pipe cleaner may be used to advantage for removing the foreign matter in such cases, or the foreign matter may be burned out. The rotor contacts of the variable condensers also become corroded and cause a scraping sound in the reproducer as the receiver is tuned. Although this condition may be corrected by cleaning the rotor friction contacts, the best repair is effected by "pig-tailing" the condenser gang rotor shaft to the chassis of the receiver.

### REDUCTION OF TUBE HISS

Any corroded or poorly soldered joints will cause unnecessary and undesirable noise. One source of this trouble, usually overlooked by many service men, is in corroded or dirty tube socket contacts. When engaged in the task of locating noise originating within the receiver itself, it is the best policy to clean all contacts thoroughly and to resolder every suspicious soldered connection to eliminate any possibility of "rosin joints" or any other trouble on this score. Many receivers come out of the factory with one or two joints poorly soldered—or not even soldered at all!

This type of noise is often due to poor set design or faulty components, but even the best receiver is apt to be noisy if it is sufficiently sensitive. Tube "hiss" is often a limiting factor to the amount of receiver sensitivity which can be employed satisfactorily.

Tube hiss in superheterodynes can be reduced considerably by the proper mixing or modulating of the oscillator voltage with the signal voltage in the first detector stage. If the ratio between these two voltages is not correct, noise current will be generated in the mixing tube. This may be amplified to considerable intensity after it has passed through the many i-f stages

of the receiver. Tube noise can also be reduced further by careful consideration of the voltages and biases on the r-f and i-f amplifier stages so that the tubes will always be operating under the most favorable conditions.

The methods of testing a receiver installation to determine whether the interference is originating in the set itself or is coming from some external source will be discussed later.

### MAN-MADE INTERFERENCE

We now come to the interference which is set up by the many man-made electrical devices. Almost every piece of electrical machinery and every electrical device is a potential producer

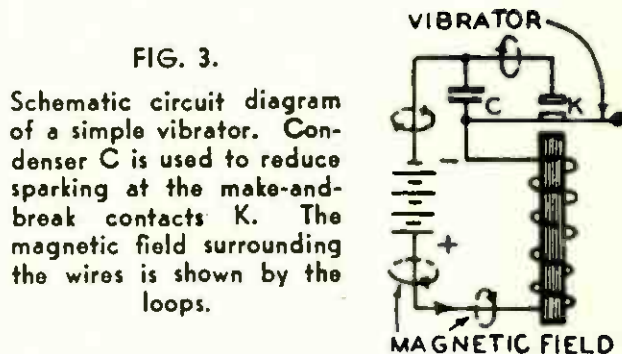

of electrical disturbances—especially if it is faulty or in need of attention. The majority include a high-frequency component which is often modulated by low-frequency disturbances falling within the audible range covered by the audio amplifier and loud speaker of the radio receiver. These electrical radiations may be picked up by some part of the antenna system, or conveyed directly to the set by the power supply line—most often by a combination of both.

Man-made interference is especially common and serious in congested city districts where many electrical appliances and devices are operated from the same power supply lines as are the electric radio receivers, and often within comparatively short distances of both the receivers and the receiving antennas. Even in outlying rural communities, this sort of interference is not absent, for it is not only produced by any electric appliances employed in the immediate vicinity, but it may be brought in along the electric light and telephone lines which are usually strung overhead on poles.

It is not uncommon for both man-made and atmospheric disturbances to be conducted by such lines for many miles and then be either conducted directly into the power supply circuits of radio receivers fed from them, or re-radiated to their antenna systems.

Although interference estimates depend entirely upon the local conditions which exist, i.e., whether it is a congested city, a rural town, a district subject to severe atmospheric disturbances, etc., it has been estimated that on the average about 15 per cent of all cases of interference can be traced to natural static and other untraceable sources, about 20 per cent to faults in the receiving installation, and the remaining

(Continued on following page)

(Continued from preceding page)

65 per cent to man-made interference caused by household electrical appliances, industrial electrical apparatus, and generating, transmission and distribution equipment. This shows that man-made interference is the most common, and incidentally presents the most serious and largest problem of all, as its origin is often difficult to trace and, even after it is finally located it may not be possible or desirable to eliminate it at the source. In such cases, attempts must be made to minimize it at the receiving equipment. It should be realized at the start that there are so many ramifications to the problem of man-made interference suppression that no study of it, or actual attempts to minimize it, will make much progress unless it is

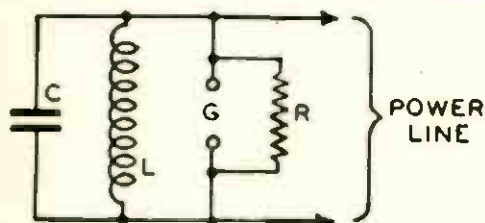

FIG. 4.

Equivalent circuit showing the analogy of a sparking motor (or any other device) and its circuit to a "spark" type radio transmitter.

systematic and proceeds with a clear understanding of the nature and causes of the interference and the many ways in which it can be propagated. Erratic "try-this" and "try-that" methods will only consume valuable time and often fail to cure the trouble at all.

### CREATION AND DISTRIBUTION

Man-made interference is generated by the sudden interruptions or variations in the operating current of many electrical devices. These generate radio-frequency disturbances. Some devices produce (in the radio receiver) noise of a uniform character, such as humming, buzzing, whining, whirring, etc. Some produce *impulse-type* noises such as rattles, clicks, crashes, etc. In the former cases, the periodic changes of operating current have a fundamental frequency, usually well within the audio-frequency range. The high-frequency disturbances give rise, in general, to a complex variation of potential in the space surrounding the devices, and may be either radiated or conducted to the radio receiving equipment.

Investigation has shown that the disturbances which they set up in the receiving equipment may usually be regarded as consisting of an infinite series of component radio-frequency disturbing e.m.f.'s distributed over the whole range of radio frequencies. These components combine with the broadcast signal carrier either in the antenna circuit of the radio receiver (if the disturbance is picked up by the antenna) or in the plate and screen circuits of the receiver tubes if the interference is borne by the power-line), and when passed through the detector give rise to an infinite series of beat notes. Of

these beat notes, those which are audible and within the reproduction band of the audio apparatus in the receiver appear as noise in the loud speaker. When the broadcast carrier is modulated by a program, the modulations due to noise exercise an interfering effect upon the program.

### EXAMPLE OF MOTOR

Let us see what happens in the case of a d-c motor. Consider a simple d-c motor connected to a d-c line as shown in Fig. 3. The motor is equipped with a commutator and one pair of brushes, which are connected to the line. The shaft of the motor may drive any number of devices, but these have no relation to our problem. Now it is clear that all the electrical power absorbed by the motor is used up in overcoming the various losses in the motor and in the device that the motor turns over; and it is just as evident that all this electrical power must come from the line. The electrical power absorbed by the motor is to equal  $E \times I$ , where  $E$  is the steady voltage of the line and  $I$  is the current. It is the current  $I$  which flows through the lower brush into one or two segments of the commutator of the armature, then through the armature coils, and out of the other end of the armature windings via the commutator segment and top brush. Since the armature is revolving, there are ripples in the wave form of this current. (A cathode-ray oscilloscope can be used to show this condition visually.) The rapid variations in the current are caused by the action of the revolving commutator segments making and breaking their contact with the brushes. They act like a series of rapidly operating switches!

If, for any reason at all, there should be sparking between the brushes and the commutator (every d-c motor has some sparking), the current  $I$ , drawn by the motor, will vary even more rapidly and erratically from instant to instant, depending upon the number of segments, the number of brushes, the speed of the armature, the amount of sparking, the cleanliness of the commutator segments and the brushes, and the power consumed by the motor. It is important to visualize this state of affairs, for it is upon this foundation that the entire understanding of interference production by electrical devices rests.

### CURRENT ANALYZED

The current which flows through the power line to the motor (even if it is d-c) has variations in it. The nature of these variations is not simple, by any means. The sparking at the brushes give rise to high-frequency variations of the line current. These are in the form of rapid impulses having no one particular frequency. The equivalent electrical circuit of the sparking d-c or "universal" motor is shown in Fig. 4. Coil  $L$  represents the inductance of the armature and the field winding of the motor;  $C$ , the distributed capacity of the armature and field windings which may be quite large);  $G$ , the spark gap represented by the sparking at the brushes; and  $R$ , the resistance of the gap.

This circuit is an oscillatory circuit if the power line has low leakage (which is usually the case). Oscillations are set up in the line and in the inductance and capacity. These oscillations are radiated into space by the coil if it is not thoroughly shielded by the frame of the motor, and by the line if it is not enclosed in a grounded conduit. If the shield and grounding is good, then the noise is conducted directly along the power line and terminates at the various outlets connected to that same line. Any radio receiver, then, that is plugged into this same line will have this interference conducted into it—resulting in “noise.”

In many instances the line terminates at a junction box into which a number of other circuits also run. The close proximity of these circuits to the line carrying the noise results in an inductive transfer of noise from the original to these other lines, so that these lines now convey the noise to various outlets. A radio receiver plugged into an outlet connected to any one of these lines will receive and amplify these interference impulses.

An important consideration is the fact that the varying exciting current is an impulse; consequently, the noise current has no definite frequency. This means that the circuits connected to the original line and those coupled to the line are excited by impulses, and oscillations are built up, the frequency of these oscillations depending upon the natural frequency of the coupled lines or circuits.

The sweeping conclusion, then, is that a sparking motor will cause the line to which it is connected, to become a source of interference. It may act as a direct conductor of interference to any radio receiver plugged into it (or any of its branches), or it may act as a radiating system radiating interference fields close to the ground where radio-frequency noise voltages that are noise-modulated abound. In this latter role, it becomes (with all its branches) a transmitting antenna network capable of radiating

the interference impulses sometimes at considerable distance from the original source of interference) either to other adjacent power circuits, or to antenna system of the receiver directly. The “adjacent” power circuits may in turn re-radiate the interference to the antenna systems of radio receivers. In the usual noisy condition, all three methods of interference transmission often occur. Noise voltages induced in neighboring lines cause noise currents to flow in them. These are conducted along the line to the various outlets. Noise will be heard in radio receivers connected to any of these outlets. These lines may be in turn re-radiate noises of some definite frequency, (depending upon the natural frequency of the lines) to the nearby antenna system of a radio receiver.

This means that some noises are “tunable” and some are not. Those that are tunable are generally the result of radiation; those that are not are the result of direct conduction. It can be seen, therefore, that the paths taken by the noise impulses are very complex, and it is possible for very annoying interference to manifest itself at points far removed from the original source.

An attempt to show this condition has been made in Fig. 5. The various branch circuits of the power line feeding the various lighting and other outlets in a building have been drawn heavy. An electric fan motor which is setting up interference, is being fed from this line at the upper left. A radio receiver is installed in a room at the lower right, and is fed from the aerial on the roof. The path by which the interference may be conducted to the radio receiver by the power line wiring is shown by the dotted-line arrows, say,  $I_c$ . The interference radiated from the incoming overhead line, and the various branch circuits to be aerial and lead-in wires, (and line cord of the receiver) is represented by the solid-line arrows, say,  $I_r$ . A “skeleton view” of this kind makes one realize  
(Continued on following page)

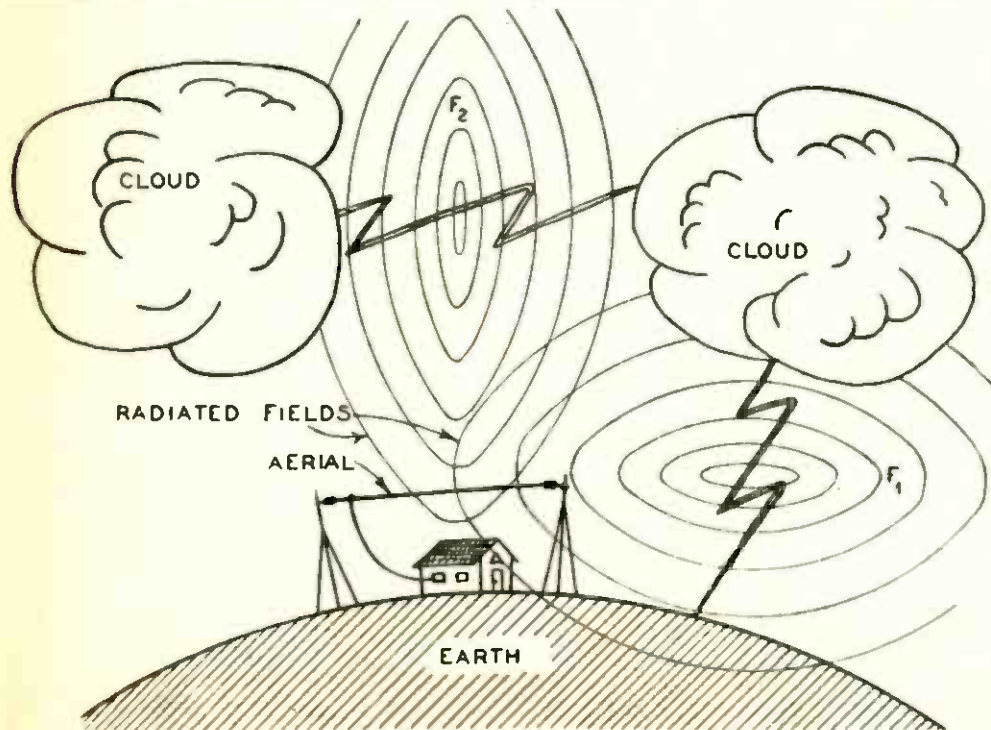

FIG. 5

The magnetic field surrounding all of the wires comprising the circuit to which a d-c (or ac- "universal") type of motor is connected. Since the current flowing is not steady and smooth, these magnetic fields also vary from instant to instant.

(Continued from preceding page)

how very many circuits, ordinarily hidden from view and therefore unthought of, may participate in conducting, radiating and re-radiating interference within a building, or even from one building to another.

### VIBRATORS AS SOURCES

Current interruptions caused by electrical devices which employ vibrators or interrupters generate interference in a fashion similar to that already considered for sparking motors. The circuit of a simple interrupter is show in Fig. 6. It will be seen that the interrupter contacts interrupt the current from the line at a definite frequency depending upon the frequency of vibration of the interrupter. The interrupted current generates a varying magnetic field which can induce a voltage in any coupled circuit by simple electromagnetic induction, (transformer action). Since sparking also occurs at the contacts, oscillatory currents will be generated if the resistance of the circuits is low enough, and interference impulses will be conducted and radiated as previously described.

In general, it may be stated that any electrical device (such as a motor or a vibrator device) that draws a varying or interrupted current from a line, or supplies a rapidly changing current to a line (such as a generator), is a potential cause of interference. Alternating-current motors and generators usually do not have commutator segments, and for that reason do not radiate much noise. Some small a-c motors of the repulsion-starting—induction-running type (these are used a great deal on washing machines, electric refrigerators, etc.) have a commutator for starting purposes only, and they generate interference only until they build up to normal running speed (if they are operating properly and are not in need of repair).

### POWER-LINE INTERFERENCE

A study of a table of possible sources of interference will show that leaky power insulators, pole transformers, trolley switches, etc. cause interference. Now it is beyond the jurisdiction of service men to attempt to eliminate the noise from these sources. In fact, the service man is not allowed to apply noise-reduction devices to any interference-creating unit unless the consent of the owner of the device is obtained. In instances where noise is traced to equipment of public utility companies or to railroads, the service man should report his findings to the proper official of the company who may take the necessary steps to eliminate the trouble. He should not attempt to eliminate such cases of interference himself, for in doing so he may cause severe trouble on the power line and may also expose himself to dangerous voltages. No matter how expert a radio service man is in his own line, he should refrain from tampering with power lines.

During the past few years public utility companies have spent considerable time and money in eliminating faulty equipment that cause interference in radio receivers in the vicinity. In many cases, these companies maintain a staff of engineers for the express purpose of tracking

down noise and eliminating the cause. Leaky insulators and power transformers are costly to the company, and it is usually more than willing to cooperate with the community it serves by eliminating all such faulty units.

### SIGNAL-TO-NOISE RATIO

It is important at this time to clearly bring out the significance of the term *signal-to-noise ratio*. The *absolute* value of the noise voltage means very little unless the intensity of the signal heard through the noise is specified at the same time. The reason for this is that the limit of the gain which can actually be employed in a receiver under actual installation conditions, is a function of the permissible noise level. Stated in another manner, the weakest signal that can be fed into an amplifier and intelligibly reproduced depends upon the fixed noise level. The greater the noise, the greater must be the signal, and vice versa, for the same degree of intelligibility.

The ratio of the signal voltage to the noise voltage is a convenient measure of the "clearness of reception." A high signal-to-noise ratio means that the signal voltage is much higher than the noise voltage; a low signal-to-noise ratio means that the signal is weak compared to the noise. Suppose, for example, that the signal-to-noise ratio is 10 and that the noise voltage is 80 millivolts. The signal voltage is, then  $80 \times 10$ , or 800 millivolts. The object of most of the practical expedients used to minimize interference is to raise the signal-to-noise ratio by *decreasing the noise voltage*, although it is practical to *increase* the signal voltage in many cases by employing a *longer* aerial, or one located in a more favorable zone of greater signal strength. This will be discussed in greater detail later.

### PATH INTERFERENCE TAKES

Now that we have some idea of what causes interference and how it may reach the receiving equipment, we are prepared to proceed to study the methods to follow in locating and suppressing or eliminating interference in actual practice. When the radio service man is called in on a complaint of "noisy reception," the fact that there is interference is all he knows about the situation. The rest is entirely up to him. The customer is interested merely in having the interference eliminated—at low cost.

There are four possible ways for interference to enter a receiver; by the receiver wiring itself picking up either the direct radiated (or re-radiated) interference, via the power supply line, through the antenna system, or by some combination of these. Since the steps which are finally taken to minimize the interference depend, among other things, upon the manner in which it enters the receiver, the first step the service man should take is to ascertain definitely through which path (or paths) it is reaching the receiver circuits.

(1) The first test is simple: Tune the receiver to a point between the programs of two stations, and increase the volume control setting to maximum. Usually, the noise will be very loud when this is done. Now remove the

lead-in wire from the *Ant* post of the receiver, and keep it several feet away from the set. This prevents any noise from reaching the receiver by way of the *aerial* and *lead-in* circuit. Listen to the noise. If it has *not* decreased materially, the aerial and lead-in wires may be removed from suspicion. If it *has* decreased noticeably, the aerial and lead-in are partly to blame for the noise. If it is hardly heard at all, they are entirely to blame.

If there was no decrease, or a noticeable decrease, short-circuit the *Ant.* and *Gnd.* posts of the set with a *very short* piece of wire and listen again. The reduction of noise should be still more appreciable. The short-circuiting of these posts is necessary to prevent the leads from the posts to the coils and condensers in the set from acting as a short aerial. The short-circuit re-

short-circuited, and compare the *character* of the noise heard when the aerial is connected, to the character heard when it is disconnected. By the term "character" is meant the *characteristic sound* of the noise, i.e., whether it is "whine" of a "crackle," whether it is low-pitched or high-pitched, etc. This is necessary in order to ascertain definitely whether or not the residual noise heard after the aerial and lead-in are disconnected and the *Ant.-Gnd.* posts are short-circuited is the same as that with the aerial and lead-in connected and the short-circuit removed. If it is the same, then the noise is entering the receiver through the power line or the chassis itself. (A list of the characteristic sounds originating from different types of interference-generating devices will be presented.)

(2) Let us assume, now, that the resi-

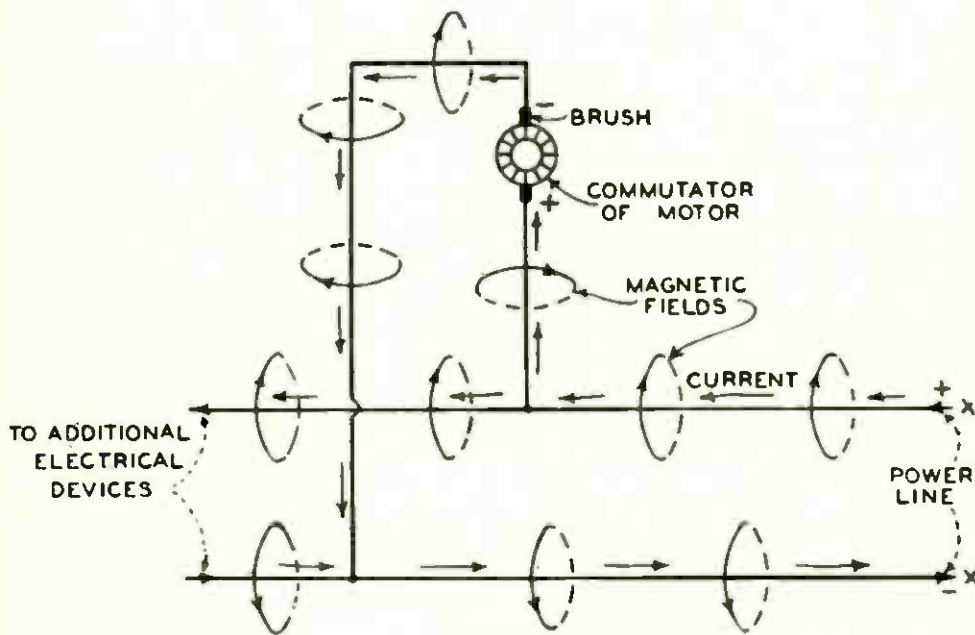

FIG. 6.

How an electrical device located in one part of a building can produce electrical interference part of which ( $I_c$ ) is conducted directly through the electric light wiring to radio receivers operating from the same lighting line; the other part ( $I_R$ ) may be radiated either directly from the device or from the electric light circuit wiring in the building to the aerial, lead-in and ground wires of the receiver, inducing interference voltages in them. These are heard in the radio receiver as disturbing noises of a certain character depending upon the nature of the interfering device.

duces this antenna-circuit impedance to such a small value that the voltage developed across the antenna coil is small.

### CLEWS AT ANT.-GND. POSTS

Now the noise may or may not drop to zero. If it does, then the aerial or lead-in is picking up, and means (to be described later) must be taken to minimize this pickup; if the noise does not drop to zero, so that a residual noise remains, then the test must be continued to determine the other point or points through which it is entering the receiver.

Before continuing the test, it is necessary to listen carefully to the noise with the aerial and lead-in disconnected and the *Ant.-Gnd.* posts

dual noise is still loud enough to be objectionable after the tests of the previous paragraphs have been made, or that disconnection of the lead-in wire from the set does not decrease the noise appreciably. The second step of the test, then, is to disconnect the ground lead from the receiver; the aerial and lead-in may or may not be attached (preferably not). Removal of the ground lead will eliminate the possibility that the "ground" (which is part of the antenna system) is conveying noise to the receiver. If, after removing the ground wire, the noise is still objectionable, short-circuit the *Ant.* and *Gnd.* posts of the receiver with a *very short* length of wire and note the noise level. A ma-  
(Continued on following page)

(Continued from preceding page)

terial reduction of the noise means that the ground is "noisy," and means must be taken to find a good ground—a ground that is free from noise.

### EACH LOCATION DIFFERENT

These two tests (tests for a noisy aerial and ground) will localize the entrance of the noise to some extent. In many cases, a large part of the noise will be eliminated by removing the aerial and ground leads, while in others the reduction of noise will be only slight. In either case further tests must be made, as the only other two possible entrances are the power line and the receiver chassis.

Modern receiver design is such that it is difficult to isolate the chassis from the power line and at the same time have the receiver operate from the line to which it normally connects. The idea in all of these tests is to make the test conditions such that the receiver is operating under normal conditions—with its normal aerial, lead-in and power supply line. For this reason, the tests become useless when an attempt is made to try the receiver elsewhere in the same vicinity. Noise conditions are often such that one power line may be noisy and another in the same building may be quiet; one receiver installation will pick up noise and another will not. Therefore, the set must be tested in the exact room in which it is to be used and under the identical conditions under which it will work normally.

### TWO METHODS EXPLAINED

Two methods of attack then present themselves. The first method is to get a definite idea of the noise level of the receiver by comparing it with another thoroughly shielded receiver under identical conditions; that is, in the same room, with the same antenna system and using the same line plug as the customer's receiver. It is important that the receivers be adjusted for the *same* degree of sensitivity, not merely set at the *maximum* degree of sensitivity on each set. Naturally if the noise levels of various receivers are measured at their maximum sensitivity, the least sensitive receiver will appear to be the quietest, when it is possible that if both receivers were measured at the same sensitivity, the most sensitive receiver might actually have the lowest noise level.

### USE OF A FILTER

The thing to do is to tune in a distant station on the two receivers which are to be compared for noise level. When both sets are adjusted to provide the same volume, on the same station, it is apparent that they are adjusted to the same approximate sensitivity. Now without disturbing the sensitivity adjustments, disconnect the aerial and ground from both receivers. Now turn them on, in turn, and note the noise level of each. If the original set is noisier than the thoroughly shielded test set, then the original set is not shielded sufficiently. This is true regardless of whether or not the actual noise level is zero.

There is but one remedy in this case—the original set must be completely enclosed in a copper shield and the shield grounded to the chassis.

This is usually not an easy job, even with simple sets. The author has had occasion to shield many receivers, and the results have not always been completely satisfactory. The placement of the wires in the set, the disposition of the coils and condensers, the location and type of tubes used, all have a bearing on the noise heard. However, the addition of the shield may tend to reduce the noise materially, so that the signal-to-noise ratio is acceptable to the customer. If the ratio is not acceptable, then the noise may be traced to its source and eliminated there, or else another thoroughly shielded receiver must be used.

### POWER LINE NOISE

Very often all of the previous tests may indicate that the noise is coming in through the power line. That is, the removal of the aerial and ground and the use of a thoroughly shielded receiver may not result in any appreciable reduction in the noise level. In such cases, the final test must involve the power supply line. It is unfortunate that the power line cannot be disconnected from the receiver (the use of a line-operated receiver is assumed here) and it is just as unfortunate that the power line is a frequent carrier noise. The only good test for the supply line is to insert a special line filter between the line and the receiver and note whether this reduces the noise level.

In work of this kind, where several possibilities exist, and the method of trial and error must be used, every step should be carried out carefully and checked before proceeding to the next one. Unless one is very familiar with a particular neighborhood and is thus aware of the general characteristics of various locations as regards noise, the power supply line to the receiver should be checked by the use of a filter. It is only after all four possible sources have been investigated that the service man can point definitely to the means of entrance of noise and take the necessary steps (to be described later) to eliminate it.

### MULTIPLE PATHS

It must not be supposed from this discussion that all interference will be found to be entering the receiver through one path at all times. In fact, the more usual cases are those where the noise enters the receiver through the aerial, the ground, the chassis and the power line. Of course, the noise is not evenly distributed among all four, and one will generally predominate, but the noisy location may require treatment in several places before the noise level drops sufficiently to give an acceptable signal-to-noise ratio. In some cases, interference radiated from the power supply line to the lead-in and aerial wires constitute the strongest and most annoying noise heard.

[This concludes the first instalment of Mr. Ghiradi's discussion of interference. Other instalments will appear in the April and May issues.—EDITOR.]



# RIGHT OR WRONG?

## PROPOSITIONS

1. When a half-wave rectifier is conducting, the plate or anode is positive to a.c. but negative to d.c., and when the rectifier's anode is negative to a.c. the anode is positive to d.c.
2. The purpose of a filter condenser in a rectifier for B supply purposes is to maintain the d.c. voltage and to offer a path of low impedance to the remaining ripple voltage, or residual pulsating d.c. present in the output.
3. When two tubes are connected in parallel their amplification factor and input capacity are doubled, but their conductance is halved.
4. A full-wave rectifier is easier to filter than a half-wave rectifier because the pulses are weaker, the frequency is doubled and the voltage is halved.
5. Increasing the biasing resistance, hence the negative bias, on an amplifier tube, decreases the gain because then a much greater proportion of the total voltage drop is across the bias resistor instead of across the tube, assuming the most favorable bias voltage was used at the start.
6. A contact rectifier, like the oxide-copper oxide type, functions because it passes current in only one direction, therefore if a.c. is applied, only one alternation will influence the half-wave rectifier.
7. A voltage doubler acts on the principle that if you use two tubes in series you will get out twice as much rectified voltage than if you used one tube alone.

## ANSWERS

1. Wrong. The half-wave rectifier, or any other rectifier, conducts when the plate or anode is positive for all purposes. The cathode is then negative. When the tube thus is made conductive, a surge of d.c. current only takes place. This takes the polarity of anode negative and cathode positive. Meanwhile the a.c. has started to subside, the d.c. values prevail over them, and with the aid of filter condensers, the d.c. is made to prevail until the next positive alternation comes along, and the action is repeated.
2. Right. The circuit looking out of the rectifier is a relatively high resistance to d.c. but a low impedance to a.c., and thus condensers make filtration effective. Also, the condensers maintain the d.c. voltage because they accept a charge instantaneously but discharge more slowly, being large enough in capacity not to complete the discharge until after the next alternation has arrived.
3. Wrong. The amplification factor, in general, is halved, but the conductance and the input capacity are doubled.
4. Right. Frequency is doubled because twice every cycle, once every alternation, there is a fresh supply or rectified current. Therefore the filter circuit acting on doubled frequency offers twice the filtration effect, if resistance considerations in other directions are ignored. In general, full-wave rectification halves the voltage, in that for the same input a.c. half output d.c. is obtained, but that has nothing to do directly with filter efficiency, or at all with frequency doubling.
5. Wrong. There may be some frail support for the general idea of the explanation, because it is not totally amiss, and reaches the correct conclusion, but the real reason why the gain is reduced is that the tube is shifted to an operating point less favorable to amplification, since at the start the correct operating point was assumed. Thus for a given change of input there is a smaller undistorted change of output.
6. Right. But the explanation is applicable to all rectifiers. The oxide film on the contact rectifier causes the electrons to be bound as to current in one direction and free as to electrons in the other direction, and it was the devising of this film that constituted the gravamen of the invention.
7. Wrong. If you use two tubes in series you are more likely to get out less than if you use one alone, because the conductance is halved, or tube resistance doubled. The voltage doubler operates on the principle that when one rectifier is conducting it charges a condenser that, during the period when that same rectifier is idling, on the next alternation, discharges through the other rectifier. This reciprocating action permits doubling, when the condensers are of sufficient capacity. While not doubled, the voltage is increased beyond what it would be by a single tube, even without the condensers, because the d.c. bias on the conducting tube is of such polarity as to make the other tube conductive during part of the alternation during which it would be idling otherwise.

# CONTACT RECTIFIERS

## In Half-Wave Instrument Circuits

By H. J. Bernard

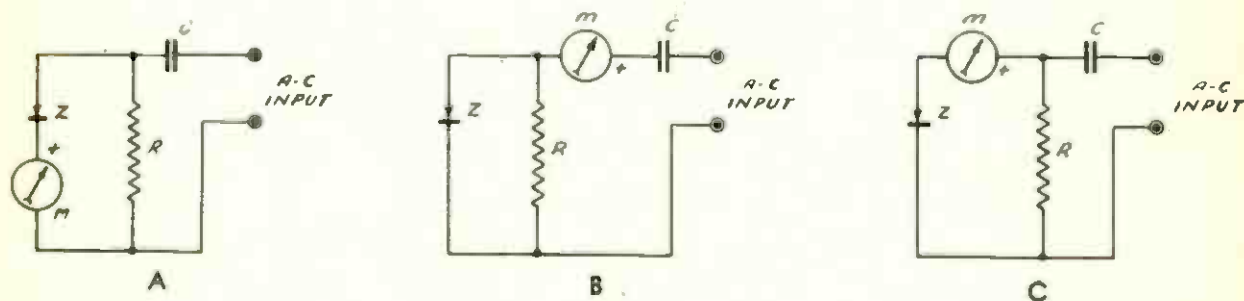

FIG. 1

The condenser-input contact rectifier is shown at A, while at B is the same circuit, but with the meter M moved to a position that causes a.c. to pass through the meter. What is the difference between A and C?

**C**ONTACT rectifiers, such as the oxide-copper oxide type, are very popular in measuring instruments, because, like the crystal detector, they require no local power for operation, so they lend themselves to portable apparatus, and, being small themselves, they conform to demands for compactness.

However, the contact rectifier is not of itself blissfully free of problems, although some means of solving difficulties are well known.

It would be most agreeable if the rectifier could be put into a circuit and read a-c voltages on exactly the same scale as d-c voltages are read. Since the electromagnetic meter will be linear, meaning equal angular displacement of the meter needle for equal changes in current, if the a-c scale could duplicate the d-c scale, that would be fine. As yet, however, no method of attaining this completely has yet been disclosed. A close approach to such attainment is established in certain full-wave rectifier circuits, but even then the sensitivities in the two classes of service differ. It would be nice if there could be both exact linearity and the same sensitivity on a.c. as on d.c.

### CONDENSER INPUT CIRCUITS

Fig. 1 shows two methods of using the rectifier, in conjunction with a d-c meter, for half-wave rectification. In A is shown the condenser type of circuit, which is distinguished by the inclusion of the stopping condenser C and the fact that d-c continuity for the meter is maintained at all times. It is all right to do this with the contact rectifiers because they have no idling current. If the method is applied to any vacuum tube, for a range of less than 50 volts (assuming a 0-1 milliammeter, or a maximum voltage deflection inversely proportionate to a more sensitive meter), enough current will flow

to give a false zero reading. That is, the meter will read as if an external voltage of around .75 volt is injected, although no such voltage is put in. The voltage exists, however, and is due to the contact potential in the space stream of the tube.

In B the meter has been moved between the stopping condenser C and the rectifier Z, with the limiting resistor R across the rectifier. B represents an objectionable use, as for an ideal rectifier Z there is no alternating current flowing through it, and if the meter is put in series with the rectifier alone, it is freed of objectionable a.c.

### A. C. MAY BE CONSIDERABLE

In some instances the a.c. would be abnormally large, and moreover could be large without much disclosure of the fact by the meter, because the d-c meter reflects the average of the injected voltage, and the average of sine-wave a.c. (considering both cycles) is zero. Do not let C fool you, for it is exactly the same as A, except that the rectifier and meter are transposed. The a.c. flows through the C-R-binding post loop, and not through the meter. There is, however, pulsating d.c. through the meter. Successively higher limiting resistors R for successively higher voltage ranges keep this pulsating d.c. within the limits of safe operation.

So we find that Fig. 1A and Fig. 1C are the same and are satisfactory for use.

However, if low voltages are to be measured, say, if only to 5 volts a.c. full scale, the stopping condenser C must be large to have a low reactance compared to the limiting resistance, or, really, the rectifier circuit resistance.

For the 0-1 milliammeter the capacity should be at least 4 mfd., and preferably 8 mfd., so that a calibration for the low-voltage range will apply to the higher voltage range, by multiplica-

tion. If C is small this could not be true, without introducing some additional remedy, because the total voltage drop would take place ideally across the rectifier, whereas if the condenser is relatively small in capacity (high reactance) much of this voltage drop takes place in the condenser.

Suppose the capacity reactance of C and the rectifier circuit resistance are equal. Then

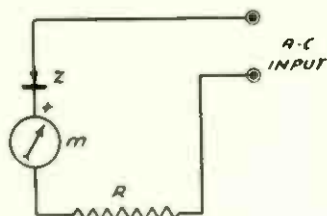

A

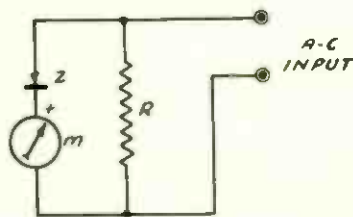

B

FIG. 2.

The open-end rectifier circuit, shown at A, has R for limiting resistor, and causes any d-c resistance in the unknown to be added to R, so that the meter will be read low, the higher the resistance in the external circuit. In B we find R is in an impractical position, because it tends either to short the unknown, or the unknown tends to short it.

there is as much voltage drop across the condenser as across the rectifier, and you would calibrate the extreme for 5 volts, whereas the rectifier would be looking into 2.5 volts.

### CONDENSER EFFECT DIMINISHES

On the next range, say ten times up, the limiting resistance would be equal to  $(10 \times RE) \div C$ , instead of  $RE \div C$ , so the small condenser becomes less and less objectionable as the load resistance is raised for higher voltage levels, because so much more of the drop takes place across the large resistor. This is one reason why instruments using such a circuit often have a minimum of 15 or 20 volts, as a compromise, at least for such purposes where a condenser may be needed for separating the d.c. of the unknown from the a.c., as in output meter service.

It can be seen that the a-c load on the condenser input rectifier may have some disturbing effect, but it will be small, because the rectifier works into low impedance circuits. It is therefore of small moment if on a.c. the sensitivity is not as great as on d.c., though equality of sensitivity is still a pardonable goal. The a-c sensitivity naturally will not be as great, not only because there is a resistance R in parallel with the unknown (assuming C infinite) but also because the ideal rectifier when conducting is a short circuit, and in practice may have an average resistance of a few hundred ohms at full-scale deflection of the meter, and with low-resistance meter there is momentary shunting of the rectifier circuit, which renders the shunting by R alone for d.c. negligible by comparison.

Thus in the condenser rectifier we have a closed d-c circuit at all times, when measuring a.c., and there will be no deflection on d-c input, save perhaps for the needle flip due to

condenser discharge. By the way the condenser can not be an electrolytic but must have a very high insulation resistance, at least 10 meg. per mfd.

### THE OPEN-END CIRCUIT

The other general form of the rectifier type instrument using the d-c meter has terminals

open both to a.c. and d.c. Fig. 1 showed circuits open to external a.c., closable on application of a.c., and while externally open to d.c., remain so even if d.c. is put across the terminals.

In Fig. 2A is shown the open-end circuits. In A the limiting resistor R is in series with the meter, with the rectifier and with the unknown, while in B the circuit is closed by a resistor. Fig. 1A is practical, but Fig. 1B is not.

The difference between the effects of the load is that in 2A any added d-c resistance increases the effective limiting resistance, i.e., adds to R and will make the meter read low, compared to the true voltage, for that reading. By having the meter sensitive enough this disparity is kept small. But in Fig. 2B if the load is a low resistance it tends to short-circuit the load, whereas if the load is of high resistance, then the tendency is for the meter to short circuit the meter, and only if they are nearly equal has the circuit any value. For these reasons Fig. 2B is said to be impractical.

Therefore, proceeding to a circuit that measures a-c voltage and provides a few ranges, in this instance three ranges, we find that in Fig. 3A we have a common input terminal, select any one of three resistance values, for 5, 50 and 500 volts, if that is to be the sequence, and obtain suitable measurements.

### THE SERIES METHOD

In this arrangement the limiting resistance beyond that for the lowest-voltage range is obtained by adding to the resistance of the preceding range or ranges, often done to aid in the current-carrying capacity of the total resistance. The wattage dissipated in the resistors is negligible for the first or lowest range and not much even for the second range, but will be ratable  
(Continued on following page)

(Continued from preceding page)

for the highest range (.5 watt). Using this series method apportioning the wattage according to the resistance, and therefore about 10 per cent. less wattage is dissipated in the highest resistor, the one with which we are concerned. But if that does not matter much, then the

own resistance greatly as the voltage range is increased, the scale will be a greater departure from the normal low-voltage a-c scale than you would expect. The crowding takes place particularly at the high-voltage end, so we have closer spacing of bars for equal voltage difference at one end and at the other.

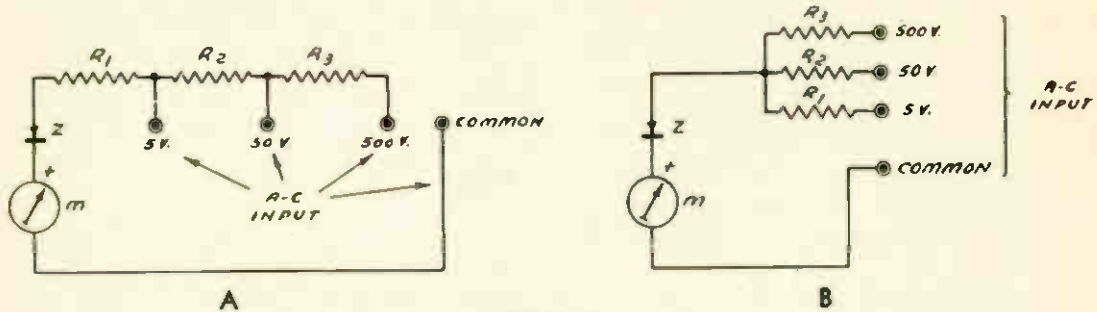

FIG. 3

Cumulative limiting resistances are shown in A, while entirely separate resistors for each range are shown in B.

separate-resistor method, no series connection, may be used to the same effect, as in Fig. 3B.

At present we are considering only the measurement of a.c., and Fig. 3A or 3B is satisfactory, provided however the rectifier is of the type that will not itself build up a high a-c resistance the moment the voltage is increased beyond some low maximum level, and also provided that the resistors are selected on the basis of the voltage that will cause full-scale a-c deflection. The second statement, about choice of resistors, refers indirectly to the first statement about rectifier a-c resistance increasing, because as that resistance increases, the decimal ratio as shown for the voltages will not apply to the resistors,  $R_1$ ,  $R_2$ , and  $R_3$ .

Stated in terms of voltage readings, the resistors for the voltages higher than the lowest range would have to be less than you might expect, because the rectifier supplies the remaining resistance. What the actual resistance values should be, therefore, depends largely on the rectifier, and an accurate a-c meter should be on hand, so that the comparison can be made, in selecting the proper resistors for full-scale deflection.

### QUESTION OF TRACKING

It should also be noted that the a-c scale positively will not be linear, and it is worth remembering that, for a rectifier that increases its

The a.c. through the meter is increased as the rectifier resistance increases. In other words, the rectifier loses efficiency as voltage ranges are increased, if resistance is increased in the rectifier by that cause, and thus real a.c., and not merely pulsating d.c. may pass through the rectifier. This is no contradiction of the previous statement that an ideal rectifier passes no a.c., because Z has now become perhaps as much a resistor as a rectifier, or is only half rectifier, and half a resistor, and to the extent that it is a resistor and not a rectifier it passes a.c. Therefore here is a special instance of increased current (a-c) with increased resistance. This is a sort of speculative negative resistance, by a juggling of terminology although not really a negative resistance. It just happens to behave somewhat as a negative resistance would behave.

### USING SAME RESISTORS

In Fig. 4A we return again to Fig. 2B. We found that 2B was impractical. However, the rectifier's d-c circuit may be closed, and the resistance R may be small, provided it is not directly connected to the source to be measured. For purposes of increasing the sensitivity of the a-c meter beyond what it would be with R alone in circuit as shown in Fig. 4A, R should be small as possible, then  $R_1$  could be large compared to R, which makes the unknown

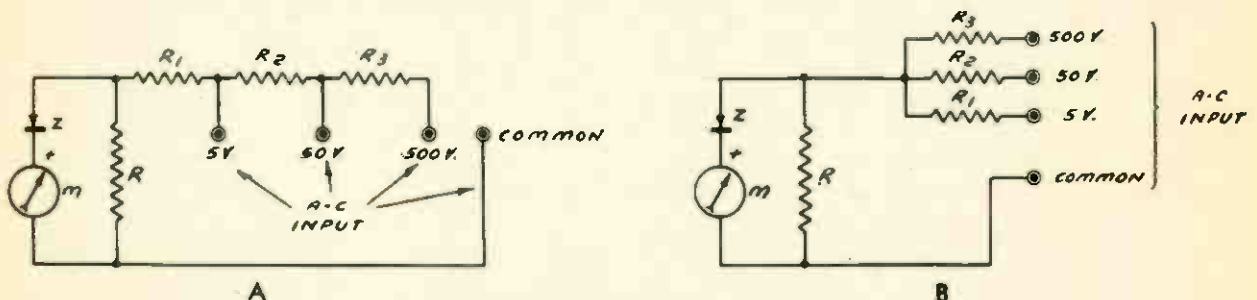

FIG. 4

The impractical circuits of Fig. 2B is changed and made practical in A, with series resistors cumulative, or in B with separate resistors.

a-c circuit look into a relatively large resistance.

However, R can not be made very small, without destroying the sensitivity. For instance if R is a short circuit nothing can be read, yet R has its practical value, because it can be selected so that the rectifier will have a sensitivity that is a submultiple of the sensitivity for d-c measurements (to be made otherwise).

If the sensitivities, a.c. and d.c., are in the multiple class, then the same limiting resistors  $R_1$ ,  $R_2$  and  $R_3$  may be used for a.c. and d.c., and if the multiple or submultiple is 10, then for a 0-1 milliammeter you would read .5, 5,

capacities need not be so large in practice that there will be much difference between 60 cycle and 120 cycle readings, the commonest frequencies at which a-c measurements are taken. The selection is made at 60 cycles.

The condensers are shown in Fig. 5A but not in Fig. 5B, which is a repetition of Fig. 4A.

For combining a-c and d-c readings in a single switch type instrument, the capacity compensation method is applied to the series hookup of limiting resistors for a-c voltages, whereas for d-c voltages these condensers have no effect. In Fig. 6 there are four voltage ranges for a.c. and four for d.c. Then there

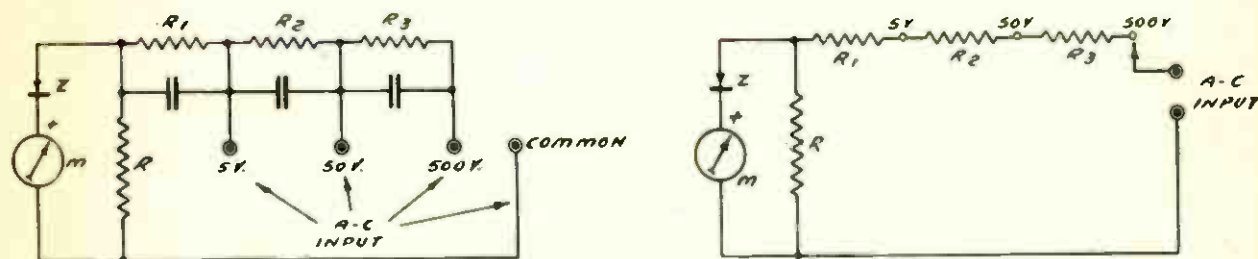

FIG. 5

Compensating condensers are included in A, so that the same resistors used for d.c. will apply for a.c. purposes, although not necessarily for identical voltage ranges. B is the same as 3A.

and 50 volts d.c. at 1,000 ohms per volt, while for a.c. you would read, at 100 ohms per volt, 5, 50 and 500 volts, for the self-same resistors. Obviously an extra range is required, so that higher d-c values can be read, and this might be supplied by an extra resistor inserted only for the high d-c range, 500 volts, requiring 500,000 ohms for the 0-1 milliammeter.

Fig. 4B is the same as Fig. 4A, except that separate, individual resistors are used, and not the chain method.

Since we are approaching a method of measuring both a-c and d-c volts with the same instrument, it is possible to take cognizance of the effect of condensers across a resistor. This effect may be viewed from any one of several angles, but let us say that the alternating voltage drop that appears across the rectifier may be increased if we reduce the obstruction offered by the resistors,  $R_1$ ,  $R_2$  and  $R_3$ , and this reduction may be accomplished by using condensers across the resistors, the largest condenser across the smallest resistor.

### REACTIVE EFFECT

Thus the same resistors used for d.c. could be used for a.c. with approximate following of the d-c scale, except for normal a-c departure from linearity, and each condenser would be considered as a unit selected as to its capacity on the basis of its effect on calibration.

The condenser is used for making the needle come to full scale for some predetermined voltage input. Of course the circuit then becomes somewhat reactive, or does not read the same voltage for higher or lower frequencies, although the voltage is the same; for higher frequencies the reading will be too high, for lower frequencies too low. However, the ca-

are four d-c current ranges. The three remaining ranges are for resistance measurements.

### THE OHMMETER RESISTORS

The fixed resistors for the additional cells or batteries are multiplications of  $R_{10}$  in proportion to the ratio of  $E_2$  to  $E_1$ , where  $E_2$  is the next highest voltage, and  $E_1$  the lowest voltage. For 0-1 ma, then,  $R_{10}$  is 1,200 ohms,  $R_9$  is a rheostat of 500 or 600 ohms or thereabouts, for 1.5 volts for the first cell. Adding 4.5 volts, totalling six volts, requires 4,500 ohms for  $R_{11}$ , while for 22.5 volts for the last battery, the total voltage is 28.5 volts, the required resistance for  $R_{12}$  is 24,600 ohms, closely held, and the three resistance ranges are about 5,000, 20,000 and 5,000,000 ohms. Close distinctions cease at 100,000 ohms.

R is used in this circuit to fix the sensitivity of the a-c meter so that the d-c readings may be multiplied by a whole number, like 5, for an a-c sensitivity of 200 ohms per volt, or 2 for a sensitivity of 500 ohms per volt. For the simple half-wave rectifier the sensitivity may be practically no greater than 200 ohms per volt, unless one possesses an unusual rectifier. Other circuits and methods, more elaborate and costly, enable usually sensitivities of 600 ohms per volt or thereabouts, with 0-1 ma, or even 1,000 ohms per volt (using a 30-henry choke in a special circuit), while in general it may be said that the sensitivity is higher for full-wave rather than for half-wave.

The main drawback to Fig. 6 is that a means of running one's own calibration, and preparing the scale, must be provided, but for simplicity, and half-wave rectification, these troubles are unavoidable, so far as any methods generally disclosed are concerned.

(Continued on following page)

(Continued from preceding page)

The a-c/d-c switch is included only to expose the meter to its full sensitivity for d.c. If this is not so important, and it would not be, if  $R$  is around 3,000 ohms, a reduction of 2% sensitivity, the a-c/d-c switch may be omitted. The binding posts are used for proper selection of circuit for a.c. and d.c., anyway. If desired,

plained, the highest a-c voltage not being at the highest d-c position, but at second from highest, e.g., 500 volts a.c., using 50,000 ohms, the same resistor used for 50 volts d.c.

The Fig. 6 method avoids the reduced sensitivity found in most universal meters, e.g., if a 0-1 ma is used ordinarily it is shunted to 3.33 ma, or 300 ohms per volt. Better grade instru-

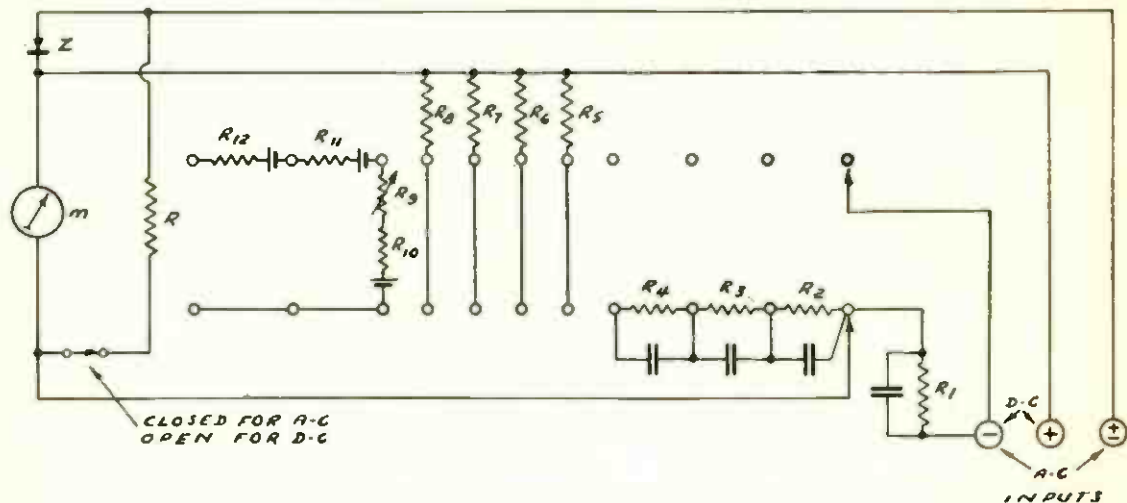

FIG. 6

Circuit for a small tester, using a d-c milliammeter and a contact rectifier (half wave). Besides a-c and d-c voltages in four ranges, there are obtainable readings of d-c currents in four ranges and resistance in three ranges, to 5 meg., if the largest battery is 22.5 volts, and the meter a 0-1 milliammeter.

the lowest range for a.c. may be established by moving the switch to a resistance-measuring position, then including a small fixed resistor, around 500 ohms, in series with the plus-minus lead to lead to the binding post. This enables measurements even to a range of 5 volts a.c. full scale, while the 5-volt d-c position, first switch position, at left, would equal 50 volts a.c.

This would be true for an established sensitivity on a.c. of 100 ohms per volt, which is handy because the decimal submultiple enables the use of the same resistors for a.c. and d.c. The voltages for each position would be ten-fold for a.c. compared to units for d.c. The lowest a-c voltage would be separately obtained, as ex-

periments use 400 microampere base meter, at 1,000 ohms per a-c volt.

### A.C. THROUGH METER

It is well to avoid passing a.c. through the meter, when a.c. is being measured, and this is sometimes safeguarded against in designs of universal instruments (those that measure a.c. and d.c.). The reason for desiring the avoidance is that the meter is of the d-c type, and considerable a.c. could pass through the meter without moving the needle, so there would be no warning, and yet damage could be inflicted on the meter, even if only disturbance of the calibration.

In Fig. 6 there is a little a.c. through the meter because the d-c voltmeter is across a possible maximum of 10 volts a.c. on all ranges. If the rectifier behaves as a rectifier and not as a resistor, and this behavior is maintained by avoidance of overload of the rectifier, the a.c. through the meter is about .5ma.,  $R$  and  $R_1$  are interdependent, and for a 10-volt range, with 0-1 milliammeter, if  $R_1$  is 10,000 ohms,  $R$  may be around 2,000 ohms, so the condenser across  $R_1$  would be around .5 mfd. It is selected of such value as to establish full-scale deflection at 10-volt a-c input.

MR measures the voltage drop across the rectifier.  $R_2$ ,  $R_3$ ,  $R_4$  and  $R_5$  serve as resistors to limit the a.c. That they will limit it too much, without compensation, has been explained, and the condensers are put across the four resistors, as shown, to adjust the resistor-capacity circuits to enable use of the same resistors on a.c. as on d.c.

## No Escaping the Slide Rule

Two radio engineers were fishing. One of them caught a fluke with large scales. The other congratulated him and said:

"What is the frequency, when the capacity is 400 mmfd. and the inductance is 250 microhenries?"

The lucky fisherman looked fixedly at his fish, ran his fingers up and down the scales and said:

"The frequency is 500 kc. How do I know? Because I just caught a fish with A, B, C, D, G, and K scales."

## WORDS OF PRAISE

### BEST HE EVER SAW

Your RADIO WORLD is the best book I ever came across for radio work.

RALPH A. SAWIN,  
Eldridge, Calif.

\* \* \*

### WHERE INTEREST CENTERS

I find your magazine very interesting, especially the articles on test equipment.

STANLEY R. PITTS,  
2412 Edward Ave.,  
Niagara Falls, Ont., Canada.

\* \* \*

### LITTLE BUT OH, MY!

Am regular reader of RADIO WORLD and believe it is the best although not the biggest.

JAMES A. OSBORNE,  
1058 Hodiament Trks.,  
St. Louis, Mo.

\* \* \*

### TOUGH ON THE OTHER FELLOWS

I have had wireless papers for seventeen years, and RADIO WORLD for about six, and can say that it is the only popular journal now worth buying.

B. C. GEORGE,  
22 King Edward Road,  
Oxhey, Watford, Herts, Eng.

\* \* \*

### IN WHAT SENSE?

I have been a reader of your magazine for more than four years, and there is no other in my opinion that can compare with it.

W. H. GIBSON,  
P.O. Box 634,  
Kentville, N. S.

\* \* \*

### WE INTEND TO

RADIO WORLD is the best radio magazine on the market. Keep up the good work.

CARL C. SKAMP  
3526 Graceland Ave.,  
Indianapolis, Ind.

## Literature Wanted

Readers whose names and addresses are printed herewith desire trade literature on parts and apparatus for use in radio construction. Readers desiring their names and addresses listed should send their request on postcard or in letter to Literature Editor, Radio World, 145 West Forty-fifth Street, New York, N. Y.

James A. Osborne, 1058 Hodiament Trks., St. Louis, Mo.

Richard Biddle, 1 Penn St., Hanover, Pa.

Bill Kiewel, 324 Grant Ave., Crookston, Minn.

Roy Haynes, Box 504, Westwood, Calif.

Robert Millis, 826 S. 17th St., Newcastle, Ind.

D. R. D. Wadia, The Automobile Co., Ltd., 5-12 Queen's Road, Bombay, India.

Frank J. Reinsch, 1437 E. 83rd St., Los Angeles, Calif.

—Television, testing equipment, amplifiers, etc.

H. E. Drabble, M.I.R.E., High Street, Staveley, Chesterfield, England. Service instruments and requirements.

Walter T. Wichner, 905 So. Minnesota Ave., Sioux Falls, S. D.—transmitters (kits); receivers (kits and custom b.); service equipment (used and new).

The Syndicate Mining Company, George E. Hicks, Manager, Rico, Colo.

F. A. Munson, Radio & Electrical Supplies, Ashland, N. Y.

E. C. Arnold (N.R.I. Radio-trician, Reg. No. 60-BB-31), Box No. 17-284, Folsom Prison, Represa, Calif. (Is conducting a radio class and wishes all information available.)

James R. Dunne, 13 Steelawanna Ave., Lackawanna, N. Y.

W. H. Gibson, P. O. Box 634, Kentville, N. S., Canada.

Edward Carlson, Box 375, Kemmerer, Wyo.

Andrew Dunn, 1462 W. Hubbard St., Chicago, Ill.

Walter Hawkins, 1308 N. Van Buren St., Wilmington, Del.

Carl C. Skamp, 3526 Graceland Ave., Indianapolis, Ind.

Frank A. Brown, 19 Reed Park, Rochester, N. Y. (a serviceman).

Charles Malinski, Sales Mgr., 34 Diamond St., Brooklyn, N. Y.

Mike Strykowski, Sales Mgr., 150-12 112th Ave., Jamaica, L. I., N. Y.

Ulysses D. Bryant, Stonega, Va.

Louis Della-Rocco, 1101 Magee St., Elmira, N. Y.

American Sales Co., Silver Springs, N. Y.

Daniel Thaler, 940 57th St., Brooklyn, N. Y.

Paul H. Gintler, New Holland, Ill.

J. Lee Cooke, 1213 Prince Edward St., Fredericksburg, Va.

C. Joseph Johnson, 3445 Evaline Ave., Hamtramck, Mich.

F. F. Feiner, 3673 Lafayette Ave., St. Louis, Mo.

Arthur Ross, 1010 3rd St., East, Calgary, Alta., Canada.

John M. Kuczko, 88 Houston St., Newark, N. J.

Morris Davidson, Sunset-DX-Club, 1445 So. Millard Ave., Chicago, Ill.

Arthur Renand, Sturgeon Falls, Ont., Canada.

## New List of I-F Peaks Is Issued by Ghirardi

Alfred A. Ghirardi has just completed a newly revised and greatly enlarged i-f peak list for servicemen, said to be the most complete and up-to-the-minute compilation of the model numbers and peaks of all super-het receivers manufactured in this country to date, and the only list of its kind available to the radio trade. Months of arduous work in assembling and compiling the information and then checking and re-

checking with all the receiver manufacturers was required to put the list in its present complete and accurate form.

This new compilation forms part of the March set of Supplement Sheets which is being sent to all subscribers to the Supplement Sheet Service for Ghirardi's loose-leaf Radio Field Service Data book. Supplements are issued approximately every other month. The subscription price is \$2 a year. Circulars describing the data book and the supplement service may be obtained free from Radio & Technical Publishing Co., 45 Astor Place, N. Y. City.

# GOING TO TOWN

## With a Volt-Ohm-Milliammeter

By **M. N. Beitman**

*Wholesale Radio Service Company*

**S**CIENTIFIC progress has been made possible by systematic classification of facts and logical approach to new problems. In radio servicing also the best and quickest way to locate the trouble with a circuit is to follow a logical sequence in testing. The author, somewhat to the pains of the test equipment manufacturers, has stressed in his previous writings the objective of simplified radio servicing. An attempt will be made now to show the versatile servicemen how to handle over 90% of all service jobs with a volt-ohm-milliammeter.

The right approach on any servicing call is to find out the history of the trouble. Do not hesitate to ask questions, for many times a hint hidden in the owner's answer will suggest the fault. Find out how the set worked before the trouble developed, how long has the difficulty lasted, etc.

Armed with this information and aided by a quick visual inspection of the chassis, you are ready to formulate your initial deductions. At this stage your reason will dictate just what part of the circuit to approach and whether to set the meter prods for voltage or resistance test. Let us see how this works out in two typical cases.

### SOME CASES GIVEN

**CASE 1.** Seven-tube t-r-f set. Tubes replaced two years back; set in use seven years. Complaint: tone quality bad; stops playing; sometimes bad hum; when working, selectivity on locals O.K. Chassis examination: set very dusty; wet three-section electrolytic condenser has excessive corrosion deposit. Deduction: dust on tuning condenser and trimmers may have detuned the r-f stages; the other complaint probably due to the electrolytic.

Procedure: clean chassis and realign set, hoping that the characteristic fault of intermittent operation will occur and permit test of the condenser under load. In any case the condenser should be replaced, as it is probably at fault.

**CASE 2.** An old-time, cast chassis. "Played wonderfully and then just stopped." Field excitation hum present; chassis appears in good condition; tube filaments light. Deductions: Since none of the tubes are burnt out and set suddenly stopped, probably tubes are not at fault. Power supply must be working, since speaker field (used as choke) is carrying current.

Procedure: Touch grids of tubes for hum

response, begin with power tube and work back. In this case the third r-f tube gave no response, with the voltmeter test for potentials on tube elements.

### VOLTAGES CHECKED

Type 27 tube in r-f stage should give between chassis negative return and point of test the following voltages:

Grid: 0 volts

Cathode: —3 to —8 volts

Plate: 180 to 250 volts.

Plate test gives no reading, indicating lack of plate voltage at the point. Plate to r-f coil wire traced; no voltage at coil on plate side; no voltage at coil B+ side. B+ side of coil connected to bypass condenser and dropping resistor. Voltage low (about 70) on the other side of resistor. Bypass condenser suspected, disconnected and found shorted by an ohmmeter test. Replaced with 0.1 mfd. 600 volt paper tubular condenser.

A test unit of the d-c volt-ohm-milliammeter type will test resistances, opens or shorts in circuits and parts, the voltage between any two points in the set, and (if the circuit is broken) the current passing through any point. In case the set is completely dead, the ohmmeter test only can be applied. In such cases when there is no plate voltage and the filaments of the tubes do not light, the fault is obviously in the power supply.

### POWER TRANSFORMER WINDINGS

The different windings of the power transformer and the chokes may be checked with an ohmmeter. All the windings should indicate low resistance. The high-voltage winding will be about 150 ohms on each side of the center-tap. If none of these windings is open and the transformer does not look burnt out because of an external short, the fault must lie in the power cord, switch or some other closely associated part. The important thing is to realize where to look for trouble. The hardest part of any repair job is finding the difficulty; the actual servicing is simple in comparison.

Consider yourself now confronted with a set where the previous methods have enabled you to trace the difficulty to the second i-f stage. You make a voltage point test on the



type 6K7 tube and the readings are within the expected limits.

Chassis to	Voltage
1. Shell	0
2-7. Filament	A.C. ripple
3. Plate	220
4. Screen grid	105
5-8. Suppr. & Cath.	Slightly positive
6. Not used	
Cap. Control grid	Slightly negative

This is an obvious case where the voltage point-to-point test fails, for according to results obtained from this very test the circuit should work correctly.

### AN ALTERNATIVE

You now have your choice of breaking the circuit, one section at a time, and measuring the current or shutting off the power and using the ohmmeter. Since it is simpler to apply the ohmmeter point-to-point test, we use it next. If the ohmmeter test was initially applied, the procedure would have been different, but the voltage test already pointed out that all connections to the power supply are operating correctly and the fault must lie in one of the parts used in the circuit. The only parts used are: the interstage i-f transformer, the output i-f transformer, and the 6K7 tube. Since this is a late model set the tubes are probably performing, or (if the need occurs) the tube may be tested by the method outlined later on. The i-f transformer windings are tested next on the low scale of the ohmmeter.

The resistance of each coil will be found to be very low, but some value of resistance should be indicated. In this case, the secondary of the interstage i-f shows no resistance; upon further examination of the unit it is found that the trimmer shunting this coil is shorted. Sometimes trimmers can be repaired, but if a replacement can be obtained it is preferable.

The case just studied would give no indication of the fault if analyzed with current readings on the milliammeter scale. But in practically every case, one of three test methods available with a simple compact volt-ohm-milliammeter unit will point out the trouble.

### GUIDED BY TUBE MANUAL

Modern tube testers usually test emission and indicate the relative ability of the tube to perform in a circuit. For this test the various elements with the exception of the cathode are tied together and are used as the plate of the equivalent diode. Knowing the circuit of a set to be performing correctly, a much more accurate test is possible by correlating the obtained plate and screen current to the expected values of current under the voltage conditions present. A tube manual will give you a list of values to expect and these should serve to guide you in determining the tube's worth.

Complex radio equipment—advanced analyzers, oscilloscopes, oscillators—is helpful in many cases and is essential in a few, but the majority of radio jobs can be handled quickly and successfully with simplified equipment and plenty of thought.

## Nine Ultra Channels Worked Multiplex

An ultra-short-wave radio telephone circuit which transmits nine completely segregated two-way telephone conversations simultaneously, the first radiotelephone installation of this capacity in the world, has been established by the British Post Office between Ireland and Scotland, the International Telephone and Telegraph Corporation announced.

It is applied on one of the busiest telephone pathways in Europe connecting the telephone system of Northern Ireland with that of England and Scotland and, through London, with the rest of the world. The radio link covers 41 miles over the North Channel of the Irish Sea between Belfast, Ireland, and Stranraer, Scotland.

The nine-channel ultra-short-wave system is the culmination of six years of intensive research and development work by laboratories of I. T. & T. subsidiaries in France and England which have pioneered the application to radio communication of micro-rays (tiny radio waves of about 10 centimeters) and ultra short waves (wavelengths of less than 10 meters). In 1931 the laboratories demonstrated for the first time the use of micro-rays on a circuit across the English Channel between Dover, England, and

Calais, France. The British Post Office became interested in the micro-ray and ultra short wave field in 1932, and in 1934 a permanent circuit across the Channel to France was established by the Air Ministry to report the flight and arrival of airplanes. An ultra short wave radio telephone installation, single channel development forerunner of the nine channel system, was installed in 1935 between the Spanish telephone network and the Island of Majorca.

It is believed by radio engineers close to this development that much of the future of radiotelephony over both short and long distances lies in the ultra short wave lengths, because of the very large number of channels available in this band and because of the high degree of directivity which the ultra short waves permit.

British officials have been particularly impressed with the economic advantages of a radio circuit of a higher capacity than most telephone cables whose cost is so much greater. The stations at both Belfast and Stranraer are unattended and are operated entirely by remote control from the nearest telephone switching point. Complete provision is made in the system for an immediate switch automatically to spare equipment in the case of trouble.

## RCA Building at Fair to Be Tube-Shaped

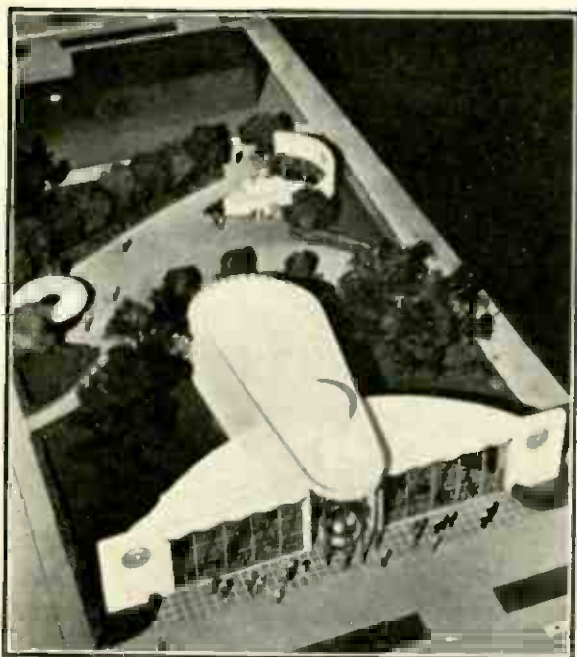

Architect's drawing of proposed World's Fair Building of RCA

Plans were announced for the erection of an exhibit building of unique design to house a panoramic display of the latest developments of the radio art and industry as reflected by RCA products and services at the New York

World's Fair, next year. The exhibits will display all the products of RCA companies, including RCA Manufacturing Co., R. C. A. Communications, Radiomarine Corporation of America, the Radio Institutes and the National Broadcasting Company.

Experimental television programs will be shown to the public in viewing rooms in the RCA Fair building. Plans call for television programs flashed through the air by RCA transmitters. Ample opportunity will be given for visitors to view various forms of television entertainment in surroundings approximating those in American homes.

The RCA Fair building, as viewed from the air, will be shaped somewhat like a huge radio tube 136 feet in length, resting on a broad base 190 feet wide. The entire front of the two-story structure will be of glass, which will be brilliantly lighted at night. Working models of various radio devices will be placed in the large rotunda, around the sides of which will be six television viewing rooms.

Proceeding further into the "tube" section of the building, the visitor will see the latest radio receiving sets and tubes in actual process of construction, together with animated demonstrations of some of the principal RCA services. A picked crew of expert workers from the big RCA Victor factories at Camden, N. J., will assemble radio sets at one exhibit, while at another RCA tubes of various types, including those used in television will be constructed.

## Dykanol Condensers Get Test in Boiling Water

The Cornell-Dubilier type DH Dykanol capacitors are designed to operate efficiently under any humidity and temperature conditions. Their light weight, compactness and convenient construction make them suitable for use in aircraft, submarine and marine radio equipment. These capacitors are impregnated and filled

with Dykanol, the non-inflamable and non-explosive chlorinated-diphenol impregnating compound, essential to the successful operation of communication systems where uninterrupted service is of prime importance.

A special test given these capacitors calls for immersion under boiling water for a minimum period of fifteen minutes. The type DH series is available in a capacity range from .05 to 2 mfd. at voltages of 400, 600 and 1000 volts d.c.



Condenser tested in boiling water

## Leipzig Fair to Be Held from March 6th to 14th

The Leipzig Trade Fair, in which radio has an important part, will hold its 1,979th session from March 6th to 14th. To accommodate new exhibits two halls, with more than 200,000 square feet of display space, will be added to the 51 exhibition halls heretofore in use. The Spring Fair will include some 10,000 exhibits of every industrial and art product assembled from twenty-one countries, including the United States. An attendance of over 250,000 business men, attracted from 74 countries in all parts of the world, is expected.

# First Tool for Servicing Television

## Phasmajector Provides Test Image

The Phasmajector (Greek for Image Emitter) is a new device for providing a uniform television test signal with relatively inexpensive associated apparatus. It is a modified form of cathode-ray tube. In place of the usual fluorescent screen swept by the cathode-ray beam and glowing to weave an image, there is in the Phasmajector a metallic plate on which is printed the desired picture or test pattern. Also, the tube includes a collector electrode as well as the conventional cathode-ray tube gun and deflecting electrodes.

When used with proper sweep circuits and amplifiers, the picture printed on the metallic plate can be readily scanned and transmitted to a receiver for reproduction on a standard television viewing tube such as the DuMont 54-10-T or 144-10-T. It is also possible to use the standard oscillograph cathode-ray tubes for viewing.

### VARIES SECONDARY EMISSION

The new image-transmitting tube operates on the principle of varying secondary emission from the image plate. In other words, as the cathode-ray beam scans the image on the metallic plate, varying amounts of secondary electrons are released depending upon whether the beam impinges upon metal or special ink used to print the picture. A larger number of electrons are released when the ray strikes the metal than

when it strikes the ink. The varying voltage output is picked up by the collector electrode and fed to the grid of the video amplifier. This signal is very stable and of much better quality than can be obtained from a photo-electric mosaic pick-up tube because of the absence of capacitance effects. The amplitude of the signal may be as high as 10 volts with high-impedance coupling and can modulate a television viewing tube directly without any video amplifier. The signal is 0.2 volt across a 10,000 ohm load.

### USE OF TWO 'SCOPES

For a simple television demonstration, two standard oscillographs such as are used by radio servicemen, can be used, one equipped with a Phasmajector tube in place of the usual cathode-ray tube, and the other with its usual tube. Certain slight modifications are required, but the oscillographs can still be used for their normal purposes when desired. With such an arrangement the principles of a television system can be readily demonstrated. Either horizontal or vertical scanning of any desired number of lines and any interlacing arrangement can be used.

The Phasmajector available to demonstrators, experimenters and others has on its plate a line drawing of Abraham Lincoln. This provides a clear received picture.

## Kenyon Offers Yoke and Television Coils

Deflecting Yoke type T-700 recently introduced by Kenyon Transformer Co., Inc., New York, N. Y., is designed for use with cathode-ray tubes of the electromagnetic deflection type for television.

The low frequency coils are so constructed that a low impedance line may be run to them from the new output transformers type T-112. This helps to minimize pick-up and eliminate coupling condensers.

More than ample deflection with negligible distortion is obtained from the type T-700 yoke on nine inch tubes at a plate voltage of 6000. The new type T-111 high frequency sweep output transformer is wound with low capacity coils in order to effectively pass the higher harmonics of 13,200 cycles necessary for the production of a linear deflection.

The power transformers T-203, T-204, and T-208 are insulated for the high voltages at which they must operate and at the same time compactness is retained.

## Cisin Grants Licenses Under His AC-DC Patent

The American Telephone & Telegraph Company, Bell Telephone Laboratories and Western Electric Company have been licensed to manufacture inter-communication systems and hearing aids, using the ac-dc circuit on which H. G. Cisin, of 98 Park Place, N. Y. City, has a patent.

Mr. Cisin applied for a patent in 1932. Several other inventors claimed to have originated this idea. After a legal battle which lasted over five and a half years, prior rights were awarded to Mr. Cisin.

The patent was granted on July 6, 1937, and since then a number of the leading manufacturers of equipment have taken out licenses.

### TREASURE-SEEKING CIRCUITS

A detailed article on methods of geophysical exploration, to capture riches embedded in the earth, appeared in the January, 1938, issue, 25c per copy.—RADIO WORLD, 145 W. 45 St., N. Y. City.

# RADIO CONSTRUCTION UNIVERSITY

Answers to Questions on the Building and Servicing  
of Radio and Allied Devices.

## WHY IS AFC NEEDED?

**W**HAT is the necessity for automatic frequency control, and what is the method by which such control is worked?—K. W. C.

The object of automatic frequency control is to provide a means of accurately tuning in a station, independent of improper adjustment of the main tuning dial. The necessity arises from the presence of automatic volume control, which requires that the set be very closely tuned, to true resonance, otherwise distortion is produced. Various indicating devices have been provided on receivers, so that one may see when the set is correctly tuned in, but users do not pay sufficient attention to this service, so distortion results anyway. Automatic frequency control brings in the station "on the nose" despite mistuning, even up to, say, 30 kc or more from resonance. A brief statement of the method is that the oscillator frequency is adjusted by the automatic control device, so that this frequency is correct to produce response from the desired station. Two tubes are used, one a discriminator, which "feels" whether the oscillator is too low or too high in frequency, or just right, and according to this "feeling," actuates a control tube that supplies bias change to the oscillator, either greater or less bias, or no change. For any required change there will be a shift of the phase in the oscillator coil the same as the proper change in inductance would produce. Since phase shift and frequency change are mathematically the same, and in the same direction, the equivalent inductance of the oscillator is altered to make the frequency right.

\* \* \*

## VOLTAGE RATING OF CONDENSER

**W**HEN a stopping condenser is used in a grid-leak oscillator circuit, or in a condenser-diode rectifier circuit for instrument purposes, is it necessary to have the peak voltage rating of the condenser at least equal to the highest voltage to be injected, or does not the full voltage drop escape the condenser, because the condenser is assumed (or is) very large?—P. W.

The condenser should be able to withstand the highest injected peak voltage because the condenser is charged to practically the full value of that peak (assuming excellent power factor of condenser) and the circuit functions on the basis of the discharge of the condenser through a resistance.

## OHMS LOAD AND DECIBELS

**W**HEN a decibel scale appears on a meter, and the zero reference point is a given voltage or power, why is it so necessary not to depart from the recommended ohms load, say, 500 ohms?—U. D.

Because the meter reflects changes in power dissipated in the resistor, and these changes as calibrated on the meter apply only to the resistance for which they were calibrated. For instance, for full-scale deflection on some given range, 500 ohms load, the power would be  $I^2 \times 500$ , whereas for 250 ohms it would be  $I^2 \times 250$ , or current squared has to be doubled.

\* \* \*

## OUTPUT METER USE

**W**HEN an output meter is used, is it actually necessary to know the voltage, or will relative indications suffice?—W. D. S.

Relative indications are all that one needs, because the meter in service practice is used for indicating maximum deflection for given input and given adjustment of controls in the device being tested. What the absolute voltage is will not be important for mere "peaking," but would be significant if, besides, an indication of the quantity of output is desired. However, matching requirements, and other considerations, introduce complications into the output measurement on a quantitative basis, and the output meter is therefore used in general for the relative deflection only. If the meter is sensitive enough to enable measurement across voice coils, it is easier to combine the two measurements in one, because the meter is assumed sensitive, hence introduces negligible loading of a voice coil in which much current is flowing anyway.

\* \* \*

## WHAT "DRIVER" IS

**W**HAT is the "driver" in a set? This tube is usually the one ahead of the output tube.—E. Q.

The driver is the audio amplifier ahead of the output tube and is selected so that it will deliver enough voltage, for full rated output of the power tube or tubes, to swing or "drive" the grid to the maximum voltage it will stand without drawing grid current. This viewpoint applies to audio amplifiers in which no power is to be delivered to the output tube. In Class B or some other circuits, where such power

(Continued on following page)

## Remarkable Earcap Developed

The mysteries of the two-thirds harmonic have fascinated Poul Jarnak, Danish engineer, for years, and he has developed devices based on his theoretical considerations and practical experimentation with these phenomena.

One of these devices is an earcap that he is manufacturing and that fits onto the popular earphones, replacing the two present caps, but in no way necessitating molestation of the electromagnets. The old earcaps are screwed off, the new ones screwed on, for which purpose they are pregrooved to match the original thread, and then a transformation takes place. Instead of the usual resonance peak there is a relative flatness of the frequency response, and the injected sound pulses determining the response almost exclusively, and not the eccentricities attendant on earphone construction.

This result Mr. Jarnak attains by moulding each cap in two companion pieces, having concentric channels of different lengths, as if circularly bent pipes had been exactly bisected and then the pieces reunited. These channels thus become Helmholtz resonators, but with open terminals, of frequencies determined by their physical dimensions. There are six channels. They set up a sufficient number of standing waves, when the earphones are excited, so that, due to the proportion of frequencies being 3 to 2, cause beats that mix. Interaction takes place between the fundamental and the standing waves and the beats, making the tubes such as to direct correction to the earphone's natural mechanical period of vibration, with optimum results when the interfering wave is one octave below the fundamental.

If the longest channel in the new earcap is 40 centimeters, corresponding to a standing wave of around 1,000 cycles, the length of the following channel is two-thirds of 40 cm, or 26 cm, corresponding to a standing wave of the three halves of 1,000 cycles, or 1,500 cycles, because the frequencies are inversely proportionate to the channel length. Due to the harmonic relationship, there is a beat between the standing waves, creating a differential wave of 500 cycles. Higher frequency standing waves are produced by the four other channels, resulting in a frequency band to 9,000 cycles or higher.

Thus the vibrations existing in the diaphragm, and often present when the injected electrical frequency is quite different than this mechanically natural period, are interfered with by standing waves, and take the curse of diaphragm rattle off the earphones. Also, the standing waves themselves united to form other waves, give the harmonics of the fundamental proper receptive balance, avoiding the overaccentuated even-order harmonics created by the fact the diaphragm moves on only one side of equilibrium.

The new caps also reduce background noise very markedly, and add much to the enjoyment of speech and music for earphone listeners, besides being valuable in monitoring work at broadcast stations and in connection with sound amplification, recording and reproduction.

The caps are distributed by Mr. Jarnak from his New York City headquarters at 69 West 83rd Street. He has many testimonials from leading laboratories and acoustical concerns.

*(Continued from preceding page)*

is required, then the driver is of the power type, sometimes of the same kind as one of the push-pull output tubes, and supplies power rather than mere voltage. When this is true, a transformer is indicated, and it must be of a special type, usually stepdown.

\* \* \*

### MAKING SHUNTS

**C**AN YOU suggest some readily obtainable wire with which I can make small shunts for my d-c meter? I desire to increase the ranges to 10 and 100 milliamperes.—O. F. C.

The resistance wire used in heater elements in home appliances will serve. Be careful to clean the ends of the wire thoroughly before attempting to solder. The resistance may be measured and cut where desired. If small resistance can not be measured well, because of lack of equipment, measure the total resistance of the wire, which may be around 20-odd ohms, and the total number of turns. Dividing the number of turns into the total resistance yields the resistance per turn. When very low resistance is needed, say, less than one ohm, con-

sideration has to be given to the resistance of the wiring in the measuring device you are building, and also to the contact resistance of any switches. That is, a considerable percentage of the resistance then will be in the device, and the inserted resistance should be less by that amount. To increase the range of the current meter, you must know the present full-scale deflection current and also the meter's internal resistance. Then decide how much you want to multiply the base current, and divide the resistance of the meter by a number one less than the multiplier. The answer is the required shunt resistance to increase the range by the specified amount. Example: For a 0-1 milliammeter, internal resistance 30 ohms, to increase the range to 10 milliamperes, the multiplication factor is  $10 \div 1 = 10$ , and the meter resistance is divided by one less than 10, or 9, so the required shunt is  $30 \div 9 = 3.33$  ohms. For 100 milliamperes the required shunt is  $30 \div 99$ , but for 100 or more as multiplier, the subtraction of one is unnecessary, so for 100 milliamperes divide the resistance of the meter by 100 and for 1,000 milliamperes (one ampere) by 1,000. The answers are .3 and .03 ohms, respectively.

# Electrolytic Condensers

By Paul McKnight Deeley

Chief Engineer, Electrolytic Division, Cornell-Dubilier Electric Corporation

[History, theory and polarization of electrolytics were discussed in the first instalment, published last month. The discussion of electrolytics will be continued next month and will end in the May issue.—EDITOR.]

## CHAPTER III.

### The Formation of Anodic Films

AS has been mentioned before, aluminum has become the metal that is used exclusively for anodes in electrolytic capacitors and any information which follows refers only to aluminum.

When aluminum is made the anode in an electrolyte, the voltage necessary to maintain a given current density increases almost in direct proportion to the time of voltage application. At a certain voltage a partial breakdown of the film occurs and minute sparking between the anode and the electrolyte occurs. This point is called, for want of a better classification, the sparking or scintillating voltage of the capacitor.

This period of polarization during which the oxide film is formed is called the formation period.

The formation of the anodic film can take place on direct current or on alternating current and both are used in commercial practice. In most cases direct current only is used but in some instances both direct and alternating current are used, either separately or in combination.

The anodic film which first appears on aluminum is both transparent and colorless, but as the thickness of the film increases, interference colors become visible. If the thickness of the film is further increased it becomes greyish in color.

With the use of direct current, the time required to form the anodic film depends upon the current density at a given voltage, the type and concentration of the electrolyte and the temperature of the electrolyte. The greater the current density for a given electrolyte the more rapid the formation of the film.

### TWO FORMATION CLASSES

With the use of alternating current the same factors apply which have been mentioned in the preceding paragraph with the additional factor of frequency having considerable influence. Obviously, the higher the frequency the slower the formation. The time required for formation of the film with alternating current is much greater than the time required with direct current, assuming the same electrolyte and current density are used in both cases.

In the formation of anodic films there are

two general classes of methods employed. These two classes are "still" formation and "continuous" formation.

In the process termed still formation, the anode is placed into the electrolyte and voltage applied until the leakage current decreases to a certain desired value. In the application of applied through a current limiting device, or a lower voltage is first applied then gradually voltage in this case the full desired voltage is increased to the desired value and left at that value until the current has decreased to the desired minimum value.

In the process termed continuous formation, the anode material is passed through the electrolyte at a fixed rate of travel. While the anode material travels through the electrolyte full desired voltage is applied and the current as well as the voltage remains constant. The current density on the surface of the anode material however changes from maximum value at the point of entrance of the anode material into the electrolyte, to minimum value at the point of exit of the anode material from the electrolyte.

Due to the voltage (IR) drop in the electrolyte the actual voltage between anode material and electrolyte at point of entrance is of a very low order and this voltage increases in proportion to the decrease in current density until the full voltage is applied at the point of exit of the anode material from the electrolyte.

### ANODIC MATERIAL

The chemical purity of the aluminum used as an anode in the electrolytic capacitor has considerable influence on the efficiency and life of the capacitor. Impurities affect:

- (a) The time of formation of the anodic film
- (b) The direct current leakage of the film
- (c) The amount of corrosion of the anode in service.

The higher the purity of the aluminum the more rapid the formation of the film and the lower the direct current leakage. It has been observed, for example, that the time required for formation of an anodic film on aluminum of 99.8 purity to a given current density at a given voltage was 1/60 of the time required for aluminum of 99.1 purity.

By experiment, it has been determined that the maximum allowable impurities in aluminum intended for use as anodes should conform to the following analysis:

Silicon (Si).....	.05%
Iron (Fe).....	.1%
Copper (Cu).....	.005%
Total others.....	.045%

.2%

# COIL WINDING; NO COMPUTATION!

**S**OLENOIDS for all radio frequencies, from the fringe of the ultra highs, to the fringe of audio, may be wound, using popular wire sizes and form diameters, with no computation, yet at 1% accuracy. This is made possible by a series of quick-answer charts constituting "The Inductance Authority," by Edward M. Shiepe, plus an 18 x 20" supplement.

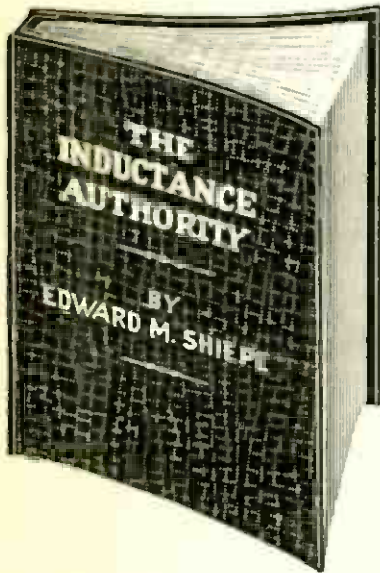

Winding solenoid coils for radio frequencies requires knowledge of the number of turns of any selected type of wire on any sensible diameter to attain an inductance suitable for the tuning condenser and lowest frequency. Hence, with capacity and frequency known, there are two unknowns: (1), the required inductance; (2), the number of turns to establish that inductance. The answers are obtained by consulting "The Inductance Authority," and the supplement. On the large supplement are

plotted the "curves of frequency, capacity and inductance in straight lines, so for a desired low frequency and known capacity the unknown inductance is solved by mere inspection. The number of turns for attainment of that inductance, for all popular tubing diameters and all generally used wire diameters and wire insulations, is read from the inductance-turns charts which are in the bound volume. Coil and set manufacturers, as well as home and shop experimenters, students and teachers freely use this book. The only book of its kind in the world.

Order Cat. INA (price includes bound volume and supplement) postpaid **\$2.00** anywhere on earth.....

Or send \$5.00 for a two-year subscription for RADIO WORLD, regular rate, and this valuable book and supplement will be sent FREE and postpaid anywhere on earth.  
Order Cat. PR-IAC.

## RADIO WORLD

145 West 45th Street New York City

## QUESTIONS ANSWERED

If you have trouble with your set, send in a detailed account of symptoms, with circuit diagram, and 28c. in stamps or coin, and Radio World's staff will make a diagnosis and report back promptly.

### RADIO WORLD

145 West 45th Street New York City

## TELEVISION

"TELEVISION WITH CATHODE RAYS," by Arthur H. Halloran. Farnsworth and Zworykin systems fully explained. The treatment is mathematical. It is a book for the well-grounded radio man who has vision, the man who wants to be among the first to cash in when the pictures go on the air commercially, but is not for novices. 100 pages or more of supplementary data. Price \$2.75 postpaid including Supplements).

### RADIO WORLD

145 West 45th Street, New York City, N. Y.

## ALLIED OFFERS RADIO'S GREATEST VALUES!



Everything in Radio at Lowest Prices!

Send for your FREE copy of the new 1938 ALLIED Catalog. 64 big pages packed with more than 2,000 parts; 26 newest Amateur receivers—National, Hallicrafters, RCA, Hammarlund, Sargent, etc.; 32 Build-Your-Own kits, from a 1 Tube set to a 14 Tube All-Wave Super; 65 new KNIGHT Radios with Automatic Tuning, AFC, etc.; P. A. Systems; Test Instruments; books, tools, etc. It's Radio's easy-to-read, easy-to-shop, easy-to-order-from catalog—write for it today!

### FREE! Builder's Parts Lists

We supply Free Parts Lists of matched kits for building any circuit described in this or in any other magazine. Just specify where seen.

ALLIED RADIO CORPORATION  
833 Jackson Blvd., Chicago, Ill.  
Dept. 16-C-8

Send your 1938 Catalog FREE.

Name .....

Address .....



Free CATALOG

# • • SENSATIONAL • • •

## New! Improved All Purpose Tester

### FEATURES . . .

- ★ D'Arsonval Meter, Guaranteed 2% Accuracy (1000 ohms per volt).
- ★ D.C. Voltage Readings 0-5-50-500-1000.
- ★ Resistance Readings 0-500-500,000 ohms.
- ★ Entirely self-contained battery, 0-1 Mill Reading—no extras to buy.

A sensationally low priced instrument that will prove itself to be the busiest meter around the shop. Its accuracy plus its compactness makes it indispensable to the servicemen for general test purposes.



YOUR NET PRICE  
COMPLETE . . . . .

**\$5.75**

<p><b>SHURE ZEPHYR</b> Crystal Pickup Special 8" <b>\$4.99</b></p>	<p><b>ELKON A.C.</b> FULL WAVE TAPERING CHARGER MAXIMUM Charging Rate 1 Ampere <b>\$2.49</b></p>	<p>Powertone 2-Tube A.C. and D.C. Tunes from 2 1/2 to 2,000 Meters Using 6J5G and 12A7 <b>\$4.95</b> Kit of Tubes <b>\$1.50</b></p>	<p>Variable Condensers .0005 Capacity <b>35 Cents</b></p>
<p>Sangamo Transformers Output <b>29 Cents</b> Input <b>69 Cents</b> Regular \$6.50 each</p>	<p>Portable A.C. Motor and Pickup in Carrying Case <b>\$9.95</b></p>	<p>R.C.A. Magnetic Pickup <b>\$3.50</b></p>	<p>Hammarlund Midget .00014 Variable Condenser <b>59 Cents</b></p>

SERVICEMEN! No need to fret over Receiver. Any Circuit Diagram from any Riders 1-8 Manuals. Each . . . **25c**

CONSULT OUR ENGINEERING STAFF FOR YOUR P.A. REQUIREMENTS. Our Engineers will show you HOW TO SAVE MONEY.

Write in for Test Equipment Catalog

**POWERTONE ELECTRIC CORP.**  
**177 GREENWICH STREET** **NEW YORK CITY**



# CLASSIFIED ADVERTISEMENTS

7 cents a word. \$1.00 minimum.

PLANS 18 DISTANCE CRYSTAL SETS—SW record 4250 miles, with "Radiobuilder" year, 25 cents. Laboratories, 151-P Liberty, San Francisco.

WE MANUFACTURE ELECTROMAGNETIC DEVICE for locating all metals. Plans for building same \$3.00. Metal Prospectors, Dept. R.W., Route 40, Box 1270, Mobile, Ala.

HAVE YOU BACK NUMBERS of Radio World, for May, August, 1935, or April, June, September, October, December, 1926, March, April, 1937? If so, please communicate with Radio World, 145 West 45th St., New York, N. Y.

## A YEAR'S GIFT FOR HIM

Is your husband, son or nephew interested in radio? Why not send him Radio World for a year?

We will send him, at your request, a post card notice telling him of your thoughtfulness in sending a gift that lasts all year!

For \$2.50 a year in the United States he will be reminded of your generosity every time the magazine arrives.

RADIO WORLD, 145 WEST 45th ST., NEW YORK CITY

RADIO WORLD AND POPULAR MECHANICS MAGAZINE—Radio World is \$2.50 a year, and Popular Mechanics Magazine is \$2.50 a year. Popular Mechanics Magazine does not cut rates, but Radio World will send both publications to you for one year for \$3.75. RADIO WORLD, 145 West 45th Street, New York City.

# MAILING LISTS

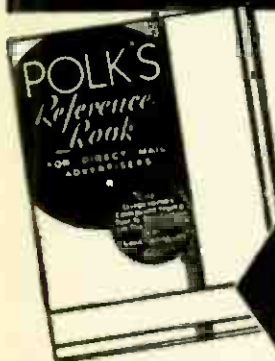

GET OUR FREE  
REFERENCE  
BOOK and  
MAILING  
LIST CATALOG  
**FREE**

Gives counts and prices on accurate guaranteed mailing lists of all classes of business enterprises in the U. S. Wholesalers—Retailers—Manufacturers by classification and state. Also hundreds of selections of individuals such as professional men, auto owners, income lists, etc.

Write today for your copy

## R. L. POLK & CO.

Polk Bldg.—Detroit, Mich.  
Branches in Principal Cities

World's Largest City Directory Publishers  
Mailing List Compilers. Business Statistics. Producers of Direct Mail Advertising.

## "AN HOUR A DAY WITH RIDER"

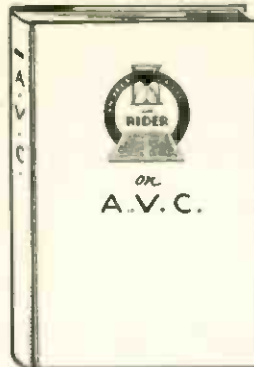

John F. Rider has written a series of pocket-sized books, 60c each, with the idea readers will spend an hour a day reading and studying them, and thus acquiring a full servicing knowledge. Latest of these is devoted to automatic volume control (a.v.c.). The subject is fully covered. 64 pages. Well illustrated. Order Cat. RAVC postpaid @ 60c.

## "ALTERNATING CURRENTS"

"Alternating Currents in Radio Receivers." Hour-a-Day, is a comprehensive book covering the basic functions of the various components of a radio receiver, what each unit does and how it works. Various types of parallel and series resonant circuits, different kinds of coupling, inductance, reactance, impedance, and how these electrical phenomena are employed in radio practice, are fully explained. 80 pages. Order Cat. RAC, postpaid, @ 60c.

A clear explanation of what happens when a circuit is tuned to resonance. All types of circuits described and how and why they work. How these circuits should be aligned so that maximum efficiency is obtained. Knowledge of the latest high-fidelity i-f. amplifiers is becoming more and more necessary and "Resonance and Alignment" tells what you should know about all this. 64 pages. Order Cat. RRA, postpaid, @ 60c.



## "D. C. VOLTAGE DISTRIBUTION"

Every receiver contains some sort of d.c. distribution system supplying the d.c. voltages from the power unit to the elements of the tubes. The many different forms these systems take are thoroughly described in Rider's "D.C. Voltage Distribution," which explains networks from the simplest to the most complicated. The calculations of the value of the resistors and their wattage ratings are more clearly described than ever before. In this brand new combination of theory and practice. 64 pages. Order Cat. RDCVD, postpaid, @ 60c.

[Above four "Hour-a-Day" books are all of the series published to date. All have hard covers. The order of their publication is No. 1 A.C.; No. 2, Resonance; No. 3, D.C.; No. 4, A.V.C.]

## RIDER'S MANUALS

Vol. VII—(new) Rider's Volume VII has 1600 pages! This is the biggest and best Manual that has ever been published. In Volume VII the number of manufacturers has been increased and therefore the size of the book was increased. The greatest collection of servicing data ever gathered and not only from the large manufacturers, but the smaller ones as well. Not only 1936-37 sets, but many old timers. 100-page Index ..... \$10.00  
Vol. VI—Data on sets produced up to October, 1935—the start of the metal tube era—are contained in this Manual. Double-Spread pages are used for the more complicated receivers. 1240 pages, \$7.50  
Vol. V—Sets manufactured up to October, 1934—and older sets, too—are covered in this volume. Electrical and mechanical data are given so that everything is where you want it. 1,200 pages..... \$7.50  
Vol. IV—In this volume will be found information on receivers manufactured up to March, 1934. 1,060 pages ..... \$7.50  
Vol. III—Sets released from the middle of 1932 to June, 1933 are presented in this volume. 1,070 pages ..... \$7.50  
Vol. II—Data are here contained on sets manufactured between early 1931 and the middle of 1932. Many sets unavailable when Vol. I was published will be found in Vol. II. 800 pages..... \$6.50  
Vol. I—This volume contains information on the old timers—from 1919 up to 1931—and there are still many of these in use today. 1,000 pages.... \$7.50  
[Order Rider Manuals by volume numbers as listed above. Remit with order. Books will be sent postpaid.]

Radio World, 145 W. 45 St., N. Y. City

# You need ... these **2** books

## RADIO SERVICING SHORT-CUTS and Money Making Ideas

A completely new and different book tells how radios may be repaired quickly with the absolute minimum of test equipment. Proves that by an actual test 9 out of 10 radios can be fixed with simple tools and volt-ohmmeter. The author, M. N. Beltman, for years in the servicing profession, realized and kept data on these facts. Page after page of practical information. Many real money-making ideas and hints applicable to all sets (Size: 8 1/4 x 11 in.)

## PUBLIC ADDRESS SYSTEMS

A practical handbook, full of useful information, fully illustrated. Considers in detail various microphones, radio and phonograph inputs, acoustic feed-back, mixing and volume controls, use of vacuum tubes, interstage coupling, power amplifiers, output coupling, loud speaker placement, the decibel, P.A. measurements, power level, and other points of importance, including actual circuit diagrams of tested P.A. systems.

Price, 50c each book.

**SUPREME PUBLICATIONS**  
3727 West 13th St., Chicago, Illinois



• Everything you need in radio. It's all in this new **RADOLEK RADIO PROFIT GUIDE**. Every repair part for every receiver. Newest radio receivers. New 1938 model public address amplifiers, outputs for 5 to 100 watts. New model public address speakers. Test instruments, Technical books. Special equipment. Leading standard brands. Every item guaranteed. It must be right or we make it right.

And everything under one roof. You get what you want promptly, and exactly what you want. Radolek's immense stock plus Radolek's efficient organization insures you fastest service. 25,000 service men depend on this service and benefit by Radolek's Radio Profit Guide. It will help you make more money.

# ---RADOLEK---

601 W. Randolph, Chicago, Dept. G-16

Send me the 1938 Radolek Radio Profit Guide FREE.

Name .....

Address .....

Serviceman?  Dealer?  Experimenter?

# Refrigeration



## Text-Book for Home Study

This complete, up-to-the-minute, practical book will teach you quickly how to service all types of refrigerators. Page after page of useful, easy to understand facts. Refrigeration is the big money field and you can get into it after studying this text-book. Size 8 1/2 x 11 in. Priced at only \$1.00, postpaid. Send for your copy now.

## SUPREME PUBLICATIONS

3729 WEST 18th STREET

CHICAGO, ILL.

When writing to Advertisers please mention that you saw the Advertisement in RADIO WORLD.

# SPECIAL 2-FOR-1 OFFER RADIO WORLD

Radio World is \$2.50 a year (12 issues), 25c. per copy. Canada and foreign, \$3.00 yearly. Offers of Radio World and other worthwhile publications for one full year on each (NET):

- RADIO WORLD and SHORT-WAVE and TELEVISION, \$3.50.
- RADIO WORLD and POPULAR SCIENCE MONTHLY, \$3.50.
- RADIO WORLD and RADIO-CRAFT (12 issues), \$3.50.
- RADIO WORLD and RADIO INDEX (monthly, 10 issues), stations, programs, etc., \$3.50.
- RADIO WORLD and EVERYDAY SCIENCE AND MECHANICS (monthly), \$3.50.
- RADIO WORLD and BOYS' LIFE (monthly, 12 issues), \$3.50.
- RADIO WORLD and TRUE STORY (monthly), \$3.00.

Select any one of these magazines and get for an entire year by sending in a year's subscription for RADIO WORLD at the regular price, \$2.50, plus a small additional amount, per quotations above. (Add \$1.50 for extra foreign or Canadian postage for both publications.)

Name .....

Address .....

City and State.....

If renewing an existing or expiring subscription for RADIO WORLD, put cross in square.

If renewing an existing or expiring subscription for other magazines, put cross in square.

Special Trial Offer for Radio World only: \$1.00 for 5 months, postpaid. Mail order with remittance to Radio World Office. NET.

RADIO WORLD, 145 W. 45th St., New York

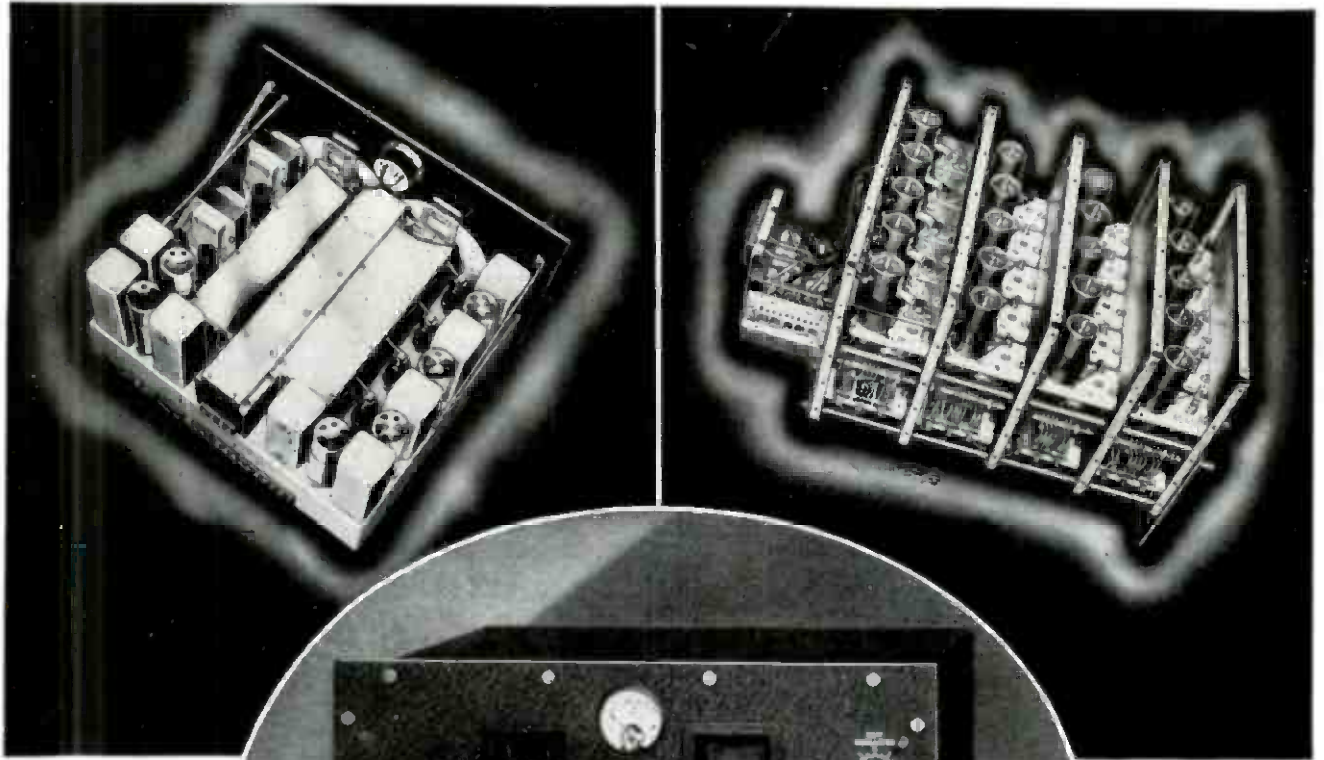

7½ to 240  
METERS

15 to 560  
METERS

## The Outstanding Receiver for 1938!

**T**HERE is no substitute for the performance of the Hammarlund "Super-Pro." It has long been acclaimed by professionals, as well as amateurs, under the most trying conditions. Whether it be for 24-hour a day commercial service or occasional amateur duty, this receiver has proved that the precision engineering and careful workmanship built into all Hammarlund products is your guarantee of satisfaction. For phone reception, the variable selectivity feature of the "Super-Pro" is an outstanding accomplishment. In crowded phone bands, such as the 14-megacycle amateur band, this receiver provides performance that cannot be duplicated. During busy hours, when thousands are operating, the selectivity control can be set at 3 k.c. band width, providing 3 times the selectivity of the average receiver. This means that three times as many

stations can be tuned in without "QRM." Then, for further selectivity, the "Super-Pro" is provided with a crystal filter which can be adjusted to razor-edge sharpness. The above features, together with two stages of preselection, band switching, noiseless operation, and rigid construction, puts the "Super-Pro" in a class by itself. For 1938 choose a "Super-Pro" and be really up to date!

HAMMARLUND MFG. CO., INC.  
424-438 W. 33rd St., N. Y. City

- Please send me new "Super-Pro" bulletin.
- Please send me new "38" catalog.

Name .....

Address .....

City ..... State ..... RW-3-38



# HAMMARLUND

WITH *Front or Rear*  
*Illumination*

**TRIPLET**

Sensitive and ultra-sensitive electrical indicating instruments. D.C. Moving Coil . . . A.C. the Repulsion Type. Sizes—2" to 7".

Specify TRIPLET for the finest, most up-to-date instruments in appearance, performance and economy.

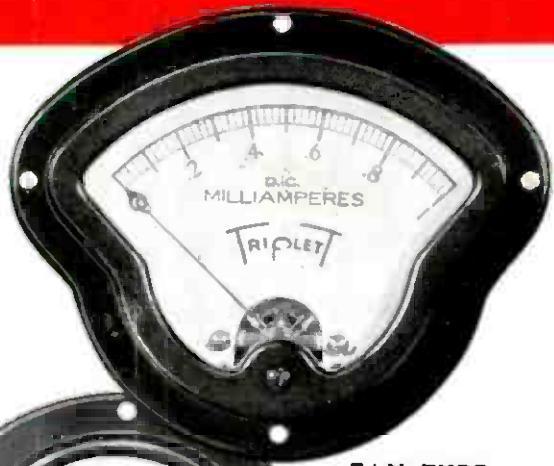

**FAN TYPE**

Model 529 . . . New . . . Full open face dial. Molded Case . . . Extra long scale.



**ROUND**

Model 321 . . . (Model 521—5"; Model 221—2") . . . a 3" Round design for flush mounting. Also available in projection mounting and with mirror scale and knife edge pointer.

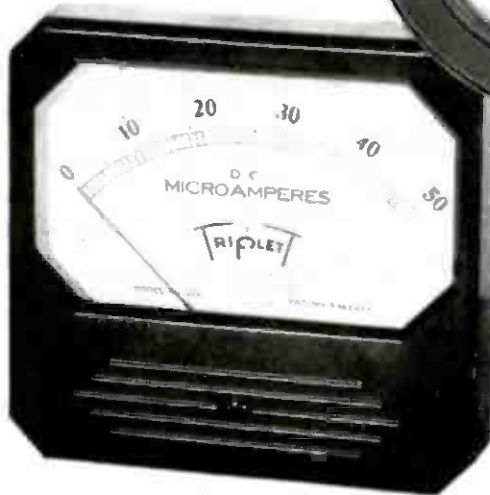

**SQUARE**

Model 426—4" instrument with Front Illumination attachment. A beautiful new design. Mounting screws concealed. (Other square models in 2", 3" and 4" sizes.)

**TRIPLET**  
*Precision*  
**ELECTRICAL INSTRUMENTS**

**The Triplett Electrical Instrument Co.  
273 Harmon Dr., Bluffton, Ohio**

Please send me more information on Triplett Model 529 . . . ; Model 321 . . . ; Model 426 . . . ; I am also interested in . . .

Name . . . . .

Address . . . . .

City . . . . . State . . . . .