

APRIL  
1938

# NEW HUM CURES

25c  
Per Copy

# RADIO WORLD

REG. U.S. PAT. OFF.

**NEW TYPE WAVE DEVELOPED**—Between the longest light wave and the shortest radio wave a new electromagnetic wave has been created. It is guided through pipes. See page 33.

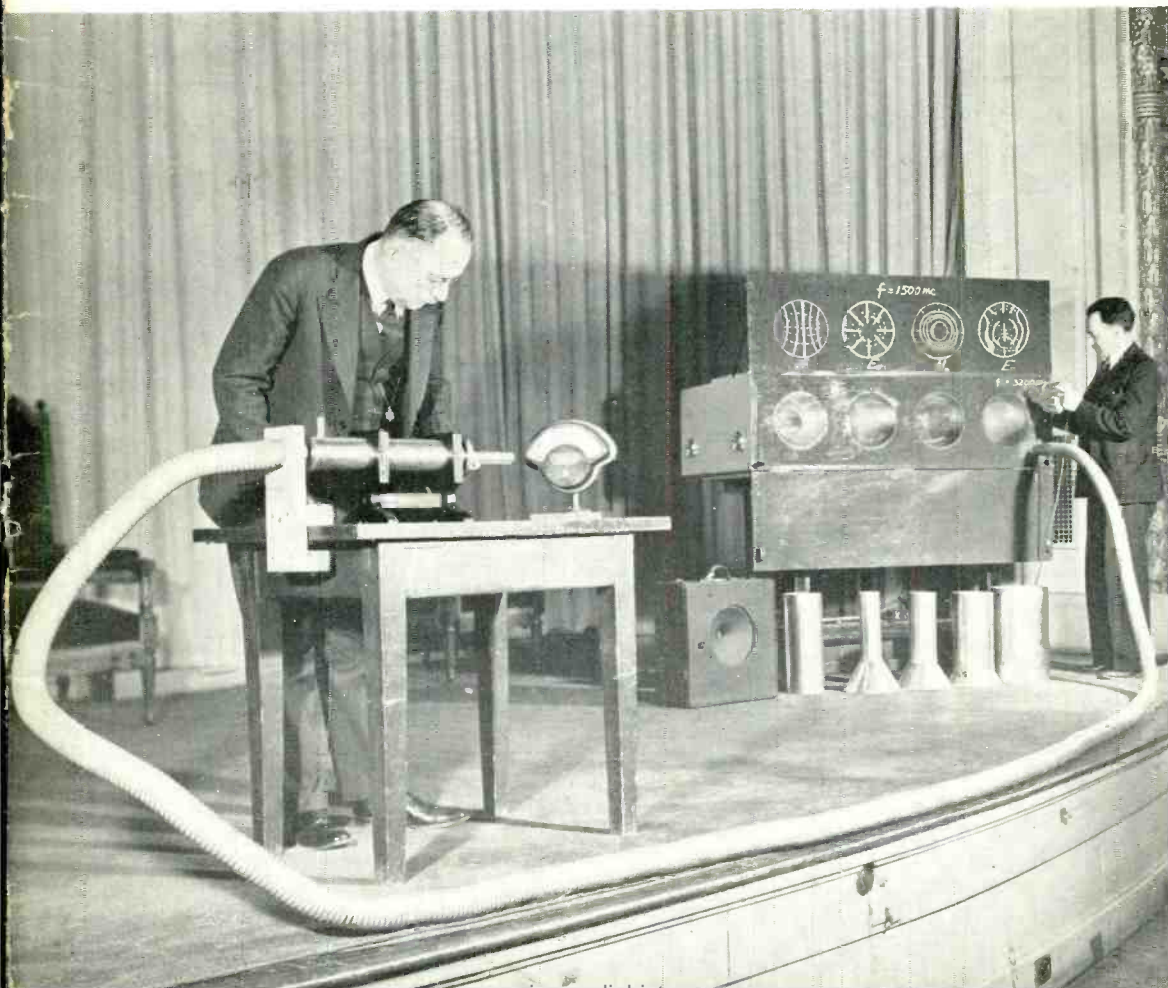

**NOW** *the smallest filter capacitor*

**C-D TYPE BR ETCHED FOIL ELECTROLYTICS**



**THE C-D**

*"Beaver"*

**IT DOES THE WORK**

**A NEW DEVELOPMENT DESTINED TO  
MARK A LARGE STEP FORWARD IN  
THE MANUFACTURE OF  
RADIO RECEIVERS**

1. Small — physical size  $1/5$ th that of corresponding types  
Convenient and simple to wire in — eliminates all mounting brackets, mounting rings, pal nuts, riveting, punched holes, and other similar assembly operations necessary with other types of electrolytic capacitors.
2. Hermetically sealed
3. Both terminals insulated; protective cardboard sleeve supplied with unit.
4. Outstanding electrical characteristics.  
Range: Available in single capacity units only. Capacities 4, 8, 12, 16, 20 and 40 mfd., 150 volts, D.C. and up to 8 mfd., 450 volts D.C.
5. Fit conveniently into the most confined spaces.
6. Unexcelled for all types of service work.
- 7.
- 8.

Illustration exact size of Type BR 16 mfd., 150 volts, D.C.  
Size:  $11/16 \times 1 \ 5/8$ "

**CORNELL**  **DUBILIER**

1024 Hamilton Boulevard

Cable Address: *Cordu*

**CORNELL-DUBILIER ELECTRIC CORP., SO. PLAINFIELD, N. J.**



# I WILL TRAIN YOU AT HOME IN SPARE TIME FOR A GOOD RADIO JOB!

J. E. SMITH, President  
National Radio Institute  
Established 1914

**HERE'S  
PROOF**



**Works for State of Illinois**  
"If I had not taken your Course I would still be digging ditches. I am working for the State of Illinois, operating their 1,000 watt transmitter. If anyone wants to write me about your Course, I shall be glad to answer."  
R. S. LEWIS, Police Radio Station WQPM, Macomb, Ill.

**Picked up \$1,800 While Learning**

"I picked up \$1,800 while studying and I call that easy money—the time I gave my Radio work did not interfere with my other business."  
OTIS DENTON, 14105 Lorain Ave., Cleveland, Ohio.



**Lesson on Radio Servicing Tips FREE**

"I'll prove that my Training is just what you need to master Radio. My sample lesson text, "Radio Receiver Troubles Their Cause and Remedy," covers a long list of Radio receiver troubles in A.C., D.C., battery, universal, auto, T. K. P., super-heterodyne, all-wave, and other types of sets. And a cross reference system gives you the probable cause and a quick way to locate and remedy these set troubles. A special section is devoted to receiver check-up, alignment, balancing, neutralizing and testing. Get this lesson Free. No obligation.

**The Tested WAY  
to BETTER PAY**

**FREE BOOK TELLS HOW  
MAIL COUPON**

Do you want to make more money? Radio offers many opportunities for well-paying spare time and full time jobs. You don't have to give up your present job, leave home or spend a lot of money to become a Radio Expert.

**Many Radio Experts Make  
\$30, \$50, \$75 a Week**

Radio broadcasting stations employ engineers, operators, station managers and pay up to \$5,000 a year. Spare time Radio set servicing pays many \$200 to \$500 a year—full time jobs with Radio jobbers, manufacturers and dealers as much as \$30, \$50, \$75 a week. Many Radio Experts operate full time or part time Radio sales and service businesses. Radio manufacturers and jobbers employ testers, inspectors, foremen, engineers, servicemen, paying up to \$6,000 a year. Radio operators on ships get good pay, see the world besides. Automobile, police, aviation, commercial Radio, loud speaker systems are newer fields offering good opportunities now and for the future. Television Promises to open many good jobs soon. Men I trained have good jobs in these branches of Radio. Read their statements. Mail the coupon.

**There's a Real Future in Radio  
for Well Trained Men**

Radio already gives good jobs to more than 300,000 people. In 1936, Radio enjoyed one of its most prosperous years. More than \$500,000,000 worth of sets, tubes and parts were sold—an increase of more than 60% over 1935. Over a million Auto Radios were sold, a big increase over 1935. 24,000,000 homes now have one or more Radio sets. More than 4,000,000 autos are Radio equipped. Every year millions of sets go out of date, are replaced with newer models. More millions need servicing, new tubes, repairs, etc. A few hundred \$30, \$50, \$75 a week jobs have grown to thousands in 20 years. And Radio is still a new industry—growing fast!

**Many Make \$5, \$10, \$15 a Week Extra  
in Spare Time While Learning**

Almost every neighborhood needs a good spare time serviceman. The day you enroll I start sending Extra Money Job Sheets showing how to do Radio repair jobs. Throughout your training I send plans and ideas that made good spare time money for hundreds. I send Special Equipment to conduct experiments, build circuits, get practical experience. I GIVE YOU A COMPLETE, MODERN, PROFESSIONAL ALL WAVE, ALL PURPOSE RADIO SET SERVICING INSTRUMENT TO HELP SERVICE SETS QUICKER—SAVE TIME, MAKE MORE MONEY.



**I Give You Practical Experience**

My Course is not all book training. I send you special Radio equipment, show you how to conduct experiments, build circuits illustrating important principles used in modern Radio receivers, broadcast stations and loud speaker installations. I show you how to build testing apparatus for use in spare time work from this equipment. Read about this 50-50 method of training—how it makes learning at home interesting. Practical. Mail coupon.

**Money Back Agreement Protects You**

I am sure I can train you successfully. I agree in writing to refund every penny you pay if you are not satisfied with my Lessons and Instruction Service when you finish. I'll send you a copy of this agreement with my Free Book.

**Find Out What Radio Offers You**

Act Today. Mail the coupon now for "Rich Rewards in Radio." It's free to any fellow over 16 years old. It points out Radio's spare time and full time opportunities and those coming in Television; tells about my training in Radio and Television; shows you letters from men I trained, telling what they are doing and earning. Find out what Radio offers YOU! MAIL THE COUPON in an envelope, or Paste on a penny post card.

J. E. SMITH, President, Dept. 8DM4  
National Radio Institute,  
Washington, D. C.

**MAIL  
COUPON  
NOW!**



**This FREE BOOK has Helped Hundreds  
of Men to Make More Money**

J. E. SMITH, President, Dept. 8DM4

National Radio Institute, Washington, D.C.

Dear Mr. Smith: Without obligation send me free the Sample Lesson and your 64-Page Book, "Rich Rewards in Radio," telling about spare time and full time Radio opportunities, and how I can train for them at home in spare time. (Please write plainly)

NAME..... AGE.....

ADDRESS .....

CITY..... STATE..... 14X1

RADIO WORLD, April, 1938. Published monthly. Vol. XXXI. No. 1. Whole No. 715. Address, 145 West 45th Street, New York, N. Y. Subscription price, \$2.50 per annum (foreign \$3.00). Single copy, 25c. Published by Hennessy Radio Publications Corporation. Entered as second-class matter March, 1922, at the Post Office at New York, N. Y., under Act of March 3rd, 1879.

# 10 DAYS FREE TRIAL

**GUARANTEE:** We guarantee each and every Instrument manufactured by us to be exactly as represented. We guarantee that it represents full value for your money; that it will reach you in perfect condition.

We guarantee to exchange or repair any merchandise returned to us that contains any mechanical or electrical defect in accordance with the standards of honest and sincere manufacturing policies.

We pledge ourselves to strict adherence to this guarantee.

## TEST EQUIPMENT COMPANY of America

No line of test equipment is better than the company behind it! That is why TECO is the choice of so many servicemen! Now for the first time YOU can buy TECO equipment DIRECT FROM THE MANUFACTURER AT PRICES THAT SAVE YOU 50%. Our years of engineering ability, the experience of our trained technicians, our factory-to-you method of selling—all combine to make TECO the best "buy" on the market. Remember, you may buy the TECO Instruments you need and try them for 10 days! If you find one does not meet your specific requirements, YOU MAY RETURN IT TO US FOR FULL CREDIT ON ANY OTHER TECO EQUIPMENT WHICH WE MAKE! Could anything be more fair?



## TECO T-15 MULTIMETER

Here's the unit you need for rapid, accurate measurements. A 1,000 ohms per volt type instrument featuring d'Arsonval type movement 0-1 Milliampmeter. Accuracy 2%. Attractive etched metal panel. For use on 110 V. 60 cycle A.C.

2 RESISTANCE RANGES 0-500 ohms, 0-5 megohms  
HIGH AND LOW CAPACITY SCALES .0005-1 mf. and .05-200 mf.  
COMPLETE AC and DC VOLTAGE and CURRENT RANGES

DC Voltage: 0-15, 0-150, 0-750 volts DC  
AC Voltage: 0-15, 0-150, 0-750 volts AC  
DC Current: 0-1, 0-15, 0-150, 0-750 Ma., DC  
AC Current: 0-15, 0-150, 0-750 Ma., AC

### THREE DECIBEL RANGES

TECO Multimeter comes complete in carrying case with test prods and instructions. Size 11 $\frac{1}{4}$ "x9 $\frac{1}{2}$ "x5 $\frac{1}{2}$ ". Shpg. wgt. 8 lbs. Our net price.....

**\$1360**

## The New TECO T-25 SIGNAL GENERATOR

A new R.F. and A.F. Signal Generator with d'Arsonval output meter built in.

### SPECIFICATIONS

Radio and intermediate frequencies, 100Kc to 60Mc in 6 bands. All on fundamentals (no harmonics used). Accuracy is within 1% on I.F. and Broadcast Bands and 2% on Higher Frequencies.

Audio frequencies in 6 bands: 60 cycle sine wave, with percentage modulation control; 100, 400, 1000, 5000 and 7500 cycles, saw-tooth modulation.

R.F. and A.F. independently accessible. Switch selection of all R.F., I.F. and A.F. and all direct reading on panel and dial.

Built-in 3" d'Arsonval type output meter of exclusive design, .5-2 volts r.m.s. in newest molded square Bakelite case. Flat characteristics: 20-7500 cycles; down 2 db. at 10,000 cycles. Operates directly from voice coil of set or may be used generally as 2 volt AC meter. Accuracy 2%.

Attenuator for R.F. and I.F. works on all bands. Leakage is extremely low.

Operates on 90-130 volts AC or DC. Sine wave modulation not present when Generator is worked on DC but saw tooth modulation is present in both instances.

Black and shielded cabinet trimmed with crystalline panel featuring German silver escutcheon plates; test leads. Uses 1-6J5G R.F. Oscillator, 1-25Z6 Rectifier and 1 modulator tube.

Latest Crowe 10" oblong vernier dial with full vision and six indications of calibrations.

Model T-25, complete with 3 tubes, test leads, handle, instructions. Size: 9x11x5 $\frac{1}{2}$ ". Shpg. wgt. 18 lbs. OUR NET PRICE.....



**\$1745**

# .. AND THIS SMASHING GUARANTEE STANDS BEHIND EVERY TECO INSTRUMENT

## TECO T-10 TUBE TESTER

A genuine achievement! For accurate and rapid work. Has d'Arsonval moving coil meter. Tests all types of receiving tubes. For use on 110v. 60 cycle AC.

### FEATURES

- ★ Tests all 4, 5, 6, 7s-7L and octal base tubes.
- ★ Tests all Diodes, Triodes, Pentodes and Tetrode receiving tubes, as well as many transmitting types.
- ★ Separate Neon Test for leakage or shorts between elements.
- ★ English reading meter, with calibrated "BAD-7-GOOD" scale.
- ★ Minimum number of adjustments, without impairing efficiency or accuracy of test.
- ★ Rugged, foolproof construction. Built for a lifetime of use.
- ★ Attractively designed etched panel, metal carrying case and cover.
- ★ Compact and lightweight. Ideal for service laboratory or field servicing.
- ★ Supplied with complete instructions and tabular data for every known receiving type of tube, including many transmitting types
- ★ Size: 11 $\frac{1}{2}$ "x9 $\frac{1}{2}$ "x5 $\frac{1}{2}$ ". Shpg. wgt. 9 lbs. **OUR NET PRICE.....**

**\$11.75**

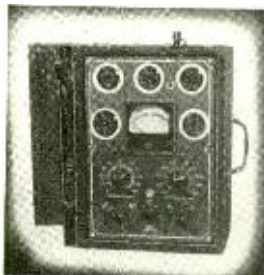

## TECO T-20 SET TESTER

A whole testing laboratory all in one unit. Combines TECO Model T-10 Tube Tester and TECO Model T-15 Multimeter. Specifications are exactly the same as on both of the models mentioned. Never before such a sensational value! Comes complete with unusually large 4" d'Arsonval type meter and attractive etched panel test prods, carrying case and instructions. For use on 110v. 60 cycles. AC. Size: 14x9 $\frac{1}{2}$ "x5 $\frac{3}{4}$ ". Shpg. wgt. 20 lbs. **Our net price .....**

**\$21.45**



## THE NEW AC-DC TECO POCK-O-METER

A new pocket sized volt-ohm milliammeter that includes AC measurements and is the lowest priced, full-service instrument ever offered! Has a 3" d'Arsonval movement 0-1 milliammeter. Comes with attractive etched panel.

### SPECIFICATIONS

- 5 DC voltage ranges: 0/1.5/15/25/75/500 volts
  - 5 AC Voltage ranges: 0/15/40/75/200/1200 volts
  - 4 DC Current ranges: 0/1/10/100/500 Ma.
  - 2 Resistance ranges: 0/500/500,000 ohms (low ohms read to 1 ohm.)
- Pock-o-meter supplied complete with batteries, test leads and instructions. Size 6 $\frac{1}{2}$ "x3 $\frac{1}{2}$ "x2 $\frac{1}{4}$ ". Shpg. wgt. 5 lbs. **Our net price.....**

**\$8.45**



# TEST EQUIPMENT COMPANY

OF  
AMERICA

139 CEDAR STREET

Dept. R-W

NEW YORK, N. Y.

**3** *New* **64-PAGE BOOKS!**  
 added to the famous

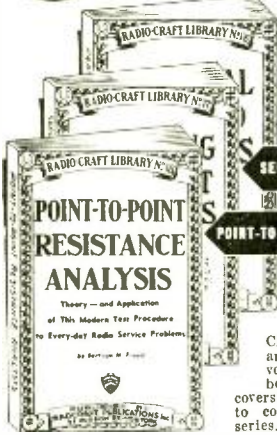

**RADIO-CRAFT LIBRARY SERIES**

**PRACTICAL RADIO CIRCUITS**

**SERVICING WITH SET ANALYZERS**

**POINT-TO-POINT RESISTANCE ANALYSIS**

RADIO MEN will want to read these new books which have just been added to the RADIO-CRAFT LIBRARY SERIES and refer to them often. Each volume contains 64 pages, bound between stiff, flexible covers, and measures 8 x 9 inches to conform with others in the series. Dozens of illustrations appear in each volume. A summary of the contents of each book appears below.

Summary of the contents of each book appears below.

No. 16  
**PRACTICAL RADIO CIRCUITS**

By David Bellare

INTRODUCTION \* BROADCAST RECEIVERS — Crystal Receivers; Regenerative Circuits; T.R.F. Circuits; etc. \* ALL-WAVE RECEIVERS — Superhet with Phase Inverter and Colorama Tuning; Circuit with AFC System; etc. \* SHORT-WAVE SETS, CONVERTERS AND ADAPTERS \* AUTOMOBILE RECEIVERS — Superhets with AVC; Custom-built; Battery-operated; etc. \* PUBLIC ADDRESS—A Variety of P.A. Systems Are Described; Audio-howl; Magic-Eye; Volume Expansion; etc. \* POWER PACKS \* TELEVISION RECEIVERS \* SIMPLE LOW-POWERED TRANSMITTERS \* TEST EQUIPMENT \* MISCELLANEOUS APPARATUS for many needs. Over 100 illustrations.

No. 17  
**SERVICING WITH SET ANALYZERS**

By H. G. McEntee

INTRODUCTION \* FUNDAMENTAL ANALYZER PRINCIPLES—Various Types and Uses of Switches; Elementary Set Analyzer Circuits \* TROUBLE SHOOTING WITH SET ANALYZER—Preliminary Checking; Testing Tubes under Operating Conditions; Point-to-Point Testing; Checking Individual Components \* ASSOCIATE TESTING EQUIPMENT—Vacuum Tube Voltmeter; Test Oscillator; Output Meter; Oscilloscope \* COMMERCIAL TESTING EQUIPMENT \* RMA SOCKET NUMBERING SYSTEM. Over 80 illustrations.

No. 18  
**POINT-TO-POINT RESISTANCE ANALYSIS**

By Bertram M. Freed

Value of Resistance Method of Servicing \* Basic Principles Involved in Point-to-Point Analysis \* Methods and Instruments Employed in Resistance Measurements \* Point-to-Point Testing Equipment \* Easily Constructed Multi-Range Volt-Ohmmeter \* Resistance in Radio Receivers \* Typical Point-to-Point Analysis of a Modern Receiver \* Combination Voltage and Resistance Point-to-Point Analysis \* Actual Service Problems \* Appendix. Over 65 illustrations.

RADCRAFT PUBLICATIONS, Inc., 99 Hudson St., New York

**CLIP AND MAIL COUPON BELOW!**

RADCRAFT PUBLICATIONS, Inc. RW-438  
 99 Hudson St., New York, N. Y.

Gentlemen: Enclosed you will find my remittance of \$..... for which please send me, POSTPAID, the books checked below, at Fifty Cents (50c) per copy.

- No. 16—PRACTICAL RADIO CIRCUITS
- No. 17—SERVICING WITH SET ANALYZERS
- No. 18—POINT-TO-POINT RESISTANCE ANALYSIS

Name .....

Address .....

City ..... State .....

(Remit by check or money; register letter if you send cash or unused U. S. Postage Stamps.)

*Like Lightning!*  
**Ghirardi's TWIN GADGETS Spot Set Troubles**  
 Speed Up Your Service Work with the handiest little service aids that ever came to the rescue of hard-working service men! They're great!

**TWIN "TROUBLE SHOOTERS"**

Here's how they work: you take up your Gadget; pick out the card marked for the Trouble Symptom you find; flip the card around—and there you'll see all the Tests to make and all the Remedies in a flash. One for HOME radios, one for AUTO radios—each gives Tests and Remedies for over 400 troubles. Save your time and money. Clip a dollar to this ad and send for your pair now. Radio & Technical Pub. Co., Dept. RW-48, 45 Astor Place, N. Y.

**MAIL NOW!**  
**\$1 FOR THE PAIR**

Money Back Guarantee

**A YEAR'S GIFT FOR HIM**

Is your husband, son or nephew interested in radio? Why not send him Radio World for a year?

We will send him, at your request, a post card notice telling him of your thoughtfulness in sending a gift that lasts all year!

For \$2.50 a year in the United States he will be reminded of your generosity every time the magazine arrives.

RADIO WORLD, 145 WEST 45th ST., NEW YORK CITY

**MAILING LISTS**

**GET OUR FREE REFERENCE BOOK and MAILING LIST CATALOG FREE**

Gives counts and prices on accurate guaranteed mailing lists of all classes of business enterprises in the U. S. Wholesalers—Retailers—Manufacturers by classification and state. Also hundreds of selections of individuals such as professional men, auto owners, income lists, etc.

Write today for your copy

**R. L. POLK & CO.**  
 Polk Bldg.—Detroit, Mich.  
 Branches in Principal Cities  
 World's Largest City Directory Publishers  
 Mailing List Compilers, Business Statistics, Producers of Direct Mail Advertising.

# COMBINATION ALL-WAVE SIGNAL GENERATOR PLUS COMPLETE TUBE TESTER ONLY \$19.90



● Truly the greatest value ever offered by any instrument manufacturer! There is no comparison to this COMBINATION INSTRUMENT made by Superior at the price of \$19.90. Consists of two fully complete units housed in a single metal cabinet of attractive design: (1) an ALL-WAVE SIGNAL GENERATOR and (2) COMPLETE TUBE TESTER. ● The Signal Generator has a range of from 110 kc. to 22 mc., all fundamental frequencies, in five bands—with front panel band-switching control. ● All frequencies are directly calibrated on the dial, and a 4 to 1 planetary drive is incorporated to allow for slow precise timing adjustment. ● I.F. signal with or without audio modulation at the control of the operator. ● Separate R.F. and A.F. outputs, with two A.F. amplitude levels. ● Accuracy 1 per cent on I.F. bands, 2 per cent on short-waves. ● Separate Neon leakage test circuit, for testing condensers, etc. ● Employs two tubes: 2—6A7's and one special neon modulator tube. The TUBE TESTER tests all 4, 5, 6, 7 and octal base tubes, including diode tubes. ● Incorporates separate neon short or leakage test, to determine whether tubes are bad, noisy or leaky. ● English reading meter, with "BAD—?—GOOD" scale. ● Uses minimum number of operating controls, allowing tube tests to be made quickly and accurately. ● Sturdy, reliable and foolproof emission type circuit. ● Operates on 110 volt A.C. current. Complete with instructions and test prods.  
Shipping weight 19 lbs.

## THE AMAZING ALLMETER!!!! 27 INSTRUMENTS IN ONE. D'ARSONVAL MOVEMENT. 1,000 OHMS PER VOLT'



The ALLMETER permits both A.C. and D.C. measurements for volts and currents, also low resistances from below one ohm, also high resistance capacities, henries and decibels, comprising 27 instruments in one.  
1—A.C. Currents, 15-150-750 ma. This extremely valuable service is practically never afforded by multitest instruments. Instruments, 3.  
2—A.C. Volts, 15-150-750 volts. Affords also output meter service. Instruments, 3.  
3—CAPACITY, .01-50 mfd., all condensers, including electrolytics. Instruments, 1.  
4—5 1,000 Henries, coil loaded or not. Instruments, 1.  
5—LOW ohms, .03-500 ohms. Extremely valuable. Instruments, 1.  
6—HIGH ohms, to 0.5 meg., covering all practical values. Instruments, 1.  
7—D.C. Volts, 15-150-750 volts. Simplified scale suits same calibration as for a.c. Instruments, 3.  
8—D.C. Currents, 15-150-750 ma. The same scale simplification, also 0-1 milliamperes. Instruments, 4.  
9—Decibels, -12 to +10. Instruments 3 + 8— + 80 (by interpolation) + 8 — + 50 by interpolation.  
10—Vacuum-tube voltmeter, 0-15-150-750 volts A.C. D.C. Instruments, 6.  
11—Continuity tester. Instruments, 1. Shipping wt. 8 lbs. \$10.40  
Net price, complete with instructions and test prods.....

## THE INFINOMETER AN ACCURATE V. T. VOLTMETER



● Measures Critical Voltages in Low-Current Circuits. Such as in Volume Expanders, A.V.C., A.F.C., Detectors, Oscillators, Noise-Suppression Stages, D.C. amplifiers, Photocell Circuits, Etc.  
● Operates from 110 Volts DC or AC (any frequency), with Less Than 5% Error on High Voltage Ranges Due to Line-Voltage Fluctuations.  
● Three DC Ranges: 0-5, 20 and 60 Volts; Four AC Ranges: 0-5, 15-50 and 150 Volts. Sensitive approximately 700,000 Ohms per Volt on DC Ranges; Approximately 300,000 Ohms per Volt on AC Ranges.  
Shipping weight 8 lbs. \$14.40

### Volt-Ohm Milliammeter



The HANDI-METER, a new volt-ohm-milliammeter, enables direct reading of d.c. volts 0/5/10/50/100 also ohms 500/20,000. Likewise direct-reading, and d.c. current determination to 20 milliamperes. Low ohms scale enables checking r.f. and l.f., as well as a.f. coils, for shorts and opens. Low priced instruments never before included low-ohms range, reading to one ohm, nor did they have an adjuster for accuracy of ohms readings. Complete with test leads and self-contained batteries. Shipping weight 5 lbs. Net price \$4.10

### GENEMETER

WITH VARIABLE  
AUDIO FREQUENCIES  
\$14.40



Complete with Four Tubes  
● Combination R.F. and Audio Signal Generator. R.F. 100 K.C. to 105 M.C. A.F. 25-10,000 cycles, all direct reading, all by front panel switching.  
● R.F. and A.F. output independently obtainable alone, or with A.F. (any frequency) modulating R.F.  
● Output meter for connection across primary of receivers' output transformer for peaking with modulation "on."  
● R.F. is subject to attenuation, and oscillation leakage is minimum.  
● Condenser and other leakages tested to 100 megohms.  
● Main dial protracted on 7 1/2" diameter, and 4-to-1 vernier planetary drive.  
● Accuracy 1% on I.F. and broadcast, 2% on higher frequencies.  
● All services on 90-130 volts a.c. or d.c.

Shipping weight 10 lbs.

## SUPERIOR INSTRUMENTS COMPANY

136 LIBERTY STREET

DEPT. R.W., NEW YORK, N. Y.

# RADIO WORLD

Sixteenth Year

ROLAND BURKE HENNESSY  
Editor

H. J. BERNARD  
Publisher

HERBERT E. HAYDEN  
Advertising Manager

## TABLE of Contents for APRIL, 1938

<b>A New System of Remote Control</b> . . . . . 10	<b>Half-Wave Contact Rectifiers</b> . . . . . 28
<i>Lighting Line Used as Conductor</i>	<i>How They Behave in Instruments</i>
<b>By Charles N. Kimball</b> <i>License Laboratory, Radio Corporation of America</i>	<b>By H. J. Bernard</b>
<b>Forecasting Sunspots</b> . . . . . 17	<b>New, Tiny Waves Originated</b> . . . . . 33
<i>Radio Transmission Conditions Also Predicted</i>	<i>Between Optical and Radio Waves, They Are Guided Through Pipes</i>
<b>By A. L. Durkee</b> <i>Transmission Development, Bell Telephone Laboratories</i>	<b>Beneficial Oddities of the 6K8</b> . . . . . 34
<b>Reduction of Hum</b> . . . . . 20	<i>Mixer Tube Has Remarkable Advantages</i>
<i>Remedies Applicable to Heater Type Tubes</i>	<b>Plate Tuning in Oscillators</b> 37
<b>Opportunities for Money-Making</b> . . . . . 23	<i>Better Stability, Elimination of Harmonics, Higher Efficiency</i>
<i>Openings Off the Beaten Track</i>	<b>Interference Tracked Down</b> 39
<b>By M. N. Beitman</b>	<i>The Detective Work and Remedies</i>
<b>Right or Wrong?</b> . . . . . 25	<b>By Alfred A. Ghirardi</b> <i>Radio &amp; Technical Publishing Company</i>
<i>Propositions to Test Your Knowledge, with Answers</i>	<b>Electrolytes for Condensers</b> 54
<b>Television Developments</b> . . . 26	<i>The Types of Capacitors Also Analyzed</i>
<i>New Universal System Interference Problems</i>	<b>By Paul McKnight Deeley</b> <i>Cornell-Dubilier Electric Corporation</i>
<i>First Television Will Be—What?</i>	<b>Bass Compensation</b> . . . . . 60
	<i>Simple Circuit for Audio Volume Control</i>
	<b>By R. K. Wheeler</b>

Vol. XXXI, March, 1938, No. 1. Whole No. 715. RADIO WORLD, published monthly by Hennessy Radio Publications Corporation, 145 West 45th Street, New York, N. Y. Editorial and executive offices, 145 West 45th Street, New York, N. Y. Executives of RADIO WORLD: Roland Burke Hennessy, editor and business manager; H. J. Bernard, publisher; Herbert E. Hayden, advertising manager. Officers of corporation: Roland Burke Hennessy, president-treasurer; Roland Burke Hennessy, Jr., vice-president, H. J. Bernard, secretary. Entered as second-class matter March, 1922, at the Post Office at New York, N. Y., under Act of March 3rd, 1879.

### SUBSCRIPTION RATE

Price 25 cents per copy. Subscription \$2.50 per year (12 issues); \$1.25 per six months (6 issues); postpaid in the United States and Possessions; \$3.00 per year. \$1.50 per six months, postpaid in all other countries. Remittance for foreign subscriptions should be by International money-order (postal or express) or draft against or discountable at New York bank.

RADIO WORLD is distributed by the American News Company and its Branches



**STOP  
GUESSING,  
Mister!**

Use these 2 Ghirardi  
SERVICING BOOKS  
*They'll tell you*  
**WHAT TO DO  
and  
HOW TO DO IT!**



**EVERY MINUTE YOU *DON'T*  
KNOW WHAT TO DO COSTS  
YOU HARD CASH!**

This great pair of Ghirardi servicing books will tell you exactly how to handle every servicing problem you'll ever run up against. One book tells you HOW and WHAT—the other supplies quickly all necessary receiver and servicing data WHEN and WHERE you need it—with a regular Supplement Service to keep it up to date at all times. These two books will give you servicing background and theory, all clearly explained in easy-to-understand language. They'll give you the "whys" and "wherefores" of every kind of servicing equipment. They'll give you the most successful "Factory-Type" repair methods used today. They'll give you receiver "Case Histories," facts—charts—tables, all that indispensable body of material that a serviceman must have today if he is to keep up with all the new developments and do rapid service work. You NEED both of these books on your service bench right now. Send for them at once! Use the coupon below.

**"Modern Radio Servicing" Shows You—**

- HOW TO** make the best use of all varieties of servicing instruments—a 420-page section that is a whole book in itself, complete with diagrams and construction data on all types of test equipment.
- HOW TO** apply the latest short-cuts in receiver testing in your own shop.
- HOW TO** repair every type of home or auto-radio receiver, old and new, with many new time-saving "Factory" methods.
- HOW TO** understand all the complexities of AVC and QAVC circuits.
- HOW TO** trouble-shoot and quickly get rid of all kinds of difficult troubles such as intermittent reception, hum, distortion, etc., etc.
- HOW TO** align and test receivers with Cathode-Ray Oscilloscopes.
- HOW TO** eliminate noise and interference from all sets.
- HOW TO** service auto-radio, all-wave, high-fidelity, and other special types of receivers.

**Radio  
FIELD SERVICE  
DATA BOOK**

**436 PAGES  
107 ILLUS.**

**BOTH  
BOOKS \$6**



**MODERN  
RADIO  
SERVICING**

**1300 PAGES  
706 ILLUS.**

**The Field Data Book Enables You—**

- TO** cut down your servicing time by using the "Case Histories" of home and auto-radio sets it contains. This is the greatest collection of Case Histories in the world—over 1,500 of them—and more being added all the time in the Supplements.
- TO** align superhets quickly—with the peak I-F alignment data it provides for over 6,000 receivers.
- TO** save time in Auto-Radio servicing by utilizing the big collection of specialized auto-radio data—car ignition system data and electrical wiring diagrams, etc., which it gives for all American cars.
- TO** "trouble-shoot" for every trouble that crops up—in the least possible time.
- TO** save work, worry and money by using the short-cuts you get in the big collection of 25 additional servicing data charts and tables you'll find in this handy time-saver!

**HOW TO GET THESE GREAT BOOKS**

Fill out the coupon below and mail it right now! You don't risk a single penny—your money back if not thoroughly satisfied. You have to have them!

**RADIO & TECHNICAL PUBL. CO.**  
Dept. RW-48, 45 Astor Place, New York

Here is \$6 for my copies of Ghirardi's MODERN RADIO SERVICING AND RADIO FIELD SERVICE DATA (including Jan. and June, '37 Supplements to Data Book) postpaid. (Foreign \$8.50)

Please send me Free Circulars.

NAME.....  
STREET.....  
CITY..... STATE.....  
MONEY-BACK GUARANTEE

# A NEW SYSTEM OF REMOTE CONTROL

By Charles N. Kimball

*License Laboratory, Radio Corporation of America*

ONE of the chief advantages of electrical machinery and electrically-controlled devices is that they are readily arranged for control from points separated from the apparatus itself. The means of control usually involves merely the extension of wires and switches. However, there are cases where the use of extension wires is impossible or inconvenient. Furthermore, even where wires are permissible, it has usually been necessary, by the nature of the apparatus, to use arrangements which consumed some stand-by power even in inactive periods. One of these cases is the remote control of home broadcast receivers, where the use of control wires is highly objectionable and where continuous operation of control vacuum tubes or other control devices is undesirable.

With these facts in mind, an investigation was undertaken with a view toward providing an improved system of remote control. The development was given considerable impetus when it was found that a-c power lines could be used as a medium for the transmission of currents of low radiofrequency (less than 500 kc). This immediately suggested the possibility of using power lines as connecting links between the remote and controlled points.

## I. NATURE OF THE PROBLEM

The general problem involving transmission of carrier currents on a-c supply lines has several aspects. First, the properties of the a-c line as a transmission medium must be determined, and the attenuation and line impedance at several frequencies must be known. Similarly, the power level required for the transmission of control signals is important, since the size and cost of apparatus are directly concerned.

The attenuation is probably the most important property of the a-c line when it is used as a carrier for r-f currents. If the attenuation is high, the power output of the control-signal source used as the remote-control unit must necessarily be quite large; this requires considerable equipment, in the form of power oscillators and amplifiers, at the control point.

The power required to actuate the control mechanisms at the controlled device is another factor which determines the required power capabilities of the remote-signal source, since, even with low line attenuation, the control power applied to the line at the remote point is a function of the energy consumed by the

controlling mechanisms. This latter quantity will be determined generally by the type of circuit element employed to utilize the control energy. If power amplifiers were operating continuously to afford amplification of the control signals at the controlled point there would be no necessity for high-power levels at the remote unit. This would permit using the amplified control impulses directly to perform the desired functions, or they could be employed to cause relays to close certain power circuits. In this latter case the control energy from the line could initiate some secondary action, which might take the form of plate current passing through a relay in a power detector. The energy used to actuate the desired device could then be drawn directly from the detector power-supply.

In case stand-by power is considered objectionable, one might use a type of control device which could be actuated directly by the control signals. The copper-oxide rectifier is one circuit element which fulfils the requirements, but its operating power consumption is generally too large.

The choice of the proper frequencies to be used for control purposes, and the a-c line impedance at these frequencies, are both quite important. The frequencies employed must lie in a certain rather limited band, because of possible interference with radio receivers operating near the controlled device. The line impedance should not be too low, if proper impedance matching at the terminating points is to be accomplished readily.

## II. TRANSMISSION AND POWER CONSIDERATIONS

Line impedance and attenuation were measured over the frequency range from 200 to 400 kc. This is the most useful range because its upper end is nearly the highest frequency which can be transmitted efficiently over the power line. Also the control frequencies should lie outside any bands used for broadcasting purposes, and also outside the i-f bands of radio receivers.

The line attenuation to these frequencies proved to be not very large. The maximum voltage attenuation on power lines in this laboratory was less than 10 to 1, as measured between the most remotely separated power outlets.

The average results of many line-impedance

[Reprinted from "RCA Review." Copyright, 1938, by RCA Institutes, Inc.]

measurements made in typical buildings wherein a teledynamic control system of this type might be installed are as follows:

- Average Line Impedance at 200 kc =  
 $25 + j40$  ohms  
 Average Line Impedance at 300 kc =  
 $40 + j60$  ohms

Loading the line with soldering irons, lamps and similar low-impedance appliances has little effect on the line attenuation, due to the low impedance of the line itself.

The maximum line attenuation to frequencies of 200 and 300 kc is about 20 db. This means that a signal source at the remote point with a power output of a watt or two would supply a resultant power of 0.01 to 0.02 watt at the controlled end of the a-c line, even under the most unfavorable attenuation conditions.

The possibility of using only a watt of r-f energy at the remote point is interesting, for, with this power rating, the remote unit may be made quite small physically. Since this unit will generally contain a radio-frequency oscillator as a source of control energy, the low power required makes the use of a small receiving-type tube quite feasible.

### CONTROL BY SMALL SOURCE

If one watt is taken as the normal r-f power supplied by the remote oscillator to the a-c line, a power attenuation of 100 means 0.01 watt available at the far end of the line. This may seem to be insufficient for control purposes, but it can be shown that it may be utilized to control, in many ways, non-power-consuming devices. Assume that the frequency of the control signals is 300 kc, and that the a-c line is properly terminated at the controlled point in an impedance of 72 ohms, (the resultant of  $40 + j60$  ohms, the line impedance at 300 kc). Then the r-f voltage available at the line terminals is about 0.8 rms volt. The use of a resonant circuit, tuned to 300 kc, will result in an increase in amplitude of this voltage, due to resonant rise, to 30 or 40 volts rms, and at this level it may be applied to various circuits for control purposes.

The rise in voltage is not accompanied by any gain in power, consequently the increased voltage can not be used to operate a power-consuming device, such as a copper-oxide rectifier, because the tuned circuit across which the voltage appears is inherently a high-impedance arrangement. The r-f power drawn from the line should be used only to initiate some control action, whose energizing power is supplied from the 60-cycle power line.

A power amplifier might be so arranged that its output current could be controlled by the 30 or 40 volts of rf available due to resonant rise in the tuned circuit connected across the line. A relay, energized by the amplifier output current, could then be used to close any desired power circuit. This arrangement requires that the amplifier be in continuous operation, receptive at all times to control signals emanating from the remote point. The stand-by power consumed is somewhat objectionable, and requires that frequent replacement of amplifier

tubes be made due to their continuous operation during quiescent periods of the controlled device. Accordingly, some means are needed for controlling the start of operation of the controlled device from the remote point without requiring the use of intervening amplifiers in continuous operation.

### III. BASIC REMOTE-CONTROL CIRCUIT

Several tube and circuit arrangements were investigated to find a way to make this "cold-starting" feature possible. The requirements

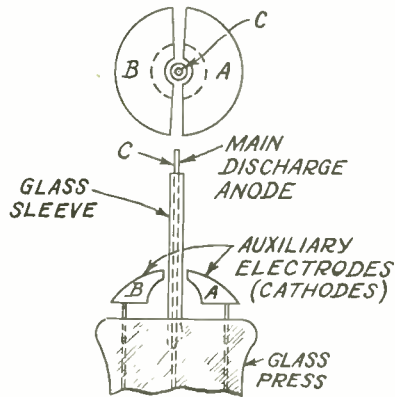

FIG. 1  
 Constructional details of gas tube.

of no stand-by power eliminated immediately the use of a tube (such as a diode) with heater operating continuously, and pointed the way to the selection of a cold-cathode type of gas tube as the vital circuit element for use in this work.

The basic arrangement finally selected involves a gas tube and associated circuit elements which are so disposed that a small radio-frequency voltage transmitted over the power line to the pick-up circuits in the controlled device, and increased in amplitude by resonant rise in a tuned circuit, may be employed to add to the potential of one of the gas tube's elements and to initiate a gas discharge. This, in turn, causes a relay to close, and its contacts may then be used to connect the controlled device to the 60-cycle power line as a source of energy.

### GAS TUBE CONSTRUCTION

Fig. 1 shows the constructional details of a gas tube which adequately fulfils the requirements. The tube consists of three elements, enclosed in an envelope containing gas at low pressure. The two similar elements, which are called auxiliary electrodes, are symmetrically disposed with respect to the third element. The two auxiliary electrodes act as cathodes, since the third element can act only as an anode to receive electrons from the other two. This is due to its construction and orientation with  
*(Continued on following page)*

(Continued from preceding page)

respect to the cathodes, which gives the tube a rectifying characteristic.

In a gas tube having the construction shown in Fig. 1, the gap between *A* and *B* becomes ionized if the potential difference across it exceeds 70 volts. This is true regardless of the polarity of the voltage difference. Once started, the discharge is maintained as long as the potential difference exceeds 60 volts. The potential difference required to initiate a discharge between the anode *C*, and either of the cathodes *A* or *B*, in the absence of ionization in the gap *A-B*, is of the order of 200 volts. The discharge in gap *C-A* or *C-B*, once started, is maintained if *C* is 60 volts or more positive

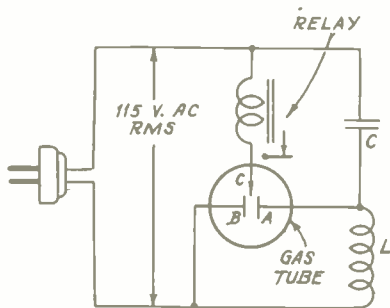

FIG. 2  
Basic gas-tube circuit.

with respect to either of the two cathodes. If gap *C-A* or gap *C-B* is broken down, due to the presence of the required discharge voltage, a low-impedance current path exists in the main gap only if *C* is positive with respect to either of the cathodes. This action is due to the rectifying characteristic mentioned above.

The main gap will become ionized at 70 volts on *C* if first the gap between *A* and *B* is broken down. Thus, the potential on *C* may be made any value less than 200 volts and no discharge in the main gap *C-A* or *C-B* will occur until gap *A-B* is broken down. When this happens, a large current can be made to flow in the anode circuit if the anode is more than 70 volts positive with respect to the cathodes when the auxiliary gap *A-B* becomes ionized.

One way to utilize the controlling effect of the r-f voltage transmitted from the remote unit is shown in Fig. 2. Here the gas tube is the same as that described above. The main gap *C-B* is supplied with 60-cycle voltage from the power line, but, since the peak voltage is only  $\sqrt{2}$  times the line voltage, or about 180 volts, there is no discharge, because of the 200-volt threshold breakdown potential in the main gap.

### RESONANT RISE

If, however, a volt or two of radio-frequency energy from the remote unit is present across the power line in Fig. 2, it may be increased in amplitude by resonant rise in the series circuit

*LC*, which is tuned to the carrier frequency of the remote oscillator. The resultant r-f voltage which appears across *L*, and consequently between *A* and *B*, may then be over 70 volts peak, and this will cause gap *A-B* to become ionized. The potential required to ionize the main gap is thereby decreased to 70 volts, and current flows through the relay winding during the portions of the a-c cycle when *C* is more than 60 volts positive with respect to *A*.

The amount of r-f voltage required to initiate the discharge in gap *A-B* may be reduced, and the sensitivity of the device increased, by supplying element *B* with a 60-cycle potential as shown in Fig. 3. The main anode current then passes between *C* and *A* through *L*, instead of from *C* to *B*, because of the large 60-cycle reactance of the capacitance connected between *B* and ground. The capacitance voltage divider may be adjusted to apply 50-peak, 60-cycle volts between *B* and *A*, thereby reducing the r-f voltage required to break down gap *A-B* to about 20 volts. The sensitivity could be further increased by applying a still larger "polarizing" 60-cycle potential to *B*, but this would make the device susceptible to line-voltage variations.

### OMITS STANDBY POWER

The use of a capacitance voltage divider, in place of a resistive potentiometer, for setting the polarizing potential of element *B*, permits the operation of the circuit with zero standby power.

The discharge in the main gap is not continuous, with operation on a-c as shown in Fig. 3. This would be true even if the auxiliary gap were continuously ionized. The reason for the intermittent nature of the main discharge lies in the sinusoidal variation of the voltage on element *C*, for, as soon as this voltage falls below sixty volts, the main discharge ceases, and is reinitiated only when the potential of *C* rises again during the next cycle to 70 volts. It is seen that the main discharge is not maintained even intermittently if the r-f voltage is removed from coil *L*, since the voltage across gap *A-B* is then insufficient to re-initiate the auxiliary discharge, which is also intermittent in nature, during the next cycle.

It is readily seen that the gas-tube discharge may be controlled from a remote point by transmitting a current of low radio-frequency over the power line. However, each gas tube at the controlled point requires a separate carrier frequency, and this means that if several functions are to be performed, the several gas-tube circuits must each be receptive to different carrier frequencies, if interaction is to be avoided and independent control achieved.

### HALF-WAVE OSCILLATION

There is, however, an expedient at hand which may readily be used to decrease the number of carrier frequencies required. This method of control makes use of an r-f voltage which is modulated in intensity by the 60-cycle line voltage at the remote unit, and the added control feature is obtained by comparing the

phase of the line voltage at the gas-tube circuit with the phase of the modulation envelope of the r-f voltage transmitted over the power line.

The source of energy for this type of remote control comprises a conventional feedback oscillator, whose plate-supply voltage is derived from the 60-cycle line, instead of from a d-c source. Application of 60-cycle a-c as plate-supply voltage permits the tube to oscillate only in the portion of the a-c cycle during

reason for this "selective ionization" is that the r-f voltage adds to the 60-cycle voltage across gap *A-B* only during a half-cycle at 60 cycles; hence, the gap *A-B* is ionized only during a portion of this interval, when the sum of the two voltages (r-f envelope plus 60-cycle polarizing voltage) is greater than 10 volts. If this auxiliary discharge occurs during the portion of the a-c cycle when element *C* is more than 70 volts positive, a low-impedance discharge takes

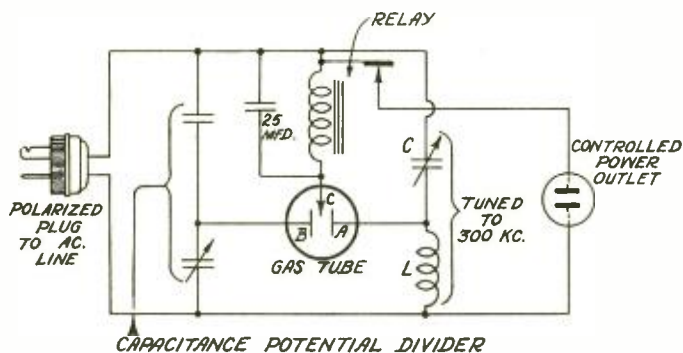

FIG. 3  
Basic gas-tube circuit with means for improving sensitivity.

which the oscillator tube's plate is positive with respect to its cathode. Consequently, the oscillator output voltage which is fed into the line at the remote point is modulated in intensity, and consists of a series of pulses as shown in Figure 4. The interval during which oscillation takes place may be shifted by 180 degrees at 60 cycles if the phase of the line voltage is reversed before being applied to the oscillator circuit. This could be done by reversing the remote-unit power-supply plug. The r-f impulses then take the position shown dotted in Fig. 4.

The r-f voltage, modulated in intensity, is picked up at the line terminals in Figure 3 and appears across coil *L*, as previously explained. The main gap *C-A* can not be broken down in this case, even with sufficient r-f voltage available across coil *L*, unless the phase of the modulation envelope is properly related to the phase of the a-c line voltage on element *C*. The

place, and the relay in the anode circuit is energized. Reversal of the phase of the r-f envelope does not prevent ionization between *A* and *B*, for this still occurs, but only when *C* is negative with respect to *A*, and, thereby, the main-anode discharge current is not sufficient to actuate the relay.

It can be seen that the gas tube must have a rectification characteristic if phase control of this type is to be possible. More current still flows in the main anode circuit when *C* is positive than flows when it is negative, otherwise the relay will be energized on either phase of the r-f envelope.

#### IV. USE OF SELECTIVE IONIZATION FOR CONTROL PURPOSES

Initiation of the gas discharge in a tube connected in a circuit similar to that of Fig. 3 may  
(Continued on following page)

FIG. 4  
Illustrating the modulated r-f output.

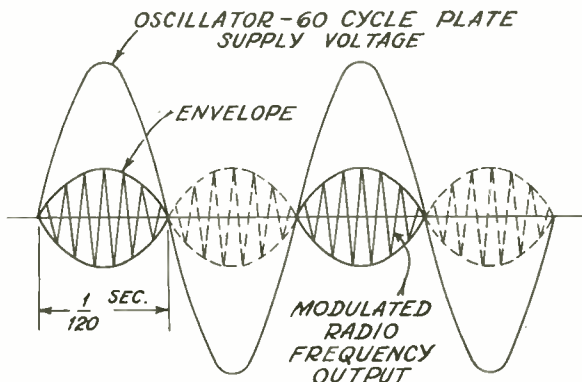

(Continued from preceding page)

be controlled by two variables; one is the carrier frequency of the remote oscillator, and the other is the phase of the r-f oscillator-output voltage envelope. Several similar gas-tube circuits may be set up at the controlled device and may be controlled independently from a remote oscillator, in which both the carrier frequency of the r-f voltage and the phase of the modulation envelope are variable.

Assume that two oscillators in a remote unit may be made to operate at either 200 or 300 kc as carrier frequency, and that the envelope phase may be controlled as desired; let the receptive circuits at the controlled unit contain four gas-tube arrangements each similar in type to that shown in Fig. 3; two of the gas tubes have their resonant circuits tuned to 300 kc, and the a-c potentials on the tube elements are so phased that the individual tubes are ignited by oppositely phased r-f envelopes; the second pair of gas tubes are arranged in the same manner for actuation by the difference in the modulation envelopes, but their resonant circuits are tuned to 200 kc; let each gas tube have a relay in its anode circuit, and let the relays be numbered respectively 1, 2, 3 and 4. It is then possible to show, as is done in the following table, that ten different combinations are available by using two oscillator frequencies, 200 and 300 kc and the two opposite phases of the r-f envelope, *A* and *B*.

The four relays may, therefore, be closed singly or in combinations of two at a time, depending upon the conditions existing at the remote unit. The relay contacts can be used to connect any electrical device to its source of power or to close other control circuits.

If three carrier frequencies are used with both phases of the modulation envelope, the number of possible combinations of frequency and phase is increased from ten to twenty-six. This would require six gas tubes at the controlled point, each with a multiple-contact relay in its anode circuit.

### LENGTH OF CLOSURE

It is to be noted that the relays remain closed only as long as the r-f voltage is supplied to the line. This requires that the oscillator at the remote point deliver the required energy during the period that the relay is closed. For

simple "on-off" switching the arrangement may be changed somewhat to eliminate the necessity for maintaining the r-f voltage during operating periods of the controlled device. This can be done by using two gas tubes, whose resonant circuits are tuned to the same frequency, but which are ignited by opposite phases of the modulating r-f envelope. One tube is used to close a small relay, which in turn closes a locking relay, whose contacts make the circuit from the line then has no effect on the locking relay. The other gas tube is arranged to be actuated by the opposite phase of the r-f envelope, and its relay is made to open the locking relay, thereby breaking the connection between the controlled device and the power line.

### V. OTHER TYPES OF PHASE AND FREQUENCY DETECTORS

The "cold-starting" properties of gas tubes, with their lack of stand-by power requirements, makes them a very suitable device for "on-off" remote-control switching. They can be used to connect in circuit other types of phase and frequency detectors, which may contain vacuum tubes, and thereby require heater and plate-circuit power for operation.

One type of phase detector which is adaptable to this method of remote control consists of a high vacuum tube of the 6R7 type, which contains a triode and two small diodes. The circuit is as shown in Figure 5. Plate-supply potential is obtained directly from the a-c line, or through a step-up power transformer. The radio-frequency voltage present across the line is increased by resonance in the tuned circuit shown, and is applied to the control grid, in series with a suitable bias source.

The function of the bias is to maintain the tube at cutoff in the absence of control signals. This may be done by applying to the grid a 60-cycle voltage which opposes the a-c plate voltage in phase, and is slightly greater than the plate voltage divided by the amplification factor of the tube. No plate current flows under these conditions, but the grid current may be excessive during positive excursions of the a-c grid voltage, especially since the a-c source may have low impedance. To reduce this grid

Oscillator No. 1		Oscillator No. 2		Gas-Tube and Relay Number
Frequency	Envelope Phase	Frequency	Envelope Phase	
300	A			1
		300	B	2
200	A			3
		200	B	4
300	A	300	B	1 and 2
200	A	200	B	3 and 4
300	A	200	B	1 and 4
200	A	300	B	2 and 3
300	A	200	A	1 and 3
300	B	200	B	2 and 4

current, one may insert a high resistance in series with the grid; this action will have no effect on the detecting properties of the circuit.

### FULL-WAVE METHOD

Another way to maintain the tube at plate-current cutoff is to use a full-wave, rectified, unfiltered, 60-cycle voltage developed in the double-diode portion of the tube, as shown in Fig. 5. The voltage is applied as grid bias, with the polarity arranged so that there is no positive grid-voltage swing with respect to cathode. The ratio of the amplitudes of the plate and grid voltages is somewhat less than the mu of the triode section. There is no grid

of Figure 6. Here the a-c plate voltages are in phase opposition, and the relay which is actuated depends upon the phase relation between the r-f envelope and the a-c plate potential. Obviously both relays will be energized if both phases of the modulation envelope are fed into the line at the remote point.

A double-triode connected for phase detection as described above may be used in conjunction with only one carrier frequency; two double-triodes may be substituted for the four gas-tube circuits described in the first part of the paper, and, operation with two frequencies and both phases of the r-f envelope results in ten combinations of phase and frequency which will

FIG. 5  
High-vacuum type of phase detector.

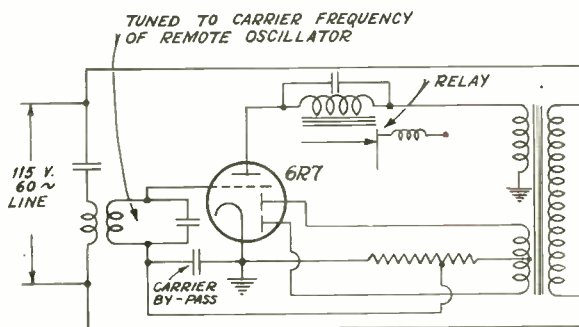

current under these conditions, hence no series grid resistor is necessary.

The detector circuit operates in the following manner. Plate current flows through the relay winding when the phase of the r-f envelope is so arranged that the peak instantaneous grid voltage occurs coincidentally with the peak positive a-c plate voltage. If the r-f envelope is shifted 180 degrees in phase at the remote-control point, no current flows in the phase detector plate circuit because the plate is negative with respect to cathode (due to the 60-cycle plate voltage) when the pulse of r-f voltage is applied to the grid.

### INCREASED SENSITIVITY

The sensitivity of the device may be increased by rectifying the modulated r-f voltage present across the tuned circuit and extracting the low-frequency modulation components. The output of the diode rectifier used for this purpose is applied to the grid in series with the bias source. The increased sensitivity is due to the fact that the average value of the voltage applied to the grid is increased due to rectification in the diode.

The circuit of Figure 5 has the necessary qualifications for selection of the proper control signals, since it has both phase and frequency selectivity. Extension of this arrangement to include relay actuation on either phase of the modulation envelope may be made by using an additional triode, whose a-c plate voltage is opposite in phase to that on the tube described. More direct, however, is the use of a double-triode of the 6N7 type, as shown in the circuit

actuate four multiple-contact relays as described in Section IV. This, of course, would eliminate the "cold-starting" feature.

Small thyratrons or gas triodes may be substituted for high-vacuum tubes in this phase detector if it is desired to operate some power-consuming device directly from the anode current of the tube. In this way a high-current solenoid or relay may be controlled by causing the gas discharge to be initiated by the properly phased r-f envelope.

## VI. APPLICATIONS OF REMOTE-CONTROL CIRCUITS

The gas-tube circuit described above may be utilized for "on-off" control of any electrical device. Experimental models of the small remote-oscillator unit and the control circuit were constructed and were used for remote control (via the power lines) of lamps, bells and other electrical appliances.

In a remote-control arrangement of this type, the "on" switching is effected by causing the r-f impulses to initiate a discharge in the gas tube at the controlled point. The r-f energy is then supplied continuously to maintain the gas discharge during the operative period of the device. The controlled device is disconnected from its power supply by merely removing the r-f impulses from the line.

The necessity for maintaining the gas discharge while the controlled device is operating may be avoided by using a small locking relay in conjunction with two gas tubes and their associated circuit elements; one circuit is used

(Continued on following page)

(Continued from preceding page)  
for "on" switching, and the other is used for breaking the locking-relay contacts to turn the controlled device off.

## VII. RADIO-RECEIVER CONTROL

This method of remote control may be readily applied to radio receivers which are already equipped for so-called "Electric Tuning." In receivers of this type the "Electric Tuning" is accomplished by means of a small motor and cam arrangement used in conjunction with push-button switches which are mounted on the front panel of the receiver. These switches are arranged to close the motor circuits to vary the tuning or volume level.

Automatic frequency control is generally used

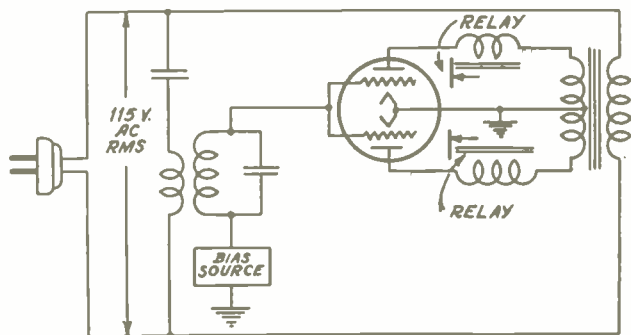

FIG. 6  
Double-triode high-vacuum  
phase detector.

in "Electric Tuning" receivers, and this is a necessary feature, for even the best motor-and-cam arrangements are not sufficiently precise in their action to permit tuning with the required degree of accuracy.

For remote control, a unit, located in the receiver, contains phase and frequency detectors of the type previously described. These are arranged to be actuated by a small oscillator at the remote point, and r-f energy transmitted over the power line causes energization of relays connected in the anode circuits of the tubes in the receiver control unit. The contacts of the relays are connected in parallel with the push-button switches in the "Electric-Tuning" receiver, so that the closure of the relays, either singly or in combinations of two at a time, causes power to be supplied to the tuning-motor circuit as in regular "Electric Tuning."

One of the circuits in the receiver unit should contain a gas tube, if remote control of the "on-off" switching is desired. The gas-tube relay may be arranged to close a locking relay for "on" switching, and, once this function is performed, the gas tube may then be used for additional control functions.

Three other gas tubes may be used to actuate the three remaining relays, or high-vacuum phase detectors of the type previously described may be employed to control the closure of the required relays.

The remote unit consists of two triode oscillators (a double-triode 6N7 type of tube may

be used) in which the carrier frequency and envelope phase are controlled by push-button switches mounted on the panel of the remote unit. The output of this device is fed into the power line at the point from which remote control is desired.

## SELECTION OF SIX STATIONS

Use of two frequencies and two envelope phases in the remote unit permits control from the remote point of the "on-off" feature, and of the selection of any six broadcast stations. In addition, remote control of the volume level is available. The stand-by power at the receiver when it is not operating is zero; similarly, the power consumed in the remote unit when no turning or volume operation is being controlled

is merely that required in the heater circuit of the oscillator tubes.

Several remote-control arrangements of the type described in this paper may be operated independently and without interaction on adjacent power circuits if means are taken for mutual isolation of the power lines for the r-f control currents. This may be done easily by inserting a small r-f choke at the meter board of each power line. If this is impracticable, different sets of carrier frequencies may be used for each remote-control installation, say 250 and 350 kc for one installation and 200 and 300 kc for another.

These precautionary measures will, however, not be generally necessary, because of the relatively high natural attenuation existing between adjacent power circuits.

## Bill to Tax Stations to Get Quick Action

Washington.

Representative John J. Boylan, Democrat, of New York, sponsor of a measure to tax radio broadcasting stations at the rate of \$1 a watt won a promise of early hearing for his bill.

At present radio stations pay no tax for broadcasting privileges. On the basic rate provided in Mr. Boylan's bill a 50,000-watt station would pay \$50,000 tax a year.



# Forecasting Sunspots and Radio Transmission Conditions

By A. L. Durkee

*Transmission Development, Bell Telephone Laboratories, Inc.*

**T**HAT there is a close relationship between the best frequencies for long-distance radio communication over short-wave circuits and the average number of spots on the sun has been recognized for some time. The frequencies which give the best transmission are considerably higher during periods of great sunspot activity than at times when sunspots are few. This has been attributed to increased ionization in the higher layers of the atmosphere when sunspots are numerous, with the result that shorter radio waves are more effectively returned to the earth. In years of high solar activity severe disturbances of the earth's magnetic field occur frequently. These disturbances, known as magnetic storms, are nearly always accompanied by disturbances of short-wave transmission.

## APPROACHES ANOTHER PEAK

Solar activity is now approaching another peak in its well known eleven-year cycle of change, and in view of its influence on radio communication, its probable magnitude is of particular interest at the present time. Attempts have been made to predict the magnitudes of the peaks on the assumption that there are systematic, long-period variations superimposed on the eleven-year cycle, but the determination of these long-period effects is quite uncertain with the limited amount of data now available. Dependable sunspot observations go back less than

two hundred years, which in terms of eleven-year cycles represents a comparatively short range of experience.

Astronomers express sunspot activity in terms of an index which is determined by the grouping as well as the actual number of sunspots present, and is called the relative sunspot number. The values of this number for each year since 1750 are shown in Fig. 1.

A new method of analyzing these data proposed by the author indicates the possibility of making short-range forecasts of the probable magnitude of succeeding peaks of the curve on the basis of the activity at the preceding minima. This analysis shows that the magnitude of each peak apparently is related to the average sunspot number at the preceding minimum and the rate at which the sunspot numbers begin to increase immediately after the minimum. High minima and high rates of increase tend to be followed by high maxima.

## HOW RESULTS WERE ATTAINED

To show this relationship each maximum sunspot number was plotted against the square root of the product of the preceding minimum sunspot number and the rate of change of activity at that minimum (Fig. 2). This particular function was selected by trial, and three-year averages of the relative sunspot numbers were  
(Continued on following page)

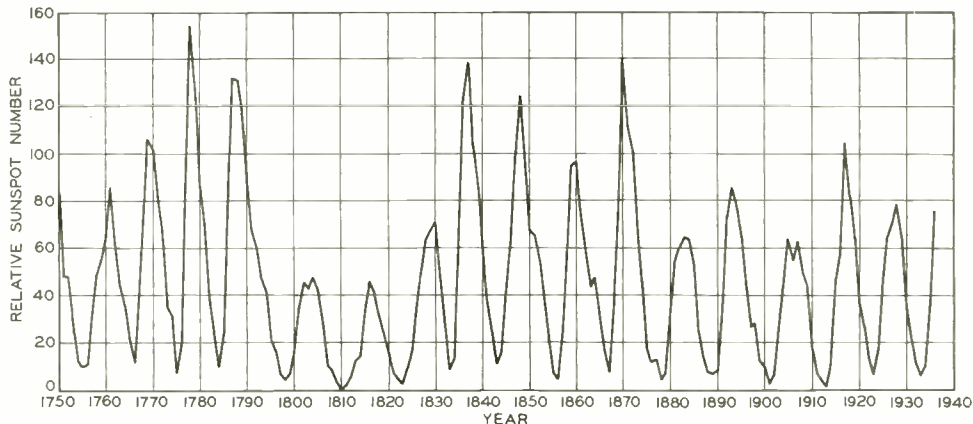

FIG. 1  
Variations in sunspot activity since 1750.

(Continued from preceding page)

used in determining the maxima and minima. The results show a correlation which is indicated by the points all falling within the band between the two straight lines. The abscissa corresponding to the minimum of 1932-1934, is 16.2; hence it appears from Fig. 2 that the three-year average sunspot number for the com-

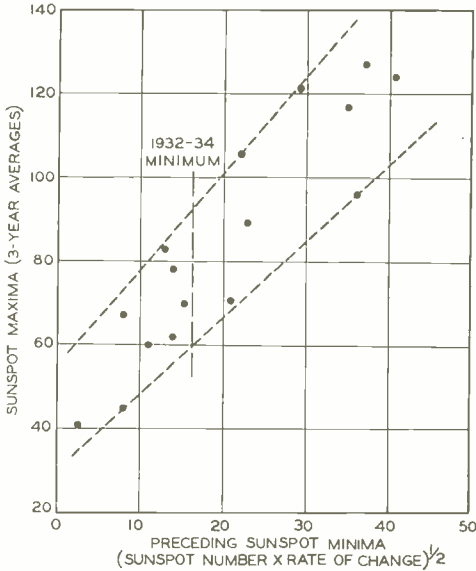

FIG. 2

Relation between sunspot maxima and preceding minima.

ing peak may fall somewhere in the region between 60 and 90.

The years of highest sunspot numbers are not always those of greatest terrestrial magnetic disturbance, although both effects follow an approximate eleven-year cycle. There is a tendency, more pronounced in some cycles than in

others, for magnetic activity to lag behind sunspot activity and the effect has been particularly noticeable in the last three cycles. This is illustrated in Fig. 4, where the three sunspot\* and magnetic activity cycles since 1900 have

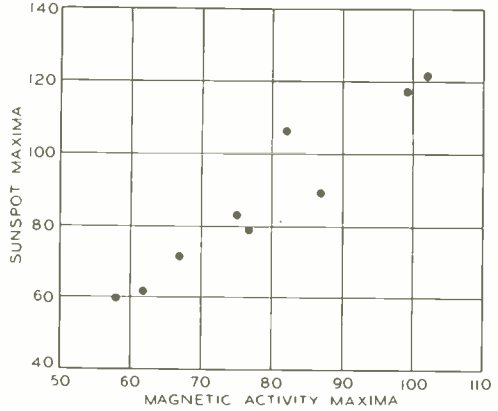

FIG. 3

Relation between sunspot maxima and magnetic activity maxima.

been superimposed and smoothed by averaging. These results show that the peaks of magnetic activity came later than the sunspot peaks, and that a given sunspot number was associated with substantially higher magnetic activity in years following than in years preceding the sunspot peak.

**Basis of Forecast**

Data on which to base forecasts of magnetic activity are more limited than those for sunspots, although consistent observations on day-

(Continued on following page)

\*Magnetic activity is represented by numbers which are proportional to the average change from day to day of the mean horizontal intensity of the earth's magnetic field.

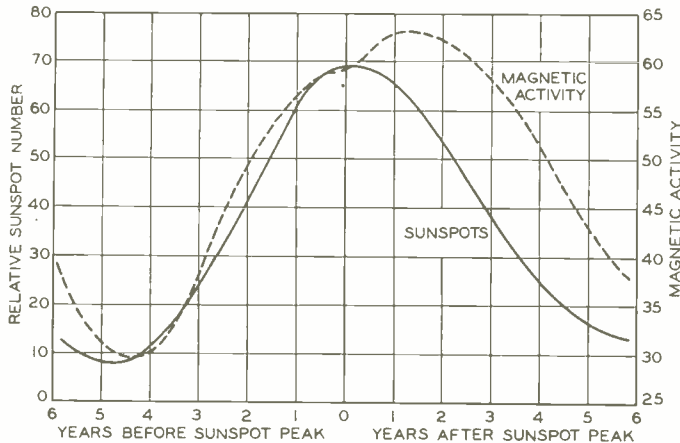

FIG. 4

Average sunspot and magnetic activity cycles.

## National Union Introduces Television Generator Tube

National Union Radio Corporation announced a new tube type called a Monotron.

The Monotron resembles in appearance a 3" cathode-ray tube. It is suitable, however, for generating a single image for television experiments or for servicing television receivers in the field.

In the Monotron a metallic signal plate takes the place of the usual fluorescent screen. Upon this metallic plate, and facing the beam of electrons within the tube, is printed a test pattern. This test pattern is fixed and may not be varied in any one tube. The test pattern, however, may be anything one desires for a particular tube, even one's own photograph, provided the original is clear and well-defined.

The test pattern when scanned by the beam causes the emission of secondary electrons. The intensity of this secondary emission is determined by whether the beam is scanning the bare metal or the ink of the design involved.

When the Monotron is used in an instrument which might be called a television oscilloscope, the current is returned to ground through a 25,000-ohm resistor and the difference of potential developed is amplified by a wide-band amplifier. This amplifier should have a gain of approximately 20. A 6C6G or 6L6G with 2,500-ohm load resistor will have an adequate wide band frequency response for the purpose. The cathode-ray gun and deflection plates are operated the same as in the 3" cathode-ray tube.

The image generated is viewed on a second tube, with elements wired in parallel through the Monotron. The output of the amplifier is applied to modulate the grid of the cathode-ray tube.

A standard 441-line, 30-picture-per-second image can be generated and is very useful in testing television amplifiers, sweep circuits and receivers.

Experiments with National Union Monotrons have also indicated that the image may be broadcast.

## Sunspot Data Give Basis of Prophecy

*(Continued from preceding page)*

to-day variations in the earth's magnetic field go back about one hundred years. In Fig. 3, three-year averages taken at the peaks over this period are plotted against the corresponding, although not always coincident, average sunspot peaks. The points fall roughly along a straight line, which naturally would indicate that these factors are correlative.

These results, together with the results shown in Fig. 4, suggest that a moderate peak of sunspot activity in any cycle probably will be accompanied by an equally moderate peak of magnetic activity and that the year of greatest magnetic disturbance will occur possibly a year or two after the year of highest sunspot number.

## Decibels, Horses and Ponies

You recently published an article on decibels, stating microphones of more "decibels up" were more sensitive, and vice versa.

Level, in decibels represents power, in watts, right? Multiplying watts by 746 gives us horsepower, doesn't it? So, the next time you see a well-fed horse, you are also looking at 51 decibels plus (approximately). A pony, without any data on pony power, could be rated up around 46 db, or 237.2 watts. Now try to make me believe that a horse is more "sensitive" than a pony!

CARL E. GRAHAM,  
706 Weiler Court, N. E.,  
Canton, O.

## Halson Is Reorganized; Factory in Meriden, Conn.

The Halson Radio Manufacturing Corporation, for seven years located in New York City, and more recently in Norwalk, Conn., has been reorganized and has moved to larger quarters in the plant formerly occupied by the Aeolian Co., in Meriden, Conn.

The company will be known as Halson Radio and Television, Inc. The officers of the new company are Hal P. Shearer, president and treasurer; Charles S. Halpern, vice-president, and Philip J. Halpern, secretary.

A complete line of receivers, consisting of midgets, consoles and phono-combination, will be shortly announced to the dealer and jobbing trade. The engineering and designing staff are prepared to aid in the production of private brand merchandise, built in accordance with specifications.

## Board Will Investigate Monopoly in Networks

Washington.

Avoidance of monopoly in chain broadcasts must be a careful rule for stations, said Frank R. McNinch, chairman of the Communications Commission, addressing the National Association of Broadcasters. He is contemplating an investigation to find out if there is a monopoly.

McNinch asserted he was not interested in whether there was a technical or legal monopoly but whether there was concentration of control such as "to amount to a practical monopoly." If such exists, it is in violation of the law, he declared.

The stations also are facing the possibility of a tax of \$1 per kilowatt. Never before were stations taxed.

# Reduction of Hum in Heater Type Tubes

A HIGH-GAIN audio-frequency amplifier is usually critical as to hum because a small hum voltage on the grid of the first tube is amplified by all the stages in the amplifier. To reduce the hum output of such an amplifier to a very low level, it may be necessary to observe special precautions in the design of the first stage. Hum voltage introduced by the heater to the grid of the second tube is of secondary importance, although hum-reducing pre-

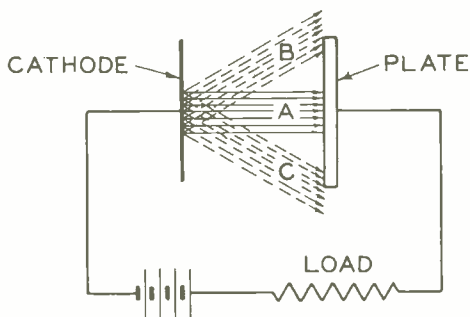

FIG. 1

An alternating magnetic field may introduce hum because the normal direction of electrons (A) is deflected upward (B), reducing plate current. During the next alternation the beam is deflected downward (C).

cautions may also be observed in the design of this stage.

This Note discusses, first, various causes of hum introduced by a-c operated heaters in heater-type tubes and, second, practical methods for reducing this hum. It will be assumed that tubes and associated wiring are adequately shielded and that the power-supply unit is adequately filtered.

There are several instances when special circuit precautions may not prove adequate to reduce hum. In high-gain amplifiers, for example, the effects of possible variations between tubes of the same type are greatly magnified by the gain of the amplifier. The type 1603 is recommended for use in such cases. This tube type is a sharp cut-off pentode having characteristics similar to those of the 6J7 or 6C6, and is especially designed for applications which are critical as to hum or microphonics. Only one special precaution need be observed in using the 1603: connect a 100- to 500-ohm potentiometer across the heater and ground the ad-

justable arm. With screen connected to plate (triode arrangement), the 1603 has characteristics similar to those of the 6C5.

## SOURCES OF HUM

Hum may be introduced by an a-c operated heater because of: (1) the presence of a magnetic field; (2) capacitive coupling between heater and other electrodes; (3) leakage through heater-cathode insulation; and (4) emission from the heater to other electrodes. It should be noted that the effects of magnetic fields, capacitive coupling and heater emission are appreciable only when the gain of the amplifier is high. In a medium-gain amplifier, such as used in a radio receiver, only the effects of heater cathode-leakage may be important.

When the heater is fed from a source of alternating voltage, the alternating current that flows through the heater may set up an alternating magnetic field of appreciable magnitude. Because this magnetic field accelerates the electrons in a direction at right angles to that of the electrostatic fields, electrode currents are modulated. Fig. 1 shows one manner in which an alternating magnetic field may introduce hum in the plate circuit. Consider the usual direction of electron flow as that shown by A. Then, during one half of the heater-current cycle, the beam is deflected upward (B); if part of the beam leaves the plate, the plate current is reduced. Similarly, during the second half of the cycle, the beam is deflected downward (C), to reduce the plate current again. This change of beam position gives rise to a hum current having a large double-frequency component. This hum current flows through the load, and causes hum voltage on the grid of the succeeding tube.

The best remedy for high hum due to a magnetic field is to use d-c on the heater. With a-c heater excitation, it is possible to reduce hum by reducing the value of load resistance, but this expedient is accompanied by a loss in gain. When it is not practicable to use d-c on the heater, the type 1603 is recommended in preference to other tube types.

## HUM DUE TO CAPACITIVE COUPLING

Fig. 2A is a simplified circuit of an a-f amplifier showing capacitive coupling between control grid and each terminal of the heater. When one side of the heater (B) is grounded, heater voltage ( $E_h$ ) is applied to  $C_1$  and  $R_g$  in series. The fraction of  $E_h$  that appears across the grid resistor,  $R_g$ , is amplified by the tube and passed on to the succeeding stages. Because the reactance of  $C_1$  is very high com-

pared to the resistance of  $R_g$ , the hum voltage that appears across  $R_g$  is  $E_{gh}$ :

$$E_{gh} = E_h R_g \omega C_1$$

For example, in a triode let  $R_g = 2$  meg.,  $\omega = 2\pi f$  or 377 radians for  $f = 60$  cps,  $C_1 = 0.5$  mmfd., and  $E_h = 6.3$  volts (rms). Under these conditions,  $E_{gh}$  equals 2.38 millivolts. When

Moreover, low hum due to capacitive coupling can be expected from a tube type which has its cathode lead between control-grid and heater leads, because the shielding action of the cathode lead reduces grid-heater capacitance.

Capacitive coupling from heater to plate causes plate-circuit hum. When grid-heater

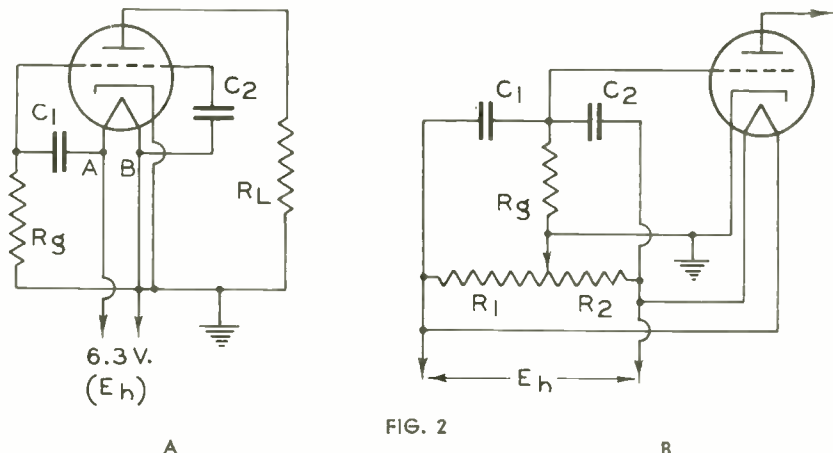

FIG. 2

A simplified circuit of an audio amplifier, with "stray" capacity couplings, is shown at A, while at B is shown a bridge circuit for eliminating hum.

this small hum voltage is multiplied by the gain of the amplifier, the output hum voltage is appreciable.

Two simple remedies are available when the capacitance of  $C_2$  is very small: (1) reduce the value of  $R_g$ , or (2) ground terminal A of the heater instead of terminal B. However, when the capacitance of  $C_2$  is appreciable, changing the ground terminal of the heater may not reduce the hum to an acceptable level. In this case, it is necessary to balance out the hum voltage by connecting a potentiometer across the heater. The bridge circuit for this connection is shown in Fig. 2B. In this circuit,  $(R_1 + R_2)$  is the potentiometer,  $C_1$  represents the capacitance of the grid to one terminal of the heater, and  $C_2$  represents the capacitance of the grid to the other terminal of the heater. When the bridge is balanced, the hum voltage across  $R_g$  is zero.

### METAL VERSUS GLASS TUBES

Most of the grid-heater capacitance is due to the close proximity of the grid lead and the heater leads in the stem press (in glass-type tubes) and in the base; only a small amount of grid-heater capacitance exists between the electrodes themselves. Hence, grid-heater capacitances of top-cap tubes are comparatively low. Of the tube types that have the control-grid lead terminating at a base pin, metal tubes have lower grid-heater capacitance than the corresponding glass types, because there is no stem press in metal tubes.

When it is feasible to ground one terminal of the heater in order to reduce hum, ground that terminal which is nearest the control-grid lead.

capacitance is low, the recommendations for reducing plate-circuit hum are the same as those discussed for grid-heater capacitance. However, it is not desirable to reduce the value of load resistance in order to reduce plate-circuit hum, because the gain of the amplifier decreases with load.

### HEATER-CATHODE LEAKAGE

The resistance of the insulation between heater and cathode is finite and non-linear. Therefore, leakage current of peculiar waveform flows from heater through heater-cathode insulation and cathode-circuit impedance  $Z_c$  to ground. When  $Z_c$  is appreciable, the hum voltage across  $Z_c$  is applied to other electrodes in the tube and appears in the output (See Fig. 3).

Three remedies are suggested for this type of hum: (1) reduce  $Z_c$  to a low value by adequate by-passing, (2) obtain bias from a source that is not common to heater and cathode, and (3) bias the heater either positive or negative with respect to cathode by about 10 volts. The value of suggestions (1) and (2) is generally appreciated, but that of (3) may require further explanation. The success of (3) depends on a resistance characteristic peculiar to heater cathode insulation. Curves showing the relation between hum voltage and d-c heater bias indicate that maximum hum occurs at biases between  $\pm 1$  volt on the heater; that hum voltage falls rapidly with increasing bias; and that hum voltage remains at a constant low value for heater cathode biases greater than approximately  $\pm 10$  volts. The general shape of a hum curve is shown in Fig. 4.

(Continued on following page)

(Continued from preceding page)

In the process of tube manufacture, it is possible for a portion of the heater to be coated with a small amount of electron-emitting material. When the potential of any electrode in the tube is positive with respect to the heater, emission from the heater to that electrode may take place.

### CONTROL GRID CRITICAL

There are two practical remedies for reducing hum due to heater emission: (1) reduce the value of impedance in the electrode circuit that

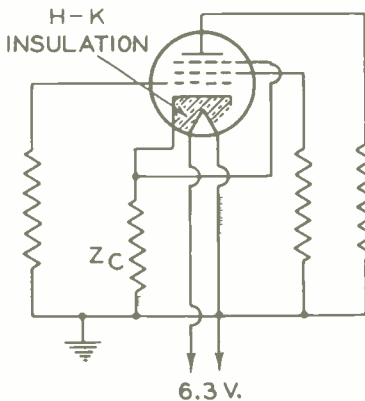

FIG. 3  
The heater-cathode insulation may not be sufficient for low hum in high-gain amplifiers.

is most critical as to hum (usually the control-grid circuit), and (2) bias the heater more positive with respect to cathode than any other electrode in the tube. In most cases, however, the control grid is the most critical electrode; it is only necessary, therefore, to bias the heater more positive than the control grid in order to

reduce hum caused by heater emission to a low value. Instances do arise, however, when it is necessary to bias the heater as much as +50 volts with respect to cathode in order to reduce hum to an acceptable level. In such cases, it is suggested that the bias be held to the lowest acceptable value.

### EMISSION AS CAUSE

In some instances emission from cathode to heater causes hum. The remedy in this case is to apply a negative bias to the heater. Whether hum is caused by cathode emission to heater or

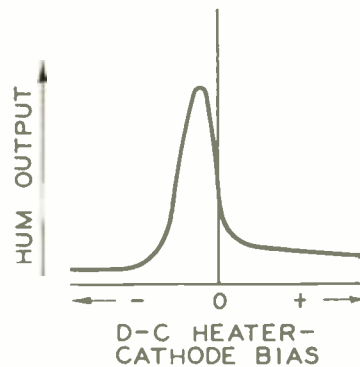

FIG. 4  
General shape of the hum curve for changes in d-c bias on the heater. When the bias is 10 volts, either plus or minus, hum is least.

by heater emission can be determined from the polarity of the heater bias that is necessary to reduce the hum. This bias should not be too high, because the effects of heater emission increase with negative heater bias.

Copyright 1938 by RCA Manufacturing Co., Inc.

## Arizona Picks Up N.Y. on 41-Megacycle Wave

General Electric's new ultra-short-wave radio transmitter erected on top of the state office building in Albany, N. Y., officially inaugurated its broadcast schedule. This new station, W2XOY, operates on a frequency of 41 megacycles or 7.31 meters with a power output of 150 watts. It is on the air four times each week, on Mondays, Wednesdays and Fridays from 8 to 9 p. m., and on Saturday afternoons from 3 to 5 o'clock. All programs originate in General Electric's short-wave studios in

Schenectady and are carried by a special wire line to the Albany transmitter.

Signals on this ultra band are supposed to travel in straight lines, the same as light waves, to be heard within a distance of 20 or 25 miles from the point of origin. However, in one of the early tests about two months ago a report was received from an amateur in Phoenix, Arizona, more than 2,000 miles distant, telling of receiving the station.

This is classed as freak reception.

# OPPORTUNITIES

## For Money-Making Off the Beaten Track

By M. N. Beitman

THE advanced radio servicemen have at present an unusual opportunity to cash in on the growing demand for industrial apparatus built around radio parts and circuits. In the medical field there is need for custom-built diathermy machines to produce artificial fever, for inexpensive cardiographs to show visually or record the behavior of the patient's heart, and for electrical equipment to give more accurate metabolism indication.

The psychologist has found the audio oscillator and amplifier definite aids in analyzing the sense of hearing in human beings. The physics teacher has come to depend on the oscilloscope as a visual aid in explaining wave phenomena. And there is the chemist who needs a direct-reading, electrically-operated pH indicator; the factory requiring a noise-level indicating instrument or perhaps a stroboscope to analyze vibration.

### AN AUDIO OSCILLATOR

There are items that operate along radio principles and that are needed in almost all industries, from oil analysis power factor measurement to indication of the carbon content of tool steel. Equipment of this type needed in industry is not subject to any standard prices and is really the best paying field in radio.

The author will try to introduce the reader to this field and suggest the right approach. Beyond that the builder of special electronic industrial equipment must rely on his ability, ingenuity and facts available in scientific literature.

Consider the need for an audio oscillator producing frequencies from 12 to 40,000 cycles, reproducing the sound either from a loudspeaker or phones, and having a constant output at all available frequencies at any one setting of the volume control. This device would permit quick and accurate testing of one's auditory ability, point out any existing unusually sensitive frequency spectrum as well as silent channels. Every ear doctor, hearing-aid dealer, psychology laboratory and physics instructor could use such an instrument to an advantage. Such a unit can be sold at prices up to \$500.

### STANDARD CHART USED

For this unit you will first need two radio-frequency oscillators to beat against each other. Set one of the oscillators at a given frequency and have the second adjustable. In this manner the adjustment will permit you to obtain the needed audio frequencies in the form of beats

between the two oscillators. The two r-f oscillators, of course, must be loosely coupled not to lock in step.

A volume control must be incorporated and the frequency control may be of a special network type to compensate for unevenness of output at different frequencies. A two-stage, high-gain, good-quality audio amplifier will complete the setup.

In testing the auditory ability of a person, produce the weakest audible signals at various frequencies and chart the values of output. Use known standard charts of normal hearing ability for comparison. Changes will suggest themselves for example, a push-button adjustment for eleven average frequencies needed for a quick test. The following pre-adjusted frequencies could be used (values are in cycles):

16	32	64	124	250	500
1,000	2,000	4,000	10,000	22,000	

Modern diathermy equipment uses wavelengths of about 13 meters and has an r-f output from 150 to 500 watts. A filtered power supply may be incorporated to produce pure d.c. for the plates. R-f chokes and by-pass condensers in the power line stop serious interference with radio receivers.

### CAUTION NEEDED IN USE

Basically the diathermy machine is a self-excited oscillator using single, parallel or push-pull tubes. The standard air-cooled transmitting tubes built for amateur radio transmitters are well adaptable for this use. Refinements are in order in the design of the power control and the cable or plates for actual application to the patient. At a reasonable price nearly every doctor is a customer for diathermy equipment. Radio literature presents little on construction and application of diathermy. The latest book on the subject is by Tibor de Chohnoky, published by Columbia University Press. In the medical literature there are scattered bits on the application of diathermy equipment.

Remember that diathermy can do great harm unless properly applied. Internal burns take months to heal. Be sure that your customer is a physician and knows how to use the equipment.

The noise level indicator is an instrument that is now receiving much attention. Being essential for solving problems of sound insulation and reduction, and vibration elimination in offices, factories, and homes, the noise level indicator also finds extensive application in vibra-

*(Continued on following page)*

(Continued from preceding page)  
tion and sound analysis of machinery and appliances.

### SEEKING BURIED RICHES

The noise level indicator should employ a wide range, non-directional crystal microphone as the pickup of acoustical energy. The amplifier may be operated from batteries or power line and give sufficient gain to operate a direct-reading decibel output meter. A battery-operated unit, of course, offers greater convenience and may be used in all localities. The meter should be calibrated to read the db output usually encountered in practice, *i.e.*, from 20 to 120 db, using the reference level of  $10^{-10}$  watts per square centimeter. The mike, amplifier and associated power supply, and the meter, should be mounted in a handy carrying case.

Man has always tried to find a way to discover the location of buried metals. A metal locator consisting of an oscillator-transmitter and receiver-detector can be used successfully for this application. The principles and construction of metal locators using vacuum tubes for greater sensitivity have been covered in the January, 1938, issue of RADIO WORLD. A well-designed unit not only will point out the place of the ore deposit but will also indicate the approximate depth.

### TEST FOR ACIDITY

The determination of relative acidity of chemical and pharmaceutical solutions is based on a scale of pH values. Until several years ago the pH or acidity value was found by means of comparing the color taken on by litmus paper dipped into the solution in question. More recently an electrical method has been developed. The electromotive force developed between two insulated metal plates of different materials dipped into a solution will be proportional to the acidity. If two such plates are connected directly to a highly sensitive meter, the scale of this meter may be calibrated directly in pH values. For better results and greater sensitivity a single stage vacuum tube voltmeter should be used, although no commercial unit to date has incorporated a vacuum tube to give greater sensitivity.

A simple hearing aid unit can be built around acorn or Hyvac tubes. Since these tubes are available in the pentode types, large gain may be realized from a two-stage amplifier. A lapel type microphone, and a belt housing portable batteries, will complete the setup.

Select one of the items suggested or some other industrial unit using radio equipment and contact the prospects. You may thus find something worthwhile to do during a slack season.

### ROBERTS DEVELOPED THE IDEA

A pocket type super-regenerative receiver, published in the November, 1937, issue of RADIO WORLD, used an application developed for such service by Dr. Walter van B. Roberts. The original set Dr. Roberts, of RCA, designed is called the Pocquette Receiver.

## Allied Radio Issues Big, New Catalogue



View of Spring-Summer catalogue just issued by Allied Radio Corporation.

Allied Radio Corporation of Chicago released its 164-page Spring and Summer 1938 Catalog. Featuring important new developments in every field of radio, the new catalog forms an exhaustive index to modern radio equipment.

Actually four complete catalogs bound in one, the Allied book devotes separate sections to radio receiving sets, service equipment and replacements parts, public address, and amateur gear.

Highlights of the new Catalog are: 62 new models of the Knight Radios with latest features such as push-button electric tuning, automatic frequency control, volume expansion, phonoradio combinations, armchair cabinets, etc.; the new line of Knight "integrated" Sound Systems, completely new in engineering design and styling; latest advances in test equipment; new Amateur transmitting and receiving equipment; and more than 12,000 exact duplicate and replacements parts, including the new Knight brand parts.

New developments in typography and illustration have been incorporated to make the new Catalog more legible and easier to use. A free copy may be obtained by writing to Allied Radio Corporation, 933 West Jackson Boulevard, Chicago.

Allied has been making very great strides in the mail order field, with progressive merchandising and advertising, and is now one of the world leaders in the field.



# RIGHT OR WRONG?

## Propositions

1. A meter that measures one volt full-scale deflection is ten times as sensitive as a meter that measures ten volts full-scale deflection. Sensitivity of a meter is a measure of the minuteness of the input that causes full-scale deflection.
2. Negative feedback amplifiers are distinguished from inverse feedback amplifiers in that the negative type has unbypassed self-biasing resistors, while the inverse type takes a small part of the out-of-phase voltage for injection into a prior stage.
3. The stability of an oscillator may be considered from the viewpoint of harmonics, in that the richer the harmonic content, the poorer the stability. By a stable oscillator one means a device that generates a frequency that stays put, despite influences, such as supply voltage changes, that otherwise would tend to make the frequency wobble a little.
4. It is possible, and also practical, to have a four-gang condenser so carefully adjusted with parallel trimmers that there is perfect tracking of frequencies in each stage of a t-r-f set, assuming the four inductances are exactly equal.
5. A short circuit is a circuit, an open circuit is not a circuit, a short-circuit represents zero potential difference across the short, while an open circuit does likewise across the open.
6. Secondary emission is the result of electrons released by the cathode striking the plate, causing some electrons to rebound, thus opposing the main drift of electrons and reducing the plate current.

## Answers

1. Wrong. The sensitivity of a meter does not depend on the magnitude of the full-scale deflection voltage, but on the amount of current the meter draws at full-scale deflection. If it draws none the sensitivity is infinite, no matter what the range. With a receiver it is different, for there the sensitivity is a measure of how small an input produces rated output (.006 watt). A 0-1 milliammeter has a sensitivity of 1,000 ohms per volt on all voltage ranges, thus proving that voltage magnitude does not affect the sensitivity rating.
2. Wrong. There is no difference between the two terms, as both mean the same thing. The supposed distinction merely states two methods of using inverse feedback.
3. Right, both as to the condition that indirectly defines whether the oscillator is stable, and the definition of frequency stability of oscillation.
4. Wrong. It may be possible, but it is hardly practical, and is one reason why sensitivity may be high in a t-r-f set, but selectivity is limited.
5. Right. A short circuit is a circuit because it is complete. An open "circuit," so-called, is not a circuit, because a circuit is something that is closed, or complete. An open is therefore only a non-connection or nonconduction. Both a short and an open represent zero potential difference.
6. Right. The reduction of the plate current is a limitation on the efficiency of the tube, hence suppressors came into vogue, to eliminate secondary emission by a screening effect.

# Universal Television System

## Requires No Sweeps, and All Control is from Transmitter

Upper Montclair, N. J.

**A** NEW technique for home television was demonstrated by Allen B. DuMont. Doing away with the synchronizing and blanking impulses heretofore required, as well as eliminating sweep circuits at the receiver, the new method reduces television reception to simplest terms, reduces cost, permits two video transmitters to operate where only one can operate today, paves the way for higher wavelengths that insure a greater service area, and is said to eliminate early obsolescence.

The Du-Mont high-definition system, already covered by several basic patent applications, calls for the transmission of a more complete television signal and the corresponding simplification of the receiver. The usual means of weaving the pictorial pattern at the receiving end are eliminated. Instead, the intercepted signal contains the means for sweeping the cathode-ray beam in horizontal lines as well as in varying degrees of brilliancy so as to weave the pictorial pattern of lights and shadows in proper order and correctly juxtaposed for a satisfactorily reconstructed image.

### NEEDS NO SWEEP CIRCUITS

Thus no sweep circuits are required at the receiving end, as in existing practice. There is no problem of synchronization or keeping in step with the transmitter. By the elimination of sweep circuits, the number of receiving tubes is reduced by six or seven. A television receiver which might cost say \$250 under existing technique, is now reduced, says DuMont, to say \$160.

Present experimental television stations transmit 441-line pictures. Therefore, 441-line television receivers must be used. Such receivers will not handle signals other than those of 441-line scanning. Manufacturers may hesitate to produce 441-line fixed receivers in any considerable quantities, knowing that any transmitting changes may cause such receivers to become obsolete.

With the DuMont system the receiver is very little more than a good short-wave receiver with a cathode-ray tube in place of the usual loudspeaker. Scanning is handled entirely at the transmitting end, and the intercepted signal contains the necessary sweep functions. Consequently, all signals can be tuned in and handled alike. Changes are limited to the transmitting end. No changes need be made in the growing number of sets that may be sold and put to use.

Mr. DuMont believes that with his system video broadcasters can even now go immediately to 882-line images or even 1,000 lines, with any interlacing schemes that may be found most desirable for minimized flicker and maximum pictorial detail. And there need be no hesitancy about any changes at any time, since the receivers can be adjusted to tune in any scanning standard.

### MORE ELBOW ROOM

Another important gain is in the matter of elbow room on the air. Present experimental television transmitters require twice the band width needed for DuMont high-fidelity television. Thus it becomes possible to use a narrower band, and place two transmitters in the present band width set aside for a single video channel. With the narrowed band television transmission may be assigned to higher wavelengths, say around 10 meters, and escape from the present quasi-optical distance limitation. In other words, instead of being limited to how much territory can be viewed from the transmitting aerial—say 50 miles or so from the lofty location of the television aerial—it now becomes feasible to cover a service area of 200 miles' radius. DuMont adds that there is no need for much coaxial transmission cable for many scattered transmitters.

DuMont has been conducting tests and demonstrations of his system over wires. In his laboratories, are both transmitting and receiving apparatus. The image picked up by one is reproduced by the other. Either horizontal or vertical scanning of any desired number of lines and any interlacing arrangement can be used.

### AWAITS FEDERAL LICENSE

Field tests of the new DuMont system are dependent upon the issuance of an experimental television license by the Federal Communications Commission. An application was filed over a year ago, and the decision is still pending.

## Financial Reports

ZENITH RADIO CORPORATION — For nine months to Jan. 31: Consolidated operating profit was \$1,418,978 after depreciation, excise taxes and reserves, but before provision for Federal income and excess-profits taxes or undistributed-profits taxes.

## Painful Beginning Prophesied for Television by Philco Executive

What will television mean to the farmer? Nothing at all at the start, declares Sayre M. Ramsdell, vice-president of Philco Radio and Television Corporation. "Unless," he adds, "television is withheld until visual broadcasting can properly cover the country, which is unlikely."

"The public introduction of television is still quite a way off," Ramsdell says. "However, there are indications that it may be introduced prematurely because of the impatience of one company or another now working on television to be first in the field. I say prematurely from the point of view of television broadcasting and not of receiving sets. At present, the maximum range of a television program is about 25 or 30 miles.

### SEES RANGE EXTENDED

"By the time television is likely to be offered to the public in what I call a premature state, the range may very well be 50 miles."

That, explains Ramsdell, is why television will have very little effect with the farmer.

"There must be stations for television, and as no network systems will be possible at the start, the cost of broadcasting will be tremendous," he says.

"The cost of building even a moderate number of stations would take millions of dollars alone. All this cost will have to be borne by the television industry because there will be no commercial value in a station until there is further development in coverage."

Ramsdell points out that it will be logical to build these stations in the greatest concentrations of population, the big cities, to cover as many people as possible within a circumscribed area.

### RURAL DISTRICTS NOT COVERED

This would leave the large farming districts without coverage until such time as broadcasting could blanket the country without meaning financial suicide to the broadcaster.

"Maybe the farmer is lucky," Ramsdell commented. "When he is properly covered by visual broadcasting, television will have recovered from its first growing pains and he will have missed them. Those growing pains may be pretty painful—to the public as well as to the industry."

## Car Interference Serious to Video But Car Makers' Aid is Expected

One of the biggest problems facing television and its general use in the home can be solved, paradoxically, only by the automobile manufacturers. So the Radio Club of America was told recently at its meeting in New York City by A. F. Murray, engineer in charge of television research for Philco Radio and Television Corporation.

Murray explained that the television receiver operates on ultra-short waves, which are extremely sensitive to the running of an automobile motor.

The effect of a passing auto in the proximity of a television set is a blurring of the picture on the screen. The interference causes thousands of tiny white specks to make their appearance, producing the semblance of a raging snowstorm.

If there were an automobile parked nearby

with the motor running, television image-reception would be impossible, Murray declares. Television engineers, he says have not found any means of coping with the situation up to the present.

Yet, he points out, there is a solution but the television engineers will have to look to the automobile producers for it. When and if television becomes prevalent in the home, the use of suppressors on automobiles will effectively eliminate auto interference with television reception.

Only the car manufacturers themselves can equip every auto with suppressors. Will they do it? Murray thinks they will when the time comes. In the meantime, he declares, it places television in the position of being dependent for a good measure of its future success upon another, entirely unrelated industry.

# A Tester with Half-Wave Contact Rectifier

By  
H. J. Bernard

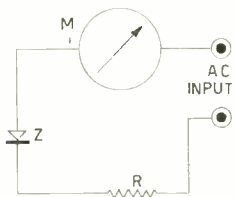

FIG. 1

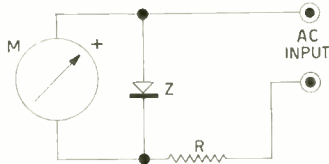

FIG. 2

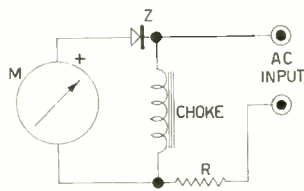

FIG. 3

Meter M, rectifier Z and limiting resistor R, constituting a series circuit, permit low voltage ranges only, in a universal meter (left). A considerable improvement obtains when the meter shunts the rectifier (center). At right is a method of increasing the sensitivity on a. c., but requires a high-inductance audio type choke.

THE use of the half-wave rectifier in instruments is fraught with more difficulties than that of the full-wave rectifier, so that despite the increased cost of full-wave operation, instrument manufacturers generally adopt the full-wave method. It is, however, quite practical to use the half-wave rectifier, and it must be true also that improvements in its use can be devised. With the growing popularity of small-sized measuring instruments, of the so-called pocket-sized type, probably fuller investigation will be made of the possibilities of the half-wave rectifier, so that valid performance can be obtained, while satisfying economic considerations.

Three types of half-wave rectifier circuits are shown in Figs. 1, 2 and 3, of which Fig. 2 is preferable. The objection to Fig. 1 is the limitation on the voltage range, including the possibly high inverse peak voltage.

## VOLTAGE LIMITATION

At all hazards, a definite voltage limitation arises for all the contact rectifiers, so that the rectifier Z becomes less and less of a rectifier, as the voltage input is increased, even though the limiting resistor R is increased in seeming proportion to the voltage. The fact is that no matter how high R is made, within reason, the rectification inefficiency at high voltage input is so low that Z behaves perhaps more as a resistor than as a rectifier, with resultant real a.c. through the meter, plus pulsating d.c. so except for low voltage ranges, Fig. 1 is of no value.

This low range may be limited by the safe current through or voltage across the rectifier, and normally will be only a few volts, some-

times only a little more than 2 volts, or, in special rectifiers, perhaps as high as 10 volts or so.

Fig. 2 is more favorable because here the electromagnetic meter is across the rectifier, so that if the limiting resistance is large enough, a tolerably small proportion of the a.c. will appear across the rectifier, hence across the meter, since the two are in parallel. It is therefore necessary for the lowest voltage range that R in Fig. 2 be selected on the basis that the meter shows not the slightest sign of any a.c. passing through it. This is largely for convenience in reading, and preservation of the calibration, since a little a.c. actually through the meter is tolerable, and will not influence the needle, whereas the pulsating d.c. will cause the needle to move.

## USE OF SAME RESISTORS

With the usual type of contact rectifier it is possible with the method shown in Fig. 2 to have a voltage maximum of 5 volts on the lowest range, which is entirely satisfactory, and the resistances for higher voltage ranges may be substantially proportionate. In fact, it is possible to use the same resistors on a.c. as on d.c., although not for the same voltage ranges, hence for four ranges of each there would have to be six resistors, or selected positions, two of which would be used exclusively, i.e., one for a.c. only, the other for d.c. only. The sensitivity on a.c. in all instances would be less than for d.c., since the rectifier, so long as it remains in circuit, shunts the meter, and on d.c., even if this shunting is retained, at least acts like a resistance.

It is therefore handy to use a separate re-

sistor for each range of voltage in each type of circuit, and the accuracy is usually better that way, too, because some sacrifice of accuracy may be expected if the resistors selected for d.c. are used also for a.c.

Fig. 3 shows a satisfactory method using a 30-henry choke coil, where the series circuit of meter and rectifier is in parallel with the choke. This method improves the sensitivity, compared to the other methods, but for reasons of economy the use of a choke is often avoided, and some other type of circuit selected.

### COMPLETE INSTRUMENT

So an instrument may be devised, based on Fig. 2, using binding posts, and this is shown in Fig. 4, where a common binding post serves for the a.c. and d.c. voltages, there being four ranges of each, a separate limiting resistor R for each voltage range. By including a switch, the rectifier is taken out of circuit when d.c.

It is necessary, anyway, to have an accurate a.c. standard, and that may be used for selection of the proper limiting resistance, in conjunction with suitable a.c. voltages from the secondaries of transformers.

### TEST METHOD

If the transformers do not yield the full-scale deflection voltages exactly, and voltage division is required, it is advisable for the voltage on a.c. to use a potentiometer that has low resistance, and preferably an a.c. voltage source that is not far above the required value. For instance, for 5 volts maximum, input voltage not more than half again as great should be used, and the potentiometer should not have a resistance much higher than 50 ohms. For the low-voltage range 15 or 20 ohms would be suitable for the potentiometer. The amount of resistance between potentiometer arm and high side of the transformer may be independently

FIG. 4

Circuit for a tester, using binding posts. There are four a. c. and four d-c voltage ranges, a d-c current range, a d-c sensitivity of the meter, and also two resistance ranges.

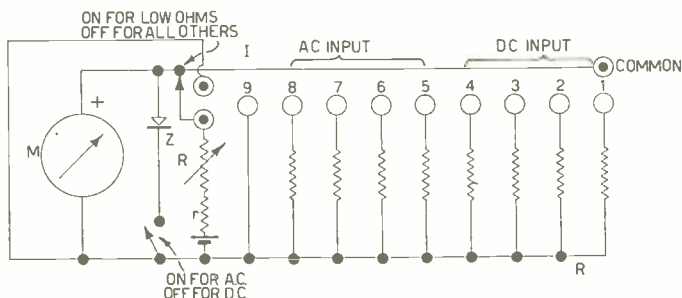

is measured, so R for d.c. is selected on the usual basis. For instance, for a 0-1 millimeter, there would be 1,000 ohms for each full-scale volt, or, for the 5-volt d.c. range, 5,000 ohms, less the resistance of the meter, if appreciable. Ordinarily the meter resistance will be 27 or 30 or 50 ohms, and may be considered of negligible resistance, and ignored as to its voltage-1k limiting effect, depending on the accuracy one sets as his standard.

### A-C SENSITIVITY

That is for d.c. On a.c. the sensitivity will be less, perhaps around 300 ohms per volt, or may be even as low as 200 ohms per volt, depending on the rectifier. What the sensitivity is may be determined by inserting an unknown voltage to create full-scale deflection on the lowest range, say, 5 volts, and then introducing additional series resistance to reduce the reading in half, while the applied voltage remains the same. The ohms per volt equals the injected voltage (5 volts) divided into the added resistance required for halving the reading. It usually happens that the ohms-per-volt is less for the lowest range than for the higher ranges, although consistent for the ranges above the lowest. So no data can be given on the required values of voltage-limiting resistors for a.c.

measured, after the test is completed, and this amount of resistance subtracted from the series resistance externally supplied for full-scaling at the desired voltage.

### RESISTANCES CONSIDERED

The equivalent resistance of transformer secondary with potentiometer across is equal to the product of their separate resistances mentioned, divided by their sum of these separate resistors. Thus, for a secondary of 8 ohms and a potentiometer of 50 ohms, the equivalent resistance to be considered is  $(20 \times 8) \div 28$  or about 6 ohms. To this add the resistance between arm and high side of the potentiometer. Hence if R, by measurement, turns out to be 560 ohms, and the resistance between arm and high side is 3 ohms, for the cited example the outside factors are 6 ohms, and 3 ohms, so R is made  $560 - 9 = 550$  ohms, approximately. If it is deemed sufficient to expect that other conditions of measurement will be much like the one made during test, then these connections for determining R may be ignored. If the potentiometer is kept of low resistance, as recommended, they may be ignored.

If voltages around 20 volts or more are to be used for calibrating, then the fact must be considered that a low resistance potentiometer will

(Continued on following page)

## Literature Wanted

Readers whose names and addresses are printed herewith desire trade literature on parts and apparatus for use in radio construction. Readers desiring their names and addresses listed should send their request on postcard or in letter to Literature Editor, Radio World, 145 West Forty-fifth Street, New York, N. Y.

Alfonso Hilado, Silay-Hawaiian Central, Occ. Neg., P. I.  
 Glen C. Welton, Box 293, Richland Center, Wisc.  
 Santos Menendez, Meirles 2- Cerro, Havana, Cuba.  
 H. Schwartz, 545 West 158th St., New York City.  
 Prescott Robins, Box 302, Troy, N. H.  
 Earl G. Hallman, 4767 Richmond St., Philadelphia, Pa.  
 Warren Preeshl, P. O. Box 113, New Richmond, Wisc.  
 John M. Brock, 7 Classic Avenue, Toronto, Ont., Canada.  
 Richard Merreck, 40 Inman St., Cambridge, Mass.  
 David McNish, Ashland Home Telephone Co., Ashland, Ky.  
 M. J. Kulka, 416 W. Union St., Nanticoke, Penn.  
 Malcolm Wadleigh, Radio Service, R. 1, Box 235, Bay H. 11, Tilton, N. H.  
 Eloy Antoine, Rose Valley, Sask., Canada.  
 A. G. Lee, Box 22, Cornwall, N. Y.  
 Arthur Grishaber, 137 So. Walter Ave., Appleton, Wisc.  
 W. B. Schagerstrom, 1509 E. 70th St., Chicago, Ill.  
 John Bruck, 266 E. Fairview St., Allentown, Penn.  
 Grover T. Colman, Horlick's Malted Milk Corp., Racine, Wisc.  
 A. A. Wallis, Eign St., Hereford, England.  
 K. Mussel, 600 West 175th St., New York City.  
 E. L. Derrick, 1311 Calhoun St., Columbia, S. C.  
 Andrew Sinkey, R. F. D. No. 3, Box 153, Uniontown, Penn.  
 Benj. H. Mooney, 3018 Guilford St., Indianapolis, Ind.  
 Lucien Pilotte, 5053 Adant St., Montreal, Canada.  
 Edward Olson, 6910 Olcott Ave., Chicago, Ill.  
 Stanley Davis, Kimberton, Penn.  
 Emory Davis, Rutledge, Georgia.  
 J. O. Pickering, Marfa, Texas.  
 Chester C. Barnett, Tupper's Plains, Ohio.  
 Robert Styer, R. F. D. No. 6, Lima, Ohio.  
 Roy L. McChesney, Bethel, Ohio.  
 Joseph Simef, 92 Spring St., Gloversville, N. Y.  
 Robert Johnson, 9 W. Berkley St., Uniontown, Penn.  
 A. J. Clay, Lovington, Ill.  
 R. F. Fuller, Jr., 2117 E. 68th St., Kansas City, Mo.  
 Miller's Radio, 128 William St., Trenton, N. J.  
 Todd Radio Service, Miltonvale, Kans.  
 Harry Richardson, Box 74, Beaverdale, Penn.  
 Vernon C. McNabb, 5105 N. Capital Ave., Indianapolis, Ind.  
 Glen C. Welton, Box 293, Richland Center, Wisc.  
 I. Kallas, c/o Curley, 420 Eastern Parkway, Brooklyn, N. Y.  
 J. J. Williams, 14 Fair Ave., Lindsay, Ont., Canada.  
 R. J. Rabour, 9 West Bowers St., Lowell, Mass.  
 Wm. A. Brownback, Linfield, Penn.  
 William D. Turner, 135 Washington Ave., Lexington, Ky.  
 Homer W. Fraser, Box 715, New Glasgow, Picton Co., N. S., Canada.  
 Anthony Miano, M. Miano & Co., 1908 Cooper St., St. Louis, Mo.  
 Lester F. Wertz, "Radio Service," Temple, Penn.  
 Geo. Solkover, 2712 East Fir St., Seattle, Wash.  
 Foster Porter, Porter's Radio Shop, Martin, Ky.  
 J. Otto, 269 W. 12th St., New York City.  
 John Robert Novak, 2305 E. Ann St., Philadelphia, Penn.  
 M. D. Post, 1012 University, Boulder, Colo.  
 Orville Wogen, Emmons, Minn.  
 T. M. Spiers, 20117 Santa Rosa Drive, Detroit, Mich.  
 M. Bauer, 600 West 175th St., New York City.  
 Leslie Gilliland, Box 205, Pinehurst, N. C.  
 L. J. Meyers, Meyers Service Shop, 415 Mill St., Ironton, Ohio.

(Continued from preceding page)

draw considerable power, and the voltage expected may not materialize, due to loading of the transformer, or perhaps one should say overloading. For the higher voltage ranges than the lowest it is permissible to increase the total potentiometer resistance proportionate to the voltage, and preferable to use power type potentiometers, of the 10-watt type or higher.

### FIG. 4 DESCRIBED

Also, by proportionality, it is not necessary to use full-scale deflection, since if the voltage obtainable is three-quarters full-scale, that would be sufficient.

The lower voltages in all these examples are obtained by using different secondaries preferably, or, lacking those, using low-resistance potentiometers. Then a curve is run, using eight or more well-spaced points, and a special scale for a.c. is protracted. The a.c. scale will not closely follow the d.c. scale, for any of the diagrams shown. But the terminal voltages can be made the same. The a.c. readings will be somewhat crowded at the low-voltage end.

The eight voltage ranges, Fig. 4, are self-explanatory. The current range is at the base sensitivity of the meter, with both switches off. One is the switch to remove the rectifier, already mentioned. The other is the switch that closes the ohmmeter circuit, so an unknown low resistance may be put across the meter only. For low ohms, then, the posts are "common" and "meter minus." For high ohms the ohms switch (top) is open, the a.c.-d.c. switch is at the off position; applicable to all d.c. and the measurement is taken between common and lower left-hand post. R is the rheostat, for adjusting the meter to full-scale, for all ohms measurements, and r is the limiting resistor, which is 10 per cent. less than the required amount. Hence R should be several times greater than 10 per cent. of the difference. In computing for r, use the factor 1.6 volts for one dry cell. More than one cell may be used, and for a 0-1 milliammeter three cells are recommended, so the low-ohms scale reaches 500 ohms conveniently, higher values being rather indistinguishable on this range, whereas high ohms would read to 250,000 ohms

## Reflected Television Wave Denotes 'Plane's Approach

Philadelphia.

Television as a means of detecting the approach of distant airplanes is being engineered for the U. S. Army and Navy by RCA.

The plan was first worked by the British. The British metal structure of an airplane in flight collects and reradiates, ultra shortwave radio impulses employed in television carries so that receiving sets produce an "echo" image.

The waves that reach the television receiver direct and those reflected from 'planes flying within range, provide the basis for noting 'plane approach.

# New 6S7 Amplifier Uses Small Power

Preliminary technical information on a new triple-grid super-control amplifier 6S7 has been made available. This tube is a pentode type of metal vacuum tube intended for service in

the r-f and i-f stages of radio receivers designed for low heater-power consumption. Its heater requires only 0.150 ampere at 6.3 volts, hence heater power is under one watt.

## 6S7

(Tentative Data)

Heater Voltage (A.C. or D.C.).....	6.3	Volts
Heater Current .....	0.15	Ampere
Direct Interelectrode Capacitances°:		
Grid to Plate.....	0.005 max.	Mmfd.
Input .....	6.5	Mmfd.
Output .....	10.5	Mmfd.
Maximum Overall Length.....		3 7/8"
Maximum Diameter .....		1 5/16"
Cap .....	Skirted	Miniature—Style B
Base .....		Small Wafer Octal 7-Pin

### Amplifier—Class A

#### Operating Conditions and Characteristics:

Heater Voltage*	6.3	6.3	Volts
Plate Voltage .....	135	250 max.	Volts
Screen Voltage .....	67.5	100 max.	Volts
Grid Voltage (Minimum).....	-3	-3	Volts
Suppressor .....	Connected to	cathode at socket	
Plate Current .....	3.7	8.5	Milliamperes
Screen Current .....	0.9	2.0	Milliamperes
Amplification Factor (Approx.).....	..	1750	
Plate Resistance (Approx.).....	..	1.0	Megohm
Transconductance .....	1250	1750	Micromhos
Grid Voltage for transconductance = 10 micromhos.....	-25	-38.5	Volts

°With shell connected to cathode.

\*In circuits where the cathode is not directly connected to the heater, the potential difference between heater and cathode should be kept as low as possible.

#### Pin Connections

- Pin 1—Shell
- Pin 2—Heater
- Pin 3—Plate
- Pin 4—Screen
- Pin 5—Suppressor
- Pin 7—Heater
- Pin 8—Cathode
- Cap — Grid

[Data from RCA Manufacturing Co., Inc.]

## Power Voltage Now 120, Up 10 Volts in Few Years

A nation-wide power survey, just completed by the Philco Radio and Television Corporation, shows that there has been a decided increase in voltage to the consumer throughout the country.

Not more than a few years ago, the average voltage fed by power companies to homes was 110. The average voltage now, as demonstrated by the survey, is almost 120 with an increasing tendency to reach that figure.

The survey, supervised by E. C. Anderson, of the Philco Engineering Department, also confirmed the fact that direct current has been

virtually eliminated for residential home use and will probably be entirely eliminated before very long.

The survey was motivated by the fact that all radio tubes and pilot lamps, which light the dial, will not stand too great a variation in power supply. A tube can withstand a variation of from 5 to 8 volts, but this same variation would put out the pilot lamp, which is a filament bulb.

It was discovered that generally there is not more than a five-volt variation in power supply to the home, and that the average voltage is 117, with a trend to 120.

# 1200 KW BEAMS SET RECORD, AID SOUTH AMERICA



Map illustration of how two powerful beams from the United States will lay down strong signals in South America and Central America.

South American reception of short-wave broadcasts from the United States will be greatly improved by General Electric's use of an effective carrier power of 1200 kilowatts—more than twice the power of any existing long-wave unit—for short-wave station W2XAD, together with a \$120,000 a year special series of programs for foreign listeners only, established by the National Broadcasting Company.

This increase in power strength, together with the program facilities of General Electric and NBC, will provide complete coverage of all parts of South America when used with two new frequencies recently granted W2XAD by the Federal Communications Commission.

## BEAMS TO BE NARROW

In the past it has not been possible for General Electric stations to reach all South American listeners at one time because of the lack of power and proper frequencies. By General Electric's new plan programs will be sent on two frequencies, with high power, on two narrow beams to Central and South America.

On the new frequency of 9550 kilocycles the

## Japanese to Begin Television in July; Images Are Square

The Japan Broadcasting Corporation started television test broadcasts at Tokyo in preparation for temporary television broadcasts in Tokyo in July.

The corporation has been studying television broadcasting, inviting Prof. Kenjiro Takayanagi of the Hamamatsu Higher Technical School, authority on television, as chief of the third department of the technical laboratory of the corporation at Kamatacho, Setagaya-ku, Tokyo, and constructing four television motor cars, a temporary broadcasting station, and a laboratory.

As the study was almost completed recently, the corporation has decided to start temporary television broadcasts next July from Kamatacho, with 500 watt power, the American Commercial Attaché reports.

The receiving set, constructed by the technical laboratory of the corporation, will be obtainable at about 1,000 yen. Further study will be made for the reduction of the cost of receiving sets.

Although the area of the received image is 20 to 22 centimeters square, it is said it can easily be enlarged to one meter square.

beam will be directed at the eastern half of South America, and the programs will be broadcast in Portuguese for Brazil. On the other frequency of 9530 kilocycles the beam will be directed to the western half of South America and will carry programs announced in Spanish for the Spanish-speaking population of Central and South America.

## FREQUENCIES TO BE USED

The two frequencies that will be used at night for broadcasting to Latin America are the present W2XAF frequency of 9530 kilocycles and the new 9550-kilocycle frequency of W2XAD. In the morning, Central and South America will be reached by the new 21,500-kilocycle frequency, and later in the afternoon by the frequency of 15,330 kilocycle (W2XAD), the latter being the station which sends programs to Europe in the afternoon which are received in the evening there.

## HOW B.F.O. WORKS

Beat-frequency oscillators produce audio frequencies due to the difference between two radio frequencies. One r.f. is fixed, the other variable. Output is practically flat.



# New Wave, Near Light, Guided Through Pipes

SOMETHING new in the generation of waves near the edge of infra-r. l. that are not light waves and are not radio waves, but are guided electromagnetic waves, was demonstrated recently by George C. Southworth, engineer of Bell Telephone Laboratories, before the Institute of Radio Engineers, in New York City.

These waves were generated from small tubes that looked like glass door knobs and were conducted through metal or rubber tubings. The diameter and other physical properties of the tubing partly determined the wavelength, and the guided waves could be quite strong when the tubing characteristics were properly related to it, so that outputs of nearly one watt were easily obtained.

His demonstration concerned two principal wavelengths, of nine centimeters and 20 centimeters, or roughly about the length of the type from one side of this page to the other, and the depth of the type from top to bottom of this page. But in Bell Telephone Laboratories wavelengths as low as three centimeters were handled easily, equally about 1.25 inches, equivalent to a frequency of 10,000,000,000 cycles per second.

## SHORTEST WAVES EASIEST

Instead of great difficulty attending these light impinging waves, it was found that the shorter the wavelength the greater the ease of working them, which is quite contrary to the usual experience with radio waves.

It was also easy to reflect the waves, which he did in the demonstration before the Institute, using bright metal discs, with a one-inch antenna for pickup. The 25-foot pipe, located on the platform of the auditorium, and illustrated on the front cover of this issue, had the small antenna at one end. He demonstrated that variety of size and shape of pipes either attenuated the wave energy or permitted full passage.

Thus there has been devised a means of utilizing the gap between the shortest radio wavelengths and the longest light wavelengths. What use the new method may be put to is not known, but its possibilities proved an engaging topic of the discussion that followed the demonstration.

## UNLIMITED POSSIBILITIES

In his talk Mr. Southworth said:

"This is a feeble beginning in a new transmission system which may be useful for all types of intelligence in the future. We are uncertain as to where it will lead, but it is apparent that many advantages will accrue if the

experiments are carried to practical operation. Very high frequencies imply very wide bands of communication, having the great advantage that multitudes of branches, or lines of individual intelligence matter, can be tucked into one guided-wave channel. That such wave guides might be infinitely multiplied, if necessary, without interference one with the other, is fundamental.

"But if our expectations are borne out, duplication of wave guides between fixed terminals or cities hardly would be necessary, as one nine-centimeter wave working at 3,200 million cycles could carry nearly 1,000,000 separate telephone messages at the same time."

## NOTABLE LABORATORY

Bell Telephone Laboratories, although primarily interested in wire telephony, has one of the outstanding radio laboratories in the world, and develops devices manufactured by Western Electric Company. The interest in radio is partly due to the fact that the use of wire lines in conjunction with radio, as in chain broadcasting, produces large revenue. In connection with television, the coaxial cable has been developed by the laboratories, which may be called another wire communication system, although permitting the handling of short or ultra radio waves, and also opening possibilities of sending many spoken messages at the same time on one carrier.

For instance, it would be possible to send nearly 500 different messages at the same time over the coaxial system, like the one laid down between New York City and Philadelphia, but the electromagnetic pipe-conducted waves, being much shorter, permit far greater multiplicity of modulation on the carrier, for instance, the 1,000,000 separate telephone messages mentioned by Mr. Southworth in his talk.

## SENT ONE MILE

So far the greatest length of tubing through which the electromagnetic waves have been sent is one mile, although it is believed that much greater distances can be covered, as no trouble developed in the mile experiment. Thus if the distance can be increased greatly, there is ample possibility of use of the electromagnetic piped wave system for television. This is of absorbing interest, as there is no known, authenticated method of communicating high-definition television over great distances, and until such a system is economically demonstrated there can be no television network broadcasting equivalent to that now existing in sound radio.

[Illustration on front cover]

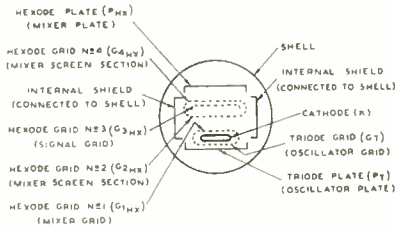

FIG. 1

How the elements are disposed in the new 6K8 converter tube that has a hexode mixer and a triode oscillator.

THE pentagrid-converter type of tube now in general use is a good frequency-converting device at medium radio frequencies. However, the performance of this tube type is not as good in the high-frequency band as in the broadcast band because undesirable effects of interaction between oscillator and signal sections of the tube increase with frequency. The type 6K8, a new all-metal converter tube, is designed for improved performance in the high-frequency band of all-wave receivers. Because the 6K8 combines the functions of oscillator and mixer, it retains the important advantage of low circuit cost; moreover, because of improved design, it gives optimum performance with a low value of oscillator amplitude.

A disadvantage of the present pentagrid converter is the large variation in the transconductance ( $g_m$ ) of the oscillator section with signal-grid bias. In practice, this characteristic is evidenced by a shift in oscillator frequency with change in avc voltage. This shift in oscillator frequency is appreciable in the high-frequency band because of the large ratio of signal frequency to intermediate frequency.

Several undesirable effects have been traced to oscillator-frequency shift with avc voltage: (1) alignment of r-f circuits may be difficult, (2) a receiver may motorboat when a strong signal is impressed, and (3) appreciable distortion may be introduced by the i-f amplifier, because the intermediate frequency differs from that to which the i-f transformers are tuned.

### DIFFICULTIES IN ALIGNMENT

Alignment difficulties which are encountered when avc voltage is applied to the signal grid of the converter is due to the dependence of oscillator frequency on avc voltage; the magnitude of the avc voltage, in turn, depends on oscillator frequency. Alignment difficulties which are experienced when no avc voltage is present may be traced to coupling between the oscillator grid and the signal grid. With the pentagrid-converter type of tube, a receiver may motorboat when a strong signal is impressed because of poor power-supply regulation or large oscillator-frequency shift with avc voltage.

# BENEFICIAL OF THE

## Circuit Q Rises as Increases—High Plate Resistance at Low Grid Current Stable

This effect is considerably reduced with the type 6K8, because oscillator frequency is not critical to changes in oscillator-plate voltage or signal-grid bias.

The electrode arrangement and socket connections of the 6K8 are shown in Figs. 1 and 2.

### CHARACTERISTIC

Direct Interelectrode Capacitances (Approx.):\*

Hexode Grid No. 3 to Hexode Plate .....	.....
Hexode Grid No. 3 to Triode Plate .....	.....
Hexode Grid No. 3 to Triode Grid and Hexo	.....
Triode Grid and Hexode Grid No. 1 to Triod	.....
Triode Grid and Hexode Grid No. 1 to Hexo	.....
Hexode Grid No. 3 to All Other Electrodes =	.....
Triode Plate to All Other Electrodes (excep	.....
Hexode Grid No. 1) = Osc. Output .....	.....
Triode Grid and Hexode Grid No. 1 to Al	.....
(except Triode Plate) = Osc. Input .....	.....
Hexode Plate to All Other Electrodes = Mix	.....
Hexode Plate Voltage .....	.....
Hexode Screen (Grids No. 2 and 4) Voltage...	.....
Hexode Control-Grid (Grid No. 3) Voltage...	.....
Triode Plate Voltage .....	.....
Total Cathode Current .....	.....

Typical Operation:

Heater Voltage .....	.....
Heater Current .....	.....
Hexode Plate Voltage .....	.....
Hexode Screen Voltage .....	.....
Hexode Control-Grid Voltage .....	.....
Triode Plate Voltage .....	.....
Triode Grid Resistor .....	.....
Hexode Plate Resistance (Approx.) .....	.....
Conversion Transconductance .....	.....
Hexode Control-Grid Bias (Approx.) for	.....
Transconductance = 2 micromhos .....	.....
Hexode Plate Current .....	.....
Hexode Screen Current .....	.....
Triode Plate Current .....	.....
Triode Grid and Hexode Grid No. 1 Current.	.....
The transconductance of the oscillator unit	.....
2400 micromhos when the Triode Plate Volt	.....

\*With shell connected to cathode.

# ODDITIES 6K8

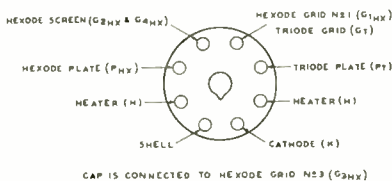

FIG. 2

Socket connections for the 6K8, bottom view. Hexode control grid is the cap.

## Frequency Plate Screen Voltage Throughput

Cathode (K), triode grid ( $G_T$ ), and triode plate ( $P_T$ ) form the oscillator unit of the tube; cathode (K), hexode mixer grid ( $G_{1HX}$ ), hexode double screen ( $G_{2HX}$  and  $G_{4HX}$ ), hexode signal grid ( $G_{3HX}$ ), and hexode plate ( $P_{HX}$ )

### CHARACTERISTICS OF THE 6K8

.....	0.03	Mmfd.
.....	0.01	Mmfd.
Triode Grid No. 1.....	0.1	Mmfd.
Hexode Plate.....	1.1	Mmfd.
Triode Plate.....	0.05	Mmfd.
R-F Input.....	6.6	Mmfd.
Triode Grid and Other Electrodes.....	3.2	Mmfd.
.....	6.0	Mmfd.
Plate Output.....	3.5	Mmfd.
.....	250	max. Volts
.....	100	max. Volts
.....	-3	min. Volts
.....	200	max. Volts
.....	16	max. Milliamperes
.....	6.3	Volts
.....	0.3	Amperc
.....	100	Volts
.....	100	Volts
.....	-3	Volts
.....	100	Volts
.....	50000	50000 Ohms
.....	0.3	Megohm
.....	360	400 Micromhos
Conversion.....	-30	-30 Volts
.....	2.3	2.7 Milliamperes
.....	6.9	6.5 Milliamperes
.....	3.5	3.5 Milliamperes
.....	0.15	0.15 Milliamperes

(not oscillating) of the 6K8 is approximately  $I_s = 100$ , and the Triode Grid Volts = 0.

constitute the mixer unit. Note that a single cathode sleeve serves both oscillator unit and mixer unit. The oscillator voltage on  $G_{1HX}$  modulates the transconductance of the mixer unit to produce the intermediate frequency.

These data show that the recommended value of hexode screen voltage for 100- or 250-volt operation is 100 volts. The use of 100 volts on the hexode screen accounts for the comparatively high conversion transconductance of the 6K8 in a-c/d-c receivers. With the pentagrid-converter type of tube, screen voltage should be lower than the plate voltage to obtain high plate resistance, because of secondary-emission effects. This restriction is not imposed on the 6K8, because the internal shield plates act as a suppressor to raise the plate resistance of the hexode unit at low values of hexode plate voltage.

### PLATE AND SCREEN VOLTAGES

Another point of interest is the recommended value of 100 volts for the oscillator (triode) plate. With the pentagrid-converter type of tube, oscillator-anode voltage should be greater than the screen voltage to obtain sufficient oscillator-anode current. This condition does not obtain in the 6K8, because its oscillator-plate current is substantially independent of the voltage on its hexode screen, due to the geometry of the tube structure.

The recommended value of 100 volts for the screen of the hexode unit and for the plate of the oscillator unit is practical, because this value is also applied to the screens of r-f and i-f tubes, and may be taken from the same point in the power-supply system in series-feed oscillator circuits. In shunt-feed oscillator circuits, a separate resistor or choke is, of course, required in the oscillator-plate circuit. When oscillator-plate and screen voltages are taken from one point in the power-supply system, this point should be adequately by-passed to ground.

A third point of interest is the low value of oscillator grid current ( $I_s$ ) required for high conversion transconductance ( $g_c$ ) and high hexode plate resistance ( $r_p$ ). Curves of  $g_c$ ,  $r_p$ , and total cathode current ( $I_a$ ) vs  $I_s$  through 50,000 ohms for 100- and 250-volt operation indicate that nearly maximum conversion transconductance is obtained over a wide range of oscillator

(Continued on following page)

(Continued from preceding page)  
grid current and that  $r_p$  increases with oscillator grid current.

The recommended minimum value of oscillator grid current is 100 microamperes, and the recommended design value is 150 microamperes. The recommended minimum value is selected on the basis of low  $r_p$  and high  $I_a$ . The cathode current varies inversely with the oscillator grid current.

### GRID CURRENT SELECTION

The recommended maximum value of cathode current (16 milliamperes) is reached at a value of oscillator grid current a little less than 100 microamperes. The recommended design value of 150 microamperes is comparatively easy to obtain in practice. Inductive (tickler) feedback circuits are usually designed for the proper value of oscillator grid current at the low-frequency end of a band; the oscillator grid current then increases with frequency over that band. It is possible to obtain substantially uniform oscillation amplitude over an entire band by using a shunt-feed oscillator circuit. In such a circuit, the series padding condenser provides electrostatic coupling at the low-frequency end of the band and the tickler provides inductive coupling at the high-frequency end of the band.

It should be noted that oscillator coils intended for use with the pentagrid converter type of tube may not be suitable for use with the 6K8, because of the possibility of over-exciting the oscillator unit of the tube. In order to use such coils, it may be necessary to reduce the oscillator plate voltage, the number of tickler turns, or the mutual inductance between tickler and secondary so as to reduce the oscillator grid current to a good value. The r-f input capacitance of the 6K8 is 6.6 mmfd. Because this value is approximately half that of a pentagrid converter, a higher tuning ratio can be obtained with a converter stage employing a 6K8 than with a converter stage employing a pentagrid converter.

Curves of the variation in oscillator transconductance with signal-grid bias for the 6K8 and for a pentagrid converter indicate the effect of avc voltage on oscillator performance. As previously mentioned, one practical effect of the improved performance of the 6K8 is a reduction in oscillator-frequency shift with avc voltage. This is shown by the curves of Fig. 3, the data of which were taken in a radio receiver of typical design after a suitable micrometer condenser was installed to permit accurate determination of frequency shift. It is seen that a frequency shift of approximately 50 kc can be obtained in practice with a pentagrid-converter type of tube and that the frequency shift was reduced to approximately 2 kc when the 6K8 was installed; these data were taken at 18 megacycles.

### EFFECT ON LINE VARIATION

Tests in a typical receiver of oscillator-frequency shift for line-voltage changes were conducted: A 6K8 was installed and electrode voltages adjusted for 250-volt operation at 18

megacycles. When the line voltage was varied from 100 to 125 volts, the oscillator frequency shifted approximately 6 kc. A pentagrid converter was installed in the same receiver under proper operating conditions and the line voltage was varied from 100 to 125 volts; the oscillator frequency shifted approximately 27 kc. The ratio of 6/27 represents a very worthwhile improvement.

At frequencies of the order of 18 megacycles, effects of the time of transit of electrons through the tube cannot be neglected. One important transit-time effect is observed in the nature of the input conductance of the mixer unit (r-f input conductance). At 18 megacycles, the r-f

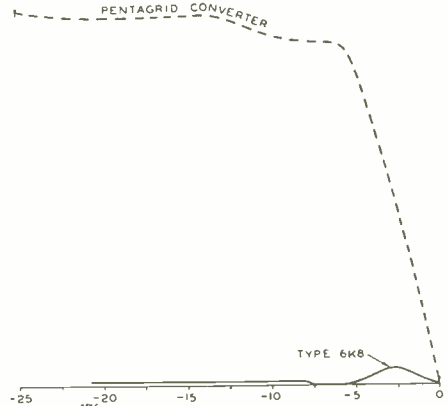

FIG. 3

avc volts are plotted along the base. The percentage frequency change resultant is represented along the perpendicular. Pentagrid results (dashes) are compared with those of the 6K8 (solid line).

input conductance of the 6K8 is negative. The effect of a negative input conductance is to improve the Q-ratio of the tuned circuit connected to the 6K8. This improvement in circuit Q was evidenced in one test by a higher image ratio. A tube type in which the input grid is adjacent to the cathode exhibits positive input conductance, and this decreases the effective Q of a circuit connected to the input grid.

The conversion transconductance of the 6K8 is 400 micromhos under the 250-volt operating conditions. The conversion gain, which is the ratio of the i-f voltage across the load to the r-f voltage input, is given by the relation:

$$\text{Conversion gain} = \frac{g_c r_p R_L}{r_p + R_L}$$

where  $R_L$  is the resonant impedance of the i-f transformer measured across the primary terminals. The conversion gain for different values of  $R_L$  show that for values of  $R_L$  less than 0.35 megohm the gain obtained from a 6K8 is only slightly less than that obtained from a pentagrid converter. More gain is obtained from the 6K8 than from a pentagrid converter at values of  $R_L$  greater than 0.35 megohm.

Copyright 1938 by RCA Radiotron Co.

# PLATE TUNING

## Favored for Oscillators

- Better Efficiency
- Better Stability
- Better Impedance

**E**CONOMIES possible with the 6J8G, improved stability and use of plate tuning were discussed by Virgil M. Grahame, of Hygrade, Sylvania, as follows:

"It is interesting to note that in view of the frequency stability of the oscillator of Type 6J8G with changes of voltage, it is possible to effect substantial savings in components by reduction of the filtering of the plate voltage of the oscillator. This filter is necessary with other converter tubes, due to their poorer frequency stability, to prevent fluttering due to sustained pulses in the B supply system.

"The use of plate tuned oscillator circuits with this type of converter has been practically universal in Europe, where these tubes have been in common use for some time.

"Along with the inherent advantages of the plate tuned oscillator circuit, the use of this type of circuit with a triode-heptode is desirable as the phase relations are such that the voltages resulting from stray capacitances between the 'high' sides of the oscillator and signal input circuits are opposite in effect to those resulting from capacitances between the oscillator grid and signal grid circuits. This minimizes the loading effect of the signal grid on its input circuit."

### LESS FILTERING REQUIRED

Other data on this tube as set forth by Hygrade-Sylvania, follow:

The 6J8G is a converter tube consisting of a triode unit and a heptode unit having a common cathode and assembled in the same envelope. The use of a triode as an oscillator with a pentagrid mixer tube is well known. Type 6J8G is essentially this combination of tubes in a single bulb, but offers some advantages because of improved operating characteristics.

The applications of the 6J8G are quite similar to those of the separate oscillator and mixer tube combination. However, this new tube construction makes possible some circuit simplifications and improved performance at high frequencies.

Type 6J8G provides true electron coupling, since the grid of the triode oscillator is directly connected to an injector grid in the mixer section. The unusually high plate resistance (4 megohms) of this tube results in very low plate loading, making it possible to use highly efficient i-f transformers to advantage. Lower fre-

quency drift than that associated with other existing types of converter tubes should make this type especially attractive.

Because of this high frequency stability it should be possible to reduce the filtering in the oscillator plate supply of the tube and not encounter "fluttering," such as is encountered with other converters.

It will be noted that under the 100 volt operating conditions the heptode plate, heptode screen grid, and the oscillator plate may all be operated at the same d-c potential. This makes possible the elimination of the dropping resistor which is usually employed in the screen circuit when the Type 6A8G or its equivalent is used in ac-dc or d-c receivers.

### PLATE-TUNING FAVORED

Although the basing arrangement of this tube is such that in some instances it may be substituted directly for Type 6A8G, necessitating only slight realigning, it is not intended to be used in this manner. For optimum performance advantage should be taken of the low input loading together with the high plate impedance, and the circuit components (antenna coil, oscillator coil, and i-f transformer) should be designed accordingly.

In its Engineering News Letter 45, concerning "Oscillator Circuits for Frequency Converters," Hygrade-Sylvania Corporation favors the use of plate-tuned oscillator circuits, especially referring to the 6J8G, since it is maintained plate tuning practically eliminates frequency instability at short waves, where it is usually most annoying, and thus, with the other advantages of this tube, considerable improvement is attained in receiver performance.

The tuned-grid type of oscillator has been used almost exclusively in this country but it provides only small output swing. The plate load impedance is relatively low, in the tuned-grid oscillator, with resultant low power efficiency and small oscillator voltage amplitude. The output voltage could be large if the current could be large, despite the low impedance, but the limits of current are imposed by tubes in general.

### NEGLIGIBLE LOADING

"A tuned-grid oscillator amounts to coupling a high impedance generator into a low-impedance (Continued on following page)

## Ghirardi's Data Book Gives Complete I.F.

The 96-page set of supplement sheets for Alfred A. Ghirardi's "Radio Field Service Data" book, which were mailed out to subscribers on March 1, contain a new and revised list of the intermediate peak frequencies of all the superheterodynes manufactured in the United States today, including 272 makes of receivers and more than 11,500 different models, even this season's new auto-radio receivers. This is considered to be the most complete and most accurate i-f list published. Even though it has been condensed as much as possible, it takes up 90 pages as compared with the 42-page list in the original book, which it supplements.

As a new feature the supplements give directions for aligning any "orphan" superheterodyne receiver for which the model number cannot be identified, or if for any reason the model number is unknown. Space has been left after the listings for each manufacturer, where servicemen can write the i-f of new sets. Both trade names and manufacturers' names are given for all sets.

The March Supplements also give a trade directory of Tube Manufacturers, giving names, addresses and types of tubes manufactured.

Further information about Ghirardi's "Supplement Sheet Service," which is issued at \$2 a year, may be obtained from the publishers, Radio & Technical Publishing Co., 45 Astor Place, New York City.

### TWO NEW C-D PRODUCTS

Cornell-Dubilier catalog flyer No. 154-A lists two new C-D products, the type BR "Beavers," tiny etched-foil dry electrolytic filter capacitors, and the type 2R silver-plated mica capacitors, exceptional units with unusually stable frequency characteristics. Address requests to Cornell-Dubilier Electric Corporation, South Plainfield, New Jersey.

## Tone Correction in New Amplifier by Universal

Universal Microphone Co., Inglewood, Calif., manufactures a professional amplifier incorporating frequency compensating networks and allowing accentuation in either high or low frequencies or both.

The equalizers employed are continuously adjustable and the settings may be changed while the amplifier is in use. The equalizers add amplification to the circuit, presenting a gain of 18 db.

The high-frequency circuit is deemed necessary for use in frequency compensation between the inside and outside diameter when recording at 33 $\frac{1}{3}$  revolutions per minute.

The low-frequency circuit is available for use in accentuating the bass frequencies in recording when the program material is particularly lacking in lows, or is not under the immediate control of the recordist. It is also valuable in reproduction and playback circuits.

Various other applications and uses of the equalizer circuits include altering reproduction for the most favorable conditions in a room or hall of poor acoustical characteristics, correcting for deficiencies in loudspeaker systems, different types of microphones, pickups, etc., or any application where there is a deficiency in either the high frequencies or low frequencies or both.

### The 1851

A new television amplifier pentode intended for use by the amateur and experimenter in experimental television receivers has been released.

This tube, the 1851, features extremely high grid-plate transconductance (9000 micromhos). It is recommended for use in the r-f and i-f stages of the picture amplifier as well as in the first stages of the video amplifier when several video stages are used. A booklet is obtainable from RCA Manufacturing Co., Harrison, N. J., on the use of this tube.

## Plate Tuning Advantages Listed

(Continued from preceding page)

dance, variable inductive load," says Hygrade-Sylvania.

By turning the coil around, so to speak, whereas instead of a load impedance of around hundreds of ohms, it may rise to 17,000 ohms, with plate circuit tuned and tickler in grid circuit, the loading and reflected reactance in the plate circuit becomes negligible.

The following is a list of advantages of plate tuning:

1. High plate load impedance.
2. Good efficiency.
3. Plate voltage in phase with plate current and 180 degrees out of phase with grid voltage. (Tuned-grid oscillators do not attain the desired 180-degree result).

4. Plate load practically a pure resistance at the resonant frequency, load line is straight and harmonic content comparatively low, because at non-resonant frequencies the load is a low reactance and harmonics are bypassed to ground.

5. Greater frequency stability, important particularly at the higher radio frequencies, due to absence of shift of grid circuit loading when a-v-c voltages are effective, since the grid circuit is then low impedance anyway.

The only difficulty attendant on plate circuit tuning is the different d-c potential on the tuning condenser, but this is avoided by the use of shunt feed, with stopping condenser, r-f choke or resistor carrying the B current. The condenser frame is then at B minus or other grounded potential.

# INTERFERENCE

## Tracked Down and Cured

By Alfred A. Ghirardi

*[The following discussion of interference is reprinted from "Modern Radio Servicing," by Alfred A. Ghirardi, E. E., by special permission of the author and his publisher, and copyright owner, Radio & Technical Publishing Company. It comprises the second instalment. The first was printed in last month's issue (March) and the final instalment will appear next month (May issue).—EDITOR.]*

**A**FTER it has been determined definitely by the foregoing tests that the interference is reaching the receiver by way of the aerial and lead-in, the ground, the power supply line, or a combination of these, the question is "what is to be done about it?" Shall no attempt be made to track the interference down to its fundamental source and apply proper interference suppression measures there so as to eliminate it, or shall the problem be attacked by attempting to apply interference prevention measures at the receiver instead? The best course to follow in any case depends entirely upon the conditions encountered. It is at this point that experience and good judgment on the part of the service man are a very important asset in pointing out the best procedure, for, if the wrong course is taken, a great deal of time and effort may be consumed without producing any worthwhile results.

Records of organizations which have done a great deal of interference elimination work show that in nearly half of the cases the trouble is caused by appliances and circuits right on the customer's own premises. Motors in household appliances, thermostats, loose lamps in sockets, faulty switch contacts, armored cable rubbing against pipes, etc.—these are common causes of noises in the set owner's own premises.

Since this is so, it is advisable to proceed first with the idea of finding the source of interference right on the premises and eliminating it there. The owner should be asked at once if there are any electrical devices in his home. Mention such common ones as an electrical refrigerator, a sewing machine, a mixing machine, an oil burner, a vacuum cleaner, etc.

### SEARCH FOR CLUE

Also ask him to tell as nearly as possible whether the noise is heard steadily or only at intervals. If it is the latter case, is it heard in the morning, afternoon, or evening; for how long, and how frequently. This may lead to a clue! The various electrical appliances on the

premises should be turned on, in turn, while the radio receiver is operated at full sensitivity with no station tuned in. Any disturbing unit will reveal itself immediately by the noise it causes. It will usually take only a few minutes to check all of the appliances on the premises in this way. If a noisy one is found, a suitable filter connected to it (as will be described later) will generally eliminate the trouble due to it. If no interfering appliance is found on the premises, or if the application of proper suppression methods to those that are found does not clear up the interference completely, another decision must be made.

If the tests previously outlined showed definitely that the interference enters by way of the power line *only*, then a suitable filter applied at the outlet to which the set is plugged will usually clear up the trouble. If it enters by way of the antenna system, the service man may either decide to give up the idea of locating the source of interference and adopt interference prevention measures at the receiver installation instead, or he may decide to continue in his hunt for the source. The choice made in any case depends on the particular conditions encountered, and should be one which will make for overall economy consistent with effective noise prevention.

It is often a very difficult matter to trace interference down to its source—for it may originate at some distance and be carried in on the power distribution system. Also, the source may be of such a nature that the cost of effectively eliminating its interference may be prohibitive, as in the case of a large industrial motor, an elevator motor, or a congested business district full of flashing electric light signs, trolley car lines, motors, etc. On the other hand, it may be impractical for the service man even to attempt to carry out the job because he may have absolutely no jurisdiction over the interfering apparatus. It will also be found at times that the owner of the offending appliance not only refuses to pay for any interference-prevention device the service man may recommend, but even refuses to permit any such device to be put on his apparatus at no cost to himself. Of course in such cases, it is futile to spend time in locating the interfering device, for after it is located nothing can be done about it unless there is a specific local ordinance covering such cases. Preventative measures must be applied at the receiver installation instead.

*(Continued on following page)*

(Continued from preceding page)

However, since there are many cases where it is desirable or absolutely necessary to track down the cause of the interference, the service man should know exactly how to do it. For this reason, we will proceed to discuss first, the method of identifying (if possible) the type of device causing the noise; then practical methods of tracking down the source; next, effective methods of filtering the interference at the source; and, finally, the latest methods employed to reduce noise at the receiver when this is the desirable course to follow.

## IDENTIFYING INTERFERENCE

In searching for an unknown source of interference, it is very helpful if one first has an idea of the type of device he is looking for. It will be realized that a search for perhaps a single motor may lead one into numerous nooks and corners, and if the service man has no idea as to the nature of the device causing the interference, a great deal of valuable time may be spent tracking down the guilty device before it is located and the actual filtering is done. For this reason, it is wise to note carefully the nature of the noise and classify it according to its characteristic sound. The following table has been prepared as a guide to give the service man an idea as to the type of device which may be causing interference according to the characteristic sound which it produces in the radio receiver.

### (1) Crackling, Scraping, Short Buzzes, Sputtering

May be caused by: door bells and buzzers, door openers, loose bulbs in electric light sockets, loose or corroded connections in electric light sockets, floor lamps, electrical appliances and cords, broken heating elements, wet power insulators, leaky power transformer insulators, power line grounded on tree branches, elevator control contacts, high tension lines, leaky cables.

### (2) Clicks

May be caused by: telephone dialing systems, switches of any kind, as in sign flashers, elevator controls, heaters with thermostats, heating pads, electric irons with thermostats, telegraph relays, etc.

### (3) Steady Hum

May be caused by: poor ground on set, antenna or ground wires running close to and parallel to power line. (This should not be confused with "tunable" or "modulation hum" which is present only when the carrier wave of a station is tuned in (See Art. 23-18 in Chapter XXIII), nor does it include those cases of steady hum where the hum is due to some trouble existing in the receiver itself (see Arts 23-19 and 23-20).

### (4) Buzzing or Rushing

May be caused by: automobile ignition, moving picture machine, arc lights, street car switches, oil burner ignition, battery chargers, diathermy machines, high frequency apparatus, X-ray or violet-ray machines.

### (5) Rattles, Machine-Gun Fire

May be caused by: telephone dial systems, automobile ignition systems, buzzers, vibrating rectifiers, sewing machine motors, dental laboratory motors, annunciators, doorbells.

### (6) Whistles, Squeals

May be caused by: defect in the receiver, heterodyning broadcast station signals, picking up radiations of an oscillating radio receiver nearby.

### (7) Buzzing, Humming, Whining, Droning, Whirring

May be caused by: electric motor noise. May be on vacuum cleaner, electric fan, electric dryer, massage machine, hair dryer, motor generator set, small blower, farm lighting plant, electric refrigerator, oil burner, dental apparatus, cash register, dishwasher, sewing machine, etc.

It must not be thought that this list is complete. It is merely intended to serve as a guide to the *type* of electrical equipment that can generate a characteristic sound in the receiver. Nor must the characteristic sound be interpreted as absolutely conclusive evidence that a certain type of device is causing the trouble. For instance, the interference caused by an electric motor may be either a staccato machine-gun sound, indicated by (5), or a buzzing sound more in the nature of a whine or drone, as indicated by (7). However, it will be found in most cases that the characteristic sound is caused by any one of the devices listed in the group. The probability that some particular device listed in the group may be in the vicinity of the receiver may be used as a clue to narrow down the choice in any case.

## INDIVIDUAL WAVE FORMS

The reason why most disturbing electrical devices can be recognized by the sounds they cause in the radio receiver output is that almost every one of these electrical devices produces in its supply line, disturbances having a particular wave-form. When these are received by the receiver, and are amplified and detected, they produce particular sounds. In order to make this clear, a number of oscillograms of the characteristic disturbances produced by several common electrical devices were taken. They are reproduced in Fig. 7 and labeled. An oscillograph was connected to the output circuit of a receiver whose antenna circuit was subjected to the interference in each case. These oscillograms show some very interesting things about such interference. Note the general similarity of interference produced by sparking devices (A), (D), (E), (F), (G). Also notice the great reduction brought about in the interference (G) which was produced by a badly sparking universal motor when the brushes were fitted properly and the commutator was cleaned (H). The use of cathode-ray oscilloscopes in noise-reduction work by service men in order to reveal the *character* of the interference, is very helpful.

As a further aid toward identifying the source of interference, the following table (which is



reproduced here by courtesy of Tobe Deutschmann, Inc.) may be of value. As shown, it lists the various devices according to the types of establishments in which they are commonly employed and found. When interference is encountered, the service man should endeavor to find out if any of these establishments are in the immediate vicinity. If one is found, investigation should be made to find out if one of the devices listed here under the heading of that type of establishment as being a potential cause of interference is being used. If so, tests should be made to find out if it is the cause of the interference complained of, and the proper filter should be applied to it if it is.

**HELPFUL LIST**

This list, in conjunction with the one previously presented, will be of material assistance in tracking down sources of interference.

**Code:**

- A indicates a-c operated equipment.
- D indicates d-c operated equipment.
- AD indicates a-c or d-c operated equipment.
- ★ indicates a-c operated equipment which may or may not create interference.

**A. General Building Equipment**

- 1.—A★D—Fans of all description
- 2.—A★D—Blowers (ventilating systems)
- 3.—D —Elevator motors
- 4.—A★D—Motors on heating plants
- 5.—A★D—Pump motors
- 6.—A★D—Air compressors
- 7.—A★D—Vacuum clean installations
- 8.—A★D—Refrigerator motors

**B. Business Office Equipment**

- 1.—AD —Dictating machines
- 2.—A★D—Calculating machines
- 3.—A★D—Mailing machines
- 4.—A★D—Multigraphing machines
- 5.—AD —Stock tickers
- 6.—D —Telegraph equipment

**C. Doctors' Offices**

- 1.—A —X-ray
- 2.—A —Diathermy apparatus
- 3.—A★D—Static machines
- 4.—AD —Massage equipment
- 5.—AD —Violet ray

**D. Dentists' Offices**

- 1.—A —X-ray
- 2.—AD —Dental motors
- 3.—AD —Laboratory motors
- 4.—AD —Chair elevating motors

**E. Beauty Parlors and Barber Shops**

- 1.—AD —Hair dryers
- 2.—AD —Motor driven clippers
- 3.—AD —Massage equipment
- 4.—AD —Violet ray
- 5.—AD —Motor driven cash register
- 6.—D —Neon sign converter

**F. Soda Fountains**

- 1.—A★D—Refrigerating equipment
- 2.—AD —Drink mixers

- 3.—AD —Fruit juice extractors
- 4.—AD —Cash registers
- 5.—AD —Electrically operated advertising display

**G. Department Stores**

- 1.—AD —Cash registers
- 2.—A★D—Carrier systems
- 3.—AD —Telautograph systems
- 4.—AD —Call systems

*(Continued on following page)*

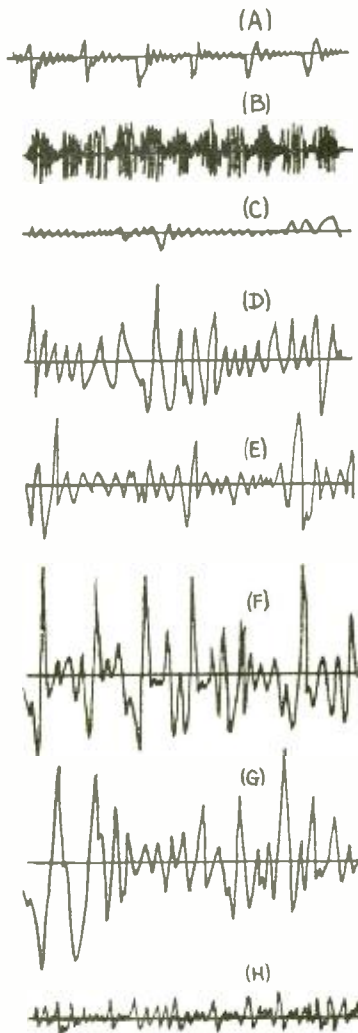

**FIG. 7**

Oscillograms of typical disturbances produced by the following electrical apparatus: (A) A short steady arc between carbon electrodes. (B) Leakage of 5,500-volt lighting circuit through a high-resistance ground. (C) small single-phase a-c motor running. (D) A loaded d-c—a-c motor generator set. (E) A mechanical interrupter. (F) Violet-ray apparatus. (G) Small universal motor with badly sparking brushes. (H) The same motor after the commutator was cleaned and the brushes were cleaned and fitted properly.

(Continued from preceding page)

- 5.—AD —Animated displays
  - 6.—AD —Display studio equipment
  - 7.—AD —Flashing signs
  - 8.—D —Neon sign converters
- II. Restaurants, Bakeries and Confectioners' Stores**
- 1.—A★D★—Rotary ovens
  - 2.—A★D—Doughnut machines
  - 3.—A★D—Electric hoists
  - 4.—A★D—Dish washers
  - 5.—A★D—Mixing machines
  - 6.—A★D—Refrigerators
  - 7.—A★D—Slicing machines
  - 8.—A★D—Food choppers
  - 9.—A★D—Ice cubing machines
  - 10.—A★D—Candy pullers
  - 11.—A★D—Corn poppers
  - 12.—AD —Cash registers
  - 13.—A★D—Coffee grinders
  - 14.—AD —Flashing signs
  - 15.—D —Neon sign converters
- I. Grocery and Butchers' Shops**
- 1.—AD —Cash registers
  - 2.—A★D—Slicing machines
  - 3.—A★D—Coffee grinders
  - 4.—A★D—Refrigerators
- J. Cleaning Establishments**
- 1.—A★D—Vacuum cleaners
  - 2.—A★D—Hat cleaners
  - 3.—AD —Cash registers
  - 4.—A★D—Shoe buffers
  - 5.—A★D—Rotary dryers
  - 6.—AD —Sewing machines
  - 7.—AD —Flashing signs
  - 8.—D —Neon sign converters
- K Shoe Repair Shops**
- 1.—AD —Sewing machines
  - 2.—A★D—Buffers
  - 3.—A★D—Grinders
- L. Printing Shops and Newspaper Offices**
- 1.—AD —Press motors
  - 2.—A★D—Cutters
  - 3.—A★D—Linotype and monotype machines
  - 4.—A —Electric neutralizers
  - 5.—AD —Flashing signs
  - 6.—D —Telegraph equipment
- M. Jewelers' and Opticians' Stores**
- 1.—AD —Cash registers
  - 2.—AD —Lathe motors
  - 3.—AD —Grinders and buffers
  - 4.—A★D—Compressors
  - 5.—AD —Drills
  - 6.—AD —Flashing signs
  - 7.—D —Neon sign converters
- N. Garages, Battery Shops and Filling Stations**
- 1.—AD —Portable motors
  - 2.—A★D—Air compressors
  - 3.—A★D—Shop motors
  - 4.—AD —Charging equipment
  - 5.—A★ —Gasoline pumps
  - 6.—A★D—Spray equipment
  - 7.—A★D—Pressure lubrication systems
- 8.—AD —Flashing signs
  - 9.—D —Neon sign converters
- O. Dressmaking, Tailoring, and Garment Shops**
- 1.—A★D—Sewing machines
  - 2.—AD —Vacuum cleaners
  - 3.—A★D—Electric cutters
- P. Laundries**
- 1.—A★D—Washing machines
  - 2.—A★D—Mangles
  - 3.—A★D—Dryers
  - 4.—AD —Sewing machines
- Q. Machine Shops**
- 1.—A★D—Motors, driving
  - 2.—AD Portable tools
  - 3.—A★D—Air compressor, electric driven
- R. Theatres**
- 1.—A★D—Ventilating systems
  - 2.—A★D—Cooling systems
  - 3.—AD —Hand dryers
  - 4.—A★D—Projectors
  - 5.—A★D—Motor generator sets
  - 6.—A★ —Synchronizing motors
  - 7.—AD —Flashing signs
  - 8.—D —Neon sign converters
- S. Hotels, Hospitals, and Institutions**
- 1.— Restaurant
  - 2.— Laundry
  - 3.— Valet
  - 4.— Soda fountain
  - 5.— Barber shop
  - 6.— Shoe cleaning equipment
  - 7.— Hand dryers
  - 8.— Vacuum cleaner installations
  - 9.— Ventilating and heating systems
  - 10.— Telegraph equipment
  - 11.— Call systems
  - 12.— Telautograph
  - 13.— Clocks
  - 14.— Medical and dental equipment
- T. Telegraph and Telephone Offices**
- 1.—D —Keys
  - 2.—AD —Battery chargers
  - 3.—D —Relays
  - 4.—AD —Clocks
  - 5.—AD —Motor generators
  - 6.—AD —Ringing equipment
  - 7.—D —Switchboard
- U. Street Railway Systems**
- 1.— Arcing at trolley wheels
  - 2.— Air compressors
  - 3.— Driving motors
  - 4.— Buzzers
  - 5.— Semaphore signals
  - 6.— Trolley crossovers
  - 7.— Trolley disconnect relays. (To signal when trolley pole is off)
- V. Street Railway Station Equipment**
- 1.— Motor-generator sets
  - 2.— Water-pump motors (run from trolley current)
  - 3.— Air compressor motors (run from trolley current)

## W. Power and Light Companies

*Transmission circuits*

- 1.— Scale on insulators
- 2.— Loose bonds
- 3.— Static discharge from unbonded hardware to adjacent hardware
- 4.— Loose tie wires
- 5.— Cracked insulators
- 6.— Pole top switches

## X. Police and Fire Alarm Systems

- 1.—AD —Battery charging equipment
- 2.—D —Relays
- 3.—D —Telegraph equipment
- 4.— Tree grounds

## Y. Traffic Signals

- 1.—AD —Blinkers
- 2.—AD —Control mechanisms

In general, it may be stated that all universal (ac/dc) motors and all d-c motors produce interference. Alternating current motors of the repulsion-starting-induction-running type often produce interference (especially when starting), while large a-c motors of the three-phase type seldom, if ever, cause interference.

## CLASSIFICATION BY PICKUP

Before proceeding with a study of the methods of tracking down interference to its source, it will be well to differentiate between the various ways in which interference may reach the receiving equipment. The following classification may prove helpful:

- (1) *Conducted* interference is that part (if any) which enters the receiver proper *via* the power supply line by simple conduction.
- (2) *Direct radiated* interference is that radiated part which is picked up *direct* from the source of disturbance by the antenna system.
- (3) *Re-radiated* interference is that part which is conducted from the source by the power supply line (or some other conductor) and is then re-radiated from the live wiring and picked up by the antenna system.

It is fortunate that the majority of interference that is heard as noise arrives through the antenna system. The first conclusion to be drawn, then, is that the interference is radiated into space for a short distance directly from the source, and for much longer distances from the power line to which it is connected. Not all of the interference is *radiated*, however, some is *conducted* along the power line and into the power circuit of the receiver as previously described. But in the majority of cases of ordinary interference, most of the interference is radiated from the power circuit wiring, like a radio signal, and is picked up by the aerial and lead-in and sometimes by the chassis. Chassis pickup is somewhat rare in well-shielded receivers, so that whatever does come

in through the chassis is caused by the same sources as those picked up by the aerial and lead-in.

Once the type of interference has been classified according to its characteristic sound, and the nature of the interfering device or the establishment it is used in has been ascertained in a general way if possible, the difficult problem of locating the actual guilty device or devices must begin if it has been decided to track the interference down to its source and apply the proper remedies to suppress it there.

## Laborious Necessity

While this procedure is usually a laborious one, there are many cases where it is absolutely necessary. For instance, although much of the noise produced by man-made interference may be greatly reduced by the use of special noise-reducing antenna systems (since the greater part of it is radiated by the line to the antenna system), the installation conditions may be such that it may be impractical to erect the aerial portion of the noise-reducing antenna system high enough to be beyond the zone of the disturbing radiations. Under conditions of this kind, the use of such systems is only partially effective, and the disturbance must be eliminated directly at its source if quiet reception is to be obtained. Placing a filter in the power line at the receiver will not eliminate the trouble, for since the interfering device is located some distance from the receiver, a considerable amount of energy may still be radiated by the line between the noise source and the filter. Of course, this noise will be picked up by the aerial and heard regardless of the filter. In those cases where the interference is reaching the receiver solely by way of the power line, it may also be advisable to track down the source if it does not take too much time—otherwise, a line filter may be installed at the receiver line plug.

At this stage of the proceedings, it is known whether or not the aerial, the ground, the receiver chassis or the power line is feeding most of the noise. This knowledge is useful in locating the source. It is much easier to describe how the sources of interference should be tracked down than it is to do the actual tracking, for many conditions which alter the procedure are usually met with in the field. Methods which are found to be effective in rural communities are worthless in congested city districts; others which are effective in private dwellings are not practical in apartment houses and hotels. So much impractical information has been published concerning this part of interference elimination work, that the inexperienced service man had better start reading the following pages by first forgetting most of what he has read about the subject in magazine articles, house organs, etc., lest he be clapped into a lunatic asylum for wandering in and out of buildings where he has no business to be, and around town in circles with an interference locator strapped on his back, a loop antenna sticking out in front of his nose and a far-

(Continued on following page)

(Continued from preceding page)  
away look in his eye hunting for the all-elusive source of interference.

He should realize that the tracking down of interference sources is no simple job (on the average) even for men experienced in this work. He should also realize that there is hardly another branch of service work where

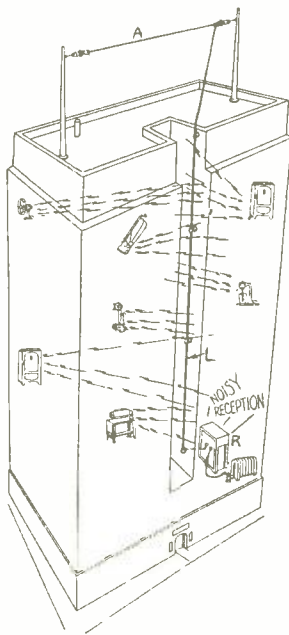

FIG. 8

How various electrical appliances in an apartment house or hotel will cause disturbances not only through the power supply line, but also by direct radiation and re-radiation to the lead-in (and possibly the aerial) due to their close proximity to it.

practical experience, attention to small details, keen observation, perseverance, tact in questioning people, and systematic methods are more necessary for success.

### HOW TO "TRACK"

This is probably the main reason why the trend (at least in large cities) has been toward the erection of specially designed noise-reducing antenna systems and the elaborate use of line filters to eliminate interference, rather than attempt to track down the interference to its source. However, the service man should know how to "track" interference if it is ever necessary for him to do so. Since the procedure depends to a great extent upon whether the receiver is installed in a hotel or apartment house, a private dwelling in a city, or a private dwelling in a rural community, we will divide our study in accordance with these conditions.

#### (1) "Tracking" interference in hotels and apartment houses:

When called upon to track *man-made* interference in a receiver installation in a hotel or apartment house, the service man should first realize that there may be fifty or a hundred different small motors or other electrical devices generating interference in the many rooms or apartments in the building. There will usually be elevator motors and contactors (usually in the elevator pent house on the roof) which will add their share to the general melee of interference. Some idea of what an X-ray eye might see in a modern apartment house is illustrated in Fig. 8. Electric fans, refrigerators, vacuum cleaners, mixers, telephones, clothes washers, violet-ray apparatus, heating pads, etc., go to make up only a small part of the list that might be found. Evidently, even if every single interfering device were located (admittedly a laborious task), it would be a very costly job to clean commutators, fit brushes, apply line filters, repair worn and frayed cords, etc., in order to eliminate all the interference (and don't forget that many of the residents would object very forcibly to any suggestion by a service man that he be allowed to do such and such a thing to the "mixing machine" because it is causing interference in Mr. Blank's radio set across the hall). Such "wholesale" tracking down and interference prevention measures in a building of this type are usually out of the question. Usually, the most practical thing to do in such cases is to install a line filter at the outlet to which the set is plugged (or at the fuse box in the apartment), and erect an effective noise-reducing antenna system with the aerial portion in a zone as free from interference as possible.

If only a particular device in the building is causing serious trouble, that is another matter. The service man may find this out by carefully questioning the set owner as to whether the interference appears at all times, or only at certain times of the afternoon or evening; whether it always starts at *exactly* the same time (or on some exact part of the hour)—also, whether it lasts a short time or a long time, etc. He may be able to furnish considerable valuable information in this connection. If the particularly annoying noise occurs only at certain times, the service man should arrange to be present at the time the noise is starting. He should note the character of the sound and attempt to form some opinion regarding the nature of the device which is producing it. Experience is valuable in this connection. If this noise lasts long enough he should attempt to find out how it is reaching the receiving equipment.

### HUNTING CULPRIT

From this point on, the problem resolves itself into hunting for the guilty device. If the service man has formed some opinion regarding the nature of the device he has something to start on. In some cases, questioning the building superintendent regarding the possible loca-

tion of such devices in the building may lead to a clue. In others, an interference-locating receiver with a loop may be helpful, but this is not usually the case in a building of this kind where so many false indications may be received. When a suspected device is found, it should be turned on and off by one person, while another listens at the radio set (some communication arrangement between the two persons is desirable here) to find out if it is causing the interference complained of. If it is, proper interference suppression measures should be applied to it (as will be explained later). If not, the search must continue—mainly by inquiry among the various occupants of the building (when this is practical) about the ownership of motors, electrical household appliances, etc. (name them for the person, as most people forget about at least one-third of the electrical appliances they have). Courtesy and tact are essential in this phase of the work. In a large building, this may be a considerable task.

In many cases, it will be found that some source outside the building is causing the disturbance. Of course, if electric surface car lines, elevated railroads, flashing electric signs, etc., are operating in the vicinity, these should be suspected at once, and in order to check the suspicion, careful observations should be made at the noisy receiver while the vehicle or device in question starts and stops. In connection with trolley lines, etc., remember that the powerful disturbance caused by a car which is out of sight may be conducted along the third rail or overhead trolley wire for a long distance and be re-radiated to the antenna lead-in wire or even the power supply lines in the building and cause interference in the radio receiver.

Of course the service man can do nothing directly regarding such sources of interference. A well-erected noise-reducing antenna system with the aerial wire located in a zone as free from the disturbance as possible (not necessarily the highest point possible) will usually be the best remedy for this trouble. Often, a line filter must also be used. The directional effects of the particular type of aerial employed should also be taken advantage of in the installation. It should be erected so that its best receiving direction (whatever that may be) is *not* the direction toward the trolley line or other seat of disturbance.

### KEEP AWAY FROM TROUBLE

The directional properties of various types of aeri-als will be discussed later. Even if a noise-reducing type lead-in is used, it should be run down from the aerial to the set in a location *as far* from the disturbance *as is practical*. For instance, the lead-in *L* shown in the installation of Fig. 8 is in a poor place since it is subject to interference radiations in 3 directions in the building and from external street disturbances from the fourth direction. It would be much better to carry it down at the rear far corner of the building and then around the far side wall to the

receiver—provided no other strong source of interference would be encountered on that side of the building!

As an example of how a source of interference external to a building in a congested section of a large city may be tracked down step by step by simple, level-headed reasoning, even though the problem seems quite hopeless at the start, the following actual case may be of interest:

One of the branch stores of a large radio retail organization located in a congested section of a large city which is noted for its severe electrical interference reported that demonstration of any radio receiver, after four o'clock in the afternoon, was impossible because of loud clicking noises. A service-man experienced in interference work was put on the job. After first going over the entire installation, he noticed that the clicks followed one another closely and resembled the type of interference created by an electric sign "flasher". Since the aerial portion of the antenna system was erected far above the street level and the lead in wires were completely shielded through metal conduit to the receivers in the demonstration booth, it was hardly possible that the interference was picked up through the aerial-ground system. A test proved this conclusively! The only remaining assumption was that the interference reached the receivers only through the power supply lines. However, the insertion of a filter into the line at the meter where it entered the building failed to accomplish any results.

An investigation was then made to determine the location of all flashing signs which were placed into operation at the observed time. As the store was located in a congested business section of the city and a great number of nearby flashing signs were switched on at or about four p. m., it was difficult to determine just which sign was the cause of the disturbance. However, the fact that the steady clicking interference started at *exactly* four p. m. every day, indicated that some timing device was being employed to operate the flasher. Further inquiry finally revealed a large 3-section flashing neon sign which was operated by a four-gang-four-circuit sign flasher unit to obtain certain running-border and other motion effects.

### USE CO-OPERATION

Through the cooperation of the manager of the store operating the neon sign, a man was stationed at the switch of the sign so that the effect produced by switching the sign on and off could be noticed by another stationed at the radio receivers. Telephone communication was established between the two. Starting the sign flasher produced the clicking interference complained of, which ceased as soon as the device was turned off. Now that the source of the interference was located, the elimination was simple. Each circuit of the four-gang-four-circuit breaker mechanism was filtered separately by the insertion of a suitable filter

(Continued on following page)

(Continued from preceding page)  
and by-pass condenser. This interesting case is related here for the purpose of demonstrating the value of employing a systematic method for locating a source of interference, and for observing all details regarding the interference itself.

(2) "Tracking" interference in private dwellings in cities:

When *man-made* interference exists in radio installations in private dwellings in cities, the service man is able to concentrate more on the building itself, since he is usually given a free hand in the job. The usual questions should be asked of the set owner in an attempt to secure as much information as possible from him regarding the noise. In addition to ques-

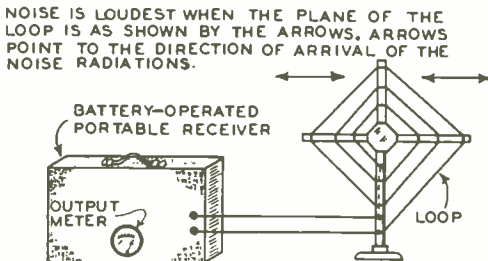

FIG. 9

An "interference locating" portable receiver with its extremely directional loop antenna. In some cases it may be advisable to mount the loop on top of a small pole which may be carried around.

tions regarding the location of all electrical appliances in the building, inquire about the possible proximity of power houses, sub-stations, trolley lines, elevated railroads, elevators in adjoining buildings, doctors' or dentists' offices in the immediate neighborhood, flashing electric light signs, etc. Any clue he gives should be checked at once.

The usual preliminary tests should be made in order to get some idea of the character of the noise, the "probable" type of device which is causing it and how it is reaching the receiver equipment. All electrical devices in the building should be checked to find out if they are causing interference. Proper filters should be applied to any that do. If the trouble still persists (perhaps it is weaker now), find out from the owner where the meter and fuse box for the electric light circuits in the building are located. With the set turned on so the noise comes in as loudly as possible and either the owner (or an assistant) listening, go down to the fuse box and unscrew one fuse at a time until you find out which one makes the set stop playing. Screw it back. That one is not to be touched again. Now unscrew *both* fuses in each branch circuit (actually remove them from the fuse block, in one branch circuit at a time) and after each pair is removed, get a report regarding the noise in the receiver. Unscrewing the fuses cuts out the branch circuit so that any loose lamp socket terminals, loose lamp plugs or cords,

noisy switches, etc., that may be in the line are prevented from affecting the receiver. If the noise stops when some branch circuit is "killed" check the connections, etc., at every outlet, switch, and plugged-in device in that circuit for a possible internal loose connection, intermittently "grounding" contact, etc. Of course, the main power supply switch should *not be opened* (as so many interference-suppression articles advise) for if this is done, the electrically-operated receiver will not operate and of course the noise will not be heard. If the branch circuit to which the receiver is connected is to be tested, the receiver may be plugged into a nearby outlet on one of the other branch circuits and its aerial and ground leads extended to it while the test is being made.

### RERADIATION SUSPECTED

If disconnection of the branch circuits makes a difference in the noise, but no loose connection, etc., can be found in them, it is possible that the circuits are re-radiating line-conducted interference to the antenna system. In this case, by-passing should be tried across the line at the "meter" side of the fuse block. If the power supply line is not the cause of the noise, the hunt should be directed to the immediate vicinity outside the building. (It is assumed of course that all power, telephone and other circuits are installed in underground ducts under the streets). It is well to investigate the possibility of electrical devices such as oil burners, x-ray, ultra-violet ray, or diathermy apparatus installed in adjacent buildings. The offices of physicians, dentists, etc., should also be checked.

(3) "Tracking" interference in rural dwellings:

The interference "tracking" procedure for rural dwellings is the same as that just outlined for city dwellings. However, if the tests show that the disturbance is being carried in on the power supply line (which is assumed to be of the elevated type supported on poles), or if it is definitely shown to originate at some other source external to the building, a portable interference-hunting receiver (shown in Fig. 9) will prove useful in tracking it down. It is in rural communities that such receivers find their most important use, but even here they have limitations which are not generally recognized but which are important.

Portable, sensitive, noise "hunting" receivers with directional "loop antennas" have been developed especially for tracking down the exact source of such disturbances. By simply carrying them in the direction in which the interference comes in louder and louder, the source is usually located. These "interference locators" usually comprise a two or three stage tuned r-f amplifier, detector, and one or two stages of audio frequency—the entire receiver being constructed in compact, battery-operated portable form. Instead of using a loud speaker, a pair of headphones and output meter are connected to the receiver so that the intensity or strength, and the nature of the interference

may be accurately gauged by both a visual and aural indication. A receiver and loop antenna of this kind are illustrated in Fig. 9. In some cases, a 50-100 turn coil wound on a 6-inch form is mounted on a rod which is carried in the hand to serve as the aerial. The advantage of this method lies in the fact that the aerial may be pointed in any direction more conveniently, than is possible with the "loop aerial." Of course, it is essential that the "noise locator," as well as the lead connecting the "coil antenna" to the receiver, be completely shielded. A receiver utilized in locating causes of interference is necessarily battery-operated for portability. Incidentally, the old Radiola 26 portable loop-operated receiver makes an excellent interference locator when an output meter is built into it.

If the incoming power supply line is suspected of carrying the disturbance, and either conducting it into the receiver directly, re-radiating it to the receiver antenna, (or both), set up the portable interference locating receiver a short distance back of the building—away from the power line.

### TUNING IN NOISE

Now tune the noise in on this portable receiver (cruise around and come closer to the power line if it cannot be heard) and observe the output meter indication. Slowly turn the loop antenna until the noise is loudest. Walk in that direction *parallel to the plane of the loop* (see Fig. 9) which leads toward the power line. If the noise intensity *increases* as you walk toward the incoming power line with the loop pointing toward it, and *decreases* when you walk back away from it, it is safe to conclude that it is responsible for the noise. Now follow the branch line from the building to the street and, follow the street line for a short distance in the direction in which the noise gets more intense (if it does).

This is about as much as any radio service man needs to do. He should not attempt to tamper with any circuits, poles, transformers, etc., belonging to the electric light company. Instead, he should communicate at once with the maintenance office and explain the situation to the person in charge, respectfully requesting that the line be checked over and any defective apparatus on it be remedied in order to stop the interference. *He should not tell the person how to do the job.* Most public utility companies are anxious to maintain their equipment in such condition that radio interference is reduced to a minimum. They therefore maintain trained test crews who are properly equipped and experienced in tracing down such troubles to their sources. Very often the trouble will be found to originate a long distance from the place where the radio service man observed it, and will be due to a cause which the radio service man would never have located or even guessed about in a hundred years!

From these discussions, it is apparent that tracking the interference to its source may

consume considerable time—in most cases an amount of time which is considerably more than it takes to actually suppress the noise at the source after it is found. For this reason, it is necessary for those service men who make interference elimination a specialty, to equip themselves with good test instruments and a thorough knowledge of the types of electrical installations, interference, etc., which are apt to be encountered in the community in which they work. Their experience and knowledge of local interference conditions also aids them to decide quickly, without waste of time, just what the best course to pursue in any case is.

### USE OF FILTERS

There is little question about the desirability of getting at the source of interference in order to eliminate it, *provided it is practical, possible and economical to do so.* If this is the case, after the interference has been traced to some particular device, and it has been definitely established that that device is causing the noise, the next step is to *eliminate the noise.*

From the theory of noise interference already presented, it is evident that interference is due fundamentally to variations or interruptions which the device causes in the line current, and to sparking which may occur. This is especially so if the construction of the device is such that sparking occurs, a very rapid oscillation of current lasting for the duration of each spark (see Fig. 7) results. This causes similar oscillations through the power lines which feed the device, with the result that electromagnetic fields (similar to the electromagnetic field around a radio transmitting antenna) are created around the lines. Thus, the *entire* line feeding the device becomes a veritable broadcasting antenna, radiating interference impulses to any radio receiving equipment which happens to be within its range.

It is evident that if the interference is to be minimized, the interruptions or variations in the current must be *minimized*, i.e., they must be *smoothed out.* This is accomplished by the use of appropriate *filters* connected between the interfering device and the line which supplies power to it, *as close to the device as possible.*

The simplest type of filter is a single condenser, connected between one side of the line and the frame of the device, as shown at (A) of Fig. 10. If the device were a motor, for instance, the condenser C would be connected to it as shown in Fig. 11. The condenser used should be of sufficient capacity to smooth out the current variations—the size required depends upon the size and type of device it is used on. About 0.1 to 1-mfd. is the average size for household appliances, (1-mfd. being most common).

The single-condenser filter is effective only on devices which draw small currents and whose interference is not of a very disturbing

(Continued on following page)

(Continued from preceding page)  
 nature. It is usually necessary to use a pair of condensers across the device, as shown at (B) of Fig. 10. This arrangement is shown in Fig. 12 for a series (universal) motor. The junction of the two condensers is connected to the frame of the device and in some cases,

about 2 millihenries are commonly used in the filters for those small and medium sized electrical devices which require them.

In most instances a single radio-frequency choke connected on one side of the line as shown at (C) is sufficient; one may be made as follows:

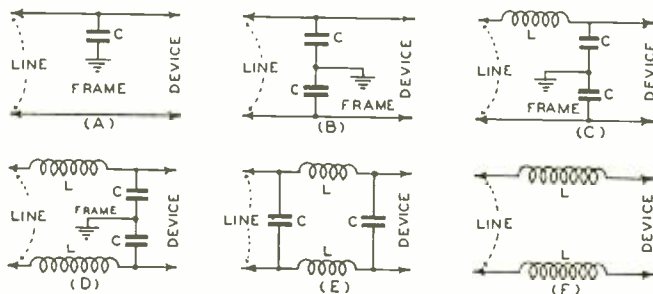

FIG. 10

Six filter arrangements which may be used for minimizing the feeding of interference from an interference-producing device into the power supply line. Arrangements (A), (B), (C) and (D) are the most common ones. The condensers may be of 0.1 to 1.0 mfd. or larger. Any of these filters may also be applied to the power supply line of a radio receiver to prevent interference from entering the receiver via the power supply line. The chokes L in [C] and [D] should be connected between the by-pass condensers and the radio receiver. When this is done, the end of the filter marked DEVICE in the above sketches becomes the "line" end, and that marked LINE becomes the "radio receiver" end.

also to a good "ground." As a safety measure, a fuse (not shown) may be connected in the line lead of each condenser. This type of filter is quite effective in most cases, and is convenient to apply if the condensers can be mounted within the housing of the interfering device or fastened to it on the outside.

### ADDING CHOKES

In instances where the interference is very severe and is not minimized sufficiently by the use of condensers alone, choke coils must also be inserted in series with the line, on the "line" side of the condensers, as shown at (C) and (D) of Fig. 10 (and also in Fig. 13) in order to aid the action of the condensers. These choke coils may be of the radio- or audio-frequency type, depending upon the type of noise, and must be wound with wire of sufficiently large size to safely carry the full load current of the device continuously without overheating. Choke coils having an inductance of

Wind 75 turns of enameled or cotton-covered wire (of proper size, depending upon the current it must carry) on a form 2 inches in diameter, wrap a piece of Empire cloth around it and continue the winding in the same direction. Wind another 75 turns over the first, making a total of 150 turns. The coil should be taped to hold the wire in place, and sealed in a metal can about 4 inches in diameter. A lead should be brought out from each end of the coil before it is sealed.

If no appreciable decrease in noise is noted after the coil is connected in the line, an iron core from any old power transformer (or ordinary stove-pipe iron) should be inserted in the form and made to form a closed ring, leaving a small air gap of about  $\frac{1}{8}$  inch. This makes it an a-f choke. It may be necessary to use two such chokes—one in each leg of the line, as shown at (D) and (E).

The length of the coil form and the size of the wire to be used are dependent upon the

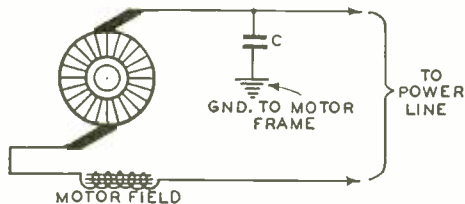

FIG. 11

Schematic diagram of a series wound (Universal) motor commonly used in household appliances. An interference-suppressing filter condenser is shown connected to it.

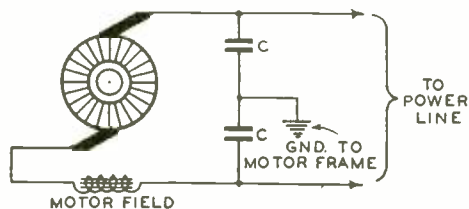

FIG. 12

Schematic diagram of a series wound (Universal) motor showing the use of two filter condensers (one for each brush). The common terminal is grounded to the motor frame.



current which the choke must carry, i.e. the current which the interfering device draws for its operation. The table below lists the safe current-carrying capacity of the various sizes of ordinary magnet wire (having silk, cotton, or enamel insulation) that may be used for those devices ordinarily encountered. The resistance of the chokes should be kept as low as is practical, so too much power will not be wasted in them.

*Wire Gauge (B & S)*

18	16	14	12	10	8	6	4
----	----	----	----	----	---	---	---

*Safe Current-Carrying Capacity (Amps.)*

1.1	1.7	2.7	4.4	6.9	11.0	17.5	27.7
-----	-----	-----	-----	-----	------	------	------

The condensers employed in interference-suppression filters should be preferably of the *non-inductive* type and have a voltage rating *double* the working voltage of the line to which they are attached. This will take care of the "peak" voltage of the line. Several typical compact condensers suitable for use in the filter circuits of Fig. 10, are illustrated in Fig. 14. The type at the right, having the pig-tail leads, is very convenient for this work.

The problem of interference elimination has been studied so thoroughly that various commercial filter units have been developed for effectively eliminating the interference from practically every type of interfering electrical device. These are made with combinations of condensers (or condensers with chokes having the proper size wire) of the proper size for the purpose. All the service man needs to do is to order the correct filter unit for the particular job at hand. These units are applicable to both a-c and d-c circuits and are particularly advantageous when inductive-capacitive filter units are required, for it is often rather difficult for the service man to build these chokes—especially if they are to carry heavy currents. In some cases, the construction is so specialized that a certain type of filter unit is specified for eliminating interference only from a certain type of device.

**BEST FILTER LOCATION**

Interference prevention filters are frequently found to be ineffective. One of the main reasons for this is that the filter is not connected close enough to the source of the disturbances in the interfering device. This point is not generally accorded the importance which it deserves. It is essential that the filter be placed as close to the unit to be filtered as possible. This means that the filter should actually be mounted inside the frame of the device if it can fit there, or, if not, it should be not more than a few inches away at the most.

The reason for this close proximity is ap-

parent when the circuit of Fig. 14 is considered. If the filter unit be placed at some distance from the interfering device, for example, then the *leads from the filter to the device* will be of appreciable length and will radiate interference because the noise current flows in the portion of the line between the device and the filter as shown. This interference may be picked up by the part of the line *beyond* the filter and be conducted to the receiver or re-radiated to the receiver antenna by it, or, it may be radiated directly to the receiver antenna system if the interfering device is close enough

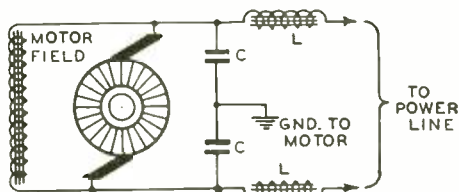

FIG. 13

Schematic diagram of a shunt type motor with an inductance-capacity filter connected to its input circuit.

to it. Remember that the filter does not eliminate the noise, it merely prevents it from flowing through the entire length of the power line to the receiver. It is evident therefore that under such conditions interference will persist even after the interference source has been hunted down and a filter has been connected to it (but improperly). This is why many filters do not produce the results expected of them. The remedy is obvious!

*Keep the leads from the filter to the seat of the interference as short as possible. Every superfluous inch of wire is a potential source of radiation and interference!* If the leads cannot be kept short, they should be shielded with a good shielding braid, and the shield grounded to the frame of the device.

The manufacturers of various electrical appliances such as drink mixers, irons, washing machines, vacuum cleaners, neon signs and beauty shop equipment are now, to a large extent, equipping their products with *built-in* filters to eliminate possible radio frequency disturbances at the source.

**NOISY GROUND**

It is interesting to note that the by-pass condensers used in interference filters are returned to the frame of the device causing the noise rather than to an actual ground. The reason for this is evident when it is realized that few easily accessible grounds have a **low** resistance. If the resistance of an available ground connection is high and if the by-pass condensers of a filter are connected to this ground, the noise current will flow through this ground wire and cause a "noise voltage" drop across it. This means that a radio receiver, connected to some other section of

(Continued on following page)

(Continued from preceding page)

this ground (it might be in the same building), will have its potential *above* actual ground by an amount equal to the noise voltage drop in the ground wire, and noise will be heard, especially when one side of the power line to which the chassis also connects is grounded. It is usually best, therefore, *not* to ground the frame of the motor. This, however, is only a gen-

The series motor (commonly called a "universal motor" because it will work on either a-c or d-c) is employed very widely in small appliances such as vacuum cleaners, sewing machines, washing machines, clippers, grinders, fans, mixers, etc. It may be recognized easily by its commutator and pair of brushes. The interference it produces in the radio receiver is distinguished by the "singing" or rotary

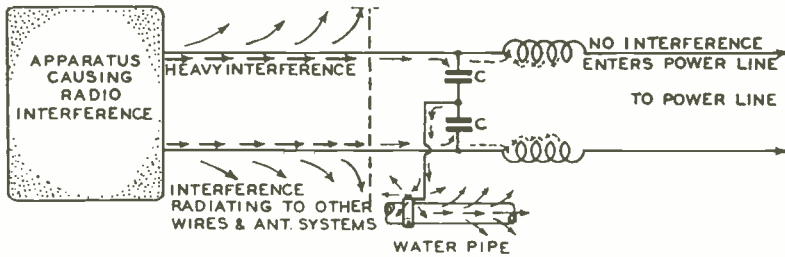

FIG. 14

Schematic circuit showing how the ground pipe may radiate interference, and how the leads which connect the filter to the interfering device may also radiate interference impulses to the part of the line beyond the filter unit, and possibly to the antenna system of the receiver, if it is near enough. The filter should therefore be mounted close to the interfering device and the leads to it should be kept as short as is possible in order to prevent this.

eral rule, and is not valid for all cases. It takes but a few moments to experiment in each case and determine whether more or less noise is obtained by actually grounding the by-pass condenser terminal and the frame of the interfering device.

A second reason for not using a real "ground" is the fact that if one is used, the "noise currents" flow through the wire to this "ground," and through this ground conductor (water pipe), as shown in Fig. 14. In doing so, they radiate interference impulses, just like an aerial. The lower the ground resistance is, the greater is the noise current in this ground lead and the ground pipe, and the more noise radiated. If radiation from the pipe is strong enough, it may affect other wires, which, in turn, will radiate energy. On the other hand, if the distance to actual "earth" is short, the *resistance* of the ground is low, and if radiation from the ground wire does not affect reception, then the use of an actual "ground" may be preferable. The best procedure is to try an "earth" ground in every installation and observe its effect on the interference—due not rely upon general rules in this work as there are too many special factors which may affect the results.

## MOTOR INTERFERENCE

The most frequent sources of interference produced by household electrical appliances are: sparking at the brushes of motors, and arcing at the contacts of thermostats and vibrators. Sparking commutators or contacts radiate a considerable amount of interference because of the oscillations set up, (see (G) of Fig. 7). It is for this reason that the spark should be reduced to a minimum even though a line filter is to be installed.

sound which increases in pitch as the motor gets up to normal speed, and by the fact that it may be tuned in at almost all parts of the broadcast band with approximately equal intensity.

Extremely annoying interference may be caused by these motors if excessive sparking occurs at the brushes due to poor commutation (which is inherent in the design of the motor and cannot be corrected by the radio service man), a dirty or worn commutator, open or shorted coils or commutator segments, dirty or poorly fitting brushes, etc. In such cases, cleaning and smoothing the commutator with fine sandpaper, refitting or replacing worn brushes are the first steps which must be taken to reduce interference—otherwise the use of a filter will not suffice. The actual effect of these steps on the interference created by the motor is shown very strikingly by the oscillograms at (G) and (H) of Fig. 7. That at (G) shows the wave form of the interference produced by a universal (series) motor whose commutator was dirty and worn and whose brushes sparked badly. The result of putting both the commutator and the brushes in first class operating condition so that very little sparking occurred is shown by the greatly subdued interference illustrated at (H).

It is often necessary to move the position of the brushes in d-c motors and generators to minimize sparking. In a motor, the brushes should be moved in a direction *opposite* to that of rotation; and in a generator in the *same* direction as that of rotation. The brushes should be moved only if the sparking is still excessive after the commutator has been cleaned and the brushes reseated. There will always be some sparking present normally, especially when the load on the motor or generator is

very close to or greater than rated load. Any adjustment of the brush positions should be made while the motor or generator is running with its normal load.

All motors used in home appliances such as vacuum cleaners, sewing machines, washing machines, hair clippers, grinders, fans, juice extractors, mixers, d-c electric refrigerators, oil burners, etc., and in such devices as cash registers, dental motors, motor generator sets and rotary converters, farm lighting units (generators) may be effectively suppressed by means of a suitable filter installed as close to the seat of disturbance as possible *and so connected that the leads from the filter unit to the device are just as short as they can possibly be made* so that no interference will be radiated from them. The filters shown at (A) and (B) of Fig. 10 are suitable for small motors up to  $\frac{1}{4}$  h.p., condensers of 0.1- to 1.0-mfd. being commonly used. Larger motors require larger capacities from 1 to 5 mfd., and often make the use of an inductive-capacitive type filter such as shown at (C), (D) and (E) necessary (see Art. 30-20 for details regarding the construction of these filters). The brushes and commutator should be attended to first so that minimum sparking occurs before the filter is connected. In motor-generator sets and rotary converters, a filter may only be necessary at one end (usually the d-c end), or quite often at both the a-c and d-c ends.

## THERMOSTATS AND CONTACTS

Thermostatically controlled apparatus in homes usually consists of heating pads, room temperature controls, electric irons, some types of refrigerators, oven controls and electric water heater-controls. As in the case of the series motors, thermostats may cause interference inherently due to their design or because their contacts require cleaning or adjustment. It is usually impracticable to attempt to repair the thermostats in heating pads, but the interference can usually be prevented from being radiated by connecting a small capacitor-type filter (condensers C-C) across the power line supplying the heating pad, as shown in Fig. 15.

In other thermostat applications, the contacts should first be put in good mechanical condition and adjusted so that they do not open so slowly that an arc is drawn out, for this will produce interference. If interference persists after adjustment has been made, two 0.1- to 1-mfd. condensers C-C should be connected across the line as shown in Fig. 15. In special cases where the contacts break circuits carrying appreciable currents, two additional condensers (shown dotted) may be required across the contacts. Finally, in very severe cases, the line choke coils L-L may be necessary. The leads from the filter to the thermostat should always be kept as short as possible to prevent radiation of interference from them.

Elevator controls, motor starter and control contactors, street cars, large power applications to ventilating systems, refrigeration, etc., all may cause interference, especially when oper-

ated from direct current. Since a great deal of such apparatus is present in dense business areas, suppression of all interference from it is usually impracticable and economically unsound. In these districts it is simpler to use a special noise-reducing antenna system. If interference caused by switch contacts in lighting circuits is to be eliminated, a 200-ohm resistor in series with a 0.1 mfd. condenser should be connected permanently across the switch contacts.

## USE OF SHIELDS

Shielding of the device causing the noise interference is not unusual, though somewhat undesirable from some standpoints. First of

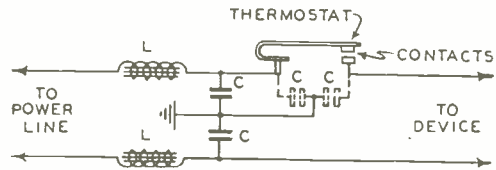

FIG. 15

Filter arrangement for eliminating the interference created by thermostat controls.

all, *complete* shielding is necessary; the entire unit must be enclosed in copper mesh and the mesh grounded to the frame of the device in several places. Second, servicing the device is difficult; the mesh must be removed and replaced, (usually by men not aware of the problems of noise reduction)—which is somewhat undesirable. Third, the proper kind of shield may hamper the operation of the device to some extent. It must be remembered that a shield *may* be built, but whether or not its presence is detrimental to the appearance of the device, or makes its operation inconvenient, depends upon the nature of the shield and the device. These considerations are usually the deciding factors in any question involving the complete shielding of the device causing the interference. Also, it must be remembered that a line filter (located *inside* of the shield) must be used even though complete shielding is resorted to, for the shielding will not keep the disturbances out of the line. It merely kills off all direct radiation of the disturbance from the interfering device.

## BUZZERS AND DOORBELLS

Interference caused by vibrating contacts, such as are used in call buzzers, door bells, dial telephones, etc., is of such an intermittent nature that filtering is usually not justified. However, if this interference must be eliminated, two 1 mfd. condensers may be connected in series across the contacts with the junction of the two condensers grounded to the device and/or to a separate ground. In some instances, however, it is also necessary to install two condensers across, (and often two choke coils in series with) the line circuit of the

(Continued on following page)

(Continued from preceding page)  
interfering device as shown in Fig. 16. When it is found, however, that the addition of the choke coils has changed the frequency of the interference so that it may be heard at another dial setting of the receiver, it is then necessary to change the inductance of the choke

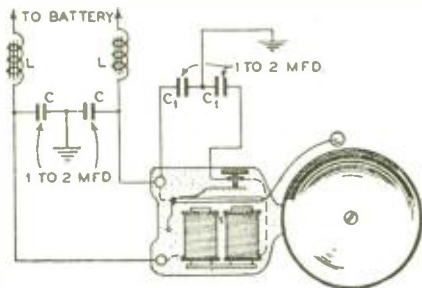

FIG. 16

Filter arrangement for eliminating the interference created by electric bells, buzzers, etc. The condensers and chokes across the battery line are only required in cases where the interference is particularly severe.

coils (either by increasing or decreasing the number of turns on them) in order to shift the interference from the broadcast band.

## OIL BURNERS

Interference caused by oil burners is due mainly to the ignition system, although a certain amount of interference may be caused by the motor that operates the blower and by the motor that operates the temperature-control system if one is used. Ordinarily, an a-c motor operating the blower of an oil burner creates interference only for a few seconds, at the instant of starting. These motors are usually of the repulsion-starting—induction-running type and create interference only for a few seconds during the starting period. *Provided the motor is in good electrical condition*, no interference should be created by this type of motor while running; if interference is present, the motor should be carefully inspected for defects or necessary cleaning. If the motor is of the single-phase type in which the brushes remain in contact with the armature, and the brush circuit is opened by means of a centrifugal switch, a slight continuous interference may result. This may be filtered out easily by a common capacitive line filter.

If the oil burner is operated from a d-c line, the d-c motor which is employed may produce interference at a steady intensity during the periods that the oil burner is in operation. This interference may be eliminated in the usual way with a proper capacitive-inductive filter unit, such as is shown in (D) of Fig. 10. It is necessary that the units comprising the filter be encased in a metal cut-out box and provided with fuses so as to conform with Fire Underwriter regulations. The choke coils used

in the filter unit must be wound with wire large enough to handle safely the current requirements of the motor. The ground lead must be connected to some part of the motor frame.

The same type of filter unit (in some cases a simple capacitive type will suffice) must be employed in cases where the small series-wound motor driving the temperature-regulating control (used in some oil burner systems) causes interference which sounds as a loud roaring noise lasting from 20 to 100 seconds. In such instances, the filter unit must be installed *directly* at the power input to this motor and its "ground" lead should be connected to a carefully cleaned part of the motor frame.

Interference caused by the ignition system and high-tension wiring of an oil burner is generally the chief cause of interference, and is heard as a loud roaring noise which may last from 15 to 60 seconds, or during the entire period during which the oil burner is in operation. To prevent disturbances from this source from feeding back into the line it is necessary that a suitable capacitive-inductive filter unit be installed in series with the input leads to the ignition transformer and as close as possible to that unit. All wiring must be enclosed by conduit or "BX" cable. The ground connection of the filter unit should be made to a cleaned spot on the metal case of the ignition transformer and to the BX cable or conduit. In some oil burners, most of the high-tension leads are contained within the fuel tube and are shielded by it to some extent. In order that no possible radiation by the high-tension wiring shall exist, every part of it must be completely shielded by conduits or shielded braid, these shields being well grounded to both the case of the ignition transformer and to the fuel tube of the oil burner. As a final measure of interference prevention, a good electrical connection should be made between the boiler (which may act as a radiator of noise interference) and the oil burner frame.

## BATTERY CHARGERS

Battery chargers of the vibrator type used in the home and in auto-service shops are very frequent offenders and are somewhat difficult to filter. After considerable experimenting, the author has found the arrangement of Fig. 17 to be effective. A choke-condenser arrangement is connected to the power line as shown, and two additional condensers are connected to the vibrator contacts. All leads from the filters to the units should be kept as short as possible. It may also be necessary to shield the unit, as many of these battery chargers are of the "open" type, with coils and vibrator contacts exposed.

When a-c operated electric refrigerators are new and in perfect electrical and mechanical condition, they may cause radio interference only during the few seconds when the motor is starting up. However, in refrigerators which have been operated for a long time, the motor starting contacts, etc., may become dirty and worn and interference may result during the

entire periods when the motor is running. A suitable inductive-capacitive type filter (see (D) of Fig. 10) mounted as close as possible to the motor and connected across the supply line at the motor with short leads will generally eliminate interference from this source.

If interference still persists after the filter has been connected, other causes may be responsible for it.

The most common cause is due to the accumulation of static charge on belt driven compressors in dry weather. On many refrigerator units the compressor and motor are mounted on spring supports or vibration absorbers in such a manner that the frames are not permanently grounded to the larger metal parts of the refrigerators. A simple remedy for this type of trouble is to bond the frame of the motor and compressor to the frame of the refrigerator or other large metal body in the immediate vicinity, with a flexible jumper. The jumper should be sufficiently flexible so as not to interfere in any way with the operation of the refrigerating unit.

### WEAK SPRINGS

In other cases, weakening of one or more of the spring supports causes a periodic contact between the motor frame and the refrigerator frame, resulting in fairly steady interference while the motor is running. Mechanical adjustment of the spring, or bonding the same units mentioned above will eliminate this noise. In general, interference from these troubles is very similar to natural static and usually does not affect receivers which are very remote from the refrigerator.

Thermostats and their associated relays are a source of trouble when not in good operating condition. When the contacts of the ther-

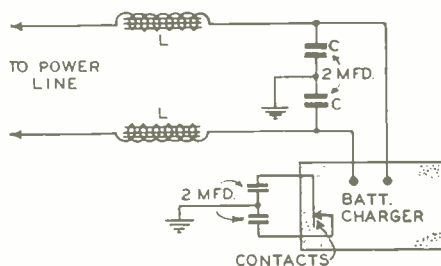

FIG. 17

Filter arrangement for eliminating the interference created by vibrator-type storage battery chargers. In some cases it is also necessary to completely shield the charger in addition to connecting the filter to it.

mostat or the relays are in need of cleaning or adjustment, a small arc is apt to be drawn while the unit is in operation. Troubles of this type sometimes become very severe from the standpoint of radio interference, particularly when the thermostat is so mounted as to permit changing of the contact pressure by the vibration of the unit. When difficulties of this type are experienced, it is advisable to communicate with an established electrical refrigerator service organization since the performance of the refrigerator depends to a great extent on the proper setting and operation of the thermostat.

If the refrigerator is operated from a d-c source, a d-c motor is employed. If the brushes and commutator require attention, interference is likely to result during the full time that the motor is operation. No filter should be connected to the motor until the commutator has first been cleaned and the brushes have been cleaned and re-fitted.

## Leon Adelman Making Flying Trips to Jobbers

Cornell-Dubilier's sales manager, Leon L. Adelman, who this year set a territory-covering record by travelling more than 15,000 miles in three weeks, is now training for another visit to his many representatives. Quick hops were made to Chicago, Washington, Pittsburgh, Detroit and other cities.

### DAWES AND DUNN ELECTED

General Charles G. Dawes, former Vice-President of the United States, author of the Dawes Plan, and subsequently Ambassador to the Court of St. James's; and Gano Dunn, scientist, engineer, administrator and President of The J. G. White Engineering Corporation, were elected to the Board of Directors of the Radio Corporation of America. They fill vacancies due to the recent deaths of Frederick Strauss, banker, and Newton D. Baker, former Secretary of War.

## MANUAL OF TRANSMITTING TUBES

A new 192-page Manual TT-3 covering RCA Air-Cooled Transmitting Tubes has just been made available. This book contains complete characteristics and ratings for each of the various types. Besides this material, there are included many curves and circuit diagrams; charts to assist the tube user in selecting conveniently a tube type for a particular application; and chapters covering installation, ratings, and application of transmitting tubes, as well as the design of rectifiers, filters, and transmitters. A copy is obtainable by addressing Commercial Engineering Section, RCA Manufacturing Company, Inc., Harrison, New Jersey.

### TEST OSCILLATOR REMEDY

The common return lead, or ground wire, often causes coupling among coils in multi-band test oscillators, hence spurious oscillations. One remedy is to short out unused coils. This reduces the frequency ratio because stray capacity is increased.

# ELECTROLYTES for Condensers, and Types of Capacitors

By Paul McKnight Deeley

Chief Engineer, Electrolytic Division, Cornell-Dubilier Electric Corporation

[Following is the third installment of "Treatise on Electrolytic Condensers." The first appeared in the February issue, the second last month; the final will be printed next month—EDITOR.]

## CHAPTER IV.

### Electrolytes Used for Anodic Film Formations

THE formation of the anodic film can take place in either an acid or an alkaline electrolyte. The presence of acid ions in the electrolyte favors the formation of the anodic film on aluminum whereas in some cases the alkaline ions favor the removal of the anodic film, especially if the aluminum is made the cathode.

Essentially, the results obtained with different electrolytes are the same, provided similar reactions occur at the anode surface, but the resulting characteristics of the completed electrolytic capacitor may be subject to a wide range of vibrations in resistance, power factor, direct current leakage and voltage factors.

By experimental determination it has been found that, in general, the electrolytes which have been proven to be most suitable are solutions of ammonium or other alkali salts of the weak acids such as, borates, tartrates, citrates, molybdates and oxalates. Sulphuric acid solutions have also found a wide range of application in present commercial usage. Although the almost exclusive use of ammonium and sodium borates has become present commercial practice, it is interesting to note that anodic films can also be formed in such electrolytes as solutions of sodium sulphate, potassium permanganate, ammonium chromate, potassium cyanide, ammonium phosphate, ammonium citrate, citric acid, malic acid, ammonium bicarbonate, sodium silicate and many of the salts of the organic acids as well as the weaker organic acids themselves.

At the present stage of development in the art of electrolytic capacitors only two types of electrolytes are in general use for the formation of anodic films. These are: first, an aqueous solution of ammonium or sodium borate and boric acid, and second, an aqueous solution of sulphuric acid. In many instances processes are in use which involve the utilization of both of

these types of electrolytes in a multiple step procedure. That is, an initial anodic formation takes place first in one type of electrolyte and is then completed in another type of electrolyte.

### SULPHURIC ACID ELECTROLYTE

The use of sulphuric acid solutions in the formation of anodic films is limited in commercial practice, in that anodic films formed in such solutions will stand only comparatively low voltages. There are, however, many advantages to be encountered in the use of such a process and not least among these is the excellent cleaning action which takes place on the surface of the aluminum by virtue of the fact that the sulphuric acid tends to digest any oil or grease film existing upon the anode material. Also very rapid forming of the anodic film, up to certain voltages, takes place due to the high current densities which can be used.

The formation of the anodic film in a sulphuric acid electrolyte can take place on either alternating or direct current, but due to the fact that relatively large currents at relatively low voltages are required it becomes most practical to use alternating current.

Because anodic films formed in sulphuric acid electrolytes are limited in voltage such a process is generally used as a preliminary formation if the anodic material is to be used in capacitors rated at higher voltages.

If there is no specific reason to the contrary it is immaterial what actual voltage is used for this type of formation. The factors which control the anodic film formation are current density, solution concentration, temperature and time. Naturally, for a given current density a certain solution concentration and voltage is necessary. To maintain a given current density with a weaker solution concentration a higher voltage will be necessary and vice versa. Voltages up to 150 volts have been used without difficulty.

### AMMONIUM BORATE - BORIC ACID

This type of electrolyte produces an excellent anodic film and has been used extensively in the commercial production of electrolytic capacitors. This type of electrolyte can be used, without variation in concentration, to produce anodic films for capacitors rated from six volts to 450

volts. The anodic film produced in this type electrolyte is much thicker than the films produced in most other types of electrolytes and is a dull grey color for that reason. Also the amount of anode surface required to give a certain capacity at a certain voltage is slightly greater on account of the reason that such films are thicker.

The specific resistivity of this type electrolyte is relatively low and for that reason current densities are high.

This type of electrolyte may be used to form anodic films without the use of any other operation or it may be used as the means of a second formation after the anodic material has been "per-formed" in a sulphuric acid electrolyte as has been previously described.

The ammonium borate-boric acid electrolyte is best suited in connection with the use of direct current but can be used in either the "still formation" or "continuous formation" processes.

In the formation of anodic films in this type electrolyte in connection with the use of the still formation process the applied voltage is built up until the desired voltage is reached then maintained at this point until the current density has dropped to the desired minimum value. At this point the anodic material is removed, washed in distilled water and carefully dried.

The continuous formation method has practically replaced the still formation on account of economical reasons and the additional fact that with such a process any voltage formation can be instantly obtained by the mere adjustment of applied voltage.

The continuous formation process also is very flexible in application and lends itself to multiple step formations. In this respect an extremely satisfactory anodic film formation can be produced by combining the use of the sulphuric acid electrolyte with the ammonium borate-boric acid process. This is accomplished by allowing the anodic material to first pass through the sulphuric acid electrolyte then successively through wash tanks and then through the ammonium borate-boric acid electrolyte. This multiple step process is not limited to the continuous formation method, however, because a series of still formation processes can also be successively carried out. Such a procedure would obviously necessitate an unnecessary amount of handling and be therefore less economical.

### SODIUM BORATE - BORIC ACID

This type of electrolyte possesses a number of distinct advantages over the ammonium borate-boric acid electrolyte already mentioned. Among these advantages is the ability of this electrolyte to stand considerably higher voltages and its stability in regard to the loss of the alkali content. It is quite obvious that the ammonium borate-boric acid electrolyte will constantly lose its ammonia content with operation at advanced temperatures. The anodic film produced with the use of the sodium borate-boric acid electrolyte is considerably thinner as evidenced by the appearance of interference colors on the surface of the anode material and the fact that a higher

capacity is obtained for a given surface area at a given voltage.

By varying the sodium borate content a wide range of variation can be obtained in different voltage formations for specific applications and for these reasons the sodium borate-boric acid electrolyte has come into almost universal use.

The specific resistivity of this electrolyte varies with the sodium borate content but is considerably higher, voltage for voltage, than the ammonium borate-boric acid electrolyte. This is another advantage on account of the fact that lower current sources are necessary in actual practice.

The sodium borate-boric acid electrolyte is an aqueous solution of boric acid and sodium borate.

This type electrolyte may be used to form anodic films without the use of any other operation or it may be used as the means of a second formation after the anodic material has been "pre-formed" in a sulphuric acid electrolyte as has been previously described.

The sodium borate-boric acid electrolyte is best suited to direct current formations but can be used in connection with both still formations and continuous formations.

### CHANGE OF RATIO

In connection with the sodium borate-boric acid electrolyte extremely satisfactory results have been obtained with a multiple procedure which consists of first forming the anodic material at a lower voltage than that finally desired, using a solution containing a heavier sodium borate content, then forming to the desired higher voltage in a solution containing a smaller sodium borate content. By this method it has been found possible to form anodic films as high as 1,000 volts.

One distinct advantage of the multiple step formation process is that in the higher concentrated solutions used in the initial formations considerable power is saved in the reduction of the IR drop in the electrolyte.

In the use of the sodium borate-boric acid electrolyte the ratio of boric acid to sodium borate and the concentration of the solution changes with the amount of anodic material formed. Aluminum tends to plate out into solution and thus causing a certain amount of suspension of the sodium borate content. Boric acid is continuously lost by evaporation and the deposition of boron upon and the occlusion into the anodic material. For these various reasons the alkalinity of the electrolyte increases with use.

## CHAPTER V.

### Types of Electrolytic Capacitors

**T**HERE are two distinct general types of electrolytic capacitors. These are the "wet" and "dry" types. The wet type has been replaced in general use to a very great extent by the dry type. A very large quantity of the wet types are however still being produced and used because in certain capacities and voltages they

*(Continued on following page)*

(Continued from preceding page)

are more easily and economically produced. In the higher voltage ratings the wet type capacitor will stand higher voltage surges without injury than will the dry type. On the other hand the wet type is very limited in both voltage and capacity ratings because of economical reasons and manufacturing difficulties. The wet type also has a very high power factor compared to the dry type and is subject to wide variations in characteristics under extreme temperature variations.

The dry type electrolytic capacitor is not handicapped by any of the limitations of the wet type. Dry types can be produced in any capacity from a fraction of a microfarad to millions of microfarads and from 6 volts to 600 volts in single units. They can be produced for operation on alternating current as well as for operation on direct or pulsating current. They can be produced in multiple capacities and for operation on different voltages in the same

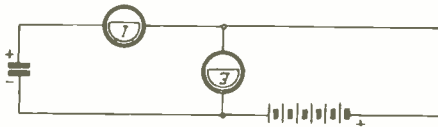

FIG. 1

Circuit for leakage test.

winding or section. The dry type has a comparatively low power factor and will stand operation under conditions of wide temperature conditions. Another distinct advantage of the dry type is that it can be made into almost any desired physical shape.

## WET TYPE ELECTROLYTIC CAPACITORS

In general the wet electrolytic capacitor is built into seamless aluminum or copper containers which vary in diameter from 1" to 1 3/4" and in lengths from 2 1/2" to 4 7/8", depending upon the voltage and capacity desired.

These containers are fitted at one end with an insulated bushing of hard or soft rubber through which passes the anode connection. Obviously this bushing must be a water tight seal to prevent any leakage of electrolyte at this point. At the other end of the container a vent must be provided to permit the escape of any gas generated during the operation of the capacitor.

Perforated strips of celluloid or hard rubber are placed around the inside of the container to prevent the anode from coming in contact with the container or cathode.

There are various types of anode construction. The simpler forms consist of hard drawn aluminum strips from 1 1/2" to 3" wide and from .005" to .010" thick. One end of the strip is riveted or swaged to an aluminum rod or strip

and coiled clock spring fashion around this supporting member. This supporting member is longer than the foil strip is wide and projects through the insulating bushing mentioned above. Another type of anode assembly consists of thinner strips of soft drawn aluminum which are corrugated or accordion pleated then wrapped clock spring fashion around the supporting post. This type construction obviously permits the use of greater anode surface areas within a given container size. Still another type of anode assembly consists of a seamless aluminum tube which is shortened in length by a series of accordion pleats or screw like convolute ring indentations. All these various anodic assemblies produce essentially the same results.

## PRECAUTIONS AGAINST CONTAMINATION

In the wet type capacitor the electrolyte consists of an aqueous solution of boric acid and sodium borate, the concentration of which varies with voltage rating. This will be covered more in detail in a later paragraph.

In the manufacture of the wet type electrolytic capacitor extreme care must be constantly exercised to eliminate all sources of contamination of those elements which may cause corrosion. This is absolutely necessary because the wet type capacitor is subject to corrosion to a much greater extent than the dry type electrolytic capacitor.

All raw materials must be carefully selected and tested for purity and each step in the manufacturing process must be guarded with almost surgical cleanliness.

Anode material is perforated, crimped or otherwise mechanically formed into shape. After this operation the mechanical assembly of the anode plate or strip to riser strips, studs or rods takes place. Any rods, strips, studs or rivets used for this purpose must be of aluminum and of the same chemical purity and analysis as that of the anode material proper.

After the mechanical assembly of the entire anode structure takes place, this entire structure must be thoroughly cleaned preparatory to the formation process.

There are a number of cleaning methods employed. One method consists of treatment of the anode assemblies in hot concentrated nitric acid, a thorough wash in hot water then treatment in a hot concentrated solution of sodium hydroxide followed by thorough washes of hot tap water and distilled water.

Another method of cleaning anode assemblies is one, which has proven to be the most satisfactory. This method incorporates first the thorough washing of the anode assemblies successively in baths of denatured alcohol, distilled water, potassium dichromate and sulphuric acid and additional washes of distilled water to remove any trace of sulphate from the anodic material.

After anode assemblies are formed they are assembled into containers, filled with electrolyte and sealed. Completed capacitors are then re-



formed or aged to the required leakage current at their rated peak voltage. The testing of the completed capacitors will be covered in a later chapter.

The electrolyte used for the final filling of the container consists of an aqueous solution of boric acid and sodium borate. Only high purity distilled water and strictly chemically pure (C. P.) boric acid and sodium borate may be used. In this electrolyte a much lower concentration is used than is used for the original anodic formation. In some cases of very high voltage rating the sodium borate content is either reduced to very minute quantities or left out altogether.

The reforming or aging of completed capacitors is accomplished by placing the unit on rated voltage for a period of time depending upon the voltage and capacity rating. The higher the capacity and voltage the longer the aging time required. During the aging cycle the capacitor is connected to a current source.

A resistor (R) is used to limit the current to prevent heating in case the capacitor does not age down to required leakage current rapidly enough and to also serve as a protective medium in case of an internal short circuit in the capacitor assembly.

A lamp (L) serves to indicate short circuited capacitors or capacitors which show abnormally high leakage currents.

A single circuit jack (J) affords a mean of current measurement.

The diagram was in the February issue.

### CHARACTERISTICS OF THE WET TYPE

There is a very definite voltage limit above which the anodic film will break down. This is the sparking or scintillating voltage and manifests itself by rapid increase in the leakage current. This point is the maximum peak voltage of the capacitor and capacitors should never be operated beyond this maximum peak voltage.

In any electrical network both the direct current voltage and the peak value of any superimposed alternating current component must be ascertained before the proper selection of capacitors can be made. The peak alternating current voltage must be added to the direct current voltage to obtain the peak voltage and this peak voltage should not exceed the peak voltage rating of the capacitor.

A capacitor will operate on any voltage up to the peak rating. It will not, however, operate satisfactorily on composite currents such as a rectifier output where there is an appreciable reversal of current during a portion of the cycle. Such an unsatisfactory condition of operation would actually be described as a condition where the peak negative value of the superimposed alternating current component becomes greater than the average direct current component. Such a condition would cause the anode momentarily to become negative with respect to the electrolyte and if continued would result in overheating and complete breakdown of the capacitor.

Capacitors may be subjected to excessive

voltage conditions or even reversed polarity conditions for reasonable lengths of time without suffering permanent injury. The actual time required to damage a unit depends obviously upon how extreme the abnormal condition of operation is. Very extreme conditions will cause the electrolyte to boil in about ten minutes. Such boiling of the electrolyte will cause loss of electrolyte and the development of excessive pressures within the containers. Actual boiling of the electrolyte will not cause permanent injury to the capacitor provided no appreciable quantity of electrolyte is lost and provided no injury occurs to the container. If the escape vent does not function then the container may be disrupted.

### FREEZING

From exhaustive life tests it is indicated that in operation no actual destruction of the anodic film takes place. There is, however, always a small leakage current with a resultant loss of electrolyte by electrolysis. Under normal conditions and on continuous operation the wet electrolytic capacitor will lose approximately 0.5 grams of electrolyte per milliamper of leakage current per 1,000 hours. Operation in high ambient temperatures will, of course, cause more rapid loss of electrolyte. On idle shelf life the loss of electrolyte is entirely negligible.

When wet type electrolytic capacitors are left on idle shelf life for long periods of time there takes place an apparent deterioration of the anodic film but this is rectified and the direct current leakage drops to normal in a short time after rated voltage is applied to the capacitor. The time required for this return to normal leakage is approximately one minute per 1,000 hours of idle period.

If a wet electrolytic capacitor is operated in a high ambient temperature an increase in leakage current takes place. This leakage current in turn causes a rise in the temperature of the electrolyte and tests show that operation at maximum voltages in an ambient of 60 degrees centigrade can be very dangerous. Operation of capacitors in ambient temperatures which exceed 50 degrees centigrade is never recommended.

At slightly below zero degrees centigrade the electrolyte freezes solid and the operation of wet electrolytic capacitors ceases altogether. This is due to the fact that the resistivity of the electrolyte increases to an almost infinite value. This freezing of the electrolyte causes no permanent damage and after the electrolyte has been thawed out normal characteristics will be resumed.

The amount of anodic surface necessary to produce a given capacity at a designated voltage is indicated in the following table.

Peak or Formation Voltage	Square Inches of Anode Surface Per Microfarad
100 volts .....	2.00
150 volts .....	3.00
200 volts .....	4.00

(Continued on following page)

(Continued from preceding page)

250 volts .....	5.00
300 volts .....	6.00
350 volts .....	7.00
400 volts .....	8.00
450 volts .....	9.00
500 volts .....	10.00
525 volts .....	10.50
550 volts .....	11.00
600 volts .....	12.00

## THE DRY TYPE ELECTROLYTIC

Fundamentally, the dry type electrolytic capacitor differs from the wet type in that the electrolyte used in the dry type is of a semi-dry nature and the condenser does not serve as the cathode terminal. The dry type consists primarily of a plate or strip of aluminum foil from .002" to .005" thick which is anodically formed. This strip of material is called the anode foil.



FIG. 2  
How tabs are brought out.

This anode foil is placed on top of a similar piece of unformed or raw aluminum foil of the same width and thickness as the anode foil and this unformed or raw foil is called the cathode foil. In between the anode and cathode foils is placed a layer of cotton gauze or highly absorbent paper which has been saturated with the electrolyte and the whole wound up into a concentric roll. The layer of gauze or paper is called the separator and is always wider than the foils. There are many different methods used to produce this type of capacitor and each of these will be covered in a different paragraph.

The anodic formation of foil for use in the dry electrolytic capacitor is best carried out by the continuous process of formation. The foil is obtained in rolls of the desired thickness and width and the formation so arranged that the raw material unrolls, passes through the formation baths and is rerolled automatically. This process eliminates the necessity of handling the material with consequent elimination of wrinkles or contamination.

## THE THREE DRY TYPES

Dry electrolytic capacitors can be divided into three types, these types being different only in that the manufacturing processes involved are different. These three classifications are: low voltage-high capacity types, regular types and alternating current types.

The electrolytes employed in the dry type electrolytic capacitors also can be divided into two general types. The difference in these two divisions are mainly physical rather than chem-

ical. The two types are: first electrolytes which are physically crystalline in structure and of a consistency similar to medium hard fudge, and second the electrolytes which are physically highly viscous liquids.

Practically all of the more satisfactory electrolytes employed in the dry type electrolytic capacitors consist of solutions of ammonium borate dissolved in one or more of the polyhydric alcohols such as the glycols or glycerols.

There has been considerable discussion relative to whether in such solutions the ammonium borate combines chemically with the glycols or glycerols to form a third compound such as glycoborate or glycerol-borate or whether the solution is simply a physical mixture consisting of the ammonium borate held in suspension. No doubt exists in the author's conception that complicated glycoborate or glycerol-borate compounds can be formed but there is considerable evidence indicating that the formation of such compounds is definitely undesirable.

## LOW VOLTAGE - HIGH CAPACITY

This designation applies to capacitors rated from 6 to 60 volts and from 500 to 10,000 microfarads. These ranges can be extended but experience shows that most commercial requirements can be covered by this range of voltages and capacities.

Experience also shows that this type of electrolytic capacitor can be most satisfactorily made by the following described process.

A. The recommended anode material is dead soft aluminum foil, .002" thick, two to four inches wide and of 99.8% chemical purity.

B. The recommended cathode material is dead soft aluminum foil of the same physical dimensions as the anode but of only commercial purity, (99.35%).

C. The separator material may be a fine mesh (at least 44-40), cotton gauze or a high purity super cellulose paper material of from .003" to .005" thick. In either case the separator material should be  $\frac{3}{8}$  to  $\frac{1}{2}$  inches wider than the foils.

The low voltage-high capacitor type capacitor is wound dry in the same general manner as a paper dielectric capacitor. That is, rolls of formed anode foil, cathode foil and separator materials are so arranged that concentric windings or rolls can be wound on a rotating mandrel. This mandrel can be driven by power or by hand. The rolls of materials are arranged so that the separator material projects and provides a margin on each side of the foils. This margin should be the same on each side of the foil.

In making these windings the cathode foil is fastened to the mandrel and one separator placed on top of cathode foil. One complete turn is made then the anode foil and other separator come next. It is best to fold across the end of the anode foil a short strip of separator material as an added protection against short circuits between the anode and cathode foils due to burrs or sharp edges.

After some fifteen linear inches of foil have been wound tabs must be cut and brought out

for connections. If a winding consists of more than 100 linear inches tabs should be brought out from each end of both cathode and anode foils. Tabs are cut as shown in Fig. 2.

A reinforcement piece of separator material should be placed over each side of each tab as well as around each end of the anode foil to minimize the possibility of short circuits between anode and cathode foils.

The capacitor windings should be firmly and smoothly wound but not too tightly wound. After windings are complete they are tied with a string to keep them from unwinding during subsequent operations.

A complete winding has the appearance shown in Fig. 3.

FIG. 3  
Electrically completed condenser. Only a finished appearance has to be supplied.

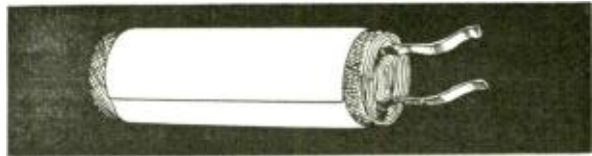

In the making of this type capacitor the section is wound dry, as has been already mentioned, and then the separator material is saturated with electrolyte by a process of vacuum impregnation.

Windings are removed from the vacuum tank and allowed to cool. They are then wrapped with a double wrap of waxed paper and the entire units then dipped into a hot bath of wax to give them a protective coating to prevent moisture absorption until they are sealed into containers.

Before being sealed into containers windings are placed on rated peak voltage and allowed to remain until the direct current leakage has dropped to desired minimum values.

After being sealed into containers the capacitors are again placed on rated peak voltage for a period of time. These are called the aging periods. After aging they are tested according to methods covered later.

### CHARACTERISTICS OF LOW VOLTAGE - HIGH CAPACITY CAPACITORS

The anode foil used in the low voltage-high capacity type capacitor should be anodically formed to a voltage 10% higher than the rated peak voltage of the capacitor.

In the calculation of the necessary anode area for a given capacity at a given voltage the following formula may be used. In this formula only one side of the anode has been considered and it is so arranged for convenience in calculation:

$$L = \frac{.015 \times E \times C}{W}$$

- L = length of foil in inches
- E = voltage of formation
- C = capacity in microfarads
- W = width of foil in inches
- .015 = constant

It is always good practice to allow the cathode foil to extend beyond the anode foil to an amount sufficient to provide one complete turn of cathode foil around the outside of the completed winding.

The dry type electrolytic capacitor, unlike the wet type, will operate at temperatures below the freezing point of water.

When the voltage applied to an electrolytic capacitor is higher than that voltage at which the "anodic" film was originally formed, the film tends to adjust itself to correspond to the new voltage. If the capacitor is large, this increased voltage may result in a very heavy flow of current which may result in overheating with resulting damage to the capacitor.

The cathode foil must match the anode foil not able to adjust itself with sufficient rapidity to the new voltage condition. Such damage can, of course, be minimized by the use of a series resistance or other current limiting device.

Under the reverse of the above condition, that is, when an electrolytic capacitor is operated at a voltage lower than the formation voltage, a very slow adjustment to the new voltage condition takes place. With continued operation at this lower voltage the capacity will gradually increase because (due to electrolytic action) the film thickness is reduced. The rapidity of this action is affected by both temperature and the type of electrolyte used. A higher ambient temperature causing a more rapid change and the more liquid or mobile electrolytes of higher borate concentrations having the same effect but to a lesser degree.

As to methods of measurement to be employed in determining characteristics of "Low Voltage-High Capacity" Type of Electrolytic Capacitors, this characteristic is determined in the conventional manner by putting the condenser in series with the d-c source, across which is a d-c voltmeter, with d-c current meter in series with the condenser. Rated voltage should be applied for ten minutes and the current read at the end of that time. A thoroughly satisfactory capacitor should show leakages within the values indicated in the following table:

Milliamperes Per MFd)	Rated Peak Voltage
.002 MA	12 volts
.002 MA	18 volts
.003 MA	20 volts
.004 MA	25 volts
.005 MA	30 volts
.006 MA	35 volts
.007 MA	40 volts
.010 MA	50 volts
.015 MA	60 volts

# AN AID TO BASS NOTES

## Compensation of the Audio Volume Control Easily Established

By R. K. Wheeler

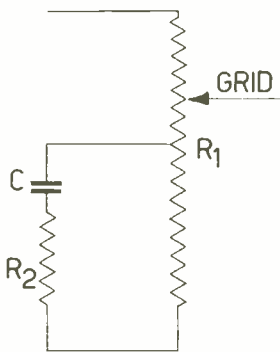

FIG. 1

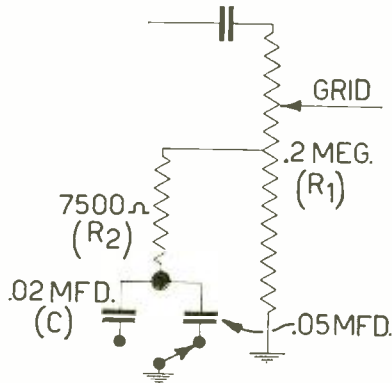

FIG. 2

The fundamental network for bass compensation is shown at left. A circuit for providing suitable compensation is given at right.

**D**URING the past year there has been an increasing tendency on the part of commercial set designers to include some form of base compensation in their receivers, generally in the form of a resistor and condenser, shunted from a tap on the audio volume control to ground, and effective at low volume settings of the control.

Recently a complete mathematical analysis of bass-compensation design was published in "Electronics."

In the case of a receiver that already incorporates bass-compensation that requires repair, it is preferable and much simpler to make replacements with exact duplicates. However, exact duplicates are not always readily obtainable, and substitution is sometimes required. Also bass-compensation may be correctly added to a receiver that does not have this desirable feature.

### TWO FREQUENCIES

The fundamental network is shown in Fig. 1. That portion of the volume control below the tap is designated as  $R_1$ , while the series resistor is  $R_2$ . The design is based on the ratio of impedances at two selected frequencies, usually 400 cycles and 100 cycles, designated as  $f_a$  and  $f_r$ . The original formula for obtaining correct

values of the network components is:

$$C = \sqrt{\frac{1}{\omega_a^2 \omega_r^2 R_2 (R_1 + R_2)}}$$

$$\omega_a = 2\pi f_a \quad \omega_r = 2\pi f_r$$

For service and repair work, the formula may be somewhat simplified. Since the terms  $f_a$  and  $f_r$  are usually fixed at 400 and 100 cycles, then  $\omega_a^2$  and  $\omega_r^2$  may be made a constant,  $157 \times 10^4$ . The term  $10^4$  is eliminated by expressing  $R_1$  and  $R_2$  in tens of thousands of ohms, and the formula may be written:

$$C_2 = \frac{.00637}{R_2 (R_1 + R_2)}$$

In practice the volume control may be selected with a tapped portion approximating the original, if possible.  $R_2$  is necessary to prevent excessive attenuation of the higher audio frequencies, and a value roughly equal to 5 to 10% of  $R_1$  will generally be found suitable. Solution of the formula will then give the value of the condenser  $C$  that will provide *maximum* compensation with the values of  $R_1$  and  $R_2$  as chosen.

Larger values of  $C$  will reduce the amount of

(Continued on following page)

# PERSONNEL

Solar Manufacturing Corporation, 599 Broadway, New York City, announces J. I. Cornell has joined the organization as consulting and field engineer. Mr. Cornell was formerly chief engineer of Magnavox Company. Previously he had been section engineer in charge of audio components, RCA Mfg. Co., at Camden, N. J.

\* \* \*

The appointment of E. F. Carter as assistant chief engineer for Sylvania radio tubes has been announced by Sylvania Chief Engineer R. M. Wise. Mr. Carter has been a member of the Sylvania Engineering Department since September, 1932, when he was appointed consulting engineer on tube application problems. In 1933 he was made division tube engineer for the Emporium, Pa., plant. He has been handling the duties of assistant chief since September, 1937. Mr. Carter was employed in the Engineering division of the General Electric plant at Schenectady, 1922 to 1929, and in charge of the Radio Division of United Research Corporation, 1929 to 1932. He is a graduate of Rice Institute, 1922, holding a Bachelor of Science degree in Electrical Engineering.

\* \* \*

Homer H. Kunkler, general sales manager of National Union Radio Corporation, announced the appointment of J. J. (Jack) McBride as district manager of National Union, covering Indiana, Ohio, Michigan, Northern Kentucky and Chicago. Mr. McBride formerly was associated with U. S. Radio & Television Corporation, of Marion, Ind., and General Household Utilities Corporation, of Chicago. More recently he was affiliated with the Radio Corporation of America.

## Table of Constants for Bass-Note Booster

(Continued from preceding page)

bass "boost," and may be used when a two or three position tone control is used. A suggested circuit is shown in Fig. 2.

Typical values for  $R_1$ ,  $R_2$  and C are approximately as follows:

$R_1$ ( $\mu p$ )	$R_2$	C
50,000	3,500	.06
50,000	20,000	.02
100,000	6,500	.03
100,000	15,000	.02
200,000	5,000	.025
200,000	30,000	.01
300,000	5,000	.02
300,000	20,000	.01
500,000	15,000	.01

The resistance values are in ohms, the capacity values in microfarads.

## More Parts Announced for Test Television

RCA has made available additional specialized television parts for use by experimenters within radius of television transmitting stations.

With the new television parts just announced, and other standard parts already available, it is now possible for the amateur experimenter who is equipped with sufficient technical knowledge, to assemble his own Kinescope deflecting circuits for use in experimental television receivers.

A deflecting yoke, designed for use with both the 5-inch and 9-inch television receiving tubes, has windings for both horizontal and vertical deflecting circuits. It is designed to have uniform flux distribution.

Two power transformers have been designed, for each of the Kinescopes. The one for the 9-inch tube and includes complete power supply for the anode and heater circuit, with a plate winding of 4,500 volts and two 2.5-volt heater windings. The other transformer has plate winding of 2,300 volts and two 2.5-volt heater windings.

The vertical output reactor is a high-quality auto-transformer for matching the output of deflecting circuits to the deflecting yoke vertical circuit. The inductance is 120 henries and it has a d-c resistance of 3800 ohms.

The vertical oscillation transformer is scientifically designed for low-frequency blocking-oscillator circuits.

The horizontal oscillation transformer is designed for high-frequency blocking-oscillator circuits. It has high efficiency at a frequency of 13,200 cycles.

The horizontal output transformer has correct characteristics to supply a 13,200-cycle sawtooth current wave to the deflecting yoke. The core and coil are rubber mounted to eliminate noise.

A power supply capacitor for the 9-inch Kinescope, provides high-voltage terminals for one center and two outside connections. It is a high-quality, 6,000-volt unit containing two .03 mfd. capacitors. Its oil-filled construction insures long life.

The other power supply capacitor is built for the 5-inch tube. It contains one .025 mfd. 4,000-volt unit and one .05 mfd. 3,500-volt unit.

The power supply reactor is newly designed for Kinescope filter circuits. An inductance of 1.500 henries insures good regulation in power supply circuits when used in conjunction with the power supply capacitors.

## Clarostat Appoints Stoll

The appointment of C. A. Stoll, 139 Alton Avenue, Dayton, Ohio, as representative for Ohio and adjacent territory was announced by Clarostat Mfg. Co., Inc., of Brooklyn, N. Y. Mr. Stoll replaces W. W. Boes.

## CLASSIFIED ADVERTISEMENTS

7 cents a word. \$1.00 minimum.

**HIGH GRADE GOLD. ORE SPECIMENS.** rare, beautiful. 50 cents postpaid. Copy, California Mining Journal, mining information, free with order. Sybil Mines, French Gulch, Cal.

**HAVE YOU BACK NUMBERS** of Radio World, for May, August, 1935, or April, June, September, October, December, 1936, March, April, 1937? If so, please communicate with Radio World, 145 West 45th St., New York, N. Y.

**RADIO EXPERIMENTERS AND SET BUILDERS:** parts and kits of parts for improved Little Giant R235, six tube R233. Pre-amplifier R228. Portable battery R223. Little Giant R220 and 205 and 6 volt R238. Guaranteed specified parts. Lund Manufacturing Co., Dept. R.W., 43 East Ohio, Chicago.

**RADIO WORLD AND POPULAR MECHANICS MAGAZINE**—Radio World is \$2.50 a year, and Popular Mechanics Magazine is \$2.50 a year. Popular Mechanics Magazine does not cut rates, but Radio World will send both publications to you for one year for \$3.75. **RADIO WORLD**, 145 West 45th Street, New York City.

## CHASSIS—CABINETS PANELS & CANS

STANDARD SIZES ON HAND  
SPECIAL SIZES MADE TO ORDER

**KORROL RADIO PRODUCTS CO.**

232 Greenwich St. RW 438 New York City

# TELEVISION

**"TELEVISION WITH CATHODE RAYS,"** by Arthur H. Halloran. Farnsworth and Zworykin systems fully explained. The treatment is mathematical. It is a book for the well-grounded radio man who has vision, the man who wants to be among the first to cash in when the pictures go on the air commercially, but is not for novices. 100 pages or more of supplementary data. Price \$2.75 postpaid including Supplements).

## RADIO WORLD

145 West 45th Street, New York City, N. Y.

## Refrigeration

\$  
1

**Text-Book for Home Study**

This complete, up-to-the-minute, practical book will teach you quickly how to service all types of refrigerators. Page after page of useful, easy to understand facts. Refrigeration is the big money field and you can get into it after studying this book.

Textbook. Size 8½ x 11 in. Priced at only \$1.00. Postpaid. Send for your copy now.

### SUPREME PUBLICATIONS

3729 WEST 18th STREET

CHICAGO, ILL.

## ADVERTISING RATES RADIO WORLD

145 W. 45th St., New York City, BRyant 9-0558.  
Rates effective January 1, 1937. (Card No. 5.)  
Agency commission 15%; cash discount 2% of net—1st of publication month.

<b>General Advertising</b>	1 li.	12 li.
1 page (224 lines).....	75.00	60.00
½ page (112 lines).....	37.50	30.00
¼ page (56 lines).....	18.75	15.00
Agate line.....	.38	.304

**Covers**

1st cover.....	No advertising	
2nd cover (2 colors).....	90.00	72.00
3rd cover (2 colors).....	90.00	72.00
4th cover (2 colors).....	90.00	72.00

**Other Special Positions**  
No extra charge for special positions, other than those known as "preferred positions" if open.

**Classified Rates**  
One time .07 word; 12 insertions .056 word per insertion. Minimum charge 1.00. Limited to 14 lines agate; must carry no display. Advertisements in "Classifications" must not exceed 100 words.

**Reading Notices**  
Not accepted.

**Contract and Copy Requirements**  
Advertising of alcoholic beverages not accepted. Stock-selling advertising not accepted.

**Minimum Depth, R.O.P. Advertisements**  
Minimum size of advertisements, 7 lines.

**Mechanical Requirements**  
Pages are 2 columns wide by 112 lines deep; 221 lines to the page.

1 page.....	5½" x 8"
½ page.....	5¼" x 4"
¼ page.....	2½" x 8"
¼ page.....	5½" x 2"
¼ page.....	2½" x 4"

Half-tones 135 screen. Supply original halftones. Mats or unmounted electrotypes can be used.

**Issuance and Closing Dates**  
Published monthly; issued 22nd of preceding month. Last forms close 10th of preceding month. No cancellations accepted after the 1st of 2nd preceding month.

EVERYTHING *New*

# "RADIO"

IN *Allied's* NEW  
SPRING CATALOG



Everything in Radio

**Allied Radio**  
CORPORATION  
3118 JACKSON BLVD. CHICAGO  
MAY 1938

at Radio's Lowest Prices!

Write today for ALLIED's big Spring Catalog—just out! 164 pages packed with everything new in radio! Over 12,000 parts, newest to oldest; dozens of Set-Builders' Kits (many new ones, beginner's and advanced); newest Amateur gear—all leading lines; sensational new Sound Systems, 10 to 70 watts; 62 amazing new KNIGHT sets—new low-priced Push-Button Tuning Models, Auto Radios, 2-way Farm Radios—sets for AC, AC-DC, 6-volt, 32-volt, battery and auto operation; new, advanced Test Equipment; books, tools, etc.—everything new in radio, complete in one great book. ALLIED's fast service and low prices save you time and money. Send coupon now for ALLIED's new Catalog—it's Free!



## ALLIED RADIO CORP.

833 W. Jackson Blvd., Dept. 16-D8,  
Chicago, Ill.

Send me your new Catalog for Spring-and-Summer—FREE.

Name .....

Address .....

City ..... State .....

# THE MOST COMPACT SIGNAL GENERATOR ON THE MARKET

Handy to use because it lies flat on the workbench and takes very little room. Large full-vision etched scale makes the frequency readings clear and distinct. Non-breakable and fire-proof transparent Bakelite pointer assures hair-splitting accuracy.



Careful construction and fine workmanship characterize this instrument. It thoroughly outperforms any other generator at anything like the price we are asking for it.

Air-cooled metal tubes, rubber-cushioned against shock, give this portable instrument high frequency stability, because of good ventilation.

90 kc to 30,000 kc on fundamentals only, using six bands by switching. The switch automatically shorts out all coils not in use. Tapped coils, six in number, wound on seasoned natural (yellow) Bakelite and mounted in a compact assembly with the special shorting switch, are distinctive features.

Beautiful black metal-etched panel with white lines, minimizing glare. Separate 400 cycle audio oscillator for modulation frequency controlled by toggle switch. Provision for external wobbler for use with cathode-ray oscillograph.

Overall size: 8 1/2" x 6" x 3 1/2" deep.

Operates from 105-125 volts AC or DC. 220 volts model also available. Price, complete with tubes....

**\$15.95**

SHIPPING WEIGHT, 5 LBS.

## HERE'S YOUR CHANCE FOR A REAL BARGAIN IN A 3-INCH CATHODE-RAY-OSCILLOGRAPH

either in KIT form or Complete-Ready-to-Operate

Delta's recent purchase of the Paragon Radio Products Co. has made it possible to make available this remarkable oscilloscope at a great saving. This offer holds only while the limited stock is still on hand. Better get yours now and save, while you still have the chance.

We will be glad to hold one of these instruments for you for a reasonable time if you will put a small deposit on it. Write for descriptive circular and act quickly, for here's the chance to get that 'scope you've always wanted. Available also in kit form. Price, complete **\$44.75** with tubes .....

Assembled Parts Kit, \$24.60

Kit of Tubes, \$15.50

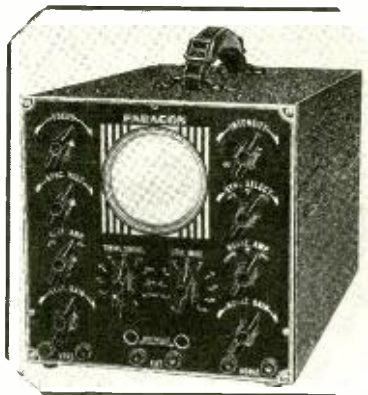

## COILS TO ORDER INDUCTANCE STANDARDS

We are equipped to wind inductance coils to your specification. Honeycomb windings for IF transformers, high-gain primaries for broadcast coils or other bands, tapped or un-tapped oscillator coils to any inductance between 1 microhenry and 50 millihenries.

Single coils mounted on bakelite with lugs and

mounting bracket, from 1 microhenry to 1 millihenry, \$2.00 each for one coil, \$3.00 for 2 similar coils, and lower quantity prices. From 1 M.H. to 10 M.H., \$2.50 per coil, \$3.50 for two, etc. 10-50 M.H., \$3.00 per coil, \$4.00 for two, etc. Accuracy better than 1 percent when required for pure inductance. These coils make excellent inductance standards.

# DELTA RADIO COMPANY

Phone  
REctor 2-6650

135 Liberty St., New York, N. Y.

## INSURANCE WITHOUT DUES

**A** WILL insures a man's wife or beneficiary of all his possessions, at a cost of only **ONE DOLLAR**. No other dues or assessments.

An insurance policy is canceled unless dues are regularly paid for years. A WILL often gives better protection. It lasts forever without other payments.

Our Booklet of Standard Wills with extra legal special clauses to cover most any special thing desired, makes it easy to write your own Last Will and Testament in secret without other legal advice.

Simply copy the Will you like best, fill in your names and personal details on the legal blank Will form that comes with Booklet, sign and have it properly witnessed as per our directions. Then you have a perfectly legal non-breakable Will.

Mail us only **ONE DOLLAR** for Will Booklet and legal Will form blank complete.

*Money Back if not satisfied.*

Address:

Dept. F. C. 38, RADIO WORLD,  
145 West 45th Street, New York City.

## A COMBINATION OFFER! RADIO WORLD and "RADIO NEWS" **\$3.50**

Canadian and Foreign, \$1.50 extra on this offer.

You can obtain the two leading radio technical magazines that cater to experimenters, service men and students, for one year each, at a saving of \$1.50. The regular mail subscription rate for RADIO WORLD for one year is \$2.50. Send in \$1.00 extra, get "Radio News" also for a year—a new issue each month for twelve months. Total 24 issues for \$3.50 and \$5.00 to foreign countries.

RADIO WORLD 145 West 45th Street, N. Y. City

## COIL WINDING; NO COMPUTATION!

**S**OLENOIDS for all radio frequencies, from the fringe of the ultra highs, to the fringe of audio, may be wound, using popular wire sizes and form diameters, with no computation, yet at 1% accuracy. This is made possible by a series of quick-answer charts constituting "The Inductance Authority," by Edward M. Shiepe, plus an 18 x 20" supplement.

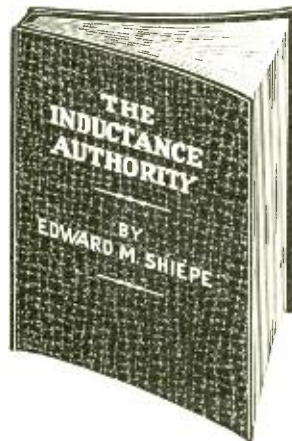

Winding solenoid coils for radio frequencies requires knowledge of the number of turns of any selected type of wire on any sensible diameter to attain an inductance suitable for the tuning condenser and lowest frequency. Hence, with capacity and frequency known, there are two unknowns: (1), the required inductance; (2), the number of turns to establish that inductance. The answers are obtained by consulting "The Inductance Authority," and the supplement. On the large supplement are

plotted the "curves of frequency, capacity and inductance in straight lines, so for a desired low frequency and known capacity the unknown inductance is solved by mere inspection. The number of turns for attainment of that inductance, for all popular tubing diameters and all generally used wire diameters and wire insulations, is read from the inductance-turns charts which are in the bound volume. Coil and set manufacturers, as well as home and shop experimenters, students and teachers freely use this book. The only book of its kind in the world.

Order Cat. INA (price includes bound volume and supplement) postpaid **\$2.00** anywhere on earth.....

Or send \$5.00 for a two-year subscription for RADIO WORLD, regular rate, and this valuable book and supplement will be sent FREE and postpaid anywhere on earth.

Order Cat. PR-IAC.

## RADIO WORLD

145 West 45th Street New York City



Now—a high powered

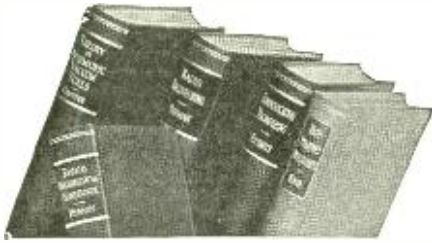

# Radio Engineering Library

—especially selected by radio specialists of McGraw-Hill publications

—to give most complete, dependable coverage of facts needed by all whose fields are grounded on radio fundamentals

—available at a special price and terms.

These books cover circuit phenomena, tube theory, networks, measurements, and other subjects—give specialized treatment of all fields of practical design and application. They are books of recognized position in the literature—books you will refer to and be referred to often. If you are practical designer, researcher or engineer in any field based on radio, you want these books for the help they give in hundreds of problems throughout the whole field of radio engineering.

5 volumes, 2891 pages, 2000 illustrations

1. **Everitt's COMMUNICATION ENGINEERING**
2. **Terman's RADIO ENGINEERING**
3. **Chaffee's THEORY OF THERMIONIC VACUUM TUBES**
4. **Hund's HIGH-FREQUENCY MEASUREMENTS**
5. **Henney's RADIO ENGINEERING HANDBOOK**

10 days' examination. Special price. Monthly payments \$26.00 worth of books cost you only \$23.50 under this offer. Add these standard works to your library now; pay small monthly installments, while you use the books.

### SEND THIS ON-APPROVAL COUPON

RADIO WORLD,  
143 West 45th St., N. Y. City.

Send me Radio Engineering Library, 5 vols., for 10 days' examination on approval. In 10 days I will send \$23.50, plus few cents postage, and \$3.00 monthly till \$33.50 is paid, or return books postpaid. (We pay postage on orders accompanied by remittance of first installment.)

Name .....

Address .....

City and State .....

Postion .....

Company ..... R.W. 4-38

## TREASURE-HUNTING CIRCUITS

By J. E. ANDERSON

Radio devices for locating buried treasure, deposits of ore bodies, etc., open a vast field for potential riches. A detailed discussion by J. E. Anderson appeared in the January, 1938, issue. Send 25c for a copy

RADIO WORLD  
145 West 45th St., N. Y. City

## SPECIAL 2-FOR-1 OFFER RADIO WORLD

Radio World is \$2.50 a year (12 issues), 25c. per copy. Canada and foreign, \$3.00 yearly. Offers of Radio World and other worthwhile publications for one full year on each (NET):

- RADIO WORLD and SHORT-WAVE and TELEVISION, \$3.50.
- RADIO WORLD and POPULAR SCIENCE MONTHLY, \$3.50.
- RADIO WORLD and RADIO-CRAFT (12 issues), \$3.50.
- RADIO WORLD and RADIO INDEX (monthly, 10 issues), stations, programs, etc., \$3.50.
- RADIO WORLD and EVERYDAY SCIENCE AND MECHANICS (monthly), \$3.50.
- RADIO WORLD and BOYS' LIFE (monthly, 12 issues), \$3.50.
- RADIO WORLD and TRUE STORY (monthly), \$3.00.

Select any one of these magazines and get for an entire year by sending in a year's subscription for RADIO WORLD at the regular price, \$2.50, plus a small additional amount, per quotations above. (Add \$1.50 for extra foreign or Canadian postage for both publications.)

Name .....

Address .....

City and State.....

- If renewing an existing or expiring subscription for RADIO WORLD, put cross in square.
- If renewing an existing or expiring subscription for other magazines, put cross in square.

Special Trial Offer for Radio World only: \$1.00 for 5 months, postpaid. Mail order with remittance to Radio World Office. NET.

RADIO WORLD, 145 W. 45th St., New York

## Make Your Present 'Phones FIDELITY



Cross-section shows where the acoustical labyrinth is located. Upper illustration shows the channels in the mould that comprise half the labyrinth. Approved by Radio World Laboratories.

A NEW earcap, suitable for all popular earphones, when replacing present caps, gives sweeter, clearer, better response. Speech intelligibility is made far higher, and the enjoyment of symphonic orchestras becomes a reality. You enjoy real fidelity.

The invention consists of an acoustical labyrinth in the moulded Bakelite caps. This also prevents mechanical vibration, thus sparing the ears. There is no diaphragm rattle even on loudest signals.

In 'phones with ordinary caps there is strong artificial high audio frequency response due to this diaphragm rattle.

Artificial response is eliminated by the new caps. All response is due only to what is in the wave and not to spurious conditions in the 'phones. Background noise is greatly diminished.

Because of these corrections, the usual low-frequency limit of 'phones, which is around 600 to 800 cycles, is extended to 60 cycles, while there is no attenuation of natural response in the high audio-frequency region. The response is flattened by bringing it up where it is down. All is gain.

Immediate delivery is obtainable of these caps for the following makes of 'phones: Baldwin, Ambassador, Brandes, Cannonball, Globe, Kellogg, Murdock, Radiocar, Solid, Trimm Featherweight, Trimm Professional and Western Electric. Two caps required for each pair of 'phones are pre-threaded to screw on in place of ordinary caps.

Send for Illustrated Circular

### POUL JARNAK

Inventor and Manufacturer  
Dept. RW-4 69 W. 83rd St.—New York, N. Y.

## QUESTIONS ANSWERED

If you have trouble with your set, send in a detailed account of symptoms, with circuit diagram, and 28c. in stamps or coin, and Radio World's staff will make a diagnosis and report back promptly.

### RADIO WORLD

145 West 45th Street New York City

When writing to Advertisers please mention that you saw the Advertisement in RADIO WORLD.



Everything you need in radio. It's all in this new **RADOLEK RADIO PROFIT GUIDE**. Every repair part for every receiver. Newest radio receivers. New 1938 model public address amplifiers, outputs for 5 to 100 watts. New model public address speakers. Test instruments. Technical books. Special equipment. Leading standard brands. Every item guaranteed. It must be right or we make it right.

And everything under one roof. You get what you want promptly, and exactly what you want. Radolek's immense stock plus Radolek's efficient organization insures you fastest service. 25,000 service men depend on this service and benefit by Radolek's lowest prices. Send now for your copy of Radolek's **RADIO PROFIT GUIDE**. Every repair part for every remedy.

### ---RADOLEK---

601 W. Randolph, Chicago, Dept. G-17

Send me the 1938 Radolek Radio Profit Guide **FREE**.

Name .....

Address .....

Serviceman?  Dealer?  Experimenter?

## You need . . . these 2 books

### RADIO SERVICING SHORT-CUTS

and Money Making Ideas

A completely new and different book tells how radios may be repaired quickly with the absolute minimum of test equipment. Proves that by an actual test 9 out of 10 radios can be fixed with simple tools and volt-ohmmeter. The author, M. N. Heitman, for years in the servicing profession, realized and kept data on these facts. Page after page of practical information. Many real money making ideas and hints applicable to all sets (Size: 8 1/2 x 11 in.)

### PUBLIC ADDRESS SYSTEMS

A practical handbook, full of useful information, fully illustrated. Considers in detail various microphones, radio and phonograph inputs, acoustic feed-back, mixing and volume controls, use of vacuum tubes, interstage coupling, power amplifiers, output coupling, loud speaker placement, the decibel, P.A. measurements, power level, and other points of importance, including actual circuit diagrams of tested P.A. systems.

Price, 50c each book.

### SUPREME PUBLICATIONS

3727 West 13th St., Chicago, Illinois

# PRECISION PARTS

*Joe*

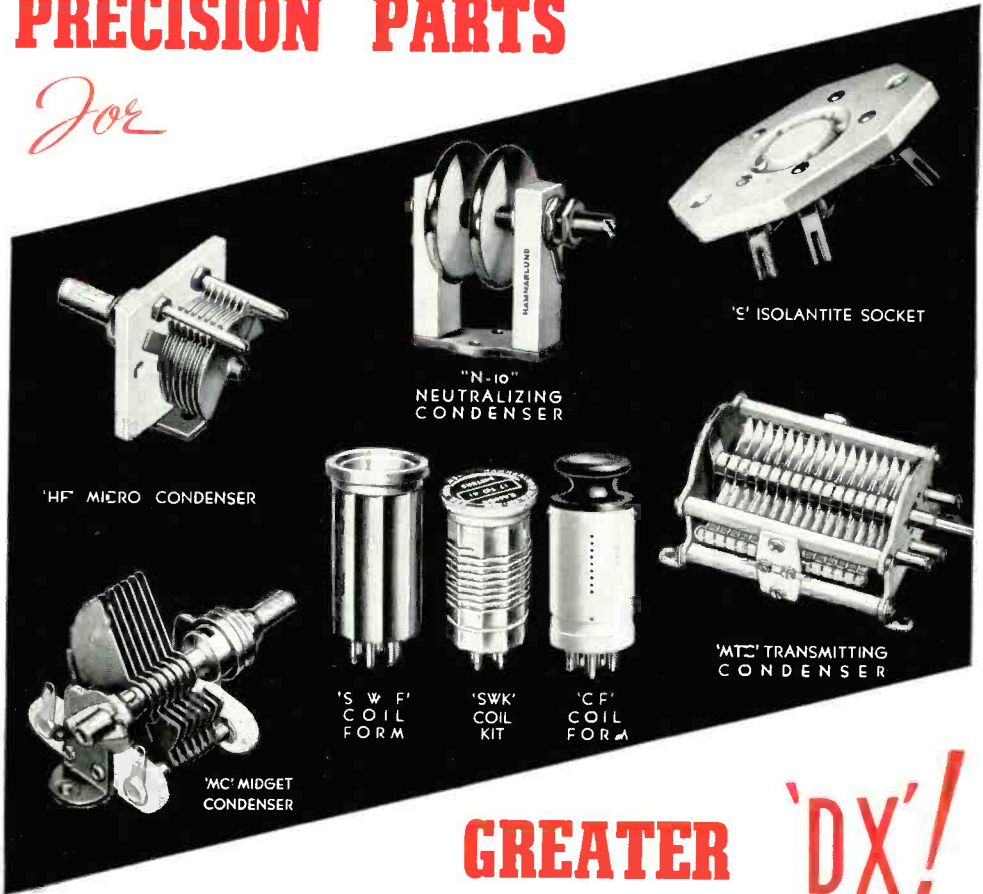

## GREATER 'DX'!

FOR over a quarter of a century, amateurs and professional operators have been using Hammarlund "precision products" in their receivers and transmitters. The unflinching service of these thoroughly engineered parts has made them the choice of experts. As an example, you will find "MC" midgets, and "HF" micro condensers built into nearly every amateur receiver and low-power exciter unit. These condensers are solidly constructed with heavy brass plates which are soldered into place and cadmium plated for highest possible efficiency. Isolantite insulation makes these condensers ideal for high and ultra-high frequency work.

"MTC" and "N-10" condensers, with their highly polished round edged plates are companion units designed for medium power

amplifiers requiring husky tank condensers and really effective neutralizing condensers.

For real "DX" incorporate these condensers, as well as Hammarlund coils, coil forms, R.F. chokes and sockets in your new rig. Be safe, go Hammarlund all the way! Send for complete 1938 catalog.

HAMMARLUND MFG. CO., INC. RW-4  
424-438 W. 33 St., N. Y. City

Please send me new "38" catalog

Name .....

Address .....

City..... State.....



# HAMMARLUND

# ASK YOUR JOBBER TO SHOW YOU THE DIFFERENCE

**Model 735  
Pocket Volt-Ohm-  
Milliammeter  
does all your  
D. C. Testing**

*Readrite*  
TESTERS **RANGER** METERS *has*

★ **MOLDED CASE**

A totally insulated case of great strength, beautiful appearance and extremely durable.

★ **LOW LOSS SELECTOR SWITCH**

Without a selector switch much more time must be spent in testing . . . no wires to plug in for changing ranges; special low loss switch minimizes contact errors.

★ **BATTERY TEST LEADS and ACCESSORIES INCLUDED**

You do not have to pay extra for this essential equipment.

★ **ACCURACY**

Guaranteed within 2%, comparing with the precision of the most elaborate testers. High class material and workmanship means this tester will maintain its accuracy.

Model 735 has a Triplett D'Arsonval type precision instrument with easily readable scales. Ranges are 15-150-750 volts at 1000 ohms per volt; 1 1/2-15-150 M.A.; 1/2-1000 low ohms; 0-100,000 high ohms at 1 1/2 volts. Provisions for external batteries for higher resistance measurements. Has selector switch for all ranges and individual zero adjustment for resistance measurements. Silver and black etched panel.



**DEALER PRICE . . . Complete**

**PRECISION  
BUILT  
ONLY**

**\$10.80**

*Readrite*  
TESTERS **RANGER** METERS

READRITE METER WORKS,  
427 College Ave., Bluffton, Ohio

Please send me more information on Model 735.

I am also interested in . . . . .

Name . . . . .

Address . . . . .

City . . . . . State . . . . .