

WWW.MONITORINGTIMES.COM

Scanning - Shortwave - Ham Radio - Equipment  
Internet Streaming - Computers - Antique Radio



# Monitoring<sup>®</sup> Times

A Publication of Grove Enterprises

Volume 32, No. 4  
April 2013  
U.S. \$6.95  
Can. \$6.95  
Printed in the  
United States

## BROADCASTING & “SOFT POWER” DIPLOMACY



### ***In this issue:***

- China vs. the West on Shortwave
- Chinese Broadcasting Expansion
- MT Reviews: Cambridge Soundworks  
Ambiance Touch and FunCube Dongle Pro+

# GROVE

## Your Source for Radio Scanners, Receivers, Accessories, and Publications

### AOR

AR-8600II	RCV11	\$989.95
AOR SR2000A (B)	RCV36	\$3,199.95
AR2300B	RCV60	\$3,809.95
AR5001D (B)	RCV68	\$4,499.95
AOR AR-ALPHA	RCV01	\$CALL

### KAITO

KA801	RCV61	\$79.95
KA1103	RCV55	\$89.95
KA1121	RCV37	\$149.95

### SANGEAN

ATS-909X (Black)	RCV67-BK	\$259.95
ATS-505P	RCV7	\$109.95
ATS-909X	RCV67	\$259.95
WFR-20	RCV40	\$239.95
WFR-1	RCV56	\$279.95

### GRUNDIG

S450DLX Field Radio	RCV70	\$99.95
G3	RCV65	\$99.95
Satellit 750	RCV58	\$299.95

### ICOM

R75	RCV32	\$719.95
R2500	RCV52	\$879.95
IC-R9500	RCV27	\$CALL

### PERSEUS

RCV57	\$999.95
-------	----------

### BONITO

RadioJet 1102S	RCV71	\$699.95
----------------	-------	----------

### Crane

CC Radio-EP	RCV72	\$64.95
-------------	-------	---------

### WINRADIO

WR-G33EM	RCV16	\$949.95
WR-G33WSM	RCV28	\$949.95
WR-G313 (Internal)	RCV31	\$1149.95
WR-G313 (External)	RCV31-E	\$1149.95
WR-G313i/180	RCV31/MOD04	\$1,399.90
WR-G313e/180	RCV31E/MOD04	\$1,399.90
WR-G305e/WFM/PD	RCV63P/MOD09	\$899.95
WR-G305i	RCV53	\$699.95
WR-G305i w/pro demodulator	RCV53P	\$799.95
WR-G305e	RCV63	\$699.95
WR-G305e w/pro demodulator	RCV63P	\$799.95
WR-G315 (Internal)	RCV54	\$CALL
WR-G315 (External)	RCV64	\$CALL
WR-G31DDC Excalibur	RCV66	\$899.95
WR-G33DDC Excalibur Pro	RCV62	\$CALL
G39DDCi Excelsior (Internal)	RCV69	\$CALL
G39DDCe Excelsior (External)	RCV69E	\$CALL
WR-G39WSBe SONOBUOY	RCV39E	\$CALL
WR-G39WSBi SONOBUOY	RCV39I	\$CALL

**Grove means service. You won't find better customer service anywhere. BUY TODAY!**

Established in 1979 by well-known communications expert Bob Grove, Grove Enterprises has become a world leader in radio monitoring equipment, accessories, and publications.

If you decide you don't like a product, Grove Enterprises doesn't penalize you for it. There is NO restocking fee so long as you call our toll free number for a return authorization within fifteen days of shipment and the item is returned in new condition. Once the item is received we will give you credit toward another item or issue a full refund (less shipping charges). Software cannot be returned if opened.

That's it! No hassle! No negotiations! Just call 1-800-438-8155 and our friendly staff will assist you with a return authorization number.

### WiNRADiO Accessories

WR-BT-3500 VHF/UHF Power Injector (BIAS T)	ACC29	\$99.95
Mounting Clamps for AX-71C	ACC71	\$18.95
WR-LWA-0130 long-wire antenna adaptor	ADP35	\$39.95
AX-71C discone antenna	ANT01	\$89.95
AX-37A wide-band log-periodic antenna	ANT28	\$389.95
AX-37AM wide-band log-periodic antenna	ANT29	\$499.95
AX-07B flexible VHF/UHF antenna	ANT47	\$27.95
AX-91M magnetic antenna base	ANT48	\$27.95
AX-81S active HF antenna	ANT51	\$189.95
WR-AX-31C	ANT58	\$189.95
AX-17C indoor active HF antenna	ANT60	\$189.95
AX-24B discone antenna	ANT63	\$319.95
WR-G3E-WMB Wall-mount Bracket for G3	BRK02	\$17.95
WR-DNC-3500 Frequency downconverter	CVR02	\$219.95
FSK Decoder	DEC01	\$379.95
WR-LNA-3500 low noise amplifier	PRE03	\$189.95
WR-PPS-G3 portable power supply for G3	PWR09	\$189.95
ERD-1500 RF Sniffer	TST06	\$49.95
WR-AMFE-3500 MULTIPLEXER (special order)	ACC13	\$1,195.00
WR-BT-650 HF/VHF POWER INJECTOR (BIAS T)	ACC15	\$99.95
WR-CMC-30 COMMON-MODE CHOKE	ACC20	\$49.95
WR-AMFE-8600 MULTIPLEXER (special order)	ACC34	\$CALL
WR-ACD-1800 DUAL COMBINER (special order)	ACC39	\$189.95
WR-AX-37AH (special order)	ANT65	\$499.95
WR-AX-31CX (special order)	ANT66	\$189.95
AX-06B VHF/UHF ANTENNA (special order)	ANT68	\$29.95
WR-AX-31CMX (special order)	ANT69	\$289.95
AX-05E LONG WIRE HF ANTENNA	ANT71	\$39.95
WR-DASP-2500 Dual-action Surge Protector	LAR02	\$49.95

### Shipping/Handling Charges (UPS Ground)

Total Order	Shipping Charges
\$1-\$19.99	\$7.95
\$20-\$99.99	\$17.95
\$100-\$399.99	\$19.95
\$400-\$899.99	\$22.95
\$900-\$1499.99	\$25.95
\$1500-\$1999.99	\$26.95
\$2000-\$2499.99	\$28.95
\$2500+	\$32.95

Make sure to  
visit us on the  
web to get  
the latest and  
greatest deals!

# GROVE

## (800) 438-8155

Grove Enterprises, Inc. - [www.grove-ent.com](http://www.grove-ent.com)

(800) 438-8155; (828) 837-9200; fax: (828) 837-2216

7540 Hwy 64 W; Brasstown, NC 28902 - email: [order@grove-ent.com](mailto:order@grove-ent.com)

**With a WiNRADiO receiver you are always onto a winner. And now you can also win\* one.**

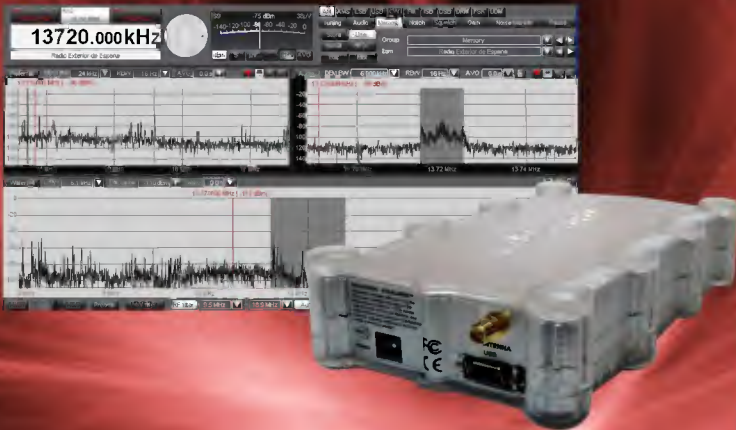

### WinRadio Excalibur Pro

WinRadio's software measurement products but it is abundantly clear that the Excalibur Pro is better than anything we have hitherto encountered. To be able to connect a full-size 6/7MHz dipole to a receiver on an autumn evening and be able to observe the sideband sets of individual broadcasters down to virtually the receiver's noise floor is – to put it mildly – an unusual position for a reviewer to find himself in! Certainly the Excalibur Pro was not remotely troubled at any time by anything our various antennas could throw at it.

#### CONCLUSION

The Excalibur Pro is the best SDR we have used – In some ways it is the best receiver we have used regardless of the underlying architecture –

[www.wrth.com](http://www.wrth.com)

Overall rating ★★★★★

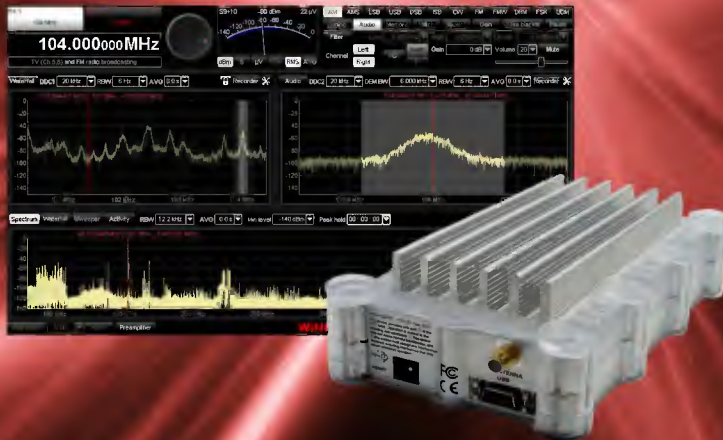

### review

Mike Richards takes a look at the WiNRADiO G39DDC Excelsior, a receiver that some might consider the best software defined radio currently available.

If there's one thing that is likely to be at the top of a radio enthusiast's wish list, it's a system that can find signals quickly. The WiNRADiO G39DDC Excelsior certainly has the ability to do this and it must be something close to a dream receiver.

#### summary

Now, the WiNRADiO G39DDC Excelsior is a stunning receiver and a dream for me. Now, I have only really covered the most interesting aspects of its performance.

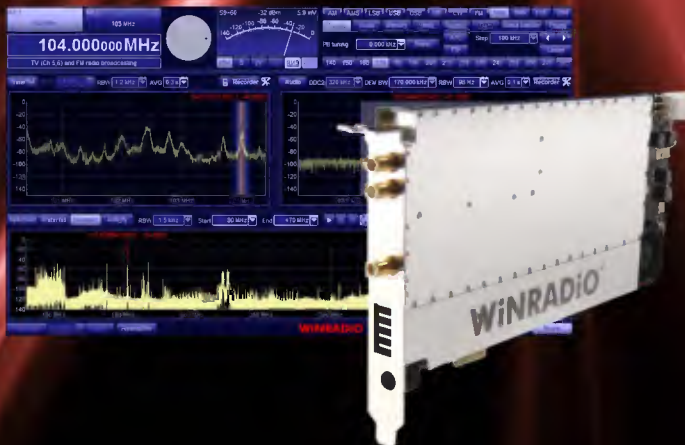

### FIRST LOOK

MT Takes a Look at the Latest Tech

By Bob Grove, W8JHD

This is the most amazing receiver I've ever encountered. It employs the latest proven SDR architecture, operates well beyond the spectral range that most of us would ever think of trying to hear, and demodulates all conventional modes.

I ordinarily find something to complain about in my reviews, but trying to find something I don't like about the G39DDC has left me at a loss, and that's a gain for this winner.

\* Yes, this does mean get one for free. Go to this web page for details:

[www.winradio.com/mt](http://www.winradio.com/mt)

WiNRADiO® by RADIXON®: Great receivers ahead of their time.™



## International Broadcasting and "Soft Power" Diplomacy

Much has been made over the past decade of the declining numbers of people worldwide tuning into shortwave broadcasts. In what amounts to a self-fulfilling prophecy, the constantly crimped budgets and closure of transmitting facilities worldwide of the BBC World Service and Voice of America has indeed resulted in fewer listeners. Seeing the declining numbers, budgeteers urge even more cutbacks in a cycle of international broadcasting decline.

That's not happening in China. Awash in money from balance-of-trade excesses and a mandate from its government to increase its on-air presence, China Radio International (CRI) and China Central TV (CCTV) rule the airwaves and satellite channels.

In this month's cover story we get two perspectives on the issue. First, from Keith Perron, former CRI broadcaster, who chronicles the rise of CRI on the global broadcast stage, and second from Azizul Alam Al-Amin, a Bangladesh-based radio researcher and journalist who explains how China has come so far so quickly.

### On Our Cover

*Voice of America shortwave transmitting antenna. (Courtesy: Broadcasting Board of Governors)*

## C O N T E N T S

### International Broadcasting: China vs. the West.....8

By Keith Perron

Former China Radio International broadcaster Keith Perron gives us an insider's view of how China has emerged in the last ten years as a dominant global broadcast and satellite player.

With an enormous budget that comes from a dozen different sources, China can do what no other developed country can today: Spend lavishly across the continents to build up its listenership, gain international respect and set the agenda for global reporting and programming.

### Chinese Broadcasting Expansion..... 10

By Md. Azizul Alam Al-Amin

While the rest of the world's economies struggle, China's still healthy economy has allowed it to leapfrog its way to the top of the international broadcasting leader board. China's "soft-power" diplomacy is winning friends and influencing enemies throughout the world with a massive presence on shortwave, satellite, even local TV and AM/FM radio. The message, says Alam Al-Amin is, "China's broadcasting media is booming and today it sees more opportunity than challenges."

### The Lafayette Surprise: Political Intrigue and Radio.... 12

By Rich Post KB8TAD

In the process of writing the article "60 Years of Lafayette Radio," which appeared in the December 2012 *MT*, author Rich Post KB8TAD came across some interesting background material on one of the major shareholders of Lafayette Radio and his activities involving radio and political intrigue pre and post WWII. This month Rich shares that story.

### Why I listen to Shortwave: Musings of a Preacher-DXer ..... 14

By Ed Kelly, Jr.

While some might find the great quantity of religious broadcasters on the shortwave bands tedious, it's right up Ed Kelly, Jr.'s aisle. The preacher-DXer explains why he's been tuning into these broadcasters since 1991 even though what he hears may often not be from kindred spirits.

### Xtreme Operating: New challenges for veteran hams..... 15

By Ken Reitz KS4ZR

What's a ham to do after he or she has logged the last DXCC entity, state, zone, county, island and lighthouse? Do it all over again, but this time make it really difficult. Put away the HF beam antenna, the linear amplifier, the 100 watt rig, even the QRP rig. Go down to zero and see what happens!

## R E V I E W S

### FunCube Dongle Pro+ .....56

By Bob Grove W8JHD

What's not to like about a Software Defined Radio that fits in a watch pocket, tunes 150 kHz through 260 MHz and 410 MHz through 2GHz in AM, NFM, WFM USB, LSB, DSB, CW-U, and CW-L modes? It's not available from U.S. sources but only through its U.K. originator. That didn't stop Bob Grove from thoroughly checking it out.

### Sangean WFR-28 WiFi/FM Radio.....57

By Larry Van Horn N5FPW

WiFi radios are great for tuning in worldwide radio stations, if you have a decent Internet connection and a home router to wirelessly connect your WiFi radio. But, when the connection goes down, what then? The Sangean WFR-28 has built-in FM band to pick up the slack when your Internet connection goes down - and that's just part of its attraction.

# AR6000 Professional Grade 40 kHz ~ 6 GHz Wide Range Receiver

Now tunes  
to 6 GHz

## Continuous Coverage That Goes Far Beyond!



**The AR6000** delivers continuous tuning from 40 kilohertz to 6 gigahertz in a wide variety of modes for professional monitoring performance that's nothing short of amazing in terms of accuracy, sensitivity and speed. Standard modes include AM, FM, WFM, FM Stereo, USB, LSB and CW. An optional module can add the capability to receive APCO25 digital communications plus an optional I/Q output can be added to capture up to one megahertz of bandwidth onto a storage device for later listening or signal analysis.

Designed for the monitoring or technical service professional, there are no interruptions in the AR6000's tuning range. With exceptional tuning accuracy and sensitivity throughout its tuning range, the AR6000 begins at the floor of the radio spectrum and continues up through microwave frequencies so it can be used for land-based or satellite communications. It works as a measuring receiver for those seeking a reliable frequency and signal strength standard. To support its broad spectrum, the AR6000 has two antenna ports, with the added capability of an optional remote antenna selector from the front panel of the receiver.

With its popular analog signal strength meter and large easy-to-read digital spectrum display, the AR6000 is destined to become the new choice of federal, state and local law enforcement agencies, the military, emergency managers, diplomatic service, lab technicians, news-gathering operations and security professionals.

*Continuously amazing, the AR6000 professional grade receiver features:*

- 40 kHz ~ 6 GHz coverage with no interruptions
- Multimode AM, FM, WFM, FM Stereo, USB, LSB and CW
- Tuning steps of 1 Hz up to 3.15 GHz; 2 Hz from 3.15 ~ 6 GHz
- Receiver is programmable and manageable through a USB computer interface
- Up to 2,000 alphanumeric memory channels
- Analog S-meter, large tuning dial, front panel power, volume & squelch controls
- Direct frequency input
- Fast Fourier Transform algorithms
- An SD memory card port can be used to store recorded audio
- Two selectable antenna input ports plus optional remote antenna selector

**Add to the capabilities of the AR6000 with:**

- Optional APCO-25 decoder
- Optional interface unit enables remote control via the internet
- Optional I/Q output port allows capture of up to 1 MHz onto a computer hard drive or external storage device



® The Serious Choice in Advanced Technology Receivers

**AOR U.S.A., Inc.**  
20655 S. Western Ave., Suite 112  
Torrance, CA 90501, USA  
Tel: 310-787-8615 Fax: 310-787-8619  
info@aorusa.com • www.aorusa.com



Available in the US only to qualified purchasers with documentation. Specifications subject to change without notice or obligation.



**MONITORING TIMES**  
(ISSN: 0889-5341;  
Publishers Mail Agree-  
ment #1253492) is  
published monthly by  
Grove Enterprises, Inc.,  
Brasstown, North Caro-  
lina, USA.

Copyright © 2013 Grove Enterprises, Inc. Periodicals postage paid at Brasstown, NC, and additional mailing offices. Short excerpts may be reprinted with appropriate credit. Complete articles may not be reproduced without permission.

**Address:** 7540 Highway 64 West,  
Brasstown, NC 28902-0098  
**Telephone:** (828) 837-9200  
**Fax:** (828) 837-2216 (24 hours)  
**Internet Address:** [www.grove-ent.com](http://www.grove-ent.com) or  
[www.monitoringtimes.com](http://www.monitoringtimes.com)  
**Editorial e-mail:** [editor@monitoringtimes.com](mailto:editor@monitoringtimes.com)  
**Subscriptions:** [order@grove-ent.com](mailto:order@grove-ent.com)

Subscription Rates: \$19.95 MTXpress; \$32.95 in US; \$42.95 Canada; and \$58.95 foreign elsewhere, US funds. Label indicates number of issues left. Renewal notice is cover sheet 3 months before expiration. Subscribe at [www.monitoringtimes.com](http://www.monitoringtimes.com).

**WRITE FOR MONITORING TIMES:**  
Learn how at  
[www.monitoringtimes.com/html/write\\_for\\_mt.html](http://www.monitoringtimes.com/html/write_for_mt.html) or  
write to [editor@monitoringtimes.com](mailto:editor@monitoringtimes.com)

**Postmaster:**  
Send address changes to *Monitoring Times*,  
7540 Highway 64 West, Brasstown, NC  
28902-0098.

**Disclaimer:**  
While *Monitoring Times* makes an effort to ensure the information it publishes is accurate, it cannot be held liable for the contents. The reader assumes any risk for performing modification or construction projects published in *Monitoring Times*. Opinion or conclusions expressed are not necessarily the view of *Monitoring Times* or Grove Enterprises. Unsolicited manuscripts are accepted. SASE if material is to be returned.

**Subscription Questions?**  
[belinda@grove-ent.com](mailto:belinda@grove-ent.com)

**Owners**  
Bob and Judy Grove  
[judy@grove-ent.com](mailto:judy@grove-ent.com)

**Publisher**  
Bob Grove, W8JHD  
[bobgrove@monitoringtimes.com](mailto:bobgrove@monitoringtimes.com)

**Managing Editor**  
Ken Reitz, KS4ZR  
[editor@monitoringtimes.com](mailto:editor@monitoringtimes.com)

**Assistant and Reviews Editor**  
Larry Van Horn, N5FPW  
[larryvanhorn@monitoringtimes.com](mailto:larryvanhorn@monitoringtimes.com)

**Editor Emeritus**  
Rachel Baughn, KE4OPD

**Art Director**  
Bill Grove

**Advertising Services**  
Larry Van Horn, N5FPW  
(828) 837-9200  
[advertising@monitoringtimes.com](mailto:advertising@monitoringtimes.com)

## TABLE OF CONTENTS

<b>Letters</b> .....	<b>6</b>	<b>QSL Report</b> .....	<b>29</b>
<i>Former MT Columnist Jacques d Avignon VE3V1A SK; Happy O1A-TV Viewer; Would Synchronous Detection help the Satellit 750?; P-25 Type 2 Reception?; VOA Sheds Smith-Mundt Act; Hooked on HD-Radio</i>		<i>By Gayle Van Horn W4GVH UPC Introduces new IRC</i>	
<b>Communications</b> .....	<b>7</b>	<b>English Language SW Guide</b> .....	<b>30</b>
<i>World Amateur Radio Day; German Ham Numbers Decline; Iowa Radio Specs Skewed to Motorola Charged; FCC Fumbles Cyber-Security Hack; FCC Report: Satellite Broadband Faster than Claimed; Bogus EAS Alert Warns of Zombie Attacks</i>		<b>Milcom</b> .....	<b>42</b>
<b>Scanning Report</b> .....	<b>16</b>	<i>By Larry Van Horn N5FPW Who's Who in the 30-88 MHz Government Spectrum</i>	
<i>By Dan Veeneman First Responders Network Authority</i>		<b>Broadcast Bandscan</b> .....	<b>44</b>
<b>Ask Bob</b> .....	<b>19</b>	<i>By Doug Smith W9WI AM Time Machine</i>	
<i>By Bob Grove W8JHD RFID chips in firearms?; Static discharge antenna connectors; Replacement components for a battery charger; Tuning 1:1 and 4:1 baluns; Antennas used on locomotives; Can cell phone be tracked when "c,f"?; Can 15 Amp service handle 1 kW linear amp?; CONELRAD stations: who stayed on the air?; What's a "Honda-clone" generator?; What makes a good noise antenna?; Where to mount marine antenna; Support for an Enafedz antenna; Will two 10 amp fuses wired together in parallel blow at 20 amps?</i>		<b>BOATS, Planes, Trains</b> .....	<b>46</b>
<b>Utility World</b> .....	<b>20</b>	<i>By Ron Walsh VE3GO Top Maritime Monitoring Frequencies</i>	
<i>By Hugh Stegman NV6H Making Sense of ALE Addresses</i>		<b>Below 500 kHz</b> .....	<b>48</b>
<b>Digital Digest</b> .....	<b>23</b>	<i>By Kevin Carey WB2QMY In Tribute to Jacques d Avignon VE3V1A</i>	
<i>By Mike Chace The Strange Case of Napa and Lion</i>		<b>Radio Restorations</b> .....	<b>50</b>
<b>On the Ham Bands</b> .....	<b>24</b>	<i>By Marc Ellis N9EWJ Buttoning up the S-38D</i>	
<i>By Kirk Kleinschmidt NT0Z Band Openings in a Brave New World</i>		<b>Antenna Topics</b> .....	<b>52</b>
<b>Beginner's Corner</b> .....	<b>26</b>	<i>By Kent Britain WA5VJB Facets of Capacitors</i>	
<i>By Ken Reitz KS4ZR Innovative WiFi Radio (Almost) has it All</i>		<b>Computers and Radio</b> .....	<b>54</b>
<b>Programming Spotlight</b> .....	<b>28</b>	<i>By Brian Wood W0DZ Ham Radio Deluxe 6.0: Worth the Wait!</i>	
<i>By Fred Waterer Spring and an SWL's Thoughts Turn to... Radio</i>		<b>First Look</b> .....	<b>56</b>
<b>Letters</b> .....	<b>6</b>	<i>By Bob Grove W8JHD FunCube Dongle Pro+</i>	
<b>QSL Report</b> .....	<b>29</b>	<b>First Look</b> .....	<b>57</b>
<b>English Language SW Guide</b> .....	<b>30</b>	<i>By Larry Van Horn N5FPW Sangean WFR-28 WiFi Radio</i>	
<b>Milcom</b> .....	<b>42</b>	<b>Global Net</b> .....	<b>58</b>
<b>Broadcast Bandscan</b> .....	<b>44</b>	<i>By Loyd Van Horn Want to Give Back? Share your Signals with the World!</i>	
<b>BOATS, Planes, Trains</b> .....	<b>46</b>	<b>What's New</b> .....	<b>59</b>
<b>Below 500 kHz</b> .....	<b>48</b>	<i>By Larry Van Horn N5FPW New go2MONITOR Decoding Software Released; Amateur Radio Public Service Handbook; Sangean WR-22 FM-RBDS/AM/USB/Bluetooth Digital Receiver; Icom ID-51A Dual Band HT</i>	
<b>Radio Restorations</b> .....	<b>50</b>		
<b>Antenna Topics</b> .....	<b>52</b>		
<b>Computers and Radio</b> .....	<b>54</b>		
<b>First Look</b> .....	<b>56</b>		
<b>First Look</b> .....	<b>57</b>		
<b>Global Net</b> .....	<b>58</b>		
<b>What's New</b> .....	<b>59</b>		

You may contact any MT staff writer by email by combining their **first and last name @ monitoringtimes.com**. By postal mail, you may write them in care of MT Headquarters in Brasstown. Please enclose a self-addressed, stamped envelope if you wish the columnist to reply.

# MTXpress

**FULL COLOR!**

**THE Magazine for every  
radio enthusiast is now  
fully digital!**



*“Just downloaded the August issue, saved it in iBooks, and have read about half. Looks \*great\* on the iPad. This is definitely the way to go....”*



✓ **FAST DELIVERY**

Every issue is delivered right to your computer every month. No need to wait for the Post Office any longer!

✓ **PRINTABLE**

If you want a hard copy of any or all of the issue, you can print it in high-resolution right to your own printer. It's even in full-color! (if you have a color-capable printer)

✓ **AFFORDABLE**

*“I continue to be very impressed with clarity of the electronic copy downloaded. The text size, the layout, colours etc are all outstanding – a first class job. To all those responsible WELL DONE”*

**Only \$19.95 per year or  
only \$11 in addition to  
your print subscription!**

Every month Monitoring Times brings you informative articles written by experienced hams and other radio experts to help you sharpen your listening skills – The latest frequency information, loggings of activity, in-depth reviews of radio equipment and accessories, background stories and schedules of international radio broadcasters, internet radio, amateur radio, and even antique radio.

**6 Month Subscription**

US 2nd Class: \$17.95

US 1st Class: \$32.95

Canada Air: \$35.95

Canada Surface: \$22.95

**1 Year Subscription**

US 2nd Class: \$32.95

US 1st Class: \$59.95

Canada Air: \$69.95

Canada Surface: \$42.95

**2 Year Subscription**

US 2nd Class: \$59.95

US 1st Class: \$119.00

Canada Air: \$125.95

Canada Surface: \$79.95

**3 Year Subscription**

US 2nd Class: \$89.95

US 1st Class: \$179.95

Canada Air: \$189.95

Canada Surface: \$119.95

**[www.grove-ent.com](http://www.grove-ent.com)**

**800-438-8155**

**[order@grove-ent.com](mailto:order@grove-ent.com)**

**Mention code MTAPR13 and as a thank you, you will get 15 ISSUES of MTXpress or 13 issues of MT Print Edition for the same price as a one-year subscription!**



# to the editors

editor@monitoringtimes.com

*This column is open to your considered comments. Opinions expressed here are not necessarily those of Monitoring Times. Your letters may be edited or shortened for clarity and length. Please mail to Letters to the Editor, 7540 Hwy 64 West, Brasstown, NC 28902 or email editor@monitoringtimes.com*  
**Happy monitoring!**  
**Ken Reitz, Editor**



**Jacques d'Avignon at SWL DXpedition Miscou3 (Courtesy: Ken Alexander VE3HLS)**

Longtime *MT* columnist and feature writer Jacques d'Avignon VE3VIA, whose column, "Propagation Conditions," ran monthly from the late 1980s to 2000, passed away February 7 in Ottawa, Canada following an illness. Jacques' column predicted propagation conditions each month for popular shortwave bands and his occasional feature articles were practical how-to guides to SWL and radio operating. He was instrumental in organizing SWL DXpeditions to the Canadian island of Miscou in New Brunswick. A tribute to Jacques may be found in Kevin Carey's "Below 500 kHz" column in this issue.

## Happy OTA-TV Viewer

Longtime *MT* reader Jim Davis, who lives near Chicago, writes:

"Referring to your article about Over-the-Air TV broadcasts on page seven ("Communications" column) of the March, 2013 issue of *Monitoring Times*, I am more inclined to agree with the *Wall Street Journal* survey that said eighteen percent of households still use Over-the-Air (OTA) television instead of cable or satellite-TV. In my neighborhood, I can clearly see 60 channels with my thirty year-old rooftop antenna. With cable being expensive, poor quality, and not transmitting *all* of the local stations, I see no reason to switch to watch mostly re-runs as well as miss viewing a number of our local stations.

"And, while the technology exists for a single receiver to receive DISH Network or DirectV satellite signals, the satellite companies want to charge a rental for each device a person has attached, in addition to the subscription fee. It's just a way to make more profit. It's no wonder so many people have cut their cables and gone back to over-the-air antennas."

## P-25 Type 2 Reception?

*MT* reader Richard Beckwell N3KGZ writes:

"I live in Prince Georges County, Maryland, and the Emergency Services have moved to 'Project 25 Motorola X2-TDMA.' The only radio proven to decode this was the GRE-800. Now that GRE is defunct, are any of the other manufacturers planning to take up the mantle?"

*MT* "Scanning Report" columnist Dan Veeman responds:

*I'm not aware of any forthcoming scanner that will be able to demodulate X2-TDMA. Because it was an interim solution prior to the finalization of the Phase II standard, there was an industry expectation that the X2-TDMA customers would eventually upgrade to Phase II. This expectation, along with the relatively few jurisdictions running X2-TDMA, may have swayed Uniden to skip implementing it.*

*Unfortunately, due to the expense of upgrading a X2-TDMA system to Phase II, some jurisdictions (including PG County) may choose to stay with what they already have. Given the waveform similarities, we can hope that when Uniden finally produces a Phase II compatible scanner that it's easy enough for them to add X2-TDMA as well.*

## Would Synchronous Detection help the Satellit 750?

*MT* reader Jonathan Coles writes:

"In your review of the 2013 Satellit 750 (*MT* February 2013 "First Look" by Larry Van Horn N5FPW page 56), I was surprised to read the following comment about synchronous detection: 'Synch detection over the years got way more hype by some as a must-have feature than it truly deserved.' Has the author never experienced a good synch detector? Perhaps he is nostalgic about noise and distortion, like those folks who prefer an LP to a CD.

"My first experience with synch detection was on the Sony ICF-SW7600G. It was a revelation. Even the local MW station's audio fidelity was noticeably improved. On shortwave, synch detection made weak and fading broadcasts intelligible that otherwise would have been obscured by noise and selective fade distortion. The ability to choose upper or lower sideband is a great help on crowded bands. The only downside was that the detector sometimes lost its lock.

"A few years later, I bought a Grundig Satellit 800, which I still use. Its synch detector is excellent. I only switch off 'AM Sync' to use SSB. Even with good reception conditions, regular AM detection has a harsh, slightly distorted sound that leads to listener fatigue. Including a synch detector in the Satellit 750 might help make up for its other shortcomings."

Larry Van Horn N5FPW, responds:

*Today, Digital Signal Processing (DSF) technology is much more effective than the much older synch detector. And now, with Software Defined Radio (SDR) technology coming onboard, we will probably see an end at some point to synch detection as we know it. Was synch detection a neat feature? Absolutely, depending on which version we are talking about. I must admit that the Sherwood version was truly a marvelous electronic achievement for its time. As for the Grundig Satellit 750, I really don't think that*

*synch detection is the answer for that radio. It's issues are much deeper and that feature won't help in that regard.*

## VOA sheds Smith-Mundt Act

Dave Trachtenberg, author of "MARS Operators in Haiti," *MT* May 2010, writes regarding the National Defense Authorization Act (NDAA), signed into law January 2, which basically repealed the Smith-Mundt Act of 1948, which prohibited U.S. government sponsored radio broadcasts from being received by citizens in the U.S.:

"Just got my March *MT* and read your article about VOA on shortwave ("Beginner's Corner" page 26). Good stuff! I've been a VOA listener since 1969 and a former congressional staffer who worked for many years on the NDAA. I look forward to seeing what changes occur this summer as a result of the repeal of Smith-Mundt. Thanks for highlighting this."

## Hooked on HD-Radio

*MT* reader Dave McDonald K4EWC writes:

"Good write up on poor old HD-Radio ("Beginner's Corner" *MT* January 2012 page 26). Stations spent a bundle on adding the gear to broadcast HD but the public never caught on. I was one of the early adopters and also got the Sangean HDT-1, I even got the \$40.00 rebate! The Sangean is truly a great HD tuner. I use it with McIntosh preamp and MC240 stereo amplifier.

"There is only one station, however, that I care to listen to down here in Clearwater, Florida. Our local public radio station, WUSF-FM mostly broadcasts the NPR program lineup but their HD-2 channel is broadcasting classical music 24-7 from WSMR-FM, Sarasota, Florida.

"I am also glad that I bought the tuner when I did. It's my only contact with HD FM and I have never regretted it. What worries me is the possibility that this broadcast mode will go away. Thanks for all the material that you have presented. I zero in on anything HD."

*Thanks for your comments! I don't think there's much chance that HD will go away. It's the ultimate goal of the FCC to eventually switch the nation's radio broadcast stations entirely to digital as was done with OIA-TV in the 2009 DTV switch. As yet there's no timeline so it could be quite a ways away, no one's even speculating.*

*One reason that HD has been more embraced by public radio is that it attracts more listeners who may be more willing to cough up during fund-raisers; the station presents more value for their donation. Commercial broadcasters have the opposite problem; having to compete with themselves while spreading ad dollars even more thinly. Like all broadcasting, some stations are simply better at it than others. – Editor*





# COMMUNICATIONS

by Ken Reitz KS4ZR

Communications is compiled and edited by Ken Reitz KS4ZR ([kenreitz@monitoring-times.com](mailto:kenreitz@monitoring-times.com)) based on clippings and links provided by our readers. Many thanks to this month's fine reporters: Anonymous, Bob Grove, Norm Hill, Lynn Kelly, Steve Karnes, and Larry Van Horn.

## April 18: World Amateur Radio Day

April 18, 1925 is the date of the founding of the International Amateur Radio Union (IARU). Nearly one hundred years ago the nations of the world realized that the explosion of interest in radio required some sort of coordination. According to the IARU web site [www.iau.org/index.html](http://www.iau.org/index.html), "At the time there were very few countries in which radio amateurs had been able to organize themselves into national associations. In many countries, amateur radio operation was actively discouraged or even illegal. Fortunately, there were far-sighted individuals who understood the problem and were able to find a solution. In 1925 they met in Paris and formally created the International Amateur Radio Union, or IARU." Get on the air April 18 and talk about it, while you can!

## German Ham Numbers Decline

According to an announcement from the Deutscher Amateur Radio Club (DARC) from February 13, 2013, the number of German amateur radio operators fell in 2012. There were a total of 70,446 German amateur licenses in 2012, down from 71,659 in 2011 and 72,293 in 2010.

The number of amateur radio license numbers in most countries is skewed because of license term, the unknown number of inactive hams, uncanceled licenses of deceased hams, etc. Further, in some countries licenses are issued for life, as is the case in Great Britain, in which there is a proviso that licensees will check in every five years to indicate they're still alive. In other countries, such as the U.S., licenses are good for 10 years. As a result, there may be a great discrepancy between the number of licensed hams on the books and the number of live hams, let alone the number of active hams. Because of the lag in deleting expired licenses, countries reporting slight up-ticks may in fact be in decline. Further, a great percentage of licensed operators lose interest in the hobby long before their licenses expire. There is no way to know what those numbers are.

The latest numbers from Spain indicate that country's ham population was slightly on the rise at the end of 2012. But that's happened only after a decline lasting more than 15 years that cut their ranks from around 60,000 to 30,000 licensees. According to the Union Radioaficionados Españoles, with an exam fee of €22.52 (\$30.13) and a one-time "Authorization Fee" of €150 (\$200.67), it's easy to see one reason for the decline. If bloggers and Twitter users faced an exam and \$230 in fees to add their voices to the universal din, there would be considerably less of it.

The German ham census is a rare glimpse into what may be the reality of the global amateur radio population. But such data are not easy to find. Many national organizations of amateur operators offer data that's years out of date. Even the above mentioned IARU information is several years old. The best in-depth analysis

of current amateur population numbers has been compiled by Joe Speroni AH0A. The most recent data available from around the world is at his website: [www.speroni.com/FCC/index.html](http://www.speroni.com/FCC/index.html)

## Iowa Radio Specs Skewed to Motorola?

An article in the *Des Moines Register* from February 17 titled, "State Agency Accused of Slanting Requests for Radio Bids," detailed the issues around radio contract requirements termed, "unusually exacting." Specifications such as that push-to-talk buttons had to be at least 44 millimeters tall and 15 millimeters wide and that knobs had to be at least 19 millimeters apart automatically excluded certain brands.

Objecting to the requirements was an Iowa-based public safety radio network operator noting that it couldn't even submit a valid bid on behalf of the radio manufacturer it represented: the Harris Corporation. The article noted, "Only one supplier, in fact, could meet every spec for a contract worth perhaps \$1 million: Illinois-based industry leader Motorola Solutions, Inc."

The wrangling has taken over a year and has spawned requests for a legislative investigation. As reported often in *Monitoring Times*, initial contracts for public service radio equipment often leads to far more lucrative future build-outs as well as expensive no-bid equipment and software upgrades that exceed initial contract layouts by many times.

## FCC Fumbles Cyber-Security Hack

An article in the February 5 *Washington Post* detailed analysis from the Government Accountability Office (GAO) that said the FCC's response to a September 2011 "network breach" at the Commission was inadequate and a future breach hadn't been properly safeguarded. The GAO report noted that the FCC improperly configured security tools, used weak encryption methods and failed to "fully implement its malware system." Normally the agency to chide others for their failures to protect the public interest, the FCC found themselves on the receiving end of critical findings which were quoted in the GAO reports as now requiring "costly and time-consuming rework." The article noted the increase of cyber-threats against government agencies quoting Department of Homeland Security numbers that showed such incidents soared from 5,500 in 2006 to almost 49,000 in 2012; roughly 134 per day.

## FCC Report: Satellite Broadband Faster than Claimed

An FCC report titled "Measuring Broadband America," released in February, updates earlier April and July 2012 reports and compares broadband speeds advertised by various companies with actual speeds delivered. The report notes three observations in particular: That many Internet Service Providers (ISPs) continue to

closely meet or exceed the speeds they advertise; that consumers are continuing to migrate to faster speed tiers, and, surprisingly, that satellite broadband has made significant improvements in service quality.

The report noted, "In our testing, we found that during peak periods 90 percent of ViaSat consumers received 140 percent or better of the advertised speed of 12 Mbps. In addition, both peak and non-peak performance was significantly higher than advertised rates. While latency for satellites necessarily remains much higher than for terrestrial services, with the improvements afforded by the new technology we find that it will support many types of popular broadband services and applications."

Latency (the amount of time it takes for data to leave the consumer's computer, reach the nearest ISP and return), is a significant issue with satellite broadband. While terrestrially-based ISPs typically had latency of 29.6 milliseconds during peak periods, satellite broadband had a latency of 638 milliseconds. This is because the data has to travel 23,000 miles just to get to the satellite which sends the signal another 23,000 miles to the server on the ground. The trip is repeated in order to return data to the consumer's home. The FCC found that during peak usage time, weekdays between 9 p.m. and 11 p.m., all ISPs delivered on average 97 percent of their advertised download speeds. Exede, the company offering Internet service through ViaSat, wasted no time lifting a glowing quote from the FCC report and pasting it at the top of their home page [www.exede.com](http://www.exede.com).

What the FCC forgot to measure in "Measuring Broadband America" is how the costs of these services compare with their advertised rates, what happens when consumers exceed their data caps and what penalties consumers have to pay to opt out of two year commitments when the service does live up to advertised rates.

## Bogus EAS Alert Warns of Zombie Attacks

The naiveté of small market television station operators was exposed in February with a hack by unnamed persons of the nation's Emergency Alert System (EAS) which allowed a bogus alert to be sent warning of a pending Zombie attack. According to numerous industry reports, four TV stations in Montana and Michigan actually sent out the alert. One station, KRTV, Great Falls, Montana, said in an online statement that the attack was initiated overseas.

Numerous other stations' systems were also under attack but were able to thwart it with routine firewall and updated password protection. Engineers familiar with the EAS system noted that those performing the hack knew what they were doing and that some stations did not change the default passwords after initial EAS equipment installation. It was noted that stations with EAS equipment tied to the Internet were most vulnerable.

# International Broadcasting: China vs. the West

By Keith Perron

Since the collapse of Communism in eastern Europe, international broadcasting has changed dramatically. During the Cold War it was the western countries' broadcast services such as the Voice Of America (VOA) and BBC World Service (BBCWS) that had the upper hand. Communist broadcasters such as Radio Moscow, which may have had many more frequencies on the air, didn't have the upper hand. Content was key. The approach of both the VOA and BBC was toward "soft diplomacy," communicating with people through music and entertainment programs, instead of straight propaganda. At this level, the Soviets could not compete.

However, today the radio war is not between the West and Russia. It's now between the West and China and the rules are quite different. Examining the international broadcasting arena today, I believe that both sides are making wins and, at the same time, suffering a number of losses.

## An RCI Insider's View

Beginning in 2001 China Radio International (CRI) realized they were losing the battle for the international audience. There were many factors that were causing this. First and foremost losses had to do with content that was boring and on-air presenters who had terrible accents; it was difficult for English speaking people, for example, to understand them.

It made no difference how many frequencies they had on air, the audience was just not there. RCI Management in 2001 were given an order from the Ministry of Culture to expand its reach and to hire more native English broadcasters. This is where the story gets personal. Back in 2001 I was the first foreigner who was hired as an on-air broadcaster, not just as an English language editor, to improve content.

I was given free reign to do whatever I wanted. In less than two weeks I created a new

department within the English language service of CRI called the Overseas Program Department. The job was to produce programs that would air on local FM and AM stations in the English speaking world and use accents from the areas being targeted. So, I brought into the department an Australian, a New Zealander and a Britain. Together we produced a daily news magazine called *Real-Time China*; the first ever CRI program produced and presented by native English speakers. It was very successful and we received a number of awards for being able to get a CRI program on local commercial stations in the U.S., U.K. and Australia. Targeted programming is not a new idea and has been done by western broadcasters for decades.

## Local Programming Expansion

Today CRI continues to follow the vision I put in place in 2001 and they have expanded on it. Africa is a region where the radio war between China and the United States has heated up. The Voice Of America has a long history of broadcasting to the continent along with the BBCWS, Radio France International (RFI) and many others. But in some areas the West is losing this war.

When broadcasters started to expand in Africa in the 90s the trend was to set up local FM and AM transmitters and, yes, this worked very well in some regions. But there is always the threat of having the FM or AM transmitter turned off by local officials and this has happened a number of times in some areas.

China too is expanding its FM and AM networks in Africa. But in areas where the BBC or VOA were taken off air China was not. Why? This has a lot to do with China's stated foreign policy of not interfering with a country's domestic politics. China has had this policy since the 1950s to not publicly interfere with the internal issues of any of the countries it has diplomatic relations with. It often invokes this same policy when it receives criticism in western media of its treatment of its own minorities' rights.

Western broadcasters have seen budget cuts that have drastically affected their work. Not so for China, which has vastly increased its budgets. Governments of the U.S. and the U.K. have also expressed concern that China has expanded in Africa, and yet at the same time



CRI launches Nairobi, Kenya FM station. (Courtesy: CRI)



CRI studios in Nairobi, Kenya FM station. (Courtesy: CRI)

they continue to cut back on shortwave transmissions and content.

Since 2006 CRI has been expanding dramatically. How? The first thing is in setting up FM and AM transmitters. The CRI approach is different; they don't just set up a transmitter, they build a full station. A good example is found in Kenya. CRI entered Kenya in 2006 and within one year built a radio station and hired locals to produce program content. Zimbabwe is another area of interest to both China and the West. But, both the BBC and VOA are banned from reporting from the country or even having transmitters in the country. But in Harare just as in Nairobi, Kenya, China Radio International is on the air 24 hours a day seven days a week.

When Western broadcasters start up local FM and AM transmitters in-country, they start immediately cutting back on shortwave transmissions to the region. CRI increases its shortwave reach. In Southeast Asia I have met many people who have told me sometimes it took them 10 to 15 minutes to realize that they had been listening to China Radio International. A number of times they thought they had been listening to Radio Australia, VOA or BBCWS.

Unlike the BBCWS and VOA, China Radio International's budget comes from various departments within the Chinese government.

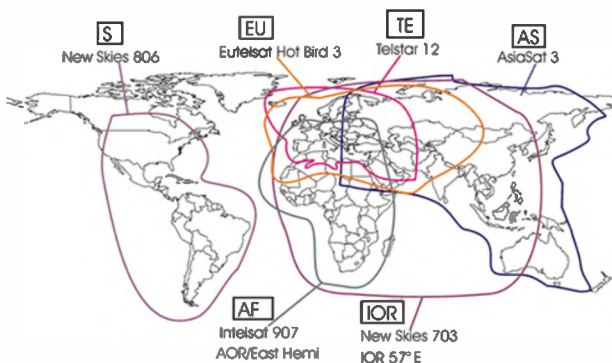

Voice of America global satellite coverage. Notice the strategic regions of the Mideast and Africa are overlapped by several satellites. (Courtesy: VOA)

Some money comes from the Central Committee, Ministry of Culture, Ministry of Propaganda, Ministry of Education, Ministry of Defense, the State Administration of Film Radio & Television, Ministry of Internal Affairs, Foreign Ministry and so on. What is the annual budget? No one really knows.

In Beijing, China Radio International also have a very large staff. When I was at CRI between 2001 and 2006 they had 4807 people. Today they have over 6,000.

We could say the first round is being won handily by China Radio International. But, despite this, western broadcasters are still in the game. People are still turning to the VOA and BBC for news and information that CRI won't report.

While the audience numbers are still high they are lower than they were before China entered the game. The VOA and BBCWS are falling behind in getting new listeners and this is where CRI has been more successful.

The radio war is less about what VOA and CRI offer, but more about politics. If countries like the United States and Britain have the same foreign policy as China, to not interfere with other country's internal politics, then these broadcasters could have a much bigger foothold than CRI.

What is interesting about all this is that China has learned from the West how to make targeted programming and use soft diplomacy. They just took it to a new level. The West has continued to do the same things they had done for decades, but never improved on it.

People have asked me who I think will win. To be honest it's impossible to say. If broadcasters like the BBCWS continue to suffer more budget cuts, the U.K. will lose. The same goes for the VOA. There are parts of the world now, Southeast Asia for example, where China Radio International has won. Finding CRI on shortwave is very easy, whereas finding VOA or BBCWS on the same dial has become more difficult. In the last year both of these broadcasters have reduced their on-band presence. Let me give you an example: To East and Southeast Asia, for every one frequency for the VOA, China Radio International has three. Yes a 3 to 1 advantage.

So who will win? It's still too early to say. But it does not look like a good outcome for the VOA or BBCWS.

*Keith Perron's previous article, "America's Voice for Asian Democracy," appeared in the October 2012 issue of Monitoring Times.*



TV Marti on Free-to-Air satellite channel via New Skies 806 satellite. (Courtesy: Ken Reitz, KS4ZR)

# Radio/TV East vs. West War of Words (and Pictures)

By Ken Reitz KS4ZR

**T**he Broadcasting Board of Governors (BBG) is the umbrella organization for all U.S. government programming around the world which includes:

**Voice of America.** While targeting its shortwave broadcasts to specific regions in Africa, the Mideast and Asia, VOA can be heard easily in the U.S. The latest frequencies and times are found here: [www.voanews.com/info/frequencies\\_and\\_schedules/2218.html](http://www.voanews.com/info/frequencies_and_schedules/2218.html) In addition, VOA radio and TV programming can be heard and seen throughout North and South America via NSS 806 satellite at 40.5°W. VOA-based programming will also be available directly in the U.S. after July of this year when newly signed legislation permits such broadcasts.

**Radio Free Asia (RFA).** RFA broadcasts in nine languages to Southeast Asia, the latest frequencies and times are found here:

[www.rfa.org/english/about/frequencies.html](http://www.rfa.org/english/about/frequencies.html)

**Radio Free Europe/Radio Liberty.** RFE/RL broadcast in 28 languages beamed to as many countries. RFE/RL programs are available on AM and FM frequencies of local radio stations in-country. A list of those stations and their frequencies is found here:

[www.rferl.org/howtolisten/default.html](http://www.rferl.org/howtolisten/default.html) RFE/RL programs are also available across the region via Free-to-Air satellite on AsiaSat3-D (105°E).

**Radio Martí** programs are beamed specifically to Cuba on shortwave via 7.405, 11.845 and 13.820 MHz. TV Martí programs are beamed via FTA satellite New Skies Satellite NSS 806 (40.5°W).

Radio and television programming for all of the above services may be found on the main home page of each of the above broadcasters.

BBC World Service continues to provide programming in 28 languages via its shortwave service. It also provides programming through-



VOA's Persian TV service on Free-to-Air satellite channel via NSS 806. (Courtesy: Ken Reitz, KS4ZR)

out the U.S. on a large number of FM radio stations and, according to a *New York Times* article from December 27, 2012, cable-TV providers Comcast and Time Warner Cable, thus making it available to some 25 million U.S. homes.

For more on TV and radio programming via satellite see "Tuning in to International Broadcast via Satellite" page 11 in the February issue of *Monitoring Times*.

Shortwave and satellite frequencies and channels from China, including China Radio International and China Central Television (CCTV) may be found in the article "Chinese Broadcasting Expansion," which follows this article in this issue.

The domestic playing field between China and the West is decidedly unlevel. While China is free to set up a full-time AM radio station inside the Washington, D.C. beltway, BBC and VOA broadcasts from outside China beamed to Chinese listeners are subject to jamming.

As recently as February 25, the BBC complained of the jamming of its broadcasts on its website, "...shortwave broadcasts in English of World Service radio are being jammed in China...extensive and coordinated efforts are indicative of a well-resourced country such as China."

According to the report, BBC Director of global news, Peter Horrocks said, "The deliberate and coordinated efforts by authorities in countries such as China and Iran illustrate the significance and importance of the role the BBC undertakes to provide impartial and accurate information to audiences around the world."



Radio Farda logo (Courtesy: Broadcasting Board of Governors)

# Chinese Broadcasting Expansion: Towards 'Soft-Power' Diplomacy

By Md. Azizul Alam Al-Amin

**W**ith its dynamic and hybrid economy, China is a key player in economics as well as global politics. To continue its progress toward a position of dominance, China is embracing 'Soft-Power' diplomacy. One aspect of this type of diplomacy is seen in the adoption of sweeping measures in the international broadcasting arena and pumping billions of dollars into this sector. China's broadcasting media is booming and today it sees more opportunity than challenges.

Chinese President Hu Jintao in his summary report to the 17<sup>th</sup> National Congress of the Communist Party of China, on October 15, 2007, stated, "...In the present era, culture has become a more and more important source of national cohesion and creativity and a factor of growing significance in the competition in overall national strength, and the Chinese people have an increasingly ardent desire for a richer cultural life. We must keep to the orientation of advanced socialist culture, bring about a new upsurge in socialist cultural development, stimulate the cultural creativity of the whole nation, and enhance culture as part of the soft power of our country to better guarantee the people's basic cultural rights and interests, enrich the cultural life in Chinese society and inspire the enthusiasm of the people for progress" (*People's Daily*, October 25, 2007).

According to China's State Administration of Radio, Film and Television (SARFT), Chinese broadcasting revenues exceeded 210 billion Yuan, or \$31.5 billion dollars in 2010. This was due to the increasing investment in the broadcasting and film industries by nearly 25 billion Yuan in 2009. "The broadcasting industry could face more opportunities than challenges as the government pushes the integration

of Internet, telecommunications and broadcasting networks in the coming years," said Yang Mingpin, Vice-Director at the Development and Research Center of SARFT.

On January 13, 2010, Premier Wen Jiabao hosted a State Council Standing Committee meeting and decided to speed up and enhance the progress of China's network convergence. The State Council launched a pilot plan for network convergence businesses in 12 cities beginning June 30, 2010. As a result, China's broadcasting industry began a new and promising era.

## Technical Innovation

China stresses innovation in broadcasting industry to maintain its success. According to the *China Times*, "Aiming for the most advanced technology in the global broadcast and TV industry, we should focus on projects of strategic importance and develop core technology featuring independent innovation," said Li Changchun, a member of the Standing Committee of the Political Bureau of CPC's Central Committee in March 21, 2012 at the 20<sup>th</sup> China Content Broadcasting Network Exhibition at Beijing China International Exhibition Center.

## Radio Frequency Synchronization Technology

By spending 35 million Yuan and seven years in their efforts, a Chinese research group, lead by Zhou Yingping invented Radio Frequency Synchronization Technology (RFST) which successfully passed a series of SARFT technical tests. Experts from the Academy of Broadcasting Science of SARFT and other authorities conducted a series of tests in single-frequency analog and digital TV networks. The results of those tests show that the RFST has solved one of the world's major technical problems of interference from signals using the same frequency.

## Audio-video Coding AVS+ Standard

China is to introduce the application and industrialization of its



*CCTV not offered in your city? Not to worry, it's available in your backyard via Free-to-Air satellite TV. (Courtesy: Ken Reitz, KS4ZR)*

self-developed audio-video coding standard (AVS+) in broadcasting and television. The AVS+ standard will meet increased demand for new broadcasting technologies such as High-Definition TV and 3D-TV.

## Satellite Transmission

In April 1984 China launched an experimental communications satellite for trial transmission of broadcasts. In February 1986 China launched its first fully operational telecommunications and broadcast satellite. China has steadily promoted the application of communications and broadcast satellites and has created a market of great scale. In 2008 China established a satellite service platform to give every village access to direct broadcast and live telecasts. It also implemented satellite broadcasting and transmissions of China Radio International and several CCTV channels, which greatly increased the radio and TV program coverage. China has also strengthened its satellite capacity in emergency communications.

## Digital Broadcasting

Being the largest radio and television audience in the world, China is developing into the biggest global market for digital broadcasting. China was committed to the introduction of Digital Radio Mondiale (DRM) because of its unique features. But, the Chinese regulator SARFT chose Digital Audio Broadcasting (DAB) for its industrial standard in May 2006. According to the Global Digital Radio Broadcasting Update of September 2012, in China DAB is now on air in three cities; Beijing, Hong Kong and Shanghai. Some of them provide several DMB (VHF and UHF) services among

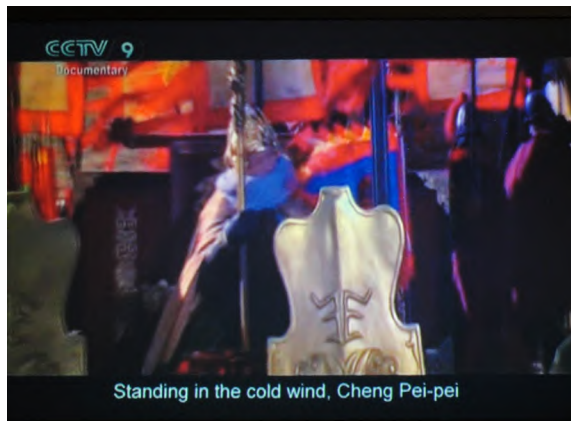

*CCTV 9 Documentary Channel (Chinese language with English subtitles) offers a Sino-centric view of history and CCTV News (offers 24/7 news in English) available Over-the-Air in the Washington, D.C. area. (Courtesy: Ken Reitz, KS4ZR)*



**China Radio International's popular program "Beyond Beijing" received on a Logitech WiFi radio. (Courtesy: Ken Reitz KS4ZR)**

audio services. There are 20 radio services (16 of which are simulcast), four video services and two data services on air in Beijing.

Global Broadcast Update, January 2012 stated that there are now DMB/DAB services on air in 11 cities across the China. After the Guangzhou launch of a commercial service in 2007, the Ministry of Industry and Information has decided to issue licenses for DMB in mobile phones. In China there are currently 2,416 radio channels, 1,279 channels for television, 66,000 transmission stations and relay stations with 100,000 kilometers of microwave lines. China will phase out analog broadcasting service by 2015. It is estimated that the transition from analog to digital broadcasting in China will create a market of several trillion U.S. dollars.

## International Partnership

According to *Indonesian News Agency* reports, China will also assist Indonesia in developing a digital television network; according to a report on [rapidtvnews.com](http://rapidtvnews.com), China will help with the digitization of Pakistan Television Corporation (PTV) by 2015; according to the Chinese government, Asia-Pacific Broadcasting Union (ABU) has stated that China is to construct a 350 meter-high communications tower in Colombo, Sri Lanka at a cost of \$100 million, which will be funded by the Export-Import Bank of China. This tower will include accommodations for 50 television service providers, 50 broadcasting service providers and 10 telecommunication providers.

## Rapid Expansion Opportunities

With its great potential, the African continent has emerged as fertile ground for the international broadcast market. China is enhancing its coverage there by signing numerous cooperation agreements and establishing broadcast connections within many African countries. Voice of America news reports that Zimbabwe Broadcasting Corporation (ZBC) will soon start airing programming from China's CCTV channels. CCTV programming is already available to many Zimbabweans, who have Free-to-Air (FTA) satellite receivers. Chinese media presence is also found in South Africa, Sudan, Tanzania, Mauritius, Kenya and

a growing number of other countries.

In 2012 CCTV Africa established its headquarters in Nairobi, Kenya. An Oxford study of 2010 indicated that China's media investment in Africa is primarily designed to improve foreign and economic ties and counterbalance the negative reporting of both China and Africa found in Western media.

China is also expanding its media presence in the United States and the United Kingdom as well as other developed and developing countries. In February 2012 CCTV opened a production center in Washington D.C. It has also launched three channels using Internet broadcast services in the UK. China Radio International (CRI) established a bureau in Sydney and another will open in Melbourne. In Cambodia, CRI launched two local radio channels. On 14 June 2011, CRI and a Greek radio channel, Greek 93.2 Happy Radio, officially launched a partnership for a daily ten-hour transmission.

Director General of CRI Wang Gengnian in his New Year's speech in January 1, 2013 mentioned, "...The theme of CRI's work in 2012 was to communicate confidence, promote cooperation and strengthen friendships... In 2012, our efforts were mainly focused on increasing the capacity of international communication. We made large changes in our communication concepts, reformed our working mechanism and improved our media awareness and service."

He also said, "Not only have we established stations overseas, we also strive to localize our radio content according to our audiences' demands and to cater to their taste and style."

The expansion of Chinese broadcast media across all platforms and the well-funded efforts by the Chinese state-owned media to increase their influence in Africa and other parts of the world, are part of their soft power drive. Soft power has become an important tool for China to build a positive image in the world and it seems that China is on the right track to achieve the goal.



**CRI Headquarters building in Beijing. (Courtesy: CRI English)**

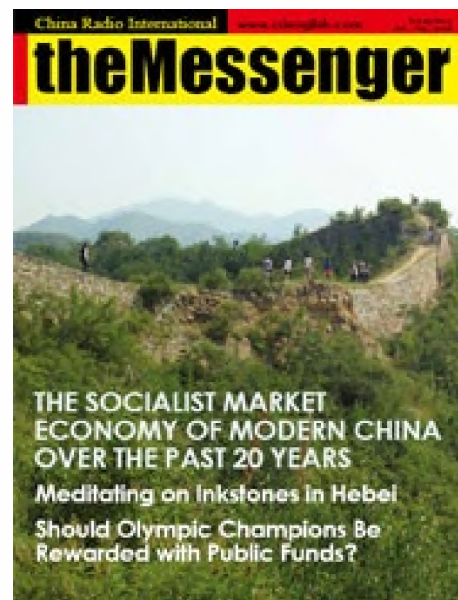

**The Messenger, a quarterly publication for CRI listeners, has "an eye on strengthening ties with listeners." (Courtesy: CRI English)**

Author's note: The concept of 'Soft Power' was developed by Joseph S. Nye, Jr., a Harvard University professor and former U.S. Assistant Secretary of Defense, in his 2004 book of that same title.

### About the Author

*Md. Azizul Alam Al-Amin is a Bangladesh based radio researcher and and journalist. He has been an avid shortwave hobbyist for more than two and half decades. His feature articles about international broadcasting have appeared in Monitoring Times and the international edition of Radio World. You may contact him at [alamin@librabd.net](mailto:alamin@librabd.net)*

## RESOURCES

China Central TV's Global Television Services span the skies above the world with CCTV programs beamed to the world's population on 46 C and Ku-band satellites, 11 over North America alone. For details on which satellites CCTV programs may be viewed and for reception parameters go here: <http://english.cntv.cn/20121108/105378.shtml>

Broadcast times and frequencies for China Radio International's English Shortwave Service may be found here: <http://english.cri.cn/7146/2010/03/30/2141s560015.htm>

Listen to China Radio International on 15 AM and FM radio stations in the U.S. and Canada here: <http://english.cri.cn/7146/2010/03/30/2141s559997.htm>

Listen to CRI on your smartphone: <http://english.cri.cn/11114/2012/09/21/1261s723419.htm#mobile>

Read CRI's *The Messenger* here: <http://english.cri.cn/messenger>

# The Lafayette Surprise: Political Intrigue and Radio

By Rich Post KB8TAD

[Editor's note: Readers will recall the MT December 2012 three page cover story, "Sixty Years of Lafayette Radio" by Rich Post. In the process of writing the article, Rich came across some interesting background material on one major Lafayette Radio shareholder and his activities involving radio and political intrigue pre and post-WWII as well as the era of the Cold War. This month Rich shares that story.]



Sometimes, when you look closely at a company, a surprise pops up. Such was the case when I was researching material for the article on Lafayette Radio. The change in corporate names from Wholesale Radio Service to Lafayette Radio in 1939-40 and the separate catalogs in 1942, as well as the sudden and permanent disappearance of Lafayette stores from Atlanta and Chicago in 1951, triggered the question in my mind; why? Was there a rift among partners?

Researching the names of the three owners, as stated in the Federal Trade Commission (FTC) action against Wholesale Radio in 1935, turned up nothing until I received a clue from John K2TQN (1) and his May 2010 *QST* column which covered the Lafayette TruTest 25 watt Junior transmitter and Professional 9 receiver.

Apparently, the FTC citation that I had previously located misspelled the names of two of the three owners and had left out their middle initials. A search on the correctly spelled names of Samuel J. Novick and Max H. Krantzberg came up with Krantzberg as the Executive Vice President of Lafayette with stock holdings just a bit less than President and Chairman Abraham Pletman in a Securities and Exchange Commission report in 1961. Each owned roughly a third

of the outstanding shares. Krantzberg was also the author of record of a number of Lafayette catalogs and equipment instruction manuals as late as 1967, as registered by the U.S. Copyright Office.

The surprise, however, was Novick. In addition to his involvement with Lafayette, Novick had purchased the Transformer Corporation of America, changing its name to Electronic Corporation of America in 1942 with himself as President and his wife as Secretary. He also set up a couple of smaller companies as divisions.

During World War II, Novick's Electronic Corporation of America had contracts with the U.S. Navy, worth \$6 million, for delivery of secret radar testing equipment. His company received an Army-Navy "E" award for production excellence. He had been honored at a dinner with 300 business and labor leaders in Chicago for his wartime contributions to harmonious labor-management relations and was presented with a scroll by the United Electrical Radio and Machine Workers Union.

At the dinner he was cited as the author of "A Plan for America at Peace," a forty page publication extolling the future with electronics through his company with all workers working in harmony for the common good. Speakers at the event were Chicago Mayor Edward Kelly and Marshall Field (believed to be Marshal Field III, investment banker and publisher of the *Chicago Sun Times*).

Novick was not actually the author of "A Plan for America at Peace" but his company sponsored and paid for the publication. He had immigrated to the U.S. from Czarist Russia in 1914 at the age of 17. One of his early jobs in

the U.S. was as a radio telegrapher. In addition to being an excellent business man, he was also an avowed Communist, allegedly paying the bills for radio commentators from the American Communist Party on the Blue Radio Network. He supported a variety of organizations later deemed to be underground Communist groups according to FBI reports. Some labor unions at the time were also said to be controlled by Communists, including the one that had honored him. Of course, in free speech America, this was allowed.

However, it was after the FBI uncovered a Russian spy that Samuel Novick came to their attention. Arthur Adams was a high-ranking undercover GRU (Soviet Military Intelligence) operative who used the code named "Achilles" and was assigned, along with others in the NKVD (forerunner of the Russian KGB), to obtain U.S. corporate and military technology secrets.

In 1937 Novick had written a letter to the U.S. Immigration and Naturalization Service vouching that Adams was a highly skilled radio engineer who had worked for him for 10 years at Wholesale Radio as its Canadian representative and was needed in the U.S. It was a lie. Novick later signed Adams' immigration papers and also gave Adams a cover job at Electronic Corporation of America which allowed him significant freedom of movement and access to technology information during World War II.

His inquiries into atomic energy developments at Oak Ridge, Tennessee and in Chicago finally caught the attention of FBI agents in 1944. They surreptitiously searched his house in December 1944, finding spy apparatus and documents pertaining to nuclear secrets at Oak Ridge. Adams eluded the FBI in New York in 1945 but his trail was picked up again in Chicago. Later, he was prevented from boarding a Russian ship in Portland, Oregon but was not arrested. The State Department wanted him detained in the U.S. but not arrested. They did not wish to antagonize Joseph Stalin and the Russians since Russia was our ally against Germany and World War II was still being fought.

Adams eluded the FBI again and then disappeared. Russian sources report that he stayed in hiding in five different safe houses before finally making his way back to Russia in secret in December of 1946.

The speed with which Russia was able to build and test a nuclear device in 1949 shocked America into the realization that the U.S. atomic bomb secrets must have been leaked. That, as well as the Berlin airlift and the Russian takeover of eastern Europe, marked the beginning of the Cold War. Fear of Communists who might advocate the takeover of the U.S. government, as had happened in Eastern Europe, triggered the McCarthy era and his infamous congressional investigations.

The House Un-American Activities Com-



Arthur Adams

mittee (HUAC) subpoenaed a number of individuals who had been investigated by the FBI, including Sam Novick. In his testimony before the committee, Novick is quoted in a newspaper column (1) as having said that Electronic Radio Corporation was “originally” known as Wholesale Radio Service Co. which was also known as Lafayette Radio Corporation. When asked further, he stated the Lafayette name “was just a name for a radio set.” When confronted with his 1937 letter to the Immigration Service on behalf of Adams, the newspaper columnist commented that Novick had difficulty keeping his lies straight. HUAC later determined that he had been part of one of several cells in the U.S. that had helped Soviet agents obtain atomic secrets. Fearing prosecution for perjury and other offenses, Novick fled the country for Mexico in 1951.

Was the Russian spy successful? Russian archives and sources reveal that Arthur Alexandrovich Adams’ most important contributions were on atomic bomb development and nuclear research. He is credited in 1940 with being one of the first Soviet intelligence officers to notice that work on uranium development seemed to have disappeared from American scientific journals. He concluded that work on such a promising scientific area could not have stopped. He soon developed a network of informers and provided a total of over 10,000 pages of documents and a variety of samples including weapons-grade uranium, plutonium, and beryllium.

Russian sources (2) further report that on the night of February 23, 1944, an American with the code-name “Camp,” believed to be a scientist who is still unknown to this day, delivered a portfolio of about one thousand pages detailing atomic weapons research along with samples of uranium and beryllium. Adams worked all night to copy the documents since the material had to be returned to “Camp” in the morning.

Radio Moscow later reported back in a coded message that the material had been received. Upon his return to Russia in 1946, he was promoted to the rank of engineer and Colonel, the GRU’s highest rank. His quick rise to that rank is reportedly unique in the history of the GRU. He retired from his espionage career in 1948. In 1999, he was posthumously named a Hero of the Russian Federation. According to one Russian language report on his career, none of his sources were uncovered. For that reason their names had been kept secret until the present (date of that publication is 2004.)

But for his part in the spy plot, Sam Novick was known. Despite unsuccessful efforts to bring him back to the U.S. for trial, he remained in Mexico with other Communist expatriates until his death in 1986. He had established a radio business there in 1945 and was reportedly called one of the “Red American Millionaires” by the Mexican press. Time magazine called Mexico a “Red Haven” for American Communists avoiding prosecution.

The timing of Novick’s departure from the U.S. coincides with the breakup of Lafayette Radio back to a New York-based company. In her book, “A Gathering of Fugitives, American Political Expatriates in Mexico 1948-1965,” Diana Anhalt quotes Novick’s step daughter as stating that he left the United States because he

1938 Lafayette catalog shows NY, CHI & Atlanta

“got a lot of flak from his business associates after his appearance before the HUAC (House Un-American Activities Committee) hearings”(3). That and passage of the McCarran Act in 1950 would have made doing business with known Communists difficult at best.

Lafayette would survive and grow again, but its mail order headquarters would remain exclusively in New York. It would take years before they would again be represented across the U.S., first by individually-owned associate stores and toward the end by about 100 or so company owned stores.

Notes:

(1) My thanks to John K2TQN for the correct spelling of Novick’s name and for a copy of a 1948 column written by Pulitzer-Prize winning syndicated columnist Westbrook Pegler.

(2) A Russian language version of Arthur Adams’ career can be found at [www.warheroes.ru/hero/hero.asp?Hero\\_id=4434](http://www.warheroes.ru/hero/hero.asp?Hero_id=4434)

(3) Anhalt, Diana; *A Gathering of Fugitives, American Political Expatriates in Mexico 1948-1965*, Archer Books 2001

About the Author:

Richard Post’s interest in electronics and radio started at age six when a friend showed him how to light a bicycle bulb using a worn lantern battery. As a teenager he repaired radios and TV sets. He passed the exam for a First Class FCC license when he was told he needed one to repair his CB. He later received his amateur radio license as KB8LAD. Rich now holds a University Emeritus title having retired from Ohio University as Assistant Dean and Director of the Instructional Media and Technology Services. One of his hobbies is collecting and restoring “boat anchors.” He maintains the web site Boat Anchor Pix at [www.ohio.edu/people/postr/bapix](http://www.ohio.edu/people/postr/bapix)



# Why I listen to Shortwave: Musings of a Preacher-DXer

By Ed Kelly, Jr.

I guess if I had to be classified in the short-wave lingo, I would be an “enthusiastic DX’er.” I have been enthralled with short-wave radio since 1991 when, as the pastor of a small, rural church in northern Iowa, I bought my first radio from –well, where else in Iowa could a person buy a shortwave radio: Radio Shack! It was the DX-375.

I remember climbing the big tree right next to the parsonage and putting up an external wire antenna, trying to pull in the far away stations. That’s how I caught the DX bug. Every night after supper, I would sit in the kitchen with a hot cup of cocoa and listen to BBC and Radio Havana.

But to my surprise there was religious programming out there and, as I listened I thought, “Well, what an added bonus!” As a pastor, of course, I had an attraction to hearing other preachers and how they communicated. And, these programs boomed through my radio from Nashville, Tennessee, and South Bend, Indiana.

Occasionally, I would even hear from smaller stations in West Virginia and the Northeast. I heard many good examples of simple authentic backwoods gospel preaching (which I have an affinity for) but I also heard some rather strange and bizarre ideas.

Now, these strange ideas included some of the teachings from preachers and some of

the advertisements which both entertained and introduced me to a strange new world, a new sub-culture; the American fascination for Christian paranoid eschatology which is fast becoming as popular, and as American, as apple pie.

As memory serves me, there were three primary characters to this new sub-culture in the 1990s: James Lloyd, Texe Marrs and Pastor Pete Peters. James Lloyd captured quite an audience with his predictions of the destruction of New York, which he called “Babylon,” and the identity of the anti-Christ and the false prophet. When his predictions failed, his audience dwindled.

Texe Marrs was the man to listen to if you believed in conspiracies. He reminds me of the character that Mel Gibson played in the movie “Conspiracy Theory.” Depending on the mood that I am in, I still find him entertaining, but in a strange, humorous way. Yes, I listen for pure humorous entertainment.

But the radio character that was probably the most dangerous of all was Pastor Pete Peters whose program *Scriptures for America* was on almost nightly. What caught my attention was his telephone call-in program. Every night from all over America, people would call and comment on the nightly tirade, usually a blend of anti-homosexuality and anti-socialism. He had a niche with his fundamentalist, down-home, country sound. Why the most dangerous? Because he

sounded like a real Christian preacher and people got sucked in, including me. I stopped listening to it because I found that form of entertainment to be dangerous, almost intoxicatingly psychotic.

Today, I still listen to shortwave radio, although not as much as I used to. I still enjoy listening to the back hills country gospel and preaching coming out of the new stations that have popped up. I have graduated to more expensive radios; the Eton 1, which I use in my office, but believe it or not, my older cheaper radios (DX-375, Philips D1875, and a KA1102) seem to do a better job pulling in those rare stations late at night.

I no longer climb trees to extend antenna wires; it is not a dignity issue, it’s my age. If there is one character that I occasionally find myself tuning into before falling asleep, entirely for entertainment, it is the new conspiracy-apocalyptic, paranoid figure of 21<sup>st</sup> Century radio, Alex Jones. His program with the theme music from Star Wars’ Darth Vader is a high quality production that I find both entertaining and humorous.

That is why I listen to shortwave radio; entertainment and, at times, I find it better than TV. But with this one word of advice: do not listen to gain wisdom and do not take anything seriously. It’s pure entertainment, like the movie *Planet of the Apes* (which my wife hates and I love).

MT



The author in his office/radio shack with Eton 1, Radio Shack DX-375, Philips D1875 and Kaito 1102 close at hand. (Courtesy the author)



# Xtreme Operating: New Challenges for Veteran Hams

By Ken Reitz KS4ZR - (Photos courtesy the author)

**H**ams love a challenge and for most it's racking up the list of countries, call districts, states, counties, islands, lighthouses, you name it. But it's not long before many are tempted by the allure of repeating all of their previous accomplishments with low power operating, known as QRP; usually defined as transmitting with less than 10 watts SSB and 5 watts in CW or digital modes.

Then came the concept of operating QRPP, where operators consider original QRP power levels as QRO (high power). QRPP operating is typically defined as being done on less than one watt and has attracted enough adherents that awards for WAS (Worked All States), WAC (Worked All Continents) and DXCC (worked and confirmed at least 100 countries on the ARRL's list of approved "entities") are regularly dispensed. These operators no longer refer to output in watts but in milliwatts, where 500 milliwatts is considered QRO.

New developments in transceiver design and digital mode software allow Xtreme operators to scoff at stations belting out 500 milliwatts. Instead they routinely operate at power levels measured in microwatts (one-millionth of a watt) with a few hardy and well-heeled hams attempting nanowatts (one billionth of a watt). There have even been reports of some attempting transmissions in the range of picowatts (one trillionth of a watt). Of course, effective transceivers rated at such low power levels are extremely expensive, basically physics lab equipment or special order gear used by NASA and DARPA, the Department of Defense's ultra-secret intelligence agency.



*Tree supported three element HF beam provides Xtreme operating action.*



*Where's the antenna? It's underground! The advantages are huge: extreme low atmospheric noise on receive and attenuated radiation potential for Xtreme operating.*

## Software Redefines Hobby

The biggest change in the popularity of Xtreme operating has come with the advent of Software Defined Radios (SDR). These radios are capable of zooming in on what might appear to be noise flecks on the ham bands but what turn out to be Xtreme operators using special digital mode software known as AF2013 that can only be detected by SDRs. Anyone else monitoring the bands simply hears a smattering of indistinguishable background atmospherics.

Contacts can be made in a matter of seconds since AF2013, which sounds through the radio's speaker like high-pitched hummingbird's wings, pauses after initial transmission to allow contacting stations to exchange data. Following the exchange, the program pauses again to allow any other stations to make a contact. If none are made, the program starts up again in CQ mode.

These data bursts take up little time, less bandwidth than any other previous digital mode and can be wedged in just about anywhere on the bands. But, early Xtreme operators realized that hoping for contacts on random frequencies at such low power using such an unusual operating mode would be too frustrating for all but the most hardcore operators. So, special frequencies have been established to ensure the probability of making the most contacts possible.

Typically these operators work 2.12345 kHz down from normal BPSK31 frequencies (see chart on page 53). For example, 20 meter AF2013 operations take place at 14.067877 MHz. Of course only SDR rigs are capable of such precision tuning so that only those operating AF2013 mode on SDR transceivers will even know the operators are actually there.

## Xtreme Operating on the Air

Since there are so few AF2013 operators on the bands, most put their transceivers and software in "beacon mode;" that's where the transmitter sends data bursts at regular intervals on any of the above frequencies until another operator finds the transmitting station and exchanges data. This allows such stations to act as propagation beacons. Other AF2013 enthusiasts can monitor the frequencies in listening mode and when propagation changes, so that the signal can be heard on any monitoring SDR, an alarm can be set to alert the operator that another AF2013 station is on the air.

Beacon mode can be turned to particular advantage at night. Normal gray line propagation allowing transequatorial contacts can easily be missed by operators who have jobs, family activities (such as dinner!) or, in fact, may be asleep when such propagation occurs. Xtreme operating allows hams to work DX even when they're asleep. It's possible to get up in the morning and check your AF2013 logs to find rare grid squares, DX entities, islands, etc., have in fact been worked while you've slept. To satisfy FCC rules regarding having a control operator present, most Xtreme operators sleep next to their radios.

A new version of AF2013 uploads the operator's log each day at 0000 UTC to Log of the World where digital QSLs are exchanged and credit for DXCC certificates are upgraded automatically. An Xtreme operator has only to check-in occasionally to see his or her progress towards various awards.

## New Wave Xtreme Operating

As with any amateur radio activity, it's not long before the more adventurous are seeking new horizons. Veteran Xtreme operators have discovered the challenges imposed not only by miniscule transmit power, but also purposely limited antennas. One pioneer Xtreme operator took his 3 element, tri-band, HF beam off his 50 foot tower and simply leaned it up against a nearby tree (see photo). He fired up his SDR in AF2013 beacon mode and waited. In just

*continued on page 53*



## First Responder Network Authority

**P**ublic safety first responders live in two different technology worlds. During their off time, like most of us, they have access to the Internet and make constant use of smartphones, run cutting-edge applications, share photos and videos, and stay in digital contact with family and friends. However, when they get to work, what communication tools do they have to help them do their job? Far less than at home: limited voice contact with coworkers and, in some cases, limited access to an agency database to retrieve information.

Although consumer services available through wireless carriers have become commonplace for the general public, first responders are far behind the curve when it comes to advanced technology and services.

### ❖ FirstNet

Public Law 112-96, the so-called “Middle Class Tax Relief and Job Creation Act of 2012,” contained the “Public Safety Spectrum Act” that, among other things, established an organization called FirstNet (First Responder Network Authority) under the National Telecommunications and Information Agency (NTIA). FirstNet is a governance authority tasked with the job of overseeing the construction and operation of a nationwide broadband network dedicated to public safety, currently called the FirstNet Nationwide Network (FNN).

Instead of letting every state and municipality choose and operate a separate network and technology, FirstNet will establish a single national network architecture that federal, state and local agencies will all access. The basic idea is that police, fire and emergency medical personnel across the country will eventually have access to a dedicated, interoperable high speed digital wireless network, over which they will be able to send and receive video, audio, data and images as well as traditional voice activity. Rugged smartphones, interactive data tablets, and other advanced technology would join the voice-only radios of today.

This nationwide network will likely follow the LTE (Long Term Evolution) standard now being deployed by commercial wireless providers. LTE is developed by the 3rd Generation Partnership Project (3GPP) and is spelled out in publicly available documents. It is a series of enhancements and improvements to existing GSM (Global System for Mobiles) technology and is fast becoming the basis for 4th generation cell phone networks. The use of LTE for public safety enables partnerships with commercial service providers, allowing first responders to “roam” in areas where FNN might not be available. It may also provide a degree of cost savings for hardware and radios, since the core LTE technology will have already been developed for consumers



and high volume manufacturing will lower the per-unit cost.

The law also allocated \$7 billion in grants to help fund the planning, development and build out of the network. This money is expected to come largely from the proceeds of FCC auctions of other spectrum and will be distributed by FirstNet.

LTE will not soon replace the handheld and mobile radios used by first responders. First, it will be many years before an LTE network will be up and running on a wide area basis. Second, the LTE standard is currently focused on cellular telephone users, it does not support group conversations or direct communication between devices without a repeater (what is called “talk around”), and none of the services meet the “mission critical” level of service needed during disasters. Third, there is a definite lack of rugged, functional LTE hardware and applications designed to meet the specialized needs of public safety users. Most importantly, \$7 billion in grants isn’t nearly enough money to put such a network into operation. Even after it is built, there will need to be a solid funding mechanism in place to service and maintain the network. All of these issues will need to be addressed before a nationwide LTE network can replace the thousands of local systems currently in operation.

### ❖ 700 MHz Public Safety

The 700 MHz band is probably better known as part of the UHF (Ultra High Fre-

quency) broadcast television band, specifically channels 52 through 69. As part of the transition to digital television (DTV), the band was reallocated from broadcasters and sliced up into various segments, each intended for a different purpose. Over the past few years, at the inconsistent direction of Congress, the FCC has been auctioning off many of these segments to various wireless service companies, establishing complicated rules and subsequently changing them as time went on. Throughout this period, parts of the 700 MHz band were set aside specifically for use by public safety organizations.

Before the Public Safety Spectrum Act was passed, the FCC had selected the Public Safety Spectrum Trust (PSST), a non-profit group of public safety officials, to be the license holder for the original nationwide broadband spectrum that runs from 763 to 768 MHz and 793 to 798 MHz. The FCC also allocated frequencies from 769 to 775 MHz and 799 to 805 MHz for narrowband operation. To reduce the potential for interference between broadband and narrowband operations, a 1 MHz guard band was established at 768 to 769 MHz and 798 to 799 MHz.

The Narrowband segment is divided into 960 pairs of channels, where each individual channel is 6.25 kHz wide.

Number of Channel Pairs	Purpose
616	Regionally planned for general use
192	Licensed directly to each state
64	Interoperability within a state
48	Reserved for future designation
18	Regionally planned low power for on-scene operations
16	Secondary trunking
6	Non-regional low power

Last November, as directed by Congress, the FCC granted FirstNet a single license in the 700 MHz band for a segment called “D Block” that runs from 758 to 763 MHz and from 788 to 793 MHz. The D Block is immediately adjacent to the 10 MHz of broadband spectrum previously assigned to Public Safety Spectrum Trust (PSST); that license was transferred to FirstNet, giving public safety 20 MHz of contiguous spectrum in which to operate the nationwide broadband network.

In exchange for this grant of spectrum, the law requires that within a decade public safety give up their licenses in the T-band spectrum between 470 MHz and 512 MHz in a dozen of the most populated jurisdictions. The FCC is directed to subsequently auction off the T-band, presumably to commercial service providers. Public safety is allowed to keep the 700 MHz narrowband spectrum, where agencies have already spent more than \$2 billion in taxpayer dollars to deploy new radio systems.

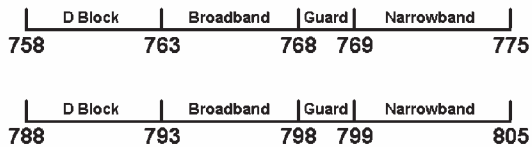

Public Safety Spectrum in the 700 MHz Band



# BROADBANDUSA

## CONNECTING AMERICA'S COMMUNITIES

### ❖ Broadband Demonstrations

Before the law creating FirstNet was passed, the federal government had awarded stimulus grants as part of the Broadband Technologies Opportunity Program (BTOP). These grants were intended to fund the deployment of 700 MHz LTE networks for public safety under a previous set of FCC rules. The original schedule was for initial deployment to be completed by last summer, but the NTIA put a temporary hold on these networks in early 2012 in order for FirstNet to have input into the initiatives. The seven BTOP grantees are:

- Adams County, Colorado
- Charlotte, North Carolina
- Los Angeles Regional Interoperability Communications System (LA-RICS)
- State of Mississippi
- Bay Area Urban Areas Securities Initiative, California
- State of New Jersey
- State of New Mexico

In February, FirstNet agreed to allow these projects to move forward on two conditions. First, each jurisdiction had to prove they had enough funding to complete the project, and second, that they agree to join the nationwide network at the appropriate time. FirstNet has taken the view that these initial projects will serve as a proving ground for public safety LTE technology and provide "lessons learned" to help future implementations.

### ❖ Charlotte, North Carolina

The City of Charlotte was one of seven jurisdictions that were awarded a stimulus grant under the BTOP program. The "CharMeck Connect" project is intended to deploy a 700 MHz public safety network for Charlotte and much of Mecklenburg County, providing service for as many as 11,000 first responders. The network would operate from 30 repeater sites, 24 of them new, and provide speeds of 3 megabits per second (Mbps) downlink (repeater site to user) and 1



Mbps uplink (user to repeater site).

The City received \$16.7 million to implement advanced services including live streaming video, computer-aided dispatch, automatic vehicle location, mapping and geolocation, field-based reporting and real-time access to criminal databases.

In August of 2012, the FCC granted Charlotte what is called Special Temporary Authority (STA) to operate their LTE system. Although Charlotte's overall project is about a quarter of the way to completion, they declined to proceed, citing the lack of assurance that their system would ultimately be allowed to operate after the STA expired.

Because STAs are limited in duration, without assurances that NTIA and FirstNet will authorize these kinds of demonstration networks for the long term, the jurisdictions run the risk of having to eventually shut down if they don't meet all of the FirstNet requirements and standards – which have yet to be fully developed.

### ❖ Harris County, Texas

Harris County covers 1,700 square miles and includes the city of Houston. The county began LTE operations on a limited basis in Baytown, a city of 70,000 people located about 25 miles east of downtown Houston. Police and Fire Departments there are using LTE on an eight-site network, although the original plan called for 14 repeater sites. Initially the network was expected to support 400 to 500 users. It would also be used to stream video from cameras placed at area refineries directly to mobile devices, to help quickly ascertain possible damage from storms or other disasters.

### ❖ New Orleans, Louisiana

In February, Harris Corporation began a six-month trial of LTE technology in New Orleans, Louisiana. The trial includes the ability to transmit live video from the scene of an accident or incident to the city's Emergency Operations Center using a ruggedized tablet computer – basically a tougher version of a commercial smartphone.



During the trial period, Harris will be testing additional hardware devices and public safety applications on 700 MHz broadband frequencies. Like Houston and Charlotte, New Orleans is operating under an STA from the FCC, giving them the legal authority to operate some new radio devices and develop procedures for using them. For example, how can police and firefighters make the best use of real-time video and data during an emergency? What information is most critical and how can it be presented to be the most effective?

# GRE PSR-120

The backlit LCD display provides a giant frequency display, signal strength bargraph, memory channel number, active memory banks, and much more.

Looking for those unknown frequencies while on the road? Spectrum Sweeper automatically registers the activity and tells you the frequency while you listen. Service search and limit search also provide quick access to those unknowns.

Concerned about the weather? The PSR-120 has NOAA SAME/FIPS warning. Need CTCSS or DCS squelch? This scanner will decode or encode it for you!



Order SCN25

**\$89<sup>95</sup>**

plus \$17.95 UPS Ground Shipping

800-438-8155

828-837-9200

fax: 828-837-2216

WWW.GROVE-ENT.COM



## WWW.SCANCAT.COM

TOLL FREE 888-722-6228

### ScanCat-Lite-PLUS

Reg. \$39.95 - Limited Time Special \$29.95

Now It's Easier Than Ever To Program Your Scanner.

FREE walk-you-through set up videos.

www.scancat.com/youtube  
Click on "Learn as you view." YouTube

### ScanCat-Lite-PLUS

- Supports over 50 Scanners in one Program
- Import One Scanner's frequencies, Program any other radio scanner with the same frequencies

### SPECIAL DISCOUNT COUPON ONE MONTH ONLY

Enter this "Coupon" at Check Out and Get an additional \$6 Off ANY placed order  
COUPON #321123

### COMBO ALL-IN-ONE CD

ScanCat-Lite-Plus.....	\$39.95
RSD Frequency CD.....	9.95
Mr. Scanner Frequency CD.....	29.95
If Purchased Separately	<del>\$79.85</del>
<b>SPECIAL \$49.95 + \$6 s&amp;h</b>	

NOW AVAILABLE \$CALL HOKA Code 3-32



### COMPUTER AIDED TECHNOLOGIES

ORDERS: (318) 687-4444 FAX: (318) 686-0449

Info/Tech Support: (318) 686-1999

(9 a.m. - 3 p.m. Central M-F)

## WWW.SCANCAT.COM

Equipment vendors are pushing the concept of convergence – blending existing voice capabilities with broadband data networks – to give emergency workers more capabilities out in the field. These capabilities include both hardware and applications.

Harris Corporation is marketing their In-Touch handheld device, a push-to-talk software application called BeOn, and MBC-100 vehicle-mounted data modems.

Cisco is providing New Orleans with what LTE calls Evolved Packet Core (EPC), a central component that links network users with the proper broadband data feeds. In earlier generation cellular systems like GSM, as with landline telephone service, voice and data are carried over a dedicated link that is connected for the duration of the call. This is known as *circuit switched* operation. In contrast, LTE is based on *packet switched* operation, where voice and data are broken up into small chunks (“packets”) and each is sent independently from source to destination. This is exactly how the Internet operates, and LTE is following suit.

Repeater site equipment for the New Orleans trial is provided by Nokia Siemens Networks, specifically their eNodeB base stations.

## ❖ Los Angeles, California

The Los Angeles Regional Interoperable Communications System Joint Powers Authority (LA-RICS) believes that it must deploy a new radio system, stating that the current systems are old, inefficient, lack capability and are not interoperable. LA-RICS had originally planned to operate in the T-band, between 470 and 512 MHz; however the Public Safety Spectrum Act requires that the T-band be reallocated for eventual auction to the highest bidder. Because the new system would require more channels than are currently available in the 700 MHz band, LA-RICS has requested licenses for a hybrid system, using T-band channels as well as frequencies in the 700 MHz band. Over time, as more 700 MHz channels become available, LA-RICS would migrate away from T-band. LA-RICS has asked the FCC for the use of all of the 700 MHz reserve channels, a total of 48 pairs, each 6.25 kHz wide.



One of the original purposes of these reserve channels was for use by portable and deployable trunked systems in the 700 MHz band, to be used in the aftermath of disasters or other events where the installed radio network is not functional. If these frequencies are assigned to Los Angeles for day-to-day operations, it's

not clear how that might affect nearby agencies hoping to use those same frequencies during an emergency.

## ❖ MACINAC

Geographic regions are also joining together to develop integrated plans. For instance, the District of Columbia, Delaware, Maryland, Pennsylvania, Virginia and West Virginia have formed the Mid-Atlantic Consortium for Interoperable Nationwide Advanced Communications (MACINAC) to oversee and coordinate operation of the new network within their respective jurisdictions.

The new FirstNet nationwide network will be expected to cover at least 95 percent of the country, including all 50 states, the District of Columbia, and all Territories. At least 98 percent of the country's population will be covered. It will be interesting to see how it rolls out in sparsely populated areas like the one described below.

## ❖ Divide County, North Dakota

Dear Dan,

Great column in *Monitoring Times*; I never miss an issue. I need your help. I will be spending a few months in Divide County, North Dakota. I would greatly appreciate it if you would help me set police and sheriff frequencies. I looked up ham repeaters and can't find any in the area.

Ken in New Jersey

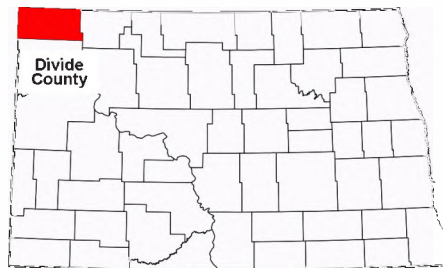

NORTH DAKOTA

Divide County is way up in the far northwest corner of North Dakota, on the border with Montana and Canada. According to the Census, there are only about 2,000 people in the entire county, so I understand why you might be having difficulty finding public safety frequencies – there just aren't that many agencies up there!

I do have the following VHF frequencies:

Frequency	Description
151.460	Sheriff (Dispatch)
154.800	Sheriff (Mobiles)
155.100	County Emergency Management
155.505	Sheriff
155.715	County Emergency Management
155.895	Fortuna Rural Fire Protection District
158.940	Sheriff

The city of Crosby, with about 1,000 residents, is the county seat. The Crosby Municipal Airport, located a mile north of town, is reported to have the following frequencies in operation:

Frequency	Description
118.0250	Automated Weather Observing System (AWOS)

122.9000	Common Traffic Advisory Frequency (CTAF)
453.1875	Sensor Data Link

## ❖ North Dakota State Radio

North Dakota operates a VHF radio system with more than 4,000 users from nearly 300 agencies. Because the entire state has only 700,000 or so residents spread across 70,000 square miles, much of the radio system is designed to cover large distances with the expectation that there will be relatively little activity.

The dispatch center for the system is located in the state capitol of Bismarck. There are 36 repeater sites across the state, including one in Fortuna. There are plans to add four more, to be located in Cavalier, Griggs, McKenzie, and Traill. All of the repeater sites can support mobile data terminals.

Although most of the voice traffic is analog, the system is being updated with APCO Project 25 capability.

Frequency	Description
148.1500	Civil Air Patrol
151.1375	Unified Command Net (Spare)
151.4600	State Radio 1 (Analog and P25)
154.0850	Civil Defense
154.1600	Capital Grounds (Security)
154.2650	Fire (Tactical 5 Spare)
154.2725	Fire (Tactical 1)
154.2800	Fire (Tactical 4 Spare)
154.2950	Statewide Fire (Channel 4)
154.3025	Fire (Tactical 4)
154.4525	Unified Command Net spare
154.6950	State Radio 2 (Analog and P25)
154.9050	State Radio Paging
154.9350	State Radio 1 (Analog and P25)
154.9950	Capital Grounds (Maintenance)
155.1600	Search and Rescue (Ground Operations)
155.3400	Statewide Emergency Medical Services (Channel 5)
155.3475	Emergency Medical Services (Tactical 1)
155.3700	Statewide Civil Defense
155.4300	State Law Enforcement (Tactical 1)
155.4750	National Law Enforcement Emergency Channel (Statewide)
155.4825	Law Enforcement (Spare)
155.5050	State Law Enforcement (Tactical 2)
155.7525	Staging Area Manager
156.0300	Highway Patrol Mobiles
158.7375	Civil Defense (Operations)
158.9100	North Dakota Special Use
158.9550	State Radio Paging (Extenders)
159.2250	State Radio 2 (Analog and P25)
159.4725	Emergency Medical Services (Tactical 2)
453.1500	Highway Patrol Mobile Repeaters
453.3500	North Dakota Heritage Center (Security)
453.4500	Highway Patrol Mobile Repeaters
460.2750	Mobile Data Terminals 1
460.3000	Mobile Data Terminals 2
460.3750	Mobile Data Terminals 3
460.5500	Mobile Data Terminals 4

That's all I have for this month. More information and links related to scanners and radio monitoring can be found on my web site at [www.signalharbor.com](http://www.signalharbor.com). I also welcome your questions, comments and activity reports via electronic mail to [danveeneman@monitoringtimes.com](mailto:danveeneman@monitoringtimes.com). Until next time, happy scanning!



**Q.** In regard to the proposal to put a tracking chip in firearms so they can be located, is this technically feasible? (Mark Burns, Terre Haute, IN)

**A.** Yes, theoretically. These are available to track diplomats, children, pets, shipments, and migratory wildlife. But put the gun in a metal case and it's all over; that's a Faraday shield.

**Q.** I have several wire antennas outdoors coming to a switch box via coaxial cables. Two have grounded baluns at the coax connection points using 8 foot grounding rods. Two others are grounded to a switching remote box which has its own 8 foot ground rod embedded in the soil. The coax shield is also grounded with a rod just outside my den. Should I incorporate any gas discharge units in the center insulated coax wire? If so, just outside the den? Should gas discharge units be installed at the remote coax cable box connections for the antennas connected to it or in the den? I have a ground buss in the den using number 6 solid ground wire. (Ron Cesarek, Ocala, FL)

**A.** Yes, you definitely want static discharge surge protectors on the antennas, and outdoors is best. Since the grounds are on the coax shields, not on the center conductor, there is still plenty of opportunity for lightning-induced surges to reach the radios.

There are several ways to protect them. One is to put a gas-discharge suppressor on every antenna coax line. Another is to put one only on the coax that comes into the radio. But we aren't talking about a direct lightning strike here; nothing will protect your radios from that. That's why many seasoned hams disconnect the line from the radio during lightning storms. Some have a shorting switch that grounds the antenna, not just the coax shield.

A trick used by broadcast stations is to coil several turns of the coax before running it into the house. This acts like a choke to retard the rapid surge. Another is to run the coax into the house through about ten feet of metal pipe which is well grounded.

**Q.** I'm trying to find a replacement transformer for a Skil SC118 battery charger. I've written to the factory twice with no response. Can you suggest a source for this component? (Dave Carter, Mineral Point, MO)

**A.** Unfortunately, finding replacement parts for such mass-merchandised accessories is virtually impossible. A search for the transformer on the Internet yielded nothing but complete chargers. Unless you can salvage a suitable transformer from a thrift shop electronic accessory, I'm afraid you'll have to bite the bullet and buy a replacement charger.

**Q.** I have a switchable balun transformer for either a 1:1 or 4:1 turns ratio. It's connected between my 52 foot dipole which is fed with 450 ohm ladder line and my antenna tuner. I can't seem to tune properly in the 4:1 position, but it tunes just fine in the 1:1 position. What gives? (James Monagle, KC9QYC)

**A.** Just because you are using a 450 ohm transmission line doesn't mean that your antenna feedpoint is actually offering a 450 ohm impedance on your operating frequency. Additionally, even if the impedance is close, it may exhibit a very high inductive or capacitive reactance which can't be handled by your antenna tuner (transmatch) on the 4:1 position.

**Q.** What type(s) of antennas do modern railroad locomotives use? I haven't seen any whips on them. (Frank Klos, National City, CA)

**A.** Most seem to prefer the "blade" or "anvil" style from Sinclair Technologies due to their low profile, rugged construction. You can see these at [www.sinctech.com/brochures/sti\\_heavy\\_transit\\_2008.pdf](http://www.sinctech.com/brochures/sti_heavy_transit_2008.pdf).

**Q.** Can my cell phone be tracked just by being turned on?

**A.** It depends on the tracking method being used, but the basic answer is yes, when your cell phone is merely turned on, but not making a call,

it can be tracked by an agency using the telephone company's data derived from constant polling of phones within range of its towers.

**Q.** What makes a good noise antenna to be used with electrical noise-interference cancellers like the Timewave ANC-4? (James Monagle, KC9QYC)

**A.** Much depends on the actual source of the noise like a distant power line or an indoor accessory. In many cases a 10 foot to 20 foot length of wire strewn under a rug or run along a wall base molding is satisfactory. In other cases you might need to run the wire out a window. It might even be possible to connect a short length of wire in series with an isolating capacitor (.001 uF @ 600 VDC) to a wall socket. Experiment for the best noise rejection.

**Q.** A ham friend of mine who lives in a mobile home community says that he could never run a 1 kW HF amplifier at his place because he only has 15 amps maximum total AC house current available from his 120V outlets. Couldn't he simply use a 13.8VDC @70 amps transistor-type amplifier with an appropriately rated power supply instead? (Mike KK2DOG)

**A.** A typical residential 120VAC distribution network has 15 amps (1560 watts) available from each circuit breaker in the panel. If he had only one breaker for his entire mobile home, then he probably did have only a total of 15 amps.

In any case, a 70 amp, 13.8 VDC power supply would deliver nearly 1000 watts, but efficiency is only about 75%, therefore it would take over 1300 watts to operate it. But it needs an AC/DC power supply to convert the 120 VAC house wiring to 13.8 VDC, also at 75% efficiency, so the total efficiency of both power supplies together is only 56%.

That means that using the two power supplies would take almost 1800 watts of AC power to deliver the same power that the original 120 VAC would have provided directly.

Questions or tips sent to Ask Bob, c/o MT are printed in this column as space permits. Mail your questions along with a self-addressed stamped envelope in care of MT, or e-mail to bobgrove@monitoringtimes.com. (Please include your name and address.)



## Making Sense of ALE Addresses

**A**LE stands for Automatic Link Establishment. Basically, it's that gurgle-gurgle-gurgle sound that is heard all over the utility bands. It comes in bursts anywhere from a few seconds to a minute in length. By design, it quickly hops frequencies, which is one of the reasons it turns up in so many places.

Given the current lifetime of most communications technologies, ALE is a very old system. It was first standardized in the late 1980s, in a military spec known as MIL-STD-188-141A.

There are a lot of these international standards. This one's introduction notes that the 188 designation is for standards that refer to "telecommunication design parameters based on proven technologies." Its Ixx series denotes "common standards for tactical and long-haul communications."

The goal of any ALE system is to automate a lot of what hams consider the fun stuff, but which slows operation down for everyone else. Stations transmit "soundings," or ask for LQA (Link Quality Assessment). The whole net uses these to automatically pick a good frequency for a call when the operator enters an address and hits the button. When link is established, voice or data can be exchanged in the normal way, usually concluded with a brief unlink burst.

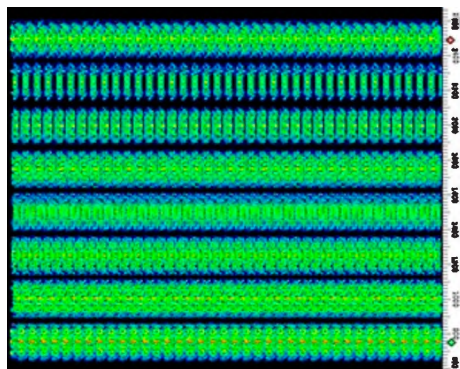

*Distinctive ALE waveform (author's plot)*

### ❖ The ALE Address

ALE has come into amazingly wide use by the world's governments and militaries, some non-governmental organizations, and even a few hams. It's text based, using a small character set, and it's extremely robust. Radios are identified by alphanumeric "addresses" of varying length, as programmed into their ALE controllers by the users.

One sees a lot of three-letter addresses, and there's a reason for this. Without spending the rest of this column explaining how ALE transmits information, let's just say that it structures character data into small units called "words."

The words have different types, and the types are important. The address of the called

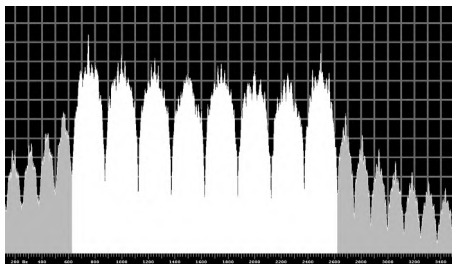

*ALE's 8 tones, with spiky peaks (author's plot)*

station, if any, is in a [TO] word, and the calling station passes theirs in a [FROM] word. A radio can also self-identify in a sounding or command with [TIS], for THIS IS, or [TWAS] (also called [TWS]), for THIS WAS.

All of these particular words contain three characters. They get sent over and over in this highly redundant protocol. The standard calls this the "basic" address. For technical reasons, it's the one that is most likely to survive a bad decode situation.

Right now, everyone's saying they've copied longer ones. True, but that's not the basic address. Anything over these three is an "extended" address, which passes the extras in subsequent words of different types. These are [DATA] and [REP] (for REPEAT).

Any remaining empty spaces in the last word get padded with the ALE "utility" character, which is the good old "at" sign (@). In fact if @ appears in an ALE address field, it's a sure sign of a bad decode, since these aren't supposed to print.

Some users tend to build up their ALE addresses in groups of three. Others don't. Let's do an example from the U.S. Civil Air Patrol (CAP). This is 0034MERCAP, where MER is the Middle East Region of the continental U.S., not that other place with the oil and stuff.

This address gets sent as [TIS]003, [DATA]4ME, [REP]RCA, [DATA]P@.@. (The REP can't follow itself.) No wonder some CAP addresses are notoriously tough decodes with the equipment and software available to the radio hobby.

### ❖ Address Quirks

Some smart ALE users put the important stuff right up front, in the first word. For example, a lot of voice calls have prefixes and suffixes. In the U.S. Navy/ Marine Corps MARS (Military Auxiliary Radio System), nearly all of these begin with "NNN0."

What they've started doing is sending the suffix first, the "NNN" second, and the zero not at all. If the [DATA] word gets wiped out, at least most people will still know who it is. Dropping the zero eliminates the [REP] word altogether, further increasing efficiency.

Quite a few U.S. agencies embed the location into the address. This is usually done

in a straightforward manner. Again doing CAP, there's 0001ARCAP. Except for the problem that a bad decode might return only "000," it breaks down as a station number, a state (Arkansas), and the agency.

But then there's New Hampshire. They love to split it up, perhaps again to get more of the essential stuff up front. NA1SH, for example is Nashua, NH. They have a lot of these. There's also the U.S. Army, where essentially anything goes.

On the other hand, the U.S. Federal Emergency Management Agency (FEMA) is pretty straightforward. There's usually a structure based on station type, region, agency (FEM), and any additional identifiers as for an auxiliary or a mobile.

One small glitch is with FC8FEM and FC8. The first is the powerful transmitter of the communications console at FEMA's Region 8 headquarters in Denver, CO. The second appears in truncated decodes, but also in proven good ones, with no discernible pattern. There is no way to tell the difference without carefully analyzing the transmission.

### ❖ COTHEN

Those wishing to find all this stuff for themselves, and who have ALE decoding software, can try several especially active networks. COTHEN, the U.S. Customs Over-The-Horizon Enforcement Network, is a great place to start. Most of its addresses have three characters. Aircraft derive these from their voice identifiers and/or end digits in their tail or registration numbers. U.S. Coast Guard cutters typically use the last three letters in their "official" radio call signs. They drop the first letter, which is always "N" anyway.

Remote transmitters typically use a standard U.S. airport or location code, and then whatever other letters are needed. ABQPRI is the primary transmitter in Albuquerque, NM, and ABQSEC is the secondary.

Two common players are PAC and LNT. These are the Coast Guard. PAC is the Communications Area Master Station, Pacific (CAMSPAC). LNT is the same thing for the Atlantic (CAMSLANT).

Scan these frequencies, or whatever subset makes sense for propagation: 4614.5, 5250, 5732, 5909.5, 7527, 8912, 10242, 11494, 12222, 13312, 13907, 14582, 15867, 18594, 20890, 23214, and 25350. These are all kilohertz (kHz), and upper sideband mode (USB).

Those who can't scan can still park on 8912, 10242, or whatever else sounds promising, and there'll be action soon enough. The really sensitive stuff is passed "in the green," using an advanced and highly encrypted digital mode. Only operator chatter goes "in the red" (clear).

## ❖ Military

Much has been made of the U.S. Air Force SCOPE Command ALE system, which is based on ALE. It is an equipment upgrade, not a replacement for the older voice and data frequencies. The stations are automated, with a control point at ADW (Andrews Air Force Base, MD). However, they are also highly flexible, and provide for local control.

Frequencies here are 2805, 3059, 4721, 6715, 6721, 7632, 8968, 9025 11181, 11226, 11250, 13215, 15043, 15091, 18003, 23337, and 27870 kHz USB. 9025 is especially interesting, as aircraft can make automatic phone patches by passing the number in an ALE message space.

Ground stations typically use three letters. Aircraft use 6-number strings built from a type designator, first year of service, and end of the



**Portable ALE tactical radio (Röhde & Schwarz)**

tail number.

Another ALE net that's finally seeing activity is the United Kingdom's DHFCS (Defence High-Frequency Communications System). It has approximately 80 frequencies, too many to list here, but the ALE list on this column's web site has them all.

The control station is XSS at Forest Moor. Its soundings are heard very well, in fact a little too well here in California. Remotes or a different station?

TASCOMM, Terrestrial Air-Sea Communication, the former ARCHITECT, is an associated net. It's for ships and aircraft working the shore.

Most addresses encountered so far use three letters, though E-3 aircraft use UKE3001, and up. Have fun!

## ABBREVIATIONS USED IN THIS COLUMN

ALE.....	Automatic Link Establishment	MARS.....	U.S. Military Auxiliary Radio System
AM.....	Amplitude Modulation	Meteo.....	Meteorological; weather office
ARQ.....	Automatic Repeat reQuest	MX.....	Generic for Russian single-letter beacons/markers
Camslant.....	Communications Area Master Station, Atlantic	NAT.....	North Atlantic oceanic air control, families A-F
CAP.....	U.S. Civil Air Patrol	Navtex.....	Navigational Telex
COTHEN.....	Customs Over-The-Horizon Enforcement Network	NDB.....	Non-Directional Beacon (Aero).
CW.....	On-off keyed "Continuous Wave" Morse telegraphy	RTTY.....	Radio Teletype
DSC.....	Digital Selective Calling	S28.....	Russian voice messages on "UVB-76"
E11a.....	English "Strich" family, group count and message	Selcal.....	Selective Calling
EAM.....	Emergency Action Message	Sitor.....	Simplex Telex Over Radio, modes A & B
FAX.....	Radiofacsimile	UK.....	United Kingdom
FSK.....	Frequency-Shift Keying	Unid.....	Unidentified
FEMA.....	U.S. Federal Emergency Management Agency	U.S.....	United States
HFDL.....	High-Frequency Data Link	USAF.....	U.S. Air Force
HFGCS.....	High-Frequency Global Communications System	USCG.....	U.S. Coast Guard
HM01.....	Cuban Intelligence, alternates voice & digital	USS.....	United States Ship
ID.....	Station identification	V02a.....	Cuban Intelligence, 3x150 group format
LDOC.....	Long-Distance Operational Control	V13.....	Taiwan music and numbers in Standard Chinese
M01/M01b.....	Unknown agency, numbers in 2-tone Morse	Volmet.....	Scheduled, formatted, aviation weather broadcasts
M12.....	Russian Intelligence, xxx/xx CW numbers	XFA.....	Russian Polytone, 20-tone version

All transmissions are USB (upper sideband) unless otherwise indicated. All frequencies are in kHz (kilohertz) and all times are UTC (Coordinated Universal Time). "Numbers" stations have their ENIGMA (European Numbers Information Gathering and Monitoring Association) designators in ( ).

18.1	RDL-Russian military strategic broadcast, short message in BEE 36/50 (a Russian FSK mode), parallel 12741 kHz, at 1608 (MPJ-UK).	3881.0	FAV22-French government, Favières, CW drill messages in 5-letter groups, also on 6825 and 10115.5, at 0711 (Lacroix-France).
514.0	GO-Estonian Air Force NDB, Amari Air Base, CW ID at 0355 (ALF-Germany).	4039.0	RIT-Russian Navy Baltic Fleet headquarters, Severomorsk, CW message for RLO, at 2101 (MPJ-UK).
518.0	"F"-Arkhangelsk Radio, Russia, Sitor-B Navtex gale warning for White Sea, at 2015 (Patrice Privat-France).	4079.0	RMP-Russian Navy, Kaliningrad, CW weather for REO, at 1638 (PPA-Netherlands).
2187.5	OVZW2-Danish flag buoy-laying ship <i>Esvagt Alpha</i> , DSC safety test with Lyngby/Bremen, who answers, at 2204 (MPJ-UK).	4209.5	TAH-Istanbul Radio, Sitor-B marker and Navtex message in Turkish, at 2213 (Lacroix-France).
2458.5	AQP2-Karachi Wireless, Pakistan, CW marker at 0001 (MPJ-UK).	4153.0	Unid-Japanese Navy phase-shift-keyed mode (XSL), idlers and encrypted data at 0944 (Boender-Netherlands).
2600.0	RMAE-Russian Navy vessel, CW weather observations at 1814 (PPA-Netherlands).	4212.0	UGC-St Petersburg Radio, Russia, CW ID in Sitor-A idler, with XSQ, Guangzhou Radio in China also audible underneath, at 2232 (MPJ-UK).
2624.0	IQX-Trieste Radio, Italy, "female" voice-synthesized Adriatic Sea weather, at 1825 (PPA-Netherlands).	4244.0	DAO24-Kiel Radio/ Global Link, CW ID in Factor idler, at 2238 (MPJ-UK).
2720.0	SPS-Witowo Radio, Poland, female with bulletin in Polish, at 2136 (Michel Lacroix-France).	4244.7	IDR-Italian Navy, Rome/ Augusta, RTTY channel availability marker, at 2244 (MPJ-UK).
2733.0	SDJ-Stockholm Radio, Sweden, navigational warnings in English and Swedish, at 2206 (MPJ-UK).	4396.0	3421-Turkish Emergency Net, calling 3011, ALE at 2037 (PPA-Netherlands).
3152.0	Hotel Whiskey-U.S. Navy, USS <i>Harry S. Truman</i> Battle Group Air Defense Commander, tracking net with Hotel Foxtrot, Golf, and others, at 2326 (Jack Metcalfe-KY).	4459.0	BCDE-Austrian military, calling CDEF, ALE at 1921 (PPA-Netherlands).
3161.0	382-Unknown agency (M01b), CW callup "382 731 731 30 30," then message in 5-figure groups; similar on 3162.3, 3181, and 3323; at 2042 (MPJ-UK).	4486.0	MX40-Algerian military, calling MX48; similar on 5736, 6921, 6985, 8894, 10528, and 10579; ALE at 2031 (PPA-Netherlands).
3274.0	8S1Q-Russian military, CW identifier on coded message "96811 KOTARNICA 840Z3 96811 K," at 1828 (PPA-Netherlands).	4490.0	197-M01, CW callup "197 127 30" and message, parallel on 4491; "197" call also heard on 5320, 5809, and 5810; at 2000 (MPJ-UK).
3395.5	RCV-Russian Navy, Sevastopol, Ukraine, calling RIR96, listening on 3572.5, CW at 2001 (PPA-Netherlands).	4595.0	4XZ-Israeli Navy, Haifa, CW marker at 1851 (PPA-Netherlands).
3455.0	New York Radio-Caribbean air control, flight plan change with N900SX, a Falcon 900 bizjet registered to SpaceX, at 0839 (Allan Stern-FL).	4625.0	The Buzzer (S28), usual buzzing noise at 0654 (Lacroix-France). MDZhB-identifier in Russian (S28) voice message "OBJAVLENA KOMANDA 135" ("Command 135"), at 0256. MDZhB, Russian voice "26 47 GERUNOK" (new short message format), at 1409 (Boender-Estonia remote).
3593.7	"D"-Russian cluster beacon (MX), Odessa/ Sevastopol, CW ID; also on 4557.7, 5153.7, 7038.7, 13527.7, 16331.7, and 20047.7; at 2024 (MPJ-UK).	4724.0	Puerto Rico-USAF HFGCS, Salinas, EAM simulcast on 8992 and 11175, at 0000 (Mark Morgan-OH).
3593.8	"P"-MX, Kaliningrad, CW ID; also on 3593.8, 3594.8, 4557.8, 10871.8, and 13527.8; at 2056 (MPJ-UK).	5154.0	"C"-MX, Moscow, CW ID at 2202 (Boender-Netherlands).
3593.9	"S"-MX, Severomorsk, CW ID; also on 3594.9, 4557.9, 5153.9, 7038.9, 8494.9, and 20047.9, at 0959 (Ary Boender-Siberia remote).	5154.2	"F"-MX, Vladivostok, CW ID; also on 7039.2 and 8495.2, at 0959 (Boender-Siberia).
3775.0	VL6R: Russian military net control, CW with several other 4-figure call signs; similar activity on 3826, 5050.5, 5077, 7637.5, 7660, 12152, 12207, and 13971; at 2123 (MPJ-UK).	5156.8	"L"-Russian Navy, St. Petersburg, single-letter channel marker (MX), CW at 0720 (Lacroix-France).
3831.0	ZLST-German Customs Control Post, Cuxhaven, calling ZBOR, Customs Boat <i>Borkum</i> , ALE at 1949. ZPRI, Customs Boat <i>Priwall</i> , calling ZLST at 2035 (Privat-France).	5170.0	BMB-Taipei central weather bureau, Taiwan, female-voice bulletin at 1920 (PPA-Netherlands).
		5224.0	RCV-Russian Navy, Sevastopol, CW signal checks with RHL80 and RFH70 (destroyer <i>Smetlivy</i> ), at 2142 (MPJ-UK).
		5454.0	Unid-Possible Russian military, high-speed CW 5-letter groups, at 0426 (Mario Filippi-NJ). RCEG-Unknown Russian Navy vessel, setting up encrypted CW traffic with RCV, at 2142 (MPJ-UK).
		5598.0	New York-NAT-A, selcal check with unknown Cubana flight, at 0812 (Stern-FL).

- 5616.0 Ranger 001-Unknown U.S. military, position and selcal check with Gander, at 0110 (Tony Agnelli-FL).
- 5622.0 9V-SKS-Singapore Airlines A380, flight SQ0322, HF DL log-on with Krasnoyarsk, Russia, at 2201 (MPJ-UK).
- 5634.0 Brisbane-Africa/ Indian Ocean air route control, Australia, working QFA 7333, a B737 VH-XML, at 1904 (PPA-Netherlands).
- 5649.0 Shanwick-NAT-C, selcal AK-RS and position check with BAW21G, a British Airways B747 reg G-CIVC, at 1829 (PPA-Netherlands).
- 5658.0 Mumbai-Middle East air route control, India, selcal CL-EK to Qatari 276, a Qatar Airways A330 reg A7-AEJ, at 1907 (PPA-Netherlands).
- 5670.0 Colombo-Southeast Asia air route control, Sri Lanka, selcal AL-PS to 9M-AHY, an Air Asia A330, at 1914 (PPA-Netherlands).
- 5687.0 GAF371-German Air Force, working DHM91, Muenster, at 2024 (PPA-Netherlands).
- 5691.0 Irkutsk Volmet, female with aviation weather in Russian, at 1927 (PPA-Netherlands).
- 5740.0 Unid-Mexican Navy, exercise comms in clear and scrambled voice, with Tadiran data tones superimposed, at 1050 (Agnelli-FL).
- 5800.0 DELTA03RS1006-Uzbek Military, ALE link checks with BURON22RS1006, many others, at 1800 (ALF-Germany).
- 6450.0 ROMA-Italian Financial Police, Rome, ALE and data with VIBOVALENTIA, at 1920 (ALF-Germany).
- 6522.0 OYR-Aasiat Radio, Greenland, female with gale warnings, at 0910 (PPA-Netherlands).
- 6532.0 ET-AOQ-Ethiopian Airlines B787 flight ET0707, HF DL position for Shannon, at 2120 (MPJ-UK).
- 6535.0 006-HF DL ground station, Hat Yai, Thailand, position from FedEx flight 508, at 1744 (PPA-Netherlands).
- 6586.0 New York-Caribbean air control, selcal check AE-GK with United 1471, a B737 reg N26210, at 0657 (Stern-FL).
- 6606.0 4XZ-Israeli Navy, Haifa, many numbered CW messages in 5-letter groups, at 0400 (Agnelli-FL).
- 6628.0 New York-NAT-E, position from Speedbird 204, British Airways, at 0736 (PPA-Netherlands).
- 6640.0 New York LDOC, patch to Medlink for Air Canada 860, a B767, regarding a sick passenger, at 0645 (Stern-FL).
- 6661.0 004-HF DL ground station, Riverhead, NY, uplinks for N422AV (Avianca A319) and N992AV (Avianca A320), at 0744 (PPA-Netherlands).
- 6676.0 9VA40-Singapore Volmet, voice synthesized male with aviation weather for Bali, at 1822 (PPA-Netherlands).
- 6690.0 OMG-Moroccan police, calling NQ2 and VOE, ALE at 1939 (PPA-Netherlands).
- 6712.0 Circus Vert-French Air Force transport command, Villacoublay, working CTM3302, at 0735 (Lacroix-France).
- 6754.0 Trenton Military-Canadian Forces volmet, aviation weather at 0830 (Lacroix-France).
- 6768.0 Unid-Cuban Spanish "female" (V02a), 5-figure-group numbers in progress, weaker than normal, at 0440 (Agnelli-FL).
- 6773.5 ZATO25-Polish military, ALE group callup LWZ123, then link checks with AS4, IKO, PP7, KX2, OR2, and OR9; at 1200 (ALF-Germany).
- 6830.0 RDP5- Russian government, RTTY operator chatter in Russian, then encrypted ARQ, at 0630 (ALF-Germany).
- 6885.0 JAXTEST01-U.S. military exercise, probably FL, ALE with 4XG11011 and 4XG44004; also on 7451, 10824, and 14876; at 1808 (Metcalfe-KY).
- 6904.0 257-Russian Intelligence CW (M12), callup 257/1; different callups on 7697, 7931, 8047, 8112, 8116, 9176, 9223, 9264, 10343, and 10598, at 1740 (MPJ-UK).
- 6923.0 Unid-"Strich" / "Oblique" numbers family (E11a), callup "955/30" and message in 5-figure groups; also on 8091, 10213, 10690, 10800, 15632, and 16112; at 1710 (MPJ-UK).
- 6985.0 CM3-Algerian Air Force Region 3 Command, Bechar, ALE link checks with MOB, CNC, and HMG (Hamaguir), at 0800 (ALF-Germany).
- 7039.0 "C"-MX, Moscow, CW ID; also on 8495, 10872, and 20048, at 0959 (Boender-Siberia).
- 7039.3 "K"-MX, Petropavlovsk-Kamchatskiy, CW ID, also on 8495.3, at 1317 (Boender-Netherlands).
- 7039.4 "M", MX, Magadan, CW ID, also on 8495.4, at 0959 (Boender-Siberia).
- 7564.0 RFH70-Russian Navy vessel, high-speed CW message traffic, at 0357. (Filippi-NJ).
- 7642.0 EBCNNN-U.S. Navy/ Marine Corps MARS NNN0EBC, WV, ALE sounding, at 2211 (Privat-USA remote).
- 7654.0 New Star Radio Station-Music and numbers in Chinese (V13); also on 7654, 7688, and 7938; at 0707 (Boender-Hong Kong remote).
- 7726.5 JUMPBNNET-U.S. Marine Corps, ALE link with CAMPDKWBNNET, possibly Camp Davis, NC, then passing encrypted data; also on 5801.5, 6967, 7593.5, and 11113; at 1801 (Metcalfe-KY).
- 7954.0 Unid-Russian military, CW message for collective group call RLO, at 0429 (Filippi-NJ).
- 7891.0 Unid-Russian Polytone (XPA), multiple FSK tone-coded message at 1900 (PPA-Netherlands).
- 8345.0 RKO81-Russian Navy tanker *Lena*, CW message in 5-figure groups, at 1812 (PPA-Netherlands).
- 8414.5 319014800-Cayman registry oil tanker *Oriental Acacia*, DSC to 006191000 (Abidjan Radio, Ivory Coast), at 1902 (PPA-Netherlands).
- 8435.0 XSQ-Guangzhou Radio, China, CW ID in Sitor-A marker, at 1557 (Lacroix-France).
- 8462.0 9MR-Malaysian Navy, Johor Bahru, RTTY all-ships broadcasts in Malay, also on 12673.5, at 1602 (Lacroix-France).
- 8467.5 JSC-Kyodo News, Japan, FAX newspaper at 1607 (Lacroix-France).
- 8495.1 "A"-MX, Astrakhan, CW ID; also on 10872.1, 13528.1, and 16332.1, at 0959 (Boender-Siberia).
- 8660.0 Unid-Unknown distressed vessel, discussing repairs in Italian and French, at 0730 (Privat-France).
- 8675.0 CVB-Chilean Navy, Valparaiso/ Playa Ancha Radio, large FAX satpic at 2340 (Filippi-NJ).
- 8710.0 UGE-Arkhangelsk Radio, Russia, phone patch in Russian, at 0814 (PPA-Netherlands).
- 8743.0 HSW-Bangkok Meteo, Thailand, station info in English, then musical chime and weather in Thai, at 1654 (PPA-Netherlands).
- 8764.0 NMN-USCG Camslant Chesapeake, weather at 2209 (Lacroix-France).
- 8806.0 Unid-Vladivostok Radio, Russia, phone patch in Russian with polar signal distortion, at 0758 (PPA-Netherlands).
- 8812.0 TAH-Istanbul Radio, Turkey, also on 13128, weather at 1000 (Lacroix-France).
- 8828.0 Auckland Volmet, New Zealand, aviation weather at 0820 (PPA-Netherlands).
- 8829.0 Ankara-Turkish Airlines LDOC, selcalling and trying to raise aircraft in Turkish, no joy, at 2204 (Lacroix-France).
- 8864.0 Gander-NAT-C, working Air Canada 849, at 1840 (PPA-Netherlands).
- 8891.0 Gander-NAT-D, working USAF C-17A REACH 431, at 0758 USB (Lacroix-France).
- 8894.0 Algiers-North African air control, working Air Algeria 50 and Royal Air Maroc 511, at 2202 (Lacroix-France).
- 8942.0 VJC867-VietJet Air, position for unknown ground station, at 1611 (Privat-France).
- 8948.0 OE-ICE-JetAlliance A318, HF DL position for Canarias, at 2158 (MPJ-UK).
- 8971.0 Pioneer 952-U.S. Navy, possibly a P-8A, returning to base after working Red Talon and Fighting Tiger 711, also on 285 megahertz, at 1539 (Stern-FL).
- 9007.0 Canforce 4068-Canadian Forces C-17A, working Trenton Military at 0858 (Lacroix-France).
- 9031.0 Hotel Sierra-U.S. Navy HST Battle Group Surface Commander, tracking net with Hotel Whiskey and Tango, at 0000 (MDMonitor-MD). Hotel Whiskey, working Tango, Romeo, and Lima, at 1935 (Stern-FL).
- 9110.0 NMF-USCG, Boston, FAX wind chart at 0819 (Lacroix-France).
- 10075.0 9V-SKR-Singapore Airlines A380, flight SQ0322, HF DL position for Al-Muharrqa, at 1629. VH-OQA-Qantas A380 "Nancy Bird Walton," flight QF0001, HF DL log-on with Al-Muharrqa, at 1730 (MPJ-UK). [Yes, VH-OQA is back in revenue service. -Hugh]
- 10123.0 761-Algerian Air Force, ALE link check with CM1 (Military Region 1 Command, Blida), at 1751 (ALF-Germany).
- 10194.0 CAOFEM001-FEMA Caribbean Area Office, San Juan, Puerto Rico, ALE sounding at 0904 (PPA-Netherlands).
- 11111.0 STAT22-Tunisian Ministry of Information, Tunis, working TUD, ALE at 0933 (PPA-Netherlands).
- 11175.0 Quick Lime-U.S. military, with 28-character EAM beginning MFUOFU, simulcast on 4724 and 8992, at 0230 (Jeff Haverlah-TX) Puerto Rico-USA FFGCS clear and secure checks with C-5A Rodd 03, then went to 11220, at 2053 (Stern-FL).
- 11184.0 F-HPJG-Air France A380, flight AF0066, HF DL log-on with Reykjavik, at 1535. 4K-AZ81-Azerbaijan Airlines B767, flight J20015, HF DL position for Reykjavik, at 1536 (MPJ-UK).
- 11220.0 Puerto Rico, came from 11175 with C-5A Rodd 03 for crypto checks, at 2054 (Stern-FL).
- 11226.0 280002-USAF VC-32A #98-0002, ALE sounding at 1002 (PPA-Netherlands). [This aircraft has sometimes been Air Force Two. -Hugh]
- 11244.0 Down Deep-U.S. military, with EAM beginning ZOID6, at 1711 (Metcalfe-KY).
- 11279.0 Gander-NAT-D, position and altitude change with United 922, a B767 reg N652UA, at 1829 (PPA-Netherlands).
- 11342.0 New York-LDOC, selcal check with JetBlue 862, an A320, at 1542 (Stern-FL).
- 11635.0 Unid-Cuban hybrid mode (HM01), alternating voice 5-figure groups and data transmissions, in AM at 2100 (Agnelli-FL).
- 12577.0 353216000-Panamanian flag bulk carrier *Crystal Tiger* (3EUJ6) DSC safety test with Madrid, at 1648 (MPJ-UK).
- 12579.0 UFZ-Vladivostok Radio, Russia, Sitor-B test loop at 1102 (PPA-Netherlands).
- 13285.0 BSQ-Beijing Volmet, aviation weather at 1049 (PPA-Netherlands).
- 13306.0 New York-NAT-A, selcal AJ-GQ to American 63, a B767 reg N348AN, at 1519 (PPA-Netherlands).
- 13321.0 008-HF DL ground station, Johannesburg, South Africa, uplink to VT-IGS, an IndiGo A320, at 1718 (PPA-Netherlands).
- 13362.0 Unid-U.S. Navy, Guam, rebroadcast of American Forces Network, at 1102 (PPA-Netherlands).
- 13927.0 AFA9AY-USAF MARS, CA, phone patches for U-2 Pinon 71, at 2242 (Stern-FL).
- 13950.0 S1B-Lithuanian military, calling P1G, ALE at 1524 (MPJ-UK).
- 14707.0 Unid-Likely JPA35, Interpol, Japan, Sitor-A with unheard station, passing long strings of 5-letter groups, at 0140 (Hugh Stegman-CA).
- 14876.0 4XG44004-U.S. military exercise, ALE text messages with 4XG11011, at 1104 (Mike Chace-Ortiz-ME).
- 16240.0 2011-Moroccan Intelligence net control, working 2518, also on 18765, ALE at 1604 (MPJ-UK).
- 19201.0 RCV-Russian military, sent several CW messages in 5-letter groups to RJE, then calling RCIV, at 1007 (Eddy Waters-Australia).
- 20890.0 NAS-USCG Cutter *Escanaba*, (WMEC-907/ NNAS), COTHEN ALE sounding at 1519 (MPJ-UK).
- 21825.0 Unid-Russian Intelligence, Mazielka selcal with tone calling in progress, at 1122 (Waters-Australia).
- 29894.0 0011AR-Partial decode of CAP 0011ARCAP, AR, ALE sounding at 1515 (MPJ-UK). AVS-"Avenging Spirit," a CAP headquarters ID, ALE sounding at 2219 (Stegman-CA).





## The Strange Case Of Napa and Lion

This month we take a look at a couple of intriguing voice networks, and the Colombian naval HF operations. There's also news from long-established Swiss decoder manufacturer WaveCom.

A few months back, I stumbled upon a seemingly innocuous net with a couple of stations speaking in French in between sets of 5 letter groups. At first, I thought perhaps Moroccan or Algerian speakers but the more I listened, the more obvious their West African accents became. I've still yet to determine the precise location of the stations, but Togo, Benin, Mali or Congo could all be possible.

So far, I and other monitors have observed scheduled contacts at 1500, 1600 and/or 1700 UTC on any day of the week including weekends. There are four channels in use: 14575, 15835, 16335 and 18045 kHz USB, the latter seeming to be the most frequently used. No selcall mechanism appears to be used with just simple voice call-ups in use. The sending station uses the callsign "Napa" and the receiving station is "Lion" or "Lyon."

Tight operating procedure is employed and nothing has been noted other than discussion of the messages themselves. The 5 letter groups are sent in groups of 6 using the standard ICAO phonetic alphabet in a 3/2-style format, so the group "ABCXY" is spoken as "Alpha Bravo, pause, Charlie X-Ray Yankee." Examining the messages shows that certain groups are repeated both within and across messages. Here is an example copied on December 26, 2012 (the group counts have been added by me and asterisks indicate where I failed to copy a letter):

DMOAE EOMUM AIDAW UGSTN TVEAU UM-ALS 6  
BKEZN EADCE ITOEK CRLED AEUSK UTELM 12  
NKPDE EIEDU URKSM DKXZU UFDKT CDEKR 18  
TDER\* HRANA RTOGU NCKQF RKART EIDKN 24  
KAPT\*PTKQ\*QEPO HDMUK EFKS IEOKS 30  
SURUK TENDE OXPTN ONTIU RDDKE LETSF 36  
BDEUK MZCEI VSFCE KEODN ISERV HDRB 42  
NOINU TMBDG SOUQI AFUSR KURTC DEDKE 48  
IOPDC KPKNU KORVE ODUAR DMNUR KD\*\*A 54  
TNTKN CZARP TUKYN ORMDU FIPVO OASNP 60  
MISEX RG\*KT KDXDN KDFIA SLGKF GDIKT 66  
VNDLR DKLCA CNEAT IDTPH DEOCN DODMU 72  
KOLOB OFKNS UKBQL TNRMS OXZRI DEDOC 78  
TZTEA RDSAN ZIEBU FPDAS QNXSZ QPTRN 84

2nd Message

ONPNK EMPIL AIDAW PUTIR ENLUR KESKV 6  
LDSUN MOX\*L RHPXC KNSIE RADLO DSKUH 12  
GUPDN EKXQE IRTCK UVQEI CUNGV RUFUN 18

UAVKE RNTIL TUIKT DEDK\* OYONR VHCRO 24  
FNCIS ETRMN VNTKL KETOF PTSCO EDSUO 30  
RNCMT DREUO QANAS UEZUT AORIN KM-VEF 36  
CSATS RXVXE OHRUS TONUW RI\*DE ORNRT 42  
INCTR QUAST ZCTNC NIMIG KRTUO IUIUK 48  
RZTUD CLGRA UINVE EROKO KUAKL PKUGN 54  
QTEQK GPRPI GIOKE CURNU UETER UEIQV 60  
DEANU NOIKN PKSDU RESTI ISETU OGKRK 66  
TILT EDIT VQKOE IDUSV IKEIR TOETL 72  
ETEST DEOKT UECSI STIAO DEJZU UIOVT 78  
D\*NUP OEIAS JEUK EHDRB PDUKT SRNLN 84  
UEIUE AUQEI TASHK EGTDI TUOCA PQAEB 90  
SATDD AIDAW

Note that the group AIDAW appears once in the first message and twice in the second, which certainly indicates some features one wouldn't expect if these had completely random letter distributions.

Two or three messages are usually sent during each scheduled contact and they can be so lengthy as to require more than an hour to transmit, especially since the stations frequently send or copy the incorrect letters and need to go back over what was previously sent. It's an excruciating process to say the least, and something that could surely be accomplished in a fraction of time using digital means with no loss of security!

### ❖ The "India Mike" Network

This voice network uses CCIR493-4 selcalls to rouse stations and puts a very respectable signal into the U.S. after dark on a frequency of 5656 kHz USB. Selcalls are sent at 1785 Hz higher than the carrier and a series of 5 beeps will be heard when stations link successfully. Selcalls and radio checks are frequent, indicating a large and active network.

The stations use English, though like Napa and Lion, are clearly not native speakers of that language and could possibly be Indian or Pakistani. Again, tight operating procedure is in use with little other than routine traffic. It certainly has all the trappings of a peacekeeping or police operation.

The main station identifies as "India Mike Base" on voice and uses the selcall 777 with outstations using 1700-series identifiers. Outstations appear to give either a name or locations when reporting, but the accents make them very challenging to decipher. You can hear India Mike Base and an outstation in the two clips shown in the Resources section.

Remember that you can use the excellent and free Rivet decoder (see Resources) to read the selcall activity in addition to a number of other interesting digital modes.

### ❖ Colombian Navy Update

The Colombian Navy HF network continues to build-out and can easily be heard across the U.S. and well into Europe. It appears that the old CCIR493-4 selcall-based component of the network continues to operate in parallel on a number of frequencies along with the Clover-2000 data traffic it initiates. Selcalls are of the 9200-series. Channels using this method of communications include the following:

5493, 5497, 5500, 5703, 5705, 5706, 5757, 5760, 6750, 7640, 7900, 8142, 8676, 9082, 9155, 10608, 11137, 11140, 11150 and 12230 kHz USB

The latest network uses the MIL-STD-188-110A serial tone modem and MIL-STD-188-141A Automatic Link Establishment (ALE). Static tactical identifiers are used including:

111NO, 201DE, 5KM, ACP, BDC, BET, BLP, BLR, BOO, BOP, BOZ, CFP, CPL, DPA, EIB, EPA, FIB, FIP, FPE, GAM, GPM, KMO, KM1, KM2, KM3, KN2, MPM, PAS, PFA, PMF, POD, POH, OCT, RADIROOM, TMM, and WLF

Channels using these data modes include:

4632, 5500, 5510, 5815.5, 6850, 6955, 7750, 8010, 8060, 8250, 9090, 10876, 11150, 11440, 11450, 12417, 13540, 14922, 16547 & 16554kHz USB.

### ❖ WaveCom's W-Cloud

It seems like everything is moving into "the cloud" these days and radio data decoding isn't immune. Word from well-regarded and long-time high-end digital data decoder manufacturer WaveCom announces the arrival of their W-Cloud offering. This new product is a TCP/IP networking application that enables encrypted transfer of I/Q data from a remote WaveCom decoder device to W-CODE software located at a different site for final processing and analysis. W-Cloud enables data decoding, signal classification and monitoring over large geographical distances.

The days are definitely here when it is possible to place a receiver and data collection device in a completely remote location and have complete control of both from anywhere else in the world with an Internet connection.

### RESOURCES

India Mike Clip A: <https://dl.dropbox.com/u/301213/5656USBA.wav>  
India Mike Clip B: <https://dl.dropbox.com/u/301213/5656USBB.wav>  
Rivet Decoder: <https://github.com/IanWraith/Rivet>

## Band Openings in a Brave New World

**A**t 0010 UTC last Monday, the bands were devoid of signals. The CW/digital sub-bands on 20 through 10 meters produced only static, save for the faint warble of a lonely PSK31 signal on 14.071 MHz. There was a nasty rumble on 30 meters, but it hardly sounded “intentional,” and even 80 and 40 meters offered only a few muted CW signals. With the present iffy propagation, the ham bands sound like this all too often.

Although Monday seemed typical, it wasn't. Just 10 minutes earlier, before the end of the 2013 CQ WPX RTTY Contest, 20 meters was “wall to wall,” 15 meters was solidly filled with RTTY “deedle-eedles,” and 10 meters was sporting numerous DX RTTY stations. It was almost like the good old days!

Well, not exactly. But thanks to a weekend spiced up by a little trans-equatorial propagation (TEP), my 5-W RTTY signals, launched from an indoor attic loop, made the round trip to Alaska, Hawaii, Brazil, Aruba, Argentina, Chile, Mexico, Puerto Rico, the U.S. Virgin Islands, Venezuela, the Dominican Republic, Jamaica, Cuba, Colombia, even the Canary Islands!

So, what difference did 10 minutes make? Ionospherically, none. Informationally, lots! When the contest was underway, *thousands* of stations were making QSOs and calling CQ, so the bands were filled with “propagation indicators” from every corner of the globe. There wasn't any doubt about whether the bands were open because the stations were plainly audible. After the contest, however, when the bands seemed dead, *they were still open*, but it just wasn't apparent. This happens every day.

Most non-contest days don't enjoy the benefit of thousands of CQing stations, so the bands may sound dead even if they're not. What we need, then, is a network of geographically spaced, frequency-agile “CQing” stations (or receiving stations that can report the strength of our transmitted signals). We have these, thankfully, in the form of various beacon and reverse-beacon networks, some of which have a real science fiction twist. Broadcast, public service and even utility stations on VLF through UHF can provide some help here, too, as can the decidedly old-fashioned technique of calling CQ on an otherwise “dead” band!

### ❖ Calling CQ

Calling CQ is an old-school, seemingly obvious way to test propagation. If you call CQ and someone answers you, there's propagation! And when it works, it works. But calling CQ isn't always a *reliable* way to validate band conditions, because not everyone who hears your CQ will answer it! I have fruitlessly called CQ on 6 meters until I was nearly exhausted,

only to later hear from a fellow ham in person who heard me calling and calling on 50.125 MHz!

And you can just *feel* the frustration of U.S. hams who are calling “CQ DX,” only to be answered by seemingly endless waves of domestic ops. “CQ DXers” will often simply ignore unwanted replies, so don't assume that they don't hear you if you're calling them!

Much of this comes down to an individual's approach to the hobby. Ragchewer types will talk to anyone, any time, while “operating achievement” types may be much more focused, and if you're in the “worked and confirmed” category (say, California, which is its own one-state call district), you probably won't get a reply (because you won't further the other op's on-air goals). So, do call CQ, and do call CQ more often, but don't rely on it to determine propagation.

### ❖ Listening to Non-Ham Signals

Thousands of broadcast and utility signals from DC to daylight, when monitored, can provide some insight into whether the bands are open to one place or another. Although somewhat disorganized, these signals are geographically and spectrally diverse, and their locations are generally known.

Listening to shortwave signals at 6 and 9 MHz, for example, may provide some insight about whether 40 meters might be open to wherever, but because broadcasters run high power to killer antennas, they might have a whopping 10-40 dB gain advantage over your 100-W backyard dipole! Still, the information is useful.

Unlike broadcasters, which have varied schedules, frequencies and transmitter sites, time-and-frequency stations such as WWV and WWVH can provide solid “reference” signals at various shortwave frequencies. But these are only really valid if you're looking to work stations near Fort Collins, Colorado, or Kekaha, Hawaii (or wherever your more obscure time station is located). Unlike shortwave broadcasters, though, WWV and WWVH use low-gain vertical dipoles with omni-directional patterns, which approximate ham station signals much more closely than do powerhouse broadcasters. See [http://en.wikipedia.org/wiki/Radio\\_clock](http://en.wikipedia.org/wiki/Radio_clock), [www.dxinfocentre.com](http://www.dxinfocentre.com), and <http://ac6v.com/standard.htm> for lists of time-and-frequency stations.

VHF TV and FM stations have long been used as propagation beacons/indicators. If you live near Chicago, for example, and your FM receiver starts receiving signals from Dallas, there's an awfully good chance that it's time

to jump on 6 or 2 meters!

In the days before digital TV, if your market had an unused channel between 2 and 4 (low VHF) you could simply park a TV receiver there (connected to an indoor or outdoor dipole), and whenever signals or raster bars showed up it was time to fire up on 6 meters! This works after a fashion with today's digital TV, but out-of-market signals need to be much stronger before reaching the “digital detection threshold.”

### ❖ Online Tools

Real-time propagation monitoring and prediction using linked online tools is already a science fiction reality. In the *very near future* you could get home from work, note that you have 17 minutes to get on the air before dinner, and sit down at your “radio.” Your radio, of course, is connected to your PC (or actually *is* a PC) so, in a few milliseconds, it checks (via the Internet) a dozen DX spotting sites worldwide, a half-dozen real-time propagation forecasts, current space weather and solar indices, and lists of ongoing DXpeditions. A second later it calculates the best odds for working all available spotted stations as ranked by your PC logbook's awards tracking database. A second after that, your PC populates the memory channels of your transceiver, sorting the stations in a complex order of “need” and “desirability” versus real-time propagation information. All you have to do is “work” the station!

And if you need additional help, your computer might sort through the pileup, displaying all of the Morse code call signs up and down the band, or use speech recognition and statistical analysis to identify all calling sta-

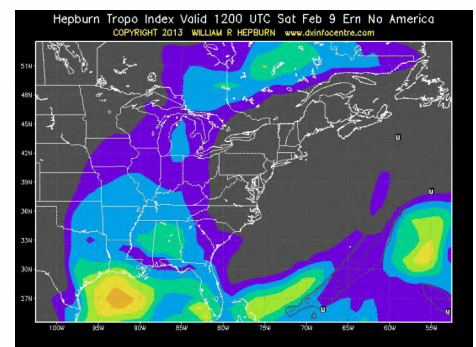

*This map forecasts potential tropospheric ducting at VHF/UHF (the Hepburn Tropo Index) for the Eastern United States on February 9, 2013. It, and many others like it, are generated daily and can be found at [www.dxinfocentre.com](http://www.dxinfocentre.com) (the “Weather Channel” for tropo propagation forecasting), which was created by Canadian monitor William Hepburn. See text for more information. (Image copyright 2013 by William R. Hepburn, [www.dxinfocentre.com](http://www.dxinfocentre.com).)*

tions (perhaps looking them up in a database, noting their signal strengths vs. geographical location for added “intelligence”) and predict where in the pileup the DX op will answer the next call—hopefully yours!

Should propagation fade before you’ve actually “worked” the stations, your PC can access multiple “local” receivers positioned all over the world to eliminate any pesky fading or noise. And should dinner be ready before “DX Time” is over, your radio can simply “work” the stations for you, as it knows your call sign and has plenty of speech samples on hand for “voice” QSOs.

Lest you think I’m pulling your leg or *merely* being cynical, 90% of this is already happening! If the amateur service rules allowed it, on a day with decent propagation, automated stations could “work” DXCC in about 10 minutes and be at the top of the Honor Roll by the end of a DX contest weekend! It *will* happen. Contest sponsors are already preparing the way.

Chances are, you’re not quite ready for *complete immersion* in this new reality, but if you want to get your feet wet, three web sites will start you down the rabbit hole.

The first is the DX Summit global DX spotting supersite at [www.dxsummit.fi](http://www.dxsummit.fi). Most “juicy” DX stations worldwide are listed in real-time for all to see (and fewer to work!). If you happen to hear a juicy station by actually listening to your radio while exploring the bands, you’d better work it *right away*, because as soon as it hits the DX spotting network, the masses will descend in mere seconds, making your task difficult or impossible.

The next site is [www.dxfinfo.com](http://www.dxfinfo.com), a tremendous and fascinating HF and VHF DXing site created by Canadian William Hepburn, of Brampton, Ontario. Among the dozens of data collections and features of use to listeners from VLF to UHF, Hepburn’s tropospheric ducting prediction maps and forecasting tools are nothing short of amazing. I have used them to successfully predict openings for TV and VHF DXing. And just looking at the maps makes you want to live in the Caribbean!

The third site, with a real-time emphasis, is [www.dxmaps.com](http://www.dxmaps.com), created by Gabriel Sampol, EA6RCM, an IT exec from Spain’s Balearic Islands, which gathers data from global DX spotting, APRS and WSPR networks, among others, and uses it to plot real-time (or recent-time) QSO maps on demand. These sites, and there are many more like them, feature data tickers, e-mail and cell phone alerts, and *many* other features too numerous to list here. It’s a brave new world. Check it out if you dare!

## ❖ Beacons

Beacons, ancient beacons, haven’t yet disappeared and are still useful. A large list of beacon frequencies and goodies can be found at <http://ac6v.com/beacons.htm>. Beacons typically transmit low-power signals on known frequencies, allowing anyone who receives them to immediately know that a propagation path exists between the beacon and the receiver. Many ham bands have beacon sub-bands (there are *many* active beacons on 10 and 6 meters),

and a large network of VLF aeronautical navigation beacons still exists (but is rapidly shrinking as navigation technology marches ever forward). The small airport in my home town of Little Falls, Minnesota, was home to VLF beacon LXL. I’m not sure if it’s still in operation, but I fondly remember listening to its Morse signals as a kid.

## ❖ The NCDXF/IARU HF Beacon Network

This special global amateur radio propagation monitoring network, started in the 1990s by the Northern California DX Foundation and administered today by volunteers through the International Amateur Radio Union, consists of 18 HF beacons scattered around the globe that each transmit on 14.100, 18.110, 21.150, 24.930, and 28.200 MHz (I’d like to see the lower bands, too).

Each beacon transmits on every frequency, every three minutes, round the clock, in a precise, GPS-disciplined sequence. Each beacon’s call sign (at 22 WPM Morse code) and four one-second dashes comprise a transmission. The call sign and the first dash are transmitted at 100 W, while the remaining three dashes are sent at 10 W, 1 W and 100 mW.

It doesn’t take long to compile an up-to-date propagation snapshot using the IARU Beacon Network, but it does take precise timing! The transmit schedule, info about the project, and links to software and hardware that will help you receive the right beacon at the right time on the right frequency can be found at [www.ncdxf.org/beacon](http://www.ncdxf.org/beacon). The web site also lists automated network monitoring stations that are Internet accessible if you want to see current and historical reception data.

## ❖ The Reverse Beacon Network

The RBN, which grew from a conversation in early 2008 between Pete Smith N4ZR and Felipe Ceglia PY1NB is so nifty that, as soon as anyone “gets” the concept, he immediately wishes he would have thought of it! Forget about beacons in the conventional sense; the computerized receivers that comprise the RBN listen to our transmitted Morse code CQ calls, decode them, and report signal strengths in near-real-time via the Internet!

Users can instantly see which RBN monitor stations can hear their signals, how strong they are, and spot band openings to nearby or faraway beacon locations on the spot! The network stores its data, so you can compare signal strengths over time, see if your buddy’s antenna is actually better than yours, etc.

New features are being added all the time and, unlike the IARU project, so are new monitors (individuals can easily get involved). Monitoring nodes typically involve SDRs and PCs running *CW Skimmer*, a revolutionary program developed by Alex Shovkoplyas VE-3NEA ([www.DXAtlas.com](http://www.DXAtlas.com)), that can decode *every* Morse transmission on an entire ham band at once.

The service is free, and the worst that can happen is that someone actually answers your CQ call! See [www.reversebeacon.net](http://www.reversebeacon.net) for more info. Similar technologies are being rapidly developed and deployed (<http://wsprnet.org>, [pskreporter.info](http://pskreporter.info), [www.aprs.org](http://www.aprs.org) and others). Before long, every ham band transmission, in every language, whether voice, digital, or carrier pigeon, will be measured, sorted and decoded. Ready or not, here it comes!

## ❖ HAMjitsu

Unless you have a photographic memory and you’ve just seen the latest copy of the membership roster, working fellow radio club members (QRP ARCI, FISTS, SKCC, etc) on Morse code can be a real hit and miss proposition. Not so with HAMjitsu, a web tool developed by Julio Jimenez AK4VL, which compares received call signs from the above-mentioned RBN with the membership rosters of a half dozen Morse code-oriented radio clubs (with permission). If a fellow club member is calling CQ, you’ll know about it instantly (and other members will know that you’re calling CQ, too). See it in action at <http://ham.jit.su>.

## ❖ Brave New World

In their present forms and with the innocent intention of pure innovation, these new tools are undeniably fantastic and very useful. But the potential for things to get out of control is very real as computing power and Internet capabilities increase exponentially. In a few short years, data from systems like the RBN (Morse code now, but *everything else* before too long) could be cross-referenced with information in every other accessible database, so you’d instantly know, in addition to membership in your favorite club, whether *every CQ caller on every band* has Type-A blood, is a single female, is a registered sex offender, owns a house (and isn’t at home), has ever filed bankruptcy, etc.

At present, owning a ham license is a *very public* thing. Just imagine if every PC, tablet and smartphone you use to access the Internet automatically tagged every e-mail, web site posting and phone call you make with your name, registered street address, the time, your present GPS coordinates, and a bunch of other personal information, and shared it instantly with every interested party around the world! Again, without harmful intent, thanks to still-innocent mash-up of packet spotting networks, the RBN, the public FCC database, Facebook, Google, and hundreds of other searchable databases full of our personal info, that’s essentially what hams have today.

If society as a whole has to deal with the explosion of interconnected data networks and Big Brother lurking behind every lamp post, why should hams be exempt? I plan to cover these amazing (and potentially scary) systems in more detail in future columns. For now, however, it’s pretty clear that, even if you can’t scare up an actual contact, checking propagation is a done deal!



## Innovative WiFi Radio (Almost) has it All

(All photos courtesy the author)

Cambridge Soundworks® (CSW) is a company based in the Boston area specializing in high-fidelity audio products including speaker systems and, occasionally, table radios. Co-founded in 1987 by famed audio engineer Henry Kloss, the company has always been a bit unconventional and has gone through a number of corporate changes over the years.

Unafraid to step out on a technology limb, the company rode the HD-Radio wave in 2008 with its 820HD (\$300) table-top model (see “HD-Radio’s Long and Winding Road” MT August, 2009). Like all of the other HD table-top radios of that time, the product was later discontinued. CSW still sells a Hi-Fi table radio of a more conventional design, the i755 (\$290), which features AM/FM reception with iPhone/iPod docking.

The advent of WiFi radio presented CSW with another opportunity to step out on that technology limb. The introduction of its Ambiance Touch World Radio is an effort to combine the most desirable elements of a modern high-fidelity table radio with the latest innovations in Internet WiFi radio. The Ambiance Touch World Radio features a touch-screen interface that lets the user navigate a large number of features including iPod/iPhone docking, an auxiliary input for other brands of smartphones and MP3 players and stereo speakers with considerable opportunity for audio equalization to fine-tune the sound to the individual’s preferences.

### ❖ Hi-Fi WiFi

As explained last month in this column, WiFi radio and Hi-Fi radio are a long ways apart. The very nature of streaming audio lends itself to low-fidelity audio reproduction. Low bit rates and abysmally small speakers in tiny devices, such as smart phones, leaves a lot for audiophiles to desire. Until now, most WiFi radios have offered only the barest essentials to music lovers including a single, monaural speaker and limited equalization. In order to offer a more attractive price tag, most WiFi radio designers have engaged in a race to the bottom. As a result, most are lacking in features as well



Cambridge SoundWorks Ambiance Touch World Radio has it all: WiFi/AM/FM radio with touch-screen access, iPod/iPhone docking; stereo speakers, audio equalizer and full-featured remote control.



Logitech Squeezebox on Ambiance Touch shows differences between the two designs. With a much larger cabinet, stereo speakers, touch-screen access, bigger display screen, the Ambiance Touch has a lot to offer. The real difference can't be seen but heard.

as audio quality. Not so with CSW’s Ambiance Touch World Radio.

Throwing out the vaguely similar designs that leave most WiFi radios indistinguishable from one another, CSW based its WiFi set on

the contemporary design of high-fidelity table radios it earlier produced. Consequently, at 14.25 inches wide by 4.25 inches high by 6.25 inches deep, it has the largest footprint of any WiFi radio I’ve seen. And, at nearly six pounds, out weighs all other WiFi sets and most full-featured table radios.

Building on a tradition of outstanding audio reproduction, Ambiance Touch speakers (yes two, as in stereo!) turn compressed, low bit rate streams into decent audio and make higher quality streams, such as found on the subscription service Pandora One, extremely pleasing to listen to. Audio on even higher bit rate streams becomes sensational, limited only by the capability of your WiFi connection to the Internet.

If you have an iPhone or iPod you can just pop the little plastic cover off the top of the cabinet which reveals the docking station for such devices. The Ambiance Touch remote control lets you navigate either device in addition to all other radio functions. If you have an outboard Sirius/XM receiver, CD player (there’s no CD slot in this radio), MP3 player or smartphone, you can use the mini audio jack in the back to connect any of those devices. You can wirelessly connect to your desktop or laptop computer to access your MP3 song catalog or connect directly with an Ethernet LAN connector.

### ❖ World Radio Attributes

Setting up a WiFi radio is very easy and this one is no different. From the “Home” button on the touch-screen, designated with the little house icon, press “Setup wizard” which, like most such radios, scans the area for a WiFi connection and goes through the setup procedure with little effort on your part.

There are a minimum of 60,000 stations available through the Ambiance Touch. If you were to spend only one hour listening to each station around the clock it would take you almost seven years to hear them all. So, it might be helpful to seek stations according to categories. Ambiance Touch gives you 55 genres to sort through, ranging from Alternative to World Tropical. The highlight of the Ambiance Touch search function is a very small qwerty-style keyboard that shows up when you press the “search stations” button. You can use the tip of your finger or, if your fingers are too big, an e-reader stylus to make typing easier.

It sounds difficult or time consuming when written out, but searching is much easier than it may appear. To search for channels just press the “Internet Radio” button on the main touch-screen. That brings up “Browse station list.” Pressing that leads to a list that includes “Stations.” Pressing “Stations” you have the



Faces of the Ambiance Touch radio: Pandora, FM radio, and Internet radio screens.



Top-mounted, lighted, touch-sensitive on/off switch, mute and sliding volume controls, all flush with the cabinet's surface. Note access door for iPhone/iPod docking.

choice of "Location," "Genre," "Search stations," "Popular stations," and "New Stations." Pressing the "Search stations" button brings up the aforementioned keyboard to type in your request.

The Ambiance Touch doesn't use third party apps so sometimes you have to do a little work to find what you're looking for. For instance, using the search function I was able to find the Soma radio channels and add Soma FM Mission Control, a mix of ambient music and vintage NASA Mission Control audio feeds (it's literally out of this world!). I used that method to save some favorite Calm Radio and AccuRadio channels too.

The most obvious difference between the Ambiance Touch and, for example, the Logitech Squeezebox (now replaced by the UE Smart Radio), is the absence of buttons and knobs. The radio's stylish case features a slightly curved front that adds to the expansive stereo sound. The case also utilizes bottom firing, dual bass ports that deliver solid bass notes. Having spent years listening to monaural WiFi radios, and not minding it a bit, it's a little bit shocking to hear the obvious stereo separation and full spectrum audio coming out of a WiFi radio.

While audio fidelity is more a matter of personal preference, in a side-by-side sound comparison with an older Bose Wave® radio (before they got rid of the top-mounted controls), I found that I preferred the factory preset audio of the Ambiance Touch to that of the Bose. And, since the Bose doesn't allow listeners to tamper with audio quality, the Ambiance Touch is more preferable for those who might like a little more bass, mid-range or take advantage of the radio's "surround sound" feature.

On the front, a non-reflective black speaker grill flanks the 3.5 inch (diagonally measured) full-color, touch-screen. The rest of the case is a high-gloss black that has some online reviewers irritated because it tends to show dust and fingerprints. I've found that cleaning the surface regularly with a soft linen towel keeps the surface dust and fingerprint free. It's just not that hard to keep the radio clean.

As with virtually all table radios today, the Ambiance Touch has two separate alarm clocks which are both individually programmed. You can assign a volume for when you wake up. And, flailing your hand at any part of the touch-screen activates "snooze" and gives you a reprieve from getting up. Pressing "Alarm Off" shuts off the alarm feature. You can select the source of the audio; radio, iPod, Internet radio, Pandora and, if you really have to, a buzzer.

### ❖ On the Downside

When there is a power outage, no matter how brief, the Ambiance Touch needs to reset itself once power is restored; a process that takes nearly a full minute to complete. All of your station presets, favorites and other aspects of the radio are stored and remain accessible once the radio resets itself. Obviously, this will happen as well if you decide to move the radio to another room. Unlike the Logitech UE Smart Radio, there's no provision for portable use.

The back of the Ambiance Touch has antenna jacks for external AM and FM antennas. While the radio comes with a small AM loop and a five foot long flexible FM wire antenna with an F-style coax connector, these will suffice only for those who live in urban areas where AM and FM signals are the strongest. Outside of those areas, reception will require more robust antenna capabilities including mast-mounted, pre-amplified, multi-element FM antennas on a rotatable mast. Even then, I've found that FM reception in no way compares to other FM radios.

AM reception is dismal. Unless you live in a city with strong AM signals, reception will be disappointing. It takes a very strong signal to ascertain that AM reception is even possible. Using an external tunable loop antenna netted very few daytime stations, nighttime listening fared a little better. Audio quality, for some reason, is not as good on the broadcast bands as it is on Internet radio, Pandora or auxiliary input.

In defense of the less than optimal broadcast reception, the main function of this radio is WiFi reception with superior audio fidelity and it does that well. The broadcast function is a convenience. When your Internet connection is down, for example, you will at least still have local broadcast radio capabilities, something you don't get with virtually any other WiFi radio. It's no DX machine but you have other

radios for that and, if you want to listen to DX radio stations via the Web, none do it better.

Occasionally, the demo unit of the Ambiance Touch I used would seem to forget what it was doing and would reboot itself. After the obligatory sixty seconds it would function normally. It seems like a software glitch which engineers at CSW could not explain.

### ❖ Bottom Line

CSW's Ambiance Touch is an ambitious table-top radio. While other manufacturers have been content to give listeners the convenience of a WiFi radio with modest audio fidelity, CSW has given radio fans almost everything they could want. Compared to all other table radios, the Ambiance Touch audio is unmatched and, with convenient features such as the touch-screen interface, one-button Pandora access, keyboard entry, equalizer settings and large, full-function remote control, the Ambiance Touch is in a class of its own.

The Ambiance Touch is priced at \$400 and is available direct from CSW at <http://store.cambridgesoundworks.com> or via their toll free number 800-367-4434. As this goes to press CSW is releasing a newer model, the Ambiance Touch World Radio 2 that uses Bluetooth® to connect to a user's smart phone, tablet, desktop or laptop computer. According to a CSW spokesperson, the Ambiance Touch World Radio reviewed here will be offered on sale at their website.



The Icom IC-R75A may be the best value today in a communications receiver. Has dual PBT, coverage to 60 MHz, notch and 99 alpha memories. Now includes UT-106 DSP.



Universal also offers Icom amateur products. Request our huge new 132 page 2013 Catalog or visit: [www.universal-radio.com](http://www.universal-radio.com)

**Universal Radio**  
 6830 Americana Pkwy.  
 Reynoldsburg, OH 43068  
 ♦ Orders: 800 431-3939  
 ♦ Info: 614 866-4267  
[www.universal-radio.com](http://www.universal-radio.com)



## Spring and an SWL's Thoughts Turn to....Radio

**A**pril showers bring May flowers, or so they say. This month we shine the Programming Spotlight on a cornucopia of programs, as varied as any floral arrangement. Perhaps this could be considered an aural arrangement.

My ancestors were Nurserymen. They knew that any floral arrangement had to feature lots of vibrant colors and textures. Radio is no different. Many radio stations have given up on shortwave as a delivery platform, but there is still much to hear on a daily basis. Radio stations seldom heard previously are no longer competing with the bigger nations for space on the bands. This is making for new opportunities to hear some programming. Other nations which once had a huge shortwave presence are now more of a challenge.

We could be heroes. Or is that gyros? The Voice of Greece continued to be heard nightly in February, with 9420 kHz putting a strong signal into North America, as it has for many years. This is an excellent place to spend a few hours of an evening, soaking in the fabulous Greek and Mediterranean music. Very little spoken word is heard here, but that's alright, because the music is worth the price of admission. It is very easy to be transported in one's mind to some beautiful Greek island with breathtaking sunsets while listening to this channel. Tune in to The Voice of Greece most evenings from 0000 UTC on. Your ears will thank you.

Shortwave radio has always given listeners an opportunity to hear a wide variety of languages. As a student of languages I have always appreciated the opportunity radio offers to hear a vast number of (what are for me) exotic tongues. Recently I listened to a few hours of programming from Radio Habana Cuba. If one tunes in around 1930 UTC, Radio Habana Cuba can be heard in such languages as French, Portuguese and Arabic. These half hour programming blocks can be heard on 15340 kHz. It was interesting to listen to these broadcasts.

The Portuguese language is very melodic to my ears. Even better, the language barrier prevented me from having to deal with the politics which inevitably creeps into RHC programming. I rather enjoyed listening to the male RHC presenter. It was also interesting to hear the style of the broadcast, sounding like any number of Brazilian stations one can hear on the bands. There was lots of music and even some reverb on various announcements and comments.

French is heard at 1930, Portuguese at 2000 and Arabic at 2030 UTC. The Arabic program featured very little music and was virtually spoken word only. Frequent mentions were made of Libya. Arabic is a language I have always been interested in, but alas I have never really studied it in any depth. Nonetheless, I appreciate the opportunity to listen to it any time it presents itself

15340 kHz is also home to Spanish programming starting at 1600 UTC. One can also listen to Spanish from Radio Habana Cuba in the evenings from 0000-0500 UTC on 6060 kHz.

In addition, Radio Habana Cuba is one of the few international broadcasters to transmit programming in Esperanto. Esperanto is a language invented by L.L. Zamenhoff in the 1880s, as a politically neutral, easy to learn alternative to English. Radio Habana Cuba broadcasts in this unique language from 1600-1630 UTC on 11760 kHz. Esperanto combines elements of many languages and is apparently quite easy to learn. Listening to these languages, I can't help but look forward to the invention of Google Translate for Audio, or the Star Trek Universal Translator. Whether you hear Greek, Spanish, French, Portuguese, Arabic or Esperanto, these broadcasts are entertaining. Understanding it all helps but is not completely necessary.



*Regardless of the language spoken, Cuba is a warm and interesting place. (Back of a Radio Havana QSL card from the Author's collection)*

In February, the dramatic news that Pope Benedict intended to resign took most observers by surprise. He became the first Pope to retire since the fifteenth century. Needless to say it was a bombshell to practicing Catholics, and non-Catholics alike. WERN became a good source of news and comment about this dramatic turn of events and the imminent Papal election. A day or so after the Pope made his stunning announcement, discussion of it dominated the programming on Eternal Word Television Network (assuming it was live), most of which is relayed by WERN.

One talk show, ostensibly about Pro-Life issues was swamped by callers reacting to the Pope's decision. The program host was supportive of his decision to retire, citing his age and infirmities (she suggested he is tormented by chronic arthritis). WERN is a good source of news and discussion about events in the Catholic world but is essential listening when major events occur such as this snap resignation. Check it out daily on 15610 kHz between 1300 and 0000 UTC. In particular listen to EWTN Open Line from 2000-2100 UTC.

Before we leave the discussion of WERN, do you like Old Time Radio?) WERN offers an obscure little gem called Family Theatre Classic Radio. "EWTN Radio is proud to present this series from the Golden Age of Radio! These award-winning programs from Family Theater Productions feature well-known movie and radio stars, a full orchestra and sound effects, and family-oriented stories." (Source: WERN website) Check it out at 0430 UTC Mondays. Nothing beats Theatre of the Mind! (Shameless plug: I host The Radio Time Capsule on Radio Scooter International, an Internet radio station run by fellow DXer Bill Bergadano from 0000-0400 UTC Wednesdays. The program features shows and music from the Golden Age of Radio)

With the demise of Radio Canada International, and the CBC Northern Quebec Service, Canada is truly a DX target now. There are three principal opportunities to hear Canada on shortwave. CFRX in Toronto relays Newstalk 1010, CFRB at 6070 kHz. This station was running comedy over night for some time, but that seems to be over. Most programming consists of centre-right talk. There are also stations on each coast, which relay CBC local programming.

CKZN in Newfoundland, Canada's easternmost province, can be heard on 6160 kHz. It relays CBC Radio One programming from CFGB-FM in Happy Valley-Goose Bay, NL.

CKZU in Vancouver, BC also broadcasts CBC Radio One programming, this time relaying CBU 690 in Vancouver. It can also be heard on 6160 kHz. CKZU (PST) is 8 hours behind UTC; CKZN (AST) is 4 hours behind UTC. Both stations carry CBC Overnight programming in the wee hours of their respective mornings, so they can and have been confused with relays of the BBC and Radio Australia!

The economic downturn has ravaged Europe and Spain in particular. It has wreaked havoc on public services and national broadcasters. The English Service of Radio Exterior de Espana has been under threat of cancellation and continues to live on borrowed time. REE is well worth listening to, not only because it may not be there much longer, but because it gives the listener eyewitness accounts of the precarious situation that country finds itself in.

As this is written Radio Exterior de Espana continues to broadcast in English at 0000 UTC on 6055 kHz. The programs of REE continue to be of high quality. One of the best of these, which comes highly recommended, is Rock in Spain. The program can be heard on alternate Tuesdays. Mario Borrego hosts an entertaining look at some aspect of the Spanish music scene, usually highlighting a popular musician or band. The first episode in February featured the Spanish metal musician Leo Jimenez. This is just one of the many programs from Madrid. Enjoy them while we still can.



## UPC Introduces New IRC

The Universal Postal Union (UPU) has introduced the newest model of the International Reply Coupon (IRC). The new Doha model will replace the current model, known as the Nairobi model. Although the U.S. Postal Service no longer sells IRCs, they are still available in other countries and post offices in the U.S. are mandated to redeem them. The Doha IRC will go on sale on July 1, 2013, and will be valid for exchange until the end of 2017. IRCs are exchangeable in every UPC member country, for stamps representing the minimum postage for an ordinary priority post item or airmail letter sent abroad for a reply.



2013 IRC (via ARRL)

Radio Free Asia reminds listeners the 2013 Year of the Snake QSL card will be used to confirm all valid reception reports to April 30, 2013. Submit your reception reports at [www.techweb.rfa.org](http://www.techweb.rfa.org) and follow the QSL Reports link, or to: [qsl@rfa.org](mailto:qsl@rfa.org). Postal reports to: Reception Reports, Radio Free Asia, 2025 M. Street NW, Suite 300, Washington, DC 20036 USA.



RFA Year of the Snake QSL card

A recent edition of DX Window newsletter announced new contact information for verifying RTM Malaysia regional broadcasts. Send electronic reports to: Mr. Zulkifli Bin Abdul Rahim at [zulrahim@rtm.gov.my](mailto:zulrahim@rtm.gov.my) or to: Deputy Director, Mr. Othman Bin Md. othman@rtm.gov.my. Postal reports to: Mr. Zulkifli AAbdul, Head of Assistant Director (Quality Measurement), Technical Section-RTM Kajang, Radio Television Malaysia, Angkasapuri, 50614, Kuala Lumpur, Malaysia. Reports may also be sent to: Mr. Othman Mohammed Said, Deputy Director, Networks

Technical Section, RTM Kajang, Radio Television Malaysia, Angkasapuri, 50614, Kuala Lumpur, Malaysia.

At editorial deadline, Radio Moldova International was evaluating their future in shortwave broadcasting. This followed an announcement by management that the administration believes the programs do not meet the requirements of the listeners. RMI is seeking audience opinions at: [presedinte@trm.md](mailto:presedinte@trm.md), [moldovainternational@gmail.com](mailto:moldovainternational@gmail.com) or follow the "Write to Us" link at [www.pmr.org](http://www.pmr.org).

DXers are reporting Peru's Radio Chaski has returned to shortwave on 5980 kHz. Armed with a new solid-state transmitter, the station operates as a religious project in the Urubamba Valley regions by Baptist Mid Mission Missionaries. Local Quechua transmissions are 1000-1500 UTC and Red Radio Integridad is relayed 0000-0100 and 2200-0000 UTC in Spanish. Send your program details to station manager, Valentin Quispe H [vaquime24@hotmail.com](mailto:vaquime24@hotmail.com) or to Bruce Maddux [brucendebbie87@gmail.com](mailto:brucendebbie87@gmail.com).

The Hard Core DX newsgroup announces a new QSL representative for utility DXers. Send your observations to: Cpl. Charles Raine,

MACS Operator, Military Aeronautical Communications System (MACS), Service des communications aéronautiques militaires, Wing Telecommunications and Information Services Squadron (WTISS), Escadron des services d'information et des télécommunications de l'escadre (ESIT Ere), 8 Wing Trenton, 8e Escadre Trenton, Défense nationale, Carrying Place, ON Canada K0K 1L0.

Radio Vanuatu has joined cyberspace. The new website at [www.vanuatu2u.com](http://www.vanuatu2u.com) includes links to Latest News, Sports, Business and plans for Live Radio feeds. The station operates on 3945 and 7260 kHz. Program details with return mint postage to: Radio Vanuatu, PMB 049, Port Vila, Vanuatu. Technical email [technical@vbt.com.vu](mailto:technical@vbt.com.vu)

Broadcast schedules for Radio Free Asia, Malaysia and Vanuatu are included in each monthly edition of MTXtra Shortwave Broadcast Guide.

68900-100 Macapá-AP, Brasil. (Llorella). Streaming audio [www.difusora.ap.gov.br](http://www.difusora.ap.gov.br)

Rádio Nacional Amazônia, 6180 kHz. No data form letter signed by Luciana Couto. Received in five weeks for registered letter. Station address: Caixa Postal 070.747, Brasília, 70359-970 Brasil. (Llorella) Website [www.ebc.com.br](http://www.ebc.com.br)

Voz Missionária, 5940 kHz. Large QSL signed by Carlos Machado, Director, plus magazine. Station address: Rua Joaquim Nunes 244 Cen-

tro, Camború SC 88340-000, Caixa Postal 2004, Brasil. (Llorella).

### CHILE

CVC-La Voz, 17680 kHz. Full data Special QSL for last week of shortwave transmissions, plus staff, studio/antenna cards. Received in five months. Mailed from Chile with U.S. return address: P.O. Box 2889, Miami, FL 33144 on the envelope. (Wendel Craighead, Prairie Village, KS)

### MEDIUM WAVE

Canada-CFOS 560 kHz AM. *The Oldies You Want, The Info You Need*. Date/frequency letter signed by Robert Coyne, Chief Engineer. Received in 24 days for fax follow up, total 276 days for AM report. Station address: 270 9th Street East, Owen Sound, Ontario N4K 5P5 Canada. (Al Muick, PA/HCDX) Streaming audio [www.560cfos.ca](http://www.560cfos.ca)

United Arab Emirates-Radio Sawa/Voice of America, 1539 kHz AM. Full data QSL scenery card of former Delano, California transmitter site, unsigned. Received in 1,185 days for October 2009 AM report. QSL address: VOA, 3330 Independence Avenue NW, Room 3166, Washington, DC 20237 USA. (Patrick Martin, Seaside, OR)

### NEW ZEALAND

Radio New Zealand International, 5950 kHz. Full data color E-QSL with kiwi bird/NZ flag graphic from Adrian Sainsbury. Received for an E-report to [info@rnzi.com](mailto:info@rnzi.com). (Fabio Cambisi, Italy/playdx) Station address: P.O. Box 123, Wellington, New Zealand. Streaming/on-demand audio [www.rnzi.com](http://www.rnzi.com).

### NIGERIA

Voice of Nigeria, 7255 kHz. Full data Zuma Rock QSL card. Received in 23 days for a French report to [voixdunigeria@yahoo.fr](mailto:voixdunigeria@yahoo.fr), after no-response from two previous English follow ups. (Bruce Portzer/playdx) Streaming audio [www.voiceofnigeria.org/](http://www.voiceofnigeria.org/)

### UTILITY

Croatia-BO Non Directional Beacon, 385 kHz. Partial data verification letter, signed by Ervin Mrkic-Pestic, Head of ATC Zadar. Received in 55 days for utility report to: Croatia Control Ltd., Podružnica Zadar, p.p. 297, N. Nodila b.b., 23000 Zadar Zračna luka, Croatia. (Patrick Robic, Austria/UDXF)

Netherlands-Stolt Kittiwake/Oil-Chemical Tanker, 2187.5 kHz. Full data verification letter signed by the Superintendent. Received for utility report to: Stolt-Nielsen Inter European Service B.V., P.O. Box 23213, 3001 KE Rotterdam, The Netherlands. (Robic)

Spain-Iberia Operaciones, 17940 kHz. No data verification letter signed by José Fernández F., plus prepared QSL card stamped as verified. Received in 15 days for utility report. QSL address: Iberia Lineas Aereas de Espana S.A., Velaquez 130, 28006 Madrid, Spain. (Robic)

USA-NNN05EJ-MARS, Johnson City, Texas, 11098.5 kHz. Verified prepared QSL card from Gus Lott KR4K. Received in 48 days (Robic).

### BRAZIL

Rádio Clube do Para, 4885 kHz. No data verification letter signed by Camilo Centeno, Director General, plus station souvenirs. Received in six weeks. Station address; Av. Almirante Barroso 2109, 3º andar, CEP Belém, Pará, Brasil. (Artur Fernández Llorella, Catalonia, Spain/HCDX) Streaming audio [www.radioclubedopara.com.br/](http://www.radioclubedopara.com.br/)

Rádio Difusora de Macapá, 4915 kHz. Full data e-verification letter from Martins Filho, Gerente Financeiro. Received in two weeks. Station address: Rua Candido Mendes 525,

## HOW TO USE THE SHORTWAVE GUIDE

0000-0100 twhfa USA, Voice of America 5995am 6130ca 7405am 9455af  
 ① ② ⑤ ③ ④ ⑥ ⑦

### CONVERT YOUR TIME TO UTC

Broadcast time on ① and time off ② are expressed in Coordinated Universal Time (UTC) – the time at the 0 meridian near Greenwich, England. To translate your local time into UTC, first convert your local time to 24-hour format, then add (during Daylight Saving Time) 4, 5, 6 or 7 hours for Eastern, Central, Mountain or Pacific Times, respectively. Eastern, Central, and Pacific Times are already converted to UTC for you at the top of each hour.

Note that all dates, as well as times, are in UTC; for example, a show which might air at 0030 UTC Sunday will be heard on Saturday evening in America (in other words, 7:30 pm Eastern, 6:30 pm Central, etc.).

Not all countries observe Daylight Saving Time, not all countries shift at the same time, and not all program scheduling is shifted. So if you do not hear your desired station or program, try searching the hour ahead or behind its listed start time.

### FIND THE STATION YOU WANT TO HEAR

Look at the page which corresponds to the time you will be listening. English broadcasts are listed by UTC time on ①, then alphabetically by country ③, followed by the station name ④. (If the station name is the same as the country, we don't repeat it, e.g., "Vanuatu, Radio" [Vanuatu].)

If a broadcast is not daily, the days of broadcast ⑤ will appear in the column following the time of broadcast, using the following codes:

Codes	
s/Sun	Sunday
m/Mon	Monday
t	Tuesday
w	Wednesday
h	Thursday
f	Friday
a/Sat	Saturday
occ:	occasional
DRM:	Digital Radio Mondiale
irreg	Irregular broadcasts
vl	Various languages
USB:	Upper Sideband

### CHOOSE PROMISING FREQUENCIES

*Choose the most promising frequencies for the time, location and conditions.*

The frequencies ⑥ follow to the right of the station listing; all frequencies are listed in kilohertz (kHz). Not all listed stations will be heard from your location and virtually none of them will be heard all the time on all frequencies.

Shortwave broadcast stations change some of their frequencies at least twice a year, in April and October, to adapt to seasonal conditions. But they can also change in response to short-term condi-

tions, interference, equipment problems, etc. Our frequency manager coordinates published station schedules with confirmations and reports from her monitoring team and MT readers to make the Shortwave Guide up-to-date as of one week before print deadline.

To help you find the most promising signal for your location, immediately following each frequency we've included information on the target area ⑦ of the broadcast. Signals beamed toward your area will generally be easier to hear than those beamed elsewhere, even though the latter will often still be audible.

#### Target Areas

af:	Africa
al:	alternate frequency (occasional use only)
am:	The Americas
as:	Asia
ca:	Central America
do:	domestic broadcast
eu:	Europe
me:	Middle East
na:	North America
pa:	Pacific
sa:	South America
va:	various

*Mode used by all stations in this guide is AM unless otherwise indicated.*

### MT MONITORING TEAM

**Gayle Van Horn**  
 Frequency Manager  
[gaylevanhorn@monitoringtimes.com](mailto:gaylevanhorn@monitoringtimes.com)

**Larry Van Horn, MT Asst. Editor**  
[larryvanhorn@monitoringtimes.com](mailto:larryvanhorn@monitoringtimes.com)

### Additional Contributors to This Month's Shortwave Guide:

*Thank You to ...*

AOKI; BCL News; Cumbre DX; DSWCI/DX Window; Hard-Core DX; DX Re Mix News; British DX Club; WWDX Club/Top News. Alokesh Gupta, New Delhi, India; Tom Taylor, UK; Ashik Egbal Tokon, Rajshahi, Bangladesh; Cladius Dedio/AWR; Brenda Constantino/WYFR; Dan Elyea/WYFR; Ron Cesarek; Victor Goonetilleke, Sri Lanka; Tom Solomon/WYFR; Georgi Bancov/Balkan DX; Ivo Ivanov, Bulgaria; Michael Puetz/MB; Sean Gilbert UK/WRTH 2013; Wolfgang Bueschel, Stuttgart, Germany.

### SHORTWAVE BROADCAST BANDS

kHz	Meters
2300-2495	120 meters (Note 1)
3200-3400	90 meters (Note 1)
3900-3950	75 meters (Regional band, used for broadcasting in Asia only)
3950-4000	75 meters (Regional band, used for broadcasting in Asia and Europe)
4750-4995	60 meters (Note 1)
5005-5060	60 meters (Note 1)
5730-5900	49 meter NIB (Note 2)
5900-5950	49 meter WARC-92 band (Note 3)
5950-6200	49 meters
6200-6295	49 meter NIB (Note 2)
6890-6990	41 meter NIB (Note 2)
7100-7300	41 meters (Regional band, not allocated for broadcasting in the western hemisphere) (Note 4)
7300-7350	41 meter WARC-92 band (Note 3)
7350-7600	41 meter NIB (Note 2)
9250-9400	31 meter NIB (Note 2)
9400-9500	31 meter WARC-92 band (Note 3)
9500-9900	31 meters
11500-11600	25 meter NIB (Note 2)
11600-11650	25 meter WARC-92 band (Note 3)
11650-12050	25 meters
12050-12100	25 meter WARC-92 band (Note 3)
12100-12600	25 meter NIB (Note 2)
13570-13600	22 meter WARC-92 band (Note 3)
13600-13800	22 meters
13800-13870	22 meter WARC-92 band (Note 3)
15030-15100	19 meter NIB (Note 2)
15100-15600	19 meters
15600-15800	19 meter WARC-92 band (Note 3)
17480-17550	17 meter WARC-92 band (Note 3)
17550-17900	17 meters
18900-19020	15 meter WARC-92 band (Note 3)
21450-21850	13 meters
25670-26100	11 meters

#### Notes

- Note 1 Tropical bands, 120/90/60 meters are for broadcast use only in designated tropical areas of the world.
- Note 2 Broadcasters can use this frequency range on a (NIB) non-interference basis only.
- Note 3 WARC-92 bands are allocated officially for use by HF broadcasting stations in 2007
- Note 4 WRC-03 update. After March 29, 2009, the spectrum from 7100-7200 kHz will no longer be available for broadcast purposes and will be turned over to amateur radio operations worldwide

### "MISSING" LANGUAGES?

A **FREE** download to MTXpress subscribers, the online MTXtra Shortwave Guide is 115+ pages of combined language schedules, sorted by time. Print subscribers: add the MTXtra SW Guide to your subscription for only \$11.95. Call **1-800-438-8155** or visit **www.monitoringtimes.com** to learn how.



**0000 UTC - 8PM EDT / 7PM CDT / 5PM PDT**

0000 0030	Egypt, R Cairo	9965am	11510al
0000 0030	USA, BBG/VO America	7560as	
0000 0030 twhfa	USA, WHRI Cypress Creek SC	9895ca	
0000 0030 sm	USA, WHRI Cypress Creek SC	7335ca	
0000 0045	India, AIR/External Svc	9690as	9705as
		11710as	13605as
0000 0045 DRM	India, AIR/External Svc	11645as	
0000 0057	China, China R International		6005eu
		6020as	6180eu 7350as 7415as
		9425as	9570as 11650as 11790as
		11885as	
0000 0100	Anguilla, University Network		6090na
0000 0100	Australia, ABC/R Australia	9660pa	12080pa
		15240pa	15415pa 17795pa 19000pa
		21740pa	
0000 0100	Australia, NT VL8A Alice Springs		4835do
0000 0100	Australia, NT VL8K Katherine		5025do
0000 0100	Australia, NT VL8T Tennant Creek		4910do
0000 0100	Canada, CFRX Toronto ON	6070do	
0000 0100	Canada, CFVP Calgary AB	6030do	
0000 0100	Canada, CKZN St Johns NF6160do		
0000 0100	Canada, CKZU Vancouver BC		6160do
0000 0100 Sun	Germany, Mighty KBC Radio		7375eu
0000 0100	Germany, R 6150		6070eu
0000 0100	Malaysia, RTM Kajang/Traxx FM		7295do
0000 0100	Micronesia, V6MP/Cross R/Pohnpei		4755as
0000 0100	New Zealand, R New Zealand Intl		15720pa
0000 0100 DRM	New Zealand, R New Zealand Intl		17675pa
0000 0100	Palau, T8WH/World Harvest R		17650as
0000 0100	Russia, VO Russia		7290ca
0000 0100	Thailand, R Thailand World Svc		13745na
0000 0100	UK, BBC World Service	5970as	6195as
		7360as	9410as 9740as 11750as
		12095as	13725as 15335as 15755as
0000 0100	USA, AFN/AFRTS		4319usb 5765usb
		12759usb	13362usb
0000 0100	USA, Overcomer Ministry		3185na
0000 0100	USA, WBCQ Monticello ME5110am		7490am
		9330am	
0000 0100	USA, WEWN/EWTN Irondale AL		11520af
0000 0100	USA, WHRI Cypress Creek SC		5920eu
0000 0100	USA, WINB Red Lion PA		9265ca
0000 0100	USA, WRNO New Orleans LA		7505na
0000 0100	USA, WTWW Lebanon TN	5830na	
0000 0100	USA, WWCR Nashville TN	3195eu	5070af
		7520af	13845af
0000 0100	USA, WWRB Manchester TN		3185na
		3215na	
0000 0100	USA, WYFR/Family R		6115na
0030 0100	Australia, ABC/R Australia		17750as
0030 0100	USA, WHRI Cypress Creek SC		7335ca
0030 0100 mtwhf	USA, WRMI/R Slovakia Intl relay		9955am

**0100 UTC - 9PM EDT / 8PM CDT / 6PM PDT**

0100 0115 Sat/Sun	Canada, Bible Voice Broadcasting		7395as
0100 0130	Vietnam, VO Vietnam/Overseas Svc		9640na
0100 0156	Romania, R Romania Intl	6145na	7325na
0100 0157	China, China R International		6020as
		6075eu	6175eu 7350as 9410as
		9420na	9570na 9580as 11650as
		11885as	
0100 0200	Anguilla, University Network		6090na
0100 0200	Australia, ABC/R Australia	9660pa	12080pa
		15160pa	15240pa 15415as 17750pa
		17795pa	19000pa
0100 0200	Australia, NT VL8A Alice Springs		4835do
0100 0200	Australia, NT VL8K Katherine		5025do
0100 0200	Australia, NT VL8T Tennant Creek		4910do
0100 0200	Canada, CFRX Toronto ON	6070do	
0100 0200	Canada, CFVP Calgary AB	6030do	
0100 0200	Canada, CKZN St Johns NF6160do		
0100 0200	Canada, CKZU Vancouver BC		6160do
0100 0200	Cuba, R Havana Cuba	5040ca	6000na
		6165na	

0100 0200 Sun	Germany, Mighty KBC Radio		7375eu
0100 0200	Germany, R 6150		6070eu
0100 0200	Malaysia, RTM Kajang/Traxx FM		7295do
0100 0200	Micronesia, V6MP/Cross R/Pohnpei		4755as
0100 0200	New Zealand, R New Zealand Intl		15720pa
0100 0200 DRM	New Zealand, R New Zealand Intl		17675pa
0100 0200	Palau, T8WH/World Harvest R		17650as
0100 0200	Russia, VO Russia		7290ca
0100 0200	South Korea, KBS World R		9690as
0100 0200	Taiwan, R Taiwan Intl		11875as
0100 0200	UK, BBC World Service	5940eu	5970as
		9740as	11750as 12095as 15310as
		15335as	15755as 17685as
0100 0200	USA, AFN/AFRTS		4319usb 5765usb
		12759usb	13362usb
0100 0200	USA, BBG/VO America		9435va 11705va
		15155va	
0100 0200	USA, KJES Vado NM		7555na
0100 0200	USA, Overcomer Ministry		3185na
0100 0200 mtwhf	USA, Overcomer Ministry		7490na
0100 0200	USA, WBCQ Monticello ME5110am		7490am
		9330am	
0100 0200	USA, WEWN/EWTN Irondale AL		11520af
0100 0200	USA, WHRI Cypress Creek SC		5920eu
0100 0200 m	USA, WHRI Cypress Creek SC		9605ca
0100 0200 twhfas	USA, WHRI Cypress Creek SC		7315sa
0100 0200	USA, WINB Red Lion PA		9265ca
0100 0200	USA, WRNO New Orleans LA		7505na
0100 0200	USA, WWCR Nashville TN	3195eu	4840na
		5935af	7520af
0100 0200	USA, WWRB Manchester TN		3185na
		3215na	
0100 0200	USA, WYFR/Family R		6115na
0115 0120 mtwhf	Kyrgyzstan, Kyrgyz Radios		4010do
0120 0200 mtwhfa	Sri Lanka, SLBC	6005as	9770as 15745as
0130 0200 twhfa	Serbia, International R Serbia		6190eu
0140 0159	Vatican City State, Vatican R		7410as 9560as

**0200 UTC - 10PM EDT / 9PM CDT / 7PM PDT**

0200 0230	Thailand, R Thailand World Svc		15275na
0200 0230	USA, KJES Vado NM		7555na
0200 0257	China, China R International		11785as
		13640as	
0200 0300	Anguilla, University Network		6090na
0200 0300 twhfa	Argentina, RAE		11710am
0200 0300	Australia, ABC/R Australia	9660pa	12080pa
		15160pa	15240pa 15415as 17750pa
		17795pa	19000pa
0200 0300	Australia, NT VL8A Alice Springs		4835do
0200 0300	Australia, NT VL8K Katherine		5025do
0200 0300	Australia, NT VL8T Tennant Creek		4910do
0200 0300	Canada, CFRX Toronto ON	6070do	
0200 0300	Canada, CFVP Calgary AB	6030do	
0200 0300	Canada, CKZN St Johns NF6160do		
0200 0300	Canada, CKZU Vancouver BC		6160do
0200 0300	Cuba, R Havana Cuba	6000na	6165na
0200 0300	Egypt, R Cairo	9720na	9315al
0200 0300	Germany, R 6150		6070eu
0200 0300	Malaysia, RTM Kajang/Traxx FM		7295do
0200 0300	Micronesia, V6MP/Cross R/Pohnpei		4755as
0200 0300	New Zealand, R New Zealand Intl		15720pa
0200 0300 DRM	New Zealand, R New Zealand Intl		17675pa
0200 0300	Palau, T8WH/World Harvest R		17650as
0200 0300	Philippines, R Pilipinas Overseas Svc		15285me
		17700me	17820me
0200 0300	Russia, VO Russia		7290ca
0200 0300	South Korea, KBS World R		9580sa 9640as
0200 0300 mtwhfa	Sri Lanka, SLBC	6005as	9770as 15745as
0200 0300	UK, BBC World Service	5875eu	5940eu
		7435af	12095as 15310as
0200 0300	USA, AFN/AFRTS		4319usb 5765usb
		12759usb	13362usb
0200 0300	USA, Overcomer Ministry		3185na
0200 0300 mtwhf	USA, Overcomer Ministry		7490na
0200 0300	USA, WBCQ Monticello ME5110am		7490am
		9330am	

0200 0300	USA, WEWN/EWTN Irondale AL	11520af
0200 0300	USA, WHRI Cypress Creek SC	5920eu
	7315sa	
0200 0300	USA, WINB Red Lion PA	9265ca
0200 0300	USA, WRNO New Orleans LA	7505na
0200 0300	USA, WWCR Nashville TN	3215eu
	5890va	5935af
0200 0300	USA, WWRB Manchester TN	3185na
	3195na	
0200 0300	USA, WYFR/Family R	6115na
0215 0227 Sun	Nepal, R Nepal	5005do
0230 0300 twhf	Albania, R Tirana	6100na
0230 0300	Myanmar, Myanma R/Yangon	9731do
0230 0300	Vietnam, VO Vietnam/Overseas Svc	9640na
0255 0300 Sun	Swaziland, TWR Africa	3200af

**0300 UTC - 11PM EDT / 10PM CDT / 8PM PDT**

0300 0320	Vatican City State, Vatican R	15460as
0300 0325 Sun	Swaziland, TWR Africa	3200af
0300 0327	Vatican City State, Vatican R	9660af
0300 0330	Egypt, R Cairo	9720na
0300 0330	Myanmar, Myanma R/Yangon	9731do
0300 0330	Philippines, R Pilipinas Overseas Svc	15285me
	17700me	17820me
0300 0330 Sat	Sri Lanka, SLBC	6005as
0300 0357	China, China R International	9770as
	9690na	9790as
	15110as	15120as
0300 0400	Anguilla, University Network	6090na
0300 0400	Australia, ABC/R Australia	9660pa
	15160pa	15240as
	17750pa	19000pa
	21725pa	
0300 0400	Australia, NT VL8A Alice Springs	4835do
0300 0400	Australia, NT VL8K Katherine	5025do
0300 0400	Australia, NT VL8T Tennant Creek	4910do
0300 0400	Canada, CFRX Toronto ON	6070do
0300 0400	Canada, CFVP Calgary AB	6030do
0300 0400	Canada, CKZN St Johns NF	6160do
0300 0400	Canada, CKZU Vancouver BC	6160do
0300 0400	Cuba, R Havana Cuba	6000na
0300 0400	Germany, R 6150	6070eu
0300 0400	Malaysia, RTM Kajang/Traxx FM	7295do
0300 0400	Micronesia, V6MP/Cross R/Pohnpei	4755as
0300 0400	New Zealand, R New Zealand Intl	15720pa
0300 0400 DRM	New Zealand, R New Zealand Intl	17675pa
0300 0400	Oman, R Sultanate of Oman	13600af
0300 0400	Palau, T8WH/World Harvest R	17650as
0300 0400	Russia, VO Russia	7290ca
0300 0400 mtwhf	South Africa, Channel Africa	3345af
	6155af	
0300 0400	Taiwan, R Taiwan Intl	15320as
0300 0400	UK, BBC World Service	3255af
	6140af	6190af
	9410eu	9460af
	15310as	17790as
0300 0400	USA, AFN/AFRTS	4319usb
	12759usb	13362usb
0300 0400	USA, BBG/VO America	4930af
	9855af	15580af
0300 0400	USA, Overcomer Ministry	3185na
0300 0400 mtwhf	USA, Overcomer Ministry	7490na
0300 0400	USA, WBCQ Monticello ME	5110am
	9330am	7490am
0300 0400	USA, WEWN/EWTN Irondale AL	11520af
0300 0400	USA, WHRI Cypress Creek SC	7520eu
0300 0400	USA, WRNO New Orleans LA	7505na
0300 0400	USA, WWCR Nashville TN	3215eu
	5890va	5935af
0300 0400	USA, WWRB Manchester TN	3185na
	3195na	
0300 0400	USA, WYFR/Family R	6115na
0330 0400	Iran, VO Islamic Rep of Iran/VO Justice	9710eu
	11700eu	11770eu
0330 0400	USA, WHRI Cypress Creek SC	6175ca
0330 0400	Vietnam, VO Vietnam/Overseas Svc	9640na

**0400 UTC - 12AM EDT / 11PM CDT / 9PM PDT**

0400 0427	Iran, VO Islamic Rep of Iran/VO Justice	9710eu
	11700eu	11770eu
0400 0455	Turkey, VO Turkey	7240as
0400 0456	Romania, R Romania Intl	6130na
	15220as	17870as
0400 0457	China, China R International	9460na
	13620va	15120as
	17725va	17855va
0400 0457	Germany, Deutsche Welle	5905af
	9470af	9800af
0400 0457	North Korea, VO Korea	7220as
	9730as	11735ca
	13760sa	15180sa
0400 0458	New Zealand, R New Zealand Intl	15720pa
0400 0458 DRM	New Zealand, R New Zealand Intl	17675pa
0400 0500	Anguilla, University Network	6090na
0400 0500	Australia, ABC/R Australia	9660pa
	15160pa	15240pa
	15415as	15515pa
	21725pa	
0400 0500	Australia, NT VL8A Alice Springs	4835do
0400 0500	Australia, NT VL8K Katherine	5025do
0400 0500	Australia, NT VL8T Tennant Creek	4910do
0400 0500	Canada, CFRX Toronto ON	6070do
0400 0500	Canada, CKZN St Johns NF	6160do
0400 0500	Canada, CKZU Vancouver BC	6160do
0400 0500	Cuba, R Havana Cuba	6000na
0400 0500	Germany, R 6150	6070eu
0400 0500	Malaysia, RTM Kajang/Traxx FM	7295do
0400 0500	Micronesia, V6MP/Cross R/Pohnpei	4755as
0400 0500	Palau, T8WH/World Harvest R	17650as
0400 0500 mtwhf	South Africa, Channel Africa	7230af
0400 0500 Sun	Sri Lanka, SLBC	6005as
	9690na	9790as
	15110as	15120as
0400 0500	USA, AFN/AFRTS	4319usb
	12759usb	13362usb
0400 0500	USA, BBG/VO America	4930af
	9885af	15580af
0400 0500	USA, Overcomer Ministry	3185na
0400 0500	USA, WBCQ Monticello ME	5110am
0400 0500	USA, WEWN/EWTN Irondale AL	11520af
0400 0500 Sat	USA, WHRI Cypress Creek SC	9640eu
0400 0500 smtwhf	USA, WHRI Cypress Creek SC	9640eu
0400 0500	USA, WINB Red Lion PA	9265ca
0400 0500	USA, WRNO New Orleans LA	7505na
0400 0500	USA, WTWW Lebanon TN	5830na
0400 0500	USA, WWCR Nashville TN	3215eu
	5890va	5935af
0400 0500	USA, WWRB Manchester TN	3185na
	3195na	
0415 0420 mtwhf	Kyrgyzstan, Kyrgyz Radios	4010do
0430 0500 mtwhf	Swaziland, TWR Africa	3200af
0430 0500	USA, WHRI Cypress Creek SC	6175ca
0455 0500 mtwhf	Nigeria, VO Nigeria	15120eu
0459 0500	New Zealand, R New Zealand Intl	11725pa
0459 0500 DRM	New Zealand, R New Zealand Intl	13730pa

**0500 UTC - 1AM EDT / 12AM CDT / 10PM PDT**

0500 0527	Germany, Deutsche Welle	5905af
0500 0527	Vatican City State, Vatican R	7360af
0500 0530	Germany, Deutsche Welle	7425af
0500 0530	Japan, R Japan/NHK World	9770sa
	11740na	17660va
0500 0557	China, China R International	7220as
	11880as	15350as
	15465as	17505va
	17540va	17725va
	17855va	
0500 0557	North Korea, VO Korea	13650as
0500 0600	Anguilla, University Network	6090na
0500 0600	Australia, ABC/R Australia	9660pa
	13630pa	15240pa
	15415as	15515pa
	21725pa	
0500 0600	Australia, NT VL8A Alice Springs	4835do
0500 0600	Australia, NT VL8K Katherine	5025do
0500 0600	Australia, NT VL8T Tennant Creek	4910do
0500 0600	Bhutan, Bhutan BC Svc	6035do

0500 0600	Canada, CFRX Toronto ON	6070do	
0500 0600	Canada, CKZN St Johns NF	6160do	
0500 0600	Canada, CKZU Vancouver BC	6160do	
0500 0600	Cuba, R Havana Cuba	6010na	6060na
	6125am	6165na	
0500 0600	Eqf Guinea, Pan Am BC/R Africa		15190af
0500 0600	Germany, Deutsche Welle	9470af	
0500 0600	Germany, R 6150	6070eu	
0500 0600	Malaysia, RTM Kajang/Traxx FM		7295do
0500 0600	Micronesia, V6MP/Cross R/Pohnpei		4755as
0500 0600	New Zealand, R New Zealand Intl		11725pa
0500 0600	New Zealand, R New Zealand Intl		13730pa
0500 0600 DRM	Nigeria, VO Nigeria		15120af
0500 0600 mtwhf	Palau, T8WH/World Harvest R		17650as
0500 0600 mtwhf	South Africa, Channel Africa		7230af
0500 0600	Swaziland, TWR Africa		3200af
0500 0600	UK, BBC World Service		6005af
0500 0600		9410af	11760eu 15310as 15360va
		15400af 15420af	17640af
0500 0600 DRM	UK, BBC World Service		3955eu
0500 0600	USA, AFN/AFRTS		4319usb 5765usb
		12759usb	13362usb
0500 0600	USA, BBG/VO America		4930af 6080af
		9885af	15580af
0500 0600	USA, Overcomer Ministry		3185na 5890na
0500 0600	USA, WBCQ Monticello ME		9330am
0500 0600	USA, WEWN/EWTN Irondale AL		11520af
0500 0600 Sat	USA, WHRI Cypress Creek SC		9615af
0500 0600	USA, WTWW Lebanon TN		5830na
0500 0600	USA, WWCR Nashville TN		3215eu 4840na
	5890va	5935af	
0500 0600	USA, WWRB Manchester TN		3185na
0502 0600	Swaziland, TWR Africa		6120af 9500af
0515 0530	Rwanda, R Rep Rwandaise		6055do
0530 0557	Germany, Deutsche Welle		9470af 11800af
0530 0600	Australia, ABC/R Australia		17750as
0530 0600	Thailand, R Thailand World Svc		12015eu
0530 0600	USA, WHRI Cypress Creek SC		6195ca

### 0600 UTC - 2AM EDT / 1AM CDT / 11PM PDT

0600 0630	China, Xizang PBS		6025do 6130do
	9580do		
0600 0630 Sat/Sun	USA, WRMI/R Prague relay		9955ca
0600 0650 DRM	New Zealand, R New Zealand Intl		13730pa
0600 0650	New Zealand, R New Zealand Intl		11725pa
0600 0657	China, China R International		11750af
	11770me	11880as	13645as 15145as
		15350as	15465as 17505va 17540as
	17710va		
0600 0657	North Korea, VO Korea		7220as 9345as
	9730as		
0600 0700	Anguilla, University Network		6090na
0600 0700	Australia, ABC/R Australia		9660pa 11945pa
	12080pa	13630pa	15240pa 15415as
	17750pa	21725pa	
0600 0700	Australia, NT VL8A Alice Springs		4835do
0600 0700	Australia, NT VL8K Katherine		5025do
0600 0700	Australia, NT VL8T Tennant Creek		4910do
0600 0700	Canada, CFRX Toronto ON		6070do
0600 0700	Canada, CFVP Calgary AB		6030do
0600 0700	Canada, CKZN St Johns NF		6160do
0600 0700	Canada, CKZU Vancouver BC		6160do
0600 0700	Cuba, R Havana Cuba		6010na 6060na
	6125am	6165na	
0600 0700	Eqf Guinea, Pan Am BC/R Africa		15190af
0600 0700	Germany, Deutsche Welle		13780af 17800af
0600 0700	Germany, R 6150		6070eu
0600 0700	Malaysia, RTM Kajang/Traxx FM		7295do
0600 0700	Micronesia, V6MP/Cross R/Pohnpei		4755as
0600 0700 mtwhf	Nigeria, VO Nigeria		15120af
0600 0700	Palau, T8WH/World Harvest R		17650as
0600 0700	Russia, VO Russia		11635eu 21800va
	21820va		
0600 0700 mtwhf	South Africa, Channel Africa		7230af
	15255af		
0600 0700	Swaziland, TWR Africa		3200af 6120af
	9500af		

0600 0700	UK, BBC World Service		6005af 6190af
	9410af	9460af	12095af 15360eu
	15400af	15310as	15420af 17790as
0600 0700 DRM	UK, BBC World Service		3955eu
0600 0700	USA, AFN/AFRTS		4319usb 5765usb
	12759usb	13362usb	
0600 0700	USA, BBG/VO America		6080af 9885af
	15580af		
0600 0700	USA, Overcomer Ministry		3185na 5890na
0600 0700	USA, WBCQ Monticello ME		9330am
0600 0700	USA, WEWN/EWTN Irondale AL		11520af
0600 0700 Sat	USA, WHRI Cypress Creek SC		7315sa
	9615af		
0600 0700	USA, WTWW Lebanon TN		5830na
0600 0700	USA, WWCR Nashville TN		3215eu 4840na
	5890va	5935af	
0600 0700	USA, WWRB Manchester TN		3185na
0617 0630 Sun	Nepal, R Nepal		5005do
0630 0656	Romania, R Romania Intl		7310eu 17780as
	21600pa		
0630 0657	Vatican City State, Vatican R		11625af 13765af
0630 0700 wa	Germany, Hamburger Lokalradio		7265eu
0630 0700 DRM	Romania, R Romania Intl		9600eu
0651 0700 DRM	New Zealand, R New Zealand Intl		11675pa

### 0700 UTC - 3AM EDT / 2AM CDT / 12AM PDT

0700 0730	Myanmar, Myanma R/Yangon		9731do
0700 0757	China, China R International		11785as
	11880as	13645eu	15125as 15350as
	15465as	17490eu	17540as 17710as
0700 0758	New Zealand, R New Zealand Intl		11725pa
0700 0758 DRM	New Zealand, R New Zealand Intl		11675pa
0700 0800	Anguilla, University Network		6090na
0700 0800	Australia, ABC/R Australia		7410pa 9475pa
	9660pa	9710pa	11945pa 12080pa
	13630pa	15240pa	
0700 0800	Australia, NT VL8A Alice Springs		4835do
0700 0800	Australia, NT VL8K Katherine		5025do
0700 0800	Australia, NT VL8T Tennant Creek		4910do
0700 0800	Canada, CFRX Toronto ON		6070do
0700 0800	Canada, CFVP Calgary AB		6030do
0700 0800	Canada, CKZN St Johns NF		6160do
0700 0800	Canada, CKZU Vancouver BC		6160do
0700 0800	Eqf Guinea, Pan Am BC/R Africa		15190af
0700 0800 wa	Germany, Hamburger Lokalradio		7265eu
0700 0800	Germany, R 6150		6070eu
0700 0800	Malaysia, RTM Kajang/Traxx FM		7295do
0700 0800	Micronesia, V6MP/Cross R/Pohnpei		4755as
0700 0800	Palau, T8WH/World Harvest R		17650as
0700 0800	Papua New Guinea, R Fly		3915do
0700 0800	Russia, VO Russia		11635eu 12015eu
	15745as	21800va	21820va 21840as
0700 0800 mtwhf	South Africa, Channel Africa		9625af
0700 0800	Swaziland, TWR Africa		3200af 6120af
	9500af		
0700 0800	UK, BBC World Service		5875eu 6190af
	13820af	11770af	12095af 13820af
	15310as	15400af	15575va 17640af
	17660eu	17790as	17830as
0700 0800 DRM	UK, BBC World Service		5875eu 7355eu
0700 0800	USA, AFN/AFRTS		4319usb 5765usb
	12759usb	13362usb	
0700 0800	USA, Overcomer Ministry		3185na 5890na
0700 0800	USA, WBCQ Monticello ME		9330am
0700 0800	USA, WEWN/EWTN Irondale AL		11520af
0700 0800	USA, WHRI Cypress Creek SC		7315sa
	9615af	9930as	
0700 0800	USA, WTWW Lebanon TN		5830na
0700 0800	USA, WWCR Nashville TN		3215eu 4840na
	5890va	5935af	
0700 0800	USA, WWRB Manchester TN		3185na
0730 0744	Vatican City State, Vatican R		15595va
0730 0800	Australia, HCJB Global Australia		11750pa
0759 0800	New Zealand, R New Zealand Intl		9765pa
0759 0800 DRM	New Zealand, R New Zealand Intl		9870pa

**0800 UTC - 4AM EDT / 3AM CDT / 1AM PDT**

0800 0830	Australia, HCJB Global Australia	11750pa
0800 0830	Australia, NT VL8A Alice Springs	4835do
0800 0830	Australia, NT VL8K Katherine	5025do
0800 0830	Australia, NT VL8T Tennant Creek	4910do
0800 0830 Sun	Canada, Bible Voice Broadcasting	7220eu
0800 0830	USA, WHRI Cypress Creek SC	11565pa
0800 0845 Sat	Canada, Bible Voice Broadcasting	7220eu
0800 0850	Austria, TWR Europe	7400eu
0800 0850	Germany, TWR Europe	6105eu
0800 0857	China, China R International	9415as
	11785as 11880as 15350as	15465as
	15625va 17490eu	17540as
0800 0900	Anguilla, University Network	6090na
0800 0900	Australia, ABC/R Australia	5995pa
	9475pa 9580pa 9710pa	11945pa
	12080pa	15240pa
0800 0900	Canada, CFRX Toronto ON	6070do
0800 0900	Canada, CFVP Calgary AB	6030do
0800 0900	Canada, CKZN St Johns NF6160do	
0800 0900	Canada, CKZU Vancouver BC	6160do
0800 0900	Eqt Guinea, Pan Am BC/R Africa	15190af
0800 0900	Germany, R 6150	6070eu
0800 0900	Malaysia, RTM Kajang/Traxx FM	7295do
0800 0900	Micronesia, V6MP/Cross R/Pohnpei	4755as
0800 0900	New Zealand, R New Zealand Intl	9765pa
0800 0900 DRM	New Zealand, R New Zealand Intl	9870pa
0800 0900 mtwhf	Nigeria, VO Nigeria	15120af
0800 0900	Palau, T8WH/World Harvest R	17650as
0800 0900	Papua New Guinea, R Fly	3915do
0800 0900	Russia, VO Russia	9625eu 11635eu
	15745as 21800va 21830va	21840as
0800 0900 DRM	Russia, VO Russia	9625eu
0800 0900 mtwhf	South Africa, Channel Africa	9625af
0800 0900 Sun	South Africa, R Mirror Intl	7205af 17760af
0800 0900	South Korea, KBS World R	9570as
0800 0900	UK, BBC World Service	6190af 12095af
	15310as 15400af 15575va	17640af
	17660eu 17790eu	17830af 21470af
0800 0900 DRM	UK, BBC World Service	5875eu 7355eu
0800 0900	USA, AFN/AFRTS	4319usb 5765usb
	12759usb 13362usb	
0800 0900	USA, KNLS Anchor Point AK	7355as
0800 0900	USA, Overcomer Ministry	3185na 5890na
0800 0900	USA, WBCQ Monticello ME9330am	
0800 0900	USA, WEWN/EWTN Irondale AL	11520af
0800 0900	USA, WHRI Cypress Creek SC	7315sa
	9930as	
0800 0900	USA, WTWW Lebanon TN	5830na
0800 0900	USA, WWCR Nashville TN	3215eu 4840na
	5890va 5935af	
0800 0900	USA, WWRB Manchester TN	3185na
0815 0827	Nepal, R Nepal	5005do
0830 0900	Australia, NT VL8A Alice Springs	2310do
0830 0900	Australia, NT VL8K Katherine	2485do
0830 0900	Australia, NT VL8T Tennant Creek	2325do
0850 0900 mtwhf	Guam, KTWR/TWR Asia	15200as

**0900 UTC - 5AM EDT / 4AM CDT / 2AM PDT**

0900 0930 mtwhf	Guam, KTWR/TWR Asia	15200as
0900 0930	USA, WHRI Cypress Creek SC	6195sa
0900 0930 mtwhfa	USA, WRMI/R Prague relay	9955ca
0900 0957	China, China R International	9415as
	15210as 15270eu 15350as	17490eu
	17570eu 17650eu	17690va 17750va
0900 1000	Anguilla, University Network	6090na
0900 1000	Australia, ABC/R Australia	9580pa 11945pa
0900 1000	Australia, NT VL8A Alice Springs	2310do
0900 1000	Australia, NT VL8K Katherine	2485do
0900 1000	Australia, NT VL8T Tennant Creek	2325do
0900 1000	Canada, CFRX Toronto ON	6070do
0900 1000	Canada, CFVP Calgary AB	6030do
0900 1000	Canada, CKZN St Johns NF6160do	
0900 1000	Canada, CKZU Vancouver BC	6160do
0900 1000 Sat/Sun	Germany, Mighty KBC Radio	6095eu

0900 1000	Germany, R 6150	6070eu
0900 1000 Sat	Italy, IRRS Shortwave	9510va
0900 1000	Malaysia, RTM Kajang/Traxx FM	7295do
0900 1000	Micronesia, V6MP/Cross R/Pohnpei	4755as
0900 1000 DRM	New Zealand, R New Zealand Intl	9870pa
0900 1000	New Zealand, R New Zealand Intl	9765pa
0900 1000 mtwhf	Nigeria, VO Nigeria	9690af
0900 1000	Palau, T8WH/World Harvest R	17650as
0900 1000	Papua New Guinea, R Fly	3915do
0900 1000	Russia, VO Russia	9625eu 15745as
	21800va 21820va	
0900 1000 DRM	Russia, VO Russia	9625eu
0900 1000 mtwhf	South Africa, Channel Africa	9625af
0900 1000	UK, BBC World Service	6190af 6195as
	9740as 11895as 12095af	15285af
	15310as 15400af	15575af 17760as
	17790as 17830af	
0900 1000	USA, AFN/AFRTS	4319usb 5765usb
	12759usb 13362usb	
0900 1000	USA, Overcomer Ministry	3185na 5890na
0900 1000	USA, WBCQ Monticello ME9330am	
0900 1000	USA, WEWN/EWTN Irondale AL	11520af
0900 1000	USA, WHRI Cypress Creek SC	9930as
	11565pa	
0900 1000	USA, WTWW Lebanon TN	5830na
0900 1000	USA, WWCR Nashville TN	3215eu 4840af
	5890va 5935af	
0900 1000	USA, WWRB Manchester TN	3185na
0905 0910	Pakistan, R Pakistan External Svc	15725eu
	17700eu	
0930 1000 fs	China, VO the Strait	6115do

**1000 UTC - 6AM EDT / 5AM CDT / 3AM PDT**

1000 1000	USA, KNLS Anchor Point AK	7355as
1000 1018 mtwhf	Guam, KTWR/TWR Asia	11840pa
1000 1030 Sat	Guam, KTWR/TWR Asia	11840pa
1000 1030	Japan, R Japan/NHK World	9625as
	11740as	
1000 1030	Vietnam, VO Vietnam/Overseas Svc	9840as
	12020as	
1000 1057	China, China R International	5955na
	7215as 11640as 13590as	13720as
	15190as 15210pa 15350as	17490eu
	17690va	
1000 1057	North Korea, VO Korea	6170va 9335sa
	9850as	
1000 1058	New Zealand, R New Zealand Intl	9765pa
1000 1058 DRM	New Zealand, R New Zealand Intl	9870pa
1000 1100	Anguilla, University Network	11775na
1000 1100	Australia, ABC/R Australia	6020pa 9580pa
	11945pa	
1000 1100 Sat/Sun	Australia, ABC/R Australia	9475pa
1000 1100	Australia, NT VL8A Alice Springs	2310do
1000 1100	Australia, NT VL8K Katherine	2485do
1000 1100	Australia, NT VL8T Tennant Creek	2325do
1000 1100	Canada, CFRX Toronto ON	6070do
1000 1100	Canada, CFVP Calgary AB	6030do
1000 1100	Canada, CKZN St Johns NF6160do	
1000 1100	Canada, CKZU Vancouver BC	6160do
1000 1100 Sat/Sun	Germany, Mighty KBC Radio	6095eu
1000 1100	Germany, R 6150	6070eu
1000 1100	India, AIR/External Svc	7270as 13605as
	13695pa 15030as 15410as	17510pa
	17895pa	
1000 1100	Indonesia, VO Indonesia	9526va
1000 1100	Malaysia, RTM Kajang/Traxx FM	7295do
1000 1100	Micronesia, V6MP/Cross R/Pohnpei	4755as
1000 1100 mtwhf	Nigeria, VO Nigeria	9690af
1000 1100	Russia, VO Russia	7260as 9625eu
	15745as	
1000 1100 DRM	Russia, VO Russia	9625eu
1000 1100	Saudi Arabia, BSKSA/European Pgm	15250as
1000 1100 mtwhf	South Africa, Channel Africa	9625af
1000 1100	UK, BBC World Service	6190af 6195as
	9740as 11760va 12095af	15285as
	15310as 15575eu 17790as	
1000 1100 Sat/Sun	UK, BBC World Service	17830af

1000 1100	USA, AFN/AFRTS	4319usb	5765usb
	12759usb	13362usb	
1000 1100	USA, Overcomer Ministry	3185na	5890na
1000 1100	USA, WBCQ Monticello ME9330am		
1000 1100	USA, WEWN/EWTN Irondale AL	11520af	
1000 1100	USA, WHRI Cypress Creek SC	7315sa	
	9930as	11565pa	
1000 1100	USA, WTWW Lebanon TN	5830na	
1000 1100	USA, WWCR Nashville TN	4840na	5890va
	5935af	6875af	
1000 1100	USA, WWRB Manchester TN		3185na
1030 1100	Iran, VO Islamic Rep of Iran	21575va	21610va
1030 1100 Sun	Italy, IRRS Shortwave	9510va	
1030 1100	Mongolia, Voice of Mongolia		12085as
1059 1100	New Zealand, R New Zealand Intl		15720pa
1059 1100 DRM	New Zealand, R New Zealand Intl		9870pa

**1100 UTC - 7AM EDT / 6AM CDT / 4AM PDT**

1100 1105	Pakistan, R Pakistan External Svc		15725eu
	17700eu		
1100 1127	Iran, VO Islamic Rep of Iran	21575va	21610va
1100 1130 Sat/Sun	Canada, Bible Voice Broadcasting		15390as
1100 1130 f/DRM	Japan, R Japan/NHK World		9760eu
1100 1130 Sat/DRM	South Korea, KBS World R	9760eu	
1100 1130 mtwhf	UK, BBC World Service	15400af	
1100 1130	Vietnam, VO Vietnam/Overseas Svc		7285as
1100 1157	China, China R International		5955as
	9570as	11650as	11795as
	13645as	13665as	13720as
			13590as
			17490va
1100 1200	Anguilla, University Network		11775na
1100 1200	Australia, ABC/R Australia	5995pa	6020pa
	6080as	6140as	9580as
			11945pa
1100 1200 DRM	Australia, ABC/R Australia	12080pa	
1100 1200	Australia, NT VL8A Alice Springs		2310do
1100 1200	Australia, NT VL8K Katherine		2485do
1100 1200	Australia, NT VL8T Tennant Creek		2325do
1100 1200	Canada, CFRX Toronto ON	6070do	
1100 1200	Canada, CFVP Calgary AB	6030do	
1100 1200	Canada, CKZN St Johns NF6160do		
1100 1200	Canada, CKZU Vancouver BC		6160do
1100 1200 Sat/Sun	Germany, Mighty KBC Radio		6095eu
1100 1200	Germany, R 6150	6070eu	
1100 1200 Sun	Italy, IRRS Shortwave	9510va	
1100 1200	Malaysia, RTM Kajang/Traxx FM		7295do
1100 1200	New Zealand, R New Zealand Intl		15720pa
1100 1200 DRM	New Zealand, R New Zealand Intl		9870pa
1100 1200 mtwhf	Nigeria, VO Nigeria	9690af	
1100 1200	Russia, VO Russia	7260as	9560as
	9625eu		
1100 1200 DRM	Russia, VO Russia	9625eu	11640as
1100 1200	Saudi Arabia, BSKSA/European Pgm		15250as
1100 1200 mtwhf	South Africa, Channel Africa		9625af
1100 1200	Taiwan, R Taiwan Intl	7445as	9465as
1100 1200	UK, BBC World Service	6190af	6195as
	9740as	11760va	11895as
	15285as	15310as	17790as
			17830af
1100 1200	USA, AFN/AFRTS	4319usb	5765usb
	12759usb	13362usb	
1100 1200	USA, Overcomer Ministry	3185na	5890na
1100 1200	USA, Overcomer Ministry	13570as	
1100 1200	USA, WBCQ Monticello ME9330am		
1100 1200	USA, WEWN/EWTN Irondale AL	11520af	
1100 1200	USA, WHRI Cypress Creek SC	7315ca	
	9930as	11565pa	
1100 1200	USA, WTWW Lebanon TN	5830na	
1100 1200	USA, WWCR Nashville TN	5890af	5935af
	6875af	9880va	
1100 1200	USA, WWRB Manchester TN		3185na
1115 1130 f	Canada, Bible Voice Broadcasting		15390as
1130 1200 f	Vatican City State, Vatican R17590va		21650va
1130 1200	Vietnam, VO Vietnam/Overseas Svc		9840as
	12020as		

**1200 UTC - 8AM EDT / 7AM CDT / 5AM PDT**

1200 1230	Japan, R Japan/NHK World		11740as
	15190na		

1200 1230	Saudi Arabia, BSKSA/European Pgm		15250as
1200 1230asmtwh	USA, WHRI Cypress Creek SC		9930as
1200 1256	Romania, R Romania Intl	15460eu	17530eu
	17765af	21570af	
1200 1257	China, China R International		5955as
	7250as	9460as	9600as
	9730pa	9760as	11760as
	12015va	13655eu	13790eu
			17490eu
1200 1259	New Zealand, R New Zealand Intl		15720pa
1200 1300	Anguilla, University Network		11775na
1200 1300	Australia, ABC/R Australia	6080as	6140as
	9580as	11945pa	
1200 1300 DRM	Australia, ABC/R Australia	5995as	
1200 1300	Australia, NT VL8A Alice Springs		2310do
1200 1300	Australia, NT VL8K Katherine		2485do
1200 1300	Australia, NT VL8T Tennant Creek		2325do
1200 1300	Canada, CFRX Toronto ON	6070do	
1200 1300	Canada, CFVP Calgary AB	6030do	
1200 1300	Canada, CKZN St Johns NF6160do		
1200 1300	Canada, CKZU Vancouver BC		6160do
1200 1300	Ethiopia, R Ethiopia/Natl Svc		9705do
1200 1300 Sat/Sun	Germany, Mighty KBC Radio		6095eu
1200 1300	Germany, R 6150	6070eu	
1200 1300 Sun	Italy, IRRS Shortwave	9510va	
1200 1300	Malaysia, RTM Kajang/Traxx FM		7295do
1200 1300 mtwhf	Nigeria, VO Nigeria	9690af	
1200 1300 DRM	Russia, VO Russia	9625eu	
1200 1300	Russia, VO Russia	5885as	7260as
	9560as	9625eu	12075as
1200 1300	UK, BBC World Service	5875as	6190af
	6195as	9740as	11760va
	12095af	15310as	17640af
	17830af	21470af	
1200 1300	USA, AFN/AFRTS	4319usb	5765usb
	12759usb	13362usb	
1200 1300	USA, BBG/VO America	7520va	9640va
	11750va	12150va	
1200 1300	USA, KNLS Anchor Point AK		7355as
	9615as		
1200 1300	USA, Overcomer Ministry	3185na	
1200 1300 mtwhf	USA, Overcomer Ministry	5890na	
1200 1300	USA, Overcomer Ministry	13570as	
1200 1300	USA, WBCQ Monticello ME9330am		
1200 1300	USA, WEWN/EWTN Irondale AL	11520af	
1200 1300	USA, WHRI Cypress Creek SC	9840na	
	11565pa		
1200 1300	USA, WTWW Lebanon TN	5830na	
1200 1300	USA, WWCR Nashville TN	5935na	9980va
	15825eu		
1200 1300	USA, WWRB Manchester TN		3185na
1215 1300	Egypt, R Cairo	17870as	
1230 1300	Bangladesh, Bangladesh Betar/Ext Svc		15105as
1230 1300	South Korea, KBS World R	6095as	
1230 1300	Thailand, R Thailand World Svc		9720as
1230 1300	USA, WHRI Cypress Creek SC		9930as
1230 1300	Vietnam, VO Vietnam/Overseas Svc		9840as
	12020as		

**1300 UTC - 9AM EDT / 8AM CDT / 6AM PDT**

1300 1315	Palau, T8WH/World Harvest R		11925as
1300 1330	Egypt, R Cairo		17870as
1300 1330	Japan, R Japan/NHK World		11730as
1300 1357	China, China R International		5995as
	7300na	9570as	9655pa
	9765as	9870as	11760as
	11980as	13670eu	13790eu
1300 1357	North Korea, VO Korea	7570eu	9335na
	11710na	12015eu	
1300 1400	Anguilla, University Network		11775na
1300 1400	Australia, ABC/R Australia	5940as	6020pa
	9580pa	11945pa	
1300 1400 DRM	Australia, ABC/R Australia	5995pa	
1300 1400	Australia, NT VL8A Alice Springs		2310do
1300 1400	Australia, NT VL8K Katherine		2485do
1300 1400	Canada, CFRX Toronto ON	6070do	
1300 1400	Canada, CFVP Calgary AB	6030do	

1300 1400	Canada, CKZN St Johns NF6160do	
1300 1400	Canada, CKZU Vancouver BC	6160do
1300 1400 Sat/Sun	Germany, Mighty KBC Radio	6095eu
1300 1400	Germany, R 6150	6070eu
1300 1400	Indonesia, VO Indonesia	9526va
1300 1400	Malaysia, RTM Kajang/Traxx FM	7295do
1300 1400	New Zealand, R New Zealand Intl	5950pa
1300 1400 mtwhf	Nigeria, VO Nigeria	9690af
1300 1400 DRM	Russia, VO Russia	9625eu
1300 1400	Russia, VO Russia	7260as 9560as
	12075as	
1300 1400	South Korea, KBS World R	15575as
1300 1400	Tajikistan, VO Tajik	7245va
1300 1400	UK, BBC World Service	5875as 6190af
	6195as 9410as 9740as 11760as	
	11890as 12095af 15310as 15400as	
	17790as 17830af 21470af	
1300 1400	USA, AFN/AFRTS	4319usb 5765usb
	12759usb 13362usb	
1300 1400 Sat/Sun	USA, BBG/VO America	7520va 9640va
	11750va 12150va	
1300 1400	USA, KJES Vado NM	11715na
1300 1400 mtwhf	USA, Overcomer Ministry	9980na
1300 1400	USA, Overcomer Ministry	15370na
1300 1400	USA, WBCQ Monticello ME9330am	
1300 1400	USA, WEWN/EWTN Irondale AL	15610eu
1300 1400	USA, WHRI Cypress Creek SC	9930as
	11565pa	
1300 1400 Sat/Sun	USA, WHRI Cypress Creek SC	9840na
1300 1400	USA, WINB Red Lion PA	13570ca
1300 1400	USA, WTWV Lebanon TN	5830na
1300 1400	USA, WWCN Nashville TN	7490af 9980va
	13845eu 15825eu	
1300 1400	USA, WWRB Manchester TN	9370na
1315 1345	Bangladesh, Bangladesh Betar/Ext Svc	7250as
1330 1400 f	Clandestine, JSR/Shiokaze/Sea Breeze	5910as 5985as 6135as
1330 1400	India, AIR/External Svc	9690as 11620as
	13710as	
1330 1400	Turkey, VO Turkey	12035eu
1330 1400	Vietnam, VO Vietnam/Overseas Svc	9840as
	12020as	

**1400 UTC - 10AM EDT / 9AM CDT / 7AM PDT**

1400 1415 Sun	USA, Pan Am Broadcasting	15205as
1400 1425 mtwhf	Guam, KTWR/TWR Asia	15225as
1400 1425	Turkey, VO Turkey	12035eu
1400 1430 f	Clandestine, JSR/Shiokaze/Sea Breeze	5910as 5985as 6135as
1400 1430	Japan, R Japan/NHK World	11695as
	11705al 11925as	
1400 1430	Laos, LNR Natl Svc/Vientiane	6130do
1400 1430	Serbia, International R Serbia	9635eu
1400 1430	Thailand, R Thailand World Svc	9950as
1400 1430	USA, WHRI Cypress Creek SC	9950as
1400 1435 swa	Guam, KTWR/TWR Asia	15225as
1400 1445 Sat	Guam, KTWR/TWR Asia	11580as
1400 1457	China, China R International	5955as
	7300na 9460as 9765pa 9795as	
	9870as 11665eu 13625as 13685as	
	13740va 17630va	
1400 1500	Anguilla, University Network	11775na
1400 1500	Australia, ABC/R Australia	5940as 5995pa
	9580pa 11945pa	
1400 1500	Australia, NT VL8A Alice Springs	2310do
1400 1500	Australia, NT VL8K Katherine	2485do
1400 1500	Australia, NT VL8T Tennant Creek	2325do
1400 1500 Sun	Canada, Bible Voice Broadcasting	15470as
1400 1500	Canada, CFRX Toronto ON	6070do
1400 1500	Canada, CFVP Calgary AB	6030do
1400 1500	Canada, CKZN St Johns NF6160do	
1400 1500	Canada, CKZU Vancouver BC	6160do
1400 1500	Eq Guinea, Pan Am BC/R Africa	15190af
1400 1500 Sat/Sun	Germany, Mighty KBC Radio	6095eu
1400 1500	Germany, R 6150	6070eu

1400 1500	India, AIR/External Svc	9690as 11620as
	13710as	
1400 1500	Malaysia, RTM Kajang/Traxx FM	7295do
1400 1500	New Zealand, R New Zealand Intl	5950pa
1400 1500 mtwhf	Nigeria, VO Nigeria	9690af
1400 1500	Oman, R Sultanate of Oman	15560af
1400 1500	Russia, VO Russia	4960va 6235as
	7260as 9560as 12075as	
1400 1500	South Korea, KBS World R	9640as
1400 1500	UK, BBC World Service	5845as 5875as
	6190af 11760as 11890as 12095af	
	15310as 15400as 17640af 17830af	
	21470af	
1400 1500	USA, AFN/AFRTS	4319usb 5765usb
	12759usb 13362usb	
1400 1500 mtwhf	USA, BBG/VO America	7520va 9760va
	12150va	
1400 1500	USA, BBG/VO America	4930af 6080af
	15580af 17530af 17725af	
1400 1500	USA, KJES Vado NM	11715na
1400 1500	USA, KNLS Anchor Point AK	7355as
	9615as	
1400 1500 mtwhf	USA, Overcomer Ministry	9980na 13570ca
	13810me	
1400 1500	USA, Overcomer Ministry	9370va 9460eu
1400 1500	USA, WBCQ Monticello ME9330am	
1400 1500	USA, WEWN/EWTN Irondale AL	15610eu
1400 1500 Sat/Sun	USA, WHRI Cypress Creek SC	9840na
	21600af	
1400 1500	USA, WINB Red Lion PA	13570ca
1400 1500	USA, WJHR Intl Milton FL	15550 lsb
1400 1500	USA, WRNO New Orleans LA	7505na
1400 1500	USA, WTWV Lebanon TN	9479na
1400 1500	USA, WWCN Nashville TN	7490af 9980va
	13845eu 15825eu	
1400 1500	USA, WWRB Manchester TN	9370na
1415 1427	Nepal, R Nepal	5005do
1415 1430	USA, Pan Am Broadcasting	15205as
1425 1455	Swaziland, TWR Africa	6025af
1430 1445 Sun	USA, Pan Am Broadcasting	15205as
1430 1500	Australia, ABC/R Australia	9475as 11660as
1430 1500 Sat	Canada, Bible Voice Broadcasting	15470as
1430 1500	China, China Business R	6190do 7220do
1430 1500	China, China Natl R/CNR11	4905do
	4920do 6130do	
1430 1500	Palau, T8WH/World Harvest R	11925as
1430 1500	USA, WHRI Cypress Creek SC	9965as
1430 1500	USA, WRMI/R Prague relay	9955ca
1445 1500	Australia, HCJB Global Australia	15340as

**1500 UTC - 11AM EDT / 10AM CDT / 8AM PDT**

1500 1530	Australia, ABC/R Australia	11945pa
1500 1530	Australia, HCJB Global Australia	15340as
1500 1530 Sun	Canada, Bible Voice Broadcasting	13740as
1500 1530 Sun	Germany, R Santec	15190as
1500 1530 Sun	Italy, IRRS Shortwave	15190va
1500 1530	Vietnam, VO Vietnam/Overseas Svc	7285as
	9840as 12020as	
1500 1550	New Zealand, R New Zealand Intl	5950pa
1500 1557	China, China R International	5955as
	6095eu 7325eu 7405as 9435me	
	9525as 9650as 9720eu 9785eu	
	9870na 13685af 13740eu 17630af	
1500 1557	North Korea, VO Korea	7570eu 9335na
	11710na 12015eu	
1500 1600	Anguilla, University Network	11775na
1500 1600	Australia, ABC/R Australia	5940as 5995pa
	7240pa 9475as 11660as	
1500 1600	Australia, NT VL8A Alice Springs	2310do
1500 1600	Australia, NT VL8K Katherine	2485do
1500 1600	Canada, CFRX Toronto ON	6070do
1500 1600	Canada, CFVP Calgary AB	6030do
1500 1600	Canada, CKZN St Johns NF6160do	
1500 1600	Canada, CKZU Vancouver BC	6160do
1500 1600	Eq Guinea, Pan Am BC/R Africa	15190af
1500 1600 Sat/Sun	Germany, Mighty KBC Radio	6095eu
1500 1600	Germany, R 6150	6070eu

1500 1600	Malaysia, RTM Kajang/Traxx FM	7295do
1500 1600 mtwhf	Nigeria, VO Nigeria	15120af
1500 1600	Palau, T8WH/World Harvest R	15680as
1500 1600	Russia, VO Russia	4960va 5900as
	11985me	
1500 1600 mtwhf	South Africa, Channel Africa	9625af
1500 1600	UK, BBC World Service	5845as 5875as
	5975as 6190af 6195as 9410as	
	9490af 9740as 9505af 11760eu	
	12095af 15400af 17640af 17830af	
	21470af	
1500 1600	USA, AFN/AFRTS	4319usb 5765usb
	12759usb 13362usb	
1500 1600	USA, BBG/VO America	4930af 6080af
	7520va 9930va 11840va 12150va	
	13570va 17725af 17895af	
1500 1600	USA, KJES Vado NM	11715na
1500 1600 mtwhf	USA, Overcomer Ministry	9980na 13570ca
	13810me	
1500 1600 Sat	USA, Overcomer Ministry	15420na
1500 1600	USA, WBCQ Monticello ME9330am	
1500 1600	USA, WEWN/EWTN Irondale AL	15610eu
1500 1600 Sat	USA, WHRI Cypress Creek SC	21630af
1500 1600 Sun	USA, WHRI Cypress Creek SC	17570eu
1500 1600 Sat/Sun	USA, WHRI Cypress Creek SC	9840na
1500 1600	USA, WINB Red Lion PA	13570ca
1500 1600	USA, WJHR Intl Milton FL	15550 lsb
1500 1600	USA, WRNO New Orleans LA	7505na
1500 1600	USA, WTTW Lebanon TN	9479na
1500 1600	USA, WWCR Nashville TN	7490af 9980va
	13845eu 15825eu	
1500 1600	USA, WWRB Manchester TN	9370na
1515 1530 Sat	Canada, Bible Voice Broadcasting	13740as
1525 1555 Sat/Sun	Swaziland, TWR Africa	6025af
1530 1545	India, AIR/External Svc	9910as
1530 1549 smtwhf	Vatican City State, Vatican R	7485as
1530 1550 smtwhf	Vatican City State, Vatican R	15595as
1530 1550 smtwhf/DRM	Vatican City State, Vatican R	15775as
1530 1600	Afghanistan, R Afghanistan	7200as
1530 1600	Australia, ABC/R Australia	11880pa
1530 1600 DRM	Belgium, The Disco Palace	12115as
1530 1600 h	Canada, Bible Voice Broadcasting	13740as
1530 1600	Iran, VO Islamic Rep of Iran	13785va 13785va
	15525va	
1530 1600	Mongolia, Voice of Mongolia	12015as
1530 1600 smtwhf	Sri Lanka, AWR Asia	15255as
1530 1600 Sat	Vatican City State, Vatican R	7585as 15595as
1530 1600 Sat	Vatican City State, Vatican R	15775as
1551 1600	New Zealand, R New Zealand Intl	9765pa
1551 1600 DRM	New Zealand, R New Zealand Intl	7285pa

**1600 UTC - 12PM EDT / 11AM CDT / 9AM PDT**

1600 1627	Iran, VO Islamic Rep of Iran	13785va 15525va
1600 1630	Australia, ABC/R Australia	9580as
1600 1630 DRM	Belgium, The Disco Palace	12115as
1600 1630	Indonesia, AWR Asia/Pacific	15215as
	15660as	
1600 1650 DRM	New Zealand, R New Zealand Intl	7285pa
1600 1650	New Zealand, R New Zealand Intl	9765pa
1600 1657	China, China R International	6060as
	6155as 7235af 7255af 7420af	
	7435eu 9435eu 9460eu 9570eu	
	9600eu 9875as	
1600 1657	North Korea, VO Korea	9990va 1154va
1600 1657	Vietnam, VO Vietnam/Overseas Svc	7216me
	7280eu 9550me 9730eu	
1600 1658	Taiwan, R Taiwan Intl	9440as 15485as
1600 1700	Anguilla, University Network	11775na
1600 1700	Australia, ABC/R Australia	5940as 5995pa
	7240pa 9475as 11660pa 11880pa	
1600 1700	Australia, NT VL8A Alice Springs	2310do
1600 1700	Australia, NT VL8K Katherine	2485do
1600 1700	Canada, CFRX Toronto ON	6070do
1600 1700	Canada, CFVP Calgary AB	6030do
1600 1700	Canada, CKZN St Johns NF	6160do
1600 1700	Canada, CKZU Vancouver BC	6160do
1600 1700	Egypt, R Cairo	15345af

1600 1700	Eqt Guinea, Pan Am BC/R Africa	15190af
1600 1700	Ethiopia, R Ethiopia/External Svc	7235af
	9558af	
1600 1700 wa	Germany, Hamburger Lokalradio	7265eu
1600 1700 DRM	Germany, Mighty KBC Radio	9755eu
1600 1700	Germany, R 6150	6070eu
1600 1700	Malaysia, RTM Kajang/Traxx FM	7295do
1600 1700	Palau, T8WH/World Harvest R	15680as
1600 1700	Russia, VO Russia	4960va 5885as
	5900as 5995as 7390as	
1600 1700	South Korea, KBS World R	9515eu 9640as
1600 1700	UK, BBC World Service	3255af 5845as
	5975as 6190af 9410va 9505as	
	9915eu 12095af 15400af 17640af	
	17830af 21470af 21660af	
1600 1700	USA, AFN/AFRTS	4319usb 5765usb
	12759usb 13362usb	
1600 1700	USA, BBG/VO America	4930af 6080af
	15580af 17895af	
1600 1700 mtwhf	USA, Overcomer Ministry	9980na
1600 1700	USA, Overcomer Ministry	9370va
1600 1700	USA, WBCQ Monticello ME9330am	
1600 1700 Sat	USA, WBCQ Monticello ME15420am	
1600 1700	USA, WEWN/EWTN Irondale AL	15610eu
1600 1700	USA, WHRI Cypress Creek SC	9840na
	21630af	
1600 1700	USA, WINB Red Lion PA	13570ca
1600 1700	USA, WJHR Intl Milton FL	15550 lsb
1600 1700	USA, WRNO New Orleans LA	7505na
1600 1700	USA, WTTW Lebanon TN	9479na
1600 1700	USA, WWCR Nashville TN	9980va 12160af
	13845eu 15825eu	
1600 1700	USA, WWRB Manchester TN	9370na
1630 1700	Indonesia, AWR Asia/Pacific	15660as
1630 1700 m	South Africa, R Mirror Intl	4895af
1630 1700 mtwhf	USA, BBG/VO America/S Sudan in Focus	
	11905af 13625af	
1645 1700 mw	Canada, Bible Voice Broadcasting	9715me
1645 1700 thfas	Canada, Bible Voice Broadcasting	9715me
1651 1700	New Zealand, R New Zealand Intl	9765pa
1651 1700 DRM	New Zealand, R New Zealand Intl	9630pa

**1700 UTC - 1PM EDT / 12PM CDT / 10AM PDT**

1700 1710	Pakistan, Azad Kashmir R	3975do 4790do
1700 1710	Pakistan, R Pakistan External Svc	15725eu
	17700eu	
1700 1715 f	Canada, Bible Voice Broadcasting	9715me
1700 1730	Australia, ABC/R Australia	11660as
1700 1730 DRM	Germany, AWR Europe	9755eu
1700 1730 m	South Africa, R Mirror Intl	4895af
1700 1745 h	Canada, Bible Voice Broadcasting	9715me
1700 1757	China, China R International	6090as
	6100as 6140as 6155eu 6165as	
	7205af 7255as 7410as 7420af	
	7425eu 7435af 9460eu 9570eu	
1700 1758	Taiwan, R Taiwan Intl	15690af
1700 1800	Anguilla, University Network	11775na
1700 1800	Australia, ABC/R Australia	5995pa 9475as
	9500pa 9580pa 11880pa	
1700 1800	Australia, NT VL8A Alice Springs	2310do
1700 1800	Australia, NT VL8K Katherine	2485do
1700 1800 tas	Canada, Bible Voice Broadcasting	9715me
1700 1800	Canada, CFRX Toronto ON	6070do
1700 1800	Canada, CFVP Calgary AB	6030do
1700 1800	Canada, CKZN St Johns NF	6160do
1700 1800	Canada, CKZU Vancouver BC	6160do
1700 1800	Egypt, R Cairo	15345af
1700 1800	Eqt Guinea, Pan Am BC/R Africa	15190af
1700 1800	Germany, R 6150	6070eu
1700 1800	Malaysia, RTM Kajang/Traxx FM	7295do
1700 1800 DRM	New Zealand, R New Zealand Intl	9630pa
1700 1800	New Zealand, R New Zealand Intl	9765pa
1700 1800	Palau, T8WH/World Harvest R	15680as
1700 1800	Russia, VO Russia	4960va 5900as
	5955as 7390as	
1700 1800 mtwhf	South Africa, Channel Africa	15235af
1700 1800	Swaziland, TWR Africa	3200af

1700 1800 Sat/Sun	Swaziland, TWR Africa	3200af	
1700 1800	UK, BBC World Service	3255af	5845as
	5975as	6190af	12095af 15400af
	15420af	17640af	17830af 21660af
1700 1800	USA, AFN/AFRTS	4319usb	5765usb
	12759usb	13362usb	
1700 1800	USA, BBG/VO America	6080af	13755af
	15580af	17895af	
1700 1800 mtwhf	USA, Overcomer Ministry	9980na	
1700 1800 Sat	USA, Overcomer Ministry	15420na	
1700 1800	USA, Overcomer Ministry	9370va	9625me
1700 1800	USA, WBCQ Monticello ME	9330am	
1700 1800	USA, WEWN/EWTN Irondale AL	15610me	
1700 1800	USA, WHRI Cypress Creek SC	9840na	
	21630af		
1700 1800	USA, WINB Red Lion PA	13570ca	
1700 1800	USA, WJHR Intl Milton FL	15550	lsb
1700 1800	USA, WRNO New Orleans LA	7505na	
1700 1800	USA, WTWW Lebanon TN	9479na	
1700 1800	USA, WWCR Nashville TN	9980va	12160af
	13845eu	15825eu	
1700 1800	USA, WWRB Manchester TN	9370na	
1715 1729	Vatican City State, Vatican R	11935va	
1730 1757	Vatican City State, Vatican R	11625af	13765af
	15570af		
1730 1800	Australia, ABC/R Australia	6080pa	
1730 1800	Turkey, VO Turkey	11730as	
1745 1800	Bangladesh, Bangladesh Betar/Ext Svc	7250eu	
1745 1800	India, AIR/External Svc	7550eu	9445va
	9950eu	11580af	11670eu 11935af
	13695af	17670af	

**1800 UTC - 2PM EDT / 1PM CDT / 11AM PDT**

1800 1815 Sat	Canada, Bible Voice Broadcasting	7365me	
1800 1825	Turkey, VO Turkey	11730as	
1800 1830	Japan, R Japan/NHK World	15720af	
1800 1830 irreg	Tanzania, Zanzibar BC/VO Tanzania	11735do	
1800 1830	UK, BBC World Service	5975as	7600as
1800 1830	USA, BBG/VO America	6080af	13755af
	15580af		
1800 1830 Sat/Sun	USA, BBG/VO America	4930af	
1800 1830	Vietnam, VO Vietnam/Overseas Svc	5955eu	
1800 1850	New Zealand, R New Zealand Intl	9765pa	
1800 1850 DRM	New Zealand, R New Zealand Intl	9630pa	
1800 1856 DRM	Romania, R Romania Intl	9780eu	
1800 1856	Romania, R Romania Intl	7300eu	
1800 1857	China, China R International	6100eu	
	7405eu		
1800 1857	North Korea, VO Korea	7570eu	12015eu
1800 1858	Taiwan, R Taiwan Intl	3965eu	
1800 1900	Anguilla, University Network	11775na	
1800 1900 mtwhf	Argentina, RAE	15345eu	
1800 1900	Australia, ABC/R Australia	6080pa	9475as
	9500pa	9580as	11880pa
1800 1900 Sat/Sun	Australia, ABC/R Australia	9710as	
1800 1900	Australia, NT VL8A Alice Springs	2310do	
1800 1900	Australia, NT VL8K Katherine	2485do	
1800 1900	Bangladesh, Bangladesh Betar/Ext Svc	7250eu	
1800 1900 Sat/Sun	Canada, Bible Voice Broadcasting	9715me	
1800 1900 Sat	Canada, Bible Voice Broadcasting	9470me	
1800 1900 Sun	Canada, Bible Voice Broadcasting	6030eu	
1800 1900	Canada, CFRX Toronto ON	6070do	
1800 1900	Canada, CFVP Calgary AB	6030do	
1800 1900	Canada, CKZN St Johns NF	6160do	
1800 1900	Canada, CKZU Vancouver BC	6160do	
1800 1900	Eq Guinea, Pan Am BC/R Africa	15190af	
1800 1900	Germany, R 6150	6070eu	
1800 1900	India, AIR/External Svc	7550eu	9445va
	9950eu	11580af	11670eu 11935af
	13695af	17670af	
1800 1900	Kuwait, R Kuwait	15540eu	
1800 1900	Malaysia, RTM Kajang/Traxx FM	7295do	
1800 1900 mtwhf	Nigeria, VO Nigeria	15120af	
1800 1900	Palau, T8WH/World Harvest R	15680as	
1800 1900	Russia, VO Russia	4960va	11985va

1800 1900	South Korea, KBS World R	7275eu	
1800 1900	Swaziland, TWR Africa	3200af	9500af
1800 1900 Sat/Sun	Swaziland, TWR Africa	3200af	
1800 1900	UK, BBC World Service	3255af	5875eu
	5945eu	6190af	9430af 11810af
	12095af	15400af	17640af
1800 1900	USA, AFN/AFRTS	4319usb	5765usb
	12759usb	13362usb	
1800 1900	USA, KJES Vado NM	15385pa	
1800 1900 mtwhf	USA, Overcomer Ministry	9980na	
1800 1900	USA, Overcomer Ministry	9370va	9625me
1800 1900	USA, WBCQ Monticello ME	9330am	15420am
1800 1900	USA, WEWN/EWTN Irondale AL	15610me	
1800 1900	USA, WHRI Cypress Creek SC	9840na	
	9930as	21630af	
1800 1900	USA, WINB Red Lion PA	13570ca	
1800 1900	USA, WTWW Lebanon TN	9479na	
1800 1900	USA, WWCR Nashville TN	9980va	12160af
	13845eu	15825eu	
1800 1900	USA, WWRB Manchester TN	9370na	
1815 1845 Sat	Canada, Bible Voice Broadcasting	6030eu	
1815 1845 Sun	Canada, Bible Voice Broadcasting	9470me	
1830 1845	Rwanda, R Rep Rwandaise	6055do	
1830 1900 mtwhf/DRM	Nigeria, VO Nigeria	15120af	
1830 1900	South Africa, AWR Africa	11830af	
1830 1900	UK, BBC World Service	6005af	9410af
1830 1900	USA, BBG/VO America	4930af	6080af
	13755af	15580af	
1851 1900	New Zealand, R New Zealand Intl	11725pa	
1851 1900 DRM	New Zealand, R New Zealand Intl	15720pa	

**1900 UTC - 3PM EDT / 2PM CDT / 12PM PDT**

1900 1930	Germany, Deutsche Welle	11800af	12070af
	15275af		
1900 1930	Vietnam, VO Vietnam/Overseas Svc	7280eu	
	9730eu		
1900 1945	India, AIR/External Svc	7550eu	9445eu
	9950eu	11580af	11670eu 11935af
	13695af	17670af	
1900 1957	China, China R International	7295va	
	9440af		
1900 1957	North Korea, VO Korea	7219eu	9975va
	11535va	11910af	
1900 2000	Anguilla, University Network	11775na	
1900 2000	Australia, ABC/R Australia	6080pa	9500as
	9580pa	11660as	11880pa
1900 2000 Sat/Sun	Australia, ABC/R Australia	9710as	
1900 2000	Australia, NT VL8A Alice Springs	2310do	
1900 2000	Australia, NT VL8K Katherine	2485do	
1900 2000	Canada, CFRX Toronto ON	6070do	
1900 2000	Canada, CFVP Calgary AB	6030do	
1900 2000	Canada, CKZN St Johns NF	6160do	
1900 2000	Canada, CKZU Vancouver BC	6160do	
1900 2000	Egypt, R Cairo	15290af	
1900 2000	Eq Guinea, Pan Am BC/R Africa	15190af	
1900 2000	Germany, R 6150	6070eu	
1900 2000	Indonesia, VO Indonesia	9526va	
1900 2000 fas	Italy, IRRS Shortwave	7290va	
1900 2000	Kuwait, R Kuwait	15540eu	
1900 2000	Malaysia, RTM Kajang/Traxx FM	7295do	
1900 2000	Micronesia, V6MP/Cross R/Pohnpei	4755as	
1900 2000	New Zealand, R New Zealand Intl	11725pa	
1900 2000 DRM	New Zealand, R New Zealand Intl	15720pa	
1900 2000 mtwhf	Nigeria, VO Nigeria	7255af	
1900 2000	Palau, T8WH/World Harvest R	15680as	
1900 2000 mtwhf	Spain, R Exterior de Espana	9605af	9665eu
1900 2000	Swaziland, TWR Africa	3200af	
1900 2000 Sat/Sun	Swaziland, TWR Africa	3200af	
1900 2000	Thailand, R Thailand World Svc	9585eu	
1900 2000	UK, BBC World Service	3255af	5875eu
	5945eu	6190af	9410af 9430af
	11810af	12095af	15400af
1900 2000	USA, AFN/AFRTS	4319usb	5765usb
	12759usb	13362usb	
1900 2000	USA, BBG/VO America	4930af	6080af
	15580af		
1900 2000 mtwhf	USA, Overcomer Ministry	9980na	13570ca



1900 2000	USA, Overcomer Ministry	9370va	9625me
	9835af	13570ca	
1900 2000 Sat/Sun	USA, Overcomer Ministry	9980na	
1900 2000	USA, WBCQ Monticello ME	9330am	15420am
1900 2000	USA, WEWN/EWTN Irondale AL		15610me
1900 2000	USA, WHRI Cypress Creek SC		9840na
	21630af		
1900 2000	USA, WINB Red Lion PA	13570ca	
1900 2000	USA, WTWW Lebanon TN	9479na	
1900 2000	USA, WWCR Nashville TN	9980va	12160af
	13845eu	15825eu	
1900 2000	USA, WWRB Manchester TN		9370na
1905 1920 Sat	Mali, ORTM/R Mali	9635do	
1930 1957	Germany, Deutsche Welle	12070af	15275af
1930 2000	Eqt Guinea, Pan Am BC/R Africa		9515af
1930 2000	Iran, VO Islamic Rep of Iran	6040eu	7345eu
	12670af	15450af	
1930 2000	Serbia, International R Serbia		6100eu
1930 2000	Turkey, VO Turkey	6050eu	
1930 2000 Sun	USA, Pan Am Broadcasting	9685af	

### 2000 UTC - 4PM EDT / 3PM CDT / 1PM PDT

2000 2027	Iran, VO Islamic Rep of Iran	6040eu	7345eu
	12670af	15450af	
2000 2027	Vatican City State, Vatican R	11625af	13765af
2000 2030	Australia, ABC/R Australia	6080pa	500as
2000 2030	Egypt, R Cairo	15290af	
2000 2030	Eqt Guinea, Pan Am BC/R Africa		9515af
2000 2030 Sat/Sun	Swaziland, TWR Africa	3200af	
2000 2030	Turkey, VO Turkey	6050eu	
2000 2030	USA, BBG/VO America	4930af	6080af
	15580af		
2000 2030 mtwhf	USA, Overcomer Ministry	13570ca	
2000 2030 Sun	USA, Pan Am Broadcasting	9685af	
2000 2050	New Zealand, R New Zealand Intl		11725pa
2000 2050 DRM	New Zealand, R New Zealand Intl		15720pa
2000 2057	China, China R International		5960eu
	5985af	7285eu	7295va
	9440af	9600eu	11640eu
			13630eu
2000 2057	Germany, Deutsche Welle	9655af	
2000 2100	Anguilla, University Network		11775na
2000 2100	Australia, ABC/R Australia	9580pa	11650pa
	11660pa	12080pa	15515pa
2000 2100	Australia, NT VL8A Alice Springs		2310do
2000 2100	Australia, NT VL8K Katherine		2485do
2000 2100	Australia, NT VL8T Tennant Creek		2325do
2000 2100	Belarus, R Belarus	6155eu	11730eu
2000 2100 DRM	Belgium, The Disco Palace	17875na	
2000 2100	Canada, CFRX Toronto ON	6070do	
2000 2100	Canada, CFVP Calgary AB	6030do	
2000 2100	Canada, CKZN St Johns NF	6160do	
2000 2100	Canada, CKZU Vancouver BC		6160do
2000 2100 f	Clandestine, JSR/Shiokaze/Sea Breeze		
	5910as	5965as	6110as
2000 2100	Cuba, R Havana Cuba		11760am
2000 2100	Eqt Guinea, Pan Am BC/R Africa		15190af
2000 2100	Germany, R 6150	6070eu	
2000 2100	Italy, IRRS Shortwave	7290va	
2000 2100	Kuwait, R Kuwait	15540eu	
2000 2100	Malaysia, RTM Kajang/Traxx FM		7295do
2000 2100	Micronesia, V6MP/Cross R/Pohnpei		4755as
2000 2100	Palau, T8WH/World Harvest R		15680as
2000 2100	UK, BBC World Service	3255af	6190af
	9410af	9430af	11810af
	15400af		
2000 2100	USA, AFN/AFRTS	4319usb	5765usb
	12759usb	13362usb	
2000 2100 mtwhf	USA, BBG/VO America	9480va	
2000 2100	USA, Overcomer Ministry	9370va	9980na
2000 2100	USA, WBCQ Monticello ME	7490am	9330am
	15420am		
2000 2100	USA, WEWN/EWTN Irondale AL		15610me
2000 2100	USA, WHRI Cypress Creek SC		9505eu
	21630af		
2000 2100	USA, WINB Red Lion PA	13570ca	
2000 2100	USA, WTWW Lebanon TN	9479na	9905af

2000 2100	USA, WWCR Nashville TN	9980va	12160af
	13845eu	15825eu	
2000 2100	USA, WWRB Manchester TN		9370na
2030 2045	Thailand, R Thailand World Svc		9535eu
2030 2100	Australia, ABC/R Australia	9500pa	11695as
2030 2100	USA, BBG/VO America	4930af	6080af
	7560as	15580af	
2030 2100 Sat/Sun	USA, BBG/VO America	4930af	
2030 2100	Vietnam, VO Vietnam/Overseas Svc		7216me
	7280eu	9550me	9730eu
2045 2100	India, AIR/External Svc	7550eu	9445eu
	9910pa	11620pa	11670eu
			11740pa
2045 2100 DRM	India, AIR/External Svc	9950eu	
2051 2100 DRM	New Zealand, R New Zealand Intl		17675pa

### 2100 UTC - 5PM EDT / 4PM CDT / 2PM PDT

2100 2115 mtwhf	Moldova, R PMR/Pridnestrovye		7290eu
2100 2130 mtwhfa	Albania, R Tirana	7465eu	
2100 2130	Australia, NT VL8A Alice Springs		2310do
2100 2130	Australia, NT VL8K Katherine		2485do
2100 2130	Australia, NT VL8T Tennant Creek		2325do
2100 2130	Austria, AWR Europe	9830af	
2100 2150	New Zealand, R New Zealand Intl		15720pa
2100 2150 DRM	New Zealand, R New Zealand Intl		17675pa
2100 2157	China, China R International		5960eu
	7205af	7285eu	7405af
	9600eu		7415eu
2100 2157	North Korea, VO Korea	7570eu	12015eu
2100 2200	Angola, R Nac de Angola/Intl Svc		7217af
2100 2200	Anguilla, University Network		11775na
2100 2200	Australia, ABC/R Australia	9500pa	9660as
	11650pa	11695pa	12080pa
	15515pa	21740pa	13630pa
2100 2200	Belarus, R Belarus	6155eu	11730eu
2100 2200	Canada, CFRX Toronto ON	6070do	
2100 2200	Canada, CFVP Calgary AB	6030do	
2100 2200	Canada, CKZN St Johns NF	6160do	
2100 2200	Canada, CKZU Vancouver BC		6160do
2100 2200	Egypt, R Cairo	11890eu	12050al
2100 2200	Eqt Guinea, Pan Am BC/R Africa		15190af
2100 2200	Germany, Deutsche Welle	11800af	12070af
2100 2200	Germany, R 6150	6070eu	
2100 2200	India, AIR/External Svc	7550eu	9445eu
	9910pa	11620pa	11670eu
			11740pa
2100 2200 DRM	India, AIR/External Svc	9950eu	
2100 2200	Malaysia, RTM Kajang/Traxx FM		7295do
2100 2200	Micronesia, V6MP/Cross R/Pohnpei		4755as
2100 2200	Palau, T8WH/World Harvest R		15680as
2100 2200	Syria, R Damascus	9330va	
2100 2200	UK, BBC World Service	3255af	3915as
	5875as	5905as	5995af
	6195as	9410af	9915af
			12095af
2100 2200	USA, AFN/AFRTS	4319usb	5765usb
	12759usb	13362usb	
2100 2200	USA, BBG/VO America	6080af	15580af
2100 2200	USA, Overcomer Ministry	9370va	
2100 2200 Sat/Sun	USA, Overcomer Ministry	9980na	
2100 2200	USA, WBCQ Monticello ME	7490am	9330am
	15420am		
2100 2200	USA, WEWN/EWTN Irondale AL		15610me
2100 2200	USA, WHRI Cypress Creek SC		9490eu
	21630af		
2100 2200	USA, WINB Red Lion PA	13570ca	
2100 2200	USA, WTWW Lebanon TN	9479na	9905af
2100 2200	USA, WWCR Nashville TN	6875eu	9350af
	9980va	13845eu	
2100 2200	USA, WWRB Manchester TN		3215na
	9370na		
2130 2156 DRM	Romania, R Romania Intl	6030eu	
2130 2156	Romania, R Romania Intl	7310na	7380eu
	9435na		
2130 2200	Australia, NT VL8A Alice Springs		4835do
2130 2200	Australia, NT VL8K Katherine		5025do
2130 2200	Australia, NT VL8T Tennant Creek		4910do
2130 2200	Turkey, VO Turkey	9610as	
2145 2200 mtwhf	Moldova, R PMR/Pridnestrovye		7290eu
2151 2200	New Zealand, R New Zealand Intl		15720pa
2151 2200 DRM	New Zealand, R New Zealand Intl		17675pa

**2200 UTC - 6PM EDT / 5PM CDT / 3PM PDT**

2200 2225	Turkey, VO Turkey	9610as	
2200 2230	India, AIR/External Svc	9910pa	11620pa
	11670eu	11740pa	
2200 2230 DRM	India, AIR/External Svc	9950eu	
2200 2230	Serbia, International R Serbia		6100eu
2200 2230	South Korea, KBS World R	3955eu	
2200 2245	Egypt, R Cairo	11890eu	12050al
2200 2257	China, China R International		5915eu
2200 2300	Anguilla, University Network		6090na
2200 2300	Australia, ABC/R Australia	9660as	9855as
	12080pa	13630pa	15230pa
	15515pa	21740pa	
2200 2300	Australia, NT VL8A Alice Springs		4835do
2200 2300	Australia, NT VL8K Katherine		5025do
2200 2300	Australia, NT VL8T Tennant Creek		4910do
2200 2300	Canada, CFRX Toronto ON		6070do
2200 2300	Canada, CFVP Calgary AB		6030do
2200 2300	Canada, CKZN St Johns NF6160do		
2200 2300	Canada, CKZU Vancouver BC		6160do
2200 2300	Cuba, R Havana Cuba	11880af	
2200 2300	Eqt Guinea, Pan Am BC/R Africa		15190af
2200 2300	Germany, R 6150	6070eu	
2200 2300	Malaysia, RTM Kajang/Traxx FM		7295do
2200 2300	Micronesia, V6MP/Cross R/Pohnpei		4755as
2200 2300	New Zealand, R New Zealand Intl		15720pa
2200 2300 DRM	New Zealand, R New Zealand Intl		17675pa
2200 2300	Palau, T8WH/World Harvest R		15180na
	15680as		
2200 2300	Russia, VO Russia	9395ca	
2200 2300 Sat/Sun	Spain, R Exterior de Espana	6125eu	
2200 2300	Taiwan, R Taiwan Intl	6115na	15440na
2200 2300	UK, BBC World Service	3915as	5875as
	5885af	5905as	6135as
	7490as		6195as
2200 2300	USA, AFN/AFRTS	4319usb	5765usb
	12759usb	13362usb	
2200 2300 smtwhf	USA, BBG/VO America	5895va	7365va
	7425va	7480va	11860va
2200 2300	USA, Overcomer Ministry	5900eu	9370va
	9980na		
2200 2300	USA, WBCQ Monticello ME7490am		9330am
2200 2300	USA, WEWN/EWTN Irondale AL		15610me
2200 2300	USA, WHRI Cypress Creek SC		9490eu
	9505eu		
2200 2300	USA, WINB Red Lion PA	9265ca	
2200 2300	USA, WTWW Lebanon TN	9479na	9905af
2200 2300	USA, WWCR Nashville TN	6875eu	9350af
	9980va	13845eu	
2200 2300	USA, WWRB Manchester TN		3215na
	9370na		
2230 2300	China, Xizang PBS	4905do	
2230 2300	Indonesia, AWR Asia/Pacific		15320as
2245 2300	India, AIR/External Svc	9690as	9705as
	11710as	13605as	
2245 2300 DRM	India, AIR/External Svc		11645as

**2300 UTC - 7PM EDT / 6PM CDT / 4PM PDT**

2300 0000	Anguilla, University Network		6090na
2300 0000	Australia, ABC/R Australia	9660as	9855as
	12080pa	15230pa	15415pa
	19000pa	21740pa	17795pa
2300 0000	Australia, NT VL8A Alice Springs		4835do
2300 0000	Australia, NT VL8K Katherine		5025do
2300 0000	Australia, NT VL8T Tennant Creek		4910do
2300 0000	Canada, CFRX Toronto ON		6070do
2300 0000	Canada, CFVP Calgary AB		6030do
2300 0000	Canada, CKZN St Johns NF6160do		
2300 0000	Canada, CKZU Vancouver BC		6160do
2300 0000	Egypt, R Cairo	9965am	11510al
2300 0000	Germany, R 6150	6070eu	
2300 0000	India, AIR/External Svc	6055as	9690as
	9705as	11710as	13605as
2300 0000 DRM	India, AIR/External Svc		11645as
2300 0000	Malaysia, RTM Kajang/Traxx FM		7295do
2300 0000	Micronesia, V6MP/Cross R/Pohnpei		4755as

2300 0000	New Zealand, R New Zealand Intl		15720pa
2300 0000 DRM	New Zealand, R New Zealand Intl		17675pa
2300 0000	Palau, T8WH/World Harvest R		7385na
	15680as		
2300 0000	Romania, R Romania Intl	6015eu	7220eu
	9530as	11810as	
2300 0000	Russia, VO Russia		9395ca
2300 0000	UK, BBC World Service	3915as	5875as
	5980as	6135as	6195as
	9740as	11955as	7490as
2300 0000	USA, AFN/AFRTS	4319usb	5765usb
	12759usb	13362usb	
2300 0000	USA, BBG/VO America	5830va	7365va
	7480va	11860va	
2300 0000	USA, Overcomer Ministry		9370va
2300 0000 mtwhf	USA, Overcomer Ministry		9980na
2300 0000	USA, WBCQ Monticello ME7490am		9330am
2300 0000	USA, WEWN/EWTN Irondale AL		15610me
2300 0000 smtwhf	USA, WHRI Cypress Creek SC		7315ca
	9490eu		
2300 0000 Sat	USA, WHRI Cypress Creek SC		7315ca
	9505eu		
2300 0000 smtwhf	USA, WHRI Cypress Creek SC		9490eu
2300 0000	USA, WINB Red Lion PA	9265ca	
2300 0000	USA, WTWW Lebanon TN	9479na	9905af
2300 0000	USA, WWCR Nashville TN	3195eu	5070af
	9980va	13845eu	
2300 0000	USA, WWRB Manchester TN		3215na
	9370na		
2300 2355	Turkey, VO Turkey	5960na	
2300 2357	China, China R International		5915as
	5990ca	6145na	7350eu
	9535as	11790as	7415as
2330 0000	Australia, ABC/R Australia		17750pa
2330 0000 tw	Indonesia, AWR Asia/Pacific		17700as
2330 0000	USA, WYFR/Family R	6115na	
2330 0000	Vietnam, VO Vietnam/Overseas Svc		9840as
	12020as		

SHORTWAVE GUIDE

**NOW AVAILABLE**

Radio hobbyists interested in receiving and identifying radio stations in the HF/VHF/UHF radio spectrums now have a new whopping 1414 page CD-ROM publication to aid them.



**International Callsign Handbook** is a concise world directory of various types of radio station identifications covering the military, government, maritime, aeronautical, and fixed radio stations on CD-ROM. Thousands of callsigns and other types of identifiers have been collected from our own personal log book, official sources and dedicated hobbyists who contributed their material.

**World QSL Book** - Radio hobbyists interested in receiving verifications from radio station now have a new CD-ROM publication to aid them in the art of QSLing. This 528-page eBook covers every aspect of collecting QSL cards and other acknowledgments from stations heard in the HF spectrum.

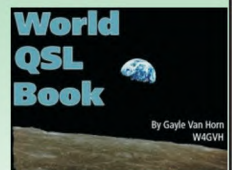

*"I'm impressed. This is a comprehensive collection of worldwide radio identifiers likely (and even some less likely) to be heard on the air. Over the years the Van Horns have earned the well-deserved respect of the monitoring community. Accurately assembling a collection like this is a mammoth undertaking. Congratulations on a job well done."*  
Bob Grove - December 2008 What's New Column, Monitoring Times magazine

Both books may be ordered directly from Teak Publishing via email at [teakpub@brmemc.net](mailto:teakpub@brmemc.net) or via our two main dealers, Grove Enterprises, [www.grove-ent.com](http://www.grove-ent.com), and Universal Radio, [www.universal-radio.com](http://www.universal-radio.com).

**TEAK Publishing**  
PO Box 297  
Brasstown, NC 28902  
[teakpub@brmemc.net](mailto:teakpub@brmemc.net)

From Teak Publishing either book is \$19.95 plus \$3.00 (US) and \$5.00 (Int'l) first class mail. Paypal, Cash, Check or Money Order accepted. NC residents add state sales tax. **Dealer inquiries/orders welcomed.**

## MTXTRA SHORTWAVE BROADCAST RESOURCE GUIDE (A-G)

Afghanistan, R Afghanistan .....	www.rta.org.af	China, China R International .....	www.cri.cn
Albania, R Tirana .....	http://rtsh.sil.at/	China, Nei Menggu PBS .....	www.nmrb.cn
Algeria, R Algerienne .....	www.radioalgerie.dz/	China, Qinghai PBS .....	www.qhradio.com
Angola, R Nac de Angola/Canal A .....	www.rna.ao/	China, Qinghai PBS-1 .....	www.qhradio.com
Angola, R Nac de Angola/Intl Svc .....	www.rna.ao/	China, VO Fujiang .....	www.cnr.cn
Anguilla, University Network .....	www.worldwideuniversitynetwork.com/	China, VO Shenzhou .....	www.cnr.cn
Argentina, RAE .....	www.radionacional.gov.ar	China, VO the Strait .....	www.vos.com.cn
Armenia, Public R of Armenia .....	www.int.armradio.am	China, VO Zhonghua .....	www.cnr.cn
Australia, ABC NT Alice Springs .....	www.abc.net.au/radio/	Clandestine, Awdalradio .....	www.awdalradio.com
Australia, ABC NT Katherine .....	www.abc.net.au/radio/	Clandestine, Badr Radio .....	www.badrradio.com
Australia, ABC NT Tennant Creek .....	www.abc.net.au/radio/	Clandestine, Dem VO of Burma .....	www.dvb.no/
Australia, ABC/R Australia .....	www.radioaustralia.net.au	Clandestine, EDC Sudan R Svc/Darfur Pgm .....	www.sudanradio.org
Australia, HCB Global Australia .....	www.hcjb.org.au	Clandestine, Furusato no Kaze .....	www.rachi.go.jp
Australia, R Symban .....	www.radiosymban.com.au	Clandestine, Ginbot 7 Dimts R .....	www.ginbot7.org
Austria, AWR Europe .....	www.awr2.org	Clandestine, JSR/Shiokaze/Sea Breeze .....	www.chosa-kai.jp
Austria, Radio O1 Intl .....	http://oe1.orf.at	Clandestine, Khmer Post Radio .....	www.thekhmerpost.com
Austria, TWR Europe .....	www.twr.org	Clandestine, Mhingui R .....	www.mhradio.org
Bahrain, R Bahrain .....	www.radiobahrain.fm	Clandestine, North Korea Reform R .....	www.nkreform.net
Bahrain, R Bahrain/Gen Prg .....	www.radiobahrain.fm	Clandestine, Open R for North Korea .....	www.nkradio.org
Bangladesh, Bangladesh Betar/Ext Svc .....	www.betar.org.bd/	Clandestine, R Biafra London .....	www.radiobiafralondon.com/
Bangladesh, Bangladesh Betar/Home Svc .....	www.betar.org.bd/	Clandestine, R Dabanga .....	www.radiodabanga.com
Belarus, Belaruskaje Radyjo 1 .....	www.radiobelarus.tv.by/eng	Clandestine, R Damal/VO Somali People .....	www.radiodamal.com
Belarus, R Belarus .....	www.radiobelarus.tv.by/eng	Clandestine, R ERGO .....	www.radioergo.org
Bolivia, R Em Camargo .....	www.radiocamargo.com.bo	Clandestine, R Free Chosun .....	www.rfchosun.org/
Bolivia, R Fides .....	www.radiofides.com	Clandestine, R Free North Korea .....	www.fnkradio.com
Bolivia, R Illimani/R Patria Nueva .....	www.patrianueva.bo	Clandestine, R Free Sarawak .....	www.radiofreesarawak.org
Bolivia, R Panamericana .....	www.panamericana-bolivia.com	Clandestine, R Hoa-Mai .....	www.radiohoamai.us
Bolivia, R Pio XII .....	www.radiopio12.org	Clandestine, R Miraya FM .....	www.mirayafm.org
Bolivia, R Santa Ana .....	www.ifrabolivia.org	Clandestine, R Tamazuj .....	http://radiotamazuj.org
Bolivia, R Santa Cruz .....	www.ifrabolivia.org	Clandestine, R VO Kurdistan .....	www.radiokurdistan.net
Brazil, Educadora/Braganca .....	www.educadora.com.br	Clandestine, R VO the People .....	www.radiovop.com
Brazil, R Alvorada/Londrina .....	www.radiovalorada.am.br/	Clandestine, R Xoriyo .....	www.radioxoriyo.com
Brazil, R Alvorada/Paritins .....	www.alvoradaparitins.com.br/	Clandestine, Sawtu Linjila/VO the Gospel .....	www.lutheranworld.org/
Brazil, R Aparecida .....	www.radioaparecida.com.br	Clandestine, Sound of Hope R Intl .....	http://sohnetwork.com/
Brazil, R Bandeirantes .....	www.bandeirantes.com.br	Clandestine, SW R Africa .....	www.swradioafrica.com
Brazil, R Brasil .....	www.brasilcampinas.com.br	Clandestine, VO Asena .....	www.assenna.com
Brazil, R Brasil Central .....	www.agem.com.br	Clandestine, VO Democratic Alliance .....	www.ert-alliance.com
Brazil, R Caiari .....	www.radiocaiari.com/	Clandestine, VO Eritrea .....	www.mahta.net
Brazil, R Cancao Nova .....	www.cancaonova.com	Clandestine, VO Iranian Kurdistan .....	www.rdkiran.com
Brazil, R Capital .....	www.radiocapitalrio.com.br	Clandestine, VO Martyrs (Freedom) .....	www.vomkorea.co.kr
Brazil, R Capixaba .....	www.radiocapixaba.com.br	Clandestine, VO Oromo Liberation/SBO .....	www.oromaliberationfront.org/sbo.html
Brazil, R Clube do Para .....	www.radioclubedopara.com.br	Clandestine, VO Tibet .....	www.vot.org/
Brazil, R Congonhas .....	www.radiocongonhas.com.br	Clandestine, VO Wilderness .....	www.cornerstoneusa.org
Brazil, R Cultura do Para .....	www.portalcultura.com.br	Clandestine, Zimbabwe Comm R/R Dialogue .....	www.zicora.com
Brazil, R Cultura Filadelfia .....	www.radiofiladelfia.com.br	Colombia, Salem Stereo .....	www.salemstereo.com
Brazil, R Cultura/Araraquara .....	www.radiocultura.net/	Congo Dem Rep, R Kahuzi .....	www.radiokahuzi.com
Brazil, R Difusora do Amazonas .....	www.difusoramanaus.com.br/	Croatia, Croatian R/HS-1 .....	www.hrt.hr/
Brazil, R Difusora Roraima .....	www.radiororaima.com.br/	Croatia, VO Croatia .....	www.hrt.hr/
Brazil, R Difusora/Caceres .....	www.difusoracaceres.com.br/	Cuba, R Havana Cuba .....	www.radiohc.cu/
Brazil, R Difusora/Londrina .....	www.radiodifusoradelondrina.com.br/	Cuba, R Rebelde .....	www.radiorebelde.cu
Brazil, R Difusora/Macapa .....	www.difusora.ap.gov.br	Cyprus, (Northern) R Bayrak Intl .....	www.brk.cc
Brazil, R Educadora/Guajara Mirim .....	www.educadora.com.br	Cyprus, Cyprus Broad Corp .....	www.cybc.com.cy
Brazil, R Educadora/Limeira .....	www.educadora.com.br	Djibouti, RDTV de Djibouti .....	www.rtd.dj
Brazil, R Gaucha .....	www.rdgauca.com.br	Dominican Rep, R Amanecer Intl .....	www.radioamanecer.org
Brazil, R Gazeta .....	www.casperlibero.edu.br	Ecuador, HCBJ/LV de los Andes .....	www.radiohcbj.org
Brazil, R Guaiba .....	www.radioguaiba.com.br	Ecuador, R El Buen Pastor .....	www.saraguros.com/radio.php
Brazil, R Guaruja Paulista .....	www.radioguarujapam.com.br	Egypt, R Cairo .....	www.ertu.org
Brazil, R Guaruja/Florianopolis .....	www.radioguaruja.com.br	Egypt, R Cairo/R VO of the Arabs .....	www.ertu.org
Brazil, R Iguatemi .....	www.radioterra.am.br	Eqt Guinea, Pan Am BC/R Africa .....	www.radiopanam.com/
Brazil, R Imaculada Conceicao .....	www.miliciadaimaculada.org.br/	Ethiopia, Amhara State Reg R .....	www.amma.gov.et
Brazil, R Inconfidencia .....	www.inconfidencia.com.br	Ethiopia, R Ethiopia/External Svc .....	www.erta.gov.com
Brazil, R Itatiaia .....	www.itatiaia.com.br/	Ethiopia, R Ethiopia/Natl Svc .....	www.erta.gov.com
Brazil, R Maria .....	www.radiomaria.net.br	Ethiopia, R Fana .....	www.radiofana.com
Brazil, R Marumby .....	www.radiomarumby.com.br	Ethiopia, R Oromiya .....	www.orto.gov.et
Brazil, R Meteorologia Paulista .....	www.radioibitinga.com.br	Finland, Scandinavian Weekend R .....	www.swradio.net
Brazil, R Mundial .....	www.radiomundial.com.br	France, R France International .....	www.rfi.fr/
Brazil, R Nacional da Amazonia .....	www.radiobras.gov.br	Gabon, Africa No. 1 .....	www.africa1.com
Brazil, R Nove de Julho .....	www.radio9dejulhocom.br	Georgia, R Abkhazia .....	www.apsua.tv
Brazil, R Novo Tempo .....	www.radienovotempo.org.br/	Germany, AWR Europe .....	www.awr2.org/
Brazil, R Record .....	www.radiorecord.com.br	Germany, Christliche Wissenschaft .....	www.awr2.org/
Brazil, R Rural .....	www.radioruralesantarem.com.br/	Germany, Deutsche Welle .....	www.dw.de
Brazil, R Trans Mundial .....	www.transmundial.com.br	Germany, HCBJ Global Voice .....	www.radiohcbj.org
Brazil, R Voz Missionaria .....	www.gideoes.com.br/	Germany, Lutherische Stunde .....	www.lutherischestunde.de
Brazil, Super R Alvorada .....	www.radioalvoradaac.com.br	Germany, Mighty KBC Radio .....	www.kberadio.eu/
Brazil, Super R Boa Vontade .....	www.boavontade.com	Germany, R 61 50 .....	www.radio-6150.de
Brazil, Super R Deus e Amor/Curitiba .....	www.superradiodeuseamor.com.br	Germany, R Dardasha 7 .....	www.dardasha7.com
Brazil, Super R Deus e Amor/Rio de Janeiro .....	www.superradiodeuseamor.com.br	Germany, TWR Europe .....	www.twr.org
Canada, Bible Voice Broadcasting .....	www.biblevoice.org/	Greece, R Stathmos Makedonias .....	www.ert3.gr/
Canada, CFRX Toronto ON .....	www.cfrb.com	Greece, Voice of Greece .....	www.ert3.gr/
Canada, CFPV Calgary AB .....	www.classiccountrysam1060.com	Greece, Voice of Greece .....	www.voiceofgreece.gr/
Canada, CKZN St Johns NF .....	www.cbc.ca/listen/index.html	Guam, AWR Asia/Pacific .....	www.awr2.org/
Canada, CKZU Vancouver BC .....	www.cbc.ca/bc	Guam, KTWR/TWR Asia .....	http://nea.ktwr.net/
China, Beibu Bay R .....	www.bbrmedia.com	Guatemala, R Verdad .....	www.radioverdad.org
China, China Huayi BC .....	www.chbcnews.com	Guinea, R Familia FM .....	www.familiafm.com
China, China Natl R/CNR1 1 .....	www.cnr.cn	Guinea, RTV Guinea .....	www.rtg-conarky.com/
China, China Natl R/CNR1 3 .....	www.cnr.cn	Guyana, Voice of Guyana .....	www.ncguyana.com

SHORTWAVE GUIDE



# Who's Who in the 30-88 MHz Government Spectrum

**A**s the weather in the northern hemisphere turns warmer and we approach the summer months, a portion of the VHF radio spectrum, known as the VHF low band, will also heat up with activity from distant radio stations.

Starting next month radio hobbyists, including milcom enthusiasts, will gear up to monitor distant radio signals in the 30-88 MHz band. Thanks to three, long-range propagation modes – E-layer skip, tropospheric bending (aka tropo) and the occasional F2 layer opening, due to higher sunspot numbers – we can enjoy distant communications from throughout the U.S. in the VHF low band.

One of the more common questions we get in the *Milcom* mailbag is, “What is in the VHF low band to hear?”

I will be the first to admit that activity in this range has fallen off in recent years due to the migration of the government and military services to higher frequencies and trunk radio systems. But, there is still enough activity around in the old low band to keep monitors clicking on that search button, spacing the search at 5 kHz intervals in the FM mode and sitting back to enjoy fascinating communications utilizing this frequency range.

Federal and military service requirements in this portion of the spectrum use both voice and data. The vast majority of military operations supports tactical training, including tactical communications to ground units, ships and aircraft, base operations, and as back-ups or supplements to satellite communications.

Department of Defense (DoD) uses the frequency bands between 30-50 MHz for tactical communication using the Single Channel Ground and Airborne Radio System (SINCGARS) and other land mobile radio (LMR) assets (e.g., Scope Shield II) as well as some non-tactical intra-base radio functions.

The Scope Shield II system provides the Air Force security police with a tactical communications capability to support their mobility mission worldwide. The Scope Shield II equipment is also used by the Air Force Surgeon General, Air Force Civil Engineer, Air Force Special Operations Command (for other than security police missions), and the Army, Navy, and Marines.



*Marine Corps 2nd Lt operates a PRC 119 SINCGARS during training in Quantico, Virginia. (Photo courtesy of DoD)*

In addition, the Air Force has an airborne SINCGARS radio designed to assist in Close Air Support (CAS) to ground forces. The SINCGARS airborne complement is installed in Air Force aircraft such as the A-10, AC-130H/U, EC-130E/H, and F-16C/D.

The Air Force also uses frequencies in this band to support contingency operations such as search and rescue; ground airbase defense training; special projects and miscellaneous activities to include Research and Development Test and Evaluation (RDTE), aeronautical, air-ground advisory, in-flight communications for A-10 training, test range operations, and explosive ordnance disposal.

## ❖ SINCGARS Rules Supreme in this Spectrum

But the biggest player by far in this portion of the spectrum these days is the previously mentioned SINCGARS radio systems.

The SINCGARS is a family of VHF-FM combat net radios which provide the primary means of command and control for infantry, armor,

and artillery units in the Army. While SINCGARS is being used by all branches of the military service the two biggest users are the Army and Marine Corps.

SINCGARS is capable of short range or long range operation for voice or digital data communications. The system's configurations include man-pack, vehicular, and airborne units. These units can be used for single channel operation or in a jam-resistant, frequency hopping mode which can be changed as needed.

When configured for use of low VHF frequencies, the system operates on any of the 2320 channels between 30-88 MHz in 25 kHz increments and is designed to survive a nuclear environment. The SINCGARS program is continuously evolving to provide the latest in improvements and capabilities to the soldier and to meet DoD's objectives for widespread digitization.



*U.S. Military Soldier Operating a SINCGARS radio. (Photo courtesy of DoD)*

The SINCGARS system, which was once a conventional voice-only radio used for communications up and down the chain of command, has evolved into a software-defined, open architecture system with extensive networking capabilities. It offers clear or secure voice and data communications capabilities that provide situational awareness and transmit command and control information across entire theaters of battle or control.

A handheld unit, an airborne unit (AN/ARC-210D), a man-pack (AN/PRC-119F(V)), and various vehicular components (AN/VRC-90F(V), AN/VRC-87F(V), AN/VRC-87F(V), AN/VRC-89F(V), AN/VRC-91F(V) and VRC-92F(V)) are in current production.

## ❖ VHF Low Band Station Characteristics

Some of the basic characteristics of the radio systems we have monitored in this frequency range include:

Govt. Non-DoD... Modulation types – Analog and digital, FM mode, single channel, data and telephony with a 16 kHz bandwidth.

DoD..... Modulation types – Analog and digital, mostly FM, but some AM mode is used, single channel and SINCGARS, data and telephony with a 16-40 kHz bandwidth.

## ❖ VHF Low Band Frequency Breakdown

In our frequency breakdown listed below, we have not included every frequency, only some of the more notable and recently heard activity in this frequency range (all frequencies are in MHz). The normal DoD spacing in each of the government sub-bands listed below is 25 kHz, but you will find some remnants of the old 20 kHz spacing still in use.

30.00 - 30.56 Military LMR – Used by the military services for tactical and training operations to include tactical air-ground and air-air communications.

Army 30.51 (Aberdeen Proving Ground, Maryland range), 30.50 (Fort Campbell, Kentucky MAST)

<p>Coast Guard 30.33, 30.41, 30.43 Marine Corps 30.15 (HMX-1 operations nationwide), 30.35 (Camp Pendleton, California range) Navy/Marine Corps 30.45, 30.55</p> <p>Non-Military LMR – Other Federal agencies use this band for natural resource management and for wildlife telemetry.</p> <p>Frequencies include 30.01, 30.02, 30.03, 30.04, 30.05, 30.06, 30.07, 30.13, 30.17, 30.18, 30.19, 30.20, 30.21, 30.22, 30.23, 30.24, 30.25, 30.26, 30.27, 30.53 Department of Energy (DoE) 30.37 Government Interop 30.075</p>	<p>37.00 - 37.50 Civilian Band – Some federal agencies are authorized to use this band for mutual aid response to local communities. Military services have some usage for tactical and training operations on a non-interference basis.</p> <p>37.50 - 38.00 Radio Astronomy – Continuum observations are performed in this band to study electromagnetic radiation from the Sun and the planet Jupiter.</p> <p>38.00 - 38.25 Military LMR – This sub-band is used primarily for tactical and training operations by U.S. military units for combat net radio operations that provide command and control for combat, combat support, and combat service support units. Frequencies also used for air-to-ground communications for military close air support requirements, other tactical air-ground and air-air communications, and experimental testing.</p>																														
<p>30.56 - 32.00 Civilian Band – Used by the military services for tactical and training operations on a non-interference basis and other federal agencies use this band for natural resource management and for forest fire fighting.</p>	<p>Army/National Guard 38.15, 38.20, 38.30 Coast Guard 38.27</p>																														
<p>32.00 - 33.00 Military LMR – This sub band is used primarily for tactical and training operations by U.S. military units for combat net radio operations that provide command and control for combat, combat support, and combat service support units. Frequencies also used for air-to-ground communications for military close air support requirements as well as some other tactical air-ground and air-air communications.</p> <p>Air Force 32.33, 32.34, 32.35 (Air Defense), 32.45, 32.65, 32.67, 32.675 (Air Defense), 32.85 Army/National Guard 32.10, 32.90 (Fort Indiantown Gap, Pennsylvania fire) Coast Guard 32.13, 32.21 Navy/Marine Corps 32.05, 32.40</p> <p>Non-Military LMR – Other uses include land management and protection of natural resources.</p> <p>Frequencies include 32.01, 32.03, 32.19, 32.25, 32.27, 32.39, 32.53, 32.55, 32.57, 32.59, 32.61, 32.63, 32.65, 32.75, 32.77, 32.79, 32.81, 32.83, 32.93, 32.95, 32.97, 32.99</p>	<p>Radio Astronomy – Continuum observations are performed in this band to study electromagnetic radiation from the Sun and the planet Jupiter.</p> <p>38.25 - 39.00 Non-Military LMR – This sub band is extensively used for land mobile radio communications in the operation, protection, and maintenance of national parks, forests, wildlife refuge areas, etc. Frequencies in this band are also used for reservation programs, law enforcement, public safety operations, control of power generation transmission and water facilities, environmental data collection, fish management, and wildlife telemetry programs.</p> <p>Frequencies include 38.275, 38.325, 38.375, 38.55, 38.57, 38.59, 38.73, 38.75, 38.77, 38.79, 38.81, 38.83, 38.85, 38.87, 38.97, 38.98</p> <p>Military LMR – This sub-band is used primarily for tactical and training operations by U.S. military units for combat net radio operations that provide command and control for combat, combat support, and combat service support units. Frequencies also used for air-to-ground communications for military close air support requirements as well as some other tactical air-ground and air-air communications.</p>																														
<p>33.00 - 34.00 Civilian Band – Federal agencies are authorized to use this band as part of mutual aid response with local communities (fire, medical, etc.). This frequency range is used by the military services for tactical and training operations on a non-interference basis.</p>	<p>Air Force 38.65, 38.67, 38.675 (Air Defense) Army/ National Guard 38.30, 38.35; 38.45 (Various ranges and Fort Lewis/Gray AAF Metro), 38.50 (various ranges), 38.51, 38.525, 38.53 (Wright AAF, Georgia Fire/Crash), 38.69 (Range Control), 38.70, 38.85, 38.89 (USA Corps of Engineers), 38.90 (Medevac/Flight Test/Range Services), 38.95 Coast Guard 38.27 Navy/Marine Corps 38.35, 38.625 (MCAS Yuma, Arizona range), 38.70</p>																														
<p>34.00 - 35.00 Military LMR – This sub band is used primarily for tactical and training operations by the U.S. military for net radio operations that provide command and control for combat, combat support, and combat service support units. Frequencies also used for air-to-ground communications for military close air support requirements as well as some other tactical air-ground and air-air communications.</p> <p>Air Force 34.17, 34.19, 34.20, 34.21, 34.55, 34.59, 34.60, 34.61, 34.75 Army/National Guard 34.10, 34.30, 34.90 Coast Guard 34.01, 34.05, 34.07 Navy/Marine Corps 34.55, 34.70, 34.75, 34.95</p> <p>Non-Military LMR – Extensive use of frequencies in this band is for natural resource management, park security/law enforcement at national parks, forests, wildlife refuge areas, etc. Some other uses of this are for law enforcement and facilities security management.</p> <p>Frequencies include 34.03, 34.05, 34.23, 34.25, 34.27, 34.37, 34.39, 34.41, 34.43, 34.45, 34.47, 34.63, 34.67, 34.77, 34.79, 34.81, 34.83, 34.85, 34.87, 34.98, 34.99</p>	<p>39.00 - 40.00 Civilian Band – Some federal usage is authorized in this band for mutual aid response to local communities (fire, medical, oil spills, etc.).</p> <p>39.46 Law Enforcement Non-Federal VHF Interoperability Channel &lt;LLAW1&gt; 39.48 Fire Non-Federal VHF Interoperability Channel &lt;LFIRE2&gt;</p>																														
<p>35.00 - 36.00 Civilian Band – Used by the military services for tactical and training operations on a non-interference basis and for experimental testing.</p>	<p><b>❖ Navy Carrier Trunk Radio Systems</b></p> <p>Recently an anonymous contributor passed along the following trunk radio system frequencies for the <i>USS Ronald Reagan</i> and the <i>USS Nimitz</i> based out of northwest Washington.</p>																														
<p>36.00 - 37.00 Military LMR – This sub-band is used primarily for tactical and training operations by U.S. military units for combat net radio operations that provide command and control for combat, combat support, and combat service support units. Frequencies also used for air-to-ground communications for military close air support requirements as well as some other tactical air-ground and air-air communications.</p> <p>Air Force 36.35, 36.45, 36.79, 36.80, 36.825, 36.83 Army/National Guard 36.09 (Fort Drum, New York range), 36.01, 36.125, 36.50, 36.70, 36.90 Coast Guard 36.25, 36.27, 36.35 Navy/Marine Corps 36.15, 36.53 (Harbor-Port Operations), 36.55, 36.57 (Harbor-Port Operations), 36.60, 36.63 (Harbor-Port Operations), 36.87 (Harbor-Port Operations)</p> <p>Non-Military LMR – Other uses include national park management, law enforcement, public safety nets, contingencies, and natural resources management.</p> <p>Frequencies include 36.07, 36.16, 36.18, 36.21, 36.22, 36.75 Department of Energy (DoE) 36.05, 36.33, 36.35, 36.39</p>	<table border="0"> <thead> <tr> <th data-bbox="805 1438 1101 1459"><b>USS Ronald Reagan (CVN-76)</b></th> <th data-bbox="1141 1438 1348 1459"><b>USS Nimitz (CVN-68)</b></th> </tr> </thead> <tbody> <tr><td data-bbox="805 1459 965 1480">LCN 01 395.0375</td><td data-bbox="1141 1459 1300 1480">LCN 01 395.3875</td></tr> <tr><td data-bbox="805 1480 965 1501">LCN 02 395.1875</td><td data-bbox="1141 1480 1300 1501">LCN 02 395.5625</td></tr> <tr><td data-bbox="805 1501 965 1522">LCN 03 395.3375</td><td data-bbox="1141 1501 1300 1522">LCN 03 395.7125</td></tr> <tr><td data-bbox="805 1522 965 1543">LCN 04 395.5125</td><td data-bbox="1141 1522 1300 1543">LCN 04 395.9625</td></tr> <tr><td data-bbox="805 1543 965 1564">LCN 05 395.7125</td><td data-bbox="1141 1543 1300 1564">LCN 05 397.1625</td></tr> <tr><td data-bbox="805 1564 965 1585">LCN 06 397.0625</td><td data-bbox="1141 1564 1300 1585">LCN 06 397.3625</td></tr> <tr><td data-bbox="805 1585 965 1606">LCN 07 397.3125</td><td data-bbox="1141 1585 1300 1606">LCN 07 397.5625</td></tr> <tr><td data-bbox="805 1606 965 1627">LCN 08 397.4625</td><td data-bbox="1141 1606 1300 1627">LCN 08 397.7125</td></tr> <tr><td data-bbox="805 1627 965 1648">LCN 09 397.6625</td><td data-bbox="1141 1627 1300 1648">LCN 09 397.9625</td></tr> <tr><td data-bbox="805 1648 965 1669">LCN 10 397.8125</td><td data-bbox="1141 1648 1300 1669">LCN 10 399.0625</td></tr> <tr><td data-bbox="805 1669 965 1690">LCN 11 399.2125</td><td data-bbox="1141 1669 1300 1690">LCN 11 399.2625</td></tr> <tr><td data-bbox="805 1690 965 1711">LCN 12 399.3625</td><td data-bbox="1141 1690 1300 1711">LCN 12 399.4125</td></tr> <tr><td></td><td data-bbox="1141 1711 1300 1732">LCN 13 399.6625</td></tr> <tr><td></td><td data-bbox="1141 1732 1300 1753">LCN 14 399.8625</td></tr> </tbody> </table> <p>Keep in mind when searching for shipboard trunk radio systems in the 380-400 MHz DoD LMR sub band, that ship based systems are opposite of land based systems for their inputs and outputs.</p> <p>Land Based TRS            380-390 MHz output and 390-400 MHz inputs Ship Based TRS            390-400 MHz output and 380-390 MHz inputs</p>	<b>USS Ronald Reagan (CVN-76)</b>	<b>USS Nimitz (CVN-68)</b>	LCN 01 395.0375	LCN 01 395.3875	LCN 02 395.1875	LCN 02 395.5625	LCN 03 395.3375	LCN 03 395.7125	LCN 04 395.5125	LCN 04 395.9625	LCN 05 395.7125	LCN 05 397.1625	LCN 06 397.0625	LCN 06 397.3625	LCN 07 397.3125	LCN 07 397.5625	LCN 08 397.4625	LCN 08 397.7125	LCN 09 397.6625	LCN 09 397.9625	LCN 10 397.8125	LCN 10 399.0625	LCN 11 399.2125	LCN 11 399.2625	LCN 12 399.3625	LCN 12 399.4125		LCN 13 399.6625		LCN 14 399.8625
<b>USS Ronald Reagan (CVN-76)</b>	<b>USS Nimitz (CVN-68)</b>																														
LCN 01 395.0375	LCN 01 395.3875																														
LCN 02 395.1875	LCN 02 395.5625																														
LCN 03 395.3375	LCN 03 395.7125																														
LCN 04 395.5125	LCN 04 395.9625																														
LCN 05 395.7125	LCN 05 397.1625																														
LCN 06 397.0625	LCN 06 397.3625																														
LCN 07 397.3125	LCN 07 397.5625																														
LCN 08 397.4625	LCN 08 397.7125																														
LCN 09 397.6625	LCN 09 397.9625																														
LCN 10 397.8125	LCN 10 399.0625																														
LCN 11 399.2125	LCN 11 399.2625																														
LCN 12 399.3625	LCN 12 399.4125																														
	LCN 13 399.6625																														
	LCN 14 399.8625																														
<p>Frequencies include 36.07, 36.16, 36.18, 36.21, 36.22, 36.75 Department of Energy (DoE) 36.05, 36.33, 36.35, 36.39</p>	<p>And that does it for this month. Until next time 73 and good hunting.</p>																														



## AM Time Machine

Every month, Marc Ellis' fascinating "Radio Restorations" column highlights a piece of equipment from the earlier days of radio. Unfortunately, if you follow in Marc's footsteps and restore a classic radio to its original function, you're still limited to listening to today's programs!

There seems to be a natural human curiosity about time travel. I doubt there are many readers who haven't felt it would be interesting to experience some of what they've learned in their history classes or read in their books. The actions of a Washington, D.C. Radio station 74 years ago make it possible for us to at least send our ears back to 1939, to hear some of what we might have heard on the radios Marc works on if we could have used them when they were new.

On September 21<sup>st</sup>, 1939, Europe had been at war for three weeks. The United States would remain neutral for another two years. Our status was reinforced by a series of Neutrality Acts. President Roosevelt felt the laws unfairly penalized Britain and France; on September 21 he scheduled a major speech in which he would ask Congress to relax the neutrality laws.

Washington radio station WJSV 1460 kHz, felt this speech would be an important waypoint in the history of the United States. The station decided to record not just the speech, but their entire day of broadcasting. And, in 1939, this was no mean feat! Tape recording was not yet available. WJSV's only option was to record on a series of actual vinyl records.

Thankfully, they did make the effort, and they deposited the recordings in the National Archive. And thankfully, those recordings are now available online at [archive.org](http://archive.org). They are fascinating listening, with many surprises! (Unfortunately, one of these surprises is some shockingly racist material. Racial attitudes were very different 74 years ago.)

The reader familiar with the modern-day Washington radio dial will notice something different at the very beginning of the broadcast day, with the sign-on announcement. There is no WJSV in Washington in 2013 – today, those call letters are on the FM station at Morristown High School in New Jersey. Even WJSV's 1460 dial position is also no longer used in Washington. Eighteen months after these recordings were made, most U.S. radio stations moved a few clicks up the dial. WJSV and the other station on 1460 moved to 1500. Four years later, WJSV changed call letters to WTOP, the name by which the station would be known for the next 63 years. Today, it's WFED.

Heck, merely having a sign-on announcement is rare today, with most stations broadcasting 24/7. All-night

broadcasting didn't become widespread until the U.S. entered the war in 1941, and it really didn't become universal until the 1970s. Yes, there was only one other station on 1460 in 1939. KSTP in St. Paul, Minnesota was that station, and it still shares its dial position with the successor of WJSV.

The 1939 programming day is remarkably void of advertising. I don't know that I heard even two ads during the entire first hour of programming. I can't imagine anyone being interested in sponsoring the sign-on "Sundial" program, where they let the announcer sing on the air between records. They shouldn't have. (I'm guessing station executives didn't get up early enough to hear this program!)

The daytime programming consists largely of soap operas, each sponsored by a single advertiser. Generally, after introducing the premise of the show, the announcer spends a minute declaring the value of the sponsor's product before recapping the previous episode & then turning things over to the actors. Another plug for the product appears at the end of the program.

There's an episode of Major Bowes' Amateur Hour on these recordings. This is the ancestor of popular modern-day television shows like The Voice and American Idol. I can tell you, most of the amateur talent on this episode was quite good!

Also surprisingly missing was news. I've only heard four news broadcasts during the program day, all of them surprisingly brief by modern-day terms. It's not that there was no news to report, in those dark early days of

World War II. On September 21, the premier of Bulgaria had been assassinated by Nazi sympathizers who were attempting to overthrow the government (they failed, for the time being); France had completed mobilizing its army; Warsaw, Poland was holding out against both the Germans and the Russians, much to the surprise of foreign observers, and there is one live foreign report, apparently delivered by shortwave. It's surprisingly clear.

During a quiz show, the announcer asks the ladies competing where they live. Today, you'd expect a question like that to generate an answer like "Bethesda, Maryland" or "Northwest Washington." In 1939 they felt safe giving their complete addresses – "1172 K Street Northwest," etc.

The recordings include the call of a baseball game between the Washington Senators and the Cleveland Indians. Amazingly, the game broadcast didn't include a single commercial! One of the Washington players did plan to make two personal appearances at local stores, and they did announce those events a few times. Without commercials, the game went pretty quickly. There was only about 30 seconds between innings, and even the seventh inning stretch only lasted about two minutes. By the way, one Cleveland player injured himself trying to stop a fly ball – next time he came to bat, the Washington crowd gave him a nice loud cheer. Unfortunately for the home team, Cleveland scored several runs in the next inning and won the game.

The baseball broadcast is also strangely lacking in statistics. In a modern baseball broadcast, if there's nothing going on on the field, a "color" announcer will read a few obscure facts about the batter, or the pitcher, or whoever. I swear, I've learned the shoe sizes of a few players' wives. In the 1939 broadcast, the only statistic you heard was the score. Although this game was late in the season, I have no idea how Washington was doing in the standings; the announcers didn't seem to have time for that. They did announce the scores of other games, received over the ticker machine which can be (annoyingly) heard in the background for the entire broadcast.

You will notice frequent use of the phrase "transcription." In the early days of radio, recorded programs were considered inferior. Regulations required stations broadcasting recordings to identify them as such. Older readers (such as myself) may remember the results of a much looser regulation that survived into the 1980s: "...part of this day's programming has been mechanically reproduced." This was generally announced once at the end of



Amore traditional shot of the WSM transmission facility (Courtesy: Bryan Turner)



*WSM-650 held an open house last summer. (Courtesy: Bryan Turner)*

the broadcast day. On the 1939 recordings, just about every recording is announced as such, including the (few) recorded advertisements. It's my understanding that the soap operas and quiz shows you hear on these broadcasts were aired live. (See the sidebar for a link to these recordings.)

DXers enjoy listening to radio from places distant in geography. I think many of you will also enjoy listening to radio from places distant in time...

## ❖ Missing Big Signals

It is, unfortunately, not unusual for this column's readers to hear of AM stations going off the air. This month, we have three more permanently gone. More than a few have temporarily suspended operations. At least, the stations believe it's temporary, though altogether too often, these suspensions become permanent.

Usually, these silent stations are small operations in small markets. Usually, they aren't 50,000-watt, full-time powerhouses. This month, I'm afraid we have two exceptions. WDCD 1540 kHz Albany, New York went silent a year ago. This station was last heard with a religious format. They've been off since April 1 of last year. As you may remember, an Act of Congress will require

the FCC to cancel the WDCD license if they don't return to the air by the beginning of this month.

As this is written, Arkansas powerhouse KAAV-1090 is also off. This station reported severe vandalism to their antenna system. I'm not sure exactly when they went off, probably some time in mid-January. DXers in the Midwest have been reporting Mexican stations on this frequency. I'm hearing an English-language station which I can't quite identify, but suspect WBAL, Baltimore. KAAV expects to resume operation once they figure out how to stop vandals from stealing their ground wiring. [Editor's Note: Since

this was written, KAAV has returned to the air. Those who enjoyed the original KAAV programming from the 1960s and 70s may revel in those memories with other KAAV fans here: <http://mighty1090kaav.blogspot.com> A retrospective of the station, "The Friendly Giant: KAAV, Little Rock," appeared in the February 2010 issue of MT written by Bud Stacey who maintains the KAAV blog.]

## ❖ All-digital IBOC test

I'm afraid I'm not going to be able to deliver on my promise to report on the results of last year's all-digital AM-IBOC test. I've been able to confirm the tests did happen in November and December of last year, and that WBCN 1660 kHz, Charlotte, was indeed the test station. Otherwise, reports I've heard are extremely vague. *Radio World* reports they're not done, there will be more tests this year. I'll keep my ears open and let you know what I hear.

## ❖ Nashville's Big Tower

Last time, I expressed my disappointment at not being able to attend the celebration of the 80<sup>th</sup> anniversary of 650 kHz WSM's iconic tower.

Bryan Turner W8LN didn't miss it though, and he sent the photos that accompany this month's column, thanks Bryan!

You've seen photos of the very large transmitters used by the powerful stations of years gone by. Some of the photos Bryan took show just how small a modern transmitter can be! In the indoor photo, the first rack on the left contains WSM's 5,000-watt backup transmitter. A 50,000-watt Harris transmitter is embedded in the wall behind the display tables; this transmitter occupies roughly the same space as the equipment racks in the foreground.

## ❖ Until next time...

Do you remember listening to KAAV late nights? (I do...) Please write, at 7540 Highway 64 West, Brasstown NC 28902-0098, or by email to [dougsmith@monitoringtimes.com](mailto:dougsmith@monitoringtimes.com). Good DX!

## STATION REPORT

### NEW STATIONS:

Applications filed for new stations:  
 Montreal, Quebec 850 50,000/22,000; French-language all sports

Permits granted for new stations:  
 Anchorage, Alaska 1470 10,000/10,000 ND  
 Santa Maria de Ocotan, Durango, Mexico 960 XETPH; 5,000 ND-D  
 Rothschild, Wisconsin 1340 1,000/1,000 ND (Rothschild is just outside Wausau)

New stations on the air:  
 Holt, Alabama 1340 WMHZ; 1,000/1,000 U (Holt is a Tuscaloosa suburb)

### CHANGES:

Stations moved to new frequencies:  
 Asheboro, N. C. 700 WZOO; from 710

Permits to move to new frequencies:  
 Belen, New Mexico 840 KARS; from 860; 1,800/30 ND  
 St. Stephen, S. C. 1120 WEFB; from 1130 at Camden, S.C.; 390 ND-D

### DELETIONS:

Stations deleted:  
 Edmonton, Alberta 680 CHFA (gone to 90.1 FM)  
 Forest, Mississippi 850 WQST  
 Starkville, Mississippi 980 WKOR  
 Port au Choix, N.L. 790 CFNW (going to 96.7 FM)  
 Armstrong, Ontario 1450 CBOL (going to 91.3 FM)  
 Hornepayne, Ontario 1010 CBLH (going to 92.3 FM)  
 Murdochville, Quebec 750 CBLJ (going to 99.5 FM)  
 Murdochville, Quebec 1270 CBGA6 (going to 97.7 FM)  
 Weymontachie, Que. 750 CFBG3 (going to 92.3 FM)  
 Bennettsville, S.C. 1550 WBSC  
 Mayo, Yukon 1230 CBDC (going to 104.9 FM)

ND: non-directional  
 ND-D: non-directional, only operates daytime  
 DA-N: directional at night only  
 DA-D: directional during daytime only  
 DA-2: directional all hours, two different patterns  
 DA-3: directional day, night and critical hours, three different patterns

### URLs in this month's column:

<http://americanbandscan.blogspot.com>  
 My AM DX blog.

<http://archive.org/details/CompleteBroadcastDay> WJSV-1460, September 21, 1939



*WSM's iconic diamond-shaped tower, from an unusual angle! (Courtesy: Bryan Turner)*



## Top Maritime Monitoring Frequencies

**W**hen this column is read, I hope the winter for Kingston, Ontario is over. A snow depth of 18 inches on the front lawn has made my visit to Myrtle Beach, South Carolina more inviting this year. We had several gale warnings in January which included forecast winds of 40 knots and waves of 13 feet.

A blast of cold weather, in late January, lead to some ice formation on Lake Ontario but we had very little up until that time. I will have returned from the South Carolina and the traffic will have resumed on the St. Lawrence Seaway. Many ships control stations and all the Coast Guard radio towers will be back on the air. AIS will increase beyond the two ferries that operate all winter in our area.

I was able to do some monitoring this winter including 2182 kHz which still has some active USB transmissions from Canadian east coast stations such as Fundy Coast Guard Radio and Bermuda Radio which were heard regularly.

I did get my SignalLink attached to my HF radio to do some digital monitoring. By using the MultiPSK program, I was able to decode several east coast Navtex stations on 518 kHz (I had to tune down to 517.3 kHz USB for copy). With the shorter days, I was able to copy stations like VCG Riviere Au Renard Radio at 1210 UTC.

I was also able to use the MultiPSK program by putting my microphone up to the speaker of the rig. Although you have to hear the signals over the speaker, you can decode them quite well. I just wanted to see if this was useful for portable operations.

Low frequency beacons were also monitored here. ML, Charlevoix Quebec on 392 kHz, YMW in Maniwaki, Quebec on 366 kHz and SB, Sudbury, Ontario on 362 kHz are some examples. A good catch would be the beacon in the French Islands of St.Pierre and Miquelon, just off Newfoundland. It operates on 386 kHz and uses the Morse identifier of SP.

Amateur radio provided some good marine information. The Maritime Mobile Service Net

on 14300 kHz was interesting as always but on Saturday mornings from 1200 to 1300 ET the United States Coast Guard Amateur Radio Net is run. When the hour is up they go up to 14327 kHz and continue the Net. Dick KE7A runs the Coast Guard Amateur Radio Club station, W5CGC, in South Lake Texas. There is always a long list of check-ins from former and present Coast Guard Members.

### ❖ Frequency Source

I found a good listing of Coastal Radio MF frequencies last December that lists many marine coastal stations using from 305 kHz to 4000 kHz. The list was said to be updated on December 26, 2012 so it should prove to be accurate. I was surprised by all the CW that is still used below 530 kHz. There is still life in long wave, however, there were some American stations listed that I could not find any information about. No listings were found on the Internet and even Richard Dillman of the Marine Radio Historical Society (MHRS) of Point Reyes, California could not verify some of them. Hopefully, some readers will have some useful information about these stations.

Their CW listing for MHRS's KSM on 426/500 kHz was correct and they also listed C6N Nassau Bahamas Radio as still using these frequencies as well. Monitoring will hopefully produce results and I hope readers will tell me what they heard. I will also check the lists in Hugh Stegman's column for any receptions information. I must admit I feel like I did 50 years ago when I was using my Hallicrafters S-38 and a long wire. In fact, I hope to hear some stations on my S-38.

I have listed some of the stations here,



Canadian lake freighter John D. Leitch approaching Iroquois lock on the Seaway

frequencies in kHz and unless noted they all use USB. If I list a pair of frequencies they are in the order of transmit then receive frequencies for the station. If there is just one frequency then it is a simplex operation. Here is hoping you get some good catches on the bands.

- 1641/2046 Torshaven Radio Faeroe islands
- 1644/2049 EAL Las Palmas/ Arrecife Radio Canary Islands, EJM Malin Head, Ireland TFA Reykjavik Iceland GUC St. Peter Port Radio Guernsey
- 1650/2075 Valencia Ireland
- 1662.5 Milford Haven CG, Wales Falmouth CG Belfast CG Humber CG many New Zealand stations, also 2045, 2065, 2068, 2082.5, 2142, and 2390
- 1740/2093 Comox, Tofino, Prince Rupert B
- 1767 Coast Guard radio broadcasts
- 1880 Suva Radio Tonga
- 1883 Evans Head Coast Guard and other Australian stations
- 1925 Auckland New Zealand Cost Guard
- 2012 ZBP Pitcairn Island HRH Honiara Radio Solomon Islands common Norwegian frequency
- 2054 ZKR Rarotonga Radio Cook Islands
- 2111/2162 ZLM Taupu Radio New Zealand
- 2110 several Coast Guard stations in Scotland
- 2129 Hebrides Range Control
- 2162 Tampico Radio Mexico also
- 2167 2320/22160 several stations in Australia, also 2524
- 2176.5 British intership frequency
- 2207/2162 Kodiak Alaska Radio
- 2207 Arklow Shipping Ireland
- 2226 Royal Navy Cape Wrath Scotland
- 2260 Danish Navy CW
- 2270/2160 Guardian Field Service English Channel
- 2284
- 2310
- 2309/2131
- 2311
- 2365
- 2357
- 2385



US Seaway tug Robinson Bay which is used to remove navigation aids before winter freezeup on the Seaway





**Birchglen approaching St. Louis Bridge on the Seaway.**

2397/2237	Ketchikan Alaska
2402/2240	Juneau Alaska
2442/2406	WDR Miami Radio also 2490/2031.5
2430/2316	WOU Boston also 2506/2406
2442/2316	KQP Galveston, KOE Eureka
2480	New Zealand stations
2506	Caribbean Public Correspondence
2506/2069	WAH St. Thomas USVI
2510/2763	VCT Tors Cove Radio Newfoundland
2512	KCJ Cold Bay Alaska Broadcast
2513	McMurdo Antarctica also 2716
2514/2118	WOM Fort Lauderdale and other US east coast stations
2530/2134	KQP Galveston
2530/2134	San Juan PR coast Guard and public correspondence
2530	KBP Honolulu Hawaii broadcast
2530/2142	East coast Canadian stations, KCC Corpus Christi, WAE Point Harbour
2550/2158	WFA Tampa
2566/2390	WOU Boston, WTO Charleston, WNJ Jacksonville
2566/2031.5	KTJ Koos Bay
2582/2206	Eastern Canadian Coast Guard Radio Stations
2582	ZBR Bermuda Broadcast
2582/2166	Marsh Harbour Radio Great Abaco Island, Bahamas
2587	Jamaica Defense Forces
2596	United Kingdom Coast Guard, also 3023
2598	Canadian east coast Weather Broadcasts, also 2749
2638	Freeport Harbour Radio Bahamas
2670	United States Coast Guard
2691	Aberdeen Scotland Coast Guard
2723	8PO Barbados
2735	Turks and Caicos Radio, 9YL North Post Radio, Trinidad
3192	New Zealand Navy
3247	Antarctica

This is just a sample of the world wide frequencies listed. I know I would like to receive reports of reception or verification of use of these frequencies. The web site also asks for input to update their listings.

I also found a listing for WQIN402 in Galveston, Texas. The frequencies listed were 2097.9, 4126.4, 6225.4, 8295.4, 12354.4, 16529.4 and 22160.4 kHz

A further check also showed that besides 2506, WAH Virgin Islands Radio has listings for 4357, 4382.5, 6515.7, 8728.2 and 13100.8 kHz. Broadcast times were given as 0400, 1400

and 2000 Jamaica was also listed as having broadcasts at 0830 and 1330 local time on 2738 kHz.

Hong Kong radio has a Navtex service on 518 kHz. They also have a South China Coastal Waters Broadcast on 8812 kHz. This broadcast is in English at 0600 and 2400 Hong Kong time.

Tokyo Japan radio uses 2019 kHz and has English broadcasts 15 and 30 minutes after the hour. Yokohama, Nagoya, Kobe and Hiroshima have listings for 2189.5. Many ports are said to use 2150 and 2177 kHz. 2150 and 2394.5 are said to be used for navigational warnings.

ZSC Capetown, South Africa has listings for 2182 and a working frequency of 1765 kHz. Their USB broadcasts are at 0448, 1333, 1718 and 1748. Frequencies used are listed as 4375, 8740 and 13146 kHz.

Do not forget the Canadian Coast Guard Arctic radio stations. They usually begin to operate in mid June. The frequencies of 2514, 2582, 4363 and 6507 kHz have been used for USB marine broadcasts. As of the time of writing this column, the 2013 listings have not been printed. Check the Canadian government publication, *Radio Aids to Marine Navigation* (RAMN) for times etc. I always enjoy hearing Iqaluit radio from Baffin Island as I know summer has reached my home area.

### ❖ The Portable Shack

My portable operations in Myrtle beach, South Carolina were different this year. We were in a third floor condominium in a 22 story building right on the beach itself. I brought a Kenwood amateur mobile rig and a small power supply. With a small VHF antenna attached to the window by suction cups, I did hear enough VHF signals. I heard the Charleston marine pilots on channel 14 as well as coast Guard Sector Charleston on channels 16 and 22A. I also monitored traffic on the Intracoastal Waterway using various channels.

I brought my Grundig Satellite 750 for shortwave monitoring but the noise level in the condo was quite high. I took the radio outside to several locations and will report what I heard in the next column. I used its internal whip antenna and also a long wire you could attach to the whip. Sure do wish I had some better HF antennas but the location did not allow for them. This radio also had an air band channel and it was quite useful here.

I also brought my Alinco dual band rig for the car, an Icom T90A portable amateur triband transceiver and a marine portable. The marine portable also doubles as my weather radio and we always have some alerts while visiting South Carolina. Again, I cannot stress enough the usefulness of a weather radio while travelling.

My amateur rig has extended receive and it sure is helpful while driving. Once you are bitten by the radio bug you never get over it, I guess. If you do visit this area be sure to contact the Grand Strand Amateur Radio Club. They are a great group of people and their Saturday breakfasts are very enjoyable. I was able to attend two meetings of the club and help with

the Myrtle Beach Marathon Communications.

I was able to operate HF from the battleship *USS North Carolina* during the North Carolina QSO party. I also visited the ship on another occasion to gather information for an article along with photographs. I have to thank Allan Pellnat KX2H for allowing me the honor to operate from the vessel. I really had to remember to sign the call sign NI4BK rather than my own VE3GO call. Hopefully, I can do this again next year. It was great to see the original radio equipment aboard the ship.

I have retired from doing any marine work this year. Looks like the photos will all be from the shore. I will also have to do some major antenna maintenance and relocation this spring as I want to improve my marine listening antennas. Some portable operations and lighthouse activations are in the works as well.

I plan to take the SWL receiver along as well and see what I can hear. There is a possibility of some island activations as well as a possible DXpedition to Zone 2 during one of the major contests. This is a rare zone as there is little activity there and we should be very busy. It will be an SSB contest but I should be able to do some CW as well. Our local emergency communications group is quite active. Bill Nangle VE3CLQ, keeps us all on our toes!

Before leaving home, I met Bill WA2DVU while he was controlling the ECARS Net on 7255. It is really fun to meet readers on the air. He said he liked my column and the content. Again I ask for any reports of maritime radio to be sent to me via the address in the magazine. I also appreciate comments about the column and content.

## CCRadio2



### Designed for Even Better Long Range AM & Now Emergencies

- AM, FM, 2-Meter Ham, Weather Band and NOAA Weather Alert
- 2-Meter Scans Five Memories for Active Frequencies, Squelch
- Built-in Twin Coil Ferrite® AM Antenna for Max. Reception
- Signal & Battery Strength Meters

\$159<sup>95</sup>

**C.CRANE**

**Free Catalog**

**800-522-8863 • ccrane.com**



## In Tribute to Jacques d'Avignon VE3VIA

**W**e encounter certain people along life's journey who make a positive difference in the way we live our own lives. Jacques d'Avignon VE3VIA was one of those people to me. Sadly, I learned that he passed away on Thursday, February 7th in Ottawa, following an illness.

Starting out in the radio hobby as a boy in 1938, Jacques knew his way around the spectrum quite well, but he had a special interest in the longwave band. Specialties for him were beacon DXing and the planning of elaborate DXpeditions. He was an early adopter of the computer in his shack, and was always eager to help others get up and running with this modern tool, whether for FAX decoding, logging, or online research and collaboration. He helped me translate my *Sounds of Longwave* tape to CD using his computer, which became the main offering from that point on.

I first met Jacques at one of the *MT* conventions in Atlanta, GA in the early 1990s. I was new to the magazine staff, but had been a follower of his column on propagation for some time. What I didn't know, was that he lived quite close to my upstate New York location, just across the border into Canada. Although we lived in different countries, he was geographically my closest *MT* associate.

Jacques followed up our initial meeting



*Jacques made sure snacks were a part of any DXing event!*



*Former MT Columnist Jacques d'Avignon on a DX-pedition*

with a phone call just a few weeks later, and we began comparing notes on what we were hearing, exchanged reception tips, discussed happenings in the hobby, etc. This was before e-mail was common, so most of our interactions were by letters or phone calls. He encouraged me to attend my first DX camp in northern New York with a group from the Mohawk Valley SWL Club. This was an enjoyable experience which I repeated several more times. We also attended the Winter SWL Fest together a couple of times. In addition, my wife and I had the pleasure of hosting Jacques and his wife at our home on several occasions.

One of Jacques' biggest accomplishments was the planning of the Miscou, New Brunswick DX-peditions, of which I've written about in this column. Realizing the benefits of a remote, low noise location, Jacques began studying the possibilities of making such a trip. When it was judged to be feasible, he thought of every last detail from start to finish and assembled a team of people to make it happen.

His fluency in French was an invaluable asset to us as we interacted with the locals at Miscou, including an adjoining landowner who did not share our enthusiasm for a newly-erected antenna farm and came over to tell us so! When Jacques finished talking with the fellow, he left smiling, and wished us a good stay on the island. I will never forget the enjoyment those trips brought to all of us.

What Jacques may not have realized, is that by reaching out to me from that early encounter in Atlanta, he helped draw me out of my well-protected shell. He was a gregarious type with the gift of gab, yet he was also interested in what others had to say. As a writer, I have often preferred the written word over live, social interactions. The reason? With writing you can

formulate words at your own pace and revise them until you're ready to release them to the world. In-person exchanges have a different dynamic and had always been a struggle for me. It's not that I didn't enjoy making new friends, I surely did, it was just that I lacked the confidence some people have for mixing freely with others. In a general sense you could call it simple "shyness" but it was a bit more complicated.

Whatever the case, it limited my ability to fully enjoy the radio hobby. In the past, other folks had kindly invited me to attend DX camps, but I worried that I wouldn't know those in attendance, or wouldn't know what to talk about once I got there. It may sound foolish, but the whole idea actually frightened me, even though it was an activity I knew I would enjoy doing. These types of fears are typically irrational, but their power is real.

In large part, through Jacques' persistent encouragement and support, I became a more open person, and have been able to better enjoy the radio hobby as a result. It is a journey that has had milestones along the way, such as giving my first talk at an *MT* convention (a biggie), meeting fellow listeners at hamfests, and dealing with a publisher for my first book project.

The journey continues today, and I am thankful that Jacques was there with his examples and encouragement to help me grow at a critical time. Farewell, my friend, and thanks for the light you were to me and the entire radio community.

### ❖ This Month on Longwave

Mario Filippi N2HUN (NJ) has sent us another great batch of loggings for this month's column. He notes several new catches in the list, including SLB, SIF, SDA, HBD, BA, and Y8. Some are as far away as Iowa, which is quite a haul to his New Jersey location. Interestingly, he points out that both SIF (423) and RVJ (424) have the same city name, but are from different states. Finally, Mario notes that he is hearing more activity on the experimental ham frequencies, perhaps due to improved conditions or because more operators are active. He is able to hear at least one station transmitting at most times of the day. Mario uses a TenTec RX-320D receiver, and a 43-foot vertical antenna with radials.

### Selected Loggings from NJ

FREQ	ID	CITY
353	IN	In'tl Falls, MN
353	QG	Windsor, ON
373	YXK	Rimouski, QC
375	7B	St. Thomas, ON
385	EMF	Augusta, GA
386	D8	Dolbeau, QC
392	CVX	Charlevoix, MI

398	HFY	Indianapolis,IN
400	CI	Sault Ste. Marie,MI
401	Y8	Drummondville,QC
405	7L	La Sarre,QC
407	ZHU	Montreal, QC
408	HBD	Hubbard,OH
409	YTA	Pembroke,ON
410	BA	Columbus,IN
411	SDA	Shenandoah,IA
412	CTZ	Clinton,NC
414	3U	Ottawa,QC
415	CBC	Cayman Brac,CYM
417	HHG	Huntington,IN
419	RYS	Detroit,MI
420	CFY	Lake City,SC
423	SIF	Reidsville,NC
424	RVJ	Reidsville,GA
426	FTP	Ft. Payne,AL
426	IZS	Montezuma,GA
428	POH	Pocahontas,IA
432	IZN	Lincolnton,NC
434	SLB	Storm Lake,IA
476*	WD2XSH/7	Natchitoches,LA
476.5*	WD2XSH/37	Groton,MA

\* 630m experimental ham station.

**Don DeCaria NF7R** (NV) has noted vastly improved conditions this season. After a frustrating fall and early winter with no off-continent DX other than Radio Rossii on 270 kHz early in the mornings, the band finally seems to have come to life. Don is now hearing broadcasters on 153, 162 (likely French), and 171 kHz (Radio Medi1, Tangiers, Morocco). In the case of 171, he was able to confirm the origin with a parallel Internet stream from Radio Medi1.

In a follow-up note that same night, Don reported hearing BBC Radio 4 on 198 kHz, also confirmed by matching with live streaming audio from the Internet. This is the first time in a couple of years he has had enough audio on 198 kHz to confirm it in English directly off the air, and it was a highlight of his listening. For receiving equipment, Don uses an Icom756 PROIII, with a Palomar VLF converter, and a "V" antenna up about 33 feet, with 136 feet of wire per leg.

**Perry Crabill W3HQX** (VA) enjoyed our *Gone but not Forgotten* coverage in the December 2012 issue, but noted that one LF navigation service was omitted; CONSOLAN. He also noted that the use of sequenced marine beacons between 285 and 315 kHz was not limited to the Great Lakes, being also used along the East Coast. He used to listen to them years ago. Perry submitted a description of CONSOLAN stations which appears below:

"CONSOLAN (Consolidated Long-Range Aid to Navigation) was a radio navigation system that transmitted a slowly rotating keyed radio field pattern, an American version of the earlier German Sonne and British CONSOL systems. The pattern began its rotation at the transmitting station's true north, sending signals heard as dots by the receiving station, changing to dashes as the pattern was aimed at the receiver's location. The one-minute rotation period of the pattern allowed a stopwatch clicked at the time of the change to be used to calculate the true bearing of the sending station.

"Two CONSOLAN stations were implemented in the U.S. The one on the East Coast was at Nantucket Island in Massachusetts, and operated on 194 kc. It was eventually replaced

by the TUK NDB on 194 kc. I used to copy it from my prewar QTH in Washington, D.C. The West Coast CONSOLAN station was in the San Francisco area and operated on 192 kc; it was believed to be at or near Point Reyes, but I never heard it. In fact, I don't believe I knew about it at the time."

**Bryan Turner W8LN** (AL) sent along an interesting link regarding longwave beacons and DGPS. Episode 149 of the *This Week in Radio Tech* (TwiRT) podcast covers longwave beacons, beacon transmitters and DGPS. It features a guest from the Nautel Company, a major manufacturer of NDB transmitters. This was an interesting surprise from a podcast that usually sticks with broadcasting. You can check it out by going to the following link and clicking on Episode 149: [www.thisweekinradiotech.com](http://www.thisweekinradiotech.com).

### ❖ Win a Free Book

A rare, out of print edition of Ken Cornell's *Low and Medium Frequency Radio Scrapbook* has been donated to the *Below 500 kHz* desk, and it will go to one lucky reader! I'm looking for

brief write-ups on how you got started in longwave and what makes this part of the spectrum special to you. Everyone submitting an essay will be entered for a drawing of the book. A second-place drawing will be made for a free copy of my *Sounds of Longwave* CD. By submitting your story, you grant permission for it to be used in *Below 500 kHz*.

That's it for this month. Please stay in touch with what you are hearing, and keep those loggings and photos coming. I'd especially like to see more shack photos with the operators in the picture. We'll run them here as space allows. 73, and best LW DX!

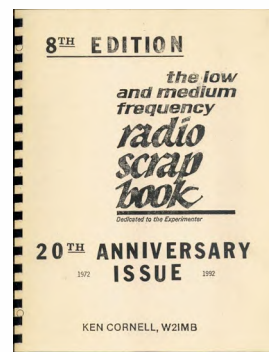

*This L/MF Scrapbook could be yours (see text)*

# Want a full year of MTXpress for **FREE**?

# Now is THE time to act!

Get four of your friends to subscribe to **MTXpress** at \$19.95 and they'll receive **15 radio-packed issues** (a 3-issue bonus for them) and you'll get an **extra 3 issues** per subscribing friend added to your current subscription! **Everybody wins!** Just have them **mention your name** when they subscribe and you **BOTH** get 3 extra issues for **FREE!**

**800-438-8155**

**[www.monitoringtimes.com](http://www.monitoringtimes.com)**



## Buttoning up the S-38D

**A**t the beginning of last month's work session, we were ready to begin restoration work on the Hallicrafters S-38 D, a cute little SWL beginner's radio from the mid 1950s. Ordinarily, that would have meant a wholesale recapping of the entire radio, but the set looked so good inside that I decided to power it up right away. It came to life even before I had reached full line voltage. And, though the radio was picking up stations, there was also occasional repetitive noise that sounded like popcorn popping.

In spite of that, I decided to begin realigning the set, a process that, as usual, began with peaking the IF transformers. However, it was immediately obvious that there was going to be trouble. Normally, IF transformer adjustments result in very satisfying well-defined peaks. But that was not the case now. It required many turns of the adjustment screws to obtain any response from the test signal passing through the transformers. The more I adjusted, the less became the response and, finally, no amount of screw twiddling would have any effect at all.

Looking for ideas, I Googled "IF transformers" and "S-38." It didn't take long to find the answer. The diminutive IF transformers in the S-38 had apparently been developed to be consistent in size with the then newly developed miniature tubes (although the S-38 used standard octals). To facilitate the downsizing (I presume), the tuning system of the conventional IF transformer was modified.

Instead of the usual pair of trimmer capacitors screw-adjusted through two holes on the top of the IF can, these little transformers had fixed capacitors built into the base. Tuning was done by a pair of cylindrical powdered iron cores surrounding the transformer coils, with one adjustment screw accessed through the top of the

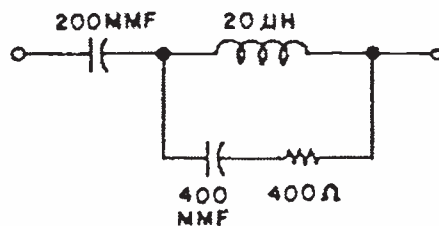

*Fig. 1. Dummy antenna circuit as recommended by The Radio and Television Manufacturers Association.*

transformer, the other through the bottom. The redesigned IF transformer was also much easier to install during manufacture. Rather than being mounted with screw-studs and nuts, it snapped into a special cut-out in the chassis, where it was secured with a push-on retaining clip.

The tuning problems and "popcorn popping" were caused by these fixed capacitors. It seems that migration of silver ions in the capacitor plates would cause multiple mini short circuits that accounted for the popping and tuning dysfunction. This could be cured by dismantling the transformer and cutting out the capacitors, replacing them with conventional silver mica caps installed externally.

### ❖ Cannibalizing a Clock Radio

With that discovery, I ended the work session, intending to begin this month with a rebuild of my two IF transformers according to the techniques I had seen described on line. (For one site I visited, with lots of pictures, see [www.ppinyot.com/if\\_transformers.htm](http://www.ppinyot.com/if_transformers.htm).) In the meantime, I discovered a radio in my "bone yard" pile that had identical transformers. It was an Automatic Electric clock radio of no particular interest and in decrepit condition. It was also missing its back and had a broken antenna loop-stick. I had no conscience pangs in deciding to sacrifice it. Incidentally, I also checked all my usual new and surplus parts sources for replacement IF transformers and found none. These components seem to have virtually disappeared from the market.

While still intending to attempt a rebuild of the original transformers as a learning experience for myself and our readers, I decided to use the Automatic's transformers in the S-38, figuring that it might be a more reliable way of getting the radio up and running. There were things I wasn't sure I understood about the rebuild process, which is quite invasive, and I thought there was a good chance that I might end up destroying a transformer with nothing to show for my efforts. Of course, I realized that I'd be chancing that the Automatic's transformers might be afflicted with the same malady as the Hallicrafters units.

Before I could remove the "donor" trans-

formers, I had to make sure I understood their pin-out. The terminals were identified on the Hallicrafters schematic with a standard numbering system, with the notation that the number 1 terminal would be identified with a green dot. However, I wasn't able to find anything recognizable as such a dot on either the Hallicrafters or Automatic transformers.

So before removing any transformers, I looked up the Automatic set in Rider's and made sure that the numbering system on the schematic was the same as the one on the Hallicrafters schematic. Then I compared the Automatic schematic with the actual circuit wiring to make sure I knew which transformer terminal number was where and marked the number 1 terminal with a green marking pen. I went through the same exercise with the Hallicrafters transformers. Later, after removing the transformers, I found that that some of the original green dot markings had been hiding under the retaining clips.

### ❖ Swapping Transformers

Now I was free to remove the transformers from the Automatic. This was as simple as clipping their leads and releasing the spring clips; the latter accomplished by prying with a small screwdriver at their retaining points on the transformer cans. Then I removed as much of the solder and wiring on the terminals as I could by the time-honored "heat and shake" method. (Don't try this if your workshop has a finished floor or if you mind picking globs of solder out of your clothes!)

When it came to removing the transformers from the S-38, I began by taking close-up photos of the wiring at each terminal area to make sure there would be no mix-ups later. Next I attempted to remove the connections intact by using desoldering braid, then uncrimping the wires using a needle-tipped tool. But the process was too slow and I began to be concerned about overheating the terminals, possibly melting solder from the connections to the fine wires from the coils on the other ends of the terminals inside the can. And, I still might need to rebuild and use these units. So, even though many of the wires had insufficient slack to make easy reconnection possible, I decided it would be more prudent to cut off all wires as close to the terminals as possible and worry about reconnection later.

Removing the disconnected cans was an easy matter, as was pressing the replacements into place, maintaining the proper orientation of the "green dot" terminals, and snapping on the retaining clips. Some of the wires to be reconnected were still long enough to reach their terminals and could be pulled away from the chassis so that I could get my insulation stripper on them. Other wires were too short, but could easily be entirely removed and replaced with ones of the



*One of the "donor" transformers being removed from its chassis cutout in the junker clock radio.*

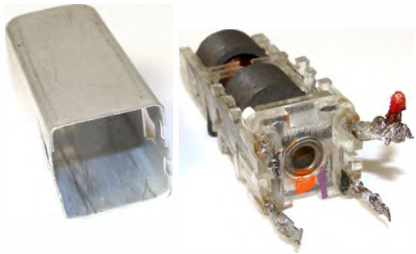

**Fig. 2.** The transformer cover slides right off after unbending two metal tabs. Note threaded powdered-iron adjustment cylinders and brass rivet (see text).

proper length.

However, leads coming from resistors or capacitors offered very little leeway. Sometimes the associated component could be pushed over to make a little more length available. But, in general, the lead simply had to be butted to, or slightly overlapped on, the terminal where it was to be connected and hooked up with a solder bridge. I had to smile when I thought about the often repeated advice that a joint had to be mechanically sound before the solder was applied. Not that I am defending the “butt” technique, but the joints seem quite strong and were definitely expedient!

With all the busywork out of the way, I was ready at last to check the results. I hooked the set up to my basement antenna and isolation transformer, turned it on and crossed my fingers. There was no popcorn popping, or any other sound, coming from the speaker, that is, until I realized that I was on one of the short-wave bands. Switching to the broadcast band, I was receiving robust signals all over the dial. “Well at least I got all that rewiring right!” I thought.

It seemed as though the IF transformers moved over from the junker Automatic set were doing their job, but the real test would come when I tried to peak them up. So I hooked up my signal generator and output meter for another try. Now the output was peaking nicely in response to movement of the adjusting screws and was increasing dramatically as I moved from screw to screw. It looked like the transformer swapping was a complete success.

## ❖ Front End Alignment

With the IF channel adjusted and operating properly, I felt comfortable proceeding with the rest of the alignment, which involved the peaking of the antenna and oscillator adjustments for each of the four bands. The antenna adjustment determines the frequencies accepted by the front end of the receiver for a given band; the oscillator adjustment controls the dial calibration for that band.

For these front end adjustments, the “hot” lead of the signal generator is connected, through a device called a dummy antenna, to the terminal of the receiver used for a single wire antenna. The other antenna terminal is grounded, as is the ground connection from the signal generator.

A dummy antenna, as recommended by The Radio Manufacturer’s Association, is a simple network containing a choke, a couple of capaci-

tors and a resistor (Figure 1). It is frequently used in the alignment of radios that would normally be connected to an antenna, such as communication receivers. Its purpose is to provide a more accurate alignment by making the signal generator look, electrically, more like an antenna.

The antenna and oscillator adjustment for each band is made with the signal generator and receiver set to the same specific frequency at the high end. Each of the two adjustment trimmers is then peaked for maximum receiver output at that frequency. Adjustment points for the four bands are as follows: Band 4, 30 MHz; Band 3, 14 MHz; Band 2, 5 MHz; Band 1 (the broadcast band), 1.5 MHz. Band 1 has an additional oscillator adjustment, called a *padder*, at 600 kHz (.6 MHz). The padder is there to secure accurate calibration throughout the entire band. The eight trimmers and the padder are arranged in a convenient grouping underneath the chassis.



**Fig. 3.** Looking down on capacitors with cover removed.

The front end alignment was carried out smoothly and without incident. After completion, the radio performed very well for what is really a bottom of the line unit. My only criticism is with the tuning mechanism. It requires quite a lot of tiresome knob twirling to get from one end of a band to the other and at times the action can be a little jerky.

## ❖ IF Transformer Repair

With the S-38D project completed, I was ready to take a look at the possibility of repairing miniature IF transformers, using one of the defective units removed from that set as an example. The first step mentioned in the instructions I found online would be to determine the size of the built-in capacitors so that I could replace them with standard silver mica units connected externally.

Apparently the built-in capacitors could be measured on a capacitor checker even though they might be riddled with tiny short circuits when connected in a powered circuit. However, each of the capacitors is connected across a transformer coil which, of course, would prevent a capacity

measurement from being made. At least one of the coil wires would have to be disconnected from each capacitor in order to make the measurements. We’ll have to get inside the transformer to find out how that might be done.

Removing the transformer can was a snap. Bending back a couple of tabs freed it up and it slid right off (Figure 2). Notice the two large powdered iron cylinders that surround the transformer coils and are used to tune the transformer. These are threaded on the outside so they will move back and forth over the coils when turned by a screwdriver. Notice also the brass rivet centered on the bottom of the base. According to the Internet information, it does double duty, serving as an access hole for screwdriver adjustment of the bottom cylinder and as a fastener for the cover of the capacitor compartment.

In Figure 3 the rivet has been drilled out so that the cover can be removed. We are looking down at the capacitors, which are the rectangular silvery objects near the sides of the compartment. The wires running to the capacitors are extremely fine and I’m not sure my thick fingers are going to be able to disconnect and reconnect them. I may have to work out a way to find the right size for my external capacitors by trial and error. We’ll continue working on this next month.

## LF Engineering Co.

Manufacturers of Low Frequency Equipment for LF/VLF Communications, Natural Radio Research, AM Broadcast, Marine and Shortwave Radio.

Low Frequency design work since 1982

Active E-Field Antennas • Loop Antennas



860-526-4759 • www.lfengineering.com

## Join the AWA

**ANTIQUÉ WIRELESS ASSOCIATION**  
THE ORIGINAL AND LARGEST HISTORICAL RADIO-COLLECTOR GROUP

- Publishes *AWA Journal* with:
  - Battery and AC receiver restoration
  - Vacuum-tube history and collecting
  - Old-time amateur-radio contests
  - Communications receivers
  - Free want-sell-swap ads
  - Early television
  - Horn loudspeakers
  - Reviews of current books
  - Keys and land-line telegraphy
  - News of U.S. and foreign clubs
  - Information on public radio museums
- Maintains unique radio-TV museum.
- Produces the annual Rochester meet.
- Co-sponsors local meets.
- Publishes the annual *AWA Review*.



Membership is only \$25 per year U.S.A. (\$30 per year elsewhere). Write to:

AWA Membership Director  
PO Box 421, Bloomfield, NY 14469-0421

[www.antiquewireless.org](http://www.antiquewireless.org)



## Facets of Capacitors

While back we went over how the wires in a coil form capacitors and how this 'stray capacitance' as shown in Figure 1 was a problem. As they like to say in the computer world, "It's not a bug, it's a feature!" Here is one example of how radio hobbyists have been using stray capacitance for about 100 years.



Fig 1 Stray Capacitance

Figure 2 shows the schematic for the classic "Oatmeal" crystal set. Oatmeal because a cylindrical oatmeal box was used as the coil form. For many years I would look at that schematic and tell myself that you just had a sliding tap as a variable inductor for tuning. There was no way you could tune a particular station with just a slider on an inductor!

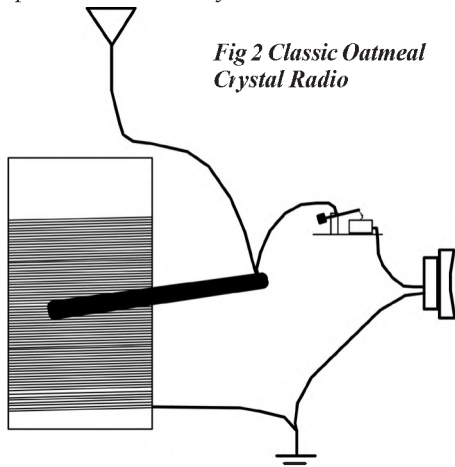

Fig 2 Classic Oatmeal Crystal Radio

But when we allow for stray capacitance, then the windings are also a capacitor and we have the circuit in Figure 3. The variable inductor and the variable capacitor are ganged together so one slider on the coil is the control for a variable tuned circuit. While it may not look like it at first, the Oatmeal box radio really did have a tuned circuit.

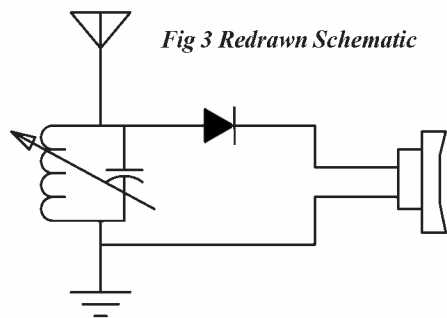

Fig 3 Redrawn Schematic

Next in Photo 2 is a Variocoupler from the early 1930's, or an even more interesting way of making a variable inductor. The basic idea is to have two coils. Keep the coils 90 degrees to each other and you have the inductance of the two coils



Photo 2 Variocoupler

added. Turn the center coil parallel and the fields combine with a theoretical four times increase in inductance. Now turn the center coil 180 deg the other way. The fields buck or cancel each other and total inductance drops to a very low value. Just by rotating that center winding you have very wide tuning range for an inductor.

In normal use the Variocoupler was mounted on the top of the radio cabinet with the coils inside the cabinet. The controls were flush with the top of the radio. In photo 3 you can see the switch that permits the four coils to be switched into eight configurations and the scale for the relative position of the coils.

Several of the switch settings allow the coil to be used as a transformer as in Figure 5. Now by changing the relative position of the coils you can change the coupling between the two windings of the transformer.



Photo 3 Variocoupler with position and switch controls

Two things are happening as you vary the coupling. Set the coils close for good coupling and you get more signal. But the frequency response is very wide. Set the coils at more of an angle for less coupling



Fig 4 Variocoupler schematic symbol

and you get less signal. But the Q or selectivity of the circuit goes way up. So, with strong signals or good rejection of other signals, you get to vary these parameters for best signals.

No computer simulators, few reference books, yet they had all this stuff figured out 80 years ago.

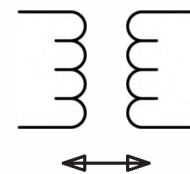

Fig 5 Variocoupler as a variable coupling transformer

### ❖ Reader's Question

Bill Riches WA2DVU from Cape May, New Jersey sent this comment on a previous comment I made:

"Please check out on page 6 March 2013 'To the Editors' column. 'Basket Weave Antenna Dimensions'" - Kent gives incorrect info in his reply. In a superhet receiver the loop antenna as pictured does not affect received frequency as it is not in the oscillator circuit. It is in the RF section and is usually in parallel with one section of the tuning gang condenser. There is usually a small adjustable condenser in parallel with these two parts to adjust tracking so, for instance, when the radio is set up to receive 900 kHz the antenna will be resonant to that frequency. Kent probably meant to say that, starting from scratch, you will have to add or take off turns to get the most gain out of the receiver so that the small adjustable compensating condenser ideally is at half of its capacity at max gain.

I have been a subscriber of MT for many years. Keep up the good work."

Hi Bill:

The challenge is to keep the Q of the antenna as high as possible. So lots and lots of turns are needed. But, you reach a point where the stray C in the coil is so high that the circuit cannot resonate at the high end of the AM Band.

So, even if you could tune your 365 pf condenser to 0 pF, you still couldn't tune the antenna to the high end of the band.

Yes, a superhet would still pick up something, but it would be a bummer for a TRF radio.

I just wanted to show the lengths they would go through to get a tiny bit more performance.

As always we welcome feedback from our readers and especially topics for future columns. The quickest way to contact me is kentbritain@monitoringtimes.com or snail mail to the QRZ.COM address for WA5VJB. For more antenna construction projects you can visit www.wa5vjb.com and open the Reference section.

Spring is in the air, time to get some more antennas in the air!

*Xtreme operating continued from page 15*

three weeks he discovered that he had made a contact. A neighboring ham 2 miles away had successfully copied his 20 microwatt signal on 10 meters in AF2013, thus earning him the very first Xtreme WAS (Worked A State) award.

If you're interested in Xtreme operating you can do as many others have done; bury your antenna six inches below the ground (see photo). Not only does it eliminate atmospheric noise, making weak signals below 10 MHz extremely easy to copy, but it increases attenuated radiation potential, the most significant requirement for Xtreme operating.

There are other techniques that have proven to be just as effective in Xtreme operating. For instance, most rigs have a button on the front panel that mystifies all new HF operators. It's typically labeled "ATT" and stands for Attenuate. Pressing the button will typically reduce a received signal by some 20 dB. Some manufacturers recommend using the switch to prevent distortion of a very strong (20+ dB over S9) signal in order to "stabilize the receiver performance." It can also be used to attenuate strong adjacent channel interference. Of course, the ATT button has no effect on transmitting, but will simulate Xtreme transmissions on all stations received. For example, if you are copying a station operating AF2013 on 20 meters on a normal half-wave dipole, engaging the ATT button lets you receive that same station reduced 20 dB as if the station were actually operating QRP.

Here's how you can use this technique in Xtreme operating in your own station. Tune in a particular station, put your antenna tuner in Dum-



*This ham station is set up for Xtreme action.*

my Load position and engage the ATT button on the front panel. Now, with your AF2013 program loaded, watch for the signal. It should still appear as a barely perceptible spike on a spectrum display or a nearly invisible line in a waterfall display (you may have to watch the display for several hours to actually see it).

**AF2013 Xtreme Operating Frequencies**

Band (Meters)	Frequency (MHz)
10	28.117877
12	24.917877
15	21.067877
17	18.097877
20	14.067877
30	10.137788
40	7.0378766
80	3.5787766
160	1.837877

(Xtreme AF2013 is not allowed on 50 meters)

When QSLing such a station you should indicate reception by adding to the signal report, for example, 5-9/DLATT (59 with dummy load and 20 dB attenuation). There are a number of awards available for those transmitting Xtreme (/X) mode and those using "simulated Xtreme" (/SX) mode.

Xtreme operating techniques can be used on any band. For example, on 2 meter FM, if you use a beam antenna, point your beam directly away from the repeater you're trying to access. On 10 meters, confine your activities only to 28.700 and 28.800 MHz. Those frequencies are rarely used by anyone; it will be nearly impossible for anyone to stumble onto your signal. Further, operate 10 meters only at night when your signal will go straight up into the air. On 160 meters, operate only during the daylight hours when your signal will be propagated only via groundwave and virtually all normal 160 meter operators will be asleep. In addition, operate using only the dummy load position of your antenna transmatch and engage 20 dB attenuation. Above all, do this only on the first day of April!

# Sangean WFR-28



**Order DS-WFR28**  
**\$149.95\***

\* plus \$19.95 UPS Ground shipping

Internet radio (over 13,000 stations) / FM-RDS waveband

10 station presets (5 iRadio, 5 FM)

USB MP3 playback

MP3 and WMA compatible

Network music player

Plays music stored on your computer

Search by country, genre and my favorite radios

UPnP / DMR music streaming (DLNA 1.5 compliant)

Normal / Flat / Jazz / Rock / Movie / Classic / Pop / News sound effect

Plays on rechargeable and dry-cell batteries

Built-in rapid battery charger

I/O jacks: DC in, Aux-in, line-out, headphone and USB socket



**800-438-8155**  
828-837-9200 fax: 828-837-2216  
WWW.GROVE-ENT.COM

order@grove-ent.com  
7540 Highway 64 West  
Brasstown, NC 28902



## Ham Radio Deluxe 6.0: Worth the Wait!

The long awaited version 6.0 of Ham Radio Deluxe (HRD) is finally out, and it represents a giant leap in HRD functionality. I'll discuss the new features and show you how to use an Android-based cellphone to control your rig using the IP server built into HRD.

In early 2003 Peter Halpin PH1PH and Simon HB9DRV started developing a simple rig control program for the ICOM IC-703. By late 2005 the number of registered users was over 20,000 and many other rigs had been added to its capabilities.

In late 2011 Simon sold HRD to Rick W4PC, Randy K0CBH, and Mike WA9PIE. They turned it from freeware with limited support to an inexpensive (\$80) for-pay program that includes a year of support. Version 6.0 has been a long time coming, but it's worth the wait. The new owners had a lot of catching up to do to learn how the original version of HRD was coded, then make improvements. Version 6.0 was officially released during the Orlando Hamcation on Friday, February 8, 2013.

According to the HRD website, [www.hrdsoftwarellc.com](http://www.hrdsoftwarellc.com), "Ham Radio Deluxe (HRD) is an integrated suite of software products for amateur radio." That's a rather simplistic statement for a very sophisticated program! Features include:

- Rig control through a full screen interface, with

support for numerous radios (See Figure 1)

- QSO logging
- DX cluster connectivity (See Figure 2)
- Callsign lookup
- Awards tracking (with integration to LoTW, eQSL, and Ham Radio DeluxeLog.net) (See Figure 2)
- Contesting
- Microsoft Access and MySQL support with strong features for backup and recovery
- Most popular sound card digital modes with direct integration to Ham Radio Deluxe Logbook
- Satellite operations with rig control and Google Earth integration
- Rotator control for 15 popular models of antenna rotators

### PC requirements are:

- Windows XP/SP3 (Windows 7 recommended)
- 1 GB RAM Memory (4 GB recommended)
- 10 GB unused hard drive storage (50 GB recommended)
- Pentium 5 (P5) Processor (Dual core recommended)
- 1024 x 768 256 color display (1920 x 1080 Hi-color suggested)

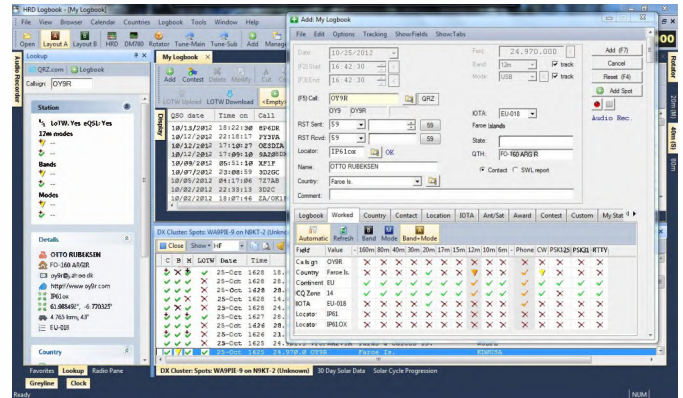

HRD Logbook and DX Cluster screens (Courtesy: HRD Software, LLC)

With version 6.0, the following new features have been added:

- Logbook Cluster new and improved "Worked Status Indicators" by station, country, country/band, country/mode, station/band/mode ("Leaderboard") and country/band/mode
- All new Awards presentation, displayed by award program with drill-down detail
- Default Award definitions added for eQSL and CQ Awards
- Integrated global "My Station" settings
- Support for AR Cluster
- Set split for QSX spots on certain rigs

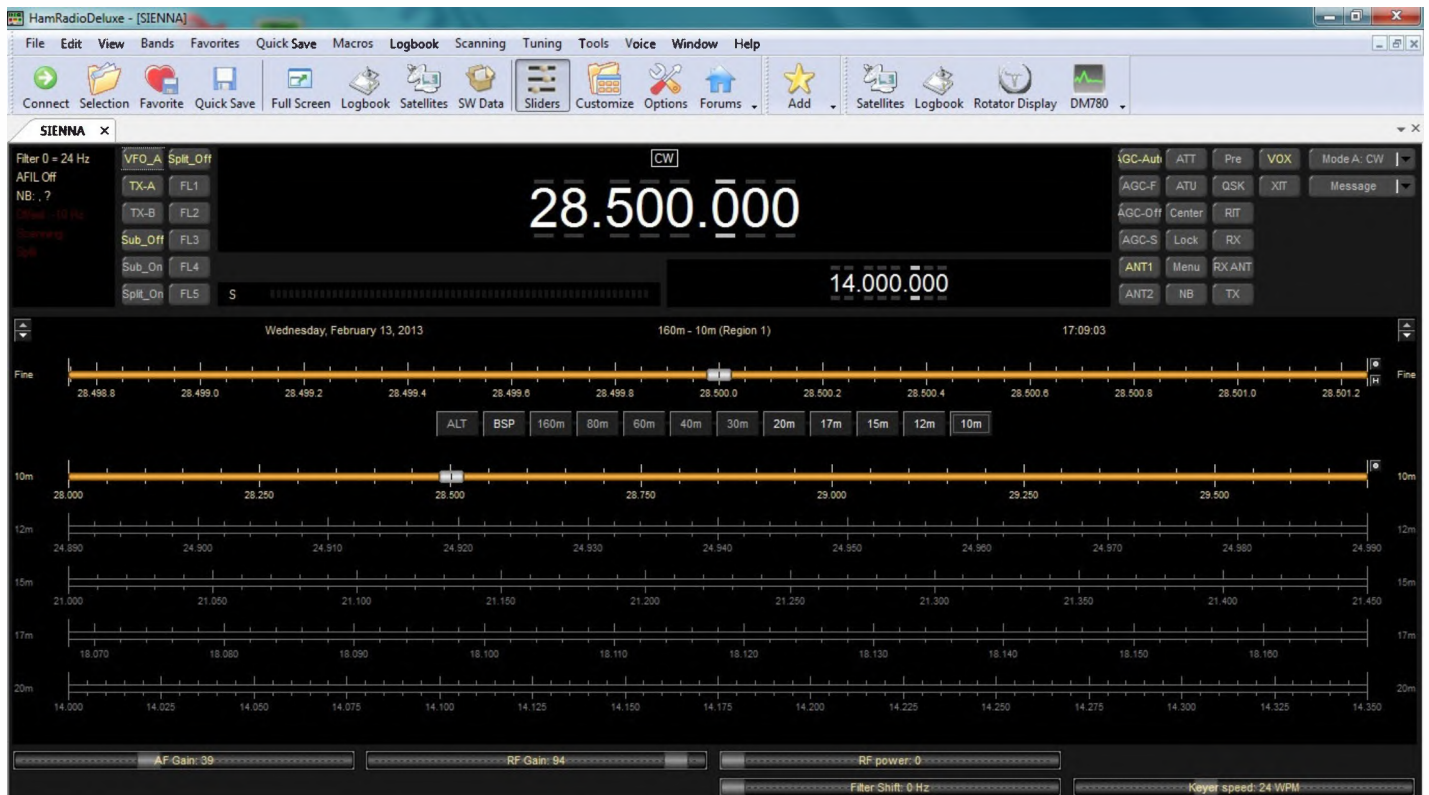

Ham Radio Deluxe main screen, showing frequency, mode, filters, potentiometer and switch settings and much more



DXCC	Country Prefix	Country	Call	QSL sent	QSL received	LOTW sent	LOTW received	QSO d
1	VE	Canada	CR6S	No	No	Yes	No	7/12/
1	VE	Canada	VO2ET	No	No	Yes	No	4/18/
1	VE	Canada	VO2NS	No	No	Yes	No	1/1/2
1	VE	Canada	VE3KI	No	Yes	Yes	Verified (Match)	11/27
1	VE	Canada	VE3EJ	No	No	Yes	Verified (Match)	11/27
1	VE	Canada	VA7QB	No	No	Yes	No	8/17/
1	VE	Canada	K6VAA/VE7	No	No	Yes	No	6/3/2
1	VE	Canada	VE6CQ	No	No	Yes	No	11/21
1	VE	Canada	VE6BZ	No	No	Yes	No	11/14
1	VE	Canada	VE7BQ	No	No	Yes	No	2/21/
1	VE	Canada	VE3EJ	No	Yes	Yes	Verified (Match)	11/29
1	VE	Canada	VY90	Yes	Yes	Yes	No	9/6/2
1	VE	Canada	XM75V	No	No	Yes	No	5/31/
1	VE	Canada	VO2EJ	No	Yes	Yes	No	4/15/
1	VE	Canada	VA7VW	No	No	Yes	No	3/12/
1	VE	Canada	VO2EJ	No	Yes	Yes	No	2/3/2
1	VE	Canada	VA2UT	Yes	No	Yes	No	1/18/
1	VE	Canada	CF2UT	No	No	Yes	No	1/18/
1	VE	Canada	CR3AT	No	Yes	Yes	No	11/10
1	VE	Canada	VG1CHP	No	No	Yes	No	8/12/

HRD DXCC Award screen (Courtesy: HRD Software, LLC)

- QSL and Address label printing including "strip" label printers
- Improved or added support for rigs:
  - Yaesu: FT-300, FT-950, FT-2000, FTDX-3000
  - ICOM: IC-9100, IC-7200, IC-7600, IC-7410
  - Elecraft: KX3 DZKit: Sienna
- RTTY multi-signal decode to DM780 Super-sweeper
- FSK-RTTY in DM780
- Support for additional rotators
- 43 bug fixes.

## ❖ How Well Does It Work?

Well, first, should it NOT work right, I have to point out the support forum, <http://forums.hrdsoftwarellc.com>, where you can go to see if the problem you are having has been resolved or to file bug reports. Like any complex program, HRD has bugs but, in general, it works very well and the new owners are very responsive to problems and enhancement requests.

One of the coolest features of HRD is its built-in IP server, which allows remote troubleshooting by the software developers, but can also be used by other applications such as Android phones, iPhones and similar devices.

I installed the "Pocket HAM bands Transceiver" app by Dan Toma YO3GGX from [www.appbrain.com](http://www.appbrain.com) (also available on GooglePlay) on my Samsung Galaxy SIII phone. (Still have trouble calling it a "phone," it's more of a Star Trek Tricorder if you ask me!) Search for "ham radio" to find it along with many other ham applications.



Pocket Ham Radio Transceiver Android app (courtesy Dan Toma, YO3GGX)

The user's manual has this to say (re-printed with permission):

This is an Android-only application used to remotely control several ham radio sources: Ham Radio Deluxe (through the HP IP Server, CAT only, sound can be done through Skype or other IP phone); An FT8x7 transceiver connected through Bluetooth (bi-directional CAT only, no sound); An SDR multi-band server located in KN34bk (multi-concurrent users SDR receiver for 80/40/30 and 20m bands).

Current version of the application has the following generic features (for all sources):

- Works on any Android device, including smartphones, tablets and Google TV, with a minimum resolution of 320x240 and Android version 2.1 or higher;
- Works in both portrait and landscape modes;
- tuning through the rotary knob or by directly entering the frequency from a numeric keypad (in MHz);
- Up/Down buttons to tune with a preset step which depends on the selected band;
- 16 presets (including frequency, mode, info). For each of the 16 memories all parameters are saved (freq, alias, description, band, mode, etc);
- ON/OFF button. When off, the application is disconnected from the server/transceiver;
- select band from the pool of available ones;
- select operation mode (AM/ LSB/USB/ CW/ etc.);
- display: SWR in both graphical and text mode;
- possibility to change application font size to match any device or taste. Font size is then

- stored in the config file and displayed on the startup screen at next run;
- a FN key to extend the number of memories to 16 and add future functionality to some buttons;
- 16 Memories to store frequency, mode and text info;
- work in both portrait and landscape modes;
- UTC clock included in the interface;

Specific functions for HRD mode:

- Set and save the hostname (or IP address) and port for the HRD IP server;
- Supports for the moment the following transceivers: FT-450, FT-817, TS-2000, IC-7200 (last two not tested);
- Control the following functions of the transceiver: Mode, Band, VFO toggle (A/B), Power, PTT, ATU (ON/OFF), Tune, PTT
- Get feedback from HRD at startup for Power, Freq, Mode ATU, VFO.
- During operation you get feedback frequency and mode if changed from HRD console or from transceiver;

Specific functions in Bluetooth CAT mode (FT8x7):

- Bidirectional control (from smartphone or from the transceiver) with feedback for: frequency, mode, output power, SWR, S, ALC, PWR, Mode, Band, VFO, PTT);

Specific functions in SDR Receiver mode:

- Control Mode (AM/USB/LSB/CW), bandwidth (Normal/Narrow/Wide), Band;
- Connect to the same receivers available through WebSDRat : <http://websdr.yoo3ggx.ro>
- Display waterfall or spectrum per band;
- Waterfall/spectrum zoom up to 8x
- Mute button;

A YouTube video of this app is available at [www.youtube.com/watch?v=b3LWF4xa6nE](http://www.youtube.com/watch?v=b3LWF4xa6nE).

The latest version, 0.4, also supports a pan-adaptor display. See the YouTube video at [www.youtube.com/watch?v=qsJUC98oHS8](http://www.youtube.com/watch?v=qsJUC98oHS8).

Figure 5 shows it running alongside the DZKit Sienna transceiver. Although not yet officially supported on the Android, it does work with Sienna and a number of other rigs besides those for which it has been tested. Communication between the "phone" and the server running on the PC that's actually connected to the radio is via WiFi, so you need to have a router or other device available for the phone to connect to.



Sienna with Pocket Transceiver app running on a Samsung Galaxy SIII. The "cell phone" is connected to HRD's server via Wi-Fi. The HRD server is running on a PC that is connected to the rig (in this case a DZKit Sienna) via an RS-232 port.

# FunCube Dongle Pro+

By Bob Grove W8JHD

In our March issue we introduced readers to a powerful, midget receiver, the FunCube Dongle SDR (Software Defined Radio). Covering 60-1700 MHz, that initial product was developed in the U.K. to enable hobbyists to monitor the amateur radio Cube satellites.

The original cube was remarkable, allowing a 90 kHz bandwidth to be observed as a spectrum display. But as critical parts, of which there are 100, became scarce, designer Howard Long realized that an entirely new design was necessary. This more than doubled the original parts count on the six-layer circuit board, but more importantly, it increased the functional limits of the tiny radio as well as increased its frequency stability with a new TCXO (temperature-compensated crystal oscillator).

As was the original dongle, the new one gets its 5-VDC power from the USB port of the computer. Howard doesn't supply a driver for his products, but there are several free downloads available on the Net. We prefer SDR#, available at [www.sdrsharp.com](http://www.sdrsharp.com). At this writing, the most recent version is 1.0.0.1113.

Using this software package, the new FunCube Dongle Pro+ receives 150 kHz – 260 MHz and 410 MHz – 2 GHz while displaying a 192 kHz sweep span. Its reception modes are AM, NFM, WFM USB, LSB, DSB, CW-U, and CW-L.

Selectivity bandwidths for all modes are continuously adjustable to suit the listener. All frequencies are expressed in Hertz, and frequency accuracy to 1-Hz is possible when the TCXO is keyboard-calibrated to a standard like WWV.

The spectrum analyzer span can be adjusted from virtually zero to its maximum 192 kHz span. There are two spectrum displays, both in real time: The traditional signal spikes and the time-revealing waterfall. Their proportional



heights are vertically adjustable from zero to full page by dragging the horizontal frame bar that separates the two displays. The baseline can be offset as desired, and the spikes exaggerated.

The receiver sensitivity is nominally 0.15 microvolts for 12 dB SINAD over the majority of its tuning range. The TCXO stability is typically 1.5 ppm. VHF/UHF noise figure is 3.5 dB.

Due to the small size of the dongle, an SMA connector is provided for antenna connection, while a conventional USB plug mates with the computer port.

A 5-VDC bias-T voltage can be selected to run on the antenna line for activation of remote accessories like an antenna-mounted preamplifier. It is activated by a check box in the configuration menu.

## ❖ Limitations

While the performance of such a low cost, multifunctional device is exceptional, there are some concessions. Lack of front-end selectivity produces many image products throughout its tuning range. These can of course, be largely minimized by external tuning, but that compromises the miniaturization of the system.

The dynamic range is somewhat limited, producing audio distortion on strong local

signals. This can be improved by temporarily disabling the front end (LNA) RF stage in the configure mode.

## ❖ Let's Try it Out

After loading the software, the receiver appears on screen, awaiting the PLAY command to

### Table 1: FunCube Dongle Pro Plus Startup Settings

(SDR# v1.0.0.1113)

On <http://sdrsharp.com/index.php/downloads>, download SDR# Dev (Rev. 1113 or higher), save SDR-nightly, select SDR sharp (application) and follow instruction to unzip the files. Select run, pin shortcut icon to task bar.

Press PLAY, select FUNcube Dongle Pro+

CONFIGURE: LNA Enable (Check), Mixer Gain (Check), IF Gain (0), Bias T (Uncheck)  
Frequency correction (2.3; set as needed to WWV comparing AM to USB /LSB)

FILTER TYPE: Hamming

MODE	Filter	Filter	CW Shift	Step Size
SETTINGS	Bandwidth	Order		
NFM	8000	50		12.5 kHz
AM	6000	50		1 kHz
LSB	2400	50		100 Hz
USB	2400	50		100 Hz
WFM	180000	50		100 kHz
DSB	6000	50		100 Hz
CW-L	300	50	800	100 Hz
CW-U	300	50	800	100 Hz

SQUELCH: (75 NFM, 30 AM aircraft)

SNAP TO GRID: (Uncheck)

STEP SIZE: 1 kHz (Set as desired)

CORRECT IQ: (Check)

SWAP I & Q: (Check)

FM Stereo: (Uncheck)

MARK PEAKS: (Uncheck unless desired to flag signal peaks)

FILTER AUDIO: (Uncheck)

AGC: Use AGC (Check), Use Hang (Check), Threshold dB (-100), Decay (1000), Slope (0)

FFT DISPLAY: View (Both), Window (Hamming), Resolution (32768), Use time marker (Uncheck), Gradient (All colors), S-Attack (100%), S-Decay (100%), W-Attack (100%), W-Decay (100%), Spectrum Offset (0%), Range (50%)

ZOOM: 0%  
CONTRAST: 50%  
SPEED: 50%

To enter a frequency, place the mouse cursor over left-most digit and right click. Next, remembering that the frequency is in hertz, place the cursor over the left-most digit representing the new frequency and type the new frequency; press ENTER.

To change the relative heights of the spectrum display and waterfall display, drag the center bar between them.

To reduce distorted reception because of strong-signal overload, select the CONFIGURE box and uncheck LNA Enable

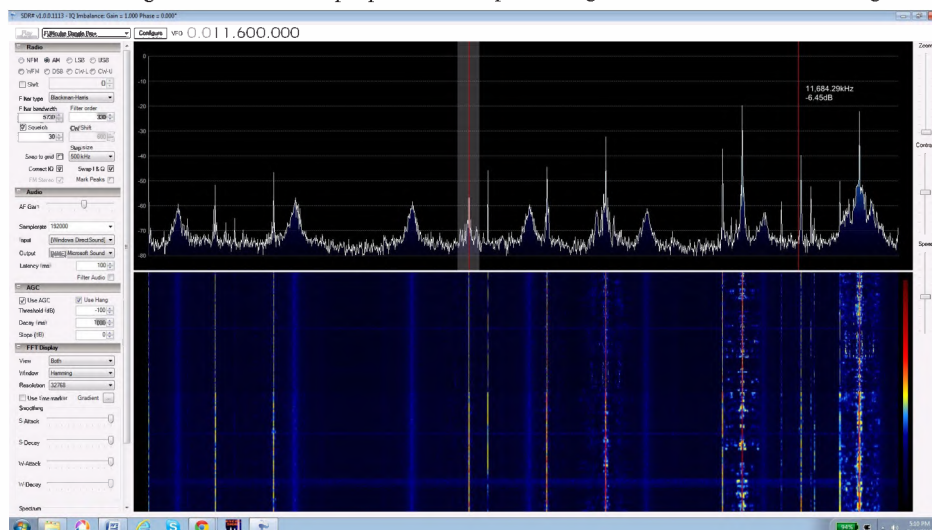

## Table 2: Specifications

Guaranteed frequency range: 150kHz to 240MHz and 420MHz to 1.9GHz  
Typical frequency coverage: 150kHz to 260MHz and 410MHz to 2.05GHz  
Maximum span: 192 kHz, real time  
Modes: AM, NFM, WFM, USB, LSB, DSB, CW-L, CW-U  
TCXO specified at 0.5ppm (in practice about 1.5 ppm)  
Standard SMA female antenna port  
USB male connection  
Eleven discrete hardware front end filters including:  
6MHz 3dB bandwidth (10MHz at -40dB) SAW filter for the 2m band.  
20MHz 3dB bandwidth (42MHz at -40dB) SAW filter for the 70cm band  
Third- and fifth-order LC bandpass filters for other bands  
Front end LNA IP3 30dB  
Typical noise figures:  
50MHz 2.5dB  
145MHz 3.5dB  
435MHz 3.5dB  
1296MHz 5.5dB  
Typical NFM 12dB SINAD sensitivity measurements:  
145MHz 0.15uV  
435MHz 0.15uV  
No additional drivers required for Linux, OSX or Windows  
Integrated 5V bias T switchable from software  
USB power required: 5 VDC @ 160 mA

be pressed. Next, a box of SDR receiver models is consulted to select the FunCube Dongle PRO+.

In order for the Dongle to work right off the bat, we have included a recommended list of settings (Table 1). Using those settings, we found the FunCube Dongle Pro+ to be a delight to use, with excellent reception throughout its tuning range.

Filter bandwidths can be custom adjusted to suit the requirements of the operator. Frequency entry is done by the user's computer keypad. The current frequency is cleared by right clicking the left-most box, then typing in the numerals in their respective boxes. The cursor can be slewed back and forth, selecting and fine-tuning the frequency. Alternatively, the cursor can be placed on any digit in the frequency display and toggled up and down in those units.

Tuning steps for slewing the cursor may be selected from among 27 step sizes ranging for 1 Hz to 500 kHz. They cleverly include all current standard channelization spacings, such as 6.25 and 12.5 kHz for NFM, 8.33 kHz for European VHF aero, and 9 kHz for European MW AM.

Since there are no instructions for the third-party driver, we have included startup settings that worked well during our review.

We found audio recovery, sensitivity, and signal stability in all modes including SSB to be outstanding. It is our understating that third party efforts are developing scanner software. We hope additional efforts will provide wider spans for the spectrum display.

At this writing, Howard Long is waiting for FCC approval. Until then, it is unlawful for the Dongle to be merchandised in the U.S. Grove Enterprises is awaiting notification for distribution. In the meantime, however, they cannot provide price or delivery information, although their European distribution seems to be in the \$200 range plus shipping.

Interested experimenters are encouraged to keep up with progress on this front by visiting Howard's website: [www.funcubedongle.com](http://www.funcubedongle.com)

# Sangean WFR-28 Radio

By Larry Van Horn N5FPW

I am a big fan of Internet radio. So much so we have quite a few of them in our household. So any chance I get to review a new I-Radio is a lot of fun and something that I look forward to. Recently, I had the chance to review another new entry in this growing marketplace and can say that Sangean has another winner in their new radio the WFR-28 Radio.

## ❖ Features

The Sangean WFR-28 is a combination Internet radio and audio media streaming device that is fully portable. With it users can listen to over 13,000 radio stations from NPR, FOX news, CNN, BBC, CBS to KROQ, and over 35,000 podcasts as well as to your regular FM band (87.5-108 MHz) with a RDS (Radio Data System).

WFR-28 features include Frontier Silicon's IR 2.2 network audio software that provides the most complete, versatile and easy-to-use software available for the next generation Internet-connected audio systems. The WFR-28 delivers some real nice sound well beyond its size, and bass and treble controls let you further adjust that sound to your liking. The built-in clock with dual alarms can wake you to FM radio, Internet radio or buzzer. This platform can serve as a network music player so it can play music stored on your computer.

DLNA, UPnP and Windows 7 Certification is supported to enhance music sharing and playing. The WFR-28 even supports remote control by iPhone and iPod touch thanks to the iSangean App.

This radio does require a broadband wireless Internet connection for all media play functions except for FM band reception and auxiliary/USB inputs. Consequently, you can listen directly from your wireless router with no PC or Mac required. Jacks include: DC in, Aux-in, Line-out, Headphones and USB Port. This unit may be operated by the supplied AC adapter or four D cells (not supplied).

## ❖ iSangean App Available

iSangean is the remote control app for Sangean Internet radios and media streamers for your iPhone or iPod touch. The app allows selection of Internet radio stations, selection and control of media for UPnP/DLNA music streaming from a local computer, server or NAS device, as well as control of FM radio and other functions (where these functions are present on the radio). The Now Playing screen provides radio station or media information with direct control of the radio volume. iSangean is available for download in the iTunes App Store.

## ❖ Bottom Line

You are going to get big sound in a small package. The WFR-28 delivers sound well beyond its size. The built-in digital EQ audio controls let you further adjust the sound.

The WFR-28 delivers a solid radio listening experience, complete with a built-in external telescopic antenna for clear FM reception. Add to that the ability to listen to over 13,000 Internet stations worldwide and you can save your favorite Internet stations as well as your FM stations on your presets.

The only down side to this unit is no remote control. But if you have an iPhone/iTouch the iSangean more than fills that role.

Overall, if you are looking for a good entry level Internet portable receiver with FM band receive capability, at a reasonable price; take a good look at the WFR-28.

This unit sells for \$150 and is available from Grove Enterprises.

## Technical Specifications

- Product Description - WFR-28 WiFi Internet / FM-RDS / Network Player / USB Portable Radio
- Tuner - Internet radio, FM-RDS waveband
- Station Presets - 10 (Five FM, Five Internet)
- Internet Radio - Over 13,000 stations worldwide, search by country, genre and my favorite radios
- Display - 1.3-inch LCD display with adjustable backlight
- Alarms - Dual alarm timer with HWS (Humane Wake System) buzzer and radio, Sleep timer and snooze functions
- Speaker - Single full range speaker, RMS output power 1.2 Watts
- Audio EQ - Normal / Flat / Jazz / Rock / Movie / Classic / Pop / News / Custom sound effects and bass/treble control
- Input/Output Jacks - FM wire external antenna, aux-in, USB, and headphone
- USB - MP3 playback, MP3 and WMA compatible, plug and play, UPnP / DMR music streaming (DLNA 1.5 compliant)
- Ethernet Technology - Ethernet
- Wi-Fi Standard - IEEE 802.11b/g
- Power Source Type - Plays on rechargeable and dry-cell batteries, built-in rapid battery charger, AC Adapter 7.5V/1.6A
- Size - 5.83-inches/148mm (H) by 2.44-inches/62mm (L) by 9.3-inches/273 mm (W)
- Weight - 1 pound 14 ounces/851 grams
- Manufacturer Website Address: [www.sangean.com](http://www.sangean.com)
- List Price - \$150





## Want to Give Back? Share your Signals with the World!

**A**t one point or another, we all have searched for a stream that just wasn't there. Maybe it was a VHF/UHF stream through an online scanner, maybe it was a stream from an airport that was in a weather hotspot. It could be that you are an amateur radio operator trying to work a certain area on HF and want to see if your signal is even making it there.

Whatever the case, we have all experienced the let down of not finding the stream we want. The best way to overcome this, obviously, is to have more people offer their streams online. Now you can be part of the solution too, it is actually pretty easy!

How do you get started? Well, most of you reading this column probably already have the majority of what you need: A scanner or receiver capable of tuning in the signals you want to share. You need an antenna capable of receiving the bands you are wanting to share. As an example, if you want to share your local emergency responder communications, you would need a scanner programmed with the appropriate frequencies, an antenna to receive the signals and finally an interface between your scanner and your computer.

Since people are going to be accessing this stream throughout the day, you might want to try to use a receiver/scanner devoted to providing the stream, or at least set a schedule of when the stream is going to be available. If you are using a Software Defined Receiver, many of these can allow multiple simultaneous connections. Likewise, you are going to need to have an "always-on" connection to the Internet through your computer, to send these streams online.

From there, it can be a bit more complicated, depending on where and how you are sharing your receiver. Some sites require you to use their own software to import signals. Radio Reference, for instance, has a preferred ScannerCast software that they recommend using. Other streaming clients are available, and Radio Reference has a page with information and links to these clients.

Another service that uses their own software is GlobalTuners. If you have a receiver you would like to provide for online use, such as an Icom PCR-100, PCR-1000, AOR 8600

and others, you can share these for the world to use and DX from your location 24 hours a day!

If you live within earshot of an airport, you can also provide air communications through LiveATC.net. Most people live within listening range of at least a regional airport, and setup to share these signals is relatively easy. All you need is a basic scanner that can receive air frequencies and a way to interface this with your computer.

Amateur radio operators, don't be left out on the fun. You can set up a node to a local repeater, or even your own radio on EchoLink and communicate with the world, even without the benefit of HF! One of my local repeaters here in Upstate South Carolina on 146.610 MHz is quite popular with EchoLink users, not only locally, but with regular users in New Jersey, Iowa and beyond!

If you have ever heard the old phrase "if you find something good, don't keep it to yourself," that really is the essence and spirit of providing streams online from your location. Sharing streams with other hobbyists is one of the surest ways to ensure that our hobby continues to thrive for years to come.

### ❖ When Severe Weather Breaks

Four years ago this month, I had the pleasure of writing a feature article about severe storm spotting for the radio hobbyist and amateur radio operator. That same month (April 2009), I also wrote a column that detailed the ways you could listen to severe storm coverage from the heart of the United States' "Tornado Alley" through online streams.



While I am not going to rehash the same information in these pages, I would like to remind everyone that there is a ton of severe weather coverage to be found online.

Four years ago, it wasn't very prevalent to see television stations stream their severe

weather coverage from their broadcast signal. However, in storm outbreaks in recent years, including the devastating outbreak event that ripped through Tuscaloosa, Alabama, we have seen a change in this.

Hurricane Sandy and Winter Storm Nemo, both hitting the U.S. northeast, are great examples of this. Television stations in the affected areas were streaming live video, news conferences and constant coverage during the peak of the storms. Combined with the fascinating listening through streaming radio stations and emergency responder streams from online scanners, we are starting to see a whole new side of severe weather coverage, even if you are thousands of miles away!

When severe weather hits this spring, don't forget to check for coverage online. While the cable networks put their unique brand of reporting on these types of events, nothing compares to getting information directly from on the scene.

Another great resource for severe storm spotting frequencies and other related information (not just streaming) is kBrewn Storm Spotting Frequencies. This list as of press time had last been updated back in 2011, but there is still a lot of relevant information to be found here. They can give you a great starting point for knowing what to search for in your streams.

### ❖ GlobalNet Mailbag

Reaching into the mailbag this month for the first time in a while, I find that I am not the only one that enjoys listening to Latin American stations online.

Loyd,

*Loved reading your column regarding streaming from Puerto Rico. Living as I do landlocked in the Midwest, listening to the tropics has always been a fun pastime for me as well. Just curious what your favorite country to tune in might be?*

Mike - Tulsa, Oklahoma

Mike,

*I have always had a sc.ft spot for the countries immediately around the Andes. Peru, Bolivia and Ecuador always seem to provide hours of entertainment through their music and culture. If you haven't spent a lot of time tuning them in, I highly recommend it!*

### GLOBALNET LINKS

kBrewn Storm Spotting Frequencies - [www.caps.ou.edu/~kbrews/spottfreq/](http://www.caps.ou.edu/~kbrews/spottfreq/)  
Become a stream provider - Radio Reference - [http://wiki.radioreference.com/index.php/Become\\_a\\_Feed\\_Provider](http://wiki.radioreference.com/index.php/Become_a_Feed_Provider)  
LiveATC - Offer a live stream - [www.liveatc.net/ct/fcontact.php](http://www.liveatc.net/ct/fcontact.php)



# What's NEW

## Tell them you saw it in Monitoring Times

Larry Van Horn, New Products Editor

### New go2MONITOR Decoding Software Released

The European company go2SIGNALS has announced a new software package go2MONITOR. go2MONITOR is a modular software solution for receiver control, classification, demodulation, decoding and recording of HF, VHF and UHF signals.

New threats demand superior information, acquired and analyzed from all potential sources. The increasing density of cryptic signals produced by new or modified modems demands the use of sophisticated demodulation and decoding systems. The Go2MONIOTR software packaged is designed to meet that need.

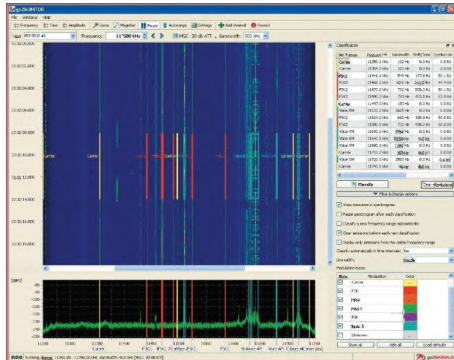

go2MONITOR is an easy to use, automated interface for monitoring tasks. This single tool provides all the necessary processing steps, classification, demodulation, recording and decoding, in a fully integrated environment.

Some of the key features and benefits of this software package include:

- 1 MHz wideband input (spectrogram, Fast Fourier Transform (FFT) classifier.
- Automated classification and production using an extensive decoder library.
- State-of-the-art GUI includes window presets, drag and drop, and integrated station list.
- Integrated receiver control with direct Software Defined Radio (SDR) interface.
- Parallel processing of up to eight buffered Digital Down Conversion (DDC) production channels.
- Decoder Description Language (DDL) support. Expand your decoder list without sharing any information.

go2MONITOR enables the operator to monitor up to eight signals in parallel. Its automatic buffering of the complete wideband signal input allows easy switching to new signals without loss of information.

Known signals can be monitored easily thanks to the included station list and extensive decoder library. The available production channel will automatically process classification, recognition and decoding.

The identification and monitoring of new or existing signals is a primary task for telecommu-

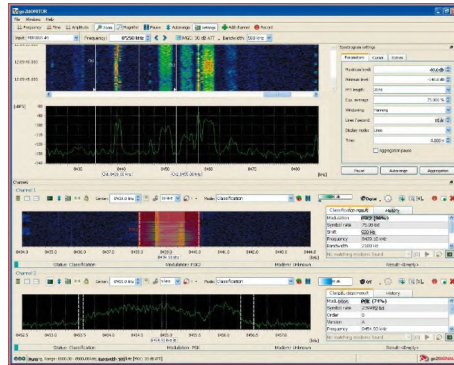

nications administrations and homeland security agencies. Many modern telecommunication systems defy manual techniques, making the automatic go2MONITOR the obvious solution.

The Go2MONITOR package is a natural for the military COMINT and signals surveillance mission. "Out-of-area" operations in an unknown electromagnetic environment must be supported by monitoring and analysis. go2MONITOR is perfectly suited for rapid reaction task forces and advanced commands. All you need is go2MONITOR, a laptop, a receiver and an antenna!

In this day and age of exotic digital modes, go2MONITOR answers the call with the capability to decode the plethora of most the commonly heard digital signals heard today in the HF/VHF/UHF spectrums. These include:

HF Decoders – 2 channel ITA-2 RTTY, ACARS HF, Alcatel 801H, ALIS/ALIS 2, AMOR/AMOR 96, AMTOR, Annex-10, ARQ-1000 duplex, ARQ-28/58, ARQ6-90/98, ARQ-E Cyc4/Cyc8, ARQ-E3, ARQ-M1, ARQ-M2-242/342, ARQ-M4-242/342, ARQ-N, ARQ-SWE, ARTRAC, ASCII 7 Bit/8 Bit, AUTOSPEC, Baudot sync (1/2/3 stop bits), Baudot async, Baudot 7F7, BEE, BF6 Baudot, BULG-ASCII, CCIR 242/342/342-2/476 A/B/493-4/518 Variant/519 Variant, CHU, CIS 10 11 11/11/12/14/20/36/36-50/405 3915/81/81-29/81-81/AT3104, Clover II/2000/2000 Broadcast/2500/2500 Broadcast, CODAN 3012 Chirp/Selcal/3012 16 Channel PSK/3212 16 Channel PSK/8580/9001 Chirp, CROWD-36, Coquelet13, Coquelet-8, Coquelet-8 FEC, Coquelet-80, Coquelet-100, Coquelet-Mk1, CW-Morse, DGPS, DSC-HF, DUP-ARQ, FEC-A, FEC12/100, FIRE, Frost, FROST1, FSK 400/500, F7B Baudot, F7B Morse, Globe Wireless FSK/PSK/Pactor, GMDSS, G-TOR, GOLAY, GW DATAPLEX, HFDL, HNG-FEC, ICAO Selcal, IRA-ARQ, ITA-2 Twin, MERLIN, MEROD, MFSK 8/16, Morse, MS5, MD674, NUM 13, Olivia, Packet 300-4800, PACTOR I/1 FEC/II/11 FEC/III, Piccolo MK6/MK12, Piccolo 6/12, Pol-ARQ, PSK10/10-AM, PSK31/31-AM/31-FEC, PSK50-AM, PSK63/63-FEC, PSK125/125-FEC, PSK220-FEC, PSK250, QPSK31/63/125/250, RAC-ARQ, RACAL-ARQ, ROU-FEC, RUM-FEC, RS-ARQ, SI-ARQ/FEC, SITOR-A/ARQ/B/FEC, SP14, SPREAD 11/21/51, Saud-FEC, SWED-ARQ, T-600, TDM 242/342/342 1 Channel, TOR dirty, TORG 10/11, Twinplex, Visel, YUG-MIL

V/UHF decoders – AIS, ACARS VHF, CCITT, CCIR-1/-2, GtyRuf, CTCSS, DSC-VHF, DMR, dPMR, DZVEI, EEA, EIA, EURO, EURO5, FLEX, FMS-BOS, GMDSS-VHF, GOLAY Pager, MPT1316/1327, Modat, Natel, NMT450, Packet 1200/9600, PCCIR, PDZVEI, PZVEI, POCSSAG, Tetra, Tetrapol, VDEW, VDL 2/3, ZVEI/1/2/3

Premium decoders – ALE 2G, CHN 4+4, Haegelin-Cryptos, HC-ARQ, LINK 11 CLEW/SLEW, MD 522, MIL188-110A serial/App. C, MIL188-110B/App.C, MIL188-110 39 Tone, MIL188-141A/B, MIL-M-55529A, STANAG 4197/4285/4415/4481 (FSK/PSK) /4529/4539/4539 HDR/5065/5066/5511/5511 SLEW, TADIL A/B

Demodulators – AM, ASK2, ASK 2 PSK 8, ASK 4 PSK 8, CW, DPSK 2/4/8/A/B, F1A, F6, F7B, FM, FSK 2 matched filter, FSK 2/3/4, GMSK, MDPSK 2/4, MFSK 2, MPFSK 2/4, MSK, Multitone (FSK), OFDM, PSK 2/4/8/A/B, QPSK, QAM 16/32/64/128/256, TFM 3, USB/LSB

### go2MONITOR Specifications

OS - Windows XP/7

Data - Digital IF (complex baseband I/Q 32bit), Bandwidth <= 1MHz

Documentation - Printed user manual / PDF Online-Help  
Recommended PC hardware - Minimum Intel I5 2 Core, 4 GB RAM, 8 GB for eight channel version, screen resolution 1900x1080 or two displays 1280x1024 pixels  
Supported receivers - Perseus, R&S EM 100, IZT R30XX, R32XX, R34XX, WiNRadio, RF-Space (extending continuously)

The go2MONITOR software package is available for government purchase and export only (due to FCC sale restrictions). Contact Grove Enterprises at 800-438-8155 in the U.S. and Canada only or 828-837-9200/FAX 828-837-2216, 7540 Highway 64 West, Brasstown, N.C. 28902 for more information and ordering.

### Amateur Radio Public Service Handbook

As we approach the severe weather season here in the United States, the amateur radio community gears up to provide their special brand of support communications.

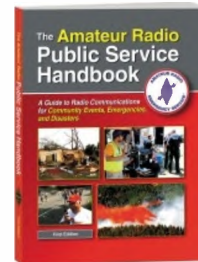

Amateur radio has consistently been the most reliable means of communications when other systems have failed. Hams work closely with disaster relief agency officials from FEMA, the American Red Cross, the Salvation Army, and other response organizations to offer wireless communications aid. From wildfires and earthquakes to marathons and road races, when getting the message through is critical, ham radio works.

The new ARRL *Amateur Radio Public Service Handbook* is for all hams that volunteer their time and skill to serve their communities. It provides knowledge needed for communicating quickly and effectively during disasters, emergencies, and community events, as well as an opportunity to learn more about the Amateur Radio Service and its unique role in supporting the public.

Some of the topics covered include:

- The ARRL & ARES
- Served Agencies
- Training and Readiness
- Nets and the National Traffic System
- The Response
- Public Service
- Digital Modes
- Other Relevant Organizations

This 304 page softcover ARRL book retails for \$40 and is available from amateur radio dealers nationwide.

## Klingenfuss 2013 Shortwave Frequency Guide

The 17th Edition of the 2013 Shortwave Frequency Guide, one of five annual radio reference books and CDs available from Klingenfuss Publications, has recently been released.

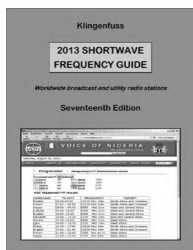

This year's 376 page book begins with a general overview of radio observations by Joerg Klingenfuss (author/publisher), followed by a section devoted to monitoring utility stations. This chapter will be of special interest to utility listeners and includes a basic explanation of the various aspects of utility monitoring and a by-frequency listing of stations with call signs, station name, mode and details.

The heart of this book and its primary focus is on shortwave broadcast stations, frequencies, and schedules. The 2013 Shortwave Frequency Guide covers the latest 2013 schedules for worldwide clandestine, domestic, and international broadcast stations, which are derived from the Klingenfuss 2013 Super Frequency List on CD.

The broadcast radio stations by frequency section, contains introductory material and a segment devoted to Digital Radio Mondiale (DRM) that includes a comprehensive list of DRM schedules, and a brief look to the future of shortwave and the debate over its decline. A three-page chapter on Internet, SATCOM and HF Radio, features an interesting evaluation of the censorship of the Internet in dictatorships.

The by-frequency list covers frequencies from 2310 kHz to 26060 kHz. Each frequency listing includes the station name, location, start and end times of each broadcast, language, target area, and selected remarks.

If you are focusing on a particular country of interest, the by-country section of the book, labeled the "Alphabetical List of Broadcast Radio Stations" in the Table of Contents, will be of particular interest.

Frequency information for international broadcast stations, clandestine, and domestic stations are accurate at time of publication and include seasonal frequency adjustments.

Klingenfuss uses a volunteer staff of worldwide radio listeners and broadcasters that contribute information to this publication and keep the information accurate and up-to-date.

The easy-to read book is a real asset at your listening post, regardless of whether you

monitor the utility bands or enjoy programming from shortwave broadcast stations. The 2013 Shortwave Frequency Guide is an excellent annual publication for the beginner or experienced radio hobbyist who seeks a complete HF spectrum reference book (utility/broadcast station listings). This is a basic no-frills radio reference guide. The book easily opens and remains open at the selected page for easy reference at your receiver. This year's edition, as in past years, is a fine addition to my listening post.

To order the 2013 Klingenfuss Shortwave Frequency Guide book, go to the Klingenfuss website at [www.klingenfuss.org](http://www.klingenfuss.org) or order from Universal Radio at [www.universal-radio.com](http://www.universal-radio.com). or via phone 1-800-431-3939; Fax 1-614-866-2339. Postal mail to: Universal Radio, Inc., 6830 Americana Parkway, Reynoldsburg, OH 43068-4113 USA. From Universal order book number 5958 for \$50 plus shipping and handling. – Gayle Van Horn, W4GVH

## Sangean WR-22 FM-RBDS/AM/USB/Bluetooth Digital Receiver

Sangean has released their latest entry into the growing home audio field: the WR-22.

The system's versatility is right in tune with the various ways we get our music today. There's a built-in AM/FM-RBDS (Radio Data System) radio. With custom system packages, you can also enjoy music from your iPod or iPhone, even your computer, tablet or any Bluetooth device as well as the expanded connections include a USB port for playing MP3/WMA files from USB drive.

With Bluetooth wireless technology, simply switch to the Bluetooth source and after initial pairing, start listening to your favorite music wirelessly. It's that simple with the WR-22.

Whether you own a Smartphone, iPod, tablet or PC, you can enjoy your music without the constraint of extra cables. The advanced AM/FM-RBDS tuner displays useful information such as song titles and artists. Additional features include snooze, adjustable tuning step, dual alarm timer by radio, buzzer or Media (by USB), and dynamic bass compensation for richer bass, rotary bass and treble control

The WR-22 has a black piano or dark walnut finish and is easy to operate. The WR-22 features an easy-to-read extra-large, backlit custom LCD display with adjustable dimmer.

### Receiver Specifications

- 10 Station presets (five FM, five AM)
- Easy To read high contrast LCD display with automatic and adjustable backlight
- Built-in Bluetooth wireless audio streaming
- Clock available for FM RBDS-CT
- Two alarm timer by radio, buzzer or media (by USB)
- Settable alarm volume HWS (Humane Wake System) buzzer and radio
- Adjustable nap timer
- Adjustable sleep timer
- Snooze function
- Adjustable tuning step



- USB MP3/WMA playback
- Loudness on/off
- Bass and treble controls
- Dynamic bass compensation for rich bass
- Rotary bass and treble control
- FM stereo on line out and headphone
- Three inch seven watt full range speaker with enlarged magnet
- I/O Jacks: DC-in, AC-in, Aux-in, Subwoofer out, headphone and FM F terminal+ AM ANT-in (USA)
- External or internal antenna selection
- Fully functional infrared remote control

The WR-22 retails for \$180 and is available from many retailers' online and local home audio stores.

## Icom ID-51A Dual Band HT

The Icom ID-51A has just been released from Icom America and it may be the most hi-tech dual band HT in the world. It covers 2 meters and 440 MHz and receives two bands simultaneously (V/V, U/U & V/U). It is IPX7 waterproof and features a built-in GPS. The 128 by 104 dot-matrix display is impressive. This radio has an astounding 1304 channel alphanumeric memory system.

There is a Micro SD card slot for an optional memory card. This can be used to store DVR Incoming/Outgoing Messages, GPS Log and Memory Backup. There is built-in CTCSS/DTCS encode/decode for analog FM. It even features an independent AM and FM broadcast receiver. A new Voice Memory feature records incoming and outgoing calls and can be used as a voice recorder.

This slim body HT has a five watt output and a rich D-STAR and integrated GPS receiver feature set.

As mentioned above FM and AM broadcast stations can be monitored while using the dual watch function for monitoring VHF/UHF ham bands. When a ham band signal is received, the broadcast station is automatically muted.

When receiving a call addressed to your call sign, this function automatically transmits your current position information. If the radio loses the GPS signal, the last position information with date and time information can be sent.

The U.S. version includes the BP-271 battery, SMA flexible antenna, MB-127 belt clip, strap and BC-167SA wall charger. The unit measures 2.3 x 4.2 x 1.1 inches and weighs 9 ounces.

The ID-51A retails for \$756 with a lower street price around \$640 from Universal Radio, a *Monitoring Times* advertiser.

Books and equipment for announcement or review should be sent to What's New, c/o Monitoring Times, 7540 Highway 64 West, Brasstown, NC 28902. Press releases may be faxed to 828-837-2216 or emailed to Larry Van Horn, [larryvanhorn@monitoringtimes.com](mailto:larryvanhorn@monitoringtimes.com).

When ordering or inquiring about the products mentioned in this column, be sure to tell them that you saw it in the pages of *Monitoring Times* magazine.

# The Best in Radio Communications

*Essential Publications for Every Ham!*

**90th Edition! It Just Keeps Getting Better!**



## The ARRL Handbook—2013 Edition

*The ARRL Handbook for Radio Communications* is widely recognized as being the standard reference among radio amateurs and other technologists—experimenters, engineers and students. It's filled with essential information from across the expanse of radio communication fundamentals, covering nearly every aspect of radio and antenna design, equipment construction, and station assembly. CD-ROM included!\*

**Hardcover Book and CD-ROM.** Retail **\$59.95**

**Softcover Book and CD-ROM.** Retail **\$49.95**

**Everything for the Active Ham Radio Operator!**

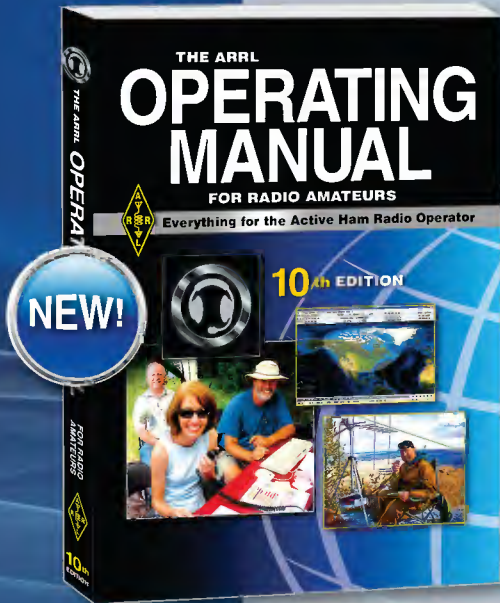

## The ARRL Operating Manual—10th Edition

*The ARRL Operating Manual for Radio Amateurs* is the most complete guide to Amateur Radio operating. You'll find everything you need to know—from exploring the broad range of ham radio activities, to sharpening your on-air skills. Put your equipment to use!

**Softcover Book.** Retail **\$34.95**

**Exciting Antenna Projects and Design!**

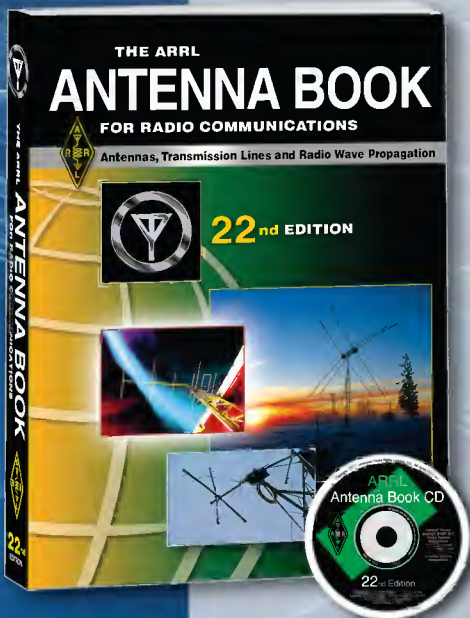

## The ARRL Antenna Book—22nd Edition

*The ARRL Antenna Book for Radio Communications* includes all of the information you need for complete antenna systems—from planning, to design and construction. It includes antennas from the HF low bands through VHF, UHF and microwave; fixed station, portable, mobile, maritime, satellite and more. CD-ROM included!\*

**Softcover Book and CD-ROM.** Retail **\$49.95**

\*System Requirements: Windows® 7, Windows Vista®, or Windows® XP, as well as Macintosh® systems, using Adobe® Acrobat® Reader® software. The Acrobat Reader is a free download at [www.adobe.com](http://www.adobe.com). PDF files are Linux readable. The ARRL Antenna Book utility programs are Windows® compatible, only. Some utilities have additional limitations and may not be compatible with 64-bit operating systems.



The national association for  
**ARRL AMATEUR RADIO®**  
[www.arrl.org/shop](http://www.arrl.org/shop)

# MTXpress

THE Magazine for every radio enthusiast is now fully digital!

FULL COLOR!



ENTIRE LIBRARY ON ONE DEVICE!

Instead of a stack of paper copies, you can have your entire library of Monitoring Times on one device! Whether it's your desktop, notebook or tablet, every issue is right there at your fingertips!



**FAST DELIVERY**  
Every issue is delivered right to your computer every month. No need to wait for the Post Office any longer!

**PRINTABLE**  
If you want a hard copy of any or all of the issue, you can print it in high-resolution right to your own printer. It's even in full-color! (if you have a color-capable printer)

**AFFORDABLE**

*I have been a long time subscriber--off and on--since the early eighties when your format was newspaper. Through the years your staff and contributing writers have done a great job in producing some very informative articles. -Mark C.*

*Have downloaded my first copy of MTXpress. The clarity of the pages is breathtaking; very easy to read. This is a brilliant idea: Wish I had known about it earlier. - Barry, UK*

INSTANT SEARCHES THROUGH THE ENTIRE MAGAZINE!

Only \$19.95 per year or only \$11 in addition to your print subscription!

[www.grove-ent.com](http://www.grove-ent.com)

800-438-8155

[order@grove-ent.com](mailto:order@grove-ent.com)

The time to go digital is NOW! ORDER TODAY!