

HIGH FIDELITY
trade news

VOLUME 22 NO. 1

JANUARY 1978

the
audio dealer's
guide
to
the
video revolution



FISHER, 1978:

THE RIGHT PRODUCTS AT THE RIGHT PRICE AT THE RIGHT TIME.

(continued)

Last year on these pages we predicted that Fisher's established brand name, unique products, and selective distribution would prove to be a winning combination.

Looking back, it's obvious we were right on target — most Fisher dealers reported banner years.

Not being inclined to tamper with a successful formula, we confidently announce a continuation of past policies with one slight difference: a somewhat increased production capacity that will permit us to consider a limited number of applications for Fisher franchises.

Here's how 1978 is shaping up:

receiver almost 20 years ago. Each superb performer is superbly styled and loaded with features, from the 22 watt per channel RS1022 to the super RS1080 at 170 watts RMS per channel, and every one has 0.5% or less THD. (A major consumer magazine recently picked the RS1040 as its "best buy" selection.)



one of the best turntable values in the industry.

TAPE DECKS. Fisher continues to lead the way in cassette and 8-track recording, with four brand-new decks and features and performance you've never seen anywhere before. Take our new CR4025 cassette deck — its wireless remote Pause control is the most exciting development in recording since the cassette. Or the new ER8150, a brand-new dual deck combining high quality cassette and 8-track transports, with dubbing and simultaneous recording capability, and Dolby on both decks.

SPEAKERS. 1978 is the year of a whole new series of Fisher speakers that combine seductive sound with exciting new cosmetics. It's our ST400 Studio Standard series — 7 models from a 10" 2-way all the way up to a floor-standing 15" 3-way, 4-driver powerhouse.



The right products.

RECEIVERS. The power, prestige, and features of Fisher receivers continue to make them strong sellers, either alone or in systems. They're our finest group of receivers ever — from the company that invented the stereo

TURNTABLES. The MT6225 120 pole Linear Motor Direct Drive turntable introduced last year remains a leader in high performance record playing equipment. Consumers have shown an unusually high degree of interest in the MT6225, and its \$200* suggested retail makes it

AUDIO COMPONENT SYSTEMS.

Nobody can match Fisher's lineup of pre-engineered, performance-matched music systems for the "other" hi-fi market — that vast group of first-time buyers who

The right price.

Fisher's franchised dealers have one thing in common: they're in business to make a profit. And the Fisher line is priced to move in quantity at realistic retails, with



ST460

The right time.

Fisher's expanded production capacity for 1978 puts us in a position to consider a limited number of new franchise applications by qualified retailers. If you're seriously interested in boosting your sales and your profit (and can qualify) please let us hear from you. Or contact your local Fisher rep.

Fisher Corporation, 21314 Lassen Street, Chatsworth, California 91311 (213) 998-7322.



CR4025

(according to a recent Gallup study) are going to account for an increasingly large percentage of your volume. We make true high fidelity systems priced between \$250 and \$2000 that mean extra sales volume and healthy profits. And all Fisher systems are an easy sell: the 85% Fisher brand awareness that the Gallup survey found is among the very highest in the business.

healthy margins for the Fisher dealer. Every Fisher product is priced right. Like our new CR4025 remote control cassette deck, which can be profitably retailed for around \$200*. Or our superb RS1052 50 watt per channel receiver, which sells very profitably for around \$300*. Our other products — turntables, speakers, and component systems, all follow the same philosophy — competitive retail pricing, with excellent profit margins for the Fisher franchised dealer.



ICS404



 **FISHER**
The first name in high fidelity.

Contact your nearest Fisher rep: ALBANY: Levin/Ross (518) 587-7852 ATLANTA: Leonard Elliott Co. (404) 875-9701 ALA., NC, SC, TENN., MISS.: Leonard Elliott Co. (800) 241-0113 BOSTON: Market Reps (617) 762-8820 CHICAGO: Shardon Marketing (312) 725-1900 CLEVELAND: F.A. Daugherty Co. (216) 449-1122 DALLAS: Tom Wachendorfer Assoc. (214) 741-7089 DENVER: Jack Rowe Assoc. (303) 753-0198 DETROIT: J.J.F. Assoc. (313) 569-6216 HOUSTON: Tom Wachendorfer Assoc. (713) 465-3092 INDIANAPOLIS: Omega Sales Co. (317) 299-7029 KANSAS CITY: Neal Spencer & Assoc. (913) 381-7905 LOS ANGELES: California Sales & Marketing (213) 430-3553 MIAMI: Southern Audio Corp. (305) 558-5826 MINNEAPOLIS: Bill Kirsch Assoc. (612) 944-3355 NEW ORLEANS: Tom Wachendorfer Assoc. (504) 863-7652 NEW YORK CITY: R.P.M. Sales (212) 564-1510 OKLAHOMA CITY: Tom Wachendorfer Assoc. (405) 721-9170 PHOENIX: Jack Rowe Assoc. (602) 948-4597 PITTSBURGH: Lienau Assoc. (412) 372-2993 ROCHESTER: Levin/Ross (716) 458-0300 ST. LOUIS: Neal Spencer & Assoc. (314) 991-3700 SALT LAKE CITY: Jack Rowe Assoc. (801) 561-0786 SAN DIEGO: California Sales & Marketing (714) 995-3914 SAN FRANCISCO: Hal Abrams Marketing, Inc. (415) 692-1501 SEATTLE: Seaport Marketing (206) 641-5721 WASHINGTON D.C.: Lienau Assocs. (301) 770-6800 CANADA: MONTREAL: Gamasonic Canada, Ltd., (514) 735-2721

Suggested retail prices shown are dealer guidelines for effectively merchandising Fisher products.

"Get everything that's coming to you!"

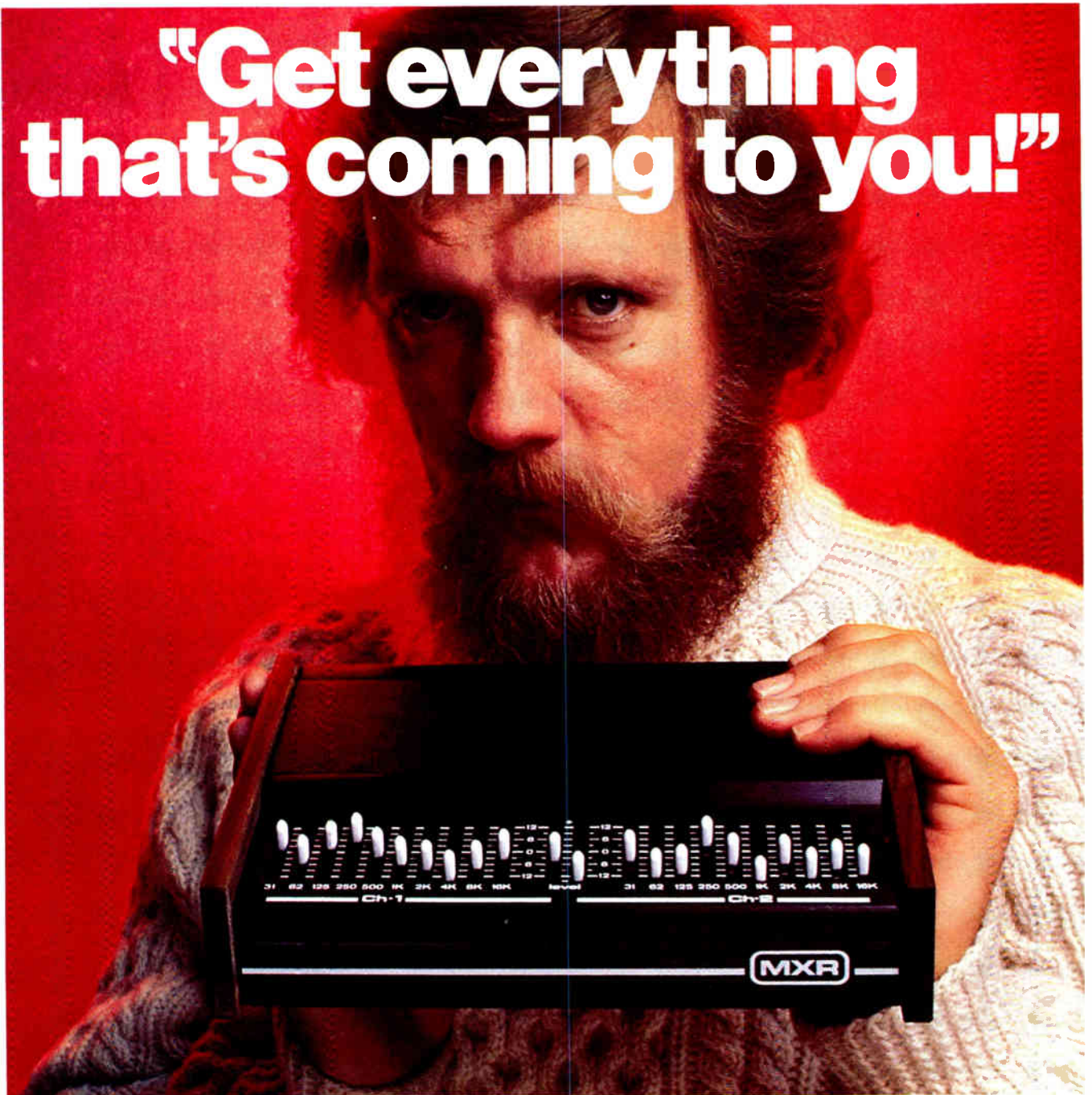

Get everything with fast-moving add-ons like The MXR Stereo Graphic Equalizer.

We knew our Stereo Graphic Equalizer would be popular. To customers, it's the answer to poor room acoustics, poor speakers and poor program quality. And with a suggested retail of \$199.95, anyone can upgrade their system with it.

But the real popularity of MXR's Equalizer is with dealers. Thousands are discovering the advantages of offering quality step-up components to perfection-minded customers. And not only with our Equalizer, but also with our Com-pander, which reduces noise during home recording, and with our new Dynamic Processor, which brings recorded dynamics back to life and removes impulse noise.

Discover how MXR's add-on products mean

easy stocking, no stale inventories, and healthy profits through higher volume sales. See how offering a family of fine products from one quality manufacturer can make your job of selling easy.

More and more people are listening to us. And that can mean everything to you. Send the coupon, write, or call us at 716-442-5320.

.....

MXR Innovations, Inc. I want everything that's coming to
 247 No. Goodman Street me! I need to carry fast-moving
 Rochester, NY 14607 add-ons like the MXR Equalizer!

Name _____ Phone _____
 Firm _____
 Address _____
 City _____ State _____ Zip _____

.....

MXR Consumer Products Group

**New.
Outperforms
every cassette now
in your store.**



The revolutionary new BASF Professional Series Cassettes.

For the dealer: The new BASF Professional Series is a double breakthrough in premium cassette performance: extraordinary sound for your customer and extraordinary profit margins for you. Our new retailer profit program offers you higher margins than anyone else in the business; our extensive merchandising programs boost your turnover; and BASF will build a deal you can't resist.

For the enthusiast: BASF offers two radically new cassettes... Professional I is a revolutionary new ferric formulation with the lowest distortion, best signal-to-noise ratio, and lowest inherent tape noise of any ferric cassette on the market. Maximum output level is unsurpassed. Professional II is our new second-generation chrome formulation with up to 3 dB more high frequency headroom than any competition, allowing this new type of tape to capture and reproduce more of the demanding high frequency signals above 10,000 Hz. It features superior signal-to-noise ratio and lower inherent tape noise.

For the expert: Most cassette decks today have chrome position bias and equalization settings that are adjusted for a "synthetic chrome" formulation such as TDK SA. Even at these settings Professional II outperforms competitive tapes, however, the truly demanding audiophile will have this position reset to match Professional II's optimum performance levels. The result will be a flatness of frequency response and lowering of distortion that is more comparable to reel-to-reel performance than to any cassette ever before offered on the market.

BASF BASF Professional Series Cassettes

No other cassette outperforms them in sound.

No other cassette outperforms them in profit.

Please visit us at Winter CES - Booth 1020

HIGH FIDELITY trade news

January, 1978 Volume 22, No. 1

Features

- | | |
|-----|---|
| 26 | If Sadat Can Do It . . . |
| 30 | Hi Fi's Close Encounters Of The Third Kind |
| 38 | The Audio Dealer's Guide To The Video Revolution |
| 46 | Selling The Excitement Of Projection TV |
| 48 | Selling The Video Revolution |
| 52 | Department Store Audio: Friend Or Foe? |
| 56 | Pioneer Sells Hi Fi Stores, Not Department Stores |
| 58 | Alternatives To Price Competition |
| 68 | Hi Fi Is The Apple Of New York's Eye |
| 70 | CES Exhibitor List |
| 74 | "CES" In Europe . . . And Japan |
| 76 | CES Products |
| 88 | 3M Sees Strong Role In Video Software |
| 100 | Micro-Acoustics Clinic Tells The Whole Story |
| 112 | From Germany's Cambridge: Canton |

Departments

- | | | | |
|----|-------------------|----|-----------------------|
| 4 | Coming Up | 26 | Hot Stuff |
| 6 | As We Go To Press | 60 | How Dealers Advertise |
| 14 | In The News | 62 | Retailing |
| 18 | FYI | 64 | Rep Rap |
| 24 | Letters | 96 | Classified |

Cover: By Bill Ashe

Publisher
Gerald F. Sweeney

Editor
Ron Marin

Advertising Sales
Richard Eicher

Production
Wendy Scharaga, Mgr.
Marcie Sheck Storz

Circulation
Mike Rubin

Executive Assistant
Etta Eisman

Art Director/Designer
Alfons J. Reich

President & Chairman
L. D. Solomon
J. T. Schwartz

6 East 43rd Street
New York, N.Y. 10017
212-949-0800

Japan:
Yukinobu Sato, Pres.
Cores Corporation
Inoue Bldg.
4-4, 1-Chome, Akasaka
Minato-Ku, Toyko
Tel. (Japan) 583-7251, 7824

HIGH FIDELITY TRADE NEWS
Vol. 22, No. 1 Copyright© 1978
by St. Regis Publications, Inc. Published
monthly by St. Regis Publications, Inc.,
6 East 43rd St., New York, N.Y. 10017.
Controlled circulation postage paid
at Miami, Fla. 33152. Advertising
rates on request. This magazine
assumes no responsibility for equipment
loaned to contributing writers for
developing story material unless
specifically authorized by the editor.
Change of address notice must give old
as well as new address. Attach
address label from recent issue.
Printed in The United States of
America. Subscription rates: 1 year —
\$15; 2 years — \$27; 3 years — \$37.
Add \$5 per year for outside U.S.,
U.S. Poss., & Canada.

Permission to reprint articles
published by *High Fidelity Trade News*
must be requested in writing, and such
articles may not be reprinted until
after written permission by
High Fidelity Trade News has been
granted.



COMING UP

JANUARY 5-8, 1978

Winter CES, Las Vegas Con-
vention Center.

FEBRUARY 17-19, 1978

High Fidelity Music Show, Cobo
Hall, Detroit, Mich.

MARCH 16-19, 1978

High Fidelity Music Show, Civic
Center, San Francisco, Calif.

MAY 19-21, 1978

International High Fidelity Show
(IHF). Georgia World Congress
Center, Atlanta, Georgia.

JUNE 10-13

Summer CES, McCormick Place/
McCormick Inn, Chicago, Ill.

JANUARY 5-8, 1979

Winter CES, Las Vegas Convention
Center.

LOOK OUT FOR #1.

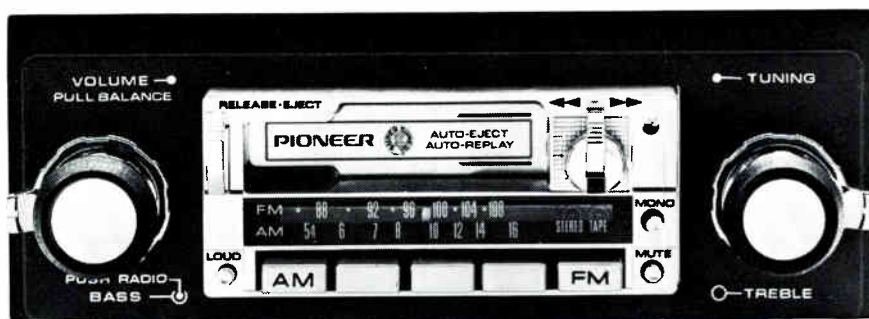

Pioneer sells more car stereos than anyone else. We have more to sell than anyone else.

And now, more than ever. More innovative products to generate new profits.

The first high performance stereo components made for automobiles, for one. Like the one you see.

The KPH-9000 AM-FM Stereo Supertuner®/Cassette Deck with a remote 20-watt power amplifier.

And our new high end

Pioneer Electronics of America, 1925 East Dominguez Street, Long Beach, California 90810

speaker systems like the TS-X9 that actually outperform most home units.

But don't overlook any of the other Pioneer car stereos. Their past selling performance is the best assurance of future sales.

So come hear Pioneer. And hear the true meaning of quality in car stereo.

Which is how we got to first place in the first place.

PIONEER®

See and hear us at Booth 1003.

AS WE GO TO PRESS

The audio industry, which accounts for the largest bloc of exhibitors and new products at Summer CES, is now becoming a major force at the Winter Show, which has never been a major hi fi event. Three times larger than last winter's CES, exhibitors here in Las Vegas include a number of hi fi companies participating in WCES for the first time...

As a result, the month of January is becoming a more important product introduction period in terms of industry cycling. For example, just prior to WCES, in New York, Pioneer unveiled seven new hi fi components for 1978, including the world's most powerful receiver ever commercially built, reportedly a 275-watt per channel unit. Kenwood is set to introduce 13 new products here at CES, headed by a new 80 watt receiver (KR-6030) with no more than 0.1% THD; a new integrated 50-watt amp (KA-6100) and a quartz/PLL direct-drive turntable (KD-750). In all Kenwood has three new receivers, three new amps, two new tuners, two turntables,

two new speakers and a new front-load Dolbyized cassette deck. Neosonic is bowing two new advanced design turntables under the Lenco banner, both direct-drive at \$275 and \$450. Dynaco is showing a new black, pro-look at its CES booth on five new hifi components. As part of its product exhibition at the Convention Center, JVC is demonstrating their new "biphonic" process-equipped portable radio cassette recorders. Hitachi is having a major product introduction here, a total of 14 new products including two Power MOSFET amps (HMA-7500,9500) at 75 and 100 watts, respectively. The units feature impressively low distortion specs. Also, with the intro of its new SR-804 50 watt receiver, Hitachi has brought to three the number of Class G receivers in its line. The new unit sets a lower Class G price point for Hitachi at \$399.95. Class G provides a second power output stage to allow doubling of power output during transient peaks. United Audio is previewing a new Dual direct-drive turntable, model 621, at the Show, priced under \$300. BASF last month un-

veiled two new cassette products as part of its premium "Professional" series. Pro I is an enhanced gamma ferric oxide designed for use at the most common bias points for Japanese tape recorders. Pro II is a new "super chrome" tape. BASF audio marketing director Jerry Hubeny claims superiority for Pro I over TDK AD and Maxell UDXL-I in maximum output level and signal-to-noise ratio (1.8dB over UDXL-I, 3.5 dB over AD). Hubeny said Pro II represents "major improvements over all other existing" chrome formulations and "in many ways" is superior to chrome "substitutes" such as TDK SA and Maxell UDXL-II. DuPont audio exec Bill Oskin told HFTN that, as a result of relationships with BASF, DuPont's American licensee should also be offering "super chrome" tapes early this year. While chrome is insignificant in terms of market share here, it is a factor in Europe. Hubeny predicted Pro II will lead the way to increased sales and market share for chrome in the U.S. In addition to this brief and incomplete summary of new product developments, you will see much, much more at the Show (turn page for more news)...

The recording industry needed it... so Stanton developed a new stylus system for playing back stampers

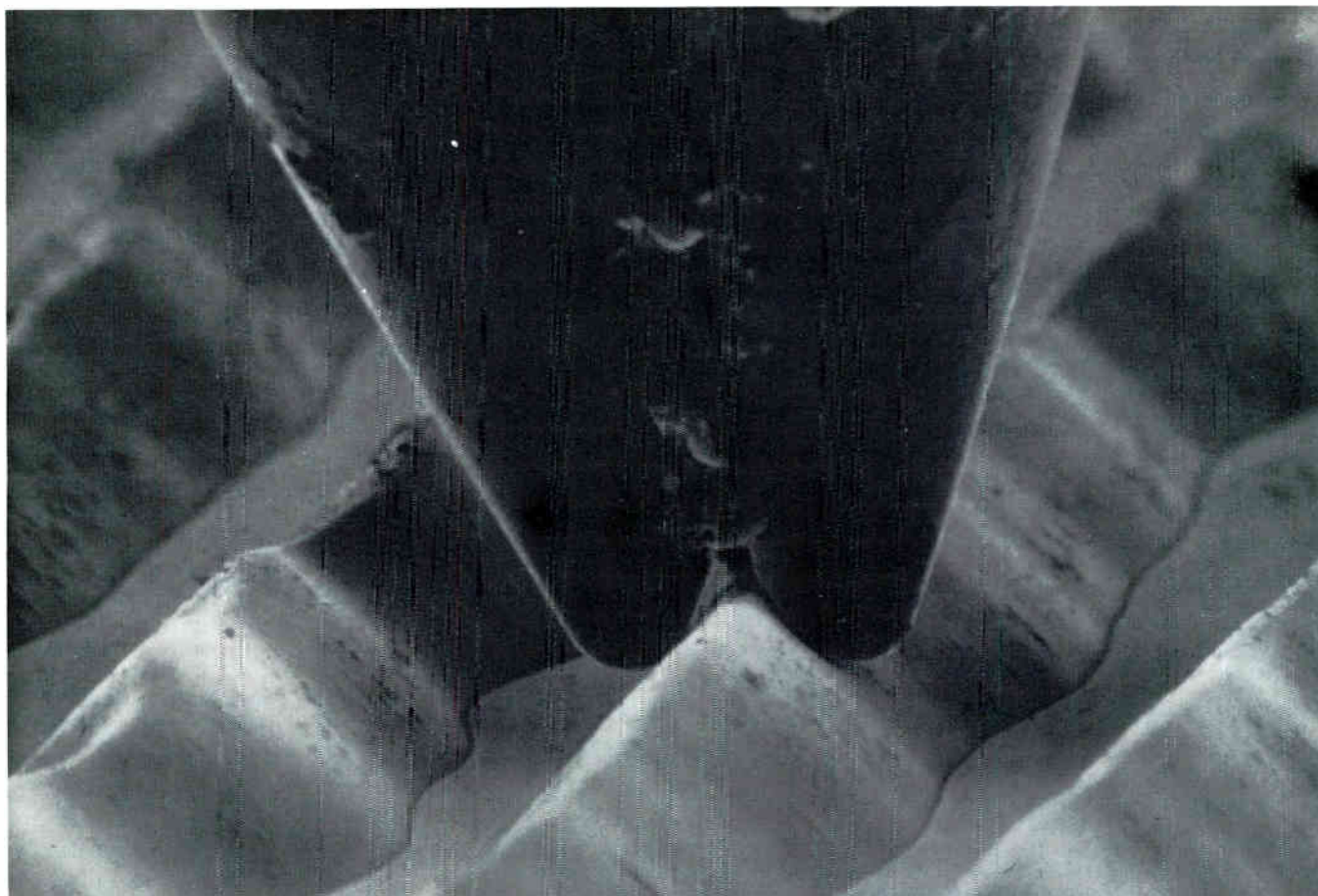

© 1977 STANTON MAGNETICS

Stanton Magnetics is proud to introduce the world's first and only stylus system Model 681 BPS*; capable of playing and repairing metal stampers and matrices.

Up until now, it was impossible to check the quality of the matrix until the metal mother was made, or the plating quality in the stamper, until actual records were pressed. By introducing this new special stylus system, Stanton is offering to the record industry the tool which will save precious time, improve the quality of the records, and offer a new way to evaluate the quality of the pressing by comparing it to the first generation copy of the master matrix.

Because this new 681 BPS stylus system is designed around the famous Stanton 681 Calibration series, its performance is recognizably superior, and matches that of a 681 Triple-E Calibration Standard cartridge.

Stampers and matrices being negatives of the record require a counter-clockwise rotation of the turntable** and a custom mounted tonearm, or a special arm with head shell offset in the opposite direction.

The new stylus system has two models: the BPSR, which tracks at 3 to 7 grams, for making minor repairs on stampers; and the BPSM, which tracks at 1 to 1½ grams, for stamper and matrix evaluation.



Audiophiles, who think highly of the professional quality of Stanton products and use them for home entertainment purposes, will find it difficult to use this new system . . . unless the distribution of metal stampers heads for the consumer market. At any rate, with this new system Stanton maintains its position as a prime innovator and supplier to the recording industry.



*Patent applied for.

**Stanton is even making special turntables for this purpose.

For further information write to: Stanton Magnetics, Terminal Drive, Plainview, N. Y. 11803

AS WE GO TO PRESS

What about price hikes in hi fi? There seems to be a lot of hedging but a general feeling that the yen/dollar ratio dictates price boosts this month. Pioneer went up 4% January 1, and Hitachi is going up selectively on three models, a 40 watt receiver from \$329 to \$349, cassette deck from

\$159 to \$169 and a turntable from \$259 to \$269...

Advent is boosting production of its three Video-Beam projection tv sets from 12,000 in '77 to 20,000 this year, according to president and chairman Peter Sprague, who adds that "better and

cheaper" sets will keep Advent ahead of Japanese competition. Sprague fears dumping by Japan projection makers (Matsushita, Mitsubishi) because they will intro sets in U.S. rather than Japan, making them immune to dumping charges if they set drastically low prices. Sprague dismisses most U.S. competitors, saying most of the 50 or so suppliers assemble through OEM purchases and virtually all use one tube instead of three (Advent) and produce 1/20th the light. "Size and brightness" is still name of game, Sprague adds. Look for new VideoBeam systems from Advent this year..

In other news, Rod Bell has been named general manager of the Harman International Audio Teams while Bob Furst (B.I.C.) has been appointed an H.I. vp. Bill Sutherland new GC Electronics advertising and sales promotion manager, Hulon Forrester, head of Elmar Associates, Atlanta, Ga., new president of Dixie ERA chapter..

Other news for follow next month, Harold Brown joins Audio-Technica; Sam Goody sold; IHF slates second management seminar; Rectilinear in bankruptcy; Detroit hi fi show looks like sellout; Discwasher suing VOR; HFTN's own survey of 1,000 dealers indicates IHF Atlanta Show a winner; and, last month, we goofed--Cecil Powell, not Taube, developed new Pixoff from Sonic Research.



TANDBERG ALONE OFFERS REEL-TO-REEL PERFORMANCE FEATURES IN A CASSETTE DECK

3 Separate Heads/3 Motors/Dual Capstans

These & other features found exclusively on Tandberg's TCD-330 make it not only the finest cassette deck, but also the cassette deck with performance exceeded only by the best reel-to-reel machines. Three separate heads for no-compromise recording & monitoring. A 3-motor, dual capstan closed loop transport, coupled with complete logic-controlled solenoid operation. Adjustable azimuth & built-in 10kHz tone generator, allowing the user to select the perfect alignment for each cassette, as well as spot dropouts and inferior tape. Equalized peak-reading meters. Automatic take-up of tape loops when cassette is inserted. Servo-controlled high speed winding. Vertical or horizontal operation, plus optional remote control & rack mounting.

Only the TCD-330 has what it takes to deliver cassette performance exceeded only by the finest reel-to-reel machines. Ask your Tandberg dealer for a "Hands-on" demonstration. Write or call us toll-free at 800-431-1506 for his name. Tandberg of America, Inc. Labriola Court Armonk, N.Y. 10504

Visit our suite at the Las Vegas Hilton during the Winter CES.

TANDBERG



a new world

Studio Lab presents a new world of sound, sales and profit with a new dimension of quality and styling . . . and a profit margin designed to keep pace with your needs.

Innovative esthetics encompass engineered quality to bring your customer a new concept in listening pleasure . . . Isonic Dispersion; total sound without total power.

Studio Lab features all pioneer drivers in hermetically sealed, walnut toned cabinetry with an acoustically transparent double knit grille.



Our elegant black thermal-mold face panel, allowing total Isonic Dispersion, is an industry breakthrough.

See the all new Studio Lab Series in booth 1010 at CES. See why we can offer a 5 year guarantee . . . and ask us about our exclusive registered dealer franchise.

There's a new world waiting for you at Studio Lab.

Call toll free 1 (800) 547-5264.

SL110 shown without grille

STUDIO LAB SERIES

A Division of Sonic International

**We're celebrating
our 50th Anniversary.**



But your golden era lies ahead.

If the past foretells the future, the most dynamic years are now in the making for JVC and its dealers.

Such JVC technical innovations as the S.E.A. graphic equalizer system, ANRS and Super ANRS noise reduction, the Sen-Alloy tape head, the development of the Shibata stylus, as well as the introduction of Phase Moire propagation pattern technology for speakers, and CD-4, the first discrete 4-channel disc system, are just a few of our contributions that have been responsible for advancing the state of the art to new heights.

JVC dealers have many reasons to celebrate. Because hand in hand with these breakthroughs, there has been outstanding acceptance for JVC products by the buying public. They have learned they can depend on JVC's consistently high quality and performance. As a result, JVC sales have escalated to an all time high.

And now JVC is looking forward to its second half century. Our past achievements are just a hint of what our unbounding vitality has in store for the future.

But JVC dealers don't have to wait for the future to take advantage of the golden opportunities that are in store for them. At JVC, the future is today.

JVC America Company,
Division of US JVC Corp.,
58-75 Queens Midtown
Expressway, Maspeth, N.Y.
11378. (212) 476-8300. Canada:
JVC Electronics of Canada,
Ltd., Scarborough, Ont.

JVC

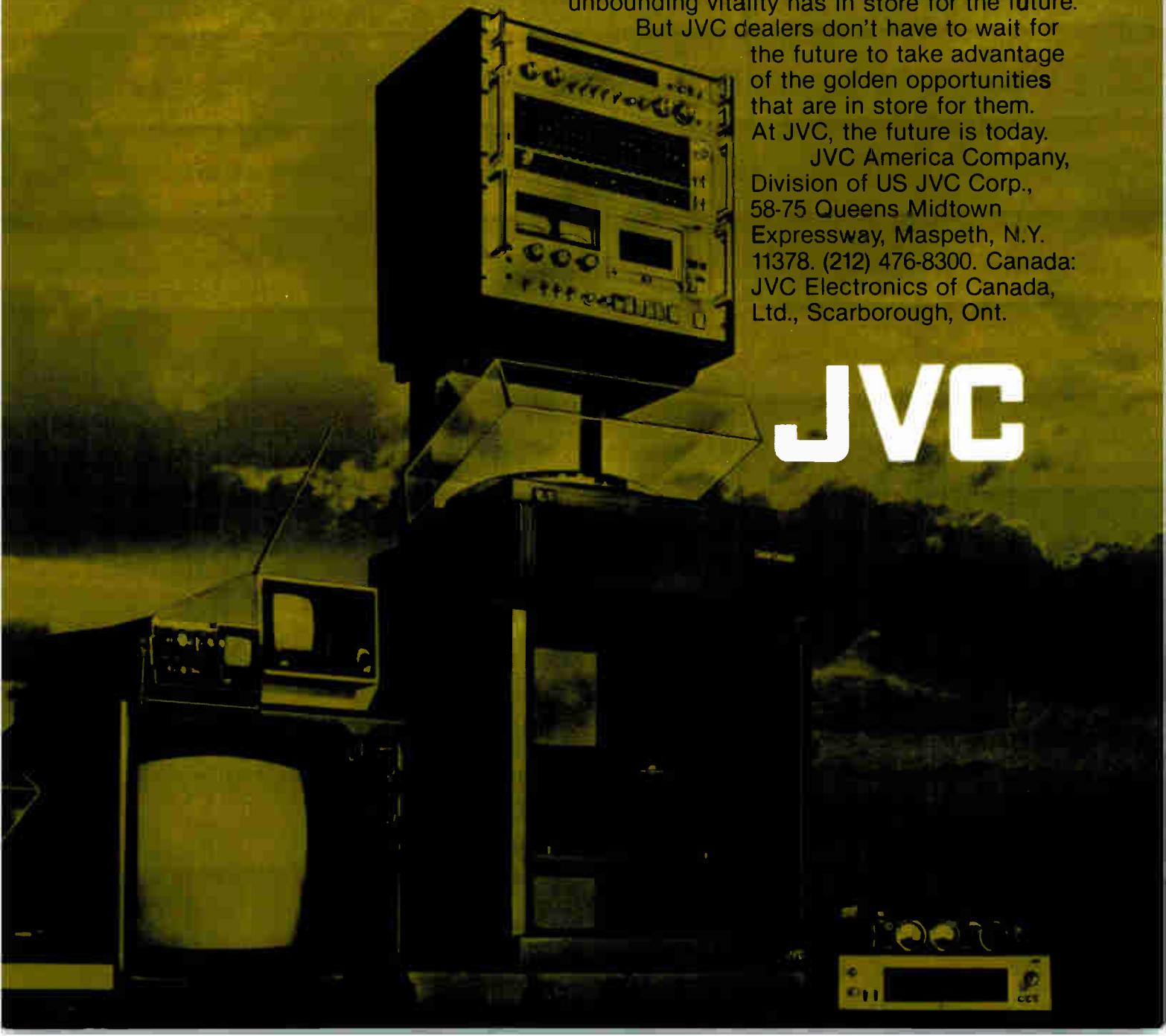

INTRODUCING GRAND MASTER™ BY AMPEX.

UNTIL NOW, ONLY THE PROS WERE READY FOR IT.

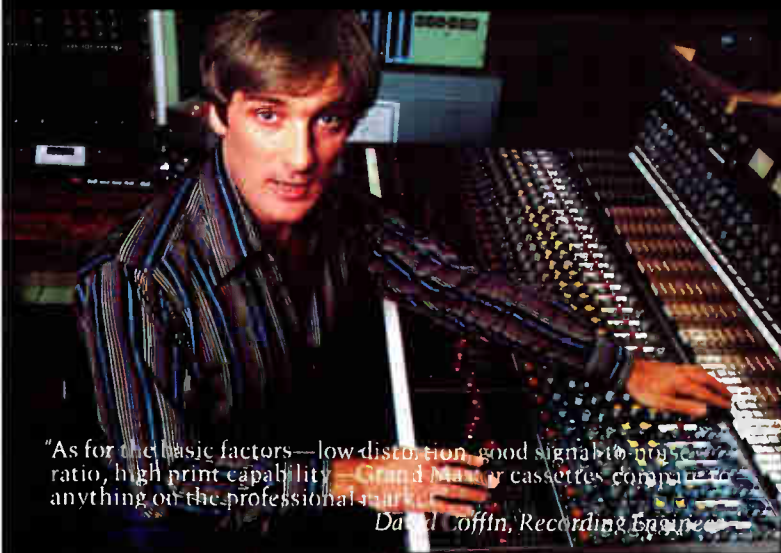

"As for the basic factors—low distortion, good signal-to-noise ratio, high print capability—Grand Master cassettes compare to anything on the professional market."

David Coffin, Recording Engineer



"Under full power, home components should distort. Grand Master wouldn't." *Steve Malcolm, Recording Engineer*

"Why shouldn't the home user have Grand Master quality if he needs it?"

Susie Foot, Recording Engineer



"Grand Master can handle high levels and maintain high dynamic range without distortion."

Geoff Sykes, Recording Engineer



In 1973, things were different.

When we invented Grand Master studio mastering tape, only professional recording engineers could appreciate its incredibly sophisticated electromagnetic properties.

Not even hard-core amateur audiophiles had the kind of equipment that could drive tape hard enough to explore Grand Master's amazing capability for undistorted output.

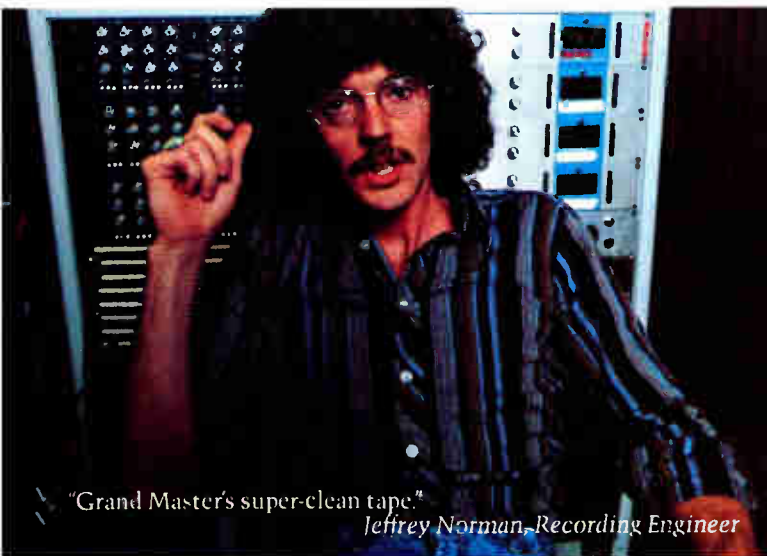

"Grand Master's super-clean tape."
Jeffrey Norman, Recording Engineer

Or begin using its incredible saturation capacity.

Or its extreme sensitivity and low distortion qualities.

Or its potentials for headroom and signal-to-noise improvement.

So while Grand Master went on to become the unquestioned leader in the professional recording industry, we had to wait for things to change before we could introduce it to the home recordist.

And change they did.

Home equipment improved dramatically.

And the same consumer who didn't care about remanence or third-harmonic

distortion in 1973 is getting to be quite an expert.

An expert willing to spend the

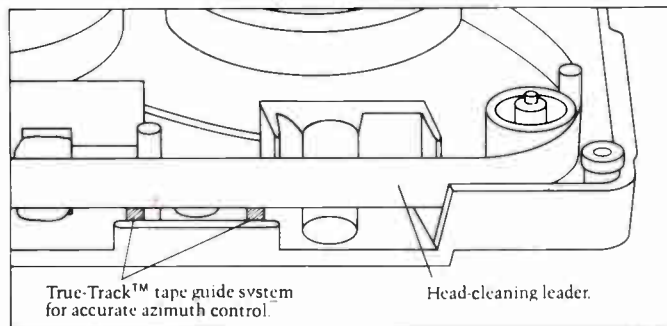

extra money it takes to get the best.

And now you have a chance to offer it to him. In three consumer versions of Grand Master designed specifically for use at home.

Cassette. 8-track. And reel-to-reel.

Each manufactured to the exact performance specifications as the original Grand Master.

Each with plenty of customers who are ready for it.

And, being the pro that you are, we think you're ready for it, too.



**GRAND MASTER
BY AMPEX.
WE THINK YOU'RE
READY FOR IT.**

AMPEX

AmpeX Corporation, Magnetic Tape Division
401 Broadway, Redwood City, California 94063 415/367-3887

IN THE NEWS



The Irving Cup

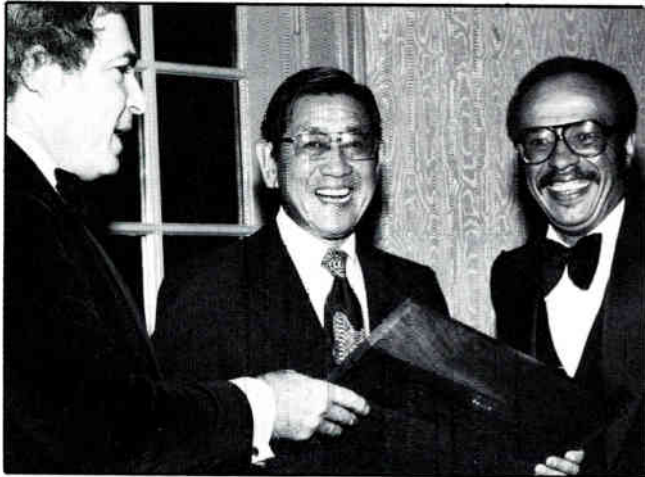

Aratani Honored



Sansui Goes To College

First annual "Irving Cup" has been awarded to **Chuck Batko** (c.) of Minneapolis-based **Schaak Electronics** for his performance in Schaak's annual employee tennis tournament. The Cup is named after **Irving Stern** who serves as **Harman International's** executive vp when not playing tennis himself. Shown are **Bob Goodman** of **Tannoy-Ortofon** and **Peter Dyke** of **Harman/Kardon** (kneeling, l. and r.) as well as **Norm Goldberg**, **Twin Cities Audio Team**, and **Roy Hidok**, also **TCAT** (r.) . . . **Kenwood** president **George Aratani** (c.) joined honorees of the past as he and **Howard Ladd of Fisher** were inducted into the Audio Hall of Fame. Aratani pioneered the Japanese stereo expedition into the American market in 1961, helping convert the meaning of "made in Japan" into a highly desirable endorsement. **Audio Times** publisher **Richard Ekstract** (l.) and **Ed Hopper** of **Stereo Review** and **Ziff-Davis Publications** present the award . . . Following the recent **Indiana University of Pennsylvania's** 3rd annual hi fi symposium, **Sansui**, donated a complete hi fi system to the University for use in consumer courses dealing with hi fi investment. **Frank Viggiano, Jr.** (l.) of the school's consumer services department, accepts the gift from **John Henry** of **J. B. Parent Co.**, Sansui rep. . . . **Al Hirsch** (l.) of **Fisher** donates a Fisher hi fi system to **Skip Hess** of **BMX Corp.** (Mongoose Motocross bikes), who will present it to the lucky winner of a drawing as part of bike promotion.

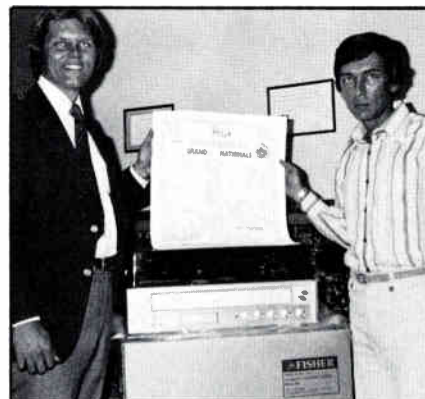

Fisher Giveaway



Some of the sharpest women in the country read Viva. Compared to Cosmopolitan, Glamour and Mademoiselle, higher percentages of Viva readers are young women (18 to 34) that*:

- (1) Have household incomes of \$25,000+.
- (2) Are employed.
- (3) Are unmarried.
- (4) Attended and/or graduated from college.

Why Viva? Obviously, these women know there's more to life than they read about elsewhere, and more and more of them are advancing to Viva.

To reach women at the top...advance to Viva.

The VIVA woman leads the life...

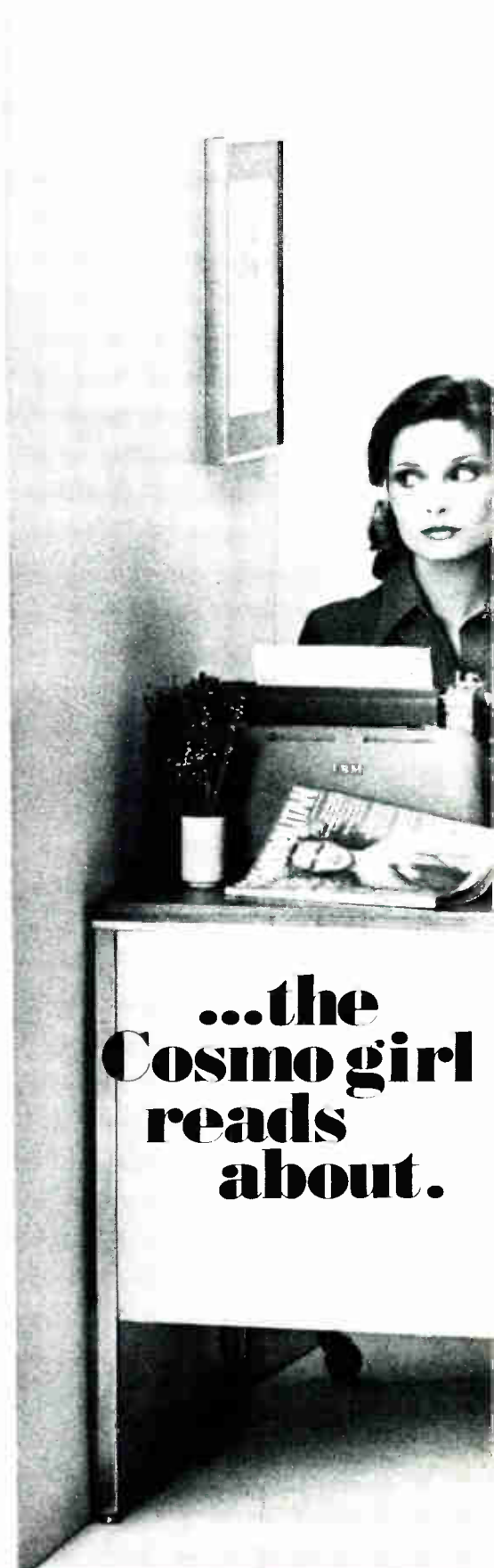

...the
Cosmo girl
reads
about.

If this is what you are looking for.

If you demand nothing less than true hi-fi performance, you'll understand the advantages and flexibility that resulted when Technics separated the basic amplifier/control/tuner functions into the five units we call the Flat Series: The automatically switchable dual IF band ST-9030 FM tuner. The SU-9070 DC preamplifier. The SH-9010 stereo parametric/graphic frequency equalizer. The SH-9020 peak/peak-hold/average metering system. And the SE-9060 stereo/mono DC power amplifier.

You'll also understand why the Flat Series challenges the performance of the most expensive professional equipment in the world. And very often surpasses it.

Look at the graphs. The reproduced waveform is virtually true to the original. All types of distortion—some measurable, some not—are negligible. And the linear frequency response is extremely wide.

We're confident that the truly discriminating critic will recognize the magnitude of our achievement. Especially when that achievement is offered at prices that are unprecedented for equipment of this caliber. And with the flexibility to incorporate one or more, or all five units into your system. Depending on your needs or budget.

To see how Technics achieved the incredible performance shown in the graphs, you have to see and compare the incredible specifications that are typical of the Technics Flat Series on the facing page.

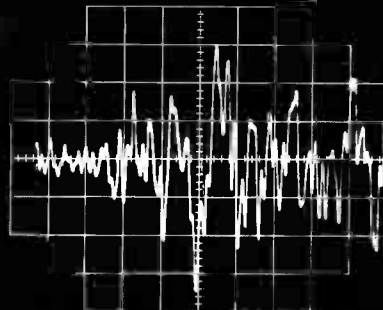

Input Waveform to ST-9030 FM tuner.

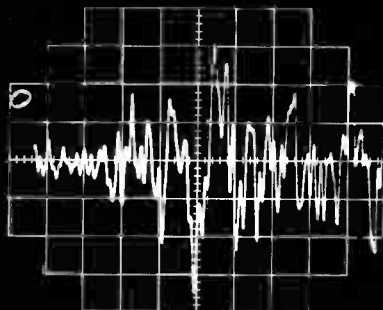

Output Waveform from Technics Flat Series.

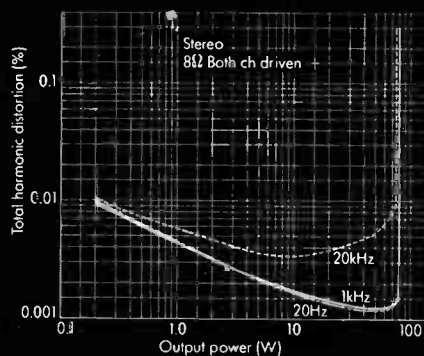

THD vs. Output Power in Stereo SE-9060.

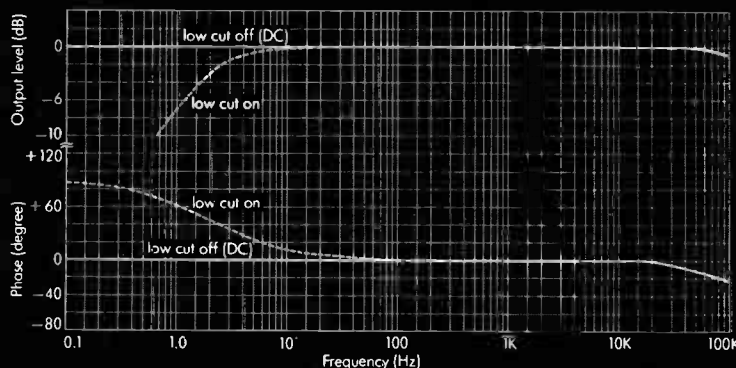

Gain, Phase vs. Frequency Response, SE-9060 Amp.

TECHNICS ST-9030, THD (stereo): Wide—0.08% (1 kHz), Narrow—0.3% (1 kHz). **S/N (stereo):** 73 dB. **FREQ. RESPONSE:** 20 Hz—18 kHz +0.1, -0.5 dB. **SELECTIVITY:** Wide—25 dB, Narrow—90 dB. **CAPTURE RATIO:** Wide—0.8 dB, Narrow—2.0 dB. **IMAGE and IF REJECTION, SPURIOUS RESPONSE (98 MHz):** 135 dB. **AM SUPPRESSION (wide):** 58 dB. **STEREO SEPARATION (1 kHz):** Wide—50 dB, Narrow—40 dB. **(10 kHz):** Wide—40dB, Narrow—30dB. **CARRIER LEAK:** Variable terminal—65 dB (19 kHz), Fixed—70 dB (19 kHz, 38 kHz).

TECHNICS SE-9060, POWER OUTPUT: 70 watts per channel (stereo), 180 watts (mono) min. RMS into 8 ohms from 20 Hz to 20 kHz with no more than 0.02% THD. **INTERMODULATION DISTORTION (60 Hz: 7 kHz, 4:1):** 0.02%. **FREQ. RESPONSE:** DC~100 kHz, +0dB, -1 dB. **POWER BANDWIDTH:** 5 Hz -50 kHz, -3 dB. **S/N:** 120 dB (IHF A). **RESIDUAL HUM & NOISE:** 100 μ V. **INPUT SENSITIVITY & IMPEDANCE:** 1V/47k Ω .

All the specifications of Technics Flat Series are too numerous and complex to list here. But their performance is too good to miss. So don't. Technics Flat Series is now available for demonstration at selected audio dealers. For very selective ears. And for very selective eyes there's Technics SH-999. A movable 19" custom rack with rosewood veneer side panels.

Technics Flat Series. A rare combination of audio technology. A new standard of audio excellence.

Technics Professional Series
by **Panasonic**

This is what you
should listen to.





Mo-Fi, Italian Style

Autosonik is a brand new name on the American highway hi fi market, but the Italian supplier of automotive electronics, speakers and accessories has already racked up a lot of mileage throughout Europe. There, the firm for the past 10 years has evolved from a specialist in kits to mount car radios to a broad aftermarket supplier.

Two years ago Autosonik took a major step forward in highway hi fi with the introduction of high-quality power loudspeakers and recently a sophisticated power booster was added.

"Autosonik tries to make their products as versatile as possible, and they can be used, with a large variety of adaptor rings and brackets, for most every foreign and American car made," says the export manager of Autosonik, located in Reggio Emilia, Italy.

Examples of this versatility cited include the production of loudspeaker terminals "double": one pair to fit Japanese cable con-

nectors; the other to fit the standard European and American cable connectors. Door loudspeakers are ingeniously equipped with a kind of "raincoat" so that condensation water cannot reach the speaker cone. Thus, loudspeaker life is guaranteed.

A sister company of Autosonik, Zendar, is specializing in the manufacture of car antennas and a complete range of antennas is available; manual, semi-automatic, fully automatic and also electronically-amplified.

New here is the presentation of a complete line of black chromium-plated antennas which fits perfectly with the black esthetics of many of today's cars.

The entire Autosonik/Zendar line can be seen during the Winter CES here in Las Vegas at Booth H-1820. For more information, contact the distributor on the west coast: Ampersand, 800-423-5167; or, on the east coast, Becker Auto-radio, 800-523-4530.

Touch-y

Nakamichi 1000 II and 700 II 3-head cassette decks are being shipped with new "touch-command" transport function controls.

The "touch" controls differ from the previous feather-touch buttons in that they are totally non-pressure-sensitive. The new 1000 II and 700 II decks respond instantly to the user's command: the lightest touch of the desired function. Transport action is positive, with no accidental triggering of an undesired function. As before, IC logic keeps operation simple and foolproof.

There is no price increase as a result of the change, and the existing Remote Controller and Digital Program Timer are fully functional with the new decks.

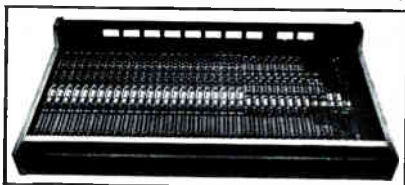

Tascam Mixer Arrives

After two years of research and development, Teac has unwrapped its big new mixer in the Tascam Series, the Model 15, a 24 in-eight out unit that features new electronics, more head room and improved sonic quality.

The model 15 was shown for the

first time at the AES meeting in New York, November 4-7. Bill Cawfield, director of product development at Teac, said the model 15 materialized out of a need for more outputs for Tascam's 80-8 and 90-16 recorder/reproducers and because feedback from the

field zeroed in on such a unit.

"The Model 15 is completely new," according to Cawfield. "It maintains the broadness of the Tascam line and is the first big board designed specifically for mass production so that the unit — again in line with general Tascam marketing philosophy — is available and affordable."

Cawfield said the sonic quality of the new mixer is faster in terms of transient response, due to the all-new electronics. "You can do many more things with the 15," he explained. "The sophisticated echo circuit, for example, can send the reverb signal to print, or the studio, or the control room." He pointed out that the Model 15 also has a great flexibility, a necessary quality for the technically expanding PA market.

The power supply is a separate unit, isolated from the mixer by up to six feet of cord, thus further reducing the possibility of hum.

Tascam national sales manager Ken Sacks said the model 15 has a nationally advertised value of less than \$9,000 (24 in, eight out) and \$7,000 (16 in, eight out).

Now you can step up to the performance of separates without overstepping your budget.

The performance of separates. That's something most people want but, up until now, couldn't afford. Now you can, with the SU-7100 integrated amp and the ST-7300 tuner.

The SU-7100 is quite a lot of integrated amp, but then we put quite a lot into it. Starting with sophisticated circuitry that's as low on noise as it is on distortion. Like a high-gain Darlington circuit to maintain low distortion levels. Like 35 watts per channel, minimum RMS into 8 ohms from 20 Hz to 20 kHz with no more than 0.1% total harmonic distortion. That's the kind of power you need to get the dynamic range you want out of your music.

It may seem complicated, but it sounds beautiful. So do pair-packed dual transistors, especially since they help keep THD down to a mere 0.1% at full-rated power, and 0.03% at half-rated power.

When it comes to your records you want to hear music...not noise. That's why the SU-7100 has a pre-amp with a two-stage, direct-coupled, low-noise phono equalizer that yields a very

impressive and very quiet 78 dB S/N ratio (2.5 mV, IHF A). Or 90 dB S/N (10 mV, IHF A).

The SU-7100 also has low-distortion main tone controls. Two-way tape dubbing. A 41-step master volume control. A or B speaker selection. And more.

That's what you get with the SU-7100 amp. What you get with our ST-7300 tuner is just as impressive. Starting with a test-signal generator for optimum FM recording level settings. And like our expensive tuners, the ST-7300 gives you flat group delay filters for high selectivity and low phase distortion. Phase Locked Loop IC's for low distortion and wide, stable stereo separation. And a zero-center and signal-strength tuning meter.

The SU-7100 and ST-7300. They're your way of turning one modest budget into two separate components.

Cabinetry is simulated wood.

Technics

by Panasonic



CANTON. A NEW PERSPECTIVE.



Visit us at CES Las Vegas, Room A-211.

Conventional marketing wisdom has it that when introducing a new speaker line, you lead off with your biggest and best and then attempt to confer the same sense of excellence on the rest of the line.

But suppose your smallest, least expensive speaker is so exceptional—so clearly different from anything else—that it demonstrates more graphically than all the rest, the kind of innovative thinking and superior technology that characterize the entire line.

What do you do then?

Introducing the Canton HC 100.

One glance at the Canton HC 100 proclaims it an original. Certainly, the visual presentation is unmistakably elegant. But it is the HC 100's remarkable performance in respect to size—a design characteristic it shares with all the other speakers in the Canton line—that will have you shaking your head in disbelief. Add smoothly extended high frequency response, excellent stereo imaging and home/auto versatility to the design mix and you have a speaker that's bound to become a classic.

Now, if Canton, Germany's immensely prestigious manufacturer of high performance loudspeaker systems, builds this kind of quality into their smallest, least expensive speaker, imagine what their more ambitious systems must be like.

But enough about us, let's talk about something more interesting, you.

For the favored few.

From any reasonable perspective, the last thing any dealer wants or needs is another over-distributed line with meaningless turn-overs and low profitability.

And we agree completely. That's why we've come up with a unique program to insure profitability by giving you what amounts to territorial exclusivity.

It's called limited production—and it works. Ask any of the quality dealers who currently carry the Canton line.

For better or worse—we think better—there just aren't that many Canton speakers made. There can't be. Not the way Canton builds them. Nor will there be that many Canton dealers either and for the same reason.

We know we can adequately supply about 100 dealers nationwide and still provide the back-up they deserve.

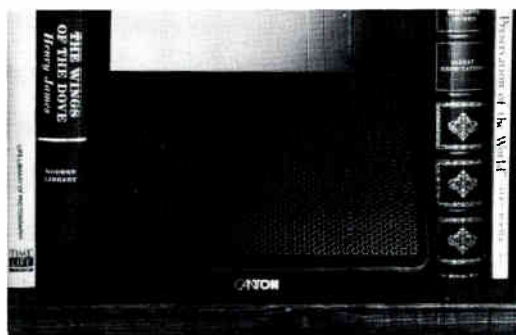

Finally, we feel bound to tell you that Canton loudspeakers are not inexpensive. This level of quality and performance doesn't come cheaply. But if you think you are a dealer who can really capitalize on this kind of program, we promise you the kind of service and support you need to operate profitably.

For additional information on Canton's new perspective, call us at (201) 828-8590. Or complete the coupon below.

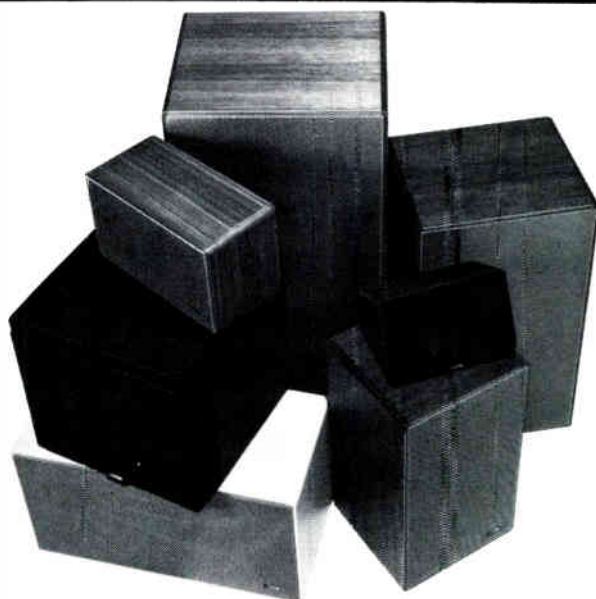

CANTON

Adcom 11A Jules Lane
New Brunswick, New Jersey 08901

Please send me additional information on Canton's
New Perspective.

Name _____

Company _____

Address _____

City _____ State _____ Zip _____

Adcom, Exclusive Distributor in U.S.A. for
Canton Electronics of West Germany.



Automatic Radio Mo-Fi

Automatic Radio is moving into the mobile hi fi market with a full line of systems and components called "Power-Sonic," including speakers in the special "Bio-Sonic" — Bio meaning power and fidelity — systems (central unit plus 60-watt amp, control box pre-amp and speakers).

The amp, APS-3240, is priced at

\$81.95, with 40 and 25-watt units also available. Preamp model PRE-3360 is for use with the 60-watt amp and is priced at \$72.95.

Extra-Curricula

Fisher Corporation is taking part in the college curriculum at Moorpark College at Moorpark, California, by donating equipment for a new course of study entitled "The Physics of High Fidelity." The course will teach traditional topics in physics and applied physics by utilizing Fisher's hardware as an educational vehicle. In addition, the students will be taught to interpret high fidelity equipment specifications so that they can make an informed choice when purchasing a home sound system. Semester enrollment in the course currently exceeds 100 students, according to Dr. Clinton D. Harper, who will direct the course.

AR's New Look

AR has a new look, if you haven't noticed. Starting with a new logo, bolder, yet elegant, the new look extends to packaging, graphics, product appearance inside and

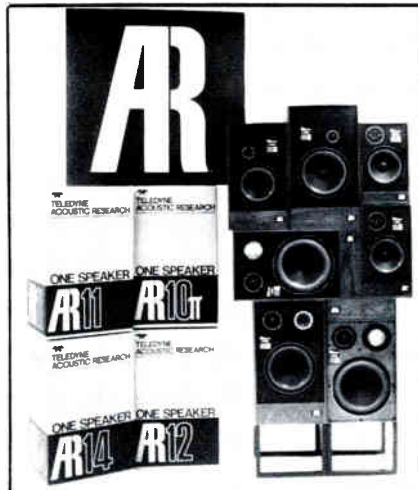

outside the grill, with brushed aluminum logo plates and serialized metal decals for identification. New catalogues, new ads, new posters, and new point-of-purchase materials round out the program.

Avid-ly Committed

Avid Corporation, the New England manufacturer of hi fi loudspeakers, audio headsets and passenger entertainment equipment, recently completed major expansion of its engineering and R & D labs at the company's main plant in East Providence, Rhode Island.

The new facilities more than double the space previously available for engineering and R & D and include new sound rooms, drafting and design labs, and model shops for speaker development. The facility also houses one of the larger anechoic chambers in the region. Company spokesmen say that the expansion evidences a major commitment to the long-term development of the company's high fidelity audio products.

The Spartan Approach

A new audio amplifier manufacturing firm was recently started in Sparta, N.J. by John R. French. The new firm, known as JRF, will feature a complete line of audio amplifiers. The approach followed in the design and manufacture of all JRF amplifiers will make use of fewer components while at the same time emphasizing reliability, serviceability and the ultimate in performance. A model 2502 Stereo Power Amplifier is the first unit being offered by JRF. It offers a simple, straightforward totally modular design. Offering 125 watts per channel, front panel gain controls and circuit breakers as well as optional VU type level meters, the 2502 is priced at \$525.

Charting A New Line

A special application and features chart has been developed by Pioneer Electronics of America for its car stereo dealers across the nation. The product slide rule includes AM/FM car stereo, 8-track, cassette and Pioneer's two CB units, 22 models in all including the new Supertuners. Features and specifications are listed for each model, and height, width and depth are conveniently and quickly spelled out. The application chart on the reverse side lists the 10 in-dash car stereo units plus six models made specifically for Chrysler, Ford and GM cars. All the units are related to 60 different makes and styles of domestic cars. The slide-rule charts are available to dealers on a first-come, first-served basis, Bill Hutcheson, Pioneer marketing and advertising manager, said.

BETWEEN THE STRIPPED DOWN MODELS AND THE EXPENSIVE PROFESSIONALS, THERE'S A TAPE DECK WITH THE BEST FEATURES OF BOTH.

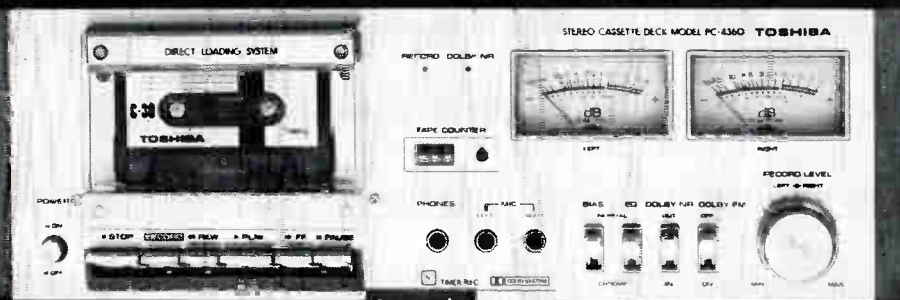

A BEST BUY
TOSHIBA
PC-4360

STUDIO QUALITY
From
rec.
S/N 59721

With most professional quality decks, you pay dearly for exotic features you'll never use—unless you're in the habit of mixing symphony orchestras, live.

But now, Toshiba makes a tape deck that delivers professional sound at a very sound price. Because it gives you only the features that a home recordist really needs.

It's our PC-4360.

Like more expensive decks, the PC-4360 features a super-quiet DC servo motor. And an advanced direct front-loading design that gives you both the feel of a reel-to-reel machine and easy access to the heads for cleaning and demagnetizing.

There's also a built-in Dolby® Noise Reduction System and FM Dolby® selector switch that cuts hiss. An Auto Play function that starts the tape after it's been rewind. An Auto Stop function that keeps the tape from snapping. Hardened Permalloy heads for super sensitivity. Cue and Review for easy editing. A metalized film condenser for low distortion. Two peak-reading level meters to prevent tape overload. Switched Bias/Equalization. Even a timer setting that lets you record a concert at home while you're out eating dinner at a restaurant.

But instead of costing a small fortune, the PC-4360 does it all for a very small investment—\$250.* It's the kind of value you'll find built into everything Toshiba makes.

TOSHIBA
In Touch with Tomorrow
Toshiba America, Inc., 280 Park Ave., New York, N.Y. 10017

*Suggested retail value solely for purpose of illustration

LETTERS

To the Editor:

In their recent memos to the audio industry, Bernie Mitchell and Jack Wayman listed various reasons why the shows they support should be supported by the manufacturers. For reasons this observer fails to understand, neither touches upon what it really takes to make any industry show successful: dealer support.

In that respect, Jack has one thing going for him. CES has always drawn dealers. And each year — under constant pressure — he has done a little more on behalf of the audio industry. Last year, he opened up McCormick Inn. This year he has promised acoustically acceptable rooms in McCormick itself, plus shuttle service to the hotels harboring the high-end hold-outs.

So at CES 1978, audio-only dealers are likely to find it easier to cover the exhibitors whose products are of special interest to them. They are also going to find a number of manufacturers covering their bets by exhibiting at both shows. (Among them, Bernie Mitchell's own company, Pioneer. Which some may consider as offering something less than "100%" support of IHFS.)

As for the IHFS, if it is to succeed, it will have to do so in the face of certain other "basic truths" beyond those listed in Bernie's memo. For example:

- Any manufacturer exhibiting at both shows will expend considerable money, time personnel and effort.

- Those coming from Europe or Asia will be inconvenienced.

- Prototypes of new models will have to be ready nearly a month earlier than usual.

- Decisions will have to be made about sales meetings — when, where and whether to hold them.

- And where and when to reveal show deals.

Then there are certain events that will have to take place in an

awkward but necessary order. First, enough manufacturers must commit themselves to exhibiting at IHFS to attract enough dealers. That commitment must be made before anyone will really know how many dealers will actually show up. Chances are that dealers who have to consider expenses, time and personnel will wait until they see for themselves which manufacturers will be exhibiting at which show, and then decide the most efficient way to cover those manufacturers.

Since the audio-only dealer is the nominal reason for holding the IHFS in the first place, it might be useful to know something about them. For example:

1. How many are there?
2. How many have usually gone to CES?
3. How many would now go to IHFS only?
4. How many would go to both shows?
5. How many would continue to go to CES only?

Unless a massive and effective research effort is made promptly, the answers are not likely to be available until both shows are behind us. And then some other answers will be known. Such as:

- The number of manufacturers who went to IHFS only and were satisfied — or not.

- The number who went to both shows and found them both worth the effort — or not.

- The number who went to CES only and found they had missed something important at IHFS — or missed nothing.

I like to assume that some of the above is what Bernie had in mind when he called in his memo for "continued open and honest discourse" about this "big, important and controversial decision" of the IHF to produce its own show in 1978.

**Joe Lesly,
President
Lesly Associates
New York, N.Y.**

To the Editor:

Charles Swift, writing "The Fear That Hangs Up Philadelphia Audio Salesmen (HFTN, October, 1977, Page 40)", poses a number of questions, the first four of which were:

1. What price range?
2. How many watts per channel?
3. What is the most important component?
4. Shall I go Quad or Stereo?

Agreeing with Mr. Swift, I'd like to add some observations gained over the past 50 years (particularly the last 30).

Starting with the third question, one successful dealer has enunciated a cliché which translated into 1977 dollars would read, "The aural difference between amplifiers costing \$400 and \$1,000 is almost negligible: The aural difference between loudspeakers costing \$400 and \$1,000 is almost startling."

Technically, the loudspeaker exhibits more kinds and higher levels of distortion at "realistic output levels" than do amplifiers. Also, loudspeakers range in efficiency from 0.03% to over 10 percent. The dealer whose cliché is quoted above set up an experiment with a speaker system of low efficiency and a 300 watt amplifier and another high efficiency system with a 10 watt amplifier. He said "as long as the demonstration material stayed in the non-dynamic realm of strings and woodwinds, there was no great lesson to be learned. After 3 bars of piano or other material of dynamic content, it was overwhelmingly evident that ten watts into the efficient speaker would put far more music into a room than the 300 watts into the low efficiency speaker.

The reasons for this are several: it can be said almost in general that the higher the efficiency, the lower the distortion (the relation is almost inverse) and the higher

(Continued on page 109)

STILL A BEST BUY.



Amazing!

More than 15 years after the AR-XA was first introduced, the AR single play manual turntable still has what it takes to earn best buy ratings among all manual turntables recently tested by two consumer research publications.

Amazing. But not surprising. Because, the original AR design is so fundamentally honest, so basically right. Today, nobody's yet been able to seriously improve on its basic design.

AR Shown here is the new AR77-XB. With all the features that have made its predecessors a legend in their time, plus additional refinements. Without cartridge approximately \$150. Fitted with Shure M91ED, approximately \$175. Full five-year turntable warranty.

If Sadat Can Do It . . .

If Sadat can go to Israel and raise the spectre of peace in the Middle East for the first time in 30 years, why can't independent U.S. hi fi dealers make love instead of war? The Palestinians of the hi fi industry, audio dealers are doomed to perpetual fratricidal price warfare unless they wake up and recognize that the "enemy" is not each other, but themselves individually and the ski and tennis manufacturers, trips to Hawaii, Porsches and maybe the emerging department stores. While "peace" both in the Mideast and here at home on the retail hi fi front may be some years away, it has long been recognized that one path to that worthy goal might be the formation of a national retail hi fi dealers' trade association. State and local trade associations for dealers have sprung up around the country in recent years, some quite effective today. If enough of these organizations appear on the local level, it is perhaps inevitable that they will lead to state, regional and, ultimately, even a national association — and voice — for the audio dealer. Toward the goal of a revived and vital dealer association in Seattle, local rep Henry Joncas recently sent a message to dealers in his market. It sums up association history in Seattle, the problems and sacrifices — as well as the rewards — of making the effort succeed. If we can be inspired to any degree by the recent extraordinary events in the Middle East, 1978 should be a year for dealers across the country to try again to achieve the elusive goal of effective association with each other.

Here is the text of the Joncas letter in full:

TO: Greater Seattle Area Stereo Component Dealers

Subject: A Proposal for Broadening Acceptance of Stereo Components

Gentlemen:

Let me make a proposal for your consideration. It has seemed to me that in recent years there has been an ever widening gap appearing between the stereo component dealers of this area. As the industry has grown and prospered this gap has seemed to widen, perhaps since everyone has more and more to do.

In the mid 60's when I owned Seattle Stereo Center one of the local dealers had the guts to get all of us together and propose that we start a local organization dedicated to broadening public knowledge and acceptance of stereo components. A magnificent goal!

We all decided it was a great idea and incorporated the "Stereo Component Dealers Association." We elected officers and met once a month at different dealers, later mostly at Seattle Radio Supply as they had the best facilities.

Did they accomplish anything? I think so. They set-up a grievance committee to handle customer complaints from disgruntled customers. They had a dinner party and gave Bill Wood an award as "Rep of the Year." They put a stereo display in the home furnishings show and made \$800 on it. That money was spent later on institutional ads promoting stereo components and the members of the association. Information was also exchanged regarding "bad check artists," audiophile professional shoppers etc.

The most important thing that happened however was that we got to know each other, quite well! We worked together, promoted the industry, helped each other out, settled law suits out of court and in

many cases developed lasting friendships where hatreds had existed before.

There is no question that all of you are very busy handling your own problems and running your own businesses. However we were as busy, even if we did not do as much business in the 60's. The point I would like to make is . . . such an organization did excellent things for us then and I believe it could do FAR MORE now!

Those of you that attended the Stanton meeting this week and had a chance to see each other, visit, get acquainted and break bread together know how interesting and productive it was.

There is no doubt in my mind that it will work and that it will prove very beneficial to each and every one of you. The possible rewards are certainly worth the efforts.

What will it take to put it together? First a desire to make it work. Also there will have to be some petty dislikes and hard feelings put aside, for to make it work it will take all of you. You should have the guys in the white hats AND the black hats included, and probably before you know it everyone will be wearing grey hats.

As a group there is a lot that we can do for the industry and for yourselves, you will all have to give a little of your talents however. And perhaps the hardest thing of all to give . . . a sincere willingness to work together!

Good luck! Think about it . . . DO IT!

Sincerely,
Henry Joncas Corporation
Henry Joncas
President

CC: Audio Sales, Everett
Bremerton Stereo, Bremerton
Bry's, Marysville
Definitive Audio, Seattle

(Continued on page 106)

Imitation is flattering, but not always good business

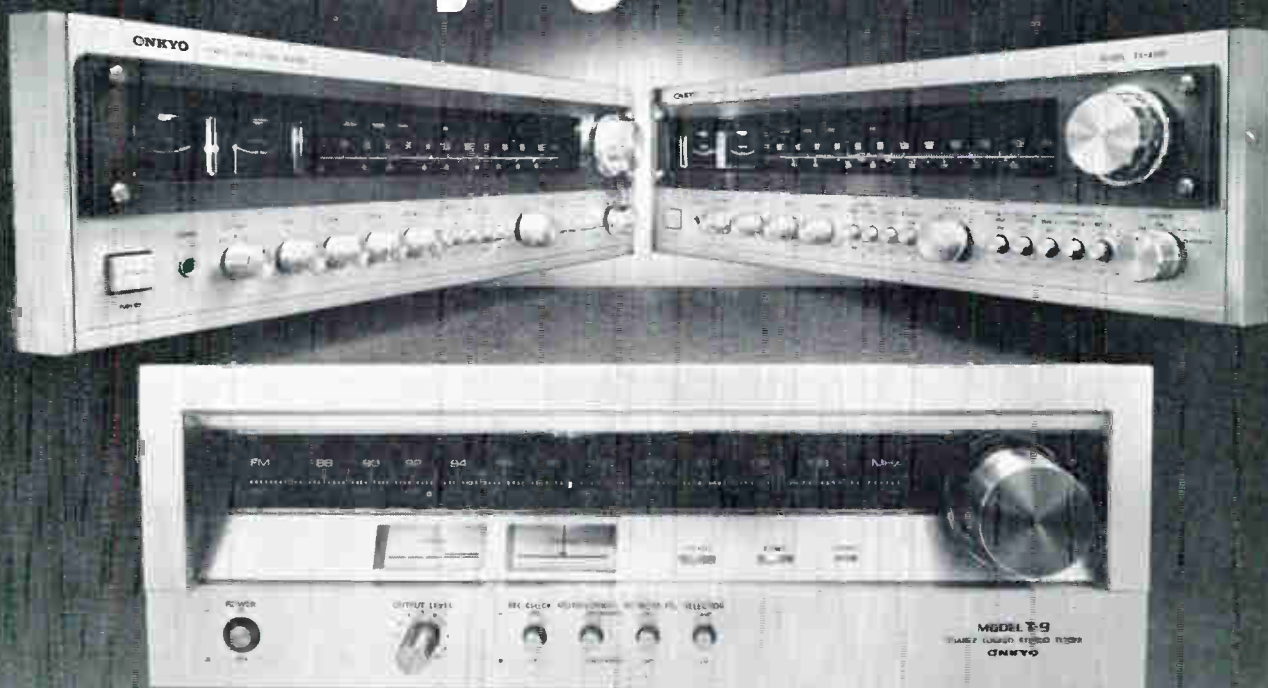

You know the impact Onkyo's Quartz-Locked Tuning System has on your sales. We know because you've sold more and more since it was introduced little more than a year ago.

It's been so successful that others are trying to get into the act. No, they're not copying us.

You might be better off if it was a copy. Then you know you'd be selling the system which Hirsch-Houck Labs said, "...was virtually impossible to mistune..."* A statement other independent labs have agreed with.

Onkyo's Quartz-Locked should be good. We had it in our labs for years before we put it on the market. That's something to think about when your customers want a system that stands up. And when you don't want warranty problems.

Because of our success with Quartz-Locked, and the reception it's got with audio fans, we're putting even more behind it this year. More advertising. More promotion.

In addition to Quartz-Locked receivers, Onkyo also has a Quartz-Locked tuner for upgrading your

audio system. But most important...more Quartz-Locked equipment coming off the drawing board now. The best way to be sure of selling the Quartz-Locked Tuning System that set the standard is to be sure you're selling Onkyo Quartz-Locked.

Perhaps it can be imitated. We doubt it can be equalled.

ONKYO QUARTZ-LOCKED AUDIO EQUIPMENT

TX-4500 Quartz-Locked AM/FM Stereo Receiver

Power output 55 watts per channel, minimum RMS at 8 ohms, both channels driven from 20 Hz to 20 kHz, with no more than 0.1% Total Harmonic Distortion.

TX-8500 Quartz-Locked AM/FM Stereo Receiver

Power output 110 watts per channel, minimum RMS at 8 ohms, both channels driven from 20 Hz to 20 kHz, with no more than 0.1% THD. Dual Power supply.

T-9 Quartz-Locked AM/FM Stereo Tuner

Dual Gate MOS FET 4-Gang Variable capacitor front end with Usable Sensitivity 1.7 μ V; 50 dB Quieting Sensitivity of 3 μ V; Harmonic Distortion: Mono 0.15%, Stereo 0.3%; Stereo Separation 40 dB at 1 kHz.

Artistry in Sound

ONKYO®

*POPULAR ELECTRONICS, AUGUST 1976

Eastern Office: 42-07 20th Avenue, Long Island City, NY 11105 (212) 728-4639

Midwest Office: 935 Sivert Drive, Wood Dale, Ill. 60191 (312) 595-2970

West Coast Distribution Center: Damark Industries, Inc., 20600 Nordhoff Street, Chatsworth, California 91311 (213) 998-6501

Canada: Sole Distributor, Tri-Tel Associates, Ltd., Willowdale, Ontario, Canada M2H 2S5

See Onkyo's Line of Quality Hi-Fi Components at their Hospitality Suite in the Sands Hotel.

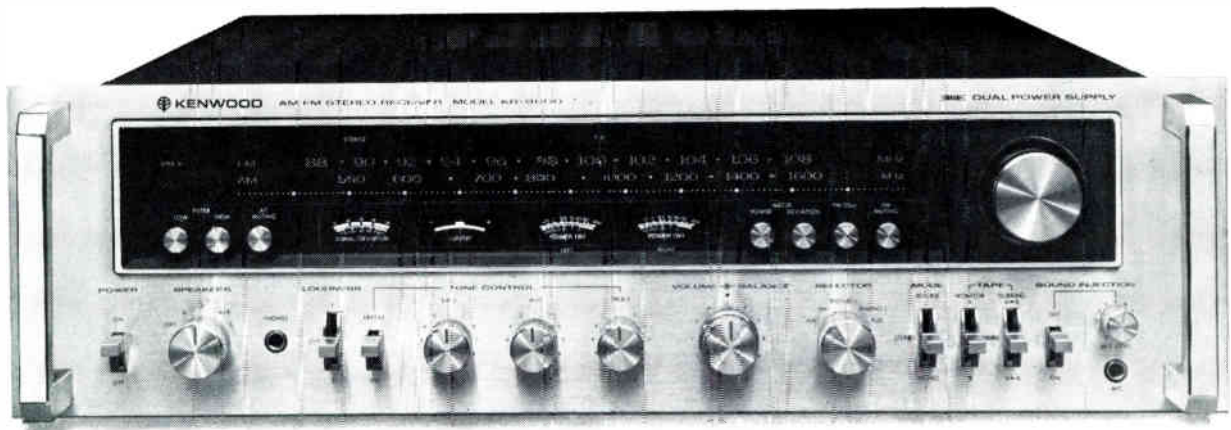

ONE GOOD THING

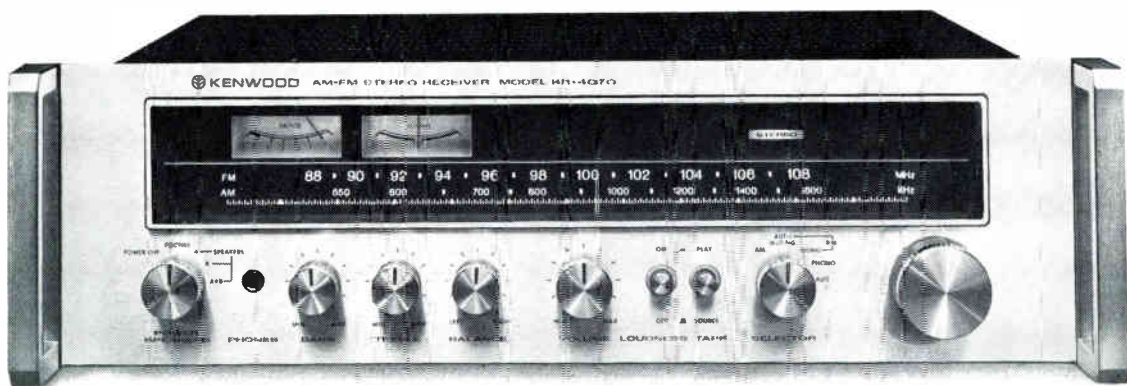

LED TO ANOTHER.

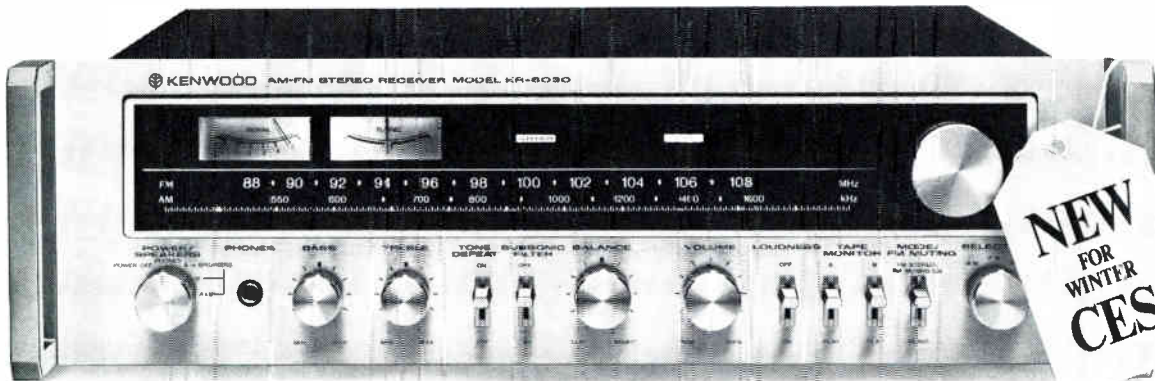

AND ANOTHER.



AND ANOTHER.

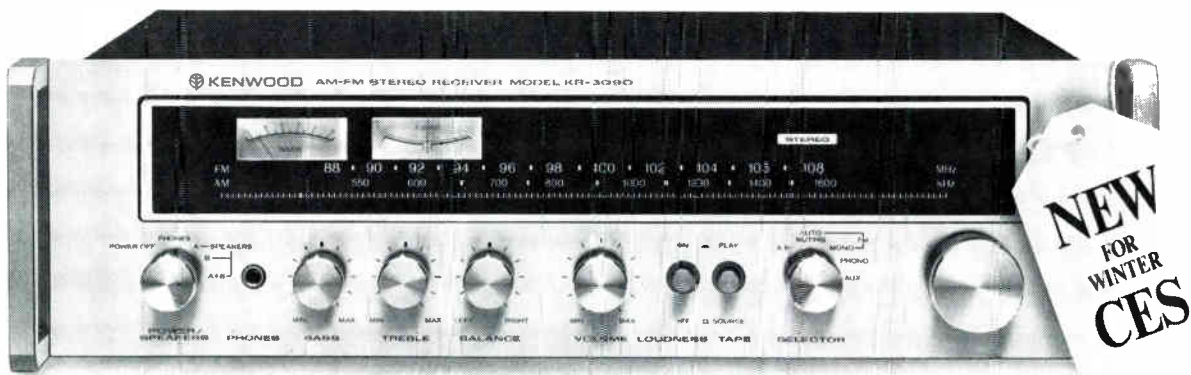

AND ANOTHER.

When we introduced the KR-9600, we knew it would set the standard for super-powered receivers.

Last June in Chicago, we introduced the KR-4070. And it's become the most popular receiver we've ever made.

The reason is simple: Both receivers deliver exceptional sound performance for an exceptionally reasonable price. With all of the features people need.

This year, we're introducing three more receivers. At three different price points to sell every one of your customers.

Come by Booth #509 and take a look. While you're there, see our new turntables, cassette decks, separates, and speakers, too.

At Kenwood, we think you can't get too much of a good thing.



KENWOOD®

1315 E. Watsoncenter Rd., Carson, CA 90745 • 75 Seaview Dr., Secaucus, N.J. 07094

Hi Fi's Close Encounters Of The Third Kind

Most of us, when we think of audio products and technology, simply relate high fidelity to electronics. Actually, ever since the birth of high fidelity, realization of good sound reproduction has depended upon a variety of related, and often unrelated technologies.

The vinyl recording disc is, after all, a product of the chemists. And so is magnetic tape, with its mylar backing and its suspended magnetic particles. Woodworking skills play their part in sound reproduction, too, as any speaker manufacturer will affirm. And there's metallurgy, thermodynamics and more.

Still, in discussing merging technologies in the world of audio today, all of these sciences seem to be coming together in ways which could not possibly have been predicted a decade or two ago.

An excellent indicator of the interrelationship between the various disciplines of electrical and electronic engineering was the merger, some years ago, of the Institute of Radio Engineers (IRE) and the American Institute of Electrical Engineers (AIEE). The coming together of these two engineering societies, to form the present IEEE (Institute of Electrical and Electronic Engineers) foretold, in a way what was to happen in the home entertainment industry.

The first crude attempts to introduce computer technology into audio products involved such seemingly simple things as applying control logic to better home tape decks. In terms of what's yet to come, such innovative products as BSR's Accutrac record play-

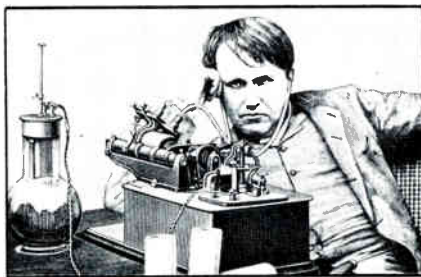

1877



1887



1948



1976

THE MARCH OF MUSICAL TIME . . . and technology: 1877 (top photo), Thomas Edison invents the first phonograph . . . 1887 (second photo from top), Emile Berliner patents first circular phonograph . . . 1948, Dr. Peter Goldmark (on left) introduces the first LP, hailing the dawn of modern high fidelity . . . 1976, the Accutrac 4000 by BSR/ADC with electronic track selection and a computerized memory bank, representing a marriage of micro-electronics, electro-optics and mechanical technologies — yet even Accutrac will seem simple in the years ahead as technologies collide and merge with increasing rapidity.

ers, for all their use of optics, digital code programing and the like, will seem simple in the years ahead.

The real "marriage" between computer technology and audio technology is only now beginning. At the recently held Audio Engineering Society Convention in New York, the big news was digital audio. Shown earlier in Japan by several firms, the digital audio tape recorder was presented to audio professionals as a product whose time had finally come. Terms such as "bits," "bytes," A/D Converters, D/A Converters — all commonly used in computer technology — are now part of the changing audio scene.

To give you some idea of what digital recording can do for audio fidelity, consider the 32-track master recording system unveiled by the 3M company just days before the AES event and subsequently demonstrated there to the audio engineering fraternity.

Here is a recording mastering system that applies coded binary pulses to specially formulated one-inch wide tape not unlike the sort of tape used for wide-band video recording. Since the recorded pulses or "bits" are of uniform amplitude, there is no problem with residual tape hiss or noise and no possibility of tape saturation. Signal-to-noise ratio becomes purely a function of the number of bits used to express each instantaneous amplitude of the audio waveform.

In a 16-bit system such as that used by 3M, the potential dynamic range possible is 96 dB! Harmonic

TNT

It'll Make Your Sales Boom

TNT is a Terrific New Trio of open reel programs from TEAC.

TNT has something big for everyone... you, your salesmen and your customers.

For you, TNT means some Terrific New Terms: a demonstrator stocking program that makes it easier than ever to sell TEAC.

For your salesmen, TNT gives them a Tempting New Target: a sweepstakes with



regional prizes and a national grand prize.

For customers, TNT is a Terrific New Tie-in: a consumer premium they get free from us when they buy an open reel tape recorder from you.

With all this help selling through, now's the time to buy in. Your TEAC rep has all the TNT details so see him soon and take advantage of a Total New Thrust in the sale of open reel tape recorders from TEAC.

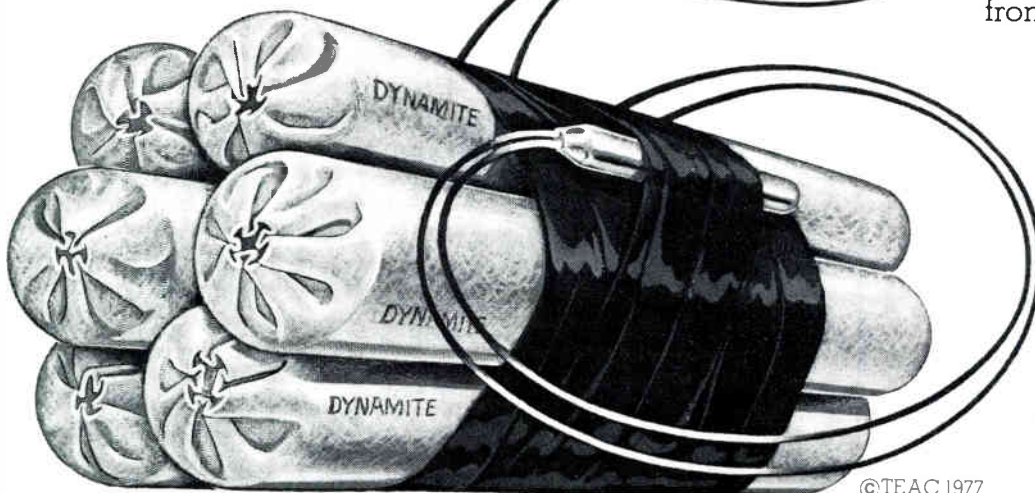

©TEAC 1977

TEAC®

First. Because they last.

TEAC Corporation of America • 7733 Telegraph Road • Montebello, California 90640 • In Canada TEAC is distributed by White Electronic Development Corporation (1966) Ltd.

Only Sherwood certifies the sound you get. Before you get it.

Sherwood Electronic Laboratories Certified Performance Series

S75 CP SERIAL NUMBER: 75 CP 701189



I certify that these are the results of my actual measurements made on the
 were made with a line voltage of 120 VAC, a fixed speaker impedance of 8 ohms
 300 ohms. All amplified measurements are made with both channels driven and an average
 reported figure.

Leonard A. Prodek
 Technician
Chancellor
 Notary Public

SHERWOOD
 Sherwood Electronic Laboratories, Inc.

Certified Performance Series

In the 25 years that we've been making receivers, we have always stood behind our products. And now we're standing in front of them too. We call it **CERTIFIED PERFORMANCE** and it's your customer's assurance that each and every Sherwood set has been individually hand-tested before it was packed. And that certification is on the **OUTSIDE** of the box, complete with a notarization and the signature of the testing engineer.

How does this help you sell more Sherwoods? By giving you a tool that no other manufacturer has. You can actually show your customers exactly what they will get in a Sherwood, because the notarized certificate of Performance spells it all out. Every Certified Sherwood receiver has been tuned to the very best specs possible, so your customer is buying the finest Sherwood available. And with our Three Year Limited Warranty, you've got them covered, coming and going. And the best proof of a great Sherwood receiver is a great Sherwood receiver, like the new 75CP.

Sherwood has made 60 separate changes in the 75CP...changes you can hear, not see. There's more power, less distortion, a vastly improved pre-amp section and remarkable distortionless tone controls. We've virtually eliminated phono overload and have made one of the finest Sherwood's you can buy. And that's just the beginning. For 1978 we have an entirely new look to our line, which you can preview at the January Las Vegas Show. Just come to the Sherwood Suite in the MGM Hotel and see for yourself what 1978 will sound like.

 **SHERWOOD We'll be there first.**

Sherwood Electronic Laboratories
4300 North California Avenue • Chicago, Illinois 60018

distortion of the recovered audio waveform is whole orders of magnitude lower than what we have come to expect from conventional, analog tape recordings — something on the order of 0.03%.

And as for wow-and-flutter, it is unmeasurable because the system borrows once more from computer technology, storing the bits in a form of computer memory and releasing them in clock-like precision using a reference "clock" (another borrowed term) to time the release of the endless stream of digital pulses for reconversion into analog audio, by means of a

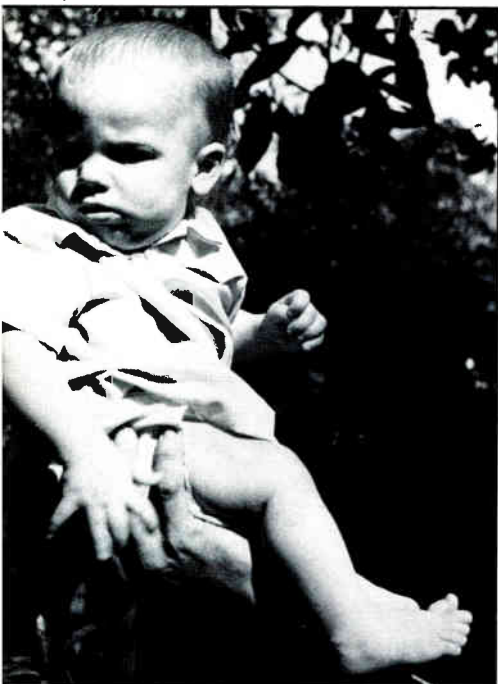

When this kid buys his first hi fi system, around 2001, it will truly be a "space age" device(s).

digital-to-analog converter (D/A).

As for frequency response, it is limited only by the rate at which the amplitude of the audio waveform is sampled. To "encode" a 20,000 Hz audio sinewave it is necessary to "sample" its amplitude at least twice — once for the positive going peak, once for the peak of opposite polarity. So, any sampling rate above 40,000 Hz will do the trick and, in the case of the 3M system, 50 kHz is used.

Nor is the computer approach to audio recording limited to professional mastering systems. Already, Sony has announced and demonstrated a compact attachment to their Betamax video tape deck

which will transform it into a PCM audio recorder. PCM stands for Pulse Code Modulation — another way of saying digital audio recording. Other companies such as Mitsubishi and Teac and Technics by Panasonic are also talking about home PCM tape decks for high quality audio recording.

Interestingly, the tape used in all of these systems is not at all like audio recording tape. It is called high-density tape and involves the same formulation technology as does video tape which must also store very dense information of wide bandwidth. So, here we see the technology of video tape recording carried over into audio, at least insofar as the software requirements are concerned.

Perhaps the most startling and exciting prototype seen at the aforementioned AES convention was a compact, self contained laser disc player. Here, again, the audio industry has taken its cue from video. It is now almost two years since MCA and Philips first demonstrated their laser-beam video disc to an eager and enthusiastic group of press people. That video disc player has yet to be marketed (and is expected to be in early 1978).

Meanwhile, as might have been expected, engineering oriented companies such as Mitsubishi Electric, Teac and Tokyo Denka of Japan have taken their cue from the video disc and have jointly developed a pulse code modulation recording system using laser beams to record and later play back high fidelity sound from a disc.

Here we see the total integration of three separate technologies and, in fact, each of the companies named was primarily responsible for one of these three areas. Mitsubishi developed the optics and the original disc. Teac handled the mechanics while both of these companies worked on the electronic circuitry and sophisticated servo systems needed to keep the tiny laser spot "tracking" an 1800 rpm revolving disc. Tokyo Denka, the third company involved, worked on making mass-produced discs from the original.

Thus far, a 30-minute polyvinyl disc has been produced, but the

companies expect to be able to extend playing time to as much as two hours (somewhat reminiscent of the way in which the original Betamax playing time has been extended from one to two hours in recent months).

Some features of the laser turntable/disc arrangement include almost "infinite" life for the disc and pickup system (since there is no physical contact between them), random access to specific sections of a recording, repeat playback, negligible wow-and-flutter, dynamic range of as much as 98 dB, frequency response from 10 Hz to 20 kHz, no distortion or tracking error, no rumble from outside vibration and no "surface noise." Mass produced PCM discs are expected to be no more expensive than current "analog" vinyl discs but, in time, could prove to be considerably less expensive to produce.

The microprocessor, that incredible "mini-computer on a chip," offers promise of hastening the day when computers will run many of our household appliances, pay our bills and keep our checkbooks balanced. The usefulness of these devices has not gone unnoticed by innovative engineering teams in the audio industry.

Witness, for example, the new Sherwood Micro CPU/100 tuner. Those readers who have seen it in operation are probably aware of its station-call-letter programmability as well as its other accurate and wondrous tuning features. What you probably did not know is that the insertion of one or more programmed IC's in certain sockets on its computer board can actually cause this instrument to analyze its own performance — even providing a readout (in schematic symbols) of any defective IC's in its complex circuitry.

Sharp (Optonica) has shown how cassette deck performance and convenience can be improved. One of their new decks has a calculator-like keyboard right on its front panel by means of which specific selections in a multi-selection cassette tape can be programmed to play in preferred sequence. Here again, the microprocessor crosses over from the world

(Continued on page 106)



Music you never knew was there.

There are probably beautiful musical passages on many of your records that you've never heard. And you never will, unless your cartridge is sensitive enough to clearly reveal all the subtle harmonics within the audio spectrum.

Today's sophisticated "direct to disc" technology has raised the quality of disc recording to a new state of the art. You need a cartridge that does justice to these fine recordings: an ADC cartridge. With an ADC cartridge, you will find the state of the art has been brought almost to the state of perfection.

Long known by audiophiles for incredibly pure sound reproduction, ADC cartridges have also proven their amazingly low record wear. This year, they have even surpassed themselves.

First, there's the remarkable new ZLM with the unique ALIPTIC stylus. It combines the better stereo reproduction of the

elliptical stylus shape with the longer, lower wearing, vertical bearing radius of the Shibata shape. As a result, sound reproduction is completely transparent and clean. Individual instrument placement is more easily identifiable. And frequency response is ruler flat $\pm 1\text{dB}$ to 20kHz and $\pm 1\frac{1}{2}\text{dB}$ to 26kHz . It tracks at $\frac{1}{2}$ to $1\frac{1}{4}$ grams.

Then there's the new XLM MK III with the same reduced mass, tapered cantilever but with a true elliptical shaped nude diamond tip. It has 50% lower mass than our previously lowest mass XLM MK II. It tracks at $\frac{3}{4}$ - $1\frac{1}{2}$ grams.

The QLM 36 MK III with the innovative Diasa elliptical nude tip also has excellent frequency response, wide separation, and an incredibly clean sound. It also tracks at $\frac{3}{4}$ - $1\frac{1}{2}$ grams.

The QLM 34 MK III offers elliptical shape and tracks as low as

1 gram with flat response out to $20\text{kHz} \pm 2\text{dB}$.

The QLM 32 MK III is a 2-4 gram elliptical with great sound. It's one of the best budget ellipticals around.

And ideal for automatic changers, the QLM 30 MK III is a 3-5 gram conical stylus that's compatible with a wide range of stereo equipment.

See the complete line of ADC cartridges and tonearms at Las Vegas, Booth 703.



A BSR Company
Audio Dynamics Corporation
Pickett District Road
New Milford, Conn. 06776

Another exclusive from the experts in cassette decks:

Synchro-

AIWA introduces a new turntable and cassette deck perfectly synchronized for ultimate recording quality.

Taken individually, the new AD-6400 Cassette Deck and AP-2200 Turntable from AIWA are unmatched in design, engineering and performance... just what you'd expect from AIWA. Put them together and you get Synchro-recording. A performance function you can't expect from anyone else.

Synchro-recording means that the deck and turntable are perfectly synchronized to maximize recording quality. AIWA designed them that way. And it's easy to use. While in the record

mode just depress the pause key on the AD-6400, lower the tone arm on the AP-2200 and you're recording. The instant the tone arm is lowered, recording begins... automatically. No hesitation, no problems... no sweat. It's simple... most good ideas are.

The New AIWA AD-6400 Cassette Deck is loaded with other high-performance features like 2 step peak reading L.E.D.s. Dolby* noise reduction, oil-damped ejection and key return, bias fine adjustment to give optimum performance with any brand of LH tape available and a wow and flutter of only 0.05% (WRMS).



*Dolby is a trademark of Dolby Laboratories, Inc.

recording

The **AIWA AP-2200 Turntable** features convenient front controls, S-type tone arm with oil-damped cueing, front-adjustment, anti-skating, a space-saving hinged dust cover and an inorganic compound resin base that eliminates howl and feedback. And the AP-2200 rests on insulator feet that satisfy any shelf size.

The AP-2200 is designed to provide Synchro-recording with these great AIWA cassette decks, too:

The AIWA AD-6550 Cassette Deck with wow and flutter of only 0.05% (WRMS), and bias fine adjustment. Plus a remaining tape time meter that lets you know exactly how much tape you have left.

The AIWA AD-6800, AIWA's Super Deck—The AD-6800 provides Synchro-recording and every feature you could want in a high-quality, high performance cassette deck including automatic cassette loading, advanced double needle metering, flat response tuning system (FRTS) and built-in 400 Hz and 8kHz mixed oscillator. The AD-6800 will precisely measure the bias of any cassette tape on the market today. And lots more.

Synchro-recording—another reason to think of AIWA if you're serious about cassette decks.

See us at BOOTH 403 Las Vegas Convention Center.

AIWA[®]

If you're serious about cassette decks.

Distributed in the U.S. by: **MERITON ELECTRONICS INC.**,
35 Oxford Drive, Moonachie, N.J. 07074

Distributed in Canada by: **SHRIRO (CANADA) LTD.**



A Guide To The Video Revolution

Moving into any new product category can be a mildly traumatic experience for even the most seasoned retailer, but the plunge into video now being contemplated by many audio dealers is turning into an absolutely terrifying ordeal for some.

The two fields are seemingly unrelated, with different customers, different merchandising requirements, different pricing structures and — in many cases — different suppliers. In addition, taking on a line of video products presents the audio dealer with added expenses in setting up display areas, training salesmen and developing promotion and advertising campaigns.

Then why do it? Because, say many video suppliers and a significant number of audio dealers already heavily involved in video, the two areas aren't really that widely separated. Unlike other non-audio consumer electronic products, video requires the kind of merchandising, sales and display expertise which audio retailers have successfully applied to the hi fi field.

With video cassette recorder (VCR) systems, in particular, many in the infant video industry see the audio retailer becoming as potent a force in the market as TV specialists, appliance-TV outlets, department stores and mass merchants. They also see a bright future for audio retailers in projection TV, and — to a lesser degree — in the programmable game field.

"Video in the mid 1970s is where stereo was in the late 1950s," says one executive in the video field. "Right now, video products appeal to a limited audience of video freaks or videophiles, similar to the audiophile of 15 to 20 years ago. Obviously, it won't take video as long as it did audio to become a

mass-market product, and it's already happening. But it's still a relatively sophisticated field — with high tickets and healthy margins — and it's something the audio dealer can apply his specific kind of knowledge to selling."

At this point, most activity in the video field is focused on the video cassette, which is the fastest-growing and has the best short-term potential of all new video products. Although there is some confusion over actual VCR sales, the industry generally agrees that 1977 saw unit sales of 125,000-150,000, and that 1978 will witness a growth to around the 500,000-600,000 mark (some put the figure as high as 750,000). If industry forecasts hold true, total sales will climb to around 850,000 units in 1979 and hit the 1.25 million mark in 1980.

As the accompanying chart indicates, there are now at least 20 different suppliers (including national catalog retailers) either in the VCR market, or making plans to enter the field. This doesn't mean that the retailer shopping around for a VCR line is faced with 20 separate systems from which to select, however. In fact, the decision involves only four basic formats; of these, just two are seen emerging as dominant systems in the U.S. market.

Those two are the Beta format developed by Sony and the VHS (Video Home System) format developed by Matsushita. By the end of 1977, five suppliers (including Sears) had committed themselves to U.S. marketing of Beta-format systems. Two others — Aiwa and Pioneer — have adopted the Beta system, but U.S. marketing plans of both firms remain indefinite. Several other audio producers have indicated an interest in the VCR concept, but so far only Akai has committed itself

to a specific format (VHS). Zenith is the only major U.S. TV manufacturer to embrace the Beta configuration, and the majority of other TV producers has chosen VHS.

Although Sony actually pioneered the concept of a home video cassette recorder deck with its original one-hour Betamax, all Beta systems now being marketed are two-hour models (a few one-hour Sony closeouts may still be in the pipelines, but not enough to exert an influence on market developments). Sony fell behind in the playing-time battle when various U.S. marketers began introducing the four-hour VHS system developed by Matsushita, but the firm expects to introduce a three-hour tape sometime this spring. Using an optional automatic one-cassette changer (about \$100) scheduled to be available at the end of 1977, Beta VCR decks effectively become six-hour systems.

Even if it wasn't the first VCR deck on the U.S. market, the VHS format is already playing a leading role in the furious video competition — primarily due to the entry of powerhouse RCA into the field with a VHS deck. While some VHS decks — including RCA's — have a four-hour playing time, without the need for a separate changer, a few firms are offering two-hour versions (VHS playing times are indicated by "VHS-2" or "VHS-4" headings in the table of suppliers). Late in November, however, JVC was set to announce a new tape which would extend the playing time of its two-hour VHS to three hours, a development which logically should provide six hours of playing time for four-hour VHS units.

So far, 12 suppliers have adopted the VHS format with specific plans for U.S. marketing (including Montgomery Ward and

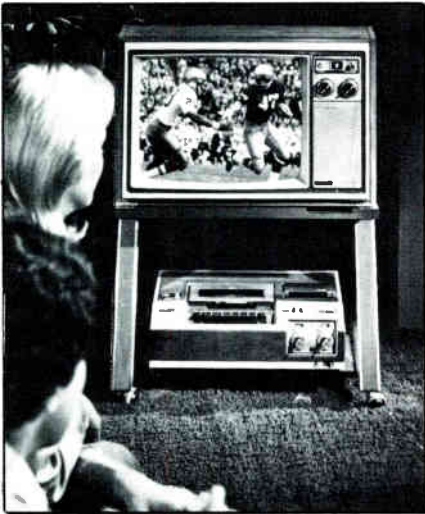

Magnavox 4-hour VHS



Toshiba color camera/power supply



Sony 2-hour Betamax with changer



Panasonic VHS

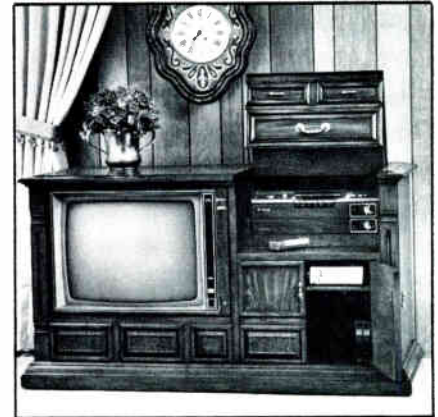

Zenith Beta-format



Toshiba Beta-format



RCA 4-hour, VHS; accessories



Sanyo V-Cord II



Zenith Beta-format



Sylvania VHS

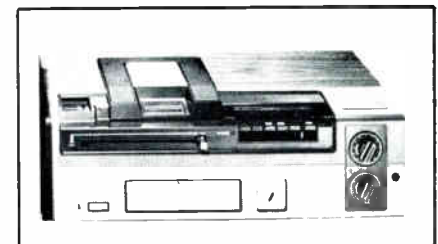

Quasar VX-2000

See chart on next page for pricing and additional specs on units shown here.

VIDEO CASSETTE RECORDERS GUIDE TO U.S. SUPPLIERS

Brand Name	List Price	Format	Availability	Manufacturer
Aiwa	Not set	Beta	Not set	Sony
Akai	Not set	VHS	Late '78	Sony
GE	Not set	VHS-4	Spring '78	Matsushita
Hitachi	Not set	VHS-2	Mid '78	Hitachi
JVC	\$1,280	VHS-2	Now	JVC
Magnavox	\$1,075- \$1,095	VHS-4	Now	Matsushita
Mathes	\$2,400	VHS-4	Now	Matsushita
(Curtis)		(console w/TV)		(VCR deck only)
Mathes	\$2,900	VHS-4	Now	Matsushita
(Curtis)		(console w/TV)		(VCR deck only)
Montgomery Ward	\$995	VHS-4	Now	Matsushita (sold under Panasonic name)
MGA	Open	VHS-2	Now	JVC
Panasonic	\$1,095	VHS-4	Now	Matsushita
Penney	\$1,000	VHS-4	Now	Matsushita (sold under RCA name)
Pioneer	Not set	Beta	Not set	Sony
Quasar	\$995	VX-2000	Now	Matsushita
RCA	\$1,000	VHS-4	Now	Matsushita
Sanyo	\$1,050	V-Cord II	Now	Sanyo
Sanyo	—	Beta	Now	Sanyo
Sears	\$995	Beta	Some markets now; national mid '78	Sanyo
Sharp	Not set	VHS-2	Not set	JVC
Sony	\$1,095	Beta	Now	Sony
Sylvania	\$1,095	VHS-4	Now	Matsushita
Toshiba	\$1,095	Beta	Now	Sony (Toshiba in '78)
Zenith	\$995	Beta	Now	Sony
Zenith	\$2,400	Beta (console w/TV)	Now	Sony (VCR deck only)

Penney), but in some cases, exact introduction dates have not yet been established.

Two other formats are also being sold in the U.S. One is the VX-2000, developed earlier by Matsushita and now being marketed through its Quasar (formerly Motorola) subsidiary. Called "The Great Time Machine," Quasar's system was actually the first competitor to the Betamax concept, and has been available in the U.S. for well over a year. The VX-2000 does not have widespread support as a basic format, however, and Quasar is seen as eventually introducing a VHS deck of its own. Whether this means the VX-2000 will be closed out, or used as a lower-priced leader for the VHS, isn't clear.

The fourth format is Sanyo's V-

Cord II system. Sanyo has also adopted the Beta format, and — like Quasar — its eventual plans for the V-Cord II are unknown. It's unlikely that any other VCR suppliers will adopt the V-Cord format, and both it and VX-2000 will unquestionably play secondary roles — if they play any at all — to the Beta and VHS formats.

As with other new product categories, the pricing situation in VCR has been nothing short of chaotic. In the beginning, Sony established \$1,300 as the suggested list price for its one-hour Betamax and carried the price over to the two-hour version introduced last year. Those other VCR suppliers who signed with Sony for the Beta format either implied, or openly said, that they would follow suit.

Then came RCA. When it took the wraps off the VHS system last August, it also took the wraps off a price that sent shockwaves through the VCR industry — \$1,000. Those suppliers who had already announced VHS prices (such as JVC, which had earlier introduced its version at \$1,280) stuck by their original prices, but most quickly made it clear to retail accounts that enough promotional support would be available so that RCA's price could be matched.

Meanwhile, Quasar — which at \$995 had the lowest suggested price to that point — lowered its dealer costs to the point where a \$795 price became possible. The next major price move came from Zenith, which quickly discovered that a \$1,300 suggested list price

THIS IS THE TIME OF YEAR WHEN PIONEER'S SALES PEOPLE NEVER SEE THEIR WIVES OR KIDS. BUT THEY HAVE PLENTY OF TIME FOR YOU.

Our reps, regional managers and even Pioneer's president will hardly be home this month. During January, they're married to the business.

They'll have dealer showings in 32 cities. Demonstrating new products. Discussing marketing plans. Previewing the new national ad campaign. Setting up local promotions. Giving and getting advice. If you're a Pioneer dealer you know it's vital that you set aside a few hours to attend the meeting in your area.

If we're willing to leave our families, surely you can get away from the store.

High Fidelity Components
PIONEER
WE BRING IT BACK ALIVE.

U.S. Pioneer Electronics Corp.
85 Oxford Drive, Moonachie, NJ 07074 Tel: (201) 440-8100
Midwest: 737 Fargo Ave., Elk Grove Village, IL 60007 Tel: (312) 593-2960
Texas District: 1875 Walnut Hill Lane, Irving, TX 75061 Tel: (214) 258-0200

February 5-6
Bazar Sales Co.
Sheffield House
Anchorage, Alaska

19 JANUARY 78

MONDAY	TUESDAY	WEDNESDAY	THURSDAY	FRIDAY	SATURDAY
1	2 Jan 3-4 Taylor Marketing Waldorf Astoria New York City	3	4	5	6
8 Jan 9-10 Capitol Audio Mandeville Hotel Washington, D.C. Jan 9-11 J. M. Flora, Inc. Tro, Michigan	9 Jan 10 L. J. Paul & Assoc. The Warwick Houston, Texas	10	11	12 Jan 12-13 Stan Clothier Co Rodeway Inn Bloomington, Minn.	13 Jan 13 L. J. Paul & Assoc. The Registry Dallas, Texas
15 Jan 15 Electronics B & B Electronics Hilton Harvest House Boulder, Colorado Jan 15-16 J. Thornton & Co. Hwy 1 Resency Hotel San Francisco, Calif.	16 Jan 15-16 Grossman Sales Sonesta Hotel Boston, Mass. Jan 16 L. J. Paul & Assoc. The Hilton Hotel Oklahoma City, OK	17 Jan 15-17 Markeal Sales Corp. Sheraton, North Shore Northbrook, Ill. Jan 17 Carolina Marketing Roadway Inn Charlotte, N.C.	18 Jan 18 E. P. Turner Assoc. Sheraton Inn (Airport) Atlanta, Ga. Jan 18 J. Thornton & Co. Red Lion Inn Sacramento, Calif.	19 Jan 18-19 Gateway Audio Stan Musial Hilton Inn St. Louis, Mo. Jan 19 B & B Electronics Little Lake City Wah.	20 Jan 21, 22 G. D. S. Marketing Sheraton Universal Hotel North Hollywood, Calif.
22 Jan 22 DePill's Assoc. Sheraton Valley Forge King of Prussia, Pa. Jan 22-23 Moeller/Pickett Alameda Plaza Kansas City, Mo.	23 Jan 22-24 Astro Sales Howard Johnson's Monroeville, Pa. Jan 23 Pastory Hunter Sheraton Syracuse, N.Y.	24 Jan 24-25 J. Belusko Co. Double Tree Inn Tukwila, Wash. Jan 24-25 L. J. Paul & Assoc. Sheraton Crest Inn Austin, Texas	25 Jan 25 Sunshine Audio Sheraton Airport Orlando, Florida	26 Jan 26-27 Astro Sales Sharonville Hilton Cincinnati, Ohio	27 Jan 27 J. Belusko Co. Travelodge Coliseum Portland, Oregon Jan 27 L. J. Paul & Assoc. Hilton New Orleans, La.
29 Jan 29 Moeller/Pickett Granada Royale Omaha, Nebraska Jan 29-30 Bazar Sales Co. 875 Weimara St Suite 610 Honolulu, Hawaii	30 Jan 29-30 Cardinal Sales Hilton Airport Indianapolis, Ind. Jan 30 L. J. Paul & Assoc. The Sheraton Little Rock, Ark.	31			

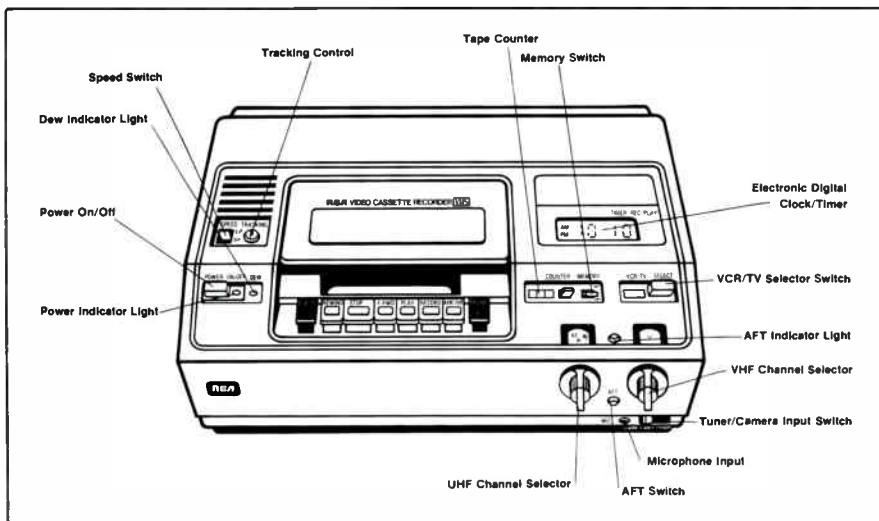

Feature controls on RCA's VHS deck.

was a definite liability in the competition with its arch rival, RCA. In November, Zenith dropped its price to \$995 (at the same time chopping \$200 off a deluxe console/VCR combination unit originally introduced at \$2,600), and Sony soon followed with its own reduction — to \$1,095. The \$1,300 Beta price finally disappeared completely late in November when Toshiba followed Sony's lead and cut its Beta price to \$1,095.

Although there will undoubtedly be other price moves in the future, the situation seems to have cooled off temporarily. What it all means is a raft of different suggested list prices but two basic price points — \$995 for Beta, VHS systems and V-Cord II, and \$795 for the Quasar VX-2000. (Late in 1977, VHS and Beta prices in the \$850-\$950 range were showing up in scattered locations around the country.) With all this price cutting, retail margins have been kept at comparatively healthy levels (20-30%) through strong price and promotional support from suppliers, including some very attractive rebate programs.

Even though most VCR suppliers have determined that the recording of TV programs for later viewing is the primary selling point of VCRs, virtually all are making cameras available. In general, black-and-white cameras are being offered with suggested list prices in the \$300 to \$400 range. Several are also offering, or planning to offer, color cameras. At this

point, they carry suggested prices higher than the VCR decks themselves; Toshiba's, for instance, is \$1,700.

Other accessories include the Beta changer mentioned above (which has a 10-12-second changing time), and Beta timers. Timers are included in the price of most Beta-format systems, but can also be purchased separately. VHS decks come with built-in digital LED timers.

Although not accessories, blank video cassette tapes are also available from every supplier in the VCR field. At this point, VHS tapes are generally priced this way: 4-hour, \$20-\$25; 2-hour, \$15-\$18. Beta tapes: 2-hour, \$16-\$18; 1-hour, \$12-\$13. The blank tape field is seen by most in the field as offering the retailer attractive add-on sales, and if current market research is accurate, VCR owners will be coming back for plenty of tapes after they buy the VCR. One study says the average buyer will part with an additional \$500 for blank tapes during the first year of VCR ownership.

As with VCR, many in the video field believe the audio dealer is naturally suited to sell projection TV. But the projection industry remains fragmented, with a bewildering variety of different systems, prices and product styling now available. A recent survey of the projection field showed just under 60 firms in the field, offering a total of over 160 separate models.

Many of these are regional firms. Since the field is so confused at the moment, laying down any specific guidelines on pricing, product characteristics or manufacturer policies, is virtually impossible. A few national firms, offering the dealer solid promotional support and servicing programs, are in the projection field, including Advent, Magnavision, MGA, Muntz, Panasonic, ProjectaVision, Sega, Sony and others.

In addition, the first major American TV maker — General Electric — is believed on the verge of entering the field with an under-\$2,000 system, and that development — combined with the activities of several major Japanese companies — could give projection a maturity it desperately needs.

Many audio retailers shied away from the game concept when the first generation of products quickly fell victim to a vicious round of price slashing and below-cost discounting. But a number of dealers are now adding second-generation programmable games, partly because they tie in easily with other new video systems and partly because they offer the retailer a reasonable profit margin.

At the same time, many audio dealers say they are offering a limited selection of programmable games to get a foot in the door; when even more complex and higher-priced units come along, they want to be ready to sell them. "Complex games appeal to the kind of sophisticated customer who shops for audio here," says one audio dealer. "The more sophisticated and complex they become, the more they will appeal to that customer."

Although a few new ones may pop up here at the winter CES, the programmable market is now owned by five companies, each of which offers a single model: Atari, Video Computer System, \$189; Bally, Bally Professional Arcade, \$299; RCA, Studio II, \$150; Fairchild, Video Entertainment System, \$170; Coleco, Telstar Arcade, \$99.

Discussion of video discs was saved for last simply because — despite an enormous amount of



Yes, the new Dual 604 at \$250*
is direct drive.

Now let's talk about something
that's really important.

You may have noticed that most turntable stories begin and end with the drive system. The tonearm is more or less an afterthought.

But not with Dual. Because the tonearm can make a big difference in how records sound and how long they last. Which is why Dual is very serious about tonearm design and performance. And why we can be very serious about tonearms in our advertising.

Let's consider the 604 tonearm.

The straight-line tubular design provides maximum rigidity with minimum mass. The four-point gimbal centers and pivots the tonearm precisely where the vertical and horizontal axes intersect. And the counter-balance houses two specially-tuned anti-resonance filters that absorb parasitic resonances originating in the tonearm/cartridge system and chassis.

Operation is semi-automatic, with another unique Dual difference: the mechanical sensor. Switch it in and you feel when the stylus is positioned precisely over the 12" and 7" lead-in grooves. At the end of play, the tonearm lifts and returns to its post, and the motor shuts off. Automatically.

Now let's talk about the direct-drive system. It employs a newly developed DC electronic motor, with speed regulated by a C-MOS IC and digital reference circuit. Speed accuracy is within 0.001 percent. Wow and flutter are less than 0.03 percent, rumble better than 70 dB. As with any great drive system, that's far beyond audibility.

But the important story with any turntable is simply this. The drive system merely turns the record. It's the tonearm that plays it.



For the life of your records.

* Actual resale prices are determined individually by and at the sole discretion of authorized Dual dealers.

publicity in both the trade and consumer press — it's a product which doesn't yet exist. Every week seems to bring forth some dramatic new technical development or marketing scheme, but so far not a single video disc player has shown up on the consumer market.

The two major competitors for the U.S. video disc market (if there turns out to be a video disc market) are RCA and Magnavox. RCA recently postponed its disc

marketing plans indefinitely. Magnavox, which hopes to market a system developed by its parent company Philips of Holland, is scheduled to introduce its disc player sometime early in 1978. Since disc introduction dates have been postponed, delayed and revised so many times in the past, however, the video disc is obviously still a product whose time simply hasn't arrived (see separate story on U.S. Pioneer's video/disc plans and timetable).

Survey Shows Strong Role For Hi Fi Dealers In Video Revolution

A survey by Sharp Electronics Corporation reveals that the TV departments of mass merchandisers and department stores, along with appliance stores, will join high fidelity specialty shops as the most likely places through which home VTR will be sold.

The survey was conducted under the supervision of Robert Garbutt, manager of Sharp's professional products department, and Robert Whitehouse, Sharp's national sales and merchandising manager-video products.

According to Garbutt, the survey showed that 92 per cent of the department stores and mass merchandisers questioned were selling home VTR in the television department. "The feeling was that their present television buyer and TV merchandising group had a good relationship already going with the VTR manufacturer," he said.

Garbutt reported that a very significant reason given by many stores questioned was that they were handling wide screened television projectors and TV games, and the addition of home VTR to the department offers an opportunity to form a more advanced

consumer entertainment department.

Garbutt said the study also showed that in many of the stores, television salesmen were on commission and that there was strong feeling that commissioned workers were better motivated to handle VTR.

It came as something of a surprise to Sharp that interest in home VTR ran so strong among hi fi specialty dealers. "Many of the better hi fi shops are handling or are interested in handling home VTR," Garbutt said.

"Some felt their customers were accustomed to spending large dollar amounts for home entertainment systems, and that home VTR was a natural extension of their product lines," he said.

Garbutt reported these high fidelity stores also felt that their sales personnel were better equipped to market home VTR because the very nature of the business requires sales personnel to learn and be able to discuss the technical aspects of the equipment they sell. "The hi fidelity salesman must know how one system compares to the other, and why they are representing one over the other," he said.

Pioneer's Videodisc On The Way — Maybe by '80

U.S. Pioneer president Bernie Mitchell says his company's joint venture with MCA (Universal-Pioneer) could begin producing videodisc hardware for the consumer market by 1980, with a commercial product likely to debut this year. He predicted videodisc software and possibly hardware would be less expensive, ultimately, than VCR.

"That doesn't mean we will opt to do that, but we will be able to, and I think that we will opt to," Mitchell said, cautioning that introductory timetables have not been cast in concrete and suggesting that dealers "shouldn't start sweeping out the corner and getting ready for it."

The tentative timetable, well behind the explosion of home videocassette recorders hitting the market today, "will not hurt the chances for success of the videodisc," Mitchell predicted. "I think the two products are tremendously compatible and I think that'll help."

Mitchell made several points in a recent interview about the potential both of the videodisc and home VCR systems. "When you start fooling around with the potential of videodisc, it's absolutely incredible," he said. "You can put the entire New York telephone book on one disc. Distribution of information rapidly, easily and inexpensively is better with videodisc than with videotape. For example, say you want to mount a widget differently, change the procedure, and tell 15,000 dealers about it all over the country. You can cut a disc and send it out and it would be infinitely cheaper than it would be to send out a videocassette."

Mitchell also expressed concern about the video tape piracy issue. "I think this entertainment phenomenon we are delivering has to provide revenue for the artist. If it doesn't our success can destroy us, by collapsing the artistic base of our industry."

THERE'S JUST ONE WORD FOR THE CES SHOW:

QUANTA^{T.M.}

Of all the product lines you see at the show, there's one to remember: the new Quanta line from BSR.

It's a new idea in total turntables, a combination of brains and beauty.

The styling and technology say it's expensive, but the price says it's not. Only BSR could deliver the value your customers will get in the Quanta line.

You have to hear and see it to believe it.

And while you're having a look at the new Quanta line ask about our exciting new programs and promotions then, say hello to our new BSR Management Group: John Hollands, Chairman of the Board; Charley Sweeney, President; Vic Amador, President BSR Consumer Products; and Jack McMurray, V.P., National Sales Manager.

Not only do we have the Quanta Line that's a mover, we have the organization to move it!



Las Vegas
Booth 703

Bib®

New in America!

proudly presents England's largest-selling record & tape deck cleaners

Dealers in America now have the opportunity to offer this same fine equipment to their customers.

Anti-static cleaner — cleans 2 ways

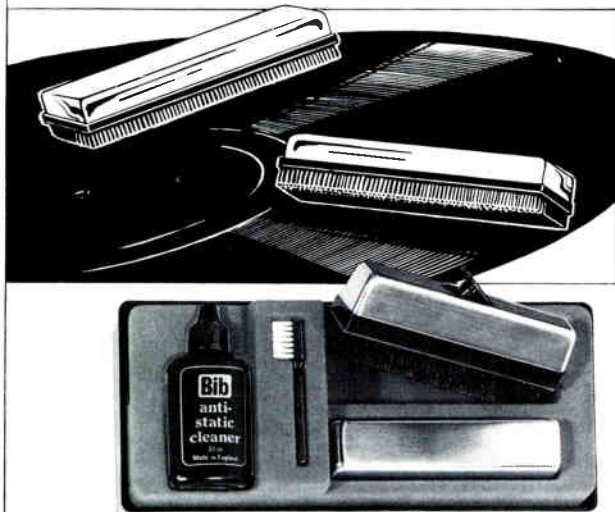

Different from all other disc cleaners on the market is Bib's exclusive two-way action . . . a fine bristled brush gently lifts the dirt out of the grooves while a velvet buffer, humidified with the gentlest touch of anti-static cleaner removes the dirt from the surface of the record, all in one easy motion. Solid stainless steel. List price \$15.00

A unique tape-head maintenance kit

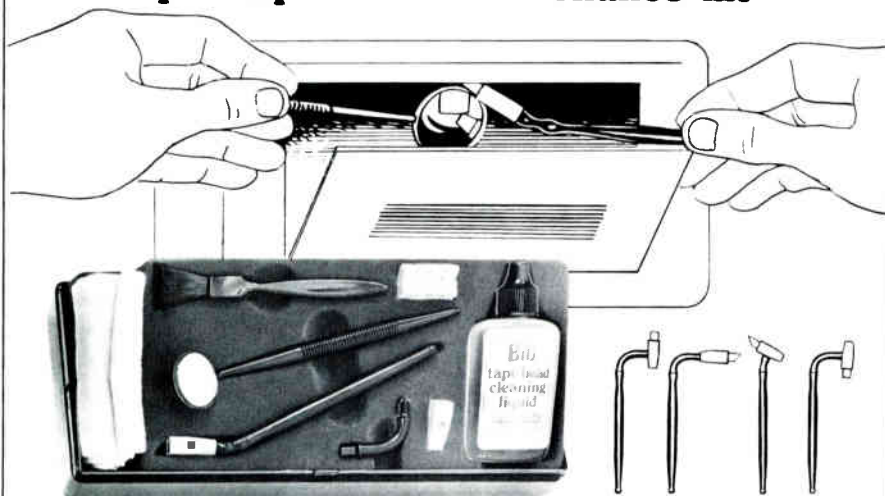

Bib's tape deck cleaning kit is unique in that it's special expandable fittings allows you to construct a tool that will reach even the most inaccessible parts of your home or car tape deck. Dental inspection mirror lets you see what you are doing. List price \$7.95

Bib®

Distributed in America by:

BIB HI-FI ACCESSORIES, INC.
3363 Garden Brook Drive
Dallas, Texas 75234 214/243-8971

Sell The Excitement Of Projection TV

Many audio salesmen are perplexed about how they can sell video projection systems effectively. The answer is that they will be highly successful if they emphasize the excitement, the involvement and realism of the system. Not to mention that a few years ago the sensation of projection TV could only be experienced in the uncomfortable surroundings of a movie theater — now the customer can experience it in their own living rooms. With video projection TV, the expression "one picture is worth a 1000 words" is



The Advent system

especially appropriate since this device will almost sell itself if you demonstrate it well.

As you probably know, a video projection system consists of three elements. They are a TV receiver (to pick up the television programs), a projector (or lens) and a large screen. There are basically two types: the rear screen model, in which all three parts are self-contained and the picture is pro-

(Continued on page 109)

Announcing a new component from Garrard that's as important to phonograph records as Dolby[®] is to tape.

Having minimized the distortions caused by rumble, wow and flutter, our engineers turned to the most disturbing distortions of all — those caused by imperfections on the surface of all old or new phonograph records.

The Music Recovery Module.[®]

Here is the solution: a component that electronically identifies and filters pops, clicks and scratches before they reach your ears. What comes through is the music — and only the music.

What it will do for you.

First. The Music Recovery Module is an exciting and effective new product. No doubt your customer will be impressed with what it does and how it does it. And that should make it easier to close the sale.

Second. The Music Recovery Module will make *all* your component demonstrations sound better. You'll never again have to explain away those pops and clicks that spoil an A-B comparison of speakers. Even shopworn demo records will sound good again. It's safe to say that when *you* hear the Music Recovery Module, you'll want one for yourself.

Get all the information you need. Just call your Garrard representative. Or call Ron Coll at 516-938-8900.



Garrard[®]

100 Commercial Street, Plainview, New York 11803

Selling The Video Revolution

by Les Davis

To many audio salesmen, even those who sell the most complex esoteric hi fi components everyday, the prospect of selling home video tape recorders (HVTR) is a bit frightening. They think of video gear as being hard to sell and totally alien from the sound reproduction products they understand so well.

As a former retail audio salesman, who also sold video, let me assure you that nothing could be further from the truth. If you are professional enough to guide a novice consumer through the intricacies of choosing an audio component system, selling home video tape recorders and related items should be a cinch for you, once you know how. This article will provide, in a question and answer format, all the information that you need to know in order to begin to sell HVTR immediately.

Q. Why should I sell HVTR?

A. The home video tape recording industry is one of the fastest growing fields in electronics today. Experts are predicting 1978 U.S. sales of home video cassette recorders (HVCR) alone to come to about 600,000 units which will be more than double the sales figures for 1977 (approximately 275,000 units).

If we calculate the retail price at as little as \$1,000 per unit (with add-ons and software, it will come to much more), then HVCR sales for '78 should exceed \$600,000,000 in volume.

As if that is not impressive enough, HVTRs are expected to become a multibillion dollar industry during the 1980s. Someone has to sell HVTR. Rather than have a former department store shoe salesman who lacks sufficient knowledge do it, why shouldn't you cash in on this boom? It will put more dollars in your pocket and if you are consci-

entious it will make your customers happy, which will generate additional repeat and referral business for you.

Besides, many of your audio consumers will be interested in HVCR when they discover that Sony has developed a Pulse Code Modulation adaptor which connects to the HVCR making this combination the most sophisticated consumer audio tape recorder available today with tremendous dynamic range and virtually no noise. Although this adaptor will retail for \$1,300, prices are expected to drop when demand makes possible mass production, manufacturing technology improves and competitive models appear on the market.

Q. How can I interest customers in HVTR?

A. With all the advertising being done (by manufacturers which include Sony, JVC, RCA, Zenith, Quasar and Sanyo) to entice the public, you will find that many consumers will already be excited about HVTR. Often all you will have to do is help them decide what is the best equipment for their needs and convince them to buy from you. You can win sales from other customers by doing the following things:

1) *Attempt to sell HVTR to every customer* — Even if they came into your store to buy hi fi, first complete the audio sale and then give an HVTR demonstration (if you have the equipment on hand) to all who are even mildly interested. By doing this you will find that, quite often, you will add on more than \$1,000 in video equipment to your original hi fi sale, increasing the store's volume and profits as well as your commissions.

2) *Entice your customers to buy VTR* by explaining the advantages: The major selling points

are that most HVCRs can:

a) Record one program in full color for viewing later (with a built-in tuner) at the same time that you watch another program on a different channel.

b) Reuse tapes — Erase recorded programs and reuse the tape to record over and over again at no additional cost.

c) Record programs when you are away from home — by using a timer.

d) Avoid commercials or boring segments of a show, skipping them by fast forwarding.

e) Provide instant replays — View exciting segments over and over again by rewinding and with a freeze frame option, stop action to examine the picture frame by frame.

f) Enable you to make your own TV shows — With an optional camera/microphone, you can produce your own programs to entertain or teach your family or friends; or use it for business purposes, or to record the growth of your children, etc.

g) Add a pulse code modulation adaptor — Enabling you to have an audio tape recorder that is better than the best conventional studio (analog) recorders.

h) Be easily connected — Attaches to a standard TV without an adaptor.

i) Have long recording time capability — RCA makes an HVCR that records 4 hours of programming on a single tape, Sony has an optional \$100 adaptor that automatically changes two 2-hour tapes, and there are many two hour machines that are available.

j) Be purchased at low cost — The average home machine now lists for around \$1,000 which is an excellent value when you consider the years of enjoyment it will provide.

(Continued on page 94)

Phono Cartridges

A Buyer's Guide from Micro-Acoustics

The phonograph record is a mechanical replica of musical performance. The job of the phono cartridge is to convert complex undulations of the record groove into an electrical signal. Here's how the different kinds of phono cartridges compare in function, performance and manufacture. This chart has been

prepared to help you make the appropriate choice for your budget and music system. The information encompasses the range of performance characteristics for each type of cartridge. Data* is compiled from manufacturers' literature and the results obtained at Micro-Acoustics cartridge clinics held throughout the U.S.A.

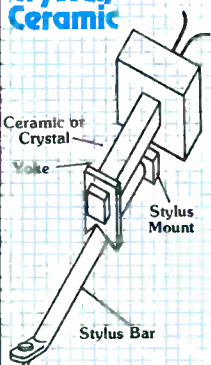
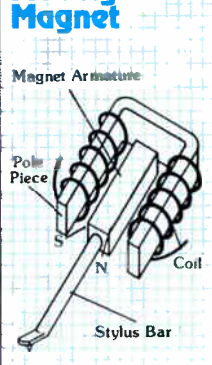
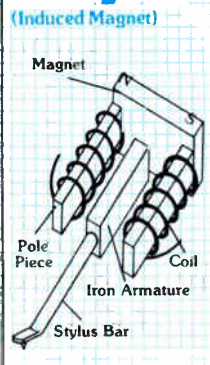
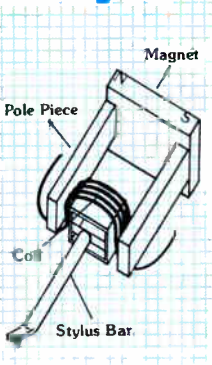
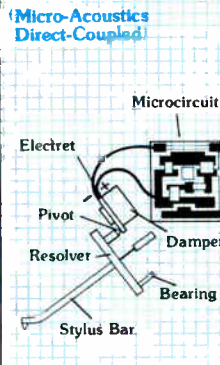
Performance Categories	Crystal, Ceramic	Moving Magnet	Moving Iron (Induced Magnet)	Moving Coil	Electret (Micro-Acoustics Direct-Coupled)
					
Operation Principle	Stylus bar moved by record groove under heavy tracking pressure (3-8 grams). Bar's motion bends crystal element causing output signal.	Stylus bar moved by record groove. Magnet armature vibrates between pole pieces, causing change in flux, and inducing signal in output coil.	Stylus bar moved by record groove. Iron armature vibrates between pole pieces, changing reluctance of magnetic path, and inducing signal in output coil.	Stylus bar moved by record groove. As coil vibrates through magnetic field, signal is induced in coil and fed to step-up transformer or pre-preamp.	Stylus bar moved by record groove. Stylus bar vibrates electrets through resolver and pivots, producing signal which is fed to microcircuit.
Tracking Ability	Poor to Fair	Good to Excellent	Good to Excellent	Good to Very Good	Very Good to Excellent
Transient Ability <i>(rise time in microseconds)</i>	60 to 100	30 to 60	25 to 50	20 to 30	17 to 20
Freq. Resp. Variation Due to Loading with Pre-Amp, Cables	± 4 dB below 1000Hz <i>(plugs directly into amp input)</i>	-10dB to +6 above 3kHz	-12dB to +4 above 3kHz	$\pm 1/2$ dB over entire range	$\pm 1/2$ dB over entire range
Ability to Perform In Variety of Tonearms	Works in low-cost units only	Good to Very Good	Fair to Very Good	Fair to Very Good	Very Good to Excellent
Ability to Track Warped Records	Poor to Good	Fair to Good	Fair to Good	Fair to Good	Very Good to Excellent
Cartridge Body Weight	5 to 10 grams	6 to 8 grams	5.5 to 7 grams	7 to 11 grams	4 to 5.25 grams
User Replaceable Stylus	Yes	Yes	Yes	Usually Not	Yes
Method of Manufacture	Mass Production	Mass Production	Mass Production	Precision Handmade	Precision Handmade
Cost Range	Least Expensive	Inexpensive to Moderate	Inexpensive to Moderate	Expensive to Very Expensive	Moderate to Expensive
Warranty	90 days (limited)	90 days to 1 year (limited)	90 days to 1 year (limited)	90 days to 1 year (limited)	2 years (full)

*All cartridges show single channel only

ma Micro-Acoustics
8 Westchester Plaza, Elmsford, N.Y. 10523

© 1977 Micro Acoustics Corp.

Join A Minority Group.

There are times when the best place to be is where everyone else isn't.

And now's your chance.

Mitsubishi wants you for The System.

The only high performance audio system with one name, one look, one warranty, one standard of quality.

The System. Where every component is made for every other component. And each created equal.

The System. Which our dealers will tell you, is respon-

sible for some of the easiest \$3000 sales in the business.

The System. Which has given our dealers some of the highest profits in the business.

We're looking for a few new dealers to sell that system. And we'll help. Because our dealers deal directly with us.

So we'll give you a technical expert to show your salesman how to demonstrate The System so your customers won't settle for anything less.

We'll give you an impressive equipment rack so they won't even look at anything less.

We'll give you national advertising that has already generated national interest. Still, we'll give you a liberal co-op allowance with no

bureaucratic red tape.

In fact, we'll give you more liberal terms all the way around. We'll even give you pre-paid freight at a lower level than any other major full-line company.

Call our sales manager, Fred Hartfelder at: (800) 421-1132. Ask how you can join The System.

Because the truth is, you just can't beat it.

 **Mitsubishi**
Audio Systems



Department Store Audio: Friend Or Foe?

Walk into the home entertainment section of a quality department store today and you're more likely to find an assortment of hi fi systems, maybe even a full-fledged sound room, then you are to see the traditional rows of consoles and compacts.

The move into selling true high fidelity in department stores is among the first steps in new marketing strategies for the audio business, a part of the effort to sell high fidelity to a new group of customers.

With U.S. Pioneer taking a forceful lead, most major full line audio manufacturers are in various stages of special programs for department stores, and department store managers say they're "getting into high fidelity because our customers demand it."

Market estimates for this year are for the department stores to get a static 3% of the high fidelity business, same as for the past two years. But that's a growing total of \$60 million if you accept the estimate of hi fi as a \$2 billion a year market at retail. And department store volume in hi fi is sure to increase next year as more chains and independent outlets jump on the bandwagon, and as hi fi manufacturers step up their fledgling department store marketing efforts. The industry will be watching to see if the family shopping stores get a larger slice of the same pie or if they increase the total market.

Competition with audio specialists in the same communities who carry the same brands as the department stores may not be as great as it might seem at first

glance. The manufacturers maintain, and the stores confirm, that "department store customers are different."

The basis of most department store programs is a special group of system packages, or in some cases a separate line within the brand. These are planned for the profile of the department store hi fi buyer — a first-time purchaser who is unsure about his/her own ability to make a correct choice of components and who prefers to buy at a familiar store where credit is established.

This profile is close to the hi fi customer of the 1980s described at the IHF marketing seminar in New York City. Changes in the population mean, several speakers pointed out, that the 18-24-year-old-male, target of recent audio merchandising efforts, is a declining

Department Store Reasons For Move To Hi Fi:

- "Our customers demand it."
- "Hi-fi is a growth product today."
- "Good sound is part of today's life style, so we have to sell it."
- "We tried components, and they've been very good for us."

group in numbers so that other market segments must be developed.

"The first-time buyer in the next five years is likely to be less knowledgeable about high fidelity systems, be more comfortable purchasing a relatively simple, inexpensive system that can be readily set up and used, be more comfortable buying an audio system from a retailer with whom they are familiar and with whom they have a relationship and a credit standing, and be more amenable to mass advertised, pre-packaged products marketed by companies

with a reputation for quality and reliability," said John Hall, vp for corporate planning for U.S. Pioneer Electronics.

Overlapping of the changing hi fi customer and the department store buyer comes at a time when both businesses are making changes in their appeal to market segments, so the association seems advantageous for both. Hi fi manufacturers are seeking to appeal to a slightly older, less knowledgeable group of buyers and this past year spent record amounts in advertising aimed directly at the wide consumer population. Department stores are looking for customers younger than the "little old ladies" which formerly were the mainstay of their business. Adding high fidelity is one of the changes department stores in all sections of the country are making to attract new customers with different life styles.

The old saying that "Macy's won't tell Gimbels" still seems to permeate department store thinking so that many store or department managers will not discuss their hi fi programs, but their advertising campaigns, store promotions and department expansions speak for themselves.

"Audio is coming back into the department stores because it's too important a piece of the market to give up," states Kenny Platt, general merchandise manager for Platt Music Co. in Torrance, CA, which is concessionaire for both the 25 May Co. stores in southern California and the 11 Emporium stores in northern California.

"The console market died off, but the hi fi market is there. The entire consumer market is demanding hi fi, whether young or old, since it's a status symbol now to have components. The hi fi area has taken the pull away from the top end stereo compacts," Platt continues, "so we've cut down on compacts and added more audio."

He reports that sales center around component packages

How to make clinics really easy

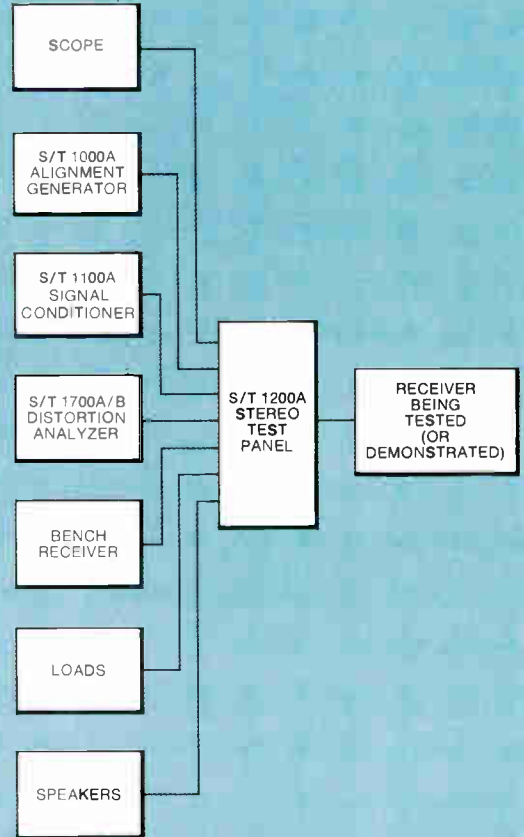
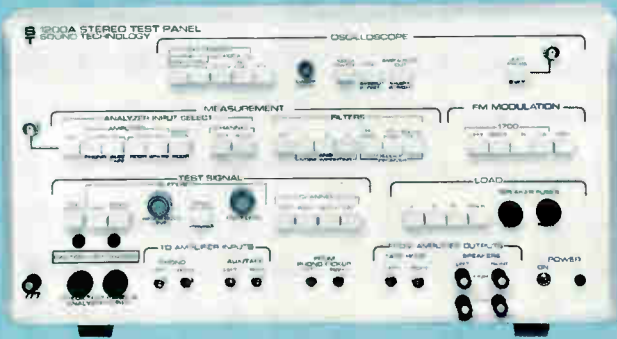

Here's a way to simplify your test setup.

This stereo test panel interfaces all the audio test equipment to the customer's receiver being tested or demonstrated.

At the clinic just connect the amplifier inputs and outputs to this new Sound Tech panel. It's that easy. (That's all you need connect in factory production testing, too.)

The diagram shows how simple the setup becomes. Note that the setup even includes the bench receiver that many technicians find helpful.

All the test equipment can be connected beforehand to the test panel. That saves you a lot of trouble, mistakes, time, and money.

PRODUCTION TESTS, TOO

Just ask any of those people who've seen me demonstrate the 1200A at CES shows.

The new 1200A panel can make clinics a lot easier for you and your salesmen.

Easier for production testing, too.



SEND FOR FREE INFORMATION

To:
SOUND TECHNOLOGY
1400 Dell Ave.
Campbell, Ca. 95008

Send coupon now and
get the literature
on this important
measuring development.

Name _____

Firm _____

Street _____

City, State _____

Zip _____

Phone _____



SOUND TECHNOLOGY

1400 DELL AVENUE
CAMPBELL, CALIFORNIA 95008
(408) 378-6540

although the stores also carry receivers, speakers, tape decks, and headphones for separate sales. Lines featured are Fisher, Kenwood, Panasonic, B.I.C. turntables and Venturi speakers. Platt adds that BSR/ADC's Accutrac +6 has been selling extremely well.

There are sound rooms in two of the May Co. stores but Platt notes that "sound rooms don't seem to make a lot of difference in sales." The stores rely on manufacturers for sales training on products and consider returns as "a normal part of the cost of doing business."

In the South, Dillard's, a 38-store chain is in its second year of aggressively moving into hi fi. "We feel good about this product classification. Our success is in putting a package together, whereas the hi fi store probably sells more individual pieces," says Jack Tierman, general merchandise manager for the Ft. Worth division.

Dillard's regularly promotes separate components in packages in a regular advertising schedule and in mailers to its charge account customers. Lines featured are Marantz, Garrard, Pioneer and Fisher. The size of the audio department, located adjacent to television, is being increased in newer stores.

A living room setting with a divan and comfortable chairs is arranged in front of the walls with component displays and switching systems so that purchases can be considered in a relaxed atmosphere. Sales training is conducted by reps, and returns are considered minimal.

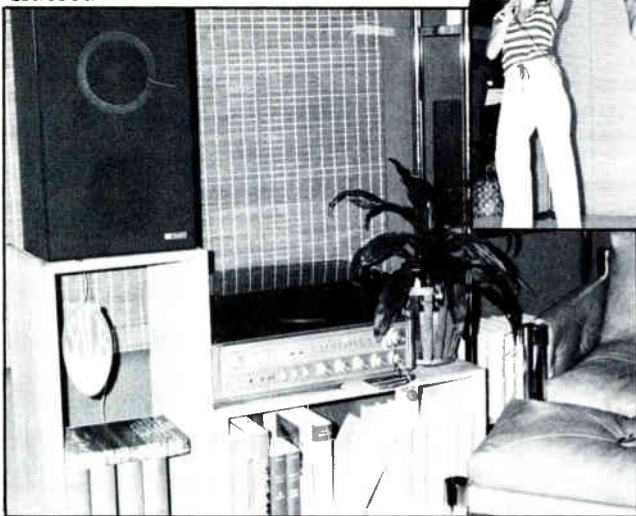

Price competition is not a big factor in Dillard's operations in Texas, Oklahoma, Kansas and Missouri, and the stores find that packages promoted at higher prices bring the largest volume.

Minneapolis-based Dayton's, with eight full-line department stores and three free-standing home stores selling hi fi, reports a 50% increase in hi fi sales this year, along with improved margins. Dayton's, a division of the Dayton-Hudson Corp., began a major effort to develop hi fi business about six years ago and has sound rooms in all but one store.

Dieter Pape, stereo components buyer, credits high traffic at downtown and shopping mall stores, increased training of the sales staff and convenience of using the store's charge card with the increased business. Recent growth started with a major promotion using the theme "Did you know there is an audio store in Dayton's?"

Four systems are set up in each sound room at prices in the \$300-\$400 range, around \$500, at \$1,000, and in the \$3,000 range to let customers hear the difference between systems at various prices. Lines carried include Technics, reported as accounting for the largest volume, Kenwood, Sony, Bose, Teac and Altec. Sales training is by Dayton's personnel department and by sales reps.

In Akron, O'Neil's held an "Audio Show and Sale" in con-



Chicago's Carson Pirie Scott kicked off recent audio expansion with mini-concert featuring Magic, trio above. At left, Fisher hi fi is displayed in home-like setting.

junction with the store's 100th anniversary. The store started with the Fisher audio program two years ago, added Pioneer last spring and also handles the Sansui Classique line. Merchandise Manager Bob Price sees audio as a category with lots of potential for department stores and plans to repeat the Audio Fair, which included customer audio clinics with consultants from Technics, Sansui and Fisher.

Success with a strong audio department depends upon sales training, Price believes, and a special cassette program is being developed to give sales people product knowledge and to build their confidence in answering customer questions. Average sales at O'Neil's are about \$500 for a package, although merchandise covers the price range from \$250 to \$1,000.

Hess's, in Allentown, PA, is an eastern store that has staged an audio show annually for several years. Participation from reps of the lines carried is combined with early morning sales training sessions for the staff and a series of special events for customers.

Other department stores in the East featuring high fidelity are Macy's (see adjacent article), Sanger-Harris, Reichs, and Foley's in Boston. Burdine's, based in Miami, does an aggressive job in merchandising hi fi.

Special programs for department stores are increasing among hi fi manufacturers. Superscope/Marantz will introduce its Imperial line, specially planned for department store sales, at WCES this month.

Kenwood offers completed 4-piece systems to make merchandising easier for department stores. Two feature the 15-watt KR 2600, and two are built around the 40-watt KR4070. "The department store program will not interfere with the audio specialist, who accounts for 90% of our business, but the department stores are an essential part of distribution to keep a firm's share of the market," comments Philip Schwartz, Kenwood's national sales manager for special markets.

"We sell only to one or two qual-



AA-1115 15 watts per channel minimum RMS at 8 ohms from 20-20,000 Hz with no more than 0.5% total harmonic distortion.



AA-1125 25 watts per channel minimum RMS at 8 ohms from 20-20,000 Hz with no more than 0.3% total harmonic distortion.



AA-1135 35 watts per channel minimum RMS at 8 ohms from 20-20,000 Hz with no more than 0.2% total harmonic distortion.



AA-1150 50 watts per channel minimum RMS at 8 ohms from 20-20,000 Hz with no more than 0.1% total harmonic distortion.



AA-1175 75 watts per channel minimum RMS at 8 ohms from 20-20,000 Hz with no more than 0.08% total harmonic distortion.



AA-1200 120 watts per channel minimum RMS at 8 ohms from 20-20,000 Hz with no more than 0.08% total harmonic distortion.

AKAI OFFERS SIX GREAT WAYS TO RECEIVE YOUR CUSTOMERS.

AKAI's line of receivers offers something for everyone.

For you, as an AKAI dealer, it means six more opportunities to profit from one of the fastest growing names in the industry. For your customers, it means a line of receivers that offers a wide range of performance and price points.

The AKAI receiver line appeals to the first-

time buyer looking for an excellent basic unit or the demanding audiophile who requires the ultimate in power, performance and features.

So start cashing in with AKAI receivers. Six great ways you can profit by giving your customers satisfaction.

For more information write AKAI America Ltd., 2139 East Del Amo Boulevard, P.O. Box 6010, Compton, CA 90224.

AKAI

You Never Heard It So Good.

ity stores in each region, as Burdine's in Florida, Macy's in New York, the Dayton-Hudson group in Minneapolis, and Stix-Baer & Fuller. Our hi fi dealers usually prefer to make up their own packages, and they can be more competitive than the department stores," Schwartz added.

Mitsubishi also has a special department store program, and most recently, Hitachi this fall launched a program of its own based on a line of packaged systems priced from \$449 to \$1,000.

The department stores, which earlier flirted with high fidelity and generally left the field, insist that this time, "We're in the business to stay." And they may be, because this time around their merchandising needs and those of the high fidelity manufacturers are coinciding.

Shop Downtown 'til 5:30! Saturdays tonight 'til 9.

want great stereo sound? choose pioneer.
want great selections? then come to foley's.

the new HPM speaker series with carbon fiber-blended cone woofers

A. HPM 100 with 5 1/4" set of speakers \$735.00

B. HPM 80 with 5 1/4" set of speakers \$189.00

C. HPM 60 with 5 1/4" set of speakers \$113.00

D. specially priced headphones offer full-range stereo sound \$17.95

E. we've put together a component set-up with a 434 stereo receiver \$329.00

F. compact cassette deck features dolby noise reduction, special. \$199.00

G. specially priced direct drive turntable with w-shaped tone arm \$169.00

Give yourself credit! Foley's has a plan for your budget.

100,000 CENTER HEATH FLOOR BOWTOWNS LINDEN ST BIRKBECK ALBERTA HALL MIDTOWN CITY HIGHTHOUSES MALL PEARLBERG SHOPS/TOWNS CENTER BROADWAY MALL

Foleys Pioneer ad in Houston Chronicle

Pioneer Sells Hi Fi Stores, Not Department Stores

"U.S. Pioneer doesn't sell components to department stores — we sell to hi fi stores," says Pioneer's president Bernie Mitchell in discussing the firm's special program for department stores.

"Our policy is to tell the department stores 'If you want our merchandise, build a sound room in every store, carry a wide assortment and have sales people who understand the business so we'll be in the business together,'" Mitchell explains.

"The department or section must be run like a hi fi store. They can't just buy two of each product and stay in the business. I must know the president of the department store or we won't sell to them — that's a fail-safe mechanism," Mitchell continues.

"As an industry we're doing a lousy job with the first-time buyer. Dealers are doing a good job selling the sophisticated customer, but today's first-time buyer is not comfortable walking into their stores

while he is comfortable in a department store. At one time our entry level buyer was the guy just home from Vietnam, the dealers did a wonderful job with him. Now they're not listening to a different type of entry level buyer.

"Every decade has its brightest merchant, someone like Ellis Gimbel or J. C. Penney. Today's is Ed Finkelstein, Macy's president. He looked at Macy's San Francisco, the biggest department store in town. It was running out of the little old ladies it appealed to, so he changed the image. He added basket shops, wine grottoes, hi fi, and now Macy's San Francisco is an exciting place for young people to go. The concept worked, and he was promoted to New York. At first I didn't want to sell Macy's,

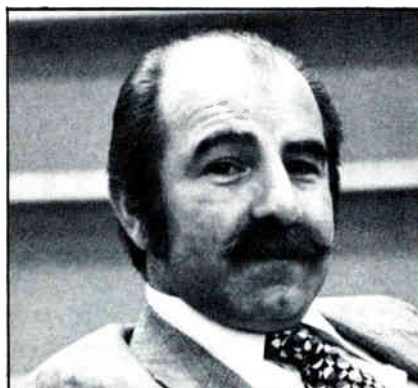

Bernie Mitchell

but he's too good a merchant to ignore.

"There are four detailed training sessions before the first department store ad under our program. There's a shakedown and more training. By the time they start, they're an audio store. Department store sales are similar in pattern to audio stores, but there are more sales in the lower price range. Tuners and amps sell in the same ratios in both types of stores.

"We've been surprised with the good results in stores in small towns not well served by hi fi shops. Stores in places like Tuscaloosa and Louisville are doing a very good job.

"There are some problems with personnel turnover, overspending in advertising, and open to buy. There might be 500 speakers in the store and no receivers — but no buying dollars. There's the need to be well disciplined on accepting returns, to know that the reason the product doesn't work is that the tape monitor button is pushed in or a fuse is blown.

"We work with committed stores only. There's no sale of just six products; they must carry 25 to 30. We'll sell only when there is a relationship with the entire management structure. Otherwise the program would be doomed to fail."

THE FIRST FM ANTENNA THAT'S AS SOPHISTICATED AS YOUR RECEIVER.

It's The Beam Box. The first electronically directable FM antenna. B·I·C invented it.

You place The Beam Box conveniently near your receiver. It doesn't need house current or batteries. And you never have to pick it up or shift it around.

By simply adjusting its knobs you can focus and fine-tune The Beam Box on any FM signal coming from

any direction. Because The Beam Box has no blind side, available FM signals can't hide from it.

It maximizes the signal you want. It minimizes signals you don't want.

If you've had problems with FM reception, The Beam Box should solve them. Especially if you live in an apartment house, a dormitory, or wherever an

effective FM antenna has been impractical until now.

For possibly the first time, you'll experience the FM performance your receiver was designed to deliver.

The Beam Box. A whole new component from B·I·C. It's a lot more than just an antenna.

THE BEAM BOX™

B·I·C®

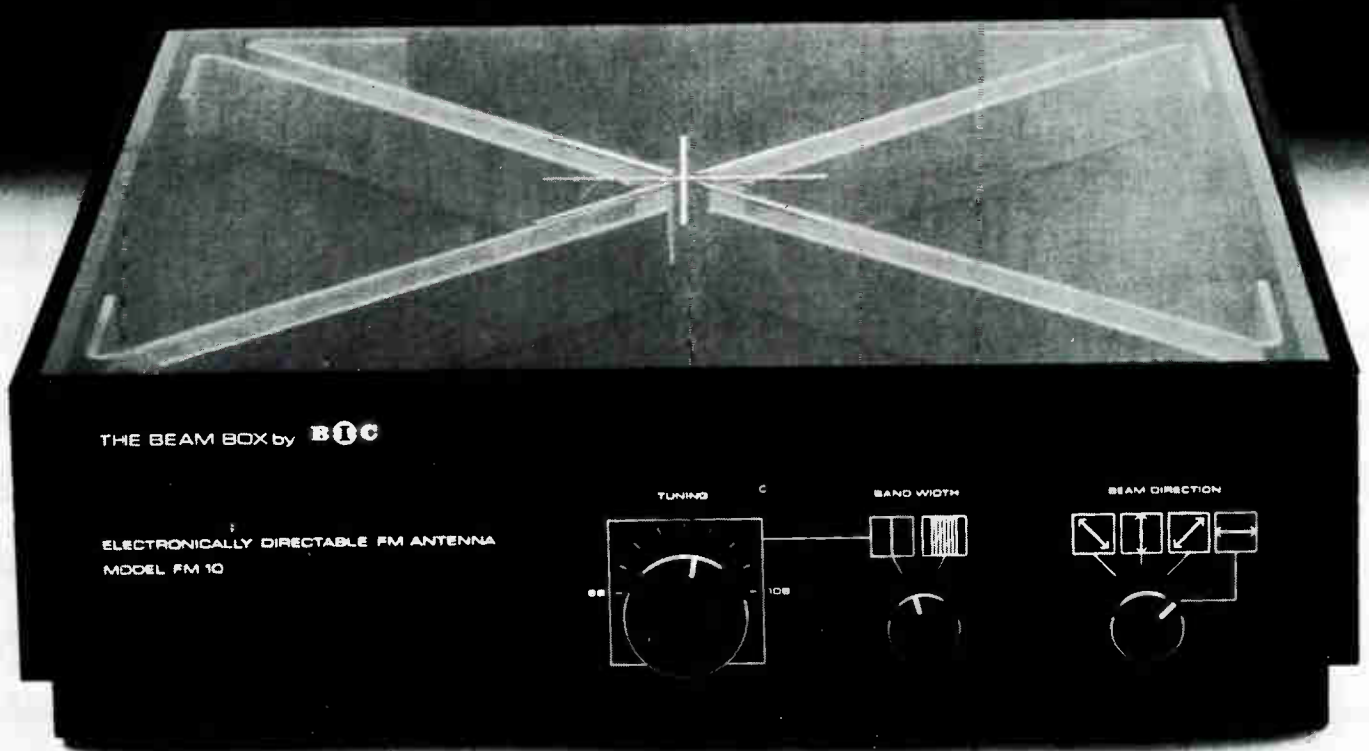

PLEASE SAY "BEE-EYE-CEE" ©1977 BRITISH INDUSTRIES CO. (TEL. 516-334-7450), WESTBURY, L.I., N.Y. 11590. A DIVISION OF AVNET INC.

HOW DEALERS ADVERTISE



by
Roger C. Parker

Alternatives To Price Competition

Part IX: "Classified Ads And The Yellow Pages."

This article concludes Roger Parker's series, "Alternatives To Price Competition." Roger, however, will continue to review dealer ads in "How Dealers Advertise" as well as write on advertising-related subjects of interest to stereo dealers. Dealers are invited to submit topics for Roger's consideration. High Fidelity Trade News promises to give them prompt attention. While the cards, letters and phone calls from dealers, reps and manufacturers have been totally positive in response to the series, we would like to hear from more of you. Tell us what you thought of the series, whether you liked it and found it valuable or not, and how it might be improved. HFTN thanks you for your interest. Now, here's Roger:

Don't overlook the potential offered by newspaper classified advertising.

Classified ads can be tremendously effective. They are relatively low in cost, and go directly to the people who are looking for a bargain. In terms of immediate response, they can't be beat.

And, don't let your Yellow Pages ad in the telephone book be a last-minute, thrown-together production. Many people will form their first impression of your store from your Yellow Pages ad. Make it a

good one, or you'll never get a chance at many first-time buyers, or people new to your area.

Who Reads Classifieds?

Study after study has shown that the classifieds are one of the most-read parts of a newspaper.

Very few people will read every classified ad, but people will generally read the classifications they're interested in.

People read classified ads out of curiosity, and the hope that somebody, somewhere, will be selling precisely what they have always dreamed of owning at an impossibly low price. People also read classifieds because they're interested in what other people are selling, and what the going price is for equipment they already own.

Classifieds present you with a unique opportunity to speak directly with stereo buyers at a remarkably low cost.

What Should You Advertise In Your Classified Ads?

Certain categories of products and services are perfect for classifieds.

First, *one-of-a-kind's*, *demo's* and *used equipment* (especially high-end used equipment). It doesn't make much sense to spend lots of money on a display ad (i.e. any ad other than a classified ad in

a newspaper) when you have only one or two units of a certain model in stock, but you can easily "clean house" with a classified ad.

Remember: a high percentage of the people who read the classifieds will know what a Whammo 5,000 is, and there will probably be — somewhere out there — one or two people who have been looking for one at a good price.

Second, *clinics* and *seminars*. Amplifier and tape clinics, especially, can be successfully promoted in the classifieds. Again, the classifieds present you with an opportunity (like direct mail) to speak directly with people who know what you're talking about, and are interested in what you have to say.

Why spend a lot of money talking about an amplifier clinic to *everybody* (including people with no interest in stereo), when you can speak directly to stereo owners and stereo buyers at less cost?

Third, *institutional reminders*. Classifieds also present you with an opportunity to "jiggle the memory" of stereo owners with a consistent message. You might want to rotate ads soliciting used equipment ("Highest prices paid for quality used stereo components!") with ads promoting your service department ("Bring your problems to us!") or your involvement in high-performance car stereos ("Buy from people who know what they're talking about!").

Likewise, if your store is becoming involved in projection television, or home video tape recorders, use the classifieds to remind people that "We're headquarters for video, too!"

Fourth, you can use classified ads to *support your other advertising*. You can use the classifieds to plant "teasers" to arouse interest in upcoming promotions, and — the day your big ad runs — you can have a small classified that says: "Looking for bargains in stereo components? See our big ad on page 9 of the TV section!" Lots of people who would otherwise never see your ad will eagerly turn to it — and people who already saw it will be motivated to look at it again.

Other Advantages Of Classified Ads . . .

No production costs. No artists, no typesetting, no paste-ups . . . just a phone call, and your classified ad is ready to run.

Late closings. Classified ads called in as late as Friday noon can still be included in the Sunday paper. This give you a unique opportunity to tailor your advertising to the onesies and twosies that you have in stock, and want to move *right now*. Compare this to the two-week closings of Sunday TV sections, or the time it takes to get a produced display ad photographed, typeset, and approved.

Involvement. Classified ads have an excitement all their own. People who find what they're looking for in the classifieds feel they've made a discovery all their own. They feel that they, alone, found a bargain. If you're good with words, and creative, you can exploit this to great success.

How To Increase The Effectiveness Of Your Classifieds Ads . . .

Ninety per cent of the classifieds look the same, but that doesn't mean yours has to. By isolating the headline with white space, or going to bold-face headings, or increasing the point-size of your headline, you can increase readership and give your classifieds a distinctive "look."

Copy can be as straightforward, or emotional, as you want. If you're confident that there are two or three people out there looking for Whammo 5,000's for \$199, it will suffice to merely list "Whammo 5,000, 2 left, \$199 each" with your name, address, and phone number.

Or, you can devote as much time to constructing your classified ads as you spend on your other advertising. Provocative headlines, full-description copy, and "call to action" conclusions can all be built into your classified ads — *if* you have the time to devote to it.

Who Uses Classifieds?

It's worth remembering that

classified ads are used by a broad spectrum of sellers — ranging from individuals upgrading their stereo systems all the way up to retail giants like Sear's and Montgomery Ward. Indeed, classified ads are used by Sear's and Ward's in 80% of the cities where they have stores.

Certainly, the people at Sear's and Montgomery Ward know what's going on — and they wouldn't use the classifieds unless it paid off.

The "Stereo and Hi-Fi" classified ads in your newspaper are going to be read tonight, and this Sunday, by thousands of stereo lovers who are looking for a bargain. Will you be offering them one?

Yellow Pages Advertising

The Yellow Pages of the telephone book can be viewed as the ultimate positioning medium.

Whereas your radio, television, and newspaper display ads will be seen/heard by many people with absolutely no interest in stereo, (and no inclination to buy at the present time), your Yellow Pages ad will be seen by people looking to buy *right now*.

Moreover, because your Yellow

For Further Reading

Words That Work: Creating Classified Ads That Click!

By Hubert K. Simon. Copyright 1974, H. K. Simon Co., Inc., (price unknown).

This book — suggested by Fred Apple, manager of direct mail services at McIntosh — has some very well thought out ideas for making your classified ads more than line-listings of hardware. The author has monitored classified advertising in dozens of fields, and there are many examples of successful classified ads to support his points. Quotations and letters from satisfied classified users are also included. Contact the publisher for price information.

Pages ad will be surrounded by ads for every other stereo dealer in town, your Yellow Pages ad presents you with a unique opportunity to tell strangers what your store stands for, and why they should buy from you, instead of anyone else.

All in all, what a splendid opportunity to *position your store* relative to the competition.

Unfortunately . . .

Unfortunately, however, life being as pressured as it is, few stereo retailers take the time to devote much attention to their Yellow Pages ad. As a result, most stereo Yellow Pages ads end up being near-identical line-listings of manufacturer's logos, store addresses, and phone numbers — with little or no positioning information.

A Better Alternative . . .

A better alternative is to start thinking *now* about your next Yellow Pages ad.

Start by thinking about how you would introduce your store to a stranger you met at a cocktail party, or on an airplane, who told you he was in the market for a stereo. After the preambles, you would soon start to describe customer benefits, and the "exclusives" that are unique to your store. You would try to convince the stranger that you could sell him a better stereo — and make him happier — than anyone else.

Well, that's *exactly* what your Yellow Pages ad should try to do.

After you have your ideas on paper, you'll probably want to go to an independent production house to create the finished ad. Let's face it: if you have the telephone company produce your ad, it's going to come out looking like every other Yellow Pages ad in the book. Much better to have your ad be visually distinct, so it will stand out from the crowd.

Remember: you're not talking about a one-shot daily newspaper ad. You're talking about an ad with a shelf-life of *one year*, that will be seen by people *ready to buy*.

HOW DEALERS ADVERTISE

Flanner & Hafsoos STEREO VALUE HEADQUARTERS

YOUR LAST CHANCE!

Special! "10" is the only one of its kind in the world of the...
 McIntosh



AIWA
 A RECEIVER-CASSETTE COMBINATION WITH PERFORMANCE NEVER BEFORE FOUND IN SUCH A COMPACT UNIT!
 \$380

WHY DIDN'T SOMEBODY THINK OF THIS BEFORE!
 THAT PUTS ALL THE CONTROLS AT YOUR FINGERTIPS!
 A CASSETTE DECK WITH A SLANTED DESIGN THAT PUTS ALL THE CONTROLS AT YOUR FINGERTIPS!
 \$230

NEW BA-5070
 IN THE SERIES
 Technics
 SYSTEM SPECIAL
 \$379

NEW JENSEN
 "LIFESTYLE" SPEAKERS
 \$199

ADDS
 STEP UP TO INVISIBLE SOUND
 \$199

TANBERG
 THE MOST OUTSTANDING FM PERFORMANCE WE HAVE SEEN WITHIN SEVERAL HUNDRED DOLLARS!
 \$199

TANBERG
 THE MOST OUTSTANDING FM PERFORMANCE WE HAVE SEEN WITHIN SEVERAL HUNDRED DOLLARS!
 \$199

RECEIVERS FROM \$450 TO \$1100
CASSETTE DECKS \$550 & \$399
REEL-TO-REEL FROM \$359

"THE SHOPPERS CORNER"
 \$218
 \$275
 \$219
 \$268
 SAVE 20%
 \$129

Flanner & Hafsoos
 86th YEAR
 MAYFAIR SHOPPING MALL—HY. 100 AT W. NORTH AVE.
 OPEN DAILY, 10-8 SAT., 10-5 SUN., 12-5, CALL 476-9566
 MAYFAIR — THE STEREO SHOPPING CENTER OF S.W. WISCONSIN

KENWOOD BRAND NEW KR-4070
 THE KR-4070 SYSTEM
 NOW ONLY \$199
 \$599

TURNABLE SAVINGS
 \$179
500EE
 \$199

JVC BUILDING IN WHAT THE OTHERS LEFT OUT
 \$199

NEW JENSEN "LIFESTYLE" SPEAKERS
 \$199

HI-FIDELITY INTRODUCES Technics by Panasonic
 WE AT HI-FIDELITY BELIEVE TECHNICS IS THE BEST VALUE - DOLLAR PER WATT IN THE INDUSTRY TODAY WE'RE PROUD TO INTRODUCE TECHNICS BY PANASONIC

Professional Series

SA-5000 \$149.95
SL-21 \$129.95
SA-5070 \$799.95
SA-5075 \$329.95
SA-5075 \$179.95

See, touch and hear this exceptional audio system.
Bang & Olufsen
 Beogram 2400 Turntable
 Beogram 4000* Turntable

TANBERG
 NEW TANBERG TCD-330
 NEW TANBERG 10XD
 NEW TANBERG TR-2075

Hi-Fidelity Specialty
 The Amazing NEW Portable Refrigerator... \$99.95
 Food or Drink when you're on the go!

DISPENSES 3 GAL. OF "40 F° COLD CONTENTS" FOR PUMP ACTION IDEAL FOR DORM OR BALL GAME
 \$29.95

Flanner and Hafsoos, Milwaukee Journal, September 22, 1977. 6 columns by full height/main news. Hi-Fidelity, Lubbock Avalanche-Journal, September 3, 1977. Full page/main news.

Here are two ads similar in appearance to the price-oriented ads, but built around higher-priced components. The ads are designed to acquaint the reader with new lines and products they might not be aware of. The Hi-Fidelity ad is stronger in terms of impact and content, yet it fades off at the end to a discussion of portable refrigerators and vacuum coffee pots. This considerably weakens the impact of the ad. The "Your Last Chance!" sub-heading in the Flanner and Hafsoos ad points out that only one week remains to take advantage of McIntosh's limited-time Extended Five Year Service Contract. It seems that more could have been made out of this point.

Brands Mart, The Real Paper, October 15, 1977. Full page tabloid.

No discussion of price advertising would be complete without Brands Mart. To get into Brands Mart, you have to have a college I.D. (or one of their courtesy cards). The campaign they have been running recently is based around "Great Mistakes." A famous mistake is tied to a local mistake . . . for example, when a customer bought elsewhere without first checking-out Brands Mart's prices.

BRANDS MART PRESENTS: GREAT MISTAKES HALL OF FAME!

1977: Mary! Don't make a local discount store's mistake and buy a no name stereo component system for only \$299. No overpay because he didn't check out Brands Mart's prices at a famous name system.

1977: Model 1 FURNITABLE Includes: Rear, Door, Center & Cartridge.

1977: Model 2 FURNITABLE Includes: Rear, Door, Center & Cartridge.

\$178

REMEMBER YOU NEED YOUR BRANDS MART CARD OR COLLEGE I.D. TO GET IN!

SPECIAL OFFER EXPIRES OCTOBER 15, 1977

THE BRANDS MART SYSTEM... DON'T BE MISTAKEN

\$298 THE DEWEY DECIMAL SYSTEM
Includes: 2x16" Bookshelf Speakers, 2x8" Tweeters, 2x8" Bass Drivers, 2x8" Center Channel, 2x8" Cartridge.

\$398 THE HONOH SYSTEM
Includes: 2x16" Bookshelf Speakers, 2x8" Tweeters, 2x8" Bass Drivers, 2x8" Center Channel, 2x8" Cartridge.

\$798 THE SOLAR SYSTEM
Includes: 2x16" Bookshelf Speakers, 2x8" Tweeters, 2x8" Bass Drivers, 2x8" Center Channel, 2x8" Cartridge.

\$498 THE EDUCATIONAL SYSTEM
Includes: 2x16" Bookshelf Speakers, 2x8" Tweeters, 2x8" Bass Drivers, 2x8" Center Channel, 2x8" Cartridge.

\$598 THE AUDICIAL SYSTEM
Includes: 2x16" Bookshelf Speakers, 2x8" Tweeters, 2x8" Bass Drivers, 2x8" Center Channel, 2x8" Cartridge.

BRANDS MART DISTRIBUTION CENTER
127 SMITH PLACE, CAMBRIDGE

WE'RE OFF LOCUSRD AVENUE BETWEEN THE SMITH SHOPPING CENTER AND SANCTA MARIA HOSPITAL. EASILY ACCESSIBLE BY THE TRAVEL CENTER BUS STOP AT HAYWARD SQUARE.

AMPERE FREE PARKING (617) 547-6900

Hours of Service: Mon-Fri 10 AM - 6 PM, Sat 10 AM - 4 PM, Sun 12 PM - 4 PM



GOOD



Save 18% **\$399**

if purchased separately:
Marantz 26 watt receiver 110.00
Garrard 3 speed turntable 114.85
Marantz 3 way speaker set 139.90
Total 364.75

Marantz 276 AM FM stereo receiver features 20 watts into 8 ohms, 30 watts into 4 ohms, 75 Hz-20 kHz with more than 9 1/2% total harmonic distortion. Garrard 3 speed turntable features 1000 rpm, 45 rpm, and 33 1/3 rpm. Marantz 3 way speaker set features 20 watt 8 ohm and 10 watt 16 ohm drivers. Marantz 276 receiver, Garrard 3 speed turntable, and Marantz 3 way speaker set.

BETTER



Save 13.50% **\$599**

if purchased separately:
Marantz 53 watt receiver 460.00
Garrard 3 speed turntable 750.00
Marantz 3 way speaker set 239.90
Total 1449.90

Marantz 272 AM FM stereo receiver features 20 watts into 8 ohms, 30 watts into 4 ohms, 75 Hz-20 kHz with more than 8 1/2% total harmonic distortion. Garrard 3 speed turntable features 1000 rpm, 45 rpm, and 33 1/3 rpm. Marantz 3 way speaker set features 20 watt 8 ohm and 10 watt 16 ohm drivers. Marantz 272 receiver, Garrard 3 speed turntable, and Marantz 3 way speaker set.

BEST



Save 51% **\$799**

if purchased separately:
Marantz 63 watt receiver 370.00
Garrard 3 speed turntable 540.00
Marantz 3 way speaker set 299.90
Total 1209.90

Marantz 258 AM/FM stereo receiver features 20 watts into 8 ohms, 30 watts into 4 ohms, 75 Hz-20 kHz with more than 8 1/2% total harmonic distortion. Garrard 3 speed turntable features 1000 rpm, 45 rpm, and 33 1/3 rpm. Marantz 3 way speaker set features 20 watt 8 ohm and 10 watt 16 ohm drivers. Marantz 258 receiver, Garrard 3 speed turntable, and Marantz 3 way speaker set.

Dillard's, Tulsa Tribune, September 22, 1977. Full page/main news. Good, clean-looking, "department store" retail ad, excellent use of co-op (all three systems use Marantz and Garrard components), and prominent — but not too much — emphasis on price savings. Color effectively heightens the impact of the page. More and more ads like this will probably be seen as department stores get increasingly involved in component stereo.

Harvey, You're Getting Stronger

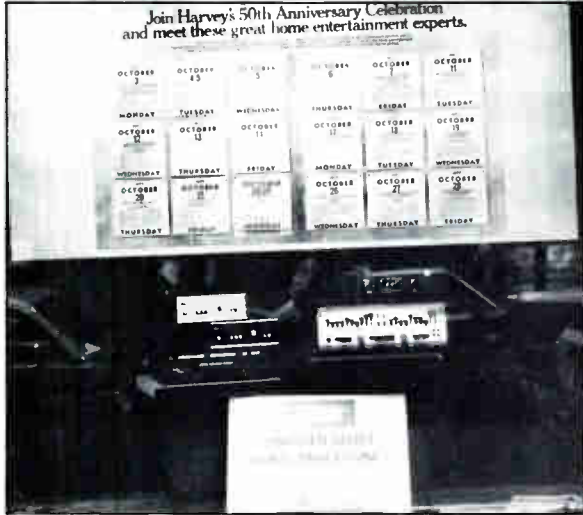

The window at Harvey's promoted the anniversary celebration with a complete calendar of events, as advertised in the *N.Y. Times*. On this particular day seminars and demos involving signal processing were in progress.

They say a man reaches a physical peak at the tender age of 18, but they're wrong. Harvey is 50 now, and like Rocky of film fame, is maturing into a dynamo with the kind of strong promotion and merchandising that pays both short and long-term benefits. We're talking about Harvey's in New York, which is celebrating 50 years of audio retailing. This fall, instead of staging an "anniversary sale," with "doorbusters" and the like, Harvey's staged a month-long series of seminars on a variety of subjects of interest to audiophiles and first-time buyers. *Hi Fi Trade News* stopped in at the West 45th Street store for several visits during the month to photograph the birthday party.



The signal-processing seminar and demo included Peter Tribeman of Audio Pulse fame.



Seminars and demos were held in rear-of-store sound rooms.

During the month, ADS president Dr. Godehard Guenther was part of a mini-speaker program.

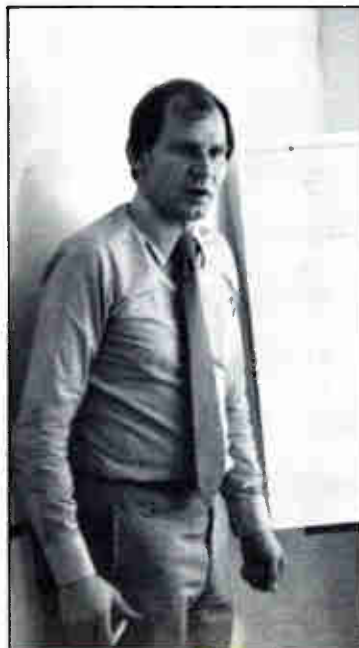

Detailed planning included variety of seminar specials.

Now — two great wow and flutter analyzers from BPI



Both with the features, accuracy and reliability our wow and flutter analyzers are noted for . . .

wow and flutter to 0.01%, speed/drift, monitor speaker, AC voltmeter and low cost. Also, the model 1600 features NAB, DIN & JIS weighting and a 1 millivolt f.s. AC voltmeter which can be used for signal to noise.

You now have a choice and we know you'll WANT one. Write or give us a call and we'll send you our specs so you can choose yours.



7853 Balboa Ave., San Diego, California 92111, Phone (714) 279-3344

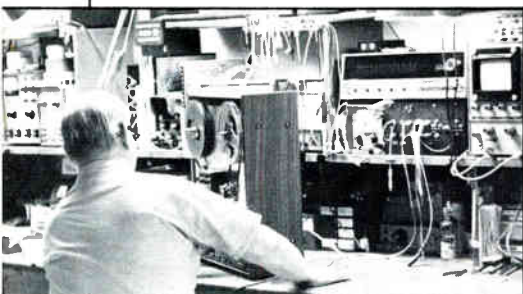

Harvey's extensive service facilities couldn't be missed by seminar attendees because area is windowed and adjacent to sound room seminar area.

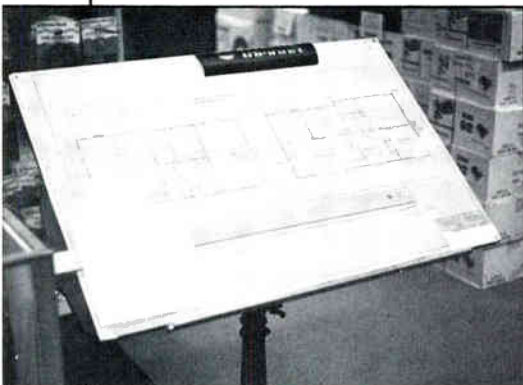

Custom installations? They're available at Harvey's, as this middle-of-the-floor display rostrum makes evident.



Tired, harried — but happy — is Harvey's busy store manager Edna Yagoda during celebration's closing days.

ELMAR ASSOCIATES

Atlanta, Birmingham, Raleigh, Mississippi, Alabama, Georgia, Tennessee, North Carolina, South Carolina

IS LOOKING FOR A LINE TO REPLACE AKAI

Tape Recorders-Receivers

Contact Hulon Forrester, 404-938-2821
3385 Thornwood Dr., Atlanta, GA 30340

P.S. Mfg. who really wants good customers need apply!

We will be in Las Vegas Jan. 4-7, 1978
at the Sands Hotel

Member ERA



REP RAP

In a series of new rep appointments by audio manufacturers, **Jensen Sound Labs** has appointed **B&H Sales Co.**, North Syracuse, N.Y., as its rep for upstate New York; **Dynamic Marketing**, Hollywood, Fla., for the state of Florida; and the **Dean Cooper Co.**, Norcross, Ga., for Georgia and eastern Tennessee.

Columbia Magnetics has appointed **Eastern Sales**, Pennbrook Fla., headed by Eugene Gayol, to handle the state of Florida; **Norro Sales**, Los Angeles, headed by Bob Garmisa and Norman Berkoff, for the states of California, Arizona and Nevada; **Nestco Associates**, Dunwoody, Ga., headed by Earl C. Neal, to cover the Carolinas, Georgia, Alabama, Mississippi and Tennessee; and **Bloom Enterprises**, Skokie, Ill., headed by Leonard Bloom, for Illinois and Wisconsin.

H. H. Scott recently appointed the **Pat Aylward corp.**, Edina, Minn., to handle its line in Minnesota, western Wisconsin and the Dakotas.

Pioneer Electronics of America has named **A.V.A. Marketing**, Albany, N.Y., headed by Dave Tamburelli, as its rep for the upstate New York area.

Altec has a new southern California rep, **C. R. McMullen Co.**, covering Arizona and Nevada in addition to southern California.

Nikko also has a new southern California rep, **Selcor**, Woodland Hills, Calif., headed by Steve Gillespie, who will also handle the Nikko line through southern Nevada.

Acoustic Research national sales manager Harvey Zelniker has announced the following rep appointments: **Ames and Associates** for southern New Jersey, eastern Pennsylvania, Maryland, Wash-



Dustin M. Addison, Jr.



Phil Lauterjung

ington, D.C. and Virginia; **The Beams Company** for Iowa, Kansas, Missouri, Nebraska and southern Illinois; **D. Neumaier and Associates**, covering Michigan; **Intracoastal Electronic Sales Co.** for Florida; **Marketing Plus** for western Wisconsin, Minnesota, and the Dakotas; and **S&A Limited** for Hawaii.

Sonic Research has named **Gilbert E. Miller Associates**, Jericho, N.Y., to represent its line of Sonus phono cartridges in the metropolitan New York market, including northern New Jersey.

Burwen Research has appointed **Cowan Associates**, Boston, Mass., as its rep for New England, and **The Pringle Group** as Canadian distributor. Burwen has also named four sales reps as "**Burwen Boosters**" and pre-

sented them with plaques for their sales efforts on behalf of Burwen signal processors, stereo headphones and indirect-to-disc records. The four Boosters are **Bill Kist**, **Audio Plus**, metro New York; **William Senescu**, **Karet-Senescu Associates**, northern Illinois and southern and central Wisconsin; **Andrew Segal**, **The Segal Organization**, upstate New York; and **John Steinberg**, **The John W. Steinberg Company**, Arizona, Nevada and southern California.

Audio Pulse has appointed **The John W. Steinberg Co.**, North Hollywood, Calif., as its rep for southern California, Arizona, southern Nevada and Hawaii.

Infinity has appointed **Phillip G. Flora Associates**, Farmington, Mich., as its rep for the state of Michigan.

Setton International has named its first sales rep, **Paul Hayden Associates**, East Point, Ga., according to Setton marketing vp Harold Weinberg. Hayden will cover Virginia, Tennessee, the Carolinas, Georgia, Alabama, Mississippi and Florida.

Personnel

Dustin M. Addison has joined the **Morris F. Taylor Co.** as consumer products and audio specialist servicing accounts in Mississippi, Alabama and Tennessee. Addison was with Vision Electronics, a large San Antonio-based distributor in Texas.

Phil Lauterjung, most recently a member of the Harman International Audio Team, has joined the sales staff at **Murray Kerdman and Associates**. Lauterjung had been servicing southern California and Arizona for Harman for the past two years. Before that he was with Pacific Stereo in both sales and management.

Our point of view:
You can't know too
much about a good
thing. Number 34 in
a series of factual
discussions.



audio-talk from audio-technica®

MICROPHONES, Basic Terms Nos. 3 and 4 Omnidirectional and Unidirectional (cardioid)

In addition to classifying microphones based on their generating elements, as we did in our first two *Basic Terms*, we can also divide them into categories based on how well they pick up sound arriving from various directions. There are a number of different types, including omnidirectional, unidirectional (cardioid), bi-directional, shotgun, and other specialized pickup patterns. The first two categories are by far the most-often encountered and are our next two *Basic Terms*.

OMNIDIRECTIONAL

Omnidirectional microphones pick up sound equally from just about every direction. They'll work just about as well pointed directly away from the subject as pointed toward it, if the distances to the diaphragm are equal. The drawing below graphically shows this pickup pattern.

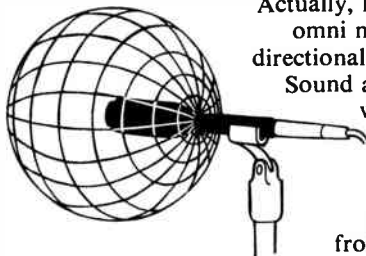

Omnidirectional Microphone

Actually, however, even the best omni models tend to become directional at higher frequencies. Sound arriving from the back will be just a bit duller than that from the front. It's because a high frequency sound pressure wave arriving from the back can't bend around the corner to the diaphragm at the end of the microphone case.

UNIDIRECTIONAL (CARDIOID)

Unidirectional or cardioid (from the Greek word for heart-shaped) microphones respond best to sound arriving from the front, while tending to reject sound that arrives from the sides or back. This effect varies with frequency, with only the better models able to provide uniform frequency response at every angle on and off axis.

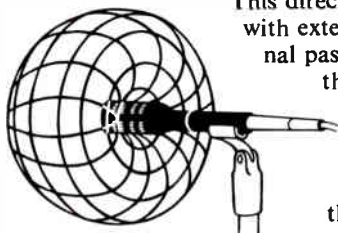

Unidirectional (cardioid) Microphone

This directional ability is achieved with external openings and internal passages in the microphone that allow sound to reach both sides of the diaphragm. Thus sound arriving at the rear of the microphone reaches the back of the diaphragm out of phase, cancelling microphone output.

POLAR PATTERNS, ANOTHER VIEW

The directional characteristics of a microphone are most often shown in a polar pattern, like these two samples. They show the differing sensitivity (in dB) at various frequencies compared to on-axis output. For instance, the cardioid pattern shown indicates the microphone is down about 6 dB at 90° off-axis. So, if two persons were talking

at equal loudness while equidistant on-axis and 90° off-axis, the person at the side would sound *half* as loud as the one in front (6 dB loss = 50% volume reduction).

Note that polar patterns are run in an anechoic (echo-free) environment. In the real world, sound *from the back* will bounce off floors, walls, and ceilings to arrive *at the front* of the microphone. So cardioid microphones can *reduce* unwanted sound, but rarely eliminate it entirely.

Polar Patterns

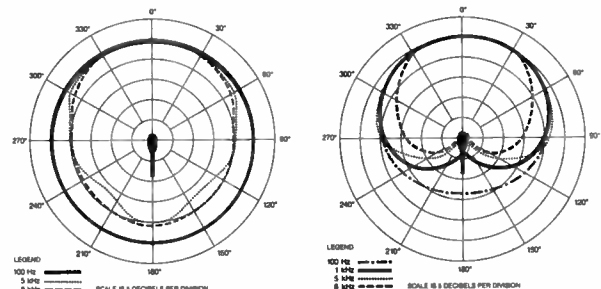

Typical Omnidirectional Pattern

Typical Unidirectional (cardioid) Pattern

HOW DO THEY SOUND?

From about 2 feet away in a "dead" room, both a good omni and a good cardioid will sound much alike. But move the pair to a "live" room and the difference is dramatic. The omni will pick up echoes and reverberation that the cardioid subdues. The cardioid will still sound relatively "dead" while the omni adds "room sound".

Now, put both an omni and a cardioid in a noisy environment, and point the back end of the cardioid toward the noise source. The cardioid (unidirectional) should prove distinctly better, especially if the performer is not ultra-close to the microphones.

Other differences are noted when the performer moves within a few inches of the two microphones. The background noise and/or reverberation will be reduced on both microphones. The cardioid may prove slightly more susceptible to "P-popping" or sibilance. And most cardioids will increase the apparent bass response. This phenomenon is known as *proximity effect*, and we'll take a closer look in our next issue.

Jon R. Kelly

Jon R. Kelly
Vice President & General Manager

AUDIO-TECHNICA U.S., INC.
Dept. 18B-34, 33 Shiawassee Ave.
Fairlawn, Ohio 44313

Available in Canada from Superior Electronics, Inc.



REP RAP

In a series of rep appointments by audio manufacturers, **Audio-Technica** has appointed **North-east Stereo Marketing**, Westwood, Mass., for New England. Northeast Stereo principals are **Arnold Goodrich** and **John Taylor**.

Marketing director Bob Morrill said **Phase Linear** has appointed seven new reps. They are **Far-north Representatives**, Anchorage, Alaska, for Alaska; **Marketing Electronics**, Auburndale, Mass., New England; **J. Nardo Associates**, New York City, for metro-New York; **Carolina Marketing Associates**, Raleigh, N.C., for the Carolinas and southwest Virginia; **Al Davis Associates**, Mariette, Georgia, for Alabama, Georgia, Mississippi and Tennessee; **L. Hass Company**, North Miami, Fla., for Florida; and **Tom Llinder Sales**, Tampa, Fla., for Puerto Rico, the Virgin Islands and Central America as well as Columbia, Venezuela and the Caribbean.

Celestion loudspeakers will be handled in southern California, Arizona and southern Nevada by **Elliot Davis & Associates**.

Winston Technologies has also appointed **Elliot Davis & Associates** to handle its line of Simplector push-button storage retrieval systems for 8-track cartridges and cassette tapes.

Allison Acoustics has named **Audio Marketing Associates**, Brecksville, Ohio, as its rep for Ohio, West Virginia and western Pennsylvania; the **Gene T. Clears Co.**, Downers Grove, Ill., for northern Illinois and Wisconsin; and **Cardinal Sales**, Indianapolis, Inc., for Indiana and Kentucky.

Videoton has named a trio of new reps on the west coast. **Ross International**, headed by Charles Ross and based in Canoga Park, Calif.,

will cover southern California; **Tony Manino & Associates**, Pacifica, Calif., will handle northern California; and **Spectrum Northwest Marketing**, Portland, Ore., will cover Oregon, Washington, Montana, Idaho and Hawaii.

BPI has named five new reps to handle its line of audio test instruments: **Rep Tech**, Lewisville, Texas, for Texas, Louisiana, Mississippi, Oklahoma, Arkansas and western Tennessee; **Audio Marketing Associates**, Brecksville, Ohio, for Ohio, West Virginia and western Pennsylvania; **Dobbs-Stanford**, Foster City, Calif., for northern California and northern Nevada; **Resource Marketing Associates**, Minneapolis, Minn., for Minnesota, western Wisconsin and the Dakotas; and **R. J. Throckmorton Sales Co.**, Ballwin, Mo. for Missouri, Kansas, Nebraska (except for west Nebraska), Iowa and southern Illinois.

Neosonic has also appointed five new reps: **Cowan Associates** for New England; **Raulson & Co.** for Florida; **Scowcroft & Associates**, Rocky Mountain region; **Jerry Bauer Associates**, southern California; and **Heaton and Keyser Sales** for northern California.

Sonic Research has appointed **R. B. Sales**, Waltham, Mass., as its New England representative. **Frank Barmakian** is president of the rep organization.

Spectro-Acoustics has appointed **FIMC International Sales & Marketing Consultants** as its international representative, responsible for worldwide sales and distribution excluding Canada. FIMC recently re-located to Westwood, Mass. At the same time, FIMC will represent the **Elac** cartridge and turntable line in the Far East and throughout Asia.

Bib Hi Fi Accessories has appointed **Ellinger Sales Corp.**, Chicago, as its rep in Illinois and Wisconsin.

Marjen has named the **Ross Co.**, Atlanta, Ga., to rep its speaker line in the Carolinas, Georgia, Tennessee, Alabama, Mississippi, the Florida panhandle and the southeast corner of Louisiana.

Hartley Products has named **Audio Sales Associates** to handle its loudspeaker line in the state of California and **C and L Sales** for Hawaii and Guam.

Vor Industries has named a military rep: **U.S. Sales Corp.**, Virginia Beach, Va.

Antenna, Inc. has appointed **Marshank Sales Co.**, Culver City, Calif., to handle its line in southern California, Arizona and southern Nevada.

AKG Acoustics has appointed **Elrep Sales Co.**, Tucker Ga., as its representative in the southeast. Elrep is headed by **Ben Van De Kreke**.

Avid has named two new reps. **Murray Kerdman and Associates**, Beverly Hills, Calif., will handle southern California and Arizona, and **Cardinal Sales**, Indianapolis, Ind., will handle Indiana and Kentucky. Avid is gearing up for an expansion drive on the west coast, where its line is now warehoused.

Audioanalyst has appointed **Little House**, Denver, and **Paul Bird**, Albuquerque, N.M. to represent its line in the Rocky Mountains. Meanwhile, Audioanalyst announced its rep-of-the-year award, won by **Steve Rosenfeld** of **Audio Marketing Consultants**, metro New York City, and its "most improved territory" award, won by **Ed D'Aleo** of **Hi-Strategy**, Chicago.

Introducing the Koss Theory of loudspeaker design and the three new Koss CM speaker systems that prove it.



© 1977 Koss Corp

Leave it to Koss to create another revolution in the audio industry. First, it was the creation of the ultimate in personal, private listening: Koss Stereophones. Today, it's the ultimate in speaker design: the new Koss CM loudspeaker systems.

By developing a complex series of audio engineering formulas and by utilizing the precise knowledge of computer science, Koss engineers have created a breakthrough in loudspeaker technology of such significance that it heralds the second major revolution in loudspeaker design technology. For the first time, it's now possible to scientifically derive and produce the

optimum system parameters for any loudspeaker at any given price point. How's that for starting a revolution in the industry? And for that matter, a revolution your customers are sure to listen to. Because we're backing it with the largest advertising budget in our history.

So contact your Koss Representative, or call Fred Forbes, 800-558-0465 today, and find out more about the incredible new Koss Theory of loudspeaker design and the three new Koss loudspeakers that prove it. Once you've heard the new Koss CM 1010, 1020 and 1030 loudspeaker systems, we think you'll agree: hearing is believing.

KOSS[®] CM SPEAKER SYSTEMS **hearing is believing[™]**

KOSS CORPORATION, 4129 N. Port Washington Ave., Milwaukee, Wisconsin 53212
Koss International/London, Dublin, Paris, Frankfurt • Amsterdam • Koss Limited/Ontario • Koss K.K./Tokyo



**Terry Rogers (l.)
and Cheryl Rixon**



**Cerwin-Vega's
Barry Goldman**



**Marty Gutenplan (l)
with Technics' Dick
Aquilina**

Hi Fi The Apple of New York's Eye

Official attendance of 41,000 made the Rogers Organization New York Hi Fi Stereo Music Show the largest show in history. More than 80 exhibitors participated in Rogers' first show effort in The Big Apple, following a history of declining attendance at similar shows sponsored at the Statler Hilton Hotel in recent years. Dealer registration was said to have exceeded 3,000.



**Andrew Carduner
of B.I.C.**



**Herb Horowitz
of AR**



**John Bubbers of
Celestion**



**Terry Rogers and
Nina Stern of JBL**

**Chuck Miller (l.)
and Rich Conforti
at AR exhibit**

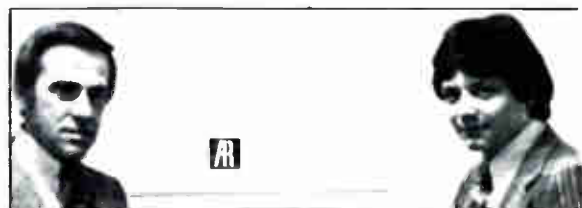



Phase Linear's Bob Morrill



Tom Frisina of JBL



Jack Smith of Pickering



Mark Scope (l.) and Ed Carrier of Epicure



Fuji's Terry Donnelly



Saul Marantz of Dahlquist

Ed Healy of Osawa



Rep Ted Roussil

Polk Audio's Sandy Gross



Ted and E. Nakamichi (l. to r.)

WCES Exhibitor List

Note: This exhibitor list was up to date at press time. For an up-to-the-minute listing, check CES TRADE NEWS DAILY at the show.

A

AAL Speaker Systems	A-232
A-Bee Syndicate, Inc.	H-1821
Accent Electronics	H-135
Acoustic Research	A-201
Acousticolor	H-130
Acoustique 3A	A-229
ACSA Corp.	H-52
Advance Transistor	439
Advance Watch Co.	417
AEI, Inc.	not assigned
Afco Electronics	H-106
Aimor Corp.	1032
AIP Universal/Casper	451
AIWA/Meriton Electronics, Inc.	403
Alaron, Inc.	1209
Almotronics Ampersand	H-1820
Ampex Corporation	511
Anderson Power Products, Inc.	
Anixter Mark	1247
Antenna, Inc.	1155
Antenna Specialists	1317 & 1417
Antler Antennas	H-1922
Apex Records, Inc.	A-227
APF Electronics, Inc.	613
Apollo Products	H-1820
Apple Computer	441
APR Industries	H-1924
A. R. F. Products, Inc.	H-1625
Arista Enterprises, Inc.	H-71
Arkota Industries	H-1504
Arrow Trading	1034
Arvin Industries	820
Astar Trading	H-87
The Astatic Corporation	H-89
Atari, Inc.	813
Audiomagnetics	A-225 & A-226
Audio Mobile, Inc.	H-138
Audio Pulse	469
Audiosonic	470
Audio-Technica U.S.	914
Audio Technology	488
Audiovox Corporation	1111
Aurora Corp.	452
Aurora Sound	492
Automatic Radio	1309
Autotronics, Inc.	H-1713
AVA Electronics Corp.	H-9
Avanti	1213

B

Ball Corporation	A-260
Bally Manufacturing	917
BASF Systems	1020
Bearfinder	1131
Belgium SA/NU	463

Berk-Tek	H-1517
Beta Electronics	1152
BGW Systems	Not Assigned
Bohsei Enterprise	A-262
Boman Industries	1411
Bomar Crystal	H-1514
Book Publishing Company	H-22
Bowmar	427
BPI Audio Test Instruments	H-47
Breaker/Hallicrafters	1228
British Industries Co. (B.IK#C.)	A-222
Brooks Mfg. Corporation	H-87A
Browning Laboratories, Inc.	H-1617
Bruerst Industries, Inc.	H-66
Brunswick Corp., Briarwood Div.	H-77
BSR/ADC	703
Buscom Systems, Inc.	H-1725
Bush Industries, Inc.	1152

C

Calfax, Inc.	H-118
California Qualitron	440
Cambridge Products	1355
Canon USA	419
Capehart Corporation	809
Car Tapes Inc./Jet Sounds	1211
Carter Corporation	1421
Casio, Inc.	413
C.C.L. Enterprises	489
Certron Corporation	A-248
Cerwin-Vega	A-202
Chelco Sound, Inc.	1125
Cibco International	H-36
Clarion	1307
Clifford Industries, Inc.	1413
Cobra Communications/Dynascan	1203
Code-A-Phone/Ford Industries	1305
Coleco Industries	623
Colt Communications	1214
Columbia Electronic Cable	H-1804
CBS/Columbia Magnetics	A-233
Comm Industries	1139
Commodore Business Machines	519
Communications Power, Inc.	1248
Communication Products Mfg., Inc.	1336
Communico	H-1608
Component Specialties, Inc.	1443
Compucolor	H-1522
Comradar Corporation	H-137
Concept Enterprises	H-1731
Concord Electronics	1442
Conic International, Inc.	A-244
CMI	466
Convoy C. B. Products	H-19
Copal	448
Cordura Marketing	H-1728
Coreco Research	H-1908
CPD Industries	H-1813
Craig Corporation	1013
Creative Marketing	H-1905
Creative Store Equipment	490
Cue Electronics (compass)	H-133
Cummins Enterprises	459
Custom Case	A-239
Custom Crystals	H-81

D

Daewoo International	H-1817
D & J Electronics	H-1724
Dagher International	H-116
Dangler Enterprises	H-1717
Data Packaging	1241
Davis-Denver	H-56
Daytron Industries	719
Dealer Services Center, Inc.	455
Decora Industries, Inc., Data Display	A-247
Decoro Products, Inc.	H-145
Dejay Corporation	837
Digital Concepts Corporation	454
Discwasher Group of Companies	A-213 & A-214
Dorchester Electronics Ltd.	A-248
Dyn-Roberts	300
Dynaco, Inc.	A-207
Dynamic Instrument Corporation	H-12
Dyusa International, Inc.	H-11

E

Eastman Sound Mfg. Co., Inc.	H-1601
Economic Swiss Time	724
Electra	1205
ERC	513
Electro Brand, Inc.	1025
Electro Industries	H-1526
Electrolert, Inc.	1445
Electronics Unlimited	H-1628
Elite Watch	450
ELPA Marketing Industries	H-1604
Emerson Radio	805
Empire Machines & Systems	1346
Empire Radio Corp.	316
Empire Scientific Corp.	A-223
Entepar California	461
Enterprex International Corporation	728
Epicure Products Inc.	1218
E S I, Inc.	H-26
ESP Systems Development	H-64
ESS, Inc.	H-1520 & H-1524
EV Game, Inc.	H-50
Everhardt Manufacturing Inc.	H-1817
Exelec	H-79
E.Z. Imports	H-41

F

Fairchild Consumer Products	715
Fanon/Courier	1207
Federal Transistor	304
Fidelitone	H-1
Fidelity Electronics	H-88
The Finney Company	1335
Fisher Corporation	507
Fold-A-Fone	H-100
Fortune Star Products	1026
Fournier Accessory Furniture	H-27
Franzus Company	H-147
Fuji Photo Film U.S.A. Inc.	911
Fuji-Svea	H-1824

G

Ganber-Johnson	1243
Gauthier Industries	H-65
GBC Closed Circuit TV	H-95
General Electric	R-3, 4, 5, 6
General Home Products	H-119
Gimix, Inc.	H-69
G. L. I.	A-206
Golden Tape	H-115
Gran Prix Electronics	920
GTE Automatic Electric	1143
GTE Sylvania	1315
GTR Products	1028
Gusdorf Corporation	817

H

Hanabashiya Limited	1147
Hanimex/International Merchandising	1012
Harada Industry of America, Inc.	H-1913
Hayden Electronics, Inc.	H-1906
Henica Electronics	H-105
Herald Electronics	1251
Hitachi	811, A-220 & A-221
Horian Enterprises	A-230
Hy-Gain Electronics	1003

I

Imperial Camera	H-1501
IMS Corporation	1027
Infinity Systems	A-204
Inland Dynatronics	1327
International Antex, Inc.	H-17
Internet, Inc.	H-2024
Internote U.S.A./Bontempi	625
Interstate Industries	819
Irish Magnetic Recording Tape	H-4
Itera Ltd.	1224
I.T.T.	1015

J

Jandy International	H-3
Janus International	247
Jasco Products	1239
Jebsee Enterprises	H-127
Jensen Sound Laboratories	503
Jerome Industries	H-1629
J.I.L.	1109
Jin Yung America	H-1729
Johnson American	1103
J. S. J. Distributors	H-45A
Jupiter Time	465
JVC America	909

K

K & K Merchandising	H-23
Katone	1242
Kenwood Electronics Inc.	509
Kingspoint	332
Kirsch Company	A-237
KLH Research & Development	A-208 & 405

Ko-Chung Electronics	H-1627
Kraco Enterprises, Inc.	1201
Kumho New York	H-144
Kustom Kreations, Inc.	1459
The Kyber Corporation	H-134
Kyowa America	1345

L

Lake Communications	1223
Langmack Co.	H-1505
L. A. S. Electronics East	A-261
Le-Bo Products	828
Leever Brothers	H-64
Leisurecraft Products Ltd. & Mercury Time & Webcor	615
Libin & Associates	478
Lloyd's Electronics, Inc.	711
L.T.L. Electronics, Inc.	H-42

M

Magnadyne Corporation	1328
Magna-Vision	922
Magnavox Company	903
Magnetic Video	H-78
Majestic Electronics	H-513
Marcel Watch	625
Marsand Industries	821
Mason Camera & Electronics	1428
Matrecs Industries	A-242
Matrix Marketing	H-70
Mattel, Inc.	H-29
Maxell Corporation of America	1023
Maxxima Electronics	H-25
Maycom Communication Products	H-1904
Memorex Corporation	412
Mesa Electronics Sales Ltd.	468
Metro Sound	1456
Microwave Filter Company, Inc.	H-109
Midex Systems	H-104
Midland International Corporation	1007
Mid-West Electronics, Inc.	H-1809
Miida Electronics, Inc.	410
Mika Overseas Corp.	H-57A
Milton Bradley Company	H-1805
Mitsubishi Audio/Melco Sales	A-215 & A-216
Monitor Crystal Service	1233
Morse Electro Products	801
Motorola	1007
Mr. Antenna	467
Mura Corporation	1113
Mustang Electronics	Not Assigned
MXR Innovations Inc.	A-253

N

National Semiconductor	415
Nemarc, Inc.	H-46
Neosonic Corp.	494
Newport of Japan	H-132
Nikko Audio	312
Non-Pareil Company	485
Norelco	825
Northern Telecom	1136
Nortronics	H-1705

Nucleonic Products	H-1623
Numark Electronics	A-256
Nuvox Electronics	1340

O

Odemer Company	H-1601
Olivetti Corp.	446
Olympos Electronic Co.	H-74
Olympus Corporation	A-252
One-Up, Inc.	434
On-Guard Corporation	1450
Orinda Recording	1831
Osawa & Co.	A-217
O'Sullivan Industries	1016

P

Page Alert Systems	H-1624
Pal "Firestik" Antenna	1119
Palomar Electronics	H-20
Panasonic Company	701
Panasonic Company (Car Audio)	1105
Panasonic (Electronic Components)	A-245
Panorama Radio & Electronics	320
Para Dynamics	H-1613
Parallax Corporation	H-93
Parentian Industries	A-203
Pathcom, Inc.	1101
Patson Electronics	1341
Peerless Audio	A-235
Pemcor	H-1520
Peymac, Inc.	H-1706
Pfanstiehl Corp.	H-1813
Phase Linear Corporation	A-205
Philips High Fidelity Laboratories	401
Phone-Mate, Inc.	1144
Phone Sonic & Schneider	719
Pickwick Mfg. Co. (formerly Soma)	H-82
Pioneer Electronics of America	1003
Plessey Consumer Products/Garrard	A-224
Polydax	A-258
PRB Industries, Inc.	328
Preferred Mfg. Co., Inc.	H-55
Presage Corporation	
President Electronics, Inc.	1329
Pride Electronics	H-1516
Prime Electronics, Inc.	H-1620
Pro Sports Marketing	1527
Professional Systems Engineering	H-1521
Progress, Inc.	1451
Promotions West	H-1726
Pyramid Industries	H-142

Q

Quasar Electronics	907
Quasar Microsystems	1414

R

Radatron Corporation	1354
Raider Corporation	H-45
Randix Industries	A-240

(Continued on page 72)

WCES Exhibitor List

(Continued from page 71)

RCA	807
Realtime Corporation	462
Record A Call	308
Recoton Corporation	1145
Redi Kilowatt	H-67
Regency Electronics	1115
Rhoades National	H-6
Riccar America	H-1630
Robins Industries	1234
Robyn International	1117
Rodco Products	H-62
Rogers Foam	H-128
Rotel of America	407
Rotelcom	H-123
Royal Typewriter	463
Royce Electronics	1011
Royex Ltd.	H-111

S

S & A Electronics	H-112
Samn Electronics	H-1808
Sampo Corporation of America	330
Sankyo Seiki (America), Inc.	709
Sansui Electronics Corporation	713
Sanyo Electric Inc.	1001
Savoy Leather	H-35
Saxton Products	1351
SBE, Inc.	1107
Scarborough Laboratories	1455
M. H. Scott C.	H-1510
Screamin Demon Products	H-16
Seal-O-Matic Corporation	H-2
Se-Kure Controls, Inc.	1246
Sensor/Micro Display Systems, Inc.	532
Service Manufacturing Co.	1018
Setton International Ltd. (USA)	A-218
Shakespeare Co.	1303
Shark Electronics Ltd.	729
Sharp Electronics	717
Sharp International	481
Sharp Electronics (Calculator Div.)	717
Shmegg Electronics Inc.	H-59
Shur-Lok Mfg. Co., Inc.	H-10
Shure Brothers, nc.	409
Siltronix	1319
Sinclair Radionics Inc.	628
Smith-Gates Corporation	H-63
Solar Sound Systems	1021
Solar Textiles Company	H-144
Solarex Corporation	452
Sonar Radio	1429
Sonic Energy Systems	A-209
Sonic International	1010
Sony Corporation	905
Sound Bound Speakers, Inc.	H-53
Soundcraftsmen	A-236
Soundesign Corporation	803
Sound Dynamics Inc.	H-68
Soundmusic Products	A-256
Sound Suspension	486
South Rver Metal Products	H-85
Space Radio Supply	H-1807

Sparkomatic	1301
Spartus Corporation	441
Spearsonic Electronics	H-43
Spectro Acoustics	H-139
Standard Communications	1342
Stoner — The Sideband People	1440
Suburban Electronics	H-1720
Summit Audio	H-16A
Sun Coast Merchandise	H-94
Sundial Enterprises	H-75A
Superex Electronics	1127
Superscope, Inc.	901
Sutton Import-Export	1135
Switcher Co.	477

T

Tamura Electric	435
Tasco	529
Tatung Company	340
TCA Incorporated	436
TDK Electronics	919
Teal Industries	520
TEI Electronic Products	H-1513
TEL Products	H-97
Telcer Telephone	H-2004
Telco Products	1347
Teleconcepts, Inc.	H-125
Teletone Co.	475
Telex Communications	1350
Tenna Corporation	1114
Texas Instruments	515 & 517
Time Trends Ltd.	438
Timex Corporation	433
Tonitron Industries	H-141
Topp Electronics — Juliette	705
Transcriber Company	H-49
Trinetics Inc.	H-1723
TRS Marketing	H-7
True Temper	H-102
TRW	H-1701
Tryome Target Marketing	H-1921
TSS Sound Systems	
T. T. Systems	H-1901
Tunel Research, Inc.	H-38
Turner Division/Conrac	1112

U

Uher of America, Inc.	A-206
U. I. T. Precision Company	421 & 444
Ultralinear Loudspeakers	A-203
Unarco-Rohn	1220
Unisonic Products	617
United Electronics International Inc.	523
Unitrex of America	521
Universal Security Instruments, Inc.	H-1917
Universal Sign Systems, Inc.	H-5A
U.S. Pioneer Electronics	501
Utah Electronics	H-125

V

Valor Enterprises	H-30
Vanco-Chicago	1425

Vanity Fair Industries	833
Venture Electronics	H-1
Veritas Electronics	1151
Vidaire Electronics	H-1607
Video Micro Computer	619
Video Technology Limited	H-124
Videomaster Ltd.	H-32
Video Micro Computer	619
Visonik of America, Inc.	R-7
VOR Industries	460

W

Wahl Clipper	H-1621
Walco-Linck Corp.	A-241
Wald Sound	A-210
Wawasee Electronics	H-1925
Weatheralert	1455
Welch-Tronics	H-134A
Whistler, Inc.	H-35
Wilson Electronics	1434
Windert Watch Company	535
Windsor Industries, Inc.	723
Winn-Tenna, Inc.	H-1821
Wood Specialty Products Inc.	A-212
WP Distributing Corporation	H-93

Y

Yorx Electronics	913
------------------	-----

Z

Zoom Telephonics	H-114
------------------	-------

Note: This exhibitor list was up to date at press time. For an up-to-the-minute listing, check CES TRADE NEWS DAILY at the show.

SONY PROUDLY ANNOUNCES A NEW SOURCE FOR ITS AUDIO CASSETTE TAPES.



That's right. Sony is now selling its blank audiotapes. Sony. A name synonymous with quality sound reproduction and reliability. A company that will stand behind you with national advertising. New, attractive packaging. And competitive pricing.

For you, it all adds up to a great profit making opportunity. For your customers, a variety of compact cassettes: Low Noise, Hi Fidelity, Chrome, and Ferri-Chrome; Microcassettes for hand-held recorders and the remarkable Elcaset®

which Sony invented. And for a limited time only, Sony is offering three colorful tape display racks.

Sounds good? Well, why shouldn't it? After all, it's Sony.

For more information, write: Sony Corporation of America, Magnetic Tape Division: c/o V.P. Sales, 9 West 57th Street, New York, New York 10019. Or better yet, while at the CES in Las Vegas, come and see our complete audio product line at Booth 905 **"IT'S A SONY."** or in our hospitality suites in the MGM Grand.

11° SIM High Fidelity 1977



Highlighting the European Show Tour was a special seminar on the Italian market held at the Milan Show by ACE International magazine, HFTN's sister publication, and chaired by ACE president Lee Solomon (fourth from left).

"CES" In Europe . . .



At CES you don't have to fight your way into exhibits past consumers and children with ice cream cones a la Berlin (photo) or Milan.



Here, an Italian model distributes ACE magazine at the Milan Show, done up like the puppet on the cover of that particular issue of ACE.

Despite the fact that this year's Winter Show-goers can leave behind zero temperatures and winter woolies, CES is still CES, albeit bigger and better.

Even if slot machines and dancing girls have been thrown in this time around, there is still a core of diehard showgoers who've probably seen it all . . . and another show is still, another show . . . yet another event in the Audio Olympics they've been competing in.

For some industry veterans, in fact, it's really hard to distinguish when one show season starts and another ends: for Electro-Voice's Bob Pabst, Harman's Walter Goodman; Empire's Howard Spanbock and Mitch Ravitz; JBL's Bruce Scroggins; Jennings' Tom Jennings, just to name a few who've been spotted showing off their new products around the world.

ACE International, HFTN's European sister publication, brought its staff of editors and reporters to the Audio Olympics as well: to the mammoth Funkausstellung in Berlin, the fall shows in England (Harrogate, Cunard and Olympia); the Salone Internazionale della Musica (S.I.N.) in Milano and the Japan audio fairs.

Highlighting the show tour was a special seminar held at the S.I.M. and chaired by ACE president Lee D. Solomon and publisher Frank Norall. With the dialogue in Italian, the panel included manufacturers, dealers and vendors discussing the Italian hi fi market and its problems.

Representing audio component manufacturers were president's Elio Milanese and Massimo Romita, of REVAC and Galactron, respectively. The dealers point of view was represented by Dionisio Ielli, Milano, and Michelle Trombone, Napoli. Importers on the panel were Edmond Jedid and Gilberto Gaudi of Gaudi and Alessandro Pirera of Polycolor. Run like a mini-United Nations, non-Italian speaking members of the audience were able to sit in on and listen to simultaneous translation into English through headphones provided. ACE, which debuted its first issue and its first conference last June, plans to hold additional conferences throughout Europe and the United States in the coming year.

Meanwhile, we hear some itinerant manufacturers are trying to find out if their extra lire will work in the slot machines over at the MGM Grand.

Between shows, a smiling Jacopo Castelfranchi reports that he is the new owner of Consumer Electronics Italia.

Castelfranchi, president of GBC and involved in other electronic firms, will soon announce his plans for the "local" Italian trade magazine.

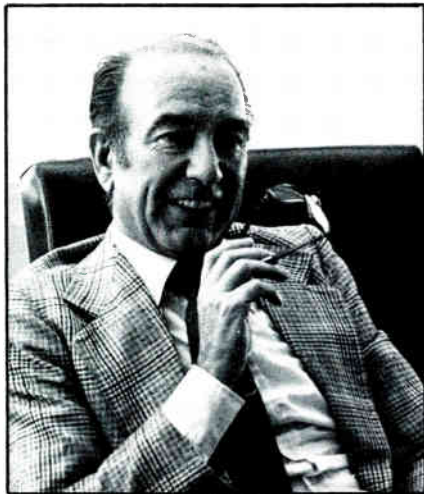

Lotario Calo, direttore generale of Bose in Italy, at Milan Show.

Empire Scientific's Howard Spanbock (l.) and Mitch Ravitz at Berlin Show.



Larry R. Frandsen, managing director of Electro-Voice S.A. (Berlin Show).



Jack Setton touring the Berlin Show.



Among the new products in Berlin were these from Hitachi.

... And Japan

Three weeks after Tokyo gets a chance to view all the new 1978 hi fi products, the equipment is hauled down island to Japan's second largest city, Osaka. And there, in mid-October, a glittering variety of new gear is demonstrated.

The show, part of a larger parts fair, is sponsored by the Japan Electronics Show Association. Osaka, home of Japan's 1970 World's Fair and near the Japanese cultural center of Kyoto, is the home base of such audio stalwarts as Fisher, Sanyo, Lux, Miida, Optonica and Technics, as well as being the setting for the novel, "Shogun," which many Americans are currently reading to better understand the Japanese mystique.

The hot futuristic product that had both trade and consumers buzzing this past fall was PCM (Pulse Code Modulation). This non-contact laser shaft picks up a signal from a metal record, and delivers a dramatic reduction in noise levels, and was clearly the hit

of the show. But don't expect laser product in your showrooms soon. PCM units, which were shown by a Teac-Mitsubishi group, a Hitachi-Denon group and Sony, were more on the order of Avery Fisher's demonstration at the 1939 World's Fair. Maybe not quite on that order.

Some products that you may be seeing soon include much new semi-conductor technology. A digital display quartz synthesizer from Technics was shown, along with a new powerful MOSFET unit from Hitachi, plus a fantastic push-button digital tuner from Toshiba. Sharp also showed a memory tuner using their program search technique.

In addition, a new linear turntable was demonstrated at the show.

American retailers can also look forward to a new high-end tape from Japan from an old reliable. Also look for a first-rate 3-head deck from Akai. And special, new Kenwood amps.

PRODUCTS FOR PROFITS

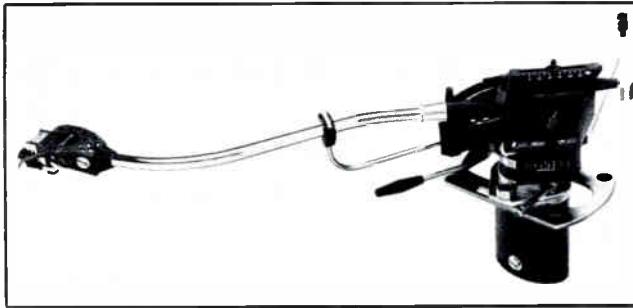

Shure SME 3009 Series III



Cerwin-Vega Metron PR-1



JVC MusicTower



Memorex Accessory line



Sansui SP-L700

Shure Brothers has a breakthrough in tonearm strength/weight ratio through the use of titanium instead of aluminum and wood. Incorporated in the SME 3009 Series III tonearm system being introduced at \$294, the FD-200 fluid damper is an optional accessory available with the unit. . . Cerwin-Vega's new international division, the Metron Group, takes its name from the Greek word for "measure." New from Metron is the model PR-1 pre-amplifier at \$500. . . JVC is introducing MusicTowers. Model LX-3000 is shown. Also available is the LK-905, a mid-sized tower, and the LK-33MK-33. . . Memorex is coming out with a new high-end line of audio accessories. Of four initial products in the line, three devoted to record care and the fourth a tape recorder care kit. Distribution is expected by February 1. . . Sansui's SP-L dual woofer technology is now available at a more affordable price — \$600 in the SP-L700 two-way speaker.

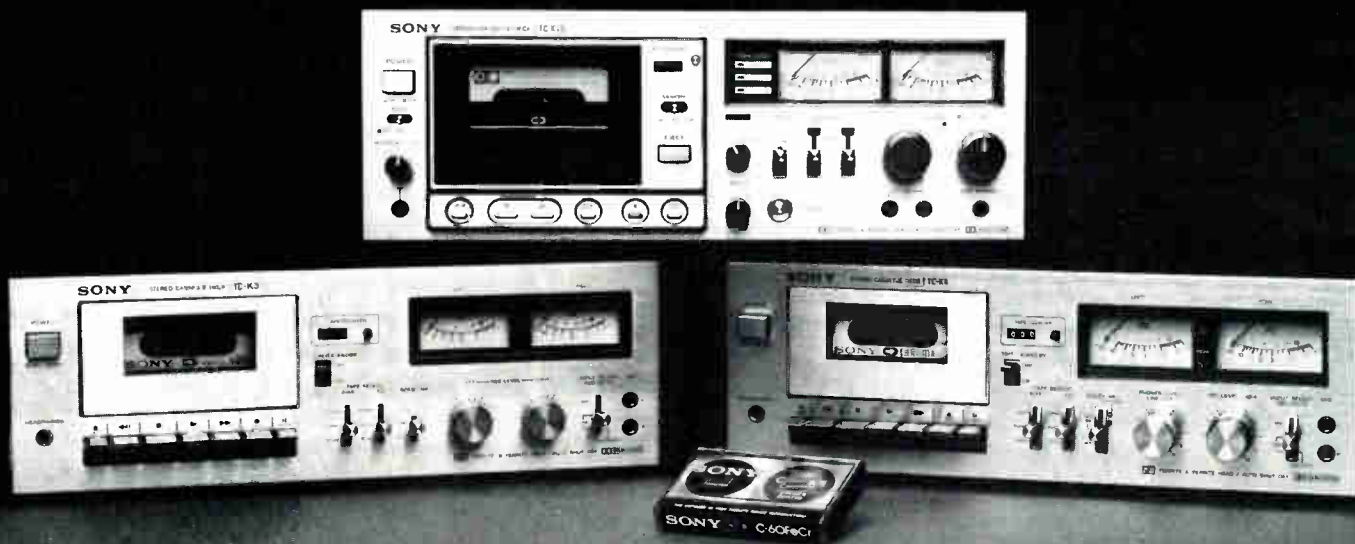

An important new chapter in recorded history.

Announcing cause for celebration: An important new line of tape decks is coming to you directly from Sony.

It's only fitting that tape decks be added to the Sony family. After all, Sony was making tape recorders when they were still in their infancy.

So imagine the kind of technical know-how accumulated in 30 years. And you can imagine why both the trade and the public await Sony's tape decks with impatience.

The line consists of 3 front-loading decks (TC-K7II, K-4 and K-3), a portable that's a virtuoso of

versatility (TC-158SD), and 2 Elcaset decks (EL-7 and EL-4).

The front-loaders offer DC servo-controlled motors; two models offer frequency generators. The heads are another reason for Sony's head-and-shoulders superiority: ferrite-and-ferrite construction. There's a 3-position switch for standard, ferri-chrome and chromium dioxide tapes. There's a Dolby Noise Reduction System. And all controls are simply and logically arrayed.

The Elcasetts take the latest form of tape reproduction, and go one step further. More and more

customers are becoming interested in this advancement that allows cassettes to approach open-reel fidelity. So Sony put more in: dual-capstan, closed loop drive; three-motor system; three-head system.

We suggest you make your move to these cassette decks at the earliest date. Because they're not only going to make recorded history, but selling history as well.

SONY[®]
AUDIO

© 1978 Sony Corporation of America, 9 West 57th Street, New York, NY 10019

PRODUCTS FOR PROFITS



Miller and Kreisel Goliath II

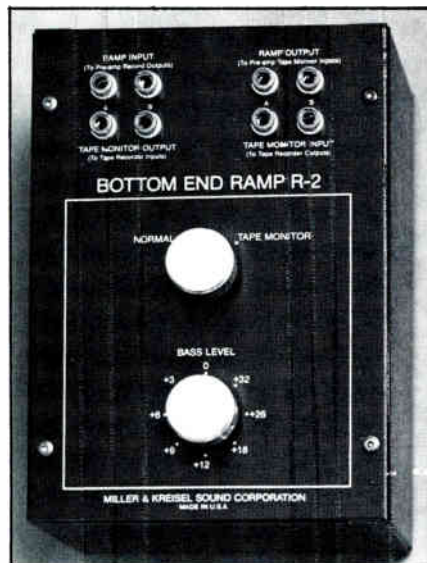

Miller and Kreisel R-2

Miller and Kreisel have introduced two new products. The **Goliath II** is the firm's new subwoofer requiring a minimum of 35 watts power output. The unit sells for \$175. In addition, the firm is offering a new **Bottom End Ramp System**, a passive electronic companion to the M&K Bottom End speaker and crossovers. The Bottom End Ramp enables the Bottom End speaker to work well with high-efficiency speakers without bi-amping. The **R-1** Bottom End Ramp is priced at \$110, the **R-2** (shown) at \$95 . . . **Tandberg's TR-2075MKII** stereo receiver represents Tandberg's **top-of-the-line**, an improved version of its predecessor. The unit is priced at \$1,100 . . . **Numark** is introducing the **model EQ-2000 frequency equalizer** as a companion to its disco mixer. Both the mixer

and frequency equalizer are priced at \$149.95 each . . . **Matrecs** is offering the new **Tri-Power** three-way **car speaker**, a six- by nine-inch system featuring a 20-ounce magnet. The speaker utilizes "**LiquiFlex**," a magnetic fluid which allows for more flexible, extended range, according to the company.



Matrecs



Tandberg

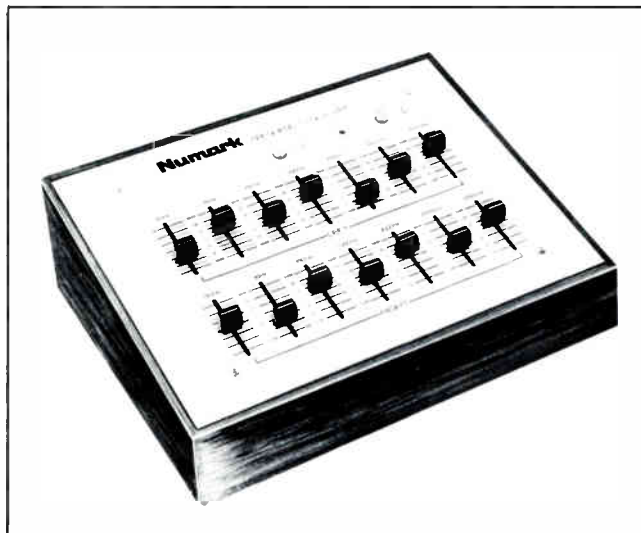

Numark



“I’ll give you the shirt off my back”

I’m Ken Busch, General Manager of Empire, and I want you to honestly evaluate the total marketing package being offered by Empire compared to the major phono cartridge competition.

Number each box according to how you rate each of the companies listed below.

If your total doesn’t show Empire to be the best line, and your Empire representative can’t convince you, I’ll send you “the shirt off my back”. The new Empire T-shirt.

However, I want you to be honest. So, no matter how you score us, I’ll send you our newest promotion item, the Empire painter’s hat.

Send your results to; Empire Scientific Corp., Garden City, N.Y. 11530.

Number the companies 1-6 in each category using number 1 to signify the best and 6 the worst.

EMPIRE

	Empire	ADC	Audio Technica	Pickering	Shure	Stanton
Product credibility						
Dealer pricing						
Packaging						
Programs						
Profit potential						
Flexibility						
Delivery time						
P.O.P. material						
Quality of consumer advertising						
Quality of literature						
Honesty of specifications						
Sales training aids						
Name _____		Company & Address _____				
Home address _____		_____				
_____		_____				
Hat size	S	M	L			
T-Shirt size	S	M	L	XL		

PRODUCTS FOR PROFITS



Epicure

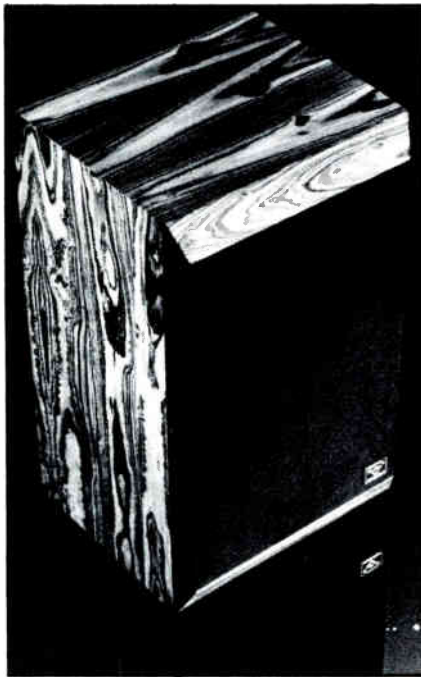

Cerwin-Vega

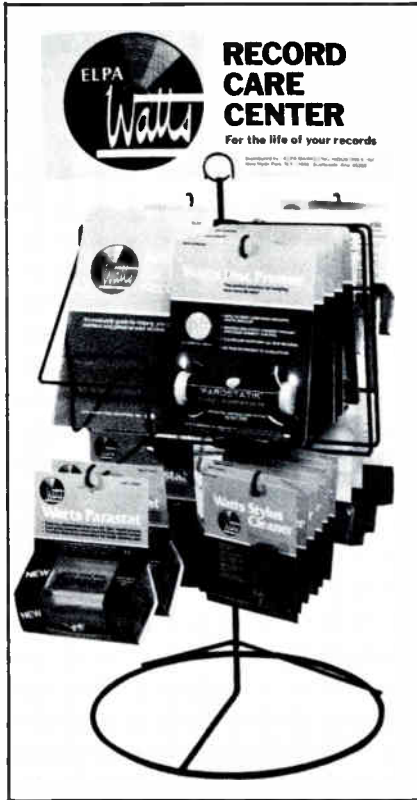

Watts

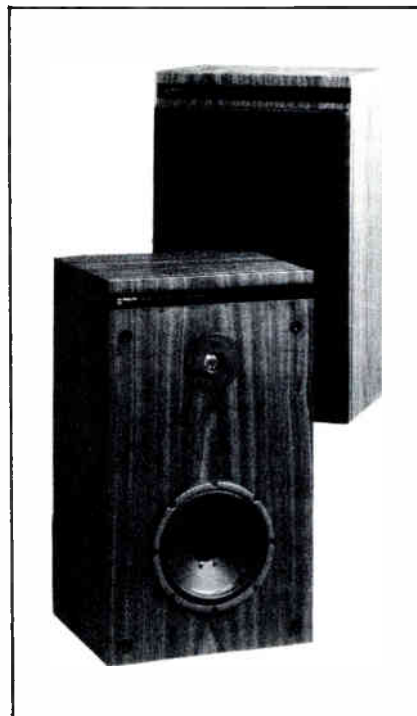

Philips

Epicure has introduced an improved version of its MicroTower 1 loudspeaker system. Dubbed the **MicroTower 1-B**, the improved unit is priced at \$109.95 . . . **Cerwin-Vega's** new **S-1 bookshelf loudspeaker** handles up to 200 watts of power and features the firm's **thermo-vapor suspension** design principle. The S-1 speakers is priced at \$350 . . . **Watts** is offering accessories dealers this **record care merchandiser**. For details contact **Elpa Marketing Industries** . . . **Philips** has added a third dynamic speaker, the **model AH475** eight-inch two-way system which handles 40 watts of power and is priced under \$110 . . . **Micro-Acoustics** has a new cartridge at the top of its line. It's the **model 530 mp** and the unit is priced at \$200.



Micro-Acoustics

Please place an order with Infinity.

For a glass of wine.

That's what we're pushing this week.

We've found a marvelous Chenin Blanc from a small and overlooked family winery in Santa Cruz County. And we want to share it with you. Along with some good music from our record collection and our library of Dolby 'A' master tapes.

Furthermore, we've left our sales pads at home. So if you want to order anything except a glass of wine, it will have to be at another time and another place. We're terribly sorry.

Not that we don't believe in writing orders; we've written more this year than in our last two years *combined*. Which is precisely why the agenda in Exhibit Space 923 is:

(1) to toast and say thank you to our dealers and their salesmen, the press and our other friends in the Industry for their understanding of our peculiar brand of fanaticism,

(2) to introduce our R&D dreamer/designer/engineering types to any and all audio aficionados who come by, and,

(3) to listen to some of our favorite music on some of our favorite state-of-the-art equipment. Ours and others. (Like the Ampex ATR 100, the Grado Signature 2 and a few R&D surprises from Infinity.)

Which reminds us— we're unveiling the QRS.

You'll hear all the abovementioned music through our new Quantum Reference Standard — the no-compromise speaker for those to whom music is the most important thing in life.

The QRS is 6 feet 6 inches tall, costs about \$6,500 and is totally impractical. We expect it will sell rather well.

By the way, it's the only speaker we'll have in the room. There won't be room for anything else.

We're not a speaker company.

We're a music company.

So when the noise and the distortion and the hassle and the slot machines and the hotshot promos and the order pads get to you — remember — there's an oasis in Exhibit Space 923.

Come listen and enjoy. And get back to what it's all about.



 Infinity™

We get you back to what it's all about.
Music.
And wine.

PRODUCTS FOR PROFITS



BPI wow and flutter analyzer

BPI's new model 1600 wow and flutter analyzer features NAB, JIS and DIN weighting networks at a price of \$795 . . . Tamon is introducing new speakers for auto or home use. The LB-103 is priced at \$179 a pair for home installation and is offered as the LB-1030 with a mounting bracket for car installation at a \$189 per pair price . . . A trio of new products is being unveiled here in Vegas by JVC, including the model T-3030 digital frequency synthesizer FM stereo tuner. In addition, among the firm's new products is the model JT-V11, an AM-FM stereo tuner which contrasts with the low-silhouette styling of the digital T-3030 system. Finally, from JVC, there is a new portable, the model RC-525JW, a portable four-band radio cassette recorder which additionally features a zoom microphone. For pricing on the units, contact JVC America.



Tamon 103 (l.) and 1030 speakers

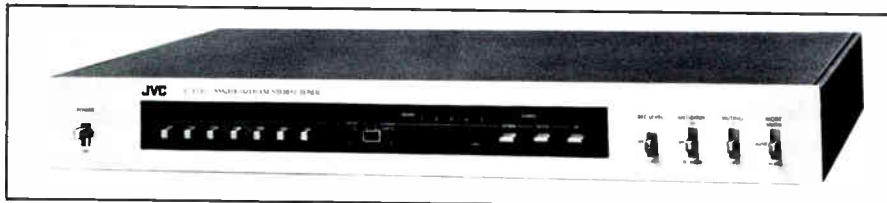

JVC T-3030 FM stereo tuner

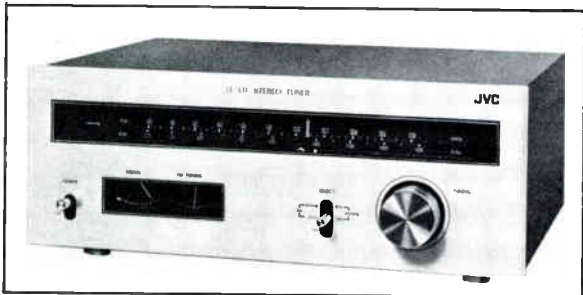

JVC's JT-V11 AM-FM stereo tuner



RC-525JW radio/cassette from JVC

The first \$250 winner
in Jensen's Floor Salesmen's Sales Tip Contest

"I almost always close a sale by concentrating on a single pair of speakers rather than A/B comparing several pairs."

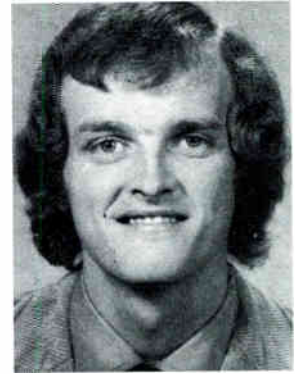

— El Clark
Dimensional Sound Center
Mount Vernon, Washington

"After qualifying the customer as to cost, efficiency, musical tastes and styling, I move to a close on a single pair of speakers rather than A/B comparing several pairs in the relative price range. I'm often quite successful in this.

The technique is to explain to the customer that he is not buying 'specs,' nor is he buying comparisons (most likely only one pair will be in his living room). What the customer is buying is entertainment, home entertainment.

Now I have the customer get comfortably seated and close his eyes. While I play a minute or two of his type of music (at his volume level, of course) I ask him to address the following questions: does this sound like real music? Is the sound pleasing? Is the sound entertaining?

If the answer to these questions is 'yes' you should be able to ask 'How much speaker wire will you need?' and go ahead and write up the sale.'

El Clark has developed a sales technique that works for him... and could work for you.

First, put yourself in the customer's place... with a pair of Jensen Lifestyle speakers. Close your eyes and give them a good listen. Ask yourself the same questions.

We think you'll be impressed with their remarkably natural sound reproduction. Experience Jensen's Total Energy Response which delivers a uniform recreation of this sound throughout the entire listening area... at all frequencies. With excellent stereo imaging and no

holes or gaps in the sound.

The full Jensen Lifestyle product line offers five speakers to fit almost every customer's budget, with features and performance that make each model an outstanding value.

But after you've heard them for yourself, play a pair of Jensen speakers for your next customer. And don't

forget to adjust the level controls on the speakers while he's listening. With El Clark's technique... and these speakers... closing the sale should be a snap.

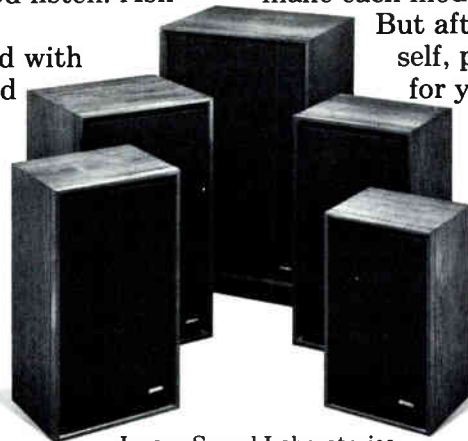

Jensen Sound Laboratories
Division of Pemcor, Inc. Schiller Park, Illinois 60176

JENSEN
LIFESTYLE SPEAKER SYSTEMS

Watch this publication for more winning speaker sales tips by hi-fi floor salesmen from across the country.

PRODUCTS FOR PROFITS

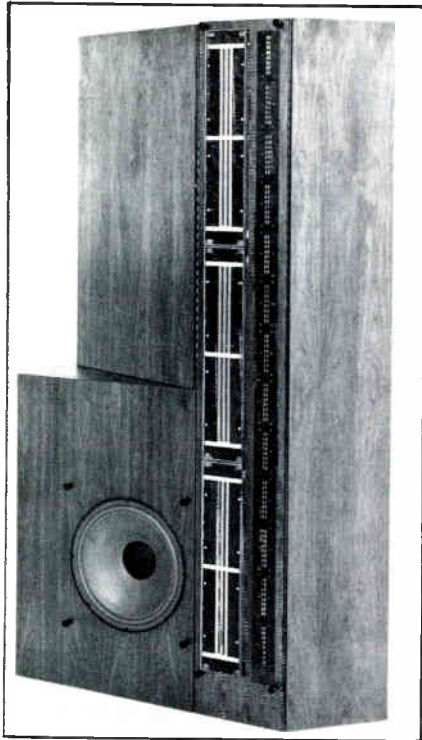

Infinity "QRS"

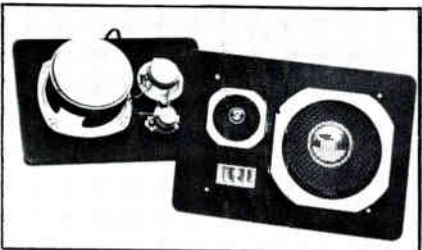

Sparkomatic auto speaker

Electro-Voice Interface



Acoustique 3A Triphonic



Elpa Marketing Editall

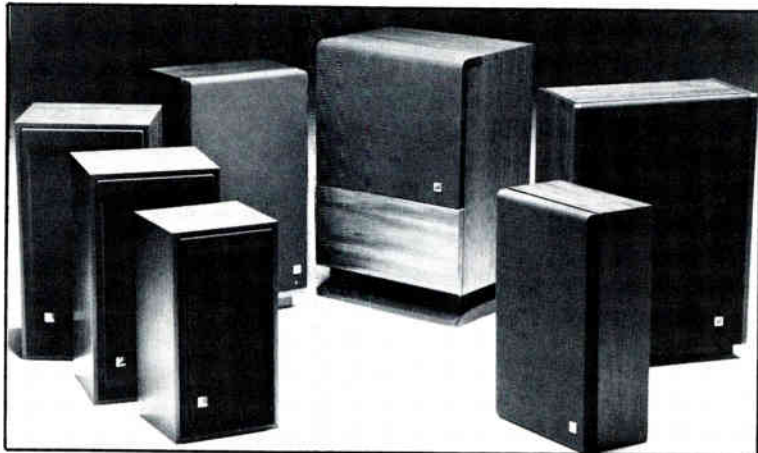

Infinity's "QRS," or Quantum Reference Standard, requires two amplifiers for each pair of speakers sold. The speakers, by the way, are priced at \$6,500 per pair . . . Acoustique 3A is introducing its new Triphonic, a completely integrated speaker system which the firm claims is the first such offered. The suggested retail price is \$1,299 per pair . . . Sparkomatic Corporation is offering the new model SK-6900, a rear-deck three speaker stereo system for the car. Contact the company for pricing information and other details . . . Elpa Marketing is offering show buyers this new Editall display merchandiser, a rotating wire rack design . . . Electro-Voice is introducing a brand new Interface line of loudspeakers. Seven models in all, the units range in price from \$100 up to \$700.

HITACHI

The New Leader In Audio Technology

Evidence:

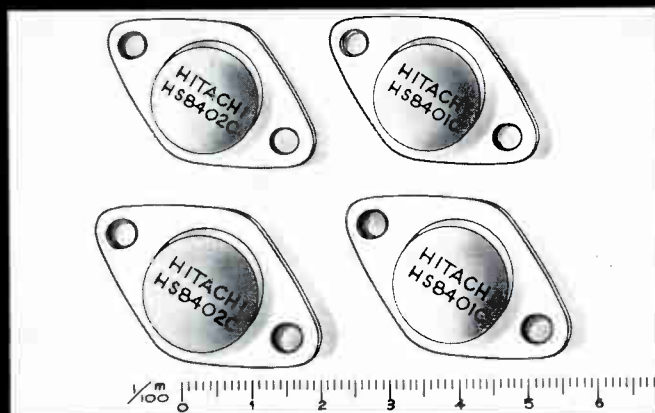

THE WORLD'S FIRST METAL OXIDE SILICON FIELD EFFECT TRANSISTOR (MOS/FET) FOR AUDIO AMPLIFIERS TO PRODUCE PERFORMANCE SUCH AS 0.01% THD at 100W + 100W, 5Hz-100KHz, 8 OHMS

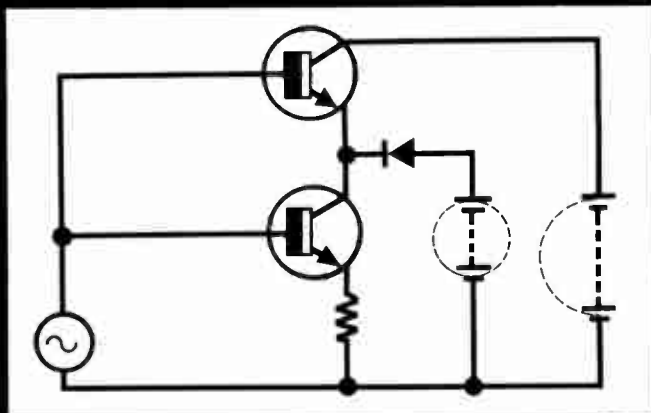

THE CLASS G AMPLIFIER—THE ONLY AMP THAT INSTANTLY DOUBLES ITS RATED RMS POWER ON DEMAND TO PREVENT CLIPPING DISTORTION



UNIQUE R & P 3-HEAD SYSTEM CASSETTE DECKS FOR NO-COMPROMISE PERFORMANCE

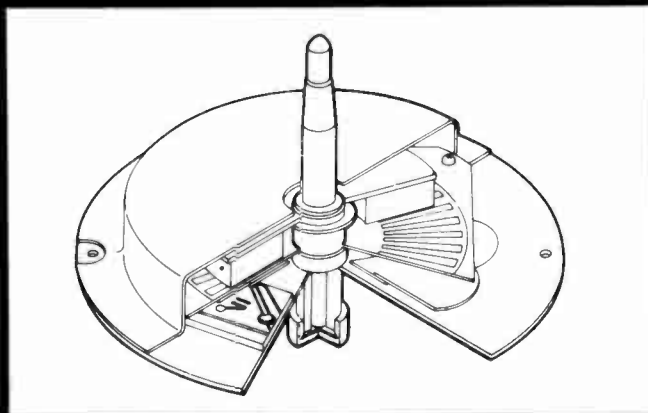

UNI-TORQUE TURNTABLE MOTORS THAT VIRTUALLY ELIMINATE WOW AND FLUTTER



GATHERED-EDGE METAL CONE SPEAKERS THAT PRODUCE OPTIMUM SPEAKER PISTON MOVEMENT

 **HITACHI**
When a company cares,
it shows.

See the new leader in audio technology in action at CES. Our audio component booths are A-220/221—and our PEP and TV booth is 811.

PRODUCTS FOR PROFITS



Almotronics



Utah American



Pyle



Olympus



Koss

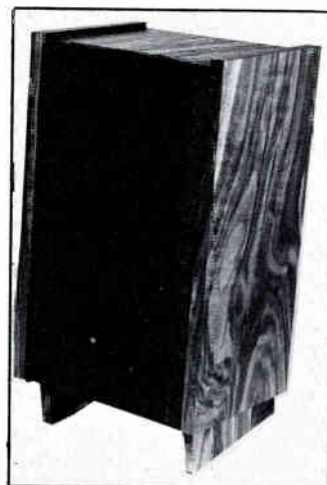

Kustom Acoustics

Almotronics is introducing new **Quoters** three- and four-way automotive speakers. The units feature 30 watts of power output handling capacity. The six- by nine-inch speakers feature 20-ounce magnets . . . **Utah American** is introducing "**The Principle**" system in this new bookshelf, allowing the user to "tune" the listening room environment . . . **Pyle Industries** is offering a new **OEM organ speaker** line to electronic parts distributors . . . **Olympus** is introducing a new **micro-cassette head cleaner**, the **model C-1**, which is priced at \$2.95 retail . . . The top of the new medium-priced speaker line from **Koss Corporation** is the **model CM1030** which is priced at \$385 per speaker. The new dynamic speaker line, recently introduced by Koss for shipping to dealers, is **computer-maximized** . . . Chicago-based **Kustom Acoustic Corp.** is unveiling the new **Regency loudspeaker** system which is priced at \$389 each and carries a three-year warranty. Kustom is also offering an **optional base** with the Regency. If elected, the system then is priced at \$415 retail.

**If Akai, Aiwa, Centrex, JVC,
Kenwood, Meriton, Nakamichi,
Optonica, Pioneer, Royal Sound,
Sansui, Sharp, TEAC, Toshiba,
Uher and Yamaha, in addition to
Bang & Olufsen, Dual, Fisher,
Harman-Kardon, Lafayette, Sankyo
and Tandberg all recommend our
SA for their machines...**

...shouldn't you?



All of the tape deck manufacturers above recommend our SA cassettes for use in their machines in the "High" or "CrO₂" bias position. In addition, all those in the first part of the list clearly indicate they prefer SA, since they bias their decks specifically for it.

So it only makes sense, when you sell one of these machines, to make sure you sell a case of TDK SA cassettes to go along with it. Especially, since tape sales are so profitable, and take up so little sales floor and warehouse space.

Our barrage of consumer advertising in over two dozen national publications, on syndicated radio shows on 225 FM stations, plus co-op local radio and print, helps you sell by telling millions of potential customers that TDK SA is "The Machine for Your Machine." All this, plus the extra help we give you with a full complement of in-store P-O-P and promotional aids.

Selling a tape deck without selling tape to use in it, is like selling a camera without film. Put extra profits into your component sales by selling the tape that's recommended for so many leading tape decks: TDK SA. It's only one product in the trend-setting TDK full line of cassettes, open reel and eight track tapes.

And if you have any doubts, all you have to do is check our references.



The machine for their machine

TDK Electronics Corp., 755 Eastgate Boulevard, Garden City, New York 11530.
In Canada, contact Superior Electronics Industries, Ltd.

3M Sees Strong Role in VTR Software

3M is moving rapidly ahead in the manufacture, distribution and sale of home videocassette software/and expects to play a leading role in the field. The firm's recently reorganized magnetic media consumer program is now headed by Don Rushin, retail products manager, who has already announced that Scotch brand Beta-format videocassettes have attained national distribution.

"Right now we're trying to complete development on VHS software and we hope to do that by late in the first quarter," Rushin told *Hi Fi Trade News* in a recent interview.

3M had conducted a market-by-market rollout of Beta-format videocassette product to its retail

dealers, with production sufficiently geared up to permit the company to exceed its original schedule for full distribution.

Both the L-250 (30/60 minute) and the L-500 (60/120 minute) videocassettes became available across the country around Thanksgiving time. The tape used is of the same quality as Scotch video tapes for broadcast and industrial/education applications.

3M says the tape provides excellent picture quality because of the use of a specially-formulated high-energy oxide. Head and tape life result from the use of ferric oxide and improved tape lubrication. Superior tape handling, wind and conductivity are provided by 3M's patented Posi-Trak backing.

Suggested retail and commercial/educational prices per single videocassette are \$12.45 for the L-250 and \$16.95 for the L-500.

While 3M has no videocassette hardware plans, despite the potential application to the field of its digital audio system introduced last fall at the Audio Engineering Society Convention in New York, Rushin sees "an extremely healthy market" for software.

"We would almost like to be more conservative, but when you

listen to the hardware guys and their figures and look at the rate at which color tv penetrated, you can't be. It's almost scary. But our own surveys bear out a healthy market, even if it's not as strong as the hardware people are forecasting. They're talking about sales of 10 to 30 blank videocassettes per year per machine. We see that figure as something less than 10 units per year per machine but we don't know exactly what the figure will be."

While distribution of videocassette hardware for the home is virtually up for grabs, with department stores, appliance-tv dealers and hi fi chains and specialists figuring to play important roles, Rushin says distribution of software is a natural for most blank audio tape companies, certainly at least for 3M.

"We're now in the department stores and consumer electronic stores, so there's no need for new distribution or special services for dealers. As with blank audio tape, it is very important that videocassette product be visible to the consumer. Impulse sales will be an important factor in overall software volume," Rushin predicts.

Neither does the 3M exec see any problem due to varying formats. "We feel very strongly that VHS and the Beta-format will exist side-by-side, the same as in blank audio tape or, more precisely, as we find in the photographic film business. There is ample room for both systems, and we intend to supply the software for both."



New 3M Beta-format tape

HIGHER FIDELITY...

EXTENDED.

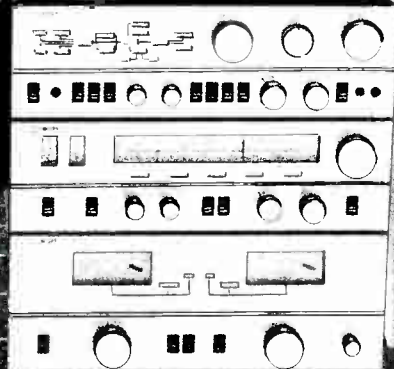
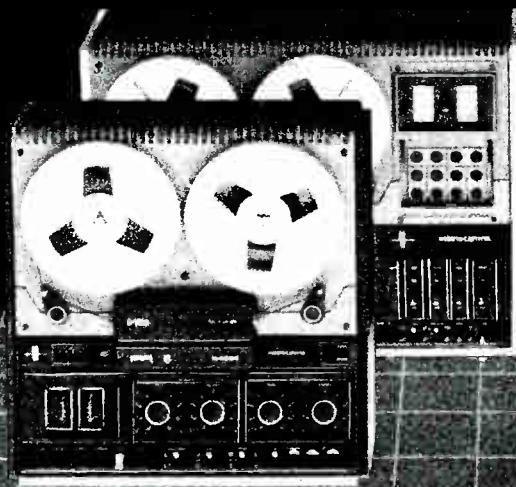
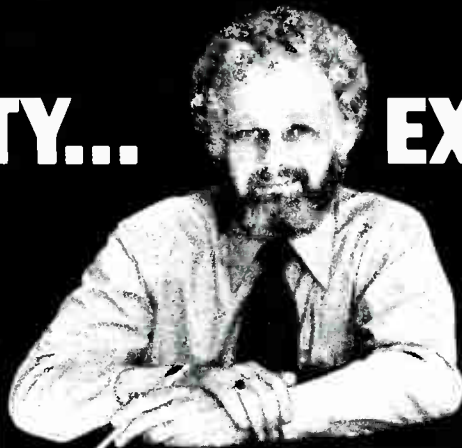

NOW. EVEN MORE COMPONENTS PRECISE ENOUGH TO BE CALLED PHILIPS.

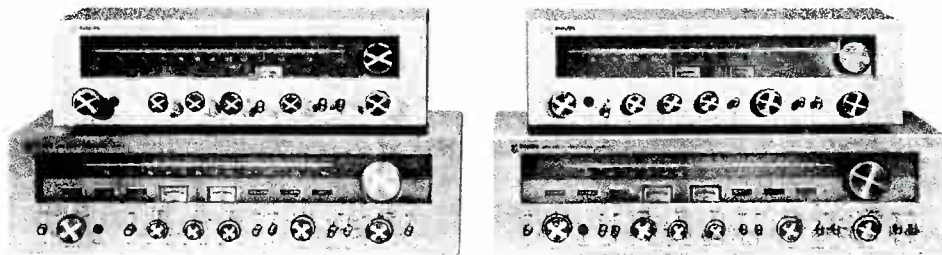

THE PRECISION RECEIVERS. Sensitive, versatile, and extremely low in distortion: 18 to 60 w/channel minimum RMS into 8 ohms, from 20-20KHz, with less than 0.1% total harmonic distortion. Prices start at less than \$200 (optional with dealer). And that gives you even more to sell.

Now, the long line of components so precise that Philips calls it "higher" fidelity is even longer. And wider.

Especially in price. The precision that Philips' customers have come to expect in a broad range of electronic turntables, separates and speakers is now available in four new receivers, two new speakers and other components to come.

At prices you'd never expect.

Come see the complete new Philips line at CES, Booth 401. We've extended ourselves.

PHILIPS

HIGH FIDELITY LABORATORIES, LTD.
BOOTH 401, CES.

New Components From Nakamichi

Nakamichi Research has developed a group of specialized components designated the BlackBox Series. The BlackBox components were designed to answer specific needs voiced by audiophiles the world over, according to the company, and to fill "gaps" which occur in even the most sophisticated stereo systems.

Seven units are being introduced simultaneously: PS-100 Power Supply; SF-100 Subsonic Filter; LA-100 Line Amplifier; BA-150 Bridging Adaptor; MB-150 Moving Coil Booster Amplifier; EC-100 Electronic Crossover; and the MX-100 Microphone Mixer.

Nakamichi has designed each BlackBox component with considerable attention to detail. Although there are only a small number of carefully selected controls, these are said to provide surprising flexibility. Special muting circuits eliminate the common problem of turn-on "thumps."

At the heart of the Nakamichi BlackBox Series is the PS-100 Power Supply, which powers any combination of up to six BlackBox components. The PS-100 has a carefully regulated output, providing a steady + 10 volts DC, regardless of fluctuations in the AC line or changes in the load. Suggested Retail Price: \$70.

Recent advances in wideband power amplification have focused attention on the problem of unwanted subsonic components. The SF-100 Subsonic Filter has specially designed active circuitry to cut response at 10 Hz by as much as 50 dB without causing phase shift at higher frequencies. Another setting provides a slight low-end boost (+5 dB at 30 Hz) in addition to subsonic filtering for playback systems that can benefit from such compensation. Suggested Retail Price: \$70.

Sometimes Preamplifier "A" lacks the gain to drive Power

Amplifier "B" to clipping. Sometimes preamp tape outputs lack the voltage for sufficient tape deck record levels. Sometimes a solid state power amplifier lacks sufficient input impedance for a vacuum tube preamplifier. The LA-100 Line Amplifier can correct these and other line level gain and impedance mismatches. The controls of the LA-100 provide a choice of 0 dB, +6 dB, +12 dB, and +18 dB gain. At 0 dB gain, the LA-100 acts as a buffer amplifier for impedance matching. Suggested Retail Price: \$70.

The well-balanced "complete Mirror" output circuitry of the Nakamichi 420 and 620 power amplifiers provides the ability to bridge left and right channels with an external adaptor. This results in monaural amplifier of greatly increased power output. The BA-150 is a phase-inverting bridging adaptor developed essentially for use with Nakamichi power amplifiers. The BA-150 is inserted between the preamplifier and a pair of Nakamichi power amplifiers for full stereo bridged operation. Suggested Retail Price: \$60.

The MB-150 is a pre-RIAA booster for low-output moving coil cartridges, providing the necessary gain with an absolute minimum of coloration. The MB-150 is connected between the cartridge and the preamplifier phono inputs. Nakamichi's circuit approaches the theoretical limits of noise-free performance. Switchable gain allows the MB-150 to accommodate the widest variety of moving coil cartridges. Suggested Retail Price: \$100.

Serious audiophiles have long used multi-amplification for high-performance systems. The EC-100 is a low-cost electronic crossover for multi-amp systems. One EC-100 can be used for stereo bi-amplification. Two or more EC-100's allow tri-amp and even more



sophisticated systems. A detented crossover frequency selector provides 29 positions from 66 Hz to 7.4 KHz; independent high/low level controls provide critical balancing of the frequency extremes. The active phase-compensated circuitry of the EC-100 provides 12 dB/octave crossover slopes and assures uncolored, controlled multi-amplification. Suggested Retail Price: \$100.

The MX-100 is a microphone preamplifier with three inputs: left, right, and blend (center). The MX-100 may be used to expand the mic capabilities of tape decks with mic/line mixing (e.g., increasing to six the number of mic inputs on the Nakamichi 1,000, 700, and 500 decks), or to make live recordings on decks that do not have mic inputs (e.g., the Nakamichi 600 Cassette Console). In addition, the MX-100 can be used with a preamplifier/amplifier for public address applications. Each input of the MX-100 has extraordinary dynamic range, and each has a separate mixer level control. Suggested Retail Price: \$80.

The PS-100 Power Supply must be used to operate the other BlackBox units (up to six per single power supply).

All BlackBox components will initially carry a one year "limited" warranty. Now available, for further information contact Ted T. Nakamichi, Marketing Director or Haddon K. Appleman, Technical Director at Nakamichi Research (U.S.A.), Inc., 220 Westbury Avenue, Carle Place, New York, 11514, (516) 333-5440.

IF YOU SELL GOOD EQUIPMENT, SELL THE TAPE THAT'S MADE FOR IT.

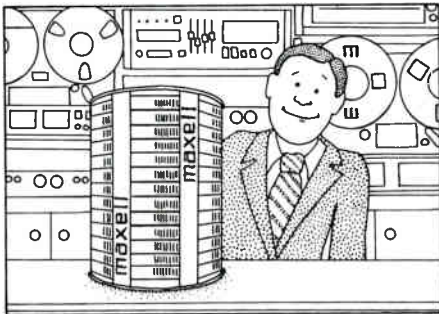

There are a lot of companies making audio tape today.

But only one of them is making tape specifically for good high fidelity components.

Maxell.

Unlike most companies, we put a special nonabrasive head cleaner on every cassette and reel-to-reel tape we make.

We take the time to test our tape every step along the way for even the slightest inconsistencies.

And we're the only company with the courage to guarantee every tape we sell.

But we not only stand behind our tape, we stand behind every dealer who sells it.

We have resident technical geniuses you can call on any time you or your customers have a question about tape.

We have a unique Contract Dealer Program that's designed to keep a constant supply of Maxell tape on hand at all times. So you won't get stuck with nothing on the shelf.

Then there's the Maxell Tape Clinic we bring into your stores to show your customers how their tape sounds. And why ours sounds better.

And since so many custom-

ers come through the door looking for Maxell, we can give you faster turnover and higher profits per square foot than any other square feet in your store.

If you sell good equipment and by some chance don't know who we are, call 201-933-4200.

Your equipment and our tape were made for each other.



Maxell Corporation of America, 130 West Commercial Ave., Moonachie, N.J. 07074.

Optonica Music Center Bridging The Gap

When Optonica introduced a European style four-band complete hi fi music center at last summer's CES, it may well have proved itself to be in the vanguard of nothing less than a "mini-trend" in the hi fi industry. Like units are being looked at by other manufacturers, who feel the timing is right for a quality "compact" to succeed where others have failed.

Initially, a number of audio manufacturers who introduced compacts in years gone by positioned them as "bridges" between low-fi console stereo and high fidelity components. It didn't really work out, but today Optonica reasons, at least in part, in a similar fashion.

"A lot of stereo owners have compact systems, already, but they do not offer a lot of quality in terms of music reproduction," notes John Bermingham, Optonica's national sales and merchandising manager. "Many of these people want better sound, but not separate components. Why not give them the sound they want in the kind of package they want?" he asks.

The argument — that hi fi dealers should not turn away customers who want better sound, even if in compact form — has won over a number of Optonica dealers. "Initially," says Bermingham, "dealer reaction was mixed. Dealers told us two things. One,

'we don't sell compacts.' Two, 'if we sell Optonica, we want it to be the upper end of our line.'

"What we did," continues Bermingham, "is put this unit in its proper perspective. It really offers component quality in a compact form, so it's not precisely either. It has component features, certainly — a semi-automatic belt-drive turntable, Dolby cassette, recording meters, slide controls, etc. — and the argument about not turning away customers who want better sound was a telling one. About half of our dealers are now trying the system out on their sales floors." Optonica has well over a hundred dealers now.

One of the key decisions in merchandising the unit was to do so without speakers, giving the dealer the flexibility to tailor a package to the consumer according to both the quality of the total system desired and the price willing to be paid by the customer. "In most cases, dealers are packaging the unit with something like a small AR or KLH speaker — or their own private label line," comments Bermingham.

Although the jury is still out on the Optonica "high fidelity music center," Bermingham sees a niche for the concept, even if it falls short of the so far unfulfilled role of the compact-type system as a bridge between low-fi and hi fi components.



The music center, SG-400, with FM electronic tuning, AM/SW radio, belt-drive turntable and Dolby cassette at \$499.95.

New Directions For Kenwood

Kenwood will be moving in some new directions in 1978. That's the word from vice president of marketing Don Palmquist, who has already helped move the company into some new areas over the past 18 months since he has been aboard at Kenwood.

"On the surface, there is the fact that our company's sales increased over 50% in the last fiscal year," he told HFTN, "and the reason for that is a combination of many things: the development of a very strong sales team, new product development work done by Henry Akiya, selective changes in our reps to strengthen distribution, products that are exciting to write ads about, the complete re-enfranchisement of our dealers so as to maintain our policy of limited distribution, etc."

Palmquist also listed Kenwood's entry into new markets with different merchandise: the high end area, department stores, premium/incentive, and their recently-launched major effort into sales of their U.S.-made speaker systems.

The marketing executive stressed their advertising philosophy of "trying to write ads that appeal to a wider public. Too often, industry ads talk over the head of first-time component buyers.

"We're going to try the educational approach, while at the same time staying aggressive, although not to the extent of product positioning with our competitors."

In addition to the year's advertising plans of making a general approach to the less-informed customer, Kenwood will be expanding its involvement in mass consumer books such as *Time*, *Sports Illustrated*, *People*, *Playboy*, *Penthouse*, etc..

An Exciting New Component For Every Audio Dealer

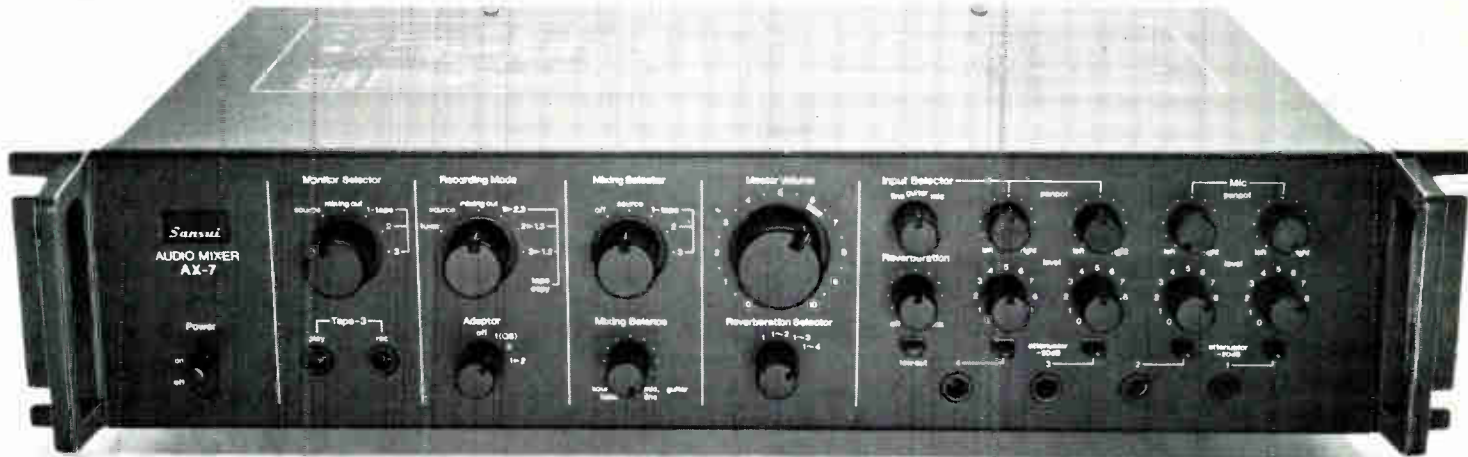

The Sansui AX-7 Mixer with Reverb.

Sansui has just introduced an exciting new component that will benefit every audio dealer. Because it is designed for every music lover. With the Sansui AX-7 mixer/reverb unit you will attract customers you never saw before, easily increase traffic and surely increase your sales.

Here's why. The serious recordist will love to use the AX-7 for mixing sources and then remixing, using as many as three stereo tape decks.

Amateur and professional musicians alike will love the AX-7 to experiment with new music and to create recordings, complete with reverberation, that are uniquely theirs.

And for the audiophile there is a special attraction. He can create professional quality recordings at home using his existing high fidelity components.

The Sansui AX-7 is an exciting compo-

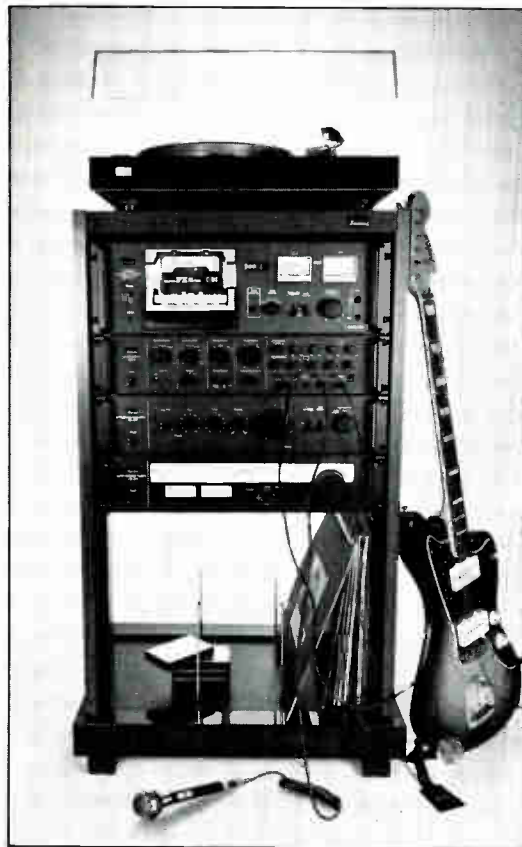

nent for every store. Rack mountable, it can be shown in the Sansui GX-5 rack, with many combinations of outstanding Sansui rack-mountable units.

And Sansui is providing you, the audio dealer, with full advertising support in many national publications, including those geared specifically to musicians.

For full information, contact your Sansui representative today.

And be sure to visit us during the Winter CES. To let you hear how superbly the AX-7 performs, we are demonstrating it, complete with live musicians, in booth

713 at the Las Vegas Convention Center.

*Approximate nationally advertised value. Actual retail price set at the option of the individual dealers.

SANSUI ELECTRONICS CORP.
Woodside, New York 11377 • (212) 779-5300
Gardena, California 90247

Sansui

SELLING

(Continued from page 48)

Q. Do I need to understand video tape recorder theory in order to sell this product?

A. No, you only need to become familiar with the features and how to use the machine to be successful at selling VTR. As a matter of fact, even if you already understand the technical aspects of video recording it is wise to avoid explaining theory to your customers (unless they ask specific questions) since you may confuse them with unnecessary details and lose the sale as a result.

Q. If I don't know HVTR theory, how will I be able to answer technical questions?

A. Here is a condensed description of how the video tape recorder works that you can keep as a reference. If you understand it, all the better; if not, don't worry. An automobile salesman need not understand how the internal combustion engine works to sell cars.

The HVTR operates in much the same way as an audio recorder; it transfers electrical impulses onto high density magnetic tape (CR02) where it is stored for later playback. The home video recorder, which uses a paperback size video cassette tape cartridge containing 1/2" wide tape, is actually two machines in one. That is, it records both picture and sound.

The speed of tape movement for the home video cassette recorder is similar to audio cassette speeds, which is fine for audio information. However, video signals and images contain much more information and consequently require greater frequency response than can be stored at this low speed. Since videotape is expensive, the cost would make it prohibitive to speed up the movement of the tape substantially enough to properly record the frequency range required for a good quality picture. Instead, the problem is solved by increasing speed by rotating the video recording heads.

Most home VCRs use two recording heads mounted on opposite sides of a drum which is spun at 1800RPM in the opposite direction that the tape travels.

This system, called helical-scanning, employs a technique in which each head records an extremely narrow track on the tape in a long slanted path. Each track contains the information for a complete TV picture field (of more than 262 lines), which is shown on your TV screen for 1/60th of a second duration. The other video head records another 1/60th of a second field on an adjacent track. During playback, a single revolution of the drum picks up both picture fields and combines them into a 1/30th second TV frame. Sound information is handled by a conventional audio head which is located elsewhere along the tape path where it records/plays back the sound along the edge of the video tape.

Q. What else does the customer have to buy in addition to the HVCR?

A. Unlike the professional machines (that require a special video monitor or an RF demodulator to hook up to a standard TV and a TV tuner to record) most HVCRs are completely self contained once they are connected to a standard TV through the antenna terminals. Users need only software (blank or prerecorded tape) and an optional camera if they desire to make their own shows.

Q. There are many different brands of HVCRs on the market: Are they all compatible?

A. Although there are about 20 brands of HVCRs on the market, most utilize one of two incompatible formats. These are the Sony Beta System and the JVC/Matsushita Video Home System (VHS). In addition, there are two other incompatible formats, Sanyo V-Cord II and Quasar Great Time Machine. And just as an 8-track audio tape can't be played on an audio cassette player, tapes recorded on one format will not work on another. Even with machines using the same format, tapes recorded in the slower speed, 4 hour mode are non-compatible with machines that do not have this extended play capability. Even so, the compatibility problem in HVCR has a minimal affect on the user.

Q. What are the important features on a home video cassette?

A. Nearly all have built in tuners for recording one channel while watching another, fast forward, and rewind modes with a pause control, provision for plugging in a TV camera and at least a one hour maximum recording time per tape.

Q. What are the major step-up features that are found on some of the better units?

A. There are many luxurious features that you can use to tempt the prospective HVCR customer to buy. They are:

- *Longer recording time* — four hour recording time is obtained in the RCA HVCR by switching to the LP mode which slows down the tape travel speed by 50%, doubling the capability of a single two hour cassette which costs \$24.95. Sony achieves four hour, continuous play or record on Beta format machines in a different way. Employing an optional cassette changer priced at \$100 which automatically changes two 2-hour long tapes (60 minute tapes played at 1/2 speed). Sony's tapes retail for \$16.95 each. Upcoming from Sony will be a three-hour tape and six-hour capability.

- *Built in timer* — to record when you are somewhere else.

- *Remote control* — for control without moving from your seat.

- *Freeze frame* — to stop action.

- *Dubbing* — to add a segment of audio or video to a previously recorded tape.

- *Two channels of sound* — capability of adding audio information on another channel for simultaneous bilingual translations, adding a music track to a program, or for recording a stereo soundtrack, etc.

- *Search* — will automatically locate in fast forward or reverse mode a preselected point on the tape.

Q. Once the customer buys the VTR, are there any accessories or add-on items I should try to sell?

A. Yes, as with audio equipment, selling accessories and add-

(Continued on page 109)

The most popular way to clean records isn't the best.

It's popular to believe that buying the best known label or spending considerably more money will get you the best product. Nowadays that isn't true.

More often than not, the best product combines quality *and* value. The new Record Conditioner by Fidelitone is a case in point.

It has a more effective cleaning fluid, The Purifier Fluid, that leaves no residue, reduces static charge and increases output sensitivity.

The Record Conditioner has a unique unidirectional pile pad with an exclusive cherry wood handle that's contoured not to slip or roll in your hand. And there's a matching cherry holder that won't cost you extra.

Speaking of value, Record Conditioner costs surprisingly less than the most popular brand.

Ask your hi-fi or music dealer for Record Conditioner with Purifier Fluid by Fidelitone.

Keeping your records clean is worth spending some money. But why spend more than the product is worth?



Record Conditioner with Purifier Fluid by Fidelitone

Fidelitone, Inc., 207 North Woodwork Lane, Palatine, Ill. 60067 Fidelitone Products are available in Canada.

© 1977, Fidelitone, Inc.

CLASSIFIED

MARKET RESEARCH ANALYST

Pioneer, the nation's leading marketer of hi-fidelity components is looking for a bright individual who will report directly to the Vice President of Corporate Planning. Responsibilities include all phases of survey work, research, and analysis of industry data. Some travel involved.

The ideal candidate will be degreed with 1 to 2 years market research experience. Analytical skills and the ability to communicate effectively are important requirements. Hi-fi enthusiasts preferred.

Pioneer offers a creative environment, and an unusually attractive company-paid benefits program. Salary for this position will be high teens. Send resumé and salary history to the Personnel Department.



85 Oxford Drive,
Moonachie, N.J. 07074
An Equal Opportunity Employer M/F

HIGH FIDELITY

NOW HEAR THIS . . .

Satter Sales Co. Inc., is expanding its sales force and efforts in the Rocky Mountain area.

We presently represent Pioneer Electronics of America and United Audio.

Please contact Fred Taylor or Charles Satter:

The Landmark Hotel, Las Vegas

or Call (303) 399-7493

Satter Sales, 4100 Dahlia St., Denver CO 80207

Wanted.

Aggressive receiver — speaker manufacturer seeks representatives and/or factory sales personnel to complete its distribution network.

We seek intelligent, inventive people with intensive high fidelity and retail experience to join our growing team of professionals.

Not all territories available.

See Nadisco, Inc. during C.E.S. at the MGM Grand
or write us at 12900 Lake Avenue, Suite 109, Cleveland, Ohio 44107.

New Lux Line Now Available

The Lux Laboratory Reference Series (LRS) of high-end separates has been expanded to a total of eight units with the addition of three new components. Previewed at the last CES, the entire line is now in full delivery. Lux is also completing delivery on its new line of three tuner/amplifiers, following the dock strike which held up the last of the three units.

Among the newly available components is the Luxman 5L15 DC direct-coupled integrated amplifier, rated at 80 watts RMS per channel minimum continuous

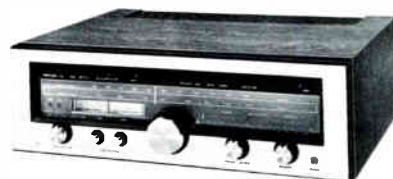

R-1050 tuner-amplifier

power, 20 to 20,000 Hz, both channels driven simultaneously into 8 ohms. THD and IM are no more than 0.02%. The amplifier features two protection circuits: speakers are protected by a DC drift-sensing and excessive input sensing circuit that triggers at DC voltages in excess of +2.5 V or when excessive inputs are applied at the speaker terminals; the power transistors are protected against shorts at the speaker terminal by an excessive current circuit.

During CES at
Circus Circus
Keith Fannon
Bruce Hagen

"THE ORIGINAL"

**AUDIO
MARKETING
ASSOCIATES**



AMA

(216) 526-2426
9470 Whitewood Road
Brecksville, Ohio 44141

Introducing The NEW "A" Series Synergistics Speakers.



Eight new high accuracy, high efficiency speakers, all designed for maximum total system performance.

When your customer buys a system from you, the most important question he or she can ask is, "which speakers are best for the system I can afford?" Only one speaker manufacturer helps you answer this vital question: Synergistics.

We've designed each of our speakers to perform best within the specific total system price range your customer is looking for. By taking the guesswork and confusion out of selecting the best speakers within each system, you'll insure that your customer gets the maximum speaker value and the best sound from the total system.

Synergistics' high efficiency design means your customers can devote more of their total system budget towards better speakers and less money on electronics.

Thanks to Synergistics, today's low distortion, low powered, moderately-priced receivers are better buys than ever.

Increasingly, your customers are demanding sonic accuracy from their speakers. Each of our models is engineered to deliver utterly open, clear, natural, life-like sound, with none of the tonal coloration found in many other high efficiency brands.

Our consistent marketing and design philosophy is already a success story with over 100 progressive audio dealers coast-to-coast. This year, we're supporting our dealers with: national advertising, dealer show support, an innovative sales training program, and even more exciting new products to come.

**The New "A" Series Synergistics: For maximum performance, high efficiency & high accuracy.
The sit anywhere, "play it like it is" speakers.**



During January C.E.S. Synergistics Speakers will be demonstrated at the MGM Grand Hotel exclusively. See you there.

Onkyo Back Into Speakers

With the introduction of two new speaker systems, model 160, a 2-way, 2-speaker acoustic suspension unit, and model 240, a 3-way, 3-speaker acoustic suspension system, Onkyo is re-discovering some long lost roots.

What makes these new products an exercise in nostalgia is the fact that Onkyo — a growing, strong contender in the audio market — began business as manufacturers of speakers, and has an impressive list of firsts in the field.

Starting in 1946, the company produced loudspeakers and phono pickups, and in two years revolutionized the industry with the first non-pressed speaker cone. From

that small start in Osaka, Japan, the company has spread over Japan and into Europe and the United States.

Since 1969, when Onkyo began to specialize in audio equipment, sales have grown tremendously, and the plateau is not yet in sight. While their efforts in the U.S. have been primarily in electronics, the company never lost sight of the speaker market, or of its origins in that market, particularly since speaker sales had grown even more since 1968.

Concentrating on high quality components and integrated receivers and amplifiers, Onkyo introduced the world's first "Quartz-Locked" tuning system in

1976, extending the system to the world's first "Quartz-Locked" tuner. This system has been noted by independent labs as "... almost impossible to mistune."

With these credits in hand, Onkyo felt the time right to return to emphasizing speaker systems in the U.S., choosing the model 160 and model 240 as the beginning of that effort.

Model 160 uses a 12" woofer and a 2 $\frac{3}{4}$ " cone-type tweeter with a duraluminum center cap, providing a frequency range of 35-20,000 Hz. Rated input power is 40 watts with maximum input power at 80 watts. System impedance is 8 ohms, and the unit is recommended for amplifiers of 15-80 watts per channel. Level control on the model 160 provides +5dB to -5dB. Crossover frequency is 2kHz.

The model 240 features a 15" woofer, a 4" carbon fiber cone-type mid-range unit and a 1" titanium dome-type tweeter. The system

(Continued on page 106)

IF YOU'RE SELLING CASSETTE DECKS WITH THREE SWITCH POSITIONS, SHOULDN'T YOU SELL A LINE OF CASSETTES TO MATCH?

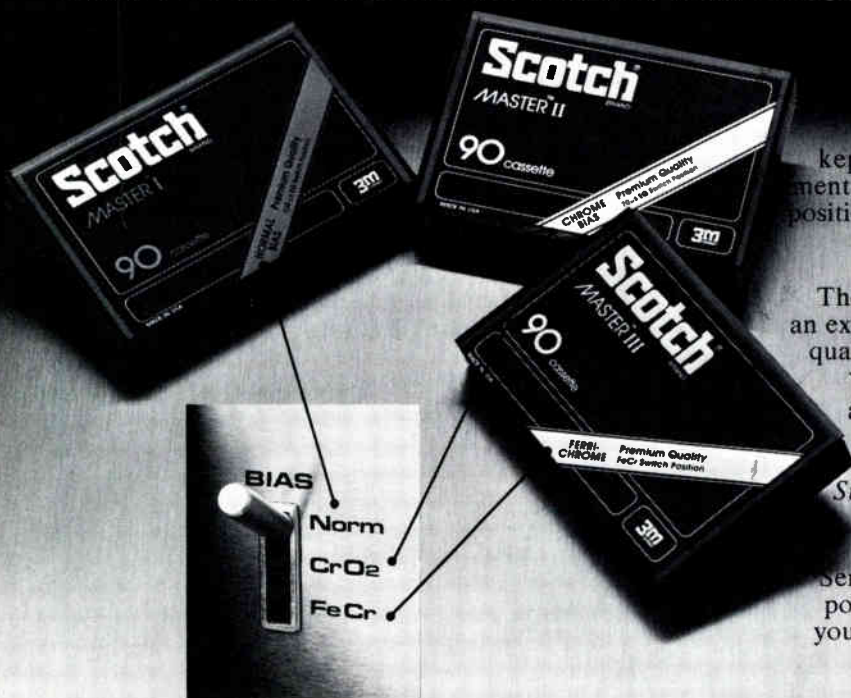

So far, only one line of cassettes has kept up with the latest advances in equipment by offering a cassette for every switch position. And it should come as no surprise to anyone that Scotch® Recording Tape is once again leading the way.

The Scotch Master™ Series of cassettes is an exciting development in true, pure sound quality. And we have the specs to prove it.

Your customers are already finding out about Scotch Master Cassettes through a national advertising campaign running in magazines like *Rolling Stone*, *Stereo Review*, *High Fidelity* and *Audio*.

So don't be the last to know.

Stock up on the Scotch Master Series, cassettes for every switch position. They might even make your cassette decks easier to sell.



**SCOTCH RECORDING TAPE.
THE TRUTH COMES OUT.**

Look For The ERA MARK



THE ERA LOGO HAS BECOME MORE THAN IDENTIFICATION FOR AN ASSOCIATION. IT'S THE SYMBOL OF AN INDUSTRY.

In an industry of superlatives. In an industry of change. Manufacturers' representatives have provided the stability necessary for true growth.

With each new surge of technology. With each new product innovation, the manufacturer's representative has translated the needs of his customers to the capabilities and the disciplines of his manufacturer.

MANUFACTURERS' REPRESENTATIVES HAVE COME OF AGE IN THE ELECTRONICS INDUSTRY.

Today the manufacturer's representative is an entity, a company with long range goals and objectives. He works his territory to develop every potential prospect into a profitable customer for his principals. He's

not in it for the "fast buck" or a promotion to the home office. His objective is to develop his territory into the best marketplace possible.

MARKET YOUR PRODUCTS THROUGH MANUFACTURERS' REPRESENTATIVES.

They are cost/effective. You not only can expect greater market coverage, but also better customer penetration. And that's a tough combination to beat!

THE MARK OF A PROFESSIONAL

Look for the ERA logo when talking with representatives. It indicates the mark of a professional. He belongs to ERA to learn, and for the opportunity to interface with other representatives like himself. It shows he cares.

It also shows that he is part of a marketing force responsible for selling over seven billion dollars worth of electronic products.

For a complete package of material about why you should be using manufacturers' representatives write or call their association.

More than an association — a philosophy



Electronic Representatives Association
233 E. Erie, Suite 1003
Chicago, Illinois 60611 312/649-1333

Micro-Acoustics Clinic Tunes Into Cartridge Maintenance

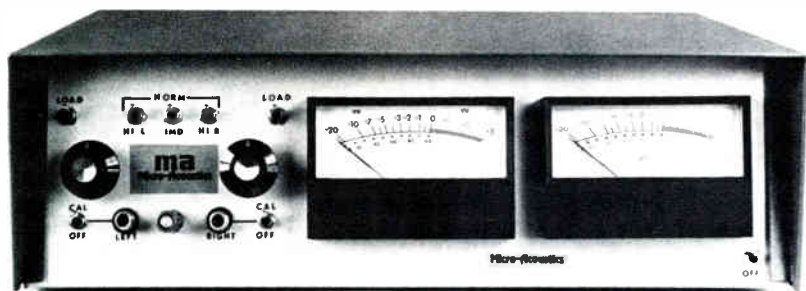

Did you know that the stylus on your phonograph cartridge travels about one mile of record groove for every hour of music you enjoy? Consumers all over the country are finding out that fact thanks to a series of local ads promoting a new Micro-Acoustics-sponsored phono cartridge and turntable clinic.

The series of ads goes on to recommend a cartridge check-up after every 300-500 hours (miles) of use. And why not? The automobile analogy is appropriate in driving home the point that phono cartridge maintenance is just as important to maintaining musical pleasure as is a tune-up and oil change to motoring pleasure. And the analogy is one that virtually every consumer can readily understand and relate to.

However, this is not just another clinic with a gimmick. Micro-Acoustics has gone beyond the usual cartridge clinic approach which views product primarily in terms of record wear and tracking

with an oscilloscope and the CBS Labs test records.

"By using the CBS test records, we're not creating a special test that suits our own cartridge, but rather a universal test that suits all cartridges," the company stresses.

The JB-2 enables Micro-Acoustics dealers to get into such areas as square-wave response, IM distortion and capacitance effects, for example, in addition to the typical frequency response curves and tracking ability tests. Of course, the firm's representatives also clean and inspect a consumer's stylus, adjust tracking and anti-skating to optimum settings, check turntable speed accuracy, channel balance, phasing and cross-talk.

Micro-Acoustics' executive vp Sandy Drelinger emphasizes that the clinic "takes a straight scientific approach. This clinic has many goals, but most important is that we do our thing objectively. You lose people in five minutes as soon as you start downing someone else's product.

"We asked ourselves initially what we wanted to say about phono cartridges, whether we wanted to measure one or two parameters or the entire ballpark. What we decided to do is develop a clinic which takes into account the whole philosophy of phono cartridges. When a dealer's customer walks out of our clinic with his cartridge, he knows exactly what he's got, and he doesn't leave wondering what else there is to the whole business."

What the customer leaves with is not just a passing memory of the clinic. Test results are recorded for the cartridge owner in a six-page comprehensive report which details the test procedure used, perhaps the first time any clinic has included such a comprehensive analysis. This is especially true in such areas as IM distortion and transient ability, which Mi-



(Top to bottom) Sandy Drelinger; the JB-2; local clinic ads.

ability. The company wanted to be more comprehensive, and wound up inventing a special cartridge analyzer which they call the JB-2 and which works in conjunction

(Continued on page 107)

World's highest power in-dash car stereo.

CONCORD HP-300 CAR-PONENT®

POWER-PLUS
STEREO AMPLIFIER
(TOTAL SYSTEM OUTPUT
40 WATTS RMS)

ULTRA-SENSITIVE
TUNER (1.8μV)



TREBLE BOOST/CUT CONTROL

SENDUST ALLOY HEADS
(40Hz-15kHz FREQUENCY RESPONSE)

AUTO EJECT

BASS BOOST/CUT CONTROL

TRUE HIGH FIDELITY, HIGH PERFORMANCE AUDIO COMPONENT FOR MOBILE USE.

A single self-contained, integrated circuit unit . . . compact (7"W x 4¾"D x 2½"H) to easily fit in-dash in most cars. True high fidelity specs:

- 20 watts per channel min. RMS into 4 ohms
- Less than 0.3% harmonic distortion
- 1.8 microvolt FM sensitivity
- Wow and flutter under 0.15%

Now, high fidelity power without external power amps. This powerhouse has a suggested retail of

\$249.50*. And only Concord makes it.

For further information, mail coupon today.

Or, see the sensational Concord HP-300 and the other exciting Concord models in our car-ponent high fidelity car stereo line at C. E. Show, Booth No. 1442.

CONCORD

18 years of innovation

Concord Electronics division of Westland International
20121 Ventura Blvd.
Woodland Hills, Calif. 91364

Please send information on the Concord Car-Ponent Line.
Please have your rep call.

Name _____ Title _____

Company _____

Address _____

City and State _____ Zip _____

Phone Number () _____

*price shown is suggested retail which is dealer guideline to effectively merchandise Concord products.

Miller Details Rank's U.S. Plans

High Fidelity Trade News recently spoke with Geoffrey Miller, marketing director for Rank Hi Fi, Inc., which recently introduced the new Wharfedale and Leak speakers to the U.S. market.

HFTN: Rank introduced two new speaker lines to this country at the past June CES. Can you describe your company for our readers?

GM: Rank Hi Fi was created as the U.S. arm of Rank Audio-Visual, a division of the billion-dollar Rank Organization of London. The Organization is known throughout most of the world for Rank/Xerox products, and has divisions active in professional and theatrical lighting, business machines, optics and a number of other high-technology areas. As far as high fidelity, our Wharfedale line accounts for fully 25% of all the loudspeakers sold in Great Britain. We also have a significant share of the entire European hi fi market.

HFTN: Wharfedale speakers are probably the best known of your products in the U.S., and they were quite popular here a few years

ago. What happened, and what are your future plans?

GM: Wharfedales have not been sold in the U.S. for several years, but we did show our newest products last June at the Consumer Electronics Show. Acceptance was extremely gratifying, so we accelerated plans to build a full-scale distribution network in the States. For the first time, our speakers are being imported directly to the U.S. by Rank, and they became available to dealers October 10. We now have virtually complete coverage via our network of representatives. We fully understand that to succeed in this country requires a firm commitment, and that commitment has been made.

HFTN: What are the specific products that you are bringing in?

GM: We are now offering four "3000 series" Leak time-delay compensated loudspeakers, ranging from around \$175 to \$550 at retail; and two newly-designed Wharfedales, the E50 and E70, computer-optimized high efficiency loudspeakers known as the "E series," which sell for approximately \$390 and \$475, re-

spectively.

HFTN: Why two new speaker lines?

GM: Briefly, the two lines represent different designs which will appeal to different market segments. Ultimately, of course, our philosophy is to deliver the best-performing speaker at the best price, whatever the design. That's not very unusual. But with loudspeakers there is an extreme subjectivity; it is difficult to define hard-and-fast rules about exactly how to go about building the best system. Loudspeaker designers still have a great deal to learn about acoustics, and we also have to consider psycho-acoustics; not just what is heard, but how the listener interprets it.

In comparison to a loudspeaker, an amplifier is much easier to evaluate objectively, since there are easily measured standardized specifications which any good amplifier should meet. But speakers are "connected" to the ears of human beings . . . and thus any conclusions are subject to the limitations of individual musical preferences and so on. Many different designers have tried various approaches and in many cases their methods have come close to trial and error. At Rank, we tried in the Wharfedale and Leak projects to rigorously apply the results of extensive research to create loudspeakers that were clearly better.

HFTN: What were you looking for in this research?

GM: Well, with the Wharfedale "E series" we wanted to maintain the high-quality sound that has always been associated with the Wharfedale name while utilizing the latest developments of our own research. The "E series" trace their origins back to the older Wharfedale speakers which were



Rank marketing director Geoffrey Miller



For the one who has everything, a little bit more. Presenting the PearlCorder®-SR501.

No matter how much audio equipment your customers have, they still have room for the SR501. Because it's the smallest, most unusual package of entertainment on the market.

In a handsome, sturdy case just the length of your hand, we've built a Microcassette recorder that tapes a full 60 minutes. Plus an FM radio, an AM radio, microphone, tape counter, antenna and eject button. Even a switch that lets people drift off to sleep without worrying about turning the unit off; it does that itself.

But some of the most impressive features of the SR501 are less obvious. Like its high fidelity capstan

drive; review and locking rewind; external mike; and earphone and speaker jack. And a full range of accessories including car and AC adapter and footswitch.

With all the SR501 offers, you can offer it to an incredibly wide range of customers.

And it'll offer you a healthy profit every time it sells. Because its suggested retail is \$199.95.

The SR501. For the ones who have everything, it's a little bit more. Why stock anything less?



PearlCorder®-SR 501

by OLYMPUS OPTICAL CO., LTD.

Never has so little done so much.

OLYMPUS CORPORATION OF AMERICA

TWO NEVADA DRIVE NEW HYDE PARK NEW YORK 11040

In Canada, W. Carsey Co., Ltd., Don Mills, Ontario

very popular in the States some years ago.

They were massive; with the materials then available we had to resort to sand-filled walls to develop the proper acoustical balance. And they were extremely fine-sounding loudspeakers, that appealed particularly to those who listened to classical music. But we made the E-50 and E-70 much more efficient, because we felt that this is what the American consumer wants today. And of course, in the pursuit of lower distortion and flutter response curves, any sort of reasonable dynamic range went right out the window. So we said, hold on, and came up with mathematical descriptions of just which variables were fundamentally important in designing a loudspeaker.

HFTN: What are those variables?

GM: Our engineers looked at size, efficiency, bass response, the way the response curve is affected around the crossover points, and so on, using exact measurements made in anechoic chambers at our research and development facility in Bradford, England. Now the process of designing of any loudspeaker involves many tradeoffs. A speaker can't practically be too large, or too expensive, and so on. And often improvements in one parameter will degrade another. So we used a computer and said, basically if we want to do this, what will it cost us over there. That's the same process a designer goes through by trial-and-error, but with the computer we were able to look at all possibilities, and in a systematic fashion we came up with the exact balance of the different variables that would give us the best loudspeaker possible, at a price where we could manufacture and sell reasonable numbers. And we can say now that it is mathematically impossible to achieve a better bass response, given the Wharfedales "E's" size and efficiency, and the state of loudspeakers engineering today.

HFTN: So the improved effi-

ciency means that people won't need as high-powered an amplifier or receiver?

GM: Yes, for a given listening level the "E's" require much less power. But in addition, and more importantly in terms of quality of reproduction, increased speaker efficiency provides greater headroom and dynamic range. Since a given amplifier need use less of its power to drive the speakers, it will be operating in a range further away from the point where it begins to "clip," and so in less danger of being driven into "clipping" by loud passages. We also added environmental contour controls to the speakers which allow variation of the shape of the response curve around the crossover points to "fine-tune" response according to room acoustics and speaker placement, or correct tonal imbalance in program sources.

HFTN: What about the Leak line of speakers? What was the rationale there?

GM: The development of the Leak loudspeakers was a two-phase effort. First, Rank Laboratories undertook a massive research effort to identify and measure every known type of loudspeaker distortion. We then created a virtually distortion-free audio reproduction system at great expense, and assembled a panel of audio and music experts, including a few "Golden ears." With the guidance of this panel, Leak engineers systematically added distortion of various types of increments, to the point where each type became audible. The project was then to develop a series of loudspeakers with distortion levels unquestionably below these "vanishing point" figures. Time delay distortion was dramatically reduced in the "3000 series" by multiple-plane mounting of the individual drivers, to ensure that all sound would reach the ear at precisely the same time. This "time-delay compensation" also markedly improves phase coherency and stereo imaging. A new combination bass/midrange driver was developed which eliminates Doppler

distortion as well. The results are quite impressive.

HFTN: Where do you think the application of advanced technology to loudspeaker design will eventually lead?

GM: I'm not an engineer, but I'd say it has been shown that wherever new developments lead, the final judge of loudspeaker design must be the human ear. We have tried to use state-of-the-art technology such as computer simulation and laser holography to aid in identifying and improving the factors which affect the way a loudspeaker is judged by the human ear, but ultimately it is the listener who must judge how successful these effort have been.

HFTN: What was the purpose of the holography?

GM: Holograms, which are three-dimensional images recorded on photographic film using lasers, helped us to study the motion of speaker cones in precise detail, and ensure that drivers operate most efficiently and with the lowest distortion possible. But I'd like to emphasize that we always strive to retain the human touch in our products. For example, the walnut veneers on our speakers are coordinated in the manner of a fine cabinetmaker when the enclosures are first assembled. Each matched pair of cabinets is then kept together throughout production, testing, and delivery, so our customers will have something nicer to look at, as well as listen to. This is a small point, but I feel that it represents the care that is taken with all our products.

HFTN: What are your plans as far as dealers?

GM: Well, we are interested in speaking with quality dealers who would like to carry Wharfedale and/or Leak speakers. They should contact one of our representatives, or notify me at Rank Hi Fi, Inc., 20 Bushes Lane, Elmwood Park, New Jersey 07407. The phone number is (201) 791-7888. And dealers can hear Leak and Wharfedale speakers at our demonstration room, A-219, here at the January CES.

READ "HOW TO SELL HI-FI TO STUDENTS" FEATURING TECHNIC'S JIM PARKS.

According to the *National Student Study*, U.S. college students will buy over 400,000 music systems this year representing about \$150,000,000 worth of components and compacts. In addition, they'll purchase large quantities of "software" such as records, tapes, and cleaning devices. To be more specific, a typical campus of 10,000 students is about a \$2,000,000-a-year market in hardware alone—which is reason enough for you to read "How To Sell Hi-Fi to Students."

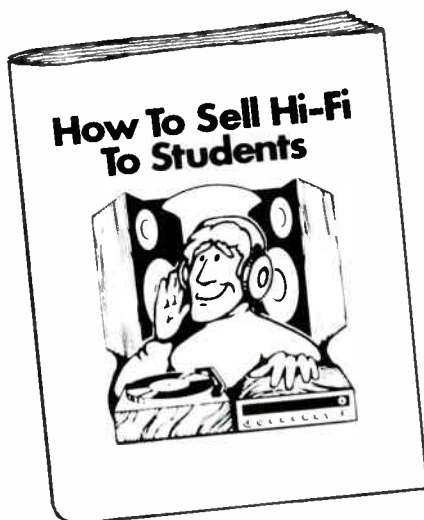

"How To Sell Hi-Fi To Students" discusses everything from how to locally promote to students to how floor salesmen should deal with them. The book is divided into two sections, the first giving you a better understanding of the buying habits of students and the second providing you with marketing tips. To develop the booklet, 13-30 involved key personnel from twenty-two companies, interviewed over 1,200 students, and talked with dealers throughout the country.

13-30 Corporation, the largest college magazine publisher in the country, has teamed up with Technics' Jim Parks and twenty-one other top hi-fi marketing executives to produce a booklet specifically for dealers who rely heavily on the student market.

The best news is that the publication is free, compliments of the contributing companies. A limited supply will be made available, so if you want to reserve your copy, do so by writing: Chris Whittle, Publisher, 13-30 Corporation, 505 Market Street, Knoxville,

Tennessee 37902. As soon as it's off press, your copy will be in the mail.

In addition to making this publication possible, Technics will also be bringing students into your store. They'll be promoting their products and your dealership in *Nutshell*, the largest college magazine, and *Graduate*, a publication which reaches over half the nation's college seniors. These special student efforts are in addition to schedules in *Rolling Stone*, *New Times*, *National Lampoon*, and *Crawdaddy*. So be ready for the business by ordering our new book—and more Technics.

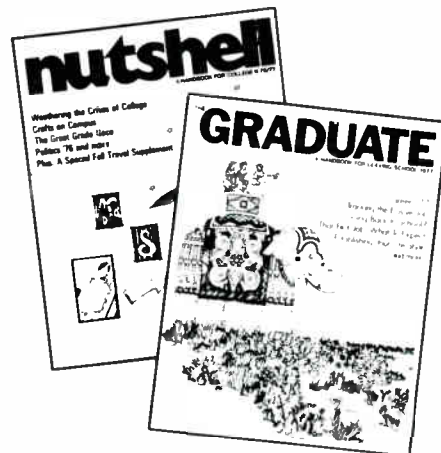

13-30

13-30 CORPORATION
13-30 BUILDING • 505 MARKET ST.
KNOXVILLE, TENNESSEE 37902

the Pyle Driver is **HEAR!**

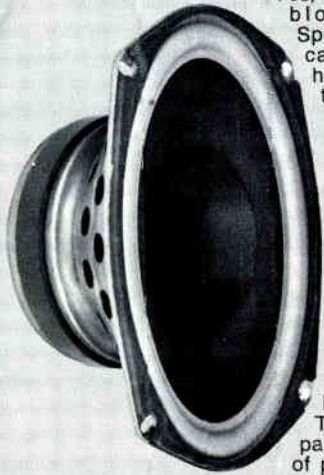

Yes, HEAR... for blocks and blocks. PYLE DRIVER Speakers are so tough they can blow out the neighborhood anytime, but rarely the speakers. They are tough and ready-guys. Largest speaker in the series is the 6 x 9 with a 30 oz. magnet. It also features the biggest special high temperature voice coil in the industry. A separate high frequency cone assures greater response to high frequencies for excellent quality and clarity.

Who builds the PYLE DRIVERS? PYLE INDUSTRIES. It's the new Company with several centuries of pure speaker design and manufacturing experience. Write for free literature today.



PYLE INDUSTRIES
HUNTINGTON, IND. 46750

SADAT

(Continued from page 26)

Dimensional Sound Center,
Mount Vernon
Electricraft, Seattle
Empire Electronics, Tukwila
Evergreen Audio, Bremerton
Great American Stereo
Warehouse, Seattle
Jafco, Tukwila
Kennelly Keys Music,
Seattle
Lakewood Villa Stereo,
Tacoma
Magnolia Hi-Fi, Seattle
Omega Stereo, Bellevue
Pacific Stereo, Bremerton
Pacific Stereo, Seattle
Paulson's, Tacoma
Speaker Factory, Bellevue
Speakerlab, Seattle
Stereoland, Seattle
Stereo Northwest, Seattle
The Stereo Shoppe, Tacoma
Tall's Stereo Center,
Seattle
Wide World of Music,
Seattle

INSTANT SHELVING



You assemble Kirsch Shelving in minutes with just a twist of the wrist. Ring-Lock® construction assures stability.

Modular design lets you start small and add on as your needs grow.

Available in Kirsch kits or components in a choice of stain-resistant, vinyl-laminated finishes.

See us at the CES Booth A237, Las Vegas Convention Center, January 5-8

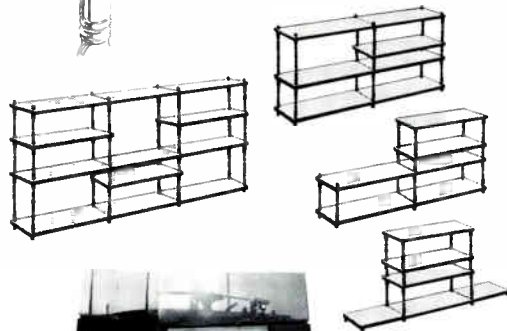

Kirsch

THE GREAT SPACEMAKER

©Registered TM,
Kirsch Company

ENCOUNTERS

(Continued from page 34)

of computers to the world of audio.

Nor is this cross-pollination limited to consumer audio products. We were recently introduced to a hand-held portable real-time spectrum audio analyzer/sound level meter developed by a company called Ivie Electronics. From all appearances, this compact unit, retailing for some \$2,800, can do the same sound system analysis job performed by bulkier equipment costing two or three times as much.

Miniaturization of components, the use of digital readouts, memory chips and more have made this possible and the availability of such audio related instrumentation at costs which are no longer prohibitive for the serious audio dealer means that dedicated dealers can perform a service to their customers beyond the blind sale of a graphic equalizer. They can make sure that the customer is getting proper benefit and satis-

faction from such accessories by following through, in the customer's home,

In terms of future possibilities, we are probably just scratching the surface of the inter-relationships that will exist between different technologies in the future. If, indeed, the mini-computer becomes a household necessity, surely one of its functions will be to catalog and program our audio entertainment — whether that entertainment comes from our own laser-disc library or from some central, computerized music library.

CLINIC

(Continued from page 100)

Micro-Acoustics asserts are the best objective measurements of overall cartridge sonic performance.

The Micro-Acoustics test instrument that enables the company to perform all these functions, the JB-2 analyzer, is priced at \$490 and, according to Drelinger, is the equivalent of two to three thousand dollars worth of test equipment. "We engineered the device and it represents something of a breakthrough that we're making available to our reps and dealers. It's a precision instrument that could even be used by hi fi test reviewers," Drelinger notes.

"Ultimately," Drelinger continues, "the clinic proves the validity of our design as well as the virtues of other phono cartridges. It gives the dealer an opportunity to evaluate what he's selling and the consumer what he's buying. The phono cartridge is still such an unknown entity that we're finding both dealer salesmen and their customers are welcoming the opportunity to find out more.

"The salesmen," Drelinger maintains, "get most of their knowledge about cartridges from manufacturers' literature, one of the few sources of competent information available. So our clinics provide some very real technical information to the sales guys which they've never had before.

"The clinic also shows," says Drelinger, "that high-end phono cartridges don't mean 'esoteric' or 'delicacy.' We're not talking about

Maseratis, we're talking about performance and nothing else. A cartridge that measures well does sound good."

Although the company is open to keeping the cartridge clinic on the road indefinitely, dealers are being urged to sign up to avoid a long wait before receiving the clinic.

"We want our dealers to hold the clinic because, really, they have most to gain from it. We gain, too, of course, but they have a

strong opportunity here to win customers and friends. In addition, we are restricting the clinic to quality cartridges. We don't test the cheapies because the test takes 15 minutes of time. We feel that helps qualify the consumer who comes in, particularly for the benefit of the dealer. We also ask that the dealer perform the stylus examination while we do the rest of the test. That has more credibility and it also involves the dealer with the consumer right on the spot."

The Small Speaker Revolution is here



It's not how big you make it, it's how big you make it sound.

The day of the big speaker box has past. It's no longer true that the bigger the speaker, the better the sound. A revolution in speaker design is occurring with the introduction of an accurate, high-fidelity loudspeaker that fits comfortably on a table-top, bookshelf, in a corner or even in your car or van. A speaker you can live with that doesn't dominate your living space and make you a slave of your sound system.

Six small speakers

The David® series from Visonik of America is a group of six loudspeakers dedicated to the proposition that "big" is not better. The revolution starts with the pint-bottle sized D-30, D-50 and specially modified D-30M0 speaker system (with mounting bracket for car and RV music systems). Also included are the larger two-way D-60 and three-way D-80 and D-100 speaker systems. Although small, they are progressively larger with deeper bass response and greater power handling capacity.

Don't be a slave to the big box.

Each speaker is the result of extensive research and design... German craftsmanship wedded with high technology. The listener will find the David® speaker

extremely linear and accurate with wide dispersion characteristics. They provide full, rich, high-fidelity sound that is comfortable to listen to; there is no coloration, strident highs or boomy lows. The Davids® naturally outperform speakers many times the size and price.

Your ears won't believe your eyes.

Join the revolution—audition a pair of David® speakers and get all the specs at your Visonik® stereo dealer.

VISONIK-DAVID®

1177 65th Street / Oakland, CA 94608 / (415) 653-9711
In Canada: White Electronics, Malton, Ontario
Manufactured by Heco-Hennel & Co. K.G. Berlin, Germany
® Registered Trademark, Visonik KG © 1977, Visonik of America, Inc.

Visit Booth R7 at WCES — Las Vegas. See the New Davids, sub-woofer and the Euro speaker line.

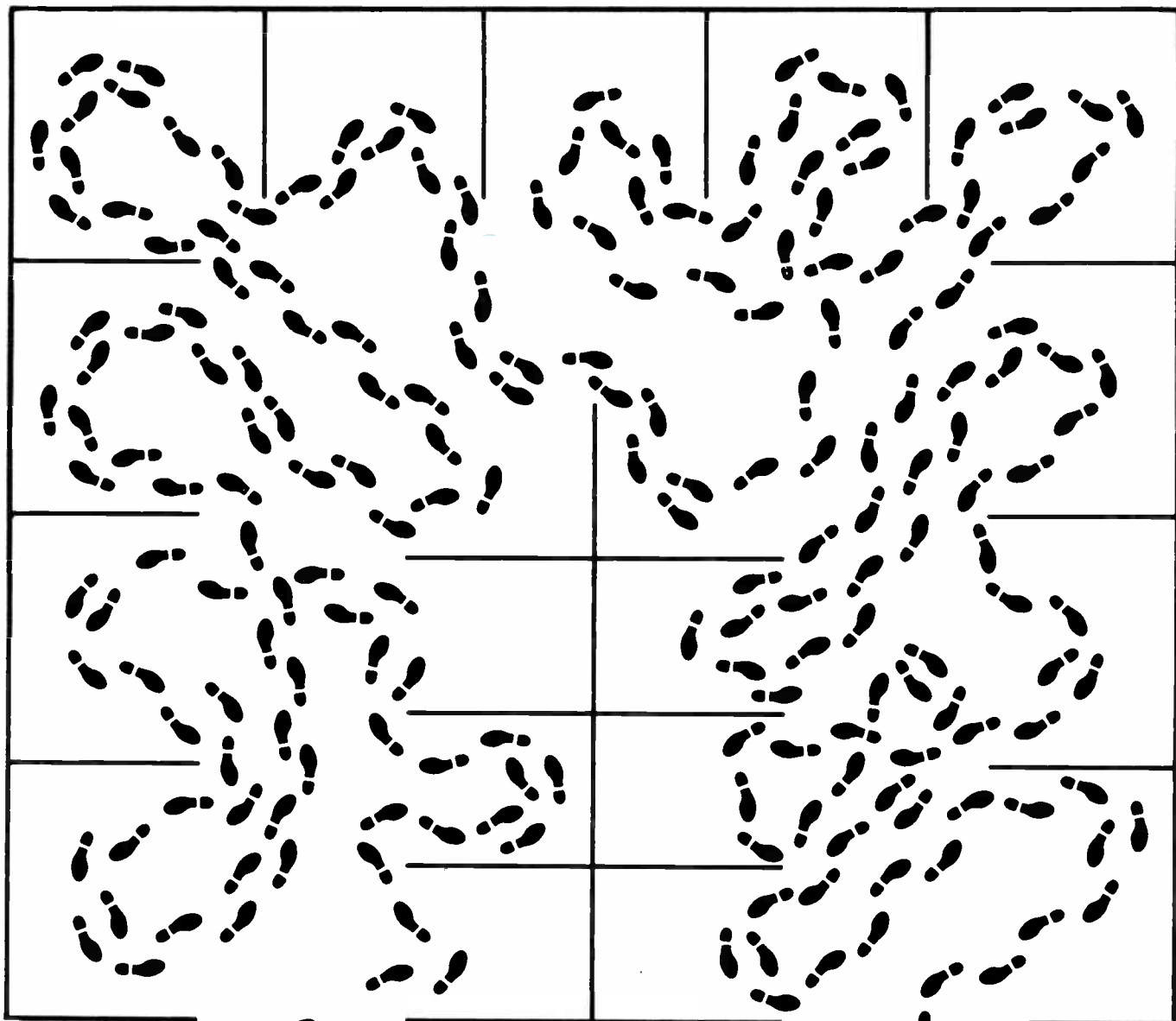

After the races, come to the Jockey Club.

After an exciting day of racing around at the CES Show, you need a break. Come over to the Jockey Club, relax and talk with us about your Bose business and how we can help you.

Jerry Ruzicka, Vice President
Allan Evelyn, National Marketing Manager
Lee Drady, National Field Sales Manager
Brian Flood, Advertising Manager

January 5-8, 4 p.m.-9 p.m.

BOSE



SELLING

(Continued from page 94)

ons will build the profitability and dollar volume of the sale as well as greatly enhance your commissions. You can increase most sales by 30% or more just by *selling related items*.

LETTERS

(Continued from page 24)

efficiency speakers offer more dynamic range and ability to deliver peaks of high level with low distortion (translation: the transients are reproduced more accurately).

The low efficiency system costs about \$2,400; the efficient one about \$1,200 in 1955 dollars.

Thus in answering the third question first, the first and second questions get meaningful answers. If the money is judiciously spent, the distortion will be inversely proportional to the loudspeaker cost, and the amplifier power needed will also be almost inverse to speaker cost.

Now about Question 4: Quad is a sales gimmick; most demonstrations of it exhibited excessive distortion, and it doesn't "reproduce" anything in the nature of original music. I certainly agree with Charlie Swift in his appraisal of Quad vs. Stereo.

With Swift's further questions and answers, I have only to agree. The various answers could be elaborated upon to the extent of a book on each subject, which the salesman hasn't time to read. I wish that noise suppressors didn't produce their own distortions: Bell Telephone Laboratories described a system over 40 years ago that changed gain slowly enough to avoid transient distortion, but it took an extra track.

About "Damping Factor": I wish the inventor of this term had simply referred to the internal resistance of the amplifier. One "bother" to salesman and customer is "how much is enough?"

I'd rather define "enough" as being the amount that affords lowest amplitude modulation distortion (AMD) and transient intermodulation distortion (TIMD).

If the salesman has time to read some of the Engineering papers, he can find plenty of, and reference to, as much further reading as he can stand. I'd suggest The Audio Papers, a binder full of reprints of important papers on Audio*.

**Paul W. Klipsch
Klipsch and Associates
Hope, Arkansas**

*The Audio Papers are available for \$10 (check or money order) from Klipsch and Associates, Inc., P.O. Box 688, Hope, AR 71801.

To the Editor:

I recently read your High Fidelity Trade News and, without a doubt, it is the best publication of its type I have ever run across. Please send a subscription.

**Gregory H. Ford, partner
Circle Stereo
Reno, Nevada**

Editor's Note: That was fast. Thanks, and your subscription is on its way.

EXCITEMENT

(Continued from page 46)

jected onto its screen from the rear; and the second type, in which the screen is separate from the rest of the unit and is free standing or wall mounted. There are also a few subdivisions within these two areas, i.e., does that particular model use a single gun projection tube or three separate tubes or a modified TV with a lens? Although there are several different systems *the key to selling video projection systems is to stress the benefits, not the differences*.

Those of you who are just getting into video projection systems sales

now are doing so at the ideal time. The video projection industry is on the upswing and there are many fine video projection systems presently available from Advent, Sony, Muntz, and others, with ESS/Tinsley, Matsushita, Mitsubishi and Sharp expected to make their units available soon. Projection TVs have been improving constantly. The products are excellent and consumers will readily buy if you present them properly. So here are a few suggestions that will help you to cash in on the video projection boom:

- Make certain you have a good TV antenna connected to the projection TV you are demonstrating. Even mild ghosts that would be hardly noticeable on a TV screen will be huge annoyances when projected onto the large screen.

- Connect a video tapedeck to the projection system and have a wide variety of recorded tapes on hand for your demonstrations. Using the video tape recorder has two advantages. First it will allow you to demonstrate the subjects which most interest the prospective purchaser and which will most likely induce him to buy. Second, it facilitates the selling of the video tape recorder as an add-on.

- Find out what your customer's viewing interests are and key the demonstration to that person's preferences using suitable program material and by relating the appropriate features to that person's needs.

- Make the demonstration exciting, but keep it short.

- Don't let the economic status of the prospective purchaser prevent you from trying for the sale. An Advent spokesman told me that one of the best sources of sales comes from the low income group, since for many, TV is their primary source of entertainment, and consequently they are willing to buy a video projection system even if they have to make time payments on it for years.

- Try to close the sale as soon as you detect interest.

- Don't give up. If you are unsuccessful the first time you ask for the sale, it is because there is a problem or an obstacle preventing the customer from buying.

Tandberg Poised For Expansion

"The situation for Tandberg of America is looking extremely interesting," says Kjell Hoel, president. Which is an understatement, since the company has recently gone through a liquidity crunch in their Norwegian home base, a situation that was solved by gaining funding from the Norwegian government.

"This retrenchment puts Tandberg — and Tandberg of America — in a better position than ever before," Hoel explained, "as it gives us great reserves and support to draw upon (the Norwegian government is currently floating on a sea of oil profits from the North Sea).

"In addition, Tandberg, which is the largest consumer electronics manufacturer in Norway and the country's leading exporter of finished goods, is going to cut back on our less-sophisticated, non-high fidelity products, take an unprecedented step in its 44-year history by cutting back employees, and will close one or two of our non-hi fi factories. The effect of all this will enable us to better utilize our tremendous capital assets and achieve an excellent equity-to-sales ratio in 1978."

The net result will be a tremendous boost for their American dealers, said Hoel, as greater management and R&D emphasis will be put on high fidelity products. "This new concentration will give our U.S. dealers more and broader products geared for their market.



Kjell Hoel

"Frankly speaking, we expect to double our business here in the U.S. We calculate that we represent between 4-5% of each of our dealers' business at the present time, but have become very successful in becoming more of a factor with them, so we figure on doubling that percentage in a couple of years.

"We are 30% ahead of last year in sales, and 1976 was our best year to date. In addition, we are offering more products in the U.S. than ever before."

In addition to their stereo receivers, cassette and reel-to-reel recorders, the company is planning a line of separate components.

"Our dealers have asked us to consider making this category of electronic product," said Hoel. "For example the tuner portion of our receiver is perhaps one of the best designs in any receiver on the market today when you compare it spec for spec, outranking even many of the finest separate tuners. As a result, our dealers have asked us to make this tuner on a separate chassis. These products are being developed right now.

"Eastern manufacturers have taken over the cheaper side of the market. This is an area where we have never competed, nor do we intend to. An added boost for us has been the yen increase; in the past we have traditionally suffered from the dollar devaluation. This time we are not affected, but the Japanese are.

As part of an aggressive new merchandising plan, the company has dropped their dealer co-op, and is using that funding for regional advertising. "We have worked this out with our dealers," said Hoel, "and when we explained how they will benefit from the program, they are almost all in favor of it. In addition, this will allow us to maintain a uniformity of image that is vital for a dealer

selling Tandberg product."

Product-wise, the company is putting greater emphasis on receivers, "as we have to overcome a situation where people only think of Tandberg as a tape recorder factor.

"Actually, we have a tremendous story to tell about our receivers, and we plan to push hard with it from now on. As an illustration, our top-of-the-line receiver offers:

- Tuner specifications that equal or surpass many of the finest separate tuners on the market today.

- We are the finest and only receiver manufacturer to openly discuss rise time, slew rate, DIM and TIM figures in our receivers.

- Our top two models feature pushbutton electronic diode switching, something that no other receiver manufacturer offers. I think that this alone says something about the type of thinking that goes into our product.

- Our top-end receiver is also a mini-recording studio; with one button the home user can insert the tone and filter controls into the Tape 2 output.

- With its provision for two turntables and its electronic switching, the home user can cut or fade from one turntable to another."

In cassette decks, the company is going to be offering a third model in the near future.

In reel-to-reel merchandise, the company says there's a pickup of interest in this product category, and they will be offering a new machine as one of several new products being offered this year.

In another area, Tandberg has had an unexpected success with its Fasett speaker, a small 2-way system in white, black or orange that can be put on the floor, hung on a wall, set on a bookshelf or hung from the ceiling.

Tandberg is an off-site exhibitor at the Las Vegas Hilton during Winter CES.

From Germany's "Cambridge": Canton

Canton is not yet a household word among U.S. audiophiles, but guided by the marketing touch of Adcom's Newton Chanin the German speaker label may one day enjoy something of the reputation and widespread appeal those well-known New England-based speaker labels enjoyed in the 1960's.

The analogy is not inappropriate. Canton's home base in the Taunus Mountains northwest of Frankfurt is the "Cambridge" of Germany, and the reputation of the Canton line in Germany and throughout Europe is not unlike that of the aforementioned U.S. speaker companies here.

Canton, launched five years ago with the introduction of a record care product before it began to market speakers, is a combination of two words, *cantare* — to sing, and *ton* — sound. Out of those words came Canton, and out of Canton came a line of well-reviewed speakers that quickly established the company as a major factor throughout Europe, despite the fact that speaker companies there are about as relatively numerous as they are in the U.S.

Perhaps that fact encouraged Canton, when they were ready, to believe they could crack the U.S. speaker jungle. Newton Chanin's marketing savvy and depth of experience both here and in Europe as a former principal in Ortofon may be the key to success in a country with many quality speaker lines available.

There are five speakers in the U.S. line and there will be a sixth, according to Chanin: a high-performance car/home sub-mini speaker, introduced this month. "I had been talking to Canton for several years about bringing the line in, but this is the first time they've had sufficient product to be able to go ahead," says Chanin, who already has about half of a targeted 100 dealers set up around the



Newton Chanin of Adcom

country.

"We're offering dealers a highly regarded line exclusively and they're dealing with a marketing organization (Adcom) that knows the market and its needs. We started six years ago to import and distribute Ortofon. Adcom also handles Braun and Elac. Partly as a result of our Ortofon distribution experience, Adcom has in place a high-end distribution network of quality reps and audio specialists," Chanin explains.

Chanin hopes to accomplish with Canton what he did with Ortofon: develop a 10-fold increase in business within a very few years without adding new dealers beyond the targeted goal of 100. "We can do this based on a high-level commitment from dealers and high turnover," predicts

Chanin.

"Canton," he says, "presents the same type of sell. A small number of qualified and motivated dealers can accomplish our goals. Because of Adcom's history and credibility, we have already won virtually immediate acceptance for the Canton line. Adcom didn't have to prove anything to dealers who have done business with us over the years."

Canton, Chanin reveals, has more to come. The company has just gone into the electronics business with its first receiver expected to be available early this year at a price about \$1,250. Features reportedly include simultaneous digital and analog read-out, preselected tuning and other high-end attractions. The unit is made by Canton in their new factory.

In terms of product, the Canton line will, with the addition of the auto speaker, cover the spectrum from floorstanding home models to car. In fact, its L-300 mini-speaker was originally conceived as a home product, but a certain percentage of units sold are employed in mobile applications. More appropriate, perhaps, would be the HC-100, a speaker designed for universal application and priced at about \$90. "It's a spectacular value considering its price/quality relationship," says Chanin.

The Adcom chief sees important growth in the U.S. for mobile hi fi stereo equipment. "Hi fi has made the consumer much more aware of quality sound. That, coupled with the fact that many consumers probably have more listening time in the car than in the home, should mean there's an important market there."

It's an emerging market Canton expects to play a strong role in, and one which Chanin expects will reinforce current efforts centered on those audiophile households.

Select what you want in a record cleaner.

**Convenience in use
and storage.**

You shouldn't need a separate shelf, elaborate motions or an act of Congress to clean your records. A comfortable, hand-held instrument that works best on a rotating turntable is ideal.

**Effectiveness against
micro-dust.**

Tiny, invisible dust particles hide in delicate record grooves and can be ground into the vinyl. Only a slanted (directional) fiber using special ultra-small fiber tips can scoop up, rather than rearrange, this micro-dust contamination.

**Effectiveness against
chemical contamination.**

Fingerprints and vapor-borne oils will deposit into channels of a record groove. Such contamination hides from adhesive rollers and all dry cleaning systems. Only a special fluid plus micro-fibers can safely remove such audible, impacted deposits.

**Total removal of
contamination/fluid.**

Capillary action—the lifting of fluid by small fiber surface tension—is totally effective. You want to get contamination off the record, along with any fluid traces.

Lasting construction.

You want quality. A record cleaner can last a lifetime. A plastic wonder can crack into oblivion—or you can purchase the hand-rubbed elegance of milled walnut befitting the rest of your audio system.

Ultimate economy.

The value of a truly fine record cleaner is justified by the cost of replacing your record collection. Fifteen dollars is a small investment in long-term protection.

All of the above.

DISCWASHER, the Superior Record Cleaner.

See the finer audio dealers for a demonstration.



discwasher, inc. 1407 N. Providence Rd., Columbia, MO 65201

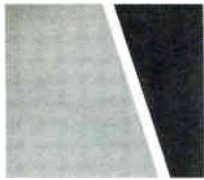

fact: one mistrack damages grooves more than 25...50...even 100 plays.

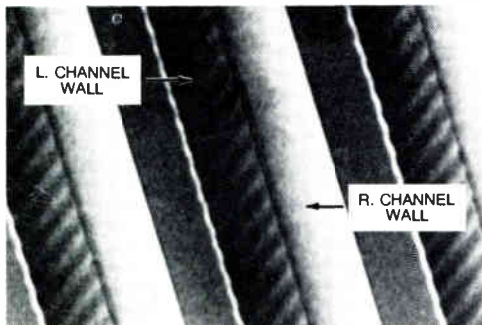

CBS STR 100 Played 75 Times With a V15 Type III Cartridge.

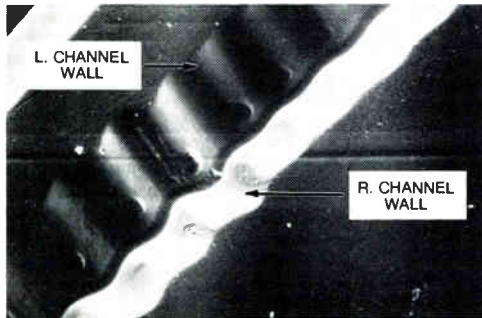

Mistracking Damage
A Commercial Recording After Just One Play With Top-of-the-Line
Name Brand Cartridge at 1.0 Gram Tracking Force. Mistracking
— Critical Damage.

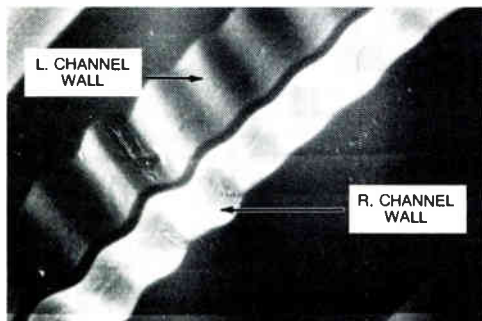

The Same Commercial Recording After 50 Plays With Shure V15
Type III Cartridge at 1.0 Gram Tracking Force. Normal (Inaudible)
Wear — Excellent Tracking.

The Optimist's View:

The cartridge that tracked the grooves shown in the top photomicrograph caused no PERCEIVABLE wear after 75 plays. But because these grooves are cut at relatively low velocities and have a continuous 20 kHz signal (only on one channel), they don't present a very challenging test. As a matter of fact, any reasonably good cartridge should produce the same results. However, under greater magnification these same grooves would probably reveal some amount of record wear (although not enough to alter sound quality). That's because record wear is a gradual but constant phenomenon . . . like tire wear every time you drive.

The Terrible Truth:

The middle photomicrograph shows a record of musical material cut at today's "hotter" velocities after only one play with a well-known competitive cartridge at its rated tracking force. This cartridge mistracked the record. Clearly, critical damage resulted. Notice the deep gouge marks on the groove walls.

A single mistrack can result in MORE damage than 25, 50 or even 100 plays of a record! Continuing our tire analogy, a mistrack is like a blowout. Once your cartridge mistracks a record passage, the damage has been done and that passage will never sound the same. TRACKABILITY is the single most meaningful yardstick by which to measure cartridge performance. That's because TRACKABILITY encompasses virtually every performance factor by which a cartridge is judged . . . including velocity of the recorded signal, frequency, compliance, and effective mass.

The bottom photo shows the same groove played 50 times with a V15 Type III at a record- and stylus-saving force of only one gram. Clearly, there is no cartridge you can buy — for any amount of money — that will protect your record collection more from the damage of mistracking than the Shure V15 Type III.



Shure V15 Type III



Outperforms the best of the rest

Shure Brothers Inc., 222 Hartrey Ave., Evanston, IL 60204, In Canada: A. C. Simmonds & Sons Limited
Manufacturers of high fidelity components, microphones, sound systems and related circuitry.