

MAY · 1955

Proceedings



OF THE I R E

LIGHT AMPLIFIER

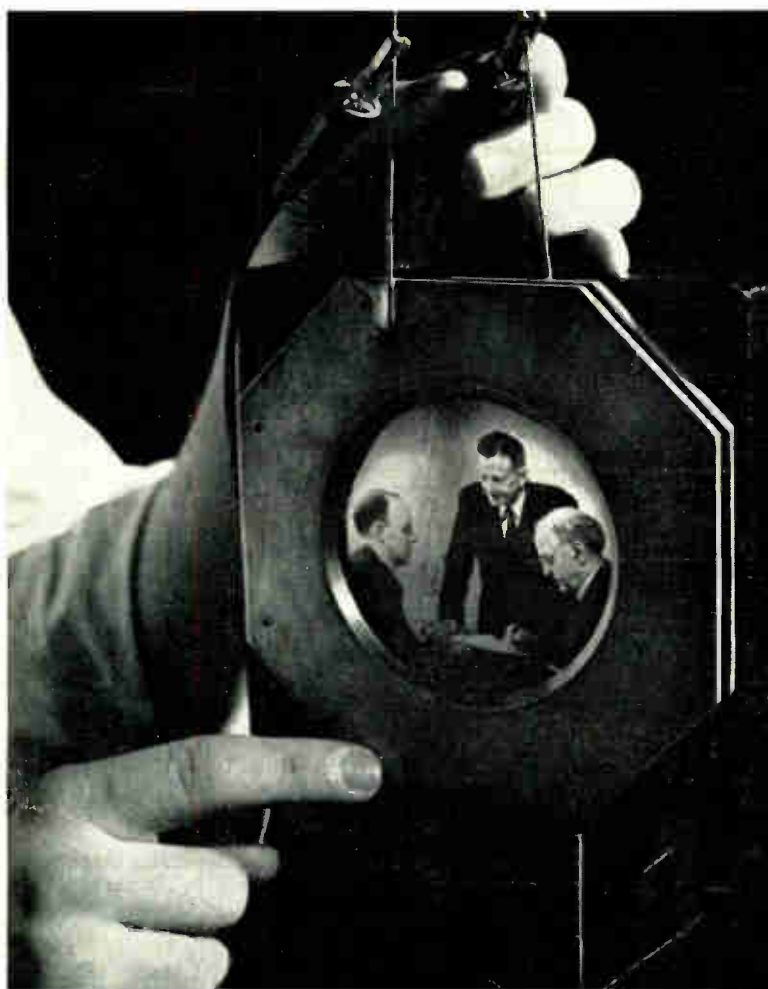

General Electric Company

The light amplifying cell shown above can increase by a factor of ten the brightness of an image which is projected on its special phosphor viewing surface when a dc voltage is applied across the screen by the terminals at the top.

Volume 43

Number 5

IN THIS ISSUE

Aircraft Antennas

Power Transistors

Image Processing

Magnetic-Core Switching Circuits

Transatlantic Signal Variations

Parallel Network Oscillators

Frequency Standards

Germanium Diode Recovery Time

Physical Realizability of Networks

Parallel-T Networks

IRE Standards on TV Terms

Transactions Abstracts

Abstracts and References

TABLE OF CONTENTS INDICATED BY BLACK-AND-WHITE MARGIN, FOLLOWS PAGE 96A

IRE Standards on Television: Definitions of Television Signal Measurement Terms appear in this issue.

The Institute of Radio Engineers

World Radio History

OUR MILLIONTH FILTER SHIPPED THIS YEAR...

FILTERS

FOR EVERY APPLICATION



TELEMETERING FILTERS

UTC manufactures a wide variety of band pass filters for multi-channel telemetering. Illustrated are a group of filters supplied for 400 cycle to 40 KC service. Miniaturized units have been made for many applications. For example a group of 4 cubic inch units which provide 50 channels between 4 KC and 100 KC.

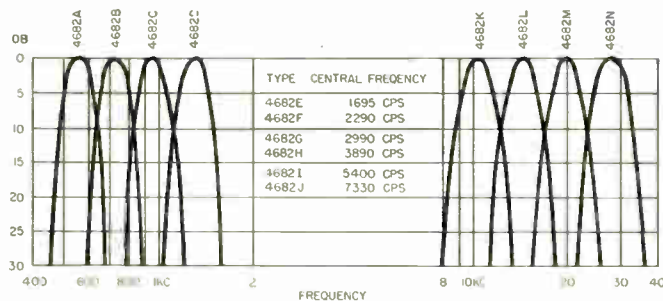

Dimensions:
(4682A) 1½ x 2 x 4"

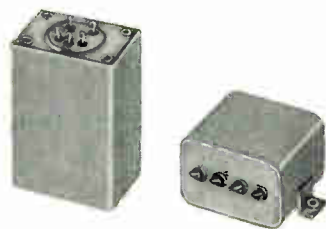

Dimensions:
(3834) 1¼ x 1¾ x 2-3/16".
(2000, 1) 1¼ x 1¾ x 1½".

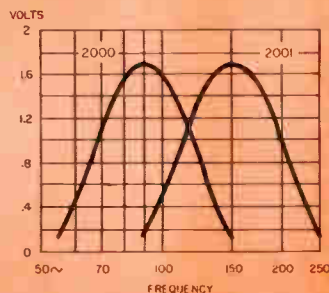
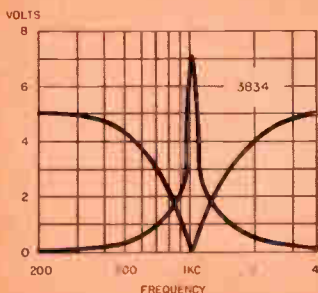

AIRCRAFT FILTERS

UTC has produced the bulk of filters used in aircraft equipment for over a decade. The curve at the left is that of a miniaturized (1020 cycles) range filter providing high attenuation between voice and range frequencies.

Curves at the right are that of our miniaturized 90 and 150 cycle filters for glide path systems.

CARRIER FILTERS

A wide variety of carrier filters are available for specific applications. This type of tone channel filter can be supplied in a varied range of band widths and attenuations. The curves shown are typical units.

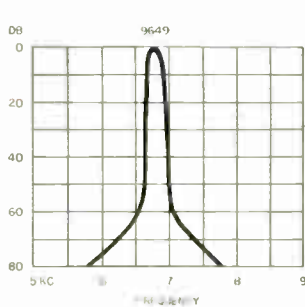
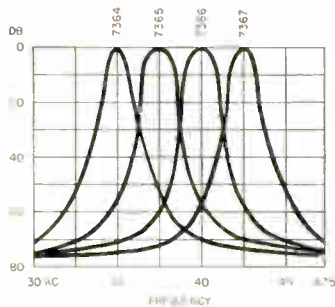

Dimensions:
(7364 series) 1½ x 1¾ x 2¼".
(9649) 1½ x 2 x 4".

DISCRIMINATORS

These high Q discriminators provide exceptional amplification and linearity. Typical characteristics available are illustrated by the low and higher frequency curves shown.

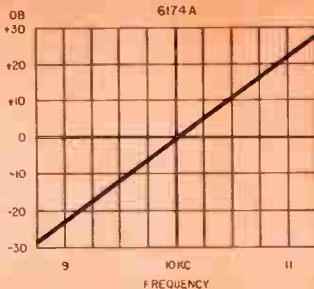
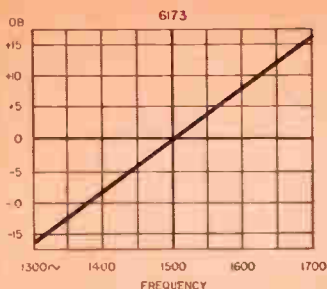

Dimensions:
(6173) 1-1/16 x 1¾ x 3".
(6174A) 1 x 1¾ x 2¼".

For full data on stock UTC transformers, reactors, filters, and high Q coils, write for Catalog A.

UNITED TRANSFORMER CO.

150 Varick Street, New York 13, N. Y. EXPORT DIVISION: 13 E. 40th St., New York 16, N. Y. CABLES: "ARLAB"

THIS IS IT!

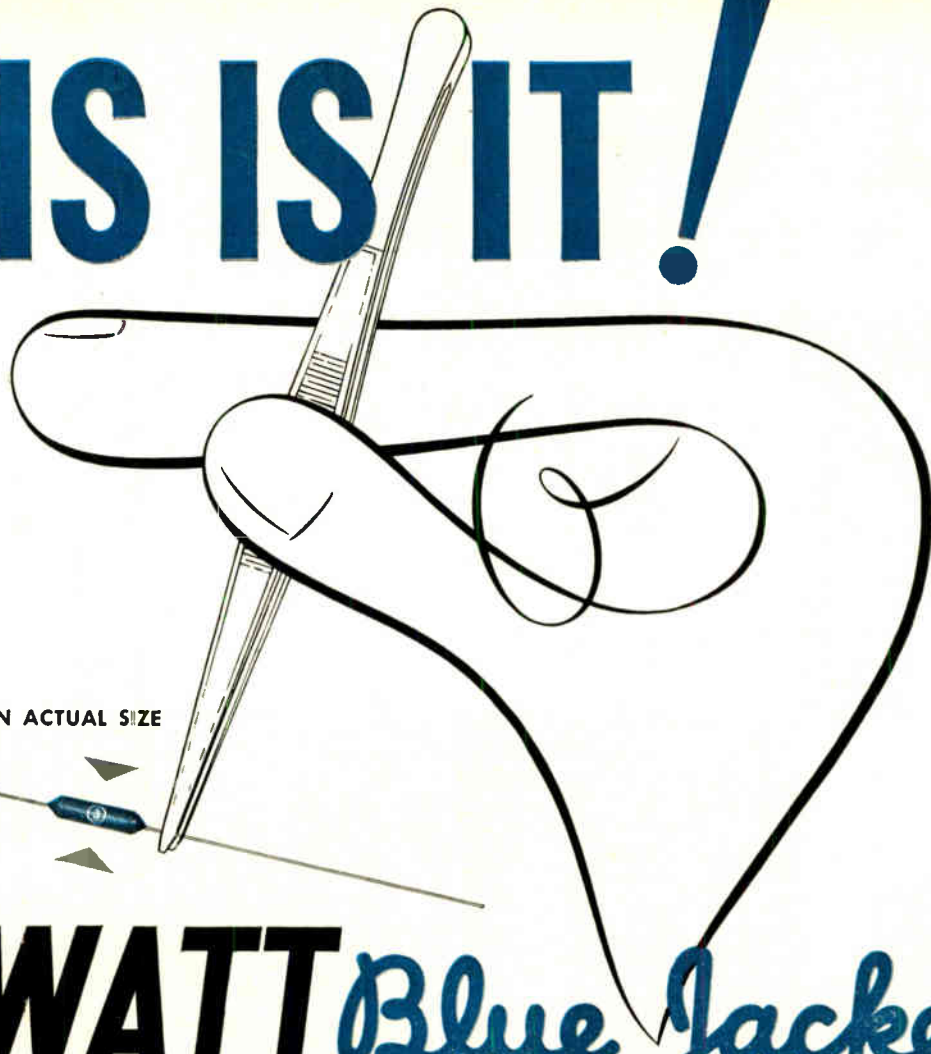

UNIT SHOWN ACTUAL SIZE



NEW 3-WATT Blue Jacket[®] miniaturized axial-lead wire wound resistor

This power-type wire wound axial-lead Blue Jacket is hardly larger than a match head *but it performs like a giant!* It's a rugged vitreous-enamel coated job—and like the entire Blue Jacket family, it is built to withstand severest humidity performance requirements.

Blue Jackets are ideal for dip-soldered sub-assemblies . . . for point-to-point wiring . . . for terminal board mounting and processed wiring boards. They're low in

cost, eliminate extra hardware, save time and labor in mounting!

Axial-lead Blue Jackets in 3, 5 and 10 watt ratings are available without delay in any quantity you require. ★ ★ ★

SPRAGUE TYPE NO.	WATTAGE RATING	DIMENSIONS L (Inches) D		MAXIMUM RESISTANCE
151E	3	1 1/2	1 3/4	10,000 Ω
27E	5	1 1/4	3/4	30,000 Ω
28E	10	1 3/4	3/4	50,000 Ω

Standard Resistance Tolerance: ±5%

SPRAGUE

WRITE FOR ENGINEERING BULLETIN NO. 111B



SPRAGUE ELECTRIC COMPANY • 235 MARSHALL ST. • NORTH ADAMS, MASS.

PROCEEDINGS OF THE I.R.E. May, 1955, Vol. 43, No. 5. Published monthly by the Institute of Radio Engineers, Inc., at 1 East 79 Street, New York 21, N.Y. Price per copy: members of the Institute of Radio Engineers \$1.00; non-members \$2.25. Yearly subscription price: to members \$9.00; to non-members in United States, Canada and U.S. Possessions \$18.00; to non-members in foreign countries \$19.00. Entered as second class matter, October 26, 1927, at the post office at Menasha, Wisconsin, under the act of March 3, 1879. Acceptance for mailing at a special rate of postage is provided for in the act of February 28, 1925, embodied in Paragraph 4, Section 412, P. L. and R., authorized October 26, 1927.

Table of Contents will be found following page 96A



NEW

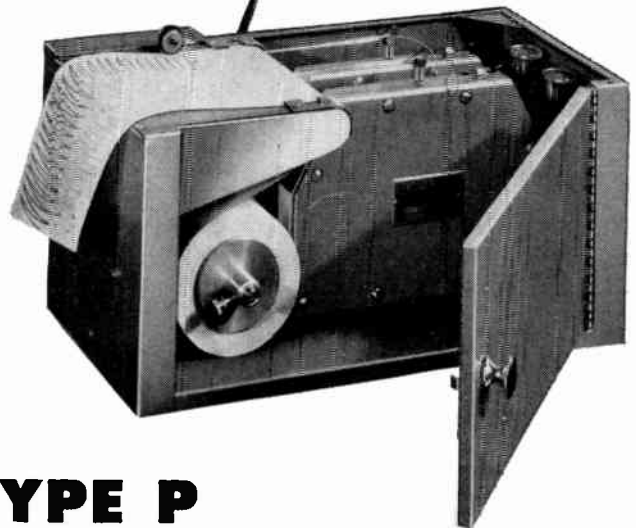

- ... 15 Microvolts D-C Sensitivity
- ... Absolutely Stable
- ... Complete Versatility

NEW...OFFNER TYPE P PORTABLE DYNOGRAPH



This high speed, direct writing oscillograph recorder provides exceptionally high, absolutely stable, d-c or a-c amplification. It may be used with reluctance type gauges without auxiliary equipment. The exceptional stability, sensitivity, and versatility of the Dynograph are made possible by the exclusive, patented chopper amplifier. It is used for recording a wide variety of transient variables, such as strain, vibration, temperature, analog computer write-out, etc.

The performance specifications of the Type P Portable Dynograph are identical with those of the Type M Console model, but it is mounted in two convenient carrying cases as illustrated. The Type P is available with one or two channels.

Check these exclusive features:

Speed plus sensitivity. The Dynograph gives you the maximum in speed and sensitivity—15 mi-

crovolts d-c per millimeter deflection with a response speed of less than 1/120th second.

Large easy to read records. Over 8 cm excursion, permitting the recording of large dynamic variations. Chart speeds 1 to 100 mm per second.

Absolute non-drifting stability. The Dynograph is absolutely stable and non-drifting—it is stable when it starts working and has *absolutely zero* base line drift.

No Hysteresis. The high-torque movement always returns the stylus to the base line—even with the paper stationary. Linearity is within one percent for four cm.

Compare and you will select the Dynograph



Write for your copy of Bulletin L-742. It gives you complete details and application information on both portable and console models of the Offner Dynograph.

OFFNER ELECTRONICS INC.

5328 North Kedzie Avenue • Chicago 25, U.S.A.

A SNAP FOR WIRING BOARD ASSEMBLIES

NEW Sprague Type 28D Push-Lok* Electrolytic Capacitors Give Fast, Fool-Proof Mounting

HERE'S THE BEST APPROACH yet to electrolytic capacitors for printed wiring board assemblies.

It's Sprague's new Type 28D Push-Lok Electrolytic. Just insert the connecting lugs through the slots in the wiring board, and the capacitor is held securely in place until the chassis is ready for dip soldering . . . so securely that solder gaps are eliminated. Spring action of the Push-Lok lugs is strong enough to hold relatively heavy capacitors in place, even when the board is carried sideways, or upside-down on a conveyor. Tab connections are always in close contact with the printed conductors. Yet, unlike other designs, no secondary operations are required for this fast and secure mounting.

Other advantages include:

Fool-Proof Positioning—A Push-Lok can only be inserted the right way. A wide index terminal is provided in the mounting ring to index the assembly on the chassis or other surface if desired.

The Ability to Print Wiring Boards on Both Sides—Shoulders on the Push-Lok lugs plus additional prongs keep the capacitors clear of the chassis.

Safety—Circular shield conforms with suggestions of Underwriters' Laboratories, Inc. Tools cannot be inserted easily between the bottom of the capacitor and the chassis.

FOR COMPLETE INFORMATION on these new Type 28D Push-Lok electrolytic capacitors, write for Engineering Bulletin to Sprague Electric Co., 235 Marshall Street, North Adams, Massachusetts.

**Push-Lok is a Trademark of the Sprague Electric Company*



Sprague, on request, will provide you with complete application engineering service for optimum results in the use of electrolytic capacitors.

SPRAGUE

WORLD'S LARGEST CAPACITOR MANUFACTURER

AN ADVENTURE

in *SILICON*

One example of junction technology at Bell Laboratories. Here a junction is produced on the surface of silicon by bombardment with alpha particles. Bombardment enhances silicon's performance at very high frequencies.

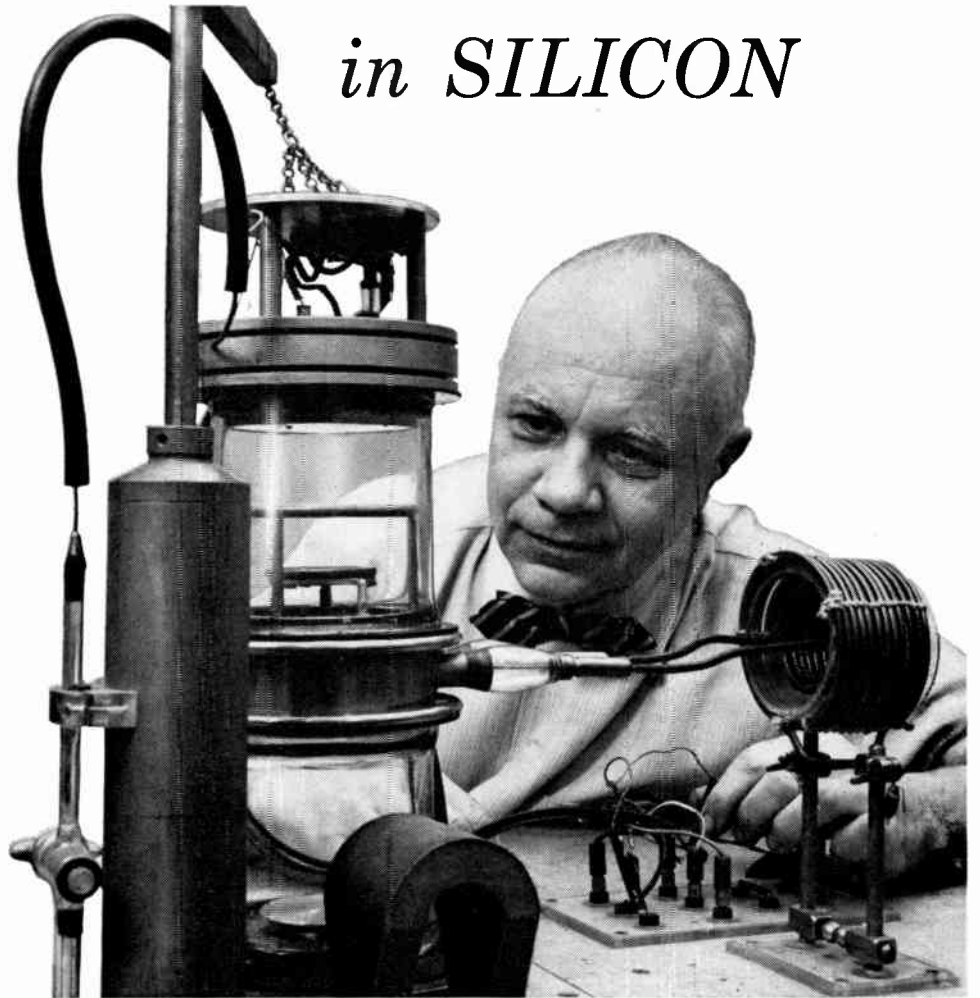

One day in the 'thirties a revolutionary adventure began for Bell scientists. They were testing an experimental silicon crystal they had grown to make microwave detectors.

Intriguingly, they found that one end of the crystal conducted by means of positive charges, the other end with negative. Positive and negative regions met in a mysterious barrier, or junction, that rectified, and was sensitive to light. It was something entirely new . . . with challenging possibilities.

The scientists went on to develop a theory of junction phenomena. They showed that two junctions placed back-to-back make an amplifier. They devised ways to make re-

producible junctions. Thus, junction technology came into being, and the 20th Century had a new horizon in electronics.

This technology has already produced at Bell Telephone Laboratories the versatile junction transistor (useful in amplifiers and switches); the silicon alloy diode (surpassingly efficient in electronic switching for computers); and the Bell Solar Battery which turns sunshine directly into useful amounts of electric current.

This is one of many adventures in science which make up the day-to-day work at Bell Laboratories . . . aimed at keeping America's telephone service the world's best.



Bell Telephone Laboratories

Improving telephone service for America provides careers for creative men in scientific and technical fields



time on our hands

Here's a handful of microtime . . . doled out in hundredths of a millimicro-second. It's our new HELIDEL* delay line.

It's precise . . . wide-band . . . continuously variable. This is not an adwriter's pipedream . . . it's an engineer's, come true.

Which means that definitions are in order.

Precise = delay increments of only 2×10^{-11} sec; resolution 0.01% and better; linearity "better than $\pm 1\%$ " . . . actually, so fine it can't be measured.

Wide-band = transmission of pulse signals up to 20 mc with negligible phase-distortion, overshoot, or distortion of waveshape.

Continuously variable = a distributed-constant, electromagnetic type . . . dreamed up in 1946 . . . developed in helical form since 1951, by Helipot and DuMont.

The HELIDEL is already used successfully in color-TV broadcasting and oscilloscopes . . . and as a trimmer in transmission systems.

What can you dream up?

 **Helipot** *first in precision potentiometers*

*Helipot Corporation/South Pasadena, California
Engineering representatives in principal cities
a division of BECKMAN INSTRUMENTS, INC.*



*To help you dream,
there's a 10-page technical
paper on the HELIDEL,
presented at the 1954
WESCON . . . and a new data
sheet, with complete specs.*

*For your copies, write
for Data File 502.*

444 *TRADEMARK

PERKIN... HAS A STANDARD POWER SUPPLY FOR YOUR EVERY NEED
IMMEDIATE DELIVERY!!



PERKIN
TUBELESS!!
MAGNETIC AMPLIFIER
REGULATED DC
POWER
SUPPLIES

MODEL
 MR 532-15
 5 TO 32 V.
 @ 15 AMP.
 (CONT.)



REGULATION: $\pm 1\%$ (a) from 5-32V DC (b) from 1.5 to 15 oms. (c) from 105-125V AC. (single phase, 60 cps.)
RIPPLE: 1% rms @ 32V and full load, increases to max. of 2% rms @ 5V and full load. **RESPONSE:** 0.2 sec.
METERS: 4 1/2" AM and VM; 2% accuracy.
MOUNTING: Cabinet or 19" rock panel.
FINISH: Baked Grey Wrinkle.
WEIGHT: 150 lbs.
DIMENSION: 22" x 17" x 14 1/2"

MODEL
 M60 YMC
 0 TO 32 V.
 @ 25 AMP.
 (CONT.)



REGULATION: $\pm 1\%$ * (a) of 28V DC; increases to 2% max. over the range 24-32V; does not exceed 2V regulation over the range 4-24V DC (b) from 1/10 full load to full load (c) of a fixed AC input of 115V.
RIPPLE: 1% rms @ 32V and full load; 2% rms max. @ any voltage above 4V
AC INPUT: 115V, single phase, 60 cps.
FINISH: Baked Grey Wrinkle.
WEIGHT: 130 lbs.
DIMENSIONS: 22" x 15" x 14 1/2"

MODEL
 MR 1040-30
 10 TO 40 V.
 @ 30 AMP.
 (CONT.)



REGULATION: $\pm 1\%$ (a) from 10 to 40V DC (b) from 100 to 130V AC (c) from 3 to 30 Amps DC. **RIPPLE:** 1% rms.
AC INPUT: 100-130V, 1 phase, 60 cycles.
RESPONSE: 0.2 sec. **METERS:** 4 1/2" AM and VM.
MOUNTING: Cabinet with 19" rock panel.
FINISH: Baked Grey Enamel.
WEIGHT: 200 lbs.
DIMENSIONS: 22" x 15" x 23"

MODEL
 MR 2432-100X
 24 TO 32 V.
 @ 100 AMP.
 (CONT.)



REGULATION: $\pm 1/2\%$ (a) from no load to full load. (b) from 24-32V DC. (c) for 230* (or 460) V $\pm 10\%$.
DC OUTPUT: 24-32V @ 100 oms.
AC INPUT: 230 or 460V $\pm 10\%$, 3 phase, 60 cycles.
RIPPLE: 1% rms. **RESPONSE TIME:** 0.2 sec.
MOUNTING: Cabinet or 19" rock panel.
WEIGHT: 250 lbs.
DIMENSIONS: 25" x 15" x 15"
 *This unit will be supplied for 230V AC input unless 460V is specified.

ALSO AVAILABLE: Standard 4 and 115 volt models, Ground and Airborne Radar and Missile Power Supplies—Write for Perkin Bulletin.

PERKIN
ENGINEERING CORP.

345 KANSAS ST. • EL SEGUNDO, CALIF. • OREGON 8 7215 or EAstgate 2-1375



Meetings with Exhibits

● As a service both to Members and the industry, we will endeavor to record in this column each month those meetings of IRE, its sections and professional groups which include exhibits.

△

May 9-11, 1955

National Conference on Aeronautical Electronics, Biltmore Hotel, Dayton, Ohio.

Exhibits: Mr. William Klein, 1472 Earham Drive, Dayton, Ohio

May 18-20, 1955

National Telemetering Conference, Morrison Hotel, Chicago, Ill.

Exhibits: Mr. Kipling Adams, General Radio Company, 920 S. Michigan Ave., Chicago, Ill.

June 2-3, 1955

I.R.E. Materials Symposium, University of Pa., Physics Bldg., Room 1-A, Philadelphia, Pa.

Exhibits: Mr. Merritt A. Rudner, United States Gasket Co., 611 North Tenth St., Camden 1, N.J.

Aug. 24-26, 1955

Western Electronic Show & Convention, Civic Auditorium, San Francisco, Calif.

Exhibits: Mr. Mal Mobley, 344 N. LaBrea, Los Angeles 36, Calif.

Sept. 12-16, 1955

Tenth Annual Instrument Conference & Exhibit, Shrine Exposition Hall & Auditorium, Los Angeles, Calif.

Exhibits: Mr. Fred J. Tabery, 3443 So. Hill St., Los Angeles 7, Calif.

October 3-5, 1955

National Electronics Conference, Sherman Hotel, Chicago, Ill.

Exhibits: Mr. G. J. Argall, c/o DeVry Technical Institute, 4141 Belmont Ave., Chicago 41, Ill.

Oct. 31-Nov. 1, 1955

IRE East Coast Conference on Aeronautical & Navigational Electronics, Lord Baltimore Hotel, Baltimore, Md.

Exhibits: Mr. C. E. McClellan, Westinghouse Electric Corp., Air Arm Div., Friendship International Airport, Baltimore, Md.

Nov. 7-9, 1955

Eastern Joint Computer Conference (IRE-AIEE-ACM), Hotel Statler, Boston, Mass.

Exhibits: Mr. J. D. Porter, Digital Computer Lab., Barta Building, M.I.T., Cambridge, Mass.

Note on Professional Group Meetings: Some of the Professional Groups conduct meetings at which there are exhibits. Working committeemen on these groups are asked to send advance data to this column for publicity information. You may address these notices to the Advertising Department, and of course listings are free to IRE Professional Groups.

KAY

Crystal Controlled TV Picture and Sound Signal Sources at VHF and UHF Frequencies

KAY *Mega-Pix*

TRANSMITTERS FOR:

1. Closed Circuit Community TV
2. Studio Monitoring at RF Frequencies
3. Low Power Satellite Operation
4. Overall Test Signal for COLOR and Black & White TV Receiver.



The Kay Mega-Pix provides two separate twelve-channel crystal controlled oscillators, frequency multipliers and output amplifiers to develop a crystal controlled RF picture and sound carrier on each TV channel.

Using the standard video signal (either from a monoscope, color bar generator or TV receiver) the Mega-Pix provides a modulated picture carrier on any of the 12 TV channels. An available FM sound carrier signal is provided on each channel to assist in monitoring at the receiver. See general specifications.

Mega-Pix UHF CONVERTER: Converts RF signal from Mega-Pix to any specified UHF channel. \$450 f.o.b. factory. Catalog 850-A.

SPECIFICATIONS

- **Output Signal Frequencies:** RF picture and Sound, all channels
- **Accuracy:** 0.01 %
- **Video/Audio Carrier Output:** At least 30 mv across 72 ohms
- **Amplitude Control:** Individual level control of carriers; simultaneous control range of 20, 20, 10, 6 and 3db switched—10 db variable.
- **RF Output Impedance:** 72 ohms
- **Video Input Impedance:** 72 ohms
- **Video Input Signal Requirements:** Approx. 1 v, peak-to-peak, black negative
- **Video Bandwidth:** Flat, 5 mc
- **Picture Carrier Modulation:** 0-85+ %, adjustable
- **Sound Carrier Deviation:** 0-25 kc, adjustable
- **Sound Modulating Frequency:** 400 cps, or external audio. Pre-emphasis supplied
- **Power Requirements:** 105 to 125 v., 50 to 60 cps, 90 w. approx.
- **Catalog No.:** 391-A

Price f.o.b. factory: \$990

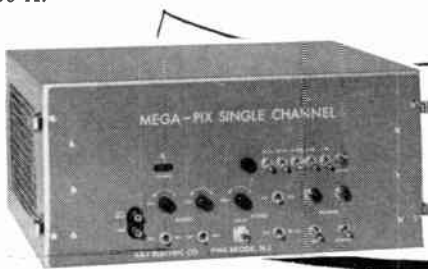

Mega-Pix SINGLE CHANNEL

Same specifications as Mega-Pix, Output Signal Frequencies: TV RF Picture and Sound frequencies, choice of any one channel, IF through 13: audio-video carrier output, 250 mv across 72 ohms. Send for catalog 392-A.

\$495 f.o.b. factory



Ultra-Pix

ULTRA-PIX: UHF crystal controlled TV picture and sound RF signal source. Provides one VHF and three UHF channels for complete TV production line, lab and field test. BASIC SPECIFICATIONS SAME AS MEGA-PIX. Also available with one VHF and one UHF channel with maximum sound picture output of 240 millivolts across 72 ohms. Send for catalog 540-A. \$795 f.o.b. factory

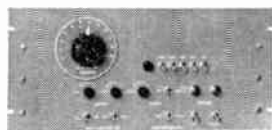

Mega-Pix Jr.

MEGA-PIX, JR.: Same specifications as Mega-Pix, through "Picture Carrier Modulation" Unit employs beat frequency technique to provide TV RF sound and picture carrier frequencies on channels 2 to 13 inclusive. Send for catalog 390-A. \$695 f.o.b. factory



Telefilter

TELEFILTER: Converts the Mega-Pix or similar generator to vestigial side band operation. Used where modulated carrier signal generators are to be operated on adjacent channels. Send for catalog 840-A. \$195 f.o.b. factory

KAY

**ELECTRIC
COMPANY**
DEPT. I-5

14 MAPLE AVENUE
PINE BROOK, N. J.

Complete instrumentation

IMPEDANCE



New! -hp- 415B Standing Wave Indicator

- measures SWR with slotted lines
- expanded scale for low SWR
- output for recorder operation
- measures rf signals with crystal detector
- serves as bridge or null indicator

Model 415B is a completely new instrument, similar to the time-tested -hp- 415A Standing Wave Indicator but containing advanced features never before incorporated in one instrument of its type.

Basically a high gain, low noise, amplifier operating at fixed audio frequency, -hp- 415B presents output on a square-law calibrated VTVM reading direct in SWR or db for operation with crystal detectors such as -hp- 440A and 444A, and -hp- 805 series slotted lines.

Among the many extra-convenience features are an expanded meter scale for accurate measurement of very flat systems (see Figure 1); a 200 K input for null or bridge measurements; a bias current for use with bolometers; a 70 db calibrated range adjustable in 5 db steps so meter may be read in a favorable portion of the scale. Output connections for recorder operation are also provided.

-hp- 415B is normally supplied for operation at 1,000 cps, but simple "plug-in" units are available on special order for other frequencies 315 to 3,000 MC. The instrument is housed in a light, compact, rugged metal case.

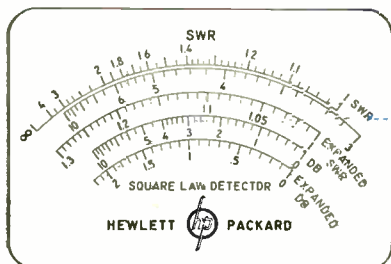

Figure 1. Meter face, -hp- 415B. Note expanded scale giving full scale indication of SWR as low as 1.3. All measurements are made in high-accuracy upper portion of scale.

SPECIFICATIONS

Frequency: 1,000 cps \pm 2%.

Sensitivity: 0.1 μ v at a 200 ohm level for full scale deflection.

Noise Level: Less than 0.03 μ f ref. to input operated from a 200 ohm resistor.

Amplifier Q: 25 \pm 5.

Calibration: Square law. Meter reads SWR, db.

Range: 70 db. Input attenuator provides 60 db in 10 db steps. Accuracy \pm 0.1 db per 10 db step.

Scale Selector: "Normal," "Expand," and "-5 db."

Meter Scales: SWR: 1-4; SWR: 3-10; Expanded SWR: 1-1.3; db: 0-10; Expanded db: 0-2.

Gain Control: Adjusts to convenient reference level. Range approx. 30 db.

Input: "Bolo" (200 ohms). Bias provided for 8.4 ma bolometer or 1/100 amp. fuse; or 4.3 ma low current bolometer.

"Crystal." 200 ohms for crystal rectifier.

"200,000 ohms." High impedance for crystal rectifier as null detector.

Output: Jack for recording milliammeter having 1 ma full scale deflection, internal resistance of approx. 1,500 ohms.

Input Connector: BNC.

Power: 115/230 v \pm 10%, 50/60 cps, 60 watts.

Dimensions: Cabinet Mount: 7 1/4" wide, 11 1/4" high, 14" deep.

Rack Mount: 19" wide, 7" high, 11" deep.

Weight: Net 20 lbs. Shipping 35 lbs. (cabinet mount).

Price: \$200.00.

COMPLETE
COVERAGE

HEWLETT-PACKARD

for fast, accurate

MEASUREMENTS

Use this equipment with 415B

FOR SLOTTED LINE SWR MEASUREMENT

-hp- 809B Universal Probe Carriage

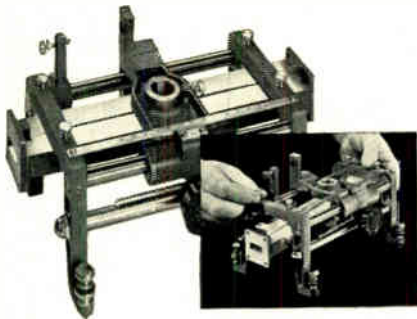

Convenient, all-purpose carriage. Operates with 6 -hp- slotted sections, waveguide or coax, covering frequencies 3 to 18 KMC. Sections interchange in 30 seconds. Precision construction, calibrated in mm to 0.1 mm; dial gauge may be mounted. Operates with -hp- 440, 442, 444 detectors, probes. \$160.00

-hp- 810A/B Waveguide Slotted Sections



-hp- 810B, for 809B carriage, is a flanged waveguide section with tapered slots minimizing reflections. Available in 5 bands, 3.95 through 18.0 KMC. -hp- S810A (illustrated), complete slotted section including integral probe carriage, 2.6 to 3.95 KMC band only. -hp- 810B, (all sizes) \$90.00. -hp- S810A, \$450.00.

-hp- 806A Coaxial Slotted Section



Precision slotted section for SWR measurements 3 to 12 KMC. Mounts in -hp- 809B Universal Probe Carriage. Used with Type N connectors, flexible cables. \$200.00

-hp- 805A/B Coaxial Slotted Sections

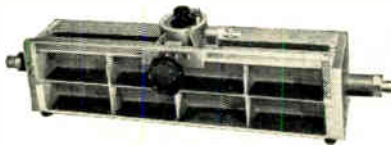

Coaxial units designed for fast, accurate SWR measurement. Exclusive parallel plane design, for operation over all frequencies 500 to 4,000 MC. Identical except -hp- 805A is for Type N connectors, and flexible cables; -hp- 805B is for rigid 7/8" RG44/U line. -hp- 805A or 805B, \$475.00.

Use this equipment with 415B FOR CONVENIENT RF DETECTION

-hp- 420A Crystal Detector



Uses a silicon crystal to detect rf signals in Type N coaxial line. Covers frequencies 10 MC to 12.5 KMC. Flat frequency response, sensitivity 0.1 v/mw. Uses modified 1N76 crystal. \$50.00.

-hp- 444A Untuned Probe



A 1N26 crystal plus a small antenna in a convenient, easy-to-use housing. Variable penetration depth, no tuning required. Sensitivity equal to single- or double-tuned probes. Range 2.4 to 18.0 KMC. Mounts in 809B carriage. \$50.00.

-hp- 440A Detector Mount



Simple, convenient means of detecting rf energy in coax or waveguide systems. For coax, operates at any frequency 2.4 to 12.4 KMC. Uses either silicon crystals or bolometer. Includes built-in by-pass. Coax connector for UG21B/U Type N; BNC output jack. One-adjustment, single stub tuning. \$85.00.

Prices f.o.b. factory.
Data subject to change without notice.

-hp- 442B Broadband Probe



Provides variable probe penetration. Probe position held by friction or locking ring. Type N rf jack simplifies receiver connection. Shielded, designed to minimize spurious response. Fits 809B carriage or others with 3/4" bore. With -hp- 440A, forms sensitive rf detector for slotted waveguide sections. -hp- 442B. \$35.00.

-hp- X421A Detector Mount



Accurate, square-law crystal detector for waveguide reflectometer measurements. Composed of waveguide-to-coax adapter terminated in a 1N26 crystal operating into a load resistance selected for accurate square-law operation over an input power range exceeding 40 db. 8.2 to 12.4 KMC; sensitivity 1 mv/0.01 mw, SWR less than 1.5 full range. \$75.00 (including crystal).

OTHER IMPEDANCE EQUIPMENT

-hp- 803A vhf Bridge



Gives fast, direct readings of any impedance between 50 and 500 MC. Measures by sampling electric and magnetic fields in transmission line. Usable for comparative measurements 5 to 1,000 MC. Impedance range 2 to 2,000 ohms. Phase angle -90° to +90° at 52 MC and above. Also measures SWR, % reflected power, vhf system flatness. \$495.00.

-hp- 417A vhf Detector



For use with -hp- 803A bridge; or general laboratory use. Super-regenerative receiver, 10 to 500 MC. 5 bands. Approx. 5 μv sensitivity over entire band. Direct reading frequency control; thoroughly shielded. \$250.00

See Your -hp- Field Engineer for Complete Details, or Write Direct

HEWLETT-PACKARD COMPANY
3328D PAGE MILL RD., PALO ALTO, CALIF., U.S.A.
Cable "HEWPACK"
Field Engineers in All Principal Areas



INSTRUMENTS

**COMPLETE
COVERAGE**



May 1955

Ceramic Capacitors

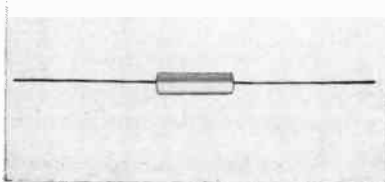

Film Capacitors, Inc., 3400 Park Ave., New York 56, N. Y., are now producing miniature Mylar dielectric capacitors housed in ceramic jackets with thermo-setting plastic end-fill. These capacitors are specially impregnated to minimize temperature coefficient. The manufacturer claims that the insulation resistance is maintained under the most severe conditions of temperature and humidity.

Power Supplies

N. J. Electronics Corp., 345 Carnegie Ave., Kenilworth, N. J., announces the availability of a diversified line of regulated power supplies ("B" Supplies).

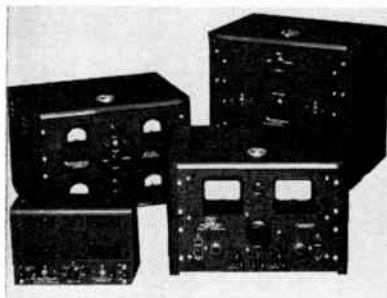

The manufacturer has divided conventional power supply needs into two major classifications: standard grade and laboratory grade. Thirty-two models of each grade are included in the line. Dual supplies, with special built-in switching, cover a wide range of requirements, from 100 volts, 100 ma to 1200 volts, 1200 ma. The switching system offers four distinct modes of operation: separate supplies, parallel (with single-knob control) series bucking, and series aiding.

The laboratory grade has the following features: blower cooling, selenium power rectifiers, 10,000 hour, super-reliable tubes, elimination of carbon resistors and carbon potentiometers, capacitors oil-filled, metal-cased, hermetically sealed, all components derated at least 30 per cent, and magnetic circuit breakers.

An eight-page catalog, No. PR5, is available from the manufacturer.

These manufacturers have invited PROCEEDINGS readers to write for literature and further technical information. Please mention your I.R.E. affiliation.

Sub-Miniature Relay

Guardian Electric Manufacturing Co., 1621 W. Walnut St., Chicago 12, Ill., announces its all-new 6-pole, double-throw, hermetically sealed, 5-ampere sub-miniature relay, Series 2005.

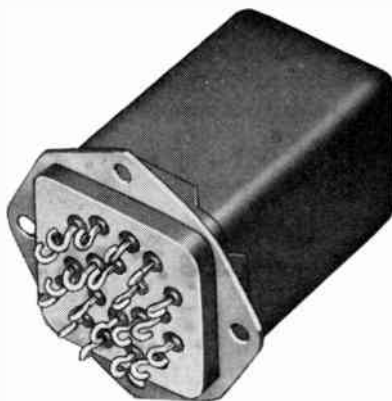

The unit is said to meet the requirement of military specifications MIL-R-6106-A, Class A, and MIL-R-5757-B, Class A.

Built to withstand 100 G shock and 10 G vibration, from 75 to 2,000 cps, in all mounting planes, the unit has silver contacts to insure low resistance. All contacts are rated at 5 amperes, 24 to 30 volts, resistive load. High contact pressure in both energized and de-energized positions insures reliable operation at both low and maximum current ratings. Nominal coil voltage is 24 to 30 volts. Further information is available from the manufacturer.

Magnetic Amplifier DC Supply

Low ripple and precise regulation characterize the new EM-28-1B tubeless magnetic-amplifier regulated dc power supply, developed by Engineered Magnetics, 11812 Teale St., Culver City, Calif.



Developed for airborne applications, this power supply is equally well adapted to laboratory bench use in operating strain gages and scientific instruments requiring precise regulation and low ripple. The size is 12 by 7 by 9 inches. Voltage is adjusted within the range of 28 to 32 volts, dc, while the single-phase input fluctuates between 105 to 125 volts and 380 to 420 cps, ac. Regulation is held to better than 0.2 per cent with 5 millivolt rms ripple throughout a temperature range of -30°F to $+120^{\circ}\text{F}$ and at altitudes up to 70,000 feet. Recovery time is better than 0.2 second.

Precision Potentiometers

New series V Helipot precision potentiometers engineered to meet non-linear requirements are available from Helipot Corp., 916 Meridian Ave., S. Pasadena, Calif.

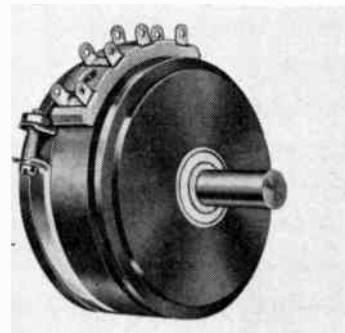

As many as 25 may be ganged on a common shaft during manufacture, while 13 tap connections can be added to each pot by using an exclusive Helipot process. Every tap is spot welded to a single turn of resistance wire, assuring a trouble-free connection without shorting out adjacent turns.

Dimensions are $1\frac{1}{4}$ by 0.8 length with a $\frac{1}{4}$ inch shaft. The series V Helipot has external clamps for rapid phasing even after installation.

Operating range is -55 to $+90^{\circ}\text{C}$. Power rating is above 5 watts at 25°C ; above 4 watts at 40°C , and 2.5 watts as high as 60°C .

Standard conformity in models having non-linear output is ± 1 per cent. Linear models have standard linearity of ± 0.5 per cent. Finer conformity or linearity is possible on special orders.

The V series also offers resistance up to 130,000 ohms. Mechanical rotation is 360° continuous; maximum electrical contact angle, 345° ; effective electrical rotation, 325°C . The V series can incorporate many special features to meet particular specifications.

(Continued on page 16A)

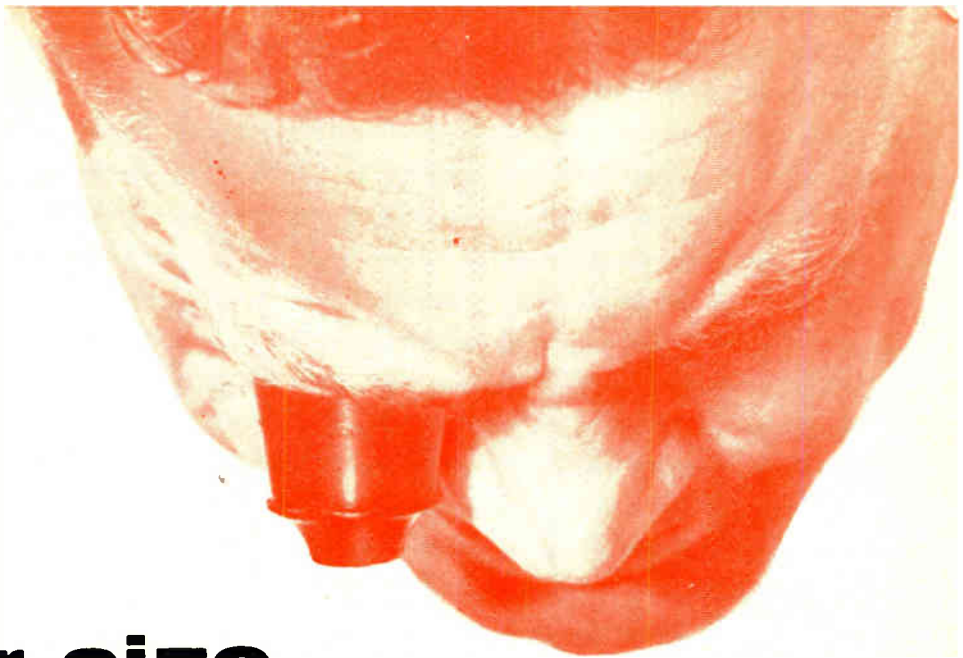

Try this for size

**For guided missiles, airborne equipment,
portable and mobile ground equipment**

In these and related fields, where lack of space is the problem, manufacturers have turned to miniaturization. Daven's new ceramic switch occupies a panel area of less than 1½ square inches—incorporates features that ensure long life and trouble-free operation.

Despite its small size, this switch is extremely rugged and has been designed to withstand all types of field service. Coin silver contacts, rotors and slip rings are provided for low and uniform contact resistance and excellent electrical characteristics. Ceramic parts are silicone impregnated to function under extreme humidity. Sturdy solder terminals are supplied for wiring.

Single pole style has 18 shorting type contact positions available. 2 or 3 pole types may also be obtained. Several sections may be "ganged" by adding supplementary wafers. Flash-over voltage at 60 cycles is 1000 volts peak . . . current carrying capacity is 2 amperes.

This sturdy, high-quality switch is precision produced . . . will give years of service in fine commercial and military equipment. DAVEN's expert engineering staff is at your service for help with special problems or orders to your specifications. Write today for further information.



**Miniature Ceramic
Switch... Series M**



THE **DAVEN** co.

195 Central Avenue, Newark 4, N.J.

WORLD'S LARGEST MANUFACTURER OF ATTENUATORS

YOU FURNISH THE PRINT, WE'LL FURNISH THE PART

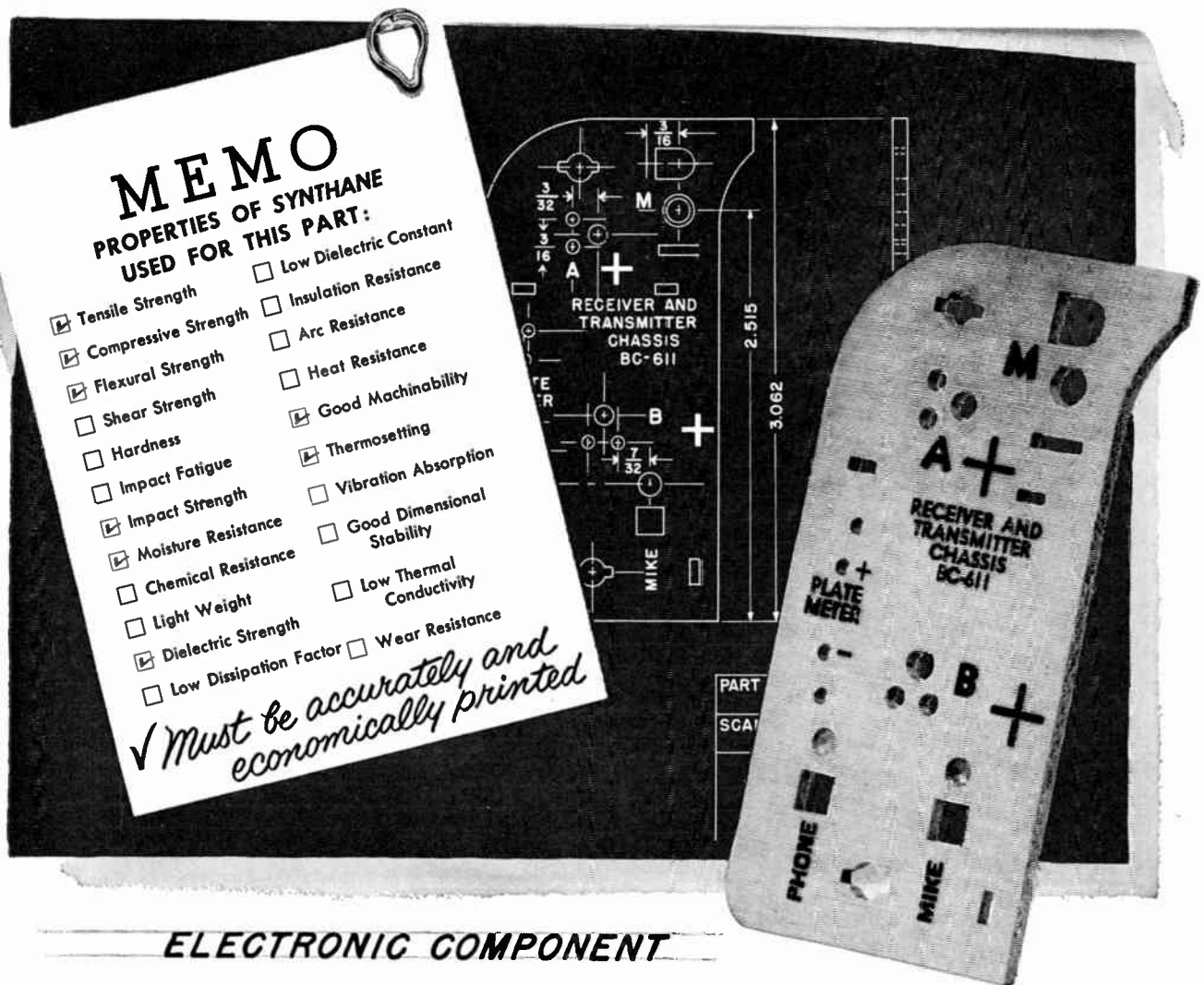

MEMO
PROPERTIES OF SYNTHANE
USED FOR THIS PART:

- Tensile Strength
- Compressive Strength
- Flexural Strength
- Shear Strength
- Hardness
- Impact Fatigue
- Impact Strength
- Moisture Resistance
- Chemical Resistance
- Light Weight
- Dielectric Strength
- Low Dissipation Factor
- Low Dielectric Constant
- Insulation Resistance
- Arc Resistance
- Heat Resistance
- Good Machinability
- Thermosetting
- Vibration Absorption
- Good Dimensional Stability
- Low Thermal Conductivity
- Wear Resistance

✓ Must be accurately and economically printed

ELECTRONIC COMPONENT

OF SYNTHANE HAS DURABILITY, DIMENSIONAL STABILITY,

DIELECTRIC STRENGTH

Although this sturdy end plate will fit into the palm of your hand, it has in combination all the dielectric strength, the physical properties, and the printability the customer requires. It's made of *Synthane*, a laminated plastic, the same material used in hundreds of other electrical, mechanical, and chemical applications.

The blue print for this part calls for accurate machining, the punching of twenty holes of various shapes and sizes, and printing or engraving in three different colors. *Synthane* delivers finished parts exactly as specified, ready for the production line. The customer gets them promptly without problems of tooling up, waste, or rejects.

If you need components with many properties in combination, you will want to know more about *Synthane* laminates and the *Synthane* fabricating service. Send in the coupon for the full story.

SYNTHANE CORPORATION, 8 River Road, Oaks, Pa.
 Please send my copy of the Synthane catalog.

Name _____
 Title _____
 Company _____
 Address _____
 City _____ Zone _____ State _____



SYNTHANE CORPORATION • OAKS, PENNSYLVANIA

what are
your
diode
requirements?

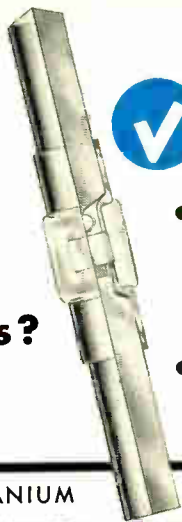

Check these
PSI features...

- Versatile lead configurations
- Glass-to-metal fusion seal
- Welded construction

Below, we've listed typical types from PSI's broad standard diode line. We also make many special diodes... and if your needs cannot be met by standard types, PSI engineers will be glad to investigate your specific problem promptly. Write us for complete product information.

GERMANIUM

GOLD BONDED DIODE SPECIFICATIONS (@ 25°C)

RETMA TYPE	PSI TYPE	OUTLINE 1	MAXIMUM INVERSE WORKING VOLTAGE (v)	MINIMUM FORWARD CURRENT @ +1v (ma)	MAXIMUM INVERSE CURRENT @ SPECIFIED VOLTAGE (ma)
HIGH VOLTAGE TYPES					
	PS200	A/B/C	200	20	0.05 (-50v) 0.2 (-200v)
1N39A		B	200	3	0.2 (-100v) 0.8 (-200v)
1N55B		A	150	5	0.5 (-150v)
HIGH CONDUCTANCE TYPES					
	PS201	A/B/C	90	150	0.02 (-10v) 0.18 (-90v)
After switching from 5 ma 1μsec forward pulse to -40v, back resistance must equal or exceed 25K in 0.3μsec. Loop resistance = 2000 ohms min.					
	PS202	A/B/C	30	100	0.02 (-20v)
	PS203	A/B/C	30	100	0.1 (-20v)
					0.35 (-20v) @55°C
GENERAL PURPOSE—MEDIUM CONDUCTANCE					
	PS205	A/B/C	80	75	0.05 (-50v)
	PS206	A/B/C	60	75	0.1 (-50v)
1N143		B	100	40	0.1 (-100v)
	PS207	A/B/C	80	40	0.05 (-50v)
	PS208	A/B/C	60	(Note 2)	0.02 (-10v) 0.12 (-60v)
After switching from 5 ma 1μsec forward pulse to -40v, back resistance must equal or exceed 80K in 0.3μsec. Loop resistance = 2000 ohms min.					
GENERAL PURPOSE					
	PS210	A/B/C	100	15	0.02 (-20v) 0.1 (-100v) 0.15 (-20v) 0.3 (-100v) @55°C
	PS211	A/B/C	60	30	0.05 (-50v) 0.2 (-50v) @55°C
1N63		B	100	4	0.05 (-50v)
1N67A		A	80	4	0.005 (-5v) 0.05 (-50v)

SILICON JUNCTION DIODE SPECIFICATIONS (@ 25°C) ⁶

PSI TYPE ³	OUTLINE	MINIMUM SATURATION VOLTAGE ⁴ -E _s (v)	TRANSITION VOLTAGE RATIO ⁵ E _t /E _s (%)	MINIMUM FORWARD CURRENT @ +1v (ma)	MAXIMUM INVERSE CURRENT @ SPECIFIED VOLTAGE
					(μa) @ 25°C (μa) @ 150°C
(D) PS500	A/B/C	300	90	3	0.01 (-150v) 5.0 (-150v)
(D) PS501	A/B/C	150	90	10	0.01 (-75v) 5.0 (-75v)
(D) PS502	A/B/C	55	95	30	0.01 (-30v) 5.0 (-30v)
(D) PS503	A/B/C	30	95	60	0.01 (-15v) 5.0 (-15v)

1. Diodes may be obtained with other configurations to meet special needs.
2. During 0.1μsec 50 ma peak half-sine forward pulse (Maximum PRF = 100 KC), forward voltage ≤ 3v.
3. (D) denotes Developmental Specification.
4. Saturation Voltage (E_s) is measured at 500μa.
5. Transition Voltage (E_t) is measured at 50μa.

6. Recovery time: After switching from 5 ma forward current to two-thirds of the minimum E_s, typically each of the diode types reaches a back resistance of 50K in less than 1μsec.

PACIFIC



SEMICONDUCTORS, INC.

THREE SALES OFFICES:

10451 West Jefferson Boulevard
Culver City, California
3959 Lincoln Avenue
Chicago, Illinois
2079 Wantagh Avenue,
Wantagh, Long Island, New York

POLARAD COLOR TV

AN INTEGRATED LINE OF EQUIPMENT FOR STUDIO AND LABORATORY

Fully integrated units that combine ease of operation with maximum stability. No additional accessories or power units required for operation.

Especially designed for:

- Testing receivers, transmitters, and terminal equipment.
- Laboratory test standards for development of color TV equipment.
- Checking components used for color TV.
- Alignment and adjustment of colorplexers or encoders.
- Testing convergence of tri-color kinescopes.



ELECTRONICS CORPORATION

COLOR BAR GENERATOR — MODEL PT-203

A complete instrument with a color bar pulse forming unit, a complete colorplexer unit and regulated B+ and filament supplies. Provides NTSC color TV test signals, for receivers, transmitters, networks and components. Internal switching provides 19 different test patterns in the form of a composite NTSC video signal. Special self-balancing colorplexer provides exceptional stability over long periods of operation without readjustment, with "I" and "Q" outputs. (See colorplexer details.)

AUTO-SELF-BALANCED COLORPLEXER

MODEL PT-205

Incorporated in the Model PT-203 Color Bar Generator, available as a separate chassis for rack mounting. Designed for high stability and negligible drift, this unit replaces old encoder units of early design. This instrument multiplexes three simultaneous color video signals (R, G, B) and properly encodes them into color information and then combines them with sync pulses and color sync signals to form a standard NTSC color TV signal. Pulse or video signals to drive colorplexer may be obtained from special (R, G, B) pulse generators, color camera or color slide scanner. Subcarrier balance is stable and dynamically independent of signal level changes over long periods of operation. Driving signals are Subcarrier, Blanking, Sync and Vertical pulses. Full bandwidth "I" and "Q" modulation is used in the chrominance channel of the colorplexer. "I" and "Q" or "B-Y" and "R-Y" video test signals are available for receiver and monitor matrix alignment. Both positive and negative polarity signals are available at high and low impedance.

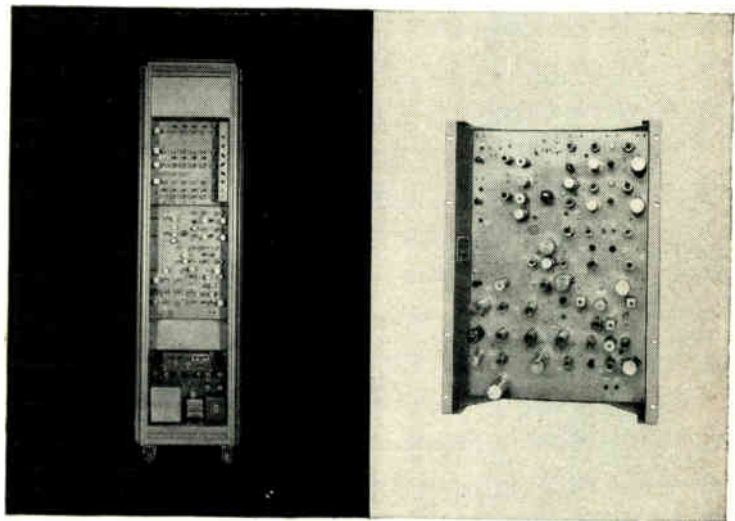

COLOR BAR GENERATOR— MODEL PT-203

Output Signals: NTSC Composite
Video 2 Outputs 0—1.4 v. pk-pk
Output Signal Information:
Color Bars—6 Bars of Color (R, G, B, C, Y, M) plus Blk/Wht
Gamma Bars—10 step grey scale
Black to White
Dots—White dots on a black field
External Video—Positive or negative (Provision for mixing ext. video with above).
System Bandwidth: Luminance Channel 6 mc
Chrominance: "I" and "Q" Channel per NTSC standard
Subcarrier balance stability: Drift not greater than 6 mv (1.4 v. pk-pk signal), 8 hour operation.
Residual Subcarrier Unbalance: 1% Signal Level
Power Requirements: AC 105-125 volts 7 amps., 60 cps.

COLORPLEXER—MODEL PT-205

Output Signals: NTSC Composite Video 2 Outputs 0—1.4 v. pk-pk
Available Test Signals: I, Q, Y, R-Y, B-Y, (Neg. and Pos.) Video
Input Signals: Subcarrier 20-30 v. pk-pk, 3.579545 mc
Sync. 3.0 v. pk-pk, negative
Vertical Drive 3.0 v. pk-pk, negative, R, G, B; 1 v. pk-pk
System Bandwidth: Luminance Channel 6 mc
Chrominance: "I" and "Q" Channel per NTSC standard
Subcarrier Balance Stability: Drift not greater than 6 mv (1.4 v. signal), 8 hour operation
Power Requirements: AC 6.3 v. @ 12 amps., DC 280 v. @ 470 ma

REPRESENTATIVES: • Albuquerque • Atlanta • Baltimore • Bayonne • Bridgeport • Buffalo • Chicago • Dayton • Fort Worth • Los Angeles • New York

SYNCHRONIZING GENERATOR — MODEL PT-201

Compact unit provides RTMA standard driving, blanking and synchronizing pulses, as well as a composite video signal comprising vertical and horizontal dots for receiver tests (positive and negative). Used to drive color bar generators, or any other NTSC color TV generating equipment. Utmost stability assured through use of delay lines and by driving all pulses from leading edge of a crystal controlled oscillator. Unit may also be locked to synchronize with 60 cps line. External drive input jack permits operation with Color Subcarrier Generator. Complete with power supply.

COLOR SLIDE SCANNER — MODEL PT-210

A complete equipment integrated into only two racks which provides a high resolution NTSC composite color video signal obtained from standard 2 x 2 (35mm) transparencies. Designed for maximum stability and high signal to noise ratio. The optical head is complete with lenses employing IN-LINE dichroic mirrors and Fresnel condensing lenses. The R, G, B signals obtained from three channel photo amplifiers are gamma corrected to give proper rendition to high lights and shading. Utilizes a highly stabilized colorplexer. (See complete description of Model PT-205 Colorplexer above.)

The scanning kinescope has fine resolution and is combined with the deflection and high voltage unit. The remaining chassis components contain regulated low voltage power units, a regulated filament power unit and a regulated photo multiplier power supply.

COLOR SUBCARRIER GENERATOR AND FREQUENCY DIVIDER UNIT

— MODEL PT-202. This rugged unit complete with regulated B+ and filament power provides standard NTSC subcarrier frequency with dual outputs and includes a frequency divider to provide a sync generator driving signal (31.5 KC) to convert standard B/W sync generators for color TV use. High stability achieved by temperature controlled crystal oscillator. All adjustments accessible at front of unit. Adapts any sync generator to NTSC color operation.

COLOR TV VIDEO MONITOR — MODEL M-200

Two portable units supplied with brackets for standard rack mounting. High definition color picture with exceptionally good color rendition is displayed on a 15 inch tri-color kinescope. Excellent for checking the quality of NTSC color video signals in the studio, on transmission lines or in the receiver factory. Special test jacks and switches are provided for analyzing R, G, B signals, matrixing and phase of color signals. Exceptionally good synchronizing capabilities over a wide range of signals. Special convergence circuits are employed to give maximum utilization of color kinescope. Model M200 has good color stability and is relatively insensitive to line voltage changes. Excellent dynamic circuit linearity assures good color stability over a wide range in signal level.

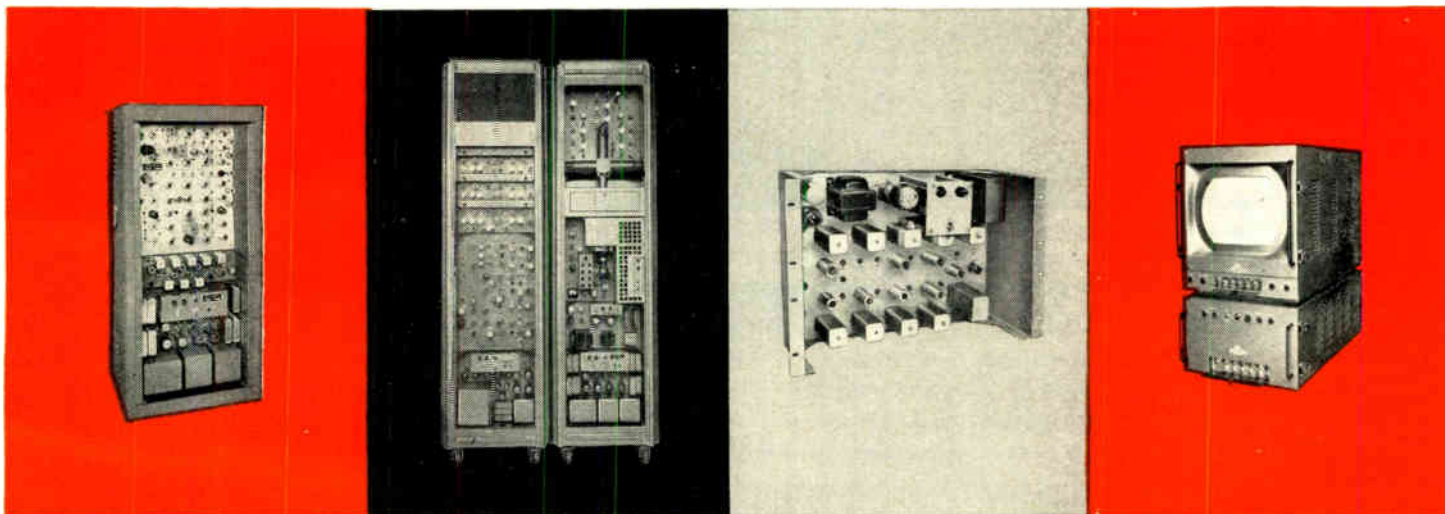

SYNCHRONIZING GENERATOR— MODEL PT-201

Output Signals: Sync. (Neg. and Pos.) 4 v. pk-pk across 75 ohms
Blanking (Neg. and Pos.) 4 v. pk-pk across 75 ohms
Horiz. Drive (Neg. and Pos.) 4 v. pk-pk across 75 ohms
Vert. Drive (Neg. and Pos.) 4 v. pk-pk across 75 ohms
Composite Video Output (Neg. and Pos) 1.4 v. pk-pk across 75 ohms
Internal Dot Pattern or External Video—1.4 v. pk-pk across 75 ohms
Input Power: 105-125 v. 4.5 amps., 60 cps.

COLOR SLIDE SCANNER— MODEL PT-210

Output Signals: NTSC Composite Video 2 Outputs 0—1.4 v. pk-pk
Optical Head: Lens—F. 2.0
50 mm, Xenon lens in tractica mount
IN-LINE dichroic mirrors
Color Slide 2 x 2 color Transparencies
Gamma Amplifier:
Three Channels (R, G, B)
Input Signal—1.4 v. pk-pk across 75 ohms
Output Signal—1.4 v. pk-pk across 75 ohms
Colorplexer: (See Model PT-205 above)
Deflection and High Voltage Unit:
Kinescope type 5AUP24;
Operating Voltage: 27 KV regulated
Linearity: 2% across raster
Horizontal and Vertical
Photomultiplier Power Supply:
Electrically regulated. Filament Supply—AC line Regulated
Input Signals: Hor. Drive—3 v. pk-pk
Ver. Drive—3 v. pk-pk. Blanking Drive—3 v. pk-pk Sync. 3 v. pk-pk
Power Requirement: AC 105-125 v., 16 amp., 60 cps.

COLOR SUBCARRIER GENERATOR AND FREQUENCY DIVIDER UNIT—MODEL PT-202

Subcarrier Frequency Dual Output:
3.579545 mc/sec. \pm 0.0003%
with maximum rate of frequency change not exceeding 1/10 cps./sec.
Subcarrier Output Voltage: 25 to 40 volts
Frequency Divider Output:
31,468 cps.
Divider Output Voltage: 0 to 100 volts
Ambient Temperature: 40° F. to 110° F.
Power Requirements: AC 105-125, 2A, 60 cps.

COLOR VIDEO MONITOR—MODEL M-200

Input Video Signal: 0.5 to 2.0 volts, pk-pk
Signal Polarity: Pos., Neg., Bal.
Input Impedance: 66 mmf across 2.2 megohms or 75 ohms
Resolution: 250-300 lines min. (Full utilization of NTSC Color Signal Bandwidth)
Linearity: (Hor. and Vert.) 2% across raster
Tricolor Kinescope: 15"
Focus: Electro Static
Net Weight: 175 lbs.
Power Requirements: 105-125 v., 4 amps., 50/60 cps.

AVAILABLE ON EQUIPMENT LEASE PLAN

FIELD MAINTENANCE SERVICE AVAILABLE
THROUGHOUT THE COUNTRY

43-20 34th STREET, LONG ISLAND CITY 1, N. Y.

Newton • Philadelphia • San Francisco • Syracuse • Washington, O. C. • Westbury • Winston-Salem • Canada, Arnprior, Toronto—Export: Rocke International Corporation

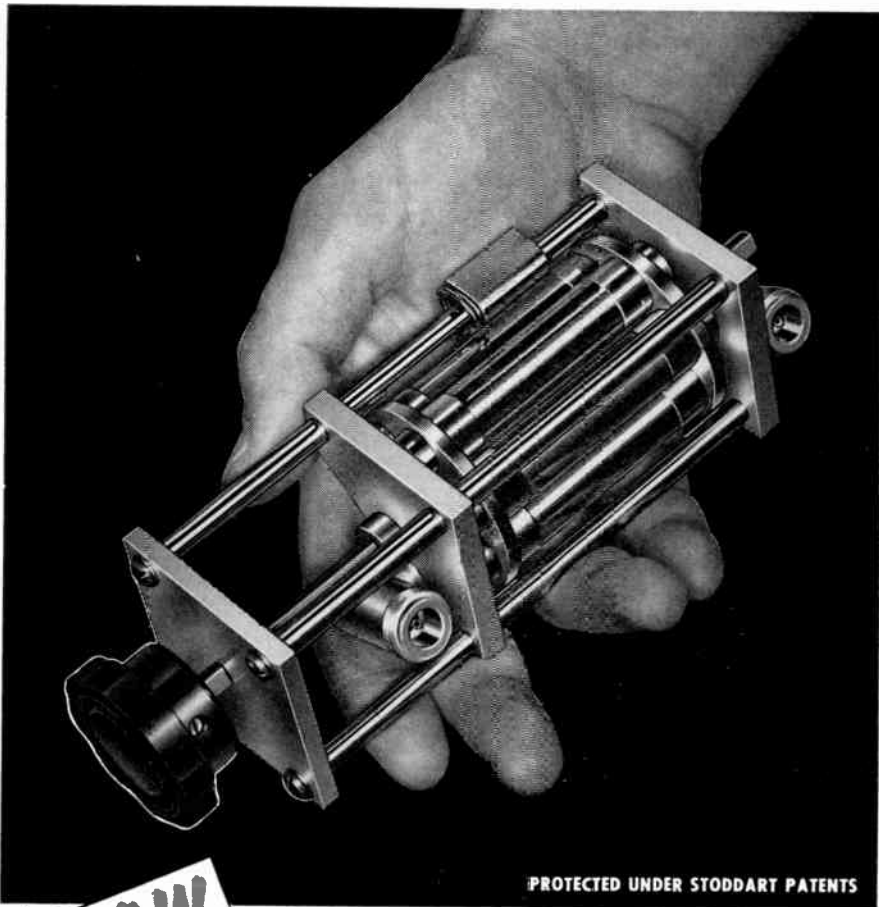

PROTECTED UNDER STODDART PATENTS

NOW

Precision Attenuation to 3000 mc!

TURRET ATTENUATOR featuring "PULL-TURN-PUSH" action



SINGLE "IN-THE-LINE" ATTENUATOR PADS and 50 ohm COAXIAL TERMINATION

- FREQUENCY RANGE:**
dc to 3000 mc.
- CHARACTERISTIC IMPEDANCE:**
50 ohms
- CONNECTORS:**
Type "N" Coaxial female fittings each end
- AVAILABLE ATTENUATION:**
Any value from .1 db to 60 db
- VSWR:**
<1.2, dc to 3000 mc., for all values from 10 to 60 db
<1.5, dc to 3000 mc., for values from .1 to 9 db
- ACCURACY:**
±0.5 db
- POWER RATING:**
One watt sine wave power dissipation

Send for free bulletin entitled "Measurement of RF Attenuation"
Inquiries invited concerning pads or turrets with different connector styles

STODDART AIRCRAFT RADIO Co., Inc.
 6644-C Santa Monica Blvd., Hollywood 38, California · Hollywood 4-9294



News-New Products

These manufacturers have invited PROCEEDINGS readers to write for literature and further technical information. Please mention your I.R.E. affiliation.

(Continued from page 10A)

Gas Detector

The Brenco Gas Detector, a precision electronic unit capable of making quantitative measurements of gas concentrations in certain mixtures of gas and air, is available from **Bristol Engineering Corp.**, Beaver Dam Rd. and Oak Lane, Bristol, Pa.

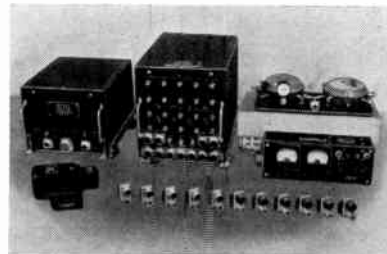

Principle of operation derives from the fact that certain gas and air mixtures (below the lower explosive limit) will burn in the presence of a platinum filament heated to the proper temperature. In burning, the gas will tend to further heat the filament thereby changing its resistance. The heated filament is placed in a Wheatstone bridge circuit and the change in resistance is detected as an unbalanced voltage.

Features of the system are: continuous sampling at ten test locations, rapid time response, an extensive compensation system which permits operation over wide ranges of temperature and pressure, a vacuum system with a pump capable of operating at more than 40,000 feet altitude.

VHF Automatic Direction Finder

A new vhf automatic direction finder with substantial reductions in weight, size and cost, and with improved accuracy, has been announced by **Olympic Radio & Television Inc.**, 34-01 38 Ave., Long Island City, New York.

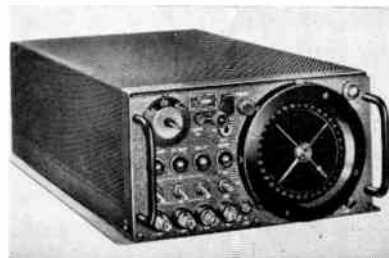

The new direction finder, a proprietary development, (Patent pending), answers the need of many airports for a dependable, low cost unit. Indicator receiver accuracy is within 1°, overall system accuracy slightly lower.

Several advantages of the new direction finder: Useful bearings are obtainable

(Continued on page 116A)



Arthur W. Richardson, Chief Engineer, Station WGBH-TV, Boston, Mass., at station's Raytheon KTR-100 microwave relay which transmits picture and sound simultaneously.

More than 75 TV stations using this equipment for STL, remotes, and network intercommunication have proved the performance of the 5976 Klystron.

Color TV relay uses Raytheon 5976 Klystrons

The new, compact Raytheon KTR-100 microwave relay is a good example of the use of the long-life Raytheon 5976 in regular and color TV relay equipment. This reliable Klystron has also been selected for additional applications by other leading manufacturers—for these five reasons:

Over 22,000 hours of life—many users report more than 22,000 hours (over 2½ years) of continuous service.

Low temperature coefficient—temperature need not be held to close tolerance. No forced air cooling.

Low power requirements—only 300 volts at 25 mA. Easy to install.

Low initial cost—lowest cost Klystron in its class. Immediate delivery in any quantity.

Low maintenance cost—long life means absolute maximum of trouble-free operation...ideal for isolated installations.

Condensed Operating Data—5976 Klystron

	3¼ Mode	2¾ Mode
Power output	110 mW av. (6750 Mc)	150 mW av. (6750 Mc)
Frequency range	6200-7425 Mc	6200-7425 Mc
Reflector voltage	-78 to -158 Vdc	-200 to -285 Vdc
Resonator voltage	300 Vdc	300 Vdc
Current	25 mA	25 mA
Modulation sensitivity	1.0 Mc/v	0.5 Mc/v
Temp. coefficient	-.10 to +.10 Mc/C°	-.10 to +.10 Mc/C°
Pulling figure	0.2% of oper- ating freq.	0.1% of oper- ating freq.

Write for valuable Data Booklets on Raytheon Magnetrons and Klystrons, including the stable, reliable 5976. Our Application Engineer Consultation Service is also available to you without cost or obligation. Call us when you have a microwave tube problem.



RAYTHEON MANUFACTURING COMPANY

Microwave and Power Tube Operations, Section PL-29

WALTHAM 54, MASSACHUSETTS

another **RAYTHEON** first!

GENUINE

RF TRANSISTORS

that make possible this

ALL-TRANSISTOR 455 kc I. F. PORTABLE

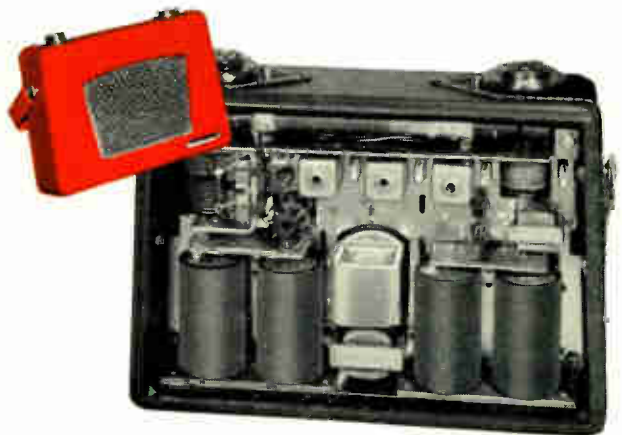
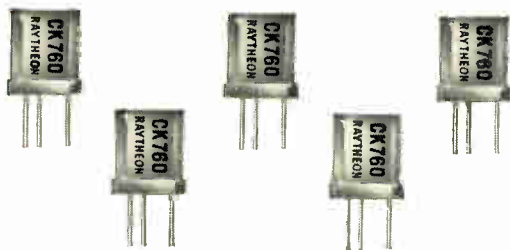

- completely interchangeable, without selection of components
- successfully field tested for an entire year
- available in production quantities
- hermetically sealed
- equipped with standard military lead spacing
- made by the Raytheon-perfected fusion alloy process that has already produced nearly two million transistors

- 455 kc performance matching highest industry standards for portable radios
- operates for 500 hours from 4 standard flashlight batteries
- delivers 120 milliwatts UPO
- ENSI (equivalent noise sideband input) comparable to vacuum tube portables

TYPE	HIGH FREQUENCY TRANSISTORS		HERMETICALLY SEALED CASE						
	Collector		Emitter mA	Extrin. Base Resis. ohms	Base Current Ampl. Factor	Alpha Freq. Cutoff mc.	Max. Junc. Temp. °C	Temp. Rise °C/mW	Coll. Capac. μmf
	Volts	Cutoff μA							
CK760	-6	1	-1.0	75	40	5	85	0.62	14
CK761	-6	1	-1.0	75	45	10	85	0.62	14
CK762	-6	1	-1.0	75	65	20	85	0.62	14

Note: above characteristics are average except where noted

RAYTHEON TRANSISTORS
- more in use than all other makes combined

RAYTHEON

SILICON POWER RECTIFIERS

to 175°C

to 15 amps.

to 200 volts

R REVERSE
R FORWARD > **100,000**

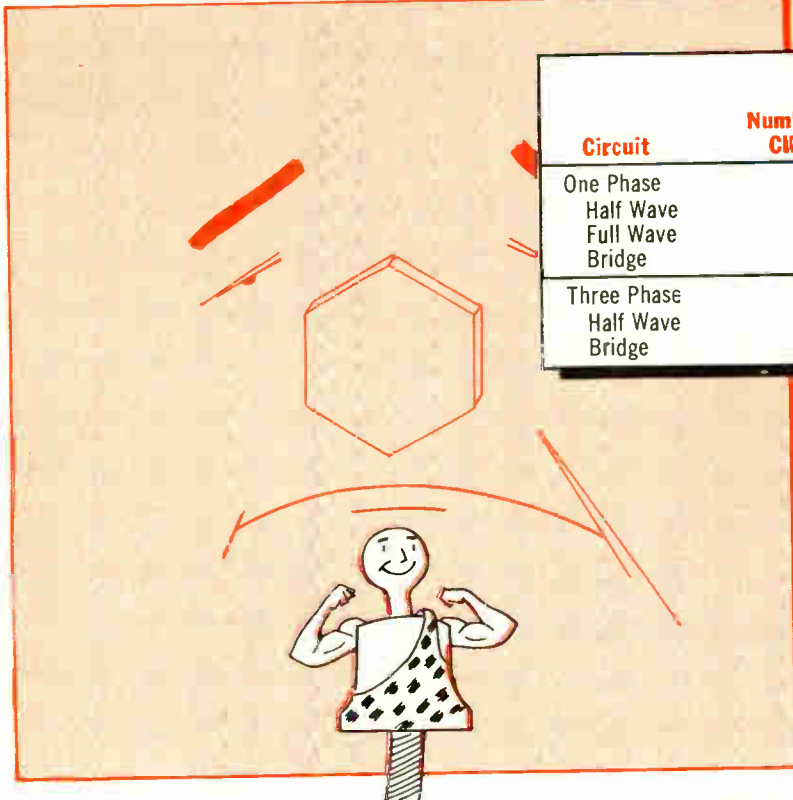

Circuit	Number of CK776	Watts Output at Case Temperature† of		
		30°C	70°C	170°C
One Phase				
Half Wave	1	700	530	265
Full Wave	2	1600	1070	530
Bridge	4	3050	2040	1020
Three Phase				
Half Wave	3	3200	2150	1070
Bridge	6	6800	4550	2270

† Maintained with heat radiator

At maximum power handling capability of CK776, an equivalent selenium rectifier could occupy as much as 100 times the volume.

RAYTHEON SILICON POWER RECTIFIER CHARACTERISTICS					
TYPE CK775	MAXIMUM VOLTAGE		MAXIMUM CURRENT		TYPICAL DISSIPATION WATTS
	RMS VOLTS	PEAK VOLTS	PEAK AMPERES	AVERAGE AMPERES	
CASE TEMP. 30°C* CASE TEMP. 170°C*	40	60	50	15	40
	40	60	15	5	10
NO HEAT RADIATOR AMBIENT TEMP. 25°C AMBIENT TEMP. 170°C	40	60	6	2.0	3.0
	40	60	2.0	0.5	2.0
TYPE CK776	125	200	50	15	40
	125	200	15	5	10
NO HEAT RADIATOR AMBIENT TEMP. 25°C AMBIENT TEMP. 170°C	125	200	6	2.0	3.0
	125	200	2.0	0.5	2.0

*maintained by external heat radiator

At 25°C both CK775 and CK776 have maximum drop at 5 amperes of 1.5 volts.

Maximum reverse current is 25mA for CK775 at -60 volts, CK776 at -200 volts.



Excellence in Electronics.

RAYTHEON MANUFACTURING CO.

RELIABLE SUBMINIATURE AND MINIATURE TUBES
SEMICONDUCTOR DIODES AND TRANSISTORS
NUCLEONIC TUBES • MICROWAVE TUBES
RECEIVING AND PICTURE TUBES

Semiconductor Division — Home Office: 55 Chapel St., Newton 58, Mass., Bigelow 4-7500

For application information write or call the Home Office or: 9501 Grand Avenue, Franklin Park (Chicago), Illinois, TUxedo 9-5400
589 Fifth Avenue, New York 17, New York, PLaza 9-3900 • 622 South La Brea Ave., Los Angeles 36, California, WEbster 8-2851



For the First Time, Miniature 2.5–20KC Audio Frequency Crystals

In a continuing effort to lead the crystal industry in the development of new products for the electronic industry, Heemco ingenuity has fostered another outstanding development... a miniature 2.5–20KC audio frequency crystal which is now available in production line quantities.

This sturdy unit, hermetically sealed in the standard Heemco holder, MIL HC-13/U, shows deviation in frequency of less than $\pm 0.010\%$ over the temperature range of -40°C to $+70^{\circ}\text{C}$ and will meet the vibration and shock requirement MIL-C-3098A.

Orders of any quantity accepted for schedules as required.

HILL ELECTRONIC ENGINEERING AND MANUFACTURING COMPANY, INC.

New Kingstown, Pennsylvania

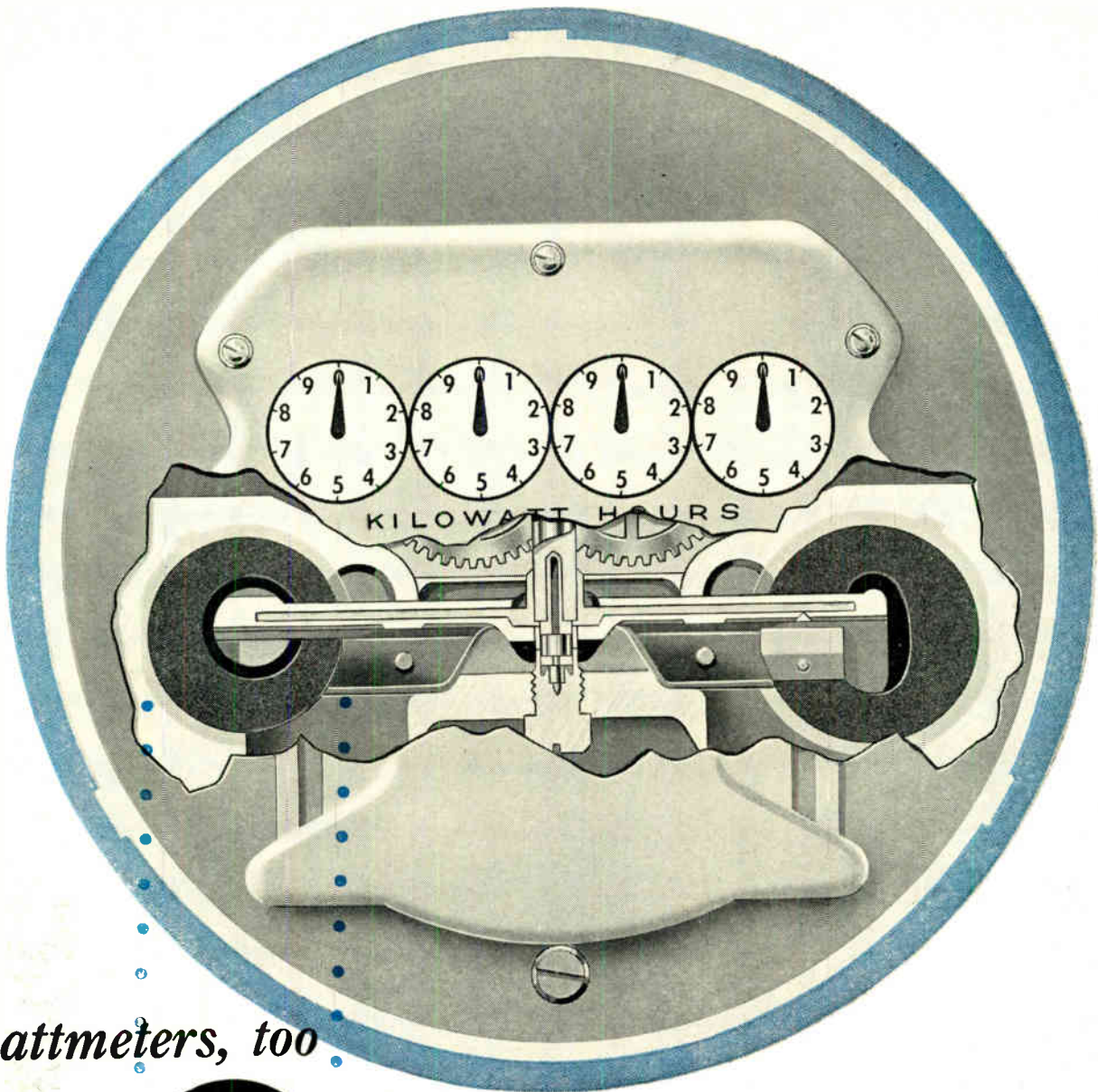

wattmeters, too

USE  CRUCIBLE PERMANENT MAGNETS

for maximum energy . . . minimum size

With Crucible alnico magnets you get *consistently higher energy product . . .* which means *more energy from a smaller magnet.*

That's why they provide maximum design freedom for manufacturers of watt-hour meters, voltmeters, and devices of all kinds requiring magnets from 0.2 ounces to several hundred pounds.

Crucible has been a leading producer of these powerful magnets ever since alnico alloys were first developed. And its magnet experience is backed by over a half-century of *special purpose* steelmaking.

For technical assistance in solving magnet applications, call Crucible. *Crucible Steel Company of America, Henry W. Oliver Building, Pittsburgh 22, Pa.*

CRUCIBLE

first name in special purpose steels

Crucible Steel Company of America



The Univac Scientific Computing System

Operation Thinking Cap...

It takes more than a slide rule alone, these days, to perform the computations necessary for scientific problems such as those encountered in atmospheric research. The scientist of today, equipped with modern data-gathering devices, is faced with a stupendous data-reduction task which requires extremely high speed computation. That's why the Univac Scientific electronic computing

system (formerly known as the ERA 1103) has proven to be invaluable to scientists and engineers alike.

Because of its ability to reduce large volumes of data at tremendous speeds, the Univac Scientific System easily handles even the most difficult research problems. Its speed is matched by many other outstanding characteristics including: superb operating efficiency, ob-

tained through large storage capacity... great programming versatility...the ability to operate simultaneously with a wide variety of input-output devices... and far greater reliability than any computer in its class.

For more information about the Univac Scientific System or for information about how you might apply the system to your particular problems, write to...

ELECTRONIC COMPUTER DEPARTMENT **Remington Rand** ROOM 1563, 315 FOURTH AVE., NEW YORK 10

CONTROLLED WELDING
 is an important part of
QUALITY CONTROL
 in the manufacture of all



RELIABLE SUBMINIATURE TUBES

Employee Training Program in welding techniques, welder maintenance and defect detection greatly reduces the incidence of operator-caused weld defects.

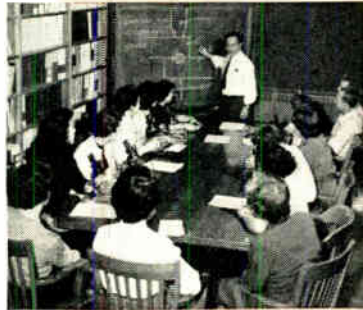

Standardized Work Place Setups for each material combination and geometric configuration to be welded, including specification of welder head, electrode material and design, welding current, time and pressure insures optimum welding conditions at all times.

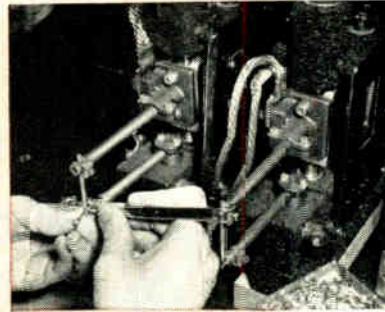

Specially Designed Precision Produced Electrodes eliminate need for hand dressing of welder points thus providing uniform contact with material to be welded.

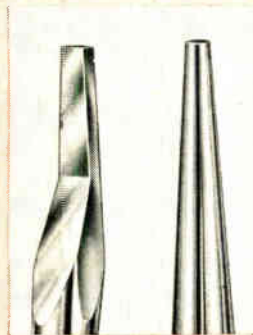

New Electronic Heat Program Controls developed by RAYTHEON permit splash free welding of coated and oxidized materials.

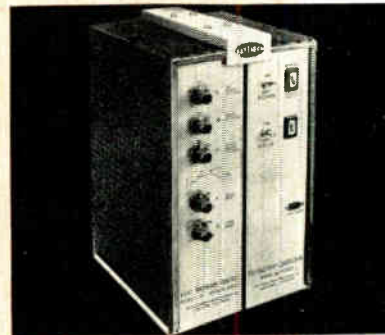

New Roytheon Designed Welding Heads have many unique features including precision controlled forging pressure insuring high weld strength, simplified design for easier maintenance, and small size which permits use of multiple welder heads by one operator.

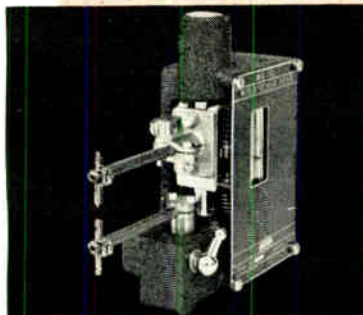

Radiographic Inspection of Welds permits precise Quality Control through non-destructive inspection techniques.

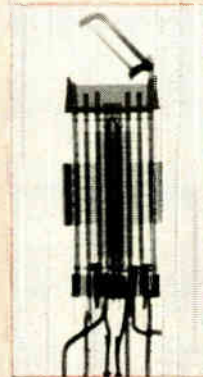

These production and testing techniques and equipments have been developed by RAYTHEON under Bureau of Ships sponsorship to improve the weld quality of guided missile tubes.



RELIABLE SUBMINIATURE AND MINIATURE TUBES
 SEMICONDUCTOR DIODES AND TRANSISTORS
 NUCLEONIC TUBES • MICROWAVE TUBES
 RECEIVING AND PICTURE TUBES



Excellence in Electronics

RAYTHEON MANUFACTURING CO.

Receiving Tube Division — Home Office: 55 Chapel St., Newton 58, Mass., Bigelow 4-7500
 For application information write or call the Home Office or: 9501 Grand Avenue, Franklin Park (Chicago), Illinois, TUXedo 9-5400
 589 Fifth Avenue, New York 17, New York, PLaza 9-3900 • 622 South La Brea Ave., Los Angeles 36, California, WEBster 8-2851

Quality, value,

hp Vacuum

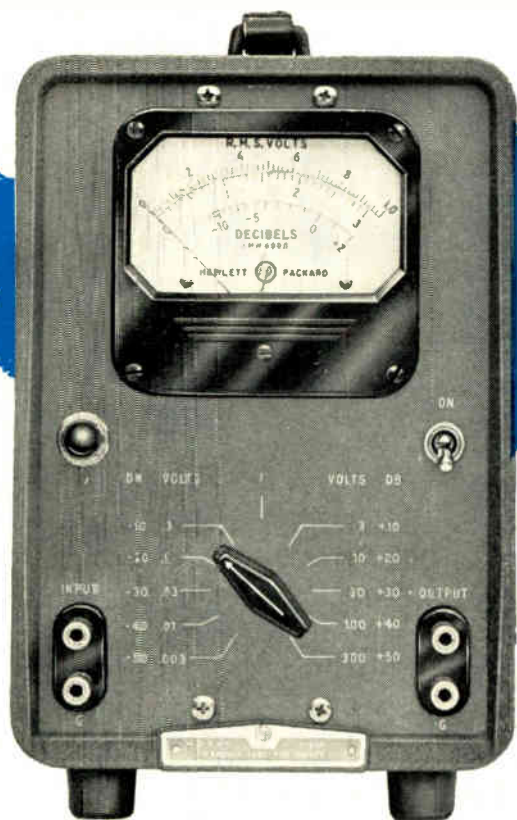

NEW! -hp- 400AB 10 cps to 600 KC

Outstanding value, general application

SPECIFICATIONS

Voltage Range: 0.3 mv to 300 volts. 11 ranges, selected with front panel switch. Full scale readings of:

0.003 volts	0.1	3.0	100
0.01	0.3	10.0	300
0.03	1.0	30	

Frequency Range: 10 cps to 600 KC.

Accuracy: With nominal line voltage $\pm 10\%$ (103 volts to 127 volts), overall accuracy is within $\pm 2\%$ of full scale, 20 cps to 100 KC, $\pm 3\%$ 10 cps to 600 KC.

Calibration: Reads rms value of sine wave. Voltage indication proportional to average value of applied wave. Linear voltage scales, 0 to 3 and 0 to 1.0; db scale, -12 db to $+2$ db, based on 0 dbm = 1 mw in 600 ohms, 10 db intervals between ranges.

Input Impedance: 10 megohms shunted by 25 μf .

Amplifier: Output terminals are provided so voltmeter can be used to amplify small signals or monitor waveforms under test with an oscilloscope.

Power: 115/230 volts $\pm 10\%$, 50/1,000 cps, approximately 70 watts.

Dimensions: 11 $\frac{1}{4}$ " high, 7 $\frac{1}{4}$ " wide, 7" deep (cabinet mount). Rack mounting available on 19" x 7" panel.

Weight: Net 15 lbs. Shipping 25 lbs. (cabinet mount).

Price: \$200.00.

Data subject to change without notice. Prices f.o.b. factory.

Model 400AB is a new precision voltmeter offering more utility, dependability and dollar value than any audio voltmeter -hp- has ever built!

Replacing the widely-used Model 400A in the -hp- line, the new instrument permits measurements from 0.3 millivolts to 300 volts over the full frequency range. Stability and sensitivity are extremely high, and accuracy is $\pm 2\%$ full scale from 20 cps to 100 KC. Input impedance is 10 megohms to prevent disturbance to circuits under test. Readings are direct in voltage and dbm. Special switching arrangements eliminate switching transients.

BROAD USEFULNESS

Model 400AB is particularly suited for measuring amplifier gain, network response or output level on audio, carrier current and supersonic ranges. In many applications it indicates hum and noise level directly and will also serve as a null indicator. It contains an output connector and can be used as an amplifier. With an oscilloscope, it also monitors waveform of a voltage under test. The instrument is moderately priced, yet of typical -hp- quality construction throughout including long-life electrolytic condensers and etched circuitry. -hp- 400AB is unusually compact, requiring only a 7" x 7" square of bench space.

COMPLETE
COVERAGE

HEWLETT-PACKARD

complete coverage

Tube Voltmeters



-hp- 400D 10 cps to 4 MC Ultimate quality, high sensitivity

Model 400D is perhaps the finest vacuum tube voltmeter built today.

Accuracy is within 2% to 1 MC, and approximately 56 db of feedback in mid-range assures high stability and freedom from calibration change due to external conditions. An exclusive switching arrangement in the cathode circuit minimizes switching transients. Input impedance is 10 megohms; circuits under test are not disturbed.

-hp- 400D is protected against overloads as great as 600 v on all ranges. The indicating meter is a special 1%, 1 ma instrument. Coupling and bypass condensers are sealed; electrolytic condensers are long-life types. Circuitry and mechanical layout are clean, permitting easy access to all parts. A rugged new all-metal case insures easy portability, and occupies minimum bench space.

SPECIFICATIONS

Voltage Range: 12 ranges: 0.001, 0.003, 0.01, 0.03, 0.1, 0.3, 1, 3, 10, 30, 100, and 300 volts.

Frequency Range: 10 cps to 4 MC.

Accuracy: Overall $\pm 2\%$ 20 cps to 1 MC; $\pm 3\%$ 20 cps to 2 MC; $\pm 5\%$ 10 cps to 4 MC.

Long Term Stability: Better than 0.5%, 20 cps to 1 MC.

Calibration: rms value of sine wave. Linear scale.

Input Impedance: 10 megohms, 15 μf shunt, 1 to 300 v, 25 μf shunt, 0.001 to 0.3 v.

Amplifier: Includes output terminals for oscilloscope use.

Power: 115/230 v $\pm 10\%$, 50/1,000 cps, 70 watts.

Size: 7 $\frac{1}{4}$ " wide, 11 $\frac{1}{4}$ " high, 11 $\frac{3}{4}$ " deep. Wt. 18 lbs.

Price: \$225.00.

Data subject to change without notice. Prices f.o.b. factory.

-hp- 410B

20 cps to 700 MC Industry's standard for vhf-uhf

The famous 410B combines in one instrument an ac voltmeter covering frequencies from audio to radar, a dc voltmeter with over 100 megohms input impedance, and an ohmmeter, capable of measuring resistances from 0.2 ohms to 500 megohms. The instrument covers its tremendous frequency range with an accuracy of $\pm 3\%$ full scale, and has a frequency response flat within ± 1 db up to 700 MC. (Good indications to 3,000 MC.)

For ac, -hp- 410B employs a special -hp- diode probe which places a capacity across the circuit under test of only 1.5 μf . Input impedance at low frequencies is 10 megohms and resonant frequency is approximately 1,500 MC. The probe is the finest available, and will measure audio, supersonic, rf or vhf voltages more accurately than any other on the market. The dc section has an input impedance of 100 megohms with outstandingly low drift and high calibration stability. The meter requires only one zero adjustment for all ranges.



SPECIFICATIONS

Ranges: ac: 0 to 300 v, 6 ranges.

dc: 0 to 1,000 v, 7 ranges.

ohms: 0.2 ohms to 500 megohms, 7 ranges.

Accuracy: $\pm 3\%$ full scale.

Frequency Response: Flat within ± 1 db to 700 MC.

Input Impedance: 1.5 μf capacity, 10 megohms at low frequencies.

Power: 115/230 v $\pm 10\%$, 50/1,000 cps, 40 watts.

Size: 7" wide, 11 $\frac{1}{2}$ " high, 8 $\frac{1}{4}$ " deep. Wt. 12 lbs.

Price: \$245.00.

Data subject to change without notice. Prices f.o.b. factory.

HEWLETT - PACKARD COMPANY 3327D PAGE MILL ROAD • PALO ALTO, CALIF.

Please send me additional information on

400AB _____ 400D _____ 410B _____

Name _____

Company _____

Street _____

City _____ Zone _____ State _____



INSTRUMENTS



this is not something new!

Leading members of the aviation industry have long known about this means of measuring aircraft and missile antenna radiation patterns. In the course of various engineering projects, they have come repeatedly to Airborne Instruments Laboratory with antenna test problems. As always, Airborne's scientists sought to create equipment, singularly perfect in performance yet flexible enough to meet many specific needs. Their efforts resulted in the Type 105 Model Range System, which automatically records polar plots of the relative field strength of aircraft radiation patterns.

The Type 105 System, however, is not only important within itself. Out of its totality have emerged several significant devices, designed for many recording purposes. Among these are the 116R Polar Pattern Recorder, the Type 20 SWR Indicator, and the Type 373 Rectangular Coordinate Recorder.

Here again is an example of creative initiative, by ALL engineers, providing a continuous succession of advanced instruments for America's industrial progress.

Send for information about the 105 Model Range System and literature on other recording devices.

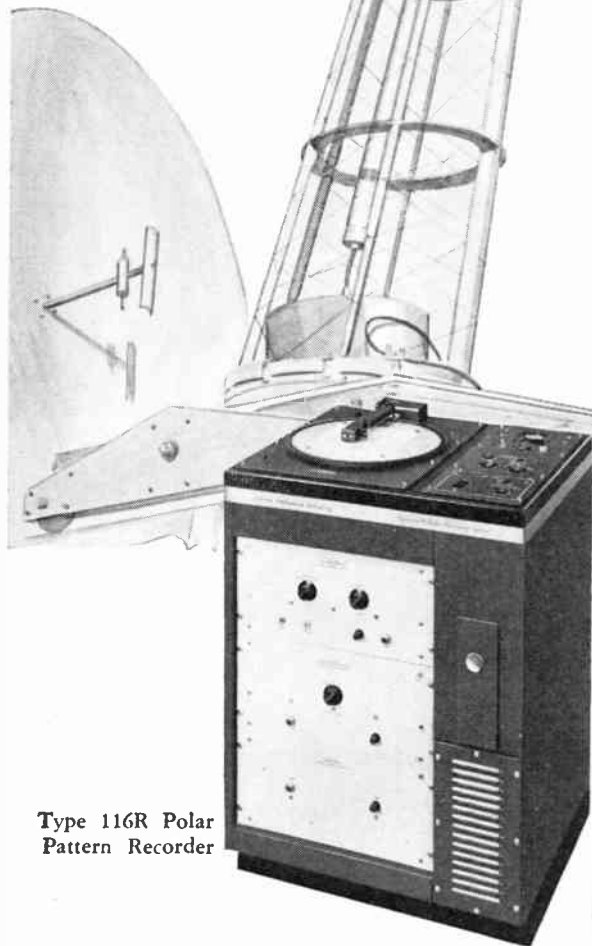

Type 116R Polar Pattern Recorder



Type 373 Rectangular Coordinate Recorder



Type 20 SWR Indicator



160 OLD COUNTRY ROAD • MINEOLA, NEW YORK

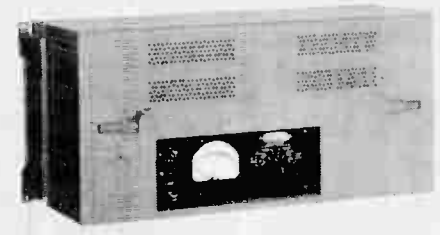
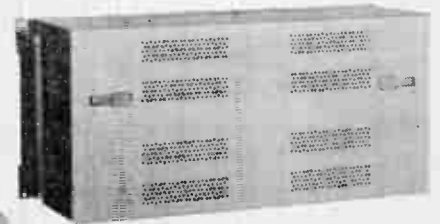
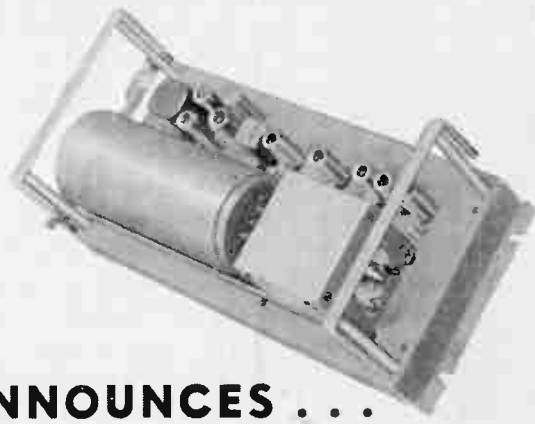
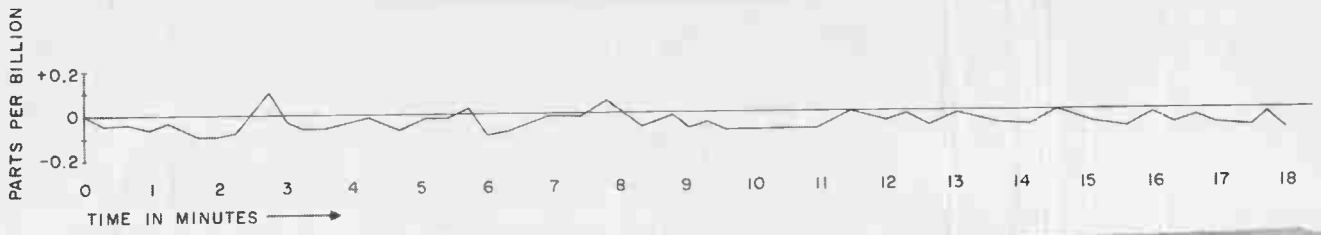

Collins ANNOUNCES . . .

A New Frequency Standard with Stability of 0.01 Cycles Per Day

New freedom in frequency measurement and frequency synthesis techniques is made possible with the new Collins 40K-1 Frequency Standard. Systems may now be designed without compromise for inadequate frequency and time stability. The 40K-1 provides a sine wave output frequency of one mc with stability of one part in 10^6 per day. It may be used as either a secondary frequency standard or base frequency generator. A matching rack mounting power supply provides the necessary power and metering facilities for one or two 40K-1 oscillators.

SPECIFICATIONS

40K-1 Standard

- Output Frequency: 1 mc
- Output Voltage: 2 v RMS into 5000 ohms
- Frequency Stability: One part in 10^6 /day
- Duty Cycle: Continuous duty
- Ambient Temp. Range: -40 to $+50^{\circ}\text{C}$
- Ambient Humidity: 0 to 95%RH
- Number of Tubes: 8
- Size: 19" open relay rack mounting, $8\frac{3}{4}$ " high, 7" deep
- Weight: 15 pounds

426A-1 Power Supply

- Power Source: 115/230 volt, 50-60 cps a-c
- Metering Facilities: d-c supply voltages, AVC and oven output of two 40K-1 oscillators
- Size: 19" wide open relay rack mounting, $8\frac{3}{4}$ " high, 7" deep
- Weight: 60 lbs.

Price complete with 426A-1 power supply \$2,250.00. Available for delivery in August, 1955. Contact your nearest Collins office for detailed specifications.

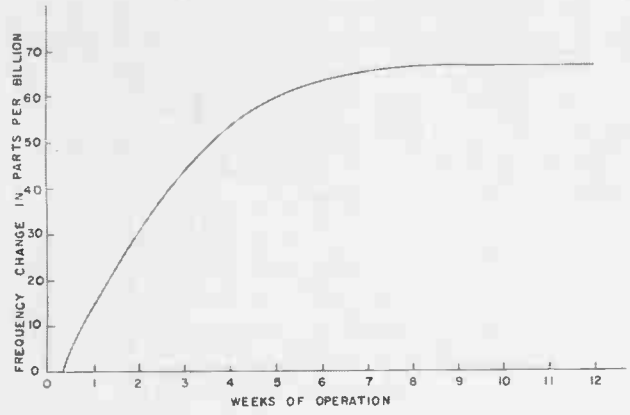

COLLINS RADIO COMPANY

CEDAR RAPIDS, IOWA

261 Madison Avenue, NEW YORK 16, NEW YORK
 1200 18th Street N. W., WASHINGTON, D. C.
 1930 Hi-Line Drive, DALLAS 2, TEXAS
 2700 W. Olive Avenue, BURBANK, CALIFORNIA
 COLLINS RADIO COMPANY OF CANADA LTD.
 74 Sparks Street, OTTAWA, ONTARIO



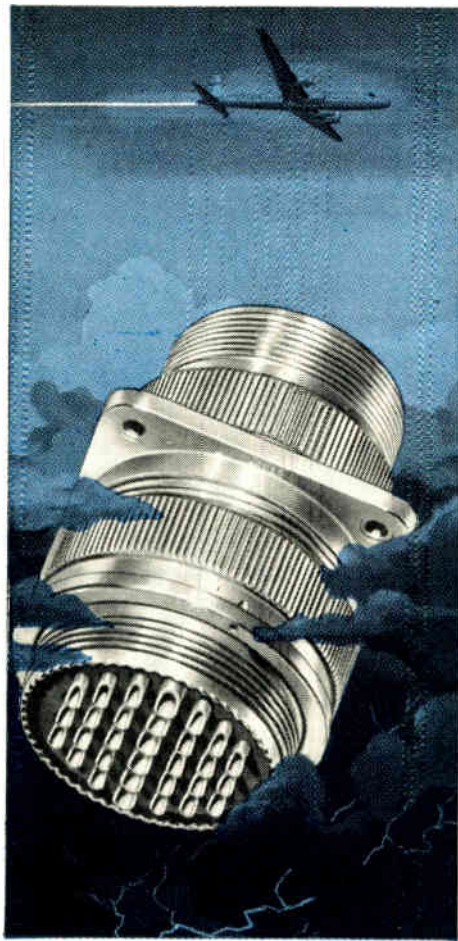

Pioneers in Development of Vibration-Resistant Electrical Connector

The unsatisfied demand for a rugged, dependable connector capable of meeting the exacting requirements of modern aircraft led the Scintilla Division of Bendix* to develop the first vibration-resistant electrical connector. These connectors using the revolutionary new insert material known as Scinflex were first used on Scintilla Division's ignition equipment for piston engines.

So outstanding was the performance of this new and better connector that its acceptance and use have now become world-wide. Today the Scintilla Division is a major contributor to the electrical connector industry.

This pioneering has never stopped. Bendix was first in the field with cadmium plated connectors, which were later made a requirement of military specifications. Our latest contribution is the best engineered closed entry socket contact available anywhere—one which cannot be mechanically overstressed.

*TRADE-MARK



Export Sales:
Bendix International Division • 205 East 42nd St., New York 17, N. Y.

FACTORY BRANCH OFFICES:
117 E. Providencia Ave., Burbank, Calif. • Stephenson Bldg., 6560 Cass Ave., Detroit 2, Mich. • 512 West Ave., Jenkintown, Pa. • Brouwer Bldg., 176 W. Wisconsin Ave., Milwaukee, Wisc. • American Bldg., 4 South Main St., Dayton 2, Ohio • 8401 Cedar Springs Rd., Dallas 19, Texas • Boeing Field, Seattle 8, Washington • 1701 "K" Street, N.W., Washington 6, D.C.

color TV shadow masks

We are now delivering shadow masks, the precision heart of the color television tube, etched to specifications. Mass production methods, perfected during more than 40 years of precise metal etching experience, enable us to meet today's exacting demands for quality and delivery.

etched and electro formed precision parts

With the technical experience and production know-how gained in producing fine metal etching and in electro-forming, we are now manufacturing many components for the electronic industry. Some specifications call for fine mesh up to 1,000,000 holes per square inch. Send us your drawings for a prompt quotation.



**BUCKBEE
MEARS
COMPANY**

Lindeke Building
SAINT PAUL 1, MINNESOTA

make sure you get the most important
TAPE WOUND CORE IMPROVEMENT
 in 6 years

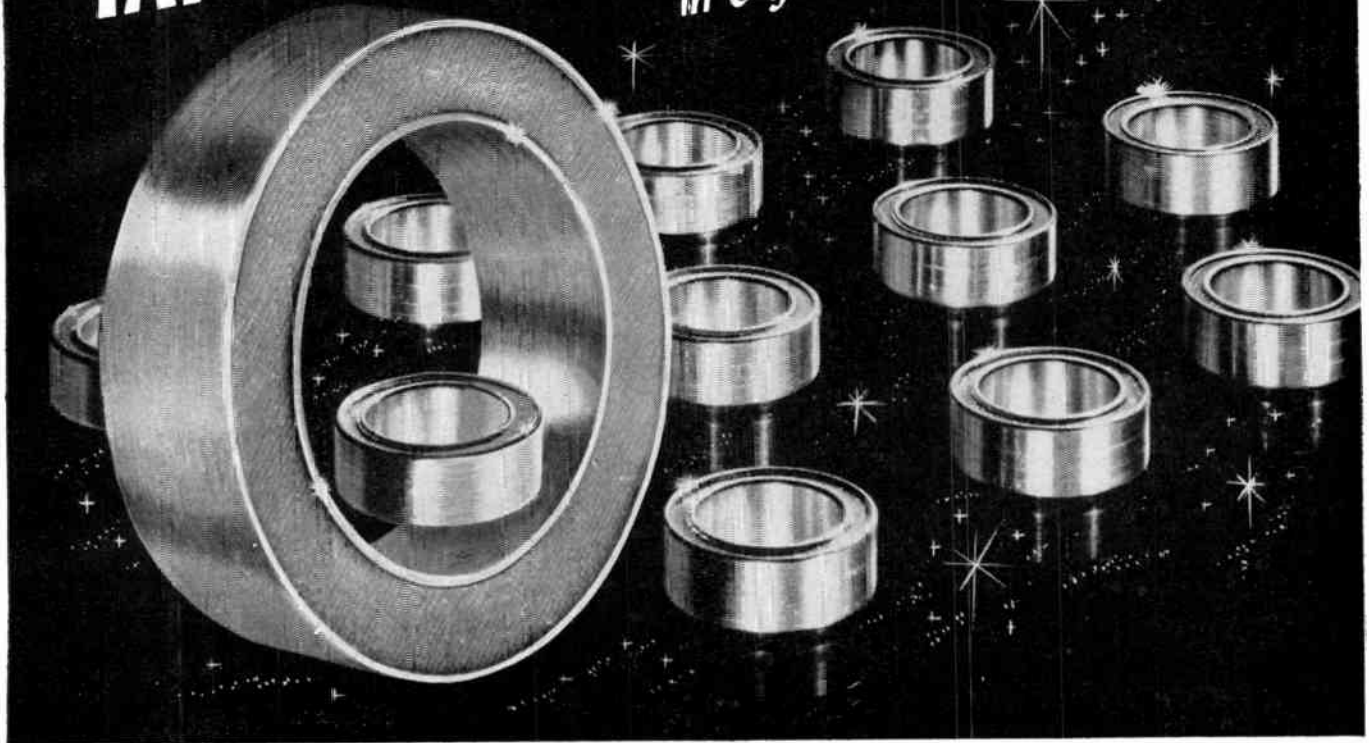

revolutionary **ALUMINUM CORE BOX[†]** construction

**withstands HIGH TEMPERATURE • VACUUM IMPREGNATION
 HEAVY WINDING STRESSES • SHOCK and VIBRATION**

This is a development which calls for immediate changes in purchasing specifications for Tape Wound Cores, because introduction of the Aluminum Core Box means designing your toroids around four important new advantages:

1. Use of an aluminum core box means the new Magnetics, Inc. tape wound cores will withstand temperatures of *at least* 450° F.
2. Because of the unusual seal provided by forming the aluminum over the silicone glass seal, true vacuum impregnation of your coils is now possible. Varnish cannot penetrate the core box and affect magnetic properties of the tape.
3. The strong aluminum construction absolutely prevents deflection of the core box when coils are wound—a distortion-free construction which means no change of magnetic properties.
4. Cushioned with an inert material, the tape winding in the core box is protected against vibration and shock. In most cases it is so completely minimized that it is no longer a problem.

Because of the many advantages of these new Magnetics, Inc. Tape Wound Cores, it will pay you many times over to specify "Aluminum Core Boxes" on your next order.

[†]PATENT PENDING

PROCEEDINGS OF THE I.R.E.

May, 1955

Immediately available in 109 standard sizes, using all commercially available magnetic materials.

ALL *Performance - Guaranteed*

For full details, write for
 Bulletin TWC-200
 Catalog TWC-100

DEPT. I-21, BUTLER, PENNSYLVANIA

Available
NOW!

New CLARE Type 11 Springdriven Stepping Switch

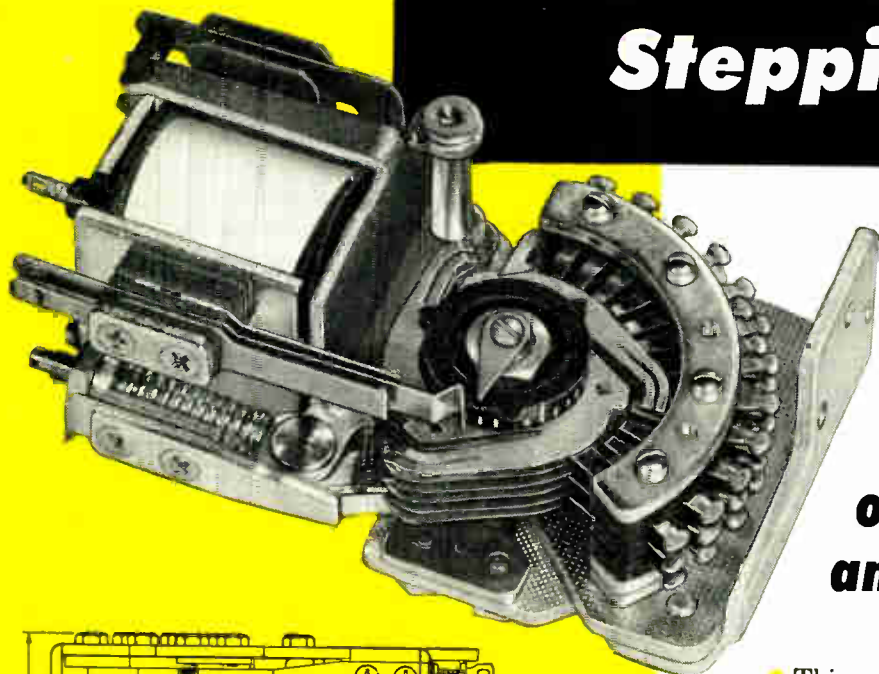

**Small,
compact design
provides millions
of steps without
any readjustment**

• This new CLARE Type 11 Springdriven Stepping Switch is the latest in the CLARE line of uniselectors, or rotary switches, for completing, interrupting, or changing the connections in a succession of electric circuits in response to momentary impulses of current.

Like the larger and older switches in the CLARE line—Types 20, 26, 40 and 52—this sturdy, fast-stepping little switch is capable of many different applications, such as:

- *Selecting any desired point in a series*
- *Selecting the first unoccupied point in a series*
- *Sequence controlling: automatically controlling a series of operations in a predetermined manner*
- *Counting and totalizing*
- *Generating timed pulses*
- *Monitoring*

The CLARE Type 11 Switch is designed to be free from critical adjustments. The few adjustment points are unusually easy to reach when required, but choice of materials and design provides millions of steps without any readjustment.

Send for Engineering Bulletin No. 121 for complete information on the new CLARE Type 11. Address: C. P. Clare & Co., 3101 Pratt Blvd., Chicago 45, Ill. In Canada: Canadian Line Materials Ltd., Toronto 13. Cable Address: CLARELAY.

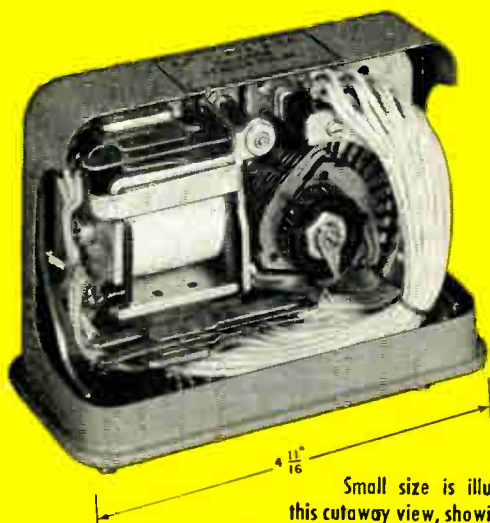
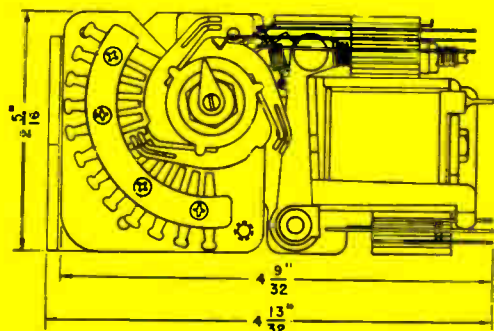
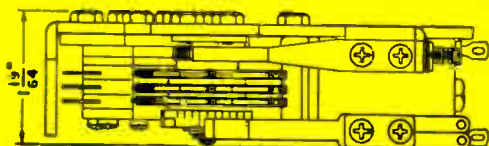

Small size is illustrated by this cutaway view, showing a three-level switch hermetically sealed in a can commonly used to enclose one CLARE Type C Relay

**FIRST
in the
industrial
field**

CLARE RELAYS

Multiple Unit Carbon Controls —in *New Cost-Saving Design*

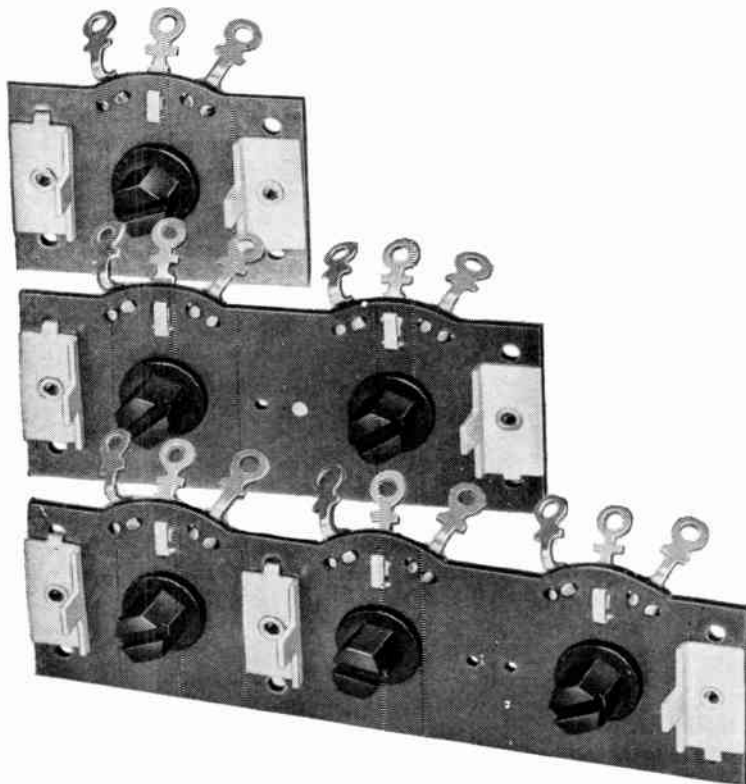

Resistance values: 250 ohms to 10 megohms, in a variety of tapers.

Shaft: Hex phenolic, with slotted end; lengths — zero up to $\frac{7}{8}$ " FMS in $\frac{1}{8}$ " increments.

Rear view shows simple, rugged design, with resistance wafer attached directly to phenolic panel.

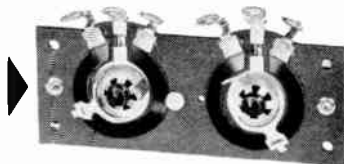

Parts distributors in all major cities stock Mallory standard components for your convenience.

Serving Industry with These Products:

Electromechanical—Resistors • Switches • Television Tuners • Vibrators
Electrochemical—Capacitors • Rectifiers • Mercury Batteries
Metallurgical—Contacts • Special Metals and Ceramics • Welding Materials

A COMPLETELY new type of carbon control just developed by Mallory offers opportunities for important savings in your production. Available in single, dual and triple units, this model features a unique strip-type phenolic panel construction that is particularly applicable to TV alignment controls.

SAVES PRODUCTION TIME . . .

A dual or triple unit can be mounted in no more time than your assemblers now need for a single control.

REDUCES COMPONENT COST . . .

The new simplified design makes it possible for Mallory to produce multiple units at costs materially lower than that for a corresponding number of conventional single controls.

FLEXIBLE DESIGN . . .

This unique design offers many adaptations . . . at low cost. Phenolic hex shaft with screw driver slot makes for ready adjustability and is supplied in $\frac{1}{8}$ " increments of zero to $\frac{7}{8}$ " FMS. Terminals can be solder lugs or wire wrap solderless type. Mounting arrangement can be holes for riveting or twist tabs. Resistances cover the range from 250 ohms to 10 megohms, with rotational stop provision.

Minimum spacing of shafts . . . $1\frac{1}{2}$ " between centers . . . is identical with that required for single controls. You can install the new units as direct replacements in many existing chassis and mounting plate designs. Special center spacings can, of course, be supplied.

Plan to take advantage of these new economies in the equipment you are now designing . . . and investigate the possibilities for using them in the products you are now manufacturing. For technical details, and for engineering assistance by Mallory specialists, write or call Mallory today.

Expect more . . . Get more from



G. E. MECHANIZED PRODUCTION AT LOWER COST...ASSURES

Both types offer high reliability at temperatures

Take a close look at the transistor values G.E. now offers. Because production lines are now mechanized, these transistors are made in *less time* at *reduced cost*. Machine methods today assure strictest adherence to the top quality standards demanded of all General Electric Germanium Products.

Mechanization results in CONTROLLED CHARACTERISTICS, removing any inaccuracy on the part of the operator. Narrow limits are built into production transistors giving

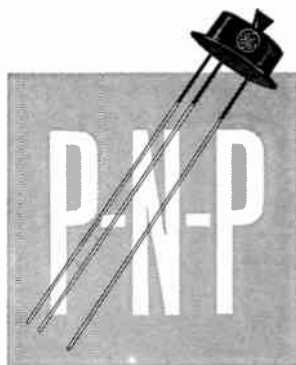

TYPE 2N43A

a more uniform product.

In military and commercial applications these G-E transistors offer precision quality, topmost reliability at mass-volume prices!

General Electric's P-N-P junction transistor, 2N43A, is the first to be written into Air

Force specifications! MIL-T-25096 (USAF) was actually written around this G-E product which was developed for the military. Now it serves an ever-increasing number of commercial as well as military applications.

APPLICATIONS AND SPECIFICATIONS

TYPICAL USES: Audio and Intercom Amplifiers, Servo Amplifiers, Carrier Current Amplifiers, Test Equipment, Fuel Gauges.

SPECIFICATIONS OF THE 2N43A and USAF 2N43A

Absolute Maximum Ratings:

Collector Voltage (Referred to base)	-45 volts
Collector Current	-50 ma
Collector Dissipation	150 mw
Storage Temperature	100° C
Collector Cutoff Current (-45 volts)	-10 microamps

DESIGN FEATURES:

- STURDY CONSTRUCTION...meets critical military tests for shock, vibration, humidity, life.
- SEALED JUNCTION...contamination gases permanently eliminated!
- HIGH POWER OUTPUT...case design makes possible a collector dissipation of 150 mw.
- HERMETIC SEAL...unaffected by moisture.
- LONG LIFE...no change in characteristics during life of equipment.

MAKES TRANSISTORS AVAILABLE CONTROLLED CHARACTERISTICS

up to 100°C...are now available in production lots!

HIGH FREQUENCY TRANSISTOR

A new, revolutionary manufacturing technique, the exclusive G-E rate-growing process, coupled with the all-welded hermetic seal, now makes possible extra long life, and noticeably-reduced manufacturing costs by —

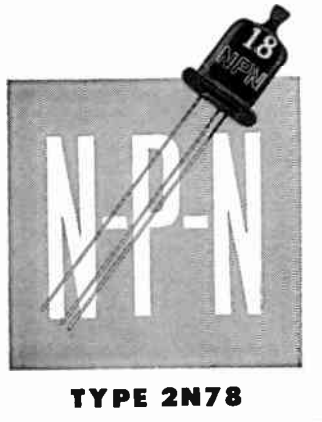

TYPE 2N78

- Making 2000 or more transistors from one rate-grown crystal.
- Achieving uniform characteristics in all 2000 transistors—*eliminating wasteful rejects.*

APPLICATIONS

For pulse and switching circuits, RF and IF amplifiers; high-frequency test equipment; telephone repeaters.

SPECIFICATIONS

Collector Voltage (Referred to Base)	15 V
Collector Current	20 ma
Emitter Current	-20 ma
Storage Temperature	100° C.
High Frequency Gain at 2 mc	13 db

- For further details on specifications and prices, write *General Electric Co., Section X5255, Germanium Products, Electronics Park, Syracuse, N. Y.*

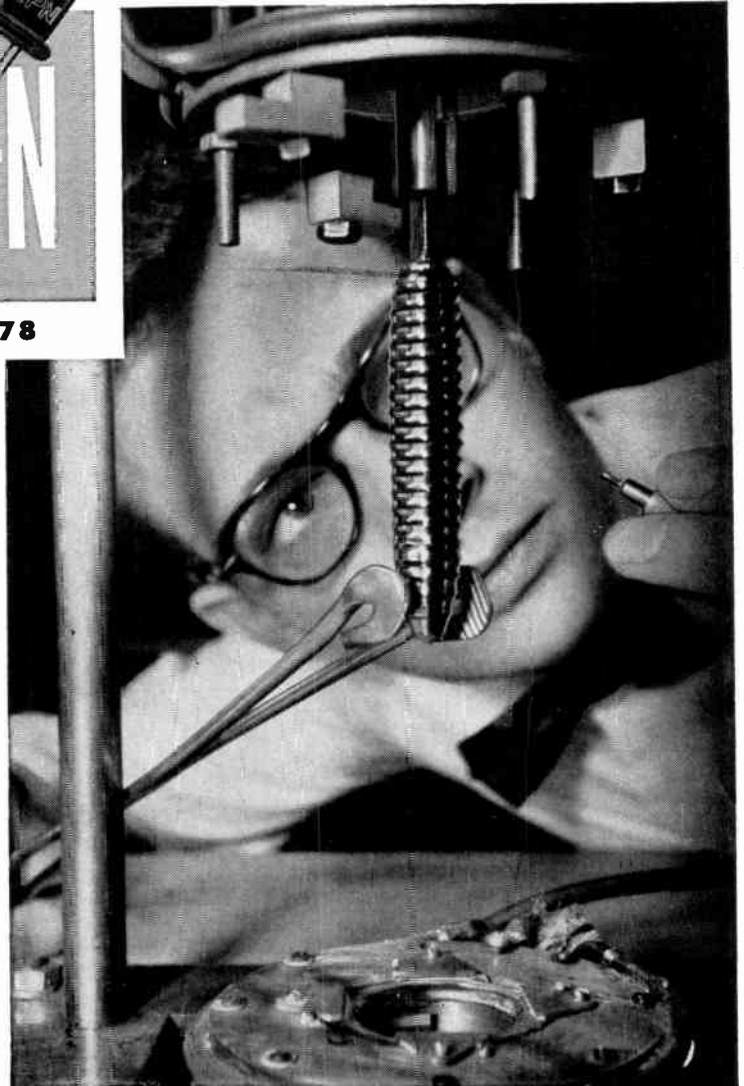

Billet of germanium is removed from furnace, prior to cutting into enough tiny pellets for 2000 transistors.

Progress Is Our Most Important Product

GENERAL  **ELECTRIC**

NEW

CHARACTERISTIC-CURVE TRACER.. Type 570



Pictures Dynamic

Vacuum-Tube Characteristics

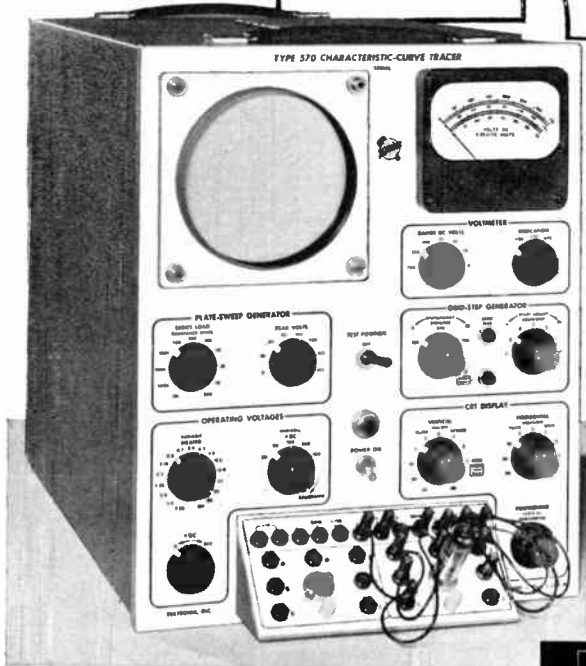

The Tektronix Type 570 Characteristic-Curve Tracer presents an accurate graphic analysis of vacuum-tube characteristics under almost any conceivable operating conditions. Circuit design can now be tailored to more closely fit the operating characteristics of available tubes. Tubes can be selected faster and more accurately for circuits requiring other than average vacuum-tube operating characteristics. Two-socket arrangement with front-panel switching permits rapid comparisons between any two tubes, or two sections of the same tube. You can also make rapid comparisons with preselected curves outlined on a crt mask. Patch-cord connector system with socket-adaptor plates gives you complete control of operating-condition setup. Various socket-adaptor plates furnished and wide range of heater voltages available fit the requirements of practically all receiving-type vacuum tubes.

Displays Families of Curves on CRT Screen

Choice of four to twelve characteristic curves per family—with as many as eight positive-bias curves per family.

Plots All Important Characteristics

- Plate current against plate voltage.
- Plate current against grid voltage.
- Screen current against plate voltage.
- Screen current against grid voltage.
- Grid current against plate voltage.
- Grid current against grid voltage.

Calibrated Controls

Accurate current and voltage readings directly from the crt screen.

Wide Display Range

- 11 current ranges from 0.02 ma/div to 50 ma/div.
- 9 voltage ranges from 0.1 v/div to 50 v/div.
- 11 series-load resistors from 300 ohms to 1 megohm.
- 7 grid-step values from 0.1 v/step to 10 v/step.

Price—\$925

f.o.b. Portland (Beaverton), Oregon

Tektronix, Inc.

P. O. Box 831 B, Portland 7, Oregon

CYpress 2-2611

Cable: TEKTRONIX

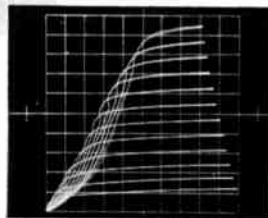

Fig. 1
Plate current—plate voltage

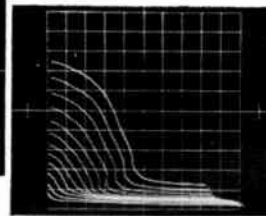

Fig. 2
Screen current—plate voltage

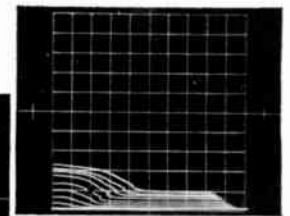

Fig. 3
Grid current—plate voltage

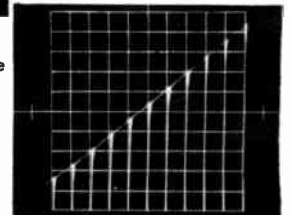

Fig. 4
Plate current—grid voltage

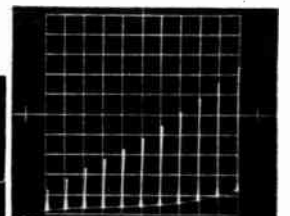

Fig. 5
Screen current—grid voltage

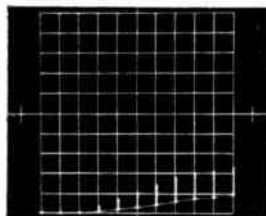

Fig. 6
Grid current—grid voltage

Series of pentode characteristic curves with grid voltage changing 2 volts/step from +16 v to below zero, illustrating Type 570 operation with eight positive-bias curves per family. Vacuum tube is a 6AQ5, under these conditions: Plate load... 300 ohms, peak plate voltage... 100 v, screen-grid voltage... 100 v, vertical scale... 10 ma/division, horizontal scale, fig. 1, 2, and 3... 10 v/division, fig. 4, 5, and 6... 2 v/division.

Please call your Tektronix Field Engineer or Representative for complete specifications, or write to:

Speaking of resistor quality

... it is worthy of note that Stackpole Fixed Resistors are one of the most widely used brands in meeting today's exacting specifications.

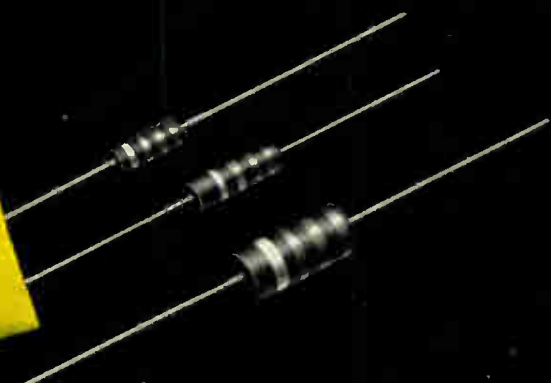

Speaking of resistor supplier co-operation

... the Stackpole record of personal attention to detail in matching resistor requirements and of following through with "on time" deliveries of dependable, fully quality-controlled units, speaks for itself.

Electronic Components Division
STACKPOLE CARBON COMPANY, St. Marys, Pa.

STACKPOLE
FIXED COMPOSITION
R E S I S T O R S

*Backed by the keen personal interest
and full co-operation of the specialists who produce them*

Never before!

NOT 2: motor + gear train
BUT ONE homogeneous unit
New Power Motor-Gear-Train

1. Unique: *Not 2* separate units but a single entity. An entirely new principle—another OSTER "first."

2. More Versatile: Any output speed from 10,000 to .3 RPM.

3. Extremely High Torque Capacity: e.g., 100 #-in. at 523:1 and 1600 #-in. at 10,500:1.

4. Lighter-Smaller: e.g., 10-1/2 oz., 1-1/2" dia., 3-1/2" long at 523:1 ratio.

5. Available in 28 V and 115 V DC or in 28 V and 115 V 400 cycle AC

6. 1.50" dia. (Type 3094) illustrated. Variations include 1.25" dia. (Type 3101), 1.062"* dia. (Type 3200) and 1.75"* dia. (Type 2487).

*Available soon.

For a precision speed reducer with low backlash and low composite error at a moderate price specify an OSTER Power Motor-Gear-Train adapted to your individual application. Write for further information TODAY.



Actual Size
1.50" dia. (Type 3094)

Oster[®]

JOHN OSTER MANUFACTURING CO.
AVIONIC DIVISION
RACINE, WISCONSIN

Your Rotating Equipment Specialist

Other products include Actuators, AC Drive Motors, DC Motors for Special Applications, Fast Response Resolvers, Servo Torque Units, Low Inertia Servo Motors, Synchro Differentials, Two-Phase Reference Generators, Tachometer Generators and Motor Driven Blower and Fan Assemblies.

Measure Difference In

Q

with

The Q METER Type 190-A



In *Designing Tuned Circuits* the effect on Q of adding capacitors, iron cores, or resistors must frequently be determined. The Q of the separate components is also often needed. These measurements made on Q Meters formerly available required the use of a small difference between two large Q values in various formulae. This led to large errors. The Q Meter Type 190-A reads the difference between the Q of a reference circuit and the Q of this circuit when new components are added. The scale that indicates this *Differential Q* has a sensitivity 4 times as great as the scale which reads Q. The accuracy and ease with which *Differential Q* can be read is greatly improved by use of the 190-A Q Meter.

The Q Meter Type 190-A has a "Lo Q" scale which reads Q down to a value of 5. The internal resonating capacitor is directly read and has a vernier arrangement for accurate reading of capacitance. The dial rotates approximately 10 times in covering the capacitance range. All readings are made on a single meter corrected for parallax.

SPECIFICATIONS

FREQUENCY COVERAGE: 20 mc to 260 mc. Continuously Variable in Four Ranges.

FREQUENCY ACCURACY: Calibrated to $\pm 1\%$.

RANGE OF Q MEASUREMENTS: 5 to 1200.

RANGE OF DIFFERENTIAL Q MEASUREMENTS: 0 to 100.

ACCURACY OF Q MEASUREMENTS: Circuit Q of 400 read directly on meter can be determined to accuracy of $\pm 5\%$ to 100 mc and to $\pm 12\%$ to 260 mc.

INTERNAL RESONATING CAPACITANCE RANGE: 7.5 mmf to 100 mmf (direct reading) calibrated in 0.1 mmf increments.

ACCURACY OF RESONATING CAPACITOR: ± 0.2 mmf to 20 mmf
 ± 0.3 mmf to 50 mmf
 ± 0.5 mmf to 100 mmf

POWER SUPPLY: 90-130 volts—60 cps (internally regulated). Power Consumption—55 watts.

(Specifications subject to change without notice)

PRICE: \$625.00 F.O.B. Factory

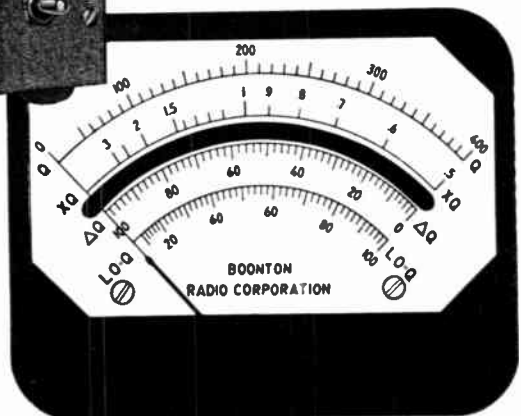

SINGLE, EASY-TO-READ METER WITH PARALLAX CORRECTION FOR ALL FUNCTIONS

- Q indicating voltmeter: 50 to 400.
- Multiply Q scale: 0.5 to 3.0.
- A differential Q scale for accurately indicating the difference in Q between two test circuits.
- Additional accurate expanded scale for measuring low values of Q.
- A counter type resonating capacitor dial for improved setting and reading accuracy.
- Regulated power supply for increased stability and accuracy.
- Careful design to minimize instrument loading of circuit under test.



BOONTON RADIO
 Corporation
 BOONTON · N.J. · U.S.A.

The most
valuable
reference
work
in the
world

- for the electronics engineer
- for buyers of component parts
- for users of electronic equipment
- for anyone who must

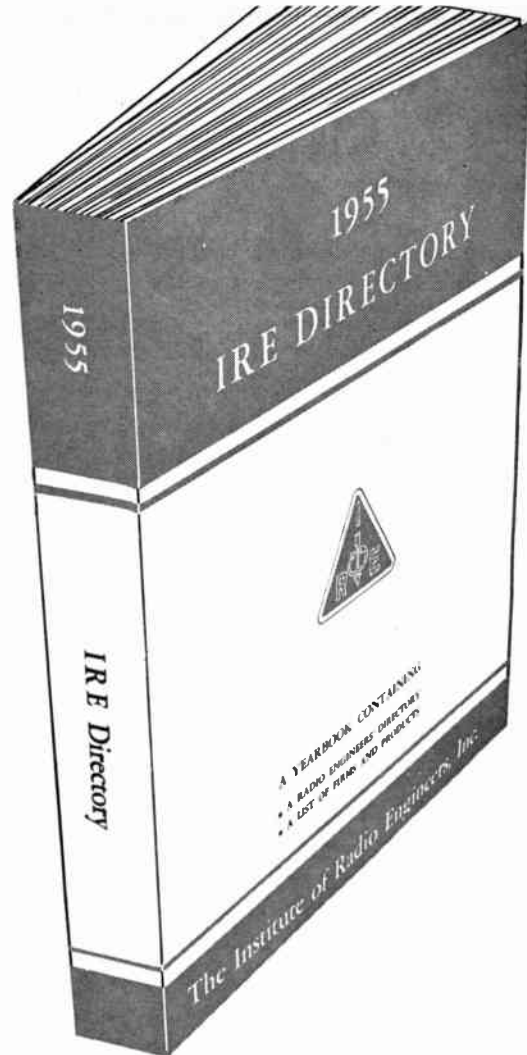

FIND FACTS FAST

The IRE Directory contains full information on 3000 firms manufacturing products or furnishing services in the radio-electronic field, brought up-to-date every year.

Arranged efficiently and logically, the way an engineer thinks, for simple location of any product or service—

675 specific products and services, arranged under
99 major headings in
4 great groups

- Communications
- Components
- Controls and Instruments
- Materials and Services

USE YOUR IRE DIRECTORY . . . IT'S VALUABLE

1955 edition coming September 15.



THE INSTITUTE OF RADIO ENGINEERS

1 East 79th Street, New York 21, N.Y.

DIRECT

ONE WAY

STREET
TO THE
RADIO-
ELECTRONICS
MARKET!

ONE WAY

IRE DIRECTORY
ALONE PROVIDES
PRODUCT FACTS
ENGINEERS NEED!

35,000 IRE members are the engineers who spark new developments in the fast-paced, fast-growing radio-electronics industry. To feed the fires of their creative thinking, they must have the latest facts. That's why they turn first to IRE DIRECTORY — a working encyclopedia of products, firms and men. This vital working information remains within arm's reach 365 days a year.

When it's packed with facts, your product catalog in IRE DIRECTORY "tells and sells" the men who specify and buy — the IRE radio-electronics engineer.

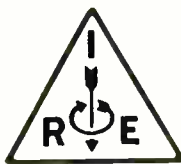

The Institute of Radio Engineers
Advertising Department
1475 Broadway, New York 36, N. Y.

WIDE BAND POCKETSCOPE

by

Waterman

Size: 12" x 6" x 7"
14 Pounds

MODEL S-14-B

DC COUPLED
REPETITIVE OR TRIGGER
1.8 μ S RISE



ANOTHER EXAMPLE OF **Waterman** PIONEERING...

The WIDE BAND POCKETSCOPE, model S-14-B, hits a new high in frequency response for light, compact, truly portable oscilloscopes. The response extends all the way from DC to 700 KC within —2 db without peaking. Thus providing a pulse rise time of 1.8 microseconds. Furthermore, sensitivity has not been unduly compromised in order to accomplish such fidelity. The vertical sensitivity is 50 millivolts rms/inch. The sweep is operated in either a repetitive or trigger mode and covers a range from 0.5 cycles to 50 KC with synchronization polarity optional. Other essential vertical and horizontal amplifier characteristics include non-frequency discriminating attenuators and gain controls as well as individual calibration voltages. Additional provisions for direct access to all the deflection plates, the second anode, and the amplifier outputs help to make the S-14-B a standout instrument of flexibility and utility. All this plus portability! The incredibly small size and light weight of the S-14-B now permits "on-the-spot" use of the oscilloscope in all industrial, medical, and electronic fields. Its rugged construction assures "laboratory performance" regardless of environment.

WATERMAN PRODUCTS CO., INC.

PHILADELPHIA 25, PA.

CABLE ADDRESS: POKETSCOPE

WATERMAN PRODUCTS INCLUDE

- S-4-C SAR PULSESCOPE®
- S-5-A LAB PULSESCOPE
- S-6-A BROADBAND PULSESCOPE
- S-11-A INDUSTRIAL POCKETSCOPE®
- S-12-B JANized RAKSCOPE®
- S-14-A HIGH GAIN POCKETSCOPE
- S-14-B WIDE BAND POCKETSCOPE
- S-15-A TWIN TUBE POCKETSCOPE
- RAYONIC® Cathode Ray Tubes
and Other Associated Equipment



WATERMAN PRODUCTS

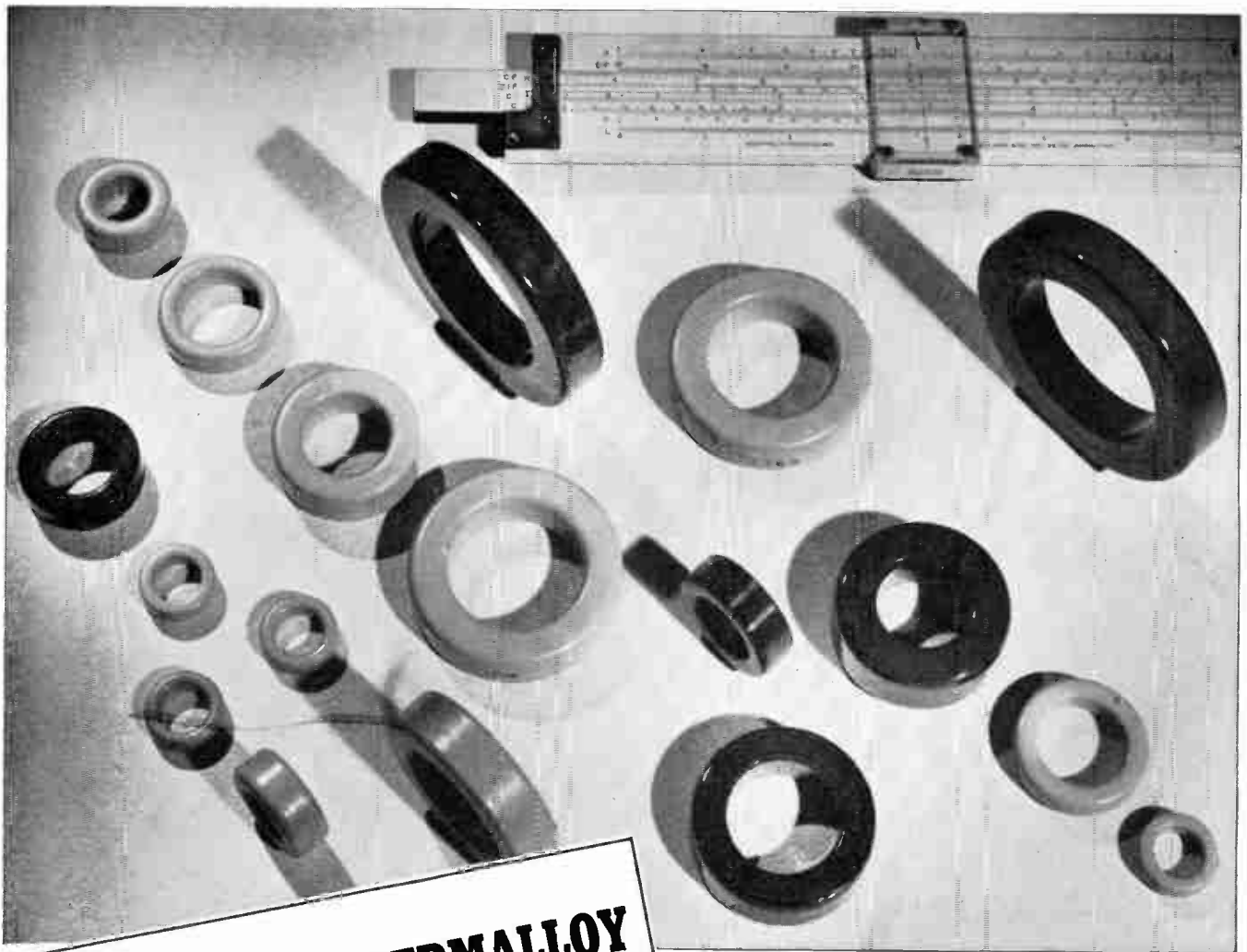

**MOLYBDENUM PERMALLOY
POWDER CORES***
(New technical data now available)
Write for Bulletin PC-104A, dated March 15, 1955

**HIGH Q TOROIDS for use in
Loading Coils, Filters, Broadband
Carrier Systems and Networks—
for frequencies up to 200 K C**

**COMPLETE LINE OF CORES
TO MEET YOUR NEEDS**

- ★ Furnished in four standard permeabilities—125, 60, 26 and 14.
- ★ Available in a wide range of sizes to obtain nominal inductances as high as 281 mh/1000 turns.
- ★ These toroidal cores are given various types of enamel and varnish finishes, some of which permit winding with heavy Formex insulated wire without supplementary insulation over the core.

For high Q in a small volume, characterized by low eddy current and hysteresis losses, ARNOLD Moly Permalloy Powder Toroidal Cores are commercially available to meet high standards of physical and electrical requirements. They provide constant permeability over a wide range of flux density. The 125 Mu cores are recommended for use up to 15 kc, 60 Mu at 10 to 50 kc, 26 Mu at 30 to 75 kc, and 14 Mu at 50 to 200 kc. Many of these cores may be furnished stabilized to provide constant permeability ($\pm 0.1\%$) over a specific temperature range.

*Manufactured under license arrangements with Western Electric Company

W&D 4744

THE ARNOLD ENGINEERING COMPANY
SUBSIDIARY OF ALLEGHENY LUDLUM STEEL CORPORATION
General Office & Plant: Marengo, Illinois
DISTRICT SALES OFFICES . . . New York: 350 Fifth Ave.
Los Angeles: 3450 Wilshire Blvd. Boston: 200 Berkeley St.



OHMITE AMRECON[®] Relays

**HIGH QUALITY, GENERAL-PURPOSE
RELAYS FEATURING COMPACTNESS,
DEPENDABILITY AND LONG LIFE!**

*hermetically
sealed or
dust-protective
enclosures*



30 TYPES
available from
STOCK

Current ratings up to 25 amp, AC or DC

When you want the utmost in relay dependability, investigate the Amrecon line. Amrecon relays are designed, produced, and tested in the new, air-conditioned Ohmite plant.

These ruggedly built relays have the ability to handle power loads usually requiring larger, heavier units. They are built to meet rigorous aircraft relay standards, and are particularly adapted to mobile equipment where severe shock and vibration are encountered.

Amrecon relays are available with screw, plug, or solder-wire terminals; in a variety of contact arrangements; with hermetically sealed or dust-

protective enclosures. Order from the 30 stock types, or let Amrecon's engineers help you work out special relay applications.

AMERICAN RELAY & CONTROLS, Inc.
3617 Howard St., Skokie, Illinois (Suburb of Chicago)

a subsidiary of

OHMITE[®]
MANUFACTURING COMPANY

Send for
Catalog R-10



Frequency Meters



COMPLETELY
SELF-CONTAINED
FIELD TEST INSTRUMENTS

by

FREQUENCY STANDARDS

These precision-built field test instruments were designed by Frequency Standards to provide rapid and accurate means of frequency measurement in the field. Frequency is determined by means of a micrometer dial. This reading is translated to frequency by accurate individual calibration charts or curves. Transducers, fittings, and cables can be supplied to meet the requirements of customers and convenient storage space for these items is provided in the lid of the instruments.



MODEL	FREQUENCY RANGE	ACCURACY
912-4	900-1200 MC	.01%
1217-4	1200-1700 MC	.02%
1723-4	1700-2300 MC	.02%
2335-4	2300-3500 MC	.02%
3545-4	3500-4500 MC	.01%
4458-4	4400-5800 MC	.01%
5882-4	5800-8200 MC	.01%

SPECIAL CAVITY DESIGNS

Frequency Standards maintains complete facilities for the design and manufacture of Reference Cavities, Preselector Cavities, and Filters to customers' specifications or blueprints. Our facilities also permit quantity production of complex wave-guide assemblies.

ILLUSTRATED
BULLETINS
SENT ON
REQUEST

Frequency Standards
ASBURY PARK, NEW JERSEY

Address inquiries to
BOX 504



NEW HIGH VOLTAGE SILICON JUNCTION DIODES

NEWLY EXPANDED TI LINE NOW INCLUDES 15 SINGLE CRYSTAL JUNCTION TYPES IN 20% VOLTAGE RANGES FROM 4.7 TO 470 VOLTS!

high temperature conditions call for silicon diodes from Texas Instruments — your most experienced source of supply for silicon semiconductor devices. The first commercial producer of silicon transistors, TI has produced for commercial and military use many thousands of silicon junction diodes and triodes. TI now introduces a completely new line of silicon diodes including many high voltage types, greatly increasing the application for these reliable devices. This new line features types with characteristics stable to 150°C.

TI

low back current, another important characteristic of TI silicon junction diodes, opens up still more space and weight saving circuit design possibilities. With back current as low as 0.001 microamp at rated voltage for many types, these silicon junction diodes can be used in applications where high operating temperatures and low back current requirements make germanium diodes unsuitable.

100 per cent inspection and aging of every TI diode assures maximum reliability. Thoroughly tested at high temperatures, these uniformly high quality silicon diodes will increase electronic equipment dependability where heat, shock and vibration are problems. Every unit is hermetically sealed, providing maximum protection against ambient moisture.

TI Type	Max. Rev. Working Voltage	Min. Junct. Break-down Voltage	Minimum Forward Current 25°C		Reverse Current Amperes*	Dissipation mw	Average Rectified Forward Current ma	Maximum Ratings at Elevated Temperatures				Typical Capacity ΔΔ ΔΔ ΔΔ f = 500 kc Temp. = 25°C Rev. Volts -12V†
			Ma.	Volts				Ambient Temp. °C	Reverse Current Amperes*	Dissipation mw	Average Rectified Forward Current ma	
600C	—	30 0	3	1	1·10 ⁻⁶ @-1V	100	25	100	0.4·10 ⁻⁴	40	15	2.5
601C	—	50 0	3	1	1·10 ⁻⁸ @-1V	100	25	150	0.5·10 ⁻⁴	20	10	2.5
604C	4.7	5.5	60	1	1·10 ⁻⁷	150	100	150	0.5·10 ⁻⁴	40	40	20
606C	6.8	7.5	35	1	1·10 ⁻⁷	150	90	150	0.5·10 ⁻⁴	40	35	16
608C	10.0	11.0	25	1	1·10 ⁻⁷	125	75	150	0.5·10 ⁻⁴	20	25	12
610C	15.0	17.0	12	1	1·10 ⁻⁷	125	60	150	0.5·10 ⁻⁴	20	20	7
612C	22.0	25.0	7	1	1·10 ⁻⁷	125	50	150	0.5·10 ⁻⁴	20	20	5
614C	33.0	37.0	5	1	1·10 ⁻⁷	125	35	150	0.5·10 ⁻⁴	20	15	3.5
616C	47.0	52.0	3	1	2·10 ⁻⁷	100	30	125	0.4·10 ⁻⁴	20	15	2.5
618C	68.0	75.0	1.5	1	2·10 ⁻⁷	100	25	125	0.4·10 ⁻⁴	20	10	2.0
620C	100.0	110.0	0.9	1	2·10 ⁻⁷	100	20	125	0.4·10 ⁻⁴	20	8	1.4
622C	150.0	170.0	6.5	4	2·10 ⁻⁷	90	15	100	0.3·10 ⁻⁴	30	5	1.2
624C	220.0	250.0	3	4	0.4·10 ⁻⁶	80	10	71	0.2·10 ⁻⁴	40	5	1.0
626C	330.0	370.0	2	4	1·10 ⁻⁶	75	7	71	0.2·10 ⁻⁴	30	4	0.9
628C	470.0	520.0	1	4	1·10 ⁻⁶	70	5	71	0.2·10 ⁻⁴	20	3	0.7

* At maximum working voltage.

† On types 604C, 606C, and 608C reverse voltage was reduced below breakdown voltage.

For detailed information about TI's complete line of silicon junction diodes, write for Bulletin No. DL-S 431.

TEXAS INSTRUMENTS
INCORPORATED
6000 LEMMON AVENUE DALLAS 9, TEXAS



Now!
Measure impedance easily
on high noise level circuits

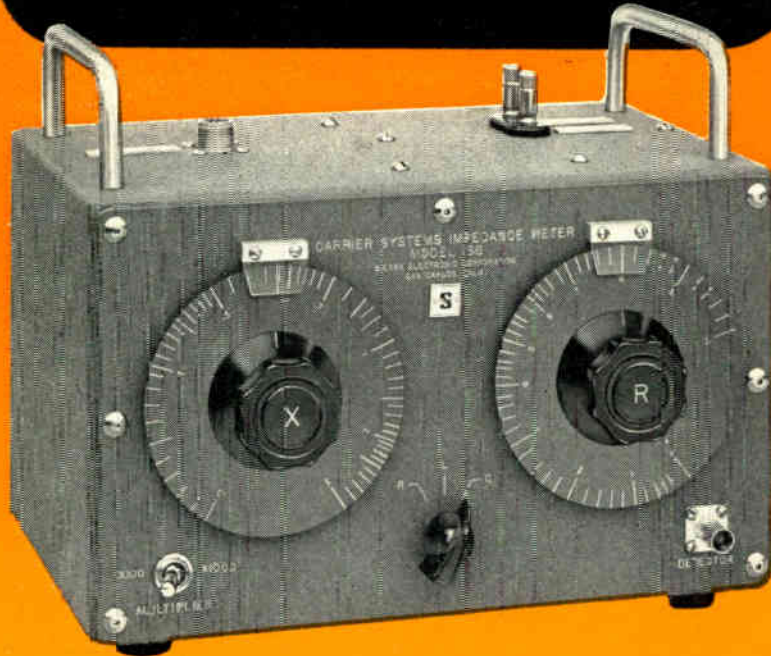

Sierra 166 Carrier Systems Impedance Meter

New Sierra Model 166 is specifically designed for measurements on high noise level power and telephone lines and circuits where conventional instruments are ineffective. Covering all frequencies from 30 kc to 300 kc, it can be used with signal sources ranging in output from 1/2 to 1600 voltamperes.

Model 166 is ideal for determining impedance vs. frequency characteristics, and its wide impedance range permits use (through series coupling capacitors) on

"hot" lines. On low noise level laboratory circuits, the instrument measures impedance using a standard vacuum tube voltmeter as a detector. Under less ideal conditions, impedance may be measured conveniently by using a frequency selective voltmeter (such as Sierra Models 101B, 104 or 108) as the detector.

Brief specifications of new Model 166 are given here. Please write for complete data on Impedance Meter and Sierra Carrier Frequency Selective Voltmeters.

TENTATIVE SPECIFICATIONS — MODEL 166

Frequency Range:	30 kc to 300 kc
Inductive Reactance Range, X_L:	30 to 3000 ohms at 100 kc $X_L = \frac{(X \text{ dial reading}) f_{kc}}{100}$
At a given frequency, f_{kc} :	
Capacitive Reactance Range, X_C:	30 to 3000 ohms at 100 kc $X_C = \frac{100 (X \text{ dial reading})}{f_{kc}}$
At a given frequency, f_{kc} :	
Resistance Range, R:	0 to 1000 ohms
Accuracy:	$\pm 5\%$ on impedance magnitude and phase angle
Maximum Signal Input:	1600 voltamperes, not exceeding 400 volts, or 4 amperes, whichever is larger.
Dimensions:	11 1/8 inches wide, 8 7/8 inches high and 8 1/4 inches deep, over all
Weight:	Approximately 8 lbs.

Specifications subject to change without notice.

Sierra Electronic Corporation

San Carlos 2, California, U.S.A.

Sales representative in major cities

Manufacturers of Carrier Frequency Voltmeters, Wave Analyzers, Line Fault Analyzers, Directional Couplers, Wideband RF Transformers, Custom Radio Transmitters, VHF-UHF Detectors, Variable Impedance Calibrated RF Loads, Reflection Coefficient Meters, Bi-Directional Power Monitors, Television Waveform Monitors, Color Television Picture Monitors, Impedance Meters.

3385

sierra



**FOR HIGH FREQUENCY
HIGH VOLTAGE**

SPACE SAVING APPLICATIONS

GARDE

Miniature & Sub-Miniature
INSULATED STAND-OFFS,
FEED THROUGHs & SPACERS

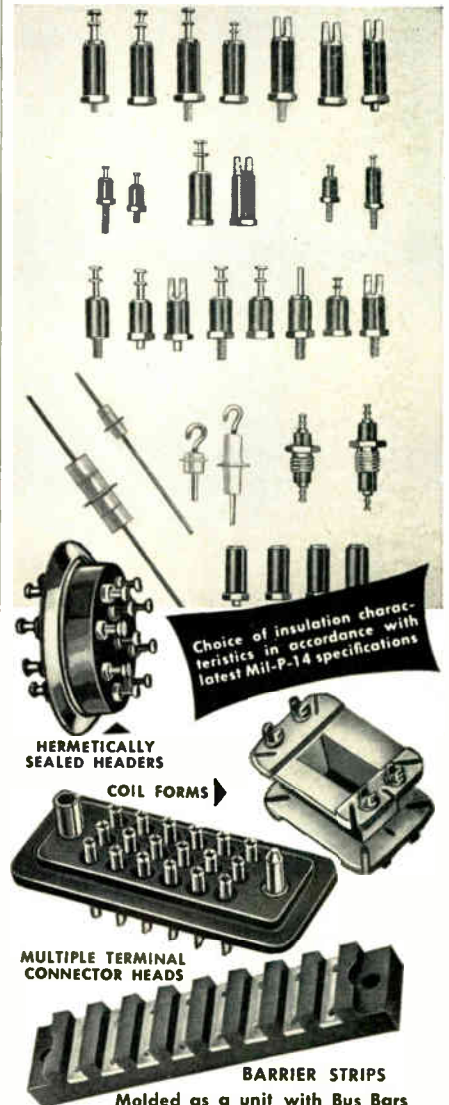

HERMETICALLY SEALED HEADERS

COIL FORMS

MULTIPLE TERMINAL CONNECTOR HEADS

BARRIER STRIPS

Molded as a unit with Bus Bars require no insulating backing.

For users to properly assess the outstanding features and advantages of Garde Components, samples will be sent on request. A detailed technical catalog is now available. Be sure your name is on our mailing list.

We have complete facilities to accommodate your special requirements, ranging from Engineering Consulting Service to Precision Design and Production.

GARDE
MANUFACTURING COMPANY

MOLDERS OF THERMOPLASTIC AND THERMOSETTING MATERIALS

588 Eddy Street, Providence 3, Rhode Island
Sales Representatives in Principal Cities



NOW...

you can **DIP-SOLDER**
resistor connections
with the NEW SPEER
SOLDER-BATH RESISTOR

Found: the answer to automatic soldering of resistors to printed circuit terminals. Speer's new solder-bath resistor assures secure dip-soldered connections . . .

without flux
without re-tinning

Here's a resistor specifically made for efficient dip-soldering on modern assembly lines. The *high solderability* of its specially tinned leads gives a firmer joint—closer to the body of the resistor.

Perhaps you are employing or developing automatic production of electronic components—based on printed circuitry. Now's the time to get all the details on a resistor designed for automatic dip-soldering: the Speer solder-bath resistor!

Send coupon for complete information.



SPEER RESISTOR DIVISION
SPEER CARBON COMPANY
Bradford, Pennsylvania
Other Divisions: Jeffers Electronics
International Graphite & Electrode

SPEER RESISTOR DIVISION
Speer Carbon Company
Bradford, Pennsylvania

Please send me the full story on your
solder-bath resistor.

Name _____

Title _____

Company _____

Address _____

ANNOUNCING

... the Eimac 4X5000A Ceramic Radial-Beam Power Tetrode



The Eimac 4X5000A ceramic radial-beam power tetrode, with a 5kw plate dissipation rating and 16kw power output in typical Class-C telegraphy operation fills a power gap in the tetrode field. Rugged ceramic replaces glass, increasing immunity to damage by thermal and physical shock, and stack type production techniques assure uniform quality characteristics. Straightforward coaxial structure allows the advantages of low lead inductance. An integral finned anode permits improved cooling with low air pressure. Especially suitable for Single Sideband operation, the versatile 4X5000A handles high inputs without going into the positive grid region and delivers 10kw peak envelope power output with zero driving power in typical Class-AB₁ operation. High power gain, low inter-electrode capacitances, simple circuit needs and non-emitting grid wire, inherent Eimac tetrode features resulting from over 20 years of transmitting tube specialization are, of course, maintained.

TYPICAL OPERATING CONDITIONS

Frequencies up to 30 Mc

	Class-C Telegraphy	Class-C Plate Mod.	Class-AB ₁
D-C Plate Voltage	7500	5000	7500 volts
D-C Screen Voltage	500	500	1250 volts
D-C Plate Current	2.8	1.3	1.9 amps
D-C Screen Current	.500	.170	.200 amps
D-C Grid Current	.250	.045	0 amps
D-C Grid Voltage	-350	-400	-300* volts
Peak R-F Grid Voltage	590	520	300 volts
Driving Power	150	25	0 watts
Screen Dissipation	250	85	250 watts
Plate Power Input	21	6.5	14.2 kilowatts
Plate Power Output	16	5.5	10 kilowatts

*In the Class-AB₁ operating conditions listed, adjust grid bias to obtain 500 ma d-c plate current with zero driving voltage.

The above operating conditions show approximate grid driving power and plate power output. Allowance must be made for r-f losses in practical circuits.

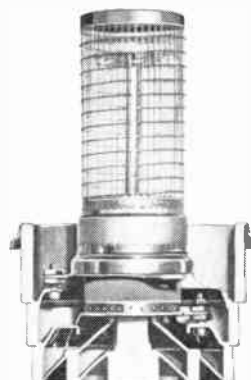

For further information, contact our Technical Services department.

EITEL-McCULLOUGH, INC.
SAN BRUNO, CALIFORNIA
The World's Largest Manufacturer of Transmitting Tubes

CAPACITORS by General Electric

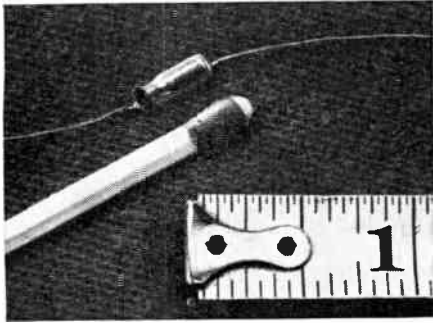

MICRO-MINIATURE

For low voltage d-c miniaturized electronic equipment (hearing aids, walkie-talkies, paging systems). Ideal for transistorized assemblies. Ratings 1-8 uf at 4 v. d-c, 1 uf at 8 v. d-c, 0.5 uf at 16 v. d-c. Tolerance -0 to +200%. Temp. range -20 to +50° C. BULLETIN GEA-6065.

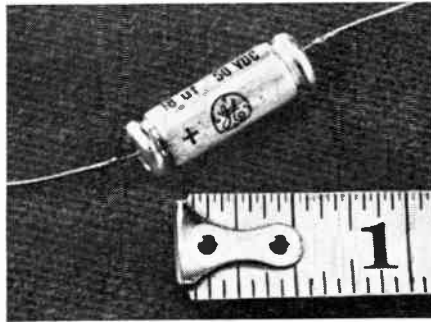

TANTALITIC*

For electronic equipment requiring small size, low leakage current, long shelf life, wide temperature range. Plain or etched foil, and polar or non-polar types, suitable for a-c or d-c. Ratings 0.25-580 uf, 3.75-150 v. Tolerance =20% (plain foil), -15 to +75% (etched). Temp. range -55 to +85° C. BULLETIN GEC-808.

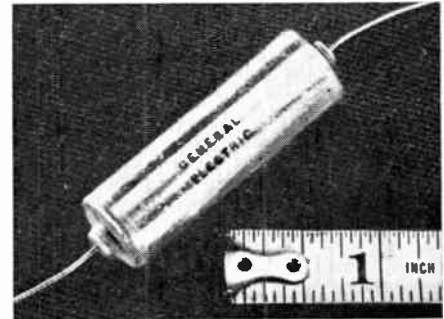

METAL-CLAD TUBULAR

For d-c uses where reliability under severe operating conditions is required (military electronic equipment). Ratings 0.001-1 uf at 100, 200, 300, 400 and 600 working v. d-c. (Can be applied to a-c circuits with adequate derating.) Tolerances =5, =10, or =20%. Temp. range -55 to +125° C. BULLETIN GEC-987.



PERMAFIL-IMPREGNATED

Designed to meet requirements of MIL-C-25A, characteristic K specifications, and are suitable for high-temperature operation. Ratings 0.05-1 uf at 400 v. d-c. Tolerance =10%. Temp. range -55 to +125° C. BULLETIN GEC-811.



STANDARD COMMERCIAL

For motors, filters, communication equipment, luminous-tube transformers, industrial control. Ratings dual rated units (a-c or d-c) rated at 0.01-50 uf, at 236-660 v. a-c, 400-1500 v. d-c. Single rated units also available. Tolerance =10%. Temp. range -55 to +85° C. BULLETIN GEC-809.

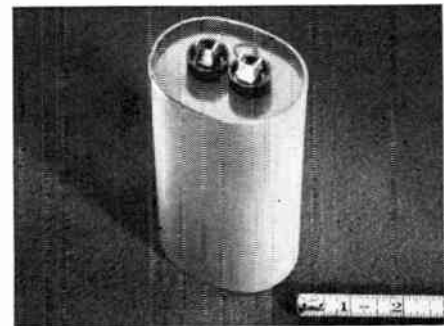

DRAWN-OVAL

For air conditioning and refrigeration equipment, fluorescent lamp ballasts, business machines, voltage stabilizers. Single, dual or triple-section types. Ratings 1-20 uf at 236-660 v. a-c, and 1-15 uf at 600-1500 v. d-c. Tolerance =10%. Temp. range -30 to +70° C. BULLETIN GEA-5777.
*Reg. trademark of General Electric Company.

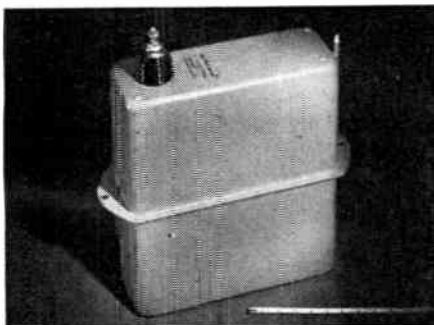

ENERGY STORAGE

For use in high magnetic fields and high intensity arc discharge. Ratings: may be built as high as 2000 joules (watt-seconds). Tolerance =10%. BULLETIN GEA-4646.

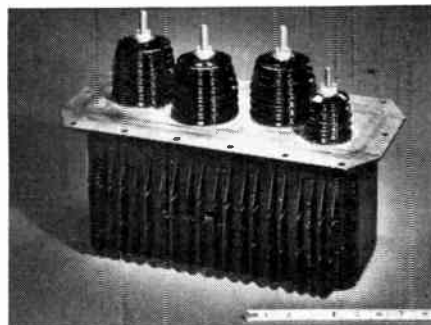

NETWORK

For guided missiles, aircraft, radar equipment. Ratings: built to user specifications. Temp. range -55 to +125° C, or to user specifications. BULLETIN GEA-4996.

NOTE: All capacitance tolerances are given at +25° C.

Progress Is Our Most Important Product

GENERAL  ELECTRIC

SEND COUPON BELOW for complete information about G-E capacitors.

General Electric Co.
Section H 442-25
Schenectady 5, N. Y.

Please send me capacitor bulletins checked below.

- | | |
|-----------------------------------|----------------------------------|
| <input type="checkbox"/> GEA-4646 | <input type="checkbox"/> GEC-808 |
| <input type="checkbox"/> GEA-4996 | <input type="checkbox"/> GEC-809 |
| <input type="checkbox"/> GEA-5777 | <input type="checkbox"/> GEC-811 |
| <input type="checkbox"/> GEA-6065 | <input type="checkbox"/> GEC-987 |

Name.....

Position.....

Company.....

Address.....

City..... Zone..... State.....



26 SERIES OF RACK & PANEL CONNECTORS

Interconnection of vital electronic equipment demands a wide variety of connector designs. At AMPHENOL this demand has resulted in the most comprehensive connector line available to the electronics industry—AN connectors, RF connectors, *Blue RIBBONS*, and hundreds of special components. In the latter category are the 26 series of Rack & Panel connectors, which includes three distinctly different designs, each offering excellent design and mechanical characteristics.

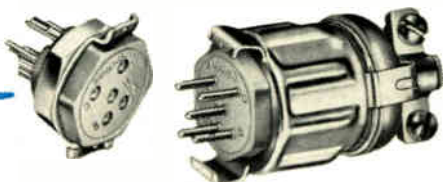

4, 5, 7 & 9 Contact Miniature Connectors

Designed to cover a wide range of miniaturized applications by the use of interchangeable hardware and contacts. Hex nut type has threaded body for panel mounting without the use of external shells. Locking Clip type permits positive mating with Hood & Cable Clamp type. All with male or female contacts. Bodies molded of AMPHENOL 1-501 blue: gold plated contacts.

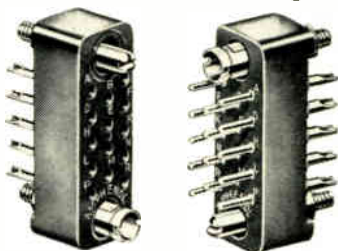

14, 15, 18, 21 & 34 Contact Miniature Connectors

Extremely small pin and socket type connectors available in numerous contact arrangements. Have guide pins and bushings for positive alignment. Contacts are brass, gold over silver plated. Bodies are melamine.



11, 15 & 20 Contact Connectors

Available with protective aluminum housings with top or side cable outlets. Connectors have eyelets inserted in the mounting holes for extra strength. Interlocking barriers prevent accidental shorting. Bodies are mica-filled phenolic; contacts are brass, gold over silver plated, and are molded into the insert.



AMERICAN PHENOLIC CORPORATION

chicago 50, illinois

In Canada: AMPHENOL CANADA LIMITED Toronto



Edward Wilson Kimbark (M'45) has been appointed Dean of the School of Engineering of Seattle University, Seattle, Wash. He will assume his new duties about May 1.

Dr. Kimbark received the B.S. degree in 1924 and the E.E. degree in 1925 from Northwestern University. From 1932 until 1937 he attended Massachusetts Institute of Technology where he received the S.M. and Sc.D. degrees.

At the present time he is in Brazil where he has been connected with the Instituto Tecnológico de Aeronáutica in São José dos Campos, São Paulo, a school for the Brazilian Air Force and civilians, run by the Federal Government. He organized and put into operation the Division of Electronics.

In addition to his duties in São Jose, Dr. Kimbark has lectured at the Electrical Engineering Institute of the University of Brazil in Rio de Janeiro, and at the Electrical Engineering Institute of the University of São Paulo. He also has been acting as consultant to the latter in the construction of a network analyzer for teaching and consulting work.



Maurice E. Kennedy (A'41-SM'47) has been appointed Director and Chief Engineer of the newly formed Department of Communications for the County of Los Angeles. The new department integrates all of the Los Angeles County radio and microwave systems, hospital electronic equipment, electronic controls and devices, wire services, telephone systems and switchboards, teletypes, and fire alarms.



M. E. KENNEDY

Mr. Kennedy was educated at the University of California and the University of Southern California.

He has for the past 18 years been Radio Engineer and Chief Electrical Engineer for the Los Angeles County Flood Control District.

Mr. Kennedy has taken an active part in the Los Angeles Section of the IRE, having served as Professional Group Chairman, Vehicular Professional Group organizer, and Chairman and Vice-Chairman of WESCON, and as a member of Convention Committees. He is at present Western Division Vice-Chairman of the National Professional Group Committee under Dr. W. R. G. Baker and a member of the Vehicular Professional Group National Committee.

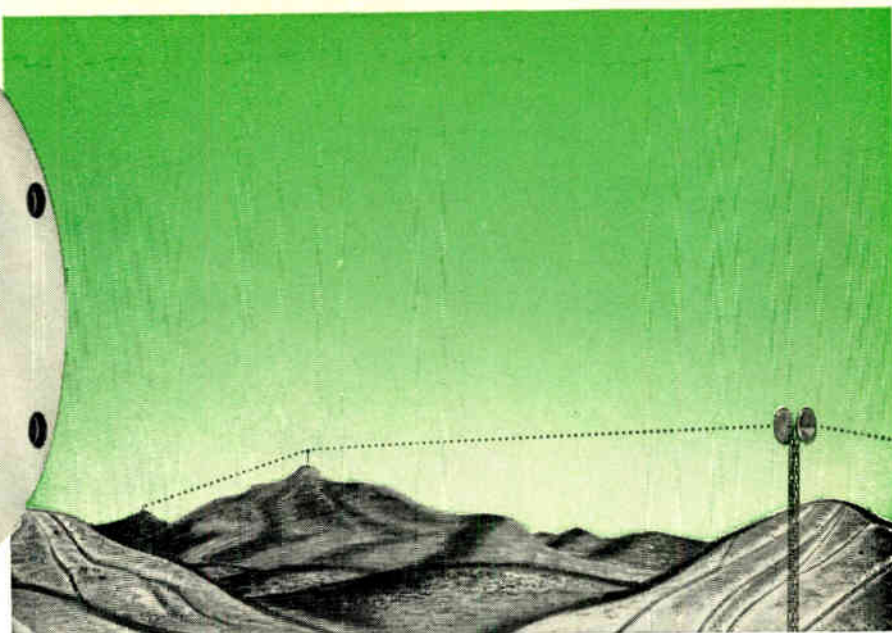
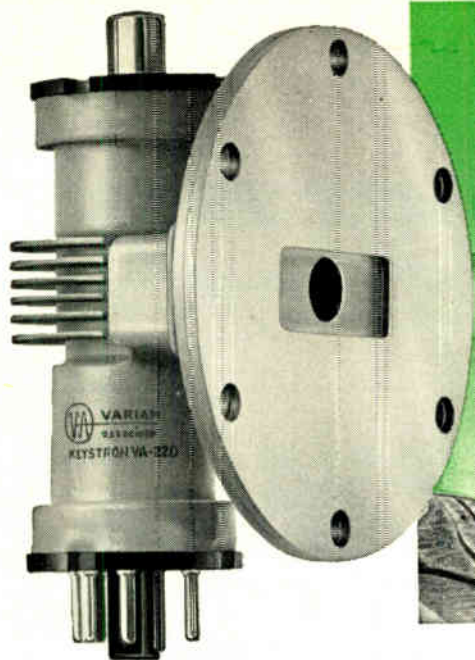

NOW... at **half** the former cost

VARIAN brings you

A NEW, HIGH PERFORMANCE RELAY KLYSTRON

It's the VA-220, another outstanding example of Varian design leadership . . . research and product engineering that brings you the most dramatic cost reduction in the history of high performance klystrons — **with no compromise in quality.**

**UNSURPASSED
FOR EVERY
RELAY APPLICATION**

Microwave relay system designers and equipment buyers have long known that Varian relay klystrons are unmatched for frequency stability, power to override noise, reliability and long life. The VA-220 gives you performance that even exceeds the high standards set by Varian X-26 klystrons . . . at half the cost.

In the 6000 - 8000 megacycle band, VA-220 klystrons will consistently outperform all others. Here are six reasons why this sensational new klystron is your best buy for all relay applications:

**THESE ADVANTAGES
MEAN TOP PERFORMANCE**

- **Greater Power**—VA-220 high power klystrons are conservatively rated. They will deliver more than rated power without failure.
- **Greater Frequency Stability**—VA-220 klystrons have negligible frequency drift.
- **Greater Uniformity**—Varian mass production techniques assure uniformity — every klystron is as reliable as a nut and bolt.
- **Longer Life**—VA-220 klystrons can be operated at full power for thousands of hours, at low power for years.
- **Less Distortion, Less Noise**—FM distortion and inherent noise are negligible — 60 db below a 1-megacycle deviation.
- **Lower Cost**—VA-220 klystrons cost far less than any other relay klystron with comparable performance characteristics.

TYPE	FREQUENCY RANGE	RESONATOR VOLTAGE	POWER OUTPUT	BANDWIDTH	MODULATION SENSITIVITY
VA-220*	5925 - 7425 mc	750 v	1.2 watts	35 mc	375 kc/v
*VA-220 B, C, D, E and F each cover a frequency range of approximately 300 mc					

FOR COMPLETE SPECIFICATIONS . . . and technical data on the VA-220 and other Varian klystrons, write to the Varian Application Engineering Department today.

IN KLYSTRONS,
THE MARK OF
LEADERSHIP IS



VARIAN associates
PALO ALTO 2, CALIFORNIA

Representatives in all principal cities.

OUR GOOD NEIGHBOR

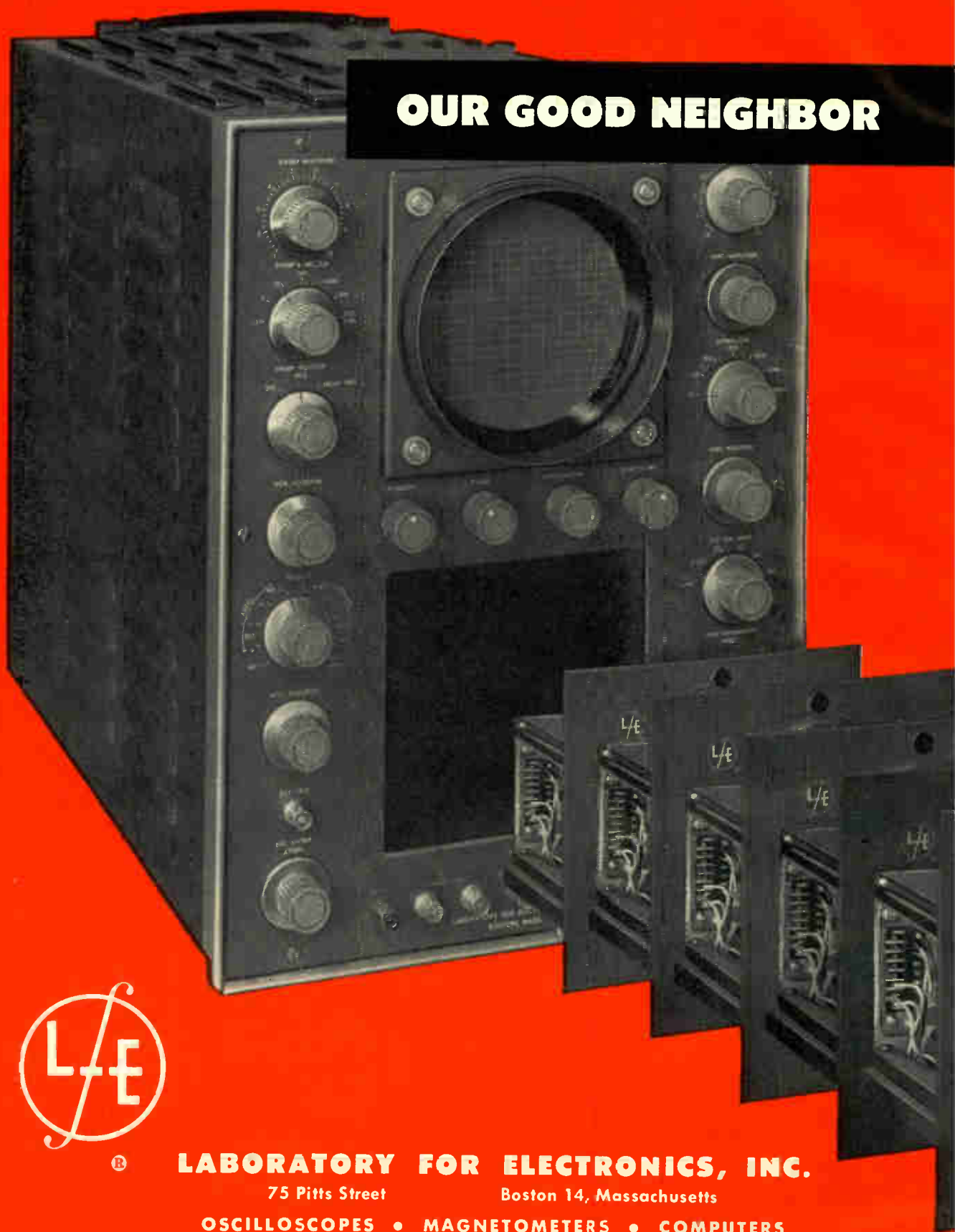

®

LABORATORY FOR ELECTRONICS, INC.

75 Pitts Street

Boston 14, Massachusetts

**OSCILLOSCOPES • MAGNETOMETERS • COMPUTERS
SOLID DELAY LINES • SPAR • SPAR-S**

ALSO KNOWS HIS OSCILLOSCOPES

**Government of
Canada among
many purchasers
of the new
ultra-versatile
LFE 411**

The 411 is a specialized Oscilloscope made versatile by 6 X-axis plug-in units. Great flexibility is now yours at quite reasonable cost. Check every feature — compare against competitive makes. And whatever your research problem, before you buy a new scope, call the nearest LFE Engineering Representative or write LFE direct about the matchless 411.

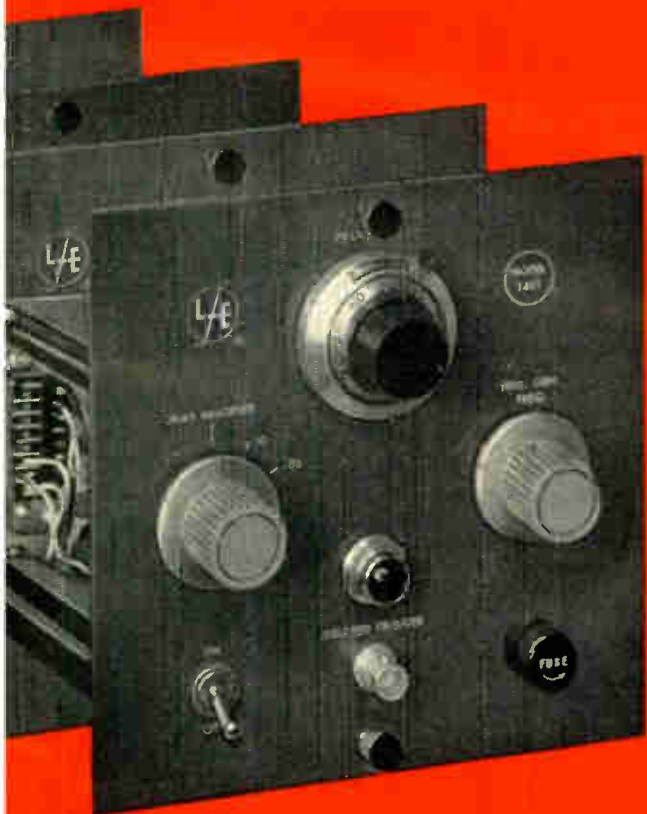

Specifications:

X-AXIS PLUG-IN UNITS

- Model (s) 1400, BASIC, with 0.5 to 5000 cps trigger generator
- 1401, SWEEP DELAY, continuously variable from 1. μ sec. to .1 sec.
- 1402, VIDEO SWITCH, time sharing circuit, BW 5 cps to 8mc.
- 1403, GATED MARKER GENERATOR, 0.1 to 10,000 μ sec. timing markers
- 1404, TV TRIGGER SHAPER, triggers on composite video signal
- 1405, LONG SWEEPS, from .1 sec./cm. to 5 sec./cm.

BASIC SCOPE

● Y-Axis Amplifier

- Deflection Sensitivity — 15 mv./cm. p-p for both d-c and a-c (max.)
- Max. Signal Voltage — 500 volts, peak
- Frequency Response — d-c to 10 mc. (3 db. point)
- Transient Response — Rise time (10%-90%) — 0.035 μ sec.
- Linearity of Deflection — Max. deflection, 5". At 2" unipolar deflection, maximum compression is 10%
- Signal Delay — 0.25 μ sec.
- Input Termination — 52, 72, or 93 ohms
- Input Impedance — 1 megohm, 30 μ f.

● X-Axis

- Sweep Time Range, calibrated — 0.1 μ sec./cm. to .1 sec./cm.
- External Sweep Sensitivity — 2 volts/cm., p-p.
- Frequency Response — DC to 1 mc, (3 db. point)
- Triggers — Internal \pm ; External \pm ; 60 cps; Internal Trigger Generator 5000 cps
- External Trigger Sensitivity — 1.0-100 volts for Triggers having a slope of greater than 40 volts per second.

OTHER FEATURES

- Flat-face CRT Type 5ABP-1 (P7 or P11 optional) — Accelerating Potential 3000-4000 volts
- Deflection Plates Accessible
- Power Requirements: 105 — 125 V., or 210-250 V., 50-60 cycles. 385 watts
- Dimensions: 13" w, 17 $\frac{3}{4}$ " h, 21" d.

Now — Accuracy $\pm .25\%$

New Expanded Scale Voltmeter Added to SHASTA'S Complete Line



ARGA Model 101 Expanded Scale Voltmeter

Any voltage from 100 to 500, over a frequency range of 50 to 2,000 cps, may be read to $\pm .25\%$ of input voltage in 39 ten-volt full scale steps with the new ARGA Model 101 Expanded Scale Voltmeter. Smallest division on the patented expanded scale is 0.2 volts; reading errors due to parallax are negligible. True RMS readings are provided by a specially-developed measuring element.

Standard instrument has provision for direct connection to 0-1 ma recorder. Special high or low base voltages, modified voltage scale expansions, and switchboard or panel mountings are available on order.

Standard Model 101 (illustrated) measures 12" wide, 8" high and 8" deep, weighs 15 lbs. Price, (f.o.b. factory) \$360.00.

New SHASTA Model 202A VTVM Now Available



SHASTA Model 202A Vacuum Tube Voltmeter

A new and improved version of the Model 202, the SHASTA Model 202A Vacuum Tube Voltmeter, offers a range of .001 to 300 volts full scale in frequency ranges from 20 cps to 2 mc. Accuracy is $\pm 3\%$ full scale to 100 kc, $\pm 5\%$ to 2 mc. DB range is -60 to $+50$ in 10 db steps. A new 6" meter provides better readability reducing parallax errors and operator fatigue. Its wide voltage and frequency range make it the ideal general-purpose instrument. Price is only \$190.00 (f.o.b. factory).

Other SHASTA Quality Instruments

Expanded Scale Frequency Meters / A. C. Vacuum Tube Voltmeters / Square Wave Generators / Square Wave Voltage Calibrators / Regulated and Unregulated Power Supplies / Filament Power Supplies / Wide Band Amplifiers / Crystal Calibrators / Impedance Bridges / WWV Receivers / Low Frequency Standards / Resistance Bridges / Intermodulation Meters

The complete line of SHASTA quality instruments offers new high standards of precision performance — why settle for less? Before you specify or buy test instrumentation, see what SHASTA offers you. Write today for technical bulletins, complete price lists. Please address Dept.SA5.

Shasta

Division S-3
BECKMAN INSTRUMENTS INC.
 P.O. Box 296, Sta. A • Richmond, California
 Telephone LAndscape 6-7730

FCC ACTIONS

The Federal Communications Commission's rules regarding multiple ownership of broadcasting and telecasting stations has been deemed invalid by the U. S. Court of Appeals in Washington, D. C. (Storer Broadcasting Co. vs. United States). The court ruled that the FCC has no authority to decide in advance and without hearing whether an applicant for a radio or TV station has the right of ownership merely on the basis of the number of stations it presently owns. The court stated that the FCC's rules which set the ownership limits at seven TV stations, five AM and five FM radio stations are not merely a "formulation of Commission policy in the licensing of stations," as the FCC said they were, but "binding rules which deprive applicants of a hearing." The court, in its decision, stated, "It is conceivable that in some circumstances, common ownership of even five TV stations, though permitted by the challenged rule, might be undue concentration of control; while in other circumstances, common ownership of a greater number might be compatible with the public interest. But whether so or not must be determined on an ad hoc basis, after consideration of all factors relevant in the determination of whether the grant of a license would be within the comprehensive concept which the Act calls 'the public interest, convenience or necessity.'"

The decision further stated that for the Commission to decide that five, seven or any given number of TV stations is a maximum beyond which no single applicant can go is not only inconsistent with but contrary to the "mandatory provisions of Sec. 390(b) of the Act" and would in effect repeal or nullify that important section which provides for mandatory hearings in such cases. . . . The Federal Communications Commission has finalized its proposed rule making and amended Parts 2 and 5 of its rules, effective March 25, (Docket 11235), to regularize the shared use of the radiolocation band 2900-3246 mc by educational stations operating in the Experimental (Research) Service for instructing and demonstrating microwave techniques. The commission also amended Part 1 of its practice and procedure rules to incorporate the requirement of a 30-day period, instead of 20 days, for filing petitions for reconsideration or rehearing, in conformity with the 1952 amendments to the Communications Act and present commission procedure. . . . In response to petitions filed by RETMA, NARTB, and other organizations, the Federal Communications Commission recently extended until June 6, 1955, the time for filing comments regarding its proposed rule (Docket 11233)

(Continued on page 54A)

* The data on which these NOTES are based were selected by permission from *Industry Reports*, issues of February 14, 21, 28 and March 7, published by the Radio-Electronics-Television Manufacturers Association, whose helpfulness is gratefully acknowledged.

PYRAMID SOLID DIELECTRIC GLASSEAL[®] CAPACITORS FOR 6 POINT PREFERENCE

Burton Browne / New York



1

Especially sturdy capacitors capable of withstanding vibrational stresses of high acceleration and frequency, and severe shock conditions encountered in guided missiles and airborne equipment.

2

Utilize new, rugged compression-seal type, glass-to-metal solder-seal terminals. Terminals will not work loose or rotate under any operating condition.

3

Functional operating range from -55°C to $+125^{\circ}\text{C}$.

4

Operates normally under severe humidity conditions.

5

Production tests for voltage breakdown, capacitance, power factor, insulation resistance and seal are performed on a 100% basis.

6

Capacitance range: .001 mfd. to 1.0 mfd.; voltage range: 100 to 600 V.D.C. operating; can be provided to standard tolerance of $\pm 20\%$ or to closer tolerances, if desired.

1. Hermetically sealed in metallic cases.

2. Power factor less than 1%.

3. Subminiature in size.

4. Available in both inserted tab and extended foil constructions.

For complete engineering information contact your local Pyramid representative or write to—



CAPACITOR DIVISION

PYRAMID ELECTRIC COMPANY

1445 Hudson Blvd. • North Bergen, N. J.

+ FACTORS



NEW TRIAD sub-miniature audio TRANSFORMERS



Especially designed for Printed Circuits and Transistor applications

AS LISTED IN TRIAD'S NEW 1955 GENERAL CATALOG



Write for Catalog TR-55H

TRIAD
TRANSFORMER CORP.

4055 Redwood Ave., Venice, Calif.



Industrial Engineering Notes

(Continued from page 52A)

to amend Part 3 concerning bandwidth and spurious emissions of AM and FM stations. The RETMA Engineering Department, acting through Panel TR-2, which was organized for the purpose of studying the proposed rule, requested the commission to extend the time for filing comments by six months to one year. This time was needed, the petition said, in order to give a study group composed of FCC representatives, broadcasters and equipment manufacturers enough time to make recommendations on (a) spurious radiation limits, (b) implementation schedules for existing and new stations, and (c) methods of measurement. The RETMA petition further stated that the panel recognizes the importance of establishing standards of spurious radiation for both AM and FM service, and that such standards must take account of (a) technological limitations in achieving attenuation of spurious signals, (b) ambient levels of spurious signals re-resulting from reradiation from non-linear elements in casual radiators such as guy wires, metallic structures, etc., and (c) availability of measuring equipment. . . . **The Federal Communications Commission has issued a Notice of Proposed Rule Making which looks toward the establishment of rules for subscription television service.** The commission requested that comments be filed by May 9 on a wide range of questions of law, fact, and public interest which it will consider in this rule-making proceeding on subscription TV. After receiving the comments, the FCC will decide whether or not to hold public hearings. . . . A plan "designed primarily to satisfy the increasing need for radio use by manufacturers," and to "pave the way for expansion of radio use by all safety and industrial services" has been submitted to the Federal Communications Commission in the form of a petition by the National Association of Manufacturers' Committee on Manufacturers Radio Use. The petition looks toward the creation of a manufacturers radio service and the establishment of 700 new frequency channels for communication purposes to be taken from the FM broadcast band, with no disturbance to present broadcasting operations. The NAM petition contemplates the shared use of unassigned FM broadcast frequencies by the new manufacturers service, as well as all present safety and industrial radio services. It was pointed out that the country's manufacturers presently are included in a "catchall group of diverse radio users known as the Special Industrial Service," and that the number of stations in this group has increased 800 per cent in the past five years, while the number of FM broadcast stations has declined 25 per cent. The petition was prepared under the supervision of Committee Chairman Victor G. Reis, of the Bethlehem Steel Company, and was filed by Washington attorney Jeremiah Courtney. The engineer-

(Continued on page 60A)

MICROWAVE MULTI-PULSE SPECTRUM SELECTOR

for use with Polarad Spectrum Analyzers



The Polarad Multi-Pulse Spectrum Selector increases the versatility of Polarad Spectrum Analyzers by displaying and allowing selection for analysis a specific train of microwave pulses as well as any one pulse in the train.

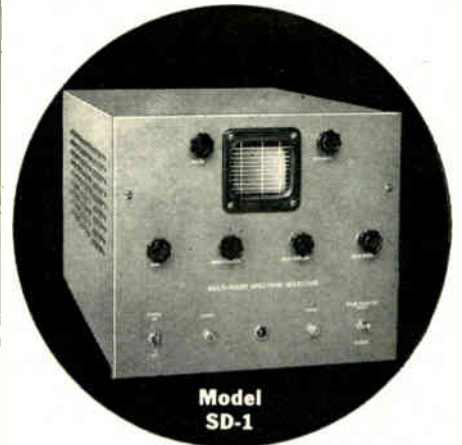

Model SD-1

It will select and gate a group of pulses up to 100 μ sec. in length; is designed to work with fast, narrow pulses; and can be adjusted to gate any pulse including the first at zero time. Special circuitry discriminates automatically once pulses have been selected. The Model SD-1 has been designed to operate with all Polarad Spectrum Analyzers at any of the frequencies they will accept.

- Completely self-powered portable unit.
- High intensity, flat-face CRT for accurate display with:
 - Continuously variable sweep widths; 10 to 100 μ sec.
 - Continuously variable gate widths for pulse selection; 0.2 to 10 μ sec.
 - Continuously variable gate delays for pulse selection; 0 to 100 μ sec.
 - Automatic gating of spectrum analyzer during time of pulse consideration.
 - Intensified gates (brightening) to facilitate manual pulse selection.
 - Triggered sweep on first pulse in any train. No sweep in absence of signal.

SPECIFICATIONS:

Maximum Pulse Train Time.....100 μ sec.
 Pulse Rise Time.....0.05 μ sec. or Less
 Minimum Pulse Separation......1 μ sec.
 Repetition Rate.....10 -10,000 pps.
 Minimum Pulse Width......1 μ sec.
 Input Power.....95 to 130 volts,
 50/60 cps., 350 watts
 Input Impedance . . . 50 ohms (to match TSA
 Output Impedance . . . 50 ohms Spectrum Analyzer)

AVAILABLE ON EQUIPMENT LEASE PLAN

FIELD MAINTENANCE SERVICE AVAILABLE THROUGHOUT THE COUNTRY



ELECTRONICS CORPORATION
 43-20 34th STREET
 LONG ISLAND CITY 1, N. Y.

PORTABLE DIRECT READING SPECTRUM ANALYZER

10 TO 44,000 mcs

5 RF HEADS

UNI-DIAL TUNING



MODEL TSA

Now, a new Polarad spectrum analyzer only 21 inches high that covers the entire frequency range 10 to 44,000 mcs with 5 interchangeable RF tuning heads. The model TSA operates simply—single dial frequency control—with utmost frequency stability. It provides highest accuracy, and reliability for observation and true evaluation of performance over the entire RF spectrum—saving engineering manhours.

This instrument is designed for maximum utility and versatility in the laboratory and on the production line providing an easy-to-read 5 inch CRT display of the RF spectrum.

Model No. Equipment

Model DSA.....Spectrum Display and Power Unit
 Model STU-1....RF Tuning Unit 10-1,000 mc.
 Model STU-2A...RF Tuning Unit 910-4,560 mc.
 Model STU-3A...RF Tuning Unit 4,370-22,000 mc.
 Model STU-4....RF Tuning Unit 21,000-33,000 mc.
 Model STU-5....RF Tuning Unit 33,000-44,000 mc.

SPECIFICATIONS:

Frequency Range: 10 mc to 44,000 mc.
 Frequency Accuracy: $\pm 1\%$
 Resolution: 25 kc.

Frequency Dispersion: Electronically controlled, continually adjustable from 400 kc to 25 mc per one screen diameter (horizontal expansion to 20 kc per inch)

Input Impedance: 50 ohms—nominal

*Sensitivity:
 STU-1 10-400 mcs —89 dbm
 400-1000 mcs —84 dbm
 STU-2A 910-2,200 mcs —87 dbm
 1,980-4,560 mcs —77 dbm
 STU-3A 4,370-10,920 mcs —75 dbm
 8,900-22,000 mcs —60 dbm
 STU-4 21,000-33,000 mcs —55 dbm
 STU-5 33,000-44,000 mcs —45 dbm
 Overall Gain: 120 db
 Attenuation:
 ** RF Internal 100 db continuously variable, IF 60 db continuously variable
 Input Power: 400 Watts
 *Minimum Discernible Signal
 **STU-1, STU-2A, STU-3A

The model TSA Spectrum Analyzer has these exclusive Polarad design and operating features:

- Single frequency control with direct reading dial. No klystron modes to set. Tuning dial accuracy $\pm 1\%$.
- Five interchangeable RF tuning units for the entire frequency range 10 to 44,000 mcs.
- Temperature compensation of Klystron Oscillator.
- Swept IF provides 400 kc to 25 mc display independent of RF frequency setting.
- Internal RF attenuator.**
- Frequency marker for measuring frequency differences from 40 kc to 25 mc.

AVAILABLE ON EQUIPMENT LEASE PLAN

FIELD MAINTENANCE SERVICE AVAILABLE THROUGHOUT THE COUNTRY

NEW! Write for Handbook of Spectrum Analyzer Techniques



ELECTRONICS CORPORATION 43-20 34th STREET, LONG ISLAND CITY 1, N. Y.

REPRESENTATIVES: • Albuquerque • Atlanta • Baltimore • Bayonne • Bridgeport • Buffalo • Chicago • Dayton • Fort Worth • Los Angeles • New York • Newton • Philadelphia • San Francisco • Syracuse • Washington, D. C. • Westbury • Winston-Salem • Canada, Amprior, Toronto—Export: Rocke International Corporation



The Sign of
QUALITY

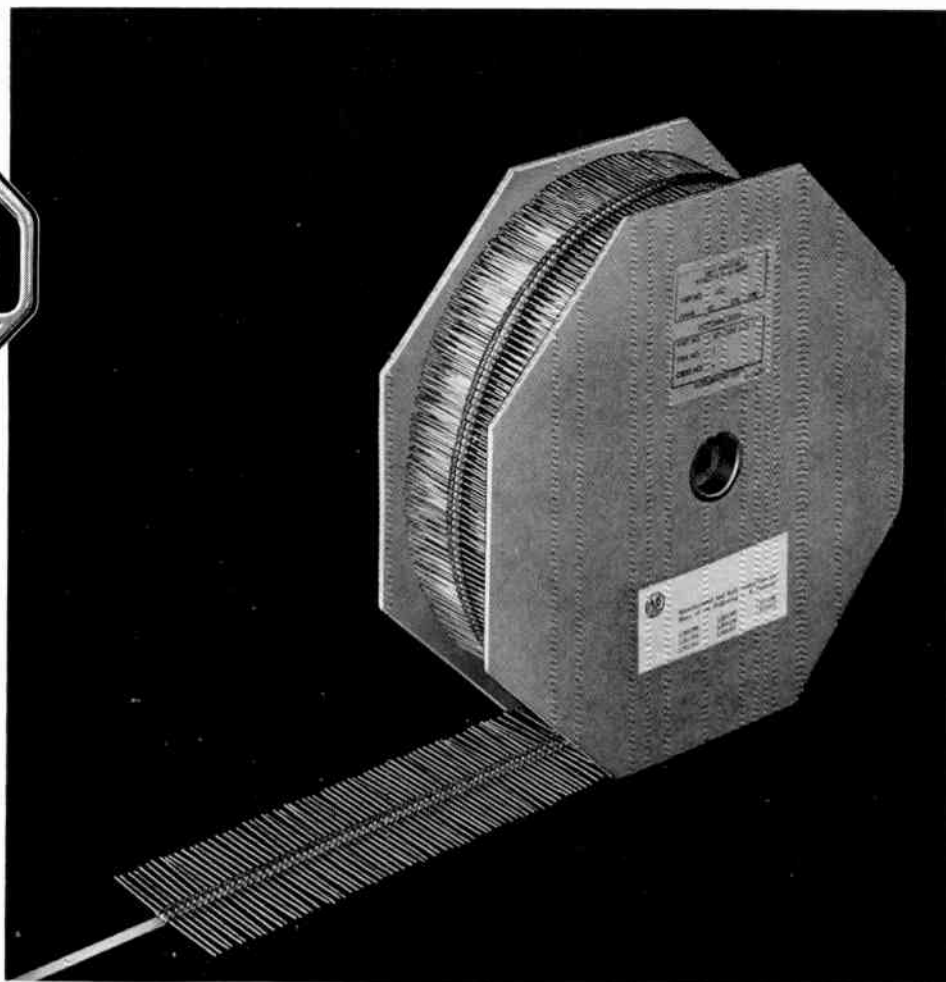

NOW — ALLEN-BRADLEY RESISTORS

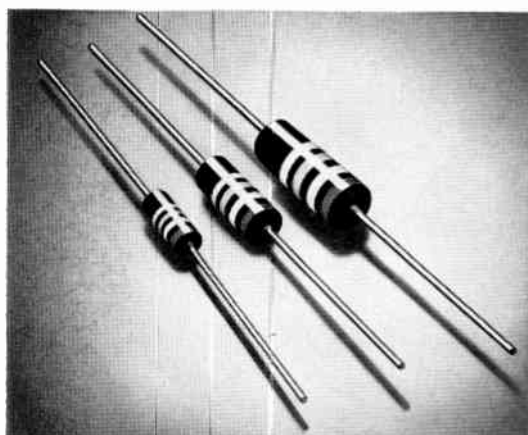

BRADLEYUNITS are available in standard RETMA values in $\frac{1}{2}$ and 2 watt sizes from 10 ohms to 22 megohms; in the 1 watt size from 2.7 ohms to 22 megohms. Allen-Bradley resistors do not use "wax impregnation" to pass salt-water immersion tests.

available in reels for automatic assembly lines

Allen-Bradley Types EB ($\frac{1}{2}$ -watt), GB (1-watt), and HB (2-watt) fixed molded resistors . . . furnished in patented cartons as standard . . . can now be packaged also in reels for use in automatic assembling equipment.

The resistors are aligned on a narrow, pressure-sensitive tape and wound on a corrugated fiberboard expendable reel with a $\frac{9}{16}$ inch mandrel. A lateral pull on the resistor leads detaches the unit easily from the tape.

Type EB resistors are packaged 5000 units per reel; Type GB resistors have 2000 units per reel; and Type HB resistors have 1000 units per reel.

Reel packaging can be supplied for Bradleyunits of any standard RETMA value or tolerance. If automatic assembly is one of your "problems" it may pay you to investigate this reel packaging of A-B "Quality" resistors.

Allen-Bradley Co., 114 W. Greenfield Ave., Milwaukee 4, Wis. • In Canada—Allen Bradley Canada Limited, Galt, Ont.

ALLEN-BRADLEY

RADIO, ELECTRONIC AND TELEVISION COMPONENTS

El-Menco

provides

*Positive Proof
of Performance*

of the powerful new...

*ideal for printed circuits!
meets all humidity, temperature and
electrical requirements of MIL-C-5 specs!*

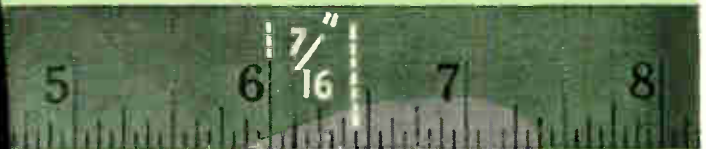

Dur-Mica DM 15

world's smallest mica capacitor

... First Miniature Dipped Mica Capacitors with Parallel Leads.

El Menco's Dur-Mica DM15 provides assurance of peak performance in a variety of transistor circuits and other miniature electronic equipment in military and civilian applications. A new, tougher phenolic casing provides assurance of long-life and stability through wide ranges in temperature. Parallel Leads provide greater versatility—allow efficient, safe use of the El Menco Dur-Mica DM15 in applications heretofore impractical. Saves Money—El Menco's Dur-Mica DM15 costs even less than the famous El Menco CM15. Provides economy of size.

CAPACITIES AVAILABLE:

- DM15—Up to 510 mmf at 300vDCw
Up to 400 mmf at 500vDCw
- DM20—Up to 5100 mmf at 300vDCw
Up to 3900 mmf at 500vDCw

Available in 125°C operating temperature. Minimum capacity tolerance available—± 1/2% or 0.5 mmf (whichever is greater).

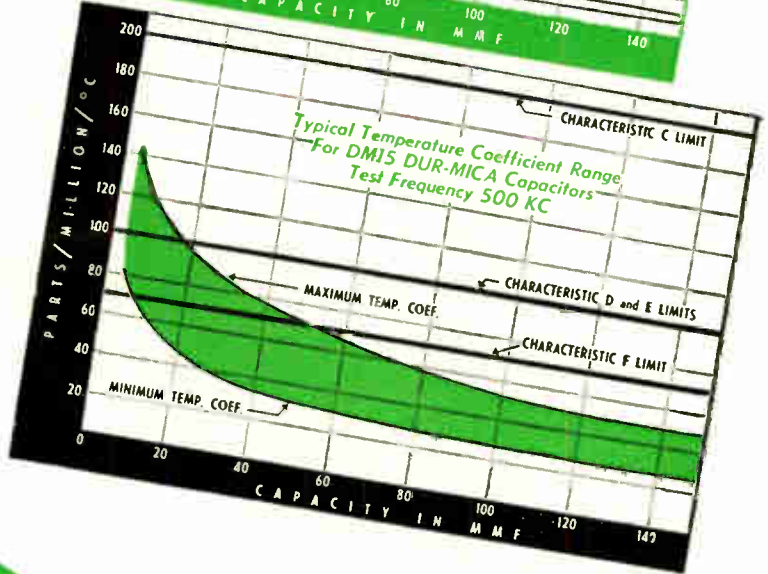

Test El Menco "Dur-Micas" For Yourself!

For your special requirements—we are pleased to offer information and assistance. Write for free samples and catalog on your firm's letterhead.

El-Menco

Capacitors

THE ELECTRO MOTIVE MFG. CO., INC.

WILLIMANTIC CONNECTICUT

- molded mica • mica trimmer
- tubular paper • ceramic

Jobbers and distributors write to Arco Electronics, Inc., 103 Lafayette St., New York, N. Y.

New
**TRANSISTORIZED
 MINIATURIZED**

**TYPE
 2007T**

SPECIFICATIONS

INPUT

20 to 35V DC
 of approx. 5 m.a.

OUTPUT FREQUENCY

400 or 500 cycles

Type 2007T

+ -0.02% from -65° to + 85°C.

Type R2007T

+ -0.002% from + 15° to + 85°C.

Type W2007T

+ -0.005% from -65° to + 85°C.

OUTPUT VOLTAGE

5 volts, sine wave.

Substantially uniform
 from -65° to + 85°C.

LIFE EXPECTANCY

several times that of vacuum tubes

INTERNALLY SHOCK MOUNTED

on Silastic

MAGNETICALLY SHIELDED

HERMETICALLY SEALED

OCTAL BASE

SIZE

4½" x 1½" diameter

WEIGHT

7 ounces

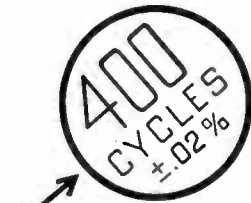

Precision

**FREQUENCY
 STANDARDS**

These units, which are the result of several years of development and testing, offer a new standard of simplicity and reliability. Particularly noteworthy is the uniformity of output signal voltage with temperature change. Small size and light weight make them ideal for airborne and portable use.

For applications where only higher B voltages are available, a simple voltage reducing circuit may be used.

**COMPLETE INFORMATION ON REQUEST
 PLEASE SPECIFY TYPE 2007T**

American Time Products, Inc.

580 Fifth Avenue

New York 36, N. Y.

MANUFACTURING UNDER PATENTS OF WESTERN ELECTRIC COMPANY

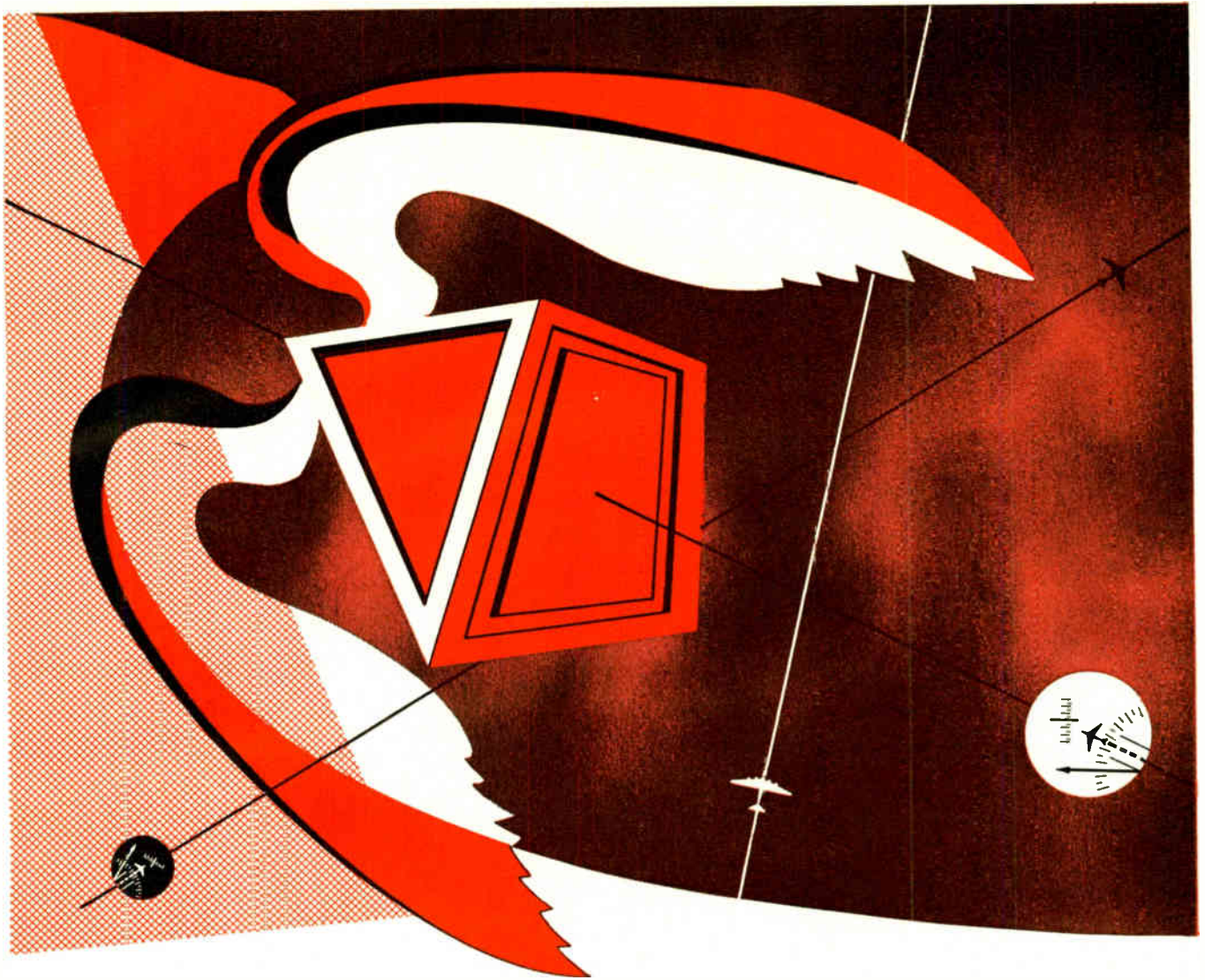

The ancient priests of Egypt were engineers whose great pyramid of Cheops was sextant, compass and slide rule—all in one. From sighting the Pole Star, to squaring the compass, to the mathematics of pi—it's all there in the pyramid of Gizeh.

flying pyramids

Wonder of the world for ages, Gizeh's pyramid was a fount of mathematical data—a tool to check measures, an aid to celestial navigation. Today's aircraft are "flying pyramids"—collecting and integrating instantaneous measurements for orientation and control. Kollsman activities cover these seven fields:

- AIRCRAFT INSTRUMENTS**
- PRECISION CONTROLS**
- PRECISION COMPUTERS AND COMPONENTS**
- OPTICAL COMPONENTS AND SYSTEMS**
- RADIO COMMUNICATIONS AND NAVIGATION EQUIPMENT**
- MOTORS AND SYNCHROS**
- INSTRUMENTS FOR SIMULATED FLIGHT TRAINERS**

Our manufacturing and research facilities . . . our skills and talents, are available to those seeking solutions to instrumentation and control problems.



kollsman INSTRUMENT CORPORATION

80-16 45th AVE., ELMHURST, N. Y. • GLENDALE, CALIF. • SUBSIDIARY OF *Standard* COIL PRODUCTS CO. INC.

Stupakoff

Kovar **HARD GLASS** Seals

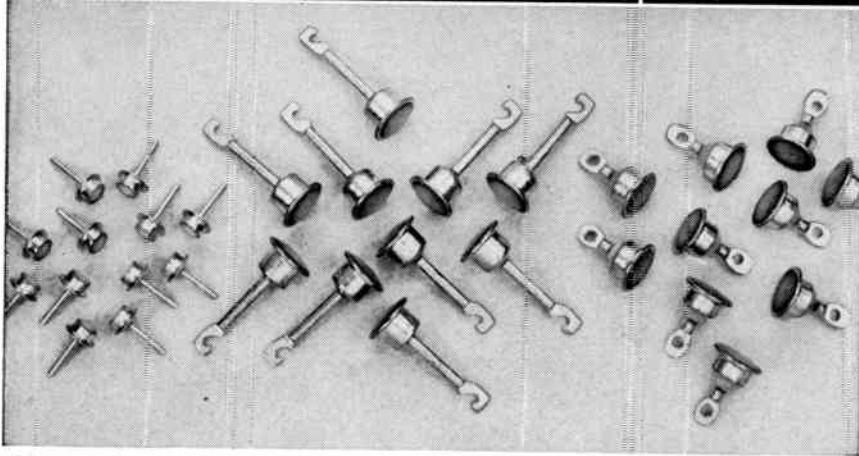
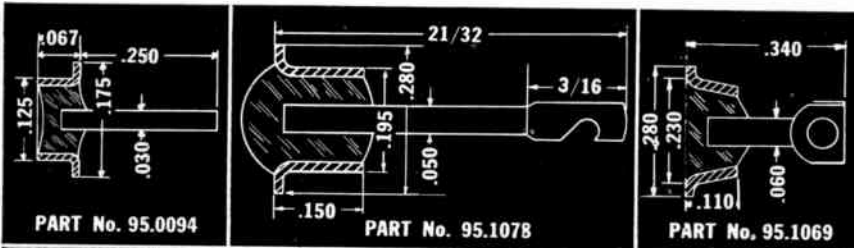

Kovar **HARD GLASS** Stand-offs for test or connection points.

Fused oxides guarantee **TRUE HERMETIC SEALING**

Stupakoff Seals are made by bonding together Kovar metal and hard borosilicate (Pyrex Brand) glass, through a heating process which fuses the oxides of these materials. The strain-free bond thus formed guarantees true hermetic sealing over a wide range of temperatures.

The smooth glazed surface of these compact, light weight seals has high insulating value, and minimizes accumulation of moisture and foreign materials. High thermal endurance permits operation at elevated temperatures, and maximum efficiency is retained even at minus temperatures.

Proper design of a Kovar **HARD GLASS** stand-off or lead-through terminal insures incorporation of these advantages in your product to provide the desired safety factor. See the "Design Information" section of Catalog 453A, on pages 29 and 30.

Complete data of hundreds of sizes, styles and ratings of standard Stupakoff Kovar **HARD GLASS** hermetic seals is given in this catalog. Send for a free copy of Bulletin 453A.



Stupakoff

CERAMIC & MANUFACTURING COMPANY • LATROBE, PA.

DIVISION OF *The CARBORUNDUM Company*



Industrial Engineering Notes

(Continued from page 54A)

ing studies were made by George P. Adair, former FCC Chief Engineer. . . The Federal Communications Commission, by a Second Report and Order, has amended Part 16 of its rules governing Land Transportation Radio Services to make effective, as of March 15, rules with respect to common or contract carriers of property (highway trucks) in the Motor Carrier Radio Service. This action represents the final step in consolidating the Highway Truck, Intercity Bus and Urban Transit Radio Services into the new Motor Carrier Radio Service, as proposed by the commission on Nov. 4, 1953, and finalized Sept. 1, 1954. The new rules establish nine frequencies to be allocated exclusively (44.10, 44.14, 44.18, 44.22, 44.26, 44.30, 44.34, 44.38 and 44.42 mc), and three frequencies (43.98, 44.02, 44.06 mc) to be allocated on a shared basis (with the carriers of passengers) to these property carriers operating between urban areas, i.e., for long range communications. The block of seven frequencies (44.18-44.42 mc) allocated in the First Report and Order to intercity passenger carriers is now shifted to 43.70-43.94 mc. Licensees in the present Highway Truck Service who are affected

(Continued on page 62A)



The New **MUELLER MINI-GATOR** (miniaturized alligator clip)

Half an "alligator" is better than one! . . . the Mini-gator is half the length of standard alligator clips. It's the smallest clip ever made, for quick temporary electrical connections.

IT'S THE ONLY MINIATURIZED CLIP IN THIS AGE OF MINIATURIZATION!

Steel (cadmium plated) or solid copper

1-1/16" long
1/20th oz.
Jaws open 3/16"
Nose 11/64" O.D.

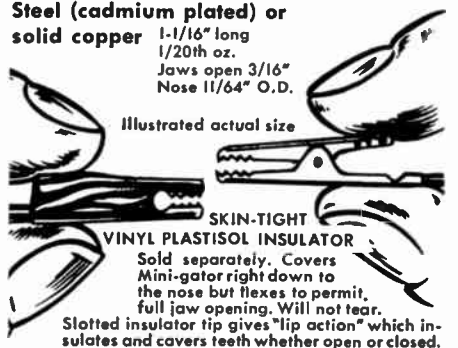

Write to factory for free samples and complete information.

Mueller Electric Co. 1563Y E. 31st Street, Cleveland 14 Ohio

For Generation of Pulse Voltages -

CHATHAM MODEL 5C22 HYDROGEN THYRATRON



A three electrode zero bias thyatron with peak power handling capacity to 2.6 megawatts

ELECTRICAL DATA

	MIN.	BOGEY	MAX	
HEATER VOLTAGE	5.8	6.3	6.8	Volts
HEATER CURRENT @ 6.3V	9.6	10.6	11.6	Amps
CATHODE HEATING TIME	300			Sec.
ANODE VOLTAGE DROP, PEAK	100	150	200	Volts

For detailed characteristic data request sheet DSW-104-1

MAXIMUM RATINGS—Absolute Values

Maximum Peak Anode Voltage	
Inverse	16 Kilovolts
Forward	16 Kilovolts
Minimum Peak Anode Voltage	
Inverse	800 Volts
Forward	4500 Volts
Maximum Cathode Current	
Peak	325 Amperes
Average	200 Milliampères
Averaging Time	1 Cycle
Minimum D.C. Anode Voltage	4500 Volts
Maximum Operating Frequency (Note 1)	1000 cps
Minimum Peak Trigger Voltage	200 Volts
Maximum Peak Trigger Voltage	600 Volts
Maximum Heating Factor (Note 2)	3.2×10^9
Maximum Current Rate of Rise	1500 Amps/ μ s.
Maximum Anode Delay Time	1 μ s.
Maximum Time Jitter	0.02 μ s.
Ambient Temperature	+90 to -50°C

NOTE 1: This is not necessarily the upper operating frequency limit but represents the highest repetition rate for present life test requirements.

NOTE 2: Heating factor is the product (epy x prr x ib).

CHATHAM TYPE VC-1257

Hydrogen filled, zero bias thyatron with hydrogen reservoir for generation of pulse power up to 33 megawatts.



CHATHAM TYPE 5948/1754

Hydrogen filled, zero bias thyatron with hydrogen reservoir for generation of peak pulse power up to 12.5 megawatts.



CHATHAM TYPE 5949/1907

Hydrogen filled, zero bias thyatron with hydrogen reservoir for generation of peak pulse power up to 6.25 megawatts.



CHATHAM TYPE VC-1258

Zero bias miniature hydrogen thyatron for the generation of peak pulse power up to 10 KW. Also available with a 2E v heater and in a super ruggedized type for extreme vibration.



Chatham Hydrogen Thyatrons are the product of many years of concentrated experience in this specialized field. Embodying the most advanced developments in the art, the tubes illustrated offer uniformly high performance

when employed in the generation of pulse voltages in the order of microseconds. For complete data and specifications on Chatham Hydrogen Thyatrons, call, write or wire today - no obligation.

Chatham Electronics

DIVISION OF GERA CORPORATION - LIVINGSTON, NEW JERSEY



▶ miniaturizing your antenna

PROBLEMS
PROBLEMS
PROBLEMS
PROBLEMS
PROBLEMS
PROBLEMS
PROBLEMS

Whether it is miniaturizing an airborne antenna down to fighting weight, or designing new ground based waveguide systems . . . Airtron's complete antenna facilities . . . including research, design, testing and mass production of precision components . . . can substantially reduce the time and expense between concept and reality.

Airtron offers you "standard" antenna plumbing . . . or will engineer a new design to fit your antenna application, and deliver it complete from flexible waveguide input to feed horn. Whatever your need, you'll get components that meet your every requirement for high power broadband operation, low VSWR, pattern accuracy, as well as special mechanical characteristics.

For full details on Airtron's microwave antenna facilities and their application to your antenna problems, write or call today.

Airtron inc.

1107 W. Elizabeth Ave.
LINDEN, NEW JERSEY
Linden 3-1000

Branch Offices:
Albuquerque
Chicago
Dallas
Dayton
Kansas City
Los Angeles
San Francisco
Seattle
London

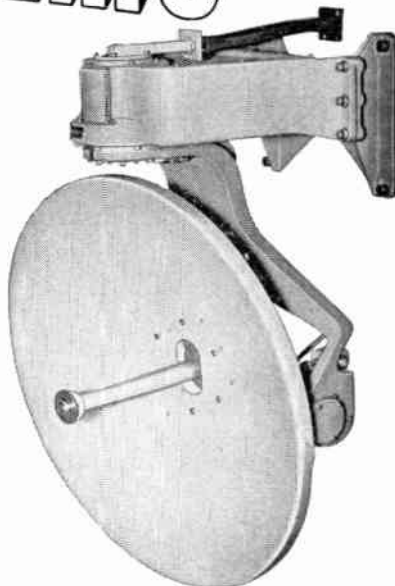

Industrial Engineering Notes

(Continued from page 60A)

by the new rules and who must shift frequencies may apply for modification of their licenses at any time after March 15, but must do so not later than 60 days prior to the expiration of their licenses. Also, licensees who have not been transferred to the proposed Special Industrial Radio Service and who will be ineligible in the new Motor Carrier Radio Service may continue to operate for five years after March 15, but during this amortization period they will not be authorized to expand their facilities or operations.

FEDERAL PERSONNEL

President Eisenhower has nominated Maj. Gen. James D. O'Connell to be Chief Signal Officer, U. S. Army, upon the Retirement of Maj. Gen. George I. Back effective May 1. Gen. O'Connell presently is Deputy Chief Signal Officer, a position he has held since December 1952. A graduate of the U. S. Military Academy in 1922, Gen. O'Connell became associated with the Signal Corps in 1936 when he was named officer in charge of the Specification and Records Section of the Corps' Laboratories at Fort Monmouth. In January 1940 he became executive officer of the Signal Corps Laboratories, and a year later was

(Continued on page 64A)

VHS* RELAY

(*Very High Sensitivity)



Model 266

Sample specs. are:
0.2 micro-ampers, (12,000 ohms coil) or, 0.1 millivolts, (5 ohms.)



• The VHS is a balanced armature, Alnico magnet type relay. It is internally shock-mounted and resistant to vibration. The screw-on cover is gasket sealed. It can be opened and resealed.

Connections: 9 pin octal style. Dimensions: 1 3/4 diameter x 2 1/4 long. Weight: 4 ounces. Sensitivity: Infinite variations from 0.2 Ua. to 10 Amp. or 0.1 Mv. to 500 volts, self contained. Higher volts or amps with external multipliers. A.C. rectifier types. Trip point accuracies to 1%. Differential 1%. The degree of resistance to shock and vibration primarily depends upon sensitivity and type of action wanted. In general, the relays will not be permanently damaged by shocks of 100 G's and vibrations up to 2,000 cps at 4 G's. The most sensitive relays may close their contacts under these conditions.

Contacts: SPST or SPDT, 5-25 Ma. D.C. Other ratings to 1/2 Amp. A.C. A locking coil gives high pressure and chatter free contact under shock and vibration.

Prices: \$20 - \$80.
Delivery 4 to 6 weeks.
Assembly Products, Inc.,
Chesterland 2, Ohio.

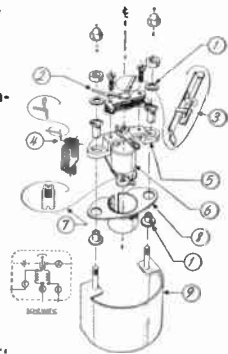

Write for explanation of symbols

THERE ARE NONE FINER!



TRU-OHM POWER RHEOSTATS
 are more and more in demand and
 there are many reasons. These
 include finest quality, better service,
 and delivery; UL approval; variety from
 25 watts up; fairest prices; AND TRU-OHM
 expedites for YOU . . . TRU-OHM ships on time.

We invite your inquiry.
 Have you received our latest catalog? **WRITE TODAY!**



General Sales Office: 2800 N. Milwaukee Avenue, Chicago 18, Ill.

Factory: Washington, Indiana

"Largest producers of wire-wound resistors in the U.S.A."

Division of
 Muel Engineering
 & Mfg., Inc.



MANUFACTURERS: Power Rheostats, Fixed Resistors, Adjustable Resistors, "Econohm" Resistors, "Tri-rib" Resistors

**Best Way TO KEEP
6080 SIZE
TUBES**



i. e. r. c.'s

T-12

Tube Shield Designed for Use in Severe Heat and Vibratory Environments greatly extends life of the larger, expensive tubes under all conditions! Effective cooling of bulb (up to 50%) makes the T-12 shield ideal for use in all equipment.

TECHNICAL BULLETIN T-12 is available by writing: Sales Dept., I. E. R. C., 177 W. Magnolia Blvd., Burbank, Calif.

Patent Pending



PROVEN

in missiles-

NOW

in production

to meet

demands

for every

application!



Industrial Engineering Notes

(Continued from page 62A)

appointed officer in charge of the Communications Projects Section there. Gen. O'Connell, in 1944, was assigned Chief of the Requirements Branch, Signal Section, of the 112th Army Group, with which he served in England, France and Germany. In 1945 he became Director of the Signal Corps Engineering Laboratories at Ft. Monmouth.

INDUSTRY STATISTICS

Over six million radios, excluding automobile receivers, were shipped to dealers during the calendar year 1954, the RETMA Statistical Department reported. During December, 1,059,166 radios went into the hands of dealers, compared with 711,554 radios shipped to dealers in November. Shipments to dealers during the calendar year 1954 totaled 6,187,503 units, compared to the 7,243,073 radios shipped to dealers in 1953.

LABOR RELATIONS

Revised lists of essential activities and critical occupations were issued by the government and, although considerably reduced from the previous lists, continue electronic and communications equipment workers and technicians in the essential category. The original lists included 25 essential activities and 62 critical occupations, as compared with 10 essential activities and 32 critical occupations on the lists just issued. Secretary Weeks said to qualify for the essential activities list the activity must be one which is: (1) necessary to the defense program, or to basic health, safety, or interest and (2) inadequate to meet defense and civilian requirements because of manpower shortages or for which the future manpower supply is not reasonably assured. The Labor Department's list of 32 critical occupations includes, in part, electronic technicians, instrument repairmen, machinists, design engineer draftsmen, mathematicians, physicists, college and vocational teachers (critical occupations only), tool and die designers, and tool and die makers.

TECHNICAL

The National Bureau of Standards recently announced that it has found increasing application of the inductance transducer in electronic distance measuring instruments, an instrument originally developed by M. L. Greenough. Until recently, design analysis of the transducer has been restricted to its immediate use in a particular instrument, the Bureau said, but there has been a growing need for general design criteria for use in future applications. To provide the necessary data, H. M. Joseph and N. Newman of the Electronic Instrumentation Laboratory have made a detailed study of the device's

(Continued on page 66A)

International



electronic research corporation

Specialists in the
Unusual

DIRECT TEMPERATURE MEASUREMENT
UP TO **3700°F.**

**IRIDIUM
vs. RHODIUM IRIDIUM
THERMOCOUPLE WIRE**

The only thermocouple material which may be used at these very high temperatures in an oxidizing atmosphere.

Ductile wire made possible by high purity and our advanced melting and drawing techniques.

Output: Over 10 millivolts at 3700°F
Uniform • Reproducible

SINCE 1901



Write for List of Products

SIGMUND COHN CORP.,
121 So. Columbus Avenue • Mount Vernon, N.Y.



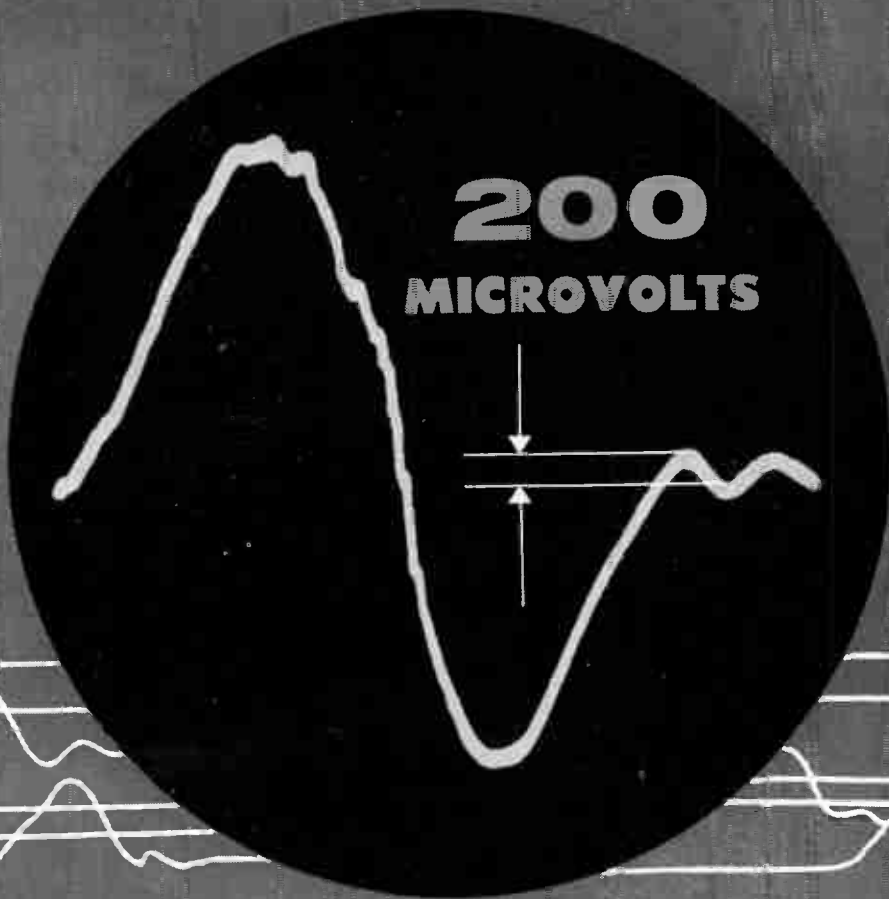

(ACTUAL SIZE PHOTO)

... and this amazing sensitivity is only one of many outstanding characteristics of the entirely new DuMont Type 324 cathode-ray oscillograph. New standards of stability, low noise and hum level assure full use of the Type 324 for d-c to 300 kc measurements even in the microvolt region. Furthermore, the Type 324 is completely calibrated to read time and amplitude directly. There are so many features incorporated in this new instrument we can't begin to give you the whole story here. Write us for complete specifications, or better still, ask for a demonstration of the

NEW **DU MONT** TYPE 324

For further information write to:

Technical Sales Department • ALLEN B. DU MONT LABORATORIES INC. 760 Bloomfield Ave., Clifton, N. J.



EPIC FAST PULSE AND COUNTING EQUIPMENT

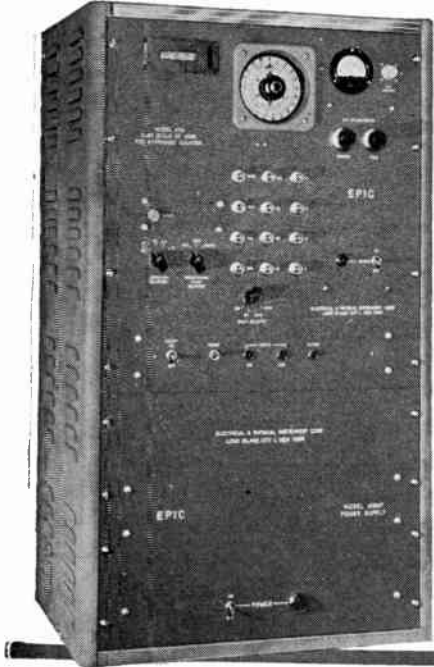

10 MC SCALERS (Model 4000 Series)

available with:

- Predetermined count
- Predetermined time
- Regulated 500-2.5kv high voltage power supply
- Automatic reset
- Decade or binary systems
- Scale of 1000 or 4096
- 0.1 microsecond resolution
- Preamplifiers and pulse height discriminators

A wide range of choice makes it possible to select the exact high-speed counting equipment desired, from the basic manual models to the most fully automatic and complex counting systems.



(Continued from page 64A)

operating principles with major emphasis on transducers using highly conducting reference plates. The study, "Design Criteria for Mutual Inductance Transducers," will appear in detail in the Bureau's monthly publication, *Technical News Bulletin*.

TELEVISION

The Technical Research Division, Office of the Chief Engineer, Federal Communications Commission, has published T.R.R. Report No. 2.4.13, "Tropospheric Field Strength of 534.75 Megacycle Signals from Bridgeport, Connecticut." Copies may be obtained from the FCC Technical Research Division, Room 7358, New Post Office Building, Washington 25, D. C. The report deals with transmissions from NBC's experimental UHF television station at Bridgeport (1950-52). Results are reported for data collected at distances of from 30 to 240 miles with the cooperation of the Radio Corporation of America, National Bureau of Standards, University of Connecticut and FCC Monitoring stations.

(Continued on page 70A)

MILLIMICROSECOND

Square Pulse Generators with single or multiple pulse-outputs: ▶

Rise Time: .001 μ sec. from 10% to 90% amplitude.

Pulse Width: .001 μ sec. to several μ sec.

Pulse Amplitude: From 100 volts to .006 volts in one db steps.

Output Imp: Matched to any impedance for standard coax lines. Multi impedance outputs also available.



WIDE BAND AMPLIFIERS (Model 700 Series)

Band Width: 2000 cycles to above 10 MC
Gain: 40 db or 60 db (Higher Gains Also Available)

Gain Control: Coarse and Fine Gain Controls Permit a Continuous Gain Variation by a Factor of 100 on Some Models.

Output Limit Level: To 50 Volts for Positive Pulses on Some Models.

Input: Positive or Negative Pulses, or Sine Wave Discriminator: 0-50 Volt Positive Amplitude Discriminator for Fast Pulses Also Available.

PULSE GENERATORS • 0-10MC COUNTING SYSTEMS • PLUG-IN COUNTING SYSTEMS • 0.1 MICROSECOND RESOLUTION COUNTER CHRONOGRAPHS

ALSO CUSTOM DESIGNED EQUIPMENT TO MEET YOUR INDIVIDUAL REQUIREMENTS!

Write for detailed engineering bulletin No. 407



ELECTRICAL & PHYSICAL INSTRUMENT CORPORATION

42-19 27th Street, Long Island City 1, N. Y.

FOIL NAME PLATES

ADHESIVE-BACKED

park "thinplates"

are .003-inch aluminum foil **ANODIZED**, and backed by pressure sensitive adhesive. These plates conform to JAN specifications.

PARK NAMEPLATE CO., INC.
61-07 32 Ave.
Woodside 77, N.Y.

for versatile **PRESSED** Ceramics

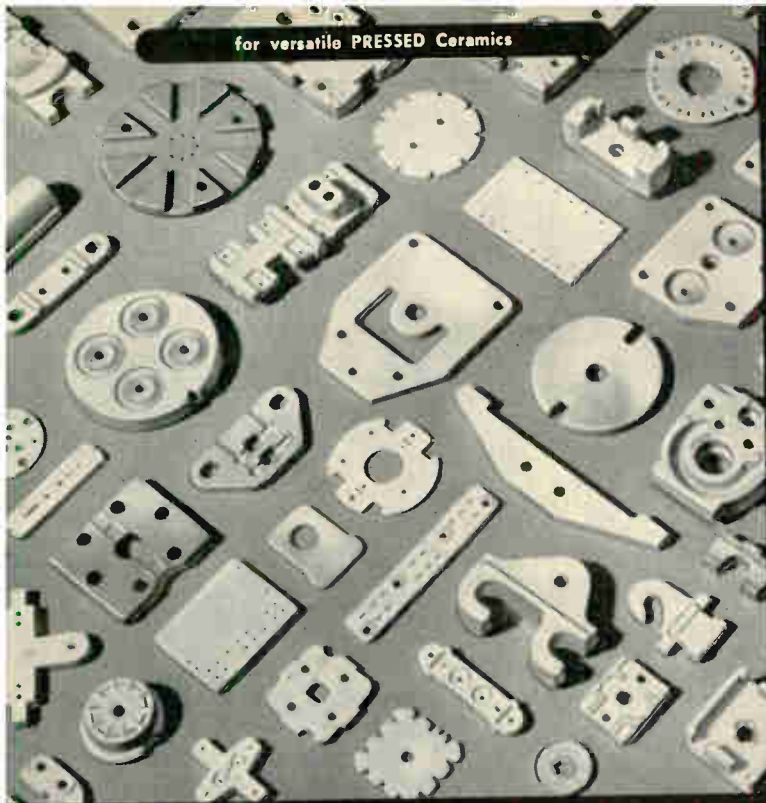

for uniform **EXTRUDED** Ceramics



Custom-made Technical Ceramics
**FOR WIDEST CHOICE OF MATERIALS
FOR VOLUME PRODUCTION
FOR DELIVERY AS PROMISED**

Send your blueprint with outline of operating conditions and let our engineers show you what ALSiMag can do for you!

ALSiMAG®

54TH YEAR OF CERAMIC LEADERSHIP

AMERICAN LAVA CORPORATION

A Subsidiary of

Minerals Mining and Manufacturing Company
CHATTANOOGA 5, TENNESSEE

BRANCH OFFICES (see your local telephone directory): Cambridge, Mass. • Chicago, Ill. • Cleveland, Ohio • Dallas-Fort Worth, Tex. • Indianapolis, Ind. • Los Angeles, Calif. • Newark, N. J. • Philadelphia-Fridborough, Pa. • St. Louis, Mo. • South San Francisco, Calif. • Syracuse, N. Y. • Tulsa, Okla. **Canada:** Irwinston Varnish & Insulator Division, Minerals Mining & Manufacturing of Canada, Limited, 290 Burlington Street, East Hamilton, Ontario. Telephone: Liberty 4-5735.



for reliable **METAL-CERAMIC COMBINATIONS**



for precision **MACHINED** Ceramics

World Radio History

CO-AX



★ ULTRA LOW

capacitance & attenuation

WE ARE SPECIALLY ORGANIZED TO HANDLE DIRECT ORDERS OR ENQUIRIES FROM OVERSEAS

SPOT DELIVERIES FOR U.S.

BILLED IN DOLLARS—
SETTLEMENT BY YOUR CHECK
CABLE OR AIRMAIL TODAY



TYPE	$\mu\mu\text{F}/\text{ft}$	IMPED. Ω	O.D.
C1	7.3	150	.36
C11	6.3	173	.36
C2	6.3	171	.44
C22	5.5	184	.44
C3	5.4	197	.64
C33	4.8	220	.64
C4	4.6	229	1.03
C44	4.1	252	1.03

NEW

MX and SM SUBMINIATURE CONNECTORS
Constant 50 Ω 63 Ω 70 Ω impedances

TRANSRADIO LTD. 138A Cromwell Rd. London SW7 ENGLAND

CABLES: TRANSRAD, LONDON

LABSCOPE

Models 115-115R



for **QUALITY**

...PERFORMANCE

...RELIABILITY

Specially designed for the critical engineer who requires a versatile low-frequency oscilloscope with identical direct coupled X and Y amplifiers; high sensitivity; brilliant, hairline trace, and other exceptional features.

LABSCOPE OFFERS:

- Identical X and Y amplifiers. 10MV. P-P/IN
- Response from DC to 200 KC (3Db)
- Vertical expansion ten times full screen
- Sweep expansion over twenty times
- Constant input impedance
- Sweep range 2 CPS — 30 KC, 6 steps
- Accelerating potential of 4 KV
- Illuminated graticule

Write for complete technical specifications

LABSCOPE Inc.

728 GARDEN STREET · CARLSTADT, N. J.

Model 115
\$375.00
Model 115R
\$395.00
F.O.B. Plant

Closely Regulated
D-C Power Source with
**Proven
Reliability**

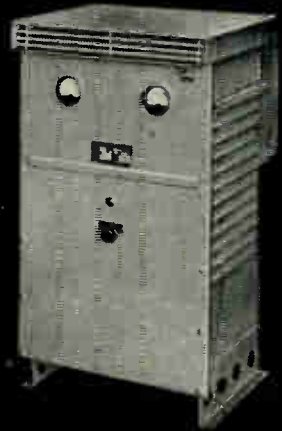

STAVOLT® POWER RECTIFIERS

Greatly simplified and stable circuitry with all-magnetic control. Fast response, no warm-up time, no hunting or drifting. Finest materials, encapsulated components. Lighter weight, smaller size, rugged. Mobile or stationary models of permanent dependability.

11 standard 28-volt models up to 1500 amps.
Meets Spec. MIL-E-7894.

Write for interesting information on STAVOLT rectifiers.

McCOLPIN-CHRISTIE CORP.

3410 W. 67th Street, Los Angeles 43, California

Specialists in Rectifier Manufacturing for 26 Years



STANDARDIZE WITH CANNON



NEW XLR
*...an important addition
to the XL Series*

Standardize with Cannon Audio Connectors . . . designed to meet all audio equipment disconnect needs. Simplify circuitry and cabling. Get quiet, continuous operation with the standard connectors of the industry - *Cannon Plugs*.

You'll find exactly the type you need in 14 extensive series expressly designed for radio, sound, TV and related fields . . . in cord, rack or panel chassis, audio and low-level, portable, hermetic sealed, miniature and subminiature, and power-supply types. Standard equipment with leading manufacturers of electronic equipment. The old reliable "Latchlock" feature on Cannon microphone connectors . . . standard on top-ranking microphones.

Complete Audio Connector Bulletin is yours for the asking . . . D Series in separate bulletin coded D-4.



P series



X series



for
simplified
AUDIO
circuitry!



BRS series



UA series



D series



U series



K series

CANNON PLUGS



Please refer to Dept. 377

CANNON ELECTRIC COMPANY

3209 Humboldt St.
Los Angeles 31, California

Factories in Los Angeles; East Haven; Toronto, Canada;
London, England. Licensees in Paris, Tokyo, Melbourne.
Representatives in all principal cities.
Distributors everywhere.



(Continued from page 66A)

RETMA ACTIVITIES

The Federal Communications Commission recently released results of a nation-wide survey of land-mobile radio services, begun last April and conducted with the cooperation of RETMA. The report, Public Notice 16187, covering stations in the Public Safety, Industrial and Land Transportation groups, is available from the Federal Communications Commission, Washington 25, D. C. Additional information requested by the industry already has been circulated by RETMA. . . . The RETMA Engineering Department has circulated a Standards Proposal covering a "Color Television Test Signal to Accompany Monochrome Transmission." The comment period expires March 23. The Standards Proposal was prepared by the Television System Committee and reviewed by the executive committees of the Technical Products Panel and Receiver Panel of the Engineering Department. The proposed test signal is designed to facilitate the installation of color television receivers and antennas by making observation possible during normal installation hours, without substantial burden to the broadcaster or significant impairment to the performance of monochrome broadcasts.



You can expect the same precision performance from both the McCoy M-1 and the M-20 "McMite," although the "McMite" is only 1/5th as big. Both crystals are produced up to 110 mc on the 5th overtone. The fact that these two crystals perform equally well in meeting widely varied job specs illustrates the versatility of McCoy design and production facilities. Whatever you need in quartz crystals, McCoy either makes them or can develop them for you. Send for free catalog today on the McCoy line of high quality, precision-made quartz crystals.

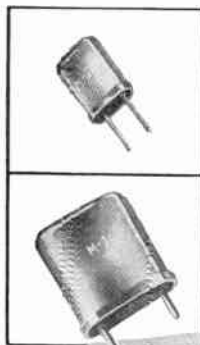

M-20 "McMite" is a sub-miniature hermetically sealed unit, adaptable to multi-channel design for communications and frequency control equipment. Can be wired into a sub-miniature selector switch assembly or soldered to a printed circuit terminal board. Furnished with either .018 inch dia. flexible wire leads or with .040 inch dia. rigid "plug-in" type pins.

M-1 is an hermetically sealed, plated crystal preferred when fundamentals below 5 mc are desired. Easily interchangeable, it plugs into a standard socket. Meets government specification MIL-C-3098A and CAA-R-916; also ARINC No. 401.

McCoy ELECTRONICS COMPANY
 MT. HOLLY SPRINGS, PENNA.
 Phone 376 and 377

Licencee under patents of
 Western Electric Company

ENGINEERS

Save your firm thousands of dollars in searching for data on **ELECTRONIC TEST EQUIPMENT** of interest to USAF.

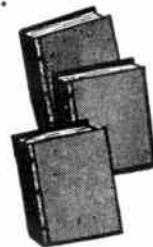

By special permission data sheets on Research supported and monitored under our WADC, ARDC contract now available to manufacturers at low cost.

- Order your copy of a three volume set containing illustrated descriptive data sheets on 870 items procured for use by the U. S. Air Force.
- Contains 2400 (8½ x 11") pages, recently brought up-to-date, mounted in 3 post expandable hard back binders.
- Price \$100 per set plus postage while supply lasts. Orders accompanied by check filled as received with postage paid.

CARL L. FREDERICK
 AND ASSOCIATES
 Bethesda 14, Maryland

marion

advancement
in instrument
design

new marion
MEDALIST*
meters



Model MM2 MEDALIST
Actual Size

Greater readability and modern styling in minimum space. Interchangeable with ASA/JAN 2½ and 3½ inch sizes. Up to 50% longer scale in same space as ordinary type. Available in various colors.

Comparison of Medalist and Standard Style

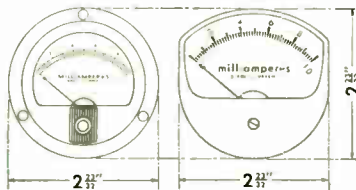

marion electrical instrument company

407 CANAL STREET, MANCHESTER, N. H., U. S. A.

Manufacturers of Ruggedized and "Regular" Panel Instruments & Related Products

copyright 1955 M.E.I. Co.

*Trademark Patents Pending.

marion meters



"MECHANISMS
ENGINEERED IN THE AIR"



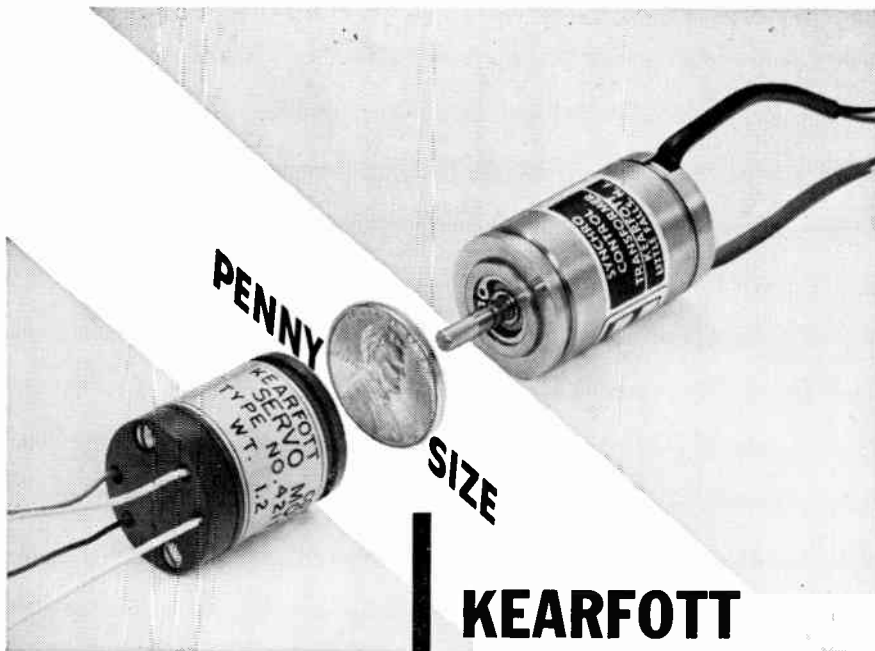

Lighter, more compact Servo Systems

Kearfott developed components to fill the need today, for tomorrow's Servo Systems.

KEARFOTT "Penny Size" Servo Motors and Synchros

SERVO MOTORS

- 3/4" Diameter x 1.5" long
.33 in. oz. Stall Torque
6500 RPM, 26 Volt 400 Cycle
- 3/4" Diameter x .937" long
.10 in. oz. Stall Torque
6500 RPM, 26 Volt 400 Cycle

Straight thru bore and potted stator construction provide environmental resistance and high order of performance to these Motors and Synchros. Technical data sheets sent on request.

KEARFOTT COMPONENTS INCLUDE:

Gyros, Servo Motors, Synchros, Servo and Magnetic Amplifiers, Tachometer Generators, Hermetic Rotary Seals, Aircraft Navigational Systems, and other high accuracy mechanical, electrical and electronic components.

ENGINEERS:

Many opportunities in the above fields are open—please write for details today.

SYNCHROS

- 3/4" Diameter x 1.240" long
Transmitter, Control Transformers, Resolvers and Differentials
10 minute maximum error,
26 volt, 400 cycle excitation



A SUBSIDIARY OF GENERAL PRECISION EQUIPMENT CORPORATION

KEARFOTT COMPANY, INC., LITTLE FALLS, N. J.

Sales and Engineering Offices: 1378 Main Avenue, Clifton, N. J.
Midwest Office: 188 W. Randolph Street, Chicago, Ill. South Central Office: 6115 Denton Drive, Dallas, Texas
West Coast Office: 253 N. Vinado Avenue, Pasadena, Calif.



Professional Group Meetings

AERONAUTICAL AND NAVIGATIONAL ELECTRONICS

The Dayton Chapter of the Professional Group on Aeronautical and Navigational Electronics met on February 3 at the Engineer's Club with P. G. Wiegert presiding. Professor P. D. Coleman of the University of Illinois spoke on "Micrometer Wavelength." Dr. Coleman described a compact, single cavity, microwave electron accelerator and buncher capable, theoretically, of producing a 1 to 1.5 mev. electron beam, space bunched to 80 microns with the order of 10^8 electrons per bunch.

ANTENNAS AND PROPAGATION

The Albuquerque-Los Alamos Chapter of the Professional Group on Antennas and Propagation met on January 5 at the University of New Mexico. F. J. Janza was the presiding officer and E. S. Gillespie of the Sandia Corporation was the speaker. Mr. Gillespie summarized airborne antennas for communication and navigation. He discussed various types of antennas, including vertical dipole, trailing wire, Vee, insulating trailing edge, insulated tail tip, notch, spike, pitot tube, protruding, and flush-zero drag.

(Continued on page 74A)

LARGEST VARIETY

of
SIZES and
TYPES

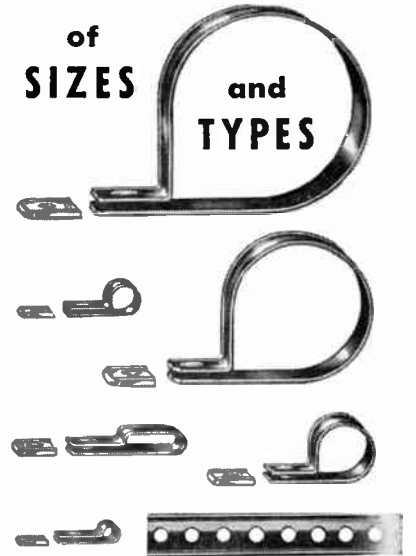

PLASTIC CABLE CLIPS and PERFORATED STRAPPING

Hold open wiring, fragile components, tubing, etc. with these safe, light weight supports.

Free samples and complete information.

WECKESSER CO.

5269 N. Avondale Ave., Chicago 30, Ill.

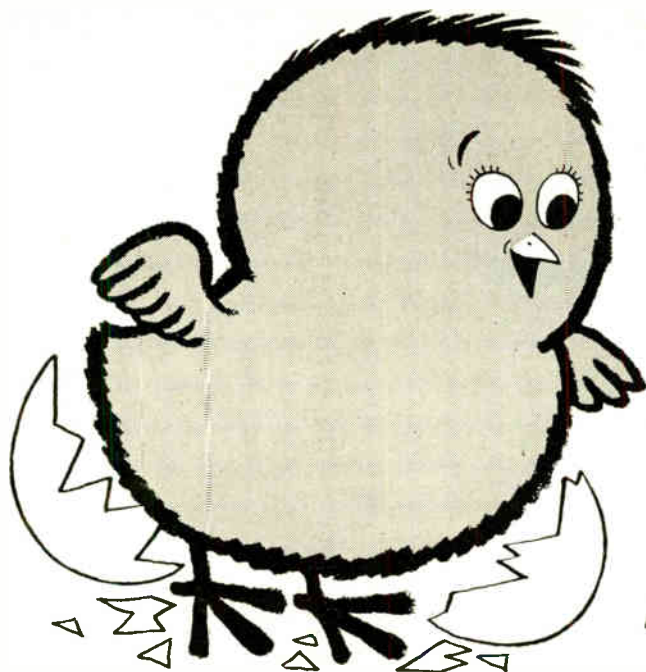

**hatched
by**
HYDRO-AIRE

a low cost **H-F TRANSISTOR** you can count on!

THE BONDED BARRIER TRANSISTOR

First dependable H-F Transistor for quantity production

ABSOLUTE MAXIMUM SPECIFICATIONS	Collector Voltage	-12 volts
	Collector Current	-3 ma
	Collector Dissipation	30 mw
	Ambient Temperature	55°C.

AVERAGE CHARACTERISTICS AT TEMP. 20° C., FREQ. 1 kc, COMMON BASE

Collector Voltage	-4.5 volts
Emitter Current	0.5 ma
H 11, input impedance, output short circuit	350 ohms
H 12, voltage feedback ratio, input open circuit	3.5×10^{-4}
H 21, current amplification, output short circuit	-0.75
H 22, output admittance, input open circuit	10 mu ohms
Ico, Collector Cutoff Current	-5 mu a.
Max. Power Gain, Gnd. Emitter	25 db
Freq. Cutoff	5 mc

**OTHER
HYDRO-AIRE
FIRSTS**

- Hermetic Sealing
- Transistor Socket Strips
- Packaged line of Transistorized Audio Pre-amplifiers



**NOW READY FOR QUANTITY
PRODUCTION AT LOW COST**

We held off counting this chicken until it was well and truly hatched! And now that time has come. The Bonded Barrier Transistor has been exhaustively tested, and found dependable in service throughout the frequency range shown at left. Not only that: the Bonded Barrier process is ideally suited for large-scale production. Hydro-Aire's Electronics Division is now completing new mass production facilities to meet the widespread demand for a transistor that offers such great potential in electronic design. Sample quantities are already being shipped to certain users. You will appreciate that we shall have to hold to certain priorities on such a much-needed item; but we shall deal as fairly as possible with all legitimate inquiries. We can only advise you to contact us right away, so that you may be high on the list, both for test quantities now and production quantities later. Please write on your company letterhead.

ELECTRONICS HYDRO-AIRE
 Division of 3000 WINONA AVENUE, BURBANK Inc.

The Aviation
Subsidiary of



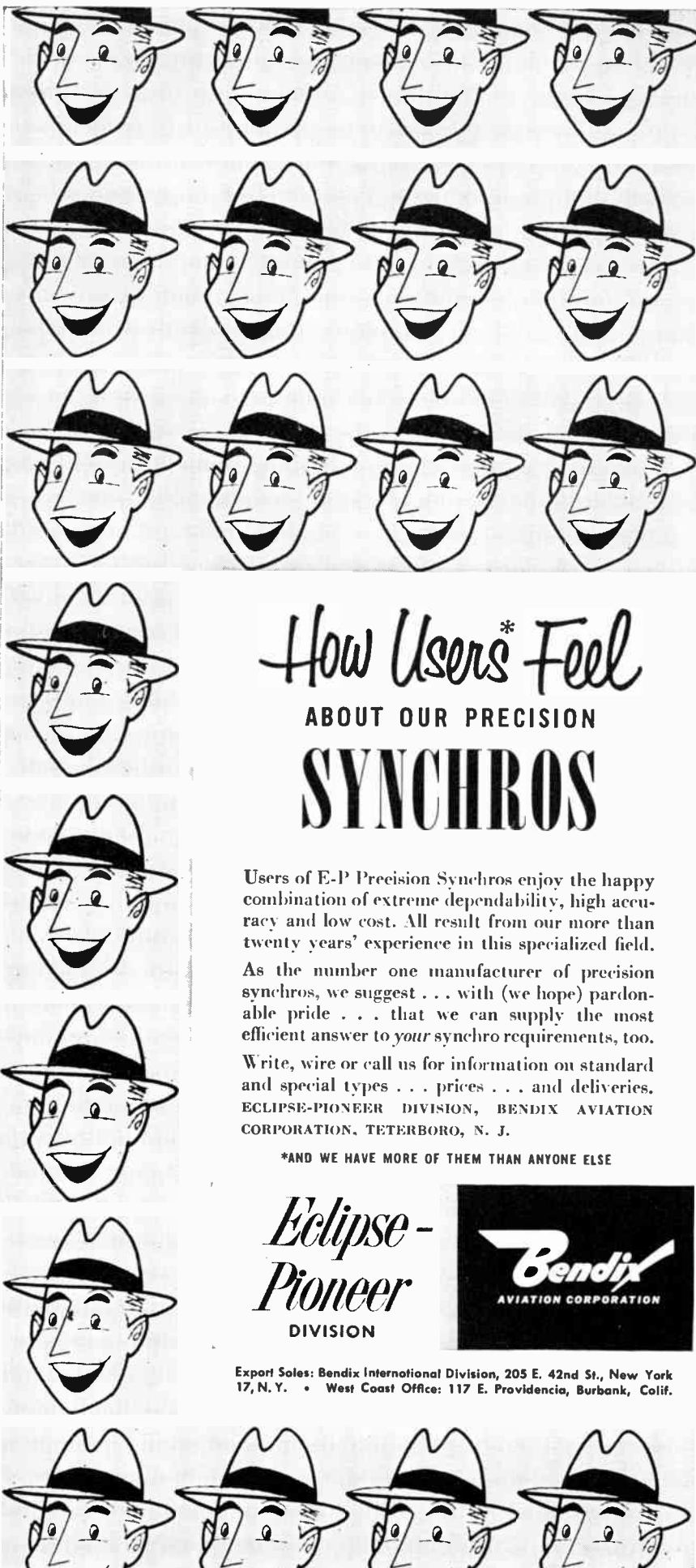

How Users* Feel

ABOUT OUR PRECISION

SYNCHROS

Users of E-P Precision Synchros enjoy the happy combination of extreme dependability, high accuracy and low cost. All result from our more than twenty years' experience in this specialized field.

As the number one manufacturer of precision synchros, we suggest . . . with (we hope) pardonable pride . . . that we can supply the most efficient answer to *your* synchro requirements, too.

Write, wire or call us for information on standard and special types . . . prices . . . and deliveries. ECLIPSE-PIONEER DIVISION, BENDIX AVIATION CORPORATION, TETERBORO, N. J.

*AND WE HAVE MORE OF THEM THAN ANYONE ELSE

*Eclipse -
Pioneer*
DIVISION



Export Sales: Bendix International Division, 205 E. 42nd St., New York 17, N. Y. • West Coast Office: 117 E. Providencia, Burbank, Calif.

Professional Group Meetings

(Continued from page 72A)

AUDIO

On February 21 the Albuquerque-Los Alamos Chapter of the Professional Group on Audio met, with Hoyt Westcott presiding. The program consisted of a tape recording and slides on "Time and Frequency Compression." The tape was made available through the national PG on Audio.

CIRCUIT THEORY

With Harry Woll presiding, the Philadelphia Chapter of the Professional Group on Circuit Theory met on February 10 at the University of Pennsylvania. There were three speakers. A. I. Frank, Brown Instrument Division of Minneapolis-Honeywell, discussed "A Compact Transistor Current-Gain Meter." D. R. Crosby, RCA in Camden, spoke on "Novel Uses of the Equivalent T Network for Distributed Structures." "An Aural Vacuum Tube Voltmeter" was the name of the paper delivered by Thomas A. Benham, Assistant Professor of Physics at Haverford College.

The Albuquerque-Los Alamos Chapter met on February 23 at the University of New Mexico. Alex Fursa presided. Col. Leo V. Skinner, U.S.A.F., continued his introduction to non-linear circuit theory and emphasized the method of equivalent linearization.

(Continued on page 76A)

for that short grid lead

use the Sangamo



First used in Navy electronic gear, Tote-m-poles are invaluable for "bug-resistant" wiring of models and production units. Advantages: Short leads; high component density; improved ventilation.

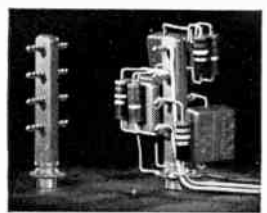

Tote-m-pole supporting "T" network of 5 resistors and 4 capacitors.

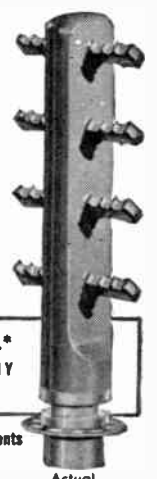

Actual Size

CUSTOM COMPONENTS DEPT.*
SANGAMO ELECTRIC COMPANY
SPRINGFIELD, ILLINOIS

*H. V. Power Supplies • Inductive Components
Servo Instruments • Low-X Resistors

VITAL SPOTS IN NATIONAL SECURITY

THESE **FREED** COMPONENTS CONTRIBUTE EFFICIENT, RELIABLE PERFORMANCE IN RADAR, LORAN AND SONAR DEVICES.

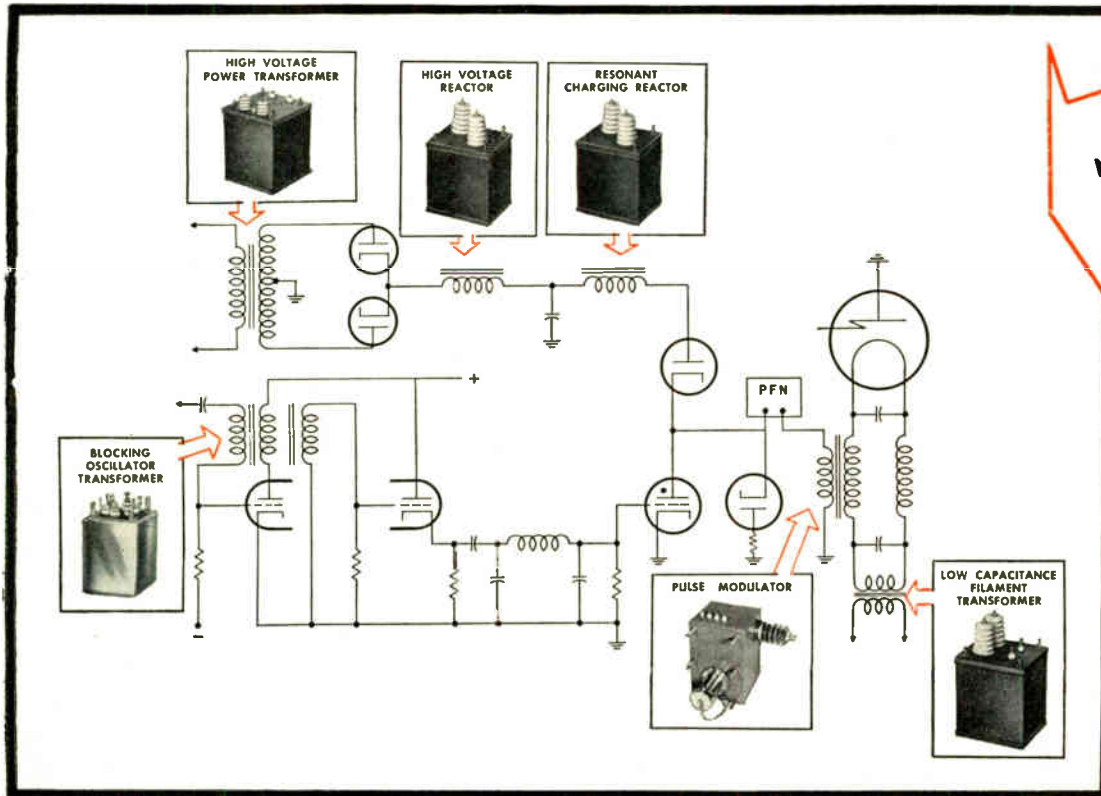

TYPICAL PULSE MODULATOR SHOWS APPLICATIONS OF FREED COMPONENTS

OTHER FREED PRODUCTS TRANSFORMERS

- High Fidelity
- High Level Pulse
- High Q Toroids
- Power
- Slug-Tuned
- Hermetically Sealed
- Step-down
- Magnetic Amplifiers
- Miniature Transistor
- High Q Reactors
- High Temperature
- Miniature Audio
- Charging Reactors
- Sub-Miniature
- Precision Reactors
- Precision Filters

INSTRUMENTS

- Comparison and Limit Bridges
- Low Frequency "Q" Indicators
- Incremental Inductance Bridges
- Universal Bridges
- Null Detectors and V.T. Voltmeters
- Power Supplies
- A.C. Bridges and Accessories
- Differential Voltmeters
- Harmonic Distortion Meters
- Wide Band Amplifiers
- Decade Amplifiers
- Decade Inductors
- Decade Capacitors
- Megohmmeters
- Filters
- Magnetic Voltage Regulators

How well our detection and warning services will function in time of emergency will depend upon the performance of each individual component. Imaginative engineering, selected materials, careful inspection and constant quality control make Freed products the ultimate in the industry.

Send for further information and catalog

FREED TRANSFORMER CO., INC.

1720 Weirfield St., Brooklyn (Ridgewood) 27, N.Y.

DECADE RESISTANCES & VOLTAGE DIVIDERS

delivered from stock

Accuracy: 10 ohms and above: $\pm 0.1\%$
 1 ohm: $\pm 0.25\%$
 0.1 ohm: $\pm 1\%$
 0.01 ohm: $\pm 5\%$

Temp. Coeff.: $\pm 0.002\%$ per degree C.

Maximum Load: $\frac{1}{2}$ -watt per step

Frequency Limit: Non-inductive to 20KC

DECADE RESISTANCE BOXES

Type	Dials	Ohm Steps	Total Resistance—Ohms	Price
817	3	0.01	11.1	\$60.00
818	3	0.1	111	51.00
820	3	1	1,110	56.00
821	3	10	11,100	60.00
822	3	100	111,000	63.00
823	3	1,000	1,110,000	77.00
824	3	10,000	11,100,000	120.00
817-A	4	0.01	111.1	75.00
819	4	0.1	1,111	71.00
825	4	1	11,110	77.00
826	4	10	111,100	79.00
827	4	100	1,111,000	92.00
828	4	1,000	11,110,000	139.00
8285	5	0.1	11,111	94.00
829	5	1	111,110	101.00
830	5	10	1,111,100	113.00
831	5	100	11,111,000	155.00
817-C	6	0.01	11,111.1	105.00
8315	6	0.1	111,111	109.00
832	6	1	1,111,110	121.00
833	6	10	11,111,100	169.00



UNMOUNTED DECADE RESISTANCES

Type	Dials	Ohm Steps	Total Resistance—Ohms	Price
435	1	0.1	1	\$12.00
436	1	1	10	13.25
437	1	10	100	13.25
438	1	100	1,000	15.00
439	1	1,000	10,000	16.00
440	1	10,000	100,000	18.50
441	1	100,000	1,000,000	32.50
442	1	1,000,000	10,000,000	60.00



DECADE VOLTAGE DIVIDERS (Potentiometers)

Type	Dials	Ohm Steps	Total Resistance—Ohms	Price
845	3	1	1,000	98.00
837	4	0.1	1,000	126.00
835	4	1	10,000	132.00
836	4	10	100,000	146.00

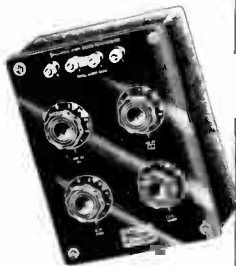

SHALLCROSS MANUFACTURING COMPANY

524 Pusey Ave., Collingdale, Pa.

Shallcross



Professional Group Meetings

(Continued from page 74A)

COMPONENT PARTS

The Washington Chapter of the Professional Group on Component Parts met on February 16 at the Manse Lecture Room of the National Bureau of Standards. Robert O. Stone, of the General Miniaturization Laboratory, National Bureau of Standards, delivered a paper called "Waveguide Filter Design Techniques." Mr. Stone demonstrated a waveguide filter assembly which was tunable by denting the walls with a specially designed denting assembly.

On January 12 the Washington Chapter again met under the chairmanship of Gustave Shapiro. W. Lucy presented a paper entitled "Magnetic Materials."

ELECTRONIC COMPUTERS

On February 14 the New York Chapter of the Professional Group on Electronic Computers met for the second time this year. Byron L. Havens, Engineer in Charge of the NORC Project of the Watson Scientific Laboratory, discussed "The Naval Ordnance Research Calculator (NORC)." Following the talk a tour of the NORC installation was given.

The New York chapter also met on

(Continued on page 78A)

new!

Microdot Brochure

...How to use the world's smallest, lightest coax

Write for our helpful free Brochure illustrating the world's only complete line of microminiature Coax Connectors, Cables, Tools and Assemblies, including Mininoise Cable to reduce self-generated noise 99%.

MICRODOT
 1826 FREMONT AVENUE
 SO. PASADENA • CALIF.

now SANBORN

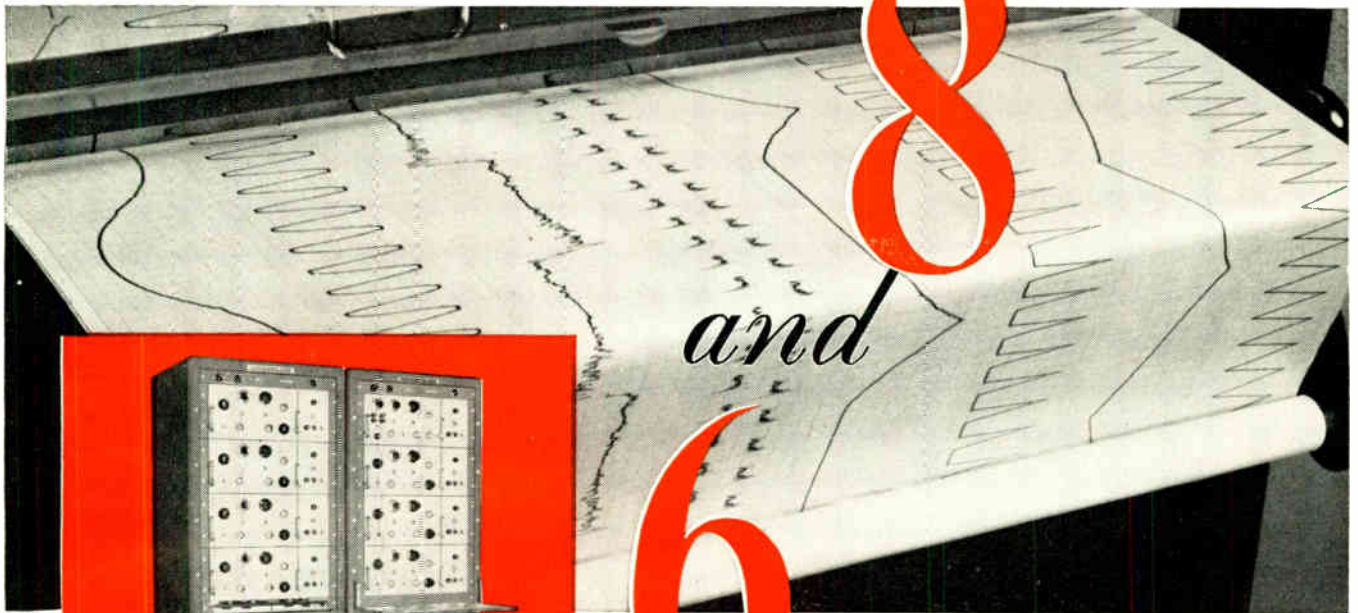

and

6

CHANNEL "150" SERIES OSCILLOGRAPHIC RECORDING SYSTEMS

in
addition to



and



Channel
Models

These new additions to the "150 family" follow the original "150" design concept which permits rapid change-over from one set of recording requirements to another by means of interchangeable, plug-in type preamplifiers.

The Model 158-5460 eight-channel system (upper left photo) consists of an eight channel recorder assembly and eight Driver Amplifier-Power Supply units. To this basic assembly the user adds any combination of Sanborn "150" plug-in preamplifiers to meet his requirements. Each channel provides a 4 cm deflection.

The six-channel system (156-5460) has the same basic assembly, except for *two less* galvanometers and *one less* Driver Amplifier-Power Supply unit in each cabinet. Each channel provides a 5 cm deflection.

Both systems offer: *nine* chart speeds (0.25 to 100 mm/sec.); *extended* frequency response; *improved* regulated power supplies; *individual* stylus temperature control for each channel; *improved* control of input signals by 1, 2, 5, 10, 20, etc. attenuator ratios; controls for timing, manual and remote coding.



Also 8 and 6 Channel Systems
for recording analog computer outputs,



or other applications where 1 volt/cm sensitivity is usable. complete eight-channel system shown comprises four Model 150-2000 Dual Channel DC Amplifiers and an eight-channel Recorder Assembly. Each Dual-Channel Amplifier is complete with common power supply. (The six-channel version is identical, except for two less galvanometers and one less Dual-Channel Amplifier.) Also four channel models.

Write for catalog material on any
Sanborn "150" Recording System

SANBORN  **COMPANY**
CAMBRIDGE 39, MASS.

**ONE
RELAY**

**53
circuits**

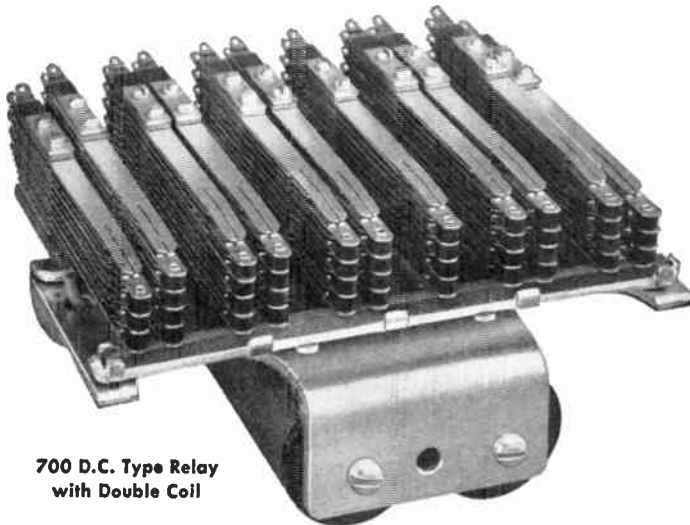

700 D.C. Type Relay
with Double Coil

North's 700 series "gang" relays provide for up to 53 circuits on an 11 pileup arrangement. They incorporate North's exclusive contact spring design featuring heavy support springs to damp impact energy of fast opening and closing, minimizing contact bounce and vibration. The unusual capacity of this relay permits a great variety of contact arrangements in compact form (mounting width 5 inches). Widely used in computers, sorting and punching machines, automation and many types of industrial controls.

For D.C. Operation

Single Coil for 10 to 32 form A or 10 to 16 form B or form C

Double Coil for up to 53 form A or up to 32 form B or form C

Operate Speed—25 to 75 milliseconds depending upon spring load and coil arrangement.

Also available with rectifier conversion units for A.C. relay operation having 10 to 32 form A contacts or 10 to 16 form B or form C contacts. Size, both A.C. and D.C. types, 4-5/16" x 5" x 1-27/32".

NORTH RELAYS

Write for new North Relay Catalog.



**THE NORTH ELECTRIC
MANUFACTURING COMPANY**

INDUSTRIAL DIVISION

545 South Market Street, Galion, Ohio, U.S.A.



Professional Group Meetings

(Continued from page 76A)

January 20. Convening at the General Electric Auditorium, the chapter heard two speakers. A. H. Sepahban discussed "Bi-Lateral Magnetic Selection Systems for Large Scale Computer Memory." Emmanuel J. Otis, Air Force Cambridge Research Station, spoke on "High Speed Core Memory."

Isaac M. Auerbach of Burroughs Research Center, on December 16, addressed the New York Chapter on "Feasibility of an All Magnetic Computer." The meeting was held at the General Electric Auditorium and Leo Stamler, Vice-Chairman, presided.

On February 15 the Philadelphia Chapter met at the University of Pennsylvania with David Lawrence presiding. The meeting, held jointly with the AIEE, was addressed by Joseph Wylene, Burroughs Corporation. In his talk, "Bimag Circuits for Digital Computers," Mr. Wylene explained that the Bimag is a fast switching rectangular hysteresis loop, ferromagnetic core characterized by its unique bistable properties. He disclosed new techniques for using Bimag in digital data processing systems.

The Detroit Chapter met on January 15 at Wayne University. Alex Orden, mathematical consultant for Burroughs

(Continued on page 80A)

BE SAFE WITH

Q-max

A-27

LOW-LOSS LACQUER & CEMENT

- Q-Max is widely accepted as the standard for R-F circuit components because it is chemically engineered for this sole purpose.
- Q-Max provides a clear, practically loss-free covering, penetrates deeply, seals out moisture, imparts rigidity and promotes electrical stability.
- Q-Max is easy to apply, dries quickly and adheres to practically all materials. It is useful over a wide temperature range and serves as a mild flux on tinned surfaces.
- Q-Max is an ideal impregnant for "high" Q coils. Coil "Q" remains nearly constant from wet application to dry finish. In 1, 5 and 55 gallon containers.

*Communication
Products Company, Inc.*

MARLBORO, NEW JERSEY
(MONMOUTH COUNTY)
Telephone: Freehold 8-1880



**MAXIMUM EFFECTIVENESS
AT LOWEST COST...**

RMC Type JL DISCAPS

RMC Type JL DISCAPS provide ideal performance over an extended temperature range. The maximum capacity change between -60° and $+110^{\circ}$ C is only $\pm 7.5\%$ of capacity at 25° C. Lower initial cost, smaller size, and greater mechanical strength combine to effect worthwhile economies in production line operations.

In addition to standard leads, Type JL DISCAPS, as well as temperature compensating and by-pass types, are available with RMC's exclusive "Wedg-Loc" leads or plug in leads for printed circuit applications.

If you have a capacitor problem RMC engineers are prepared to work with you. Your inquiry is invited.



Wedg-Loc Leads

Plug-in Leads

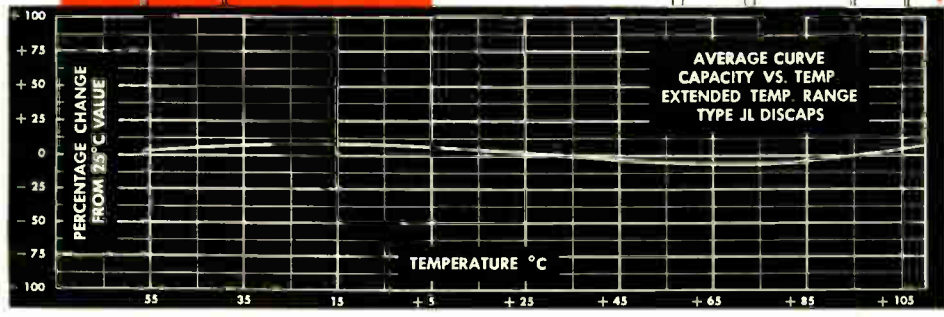

POWER FACTOR: 1% max. @ 1 K C (initial)
POWER FACTOR: 2.5% max. @ 1 K C, after humidity
WORKING VOLTAGE: 1000 V.D.C.
TEST VOLTAGE (FLASH): 2000 V.D.C.
LEADS: No. 22 tinned copper (.026 dia.)

INSULATION: Durez phenolic—vacuum waxed
INITIAL LEAKAGE RESISTANCE: Guaranteed higher than 7500 megohms
AFTER HUMIDITY LEAKAGE RESISTANCE: Guaranteed higher than 1000 megohms
CAPACITY TOLERANCE: $\pm 10\%$ $\pm 20\%$ at 25° C

DISCAP
CERAMIC
CAPACITORS



RADIO MATERIALS CORPORATION

GENERAL OFFICE: 3325 N. California Ave., Chicago 18, Ill.

FACTORIES AT CHICAGO, ILL. AND ATTICA, IND.

Two RMC Plants Devoted Exclusively to Ceramic Capacitors

VICTOREEN KNOWS HOW TO BUILD VOLTAGE REGULATORS

FROM 50 VOLTS
TO 30,000 VOLTS

• Regardless of your application, Victoreen can probably supply voltage regulators with the exact characteristics for developing maximum performance of the circuit. From sub-miniature glow type regulators for low voltage application to sturdy metal case designs for high voltage regulation, the range of types, designs and ratings offers a wide choice.



Our new catalog, listing the various type Voltage Regulators of our standard production may give you problem solving ideas. Write for your copy of Bulletin 3023.



The Victoreen Instrument Co.

COMPONENTS DIVISION: 3813 Perkins Ave., Cleveland 14, Ohio



Professional Group Meetings

(Continued from page 78A)

Corporation, delivered a paper entitled "Applications of the E101 Electronic Digital Computer." This computer, Dr. Orden explained, is desk-size and pin-board programmed with an operating speed ten times that of a desk calculator.

The Akron Chapter met on January 25 at Goodyear Hall with C. D. Morrill presiding. Craig Andrews, Teleregister Corporation, spoke on "Digital Computer Data Storage Devices."

On February 22 the Akron Chapter met again. Professor William K. Linvill of M.I.T. presented a paper entitled "The Analysis of Closed Loop Digitally Controlled Systems." Prof. Linvill presented the techniques which apply to the analysis and design of a sampled data system. He demonstrated that these were substantially the techniques which apply to the analysis and design of conventional servo systems. Finally, the possibilities of mixing logical and quantitative signals were explored.

The Chicago Chapter met on December 17 at the Western Society of Engineers Building. John Ducker presided, and Leonard Swanson, of the Applied Science Division of IBM, discussed "The IBM 704 and 705 Data Processing Machines."

ENGINEERING MANAGEMENT

The Washington Chapter of the Professional Group on Engineering Management met on January 24 at the National Science Foundation. A. V. Astin, Director of the National Bureau of Standards, spoke to the group on "Management Practices at the National Bureau of Standards." Dr. Astin prefaced his subject with a summary of the history and responsibility of the National Bureau of Standards. The body of his presentation consisted of a description of NBS management practices, particularly in regard to research programming and scientific personnel.

The Dayton Chapter met on February 3 at the Engineer's Club with Elbert W. Peity presiding. "Basic Management Philosophies of Armco Steel Corporation" was the topic presented by Brookes D. Billman, Assistant Director of Personnel Relations at Armco. Mr. Billman traced the history of the Armco Steel Corporation which has grown in fifty years from one to 50 plants encompassing 30,000 men and women. The Armco management philosophy is based on "confidence, good will, and a square-deal." The speaker discussed his company's objectives, policies, and program and explained that each company, whether its management be centralized or dispersed, can claim by its own success that its management system is correct.

The Los Angeles Chapter met on January 19 at the Institute of Aeronautical Science with Lawrence W. Baldwin presiding.

(Continued on page 82A)

IN TOP QUALITY CORES

FOR HIGHER FREQUENCIES

FROM 20 TO 300 MC.

TYPES SF, J AND W

GA&F® CARBONYL IRON POWDERS

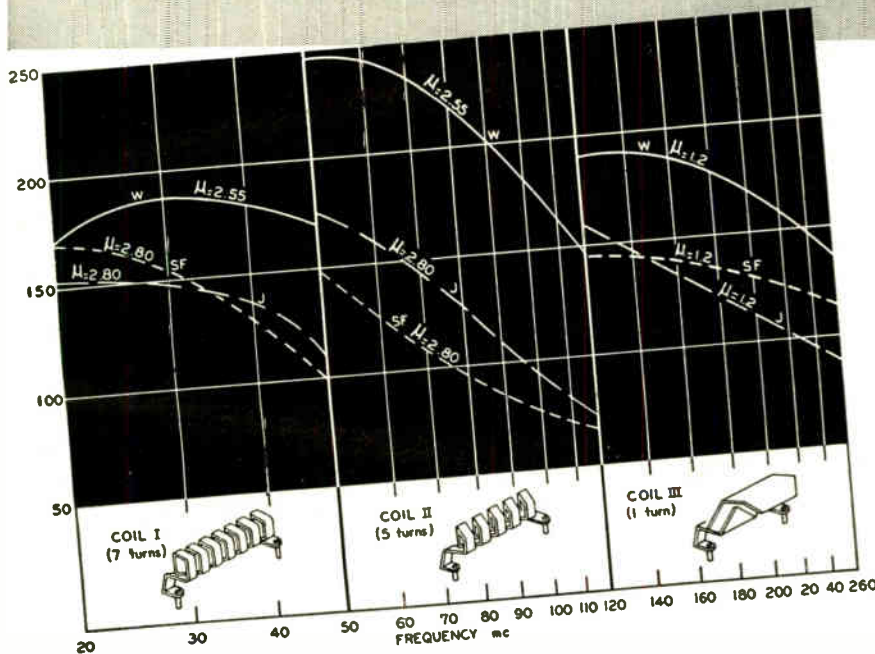

Three types of G A & F Carbonyl Iron Powders are particularly satisfactory in cores designed for use at the higher frequencies. To assure low losses and good magnetic and temperature stability at 20 mc. to 300 mc., we invite you to test Types SF, J and W. These powders are microscopic, almost perfect spheres—ranging from 3 to 9 microns in diameter—with the same rigorous uniformity that characterizes all G A & F Carbonyl Iron Powders.

Today, Carbonyl Iron Powders—a total of ten types—are widely used in the production of cores for transformers and inductor coils—to increase Q values, to vary inductances, to reduce coil size, to confine stray fields or to increase the coupling factors.

We urge you to ask your core maker, your coil winder, your industrial designer, how G A & F Carbonyl Iron Powders can increase the efficiency and performance of the equipment or product you make, while reducing both the cost and the weight.

We offer you two books—one covering SF, J and W Powders only—the second covering the other seven types. In both books, characteristics and applications are given with diagrams, performance charts and tables. For either or both books, address Department 32.

PHYSICAL CONSTANTS	W	J	SF
Percent retained by 325 mesh screen.....	trace	trace	trace
Weight-average particle diameter (Roller Analyzer) $d = \sum d_i^4 / \sum d_i^3$ (microns).....	3	9	3
Surface-average particle diameter (Fischer Sub-Sieve-Sizer) $d = \sum d_i^2 / \sum d_i$ (microns).....	2.5	4.5	2.5
Density of particles, g/cm ³	7.35	7.35	7.81
Apparent density, g/cm ³	2.6	2.8	3.0



From Research to Reality...

ANTARA CHEMICALS

A SALES DIVISION OF GENERAL ANILINE & FILM CORPORATION
435 HUDSON STREET • NEW YORK 14, N. Y.

MEMBER
mpa
METAL POWDER ASSOCIATION

Another Step in

Getting to the bottom of things

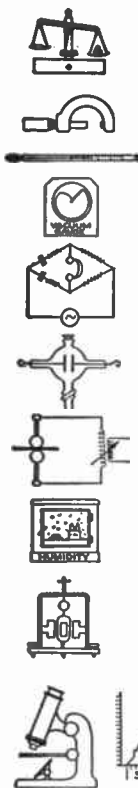

At John E. Fast and Co., the watch-dogs of quality are on the job twenty-four hours a day, in every stage of capacitor production. Recording controls indicate the smallest variations in heat, humidity, pressure and vacuum at each process point. Every precaution is taken to assure that environmental conditions are held at precise levels specified by our engineers.

The air in our winding rooms, for example, is continuously filtered so that no foreign particles may settle upon the windings themselves and contribute to ultimate failures. Similarly, capacitors are assembled, after vacuum impregnation, in clean rooms, where relative humidity is controlled at all times. These safeguards against inclusion of extraneous matter or moisture have resulted in increasingly satisfactory life and allied performances in Fast capacitors.

Supplementing this automatic vigilance is a completely equipped quality-control organization which functions at every process-stage from incoming inspection to final testing. At points where statistical control is applicable, our inspectors utilize techniques which comply with or exceed specifications laid down by the Armed Services Procurement Branches.

At final testing stations each production lot is given 100% test and inspection. Our belief is that a single failure out of a thousand may satisfy any sampling requirement, but it may be extremely costly to the consumer. Our investment in precision testing devices and extensive lab-

oratory equipments is great, but its worth is reflected in our national reputation as producers of quality components.

Comprehensive reports are maintained by inspection centers located at strategic production points. These reports are summarized weekly, and it is quite significant to note that both the President of the Company and the Vice-President and Chief Engineer meet each Saturday morning with supervisors, engineers and military representatives to discuss the various problems indicated by process averages, and yield analyses for each production department.

In these days when every hour taken from the production job is spared grudgingly, we still take these hours every week to analyze and combat any threat to quality performance. Increasingly rigid specifications for dimensional and operational characteristics have shown very clearly that control of quality can be achieved and maintained only by rigorous application of all the techniques and tools we are employing.

No greater assurance of excellence may be given than that which has established our reputation. Our fixed objective will always be to maintain that reputation.

AVAILABLE LITERATURE:
 Tubular Capacitors in Cardboard Tubes
 Tubular Capacitors in Molded Phenolic Cases
 Polystyrene Film Capacitors
 Hermetically-Sealed Tubular Capacitors
 Subminiature Hermetically-Sealed Capacitors
 High-Reliability Hermetically-Sealed Capacitors
 MIL-C-25A Approved Capacitors; Refer to "MIL-C-25A Specifications"

JOHN E. FAST & CO.

Capacitor Specialists For Over A Third of A Century

3177 North Pulaski Road, Chicago 41, Ill.

"WHEN YOU THINK OF CAPACITORS . . . THINK FAST"



(Continued from page 30A)

ing. "Developing Ourselves for Leadership" was the subject discussed by Irving R. Weschler of U.C.L.A. who addressed the group.

On December 15 the Los Angeles Chapter met again. C. J. Breitwieser, of Lear Incorporated, presented a paper called "Engineering Management in Europe."

On January 25 the Philadelphia Chapter met at the Gold Room of the Engineers Club. A. M. Levine of the Federal Telecommunication Laboratories presented a paper entitled "Humanengineering." Mr. Levine discussed the humane management of individuals and groups according to principles analogous to those of engineering. Application of these principles in a research and development organization were described. The relationships of the supervisor to his superiors and to his employees were also discussed.

The New York Chapter met on February 17 at the General Electric Auditorium with Charles Cambridge presiding. T. R. Jones, President of Daystrom Incorporated, talked to the group on "Functions of an Executive."

ELECTRON DEVICES

The San Francisco Chapter of the Professional Group on Electron Devices met on February 9 at Stanford University. Stanley F. Kaisel presided. L. M. Field, Professor at the California Institute of Technology presented a paper called "Attempts at a Unified Approach to Electron Beam Devices."

The Philadelphia Chapter met on January 26 at the University of Pennsylvania Sciences Building. Leon S. Nergaard, RCA Laboratories Division of Princeton, New Jersey, read to the group a paper called "The Interface Layer in Oxide-Coated Cathodes."

INDUSTRIAL ELECTRONICS

Julius Solomon presided at the January 21 meeting of the Chicago Chapter of the Professional Group on Industrial Electronics. Conrad Hilpert, Chief Instrumentation Engineer of the Twin Disc Clutch Company, spoke on "Electronic Measurements Concerned with the Design and Test of Hydraulic Mechanisms."

INFORMATION THEORY

The Albuquerque-Los Alamos Chapter met on February 9 with C. H. Bidwell presiding. Alex Fursa was the speaker. C. H. M. Turner's paper on "The Instantaneous Power Spectra" was reviewed.

The Los Angeles Chapter met on January 27 at the Institute for Numerical Analysis with Eberhardt Reichtin presiding. "Operational Treatment of Non-Linear Filtering" was the paper presented by Albert Wheelon of Ramo-Wooldridge Corporation.

(Continued on page 34A)

READ-RECORD HEADS

OPTIMUM
 READ-BACK SIGNAL
 LOW NOISE FACTOR
 HIGH FREQUENCY
 OPERATION

Librascope read-record heads are designed for recording and reading on magnetic drums or other magnetic storage systems and consist of a center-tapped coil wound on a toroidal core and molded into a temperature-stable epoxy resin package $\frac{3}{4}$ " long. Optimum read-back signal at high frequencies is made possible by sintered ferrite core, a winding with low distributed capacity and with back gap eliminated. Positioning dowel hole permits precise mounting. All heads subjected to 1200 volt RMS high potential test. Write for catalog.

SPECIFICATIONS:

Crosstalk limited to minus 60 Db for adjacent heads. Resonant frequency above 500 KC
 Track width: .090 in.
 Gap width: .0015 in.

Computers and Controls

LIBRASCOPE

A DIVISION OF GENERAL PURPOSE EQUIPMENT CORPORATION

1607 FLOWER ST., GLENDALE, CALIF.

LIBRASCOPE, INCORPORATED

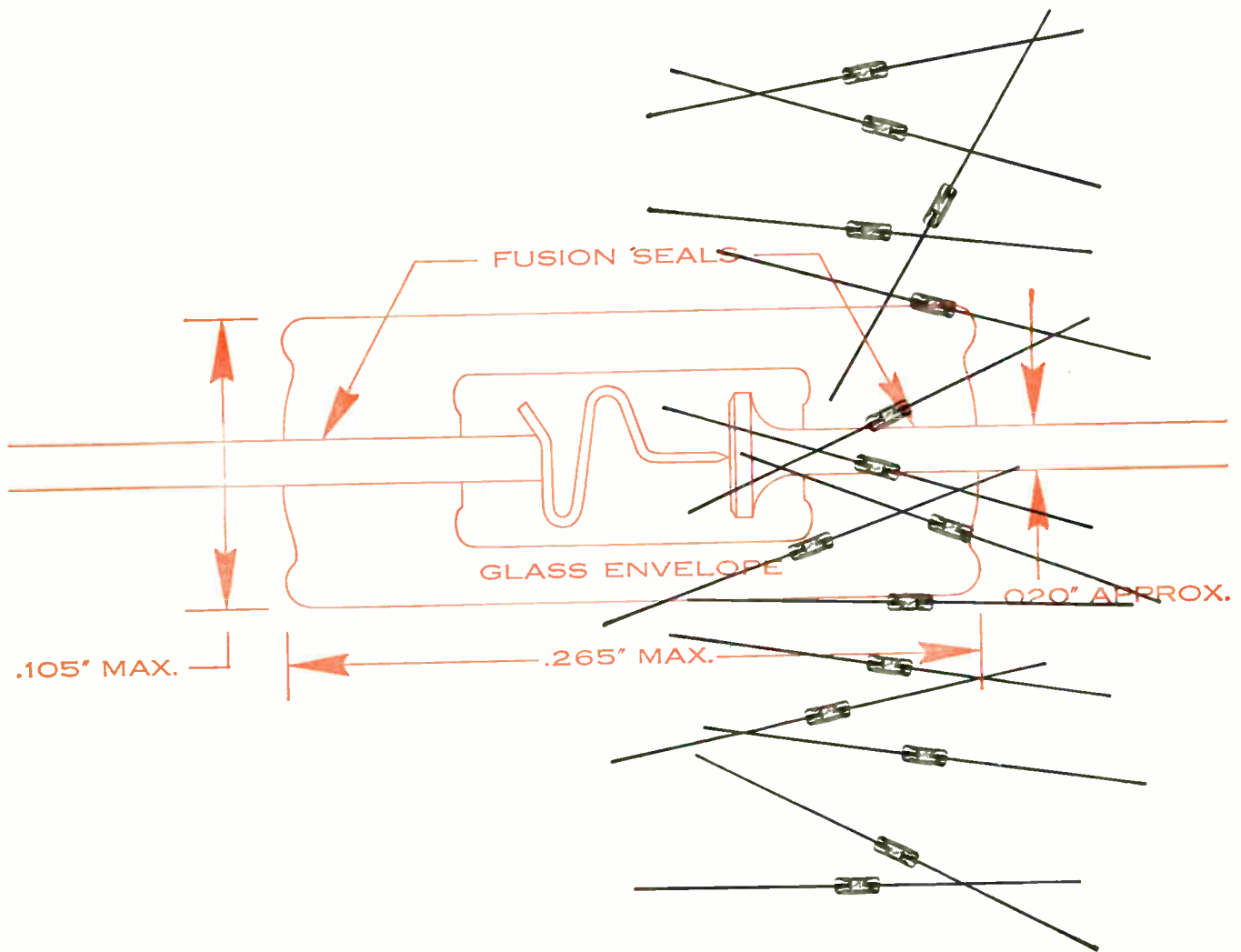

FIRST OF ALL FOR **RELIABILITY**

HUGHES SEMICONDUCTOR PRODUCTS

Why should YOU use Hughes semiconductors? First of all—for reliability. You can depend on these devices to stay within published ratings and specifications under varied and severe operating conditions.

All diodes made by Hughes are:

MOISTURE-PROOF—Fusion-sealed in a one-piece glass envelope. This construction eliminates a major cause of diode failure.

RUGGED—Small volume and mass enable them to withstand physical shock and vibration.



STABLE—Internal elements are isolated from damage or contamination. Mechanical and electrical characteristics remain stable throughout a long operating life.

THOROUGHLY TESTED—All diodes are tested for electrical and mechanical characteristics. They operate faithfully over wide ambient temperature ranges.

SUBMINIATURE—In miniaturized circuitry, the high component density possible with these diodes promotes greater volumetric efficiency.

For instance, Hughes subminiature diodes have now been used by many major manufacturers of electronic equipment. Without exception, available performance reports indicate that, in military and commercial installations alike, the Hughes components have maintained an extraordinary record of failure-free service. Today, these same diodes are continuing to add to the reputation for superior reliability synonymous with Hughes Semiconductor Products.

The Hughes line of semiconductor devices is being steadily expanded. It now comprises a wide selection of Germanium Point-Contact and Silicon Junction Diodes, and Photocells. New products, now under development, are being readied for commercial production. Watch for their release. They, too, will embody the same Hughes quality in design and manufacture that spell out unsurpassed stability and reliability. Specify Hughes—with confidence.

HUGHES	SEMICONDUCTOR SALES DEPARTMENT	
<i>Aircraft Company, Culver City, California</i>	 	<i>New York Syracuse Philadelphia Chicago</i>

**Maximum dimensions, standard germanium diode glass envelope: 0.265 inch by 0.105 inch.*



SINCE 1915 LEADERS IN AUTOMATIC CONTROL



Professional Group Meetings

(Continued from page 82A)

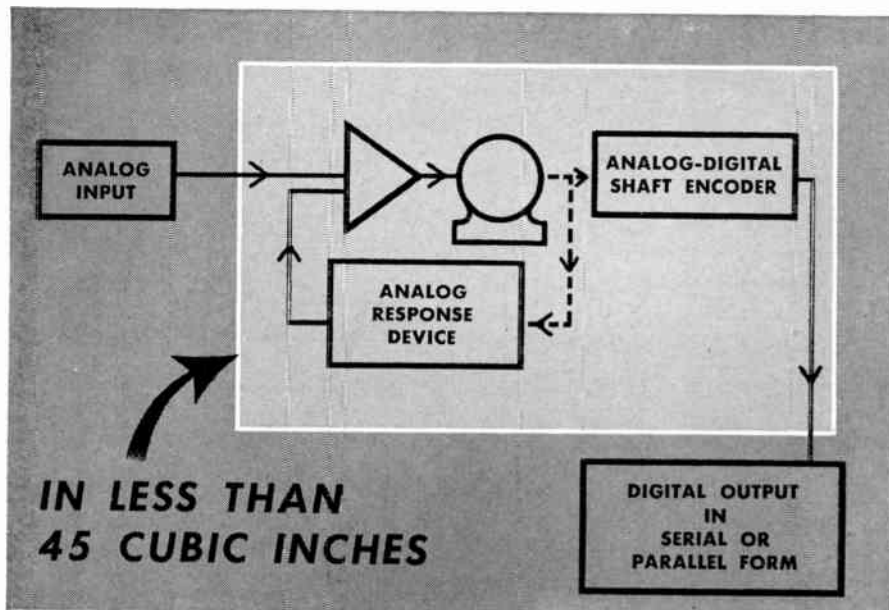

IN LESS THAN
45 CUBIC INCHES

ANALOG TO DIGITAL CONVERSION in less than 45 cubic inches

In an aircraft navigational system, input information (such as compass headings, speeds, etc.) is received in analogs. The Ford Instrument Company engineers recently had a problem which required the presentation of this information in digital forms. Along with this was the physical problem of weight and size minimization. An Analog-Digital converter was developed which solved the problem. This unit occupied less than 45 cubic inches and required only line voltage with no special power supply.

This is typical of the way Ford Instrument engineers solve problems in the computing and control field. For forty years Ford has been pioneering techniques in servomechanisms; developing, designing and manufacturing systems and components to solve the complex problems of automatic control. Should you have a problem in control engineering it will pay you to talk to one of the Ford Instrument Company engineers.



FORD INSTRUMENT COMPANY
DIVISION OF THE SPERRY CORPORATION
31-10 Thomson Avenue, Long Island City 1, N.Y.

ENGINEERS

of unusual abilities can find a future at FORD INSTRUMENT COMPANY. Write for information.

INSTRUMENTATION

The Chicago Chapter of the Professional Group on Instrumentation met on February 18 at the Western Society of Engineers Building. Adolph Hitzelberger, Motorola Incorporated, spoke to the group on "Production Line Testing of Television Receivers."

On December 17, with Frank Waterfall presiding, the Chicago Chapter met again. "VHF Impedance Measurements" was presented by Bert Zarky and Neil Frihart, both of Motorola, and Norman Foot of Hallicrafters.

MEDICAL ELECTRONICS

On February 1 at the University of California Medical Center the San Francisco Chapter on Medical Electronics met. G. D. Adams presented a paper called "Problems in High Energy Radiation Dosimetry," and R. S. Stone spoke on "Clinical Sidelights in Dosimetry."

MICROWAVE THEORY AND TECHNIQUES

The Baltimore Chapter of the Professional Group on Microwave Theory and Techniques has elected the following officers for this year: Chairman, Helmut E. Schrank of Bendix Radio; Secretary, S. D. Schreyer of Westinghouse Electric Corporation.

On February 10 the Boston Chapter met with T. S. Saad presiding. Alfred C. Beck of Bell Telephone Laboratories spoke on "Multimode Waveguides, Millimicrosecond Pulses and Broadband Communication."

On February 9 the Baltimore Chapter met with H. E. Schrank presiding. D. D. King, Associate Director of Johns Hopkins University Radiation Laboratory, spoke on "Dielectric Rod Scheme". Dr. King reviewed the properties of low-loss transmission lines for millimeter waves and described a new dielectric rod scheme with its features and associated components.

NUCLEAR SCIENCE

The Oak Ridge Chapter has elected the following officers to serve for this year: Chairman, R. W. Schede; Vice-Chairman, D. J. Knowles; Secretary-Treasurer, S. E. Groothuis. The Albuquerque-Los Alamos Chapter met on February 15 in the Physics Building Conference Room, and William L. Briscoe presided. Carl Buckland, of Los Alamos Scientific Laboratory, spoke on "Care, Preparation, and Use of Radioactive Sources."

On January 25 the Connecticut Valley Chapter met at the Underwater Sound Laboratory with T. H. Kirby presiding. Director of Research and Design at General Dynamics Corporation, A. I. McKee addressed the group. His topic was "Rescue and Salvaging of the Submarine USS Squalus."

(Continued on page 86A)

FIRST V-O-M with ALL in ONE!

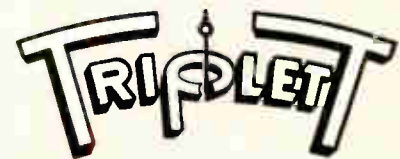

MODEL 630-NA
 Volt-Ohm-Mil-Ammeter
 DEALER Net Price . . . \$69.50

MODEL 630 Famous
 Volt-Ohm-Mil-Ammeter \$39.50
 33 ranges and many other
 features making this the
 favorite in a popular V-O-M line

MODEL 630-A Laboratory Type
 Volt-Ohm-Mil-Ammeter with
 mirror scales, 1-1/2% DC
 accuracy and special 1/2%
 resistors for greater accuracy.
 Found in the best laboratories
 and production lines. \$49.50

MODEL 631 Combination
 V-O-M and VTVM \$59.50
 This sensational 2-in-1 battery
 operated combination saves
 you money — will do all your
 work easier at half the price.

MODEL 666-R Pocket size
 V-O-M. Practically a portable
 laboratory with self contained
 snap-in type batteries. \$26.50

The above are examples of
 the complete Triplet V-O-M
 line in which 10,000 ohms per
 volt AC sensitivity has been
 featured for 10 years.

TRIPLETT HAS THE MOST COMPLETE V-O-M LINE

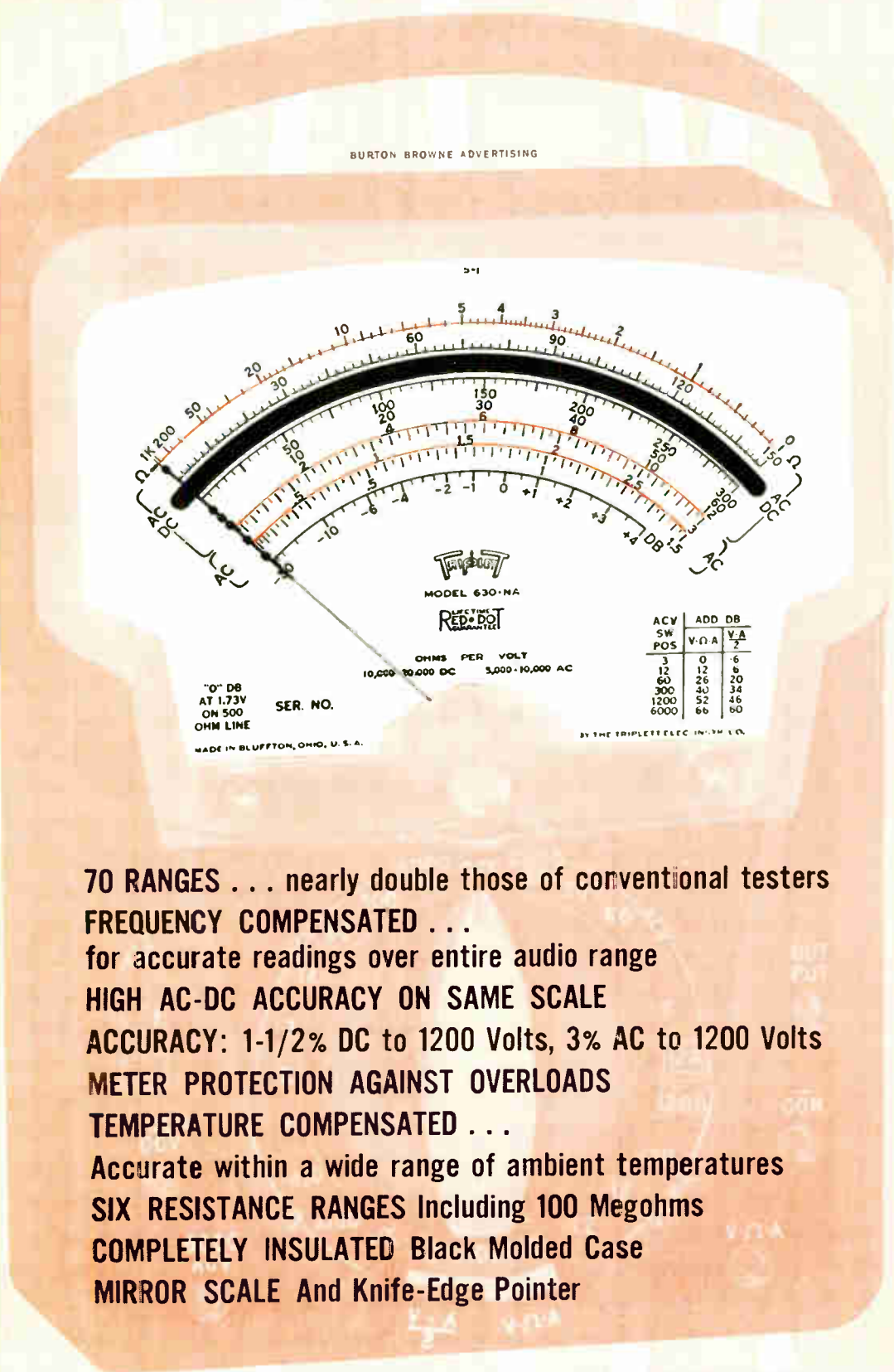

"0" DB
 AT 1.73V
 ON 500
 OHM LINE

SER. NO.

OHMS PER VOLT
 10,000 10,000 DC 5,000-10,000 AC

ACV SW POS	ADD DB V-Ω A	V A 2
3	0	6
12	12	6
30	26	20
300	40	34
1200	52	46
6000	66	60

BY THE TRIPPLET ELEC. INSTR. CO.

- 70 RANGES . . . nearly double those of conventional testers
- FREQUENCY COMPENSATED . . . for accurate readings over entire audio range
- HIGH AC-DC ACCURACY ON SAME SCALE
- ACCURACY: 1-1/2% DC to 1200 Volts, 3% AC to 1200 Volts
- METER PROTECTION AGAINST OVERLOADS
- TEMPERATURE COMPENSATED . . . Accurate within a wide range of ambient temperatures
- SIX RESISTANCE RANGES Including 100 Megohms
- COMPLETELY INSULATED Black Molded Case
- MIRROR SCALE And Knife-Edge Pointer

actual size

ALL TRIPLETT TESTERS APPROVED FOR COLOR
 see them at your distributors



TRIPPLET ELECTRICAL INSTRUMENT CO.
 Bluffton, Ohio

BALLANTINE Sensitive, Wide Band Electronic Voltmeter



MODEL 314
Price \$285

To measure..... 1 millivolt to 1000 volts
 from..... 15 cycles to 6 megacycles
 with accuracy of..... 3% to 3 mc; 5% above
 with input impedance.... 7.5 mmfds shunted by 11 megs

When used without probe, sensitivity is increased to 100 MICRO-VOLTS but impedance is reduced to 25 mmfds and 1 megohm

Featuring customary Ballantine

SENSITIVITY — ACCURACY — STABILITY

- Same accuracy at ALL points on a logarithmic voltage scale and uniform DB scale.
- Only ONE voltage scale to read with decade range switching.
- No "turnover" discrepancy on unsymmetrical waves.
- Easy-to-use probe with self-holding connector tip and unique supporting clamp.
- Low impedance ground return provided by supporting clamp.
- Stabilized by generous use of negative feedback.
- Can be used as 60 DB high fidelity video pre-amplifier.

Write for catalog for more information about this and other BALLANTINE voltmeters, amplifiers, and accessories.

BALLANTINE LABORATORIES, INC. 

102 Fanny Road, Boonton, N.J.



Professional Group Meetings

(Continued from page 84A)

On January 21 Joseph W. Ranftl of the x-ray division of General Electric Company addressed the Chicago Chapter of The Professional Group on Nuclear Science. The title of his paper was "The Use of Nuclear Radiations in the Sterilization of Foods and the Transformation of Plastic and Chemical Materials."

TELEMETRY AND REMOTE CONTROL

On February 18 the Chicago Chapter of the Professional Group on Telemetry and Remote Control met with G. H. Brittain presiding. J. F. McManus of Armour Research Foundation spoke to the group on "Multiplexing Systems in Radio Telemetry."

On February 15 the Los Angeles Chapter met at the IAS Building. There were two speakers. "Recording of Precision Data on Magnetic Tape" was the name of the paper presented by Robert L. Sink, and W. H. Pickering spoke on "The RDB Telemetering Standards for Guided Missiles."

The Dayton Chapter met on January 6 with M. A. McLennan presiding. A magnetic tape by the Audio Cincinnati Section called "How Much Distortion Can You Hear?" was presented to the group.

At the Engineers Club on December 2 the Dayton Chapter met again. William H. Duerig spoke to the group on "Elimination of Dynamic Errors in the FM/FM Telemetry Ground Equipment."

VEHICULAR COMMUNICATIONS

The Chicago Chapter of the Professional Group on Vehicular Communications met on December 17. C. J. Schults of Motorola Incorporated addressed the group on "Spectrum Compression and Its Problems."



Section Meetings

AKRON

"Military Operations Research Organizations and their Functions," by Dr. James C. Mouzon, Johns Hopkins University; February 15, 1955.

Student Prize Paper Competition: "Principles of Eddy-current Machinery," by Donald Lambing, "Radio Control of Model Airplanes," by Jerry McKeel, "A D-C Chopper Amplifier," by Joe Takass and "Guided Missile Telemetering Systems," by Richard Smith; March 8, 1955.

ATLANTA

"Seeing Light and Color," by Ralph Evans, Eastman Kodak Company; February 25, 1955.

"Telemetering by Radial Scan Television Methods," by John Jamgochian, Jr., Lockheed Aircraft Corp.; March 18, 1955.

BALTIMORE

"Principles of Progress," by James Adshead, Jr., DuPont Company; March 9, 1955.

(Continued on page 88A)

RADIO RECEPTOR

selenium rectifiers used in induction furnace controls

*“Pouring molten metal calls
for reliable controls with
reliable components”*

says AJAX ELECTROTHERMIC
CORPORATION

It's built-in dependability and flexibility of control that keeps all those AJAX-NORTHROP induction furnaces operating constantly at full rated capacity — and AJAX insures that dependability by using “Really Reliable” RRco. rectifiers.

For example, the control panel illustrated includes five industrial type units which “go in and stay in” as part of a strong team. AJAX, a Radio Receptor customer for many years, knows from long experience that it can rely on RRco. rectifiers.

The Radio Receptor line is a comprehensive one and our engineers are semiconductor specialists. May we study your specs *now* without obligation and offer recommendations not only on rectifiers, but on transistors and other germanium and silicon products. See our rectifier catalog in Sweet's Product Design File and write us for our latest bulletin P-4.

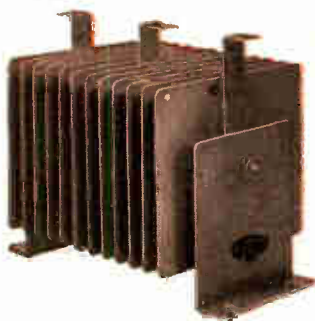
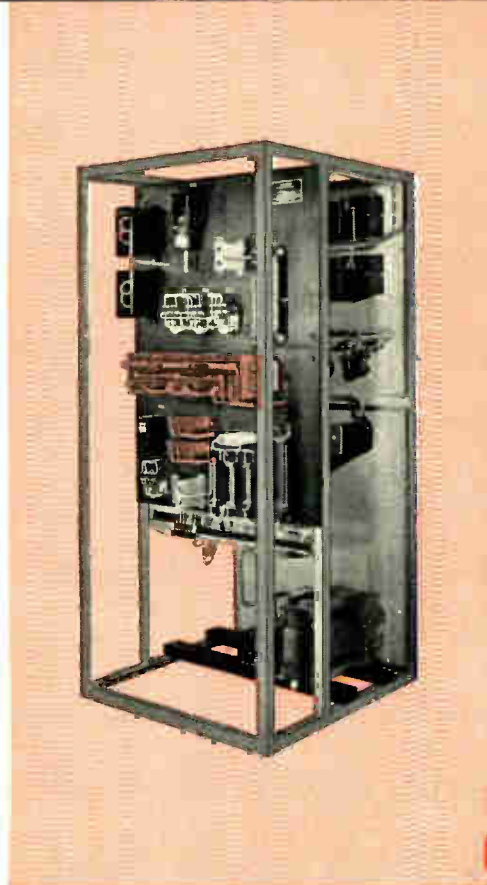
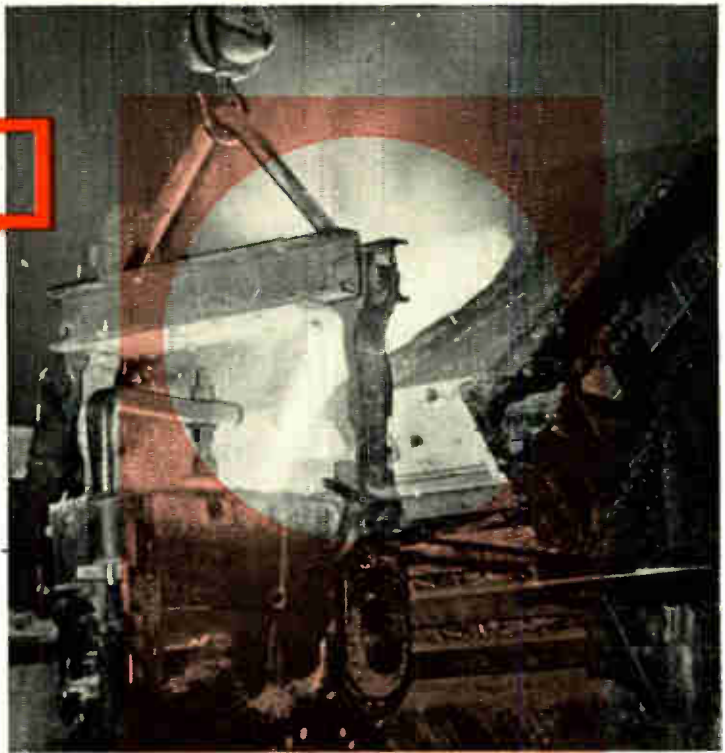

Semiconductor Division

RADIO RECEPTOR COMPANY, INC.

In Radio and Electronics Since 1922

SALES OFFICES: 251 WEST 19TH STREET, NEW YORK 11, N. Y.

Telephone: WAtkins 4-3633 • Factories in Brooklyn, N. Y.

TRANSISTORS • GERMANIUM & SILICON DIODES • SELENIUM RECTIFIERS • THERMATRON INDUSTRIAL ELECTRONIC HEAT SEALING GENERATORS & PRESSES • RADAR, NAVIGATION & COMMUNICATIONS EQUIPMENT

Introducing— THE MYCALEX PARTS KIT

- * For design projects
- * For experimental use
- * For emergency repairs

To acquaint engineers with the superior qualities of Mycalex glass-bonded mica—the world's most nearly perfect insulation—a conveniently packaged kit containing more than 30 Mycalex products has been assembled.

This assortment includes 46 miniature and sub-miniature tube sockets, terminal boards, rods and strips of fabricated Mycalex 400 and various Mycalex 410 injection-molded products such as connector sleeves, coil forms, stand-off terminals, rotors and rings, motor slot wedges and switch wafers. A handy reference table compares the superior physical and electrical properties of Mycalex glass-bonded mica with those of other insulating materials.



MYCALEX

- * withstands extreme operating temperatures
- * offers high arc resistances
- * possesses low loss and power factors
- * for permanent dimensional stability

The Introductory Mycalex Kit is being offered to qualified engineers and others who are interested.

Mycalex Corporation of America, Dept. III
Clifton Boulevard, Clifton, New Jersey

Please send me the new Mycalex Parts Kit at the introductory price of \$10.00.

Enclosed find Check.....Cash.....Money Order.....

Name.....Title.....

Company.....

Street.....

City.....Zone.....State.....



Executive offices:
30 Rockefeller Plaza
New York 20, New York

MYCALEX CORPORATION OF AMERICA
World's largest manufacturer of glass-bonded mica products

Section Meetings

(Continued from page 86A)

BEAUMONT-PORT ARTHUR

"Remote Supervisory Control," by C. Wylie Head, Control Corp.; March 8, 1955.

BINGHAMTON

"Antenna Design," by R. T. Leitner, Technical Appliance Corp.; February 14, 1955.

"Toll Recording Equipment," by H. E. Webb, IBM Corp.; March 14, 1955.

BUFFALO-NIAGARA

"Cinefluorography," by Sidney Weinberg, University of Rochester; February 8, 1955.

CEDAR RAPIDS

"Automation in Electronics," by John D. Ryder, Michigan State College, President of IRE; February 16, 1955.

CHICAGO

"Telephone Switching," by Dr. J. W. McRae, Sandia Corp.; December 17, 1954.

"The Development of Compatible Color Television," by Dr. G. H. Brown, RCA Labs; January 21, 1955.

"The Power of the Atom in Research," by L. V. Berkner, Associated Universities, Inc.; February 18, 1955.

CINCINNATI

"Reliable Receiving Tubes Designed for Automatic Production," by W. R. Wheeler, Sylvania Electric Products Co.; "Hot Air at Work," by T. F. Stirgwalt, General Electric Company; January 18, 1955.

CLEVELAND

"Electronics—A Preview of the Future," by Dean Woolldridge, Ramo Woolldridge Company; March 2, 1955.

DAYTON

"Telemetry—The Intelligence Link," by M. V. Kiebert, Jr., Pomona Division of Convair; March 3, 1955.

EMPORIUM

"Ultrasonic Impact Grinding," by Neil Clark, Jr. and R. M. Moschella, Raytheon Mfg. Co.; February 15, 1955.

EVANSVILLE-OWENSBORO

"Recent Advances in the Art of Audio Reproduction," by A. M. Wiggins and H. T. Souther, Electrovoice Company; March 9, 1955.

HOUSTON

"Lorac," by W. R. Hunsicker, Seismograph Service Corp.; March 15, 1955.

HUNTSVILLE

Tour of WMSL-TV studios and transmitter; February 26, 1955.

"Possibilities for Electric Space Ship Propulsion," by Dr. Ernst Stuhlinger, Redstone Arsenal; March 18, 1955.

INYOKERN

"Current Trends in Color Television," by D. E. Foster, Hazeltine Research, Inc.; February 21, 1955.

ITHACA

"Automatic Fabrication of Electronic Equipment," by Dr. Cleo Brunetti, General Mills, Inc.; March 9, 1955.

LITTLE ROCK

"Color Television and Some of Its Problems," by A. R. Garrett and Joe Elder, KATV; March 17, 1955.

(Continued on page 90A)

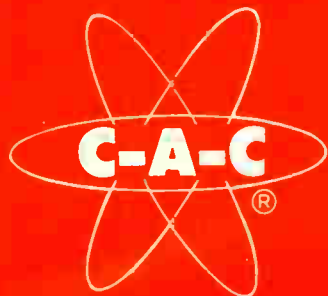

Airborne Components...

a C. A. C. Specialty

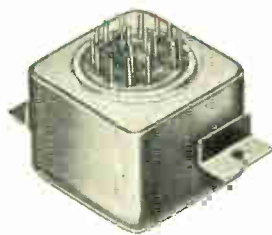

POWER TRANSFORMERS

Range—400-6000 cps
Efficiency—up to 95%
Wattage—6mw-200 watts
Temperature—-55 to +155° C.

Depicted—6KC 100 Watt Unit
Less than 1.65 cubic inches

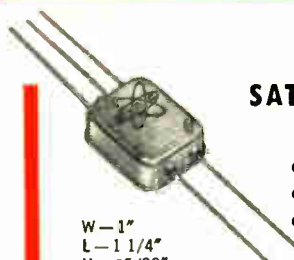

SATURABLE REACTORS

Applications
● Servo Systems
● Data Telemetry
● Remote Frequency Control

W—1"
L—1 1/4"
H—15/32"

Illustrated—High Frequency Reactor Tuned by Varying D. C. Current

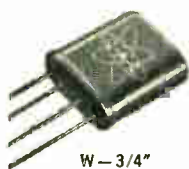

PULSE TRANSFORMERS

Pulse Width—.2-50 microseconds
Rise Time—from .03 microseconds

- Blocking oscillator
- Pulse coupling
- Toroidal construction

W—3/4"
L—3/4"
H—5/16"



MAGNETIC AMPLIFIERS

Wattage (output) .5-200 watts
Response—1 cycle up

W—1 1/4"
L—1 3/4"
H—2 5/32"

Illustrated—Auto Pilot Application for Printed Circuit Mounting



SUB-MINIATURE FILTERS

For Chassis Mount
Frequency—2.3-35Kc
Impedance in—600-10K Ohms
Impedance out—Grid

- Hermetic Sealed
- Temperature Compensated
- Internal D. C. Isolation
- Balanced or Unbalanced
- Military Specifications

W—23/32"
L—23/32"
H—1 1/16"

Illustrated
4KC
Band Pass



SUB-MINIATURE TUNED CIRCUITS

For Printed Circuit Applications

- Multiple Tuned Transformers
- Delay Lines
- Tuned Circuits

W—1"
L—4 1/4"
H—7/16"

FOR ADDITIONAL INFORMATION CONTACT

COMMUNICATION ACCESSORIES COMPANY

HICKMAN MILLS, MISSOURI • PHONE KANSAS CITY, SOUTH 5528

3 55/1 0

(Continued from page 88A)

LONDON

Student papers: "Boolean Algebra," by W. F. Elliott, "The Trachatron Tube," by W. J. King, "Scintillation Counters," by K. D. Adams, and "Electrical Scanning as a Possible Factor in Visual Perception," February 22, 1955.

LONG ISLAND

"Microwave Measurements," by Prof. A. B. Giordano, Polytechnic Institute of Brooklyn; February 17, 1955.

"Measurements on Transmitters and Receivers," by N. J. Oman, RCA; February 24, 1955.

"Measurement Techniques in the Millimeter Wavelength Range," by A. G. Fox, Bell Telephone Labs., Inc.; March 3, 1955.

MIAMI

"Principles of Color Television," by Dr. C. N. Hoyer, RCA Labs.; March 4, 1955.

"A New Type F.M. Transmitter," by Mr Rawlins, Lockheed Aircraft Corp.; March 18, 1955.

MILWAUKEE

"High-Powered Television Tubes," by A. R. Koch, General Electric Co.; January 27, 1955.

"The Engineer—The Builder," by E. S. Lee, General Electric Company; February 22, 1955.

"Camera Tubes for Colored Television," by R. G. Newhauser, RCA; March 17, 1955.

NEW ORLEANS

Tour of A. T. and T. Toll Test Center with demonstrations of the microwave, video and carrier equipment, guided by Guy Sawyer, A. T. and T.; March 11, 1955.

NEW YORK

"Silicone Dielectric Materials and Their Application in the Electronic Industry," by Lee Teichthesen, Dow-Corning Corp.; and "Characteristics of Teflon, Zytel and Nylon," by Bert Ely, Du Pont Chemical Company; March 2, 1955.

NORTH CAROLINA-VIRGINIA

"Duke Power Company's Telemetry and Communications System by Microwave," by W. J. Wortman, Duke Power Company; and "Transistors," by J. C. Gregory, Jefferson Standard Broadcasting Company; March 18, 1955.

OKLAHOMA CITY

"LORAC—Radio Location by Phase Comparison," by W. R. Hunsicker, Seismograph Service Corp.; March 8, 1955.

OTTAWA

Student papers: "A Multi-purpose Portable Broadcast Amplifier," by S. R. Penstone, "Application of Hybrid Coils in Telephone Circuits," by M. A. Lennox, "Oxide-coated Cathodes," by W. J. Haslett, "Line Distortion in Telephone Cables," by H. R. Burnham, "Vector Representation of Feedback Problems," by James Cassidy, "Short Wave Propagation," by W. A. Caton, "Cutting of Radio Crystals," by J. H. St. Louis, and "The Transistor," by G. E. Berlinguette; February 10, 1955.

"Transistors: A Progress Report," by P. M. Thompson, Defence Research Board Electronics Lab.; March 17, 1955.

PHILADELPHIA

"Improving VHF TV Coverage with a Booster Station," by W. C. Morrison, RCA Labs.; March 2, 1955.

(Continued on page 92A)

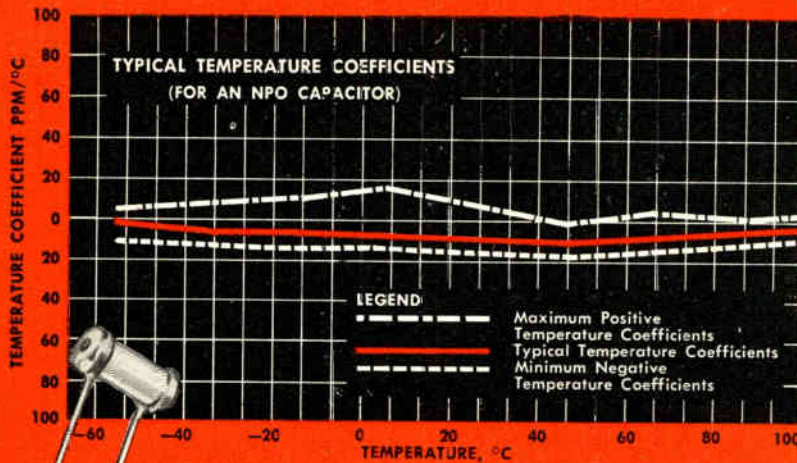

FOR STILL CLOSER TEMPERATURE-COEFFICIENT TOLERANCES THAN THOSE PREVIOUSLY AVAILABLE

Hi-Q*
PRECISION
Temperature-Compensating
Ceramic Capacitors
TYPE CNP

Further refinement in ceramic dielectrics by leading ceramic-capacitor specialists, is reflected in the accompanying performance curve.

Made by an unique production process, Hi-Q Type CNP units are of such high uniformity that individual TC testing can be eliminated. Such components are intended specifically for applications requiring still better temperature compensation. Available in capacitance tolerances of 2%, 5% and 10%. Non-insulated tubular style.

Radial leads. Clean non-hygroscopic plastic coating. Three sizes: CNP-1, .200" d. x .375" l.; CNP-2, .200" d. x .625" l.; CNP-7, .230" d. x .812" l. Working Voltages: CNP-1 and CNP-2, 300 DC; CNP-7, 500 DC. Test Voltages: CNP-1 and CNP-2, 1000 DC; CNP-7, 1200 DC.

Literature on request. Let our application, research and production engineers help you select the most suitable capacitors for any capacitor need.



*Trade-mark



AEROVOX CORPORATION
OLEAN, N. Y.

In Canada: AEROVOX CANADA, LTD., Hamilton, Ont.

Export: Ad. Auriema, 89 Broad St., New York, N. Y. • Cable: Auriema, N. Y.

AEROVOX CORPORATION, NEW BEDFORD, MASS. • ACME ELECTRONICS, INC., MONROVIA, CALIF. CINEMA ENGINEERING CO., BURBANK, CALIF. • HENRY L. CROWLEY & CO., WEST ORANGE, N. J.

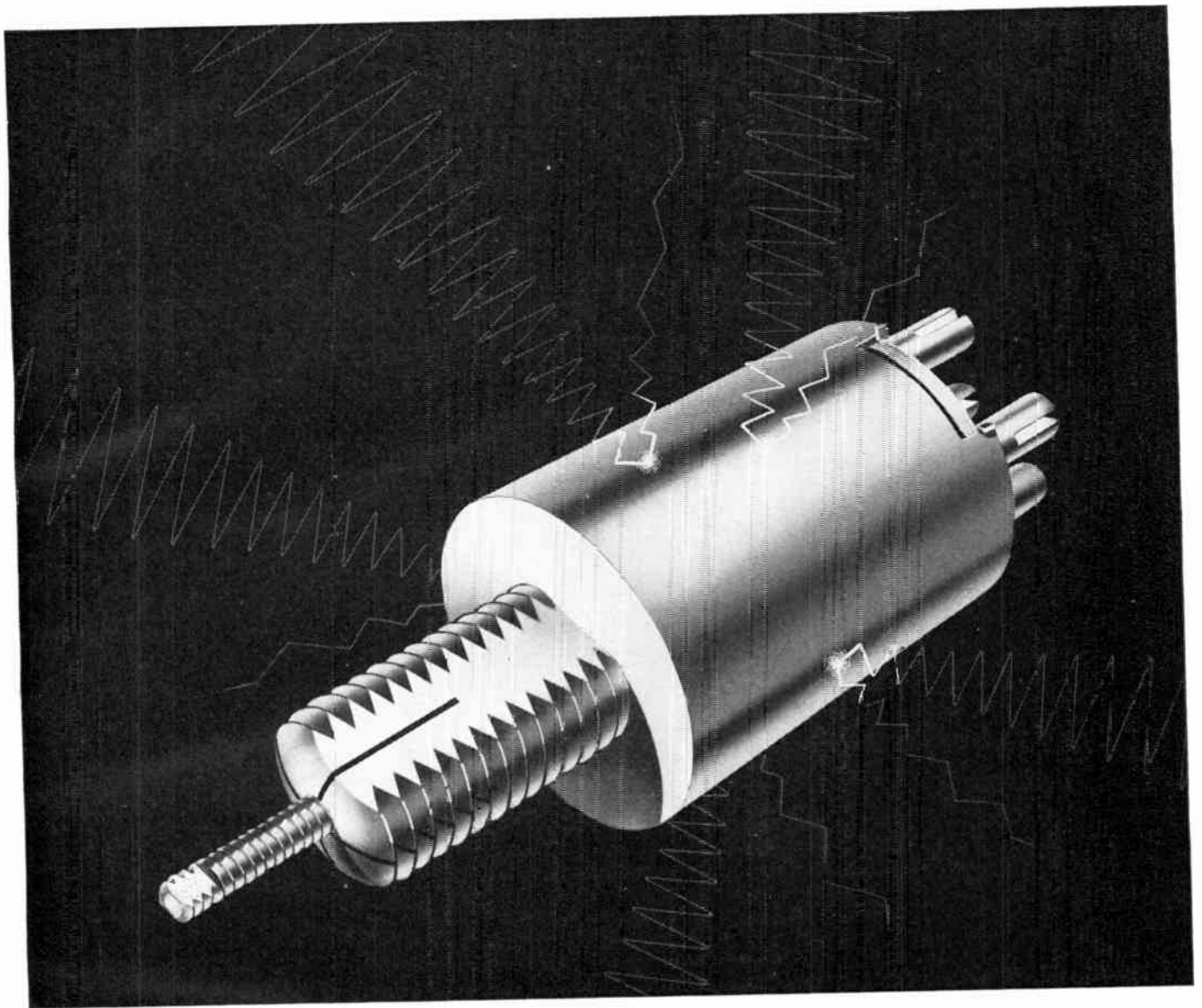

Built for close "combat" in tight spots

Into the construction of this coil form goes C.T.C.'s rigid *quality control* to highest production standards.

The result is another C.T.C. *first* — a miniaturized coil form ($\frac{1}{16}$ " diameter by $\frac{1}{2}$ " high when mounted) that is shock-resistant and exceptionally rugged — shielded against radiation, electrically, and therefore ideal for "close quarter" use in I.F. strips and numerous designs where adjacent mounting is necessary.

C.T.C.'s policy of continuous step-by-step quality control in the manufacture of every component means guaranteed performance. Already certified materials are doubly checked before manufacture.

Whatever your component need — let C.T.C. solve your problem — with either custom or standard designs of *quality-controlled, guaranteed* components — including insulated terminals, coil forms, coils, swagers, terminal boards, diode clips, capacitors and a wide variety of hardware items.

Put your component problem up to

C.T.C. now. For samples, specifications and prices — write today to Sales Engineering Dept., Cambridge Thermionic Corporation, 456 Concord Ave., Cambridge, Mass. On West Coast, contact E. V. Roberts, 5068 West Washington Blvd., Los Angeles 16 or 988 Market St., San Francisco, California.

Coil Form Data: C.T.C.'s LS-9 coil form has a brass shell enclosing a powdered-iron cup-core, tuning slug, phenolic coil form and silicone fibreglas terminal board. Three terminal boards are available with choice of two, three or four terminal layout. Forms, unassembled, may be had *without windings . . . or wound and assembled to your specifications.*

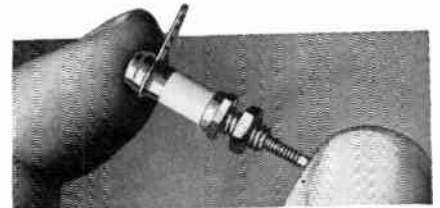

Capacitor: New CST-50 variable ceramic capacitor surpasses range of capacitors many times its size. Stands only $1\frac{1}{32}$ " high when mounted, is less than $\frac{1}{4}$ " in diameter and has an 8-32 thread mounting stud. A tunable element of unusual design practically eliminates losses due to air dielectric giving large minimum to maximum capacity range (1.5 to 12MMFD).

CTC

CAMBRIDGE THERMIONIC CORPORATION

*makers of guaranteed electronic components,
custom or standard*



Miniaturize...
and maintain reliable
performance characteristics

with **ERIE**
DISC CERAMICONS®

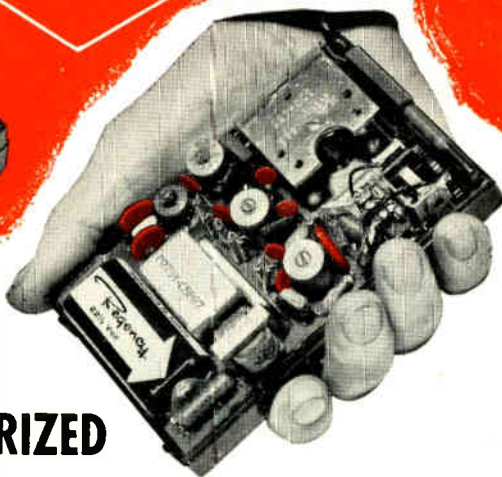

**AS SHOWN
HERE IN THE
FIRST TRANSISTORIZED
COMMERCIAL RADIO**

Nine ERIE DISC CERAMICONS are used in the Regency pocket radio.

- Standard ERIE DISC CERAMICONS are small. Their reliable performance characteristics are not sacrificed for size.
- Leads of ERIE DISC CERAMICONS are tinned with a coating of .001" minimum thickness to assure ease of soldering even after long storage. This allows trouble-free dip-soldering assembly.

**GENERAL PURPOSE
TEMPERATURE
COMPENSATING**

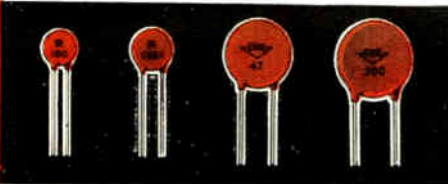

For miniaturization, ERIE DISC CERAMICONS are made in sizes from $\frac{5}{16}$ " max. to $\frac{3}{4}$ " max. diameter and .156" max. thickness. They are available in the following values:

GENERAL PURPOSE DISC CERAMICONS in values from 5.0 MMF to .02 MFD. Rated at 500 volts D.C. working.

TEMPERATURE COMPENSATING DISC CERAMICONS in capacity values from 2 to 2000 MMF at 500 V.D.C.W.

Erie's Sales Engineers will gladly furnish complete descriptions and specifications for your capacitor miniaturization problems.



(Continued from page 90A)

PITTSBURGH

"Electric Spark Machining of Hard Metals," by Peet Sylvester, student, Carnegie Institute of Technology, and "60-Cycle Induction Heating in the Steel Industry," by J. R. Garnett, student, University of Pittsburgh; February 14, 1955.

"Attempts to Simulate Learning by Digital Computer," by B. G. Farley, Lincoln Lab., M.I.T.; March 14, 1955.

PORTLAND

"Information Theory," by Don Aufenkamp, Reed College; March 17, 1955.

PRINCETON

"Ionization of Atmospheric Air—Its Effect upon Human Beings and Other Forms of Life," by Dr. C. W. Hansell, RCA; February 10, 1955.

ROCHESTER

"Ferrite Memory and Switching Devices," by Frank Gelbard, General Ceramics Corp.; January 27, 1955.

"Solid State Physics as Related to Transistors," by N. B. Nichols, Raytheon Mfg. Corp.; February 3, 1955.

ROME-UTICA

"Recent Experiments on Cloud Seeding," by R. E. Falconer, General Electric Research Lab.; March 1, 1955.

SACRAMENTO

"Principles and Application on Direct Coupling Between Transmission Lines," by P. D. Lacey, Hewlett-Packard Co.; March 11, 1955.

ST. LOUIS

"Super Highways for your Voice," by Irvin Mattick, Bell Telephone; February 24, 1955.

SALT LAKE CITY

"Geiger and Scintillation Counters," by John Reynolds, Universal Counters Co.; February 15, 1955.

SAN DIEGO

"Transistors as Working Circuit Devices," by G. M. Dodd, Navy Electronics Lab., Point Loma, Calif.; February 1, 1955.

"Telemetry—The Intelligence Link," by M. V. Kiebert, Jr., Convair Guided Missile Div.; March 2, 1955.

SCHENECTADY

Inspection of Telephone Company's television relay equipment and cross-bar dial phone; February 14, 1955.

SYRACUSE

"Mechanical Considerations in Disc Recording," by W. S. Bachman, Columbia Records, Inc.; March 3, 1955.

TORONTO

"Transistor Parameters and Their Application in Circuit Analysis," by Prof. V. G. Smith, University of Toronto; March 14, 1955.

TULSA

Lecture and Demonstration of an Atom Smasher by Dr. T. P. Hubbard, Well Surveys, Inc.; February 24, 1955.

TWIN CITIES

Forum on Computation and Control. Speakers: W. W. Butler, A. C. Cohen, C. W. Fritze, J. L. Hill and W. R. Keye, all of Remington Rand, Inc.; February 15, 1955.

WASHINGTON

"Management of a Research Enterprise," by Dr. E. W. Engstrom, Radio Corp. of America; March 14, 1955.

(Continued on page 94A)

ERIE ERIE ELECTRONICS DIVISION
ERIE RESISTOR CORPORATION
Main Offices and Factories: ERIE, PA.
Manufacturing Subsidiaries
HOLLY SPRINGS, MISSISSIPPI • LONDON, ENGLAND • TRENTON, ONTARIO

SCATTER

ANDREW Parabolic Antennas for this exciting new method of communication are available in standard sizes of 15, 30 and 60 ft. diameter.

The 30 ft. Type P-30-1 illustrated has a gain of 36 db at 800 MC and the Dual feeds have 40 db isolation. Antenna is adjustable in both elevation and azimuth. Construction is of sectionalized sheet steel, field welded. Type 16607 tower supports antenna center 50 feet above ground.

Look to ANDREW for your complete antenna system, including transmission line. Specify HELIAX[®], a truly flexible air-dielectric coaxial cable.

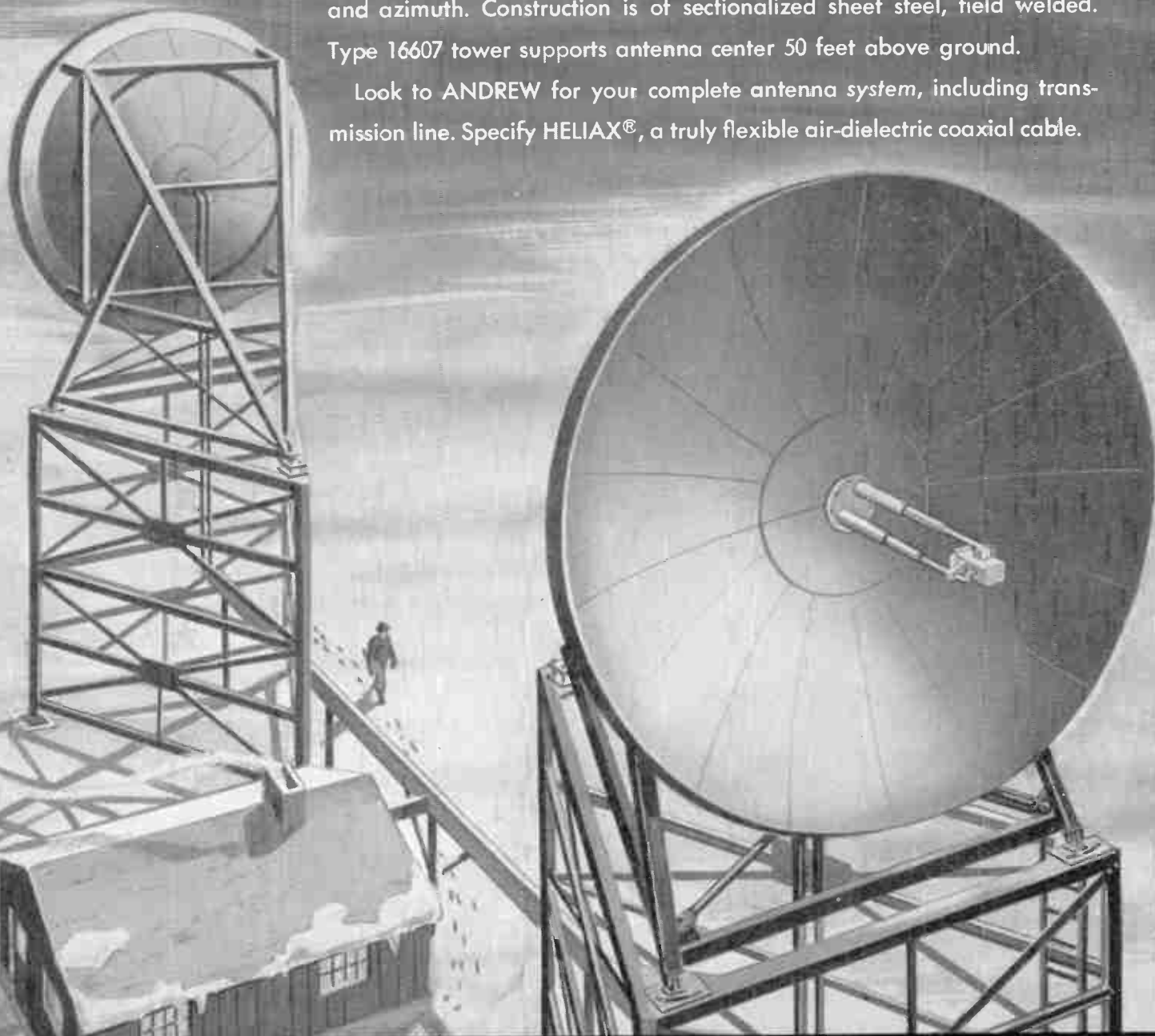

Andrew
CORPORATION
363 EAST 75th STREET • CHICAGO 19

TRANSMISSION LINES • ANTENNA EQUIPMENT



WESGO... for the best vacuum tube ceramic



WESGO AL-300 a very high alumina ceramic

Non-gassing at elevated temperatures • Extremely high strength • Very low loss at all frequencies • Vacuum tight • Very high bond strength to a "moly-manganese" metallized coating • Can be supplied in most shapes to precise dimensional tolerances.

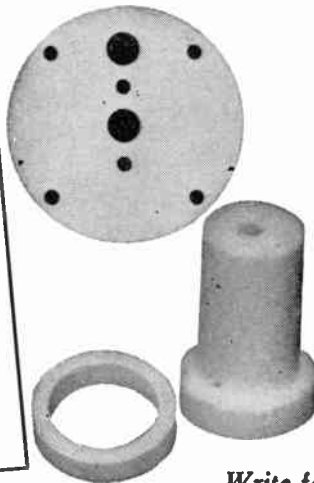

Write for additional information

WESTERN GOLD & PLATINUM WORKS
589 BRYANT • SAN FRANCISCO 7, CALIF.

VARIABLE DELAY NETWORKS by *ESC*

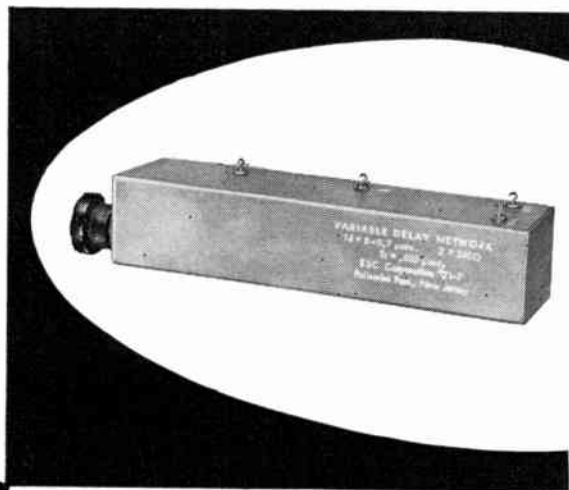

A new series of Variable Delay Networks, designed for laboratory use to facilitate design and development of advanced computer and radar systems is now available. Compactly designed for front panel mounting (gussets provided as specified), these delay networks offer a variation of delay from 0 to .75 μ sec in 10 turns of a Vernier control shaft.

Write for complete, new catalog!

C O R P O R A T I O N

534 Bergen Blvd., Palisades Park, New Jersey



ESC



Section Meetings

(Continued from page 92A)

WINNIPEG

"Traffic Signals," by J. L. Clarke, Winnipeg Traffic Dept.; January 19, 1955.
Conducted Tour of Telecom. Centre, Fort Osborne, guided by Major Clay; February 2, 1955.

SUBSECTIONS

AMARILLO-LUBBOCK

Discussion of 7th Annual Southwestern IRE Conference; February 17, 1955.
"Remote Control of Broadcast Transmitters," by Mark Bullock, Continental Electronics; March 10, 1955.

BUENAVENTURA

"Telemetry in the Oil Industry," by W. F. Abbott, Industrial Instrument Service Co.; February 10, 1955.

EAST BAY

"Transformers and Some Special Applications of Iron Core Inductors," by Prof. Wilson Pritchett, University of California; January 5, 1955.
"Electronics in Petroleum Research," by Carl Penner, Shell Development Company; March 16, 1955.

LANCASTER

"Characteristics of Currently Available Small Digital Computers," by H. M. Livingston, Burroughs Research Center; February 9, 1955.
"Printed Circuits—Background for Automation," by Donald Mackey and "Mechanism, Techniques and Standards for Use of Printed Circuits," by Jack Gordon and Frank Iles, all of Radio Corp. of America; March 9, 1955.

MID-HUDSON

"Electronics in Jet Engine Measurements," by Arnold Waterman, United Aircraft Corp.; March 1, 1955.

MONMOUTH

Field Trip to Bendix Aviation Corp. under Direction of Dr. W. C. Caldwell; March 9, 1955.

PALO ALTO

"Naval Communication Equipment," by Prof. E. G. Goddard, "Naval Radar Equipment," by Prof. R. L. Miller, and "Naval Underwater Sound," by Prof. L. E. Kinsler, all of Naval Post Graduate School; February 18, 1955.



Membership

The following transfers and admissions were approved to be effective as of April 1, 1955:

Transfer to Senior Member

Adams, G. E., R.F.D. 9, East State St., Ext., Fort Wayne, Ind.
Avis, A. J. A., 12560 Knoll Dr., Los Altos, Calif.
Bailey, A. D., Electrical Engineering Department, University of Illinois, Urbana, Ill.
Berry, H. W., 1986 N. Hamline, St. Paul 13, Minn.
Bowers, J. L., 830 El Dorado Dr., Fullerton, Calif.
Charton, P. W., 203 W. Upland Rd., Ithaca, N. Y.
Corl, J. L., 622 Rincon Rd., Richmond 11, Calif.
Darden, R. R., Jr., 216 E. James Ave., Oxnard, Calif.
Dea, D. Y. F., 643 W. 30 St., Los Angeles 7, Calif.
Dukat, F. M., 22 Madison Rd., Waltham, Mass.

(Continued on page 98A)

IT OPENED MY EYES. These fellows have actually *mass-produced Regulated Power Supplies!* If you're thinking they made a single, expensive "Universal" . . . guess again! They've got 64 different models . . . you buy only as much power supply as you need, and you can have it right off the shelf.

I wrote for this new catalog and **woke up!**

HOW? It's all right here in the catalog. The 64 models are not 64 designs. They've standardized on *two*, and build all 64 models on only *three* chassis. While they were at it, they cooked up two *good* new ideas: a four-way dual, and an ultra-dependable type using *only* 10,000 hour components.

And the prices . . . The lowest I've ever seen!

Send for your copy of "A Sensible Approach to Regulated Power Supply Design". Full price and performance data on the industry's most complete line of regulated plate supplies.

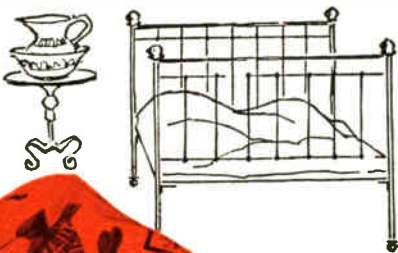

NEW JERSEY ELECTRONICS CORP.

349 Carnegie Avenue, Kenilworth, New Jersey

Competent Engineering Representation Everywhere



Rapid, complete, competitive custom quotes from 500 amperes (low voltage) to 100 KV (low current).



RCA 'Balanced Line' features "ADVANCED TECHNIQUE" ALUMINIZING

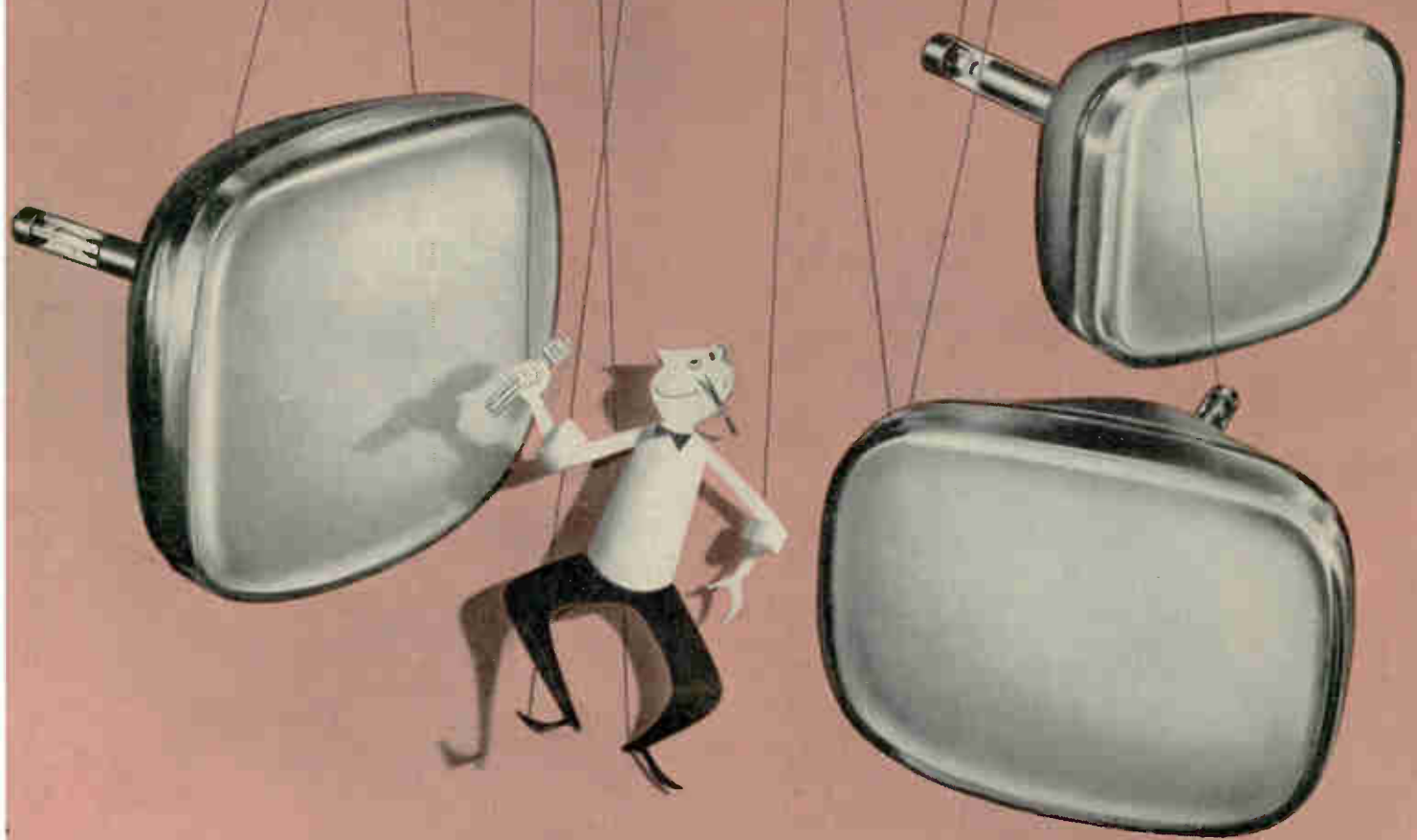

NEW 24-INCH Aluminized Picture Tubes—RCA-24CP4-A, RCA-24DP4-A, and RCA-24YP4—round out the RCA 'Balanced Line' for the new look in *your* receiver line.

These new tubes bring you the advantages of RCA "Advanced Technique" Aluminizing—an example of the forward thinking, planning, and engineering that make RCA Tubes famous for quality.

See for yourself how RCA top-quality aluminized picture tubes emphasize clarity and sharp detail in your new set designs. See your RCA Field Representative for your needs.

For technical data, write RCA, Commercial Engineering, Section E35Q, Harrison, N. J.

RCA "Advanced Technique" Aluminized Picture Tubes		
type	diagonal deflection angle	focus
21ALP4-A	90	E
21AMP4-A	90	M
21ATP4	90	E
21AVP4-A/21AUP4-A	72	E
21AWP4	72	M
21YP4-A	70	E
21ZP4-B	70	M
24CP4-A	90	M
24DP4-A	90	E
24YP4	90	E

E = low-voltage electrostatic M = magnetic



RADIO CORPORATION of AMERICA
ELECTRON TUBES
HARRISON, N. J.

BOARD OF DIRECTORS, 1955

J. D. Ryder
President

Franz Tank
Vice-President

W. R. G. Baker
Treasurer

Haraden Pratt
Secretary

John R. Pierce
Editor

J. W. McRae
Senior Past President

W. R. Hewlett
Junior Past President

1955

S. L. Bailey
A. N. Goldsmith
A. V. Loughren
C. J. Marshall (R5)
L. E. Packard (R1)
J. M. Pettit (R7)
B. E. Shackelford
C. H. Vollum
H. W. Wells (R3)

1955-1956

E. M. Boone (R4)
J. N. Dyer (R2)
J. T. Henderson (R8)
A. G. Jensen
George Rappaport
D. J. Tucker (R6)

1955-1957

J. F. Byrne
Ernst Weber

George W. Bailey
Executive Secretary

John B. Buckley
Chief Accountant

Laurence G. Cumming
Technical Secretary

Evelyn Davis
Assistant to the
Executive Secretary

Emily Sirjane
Office Manager



Responsibility for the contents of papers published in the PROCEEDINGS OF THE I.R.E. rests upon the authors. Statements made in papers are not binding on the Institute or its members.



PROCEEDINGS OF THE IRE

Published Monthly by

The Institute of Radio Engineers, Inc.

VOLUME 43

May, 1955

NUMBER 5

CONTENTS

D. J. Tucker, Director, 1955-1956.....	532
5338. Aircraft Antennas..... J. V. N. Granger and J. T. Bolljahn	533
5339. Some Aspects of the Design of Power Transistors... N. H. Fletcher	551
5340. Image Processing..... L. S. G. Kovásznyay and H. M. Joseph	560
5341. Pulse-Switching Circuits Using Magnetic Cores... M. Karnaug	570
5342. The Diurnal Carrier-Phase Variation of a 16-Kilocycle Transatlantic Signal..... J. A. Pierce	584
5343. Parallel-Network Oscillators..... J. L. Stewart	589
5344. A Simple Circuit for Frequency Standards Employing Overtone Crystals..... E. P. Felch and J. O. Israel	596
5345. Recovery Time Measurements on Point-Contact Germanium Diodes..... T. E. Firlie, M. E. McMahon, and J. F. Roach	603
5346. On the Physical Realizability of Linear Non-Reciprocal Networks... H. J. Carlin	608
5347. Design of Parallel-T Resistance-Capacitance Networks... Yosiro Oono	617
5348. IRE Standards on Television: Definitions of Television Signal Measurement Terms, 1955.....	619
Correspondence:	
5349. "A New System of Logarithmic Units"..... J. B. Moore	622
5350. "A Design Philosophy for Man-Machine Control Systems"..... Max Hoberman	623
5351. VHF Field Strength Far Beyond the Radio Horizon... T. F. Rogers	623
5352. Temperature Dependence of the Microwave Properties of Ferrites in Waveguide..... B. J. Duncan and L. Swern	623
5353. Notes on Hybrid Coding..... M. J. E. Golay	625
5354. Rebuttal..... M. Balsler and R. A. Silverman	625
5355. "Synthesis Techniques"..... R. H. Pantell	625
5356. Rebuttal..... G. L. Matthaci	626
5357. Diversity Combining..... J. B. Moore	626
5358. Rebuttal..... L. R. Kahn	626
5359. "Large Reduction of VHF Transmission Loss and Fading by the Presence of a Mountain Obstacle in Beyond-Line-of-Sight Paths"..... J. H. Crysdale	627
5360. Rebuttal..... F. H. Dickson, J. J. Egli, J. W. Herbstreit, and G. S. Wickizer	627
5361. "Scattering of Electromagnetic Waves by Wires and Plates"..... D. B. Brick	628
5362. Rebuttal..... J. Weber	628
Contributors.....	629

IRE News and Radio Notes:

Convention News Picture Section.....	631
Calendar of Coning Events.....	634
Twenty-four Organizations in Nuclear Conference.....	634
Obituaries.....	636
Technical Committee Notes.....	636
Professional Groups.....	637
Sections.....	637
5363. Abstracts of Transactions.....	639
5364-5365. Book Reviews.....	642
5366. Abstracts and References.....	643
Meetings with Exhibits..... 6A	86A
News and New Products..... 10A	94A
IRE People..... 48A	Positions Wanted by Armed Forces Veterans..... 128A
Industrial Engineering Notes.. 52A	Positions Open..... 138A
Professional Group Meetings.. 72A	

EDITORIAL DEPARTMENT

Alfred N. Goldsmith
Editor Emeritus

John R. Pierce
Editor

E. K. Gannett
Managing Editor

Marita D. Sands
Assistant Editor

ADVERTISING DEPARTMENT

William C. Copp
Advertising Manager

Lillian Petranek
Assistant Advertising Manager

EDITORIAL BOARD

John R. Pierce, *Chairman*
D. G. Fink
E. K. Gannett
T. A. Hunter
W. R. Hewlett
J. A. Stratton
W. N. Tuttle

Change of address (with advance notice of fifteen days) and communications regarding subscriptions and payments should be mailed to the Secretary of the Institute, at 450 Ahnaip St., Menasha, Wisconsin, or 1 East 79 Street, New York 21, N. Y.

All rights of publication, including translation into foreign languages, are reserved by the Institute. Abstracts of papers with mention of their source may be printed. Requests for republication privileges should be addressed to The Institute of Radio Engineers.



Durward J. Tucker

DIRECTOR, 1955-1956

Durward J. Tucker was born May 16, 1906 in Rice, Texas. He graduated from Southern Methodist University Engineering School in 1931 with a Bachelor of Science degree in electrical engineering and worked with the Engineering Department of the Southwestern Bell Telephone Company until 1933. He next joined WRR as a control room engineer and, in 1937, became Chief Engineer for the station. On June 1, 1951 he became Managing Director of WRR and WRR-FM as well as the Municipal Radio Department of the City of Dallas. In addition to the operation of commercial broadcast stations, WRR and WRR-FM, the City of Dallas Radio Department operates communication systems for various other departments of the city, such as Police, Fire, Water, Park, and Public Works.

In 1939 Mr. Tucker designed and supervised the construction of WRR's studios on the grounds of the Texas State Fair. His thesis on this subject together with other engineering accomplishments earned for him in 1941 an Electrical Professional Degree. In 1941 Mr. Tucker directed the construction of the 5,000-watt WRR-AM broadcasting plant, and in post-war years he headed the installation of WRR-FM with an effective power of

68,000 watts. In the period 1950 to 1952 he designed and supervised construction of a new police radio communications center and system.

In addition to writing articles for trade journals and technical magazines, he is the author of *Introduction to Practical Radio*, a textbook for beginners in radio. Mr. Tucker is active in Civilian Defense, being assistant to the Director of Civilian Defense of the Dallas area as Director of Communications covering radio broadcasting, police radio and other emergency radio facilities. In this same connection, he is a Lieutenant Colonel in the Texas State Guard, heading up all radio communications for the Third Brigade, whose area roughly covers the northern half of the state of Texas. He has been a licensed radio amateur, holding numerous amateur calls since 1923, with the present call of W5VU, which he has held for the past 24 years. He is a member of the American Institute of Electrical Engineers, National and Texas Societies of Professional Engineers, and Dallas Technical Club.

Mr. Tucker became an Associate Member of the Institute of Radio Engineers in 1930, a Member in 1941, and a Senior Member in 1943. He was elected Director of Region Six for the years 1955-1956.

Aircraft Antennas*

J. V. N. GRANGER,* SENIOR MEMBER, IRE AND J. T. BOLLJAHN†, SENIOR MEMBER, IRE

This is one of a series of invited papers. This paper summarizes the state of the art as regards the development of communication and navigation antennas for conventional aircraft.—*The Editor.*

INTRODUCTION

THERE ARE several reasons why the subject of aircraft antennas merits discussion separately from the general subject of antennas and why aircraft antenna design is a specialized field. From the electromagnetic standpoint, the conducting airframe forms a complex environment unlike the plane earth or free space conditions which may be assumed in many branches of antenna design. The requirements which prevail for high-speed aircraft—that antennas must not violate the aerodynamic contours nor compromise the structural integrity of the aircraft—introduce restrictions on the physical form of the radiating elements which are unique to the aircraft antenna problem. Finally, the fact that the electronic systems with which aircraft antennas must function are designed in many cases to meet needs peculiar to aircraft operations leads to novel requirements for the radiation or reception characteristics of the antennas.

The problem of the aircraft antenna designer is to provide antennas having electrical performance which meets the exacting requirements of the aircraft communication and navigation systems while working within the electrical and mechanical limitations set by the configuration and construction of the aircraft. Although this paper is concerned primarily with the nature of the limitations thus imposed, some discussions of system requirements and design objectives are included so that the extent and importance of these limitations may be viewed in proper perspective.

In discussing the electromagnetic behavior of an airframe it is convenient to divide the presentation into three frequency ranges, namely, the low-frequency range, the longitudinal resonance range, and the transverse resonance or diffraction range. The distinction between these ranges lies in the relationship between the airframe dimensions and the wavelength. The transition frequencies between these three ranges are not well defined in general but recognition of such a division is of considerable value conceptually. Note that the transition frequencies—poorly defined though they are—are inherently related to the airframe dimensions and are hence widely different for large and small aircraft.

Typical of the change in radiation characteristics of an antenna as its excitation frequency is varied through the three ranges is the change in the radiation pattern of a tail-cap antenna on a DC-4 aircraft shown in Fig. 1. In the low-frequency range—defined as the range within

which the maximum dimensions of the airframe are well below $\lambda/2$ —the pattern is seen to be that of a simple dipole. In the longitudinal resonance range, where the lengths of the major structural elements (i.e., the wings and fuselage) are of the order of the wavelength, the patterns exhibit greater complexity than in the low-frequency range due to phase cancellation and addition of the radiation from different portions of the airframe.

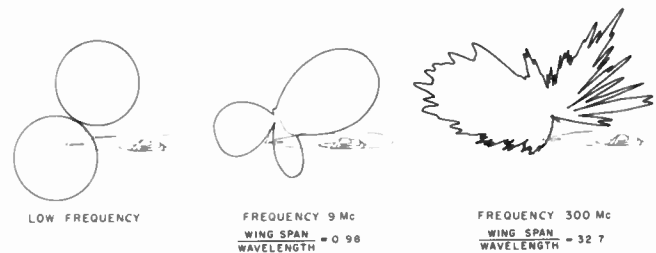

Fig. 1—Typical radiation patterns of a tail-cap antenna on a DC-4 aircraft in (a) the low-frequency range, (b) the longitudinal resonance range, and (c) the transverse resonance or diffraction range.

The general nature of radiation patterns in this range may be explained by considering the fuselage, wings, and horizontal and vertical stabilizers as current filaments with appropriate relative amplitudes and phases.

In the transverse resonance or diffraction region, where the over-all dimensions of the airframe are large compared with the wavelength, the patterns are typified by deeply shadowed regions and a fine structure which is at least superficially accounted for by considering the radiation to travel from the antenna to the observer by both a direct path and a path which involves a reflection at some point on the airframe. The following three sections consider antenna behavior in these frequency ranges in greater detail.

LOW-FREQUENCY ANTENNAS

Frequencies below about 2 mc are characterized by relatively low ground-wave attenuation, stable sky-wave propagation at large transmission distances and freedom from the effects of scattering objects on the ground. These attributes all favor the use of such frequencies for long-range navigational aids, and indeed, such services as the Four-Course Radio Range system, the Loran navigation system, and the British Decca navigation system all use frequencies below 2 mc. The wavelength at 2 mc is 492 feet, which is of the order of four times the maximum dimension of the largest commercial aircraft in current use. Because of the great difficulty encountered in transmitting efficiently and without excessive antenna voltages with antenna systems small relative to the wavelength, virtually all aircraft

* Original manuscript received by the IRE, February 23, 1955.

† Stanford Research Institute, Stanford, California.

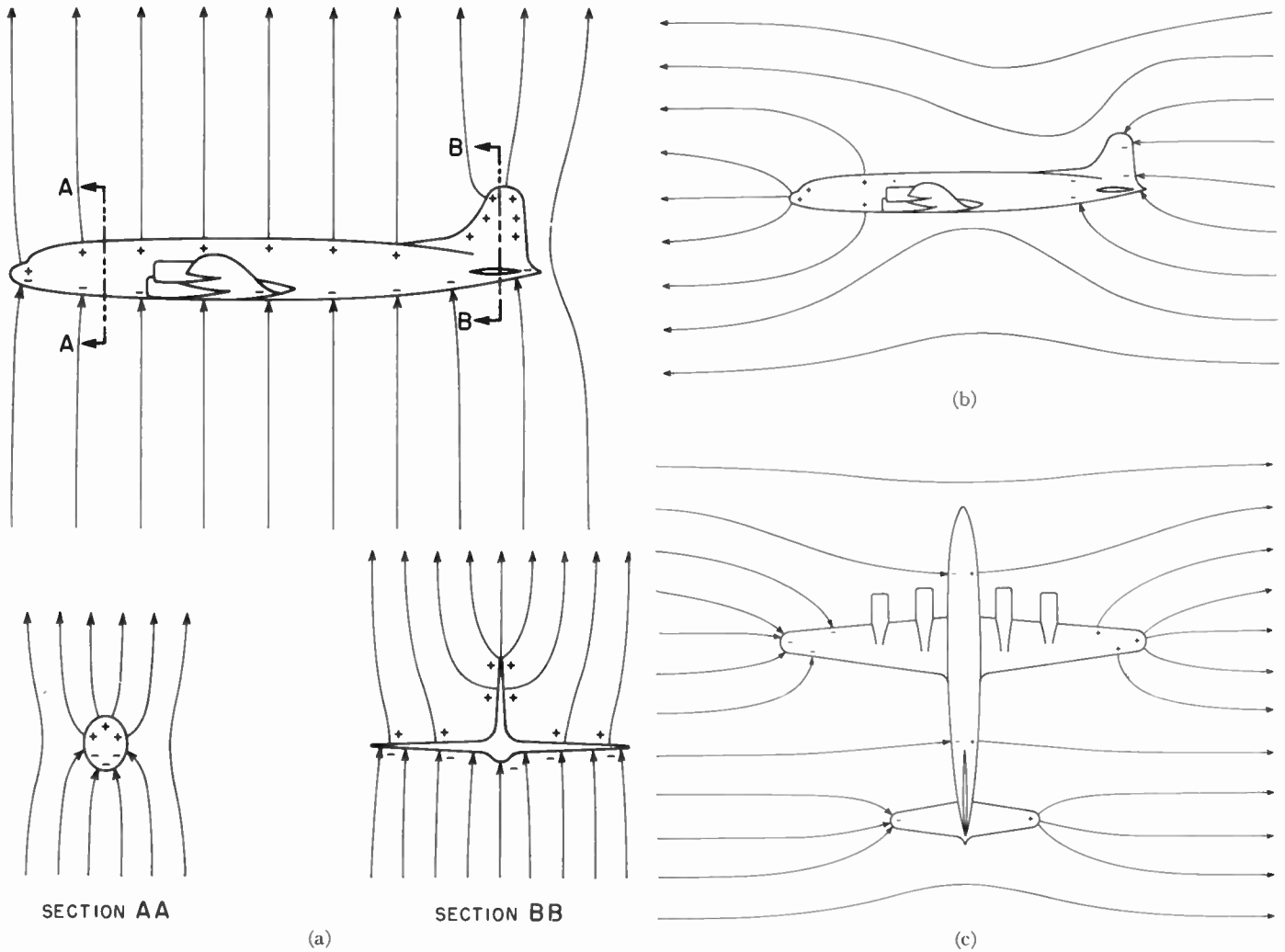

Fig. 2—Field fringing and airframe charging produced by incident electric fields in (a) the vertical direction, (b) the longitudinal direction, and (c) the transverse direction.

radio systems operating at these lower frequencies are so designed that only receiving equipment is required aboard the aircraft. For this reason, the design parameters customarily considered with antennas for this range are those used with low-frequency receiving antennas in general; namely, the effective length and the antenna reactance. Radiation resistance is small compared with the loss resistance of the antennas and the circuits to which they are connected, and hence it is usually neglected in drawing equivalent circuits and in analyzing the response of the receiving system.

From the electromagnetic standpoint, the lf range is the frequency range over which the quasi-static approximations may be used in analyzing the scattering of an electromagnetic wave by the airframe.¹

Electric-Dipole Antennas

Consider an aircraft flying through a uniform, vertical, electrostatic field. If the aircraft carries no net charge, the impressed field will cause a charge separa-

¹ J. T. Bolljahn and R. F. Reese, "Electrically small antennas and the low-frequency aircraft antenna problem," *TRANS. I.R.E.*, vol. AP-1, pp. 46-54; October, 1953.

tion, with positive charges on the lower portion of the airframe, as in Fig. 2(a). Because of the fringing of the electrostatic field about the airframe, the local field intensity along the upper and lower centerlines will exceed the impressed field intensity while the intensity along the sides at the boundary between the positively and negatively charged regions will go to zero.

If a small charge probe were touched to various points on the airframe surface the charge induced on it would vary from point to point and would be proportional in magnitude and sign to the charge density or normal field intensity at each point. The field and charge distributions produced about the airframe by a low-frequency vertically polarized electromagnetic wave are the same as those produced by the electrostatic field except, of course, that they vary in time synchronously with the rf field. The rf voltage induced in a small test antenna located at various points on the airframe would vary in the same way as does the induced charge on the test probe in the electrostatic analogy—a 180 degree shift in phase occurring as the antenna is moved from the positively charged to the negatively charged region.

If the impressed field were polarized in the direction of the line of flight, positive charges would be drawn to the nose and negative charges to the tail [Fig. 2(b)]. Similarly, an incident field in the transverse direction would set up still another charge pattern, with the boundary between positively and negatively charged regions in this case coinciding with the top and bottom centerlines of the airframe [Fig. 2(c)]. A particular antenna element will in general respond to all three of these mutually perpendicular incident fields in relative amounts which vary greatly for different antenna locations.

Since the response in each case is proportional to the projection of the equivalent dipole moment of the antenna-airframe combination on the corresponding electric field direction, it is clear that the orientation of the equivalent dipole is strongly dependent upon the location of the antenna element on the airframe. On the other hand, while the level of response of the antenna to a given incident field will obviously depend upon the size and configuration of the antenna element, its relative response to the three mutually perpendicular field components (and hence the orientation of the equivalent dipole axis of the airframe-antenna combination) will be relatively independent of the physical form of the element. The essential steps in the design of an electric dipole type antenna for the lf range consist, therefore, of selecting a location to give the required pattern orientation and an antenna element configuration to provide the required system sensitivity.

In some cases, the orientation of the equivalent dipole axis is of little concern, and the design objective is simply to maximize the response to vertically polarized signals. A moment's reflection on the behavior of electrostatic fields indicates that the fringing fields produced by a vertically polarized incident field should be particularly intense near the tip of the vertical stabilizer and that this region should hence be an ideal location for an antenna. Fig. 3(a) illustrates a Loran antenna designed to take advantage of the field fringing at the stabilizer tip on a DC-6B aircraft.² In this case the upper 23 inches of the stabilizer has been removed and replaced by a plastic shell. The antenna element consists of a piece of conducting screen fitted inside the plastic shell.

A measure of the degree to which field fringing increases the response of this antenna may be made by returning again to the electrostatic analogy. It may be shown from measured design data that the number of electric field lines which would terminate on this antenna (which has a total surface area of less than one square meter) if it were short-circuited to the airframe in the presence of a vertical electrostatic field is equal to the number of lines passing through an area of approximately 10 square meters, in the undisturbed portion of the impressed field.

² J. V. N. Granger, "Design limitations on aircraft antenna systems," *Aero. Engrg. Rev.*, vol. 11, pp. 82-87; May, 1952.

The number of lines terminating on the antenna is, of course, proportional to the total charge induced on the antenna. This charge may be shown to be related to the rf constants of the antenna through the relationship³

$$\frac{q}{E_v} = C_A l_v; \quad (1)$$

where

q = charge induced on short-circuited antenna (coulombs),

E_v = intensity of impressed vertical electrostatic field (volts/m),

C_A = antenna capacitance (farads), and

l_v = effective length for vertically polarized field (m).

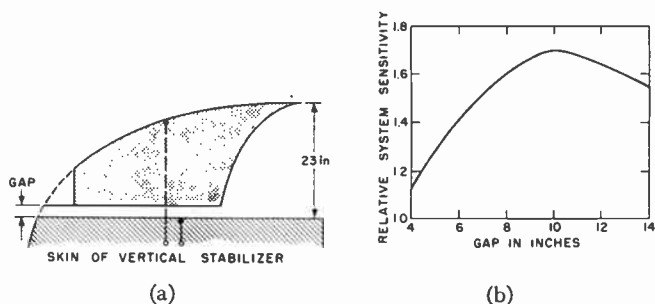

Fig. 3—Loran antenna on DC-6B aircraft: (a) physical configuration of antenna element, (b) dependence of system sensitivity on gap spacing.

The main physical parameter available to the designer once the size of the cap has been selected is the gap width between the antenna conductor and the conducting portion of the airframe. Varying this gap width will clearly not change q (and hence the sensitivity product $C_A l_v$) greatly as long as the gap is kept small relative to the height of the antenna. The individual values of C_A and l_v , on the other hand, are strongly dependent on the gap width, the former approaching infinity and the latter zero as the gap width approaches zero. Frequently an optimum antenna configuration will be found if the variations of C_A and l_v are considered in terms of their effects on the equipment with which the antenna is to work. In the case illustrated, the antenna was to feed, in conjunction with a preselector located at its base, into a Loran receiver. The characteristics of the preselector were such that decreasing the antenna capacitance resulted in a lower voltage delivered to the receiver for a given antenna induced voltage. As the antenna capacitance is decreased by widening the gap in an antenna such as this, however, the effective length is increased, and the result is that two opposing factors come into play as the gap width is varied. Fig. 3(b) shows that an optimum gap width was found to exist in this case. Since the receiving system noise level was virtually independent of antenna capacitance, the ordinates in the figure are hence proportional to signal-to-receiver-noise ratio as well as to system sensitivity.

³ J. T. Bolljahn and R. F. Reese, *loc. cit.*

The equivalent dipole pattern of this antenna on the DC-6B is tilted approximately 60 degrees from the vertical so that although the antenna was designed for maximum response to vertically polarized signals, its response to horizontally polarized signals is even greater. The main effect of the horizontally-polarized response is to increase the atmospheric noise entering the system, since the Loran signals are primarily vertically polarized signals.

The sensitivity to vertically-polarized signals is always a factor of importance in LF antenna design since maximum range of operation with ground-wave signals is an unvarying design objective. In some cases, however, the ADF or automatic direction finder sense antenna being a notable example, response to horizontally polarized signals can be sufficiently undesirable to render tail-cap antennas unacceptable.

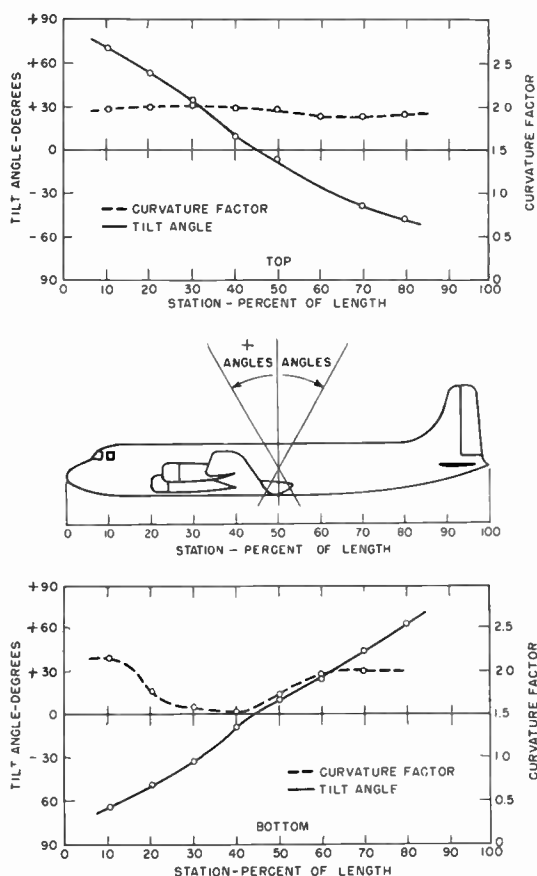

Fig. 4—Curvature factor and tilt angle survey data for DC-6 aircraft.

The operation of the ADF receiver is such that on a straight flight over the ground station the bearing indication tends to reverse, thus indicating station passage, when the null of the aircraft sense antenna crosses the ground station. The over-station indication will occur when the aircraft is directly over the station, therefore, only if the equivalent dipole axis of the sense antenna is vertical. Fig. 4 shows survey measurements of the type used in sense antenna design for the DC-6 aircraft. The curves labeled " F_v " show the factor by which the local

field intensity along the top and bottom center lines exceeds the impressed field intensity when the latter is vertically polarized. This factor—called the curvature factor for vertical polarization—is also approximately equal to the ratio of the effective length of an antenna as installed on the airframe to the effective length of the same antenna on a flat ground plane. The theoretical value of F_v for a horizontal conducting cylinder is 2. Its value is seen to be of this order on actual airframes also, except in the vicinity of the wings and vertical stabilizer where it is decreased somewhat due to shielding effects. The curves labeled "tilt angle" show the orientation of the equivalent dipole moment, measured from the vertical, as a function of antenna location along the top and bottom centerlines. On conventional airframes such as this, there are just two locations, one on the top and one on the bottom centerline, for which the equivalent dipole axis is vertical.

Currently used ADF sense antennas and radio range antennas on the larger aircraft are nearly all "T" or "L" antennas consisting of a horizontal wire and a lead-in. The horizontal wire, which is usually 12 to 18 feet in length, is supported on masts 12 to 18 inches off the bottom of the airframe. The effective length of such an antenna is, to a good approximation, equal to the spacing between the horizontal wire and the aircraft skin multiplied by the factor F_v appropriate to its location, and the capacitance may be estimated by considering the antenna as an open-circuited transmission line and employing standard formulas.

Various forms of flush and low-silhouette antennas are of interest at present as possible alternatives to these wire configurations for use on the newer high-speed aircraft and, indeed, some such antennas are already in use. Measured values of C_A and l_v for typical flush and short top-loaded antennas mounted on a flat ground plane are shown in Fig. 5. Fig. 5(a) is for a 7 by 14 inch cavity with an antenna element consisting of nine conducting strips one inch wide, spaced one-half inch, with one-half inch clearance from the cavity edge. C_A and l_v are shown as functions of the cavity depth. Figure 5(b) is for a vertical wire, one-eighth inch in diameter, top-loaded by a 6 by 12 inch metal plate. The antenna parameters are shown as a function of the height. The antenna sizes indicated are the model sizes used in making measurements and are considerably smaller than those required for aircraft installations. Both l_v and C_A scale linearly with the antenna's dimensions.

In the flush configuration of Fig. 5(a), the grid structure in the cavity aperture is insulated from the aircraft skin and serves as the actual antenna element. The element is made in the form of a grid so that it will serve as a Faraday screen, intercepting most of the electric field lines incident on the region of the aperture opening but not interrupting the magnetic field lines which may thread into the cavity virtually as though the aperture element were not present. This arrangement permits the

⁴ J. T. Bolljahn and R. F. Reese, *loc. cit.*

loop antenna of the ADF system to be placed within the cavity so that both ADF antennas may be flush mounted with a single cut-out in the aircraft skin.

The measured properties of this antenna show that both l_v and C_A vary as the cavity depth is varied but that their product is relatively independent of cavity depth. The reason for this behavior is readily explained in terms of the quasi-static point of view introduced above. If the antenna element were shorted to the ground plane and an electrostatic field were impressed normal to the ground plane, the quantity of charge induced on the element would be relatively independent of cavity depth since the grounded element in the cavity aperture would effectively shield the interior of the cavity. It follows, from (1), that the product $C_A l_v$ should likewise

antenna is usually located on or near the top or bottom centerline of the aircraft with its null axis in the horizontal plane. The loop element is rotatable about a vertical axis so that its null may be directed to any azimuthal heading. The direction to a transmitter on the ground is determined by rotating the loop until its output goes to zero, thus indicating that the loop null is pointed toward the signal source. The loop antenna, being less responsive than an electric dipole antenna to precipitation static noise generated on the aircraft, is frequently used also under precipitation static conditions to receive signals from the radio range navigational facilities or to identify other low-frequency stations.

Since the loop responds to the magnetic field rather

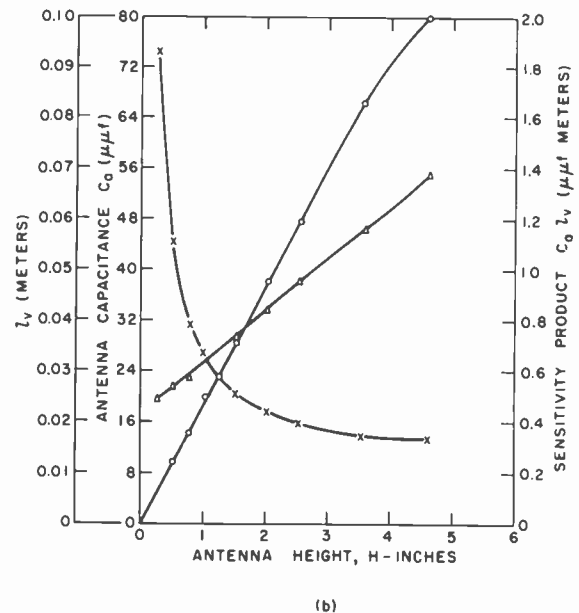
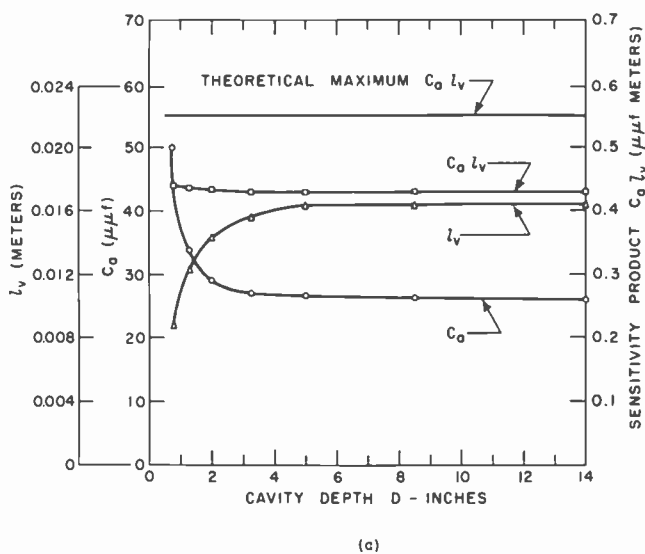

Fig. 5—Low-frequency design parameters, l_v and C_A for (a) flush antenna, and (b) low-silhouette protruding antenna.

be independent of the cavity depth. The curve labeled “theoretical maximum $C_A l_v$ ” was calculated from (1) with q taken as the total charge which would terminate on the antenna element if it were in the form of a solid conducting sheet filling the entire aperture area.

Antennas of the type shown in Fig. 5(b) with relatively small values of the plate spacing, H , are considered as possible alternatives to the completely flush cavity antenna in this frequency range. Although some aerodynamic drag will be produced even for small projections, this may be kept to a moderate value by fairing the antenna gradually into the airframe contour. In choosing between such a structure and a completely flush antenna, it is necessary to weigh the relative advantages of the cavity configuration which eliminates drag and the protruding antenna which avoids the structural complexity involved in the installation of a cavity in the aircraft skin.

The Magnetic Dipole Antenna

Low-frequency loop antennas are used on aircraft as one of the elements of the ADF system. The ADF loop

than the electric field, the effect of the conducting airframe on loop performance is quite different than its effect on the electric dipole elements discussed above. In the quasi-static frequency range, the airframe causes the magnetic field lines to distort in such a way that they avoid entering the airframe as shown in Fig. 6 (next page). The nature of field distortion depends of course, on the orientation of the aircraft relative to the direction of the initial field. The field line sketches in Fig. 6(a) and 6(b) illustrate the airframe effect for the two cases in which the ground station is to the side of the aircraft and ahead of the aircraft respectively. For most locations near the top or bottom centerline, the local field intensity is greater than the initial field intensity in both cases. The field enhancement produced by the airframe is important because it serves to increase the signal induced in the loop antenna and also is directly related to the bearing accuracy of the loop direction finder.

Indicating the ratio of local field intensity at a particular point to the incident field intensity as a_{yy} for the case in which the incident field is transverse to the line of flight and as a_{xx} when the field direction is along the

line of flight, it may be shown that bearing errors are always introduced into the direction finder when $a_{xx} \neq a_{yy}$. In the low-frequency range and for top or bottom centerline antenna locations, the bearing errors will be of the familiar quadrantal form, reducing to zero at bearings of 0, 90, 180, and 270 degrees, and alternating

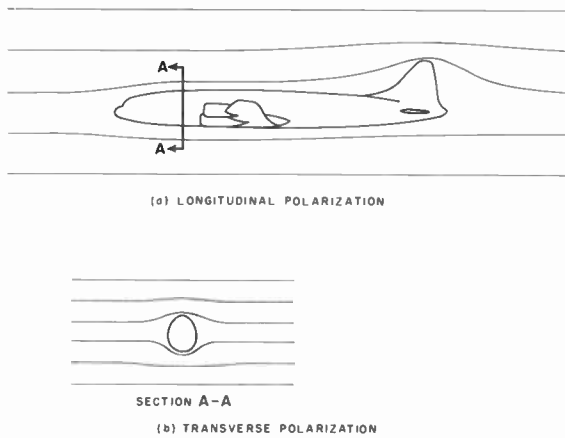

Fig. 6—Magnetic field distortion caused by conducting airframe for (a) longitudinal polarization, and (b) transverse polarization.

in sign in the successive quadrants. The bearing error curve may be readily calculated if the values of a_{xx} and a_{yy} are known, since for a direction of the incident field which is neither parallel nor transverse to the line of flight, the local field may be calculated by resolving the incident field into parallel and transverse components, increasing the components by a_{xx} and a_{yy} respectively, and recombining the modified components.⁵ The resulting change in the direction of the local field is, of course, equal to the error made in the determination of the source direction by the direction finder system. Measured curves of the factor a_{yy} and of the maximum bearing error for loop locations along the top and bottom centerlines of a DC-4 aircraft are shown in Fig. 7. The corresponding values of a_{xx} are very close to unity except for locations on the top centerline just forward of the vertical stabilizer where the shielding effect of the stabilizer causes this factor to become very small with a resulting abrupt rise in the maximum bearing error.

Bearing error curves are compensated in conventional installations by means of a mechanical compensating cam which causes the take-off synchro used to transmit angular loop position information to the bearing indicators in the aircraft to turn at a varying rate as the loop is rotated at a uniform rate. Such cams are adjustable so that they may be used to compensate bearing errors having maximum values up to about 20 degrees. Electrical compensation is employed in some of the newer flush loop designs. Such compensation may be achieved by modifying the structure of the airframe in the immediate vicinity of the loop element in order to make the ratio a_{yy}/a_{xx} equal to unity. Iron bars placed along

the aircraft centerline may be used to increase a_{xx} , or a closed conducting loop placed over the loop antenna with its axis transverse to the line of flight may be used to decrease a_{yy} in order to achieve compensation.⁶ Another compensation technique which may be used in conjunction with the flush sense antenna designs discussed above is to place the loop inside a rectangular cavity having its long dimension parallel to the line of flight. Immersing the loop in such a cavity will decrease both a_{xx} and a_{yy} but in different amounts. This system has the disadvantage of decreasing the sensitivity of the loop antenna more than the other two methods, but the decrease in a_{xx} may be made quite small by proper selection of the cavity dimensions provided that the error to be compensated is not too large.

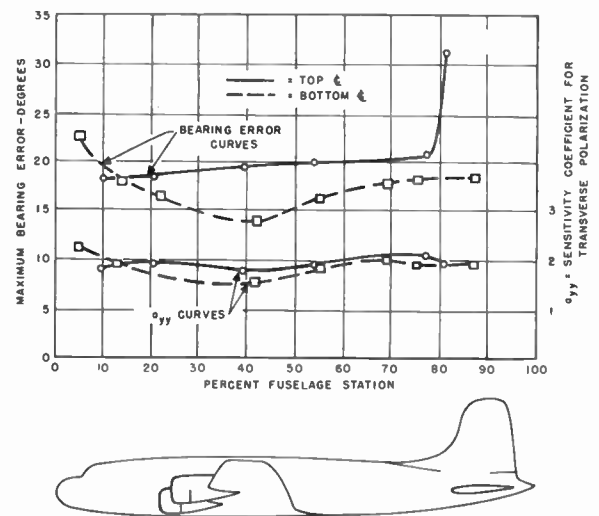

Fig. 7—Low-frequency loop antenna survey data for DC-4 aircraft showing maximum bearing error and sensitivity coefficient for transverse polarization for top and bottom centerline locations.

ANTENNAS IN THE LONGITUDINAL RESONANCE RANGE

The frequency range extending roughly from 3 to 30 mc is widely used for medium and long distance communications between an aircraft and the ground. Since, during its normal operations, a given aircraft may be required to communicate over distances ranging from a few miles to perhaps two thousand miles, at any hour of the day or night, and from almost any point on the earth, the communications system is required to operate at any of a large number of fixed frequencies, and at a relatively high power level.⁷ The aircraft antenna system for this application, then, must provide an input impedance into which the transmitter output can be matched with a minimum of power loss and—where high altitude operation is encountered—at peak voltage

⁶ In the recently announced model LP-70 flush loop antenna manufactured by the Bendix Radio Corp., powdered-iron bars are placed near the loop element in both the longitudinal and transverse directions. Electrical compensation is achieved by changing the dimensions of end-loading sections on the longitudinal and transverse bars as required to equalize a_{xx} and a_{yy} .

⁷ Current airborne equipments for this application provide up to 144 crystal-controlled frequencies and 100 watts of carrier power.

⁵ R. Keen, "Wireless Direction Finding," London, Illife and Sons Ltd., 4th Ed., p. 160; 1949.

levels below the corona threshold. For many applications the radiation pattern is not of particular concern since the transmission path will, from time to time, occur at any of a large number of azimuth and elevation angles with respect to the airframe, and pattern differences thus tend to average out. In comparing the performance of various antenna types for this application, it is customary to ignore radiation pattern differences below 6 mc, and to compare the patterns above 6 mc on the basis of the power gain (without regard to polarization) averaged over an angular sector bounded by the surfaces defined by angles of 30 degrees above and below the horizon.

The major dimensions of a typical transport aircraft are of the order of a wavelength in the 3–30 mc range, and therefore the wings and fuselage will serve as excellent radiating elements when appropriately excited. The antenna design problem is to devise a means of excitation which will provide good power transfer efficiency from the transmitter to space, and which is structurally and aerodynamically compatible with the airframe design. In examining the fundamental features of this problem, it is instructive to inquire first into the basic modes of current flow on an airframe and the electromagnetic resonance phenomena associated with them.

Resonant Current Modes of an Airframe

Virtually all airframes are symmetrical about a vertical plane containing the longitudinal axis of the fuselage, and it is therefore convenient to divide the various modes of current flow into two classes, one symmetric and the other anti-symmetric with respect to the airframe. Fig. 8 illustrates the typical form of these two

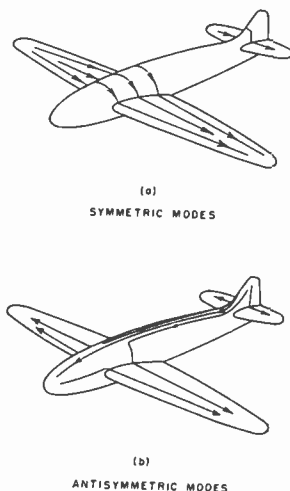

Fig. 8—Symmetric and antisymmetric modes of current on an airframe.

groups of modes and suggests the nature of the exciting devices which will couple to one or the other of the two types of modes. If exciting element—which may be in the form of an auxiliary conductor, such as a fixed wire, or may be formed by electrically isolating a portion of the aircraft, such as the tip of the wing—is so arranged as to produce no electric field across the plane

of symmetry of the airframe, only the anti-symmetric modes are excited. If, on the other hand, the excitation produces no magnetic field across the plane of symmetry, only the symmetric modes are excited. Many forms of exciting devices possess neither of these symmetry properties, and therefore give rise to currents on the airframe in both types of modes.

When only one class of modes is excited, the radiation pattern of the resulting antenna system will possess a characteristic symmetry directly related to the symmetry of the excitation scheme. A fixed wire antenna located in the plane of symmetry of the airframe, for example, produces no electric field across the plane of symmetry and thus excites only the anti-symmetric modes of current. The horizontally polarized component (E_{ϕ}) of the radiation from this antenna system, then, will always be zero in the plane of symmetry, and will exhibit the same intensity at any pair of angles symmetrically disposed with respect to the airframe.⁸

Let us examine the behavior of the input impedance of various antenna configurations in the light of these symmetry considerations. The impedance of any antenna configuration possessing one or the other of these types of symmetry will exhibit a series of peaks which occur when the various current paths associated with modes of that symmetry are of resonant lengths. The relative importance of the different modal resonances will depend on the details of the particular feed configuration. A feed configuration, such as a single isolated wing tip, which possesses neither symmetry, will excite both classes of modes and therefore its impedance curve will display both sets of resonant peaks. While the coupling to some of the modes may be so small as to make the associated peak indistinguishable on a measured impedance curve, no mode will occur which does not belong to one or the other of these two classes.

There are three anti-symmetric modes of practical importance. In the first, current flows from the tip of the vertical fin along the dorsal and the fuselage to the two wing roots, and thence outward along the wings to the wing tips, the two wing tips thus having the same rf potential. In the second mode, the current flow is from the nose to the two wing tips. The third is similar to the first, except that the current flows to the two horizontal stabilizer tips rather than to the wing tips. The lowest order resonances of these modes occur at those frequencies where the lengths of the current paths just described, as measured along the most direct route on the surface of the airframe, are approximately equal to $\lambda/2$. The most important symmetric mode is that associated with half-wave resonance of the wing. The effects of these resonances on the input impedance will be evident in the data which follow.

⁸ It is customary in describing aircraft antenna patterns to employ a system of spherical coordinates in which θ is measured from the zenith and ϕ is measured in a counter-clockwise direction from the nose of the aircraft. Defining polarization components in terms of this co-ordinate system avoids the ambiguity associated with the terms horizontal and vertical for angles near zenith.

Fixed-Wire Exciters

The fixed-wire antenna, in which a wire is supported between an insulated mast on the top of the fuselage just aft of the cockpit and the tip of the vertical fin, was the earliest form of aircraft antenna, and is used on most transport aircraft today. The feedpoint is usually at the forward end of the wire and the aft end may either be insulated from or short-circuited to the fin. Aerodynamic drag considerations limit the angle between the wire and the fuselage to a maximum of about 15 degrees, so that the wire, together with the top surface of the fuselage, can be visualized as a section of transmission line with a loss component in its input resistance due to radiation. The input impedance curves of Fig. 9,

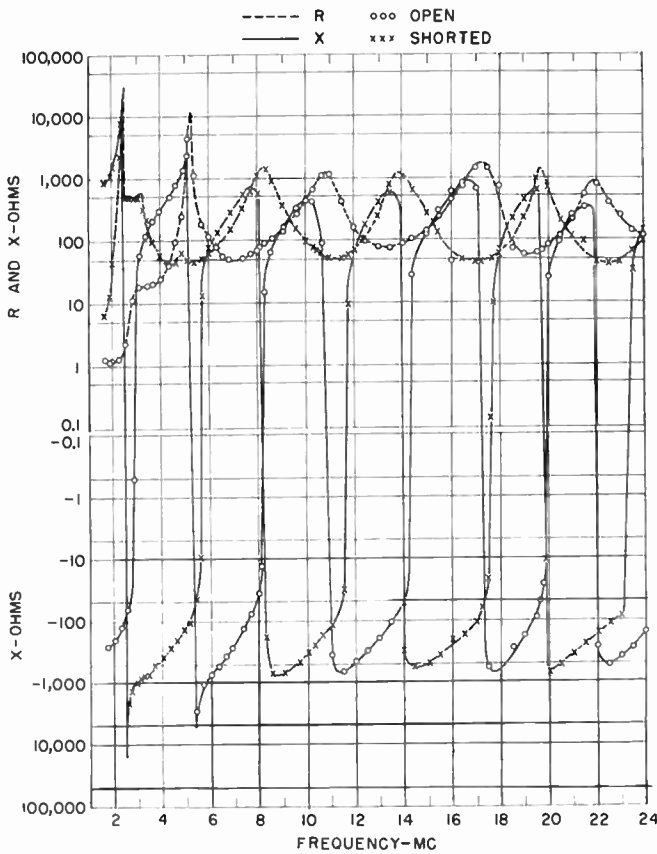

Fig. 9—Input impedance of 81-foot, open and shorted fixed-wire antennas on 1049 Constellation aircraft.

for an 81 foot wire on a Lockheed Super Constellation aircraft, exhibit the characteristic behavior of a moderately lossy transmission line, with regularly spaced resonances and anti-resonances which can be directly associated with the electrical length of the wire. The curves labeled with O's refer to a wire insulated from the fin at the attachment point while the curves labeled with X's refer to the short-circuited case. The "bumps" in the resistance curves which occur in the vicinity of 3 mc are the result of coupling to an anti-symmetric mode of the airframe, the first resonant frequency of the fin-fuselage-wing mode falling at 3 mc. That the modal resonances exert so little influence on the impedance

curve is due to the small degree of electromagnetic coupling that exists between the wire and the airframe.

A better understanding of the mechanism of radiation of the fixed wire-airframe combination may be obtained by employing the concepts used in the analysis of radiation from folded dipole antennas having unequal conductor diameters.⁹ Fig. 10(a) shows an idealized fuselage in the form of a conducting cylinder which is ex-

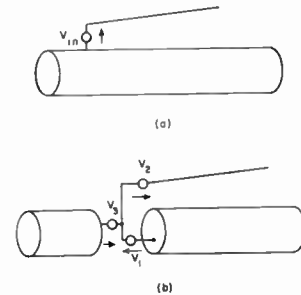

Fig. 10—Illustrating the decomposition of an idealized fixed-wire, airframe combination into transmission line and antenna modes.

cited by a fixed wire antenna and Fig. 10(b) shows how this feed system may be decomposed into a group of three generators for the purpose of separating the so-called transmission-line and antenna modes of the structure. Clearly the feed arrangement indicated in Fig. 10(b) is equivalent to that in Fig. 10(a) as long as $V_3 = V_1$ since, although the fuselage is separated at the feed point of the wire in the decomposition, the equality of V_1 and V_3 insures that no net voltage is impressed across this artificial separation section. If the portion of the system including the smaller sector of the simulated fuselage and the generator V_3 were removed, generators V_1 and V_2 would drive the antenna wire and the remainder of the fuselage as a transmission line, with one of the conductors swinging positive while the other swings negative. It would be possible to adjust the ratio V_1/V_2 to a particular value (in this case a small value) such that the common junction of these two generators remained at zero potential. If the ratio were set to this value, it would now be possible to reconnect generator V_3 and the fuselage extremity without disturbing the response of the system to the generator pair V_1 and V_2 since doing so would not "load" the transmission line mode. The generator V_3 drives the system as an asymmetrically driven dipole, and it is this generator which produces the radiating currents in the antenna mode. Since V_1/V_2 and hence V_3/V_2 must be small, and since the total driving point voltage, V_{in} in Fig. 10(a), is equal to $(V_1 + V_2)$ or $(V_1 + V_3)$, it is seen that only a small fraction of the driving-point voltage is active in exciting the antenna currents on the structure. When the analysis is carried through, it develops that in the expression for the input admittance of the antenna system, the contribution due to the "antenna" element is

⁹ W. Van B. Roberts, "Input impedance of a folded dipole," *RC:1 Rev.*, vol. 8, p. 129; June, 1947.

multiplied by $V_1^2/(V_1+V_2)^2$. Numerical values for this ratio are not available but it is clear that the voltage ratio must be of the same order of magnitude as the ratio of the diameter of the wire to that of the fuselage, and therefore the factor multiplying Y_a is of the order of 10^{-4} . From these considerations, then, it is seen that the fixed wire is very poorly coupled to the current modes of the airframe, and that the measured impedance curves of Fig. 9 are consistent with the mechanisms described.

Many other forms of fixed-wire antennas can be devised, and several are in use, but none of them afford a really effective means of taking advantage of the capabilities of the airframe itself as a radiator.

Isolated Cap Antennas

A much more effective means of exciting the airframe as a radiator is found in the isolated cap type of antenna. In this configuration, a limited portion of the tip of the vertical fin or of one of the wings is electrically isolated from the remainder of the airframe by means of a dielectric structure, thus forming the antenna terminals. The behavior of this type of structure is closely related to that of the asymmetrically driven dipole, and an approximate theoretical expression for the input impedance of the latter is of great value in understanding the behavior of cap-type antennas. It follows from a very simple argument¹⁰ that the input impedance of the asymmetrically-driven linear dipole sketched in Fig. 11



Fig. 11—Asymmetrically driven dipole.

can be approximated by the expression

$$Z_{in} = \frac{1}{2}(Z_1 + Z_2) \tag{2}$$

where Z_1 is the impedance of a center-driven dipole of half-length l_1 , and Z_2 the same for a half-length l_2 . It is clear, then, that if the length of the cap, l_1 , is very short compared with the wavelength, while the total length, (l_1+l_2) , is of the order of the wavelength, the input reactance will be largely determined by l_1 , while the input resistance will depend only on l_2 . It is clear also that the resistance maxima of Z_{in} will occur when l_2 is equal to an integral multiple of $\lambda/2$. This is the behavior which is typical of wing cap and tail cap aircraft antennas.

The tail-cap antenna excites only the anti-symmetric modes of the airframe, and is coupled to them very closely. Fig. 12 shows the measured input impedance of 7-foot tail cap on a DC-4 airframe. It is seen that the reactance curve is similar to that of a very short dipole, while the resistance curve shows two marked peaks, one at 4 mc and one at 17 mc, the first resonant frequencies of the fin-fuselage-wing mode and the fin-horizontal stabilizer mode, respectively. The impedance curves shown are typical, and for a wide variety of airframes

the two resonant peaks of resistance appear as shown at the frequencies appropriate to the dimensions of the airframe. Changing the size of the cap while maintaining a constant gap width has a very small effect on the resistance curve, but shifts the level of the reactance curve almost directly with the dimensions of the cap.

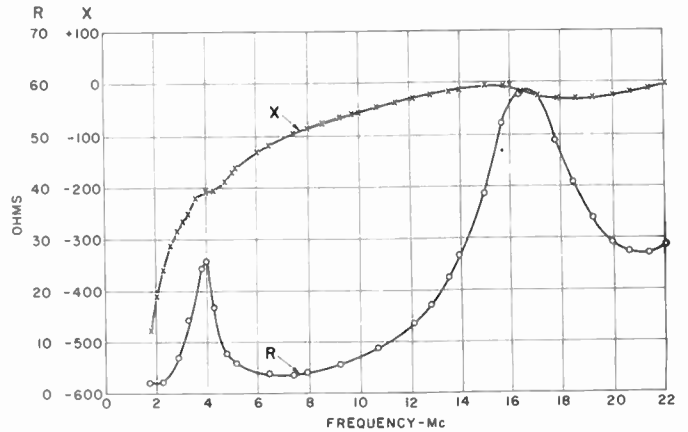

Fig. 12—Input impedance of 7-foot tail-cap antenna on DC-4 aircraft.

Changing the width of the isolating gap has marked effect on the impedance level, associated with the base shunting capacitance. The gap spacing is ordinarily chosen as the smallest consistent with the high-altitude voltage breakdown requirements for structural reasons.

The wing-cap configuration does not possess symmetry, and hence excites both symmetric and anti-symmetric current modes on the airframe. Fig. 13 shows the measured input impedance of a 2-foot wing cap on a

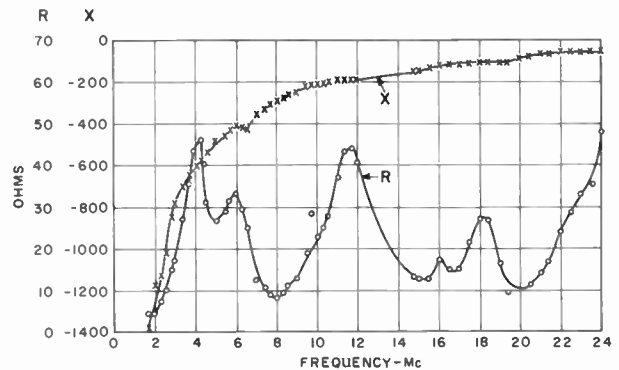

Fig. 13—Input impedance of 2-foot wing-cap antenna on DC-4 aircraft.

DC-4 aircraft. The reactance behavior is as before, but in this case the resistance curve exhibits resonant peaks at several frequencies within the band. The resonant frequencies associated with the fin-fuselage-wing anti-symmetric mode and the first symmetric mode of the wing are coincident, and fall at 4 mc. The peak at 6 mc is related to resonance of the path from the wing tip to the wing root and thence to the nose. Surface current density measurements made on scale models indicate that the peaks at 12, 18 and 24 mc are identified with

¹⁰ R. King, "Asymmetrically driven antennas and the sleeve di-hole," Proc. I.R.E., vol. 38, pp. 1154-1163; October, 1950.

the same path, the shielding effect of the fuselage acting to suppress symmetric modes involving the entire wing.¹¹

Shunt Feed Excitation

It is possible to excite an airframe as an antenna in the longitudinal resonance range by a conductor placed in shunt with a major element of the airframe, or across a notch cut into one of the airframe elements. These structures are analogous to the familiar folded dipole, and their behavior can be explained on a similar basis.

The ordinary fixed-wire antenna, shorted to the airframe at the vertical fin, can be regarded as a shunt feed structure. The decomposition of this structure into "transmission line" and "antenna" elements was described above, and the reason for the relatively poor behavior of such structures was explained in terms of the unfavorable division of the "antenna" current between the wire and the fuselage. The performance of structures of this type can be improved by redesigning them so as to yield a more favorable current division ratio. One means by which this can be accomplished is by increasing the effective diameter of the feeding conductor, and two ways in which this might be done are sketched in Fig. 14, where the fuselage is the airframe element being shunt fed. Although the electrical improvement over the conventional fixed wire achieved in this way is modest, the structure lends itself to a flush or low-drag installation which can be accomplished without interference with the primary structural members of the airframe, so that this configuration is of some practical interest. A similar arrangement was flight-tested in Germany in the late 1930's¹²

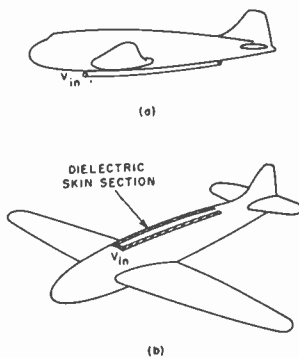

Fig. 14—Increasing the effectiveness of coupling to airframe resonances with fixed-wire type exciters, (a) by use of a large diameter feed wire and (b) by use of a wide flush strap rather than a wire

A second and more promising way in which a favorable current division can be achieved in a shunt-fed configuration takes advantage of the concentration of surface currents near the leading and trailing edges of the wings. If the shunt feed conductor is placed in the plane

of the wings near the leading or trailing edge, or is located inside a dielectric fairing replacing one of these wing components, as sketched in Fig. 15, the current division ratio is of the order of 1/10, rather than 1/10,000 as in the fixed-wire case. With this rather effective degree of coupling to the airframe current modes, a

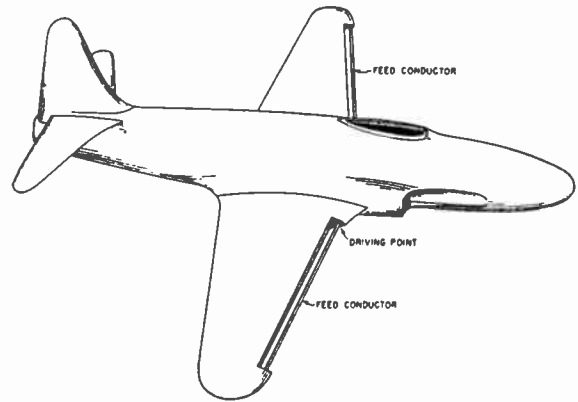

Fig. 15—Shunt feed technique utilizing leading edge of wing.

useful input impedance characteristic is achieved.¹³ Both wings can be fed in a balanced fashion, exciting only the symmetric modes of the airframe, or only one wing can be fed, so that both symmetric and anti-symmetric modes are excited, as with a wing cap. Fig. 16 (opposite) shows an impedance curve typical of the latter.¹⁴ The data are for the Super Constellation aircraft, and a shunt feed conductor $\frac{7}{8}$ inch in diameter and 30 feet long set in the inboard trailing edge of one wing.

In England, considerable interest has been shown in the notch-feed arrangement (Fig. 17, opposite). Set in one wing root, such a configuration will excite both anti-symmetric and symmetric modes of the airframe. Coupling to these modes is relatively weak, however, and the inductive shunting reactance associated with the notch itself is very small, so that high circulating currents must exist for useful radiated power. Not enough data has been obtained to evaluate fully the potentialities of this scheme. It is attractive from the structural standpoint in that the entire antenna is located in a region in which the structural loads are small.

Impedance Matching

A discussion of hf communications antennas for aircraft would be incomplete without some mention of the problem of matching the antenna to the transmitter, or more accurately, since the transmitters are usually located at some distance from the antenna terminals, to a transmission line. Since the impedance of any practical antenna varies widely over this frequency range, and the matching requirements for maximum radiated power are stringent, it is impractical to use a single broadband

¹¹ I. Carswell, "Current Distribution on Wing-Cap and Tail-Cap Antennas," Tech. Report No. 43, Contract AF 19(604)-266, Stanford Research Institute; May, 1954.

¹² R. Appel, H. Schlicke, and H. Rindfleisch, "Problems in Theory and Technique of Antennas, Part I," Translation Report No. F-TS-2222-RE, Hq., Air Materiel Comm., Wright Field, Dayton, Ohio; November, 1947.

¹³ J. V. N. Granger, "Shunt-excited flat-plate antennas with application to aircraft structures," *PROC. I.R.E.*, vol. 38, pp. 280-286; March, 1950.

¹⁴ J. Taylor, "Flush-Mounted H-F Antennas for the 1049 Constellation Aircraft," Stanford Res. Inst., February, 1952 (Prepared for Lockheed Aircraft Corporation).

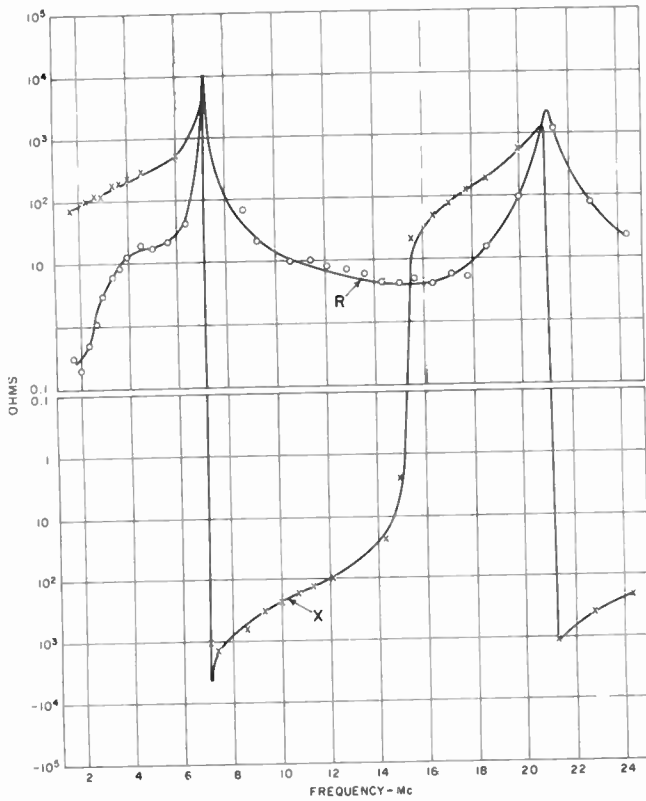

Fig. 16—Input impedance characteristic achieved with 30-foot shunt-feed element at inboard trailing edge of wing in 1049 Constellation aircraft.

matching configuration, and the antenna must be matched by a network with its elements appropriately adjusted at each frequency. With modern equipment, this is accomplished either by “remembering” the appropriate matching element settings in some mechanical

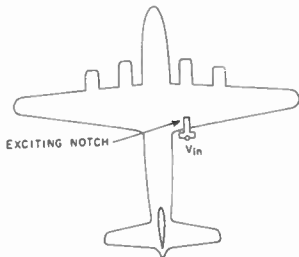

Fig. 17—Notch feed high-frequency antenna.

device, or by providing a servomechanism which senses the output power and automatically adjusts the matching elements so as to maximize it.¹⁵ In either case, the problem of achieving useful power transfer efficiencies is severe. Fig. 18, following page, shows the maximum power transfer efficiency to be obtained from a matching network employing inductances with a Q of 100 and capacitors with a dissipation factor of 0.001 as a function of load impedance, for a transmission line of 50 ohms characteristic impedance.¹⁶ Comparison with

the impedance data shown earlier will indicate the severity of the design problem. If inductances can be eliminated from the matching network entirely, the power transfer efficiency will be improved, since practical capacitors have Q factors much higher than can be obtained in practical inductances. Only a limited range of load impedances can be matched with such networks, however.¹⁷ With some forms of antennas, the input impedance can be arranged to fall within this range at all, or nearly all, frequencies. With a fixed-wire antenna of the type shown in Fig. 9, a shorting relay can be located at the point of attachment of the wire to the vertical fin and, when appropriately actuated, produce an antenna whose input reactance is always positive. Shunt-feed arrangements are attractive possibilities for this reason also. In those frequency ranges in which the input reactance of the basic structure is negative, it is usually possible to produce a positive reactance by a simple modification of the structure, such as shorting the shunt-feed conductor to the airframe at an intermediate point.

Another problem in matching network design which is of importance is that of accuracy of setting of the matching elements. Since the matching elements must frequently be designed to cover very broad reactance ranges, it is difficult to achieve a high precision of setting accuracy in a practical fashion. High setting accuracies are frequently required, however, if the residual VSWR's on the transmission line must be confined to low values for proper transmitter operation. Fig. 19 (page 545), illustrating a simple graphical construction on a Smith chart, shows how the required accuracy of setting of the matching elements is increased as the load impedance moves away from the characteristic impedance of the transmission line.

ANTENNAS IN THE TRANSVERSE RESONANCE OR DIFFRACTION RANGE

Frequencies of 100 mc and above are widely used in short range communications and navigation systems for aircraft. Despite the limited operating range imposed by the propagation characteristics of these higher frequency signals, systems operating in this range achieve a freedom from atmospheric noise and precipitation static noise which makes them preferable to their lower-frequency counterparts for short range service.

Since the wavelengths in this range are small relative to the airframe dimensions, it is possible in most cases to employ antennas of resonant size and, with proper design of the antenna element and a passive matching circuit, to achieve an acceptable match to a coaxial feed-line over a considerable frequency bandwidth.

It is in obtaining adequate radiation pattern coverage that most of the outstanding difficulties arise in this range.

¹⁵ E. W. Schwittek, “Servocoupler matches aircraft antennas,” *Electronics*, vol. 27, pp. 188-192; October, 1954.

¹⁶ R. L. Tanner, “Antenna-matching network efficiency,” *Electronics*, vol. 26, pp. 142-143; November, 1953.

¹⁷ P. H. Smith, “L-type impedance transforming circuits,” *Electronics*, vol. 15, pp. 48ff; March, 1942.

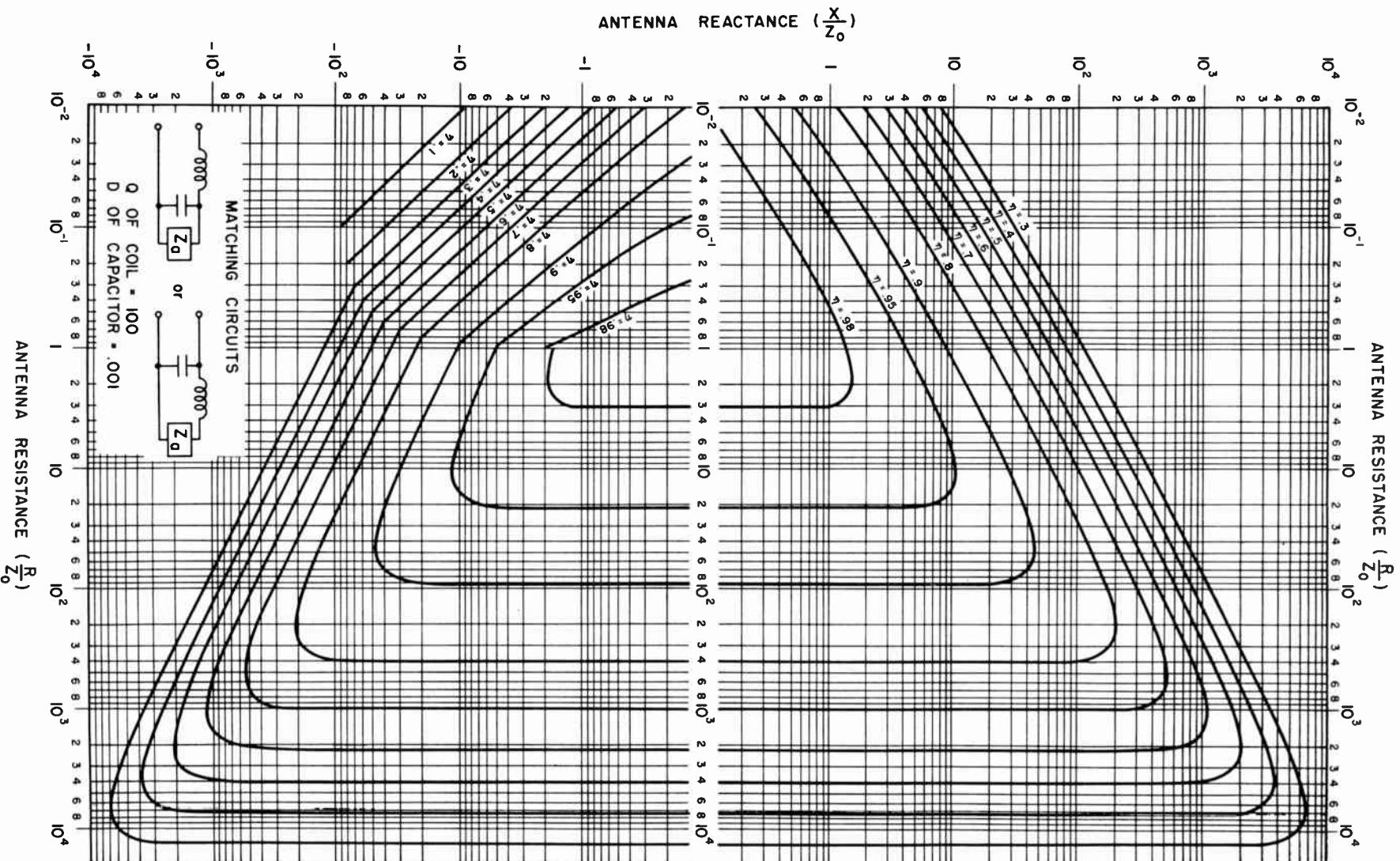

Fig. 18—Matching efficiency chart for L networks showing contours of equal power transfer efficiency on normalized R/Z_0 coordinate grid. Assumes coil Q of 100 and capacitor dissipation factor of 0.001.

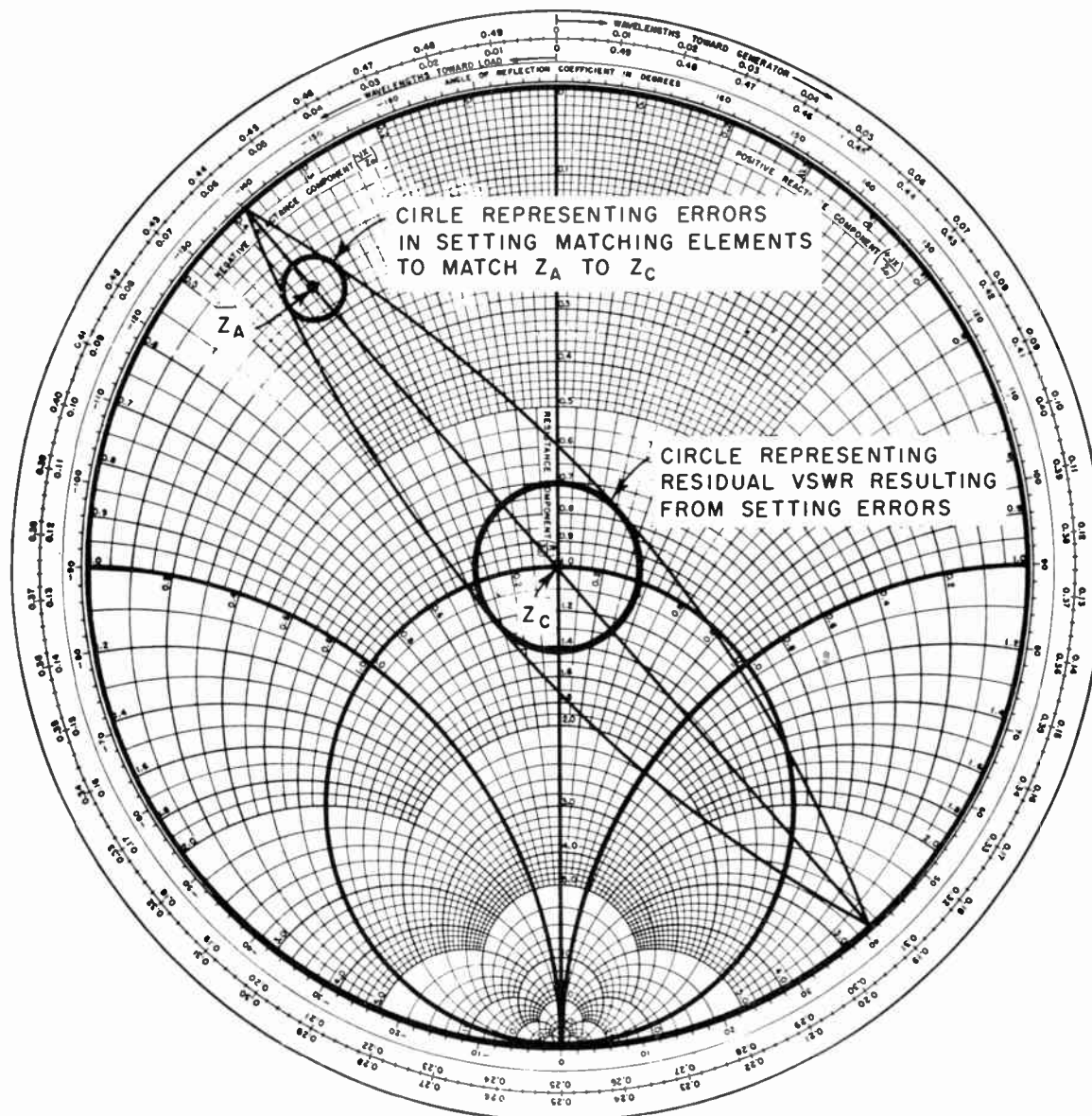

Fig. 19—Smith chart construction relating residual VSWR to error in setting network elements in a dissipationless matching circuit.

Antennas with Uni-Directional Patterns

Some of the standard aircraft navigational aids have coverage requirements which are relatively easily satisfied by antennas yielding a simple beam directed away from the surface on which the antenna is mounted. Systems in this category include the glide slope receiver which operates in the frequency range 329–335 mc and which receives signals only from forward of the aircraft, the 75 mc marker beacon receiver which receives signals only from below the aircraft, and the radio altimeter which also requires only downward coverage and which operates in the frequency range 400–440 mc. In the case of the glide slope and marker beacon antennas, the requirements are particularly simple since the systems with which they function are adequately powered for their short service range, and proper functioning is not disturbed if the antenna coverage extends beyond the sectors for which coverage is required. The glide slope

antenna most commonly used is in the form of a small loop, mounted with its axis vertical [Fig. 20(a) on the next page]. This antenna element may be mounted externally on the nose of the aircraft or inside the nose radome in aircraft equipped with radar.

Since the marker beacon receiver operates only on a fixed frequency of 75 mc, bandwidth is not a problem, and it is customary to use a very small antenna in order to simplify the installation problem. One widely used marker beacon antenna is in the form of a cavity similar to the sense antenna cavities discussed in the second section but with a feed which is inductive rather than capacitive [Fig. 20(b)].¹⁸ Unlike the sense antenna, this antenna must be matched to a 50-ohm coaxial line at the design frequency. Adequate efficiency and stability of match are obtained with cavity dimensions of only

¹⁸ H. Kees and F. Gehres, "Cavity aircraft antennas," *Electronics*, vol. 20, pp. 78–79; January, 1947.

10 inches in length by 6 inches in width by 3 inches in depth (corresponding to $0.064\lambda \times 0.038\lambda \times 0.019\lambda$ at 75 mc). This antenna has a radiation pattern similar to that of a loop antenna with its axis in the width direction of the cavity. The pattern is modified, of course, by the airframe but the coverage is acceptable for most locations along the bottom of the fuselage.

The most common type of radio altimeter antenna is a balanced half-wave dipole spaced about $\lambda/4$ from the bottom of the wing surface with the dipole oriented parallel to the line of flight [Fig. 20(c)]. The transmitting and receiving dipoles are usually mounted symmetrically on the two wings or in line along the bottom of the fuselage. Although maximum downward gain is a design objective with the radio altimeter system, considerable latitude is available in the placement of these antennas since the gain does not vary greatly with antenna location as long as the antennas are placed on a reasonably flat surface which is removed by a distance of the order of a wavelength from the edges of the wing.

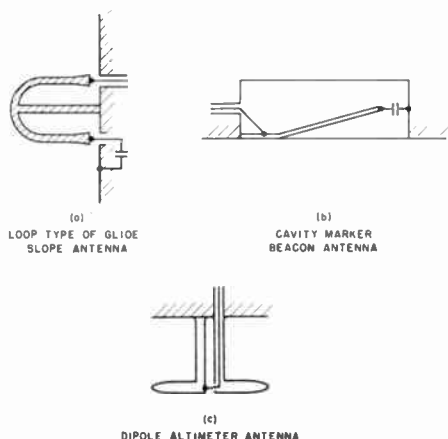

Fig. 20—Typical vhf aircraft antennas, (a) glide-slope antenna, (b) market beacon antenna, and (c) altimeter antenna.

impinging on the metal surfaces of the airframe is reflected in accordance with physical laws akin to those of geometric optics, so that the patterns are characterized by shadow regions in which almost no signal is present and interference regions of alternating lobes and nulls. These effects are clearly visible in Fig. 21 which shows the patterns of a 1,000 mc monopole on a B-50 aircraft.¹⁹

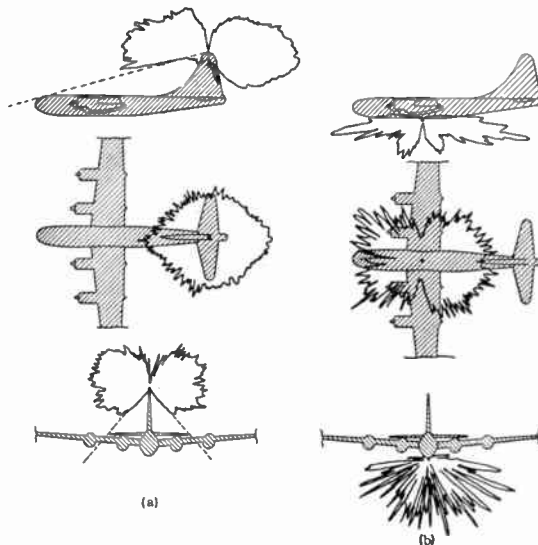

Fig. 21—Radiation patterns of 1000 mc stub antennas mounted (a) on the tip of the vertical stabilizer and (b) on the bottom centerline of a B-50 aircraft.

At the lower end of the vhf spectrum where the wavelength is no longer small with respect to all of the dimensions of the airframe, additional complicating phenomena arise, particularly in the case of the fin-tip location. Fig. 22, which shows the patterns of a monopole on the fin of a fighter aircraft at 300 mc, demonstrates that in this case the region of severe interference lobing ex-

Slot antennas are sometimes used in cases where flush mounting is required. In order to achieve a directive gain equivalent to that of the dipole and its image, a pair of resonant length slots spaced $\lambda/2$ apart and driven in phase is used.

Omni-Azimuthal Patterns

Many aircraft radio systems, such as the vhf and uhf communications systems, the vhf omni-range receiver (VOR) and the distance measuring equipment (DME), require coverage at all azimuths and for a range of elevation angles above and below the horizon to permit contact during normal aircraft maneuvers. The provision of antennas meeting these requirements is a difficult design task. In this frequency range, where the operating wavelength is small compared with the dimensions of the airframe, the airframe has a major effect on the radiation pattern. The most important features of radiation patterns obtained in this range can be visualized in the terms of elementary optics. Radiation

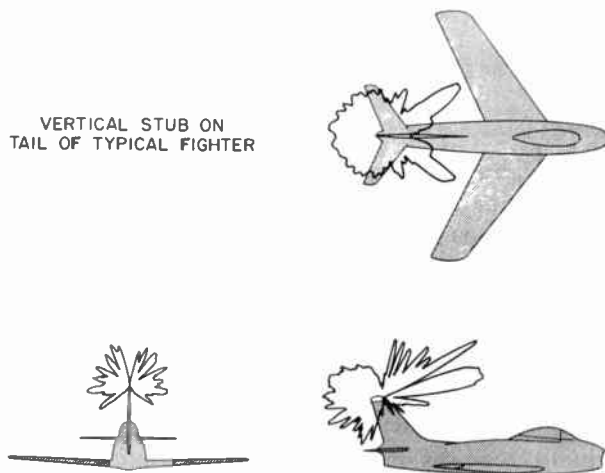

Fig. 22—Radiation patterns of a 300 mc stub antenna on the stabilizer tip of a fighter aircraft.

¹⁹ The deep lobing of the transverse vertical plane pattern for the belly location is due to the intense illumination of the sharply curved surfaces of the engine nacelles. This effect is less severe for locations away from the wings, but for these locations the azimuthal pattern is even less circular. If a belly installation is used, the designer must find the optimum location by experiment.

tends into the important forward directions. Since the fin-tip location is generally the preferred one for antennas requiring all around coverage, the explanation for this effect and measures for controlling it have been the subject of much investigation. The explanation appears to be that the tail structure adjacent to the antenna element modifies the distribution of the energy emanating from the antenna before it reaches the main bulk of the airframe in such a way that an alternate signal path is produced in the forward direction.²⁰ The nature of the local field distortion produced by the vertical stabilizer is indicated in Fig. 23 which shows the radiation pattern

VERTICAL STUB $\frac{\lambda}{4}$ AFT OF
LEADING EDGE - FIN ONLY

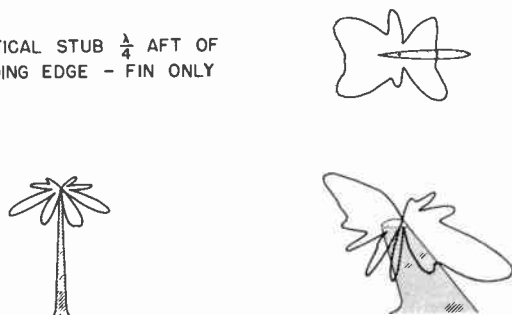

Fig. 23—Radiation patterns of a 300 mc stabilizer tip stub antenna with the stabilizer removed from the aircraft.

of a stub antenna on a stabilizer which has been removed from the remainder of the aircraft. The radiation lobe directed downward indicates that strong traveling-wave currents are set up along the leading edge of the stabilizer due to excitation of the antenna. When the stabilizer is in place on the aircraft, these currents are prevented from forming a downward lobe by the shielding effect of the fuselage. The energy intercepted by the fuselage is partly scattered into high angles above the horizon and partly directed along the fuselage from whence it radiates forward to combine with the direct signal from the antenna, thus producing interference effects at low elevation angles.

Investigators in this field have noted that the main source of the leading-edge currents is simply the normal ground-plane currents required to maintain continuity of current through the generator feeding the antenna. This point of view indicates that some forms of antennas should be much less effective than others in producing leading edge currents. For example, consider two antenna elements, one $\lambda/2$ in length and one $\lambda/4$ in length, both driven against an infinite ground plane and both radiating the same amounts of power. At large distances from the two, the ground-plane currents from the $\lambda/2$ radiator will be somewhat greater than those from the $\lambda/4$ radiator due to the higher gain of the larger element. However, since the $\lambda/2$ element has a current minimum at its base, while the $\lambda/4$ element has a current maximum at its base, the ground-plane currents

near the feed points will be very much smaller in the former case. It follows that a $\lambda/2$ antenna driven against the stabilizer tip will produce patterns more nearly like those predicted by the optical analogy than will a $\lambda/4$ antenna in the same location. Measurements confirm that this is indeed the case, the $\lambda/2$ element giving a pattern virtually free of interference lobes in the critical region while the normal tail-cap antenna is subject to severe lobing in this region. Unfortunately, for a given antenna length this method of pattern improvement will be limited to a relatively narrow frequency band. Ellis has achieved broadband decoupling between normal types of UHF antennas and the stabilizer leading edge through the use of a system of choke slots in the stabilizer.²¹ Further investigation of this problem is currently under way.

The design of a fin-tip antenna for the uhf communications system is relatively straightforward from the impedance matching standpoint. Numerous configurations, each intended for installation inside a dielectric housing of the same shape as the original fin tip, have been devised.²² Three typical examples are illustrated in Fig. 24.

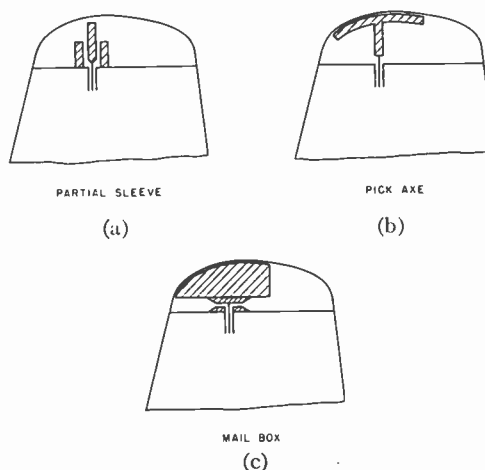

Fig. 24—Typical forms of tail-cap vhf antennas: (a) The partial sleeve antenna, (b) the pickaxe antenna and (c) the mailbox antenna.

The antenna design problem for the VOR system involves design concepts which are quite different from those discussed above since, although the VOR requires omni-azimuthal coverage, it employs horizontally polarized signals. A horizontally polarized radiator located close to a horizontal infinite conducting sheet will produce no signal in the plane of the sheet but will have its radiation directed away from the sheet. As the spacing of the antenna from the sheet is increased, the principal radiation lobe will become progressively lower but a null will always occur in the plane of the sheet. If the same antenna is placed over a conducting sheet of finite size, or a conducting airframe as in the design of a VOR antenna, the general pattern behavior will be quite similar except

²¹ A. R. Ellis, *loc. cit.*

²⁰ A. R. Ellis, "Methods of Improving Tail-Cap Antenna Patterns," Tech. Report No. 35, USAF Contract AF 19(604)-1296, Stanford Res. Inst.; January, 1955.

²² "Communication and Navigation Antenna Design," Commun. and Nav. Lab., Wright Air Dev. Center, Wright-Patterson A F Base, Ohio; August, 1949.

that some signal will be produced in and below the plane of the conductor. The amount of signal produced in the horizontal plane depends, of course, on the size and shape of the conducting sheet or body and upon the spacing of the antenna element from it. Within the practical limits of interest in the VOR problem, increased spacing will always increase the signal on the horizon.

Mechanical and aerodynamic constraints are particularly severe in the design of externally mounted VOR antennas since the horizontally polarized element, which must be relatively massive and bulky to meet the impedance bandwidth requirements must also be supported off the aircraft skin by means of a mast. The resulting structure is clearly one which is difficult to design mechanically and which may be expected to have a large aerodynamic drag. One widely used type of VOR antenna which incorporates many desirable mechanical features is the so-called ram's-horn antenna.²³ This antenna consists of a horseshoe-shaped element which is supported 12 inches off the aircraft skin by means of a mast so that the element lies in a horizontal plane with the open portion toward the rear of the aircraft. Since the frequency range required of the VOR antenna is 108–122 mc,²⁴ it is seen that this spacing is a relatively small fraction of a wavelength. As a result, the horizontal-plane coverage of this type of antenna is rather poor.

the radiation pattern of a symmetrical, balanced antenna is not affected by the addition of a thin conducting body in its plane of symmetry, regardless of the extent of the conducting body. This principle is illustrated in Fig. 26 both for a balanced loop and a balanced pair of

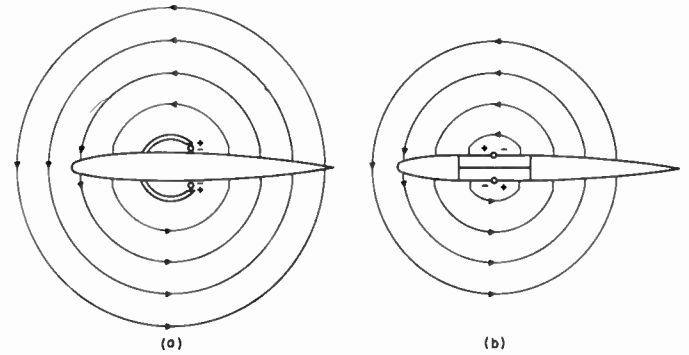

Fig. 26—Illustrating the technique for avoiding diffraction effects due to the vertical stabilizer by properly phasing a pair of symmetrically-located radiators.

slot antennas on a vertical stabilizer. The sketches of the electric field lines in this figure show how the fields from the two halves of the balanced antenna combine at the forward and trailing extremities of the stabilizer to eliminate diffraction effects. This technique does not eliminate the deleterious effects on the pattern due to the other portions of the airframe but merely serves to elevate the antennas as high as possible above the bulk of the airframe by using the stabilizer as the mast. Various types of both flush and protruding antenna elements have been designed to take advantage of this principle, the most successful of the flush designs being the so-called *E*-fed cavity antenna which is described in the following section.²⁵ Radiation patterns of an *E*-fed cavity system on the DC-6B aircraft are shown in Fig. 27. The horizontal-plane coverage of this antenna is seen to be considerably better than that of the ram's-horn antenna on the same aircraft (Fig. 25).

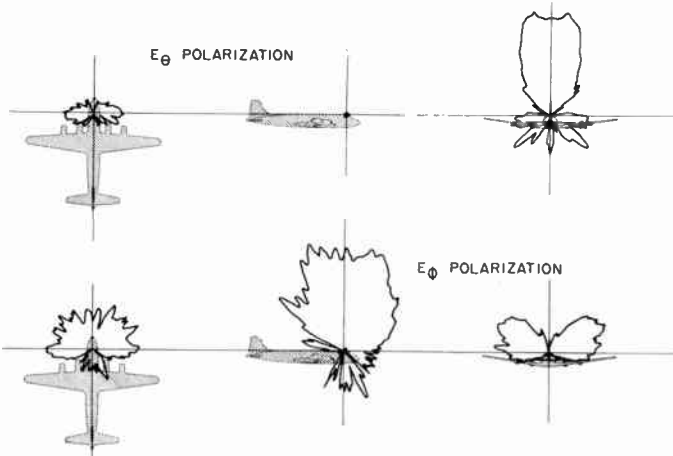

Fig. 25—Radiation patterns of a ram's-horn VOR antenna located on top centerline near nose of a DC-6B aircraft. Horizontal-plane E_{ϕ} polarization pattern shows response to signals of interest.

The typical ram's-horn patterns shown in Fig. 25 for the DC-6B aircraft show that the greatest sensitivity is for signals arriving from directly above the aircraft and that the sensitivity to the important signals arriving in the horizontal plane—particularly from behind the aircraft—is relatively quite poor.

The design technique which has proved most successful to date in obtaining the required VOR coverage is the use of balanced elements on either side of the vertical stabilizer. This technique is based on the principle that

²³ The model 37-J3 antenna manufactured by the Collins Radio Co. is typical.

²⁴ A portion of this band is devoted to the localizer receiver—a component of the Instrument Landing System—which is also served by the VOR antenna.

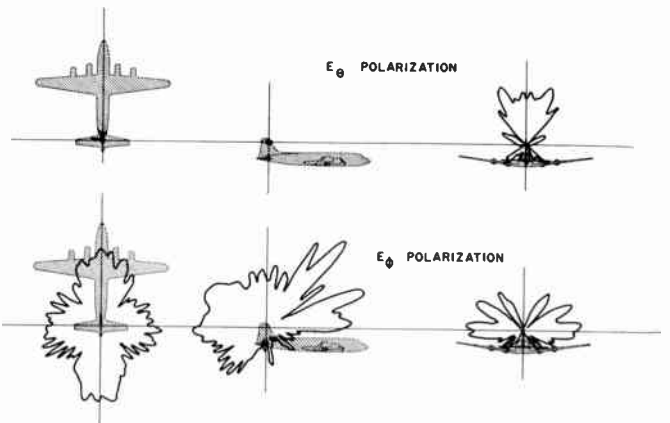

Fig. 27—Radiation patterns of a pair of *E*-fed cavity VOR antennas in the vertical stabilizer of a DC-6B aircraft.

²⁵ I. J. Stampalia, "Interim Engineering Report on the *E*-Fed Cavity, A Flush-Mounted Antenna for Use With Radio Receiver Set AN/ARN-14 on the XB-52 Aircraft," Document No. D-10799, USAF Contract No. W33-038-ac-15065, Boeing Airplane Co.; June 15, 1950.

Impedance Matching

It was stated earlier that in this frequency range the problem of impedance matching was of secondary importance, since antenna dimensions in the order of a wavelength were usually possible. The VOR antenna, which operates at relatively long wavelengths, and the uhf communications antenna, which must cover a wide frequency band, are the most difficult design problems from the impedance matching standpoint. This is especially true if a flush-mounted design is required. We will conclude our discussion of antennas for the transverse resonance or diffraction region, then, with a brief discussion of the design of the *E*-fed cavity and the annular slot as examples of flush-mounted antennas for these applications.

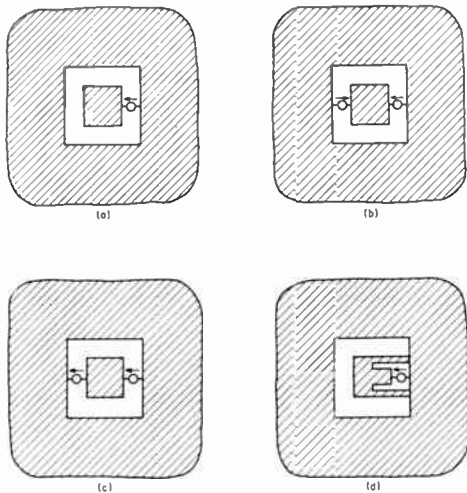

Fig. 28—The modes of operation of a patch antenna and the related *E*-fed cavity antenna: (a) the patch antenna, (b) anti-symmetric mode, (c) symmetric mode, and (d) the *E*-fed antenna.

The basic form of the *E*-fed cavity VOR antenna is sketched in Fig. 28(d). The design procedure used in matching the *E*-fed cavity is a cut-and-try process with successive changes in the physical dimensions required to achieve the optimum impedance characteristics. The cut-and-try sequence can be greatly simplified by the use of an equivalent circuit, the network elements of which can be identified with various regions of the antenna cavity and driven element. The equivalent circuit in the case of the *E*-fed cavity is somewhat complicated, and its detailed development is beyond the scope of this paper. An appreciation of the important factors which must be accounted for in the equivalent circuit may be gained, however, from the following simplified description of the operation of the antenna.

Consider a cavity antenna with an aperture plate driven as shown in Fig. 28(a). The asymmetrical feed arrangement may be considered as a superposition of the anti-symmetric and symmetric feed configurations illustrated in Figs. 28(b) and 28(c) respectively. The radiation pattern produced by the former is essentially that of a monopole normal to the surface (i.e., it is similar to the pattern of the annular slot) while that of

the latter is a loop pattern similar to that of a small loop placed next to the aperture with its axis vertical. The equivalent circuit of the asymmetrically driven system [Fig. 28(a)] must account for radiation in both of these modes and must properly account for the effect of cavity and aperture slot dimensions on their levels of excitation.

The *E*-fed cavity [Fig. 28(d)] is similar to the asymmetrically driven cavity except that the driven element, instead of being a single isolated conductor, is now a folded monopole. The equivalent circuit of the *E*-fed cavity bears the same relation to the asymmetrically driven cavity that a folded monopole does to a simple monopole (i.e., it consists of the equivalent circuit of the asymmetrically driven cavity, an ideal transformer, and an additional shunt susceptance which represents the transmission line mode of excitation of the aperture plate). The *E* configuration leads to a substantially better impedance characteristic than that obtained with a simple aperture plate.

The radiation pattern as well as the impedance of an antenna of this type is dependent upon the physical proportions of the structure, since the relative amounts of power radiated by the monopole and loop modes will vary as the antenna configuration is varied.

Typical VOR installations having cavity dimensions of the order of 30 inches high by 20 inches wide by 4½ inches deep (the latter dimension being limited to half the stabilizer thickness in the balanced-cavity antenna system) suppress the monopole mode of radiation quite effectively while giving adequate impedance bandwidth.

The annular slot communications antenna is usually installed at some point along the bottom centerline of the aircraft fuselage. Since the aircraft skin in this region is subject to high mechanical stresses, it is obvious that an important design objective is an antenna with the minimum possible diameter. This is also desirable from the standpoint of the radiation pattern, since it is known that the principal lobe approaches the plane of the slot only when the slot diameter is reasonably small compared to the wavelength.²⁶ On the other hand, if the slot is regarded as the region between the inner and outer conductors of a coaxial line terminating in a ground plane, calculations of the slot admittance show that the radiation conductance is extremely small compared with the slot susceptance, with the former reaching a peak for a slot diameter near one wavelength and increasing in an oscillatory fashion with increasing diameter. From the standpoint of matching the impedance to the required VSWR over the entire band, the significant parameter is the ratio of the slot susceptance to the conductance, or the antenna *Q*. Fano²⁷ has developed a

²⁶ A. A. Pistolokors, "Theory of the circular diffraction antenna," *Proc. I.R.E.*, vol. 36, pp. 56-60; January, 1948.

²⁷ R. M. Fano, "Theoretical Limitations on the Broad-Band Matching of an Arbitrary Impedance," *Journal of the Franklin Institute*, Vol. 249, pp. 57-83 and 139-154; January, February, 1950.

general theory for the relationship between maximum bandwidth and antenna Q , and Tanner²⁸ has recast Fano's analysis in a form more directly applicable to vhf antenna design. To date the most successful application of their work to the design of a uhf annular slot was carried out by A. S. Dorne. His final design is shown in Fig. 29, together with its approximate equivalent circuit. In the equivalent circuit the net aperture impedance of the driven annular slot and the inner, parasitic

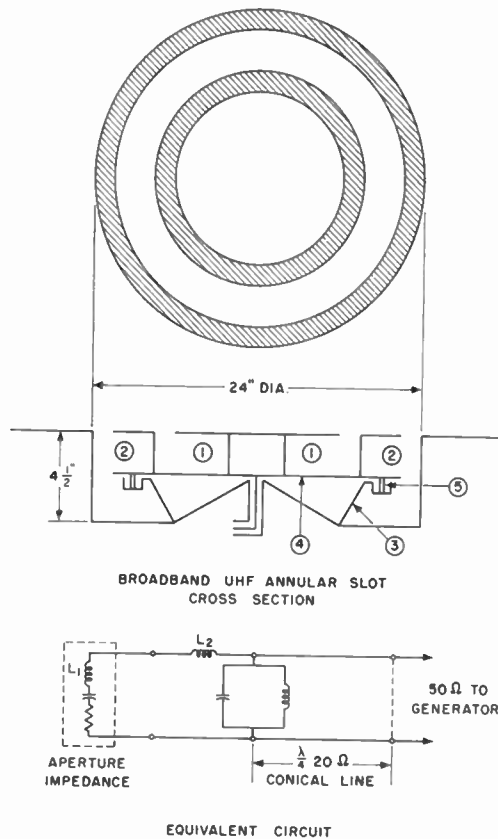

Fig. 29.—Annular slot antenna for the 225–400 mc band and equivalent circuit.

annular slot is shown as a series RC circuit.²⁹ The annular region 1 which is coupled to the radiating aperture through the mutual impedance between the two slots, and the annular region 2 which is part of the feed system are so positioned and proportioned that they store primarily magnetic energy when the antenna is driven. The inductances associated with the energy storage in these regions are designated as L_1 and L_2 in the equivalent circuit. The parallel-tuned circuit indicated in the equivalent circuit is formed by the shunt capacitance between the vane 3 and the horizontal disk 4 together with the shunt inductance provided by four conducting posts, 5, equally spaced about the periphery of 4 which also serve to support 4 above 3. From this element inward to the coaxial line, the base plate is cambered up-

²⁸ R. L. Tanner, "Theoretical Limitations on Broad-Band Impedance Matching," *Electronics*, vol. 24; February, 1951.

²⁹ In this system, the phase relations are such that the radiation from the parasitic slot tends to augment that from the driven slot. In terms of Babinet equivalents, this pair of slots approximates a two-turn loop equivalent.

ward to form a conical transmission line region of low characteristic impedance. A short additional section of low impedance line is added external to the cavity to complete the required impedance transformation.

Arrangement of the internal structure of the cavity to approximate a circuit of this form permits the designer to employ a systematic procedure based upon bandpass filter design concepts in selecting the appropriate element dimensions and spacings in his search for the smallest antenna which will meet the bandwidth requirements. Actually the equivalent circuit is only an approximate representation of the antenna system, since the network elements all vary to some extent with frequency, and the final selection of optimum dimensions is based upon a cut-and-try procedure. The minimum diameter antenna which may be designed using this configuration to meet the required 2:1 VSWR termination over the UHF band is smaller than the 24-inch value indicated here. The diameter has been made this large in the design illustrated so that the antenna may be mounted on surfaces with widely varying radii of curvature without exceeding VSWR tolerance.

CONCLUSION

This paper has described in rather general terms the current state of the art as regards communication and navigation antennas. It has been necessary to devote a rather large amount of space to describing the various aircraft antenna problems in terms which, it is hoped, will relate them to the experience of the engineer who is not a specialist in this field. Because of this, many topics of considerable interest have been mentioned only in passing or omitted altogether. In particular, relatively little has been said about the details of practical antenna design. No mention has been made of radar antennas, or of the numerous specialized microwave antennas which decorate modern military aircraft. The treatment presented here has been restricted to conventional aircraft, so that the special problems which arise in missile applications or in helicopter installations, for example, are not mentioned. The latter in particular are of considerable scientific interest because of the important, but little understood, dynamic effects of the moving rotor blades. It has been necessary to omit mention of the problem of precipitation static which, although not strictly an antenna problem, has a significant influence on practical antenna design, particularly for the lower frequencies. The lightning and corona protection of airborne antennas is another important topic which has been omitted to conserve space.

The design of antennas for aircraft is an intricate and subtle art which draws on a wide range of engineering and physics. The designer is seriously handicapped by the relatively meager literature in his field. It is the hope of the authors that this paper will stimulate wider interest in aircraft problems among antenna engineers, and intensified publication, in amplification or rebuttal, by the many experts in this special field.

Some Aspects of the Design of Power Transistors*

N. H. FLETCHER†

Summary—This paper discusses some factors which have to be taken into account in the design of high power transistors. An effect of great importance is the reduction of emitter bias caused by transverse current flow in the base region. This effect is examined in some detail and the results of the discussion are applied to the design of improved transistor types. Finally, a short discussion of thermal stability and mechanical design is given.

INTRODUCTION

TRANSISTORS are mostly considered as very low level small signal devices and much of the design theory of transistors has assumed their use in such applications. It will be our purpose in this paper to point out some of the considerations which enter design theory when the transistors are explicitly intended for high level operations.

Low Level Operation

As we pointed out above, most design theory so far developed is for the low level case. An excellent account of this subject is given by Early¹ who summarizes the current position in small signal terms.

The basic assumption of low level theory is that all perturbations are small and the theory is thus linear in all important respects. Among the important assumptions and approximations made in Early's theory are the following:

1. Junctions are assumed parallel and planar.
2. Surface effects are neglected.
3. Emitter current densities are assumed small.

It happens that in high power design we cannot validly make any of these approximations so that to this extent the theory is more complicated. However, at the moment we are not trying to develop a complete theory but merely to investigate some important problems which arise in high level operation, and for our present purpose, many of the factors involved in small signal operation can be recognized and neglected as of secondary importance. In this way, we shall be able to get a semi-quantitative idea of those design considerations which are of most importance in our present work, namely, the design and construction of power transistors with output ratings greater than one watt, to operate in the audio frequency range.

The Design Problems

These may be divided into two main classes:

1. Electrical Problems
2. Thermal and Mechanical Problems

* Original manuscript received by the IRE, December 10, 1954; revised manuscript received, February 9, 1955.

† Transistor Products, Inc., Waltham, Mass. (On leave from Division of Radiophysics, CSIRO, Sydney, Australia.)

¹ J. M. Early, "Design theory of junction transistors," *Bell Sys. Tech. Jour.*, vol. 32, p. 1271; 1953.

Electrical problems relate to the fact that we can no longer make the approximation that the injected carrier density is small enough to be considered a linear perturbation. Along with this, we have to recognize that in fact none of the electrical quantities involved is small and some approximations are no longer valid. It is with problems of this type that we shall be mainly concerned in an attempt to see what we should do to optimize performance at high power levels.

The second class of problems is in a sense incidental but nevertheless of considerable importance. It relates mainly to suitable mechanical design so that heat generated in the transistor can be adequately removed. Other mechanical considerations are of stability to thermal and mechanical shocks and of ease and economy of fabrication. These problems will be much more briefly dealt with, though this should not be understood as minimizing their importance.

ELECTRICAL DESIGN

High power output from a device clearly involves high currents, high voltages, or both, and each brings its own problems. If a transistor is to operate with a collector voltage V_c , then it must withstand, in general, a voltage $2V_c$. Whilst diodes can be made with reverse characteristics extending to several hundreds of volts, operation of transistors in this region is not usually of advantage since stability is sacrificed. The power gain is, however, increased at high voltages since higher load impedances can be used. For this reason, we should like to operate at as high a collector voltage as is compatible with other considerations.

Since direction of increasing voltage (first by stability considerations and ultimately by the breakdown voltage attainable) is limited, let us examine the extension we can make in the direction of increasing current.

It is well known that the current transfer ratio α for a junction transistor first increases as emitter current increases, reaches a peak and then falls off to low values. Low level transistors can be conveniently operated near the peak, which occurs at emitter currents of less than 1 ma for ordinary small transistors. However, for moderate output, we are already operating with tens or hundreds of milliamperes and, for high powers, amperes are required. We must therefore find some way to shift the peak of the curve to higher current values and to minimize α fall-off at high currents.

A careful analysis of this effect has been made by Webster.² We shall give a brief account of his findings and illustrate them on a simple physical basis.

² W. M. Webster; "On the variation of junction transistor current amplification factor with emitter current," *Proc. I.R.E.*, vol. 42, pp. 914-920; June, 1954

Consider a $p-n-p$ transistor with a bar-like structure so that the junctions are plane and parallel. In the low level case, holes are injected into the base region from the emitter and flow by diffusion down a concentration gradient to the collector, a small fraction recombining with electrons which flow in as base current. This is the small signal theory and does not predict any variation of α with emitter current.

Now consider what happens when injected hole densities become large enough to become comparable with the equilibrium electron density of the base region. We still have a concentration gradient of holes in the base region and this yields a diffusion current of holes toward the collector, as illustrated in Fig. 1.

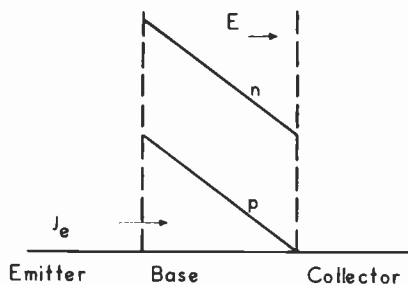

Fig. 1—Distribution of carriers in the base region for large injected current density. ($p-n-p$ transistor.)

However, we must have a similar gradient in the electron density in the base region in order that approximate electrical neutrality may prevail ($n-p = \text{Constant}$). This is also shown in Fig. 1. However, no electron current can flow across the collector barrier so that if Fig. 1 is to represent a steady-state situation, there must be an electric field E generated in the direction shown to maintain the electron distribution (by contributing an electron drift current equal and opposite to the electron diffusion current). However, this field acts also upon the holes and is in a direction to aid the flow of hole current to the collector. In view of the Einstein relation

$$\frac{\mu_p}{D_p} = \frac{q}{kT} = \frac{\mu_n}{D_n}$$

this field ultimately doubles the hole current due to diffusion alone. Thus as the injected hole current density becomes large, we effectively double the diffusion coefficient for holes in the base region. This reduces the hole density at the emitter necessary to cause a given current to flow and thus decreases the proportion of holes lost by surface recombination. This leads to an increase in α as j_e is increased.

As the emitter current becomes larger still, other effects begin to enter. The injected holes increase the density of electrons in the base region adjacent to the emitter junction. This effectively lowers the resistivity of the base region near the emitter junction and this in turn decreases the emitter efficiency, and hence α .

As the density of injected holes increases, the rate of recombination increases nonlinearly. This rate is or-

dinally proportional to the product np which is linear for $p \ll n$ but more nearly quadratic when p is comparable to n due to electrical neutrality requirements. It is not clear yet what the exact dependence is at very high currents, but in any case, the trend is toward a lowered value of α .

Webster derives an expression giving the complete dependence of α on emitter current and calculates a numerical case for a typical low level $p-n-p$ alloy junction transistor, with emitter area 10^{-3} square centimeters. His curve is illustrated in Fig. 2 and shows the increase, peak, and fall-off we discussed above. The curve agrees well with experiment.

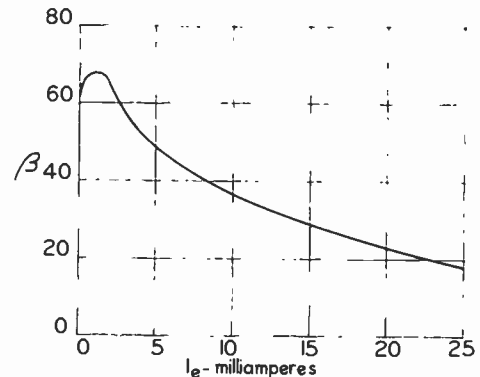

Fig. 2—Behavior of grounded emitter current gain, β , with I_e for typical low level transistor (after Webster,² Fig. 6).

Some of the effects of variations in electrode geometry have been investigated by Moore and Pankove³ for the case of a typical low level $p-n-p$ alloy transistor. They find that for such a transistor, the main loss of injected carriers is due to surface recombination in an annular region around the emitter, volume recombination being comparatively unimportant for base layer widths less than a few thousandths of an inch. On the basis of their calculations and an analog plotting technique for determining hole flow paths, they were able to predict the optimum emitter diameter for a given collector diameter, this optimum representing a compromise between most efficient collection and an excessive ratio of emitter circumference to emitter area. The optimum diameter is clearly a function of surface recombination velocity in an annular region surrounding the emitter.

In discussing the design of high power transistors, we shall make use of many of the ideas discussed above, modifying or extending them as necessary in view of the large currents involved.

Base Resistance Bias Effects

We shall now proceed to discuss an effect of very great importance in the design of power transistors which has been validly neglected in low power theory.⁴

³ A. R. Moore and J. I. Pankove, "The effect of junction shape and surface recombination on transistor current gain," Proc. I.R.E., vol. 42, pp. 907-913; June, 1954.

⁴ This effect has been recognized by Early, op. cit., but his treatment is confined to the small signal case.

In a high power transistor the current which flows transversely through the base region to the base lead is of considerable size, ranging to tens of milliamperes—an order of magnitude larger than is encountered in low level transistors. Because of the small thickness and finite resistivity of the base layer, this current causes an ohmic voltage gradient which is in such a direction as to reduce the effective forward bias on parts of the emitter distant from the base lead. This in turn causes a large drop in the current density injected by these parts of the emitter, and consequently a drop in the efficiency of the transistor. To obtain an expression for the magnitude of this effect we shall examine a simple idealized case.

Consider what we can call a “sem-infinite one-dimensional transistor,” as shown in Fig. 3. Suppose that we have a semi-infinite region of *P*-type germanium containing an *N*-type region (the base) of width *W* bounded by two parallel planes normal to the boundary of the region. An ohmic base contact is made to the whole exposed area of the base region as shown. For purposes of calculation, we shall consider a slice of this semi-infinite region normal to its boundary and to the boundaries of the base region, the slice being of unit thickness.

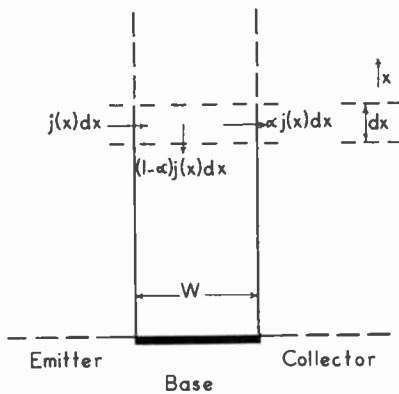

Fig. 3

We shall make the following assumptions:

1. The conductivity of the emitter region is very large so that emitter efficiency approaches unity.
2. The conductivity of the base region is sufficiently high that it is not severely altered by the presence of injected carriers at the levels considered.
3. Flow of minority carriers across the base region is by field-aided diffusion, as discussed by Webster, the effective diffusion coefficients being *g* times the normal coefficient where $1 \leq g \leq 2$.
4. Recombination of injected holes in the base region is approximately monomolecular and described by an effective lifetime τ which is independent of injected carrier concentration in range considered.

Before proceeding further, let us examine these assumptions to see that they are reasonably valid and applicable to practical cases. Consider an alloyed junction transistor with base width 0.0025 cm. Typically, emitter

and collector region resistivities will be ~ 0.001 ohm-cm and base region resistivity ~ 1 ohm-cm. Assumption (1) is thus fairly valid and any departure of emitter efficiency from unity can be indicated in the effective α . For an injected emitter current density of 10 amps per square cm, the injected hole density at the emitter junction [making assumption (3) with $g=1.7$] is about 2×10^{15} per cubic centimeter which corresponds to a resistivity of about 1 ohm-cm for the associated electron density. The injected hole density of course decreases approximately linearly across the base region and is zero at the collector junction so that the effective value is about one-half of this. Thus assumption (2) is valid up to injected current densities of a few amps per square cm. We shall examine the case where this assumption is not valid at a later stage in the discussion.

The value of *g* to be used in assumption (3) can be found from Webster's paper.² In the present example $g > 1.5$ for emitter current densities greater than about 5 amps per square cm. The exact value will not concern us for the moment.

Assumption (4) is just a simplifying assumption which appears very reasonable in the light of assumption (2). Its effect will be examined later.

Now let us proceed with our derivation, referring to Fig. 3:

Suppose a current density $j(x)$ is injected by the emitter into the base region at *x* in the element *dx*. This represents a current $j(x)dx$ of which $\alpha j(x)dx$ flows into the collector and $(1-\alpha)j(x)dx$ flows through the base region towards the base lead. Here α is the effective α of this idealized transistor and includes current due to non-unity emitter efficiency and to recombination of carriers within the base region. The first effect contributes $(1-\gamma)j(x)dx$ and the second $(1-\alpha')j(x)dx$, where from the usual theory

$$\alpha' \approx 1 - \frac{1}{2} \left(\frac{W}{L_p} \right)^2, \quad (1)$$

where $L_p = \sqrt{D_p \tau_p}$ is the diffusion length for holes injected into the base region. For typical values, $W \approx 0.0025$ cm, $\tau_p \approx 100 \mu\text{sec}$, $\alpha' \approx 0.9995$, so that it may well be the $(1-\gamma)$ term which gives the major contribution to $(1-\alpha)$. We should point out here that these very high values of α are due to the fact that as yet we have not considered surface effects.

We now make the assumption, a result of assumptions (1)–(4) discussed above, that α is constant over the whole of the base region. The injected current I_e can be expressed in the usual way as a function of emitter-base voltage *V* as

$$j(x) = j_0 (e^{qV(x)/kT} - 1), \quad (2)$$

where j_0 is the reverse saturation current of the emitter junction.

Now the base region has a resistivity ρ which we have assumed constant so that its linear resistance in the *x* direction is ρ/W ohm-cm. The emitter region is in effect

equipotential and we take the emitter to be at a potential V_0 with respect to the base contact at $x=0$. The base current at x is

$$i_b(x) = \int_x^\infty (1 - \alpha)j(x)dx,$$

whence

$$\frac{di_b(x)}{dx} = -(1 - \alpha)j(x).$$

The current $i_b(x)$ causes a voltage drop given by

$$\frac{dV(x)}{dx} = -\frac{\rho}{W}i_b(x),$$

whence

$$\frac{d^2V(x)}{dx^2} = -\frac{\rho}{W}\frac{di_b(x)}{dx},$$

so that we have

$$\frac{d^2V(x)}{dx^2} = +\frac{\rho}{W}(1 - \alpha)j(x),$$

and using our previous expression (2) for $j(x)$

$$\frac{d^2V(x)}{dx^2} = \frac{\rho}{W}(1 - \alpha)j_0(e^{qV(x)/kT} - 1). \tag{3}$$

In (3) let $y = dV/dx$ then

$$\frac{d^2V}{dx^2} = y \frac{dy}{dV}$$

and we have

$$y \frac{dy}{dV} = \frac{\rho}{W}(1 - \alpha)j_0(e^{qV/kT} - 1). \tag{4}$$

Integrate from the general point considered to $x = \infty$ using the fact that $y(\infty) = 0, V(\infty) = 0$.

$$\begin{aligned} \frac{1}{2}y^2 &= \frac{\rho}{W}(1 - \alpha)j_0 \left(\frac{kT}{q} e^{qV/kT} - \frac{kT}{q} - V \right) \\ \therefore \left(\frac{dV}{dx} \right)^2 &= \frac{2\rho}{W}(1 - \alpha)j_0 \frac{kT}{q} \left(e^{qV/kT} - 1 - \frac{qV}{kT} \right) \\ \therefore \int_{x=0}^x \left(e^{qV/kT} - 1 - \frac{qV}{kT} \right)^{-1/2} dV \\ &= \pm \left(\frac{2\rho}{W}(1 - \alpha)j_0 \frac{kT}{q} \right)^{1/2} \int_0^x dx, \end{aligned} \tag{5}$$

and using the boundary condition $V = V_0$ at $x=0$ this is the complete solution in terms of an integral. For our purposes, an approximate solution will be sufficient. At room temperature $(q/kT) \approx 39$ volts⁻¹ and in a power transistor $V \sim 1$ volt. We therefore make the approximation $qV/kT \gg 1$ and neglect the term $[-1 - qV/kT]$ in comparison with the exponential. The solution so obtained will be valid in regions not too far distant from

the base connection. Making this approximation, (5) can be integrated directly to give

$$\begin{aligned} -\frac{2kT}{q} (e^{-qV/2kT} - e^{-qV_0/2kT}) \\ \approx \pm \left(\frac{2\rho}{W}(1 - \alpha)j_0 \frac{kT}{q} \right)^{1/2} x, \end{aligned}$$

whence

$$\begin{aligned} V(x) \approx -\frac{2kT}{q} \log_e \left[e^{-qV_0/2kT} \right. \\ \left. \mp \frac{q}{2kT} \sqrt{\frac{2\rho}{W}(1 - \alpha)j_0 \frac{kT}{q}} \cdot x \right]. \end{aligned} \tag{6}$$

We shall be more interested in emitter current density and this is given by

$$\begin{aligned} j(x) &= j_0(e^{qV/kT} - 1) \\ \therefore j(x) &\approx j_0 \{ e^{qV_0/kT} [1 \pm A x e^{qV_0/2kT}]^{-2} - 1 \}, \end{aligned} \tag{7}$$

where

$$A = \frac{q}{2kT} \sqrt{\frac{2\rho}{W}(1 - \alpha)j_0 \frac{kT}{q}}. \tag{8}$$

Now $A > 0$ and we know that $j(x)$ decreases as x increases from zero so that the ambiguous sign should be plus, giving

$$j(x) \approx j_0 \{ e^{qV_0/kT} [1 + A x e^{qV_0/2kT}]^{-2} - 1 \}. \tag{9}$$

The expression (9) together with (8) then gives an approximate description of the fall-off of emitter current density away from the base lead connection. Under our assumptions, this solution is only valid fairly close to the base connection where the approximation $[qV(x)/kT] \gg 1$ is valid. We can thus simplify (9) and write to sufficient approximation

$$\begin{aligned} j(x) &\approx j_0 e^{qV_0/kT} [1 + A x e^{qV_0/2kT}]^{-2} \\ &\approx j(0) \left[1 + x \sqrt{\frac{\rho}{2W}(1 - \alpha) \frac{q}{kT} j(0)} \right]^{-2}, \end{aligned} \tag{10}$$

and, if we assume $\gamma = 1$, then using (1)

$$j(x) \approx j(0) \left[1 + x \sqrt{\frac{\rho}{4} \frac{q}{kT} \frac{W}{D_p \tau_p} j(0)} \right]^{-2}. \tag{11}$$

We should notice, in looking at this result, that the scale in x is determined by the factor

$$\frac{\rho}{4} \frac{q}{kT} \frac{W}{D_p \tau_p} j(0),$$

and the significant thing to note is that this varies as $W^{1/2} \tau_p^{-1/2}$, so that we should strive for as long a lifetime and as small a base layer thickness as possible, to achieve minimum variation. This requirement of a thin base layer is at first sight a little surprising until we remember that though the base resistance varies as $1/W$, the factor $(1 - \alpha)$ varies as W^2 .

We should point out that there are two reasons why we wish to minimize this variation in emitter current density. The first is the obvious desire to pass as much current as possible, which clearly presents fewer problems if its density is approximately constant. The second is to preserve a large value of $\beta = \alpha / (1 - \alpha)$ at high currents. Since to a first approximation β varies as $1/j$, the integrated value of β for the transistor as a whole is greatest for a uniform current distribution.

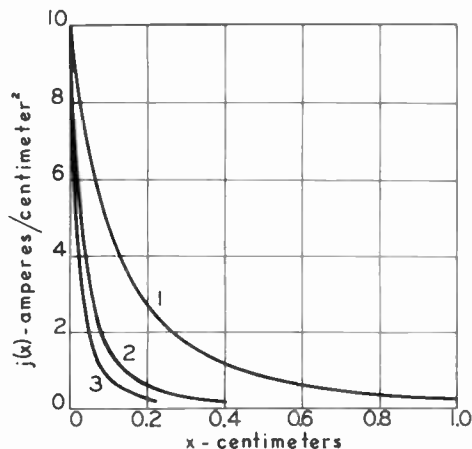

Fig. 4—Calculated fall-off of injected current density $j(x)$ as a function of distance x from the edge of the emitter for the three cases discussed in the text.

Numerical Examples

To give concrete realization to some of our ideas, we shall plot the dependence shown in (11) for three more or less typical cases. The transistor structure is as shown in Fig. 3.

- 1. $W = 0.002$ cm
 $\tau_p = 100$ μ secs
 $\rho = 0.5$ ohm-cm
 $j(0) = 10$ amps per square cm

then

$$j(x) = 10[1 + 4.7x]^{-2} \text{ amps per square cm.}$$

- 2. $W = 0.002$ cm
 $\tau_p = 10$ μ secs
 $\rho = 0.5$ ohm-cm
 $j(0) = 10$ amps per square cm

then

$$j(x) = 10[1 + 14.9x]^{-2} \text{ amps per square cm.}$$

- 3. $W = 0.006$ cm
 $\tau_p = 10$ μ secs
 $\rho = 0.5$ ohm-cm
 $j(0) = 10$ amps per square cm.

then

$$j(x) = 10[1 + 25.8x]^{-2} \text{ amps per square cm.}$$

These three current distributions are plotted in Fig. 4. (Numbers correspond.)

More Refined Theory for Very High Level Injection

We noted above when discussing the assumptions of our simple theory that only at quite moderate injection levels can we assume that emitter efficiency is unity and that the base region resistivity is not changed by the injected carrier density. We shall now attempt to formulate a more complete theory where these effects are not neglected.

We shall make the same assumptions as in our earlier theory except that we shall not neglect the effect of injected carriers on the base resistivity.

For clarity, consider a $p-n-p$ transistor, then for an emitter current $j(x)$ and base width W , the average injected carrier density in the base region is $\frac{1}{2}p$ where

$$i(x) = -gqD_p \frac{p}{W} \quad \text{where } 1 \leq g \leq 2.$$

This injected hole density carries with it an equal electron density which contributes to the majority carrier conductivity. The conductivity due to this cause is

$$\sigma' = \frac{1}{2} \frac{\mu_n W}{gD_p} j(x),$$

so that the total conductivity is

$$\sigma = \sigma_0 + \sigma' = \sigma_0 + \frac{1}{2} \frac{\mu_n W}{gD_p} j(x), \quad (12)$$

where σ_0 is the original conductivity of the base region. We shall write

$$\rho(x) = \frac{1}{\sigma(x)}. \quad (13)$$

Referring to Fig. 3, the current $(1 - \alpha)j(x)dx$ originating in dx at x flows through a resistance

$$\int_0^x \frac{\rho(y)}{W} dy,$$

and so contributes a voltage drop

$$[(1 - \alpha) + (1 - \gamma)]j(x)dx \int_0^x \frac{\rho(y)}{W} dy.$$

Summing all such voltage drops, the emitter-base potential at point x_0 is thus

$$V(x_0) = V_0 - \int_0^{x_0} [(1 - \alpha) + (1 - \gamma)]j(x) \int_0^x \frac{\rho(y)}{W} dy \cdot dx - \int_{x_0}^{\infty} [(1 - \alpha) + (1 - \gamma)]j(x)dx \int_0^{x_0} \frac{\rho(y)}{W} dy. \quad (14)$$

This integral equation, together with (12) and (13), and Webster's expression for γ , is sufficient to determine $V(x)$.

For the particular case we considered before when α , γ and ρ are assumed constant, (14) reduces immediately to (4) upon differentiating twice with respect to x_0 . This reduction cannot, however, be easily performed in the general case.

For our present purposes we shall not require this general solution, and it will be sufficient to observe some general properties of the current distribution which it yields. The distribution will be quite similar to that given by (11); it will, however, tend to be more steep all over because of the appreciable magnitude of $(1-\gamma)$, though for small x this will be compensated for somewhat by the increased base region conductivity. It is hoped to obtain a detailed solution of (14) at some later date.

We should perhaps emphasize again at this stage that the result (10) was derived neglecting completely the effects of surface recombination. The expression $(1-\alpha)$ used in (10) includes only contributions from nonunity emitter efficiency and from transport loss by volume recombination. In the case where surface recombination is considered, (10) is still valid, and $(1-\alpha)$ still has the value given above, to a first approximation. There is, however, an additional loss of carriers to the surface—mostly carriers injected near $x=0$ so that they have little effect on the phenomenon we have been discussing—which lowers the over-all α of the transistor in a manner which is approximately independent of the current.

Conclusions—Design of Emitter Region

From the discussion presented above and the curves plotted in Fig. 4, it is clear that we cannot achieve a large emitter current merely by increasing the area of the emitter since only those parts of the emitter closest to the base electrode connection will carry appreciable current. In fact, in even the best case considered, the emitter current density has fallen by a factor of 2 by the time we have gone in 1 mm from the edge of the emitter nearest to the base lead.

These remarks make the next step obvious—we must arrange the emitter-base geometry so that the electrical resistance between any point on the emitter and the base connection is as uniform as possible. It is also desirable that this resistance be as small as possible. A convenient geometry at once suggests itself. Let us make the emitter a very long thin bar, and use for a base electrode two long bars flanking the emitter and as close to it as possible. The collector, of course, is on the opposite side of the semiconductor as is usual with alloy junction transistors. This arrangement is shown in Fig. 5. The geometry is really similar to that discussed previously and illustrated in Fig. 3 except that the transistor structure extends only a distance d (the width of the emitter bar) in the x direction and another base contact is applied at this edge.

The results of the calculation made above cannot strictly be applied to this case since now the boundary condition is

$$\frac{dV}{dx} = 0 \quad \text{at} \quad x = \frac{d}{2}.$$

The analysis for this case is, however, more difficult and (11) can be used to give a first approximation to the current distribution. The true current distribution will vary less than that predicted by (11) but it is still a useful approximation.

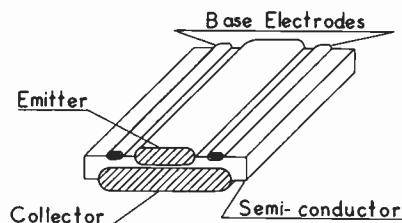

Fig. 5—Proposed electrode configuration for high power transistor.

Standard Emitter-Base Configuration

Optimum dimensions could of course be worked out for each particular transistor design, but the state of the art is not yet such that transistor dimensions (particularly base layer thickness W) and germanium properties can be controlled with great precision. It is therefore convenient in practice to design a standard configuration which can be modified to yield various desired transistor characteristics. In this section, we shall propose such a configuration and show how it can be modified to give transistors of different ratings.

As far as materials are concerned, germanium is available in a large range of resistivities and lifetime can be held to greater than 100 μ secs. The resistivity to be used is dictated by breakdown requirements in general, though often no very good correlation appears to exist for large area junctions. We wish to use as low a resistivity as is compatible with sufficient breakdown voltage. Usually 0.5–3 ohm-cm germanium will satisfy most common requirements, selected units having breakdowns (which are soft in any case) in excess of 100 volts.

From the point of view of our bias cut-off effect, the smaller we make the width d of our emitter bar, the more efficiently do we use this area. However, several other factors enter in the opposite sense and so we can in fact find a finite optimum width. The first of these "other factors" is surface recombination which we mentioned earlier. The number of minority carriers lost at the surface is approximately proportional to emitter perimeter, so that very thin emitters, having a large ratio of perimeter to area, are bad from this point of view. We must also remember that our transistor will be made by an alloying process and depth of penetration is finite. In order that the base region be as uniformly thin as possible, we require the emitter width to be large compared to the alloying depth. We should finally mention that very narrow emitters will be mechanically weak and difficult to fabricate.

The relative importance of these various effects depends upon many things, surface recombination velocity (which is closely dependent on manufacturing technique) being one of the most important. Ideally an analysis similar to that of Moore and Pankove³ should be carried out for this transistor design and for particular surface conditions. In the absence of such an analysis, experience shows that for typical transistor requirements and manufacturing methods an emitter width of 1–2 mm is close to optimum. The base electrodes are equally spaced and as close to the emitter as possible, their proximity being dictated primarily by mechanical considerations.

We have said very little about the collector as yet, and indeed little can be said at the moment. From the viewpoint of collection efficiency, the collector should be as large as possible, but on the other hand, increasing the collector area increases the saturation current I_{∞} and also increases the likelihood that the collector region contain some serious imperfection. In practice, if the collector is made to extend one or two diffusion lengths sideways past the emitter, the collection will be sufficiently good.

Possible Electrode Configurations

So far, we have merely designed a “standard” emitter-base configuration. We shall now show how it can be modified to yield several important and useful transistor types.

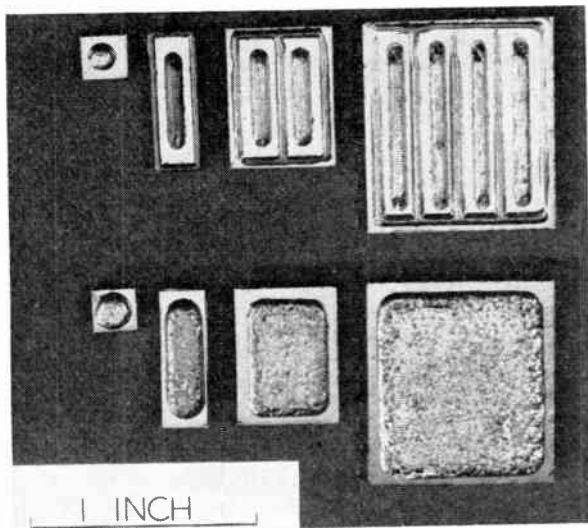

Fig. 6—Transistor types: (left to right)—(1)X-78 standard power transistor (without base electrode); (2) single-bar transistor; (3) double-bar transistor; (4) multi-bar transistor. The upper row shows the emitter-base side of the transistors and the lower row the collector side.

Single-Bar Type: For medium power applications where currents up to 2 amps or so are required, it is convenient to make a transistor consisting merely of a short length (say 1 cm) of our standard configuration. The dimensions of such a structure are mechanically reasonable and units made to this design behave as expected. A unit of this type is shown in Fig. 6, while

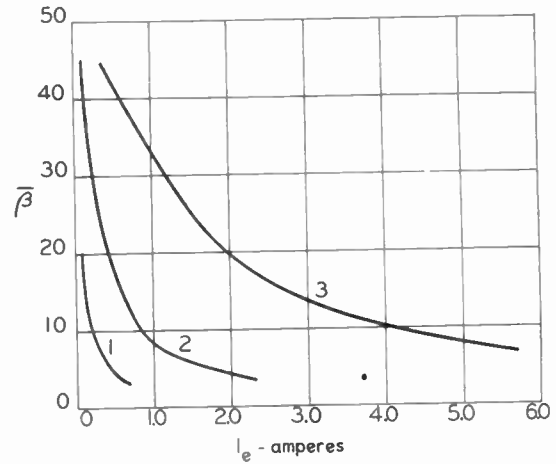

Fig. 7—Average grounded emitter current gain $\bar{\beta} = I_c/I_b$ as a function of I_e for (1) X-78 standard power transistor, (2) single-bar unit, (3) double-bar unit. All $p-n-p$ types with $V_c = -12$ volts.

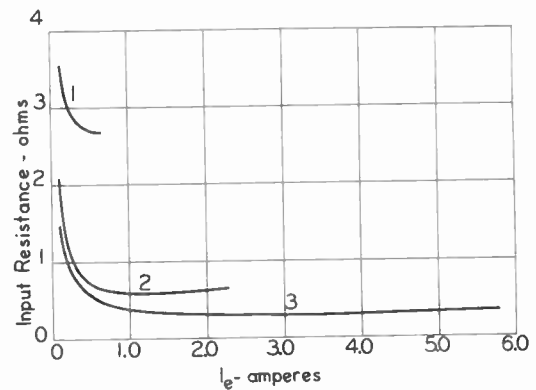

Fig. 8—Average grounded base input resistance V_e/I_e as a function of I_e for (1) X-78 standard power transistor, (2) single-bar unit, (3) double bar unit. All $p-n-p$ types with $V_c = -12$ volts.

a typical plot of $\bar{\beta} = I_c/I_b$ vs I_e is shown in Fig. 7. A similar curve for input resistance is shown in Fig. 8.

Multi-Bar Type: For higher current requirements, the standard configuration is inconveniently long, so a convenient modification is to place two or more of these configurations parallel to each other. Units of this type are shown in Fig. 6. If many bars are used, they may be conveniently connected together into a comb-like structure, the base leads being connected similarly.

It should be pointed out that despite a superficial resemblance to the comb-like power transistor reported by Hall,⁵ this unit is of a basically different geometry, Hall's transistor having base and collector geometry interchanged with respect to our unit.

One of the most successful units of this type is a double-bar unit, 1.5 cm in length, which has an efficient emitter current rating of about 5 amps. A $\bar{\beta}$ vs I_e curve for such a unit is shown in Fig. 7 and a similar curve for input resistance in Fig. 8.

Annular Type: As a further variation, a length of standard configuration can be bent to form a ring so

⁵ R. N. Hall, “Power rectifiers and transistors,” PROC. I.R.E., vol. 40, pp. 1512–1518; November, 1952.

that the emitter is an annulus. Several concentric rings of this type can then be built up into a larger unit. Units of this type have some slight disadvantage in base resistance in the innermost ring but are otherwise approximately equivalent to a multi-bar unit. It appears that fabrication methods are not so simple for a unit of this type as for a bar-type unit.

THERMAL AND MECHANICAL DESIGN

Thermal Design

We have completed our brief survey of some of the electrical considerations in power transistor design. We turn now to have a brief look at some of the thermal and mechanical problems for which solutions must be sought.

It is well known that as its temperature increases, the number of free carriers in a semiconductor also increases until the number of holes and electrons become comparable, at which stage the semiconductor is said to be in its intrinsic range, and many of the attributes necessary for transistor action disappear. Even before the intrinsic range is reached, many undesirable phenomena appear, chief among these being the increase in the saturation current I_{co} flowing in the collector circuit. For germanium, the temperature at which these effects become severe is ordinarily less than 100 degrees C.; for silicon, it is considerably higher.

In operation, a power transistor usually has a considerable amount of power dissipated within its structure in the form of heat, and unless this heat is removed efficiently, the temperature will rise and the undesirable effects discussed above will set in. In practice, we must therefore provide a suitable low resistance path through which heat can be removed from the transistor. This may be done by means of conduction, convection or radiation, or a combination of these three. The usual method is to mount the transistor on a piece of metal to which is attached a suitable system of cooling fins. For the small temperature rises encountered, Newton's law of cooling is valid and the maximum allowable dissipation is

$$P = \frac{T - T_A}{R}, \quad (15)$$

where T is the maximum permissible device temperature, T_A is the ambient temperature and R is the thermal resistance between the device and the ambient.

Design of a proper fin system is very important, since if we make R small, we increase P the allowable dissipation. The subject of fin design falls outside the scope of this paper so we shall not consider it here.

Another thermal problem which we must consider is that of stability. Since the saturation current I_{co} increases with temperature, the heat generated by this current is $V_c I_{co}$, where V_c is the collector voltage, and this similarly increases with temperature. The device may thus be temperature unstable unless it is properly designed.

Suppose the transistor is in equilibrium at a temperature T and that its collector voltage is V_c and its collector current I_c . Consider a small random increase in temperature dT . This causes a corresponding increase dI_c in I_c . The increased dissipation is thus

$$dP = V_c dI_c.$$

Suppose the thermal resistance between the transistor and the ambient is R then the increase dT allows an additional conduction of heat

$$dH = \frac{dT}{R}.$$

Then the equilibrium is stable and the system will return to its initial temperature state if

$$\begin{aligned} dP &< dH \\ V_c dI_c &< \frac{dT}{R} \\ V_c \frac{dI_c}{dT} &< \frac{1}{R}. \end{aligned} \quad (16)$$

Eq. (16) then determines the critical value of T for stability.

We should note that the thermal resistance R in (16) is, more properly speaking, an impedance. In a typical case, the collector of a transistor may be soldered to a large copper or aluminum fin structure. A first approximation to R is then given by the electrical analog shown in Fig. 9. Here, R_1 is the thermal resistance between the collector junction and the fin assembly, R_2 is the thermal resistance between the fin assembly and the ambient, and C is the heat capacity of the fin structure; ordinarily $R_2 \gg R_1$.

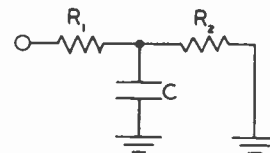

Fig. 9—Electrical analog for thermal impedance R .

For perturbations much less than $R_1 C$ in duration, the value of R to be used in (16) is essentially R_1 while for steady-state considerations ($t \gg R_1 C$), the appropriate thermal resistance is $R_1 + R_2$. Electrical analogs of this type may be helpful in the investigation of more complicated cases, such as switching circuits, where there is a very great difference between peak and average dissipations.

We should note that a higher temperature limit can be achieved by

1. Decreasing R .
2. Decreasing I_{co} .
3. Decreasing V_c .

All these should be borne in mind in designing transistor structures and in using transistors in circuits. When we

have done the best we can with the transistor along the above lines, we can improve stability further by incorporating suitable thermally-sensitive elements in the electrical circuit.

We noted above three means by which thermal stability could be improved. The first two of these, namely decreasing R and decreasing I_{co} , can be considered a little further. We should note that by (15) the maximum allowable dissipation will also be increased if we decrease R .

R can be minimized by using materials of high thermal conductivity in the assembly. Indium ($K=0.057$ cal/cm sec degrees C.) is particularly bad in this respect and R can be reduced considerably if the indium collector (for a $p-n-p$ transistor) is reduced in thickness as much as possible and then soldered to a piece of copper. The major contribution to R comes, however, between the fin structure and the ambient, and can be reduced by proper fin design. We shall not consider this further here.

I_{co} can be minimized by using as small a collector area as is compatible with other requirements, and, other things being equal, by using a low resistivity semiconductor with large energy gap. Since we are mostly concerned with germanium, we cannot alter the energy gap but we should note that semiconductors with larger energy gaps, for example silicon or silicon-germanium alloys, should give improved performance in this respect. I_{co} in this context includes the leakage current as well as the true saturation current. The temperature dependence of this leakage component is not as great as that of the saturation current, but we should try to minimize its value by choice of germanium (orientation may be important) and by proper etching technique.

Mechanical Design

This is a subject which we will discuss briefly without intending to ignore its importance in final transistor design. The mechanical package must be such as to maintain those desirable electrical characteristics which have been built into the transistor and to preserve them from environmental influences such as humidity, shock, vibration, etc.

The transistor package may either be integral with the fin structure (e.g., Transistor Products type X-107), or may be a separate unit which is subsequently attached to the fin structure. This latter procedure has much to recommend it in the case of high power transistors where the fin structure required may vary considerably depending upon the application. A package of this type, housing a double-bar transistor of about 20-watts dissipation rating is shown in Fig. 10. Also shown is an X-107 transistor package rated at 3-watts dissipation in a 25 degrees C. ambient and an experimental package of intermediate rating. The fin structure for the 20-watt unit may typically be a larger version of that shown on the intermediate design, or alternatively, the transistor may be bolted to a chassis

or other convenient "heat sink."

The package may be either plastic filled or hermetically sealed to afford humidity protection. Plastic filling is cheaper and easier and provides a very good seal if proper encapsulants are used, but in some cases the more certain protection of an hermetic seal may be desired, the container then either being evacuated or filled with some inert substance.

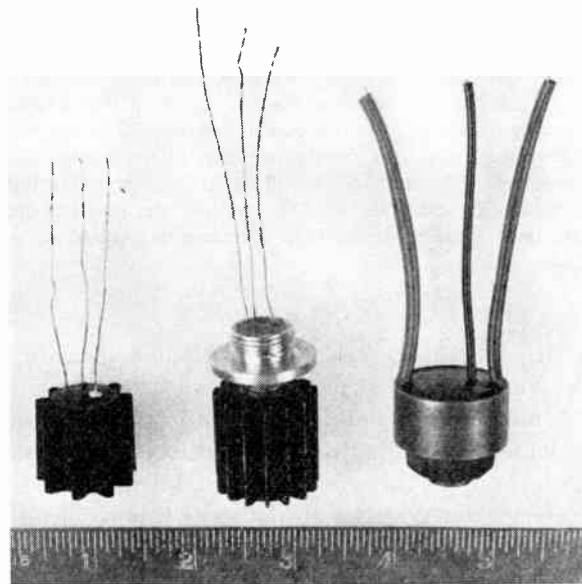

Fig. 10—Power transistor assemblies: (1) X-107 (3 watts), (2) experimental unit (about 5 watts), (3) high power unit, cooling fins not shown (up to 100 watts).

CONCLUSION

It has been the aim of this paper to present certain considerations which are important in the design of high power transistors. The theory is of quite a general nature and shows how units can be designed to have improved performance at high currents and at high dissipations. Although the theory is generally useful, it has been here only specifically applied to alloyed junction transistors. The results reported are for $p-n-p$ units but theoretical considerations as well as measurements indicate that $n-p-n$ units should be even more suitable for high current applications. By following the precepts outlined above, transistors with class A output ratings over 50 watts have been successfully designed and fabricated.

ACKNOWLEDGMENT

I should like to thank the members of the Engineering Department of Transistor Products, Inc., who helped make this study possible, both by discussion, and by experimental assistance. I should also like to thank the the Australian Commonwealth Scientific and Industrial Research Organization for giving me the opportunity to do this work.

The study was supported by Signal Corps Contract No. DA-36-039-SC-63135.

Image Processing*

L. S. G. KOVÁSZNAY†, SENIOR MEMBER, IRE, AND H. M. JOSEPH‡, SENIOR MEMBER, IRE

Summary—A scalar function of two independent variables can be visualized as an image. All mathematical operations can be conceived as a modification or processing of the original image. An important class of modifying operators can be realized by special scanning techniques without using a rapid access memory storage device. It was found that the two important operators so far explored may have practical importance. One is contour enhancement which has a “de-blurring” effects akin to aperture correction and “crispning” in television practice; the other is contour outlining that produces a line drawing from a picture with continuous tones. The general concepts developed may also permit extension of the method to analog computers for certain classes of partial differential equations. The flexibility and adaptability of the system offer practical application whenever some predetermined operation is required on picture material.

INTRODUCTION

A BLACK AND WHITE continuous picture or a black line drawing can be regarded as a communication channel, i.e. as a carrier of information. Before the advent of modern electrical communication techniques the most common means of transmitting information over great distances was to physically transport a sheet of paper with drawings or symbols on it. The electronic techniques, the applicable circuit theory, and correspondingly the concepts of the supporting theory of communication, all revolve about functions of one independent variable, namely, time.

An interesting thought arises. The techniques and the explicit findings of communication theory can be generalized to functions of two independent variables. The optical reflectivity of a paper print for a given angle of illumination is a function of two co-ordinates and therefore is a function of two independent variables. Operations or functional relationships can be visualized in this case as obtaining a new picture from an old one by a prescribed process.

The major objective of the present study was the development of a method for processing pictures by electronic techniques, similar to those used in television with emphasis upon the realization of a few important operators.

The attention of the authors was attracted to this problem when thinking about the following intriguing question: How does one perceive, identify, and recollect pictures? Naturally the solution of the mystery of visual perception is far beyond our objectives. However, the at-

tempts reported here may contribute some insight into particular aspects of the general problem.

It does appear that the process of visual perception is homogeneous and isotropic, in the sense that translation or rotation of a viewed scene produces no change in the character of the result except for the positional change itself. In consequence prime emphasis was placed upon isotropic operators.

The first operator explored was named contour enhancement. It is worthwhile to note that a similar phenomenon occurs in visual perception and is called different names by the biologist and psychologist. One such is “brightness contrast effect” (Fig. 1). It involves a sharpening of the diffuse boundaries of adjacent domains of different intensities.¹ Later it will be shown that it can be accomplished by a linear operator involving the Laplacian of the picture function.

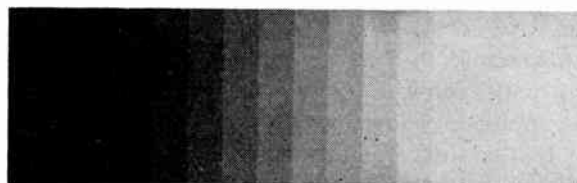

Fig. 1—Step tablet illustrating contour enhancement in the eye. Each step is a uniform shade of gray, although it appears lighter near the darker step and darker near the lighter one. The uniformity of each area can be checked by masking all steps except one.

The second operator developed was named contour outlining and it is probably an inherent process in humans,^{2,3} since even the prehistoric caves exhibit drawings that are essentially the outline sketches of animals. It seems that it is a rather simple and convenient method for “stripping-down” a picture of its unnecessary details.⁴ Broadly speaking it appears that human visual perception somehow reduces the amount of picture information by outlining the picture before storing it or before comparing it with other stored images. The fact that cartoons and caricatures can be recognized and understood by most people suggests that there might be processes which are more of a “mechanical” nature than a “mental” one, meaning that they do not rely upon extensive memory storage, since the sig-

* Original manuscript received by the IRE, August 22, 1954; revised manuscript received January 31, 1955. This work was done at the National Bureau of Standards under a program of Basic Instrumentation, Research, and Development sponsored by the Office of Naval Research, the Air Research and Development Command, and the Atomic Energy Commission.

† Johns Hopkins University, Baltimore, Md., also Consultant to the National Bureau of Standards.

‡ ACF Electronics, a division of ACF Industries, Inc., Alexandria, Va.; formerly with the National Bureau of Standards.

¹ George M. Bryan, “The physical and photochemical basis of visual resolving power,” *Jour. Opt. Soc. Amer.*, vol. 34, pp. 718–738; December, 1944.

² K. S. Lashley, “The problem of cerebral organization in vision,” *Biol. Symp.*, vol. VII, (Visual Mechanisms), Heinrich Klüver, ed., The Jacques Cattell Press, Lancaster, Pennsylvania; 1942.

³ K. Koffka, “Principles of Gestalt Psychology,” Harcourt, Brace and Co., New York; 1935.

⁴ F. Attneave, “Some Information Aspects of Visual Perception,” *Psych. Rev.*, vol. 61, pp. 183–193; May, 1954.

nificance of cartoons seems to be the same for everyone irrespective of diverse individual experiences.

The process by which "stripped down" pictures are identified by comparing them with the stored ones is the so called "Gestalt" problem which puzzles many students of the life sciences. This more general problem, namely, how outlines (black line pictures) can be further processed, clarified, and identified has not been attacked in the present study. The authors believe, however, that exploration along these lines will inevitably occur, perhaps as a result of stimulation from the present work.

LIST OF SYMBOLS

x, y, x', y'	Cartesian co-ordinates
t	Time
ξ, η	Displacement in coordinates
$f(x, y)$	Function describing original picture
$F(x, y)$	Function describing resulting picture
Ω	Functional operator
θ	Angle of rotation
A, B, C, C_1, C_2	Arbitrary constants
$\nabla^2 = \frac{\partial^2}{\partial x^2} + \frac{\partial^2}{\partial y^2}$	Laplacian operator
$g(x, y)$	Function describing perfect picture (before blurring)
τ	Time interval, or time constant (e.g. $\tau = RC$)
k	Diffusion coefficient
ψ	Rescaling operator
$F^*(x, y)$	Outline picture
U	Speed of scanning spot
T	Period or repetition in scan (frame period)
f_0	Frequency of scan pattern repetition
f_1	Frequency of horizontal scan
f_2	Frequency of vertical scan
n_1	Number of horizontal scan periods during a full frame period
n_2	Number of vertical scan periods during a full frame period
D	Photographic density (logarithmic definition)
r	Transmittance
I, I_0, I_1	Luminous intensity of cathode-ray spots
e	Voltage delivered by feedback amplifier
E_g	Intensity grid voltage measured from cut-off
E_0	Intensity grid bias in absence of video signal
K	Feedback ratio
e_0	Output voltage
ϵ	Base of natural logarithms
(\cdot)	Dot indicates differentiation with respect to time, $d(\cdot)/dt$
(\cdot) _{x} , (\cdot) _{yz} , (\cdot) _{xy}	Subscripts x and y indicate differentiation with respect to x and y

P Distribution of scanning spot intensity
 P^* Modified function of spot intensity

CLASSES OF OPERATIONS IN TWO DIMENSIONS

The mathematical formulation of the problem is the following: The image that is being processed is called the "original" picture; the image that results from processing is called the "resulting" picture. The process is completely defined if we know the resulting picture for every conceivable original. Mathematically the process can be characterized by an operator. If the original picture is given as $f(x, y)$ and the resulting picture as $F(x, y)$, where f and F may represent reflective (or transmittance),

$$F(x, y) = \Omega[f(x, y)]$$

Ω is an operator that represents the processing. Ω can be linear or nonlinear, and it can involve derivatives or integrals of the function.

Let us introduce the following definitions:

Definition 1

An operator is said to be homogeneous if the operation is independent with respect to translation of the coordinate system.

If

$$x' = x + \xi$$

$$y' = y + \eta,$$

then the operator is homogeneous if

$$F(x, y) = \Omega[f(x, y)]$$

and

$$F(x', y') = \Omega[f(x', y')].$$

Definition 2

An operator is said to be isotropic if it is homogeneous and the operation is independent with respect to rotation and reflection of the coordinate system.

If

$$x' = x \cos \theta \pm y \sin \theta + \xi$$

$$y' = x \sin \theta \mp y \cos \theta + \eta,$$

then Ω is isotropic if

$$F(x, y) = \Omega[f(x, y)]$$

and

$$F(x', y') = \Omega[f(x', y')].$$

Definition 3

An operator is said to be linear if the operation is distributive with respect to summation and commutative with respect to multiplication by a constant.

Let c_1 and c_2 be arbitrary constants and f_1 and f_2 be arbitrary functions: then Ω is linear if

$$\Omega(c_1f_1 + c_2f_2) = c_1\Omega(f_1) + c_2\Omega(f_2).$$

Although isotropy implies homogeneity, the reverse is not true. Linearity, however, is an independent property and may or may not coincide with homogeneity or isotropy.

Another classification of operators can be made if we consider whether derivatives or integrals are used. This classification, however, is somewhat misleading since with the inclusions of the Dirac delta function, $\delta(x)$ and its derivatives, as possible kernels, even differential operators can be written in disguise of integral operators.

The operators involved in our present study are generally homogeneous and isotropic operators. This is natural since it corresponds to the properties of vision in that the resulting picture remains the same when we shift or turn the original picture except for the shifting and turning.

If the resulting picture F depends only on the behavior of f in the infinitesimal neighborhood of the point (x, y) we can restrict our attention to differential operators. The most general homogeneous linear differential operator is a linear expansion of the function and its derivatives at the point (x, y) with constant coefficients. (If the homogeneity is not required the coefficients may be functions of x and y .) The space derivatives of order n form a symmetrical tensor of rank n . If isotropy of the operator is also required, the tensors must be isotropic tensors. It is possible to show⁵ that only even order derivatives occur in isotropic linear differential operators and they form the Laplacian operator and its repeated forms. Thus the most general linear isotropic operator is given by

$$F(x, y) = Af(x, y) + B\nabla^2f(x, y) + C\nabla^4f(x, y) + \dots$$

where

$$\nabla^2 = \frac{\partial^2}{\partial x^2} + \frac{\partial^2}{\partial y^2}.$$

If only the first two terms are kept, we have the simplest nontrivial isotropic linear differential operator. With a convenient choice of A and B , we obtain

$$F(x, y) = f(x, y) - \gamma^2 \left[\frac{\partial^2 f}{\partial x^2} + \frac{\partial^2 f}{\partial y^2} \right]. \quad (1)$$

We shall call this operation "contour enhancement."

We can also form nonlinear differential operators. The isotropic condition permits odd derivatives (e.g. first) only if their even functions occur. Keeping only first derivatives and their simplest even function (square), we obtain the simplest nontrivial essentially nonlinear isotropic differential operator

$$F(x, y) = \text{constant} \times \left[\left(\frac{\partial f}{\partial x} \right)^2 + \left(\frac{\partial f}{\partial y} \right)^2 \right]. \quad (2)$$

⁵ H. Jeffreys and B. S. Jeffreys, "Mathematical Methods of Physics," Cambridge University Press, Cambridge, Mass., p. 87; 1950.

The resulting picture is the square of the absolute magnitude of the gradient vector of the original $f(x, y)$ and as such its value is invariant with respect to translation or rotation of the co-ordinate system. Since we are dealing with nonlinear operators, we can also have an arbitrary rescaling of the square of the gradient.

Using the operator given by (2), the resulting function is always positive or zero, the latter for areas of constant intensity. High values of F indicate high gradients, and therefore indicate contour regions. The operator can be modified into a genuine outlining operator by clipping the function F so that

$$F^*(x, y) = \begin{cases} 1 & \text{if } F(x, y) > c \\ 0 & \text{if } F(x, y) < c. \end{cases}$$

$F^*(x, y)$ will be a line drawing, indicating the zones of intense gradient. There will be no intermediate shades. Further circuit combinations can produce outlines with constant line thickness that suggest pencil or ink drawings. A quantization of values can be introduced in a similar manner. The contour enhancing operator

$$\Omega = 1 - \gamma^2 \nabla^2$$

is a first approximation to an "anti-diffusion" or "deblurring" operator. Let us assume that the original picture $f(x, y)$ is really the result of a degrading process obeying the diffusion equation

$$\frac{\partial f(x, y, t)}{\partial t} = k\nabla^2 f(x, y, t), \quad (3)$$

where k is the (positive) diffusion coefficient and f is also a function of time as well as of the space coordinates. The initial condition is given by

$$f(x, y, 0) = g(x, y),$$

where $g(x, y)$ is the perfect picture. Experimentally we have at our disposal $f(x, y, \tau)$ where τ is the length of diffusion time interval. Expanding $f(x, y, t)$ into a Taylor series around $t = \tau$ we obtain

$$g(x, y) = f - \tau \frac{\partial f}{\partial t} + \frac{\tau^2}{2} \frac{\partial^2 f}{\partial t^2} - \dots (-1)^n \frac{\tau^n}{n!} \frac{\partial^n f}{\partial t^n} + \dots \quad (4)$$

Substituting the Laplacian operator for the time derivatives according to (3), we obtain

$$g(x, y) = f - k\tau\nabla^2 f + \frac{k^2\tau^2}{2}\nabla^4 f \dots - \frac{\tau^n k^n}{n!}\nabla^{2n} f \dots \quad (5)$$

If the series converges (and it certainly does if $g(x, y)$ is a continuous function) the perfect picture can be recovered. The first two terms give the contour enhancing operator (1) with

$$h\tau = \gamma^2.$$

Diffusion blurs a point into a spot with a Gaussian distribution having a standard deviation proportional to

$\gamma = \sqrt{k\tau}$. If blurred spots corresponding to original pin points are known in $f(x, y)$, then γ can be determined. An alternate practical method is to vary γ and find the best enhancement by human judgment.

CONVERSION OF SPACE DOMAIN TO TIME SIGNALS BY SCANNING

It is quite conceivable that an operation can be performed readily if the entire function $f(x, y)$ representing the original picture is stored and is available at all times. However, if one desires to dispense with the storage system and realize at least a class of operators, one may still succeed by selecting an appropriate scanning system.

The scan can be defined in the following manner:

$$x = x(t) \quad (6a)$$

$$y = y(t) \quad (6b)$$

$$f(x, y) = f[x(t), y(t)] = \phi(t) \quad (6c)$$

If the scanning raster is sufficiently dense, and $f(x, y)$ is free of singularities, the function $\phi(t)$ represents the picture.

The following equations apply:

$$\dot{\phi} = \dot{x}f_x + \dot{y}f_y \quad (7a)$$

and

$$\ddot{\phi} = (\dot{x})^2 f_{xx} + \ddot{x}f_x + 2\dot{x}\dot{y}f_{xy} + (\dot{y})^2 f_{yy} + \ddot{y}f_y. \quad (7b)$$

If a scan is chosen so that in four subsequent strokes, denoted *A*, *B*, *C*, and *D*, a spot on the image is scanned linearly in all four directions—forward and return on both *x* and *y* axes—then during

$$A: \dot{x} = U \quad \text{and} \quad \dot{y} = 0$$

$$B: \dot{x} = 0 \quad \text{and} \quad \dot{y} = U$$

$$C: \dot{x} = -U \quad \text{and} \quad \dot{y} = 0$$

$$D: \dot{x} = 0 \quad \text{and} \quad \dot{y} = -U,$$

where *U* is a constant velocity. Hence

$$\ddot{x} = \ddot{y} = 0.$$

Taking the average of the four strokes,

$$\ddot{\phi}_{av.} = \frac{U^2}{2} f_{xx} + \frac{U^2}{2} f_{yy} = \frac{U^2}{2} \nabla^2 f. \quad (8)$$

The average of the second derivative with respect to time is proportional to the Laplacian of the function $f(x, y)$.

Similarly, for the squared time derivative,

$$(\dot{\phi})^2 = (\dot{x})^2 (f_x)^2 + (\dot{y})^2 (f_y)^2 + 2\dot{x}\dot{y}f_x f_y.$$

With above type of scan the average of four strokes is

$$[(\dot{\phi})^2]_{av.} = \frac{U^2}{2} (f_x^2 + f_y^2) = \frac{U^2}{2} (\nabla f)^2. \quad (9)$$

The average squared time derivative of $\phi(t)$ is proportional to the squared gradient of $f(x, y)$.

The above analysis has demonstrated that a linear scan that sweeps any picture element in turn from all four directions with identical velocity can be used to realize certain isotropic operators without the need for rapid access memory storage of the entire picture. The averaging of the four strokes occurs automatically if the scan is sufficiently fast so that the persistence of the phosphor, the time lag of the retina, or the retentivity of the photographic emulsion, provides the averaging.

The velocities of the different strokes and the scanning program may be further modified to obtain the higher order isotropic operators. This is discussed in Appendix III. Of course, repeated processing using intermediate pictures may also be used to realize these operators.

Definition 4:

A scan is isotropic at a point if certain averages formed over all crossings at the point during the entire scan sequence obey the following three conditions:

1. The average first time derivative is zero,
2. The average of the squared first time derivative is proportional to the square of the gradient,
3. The average second derivative is proportional to the Laplacian.

A scan may be isotropic in one region but not everywhere (e.g., a Lissajous figure formed by two sine waves of different frequencies is isotropic at the center but not elsewhere).

GENERATION OF THE SPECIAL SCAN

An isotropic scan, by which the realization of certain important isotropic operators becomes simple, can be performed in several ways.

1. The central portion of a Lissajous figure formed by two sine waves may be employed. However the requirements are approximately satisfied over only a small central portion.

2. An interlacing raster of curves such as cycloids or spirals.⁶

3. A conventional television scan rotated 90 degrees after each frame is completed.

4. Symmetrical triangular waves of slightly different frequencies for the horizontal and vertical deflections. The resulting Lissajous figure consists of straight lines and, if operated slowly, has the appearance of a slowly varying rectangle.

The repetition rate of the raster is held constant by synchronizing the difference frequency of the two waves to the frequency of one of the waves. In this way slow drifts in the oscillator frequency do not cause relatively large changes in the density of scan.

Arithmetic relations between the two scanning frequencies follow. If the respective frequencies of the two triangular waves are f_1 and f_2 and they are commensurable, then at one instant their zero crossings occur simul-

⁶ K. R. Wende, RCA, U. S. Patent 2531544, November 28, 1950. A diagonal interlacing scan is described in this paper.

taneously and after a time interval T , the zero crossings again occur simultaneously. Accordingly,

$$T = \frac{n_1}{f_1} = \frac{n_2}{f_2},$$

where n_1 and n_2 are integral numbers and each is the number of full scan cycles during a complete frame cycle. The repetition rate of the entire pattern will be

$$f_0 = \frac{1}{T} = \frac{f_1}{n_1} = \frac{f_2}{n_2} = \frac{f_1 - f_2}{n_1 - n_2}. \quad (10)$$

The difference $n_1 - n_2$ is the number of frame interlaces and this can arbitrarily be made unity. Then

$$n_1 = n_2 + 1$$

and

$$f_0 = f_1 - f_2.$$

A scan in which $n_1 = 5$ and $n_2 = 4$ is illustrated in Fig. 2.

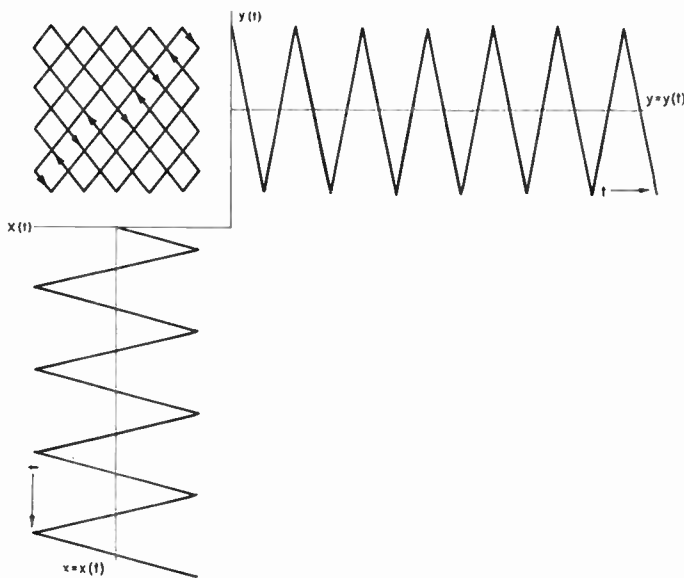

Fig. 2—Isotropic scan formed by triangular waves. Both the horizontal and vertical sweeps are triangular waves. In the present example there are five full waves in the vertical direction for every four full waves in the horizontal direction.

The number of traverses within a fundamental period T should be large and hence both n_1 and n_2 should be comparatively large. In our experiments, for convenient use of binary circuits, the following values were chosen.

$$\begin{aligned} f_1 &= 256 \text{ cps} \\ n_2 &= 512 = 2^9 \\ n_1 &= 513 = 2^9 + 1 \\ f_0 &= .5 \text{ cps} \end{aligned}$$

EXPERIMENTS

Equipment

A block diagram of the basic equipment used to carry out the experiments is shown in Fig. 3.

The picture generating equipment consists of a flying spot scanner that utilizes feedback around fluorescent screen. Its mode of operation follows.

Corresponding to an instantaneous position of the luminous spot on the scanning tube, a real image of the spot is formed on the transparency. A portion of the light is transmitted through the transparency and condenser lens to the phototube. The amount of light and

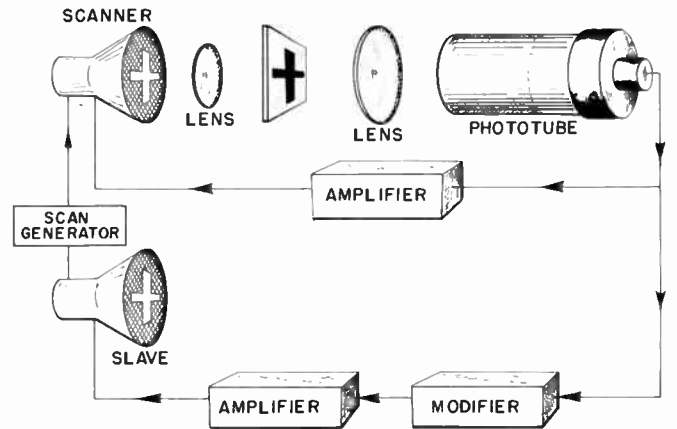

Fig. 3—Block diagram of experimental image processing system. Feedback around the fluorescent screen of the scanning cathode ray tube is accomplished by feeding the amplified phototube signal to the scanner. This signal is also modified and the resulting picture is displayed on the slave cathode-ray tube screen.

hence the phototube signal depends upon the local transmittance of the transparency. The phototube signal is amplified and applied to the scanner tube intensity grid so that it reduces the intensity of the scanning spot.⁷ The equilibrium produced is such that for high values of transmittance the spot intensity is much reduced and for completely opaque regions there is no reduction of intensity. The resulting intensity pattern on the scanner face is a negative of the transparency. It is shown in Appendix II that the resulting negative has the tone gradations of a true photographic negative if the amplifier has a high gain (feedback ratio is high). This feedback has advantages similar to negative feedback in amplifiers. The nonlinearity is reduced, the bandwidth is increased, and the effect of phosphor persistence is reduced. The disadvantages of reduced signal amplitude and increased possibilities of oscillation common to systems that employ inverse feedback also occur.

The scan is provided by a scan generator (see block diagram, Fig. 4, page 565). Since two different frequencies, having a well-regulated difference, are required, a two-phase rotating transformer is used to give a uniformly increasing phase lag. As the shaft is rotated, the frequency of rotation is added to the frequency of the input sine wave. In order to reduce resolution errors, the rotating transformer is operated at a frequency 16 times that of the final scan frequency. The master oscillator is usually set at 4 kc, resulting in a scan frequency of about 250 cps. The rotating transformer is driven by a

⁷ R. Theile and H. McGhee, "The application of negative feedback to flying spot scanners," *Jour. Brit. IRE*, June, 1952.

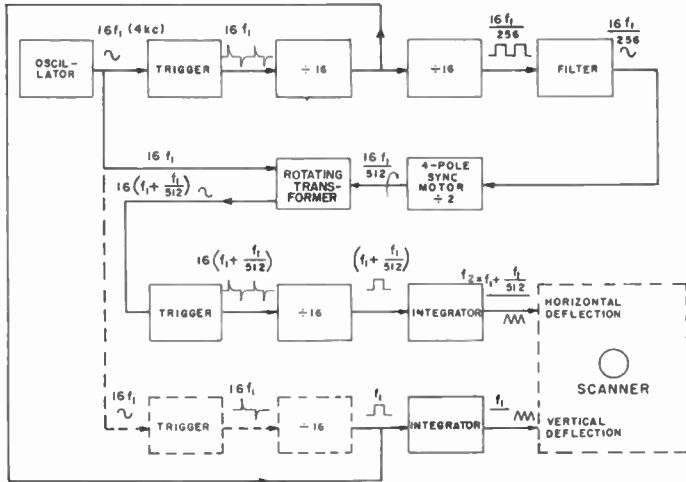

Fig. 4—Block diagram of the scan generator. The dotted line shows alternative connection

synchronous motor, whose input is in the form of a sine wave with a frequency $\frac{1}{18}$ that of the scan frequency. In this manner, the integer ratio relation between the two scan frequencies is maintained. Two square waves, having a small difference in frequency, are formed and the triangular waves are obtained by integration.

The phototube signal is fed through the modifier and an amplifier identical to the scanner amplifier, to a monitor or "slave" cathode-ray tube whose sweep is identical to that of the scanner. If the signal is fed to the monitor without modification, the monitor screen pattern will be identical to that of the scanner.

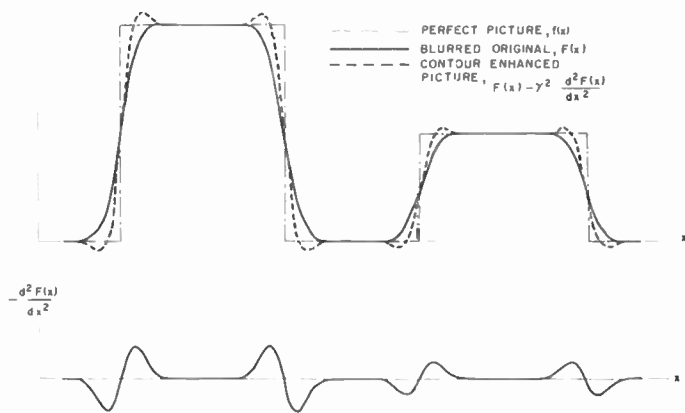

Fig. 5—Principle of contour enhancement. The upper part shows three pictures functions: one is the perfect picture signal, the second is the picture signal from the degraded original, and the third shows a partial restoration towards the perfect picture signal. The lower figure shows the negative second derivative of the original signal that was added as a correction signal to the signal from the degraded original.

Contour Enhancement

The deblurring operator was given before, in (1). With the use of the isotropic scan, the operation involves adding a certain amount of negative second time derivative to the picture signal [see (8)]. A diagrammatic explanation of contour enhancement is given in Fig. 5.

The results of applying contour enhancement are shown in two sets of pictures shown in Fig. 6. Fig. 6(a)

and 6(d) show the pictures reproduced by the video signal. Fig. 6(b) and 6(e) show the pictures produced by the negative of the doubly differentiated signal. Fig. 6(c) and 6(f) are the result of subtracting a portion of the doubly differentiated signal from the video signal.

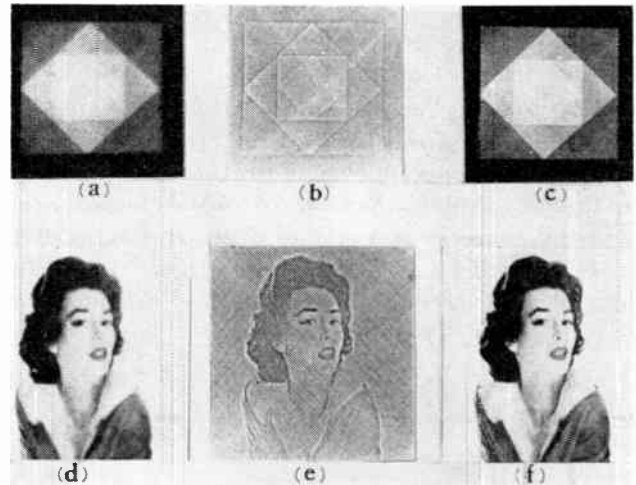

Fig. 6—Experiments in contour enhancement. (a) Blurred original picture, (b) correcting signal (negative Laplacian), (c) enhanced resulting picture. (d) blurred original picture, (e) correcting signal (negative Laplacian), (f) enhanced resulting picture.

The special scan offers some saving in circuits for obtaining the second derivative. When every point is scanned both in the positive and negative directions the resulting picture is formed by the arithmetic average of the two video signals in the two strokes. The sign of the first derivative (and every odd derivative) changes with the reversal of scan direction (Fig. 7, next page), but the second derivative (and every even derivative) remains the same for both scan directions. In practical application the differentiating circuit has a time constant $\tau = RC$. The operators to be considered follow:

- (a) Perfect first derivative: $j\omega$
- (b) Perfect second derivative: $-\omega^2$
- (c) Practical first derivative (by $RC = \tau$ circuit)

$$\frac{i\omega\tau}{1 + j\omega\tau}$$

- (d) Practical second derivative (by cascading two differentiating circuits)

$$\frac{-\omega^2\tau^2}{1 - \omega^2\tau^2 + 2j\omega\tau}$$

[Average of two opposite scan strokes eliminate the out-of-phase (imaginary) components]

- (e) Average perfect first derivative: 0
- (f) Average perfect second derivative: $-\omega^2$
- (g) Average practical second derivative by cascading two differentiating circuits

$$\frac{-\omega^2\tau^2(1 - \omega^2\tau^2)}{(1 + \omega^2\tau^2)^2}$$

- (h) Practical second derivative by averaging the

practical first derivatives

$$\frac{\omega^2 \tau^2}{1 + \omega^2 \tau^2}$$

It is plain that (g) is inferior to (h) by a factor

$$\frac{1 - \omega^2 \tau^2}{1 + \omega^2 \tau^2},$$

and (h) involves only one differentiating circuit. The physical explanation is simple: the "practical" first derivatives have some time lag of the order of τ and therefore do not cancel in the forward and backward stroke. Their difference is of a second order and supplies the necessary second derivative (with negative sign). When performing the second differentiation in this manner in

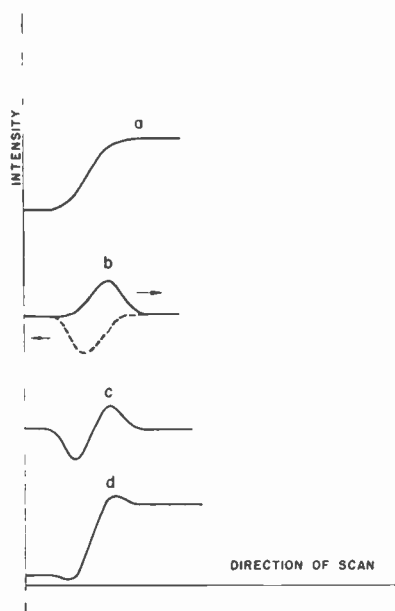

Fig. 7—Practical realization of contour enhancement by one differentiation only. (a) A somewhat degraded picture signal of a transition between two levels. (b) The derivative of this signal, but delayed slightly in the direction of scan. The dotted line refers to the return signal. (c) The algebraic sum of the two signals shown in (b). This is approximately equal to an undelayed negative second derivative signal. (d) The sum of the signal shown in (c) and that shown in (a).

two mutually perpendicular directions we obtain the Laplacian operator. However, this short cut method for obtaining the second spatial derivatives does not exist for the conventional television scan.

The actual contour enhanced pictures (Fig. 6), were obtained by this latter method since it required less gain in the system and therefore fewer stages.

There were previous attempts to improve a degraded television picture by adding a suitable compensating signal by such methods as "crispensing."⁸ However the application of these methods, is limited by the unidirectional character of the conventional television scan.

⁸ P. C. Goldmark and J. M. Hollywood, "A new technique for improving the sharpness of pictures," *PROC. I.R.E.*, vol. 39, p. 1314; October, 1951.

Contour Outlining

As mentioned above, formation of the absolute value of the squared gradient will produce outlining effects independent of the pattern orientation. If, in addition, the differentiated signal is amplified and clipped to a constant value, there results a pattern that shows the position of each change of contrast or more explicitly where the contrast gradient is sufficiently great to produce a signal. The results of applying this process to a pattern are shown in Fig. 8.

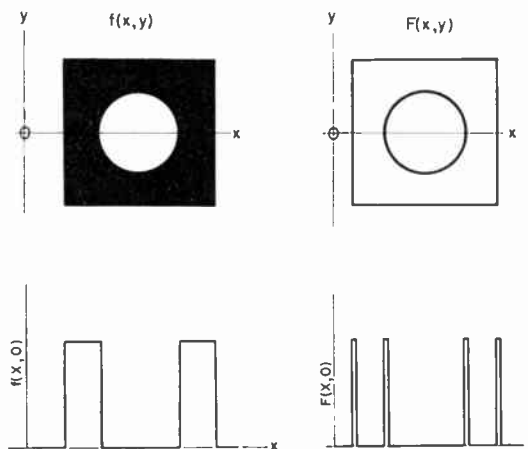

Fig. 8—Principle of contour outlining. The upper part shows a picture and its derived outline. The lower part shows the corresponding video signals across a single scan ($y = 0$).

The practical procedure for producing a signal that outlines each change in contrast is more involved than appears from the above. Practical pictures often have areas of continually changing contrast although the gradient may not be large but is not zero. In addition there are areas of small and unimportant detail, "fuzz," that is unduly emphasized by linear differentiation.

The process will be described in Fig. 9 (page 567) by showing how contour outlines are produced from a pattern resulting from poorly focused squares somewhat like those in Fig. 6.

The transmittance variation across a diagonal of the figure will appear like Fig. 9(a). The differentiated signal resulting from the forward sweep is shown in Fig. 9(b). The negative signal resulting from the return sweep is suppressed by a half-wave rectifier; also the threshold of the rectifier is set so as to suppress the small signal "fuzz."

The signal of Fig. 9(c) is differentiated again to form the doubly differentiated signal shown in Fig. 9(d). This signal is applied in turn to a trigger circuit (which responds to positive signals) to form the result shown in Fig. 9(e).

It will be noted that the trailing edges of the square waves correspond to the appropriate position on the center of the changes in Fig. 9(a). These square waves are differentiated, rectified, and then inverted, to form the result shown in Fig. 9(f). The position of the pulse is indicated by the pulse on the baseline of Fig. 9(a).

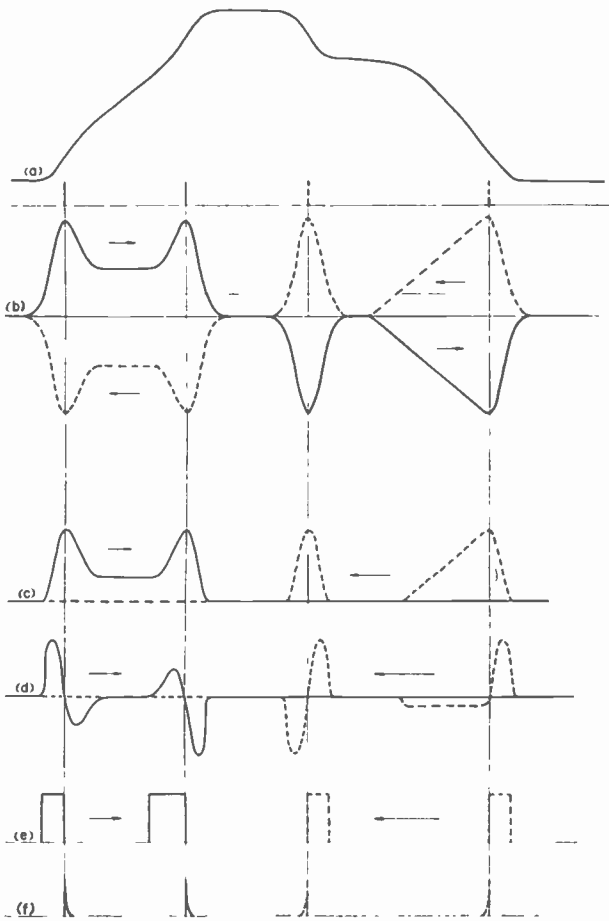

Fig. 9—Practical contour outlining procedure. The procedure consists of obtaining an outline at the points where the slope of the video signal has a local maximum exceeding a threshold value. The steps are indicated below. The forward scan is shown in solid lines and the return traces with dotted lines. (a) Original picture signal, (b) first derivative, (c) rectification with bias, (d) second derivative (when first derivative exceeds threshold), (e) trigger driven by (d), (f) pulses, differentiated and rectified (e).

The picture that is obtained appears to be an outline drawing drawn with a pencil whose width is determined by the pulse width that appears on the screen. This can be varied by changing the time constant and amplitude of the last differentiating stage. Fig. 10 shows outlines made from the same originals as in Fig. 6.

There are some errors, due to the combined delays of the differentiating circuits, in the time taken for the pulse to rise to the triggering value, and for the delay in the trigger circuit itself. This last depends upon the amplitude of the trigger signal and hence is not constant, but it can be minimized. All the delays but the last could be compensated for by delaying the monitor sweep for the appropriate time interval.⁸ This sweep delay may permit the use of larger values of differentiating time constants (τ) and hence require less amplification after differentiation. Therefore greater freedom from noise may be obtained.

The effect of these delays upon the resulting picture is determined by the experimental procedure. In the processes indicated in Fig. 9 delays in the differentiating will have the effect of shifting the outlining pulses toward lighter or darker regions, depending upon the po-

larity of the picture signal. Therefore, using a positive or a negative transparency as the original will result in contours of somewhat different location. A calibration of the system can be performed by outlining both a positive and a negative picture. When identical results occur the system is in proper alignment.

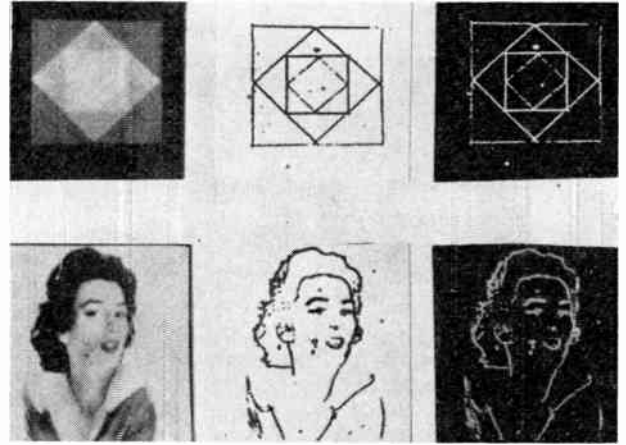

Fig. 10—Experiments in contour outlining. The originals have been processed to make the outlines. The monitor shows the outlines as light lines on a dark background. The dark line pictures are obtained by a photographic reversal.

FURTHER APPLICATIONS

The investigation so far has covered the possibilities of some elementary processes applied to an image.

Conversion of the image to a time-varying signal permits considerable flexibility in the reformation of the pattern. The co-ordinate measure numbers of the two-dimensional, monitor screen picture can be varied at will within fairly wide limits. The resulting pattern can be stretched, warped, changed in position, rotated with respect to the original pattern, or interchanged about an arbitrary axis by using negative measure numbers.

This suggests that recognition by matching to a known pattern or to a given mathematical formula may be possible since distortion can be tried easily. The Gestalt problem may be illuminated by such a method. Possibly automatic devices for recognizing patterns or shapes can be constructed.

The potential uses of the contour enhancement process may include transmission of an image with less impairment through a lesser bandwidth channel or to pre-emphasize a picture that is to be sent through a low definition channel, in a manner analogous to pre-emphasis in an audio amplifier for the purpose of improving the response at higher frequencies. This apparent improvement may be made on inherently low definition patterns such as an X-ray picture of soft tissues to make the detail more apparent, that is, more quickly visible. An X-ray picture, Fig. 11(a), processed in this manner is shown in Fig. 11(b) on the next page.

The contour outlining may be a means of making a sketch map of terrain, or it may be used as a means of reducing the information content to lower the band-

width requirements for transmission or for the recognition mentioned above. In addition this method may be useful for establishing the position of the contour. For instance, the contour of the heart may be set by the contour outline process without human error, a matter of some importance in measuring the heart volume. This may be especially significant when large amounts of data must be processed.

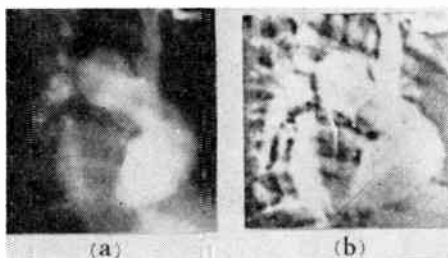

Fig. 11—Contour enhanced by X-ray picture. Left—photographic copy of original heart X-ray. Right—contour enhanced picture of the same.

An interesting further application is the use of the scan lines in order to simulate the method of characteristics used for solving hyperbolic partial differential equations. By using the special scan, but only two perpendicular strokes without their return sweeps, we obtain two sets of characteristics

$$x + y = \text{constant}$$

and

$$x - y = \text{constant.}$$

A solution of the hyperbolic differential equation

$$\frac{\partial^2 F}{\partial x^2} - \frac{\partial^2 F}{\partial y^2} = 0$$

is

$$F(x, y) = A(x + y) + B(x - y),$$

where A and B are arbitrary functions of their arguments.

If the video signal is provided by integration, F will be a constant along characteristics as long as the integrand is zero. This fact may be used to generate the functions $A(x+y)$ and $B(x-y)$ by integrating an original cutout picture that will impose the boundary conditions. Away from the boundaries the integral will be constant at the value it attained at the boundary. Thus it represents a solution of the form given above. Naturally a reset or clamp is necessary so that the integral value may be reset when the pattern is scanned again.

The method may be extended to nonlinear hyperbolic differential equations if the scan angle is modified by the video signal itself. These further lines of research will be reported later.

ACKNOWLEDGMENT

The intelligent and painstaking assistance of Mr. Nathan Newman is gratefully acknowledged.

APPENDIX I

Integral Operators

Integral operators in general represent a blurring process. Scanning with a finite size spot or imperfection in the optical system all can be expressed in an integral operator form. A blurred picture $F(x, y)$ can be related to the original $f(x, y)$ as

$$F(x, y) = \int_{-\infty}^{+\infty} \int_{-\infty}^{+\infty} f(\xi, \eta) P(x, y, \xi, \eta) d\xi d\eta, \quad (11)$$

where $P(x, y, \xi, \eta)$ is the blurring function (e.g., intensity of finite spot). If the blur is independent of location the operator is homogeneous and P is only a function of $x - \xi$ and $y - \eta$. If the finite spot has a Gaussian distribution this is equivalent to a diffusion process [see (3)] and the perfect picture can be fully recovered. If a homogeneous linear differential operator Ω is applied to $F(x, y)$ to obtain $F = \Omega[F]$ the operation can be performed in one step by a modified kernel $P^* = \Omega P$

$$\begin{aligned} \widehat{F} = \Omega[F] &= \int_{-\infty}^{+\infty} \int_{-\infty}^{+\infty} f(\xi, \eta) \Omega[P(x - \xi, y - \eta)] d\xi d\eta \\ &= \int_{-\infty}^{+\infty} \int_{-\infty}^{+\infty} f(\xi, \eta) P^*(x - \xi, y - \eta) d\xi d\eta \end{aligned} \quad (12)$$

with

$$P^*(x - \xi, y - \eta) = \Omega[P(x - \xi, y - \eta)].$$

Knowing the general nature of the blur, P , one can always decide how much improvement can be obtained by applying a contour enhancing operator. A generalization of filter concepts applied to blurring and aperture correction has been made.⁹

A special case occurs when P^* becomes a delta function.

$$\Omega P = P^* = \delta(x - \xi) \delta(y - \eta)$$

then

$$\widehat{F} = \Omega F = f(x, y),$$

and the picture is exactly deblurred. In such a case, P must be an elementary solution of differential equation

$$\Omega P = 0. \quad (13)$$

For the contour enhancing operator in one dimension, as in (13),

$$P(x) - \gamma^2 \frac{\partial^2 P}{\partial x^2} = 0,$$

the special solution for $P(x)$ is

$$P(x) = \frac{1}{2} e^{-1x - \xi/\gamma}.$$

⁹ Otto Schade, "Electro-optical characteristics of television systems," *RCA Rev.*, vol. 9, pp. 5-37, 245-286, 490-530, 653-686; 1948.

Naturally this is not a very realistic blur distribution, it is only indicative of the feasibility of perfect deblurring. (But in two dimensions operator $1 - \gamma^2 \nabla^2$ corresponds to a P with logarithmic singularity at origin.)

If, however, the contour-enhancing operator is extended to include the bi-Laplacian, more realistic blur distributions can be found (such that the original can be more nearly recovered), than with a blur distribution that uses just the Laplacian.

APPENDIX II

Negative Feedback Analysis on a Flying Spot Scanner

It is assumed that the cathode ray tube intensity grid voltage E_g is measured from the point of extinction (cut-off) and that the luminous intensity I is either proportional to the grid voltage (linear assumption) or to the square of the grid voltage (square law assumption). The former is a better approximation for high, the latter for low intensities.

For the linear assumption,

$$\frac{I}{I_0} = \frac{E_g}{E_0}, \tag{14}$$

For the square law assumption,

$$\frac{I}{I_0} = \frac{E_g^2}{E_0^2}. \tag{15}$$

where I_0 and E_0 are corresponding values of I and E_g when no feedback signal is applied. The feedback voltage e is obtained from the photo multiplier through the amplifier.

$$-e = \text{constant} \times rI \quad 0 < r < 1, \tag{16}$$

where $r(x, y)$ is the transmittance of the inserted (negative) slide. For convenience introduce the feedback ratio K by rewriting (16) as follows:

$$-e = \frac{KrI}{I_0} E_0. \tag{16a}$$

The grid voltage is originally set at E_0 and with feedback it now becomes

$$E_g = E_0 - e. \tag{16b}$$

Using (14), (15), (16a) and (16b) to solve for I/I_0 , we obtain the following: with linear assumption

$$\frac{I(x, y)}{I_0} = \frac{1}{Kr(x, y)} \cdot \frac{Kr(x, y)}{1 + Kr(x, y)}; \tag{17}$$

with square law assumption,

$$\frac{I(x, y)}{I_0} = \frac{1}{Kr(x, y)} \left[1 - \frac{1 - \sqrt{4Kr(x, y) + 1}}{2Kr(x, y)} \right]; \tag{18}$$

in both cases,

$$\frac{I}{I_0} \rightarrow \frac{1}{Kr} \quad \text{when } Kr \rightarrow \infty.$$

The image appearing on the screen and the original negative placed into the focal plane of the scanner have a relationship very similar to that of a positive transparency and its original negative. This indicates that the function $f(x, y)$ has to be fed into the equipment in the form of a negative (with "gamma" equal unity). This is not an inconvenience. On the contrary, it makes recycling, for instance, much easier. Using photographic convention, we can state that the equipment behaves like a negative emulsion characterized by the density vs illumination curve

$$D = -\log \frac{I}{I_0} = \phi(\log r).$$

It can be plotted using (17) or (18). The contrast is measured by

$$\text{"gamma"} = -\frac{\partial \log I}{\partial \log r}.$$

For square law assumption,

$$\begin{aligned} \frac{\partial \log I}{\partial \log r} &= -\left(1 - \frac{1}{\sqrt{1 + 4Kr}}\right) \\ &= -\left(1 - \sqrt{\frac{I}{I_0}}\right); \end{aligned} \tag{19}$$

or, for linear assumption,

$$\frac{\partial \log I}{\partial \log r} = -\frac{Kr}{1 + Kr} = -\left(1 - \frac{I}{I_0}\right). \tag{20}$$

The negative sign indicates a negative process and for large feedback ratios the gamma becomes unity.

Contrast can be even boosted at the dark end of scale by operating monitor at lower (dc) intensity.

Let

I_m = the luminous intensity on the monitor,

and

μE_0 = the voltage setting of the monitor with no video signal.

Then, using the square law assumption, the ratio of intensities on the monitor and scanner becomes

$$\frac{I_m}{I_0} = \left(\frac{\mu E_0 - e}{E_0}\right) = \left[\sqrt{\frac{I}{I_0}} - (1 - \mu)\right]^2, \tag{21}$$

and the gamma of the modification becomes

$$\frac{\partial \log I_m}{\partial \log I} = \sqrt{\frac{I}{I_m}} = \frac{1}{1 - (1 - \mu)\sqrt{\frac{I_0}{I}}}. \tag{22}$$

For $\mu < 1$, the contrast increases and at the point of extinction becomes infinite. Naturally, with the linear assumption, similar results can be obtained.

APPENDIX III

The method of forming the Laplacian [see (8)], by averaging the second derivative can be extended to the bi-Laplacian operator

$$\nabla^4 = \frac{\partial^4}{\partial x^4} + 2 \frac{\partial^4}{\partial x^2 \partial y^2} + \frac{\partial^4}{\partial y^4}. \quad (23)$$

Using a scan pattern that consists of the present scan pattern (Fig. 2) but applying it twice: the first time as it is and the second time rotated by a 45 degree angle, we obtain a scan raster that consists of eight strokes symmetrically distributed. Using eight frames of conventional television scan each rotated by 45 degrees with respect to the previous one would be equally acceptable.

If the scanning spot moves with a uniform velocity in the direction forming an angle θ with the x -axis.

$$\dot{x} = U \cos \theta; \quad \dot{y} = U \sin \theta; \quad \ddot{x} = \ddot{y} = 0.$$

The fourth time derivative of the video signal becomes

$$\begin{aligned} \ddot{\phi} \dots = U^4 & \left[\frac{\partial^4 f}{\partial x^4} \cos^4 \theta + 4 \frac{\partial^4 f}{\partial x^3 \partial y} \cos^3 \theta \sin \theta \right. \\ & + 6 \frac{\partial^4 f}{\partial x^2 \partial y^2} \cos^2 \theta \sin^2 \theta + 4 \frac{\partial^4 f}{\partial x \partial y^3} \cos \theta \sin^3 \theta \\ & \left. + \frac{\partial^4 f}{\partial y^4} \sin^4 \theta \right]. \end{aligned} \quad (24)$$

If we take eight strokes so that in turn

$$\theta = 0, \quad \frac{\pi}{4}, \quad \frac{2\pi}{4}, \quad \frac{3\pi}{4}, \quad \frac{4\pi}{4}, \quad \frac{5\pi}{4}, \quad \frac{6\pi}{4}, \quad \frac{7\pi}{4};$$

the average fourth time derivative becomes

$$\langle \ddot{\phi} \dots \rangle_{av} = \frac{3}{8} U^4 \left[\frac{\partial^4 f}{\partial x^4} + 2 \frac{\partial^4 f}{\partial x^2 \partial y^2} + \frac{\partial^4 f}{\partial y^4} \right] = \frac{3}{8} U^4 \nabla^4 f. \quad (25)$$

Naturally a continuously rotating scan pattern (either conventional television or our special scan) would also be acceptable for both the Laplacian and bi-Laplacian if the average occurs over an entire cycle. It is conceivable that by similar methods, higher order Laplacian operators may be obtained from the corresponding orders of time derivative.

Pulse-Switching Circuits Using Magnetic Cores*

M. KARNAUGH†

Summary—The synthesis of a large class of pulse-operated magnetic logic and switching circuits is developed from basic principles. Simple design methods, as well as circuit organization and logic, are treated in detail. Some new circuit types are presented along with innovations in notation and design procedure. However, material from other sources is included for the sake of completeness. A bibliography of related works is appended.

INTRODUCTION

MAGNETIC CORES having nearly rectangular hysteresis loops seem destined to become important components of digital computers. They offer unique reliability, versatility, and economy, for applications which do not require extremes of high speed or low-power dissipation.

Considerable work has already been done in building both large scale and small scale memories with such cores. They have also been employed in logic and switching circuits, but a great deal remains to be accomplished in this field.

The material that follows deals with the latter use.

The treatment is intended to be fairly general, and certain special techniques, dealt with elsewhere in the literature, will be omitted. The most notable omissions are the use of nonmagnetic interstage delays,¹ the standardized magnetic decision elements,² and the co-incident-current selection schemes.³

Also, the design of the necessary pulse generating circuits will not be discussed. It will be assumed that sources of current pulses are available to power the circuits and that the current waveforms are rectangular unless otherwise specified. While rounded pulses may also be used, this assumption will simplify the exposition.

THE SWITCHING PROCESS

The magnetic cores currently available which have the most desirable characteristics are toroidal in form, consisting either of ceramic ferrite material or of ultra-thin ferromagnetic alloy tape wound on a nonferromag-

* Original manuscript received by the IRE, January 19, 1955.

† Bell Telephone Labs., Murray Hill, N. J.

¹ See bibl. ref. 14, 15.

² See bibl. ref. 18.

³ See bibl. ref. 19-29.

netic spool. The distinguishing feature of these cores is a nearly rectangular hysteresis loop. A loop of this type is shown in Fig. 1.

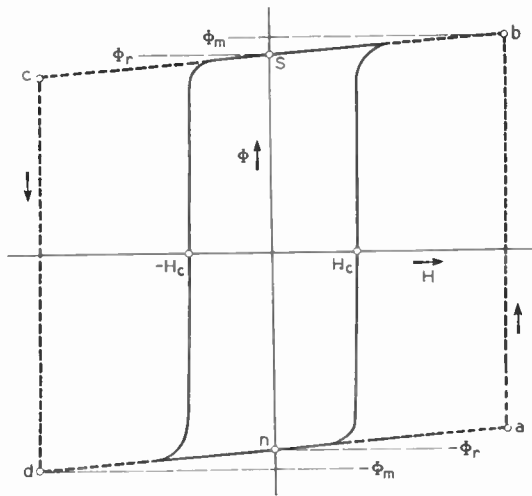

Fig. 1—A nearly rectangular hysteresis loop.

Magnetic states *s* and *n* are the states of maximum remanent flux, $\pm\Phi_r$, at zero external field. They will be called the *set* and *normal* states, respectively. A core can be switched from one of these states to the other by suitable passage of a pulse of current through a winding. The core is *set* when it is switched to state *s* and it is *reset* when it is switched to state *n*.

In Fig. 1, the dynamic paths followed during switching are indicated by the dotted lines *nabs* and *scdn*. The nearly horizontal path segments are traversed during the rise or fall times of the applied pulses. The nearly vertical path segments, which give rise to most of the flux reversal, take up most of the switching time.

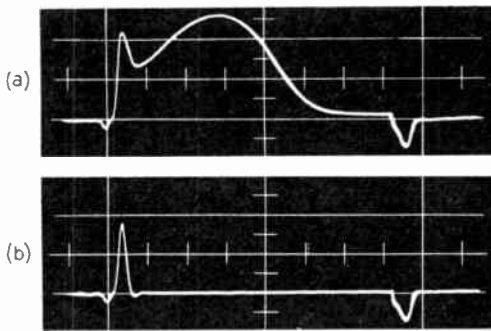

Fig. 2—Output voltage waveforms. (a) Switching voltage, (b) shuttle voltage.

Fig. 2(a) shows the switching voltage waveform on a sensing winding. This is proportional to the rate of flux reversal. The initial peak is caused by the rapid traversal of horizontal path segment *na* or *sc* of Fig. 1. The remainder of the positive waveform is generated on the vertical segment *ab* or *cd*. Finally, the brief negative peak occurs during the fall of the applied pulse, while the horizontal segment *bs* or *dn* is traversed.

When a core is pulsed in a sense opposite to that which would switch it, it will be said to be *shuttled*. The state of a core being shuttled follows the horizontal segment *nd* or *sb* on the rise of the applied current, and it returns to its starting point, *n* or *s*, on the fall of the current. The shuttle voltage waveform, shown in Fig. 2(b), is much smaller than the switching voltage waveform. In fact, the areas of the positive and negative peaks are equal, because there is no net change in flux linkage.

For the uses contemplated, it would be desirable to reduce the area under the positive shuttle voltage peak to a negligible value. This would result in an output consisting of either a switching voltage pulse or no pulse at all, depending upon whether the core in question is switched or shuttled. For this reason, the ratio Φ_r/Φ_m is desired to be near unity. Values in the range 0.90 to 0.96 are readily attainable at present.

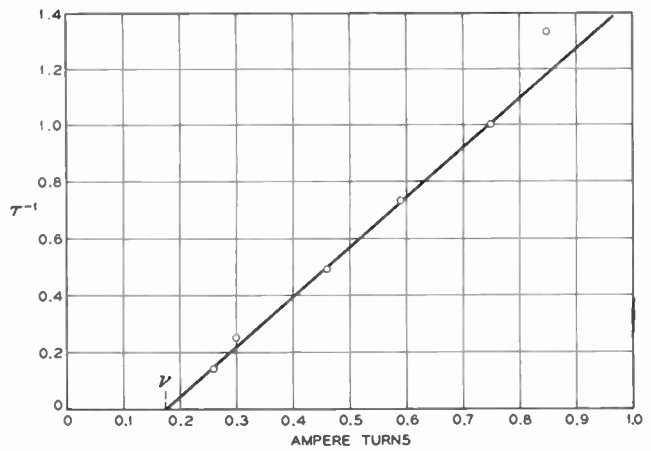

Fig. 3—Inverse switching time as a function of applied ampere-turns. A typical measurement.

The switching time τ may be defined as the interval from the beginning of the applied current pulse to the time when some large fraction, say 0.9, of the flux reversal is completed. When τ^{-1} is plotted against the applied ampere turns, the resulting curve is very nearly linear in the region of practical interest. Such a curve is shown in Fig. 3. It corresponds to the relation

$$\tau^{-1} = (NI - \nu)/C. \tag{1}$$

Here, C^{-1} is the slope and ν is the horizontal intercept of the extrapolated line. The latter may be thought of as a pseudo-coercive force, for $NI = \nu$ would result in infinite switching time according to (1). The true coercive force of the core is somewhat smaller than ν .

Because of the use of ampere-turns rather than oerstedts in (1), the parameters C and ν depend upon the core's mean diameter as well as the material. However, these are the more convenient units from the standpoint of circuit design.

The induced electromotive force per turn in a winding is proportional to the rate of reversal of magnetic flux in the core. The crude but simple approximation that this

is constant during the switching time leads to the relation

$$\epsilon = \frac{9 \times 10^{-3}(\Phi_r + \Phi_m)}{\tau} = \frac{9 \times 10^{-3}(\Phi_r + \Phi_m)(NI - \nu)}{C}$$

$$= k(NI - \nu) \text{ volts per turn,} \quad (2)$$

where Φ is measured in electromagnetic cgs units and τ is in microseconds. A factor 0.9 enters the numerator because of the definition of switching time.

When currents are simultaneously applied to several windings, NI must be replaced by $\sum NI$ in the above relations. Defining the *drive* D on a core to be

$$D = (\sum NI) - \nu, \quad (3)$$

they may be written in the simple forms,

$$\tau = C/D \text{ microseconds} \quad (4)$$

which gives the switching time directly, and

$$\epsilon = kD \text{ volts per turn.} \quad (5)$$

Knowledge of the values of ν , C , and k makes it possible to design adequate circuits. A reasonable degree of over-engineering is recommended in view of the inexactness of the assumption that the switching voltage waveform is rectangular.

NOTATION AND BASIC CONSIDERATIONS

The schematic representation of magnetic circuits is facilitated by the use of mirror symbols.⁴ In this paper, cores are represented by heavy vertical line segments, winding leads by horizontal line segments, and windings by 45-degree mirror symbols at the intersections of the vertical cores and the horizontal leads. Fig. 4 illustrates this notation.

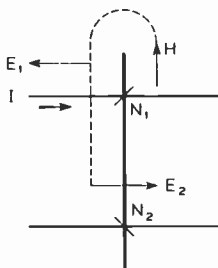

Fig. 4—Mirror symbol notation for schematics of magnetic core circuits.

The sense of the magnetic field associated with a current in a given winding is obtained by "reflecting" the current in the winding mirror symbol. To find the directions of the electromotive forces induced when the applied field switches the core, reverse this field and reflect it in each winding mirror symbol. These conventions are clearly consistent with Lenz's law.

Two additional conventions will be used.

1. Whenever the complete circuit containing an input winding lead is not shown, the current, when present, is assumed to flow from left to right.
2. An upward applied magnetic field is assumed to leave the core in its set state and, consequently, a downward field will leave the core in its normal state.

The basic circuits to be presented are cyclic in operation. Initially, all cores of a given circuit are in the normal state. During the input phase ϕ_1 , each core may or may not be set, depending upon which of the possible input pulses appear and which are absent. During the output phase ϕ_2 , all cores are reset by a single driving pulse, called the *advance pulse*. Then, switching voltages appear on the output windings of all the previously set cores. These output windings are combined in an output network which produces the desired output action of the circuit. After ϕ_2 , all cores are again in the normal state, ready for the next cycle of operation.

Clearly, the output phase requires only a single switching time for completion. The input phase may require one or more of such intervals. When the circuits are designed so that ϕ_1 and ϕ_2 are of equal duration, it is possible to combine them in a two-phase synchronous system. However, it is important to distinguish the clock phases, C_α and C_β , of the system from the local phases, ϕ_1 and ϕ_2 , of one of its circuits. For example, suppose that the output of one circuit is used as an input to another. Then ϕ_2 for the first circuit coincides with ϕ_1 for the second; they are 180 degrees out of phase with one another and their local phases are oppositely associated with C_α and C_β .

When ϕ_1 is simultaneous with C_α , the circuit will be said to operate in *mode α* . When ϕ_1 is simultaneous with C_β , the circuit will be said to operate in *mode β* . In a two-phase synchronous system of magnetic circuits, information is shifted from a circuit operating in one mode to another circuit operating in the other mode. The familiar Harvard shift register is a simple example of this kind of operation.⁵

The notation developed in the remainder of this section is useful in describing the logical structure of digital circuits.

The input variables for any circuit will be denoted by x_1, x_2, \dots, x_n . During ϕ_1 , each of them will have one of the two possible values, 0 or 1. The *negation* of any variable x_i , denoted by x_i' , will always have the complementary value. In view of this relationship, x_i' is as much a logical variable as x_i . They will both be called *literals*.⁶ It will often be convenient to denote one of a pair of literals, x_i or x_i' , in a context in which either one may be used. An asterisk will be employed in such cases. Thus, x_i^* means " x_i or x_i' ."

If it is to generate an output which depends nontrivially upon each of its input variables, a circuit must have

⁵ See bibl. ref. 8, 10, 11.

⁶ This term is borrowed from W. V. Quine, "The problem of simplifying truth functions," *Am. Math. Monthly*, vol. 59, pp. 521-531; October, 1952.

⁴ Adapted from R. P. Mayer, "A Proposed Symbol for Magnetic Circuits," Engineering Note E-472, Digital Computer Lab., Mass. Inst. Tech.; August 14, 1952.

at least one input lead per variable. The lead x_i^* , which is associated with the literal x_i^* , will carry an input current pulse during ϕ_1 if $x_i^* = 1$ but will carry no pulse if $x_i^* = 0$.

A circuit will be said to have *double-sided* inputs with respect to x_i if it has x_i and x_i' leads. If only one of the two is present, the input is *single-sided*.

In addition to the input leads associated with input literals, it is sometimes convenient to have a *unit* input lead u which always conducts a pulse during ϕ_1 .

Each input lead will be connected to a separate set of windings on the cores,⁷ one on each core upon which it must act. When an input lead has windings on several cores, they will be connected in series.

The setting (or nonsetting) of a core by its inputs during ϕ_1 is a function, $s(x)$, of the values of its input variables. By convention, $s(x) = 1$ when the core is set and $s(x) = 0$ when it is not set. Such two-valued functions may be expressed in terms of the operations of Boolean algebra. These operations will be called multiplication and addition and are defined in Table I.

TABLE I

DEFINITIONS OF BOOLEAN MULTIPLICATION AND ADDITION

x_1	x_2	x_1x_2	$x_1 + x_2$
0	0	0	0
1	0	0	1
0	1	0	1
1	1	1	1

With these conventions, multiplication corresponds to logical conjunction (i.e., to the English connective, "and") while addition corresponds to logical disjunction (i.e., to the English connective, "or," in the inclusive sense). For example,

$$s_i = x_1x_2' + x_3x_4$$

means that core i is set when x_1 and x_2' , or x_3 and x_4 have the value 1.

Table I shows that Boolean multiplication is the same as multiplication of the integers 0, 1. Boolean addition, however, has the unfamiliar property, $1 + 1 = 1$. In spite of this, it does not seem necessary to employ a special symbol to distinguish this operation here. The plus sign will represent Boolean addition only in connection with the logical setting functions s and the logical output functions f .

An input lead can be connected to an input winding in two ways. In one case, a current in the lead will flow through the winding so as to set the core. But if the connections to the winding are reversed, the same current will oppose setting the core. The winding will be said to be *positively* connected in the first case and *negatively* connected in the second case.

⁷ More than one input lead may be connected to a given winding when it is no longer necessary to keep the input leads separate. Such economies are often possible but they will not be emphasized in this rather general discussion.

For simplicity, it will temporarily be assumed that all input currents flow simultaneously and have the same amplitude, I_1 .

Now it is possible to introduce a simple linear expression which represents the inputs to a core unambiguously. Suppose a winding of N_i^* turns is positively connected to lead x_i^* . This contribution to the core's input will be represented by $N_i^*x_i^*$. If the winding is negatively connected, it will be represented by $-N_i^*x_i^*$. The effects of the inputs must be added algebraically in order to determine the net effect on the core. Therefore, the entire *input composite*, $J(x)$, is conveniently represented in the form,

$$J(x) = \sum_{i=1}^n (q_i N_i x_i + q_i' N_i' x_i') + q_u N_u \quad (6)$$

in which each q is either $+1$ or -1 or 0 , and each N is a positive integer. N and q are parameters which refer to numbers of turns and types of connection of the windings, respectively, while the associated literals tell whether or not input pulses are present. The latter may change from one cycle of operation to the next and are therefore the variables which determine the value of the function $J(x)$. The term $q_u N_u$ in (6) refers to the unit input lead and its input winding.

During ϕ_1 , the net ampere-turns applied to the core in the setting direction is easily seen to be

$$\sum NI = I_1 J(x), \quad (7)$$

because a current, I_1 , flows in a given winding if and only if the associated literal has the value 1.

Three examples of the equivalent schematic and algebraic representations of inputs to magnetic cores are given in Fig. 5.

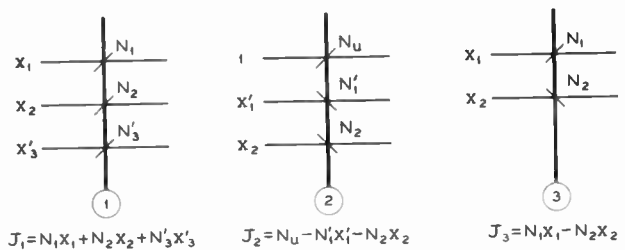

Fig. 5—Schematic and algebraic representations of input leads and windings on magnetic cores.

From (7), it is obvious that two different input composites that have the same functional dependence upon the input variables are *equivalent* in their actions on a core.

Ordinary algebraic manipulations will always change an input composite into another equivalent input composite. For example,

$$\text{(Rule 1)} \quad N_1x_i^* \pm N_2x_i^* = (N_1 \pm N_2)x_i^*$$

A less trivial transformation rule results from the logical properties of the literals.

(Rule 2) $x_i + x_i' = 1$

From this it follows that

(Rule 3) $x_i^* = 1 - (x_i^*)'$

By means of these simple rules, an input composite may be transformed into some equivalent one. Thus, one can change the arrangement of input leads and windings while the setting function of the core, which depends upon the net magnetic effect of the input composite, remains unaltered.

INPUTS

Suppose that the input pulses I_1 are applied with duration t_1 during ϕ_1 and that $N_1 I_1$ ampere-turns are required to set a core in this time. Then, as one can see from (1) and (7), the magnetic effect on the core is as follows.

1. If $I_1 J(x) \leq \nu$, then the core will remain in its normal state.
2. If $\nu < I_1 J(x) < N_1 I_1$, then the core will be partially set.
3. If $I_1 J(x) \geq N_1 I_1$, then the core will be set.

Therefore, if the core is to behave in a strictly two-valued manner, the range of values for $J(x)$,

$$\nu/I_1 < J(x) < N_1$$

must be forbidden. When this is done, the input composite $J(x)$ and the setting function $s(x)$ are related as in Table II.

TABLE II
CORRESPONDING VALUES OF INPUT COMPOSITE AND SETTING FUNCTION

$J(x)$	$s(x)$
$\leq \nu/I_1$	0
$\geq N_1$	1

The use of the pseudo-coercive force in the above inequalities is not strictly correct, for ν ampere-turns will cause a core to switch very slowly. Furthermore, even a pulse not exceeding the coercive force will cause some flux reversal. For circuits sensitive to such disturbances, ν may be replaced by zero in this section. In most cases, however, slight disturbances are tolerable.

Given any input composite, the problem of ascertaining that it satisfies the requirements for two-valued operation and finding the corresponding setting function may be called *analysis*. The analysis of an input composite may be simplified by use of Rules 1, 2, and 3, given in the preceding section, to transform it into the equivalent standard form \bar{J} , defined below.

1. No literal has a negative coefficient.
2. Only one member of each complementary pair of literals appears.
3. Coefficients of like terms are summed.

Consider the examples in Fig. 5, modified so that all windings have N_1 turns. Input composite of core 1 is

$$J_1 = \bar{J}_1 = N_1 x_1 + N_1 x_2 + N_1 x_3'$$

This is clearly equal to zero when $x_1 = x_2 = x_3' = 0$ and is greater than or equal to N_1 otherwise. Hence, core 1 is set if and only if $x_1 = 1$ or $x_2 = 1$ or $x_3' = 1$. Partial setting cannot occur and the setting function is

$$s_1 = x_1 + x_2 + x_3'$$

In the case of core 2,

$$J_2 = N_1 - N_1 x_1' - N_1 x_2,$$

which may be transformed to the equivalent,

$$\bar{J}_2 = N_1 x_1 + N_1 x_2' - N_1.$$

This is equal to N_1 when $x_1 = x_2' = 1$ and is less than or equal to zero otherwise. Core 2 is set if and only if $x_1 = 1$ and $x_2' = 1$. The setting function is

$$s_2 = x_1 x_2'$$

In the third case,

$$J_3 = N_1 x_1 - N_1 x_2$$

$$\bar{J}_3 = N_1 x_1 + N_1 x_2' - N_1$$

Therefore J_2 and J_3 are equivalent, and

$$s_3 = s_2 = x_1 x_2'$$

The general analytic procedure is to compute the value of the input composite for each possible combination of input variable values. Table II then gives the corresponding values of the setting function if the input composite is a proper one. In all practical cases, the whole process may be carried out by inspection of the equivalent standard input composite.

The synthesis of input composites is not quite so straightforward. In fact, not all logical functions can be realized as setting functions by means of input composites. Fortunately, there exists a very useful class of easily realized setting functions which, together with the output logic to be discussed in later sections, makes it possible to obtain any function of the input variables as the output function of a two-phase magnetic core circuit.

Consider the standard input composite,

$$\bar{J} = N_1 x_1^* + N_1 x_2^* + \dots + N_1 x_n^* - (\mu - 1)N_1, \tag{8}$$

where μ is an integer in the range, $1 \leq \mu \leq n$. This input composite has the values

$$-(\mu - 1)N_1, -(\mu - 2)N_1, \dots, 0, N_1, \dots, (n - \mu + 1)N_1,$$

as 0, 1, \dots , $(\mu - 1)$, $\mu \dots$, n , respectively, of the literals in its argument have the value 1. Thus, the corresponding setting function is equal to unity if and only if μ or more of the literals in \bar{J} are equal to unity.

Setting functions of this type may be represented by polynomials in Boolean algebra, but these are often cumbersome. It is more convenient to use the compact representation

$$s = (\mu \mid x_1^*, x_2^*, \dots, x_n^*) \tag{9}$$

for the function defined above. This function is invariant

with respect to permutation of the literals in its argument. The same is true of the input composite which realizes it. Because of this symmetry, any input composite which gives rise to a setting function of the form (9) will be called a symmetric input composite.

In the special case wherein all the literals are unprimed, it is possible to make the further abbreviation,

$$(\mu | x_1, x_2, \dots, x_n) = (\mu | n). \quad (10)$$

It is possible to transform the standard symmetric input composite (8) to an equivalent minimal symmetric input composite which requires the smallest number of input windings. This is done by eliminating the constant term. For example,

$$J = N_1 x_1^* + \dots + N_1 x_{n-\mu+1}^* - N_1 (x_{n-\mu+2}^*)' - \dots - N_1 (x_n^*)' \quad (11)$$

is one such form. Equivalent minimal symmetric input composites may be obtained from this by permuting the literals.

The general rules for a minimal realization of the symmetric setting function (9) are given below.

1. Let the leads corresponding to any $(n-\mu+1)$ literals of the argument be positively connected to input windings.
2. Let the leads corresponding to the *negations* of the remaining $(\mu-1)$ literals of the argument be negatively connected to input windings.

There are two extremely important special cases of symmetric setting functions. First is the *or* function,

$$(1 | x_1^*, x_2^*, \dots, x_n^*) = x_1^* + x_2^* + \dots + x_n^*, \quad (12)$$

which occurs when $\mu=1$. The minimal symmetric input composite for the *or* function is obtained from (11) by setting $\mu=1$;

$$J_{or} = N_1 x_1^* + N_2 x_2^* + \dots + N_n x_n^*. \quad (13)$$

The second important special case, the *and* function, is encountered when $\mu=n$.

$$(n | x_1^*, x_2^*, \dots, x_n^*) = x_1^* x_2^* \dots x_n^*. \quad (14)$$

The minimal input composite for the *and* function is obtained from (11) by setting $\mu=n$.

$$J_{and} = N_1 x_1^* - N_1 (x_2^*)' - \dots - N_1 (x_n^*)'. \quad (15)$$

Any permutation of the literals in (15) will result in an equivalent form.

The transformation rules for input composites have been applied above in analysis and for the minimization of windings. They may also be used to find input composites which require only a given set of single-sided inputs. For example, consider the function

$$s = (4 | x_1', x_2, x_3', x_4) = x_1' x_2 x_3' x_4.$$

Its minimal realization requires an x_2' lead or an x_4' lead;

$$\begin{aligned} J &= N_1 x_2 - N_1 x_1 - N_1 x_3 - N_1 x_4' \\ &= N_1 x_4 - N_1 x_1 - N_1 x_2' - N_1 x_3. \end{aligned}$$

However, a simple transformation to

$$J = N_1 x_2 + N_1 x_4 - N_1 x_1 - N_1 x_3 - N_1$$

makes it possible to work with the unprimed variables only.

The same method is useful in generating the negation of a single variable. The setting function, $s=x'$, is realized by $J=N_1 x'$. However, if an x' lead is not available, then $J=N_1 - N_1 x$ may be used. This will be called a *negating* input.

It has been assumed that the input pulses are simultaneous and of equal amplitude. While these assumptions have lent a very desirable simplicity to the argument, it is time to examine the requirements for timing and amplitude control in a realistic manner. The question of timing will be disposed of first.

Consider the minimal input composite for the *or* function. All windings are positively connected and a pulse in any one of them will set the core. Therefore, the pulses may be timed arbitrarily. In particular, they may occur serially.

When the *and* function has its minimal realization, one winding is positively connected and the others are negatively connected. The core is to be set if and only if the first winding receives a pulse and all of the others are inactive. A pulse in the positively connected winding is sufficient to set the core and a pulse in any negatively connected winding is sufficient to reset the core. If the inputs are not simultaneous, the setting pulse must be the earliest. With this restriction, the core will always be in the proper state at the end of ϕ_1 . The same is true of any other input composite, such as the negating input, which has just one positively connected winding.

Other symmetric input composites depend upon a balance between the effects of various numbers of oppositely connected windings. They require accurately simultaneous input pulses.

Variations among the input current amplitudes may pose a serious problem. At the very least, the numbers of turns in the input windings must be modified.

Suppose that the currents vary within the range $(1-\delta)I_1 \leq I \leq (1+\delta)I_1$, where $0 < \delta \ll 1$. In order to cope with this situation, it is advantageous to introduce two new parameters. These are N_p , the number of turns in each of the positively connected windings, and N_n , the number of turns in each of the negatively connected windings. They will be evaluated in terms of N_1 , I_1 , and ν . As before, $N_1 I_1$ is the number of ampere-turns required to switch a core in the allotted time and ν is the pseudo-coercive force.

The symmetric input composite permits simultaneous pulses in both positively and negatively connected input windings. In order to provide adequate margins, it is necessary to examine the most critical conditions which will give rise to the two possible results, $s=1$ and $s=0$.

The most critical case for $s=1$ occurs when the maximum possible number of windings are pulsed in such a way that the number of pulsed positively connected

windings exceeds the number of pulsed negatively connected windings by one. It can be seen from (11) that if λ is the former number,

$$\begin{aligned} \lambda &= \mu && \text{when } \mu - 1 < \frac{n}{2} \\ \lambda &= n - \mu + 1 && \text{when } \mu - 1 \geq \frac{n}{2} \end{aligned} \quad (16)$$

for minimal symmetric input composites. The inequality to be satisfied in this case is

$$\lambda N_p(1 - \delta)I_1 - (\lambda - 1)N_n(1 + \delta)I_1 \geq N_1I_1,$$

whence

$$\lambda(1 - \delta)N_p - (\lambda - 1)(1 + \delta)N_n \geq N_1. \quad (17)$$

The most critical case for $s=0$ occurs when the maximum possible number of windings are pulsed subject to the restriction that the numbers of positively connected and negatively connected windings pulsed are equal. Let this number be ρ . Eq. (11) shows that

$$\begin{aligned} \rho &= \mu - 1 && \text{when } \mu - 1 < \frac{n}{2} \\ \rho &= n - \mu + 1 && \text{when } \mu - 1 \geq \frac{n}{2} \end{aligned} \quad (18)$$

for minimal symmetric input composites. The inequality to be satisfied in this case is

$$\rho N_p(1 + \delta)I_1 - \rho N_n(1 - \delta)I_1 \leq \nu,$$

whence

$$(1 + \delta)N_p - (1 - \delta)N_n \leq \nu/\rho I_1. \quad (19)$$

Thus, the design of a symmetric input composite requires simultaneous integral solutions N_p, N_n of (17) and (19). In order to facilitate solution, the inequalities may be written in the form,

$$\begin{aligned} \frac{(\lambda - 1)(1 + \delta)}{\lambda(1 - \delta)} N_n + \frac{1}{\lambda(1 - \delta)} N_1 &\leq N_p \leq \frac{1 - \delta}{1 + \delta} N_n \\ &+ \frac{\nu}{(1 + \delta)\rho I_1} \end{aligned} \quad (20)$$

Then, a value of N_n must be found, such that the right hand member of (20) exceeds the left hand member and there is an integer between the two. It is always possible to do this by choosing N_n sufficiently large, provided that

$$\frac{1 - \delta}{1 + \delta} > \frac{(\lambda - 1)(1 + \delta)}{\lambda(1 - \delta)}.$$

This leads to the criterion

$$\lambda < \frac{(1 + \delta)^2}{4\delta} \quad (21)$$

for solvability of inequalities (20). The inverse relation,

$$\delta < \Lambda = 2\lambda - 1 - 2\sqrt{\lambda(\lambda - 1)}, \quad (22)$$

is also useful. Table III gives the values of Λ for small integral values of λ . This represents an upper bound on permissible fractional variation δ in input currents.

TABLE III
VALUES OF Λ FOR SMALL INTEGRAL VALUES OF λ

λ	Λ
1	1.000
2	0.172
3	0.102
4	0.072
5	0.056
6	0.046
7	0.039

In order to realize the input action desired with reasonably small windings, δ must be restricted to values substantially less than Λ .

In the special case of the *or* function, $\mu=1$. Thus, (16) and (18) show that $\lambda=1$ and $\rho=0$. Table III makes it clear that current control poses no great problem in this case, and inequalities (20) reduce to

$$\frac{1}{1 - \delta} N_1 \leq N_p \leq \infty, \quad (23)$$

all windings being positively connected.

The *and* function also is easily realized. Here, $\mu=n$, whence $\lambda=1$ and $\rho=1$. The inequalities to be satisfied in this case are

$$\frac{1}{1 - \delta} N_1 \leq N_p \leq \frac{1 - \delta}{1 + \delta} N_n + \frac{\nu}{(1 + \delta)I_1}. \quad (24)$$

While input composites for which $\lambda > 1$ are of limited usefulness because of the necessary current control, they may occasionally produce economies in systems where this is possible.

Most examples of input composites which have appeared in the literature⁸ may be considered special cases of the symmetric input composite. In particular, they are realizations of the *or*, *and* setting functions, but not always in a minimal form.

A method of obtaining the *and* function deserves separate review.⁹ This method requires that the input phase consist of two clock phases. In the first of these, the core is always set. In the second, the negations of each of the setting function literals drive negatively connected input windings. The core will remain set at the end of ϕ_1 , if and only if none of these windings receives a pulse. This scheme has the very substantial advantage of not requiring equality or simultaneity of the second-phase input pulses. However, there are three drawbacks against which they must be weighed.

1. Including the output, such circuits require a three-phase clock cycle.
2. Each core in such a circuit must be switched exactly twice per cycle. This may aggravate the heat dissipation problem in high speed systems.

⁸ See bibl. ref. 13, 16, 17, 23.

⁹ See bibl. ref. 16, 17.

- The output network must be such that the output voltages induced by resetting cores during the second input phase cause no false operation.

OUTPUT NETWORKS

While the output of a magnetic core logic circuit is a function of the input variables, it is also, more directly, a function of the states of the cores at the start of the output phase ϕ_2 . The output network may be considered the means whereby each of one or more loads receives a pulse or no pulse during ϕ_2 , depending on the initial states of the cores. These states are defined by the variables s_1, s_2, \dots, s_m , which are simply the setting functions of the m cores in the circuit. However, these setting functions are determined by input composites and are not completely arbitrary. Therefore, it is possible to impose certain restrictions upon them. For example, it will sometimes be required that one and only one of the cores be set by any combination of input variable values.

The simplest and probably the first type of output network to have been used depends upon the transformer action of the cores during switching. It will be called the T-type output network. Such a network is shown in Fig. 6. The input composites are not shown in this schematic but must be assumed to exist.

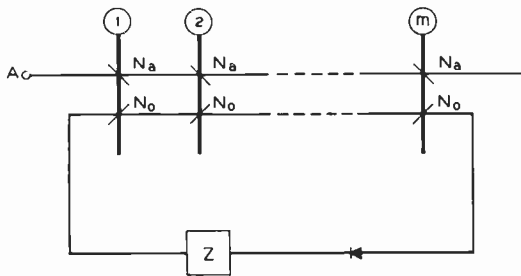

Fig. 6—A simple T-type output circuit with a passive load, Z .

The advance pulse, applied at point A during ϕ_2 , resets each previously set core as it flows through the series advance windings N_a . If none of the cores was set during ϕ_1 , then only the shuttle voltages appear on the output windings N_o . However, if any core was set, then a switching voltage pulse is induced in its output winding. Thus, if the sum of m shuttle voltages may be neglected, the load Z receives an output pulse if and only if one or more of the cores were set during ϕ_1 . The corresponding Boolean output function,

$$f = s_1 + s_2 + \dots + s_m,$$

is the *or* function. The setting functions s may have any of the realizable forms discussed in the preceding section. In particular, they may be *and* functions of input literals. It is well known that any Boolean function may be expressed in the above form when each s is a product of literals (i.e., the *and-or* form).

The diode in the output loop of Fig. 6 permits current flow when the cores are reset but not when they are set.

Therefore the inputs need supply only enough power to set the cores, while the output power may be considerably greater. It follows that such circuits can amplify the information carrying signals, drawing power from the advance pulse, and may be cascaded without interstage amplifiers. The other types of output network to be discussed share this useful property.

When the load of a T-type network is an input winding on another core, some complications arise. Fig. 7(a) is a simple illustration of this. Here, the output of core 1, which operates in mode α , is the input to core 2,

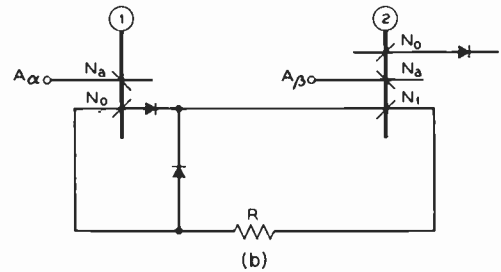
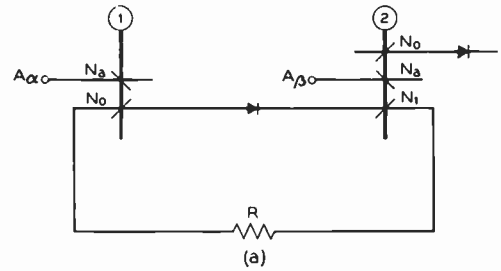

Fig. 7—T-type circuit with an input winding as the load. (1) One-diode configuration, (b) two-diode configuration.

which operates in mode β . The resetting of core 2 by A_β induces a current in the output loop of core 1. This induced current flows in the output winding of core 1 in such a sense as to tend to set it, even if the inputs to core 1 (not shown) would not do so. This undesirable backward action may be reduced to a tolerable level by inserting the resistance R and by using an appropriately large turns ratio N_o/N_1 . Too large a turns ratio, however, may result in the partial setting of core 2 by a shuttle voltage from core 1, an equally undesirable effect. Further reduction of the backward action may be had at the cost of another diode, as in Fig. 7(b). This problem is of importance in the design of magnetic shift registers.¹⁰

It would be advantageous to prevent current flow in the output network except during ϕ_2 , but the insertion of an electronic gate into each T-type output loop is not economically attractive. The output networks described below accomplish this end by using the advance pulse source for the gating function. Such networks, as a class, will be referred to as A-type networks.

In the A-type networks, the output network is in series with the advance windings. The advance current

¹⁰ See bibl. ref. 8, 10, 11.

pulse, directed along one of a number of alternative output paths, serves as the output pulse. There are two major subclasses of A-type networks. In the AF-type networks, the resetting of a core by the advance pulse induces a forward electromotive force in its output winding which causes the current to flow through that winding rather than through some other path. In the AB-type networks, the resetting of a core by the advance pulse induces back electromotive forces in its output windings which prevent the current from flowing through those windings.

Fig. 8 shows a very simple circuit with an AB-type output network. During ϕ_1 , core 1 is set if $x=1$ and core 2 is set if $x=0$. Suppose $x=1$ and core 1 has been set. The advance pulse is applied at A during ϕ_2 and resets core 1 as it flows through the advance winding N_a . It also flows through the advance winding of core 2 but merely shuttles this core, which was not set. A large back electromotive force is induced in the output winding N_0 of core 1 as it is reset. This prevents the advance current from flowing through this winding and causes it to take the other path through the output winding of core 2 and load Z_x , where it functions as an output pulse. Similarly, if $x=0$, the advance pulse will be directed to load $Z_{x'}$.

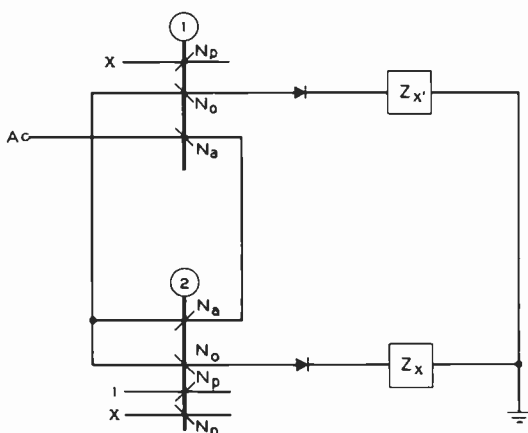

Fig. 8—A two-position AB-type switch.

In designing such a circuit, the number of turns N_a in the advance windings is determined by the amplitude of the advance current and the desired switching time of the core. It is important to terminate the advance pulse when the switching action is complete so as to avoid the appearance of a spurious half-amplitude output pulse on both loads.

The number of turns N_0 in the output windings is determined by the desired back electromotive force. This must exceed the voltage drop along the output path in which the advance pulse flows.

The diodes prevent the flow of induced current during ϕ_1 . The source of advance pulses must present a high impedance when not active, and it can be seen that, with the diodes present, there is no low-impedance loop

during ϕ_1 . In addition, the diodes prevent any reverse current from flowing in the blocked path during ϕ_2 .

With the input composites indicated, the circuit in Fig. 8 is capable of providing amplified negated and non-negated outputs with one phase of delay. However, this is one of the most trivial forms of the AB-type circuit. In general, the output windings in an AB-type circuit may be used as are contacts in a relay circuit. When a core has been set, its output windings are non-conducting (i.e., open) to the advance pulse; when it has not been set, its output windings are in a conducting (i.e., closed) condition. Quite complicated multi-output networks may be constructed. All that is necessary is that, for any set of inputs, the advance pulse will be admitted to one and only one of the possible output terminals. Further examples are given in the next section.

If only a single output is desired, a modification is useful. This involves the use of a two-terminal AB-type network as a shunt across the load. If the network blocks the advance pulse, then it flows through the load impedance. If the network is in a conducting state, then the advance pulse is shunted across the load and no output pulse is received.

The organization of this output network, which will be called ABS-type, is shown in Fig. 9. The block marked "AB-type network" represents a two terminal AB-type network of output windings. The block marked N_a represents advance windings on all the cores in series. The LC low pass filter shields the load Z from short spurious pulses caused by the generation of shuttle voltage waveforms on the windings in the AB network in cases where the net is otherwise in a conducting state. However, the network may function adequately without this refinement. It is noteworthy that the advance pulse may be applied for a time longer than the switching time of the cores, for the remaining part of the pulse will simply be shunted around the load.

An example of the ABS-type output network is given in the next section.

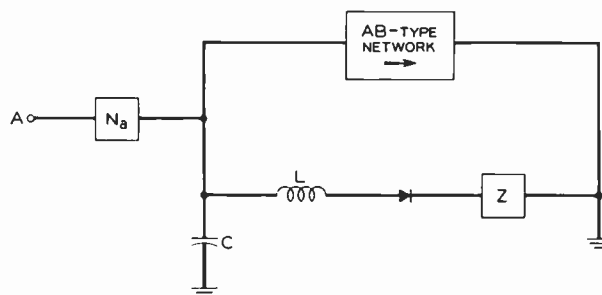

Fig. 9—Representation of the general ABS-type output circuit.

A simple AF-type switch is illustrated in Fig. 10 (opposite). Indicating all of the series advance windings by the block N_a will be continued because it simplifies the schematic considerably. As always, these windings are negatively connected.

The *and* function of two literals indicated near each output terminal is both the output function and the setting function of the corresponding core, for $f_i = s_i$ in each case. It can be seen that, no matter what values are given the input variables, one and only one of the four cores will be set.

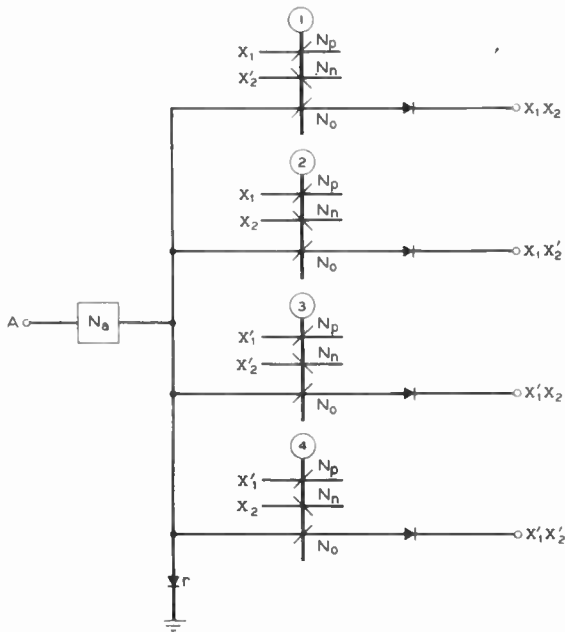

Fig. 10—A four-position AF-type switch.

Suppose $x_1 = 1, x_2 = 0$. Then core 2 is set during ϕ_1 . The resetting of this core during ϕ_2 generates a forward electromotive force in its output winding and the advance pulse flows through this path to the exclusion of the others. The voltage rise across the active output winding must exceed the drop caused by the flow of advance current through the output diode and load (not shown). This criterion determines the numbers of turns in the output windings. The number of turns in each advance winding must exceed the number of turns in the corresponding output winding by an amount which is determined by the desired switching time. Essentially the same current flows in the advance winding and the output winding of the active core, but the two windings are oppositely connected.

When the switching action is completed, the diode *r* will provide a shunt path for any remaining advance current. Also, if the circuit were such that some inputs would result in no core being set, the diode would conduct most of the advance pulse.

Clearly, the switch in Fig. 10 may be generalized to have 2^m cores and 2^m outputs with m input variables. It has the advantage over a similar AB-type switch of requiring just one core to be switched per cycle rather than switching all but one core to block $2^m - 1$ paths. However, the advance windings in the AF-type circuit are larger than those in the AB-type circuit by an amount roughly equal to the output windings.

The AF-type circuit is particularly well suited to the design of access switches, stepping switches, and ring counters.

ILLUSTRATIVE NONSEQUENTIAL APPLICATIONS

The two-position AB-type switch in Fig. 11 may be used to write a "1" or "0" on a magnetic drum, using only one source of driving pulses. This is accomplished by directing the advance current through the appropriate half of the split winding on the writing head. The

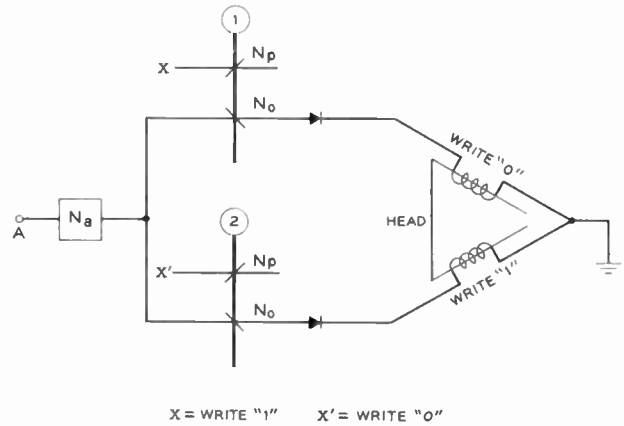

Fig. 11—Circuit for writing on a magnetic drum.

head has a large inductive impedance, so it is advisable to use fairly large cores and rounded, rather than rectangular, advance pulses. If neither core is set, advance current will divide in an approximately noninductive manner through the two half-windings on the head.

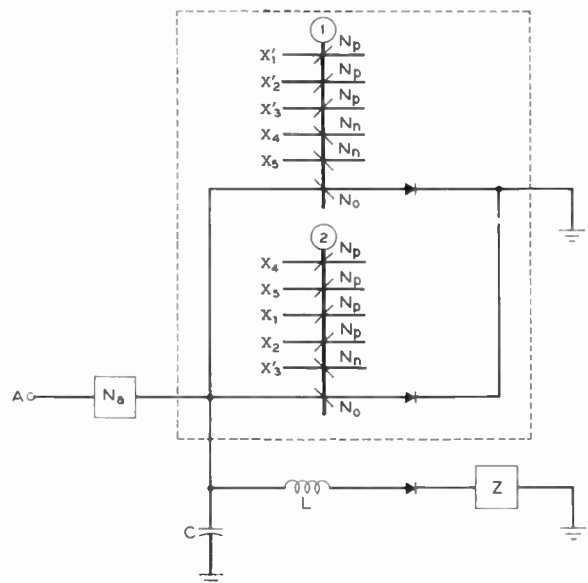

Fig. 12—An ABS-type checking circuit for a two-out-of-five code.

A code-checking ABS-type circuit is drawn in Fig. 12. The code in question represents decimal digits by means of five binary input variables, with the restriction that, for any digit, exactly two of the five variables must

have the value 1. The circuit in Fig. 12 verifies the correctness of a set of code variables by producing an output pulse when two of them are equal to unity, but no output pulse for any other condition.

The two-terminal AB-type network used in this circuit is enclosed by the broken line. It is required that this network block the advance pulse if and only if two of the variables x_1, x_2, x_3, x_4, x_5 are equal to unity.

In the case of core 1,

$$J_1 = N_p x_1' + N_p x_2' + N_p x_3' - N_n x_4 - N_n x_5$$

$$s_1 = (3 | x_1', x_2', x_3', x_4', x_5')$$

Hence the core will be set when three or more of the negated variables are equal to unity or, in other words, when two or less of the input variables are equal to unity. But

$$J_2 = N_p x_4 + N_p x_5 + N_p x_1 + N_p x_2 - N_n x_3'$$

$$s_2 = (2 | 5),$$

which means that core 2 will be set when two or more of the input variables are equal to unity. Thus, only when exactly two of the variables are unity will both cores be set. In this case, both cores will develop blocking electromotive forces in their output windings and the advance pulse will be directed to the load Z , which may be a winding on another core. When the load is a winding, it may be advisable to add a resistance in series with it so as to improve the shunting action of the output winding network.

As is the case with all but the T-type output networks, diodes are placed in the code-checking circuit to break the low-impedance loops which would otherwise exist.

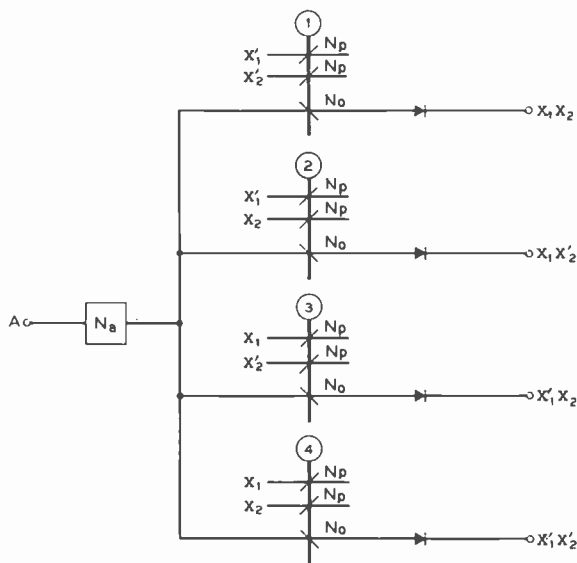

Fig. 13—A four-position AB-type switch.

The four-position AB-type switch in Fig. 13 should be compared with the corresponding AF-type circuit in Fig. 10. The setting functions of the cores in Fig. 13 are two-literal *or* functions and, for any assignment of in-

puts, all but one of them are set. The advance pulse flows through the output winding of the core which was not set; hence the output functions, indicated at the four output terminals, are the negations of the setting functions of the corresponding cores. This switch can also be enlarged so as to have 2^m cores and 2^m outputs with m input variables.

Another four-position AB-type switch is shown in Fig. 14. This circuit uses single-sided inputs of a very simple type, and is easily modified to use even simpler double-sided inputs. Two of the cores must have two output windings each. This is quite permissible in the

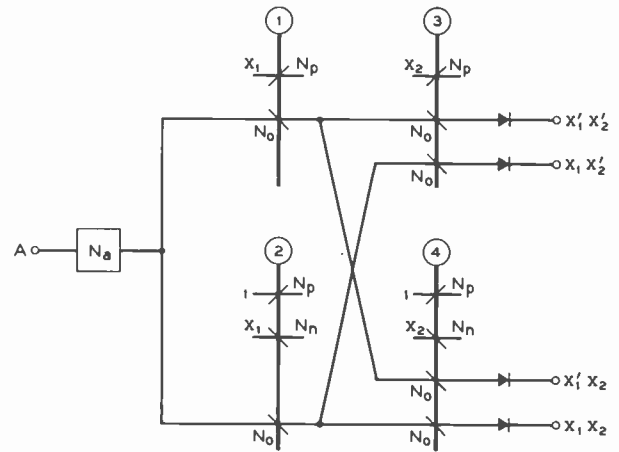

Fig. 14—Another four-position AB-type switch.

AB-type network because current does not flow in any output winding of a core that is being switched.

As suggested in the preceding section, AB-type networks can be constructed which are very much like the analogous relay contact networks. The symmetric switch in Fig. 15 is a good example of this technique. The inputs are similar to those in Fig. 14, except that there are now three input variables x_1, x_2, x_3 . It should be understood that the x_1 leads for cores 1 and 2 are in series, even though this is not explicitly shown. The same is true of the x_2 leads for cores 3 and 4, and the x_3 leads for cores 5 and 6. During ϕ_1 , 0, 1, 2, or 3 of the input variables may be equal to unity. Correspondingly, the advance current will be directed to output terminal 0, 1, 2, or 3 during ϕ_2 . Note that diodes are so placed in the output network that no low-impedance loops exist. This is done by placing them in all leads coming to a junction of output paths or to an output terminal.

The labels of the internal nodes of the output network have interpretations similar to the labels of the output terminals. For example, for the advance current to pass through the node 1, in the center of the network, just one of the first two variables must have been equal to unity. There are two paths leading to this node, corresponding to the two ways in which the above condition may be realized.

It is clear that the circuit in Fig. 15 constitutes the major part of a serial binary adder. The two bits to be

added and the carry input are $x_1, x_2,$ and x_3 . The binary sum is 1 when one or three of these variables are 1; the carry output is 1 when two or three of the variables are 1. Thus, both sum and carry functions are obtainable as setting functions for cores whose input windings are appropriately connected to the output terminals of this network.

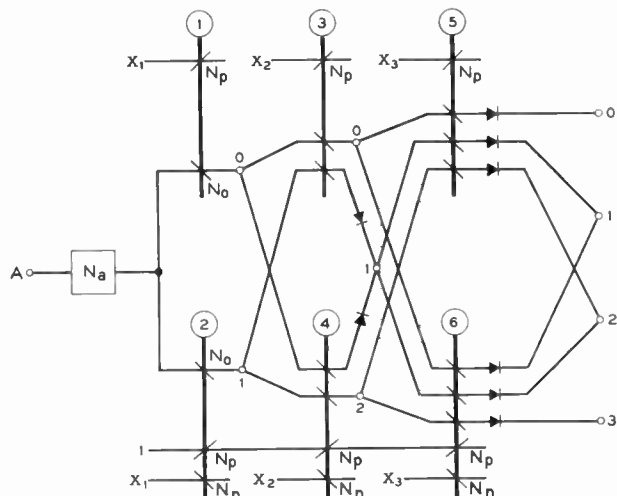

Fig. 15—A three-variable AB-type symmetric switch.

TWO-PHASE SEQUENTIAL CIRCUITS

The nonsequential circuits which have been discussed thus far are characterized by the fact that they begin each cycle of operation in the same initial state. A sequential circuit, on the other hand, may begin a cycle of operation in any of a number of internal states, depending on its past history. Therefore, a sequential circuit must have some memory, even though it may not be primarily a storage circuit.

There are two principal reasons for the very common use of sequential circuits which are not simply stores.

1. It is usually economic and sometimes necessary to provide the inputs to a logical or arithmetic unit sequentially.
2. Many logical or arithmetic functions may be realized in a sequential manner with an enormous saving in equipment.

It is possible to construct sequential circuits of very great complexity. However, the two-phase magnetic sequential circuits with which this section deals can duplicate the functions of any of them. This is simply a case of logical generality achieved with special techniques and special equipment.

The class of two-phase magnetic sequential circuits is characterized by the block diagram in Fig. 16. This consists of two nonsequential circuits which are interconnected so that some of the outputs of each one, called variables of state, act as inputs to the other. It is through these variables of state that past history affects the successive outputs of the circuit. The designations C_α, C_β of the sets of leads in Fig. 16 refer to the

clock phases in which they are active. Any of the input or output leads may be eliminated without changing the sequential nature of the circuit. However, there must be at least one variable of state lead present.

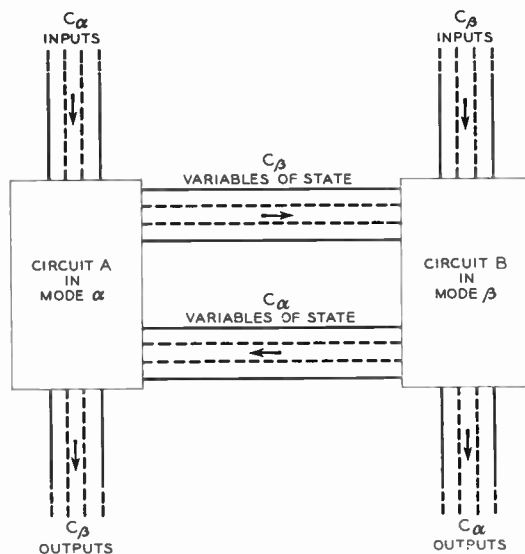

Fig. 16—Block diagram of a two-phase sequential circuit.

In order to obtain the desired sequential circuit action, it is first necessary to bring the circuit into the appropriate initial state. Means for doing this must be provided, although they may vary in form as in the two examples that follow.

Fig. 17 is a complete schematic, except for the output loads, of a four-position AF-type stepping switch. The two nonsequential parts are two-position AF-type switches. The first of these contains cores 1 and 3, and is powered by A_α . The second switch contains cores 2 and 4, and is powered by A_β . In this case the variable of state leads are in series with the output leads and go to output terminals 1, 2, 3, and 4.

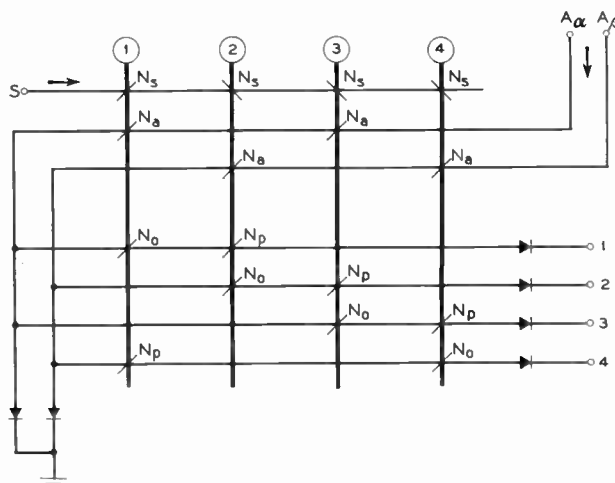

Fig. 17—Schematic of a two-phase AF-type stepping switch.

To begin operation, a pulse is applied at S to switch each core to the correct initial state. This results in core 1 being set and all others reset.

When the first advance pulse, A_α , occurs, core 1 is reset, inducing a forward electromotive force in its output winding N_0 . The advance current flows through this winding to output terminal 1, setting core 2 on the way. Then advance pulse A_β occurs, resetting core 2, flowing to output terminal 2, and setting core 3 on the way. Thus, the application of alternate pulses at A_α , A_β causes output pulses to appear cyclically at outputs 1, 2, 3, and 4. The same scheme may be used to generate a larger even number of outputs.

Note that the number of outputs in a circuit of this type must be a multiple of the number of phases per clock cycle. If three cyclic advance pulses are available, a similar switch may be constructed with $3m$ cores and $3m$ outputs, where m is an integer greater than unity.

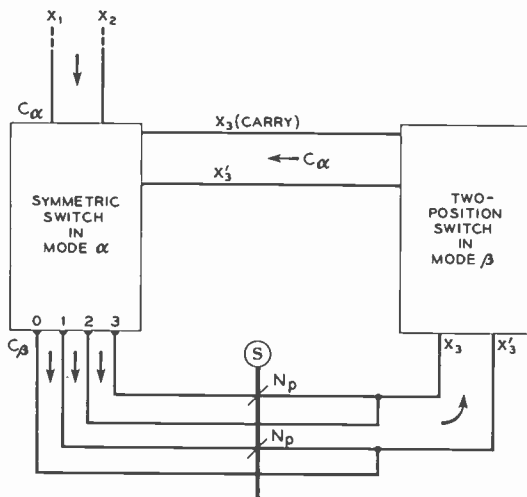

Fig. 18—Block diagram of a two-phase serial binary adder.

Another important sequential circuit is the binary adder illustrated in Fig. 18. The symmetric switch is a circuit like the one in Fig. 15, modified so as to use double-sided inputs for the variable x_3 , which represents the carry digit, and its negation. The two-position switch may be an AB-type circuit like the one in Fig. 8, also modified to use the double-sided inputs x_3 , x_3' . This switch stores the carry output and then feeds it back into the symmetric switch simultaneously with the next pair of input digits x_1 and x_2 . The core s , to which only the inputs are shown, has the binary sum as its setting function. This core may be the initial core in a static magnetic shift register which stores the output digits.

In operation, the adder must always be worked one cycle beyond the last pair of input digits, so that a terminal carry 1 may appear at the output. This action also clears the carry register (i.e., the two-position switch is set to store $x_3 = 0$), putting the adder in its correct initial state. The sequence of input digits begins with the pair of least significant digits, so that the last carry digit is the most significant digit of the sum.

SPECIAL CONSIDERATIONS

The circuits which have been described above are blessed with relative structural simplicity. Nevertheless,

there are a number of difficulties to be faced at the design level. Some of these, and a few possible remedies, will now be considered.

AB-type networks operate best when the advance pulse is terminated just as the switching of the cores is completed. If the pulse ends too soon, the cores will not be completely reset for the next cycle; if it lasts too long, spurious outputs will appear. Because the same advance pulse may pass in series through several circuits, and also because the cores may vary slightly in switching time, the exact adjustment of advance pulse duration for a given circuit may not be practical.

A device for overcoming these difficulties is shown in Fig. 19. The timing core t is always set during ϕ_1 . Then, while the core is being reset during ϕ_2 , the switching voltage induced in its output winding N_0 prevents the advance current from flowing through that winding. The switching time of core t should not exceed that of any of the cores in the network. When core t has been reset, its output winding serves as a shunt for the remaining advance current. The block marked N_a represents series advance windings on core t and each core in the network. Thus, the entire advance pulse flows through these windings and resets the cores completely.

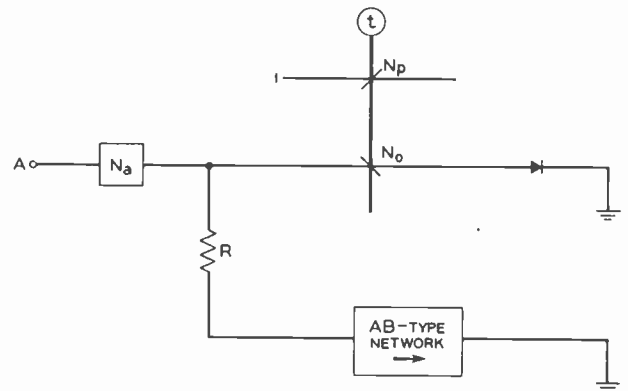

Fig. 19—A pulse timing shunt.

Another problem arises when it is necessary to build a circuit containing many cores. The series connection of advance windings results in a path for the advance pulse which has the properties of an electrical delay line. This effect is particularly noticeable when the advance windings are large, and consequently have high self-inductances, as in AF-type circuits. In such cases, the time interval between current build-ups in the first and last of the series windings may be comparable with the advance pulse duration. The following measures are helpful.

1. Select cores of a type having a Φ_r/Φ_m ratio close to unity.
2. Mount the cores coaxially and thread a common advance winding through them, keeping the area within the winding small.

When the advance current amplitude and the desired switching time are specified, it may be the case that the

necessary number of turns in each advance winding is nonintegral. However, it is possible to use a larger integral number of turns N_a and place a resistive, unidirectional shunt across the series advance windings, as in Fig. 20. With a suitable resistance R , this branch will divert enough of the advance current to increase the switching time to the desired value. The diode is necessary to prevent induced current during ϕ_1 , when some of the cores may be set.

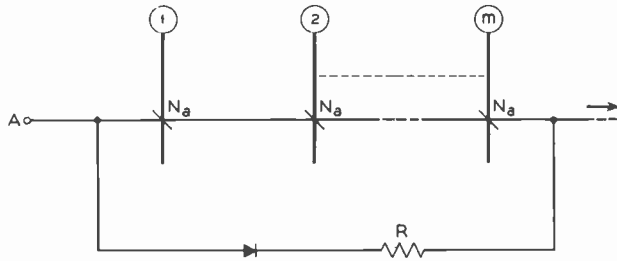

Fig. 20—Resistive shunt for adjustment of the switching time.

The presence of a resistive shunt across the advance windings will often materially improve the performance of a circuit by reducing the effects of shuttle voltages. This is particularly true of AF-type circuits, in which only one core is switched at a time and all the other cores are shuttled. While the shuttle voltages remain comparable in amplitude to the switching voltage, the advance current does not flow through the output winding solely of the selected core, but divides in a number of parallel paths. This results in excessively rapid switching of the selected core during the rise of the advance pulse. However, if a resistive shunt is present across the advance windings, it will tend to limit the voltages developed therein by diverting proportional amounts of advance current.

CONCLUSION

Magnetic core circuits have been described which can perform most of the nonstorage functions of a digital computer. Magnetic shift registers and coincident-current memories are already in common use. Therefore, computers built almost entirely of magnetic core circuits are possible. Operating frequencies exceeding 100 kilocycles per second can be attained.

On the other hand, power dissipation in high speed magnetic core circuits is higher than in comparable transistor-and-diode circuits because of the required switching power. Very little data on life are available, but there is reason to believe that most malfunctions are caused by circuit elements other than the magnetic cores.

An application which has not been stressed, but which may well be worth while, is the use of suitably modified magnetic core circuits in electromechanical systems. One of the special requirements here is a satisfactory way to control relays by means of the core output pulses.

Two other problems seem to merit special consideration. One of these is the use of transistor pulse genera-

tors for driving magnetic core circuits. The other is the development of improved winding and mounting methods for the small toroidal cores.

ACKNOWLEDGMENT

The work reported in this paper was largely inspired by early progress at the Harvard Computation Laboratory toward the same goal. The author is particularly indebted to Professor Howard H. Aiken and to Dr. Robert C. Minnick for a number of stimulating discussions of the Harvard circuits, which have since been published.⁹

Many others have contributed, directly and indirectly, to the success of this investigation. The author is grateful to F. T. Andrews, Jr. for the method of using AB-type networks as shunts, to R. P. Mayer for the mirror symbol notation, and to numerous workers at the Bell Telephone Laboratories and at the Massachusetts Institute of Technology for the benefit of their understanding of the switching process in rectangular loop cores.

BIBLIOGRAPHY

Materials and Pulse Response

- (1) Littmann, M. F., "Ultrathin Magnetic Alloy Tapes with Rectangular Hysteresis Loops." *Electronic Engineering*, Vol. 71 (September, 1952) pp. 792-795.
- (2) Brown, D. R., and Albers-Schoenberg, E., "Ferrites Speed Digital Computers." *Electronics*, Vol. 26 (April, 1953) pp. 146-149.
- (3) Albers-Schoenberg, E., "Ferrites for Microwave Circuits and Digital Computers." *Journal of Applied Physics*, Vol. 25 (February, 1954) pp. 152-154.
- (4) Hegyi, I. J., "Ferromagnetic Spinel with Rectangular Hysteresis Loops." *Journal of Applied Physics*, Vol. 25 (February, 1954) pp. 176-178.
- (5) Sands, E. A., "Behavior of Rectangular Hysteresis Loop Magnetic Materials under Current Pulse Conditions." *PROCEEDINGS OF THE INSTITUTE OF RADIO ENGINEERS*, Vol. 40 (October, 1952) pp. 1246-1250.
- (6) Wylen, J., "Pulse Response Characteristics of Rectangular Hysteresis Loop Ferromagnetic Materials." *Communication and Electronics* (November, 1953) pp. 648-656.
- (7) Van Sant, Jr., O. J., "Considerations for the Selection of Magnetic Core Materials for Digital Computer Elements." *Convention Record of the I.R.E.*, 1954 National Convention, Part 4 (March 22-25, 1954) pp. 109-113.

Shift Registers and Logic Circuits

- (8) Wang, A., and Woo, W. D., "Static Magnetic Storage and Delay Line." *Journal of Applied Physics*, Vol. 21 (January, 1950) pp. 49-54.
- (9) Wang, A., "Magnetic Triggers." *PROCEEDINGS OF THE INSTITUTE OF RADIO ENGINEERS*, Vol. 38 (June, 1950) pp. 626-629.
- (10) Kincaid, M., Alden, J. M., and Hanna, R. B., "Static Magnetic Memory for Low-cost Computers." *Electronics*, Vol. 24 (January, 1951) pp. 108-111.
- (11) Wang, A., "Magnetic Delay Line Storage." *PROCEEDINGS OF THE INSTITUTE OF RADIO ENGINEERS*, Vol. 39 (April, 1951) pp. 401-407.
- (12) Haynes, M. K., "Magnetic Cores as Elements of Digital Computing Systems." Doctor's thesis, Univ. of Illinois; August, 1950.
- (13) Saunders, N. B., "Magnetic Binaries in the Logical Design of Information Handling Machines." *Proceedings of Association of Computing Machinery*, Pittsburgh Meeting (May 2-3, 1952) pp. 223-229.
- (14) Kodis, R. D., Ruhman, S., and Woo, W. D., "Magnetic Shift Register Using One Core Per Bit." *Convention Record of the I.R.E.*, 1953 National Convention, Part 7 (March 23-26, 1953) pp. 38-42.
- (15) Guterman, S., Kodis, R. D., and Ruhman, S., "Circuits to Perform Logical and Control Functions with Magnetic Cores." *Convention Record of the I.R.E.*, 1954 National Convention, Part 4 (March 22-25, 1954) pp. 124-132.
- (16) Minnick, R. C., *The Use of Magnetic Cores as Switching Devices*. Doctor's thesis, Harvard Univ.; April, 1953.

- (17) Minnick, R. C., "Magnetic Switching Circuits." *Journal of Applied Physics*, Vol. 25 (April, 1954) pp. 479-485.
- (18) Goodell, J. D., "Testing Magnetic Decision Elements." *Electronics*, Vol. 27 (January, 1954) pp. 200-203.
- Memory and Access Circuits*
- (19) Papian, W. N., *A Coincident-Current Magnetic Memory Unit*. Master's thesis, Mass. Inst. of Technology; August, 1950.
- (20) Forrester, J. W., "Digital Information Storage in Three Dimensions Using Magnetic Cores." *Journal of Applied Physics*, Vol. 22 (January, 1951) pp. 44-48.
- (21) Goodell, J. D., and Lode T., "Multistable Magnetic Memory Techniques." *Radio-Electronic Engineering*, Vol. 17 (December, 1951) pp. 3-5.
- (22) Papian, W. N., "A Coincident-Current Magnetic Memory Cell for the Storage of Digital Information." PROCEEDINGS OF THE INSTITUTE OF RADIO ENGINEERS, Vol. 40 (April, 1952) pp. 475-478.
- (23) Rajchman, J. A., "Static Magnetic Matrix Memory and Switching Circuits." *R.C.A. Review*, Vol. 13 (June, 1952) pp. 183-201.
- (24) Wang, A., "Static Magnetic Memory—Its Applications to Computers and Controlling Systems." *Proceedings of Association of Computing Machinery*, Pittsburgh Meeting (May 2-3, 1952) pp. 207-212.
- (25) Auerbach, I. L., "A Static Magnetic Memory System for the ENIAC." *Proceedings of Association of Computing Machinery*, Pittsburgh Meeting (May 2-3, 1952) pp. 213-222.
- (26) Haynes, M. K., "Multidimensional Magnetic Memory Selection Systems." *Transactions of the Institute of Radio Engineers, Professional Group on Electronic Computers* (December, 1952) pp. 25-29.
- (27) Rajchman, J. A., "A Myriabit Magnetic Core Matrix Memory." PROCEEDINGS OF THE INSTITUTE OF RADIO ENGINEERS, Vol. 41 (October, 1953) pp. 1407-1421.
- (28) Buck, D. A., and Frank, W. I., "Nondestructive Sensing of Magnetic Cores." *Communication and Electronics* (January, 1954) pp. 822-830.
- (29) Guterma, S., and Kodis, R. D., "Magnetic Core Selection Systems." *Convention Record of the I.R.E.*, 1954 National Convention, Part 4 (March 22-25, 1954) pp. 116-123.
- Physics of Flux Reversal*
- (30) Galt, J. K., Andrus, J., and Hopper, H. G., "Motion of Domain Walls in Ferrite Crystals." *Review of Modern Physics*, Vol. 25 (January, 1953) pp. 93-97.
- (31) Menyuk, N., and Goodenough, J. B., "Magnetic Materials for Digital Computer Components. I. A Theory of Flux Reversal in Polycrystalline Ferromagnetics." *Journal of Applied Physics*, Vol. 26 (January, 1955) pp. 8-18.

The Diurnal Carrier-Phase Variation of a 16-Kilocycle Transatlantic Signal*

J. A. PIERCE†, FELLOW, IRE

Summary—The diurnal variation of the time of arrival of a 16-kilocycle signal traversing a transatlantic path has been found to be about 40 microseconds. This variation is presumably caused by a day-to-night change in the equivalent height of reflection of 10 to 12 kilometers, and appears to be very predictable.

The great phase stability of very low frequency transmission permits intercontinental frequency comparison to a precision of at least 1 part in 10^{10} .

Variations of the frequency of the arriving signal are apparently always less than ± 3 parts in 10^9 ; a figure to be compared with estimates of the order of ± 2 parts in 10^7 for high-frequency transmission. With such stability of propagation, extremely narrow receiving bandwidths are attainable. These bandwidths, in turn, make possible highly reliable networking of frequencies for communication station allocation and for navigational purposes.

INTRODUCTION

VARIATIONS in the time of transmission of a received signal can be measured if the transmitter is controlled by a stable oscillator and the signal is observed in terms of another stable oscillator. The relative phase as a function of time depends upon the properties of the transmission medium and upon the relative frequencies and rates of change of frequency of the two oscillators. Other minor variables, such as thermal effects upon tuned circuits, can usually be neglected or minimized.

Measurements of this kind have been made by several observers, but usually only to the precision required, for instance, to delineate the various modes of propagation of a pulsed signal. In that case, relative variations of various components can be measured easily but the time variation of a reference component is usually un-

known. The measurements described in this paper constitute a successful attempt to extract the diurnal variation of the resultant phase of a vlf carrier. This variation is only a few tens of microseconds so that the frequency stability required is of the order of a part in 10^9 over intervals of at least a day. It will be shown, I believe, that in retrospect the characteristics of a "good" oscillator can be determined to at least a part in 10^{10} for intervals of a day or two.

Unfortunately, oscillator frequency vagaries are frequently of a magnitude greater than the transmission effect we are searching for. Thus careful study of oscillator behavior and a share of good luck are required. Any discontinuity in oscillator operation produces a frequency discontinuity and further usually initiates a period of days or weeks of unstable behavior. Thus some discussion of oscillator performance is desirable.

CRYSTAL OSCILLATOR BEHAVIOR

A typical characteristic of a "good" crystal oscillator is an aging rate of the order of a part in 10^9 per day. That is, the frequency generated is about a part in 10^9 higher each day than the day before. A few oscillators¹ have rates of change of frequency an order of magnitude less than this figure, but they are not generally available and can be excluded from this discussion with the remark that it would be good to have one. It will be noted that in the vlf case the aging rate is of the same order as the required precision of frequency. Hence the rate of change of frequency must be considered carefully. For reasons to be shown presently, it will be well to examine the typical life history of a crystal oscillator. The magnitudes of the numbers to be adduced are those appropriate to the Western Electric D-175730 Frequency

¹ Compare H. T. Mitchell, "Aging of quartz crystal vibrators," *Nature*, vol. 174, pp. 41-42; July 3, 1954.

* Original manuscript received by the IRE, October 18, 1954; revised manuscript received, February 7, 1955. The research reported in this document was made possible through support extended Cruft Laboratory, Harvard University, jointly by the Navy Department (Office of Naval Research), the Signal Corps of the U.S. Army, and the U.S. Air Force, under ONR Contract N5ori-76, T.O. 45.

† Cruft Laboratory, Harvard University, Cambridge, Mass.

Standard (also known as Navy RF Oscillator 0-76/U), although the behavior is common to all good crystal oscillators.

When new, an oscillator ages rapidly, the frequency increasing some 20 to 50 parts in 10^9 per day. This rate drops quickly at first and then more slowly; the rate itself being approximately an equilateral hyperbola with the origin at a time shortly before the oscillator was first used. In the case of one of my oscillators the rate was

$$\frac{1063 \text{ parts in } 10^9}{\text{Days of operation} + 47 \text{ days}}$$

The frequency variation that accompanies such an aging rate is often best expressed in terms of the dial setting that will produce a desired constant frequency. This relation has of course a logarithmic form.² For the same oscillator dial setting (in parts in 10^9) was found to be

$$6091 - 1063 \log_e (\text{Days of operation} + 47 \text{ days}).$$

After operation for two or three years, aging tends to approach a linear rate, the magnitude of which is an inverse function of excellence of the oscillator. The reason for continued linear increase in frequency I do not know.

In this part of the lifetime of an oscillator its rate may be predicted with good success except for two effects. The most serious limit is set by the fact that sooner or later something always goes wrong with the oscillator temperature control. The second effect is essentially noise; random variations in rate or frequency the cause of which cannot be assigned.

Two temperature effects are shown in Fig. 1 where the frequency variation of an oscillator is shown over a period of 100 days. In this case the previous history of

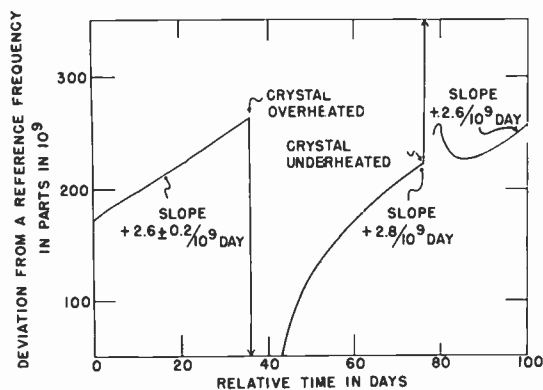

Fig. 1.—Examples of the effects of temperature discontinuities on the frequency of a crystal oscillator.

the oscillator had been unfortunate, resulting in an aging rate somewhat higher than normal. The minor fluctuations on the first part of the curve are indicated by the uncertainty figure. At about day 36 the crystal oven's thermostat failed and the oven was overheated for about two days. After the temperature had been re-

² Compare J. M. Shaull and J. H. Shoaf, "Precision quartz resonator frequency standards," *PROC. I.R.E.*, vol. 42, pp. 1300-1306; August, 1954.

stored to normal the frequency was found to be several hundred parts in 10^9 lower than it had been; thereafter it returned toward "normal" in a way reminiscent of the early part of the oscillator's history but with a much shorter time constant. So far as I know, the effect of overheating is always to set the oscillator back to repeat (more rapidly) some of its earlier history.

A "negative overheating," as shown to the right of day 76 in Fig. 1, is much less drastic in its effects but it may be equally long (some two or three months) before its effects have completely subsided. This is a kind of variation to which I shall need to refer presently.

If an oscillator is behaving well, its aging rate can be predicted to a fraction of a part in 10^9 per day for a few days in advance. Advantage may be taken of this fact to compensate the aging. A simple and adequate way is to use a synchronous motor and a set of change gears to rotate the oscillator dial at the proper rate to keep the output frequency constant with respect to a reference oscillator. I use change gears with a total of some 200 teeth and a gear train such that I can obtain rates from about 0.4 to 10 parts in 10^9 per day, with a possible adjustment to within one or two per cent of a desired rate.

LOW-FREQUENCY DATA

I cannot begin this section without pausing to express great appreciation to Dr. L. Essen of the (British) National Physical Laboratory and to Mr. H. T. Mitchell of the (British) Post Office Engineering Department. In February, 1950, the Post Office provided at its Rugby Radio Station a 100-kilocycle frequency standard of the highest grade³ in order to transmit the standard frequency service of the National Physical Laboratory on 2.5, 5, and 10 megacycles and on 60 kilocycles. Dr. Essen's great interest in the frequency measuring aspects⁴ of this work stimulated Mr. Mitchell to arrange that, from June, 1954, the 16-kilocycle carrier frequency of GBR, the high-power telegraph transmitter at Rugby, is derived from the same oscillator as that used for the standard frequency transmissions. It is the reception of the signal from GBR at Cambridge, Massachusetts, at a distance of 5,180 km that forms the subject of this paper.

Records have been made by using the incoming carrier frequency to modulate the intensity grid of an oscilloscope. The linear sweep is triggered at 200 cps, a sub-multiple of 16,000 (and 60,000) cycles that is derived from a local crystal oscillator. The pattern is photographed on a photo-sensitized paper moving slowly across the optical image of the oscilloscope trace. As shown in Figs. 2 and 3 (next page) the length of the sweep is 61 μ sec, or a little less than one period of 16 kc.

³ H. B. Law, "Standard Frequency Transmission Equipment at Rugby Radio Station," *I.E.E. Paper No. 1762*, in press. Read November 10, 1954.

⁴ J. A. Pierce, H. T. Mitchell, and L. Essen, "World-wide frequency and time comparisons by means of radio transmissions," *Nature*, vol. 174, p. 922; November 13, 1954.

Fig. 2 shows the daytime hours on a date when the local oscillator was in unusually good frequency agreement with the incoming signal. The dark band at the top of the record is the positive-going part of a 16 kc carrier cycle. The scales are such that a diagonal of Fig. 2 (61 μ sec in 12 hours) would correspond to a frequency difference of about 1.4 parts in 10^9 . During the time of full daylight on the whole path, from about 06^h to 14^h, the slope of the light-dark boundary is slightly less than $-1/10^{10}$. The blurring at the edge of the band is caused by phase fluctuations, amplitude changes, and noise. The edge is determinate to at least $\pm 2 \mu$ sec. or about 10 degrees of phase.

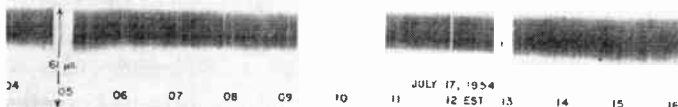

Fig. 2—A daytime record of the received carrier phase of a transatlantic signal. Between 09^h.3 and 10^h.5 EST the record shows MSF at 60 kc. At other times the single light and dark horizontal bands show GBR at 16 kc.

From 09^h.2 to 10^h.8, the recording oscilloscope was switched to a 60 kc receiver to observe the 1-hour transmission and MSF, the Rugby standard frequency station, shown by four cycles on the record. The GBR transmission was interrupted briefly at about 05^h and 13^h EST.

In contrast to the very straight daytime pattern of Fig. 2, Fig. 3 shows the continuation of the record at night. The phase shift (or increase in transmission time) during the night is clearly shown. It should be noted that by 04^h July 18 the local oscillator had run off in phase so that the negative slope then is considerably greater than at the same time on July 17 (Fig. 2).

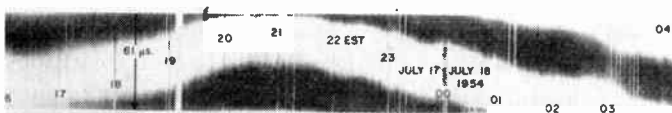

Fig. 3—The nighttime record of GBR immediately following Fig. 2. The increase in transmission time has a maximum near 21^h EST.

Two propagational points are worth noting in Fig. 3. Perhaps the most conspicuous is the sunrise dip in field intensity, shown by the narrowing of the dark band just after 03^h EST. More interesting is the indication of a three-hop transmission mode in the step-wise fall in transmission time in the morning as the sun's rays reach the various reflection points. These steps may be seen between 23 and 23 $\frac{1}{2}$, 01 and 01 $\frac{1}{2}$, and 03 and 03 $\frac{1}{2}$ hours EST. It will be shown later that these times are reasonable.

A fourth fluctuation, at about 22 hours, on July 16, appears to be an example of a phase vagary that occurs at random times at night. Further evidence may indicate that it is associated with the diurnal phenomena, although its probability of occurrence is low.

EVALUATION OF THE DIURNAL VARIATION

We must now examine in greater detail the effect of the oscillator aging rate upon the form of the records.

Suppose, for example, that the transmitter operates at the reference frequency and that the local oscillator at the receiver is correct at time zero but ages faster than the reference by 1 part in 10^9 per day. Then the frequency, or the rate of change of phase, will be 1 part high at the end of one day, 2 parts at the end of two days and so on. In a phase diagram (like Figs. 2 and 3) the slope at the end of one day will be $+86.4 \mu$ sec/day and the displacement from the original phase will be $+43.2 \mu$ sec. After two days the rate will be $+172.8 \mu$ sec/day and the displacement will be $+172.8 \mu$ sec. Thus the recorded phase (neglecting diurnal variations) takes the form of a parabola with its vertex at the time when the two frequencies are in exact agreement. If the local oscillator at the receiver has the greater aging rate the parabola will be concave upwards.

The records reproduced in Figs. 2 and 3 are a part of a continuous record of 48 hours' duration, except for the time lost during the reception of MSF at 10 A.M. EST. The phase of the light-dark boundary relative to the local oscillator (or to the edge of the record) is plotted in Fig. 4. The "phase" is taken in microseconds

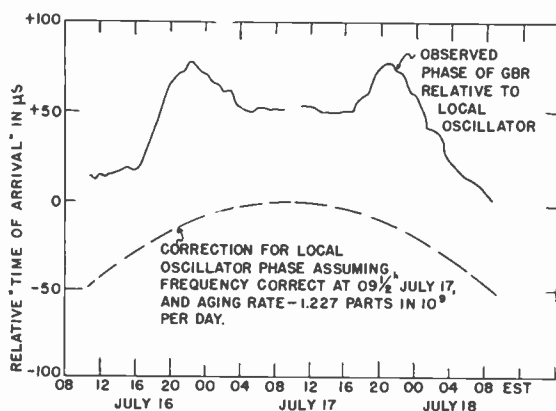

Fig. 4—The relative phase variation of GBR over a period of nearly 48 hours. The lower curve gives the presumed phase variation of the GBR frequency source relative to the local oscillator.

because the apparent time of arrival is of primary interest. On the same figure is an assumed curve for the phase variations of the local oscillator, obtained by fitting the best parabola to the daytime parts of the GBR curve. This procedure is justified by the extreme consistency of the daytime transmission, as shown in Fig. 2. The fact that the parabola is concave downward will be explained below.

The diurnal variation of Fig. 5 (facing page) was obtained by subtracting the parabolic curve of Fig. 4 from the observed curve and reducing the difference to deviations from the arithmetic mean. It will be seen that the agreement between the two dates is good, except that the daytime part on July 16 seems to have been controlled by a somewhat different oscillator law. The tendency to fall in three steps through the sunrise period, noted above, will be seen here.

Lines are shown in Fig. 5 giving the times of ground-level sunrise and sunset at both ends of the transmission path. The evening rise begins some half an hour after Rugby sunset and ends about an hour and a half after

sunset at Cambridge. In the morning the total drop begins and ends about a half an hour before the two sunrise times. These times seem entirely reasonable.

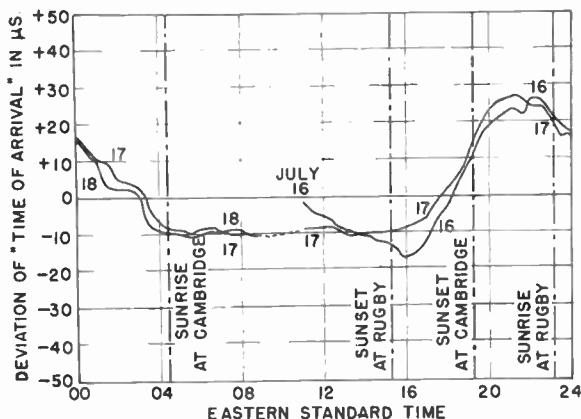

Fig. 5—The diurnal variation of the GBR transmission time, reduced from Fig. 4. The difference in behavior on July 16 and 17, in the interval between 11^h and 18^h EST, is probably caused by an oscillator anomaly.

Fig. 6 gives another example of recorded data about six weeks later. In this case the aging rate was more nearly correctly compensated, as shown by the smaller curvature of the parabola, but the time when the oscillator was at GBR's frequency was somewhat before the

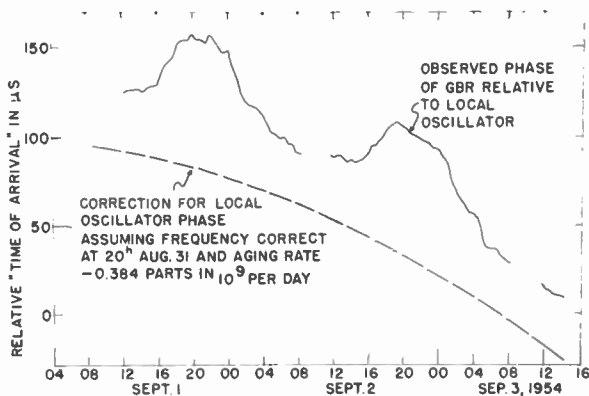

Fig. 6—Another example of the relative GBR phase, and of the presumed relative phase of the source, similar to Fig. 4.

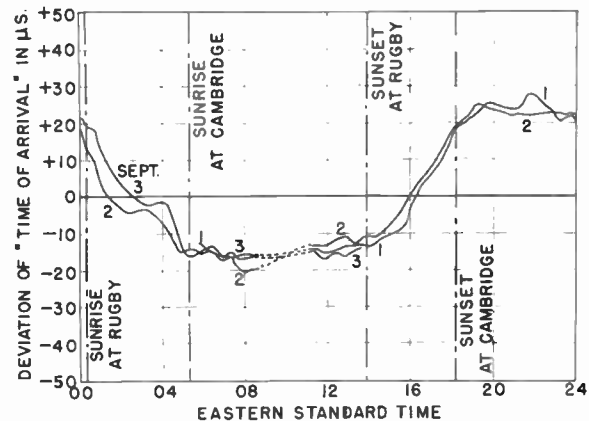

Fig. 7—The diurnal variations of GBR's transmission time for Sept. 1 to 3, 1954. Note that the anomaly of Fig. 5 is not present here.

record began. Fig. 7 is superficially similar to Fig. 5, except that the diurnal range is a little greater (possibly a seasonal effect?) and that the length of the day is

about two hours less. The times at which the major variations begin and end are clearly controlled by the rising and setting of the sun. Fig. 7 thus certainly shows true diurnal variations in the transmission time, or at least of the phase of the arriving signal. It should be noted that the anomaly in the afternoon of July 16 (in Fig. 5) has not been repeated here.

SUPPORTING DATA ON OSCILLATOR BEHAVIOR

About a week before taking the first of the records described above, the oscillator controlling the oscilloscope timing was placed in a new and better environment. This involved cooling the crystal oven and caused an aging anomaly of the kind shown at the right of Fig. 1. The aging of the oscillator since this change is shown in Fig. 8. In this case the ordinate is the dial setting at which the frequency would have been in exact agreement with the signal from MSF at 10 A.M. That is, each day's actual setting has been modified by the slope of the MSF record which, as can be seen from Fig. 2, can be scaled to 1 or 2 parts in 10¹⁰. The curve is inverted as compared with Fig. 1. As in that figure, the overshoot in dial setting and the subsequent falling faster and faster can be recognized.

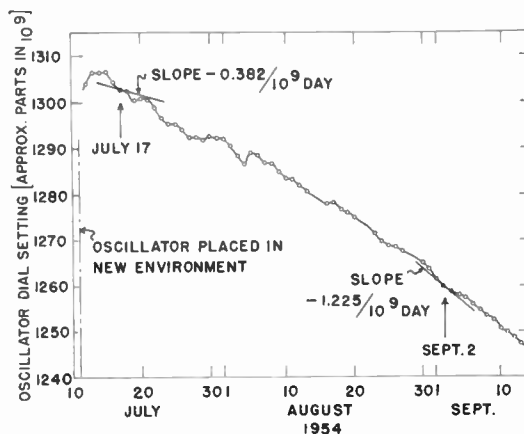

Fig. 8—History of the Cambridge oscillator relative to the MSF daily transmissions at 60 kc. Note that slopes derived from the parabolas of Figs. 4 and 6 are in approximate agreement with the curve for July 17 to 18 and Sept. 1 to 3, but not for July 16 to 17.

The minor irregularities might be taken for variations in propagation of the MSF signal or errors in measurement. After much study, however, I believe that the individual points are accurate to at least a few parts in 10¹⁰; therefore most of the irregularities are actual frequency vagaries of one or both oscillators involved.

For some time before moving the oscillator, the aging compensation had been set at a value of -1.609 parts in 10⁹ per day. After moving, it was recognized that determination of a new rate would take a month or two. The compensation was, in fact, not changed until early September, the frequency having been kept in approximate adjustment by occasional manual changes. It is this "overestimate" of the aging compensation that inverts the parabolas of Figs. 4 and 6. Now it happens that the record of July 16-18 was taken when the actual aging was small because of the recent interruption. For

September 1–3 the actual rate was about what appears to be the “final” one. The vertical arrows in Fig. 8 indicate the central dates for the records of Figs 4 and 6. Above each of them I have drawn a segment of a line at a slope equal to the difference between the aging compensation ($-1.609/10^9$ day) and the constants of the parabolas of Figs. 4 and 6. The agreement of the slope of each line segment with the slope of the curve indicates the general accuracy of the parabolic assumption. It is perhaps worth noting that on July 16 the curve did depart from the assumed slope, thus justifying the distrust I expressed in the afternoon values for July 16, shown in Fig. 5. The agreement for September 1–3 indicates that considerable confidence can be placed in the diurnal variation of Fig. 7.

CONCLUSIONS

Radio Wave Propagation

The diurnal variation in the apparent arrival time of a transatlantic 16 kc signal has a double amplitude of some 35–40 μ s. If we presume that the resultant phase is dominated by a three-hop mode, the variation corresponds to an apparent day-to-night increase in the equivalent height of reflection of some 10 to 12 kilometers. This experiment teaches us nothing about the absolute value of these heights. Even the apparent variation must be considered with some reserve, as phase interference effects between a third- and a fourth-hop mode may make the resultant phase vary either more or less than that of the third-hop alone. Calculations too intricate to be worth reproducing here indicate that, at 16 kc, a 40 μ s diurnal range might be produced by a change in virtual height of reflection as small as 4 or 5 km, or as large as 16 or 18 km. A tendency in the direction of the larger numbers seems somewhat more probable. Experiments at two or more frequencies may be expected to resolve this question, and to give a fairly complete solution to the height problem.

Aside from these details. I have demonstrated, I hope, that the simple mechanism discussed here can yield information of hitherto unrevealed precision. The technique is applicable to any frequency, except that direct carrier-phase observation becomes uncertain at high frequencies. I have used it with good effect at high frequencies by recording the modulation envelope of a pulse.

Standard Frequency Transmission

The various doppler and phase interference effects at very low frequencies are extremely small compared to those at high frequencies. For example, the short-term precision of WWV's signals is usually⁵ assessed as about $\pm 2/10^7$. The transmission mechanism at vlf appears to have an accuracy of $\pm 3/10^9$ at all times and in the daytime gives measurements to $1/10^9$ in a few minutes.⁴ Integration over several daytime hours, or preferably from day to day, yields measurements to $1/10^{10}$. This is

⁵ L. Essen, “Standard frequency transmissions,” *Proc. IEE*, Part III, vol. 101, pp. 249–255; July, 1954, is an example.

best shown by examining the three daytime traces in Fig. 7, remembering that 1 part in 10^{10} is equal to 8.64 μ s in 24 hours. The low-frequency transmission mechanism is considerably more constant when integrated over a few minutes or more, than the rotation period of the earth itself.² This raises some real problems in the definition of time and frequency, but that does not limit the precision to which measurements can be made in terms of an agreed reference.

Aids to Navigation

The radio navigational problem is basically one of measuring the phase of some interference pattern fixed in space. Such measurements in a timing system must be made to 10 microseconds or less for each mile of error that can be tolerated. Thus, for a long-distance aid to navigation, the stability of propagation may easily make the difference between interesting and uninteresting accuracies. At vlf this paper shows, as has previously been hoped but not demonstrated, that (when sufficient data have been taken) the transmission time of a signal can probably be predicted to a precision of 5 to 10 μ s. Thus it is possible to say that we can eventually—after solution of some delicate technical and economic problems—have a position fixing system with a range of several thousand miles and an accuracy of about a mile.

New Techniques

The utility of frequency standardization is obvious, but some possibilities have not often been discussed. Chief among these is the axiomatic notion that the minimum useful bandwidth of a filter is proportional to the precision with which frequency is known. At low radio frequencies, for example, a receiver with a noise bandwidth of less than a thousandth of a cycle is possible. With such techniques for extraction of a weak signal frequency comparison, navigational aids, or other narrow-band services, can function at surprising distances with moderate transmitted power and with exceptional spectral economy. For example, I have measured the relative frequency, or changes in phase, of MSF at 60 kc in spite of the interference from a stronger signal at 60.000001 kc.

Requirements for frequency allocation will become more stringent and the possibilities of coherent detection will be exploited more and more. Certainly the more we can predict about the characteristics of a signal the easier it is to decipher it. For these and similar purposes it seems to me very possible that slave oscillators locked to a vlf standard may presently be found cheaper and more reliable than individual high-grade crystal oscillators. Consideration of bandwidth and noise factors leads me to suggest that a single international frequency standard at 10 kilocycles would be of exceptional world-wide utility. I shall not be surprised to find, if I live to a normal retirement age, that most major radio transmissions will operate at frequencies derived directly from that of some such standard.

Parallel-Network Oscillators*

J. L. STEWART†, MEMBER, IRE

Summary—A parallel-network oscillator is a two-path oscillator with the gains of the two paths varied symmetrically about a mean value by means of control voltages. The result is a wide-range, electrically tunable, low-level oscillator. Design fundamentals and considerations relating to different types of such oscillators are discussed and analyses made of the two principal types. The tuning ratio of one of the types is limited to about two-to-one and that of the other is limited to a frequency coverage rather than any specific tuning ratio—up to about half the gain-bandwidth product of the tubes employed. The amplitude of oscillations is relatively constant over the major portion of the tuning characteristics. Stability, waveform, and noise are also discussed. Two examples are given, one of which makes use of a single twin-triode tube without amplitude stabilization which covers a range of about 15 to 24 mc. The second example uses four pentodes and covers a range of about 15 to 43.5 mc. Finally, some of the future possibilities of parallel-network oscillators are mentioned.

INTRODUCTION

MANY TECHNIQUES are available for realizing wide-range electrical tuning of low-level oscillators below microwave frequencies. The most important of these (where devices employing special tubes are not considered) are (1) reactance-tube tuning, (2) resistance tuning, (3) ferrite tuning, (4) pulse-circuit tuning, and (5) parallel-network tuning.

The main limitation of reactance-tube tuning is the small tuning range normally obtainable. Resistance tuning (e.g., crystal diodes or variable triode plate resistance) is most effective in rc oscillators at frequencies below a few mc (limited upper frequency) but does not favor constancy of output without special measures of amplitude control. Tuning with either ferroelectric or ferromagnetic materials can yield a large tuning range but suffers from annoying hysteresis and temperature effects. Pulse-circuit tuning (e.g., multivibrators) is limited to the lower frequencies.

Parallel-network tuning has few of the disadvantages enumerated above. Unlike most devices, the tuning range is not dependent upon components but is ultimately limited by the gain-bandwidth product of the tubes employed. Thus, for one type of oscillator, very large tuning ratios can be achieved at the lower frequencies with ratios decreasing as the center frequency increases; in the limit, the megacycle tuning range is a constant not dependent upon the center frequency which allows (in principle) the range 1 cps to 20 mc to be covered as easily as the range 20 mc to 40 mc. Another type of parallel-network oscillator has a tuning ratio limited to about two-to-one which makes the range 500 cps to 1,000 cps as difficult to cover as the range 30 mc to 60 mc.

* Original manuscript received by the IRE, October 11, 1954; revised manuscript received, Jan. 17, 1955. This work was sponsored by the Signal Corps, Department of the Army.

† Dept. of Elec. Engrg., University of Michigan, Ann Arbor, Michigan.

DESCRIPTION OF OPERATION

A parallel-tuned system is one having two signal paths with the outputs of these two paths combined and fed back to a common input. Similar systems using several signal paths are also possible; however, they do not appear as practical as systems having only two paths and are not considered further. Tuning is accomplished by varying the relative gains of the two signal paths.¹

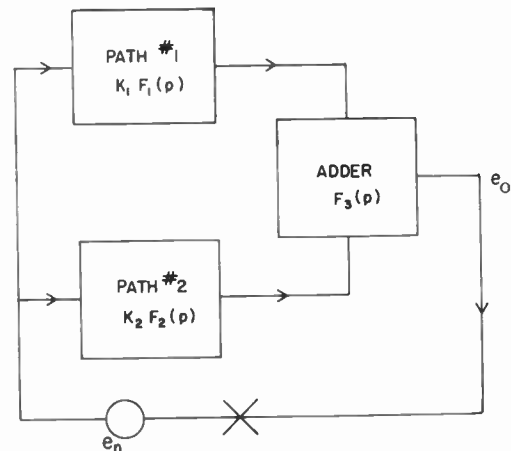

Fig. 1—Block diagram of the general parallel-network oscillator.

The basic block diagram is shown in Fig. 1. Let a small test signal voltage be added in the feedback path and let the feedback path be opened at point *x* as described in Fig. 1. Then, the open-loop transfer function becomes

$$\frac{e_o}{e_n} = [K_1 F_1(p) + K_2 F_2(p)] F_3(p), \quad (1)$$

in which $p = j\omega$. Let the relative gains of the two channels be varied symmetrically about the mean gain K_0 as

$$K_1 = K_0(1 + k) \quad K_2 = K_0(1 - k) \quad (2)$$

where $|k| \leq 1$ and where k may be either positive or negative. Then,

$$\begin{aligned} \frac{e_o}{e_n} &= K_0 [(1 + k)F_1(p) + (1 - k)F_2(p)] F_3(p) \\ &= K_0 \{ [F_1(p) + F_2(p)] + k[F_1(p) - F_2(p)] \} F_3(p). \end{aligned} \quad (3)$$

Oscillation will take place at a frequency where the phase shift of the open-loop function is a multiple of 360 degrees, providing that the open-loop gain at that frequency is greater than unity. Clearly, varying k will

¹ F. B. Anderson, "Seven-league oscillator," *PROC. I.R.E.*, vol. 39, pp. 881-890; August, 1951. The two-path oscillator described by Anderson adjusts the path gains mechanically by means of a ganged potentiometer.

have a profound effect in determining the oscillation frequency if F_1 and F_2 and to a lesser extent F_3 are suitable functions. Also, it is possible by careful selection of networks to make the magnitude of e_0/e_n fairly constant with k , in which case the amplitude of oscillations will be fairly constant with frequency. For obvious reasons [which are represented by the negative sign in (3)], F_1 and F_2 must be considerably different functions of frequency if tuning is to be achieved.

Often, a nonconstant function F_3 is something forced upon one as a practical necessity. Although its existence may sometimes be used to advantage in making the output amplitude more constant with frequency, it usually reduces the tuning range as compared to that when F_3 is constant.

A qualitative understanding of the behavior of parallel-network oscillators can be had by considering the first part of (3). Two cases exist depending upon whether K_0 is positive or negative (which usually depends upon the number of grounded-cathode tubes in the two signal paths and in the adder). For simplicity, it will be assumed that $F_3=1$. Then, for K_0 positive, the weighted sum of F_1 and F_2 must always have a phase angle of zero. This means that the phase shift of F_1 must always be lagging and that of F_2 always leading (or conversely). Thus, at all oscillation frequencies,

$$\begin{aligned} 0 < \text{Arg } F_1(p) < +90^\circ \\ 0 > \text{Arg } F_2(p) > -90^\circ. \end{aligned} \quad (4)$$

The weighted vector sum of F_1 and F_2 will have a phase angle of zero at some unique frequency. Changing the weighting by changing the value of k will result in the weighted sum having a phase angle of zero at some different frequency. Clearly, if the angle of F_1 increases with frequency, that of F_2 should also increase.

If F_1 is a lead network and F_2 a lag network, proper operation can be achieved. If the tuning characteristic is to be symmetric, the rate of phase angle change with frequency from these two networks must be approximately the same and both must be effective over the entire tuning range. Further, if a constant output is desired, the magnitude of the weighted sum must be constant. This type of oscillator is similar to a bridge oscillator although operation is not dependent upon a null effect.

The general types of networks useful with parallel-network oscillators for K_0 positive are of some interest. The lag network in its most elementary form is a simple rc network. An almost equally simple lag network is a parallel resonant circuit operating above its resonant frequency. One would not use a more complicated type of lag network (at other than low frequencies) if a large tuning ratio were desired because a 90-degree phase angle change would then occur over too small a frequency range. A lead network at low frequencies can most easily be constructed as an rc coupling-type circuit. At higher frequencies, one is limited to some resonant type of circuit, for example, a parallel resonant circuit operating below its resonant frequency.

The second type of parallel-network oscillator is given for K_0 negative. Then, the weighted sum of F_1 and F_2 (assuming $F_3=1$) must have a phase angle of 180 degrees at the oscillation frequency. This requires

$$\begin{aligned} 90^\circ < \text{Arg } F_1(p) < 180^\circ \\ 180^\circ < \text{Arg } F_2(p) < 270^\circ. \end{aligned} \quad (5)$$

As the phase angle of F_1 increases from 90 to 180 degrees, that of F_2 should increase from 180 to 270 degrees. In this case, both F_1 and F_2 must be furnished by lag networks (or both by lead networks). However, because these lag networks must furnish a relatively large phase shift, they must take the form of multi-section filters. In essence, this contracts the ratio of frequencies, over which a 90-degree phase change can take place, to something on the order of a two-to-one ratio.

It should also be pointed out that lag networks can be used for F_1 and F_2 for oscillators with K_0 positive much as they can for K_0 negative. Then, there is really little difference between the two types. For example, if F_1 furnishes a phase shift between 270 and 360 degrees and F_2 a phase shift between 360 and 450 degrees, the behavior of the two signals will be similar to that when F_1 is a simple lag network and F_2 a simple lead network. However, such oscillators require the use of rather complicated phase-shift networks and will have relatively small tuning ranges because phase angles change so rapidly with frequency.

The third class of parallel-network oscillators is a mixed class where one takes the weighted difference between F_1 and F_2 rather than the weighted sum. This would occur, for example, if a subtractor were used rather than an adder or if an extra grounded-cathode tube occurred in one of the two signal paths. The open-loop transfer function would then be the same as (1) except that a negative sign rather than a positive sign would precede the term $K_2 F_2(p)$. Two different oscillator arrangements result from this mixed class depending upon whether K_0 is positive or negative. In the interests of economy, the mixed class will not be discussed. In any event, it appears difficult to find networks to use for the functions F_1 and F_2 such that the rates of change of phase with frequency for the two networks are comparable. The tuning range for such oscillators would therefore appear to be limited to something between that obtainable with the first two types discussed.

Four types of parallel-network oscillators have been discussed, two types resulting from weighted addition of the signals at the outputs from the two signal paths, two from weighted subtraction of these two signals. The following analyses and examples, being idealized, are necessarily concerned only with types using addition.

ANALYSES OF AN OSCILLATOR EMPLOYING IDEAL TRANSMISSION LINES

One can generalize oscillators having K_0 negative as those employing some type of rc or lc transmission line or an actual transmission line as a fundamental circuit

element. Ideally, these lines provide constant delay with frequency and have flat gain characteristics. Practically, they are built with lumped elements or with transmission line segments associated with shunting capacitances and other lumped elements. In order to study the idealized system, it will be assumed that the delays of the functions F_1 and F_2 are constants according to

$$F_1(p) = \exp(-pT) \quad F_2(p) = \exp(-paT) \quad F_3(p) = 1. \quad (6)$$

Then, (3) becomes

$$\frac{e_o}{e_n} = K_0[(1+k)\exp(-pT) + (1-k)\exp(-paT)]. \quad (7)$$

Using $p = j\omega$ and combining real and imaginary parts,

$$\begin{aligned} \frac{e_o}{e_n} &= K_0[(1+k)\cos\omega T + (1-k)\cos a\omega T] \\ &\quad - jK_0[(1+k)\sin\omega T + (1-k)\sin a\omega T]. \quad (8) \end{aligned}$$

The frequency of oscillation is such as to cause the imaginary part of (8) to be zero. This frequency is defined by

$$(1+k)\sin\omega T + (1-k)\sin a\omega T = 0. \quad (9)$$

Of course, the open-loop gain at the oscillation frequency must be greater than unity.

$$|K_0(1+k)\cos\omega T + (1-k)\cos a\omega T| > 1 \quad (10)$$

The limits of oscillation take place at frequencies ω_1 and ω_2 where $k = \pm 1$. The center frequency ω_m is given when $k = 0$. Thus,

$$\begin{aligned} \sin\omega_2 T &= 0 \quad \text{at } k = +1 \\ \sin a\omega_1 T &= 0 \quad \text{at } k = -1 \\ \sin\omega_m T + \sin a\omega_m T &= 0 \quad \text{at } k = 0. \quad (11) \end{aligned}$$

If we assume the special case where oscillation takes place at the lowest possible frequency, then $\omega_1 = \pi/aT$, $\omega_2 = \pi/T$, and $\omega_m = 2\omega_1\omega_2/(\omega_1 + \omega_2)$. Continuing with this most important case, the question of the magnitude of e_o/e_n becomes of interest. At the extreme oscillation frequencies ω_1 and ω_2 , the cosine function is unity and the magnitude of e_o/e_n is $2K_0$. At the center frequency, it is

$$K_0 \left[\cos \frac{2\pi}{a+1} + \cos \frac{2a\pi}{a+1} \right], \quad (12)$$

which will be less than $2K_0$ except for the trivial case of $a = 1$ which yields a tuning range of zero. For $a = 2$, the gain magnitude at the center frequency is $\sqrt{3}K_0$ and the tuning ratio is two to one. For $a = 3$, the gain magnitude falls to zero and oscillation would cease at the center frequency. Therefore, this type of parallel-network oscillator is not suited for tuning ratios larger than three-to-one and more practically about two-to-one. It should be especially noted that for $a = 2$, the open-loop gain varies only by a factor of $\sqrt{3}$ to 2 over the entire tuning range and for $a < 2$, the variation is even less. Therefore, if the tuning ratio is equal to or less than two-

to-one, the amplitude of oscillations will be relatively constant with frequency.

Practically, it is difficult to construct an adding device having a transfer function of unity. If $F_3(p) = \exp(-bp)$ instead of unity, the preceding relations become somewhat modified. The main effect is a slight reduction in the tuning range if b is somewhat smaller than T . If b and T are comparable, the tuning range will be approximately halved compared to that when $b = 0$. The open-loop gain magnitude as a function of frequency is not affected when F_3 is the exponential function. If F_3 is made a bandpass function, oscillation amplitude can be made virtually constant with frequency although a price must be paid in the form of a reduced tuning range.

There exist innumerable variations of this type of parallel-network oscillator, only a few of which can be mentioned here. If F_1 and F_2 are derived from artificial transmission lines (either rc or lc), the delays as functions of frequency will not be constant nor will the magnitudes. This imposes calculation difficulties although the basic behavior is little different from that discussed in connection with the idealized example. However, the use of lumped low-pass networks has some advantages; that is, all but the lowest oscillation frequency are suppressed and the gain reduction at high frequencies attenuates harmonics introduced by nonlinearities in the vacuum tubes.

Another variation is that of using high-pass networks instead of low-pass networks—for example, rc networks. Again, behavior is similar to that of the idealization discussed before although harmonics may not be suppressed as is the case with low-pass networks.

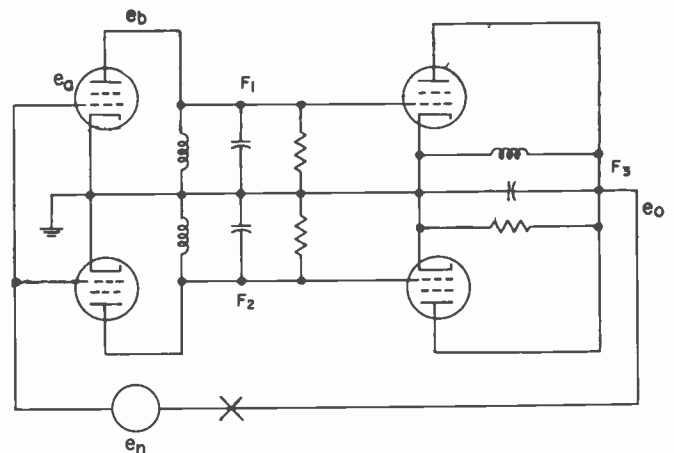

Fig. 2—A parallel-network oscillator employing resonant circuits.

ANALYSES OF AN OSCILLATOR EMPLOYING PARALLEL RESONANT CIRCUITS

Consider Fig. 2 which shows a parallel-network oscillator employing parallel resonant circuits for F_1 , F_2 , and F_3 .² It is assumed that all tubes are identical and

² O. E. DeLange, "A variable phase-shift frequency-modulated oscillator," *Proc. I.R.E.*, vol. 37, pp. 1328-30; November, 1949. Structurally, this oscillator is similar to one described in this article.

ideal current generators. The function e_b/e_a has the form

$$\frac{e_b}{e_a} = - (g_{m1}/C_1) \frac{p}{p^2 + pB_1 + \omega_1^2}, \quad (13)$$

where g_m is the transconductance, C_1 is the shunt capacitance, B_1 is the half-power bandwidth, and ω_1 is the resonant frequency. The expressions for F_2 and F_3 are similar. If it is assumed that $C_1 = C_2 = C$, $B_1 = B_2 = B$, $C_3 = C'$, $B_3 = B'$, $\omega_3 = \omega_0$, and

$$g_{m1} = (g_m/2)(1 + k) \quad g_{m2} = (g_m/2)(1 - k), \quad (14)$$

then the open-loop transfer function is

$$\frac{e_o}{e_n} = \frac{g_m^2}{2CC'} \left[\frac{(1+k)p}{p^2 + pB + \omega_1^2} + \frac{(1-k)p}{p^2 + pB + \omega_2^2} \right] \frac{p}{p^2 + pB' + \omega_0^2}. \quad (15)$$

In order to keep the analysis relatively simple, the narrow-band approximation will be employed. Admittedly, this may not be very exact in many cases but it does have the advantage of simplicity. Therefore, if we assume that $\omega_2 - \omega_1$, B , and B' are all small compared to ω_0 , then (15), upon translating the system centered around ω_0 to a center frequency of zero (bandpass to low-pass transformation), becomes

$$\frac{e_o}{e_n} = \frac{gm^2}{4CC'} \left[\frac{p + B/2 - jk\omega_x}{(p + B/2 + j\omega_x)(p + B/2 - j\omega_x)(p + B'/2)} \right], \quad (16)$$

where $\omega_x = \omega_2 - \omega_0 = \omega_0 - \omega_1$. This function has poles as indicated in Fig. 3 with a zero which moves along a

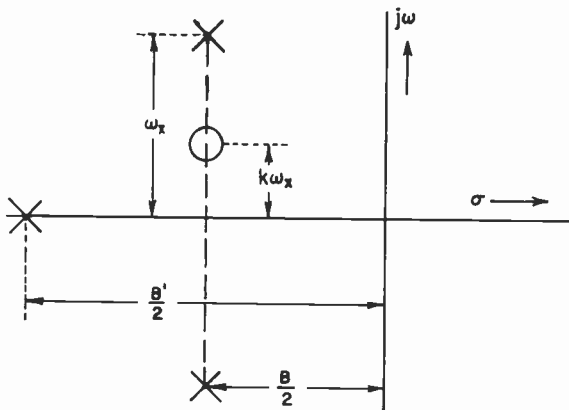

Fig. 3—Poles and zeros of the resonant-type oscillator.

vertical line a distance proportional to k . At the extremes of the tuning range, $k = \pm 1$; in which case, the zero cancels a pole and the oscillator is a simple two-stage single-channel resonant device, one of the two parallel channels being cut off. The extreme frequencies are found from the requirement that the two remaining

poles furnish a phase shift of zero, giving the tuning range

$$\Delta B = \frac{2\omega_x}{1 + B/B'} = \frac{2(\omega_2 - \omega_0)}{1 + B/B'}, \quad (17)$$

which approaches a maximum for $B' \gg B$ and is half the maximum possible value for $B' = B$.

The open-loop gain at the extreme frequencies is

$$\left(\frac{e_o}{e_n} \right)_{ez} = \frac{g_m^2}{4CC'} \left[\frac{4(B + B')^2}{BB'[4\omega_x^2 + (B + B')^2]} \right], \quad (18)$$

and that at the center frequency is

$$\left(\frac{e_o}{e_n} \right)_{ct} = \frac{g_m^2}{4CC'} \left[\frac{B/B'}{\omega_x^2 + B^2/4} \right]. \quad (19)$$

The ratio of (18) and (19) is

$$\frac{(e_o/e_n)_{ez}}{(e_o/e_n)_{ct}} = \frac{1 + (2\omega_x/B)^2}{1 + [(2\omega_x)/(B + B')]^2}, \quad (20)$$

which gives a characteristic dip to the oscillation amplitude as a function of frequency at the center frequency. Not much can be done to minimize this variation except for the obvious procedure of making B and B' large compared to ω_x . Clearly, ω_x is primarily determined by the desired tuning range.

The pole-zero plot of Fig. 3 is rather typical of parallel-network oscillators. The poles are those of both of the two channels plus those common to the two channels. In addition to the fixed poles, zeros are introduced by the paralleling process. These zeros move in position as k is varied. It is their motion that causes changes in the frequency of oscillation.

WAVEFORM, STABILITY, AND NOISE

Whenever a parallel-network oscillator is made to have a tuning ratio appreciably greater than two-to-one, grid and plate saturation will have profound effects upon the waveform and cause considerable disagreement between linear theory and practice. In order to make theory and experiment agree at all, it is necessary to limit the amplitude of oscillations to a small value.

The amplitude of oscillations is theoretically most constant with frequency at the output of the adding device. If the tuning range is small, a bandpass filter can be used at this point such that the harmonics are attenuated. Then, not only will the output have good waveform, but the feedback voltage will be a single-frequency signal in which case the agreement between experiment and theory will be good. However, if the tuning ratio is large, harmonics at the output cannot be entirely avoided. When such a distorted signal is fed back to the input, the agreement between theory and experiment may be quite poor—in the extreme case, discontinuities in the tuning characteristic may result. Further, a distorted signal, if too large, will not permit a reasonably linear addition of the signals from the two paths of the oscillator to be made.

If the tuning characteristic is satisfactory (even though there may be considerable distortion), the waveform can be improved by passing the oscillator output through an electrically tuned tracking amplifier (which might also serve as a limiter). The tracking of this amplifier need not be critical nor will moderate hysteresis effects be important as, for example, when the tracked amplifier is tuned by means of ferromagnetic materials.

In order to minimize distortion, the amplitude of oscillations must be minimized. It is generally overly critical to minimize the open-loop gain in order to accomplish this; rather, some amplitude limiting device (other than the natural limiting characteristics of the amplifying tubes necessary to the oscillator) must be employed. For example, an automatic volume-control circuit can be applied to a tube that carries the weighted sum signal. Another procedure that can be employed is to establish a symmetric saturation characteristic which effectively removes all even-order harmonics from the signal. A device commonly used to accomplish this is a thermistor. However, devices dependent on thermal behavior are not satisfactory when fast frequency modulation is desired. A less effective method but one that can handle fast modulation is to shunt some signal path to ground with crystal diodes connected in a back-to-back fashion such that large signals are amplified less than small signals.

Whatever the saturation characteristics may be, it can be expected that the tuning characteristics will be dependent upon them because the phase and magnitude characteristics of networks subject to saturation are generally dependent on the amount of damping furnished by grid loading and similar phenomena. If the saturation characteristics are determined largely by back-to-back crystal diodes, then the characteristics of the diodes will affect the tuning characteristics depending upon how important is the phase shift of the circuit in which they are located. Certainly, no general rules can be set down in this regard.

Tuning parallel-network oscillators is accomplished by varying the operating points of tubes. Therefore, the frequency stability can be ascertained in analogy to the stability of a dc amplifier. Good stability is consequently dependent on good supply voltage regulation. Because of the push-pull type of connection of the controlled stages, variations in tube operating points due to supply fluctuations tend to cancel such that stability is analogous to that of a balanced dc amplifier. In general, the frequency stability of a parallel-network oscillator will be proportional to the megacycles tuning range and will be little different from that of a hypothetical reactance-tube system of comparable frequency range.

The noise on the output signal is largely of the frequency-modulated type. Consequently, rather than a delta function type of output with a uniform background of noise, there will exist a smooth (but very nar-

row) output power spectrum.³ Low-frequency noise due to flicker effects will produce a narrow Gaussian power spectrum upon which is superimposed a much narrower single-tuned type of power spectrum arising from the discrete nature of the electron. Again, the noise in the output signal is comparable to that of a hypothetical reactance-tube system of similar tuning range.

EXAMPLES

As a practical example of a parallel-network oscillator making use of transmission lines, let F_1 be given by a pi network approximation to a transmission line and let F_2 be given by two similar pi sections in cascade. Then, $a \cong 2$ because the phase shift of the two sections at any given frequency within the pass band is (ideally) twice that of one section. The result is the circuit of Fig. 4. Varying the relative gains of the two channels is achieved by applying push-pull modulation to the plates of V_1 and V_2 . Of course, grid or cathode modulation (or screen modulation if pentodes are used) can also be employed. It should be observed, however, that plate modulation for frequency variations in parallel-network oscillators has the same advantages as plate (or plate and screen) modulation for amplitude variations in conventional oscillators in that it is more linear and not quite so dependent upon nonlinearities brought about by saturation effects.

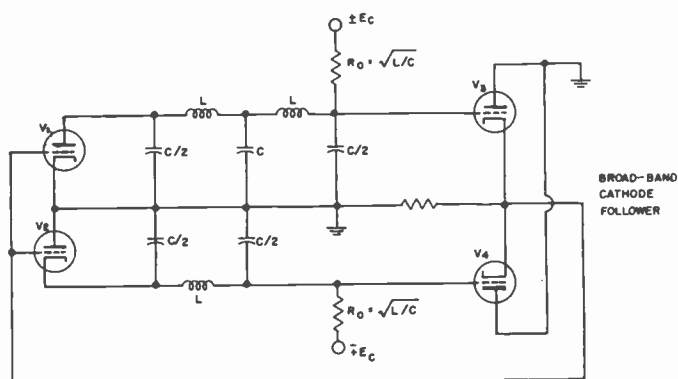

Fig. 4—A parallel-network oscillator employing artificial transmission lines.

It can be seen in Fig. 4 that the single pi network has at its output a voltage similar to that at the center of the two-section network. This leads to certain obvious simplifications of Fig. 4 resulting in the circuit of Fig. 5. The filter structure is that of the usual constant- k filter. In a sense, time delay isolation has been used in the adding circuit resulting in advantages similar to those obtained in distributed amplifiers. In fact, a whole string of tubes can be placed along an artificial transmission line to give the distributed equivalent of a parallel-network oscillator having several signal paths. However,

³ J. L. Stewart, "The power spectrum of a carrier frequency modulated by Gaussian noise," *Proc. IRE*, vol. 42, pp. 1539-42; October, 1954.

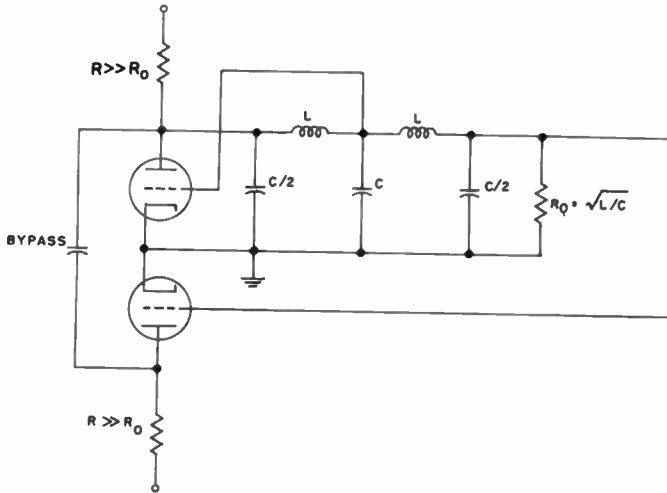

Fig. 5—Simplification of the oscillator employing artificial transmission lines.

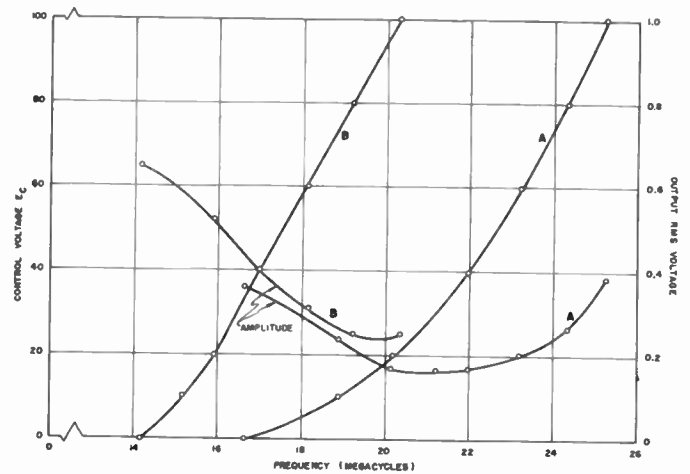

Fig. 7—Tuning characteristics of transmission line type oscillator.

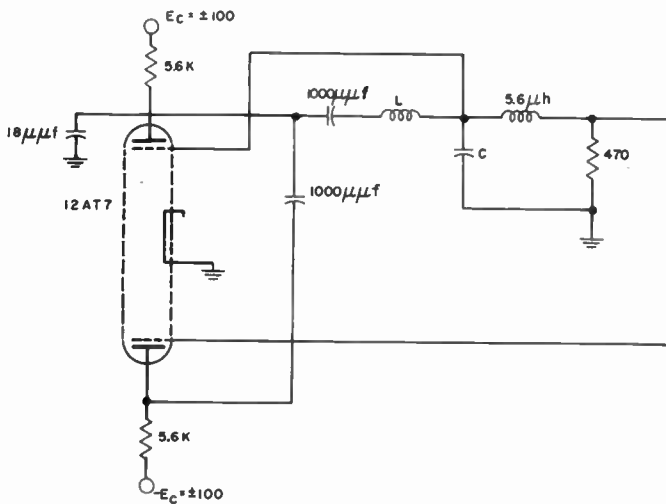

Fig. 6—A practical oscillator employing an artificial transmission line.

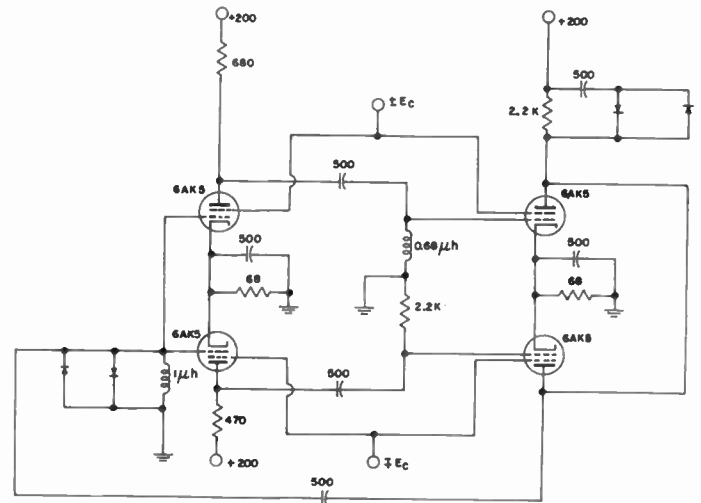

Fig. 8—An oscillator employing lead and lag networks.

unlike the distributed amplifier, only a few tubes are active at any given frequency. Therefore, the problem of providing a suitable control voltage is quite difficult—e.g., if three tubes are used, means must be provided for shifting the plate voltage from tube to tube in a continuous fashion. (An approximation to a three-tube system is that of operating the center tube at a constant voltage and modulating the plates of the first and third tubes in a push-pull manner.)

It is somewhat surprising that the circuit of Fig. 5 is precisely that of a reactance-tube modulated oscillator described by Dennis and Felch having a practical tuning range of about 20 per cent.⁴ However, whereas the oscillator described by Dennis and Felch was tuned by varying only one of the two plate voltages, the parallel-network oscillator is tuned by varying both of the plate voltages which doubles the practical tuning range to something approaching two to one.

⁴ F. R. Dennis and E. P. Felch, "Reactance-tube modulation of phase-shift oscillators," *Bell Sys. Tech. Jour.*, vol. 28, pp. 601-607; October, 1949.

An oscillator similar to that of Fig. 5 was constructed and tested. Its actual circuit diagram is shown in Fig. 6—not shown are the important tube and stray capacitances. The capacitance C was experimentally adjusted to give a satisfactory compromise behavior (about 15 μmf). The circuit is simplicity in itself yet gives the desirable tuning characteristics of Fig. 7 without any amplitude stabilizing devices. Curves A of Fig. 7 are for $L=3.3$ microhenries and curves B for $L=5.5$ microhenries. The capacitance C is not quite the same for the two circuits.

The second example is an oscillator quite similar to that of Fig. 2. Screen modulation of all four tubes is employed which greatly simplifies the modulating source requirements. However, the circuit differs from Fig. 2 in that an rc low-pass network is used in one of the two signal paths. Parallel resonant circuits are used in the other signal path and in the adder. Two sets of back-to-back diodes are used to establish a symmetric saturation characteristic although one set gives nearly as good behavior. The actual circuit is shown in Fig. 8 and the measured tuning characteristics are shown in Fig. 9

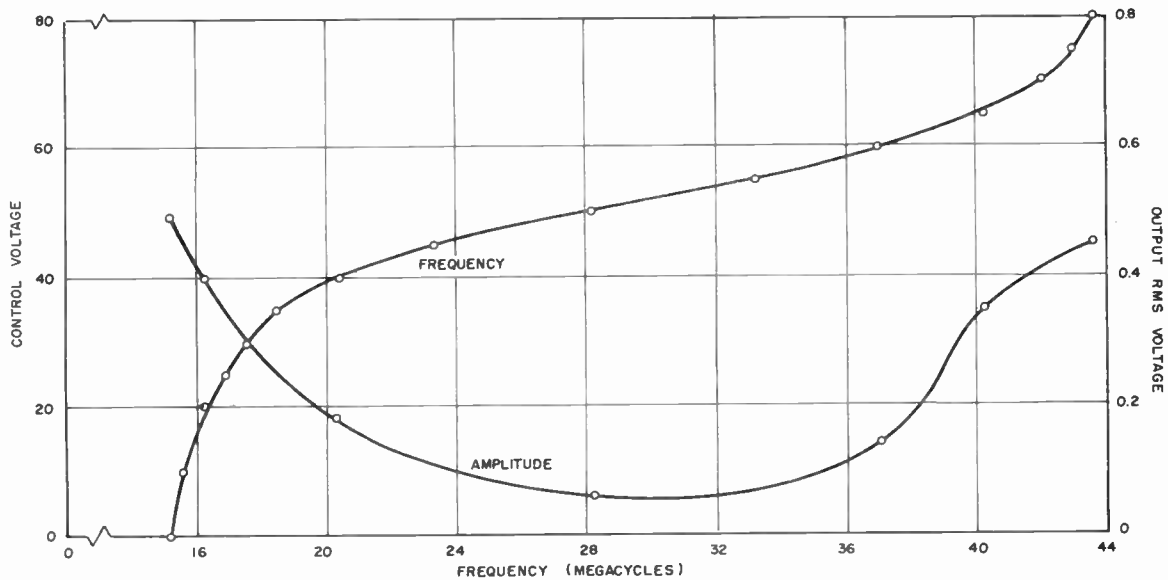

Fig. 9—Tuning characteristics of oscillator employing lead and lag networks.

—the tuning ratio of this circuit is nearly three to one.

It is of interest to note that the predicted dip in the amplitude characteristics occurred in the examples. A simple bandpass amplifier for amplifying the signal from the oscillator can very easily be made to provide equalization. The amplitude of oscillations can be made much more constant with frequency than that of the examples if a slightly reduced frequency range is employed.

FUTURE POSSIBILITIES

Several rather interesting devices may be feasible when constructed as parallel-network oscillators. One of the major requirements is the linear addition of the signals from the two signal paths. It is certainly possible to perform this addition in linear circuits composed of lumped elements rather than with vacuum tubes—this is obvious at least at low frequencies. At the higher frequencies, the use of mutual inductance and mutual

capacitance in realizing passive adding circuits may prove advantageous.

There is no reason why parallel-network oscillators covering hundreds of megacycles cannot be made to work into the microwave region by using close-spaced triodes. The advantages of such oscillators over existing tunable low-level microwave oscillators are too obvious to warrant discussion.

Finally, it should be possible to construct a crystal-controlled oscillator capable of being deviated several kilocycles by using crystals in place of ordinary parallel or series resonant circuits for the critical functions F_1 and F_2 of Fig. 1.

ACKNOWLEDGMENT

The author is indebted to Mr. K. S. Watkins for his considerable aid in performing much of the experimental work involved in the development of the oscillators described here as well as several versions not touched upon.



A Simple Circuit for Frequency Standards Employing Overtone Crystals*

E. P. FELCH†, FELLOW, IRE AND J. O. ISRAEL‡, SENIOR MEMBER, IRE

Summary—A simple oscillator suitable for use as a primary standard of frequency has been developed. Employing a new quartz crystal unit operating in the fifth overtone mode at 5 megacycles, this oscillator has exhibited a frequency stability better than 1 part per billion over periods of several hours; over extended periods the frequency drifts less than 10 parts per billion per month.

The oscillator comprises a single stage Class A amplifier with a pi section feedback network; this circuit minimizes the influence of variations in electron tubes and circuit components. Class A operation is accomplished by amplified automatic amplitude control that also holds the crystal dissipation to less than a microwatt.

A novel feature is use of a resistor in parallel with the crystal to suppress oscillation at the fundamental and unwanted overtone frequencies, without significantly affecting the frequency stability.

INTRODUCTION

A NEW QUARTZ crystal for frequency-standard oscillators has recently been developed.¹ Operating in the fifth overtone mode at a frequency of 5 mc, this new crystal has exhibited performance characteristics markedly superior to those of conventional frequency standard crystals. To derive full benefit from these performance potentialities a suitable oscillating circuit must be employed. A simple and reliable circuit, substantially immune to variations in electron tubes and components, is described in this paper. Significant features are treated analytically in an Appendix.

The circuit for a precise frequency standard is called upon to perform only three simple functions. It must provide sufficient gain to maintain oscillation of the crystal, a means of controlling the amplitude of oscillation and a suitable coupling means to furnish the electrical output. The circuit designers' real difficulties only come to light upon consideration of the following requirements: the associated phase shift must be stable to within minutes of arc; the amplitude control must maintain the dissipation in the crystal within a db at a power level of less than a microwatt; the output circuit must provide milliwatts of power without reaction of load impedance changes upon the oscillator frequency.

Employment of an overtone crystal imposes an additional requirement. Oscillation at undesired frequencies such as the fundamental or unwanted overtone modes must be suppressed. The methods of attack on these design problems are discussed in turn below.

AMPLIFIER AND FEEDBACK NETWORK

A single pentode electron tube was chosen as the active element to provide the required gain, as shown on

* Original manuscript received by the IRE, November 17, 1954; revised manuscript received, January 25, 1955.

† Bell Telephone Labs., Inc., Murray Hill, N. J.

‡ A. W. Warner, "High-frequency crystal units for primary frequency standards," *Proc. I.R.E.*, vol. 40, pp. 1030-1033; September, 1952.

Fig. 1. When this experimental work was being carried out, transistors did not exhibit sufficient stability of impedance and gain at the operating frequency of 5 mc to compete successfully with electron tubes in this application. Continuing advances in the transistor art may modify this choice in the future.

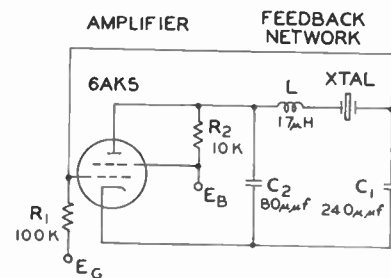

Fig. 1—Simplified schematic of single-tube crystal oscillator.

The purpose of the electron tube amplifier is to provide the few db of gain required to maintain oscillation of the crystal. The phase shift associated with this gain must be stable to within a few seconds of arc. The reasons behind these requirements may be explained as follows: Barkhausen's condition for oscillation states that the frequency of oscillation is that for which the total phase shift around the oscillating loop (amplifier plus feedback network) is 0 (or 360) degrees, and the gain is unity. The crystal unit as a network element provides a large coefficient S_f of phase shift vs frequency change,² in this case about 15 minutes of phase shift per part per billion in frequency. Hence a change of 15 minutes in loop phase shift arising from any cause external to the crystal is compensated by an undesired change in frequency of one part per billion. Variations in element parameters may be translated into corresponding phase shifts in order to evaluate stability.

An alternate method of analysis relates frequency changes directly to element variations through a "stability index" SI . This is developed in Appendix I(A).

Experience has shown that the chief contributions to unstable phase shift in electron tube amplifiers may be charged to variability of the effective grid input capacitance and the effective internal plate resistance. The effective grid input capacitance is composed of two parts: first, the grid to cathode plus the grid to screen capacitances, and second, the Miller effect capacitance. This latter, which is more significant from the stability standpoint, is the product of the grid-to-plate capacitance and the grid-to-plate voltage gain of the tube.

² W. A. Edson, "Vacuum-Tube Oscillators," John Wiley & Sons, Inc., New York, N. Y., p. 7; 1953.

This means that the effective grid capacitance is influenced by any factor affecting the voltage gain of the tube. However, if linearity of the amplifier is assumed and the loss of the feedback network is constant, the voltage gain of the amplifier must be constant also in order to meet Barkhausen's unity gain condition mentioned above. This eliminates the Miller effect as a significant contributor to frequency instability. The required linearity is attained by methods discussed in the next section.

The effective plate resistance is primarily influenced by variations in grid bias. However, the use of a low-plate load impedance in parallel renders this effect negligible. In fact, the magnitudes of the phase-shift changes arising from variations in the grid-input capacitance and in the plate resistance obviously depend to a major degree upon the magnitudes of the facing-circuit impedances. The lower these can be made, the smaller is the effect of undesired variations upon over-all phase shift.

The desirability of maintaining circuit impedances at low values suggested the use of a series resonance connection of the frequency-controlling crystal. The overtone crystal, having an effective resistance at resonance of only about 100 ohms, is particularly well-adapted to this mode of operation.

Since a single-stage electron tube amplifier introduces 180-degree phase-shift, an additional 180-degree phase-shift must be provided to insure oscillation. This might be accomplished by adding a second electron tube, a transformer or a phase-shifting network. A pi configuration phase-shifting network was chosen. It affords a maximum of element stability, design simplicity and impedance flexibility. As shown in Fig. 1, the pi network is connected between the grid and plate of the electron tube; the frequency-controlling crystal is inserted between the series coil and the shunt-terminating capacitor. This offers the enticing possibility of placing within an oven all of the circuit elements comprising the feedback network, and the crystal; the shunt capacitances may then be used to absorb capacitance of relatively long-connecting cables. In one model over four feet of RG71/U cable was successfully employed.

The element values in the pi network are dictated by three considerations: the relative magnitude of grid and plate capacitance variations; the available gain of the amplifier; and the requirement that the phase shift be 180 degrees. The 3 to 1 ratio of the shunt capacitors is the square root of the empirical ratio of about 10 to 1 for grid and plate capacitance instabilities. The absolute values of the shunt capacitors are then established by the tolerable network loss, which, of course, corresponds to the amplifier gain. With the capacitor values established, the value of the inductor is determined by the phase-shift criterion. The network of Fig. 1 is designed to operate with a 6AK5 tube at a transconductance of about 2,500 micromhos, yielding a gain of about 12 db. This tube combines the desirable features of low-

thermal dissipation, long life, and excellent stability of interelectrode capacitances. Appendix I(B) contains an analysis of the oscillator.

AMPLITUDE CONTROL

Amplitude control is required to hold the dissipation in the crystal unit within one db of a value of less than a microwatt. The new crystals exhibit a dependence of frequency upon drive current such that the crystal current must be controlled within one db at a value of about 50 microamperes for optimum stability. Higher currents impair the stability through crystal heating and require more precise regulation for the same frequency stability. With lower currents, noise becomes a limiting factor.

A second but vital function of the amplitude control is to insure Class A operation of the amplifier in order to meet the linearity requirement mentioned above.

The electron tube itself was chosen as the variable gain element in the amplifier. Self-energized nonlinear devices, such as varistors and thermistors, are undesirable because of the low levels of energy available in the oscillating circuit; indirectly-heated thermistors are unattractive because of their relative inefficiency and the possibility of introducing undesired variations in phase shift.

In order to obtain sufficient voltage to exercise adequate control over the transconductance by grid bias variation, it is necessary to amplify the oscillating circuit voltage prior to rectification. This is accomplished in a two-stage electron tube amplifier stabilized by local feedback. The amplified voltage is rectified in a high-vacuum rectifier tube. The rectified control voltage is then applied through a suitable filter to the grid of the oscillator tube. The amplitude control arrangement, shown in Fig. 2, maintains the ac crystal current within

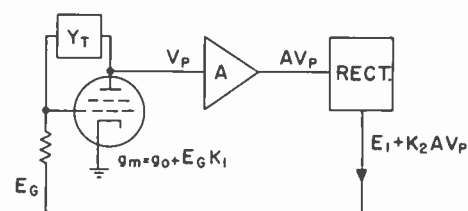

Fig. 2—Amplitude control circuit.

1 db at a value of about 50 microamperes. The corresponding ac grid voltage is about 7 millivolts, which with a grid bias of more than 1.5 volts assures linear Class A operation. The amplitude control circuit is analyzed in Appendix I(C).

OUTPUT CIRCUIT

The output circuit is required to furnish a few milliwatts of useful output power with adequate isolation. Extreme changes in load impedance should not affect the frequency of oscillation to a perceptible degree. This has been accomplished quite simply by connecting a

pentode amplifier to a suitable point in the amplitude control amplifier. The loose coupling of the amplifier to the oscillating circuit and the buffer action of the tubes provide the necessary isolation.

SUPPRESSION OF OSCILLATION AT UNDESIRED FREQUENCIES

Consideration of the possibility of oscillation at frequencies of undesired crystal modes has been conveniently omitted up to this point. In practice the circuit described above is far more prone to oscillate at the fundamental mode than at the desired fifth-overtone mode. The more obvious expedients for eliminating such unwanted oscillation, such as resonant traps and band-elimination filters have one undesirable feature in common. They all introduce reactance elements which significantly impair the stability of the oscillator phase-shift at the desired operating frequency, by increasing the number of sources of potential phase instability.

A simple remedy has been found that does not impair the stability at the desired operating frequency of 5 mc, but effectively prevents oscillation at the fundamental or any of the other undesired modes such as the third, seventh, ninth or eleventh overtone. It consists of a resistor of the proper value shunted across the crystal. At the operating frequency the crystal is at series resonance and, consequently, appears resistive. The shunt resistor is of such a value that it reduces the overall Q (the Q of the crystal is greater than two million) by only a few per cent. However, at the frequencies of the undesired modes of oscillation of the crystal, the shunt resistor limits the magnitude of the phase shift that the crystal is capable of introducing to less than a critical value; this critical value is that which, when added to the phase shift of the remainder of the circuit, will produce a loop phase shift of 360 degrees. This means that one of the primary conditions for oscillation cannot be met at any of these undesired frequencies. In

addition, the effective Q of the circuit at the undesired modes is substantially reduced.

The effect on phase shift of adding the resistor is shown in Fig. 3 which depicts (not to scale) the negative of the network loop reactance X_L , the reactive component X_e of the crystal effective impedance and this component X_e' after the parallel resistor has been added. Now the network is initially adjusted for oscillation at 5 mc, at which frequency X_L is zero, and X_e is zero also. The phase shift through the network is 180 degrees and oscillation occurs. However, since the crystal unit has other modes, X_e will exhibit the characteristic shown,

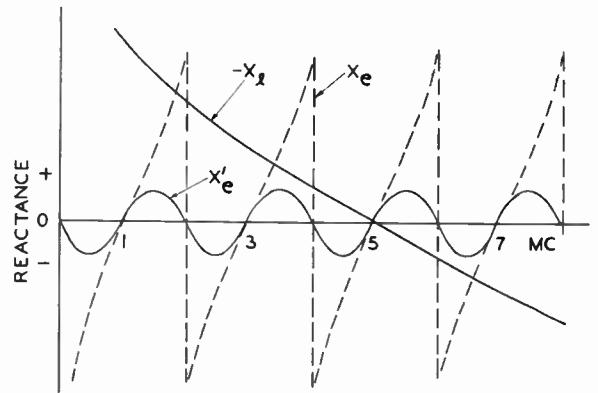

Fig. 3—Action of mode-suppression resistor.

and wherever the curves $-X_L$ and X_e cross, the phase shift will be 180 degrees and oscillation may occur. The effect of the resistor R_M is to limit the maximum value of X_e , producing the curve X_e' (See Appendix I(D)). This curve obviously never meets $-X_L$ except at one point, 5 mc, and this is the only point at which the oscillation can occur.

PERFORMANCE

The complete frequency standard oscillator circuit is shown in Fig. 4. The unwanted mode suppression resistor, R_M , is shown shunted across the crystal, X , and

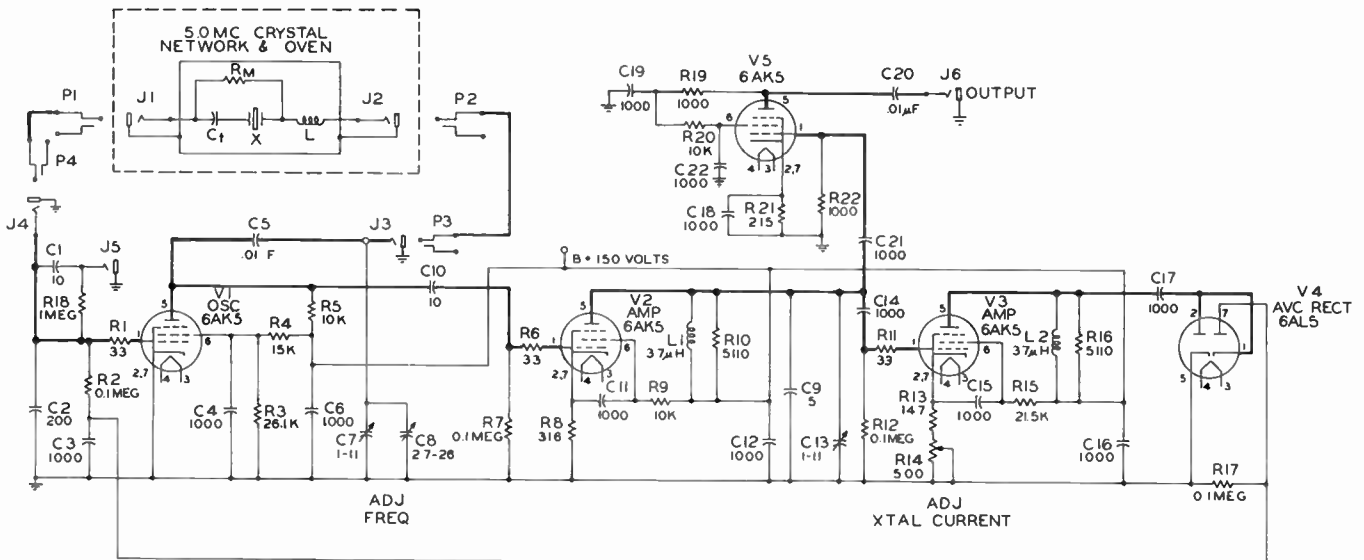

Fig. 4—Standard frequency oscillator circuit.

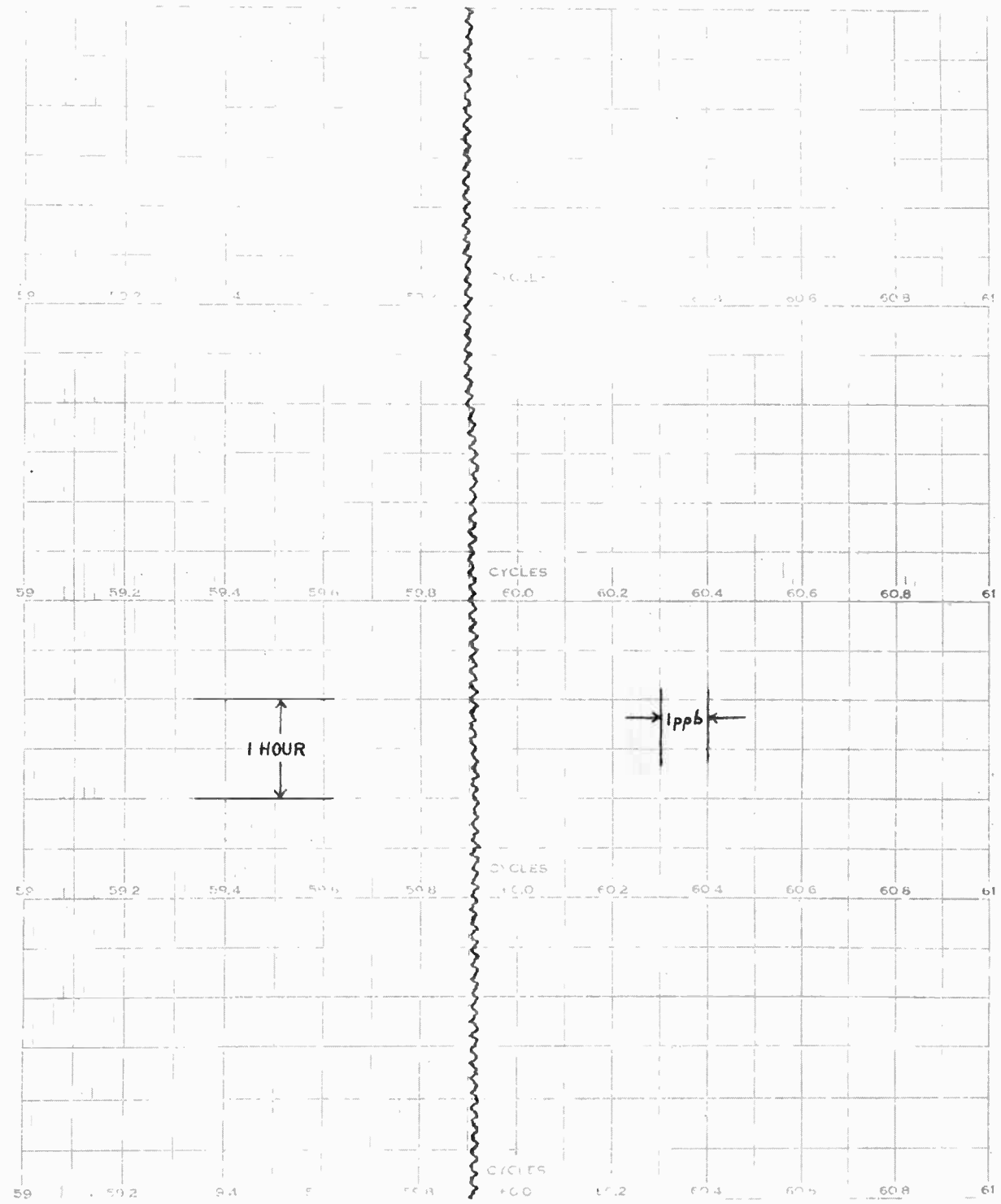

Fig. 5—Typical performance of the standard frequency oscillator.

a frequency adjusting capacitor, C_t , which permits fine adjustment of the oscillator frequency.³ Fig. 5 shows that such an oscillator produces an output frequency stable to within a few parts in 10^{10} over short intervals when the frequency-determining crystal is enclosed in a suitable oven. Variations of ± 10 per cent in supply

voltages affect the frequency by less than 1 part in 10^9 . Replacement of the electron tubes affects the frequency by less than 1 part in 10^8 .

One model of this oscillator has been observed for several months. After the initial warm-up, the oscillator exhibited a drift rate of less than 10 parts in 10^9 per month, which compares favorably with the best reported performance of any frequency standard oscillator.

³ The crystal is initially adjusted to resonate slightly below 5 mc.

This simple circuit appears to exploit the stability possibilities of the new overtone crystal to a degree compatible with the quality of the crystal and the state of the oven temperature control art.

ACKNOWLEDGMENT

The authors wish to acknowledge particularly the assistance of Dr. D. B. Sinclair of the General Radio Company, who offered many helpful suggestions. Messrs. J. G. Ferguson, F. G. Merrill, G. N. Packard and J. J. Lebeyka of Bell Telephone Laboratories participated in this project.

APPENDIX I

A. The Quartz Crystal as a Frequency-Control Element

Electrical equivalent circuits for quartz crystals are well known.⁴ Fig. 6(a) shows such an equivalent circuit when the crystal is in series with a frequency-adjusting capacitor, C_t . Fig. 6(b) shows a simplified equivalent circuit, in which the crystal and associated capacitor are represented as a simple series circuit. We are interested in two features of this circuit: (1) the effective resistance, which determines the oscillator tube transconductance as shown in Appendix IB; and (2) the rate of change of reactance with frequency, which is a measure of the frequency stability of the circuit.

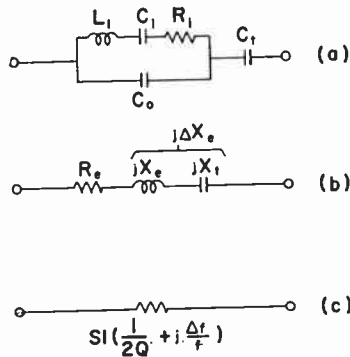

Fig. 6—Equivalent circuits of the crystal unit.

Referring to Fig. 6(a), the effective resistance at the operating frequency is shown by Fair⁵ to be

$$R_e = R_1(1 + C_0/C_t)^2. \tag{1}$$

Referring to Fig. 6(b), the effective reactance near resonance is given approximately by

$$X_e = \omega L_1 - 1/\omega C_1.$$

When the circuit is adjusted, X_t is made equal to X_e so that ΔX_e is zero. Now consider the effect of a small change of frequency. The effect on X_t is negligible. The effect on X_e is given by the derivative

$$dX_e/d\omega = L_1 + 1/\omega^2 C_1 = L_1(1 + \omega_1^2/\omega^2).$$

⁴ R. A. Heising, "Quartz Crystals for Electrical Circuits," D. Van Nostrand Co., Inc., New York, N. Y., p. 357; 1946.

⁵ *Ibid.*, p. 399.

Since ω is very nearly equal to ω_1 , their ratio is approximately unity. With this substitution and some manipulation we obtain

$$\Delta X_e = 2\omega L_1 \cdot \Delta f/f, \tag{2}$$

where we have replaced the differentials by increments. This is justified since we are going to deal with very small changes of reactance and frequency. ΔX_e is a measure of the frequency-corrective action of the crystal. A more useful expression is obtained if we solve (2) for $\Delta f/f$, obtaining

$$\Delta f/f = \Delta X_e/2\omega L_1 = \Delta X_e/SI, \tag{3}$$

where SI represents the "stability index" of the crystal unit for operation near the resonant frequency. It is shown below⁶ that the change in oscillator frequency, caused by a change ΔX in any component, can be determined immediately by dividing $-\Delta X$ by SI .

If we now replace R_e by its equivalent $SI/2Q$ we can express the equivalent circuit of the crystal, in the vicinity of resonance, as a complex impedance having the value $SI(1/2Q + j\Delta f/f)$ as shown in Fig. 6(c).

The crystal unit that we are using is an improved version of the one previously discussed by Warner.¹ Constants and operating conditions for this crystal are shown in Table I.

TABLE I
CRYSTAL CONSTANTS AT 5 MC

R_1	100 to 125 ohms
L_1	9 henries
C_1	0.00011 mmf
C_0	3.75 mmf
$r = C_0/C_1$	34,000
Q	>2,000,000
Nominal series resonant freq. (fr)	5 mc—8 cps ($-1.6 \text{ } \mu\text{p} 10^6$)
Manufacturing range Δfr	± 5 cps ($\pm 1 \text{ } \mu\text{p} 10^6$)
Aging for 6 months Δfr	± 1 cps ($\pm 0.2 \text{ } \mu\text{p} 10^6$)
Operating temperature	75 degrees C
Temperature coefficient	$\pm 1 \text{ } \mu\text{p} 10^7/\text{C}$ degrees
Operating current, approx.	50 μa
Current coefficient, max.	1 $\mu\text{p} 10^9/\text{db}$

The nominal resonant frequency of the crystal unit is made 8 cps below 5 mc in order to permit the use of a practical series adjusting capacitor. The nominal value for C_t is 32 mmf.

The effective resistance at the operating frequency can be as high as 150 ohms, as determined by use of (1).

The inductance value of 9 henries, inserted in (3), gives the value of SI as $600 \cdot 10^6$.

B. Analysis of the Oscillator Circuit

The oscillator circuit of Fig. 1 can be represented by the equivalent circuit shown on Fig. 7 (opposite), assuming that the grid and plate conductances and capacitances of the tube are included in the network. Referring to Fig. 7 we derive the loop equation of the oscillator as follows. The oscillator tube is an ideal constant current

⁶ See Appendix I(B).

generator driven by a voltage V_G and producing a current I_p defined as

$$I_p = g_m V_G, \tag{4}$$

where g_m is the transconductance of the tube. The feedback portion of the oscillator is represented by a 4-terminal network having a transfer admittance Y_T defined as

$$Y_T = -I_p/V_G. \tag{5}$$

Combining (4) and (5) yields the important relation

$$g_m = -Y_T \tag{6}$$

which is the necessary condition for oscillation. This, slightly disguised, is actually the classic formula $\mu\beta=1$.

Let us now find an expression for Y_T in terms of its branches, as shown in Fig. 7. Assume that a current I_c flows through the crystal branch of the network. Then we can write the following equations by inspection:

$$V_G = I_c/Y_1 \tag{7}$$

$$V_p = I_c/Y_1 + I_c Z \tag{8}$$

$$-I_p = I_c + V_p Y_2 = I_c(1 + Y_2/Y_1 + ZY_2), \tag{9}$$

and dividing (9) by (7) and combining with (5) yields the desired expression:

$$Y_T = Y_1 + Y_2 + ZY_1Y_2. \tag{10}$$

Expanding (10) by substituting $Y_1 = G_1 + jB_1$, $Y_2 = G_2 + jB_2$, and $Z = R_e + j\Delta X_e + jX$, and rearranging, gives

$$\begin{aligned} Y_T = & G_1 + G_2 + R_e G_1 G_2 - R_e B_1 B_2 \\ & - (X + \Delta X_e)(G_1 B_2 + G_2 B_1) \\ & + j[B_1 + B_2 + R_e(G_1 B_2 + G_2 B_1) \\ & + (G_1 G_2 - B_1 B_2)(X + \Delta X_e)], \end{aligned} \tag{11}$$

where we have neglected the resistive component of Z since it is very small in comparison with R_e . This expression for Y_T must be reconciled with the one in (6).

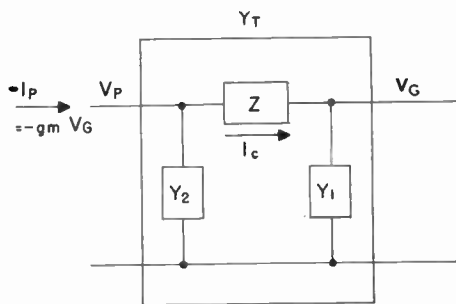

Fig. 7—Equivalent circuit of the oscillator.

The transconductance of the oscillator tube is real and positive. Thus we must equate $-g_m$ with the real portion of (11) and set the imaginary portion equal to zero.

Taking the real portion first, and assuming that G_1 and G_2 are very small we have

$$g_m \doteq R_e B_1 B_2 = \frac{SI}{2Q} \omega^2 C_1 C_2. \tag{12}$$

Thus we have satisfied the condition that the tube transconductance be real and positive. The problem of controlling its magnitude is considered in Appendix I(C). Eq. (12) shows also that the required transconductance is proportional to the stability index and inversely proportional to the Q of the crystal.

Now consider the imaginary portion of (11). Setting it equal to zero, and making the assumption that $G_1 G_2$ is very much smaller than $B_1 B_2$, we solve for ΔX_e obtaining:

$$\Delta X_e = -X + X_1 + X_2 + R_e(G_1 X_1 + G_2 X_2), \tag{13}$$

where we have replaced B_1 by $1/X_1$ and B_2 by $1/X_2$. Eq. (13) must always be satisfied in order to meet the condition for oscillation specified by (6). Assume that we have adjusted the circuit to oscillate at the proper frequency, with the crystal and C_t replaced by a resistor equal to R_e . Then with the crystal and C_t restored we have $\Delta X_e = 0$. However, if any element of the circuit changes there must be a corresponding corrective change in ΔX_e in order to satisfy (13). Since the right side of (13) is normally zero we can replace it by the sum of the incremental changes in the elements. At the same time we can combine (3) and (13) obtaining

$$\Delta f/f = \frac{-\Delta X + \Delta X_1 + \Delta X_2 + \Delta R_e(G_1 X_1 + G_2 X_2) + \Delta G_1 R_e X_1 + \Delta G_2 R_e X_2}{SI}. \tag{14}$$

Eq. (14) shows directly the effect on frequency of any element change. For example, assume that $-\Delta X = 6$ ohms. Then $\Delta f/f = 6/SI = 6/(600 \cdot 10^9)$ or $1 \text{ } pp \text{ } 10^8$. Conversely, we can find the required stability of each element for a given change of frequency. Using the values given in Fig. 1 and assuming that $R_e = 150$ ohms we obtain the requirements shown in Table II for element stability to maintain the frequency within $1 \text{ } pp \text{ } 10^9$.

TABLE II

Element	Value	Required stability	Required stability in per cent
$L(X)$	17 μH	0.02 μh	0.12
$C_1(X_1)$	240 mmf	1 mmf	0.46
$C_2(X_2)$	80 mmf	0.12 mmf	0.15
R_e	150 ohms	15 ohms	10.
G_1	10 μ mhos	30 μ mhos	300.
G_2	100 μ mhos	10 μ mhos	10.

C. The Amplitude Control Circuit

The equivalent circuit of the amplitude control circuit is shown in Fig. 2. The oscillator-tube transconductance is represented by two terms, g_0 which is constant for constant supply voltages, and $E_G K_1$ which comprises the dc control voltage E_G and a constant K_1 which represents the slope of the transconductance and is expressed in micromhos per volt. The total amplifier gain is represented by A . The rectifier output consists of two dc voltage terms, E_1 the "contact" potential and

$k_2 A V_p$ the rectified signal voltage where K_2 is the rectifier "gain."

From the figure it is apparent that

$$g_m = g_0 + k_1(E_1 + k_2 A V_p). \quad (15)$$

Replacing g_m by its value $-Y_T$ as given by (6) and solving for V_p we obtain

$$V_p = (Y_T + g_0 - k_1 E_1) / k_1 k_2 A. \quad (16)$$

However, since we are interested in I_c , the current through the crystal, rather than V_p , we can use (8) to eliminate V_p from (16), obtaining

$$I_c = (Y_T + g_0 + k_1 E_1) / k_1 k_2 A (Z + 1/Y_1). \quad (17)$$

This is rather a formidable formula, indicating that I_c is a function of every element in the circuit. However, since the oscillator is designed to be extremely stable with frequency, we can assume that Y_T , Z , and Y_1 are constant. We find then that I_c is a function of the oscillator-transconductance parameters g_0 and k_1 , the rectifier contact potential E_1 , the rectifier efficiency k_2 , and the amplifier gain A . Taking the partial derivatives of I_c with respect to these factors gives, with some manipulation, the following expression for differential I_c :

$$\begin{aligned} \frac{dI_c}{I_c} = & \frac{dA}{A} - \frac{dk_2}{k_2} + \frac{g_0}{D} \frac{dg_0}{g_0} + \left(\frac{k_1 E_1}{D} - 1 \right) \frac{dk_1}{k_1} \\ & + \frac{k_1 E_1}{D} \frac{dE_1}{E_1}, \end{aligned} \quad (18)$$

where $D = Y_T + g_0 + k_1 E_1$.

We now introduce in Table III a set of typical values for the parameters, in order to show the magnitude of possible changes in I_c .

TABLE III

Parameter	Typical value
Y_T	-2500 μ mhos
g_0	7000 μ mhos
k_1	2000 μ mhos/volt
E_1	-0.7 volt
k_2	-2
A	50
$Z + 1/Y_1$	400 ohms

Substituting these typical values into (17), we find that I_c is approximately 50 microamperes as required. Substituting the typical values into the coefficients of the differentials in (18) gives

$$\begin{aligned} \frac{dI_c}{I_c} = & - \frac{dA}{A} - \frac{dk_2}{k_2} + 2.25 \frac{dg_0}{g_0} \\ = & - 1.2 \frac{dk_1}{k_1} - 0.2 \frac{dE_1}{E_1}. \end{aligned} \quad (19)$$

Of these five factors contributing to instability of I_c , the first can be made very small by the use of negative feedback in the amplifier. The remaining four, relating to the

oscillator and rectifier tubes, can be minimized by regulation of the heater and plate supply voltages.

D. Suppression of Unwanted Modes

In the oscillator circuit of Fig. 1, oscillation can occur at the resonant frequency of the loop represented by L , ΔX_e , C_1 and C_2 . For the desired operation at 5 mc, the fifth overtone of the crystal, we adjusted L , C_1 and C_2 so that ΔX_e would normally be zero. However, it is well known that the equivalent circuit of the crystal at the fundamental mode and at other odd overtones is similar to that shown in Fig. 6. Consequently we find that ΔX_e in the neighborhood of these other frequencies can assume a wide range of values, either positive or negative, and may cause oscillation by providing loop phase shift of 360 degrees.

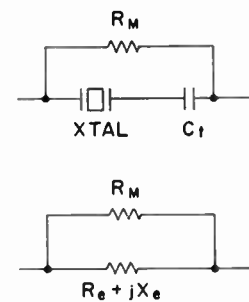

Fig. 8—Crystal unit with mode-suppression resistor.

We prevent oscillation at these undesired frequencies by shunting the crystal and the frequency adjusting capacitor C_t by a resistor R_M , as shown in Fig. 8. This effectively limits the maximum reactance of the crystal branch of the circuit to a value that is insufficient to resonate the loop at the undesired frequencies. The resistor also decreases the circuit Q at these frequencies,⁷ but this effect will not be considered in the following analysis. The effect of the resistor at the desired frequency of 5 mc is small, as will be shown below.

The approximate value for R_M can be determined readily by first obtaining the equivalent series impedance of the circuit of Fig. 8. Letting R_S denote the equivalent series resistance and X_S the equivalent series reactance, we have

$$R_S = R_M \frac{R_e(R_M + R_e) + X_e^2}{(R_M + R_e)^2 + X_e^2} \quad (20)$$

$$X_S = R_M^2 \frac{X_e}{(R_M + R_e)^2 + X_e^2}. \quad (21)$$

We are interested in the maximum value of X_S . The derivative of X_S with respect to X_e is

$$\frac{dX_S}{dX_e} = R_M^2 \frac{(R_M + R_e)^2 - X_e^2}{[(R_M + R_e)^2 + X_e^2]^2}. \quad (22)$$

Setting this derivative equal to zero and solving for X_e gives the value of X_e when X_S is maximum. Thus

⁷ Under some conditions this is the major effect.

$$X_e = \pm (R_M + R_e). \quad (23) \quad \text{and}$$

Substituting this expression for X_e into (21) yields

$$X_S (\text{max}) = \frac{R_M^2}{2(R_M + R_e)}. \quad (24)$$

We can now compute the reactances of L , C_1 and C_2 at the nearest undesired frequency (in our case this is the 7th overtone, or 7 mc) and select R_M so that $X_S (\text{max})$ is insufficient to meet the 360-degree loop phase-shift criterion for oscillation.

Let us now determine the effect of the resistor R_M at the operating frequency. Recalling that the crystal branch is very nearly resonant at this frequency, we set X_e equal to zero in (20) and (22), obtaining

$$R_S = \frac{R_M R_e}{R_M + R_e} \quad (25)$$

$$\frac{dX_S}{dX_e} = \frac{R_M^2}{(R_M + R_e)^2} = \frac{1}{(1 + R_e/R_M)^2}. \quad (26)$$

Eq. (25) shows that the circuit resistance is diminished by the addition of R_M , as we might expect. Eq. (26) shows that the relative slope of the crystal branch has been diminished, and as a result the frequency stability of the circuit will be diminished in the same proportion. However, using typical values for R_e and R_M of 125 ohms and 2200 ohms,⁸ respectively, we find that $dX_S/dX_e = 0.9$, indicating a negligible effect.

⁸ This value for R_M was determined experimentally. The value as determined by the use of (22) will be, in general, much smaller than is required, since we have neglected other effects caused by the addition of R_M , in particular a decrease of the circuit Q when X_e and X_i are not equal.

Recovery Time Measurements on Point-Contact Germanium Diodes*

T. E. FIRLE†, ASSOCIATE, IRE, M. E. MCMAHON‡, ASSOCIATE, IRE, AND J. F. ROACH‡

Summary—The use of point-contact diodes in computer circuitry has shown that diode transient response is important in circuitry employing fast waveforms. Diodes which are pulsed in the back direction from a forward-conducting state may require microseconds to attain a specified back resistance. Transient response depends on circuit impedance and operating conditions, as well as on the diodes themselves. The present lack of ready extrapolation from one transient situation to another requires different tests and criteria for the determination of diode applicability to varying situations. The development and acceptance of a limited number of broadly applicable standard pulse tests is necessary.

INTRODUCTION

RECOVERY time is one of the more troublesome aspects of point-contact germanium diode behavior. The headaches this causes stem in part from a lack of information concerning recovery time in diode characteristics as specified today. For reasons which become apparent later, there is no standard definition for recovery time or even a standard nomenclature for it.

Results obtained from measurement of "back recovery time," "enhancement time," or "recovery" are dependent upon a number of parameters which are not necessarily properties of the diode alone. This paper discusses evidence considered by the authors during investigation of recovery time measurements.

One of the first questions to be considered is the meaning of "recovery" time and why it is of such concern. Recovery, as the word implies, is the property of regaining a previous state. In the case of diodes, recovery refers to the way in which the diode attains its high back resistance after reverse voltage is applied. In speaking of recovery, one usually refers to back response, since the lag of instantaneous recovery in the back direction is quite important in most applications. While considering recovery, it may also be important to include the time function describing the diode resistance until a final low forward resistance value is reached. While the effect of forward recovery time has recently become important, this paper is concerned mainly with the back recovery characteristic.

When is this back recovery effect of consequence? Generally, it is important in all applications where transients are impressed on diodes, whether as square waves, or pulses in switching, gating, and clipping. Indirectly, rectification efficiency is decreased by the inability of the diode to cut off instantaneously at higher frequencies.

Because of the extensive application of pulse techniques today, the widespread use of point-contact germanium diodes is natural. For lack of better knowledge, diodes have been chosen indiscriminately. It has rapidly become apparent that knowledge of the static characteristics alone is insufficient to describe the pulse response. Prototype circuits are therefore often employed to se-

* Original manuscript received by the IRE, July 19, 1954; revised manuscript received, January 31, 1955.

† Hughes Aircraft Co., Los Angeles, Calif.

‡ Pacific Semiconductors, Inc., Culver City, Calif.

lect diodes for particular applications on a "go/no go" basis, inasmuch as there has seemed to be little correlation between available diode characteristics and failure in pulse circuits.

DISCUSSION

A large number of diode types are commercially available with the specification of direct-current properties such as forward current, reverse current, working inverse voltage and peak inverse voltage. The increasing use of diodes in computer circuitry has necessitated pulse test specifications to describe their transient properties.

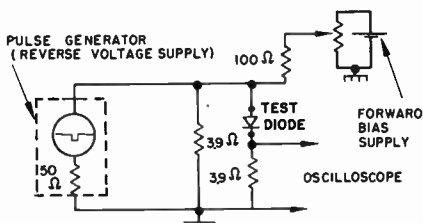

Fig. 1—Circuit for observing pulse response and recovery dependence on forward current.

Fig. 1 shows a circuit used to display the general pulse response and the effect of forward bias on the diode back recovery. It is to be noted that the total diode loop resistance is less than 8 ohms and that the reverse pulse was applied across a low resistance (3.9 ohms) in order to have a stiff voltage source and to decrease stray capacitance effects. The current through the diode is observed as voltage drop across the series resistor.

The lower trace displays the response of a silicon point-contact diode for comparison; it does not show any measurable recovery time. Because of the low breakdown of the microwave silicon diode used, the negative pulses had to be kept small. The pulse response of junction diodes has been discussed elsewhere.¹⁻³

Because of the main concern with back recovery time, let us examine the effect forward bias will have on this characteristic. The oscillograms in Fig. 3 have been taken with the time scale of 0.1 microsecond/division so that the back current spike may be observed more closely. The forward biases are 5, 10, and 20 ma. More reverse current is observed initially, and at short times after the reverse voltage is applied the diode has not fully recovered. The dependence of recovery on forward bias is apparent.

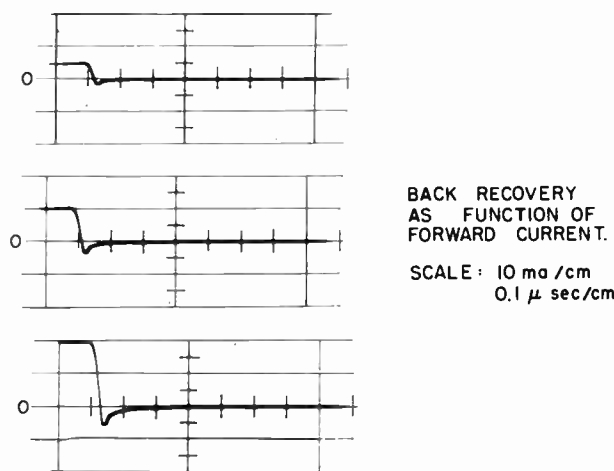

Fig. 3—Reverse recovery as a function of forward current.

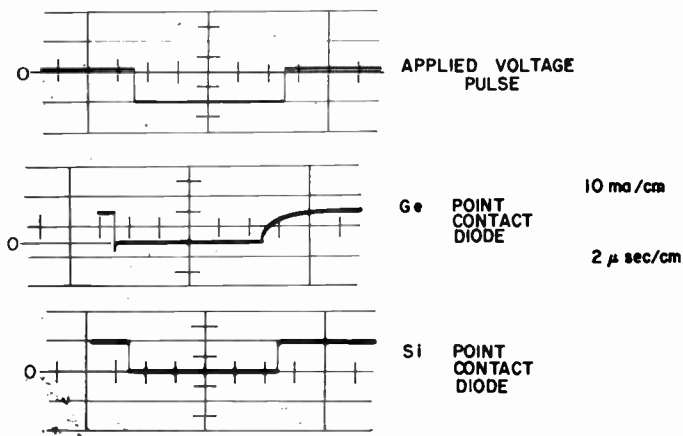

Fig. 2—Pulse response.

The upper trace in Fig. 2 shows the voltage pulse applied to the diode. The center trace displays the current through the germanium diode. The diode is biased at about 10 ma forward current. To the left of the center trace the reverse current spike is clearly visible, indicating that the transition from low forward to high back resistance took a finite time. To the right, it is shown that the diode requires an appreciable time in order to conduct the full forward current when it is returned to its forward bias. This is called forward recovery time.

Generally, then, one can say that high forward currents lead to slower recovery. This can be expected from considering the mechanism of conduction in a diode carrying high forward current. The important factor is carrier injection. High forward current in a diode corresponds to high injection, hence a high minority carrier concentration in the crystal. These injected carriers must be removed when a diode is pulsed in the reverse direction from a forward-biased condition, resulting in a surge of back current.

A crude equivalent circuit would be presented by a capacitor in series with a resistor. For a given resistance the discharge time to a given current level will increase with the charge initially present. The effect on the diode is similar, for as forward current is increased the higher injected carrier density causes slower recovery. Also, if

¹ E. M. Pell, "Recombination rate in germanium by observation of pulsed reverse characteristic," *Phys. Rev.*, vol. 90, pp. 278-279; April 15, 1953.
² R. G. Shulman and M. E. McMahon, "Recovery currents in germanium p-n junction diodes," *Jour. Appl. Phys.*, vol. 24, pp. 1267-1272; October, 1953.
³ S. H. Barnes, "A Silicon Junction Diode Sealed in Glass," Paper presented at AIEE Winter General Meeting, New York, N. Y.; January 18-22, 1954.

one decreases the resistance in the analogous circuit, the capacitor loses its charge faster. Hence, shorter recovery is observed if the loop circuit resistance is decreased. Although a capacitor was chosen for this analogy, the recovery effect is not due to electrostatic capacitance but to the presence of injected carriers which take a finite time to be swept out or to decay. This effect ("diffusion capacitance") is much greater than that due to the rated diode shunt capacitance.

The circuit shown in Fig. 4 was used to determine whether or not recovery really depends upon the diode loop resistance. The resistance the diode "sees" is the series resistor and the resistance of the parallel branches which contribute about 250 ohms. The capacitor in conjunction with the battery and the 1,000 ohm resistor constitute the forward current supply.

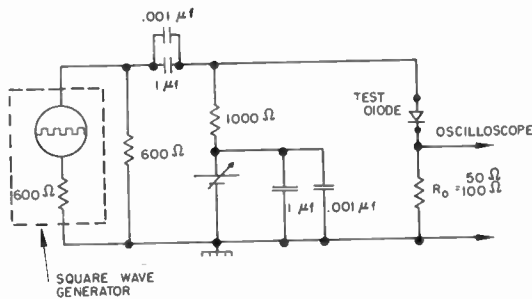

Fig. 4—Circuit for observing the effect of different diode-loop resistances.

Fig. 5 shows the effect produced by changing the loop resistance. In both cases the forward current was 30 ma, the reverse voltage -35v, and the frequency 50 kilocycles per second. The sensitivity is the same for both traces. As the loop resistance is increased by changing the series resistor, the recovery to a given back resistance becomes slower, since the same number of injected carriers was initially present. This is an important effect. Since in many applications there may be several thousand ohms in the diode loop, recovery time necessarily increases over that of the low resistance circuit.

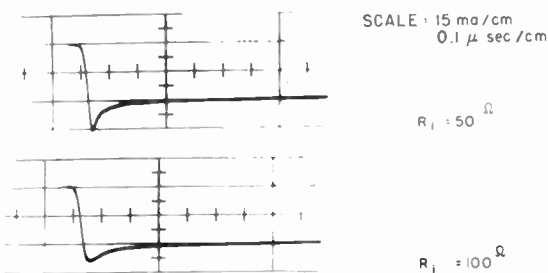

Fig. 5—Reverse recovery as a function of diode-loop resistance.

Assume that a test application calls for an R_0 of 2,000 ohms in series with a diode. A large signal amplitude will be observed because of the IR drop due to forward current. However, that part of the trace which is of principal interest is relatively small. The permissible oscillo-

scope sensitivity will be determined by the maximum signal that can be applied without overloading. To avoid this difficulty, the voltage drop across the 2,000 ohm resistor is reduced during the forward current period by shunting it with one or more diodes to by-pass the forward current.⁴

International Business Machines Corp. pioneered in the setting of quantitative measurements and specifications of diode recovery characteristics. The original IBM test circuit⁵ is shown in Fig. 6. It is essentially the

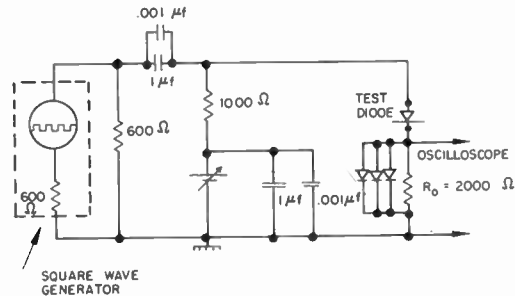

Fig. 6—IBM recovery circuit with semiconductor by-pass diodes.

same as that of Fig. 4 except that $R_0 = 2,000$ ohms and it includes three shunt diodes. Three shunt diodes are used in order to present a low resistance across R_0 in the forward direction, thus minimizing oscilloscope saturation. Selecting by-pass diodes with short recoveries should yield fairly reliable results, but only if the recovery of the diode under test is relatively long. Unfortunately, we are not looking for long recoveries but for short ones and, hence, find ourselves momentarily in a dilemma.

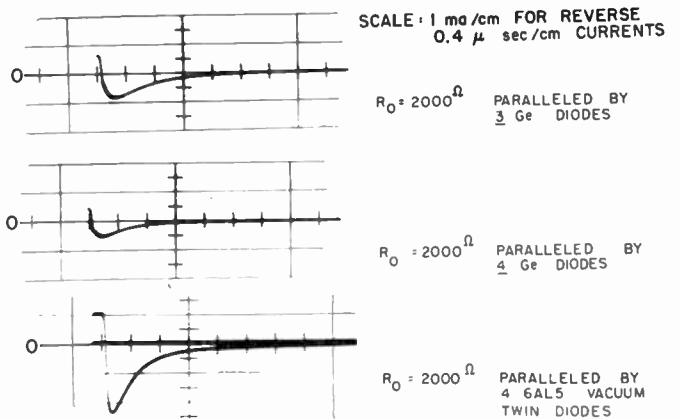

Fig. 7—Effect of by-pass diodes.

For the upper trace in Fig. 7, three germanium point-contact diodes with recoveries a little better than that of the test diode were chosen. Note that the forward current is scaled down appreciably so that the sensitivity can be increased by a factor of 15. For reverse currents the sensitivity is 1 ma/major division.

⁴ D. J. Crawford and H. F. Heath, Jr., "Germanium Diode Testing Program," Paper presented at IRE Convention, New York, N. Y.; March 16, 1952.

⁵ *Ibid.*

The center trace was obtained by adding another diode in parallel with the three already there. This fourth diode also displayed excellent dc characteristics and a recovery comparable to that of the test diode. What could be considered a better recovery of the test diode is observed. This would, of course, be untrue; the output resistor is shunted by a lower resistance in the time range of interest because of poor recovery characteristics of the additional shunting diode. Aside from the objection of measuring one unknown with another unknown, the comparison of these oscillograms shows that it takes only one poor recovery by-pass diode to give unreliable results.

To overcome these difficulties the original IBM circuit was modified by using four 6AL5 twin diodes to shunt the 2,000 ohms resistor. Vacuum tubes were chosen because of their negligible transient effects. The resulting recovery under the same conditions (30 ma forward current, -35v reverse voltage, and a square-wave frequency of 50 kilocycles per second) is seen in the lower trace.

Fig. 8 is a diagram of the modified IBM circuit which furnishes reproducible results. The voltage divider in conjunction with the 1.5v battery balances out the residual current of the vacuum diodes. The filament transformer supplies heater current and operates the mercury relay which provides a ground reference on the oscilloscope display.

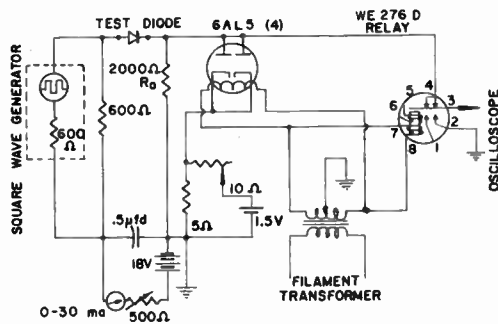

Fig. 8—Modified IBM circuit.

The use by IBM of a cathode follower between the test circuit output and the oscilloscope gives an even more correct picture of the diode response at the shorter times. This is because the shunt capacitance of the scope input across R_0 is reduced.

Fig. 9 shows the dependence of diode reverse recovery on forward current using the modified IBM circuit. The final value of the reverse current shows a marked increase for the case of 30 ma forward current, principally due to heating of the crystal. The traces are positioned so that the graduated horizontal line corresponds to a diode back resistance of 400,000 ohms.

Voltage pulses are most often used in pulse testing in preference to current pulses. A constant-current gener-

ator which can supply currents into a load which may have resistances of the order of megohms becomes very dependent on capacitance effects. Most circuit applications lie between the constant-voltage and the constant-current situations. As the resistances involved increase, it becomes more meaningful to observe the rate of voltage rise across the diode rather than the current through it, corresponding more closely to a constant-current test.

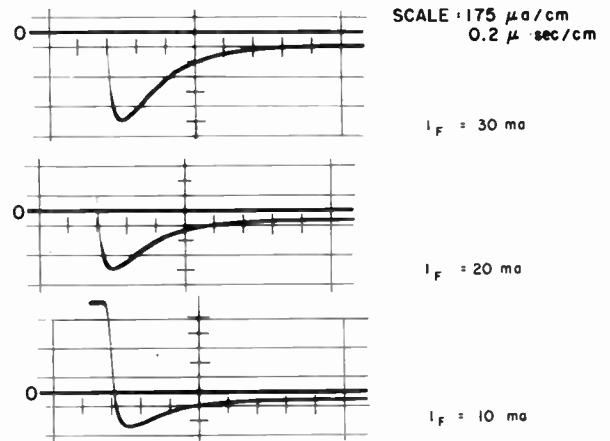

Fig. 9—Reverse recovery as a function of forward current using modified IBM circuit.

The circuit shown in Fig. 10 was developed by the Bell Telephone Laboratories.⁶ Both forward and reverse currents are furnished from batteries, and switching is done by a mercury relay. The reverse current will be constant only during the early part of the transient

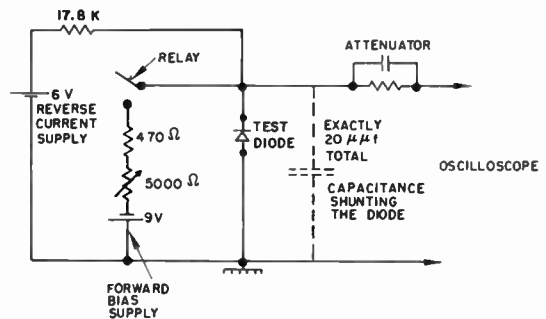

Fig. 10—Bell Telephone Laboratories recovery circuit.

when the diode resistance is low compared to 17,800 ohms. Furthermore, this voltage transient depends strongly upon the shunt capacitance. For this reason a fixed total shunt capacitance is specified. The oscillogram in Fig. 11 shows the voltage across the diode and 20 micromicrofarads parallel combination. The criterion used is to measure the time required until a given reverse voltage drop appears across the diode, with the initial forward current being adjusted to a specific value.

⁶ Personal communication with J. R. Harris of Bell Telephone Laboratories.



Fig. 11—Voltage drop across diode using BTL circuit.

The effect of diode recovery upon rectification is of interest because of the degradation of high-frequency operation when heavy currents are drawn. In order to look into this, a circuit was employed which would show the worst case; namely, drawing high dc load currents and, hence, high currents through the diode during the conduction cycle, resulting in heavy minority carrier injection.

Using a load resistance of 51 ohms rather than the conventional 5,000 ohms, a finite time is required to get reasonably low reverse currents. Conduction occurs in what should be the cut-off period. Forward recovery time which may be of the order of several microseconds results in decreasing the rectification efficiency at relatively low frequencies if heavy currents are drawn from the diode. Fig. 12 represents rectification efficiency vs frequency for a diode passing high load currents. The rectification efficiency has been normalized at 10^4 cps. Much higher rectification efficiencies can of course be obtained at the higher frequencies when the conventional 5,000 ohms are used.

CONCLUSION

The pulsing of germanium point-contact diodes shows that a forced impedance change cannot be accomplished instantaneously. A period of time is necessary before the diode recovers; this occurs in both the reverse and forward directions. Forward recovery time is unimportant in many applications because the forward impedance reaches a small value almost instantly even though the time to attain the final forward resistance itself might be relatively long. The back recovery time is usually more

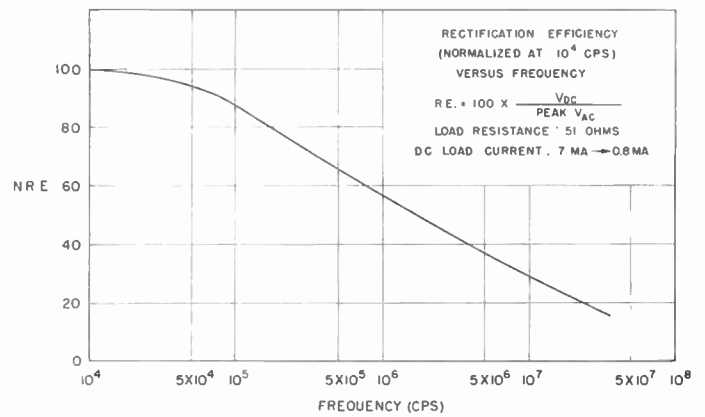

Fig. 12—Rectification efficiency vs frequency for heavily-loaded diode, normalized to 10^4 cps.

important because the back resistance builds up gradually following roughly an exponential except for the millimicrosecond range. The reverse recovery time depends upon forward current, loop impedance, reverse voltage, and diode temperature, as well as on the physical parameters of the diode itself.

The present state of transient response analysis and measurement necessitates the following approach: After carefully screening diode applications, it may appear that there are certain conditions which are found in a majority of cases. Conditions can then be evaluated to specify the test to be used as a standard. From this standard, it is possible to extrapolate either through analysis or by empirical methods to other conditions which might occur in a particular application. A standard test would in this manner provide the information necessary to tell whether or not a certain diode is suitable for the applications under consideration. It is urged that a test circuit such as that of Fig. 8 be used throughout the electronics industry and that it be used in all possible cases. The use of a different test circuit for each diode application would impose an impossible load on the diode manufacturers.



On the Physical Realizability of Linear Non-Reciprocal Networks*

H. J. CARLIN†, SENIOR MEMBER, IRE

Summary—The necessary and sufficient conditions are given that a matrix with arbitrary complex number elements be the impedance, admittance or scattering matrix of a physical linear reciprocal or non-reciprocal network. A canonical form for non-reciprocal network synthesis is presented which applies to any linear n -terminal pair (n -port) system at any fixed frequency. If the network is passive the only circuit element required in addition to lossless inductors, capacitors, transformers and positive resistors is the gyration. If the network is active, negative resistors and gyrators must be used in addition to conventional passive elements. Some discussion of matrixes with frequency variable elements is also given.

THE GYRATOR

THE ELEMENTS used in the synthesis of reciprocal, lumped, linear networks include resistors, inductances, capacitors, and ideal transformers. It has been shown¹⁻³ that these elements are sufficient to realize any linear, lumped, passive reciprocal network with n -terminal pairs (n -port). A new circuit element the "gyrator" has recently been proposed by Tellegen⁴ to apply to non-reciprocal networks. The gyrator is a lossless transducer which may be mathematically defined as the two-port of Fig. 1 whose open-circuit impedance matrix is given as:

$$Z = \begin{bmatrix} 0 & -\alpha \\ \alpha & 0 \end{bmatrix} \quad (1)$$

For comparison purposes Fig. 1 also shows an ideal transformer and a general two-port.

Realizations of this ideal non-reciprocal passive element have been constructed or proposed. Ferrites permit the realization of a gyrator at microwave frequencies,⁵ and other investigators have discussed the realization of a gyrator at low frequencies by using solid-state germanium crystals, which applies the Hall effect.^{6,7}

It is the purpose of this paper to present the necessary and sufficient conditions for the realizability of any arbitrary linear, non-reciprocal, passive network (n -port) at any single frequency. As a corollary of this result, the necessary and sufficient conditions for realizing an arbitrary linear active network (n -port) at any single frequency will also be given. An important result of this paper is its demonstration that the realization of arbitrary non-reciprocal linear passive networks requires only the conventional circuit elements discussed in the first paragraph plus the one new element, the gyrator, defined in (1). To realize arbitrary active networks in canonical form one needs negative resistance elements in addition to the gyrator.

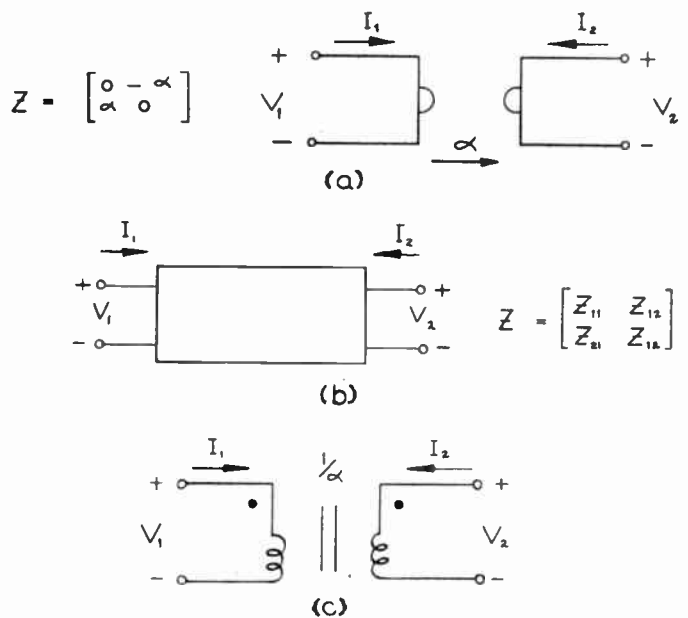

Fig. 1—Reciprocal and non-reciprocal circuits. (a) Gyrator. (b) General two-port. (c) Ideal Transformer.

REALIZABILITY OF AN ASYMMETRIC IMPEDANCE MATRIX WITH COMPLEX ELEMENTS

In order to clarify the range of application of this paper, the following definitions are specified:

1. Linear Network—One in which the principle of superposition is satisfied.
2. Passive Network—A network in which the average dissipated power is non-negative when a set of sinusoidal excitations of arbitrary amplitude and phase is applied to the accessible terminal pairs of the network. (Since a major part of this paper is concerned with single-frequency synthesis this definition does not include requirements for non-

* Original manuscript received by the IRE, September 29, 1954; revised manuscript received, February 18, 1955. A portion of this work was sponsored by the Rome Air Development Center, Griffiss AF Base, Rome, N.Y., under contract AF-30(602)-387 with the Polytechnic Inst. of Brooklyn, Brooklyn, N.Y.

† Microwave Research Inst., Polytechnic Inst. of Brooklyn, Brooklyn, N.Y.

¹ Y. Oono, "Synthesis of a finite n -terminal network by a group of networks each of which contains only one ohmic resistance," *Jour. Math. Phys.*; April, 1950.

² M. Bayard, "Synthesis of N -Terminal Pair Networks," Proc. Symposium Modern Network Synthesis, Polytechnic Inst. of Brooklyn, Brooklyn, N.Y., vol. 1, 1952.

³ V. Bélévitch, "Synthesis of an n -terminal pair network from a prescribed scattering matrix," (In French), *Ann. Telecommun.*, vol. 6, pp. 302-312; November, 1951.

⁴ B. D. H. Tellegen, "The gyrator—a new electric network element," *Phillips Res. Rep.*, vol. 3, pp. 81-101; April, 1948.

⁵ C. L. Hogan, "The ferromagnetic Faraday effect at microwave frequencies and its applications," *Bell Sys. Tech. Jour.*, vol. 31; January, 1952.

⁶ R. F. Wick, "Solution of the field problem of the germanium gyrator," *Jour. Appl. Phys.*, vol. 25, pp. 741-756; June, 1954.

⁷ W. Shockley and W. P. Mason, "Dissected amplifiers using negative resistance," *Jour. Appl. Phys.*, vol. 25, p. 677; May, 1954.

negative total energy with complex frequency excitation. This restriction is considered in the last section, "Network Properties in the Frequency Domain.")

3. Lumped Positive Network—A network which only contains positive resistors, positive inductances, positive capacitors, ideal transformers, gyrators.

Note that a network defined according to 1, 2, 3 above does not necessarily obey the law of reciprocity. Furthermore a network with distributed parameter elements may still satisfy 1 and 2.

The open-circuit impedance matrix⁸ Z , of a non-reciprocal n -port with complex number elements (i.e., at any single frequency), has a quite arbitrary appearance with no obvious symmetries. It is possible to write such a matrix as the sum of two matrixes, each of which possesses special symmetry properties. Thus

$$Z = Z_H + Z_S \quad (2)$$

$$Z_H = \frac{1}{2}[Z + Z^{*T}] \quad (3)$$

$$Z_S = \frac{1}{2}[Z - Z^{*T}] \quad (4)$$

The asterisk denotes "complex conjugate," and the superscript T means matrix transpose. The matrix Z_H is an "hermitian matrix"^{9,10} and may be readily shown to satisfy

$$Z_H = Z_H^{*T} \quad (5)$$

That is, elements symmetrically located with respect to the principal diagonal are complex conjugates of each other, and principal diagonal elements are all real. In a reciprocal network the real part of Z is a special case of an hermitian matrix.

The matrix Z_S is a "skew-hermitian matrix"⁹ and satisfies

$$Z_S = -Z_S^{*T} \quad (6)$$

with elements symmetrically located about the main diagonal negative conjugates of each other and main diagonal elements purely imaginary. The reactance matrix of a reciprocal network is a special case of a skew-symmetric matrix.

Any arbitrary square matrix can be written as the sum given by (2). In terms of Z_H and Z_S the necessary condition that any physical linear passive network (see definitions 1, 2) must satisfy is that Z_H , the hermitian part of Z , the open-circuit impedance matrix,¹¹ be the matrix of a positive definite or semi-definite hermitian form.⁸⁻¹⁰ The derivation of this result follows from a

⁸ Upper case letters will represent matrixes, lower case scalars.

⁹ I. S. Sokolnikoff, "Tensor Analysis," John Wiley & Sons, Inc., New York, N.Y., Ch. 1; 1951.

¹⁰ A hermitian matrix is associated with the hermitian form $P = X^{*T}Z_H X$ where X is a column matrix of complex elements. P is always a real scalar, and if it is always positive for any X then the form is positive definite (PD). If P is non-negative (sometimes zero) the form is positive semi-definite (PSD). If the elements of X are the currents at the network terminals then P is the real power absorbed.

¹¹ All of the following discussion is confined to impedance matrixes, but a simple application of duality gives exactly similar results in terms of the short-circuit admittance matrix.

straightforward application of the law of the conservation of energy.^{12,13} In particular any lumped positive network (definition 3) must satisfy definitions 1 and 2.

It remains now to prove that the positive character of the hermitian part of Z is sufficient for physical realizability in the form of a lumped positive network. To show this, a method for synthesizing an open circuit impedance matrix in terms of conventional circuit elements and gyrators will be given. Completion of this proof will show that any linear, passive network can be represented in a form which satisfies definition 3.

Suppose, then, that an arbitrary $n \times n$ matrix Z is given with complex number elements whose hermitian part is positive definite or semi-definite (PD or PSD) and a network is to be synthesized with Z as open-circuit impedance matrix. The matrix Z is first resolved into the components Z_H and Z_S , as in (2), (3) and (4). Z_H and Z_S will then be synthesized separately as n -ports and the final n -port network is the series interconnection of these two.

Consider first the skew-symmetric part Z_S . This may be written as the sum of real and imaginary part matrixes. Thus

$$Z_S = \text{Re } Z_S + j \text{Im } Z_S = R_S + jX_S \quad (7)$$

Referring to (6) it is clear that X_S is symmetric ($x_{ij} = x_{ji}$), and R_S is skew-symmetric ($r_{ij} = -r_{ji}$, $r_{ii} = 0$). X_S is easily synthesized as an n -port network of positive and negative reactances. This can be done by simply laying out a suitable n -mesh network with n -accessible pairs of terminals since there are no restrictions on negative elements.¹⁴ The negative elements are interpreted as capacitors, the positive elements as inductances.

The skew-symmetric part R_S of Z_S is an n -port network entirely composed of interconnected gyrators. Since the principal diagonal elements of R_S must be zero, there are a maximum of $[n(n-1)/2]$ gyrators which must be employed. The construction of the gyrator network can be accomplished always by connecting the gyrators so that terminals of $n-1$ of these are in series with each port of the network.¹⁵ An example of the process for a four-port network is, p. 611 in Fig. 2. The validity of this can be verified with the aid of (1). The extension to an arbitrary number of ports is clear.

¹² A. E. Laemmel, "Scattering Matrix Formulation of Microwave Networks," Proc. Symposium Modern Network Synthesis, Polytechnic Inst. of Brooklyn, Brooklyn, N.Y., vol. 1; 1952.

¹³ H. J. Carlin, "Theory and Application of Gyrator Networks," Microwave Res. Inst., Polytechnic Inst. of Brooklyn, Brooklyn, N.Y., Rept. R-355-53, PIB-289; March, 1954.

¹⁴ This can generally be done by inspection. However, a formal process is to write X_S as the sum of a purely diagonal matrix and $[n(n-1)/2]$ additional matrixes. Each of the latter has only two nonzero elements symmetrical about the main diagonal, and is readily realized as an n -port consisting of $n-2$ decoupled one-ports of zero input impedance plus a 2-port, T , of finite reactances. The diagonal matrix is realized as n -decoupled one-ports, each of whose input impedances is a diagonal element of the matrix. The series connection of all these is the required reactance n -port.

¹⁵ A formal procedure for realizing the all-gyrator network is to write R_S as the sum of $[n(n-1)/2]$ matrixes, each of which has two elements, is skew-symmetric, and is realized as a gyrator 2-port plus $n-2$ short-circuited one-ports. The series interconnection of these networks is the required realization of R_S .

The above realization does not result in the minimum number of gyrators. The minimum number, for an all gyrator network (i.e. one whose impedance matrix is real and skew-symmetric), can be shown¹³ to be $R/2$, where R is the rank of R_S (R is always even). To obtain this minimal form R_S is diagonalized along its skew diagonal and synthesized as the interconnection of gyrators and ideal transformers.

$$Z_S = \begin{bmatrix} 0 & -a_{12} & -a_{13} & -a_{14} \\ a_{12} & 0 & -a_{23} & -a_{24} \\ a_{13} & a_{23} & 0 & -a_{34} \\ a_{14} & a_{24} & a_{34} & 0 \end{bmatrix}$$

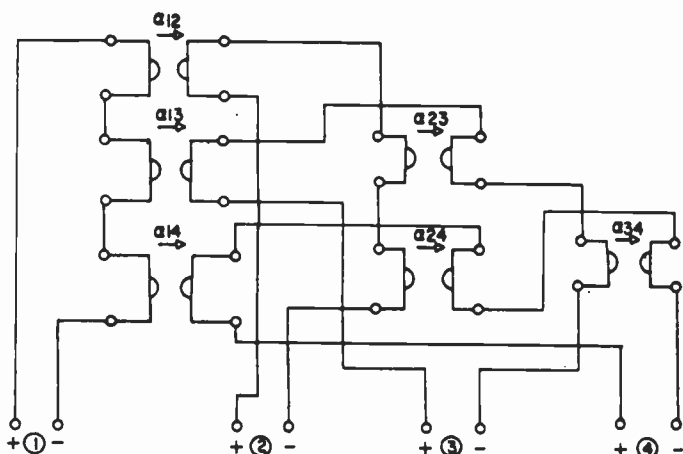

Fig. 2—Four-port all-gyrator network.

Returning to the original discussion, the skew-hermitian matrix Z_S is now realized by series interconnecting the networks representing R_S and jX_S .

The resolution of Z_H into real and imaginary parts as was done for Z_S does not lead to physical networks, and a somewhat more involved procedure must be used. The basis of the method used to synthesize Z_H depends on first transforming this matrix into a simple diagonal form with all elements off the main diagonal equal to zero. This diagonal matrix is symbolized by \bar{Z}_H . The transformation is performed in a special fashion so that the resulting diagonal matrix \bar{Z}_H is still hermitian. This means that the diagonal elements are all real and it is not a difficult matter to synthesize this transformed matrix as a group of resistors. The final step in the synthesis procedure is to interconnect the network corresponding to the diagonal matrix so as to get a new network whose impedance matrix is the original Z_H . This interconnection is specified by the form of the transformations used to obtain the simple diagonal form \bar{Z}_H . It is further shown that if Z_H is positive-definite or semi-definite, then the network for \bar{Z}_H consists of a number of *real positive* resistors. The interconnection of these resistors requires only conventional network elements *and gyrators* and can always be performed.

To see how this is done suppose a positive definite or

semi-definite $n \times n$ matrix Z_H with complex number elements is specified. This is to be the open-circuit impedance matrix of an unknown network with n -ports whose physical existence and synthesis must be demonstrated.

Assume a set of n currents, given by the column matrix of n rows, I_H , which exists at the ports of the unknown network. Suppose a new column matrix of n currents \bar{I}_H is formed satisfying the equation

$$I_H = U\bar{I}_H. \quad (8)$$

The matrix U has complex elements and n rows and columns, but for the moment is not further constrained.

Suppose further that the voltages V_H at the ports of the unknown network are transformed to give a new set of n voltages \bar{V}_H with

$$\bar{V}_H = U^{*T}V_H. \quad (9)$$

Then, since the unknown network must satisfy

$$V_H = Z_H I_H \quad (10)$$

at its accessible ports, substituting (8) and (9) into this gives

$$\bar{V}_H = \bar{Z}_H \bar{I}_H, \quad (11)$$

where

$$\bar{Z}_H = U^{*T}Z_H U. \quad (12)$$

The barred quantities may be considered associated with a new network whose currents and voltages satisfy (11) and (12). From algebraic considerations⁹ it can be shown that it is always possible, given Z_H hermitian and PD or PSD, to choose U so that \bar{Z}_H has the following properties:

1. \bar{Z}_H has only diagonal elements; all off-diagonal elements are zero.
2. \bar{Z}_H is hermitian, hence all diagonal elements are real.
3. \bar{Z}_H is PD or PSD. Since⁹ all principal minors of \bar{Z}_H must be non-negative, the elements of \bar{Z}_H are all positive or zero, and there are n elements.

A particular matrix U which can effect the desired diagonalization is one which satisfies⁹

$$UU^{*T} = I. \quad (13)$$

I is the identity matrix and the matrix U of (13) is said to be *unitary*.

Since the matrix \bar{Z}_H has n positive (or zero) diagonal elements and all off-diagonal elements are zero, it is simply represented as a network of n disconnected positive resistors (and possibly short circuits). The pair of terminals across each of these resistors constitutes a port of the network \bar{Z}_H . The form of this network is shown in Fig. 3(a), with resistors r_1, r_2, \dots, r_n .

Consider now the problem of taking the elementary resistor network and reconnecting it according to the transformation of (8) and (9) to obtain the required network with matrix Z_H . Typical voltage and current equations obtained from (8) and (9) are:

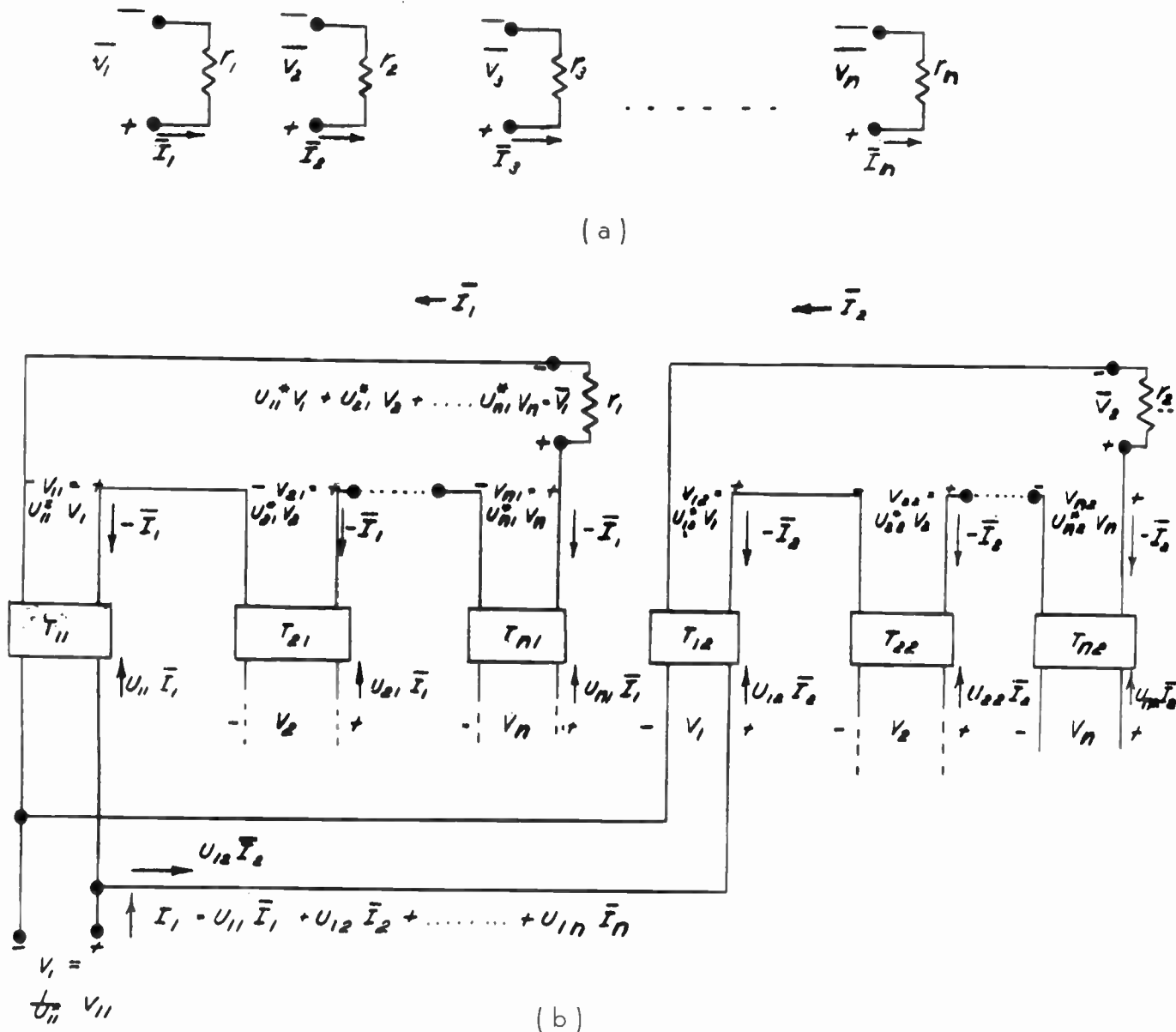

Fig. 3—Synthesis of non-reciprocal network. (a) Resistor network for diagonalized impedance matrix. (b) General circuit for an hermitian impedance matrix.

$$I_1 = u_{11} \bar{I}_1 + u_{12} \bar{I}_2 + \dots + u_{1n} \bar{I}_n \quad (14)$$

$$\bar{V}_1 = u_{11}^* V_1 + u_{21}^* V_2 + \dots + u_{n1}^* V_n \quad (15)$$

Now compare these two equations with the interconnected network of Fig. 3(b). It is clear that this interconnection represents all the equations of the form (14) and (15). Thus the complete network, resistors r_1, r_2, \dots , and two-ports labeled $T_{11}, T_{21}, \dots, T_{n1}$, is the required realization for Z_H . The only point still at issue is the construction of the two-ports T_{11}, T_{21}, \dots . Fig. 4(a), next page, shows a typical one, with voltages and currents at the terminals of which must satisfy

$$V_1 = \frac{1}{\beta^*} V_2 \quad (16)$$

$$I_1 = -\beta I_2 \quad (17)$$

with β an arbitrary complex number equal to a typical

element of the matrix U :

$$\beta = |\beta| e^{j\Phi} = u_{jk} \quad (18)$$

The impedance and admittance matrixes for this two-port do not exist, but by removing a gyrator a network can be obtained which does possess an impedance matrix and the synthesis may then be completed.

If a gyrator of ratio $1/|\beta|$ is removed from the network of Fig. 4(a) the result is as shown in Fig. 4(b). (Next page.) For the gyrator portion, and with polarities and symbols as shown on the figure:

$$V_1 = -\frac{1}{|\beta|} I_2' = \frac{1}{|\beta|} \bar{I}_1 \quad (19)$$

$$V_2' = \bar{V}_1 = \frac{1}{|\beta|} I_1 \quad (20)$$

Substituting (17) into (20) and (19) into (16):

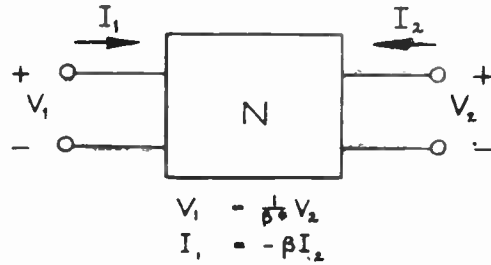

(a)

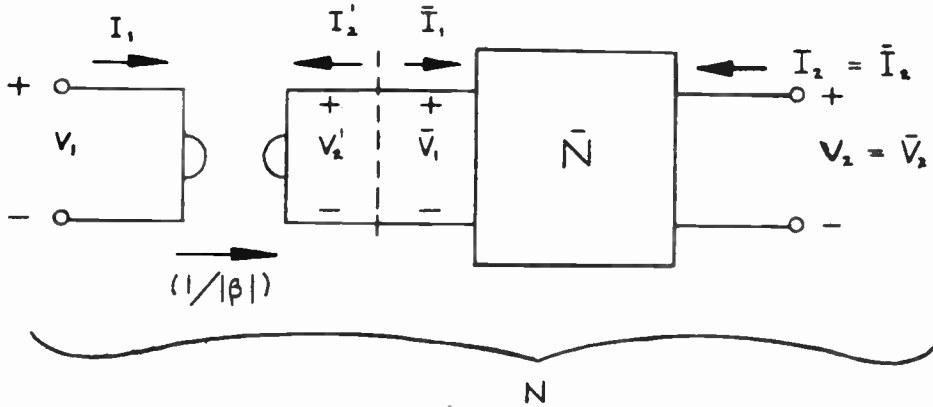

(b)

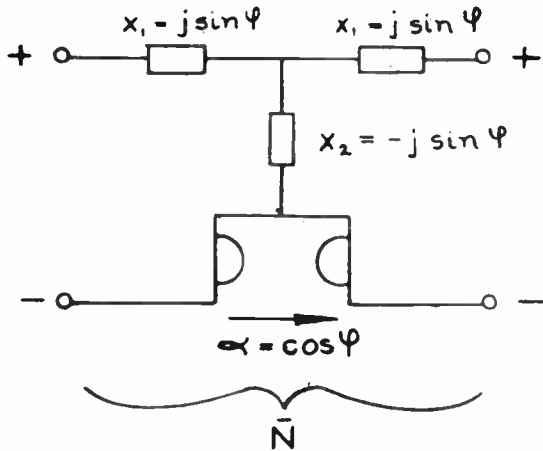

(c)

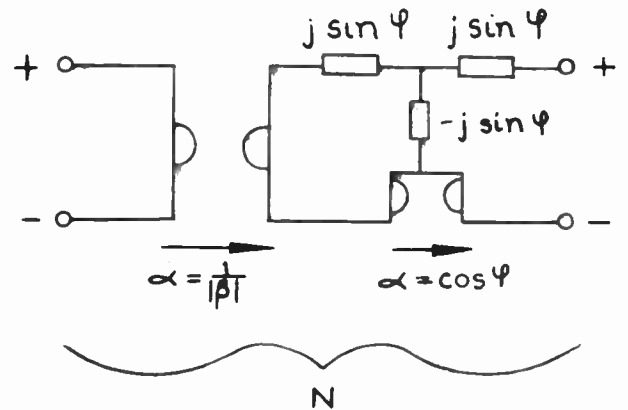

(d)

Fig. 4—Representation of complex ideal transformer.

$$\bar{V}_1 = -\frac{\beta}{|\beta|} I_1 = -\epsilon^{j\Phi} \bar{I}_1 \tag{21}$$

$$V_2 = \bar{V}_2 = \frac{\beta^*}{|\beta|} \bar{I}_1 = \epsilon^{-j\Phi} \bar{I}_1. \tag{22}$$

The impedance matrix of the network \bar{N} is therefore:

$$\bar{Z} = \begin{bmatrix} 0 & -\epsilon^{j\Phi} \\ \epsilon^{-j\Phi} & 0 \end{bmatrix} = \begin{bmatrix} 0 & (-\cos \Phi - j \sin \Phi) \\ (\cos \Phi - j \sin \Phi) & 0 \end{bmatrix}. \tag{23}$$

This is a skew-symmetric matrix and is easily constructed according to the method described above for Z_S as the interconnection of a gyrator and a reactance network. The resultant network representation for \bar{N} is given in Fig. 4(c). The complete complex ideal transformer is shown in Fig. 4(d).

The final network is obtained by series interconnecting the networks for Z_H and Z_S to give a structure which realizes Z and has only gyrators in addition to conven-

tional reciprocal circuit elements. The following theorem may therefore be stated:

Theorem 1

The necessary and sufficient condition for a linear, passive network (definitions 1 and 2), which possesses an open-circuit impedance matrix with complex number elements to be physically realizable as a lumped positive network (definition 3), is that the hermitian part of the impedance matrix be positive definite or semi-definite. This implies that the network realization never requires elements other than the conventional reciprocal types and gyrators. The theorem is also true (by a dual proof) if "admittance" replaces the word "impedance."

REALIZABILITY OF A NON-RECIPROCAL NETWORK WHICH HAS NO IMPEDANCE OR ADMITTANCE MATRIX

In many physical situations a network may have neither an open-circuit impedance matrix nor a short-circuit admittance matrix. A simple example of this is the ideal transformer of Fig. 1(c). In order to handle the synthesis problem for all such degenerate cases, the scattering formulation of the network equations will be used.^{12,16,17} This is important since any given passive network always possesses a scattering matrix.

The first step in the general proof will be to determine the requirements on a normalized scattering matrix of a network, when the impedance (or admittance) matrix exists,¹⁸ corresponding to Theorem 1.

The relation between the impedance matrix Z and the normalized voltage scattering matrix S is:^{12,16,17}

$$S = (Z - I)(Z + I)^{-1}. \quad (24)$$

In this equation I is the identity matrix, with unit diagonal elements and zeros everywhere else, and the $^{-1}$ superscript indicates the matrix inverse. Z as determined from (24) is

$$Z = 2[I - S]^{-1} - I. \quad (25)$$

The hermitian part of Z is given by (3) as $\frac{1}{2}(Z + Z^{*T})$ and using this in conjunction with (25):

$$\begin{aligned} Z_H &= \frac{1}{2}[2(I - S)^{-1} - I + 2(I - S^{*T})^{-1} - I] \\ &= (I - S)^{-1} - (I + S^{*T})^{-1}. \end{aligned}$$

Now premultiply the above equation by $(I - S^{*T})$, and postmultiply it by $[I - S]$ and collect terms. The result is

$$I - S^{*T}S = (I - S^{*T})Z_H(I - S). \quad (26)$$

¹⁶ C. Montgomery, R. H. Dicke, and E. M. Purcell, "Principles of Microwave Circuits," McGraw-Hill Book Co., Inc., New York, N.Y., 1948.

¹⁷ H. J. Carlin, "An Introduction to Use of the Scattering Matrix in Network Theory," Microwave Res. Inst., Polytechnic Inst. of Brooklyn, Brooklyn, N.Y., Rep. R-366-54, PIB-300; August, 1954.

¹⁸ This portion of the proof is similar to that given in reference 3 for reciprocal networks.

Several points are important regarding (26). In the first place the right- and left-hand sides are both hermitian matrixes. This only depends on the fact that Z_H is hermitian. Further $(I - S)$ (and hence $I - S^{*T}$) has an inverse, since it is presumed that Z , as given by (25), exists. Thus $I - S$ is "nonsingular." As a consequence of this fact it follows that if Z_H is the matrix of a PD or PSD hermitian form, then $I - S^{*T}S$ as defined by (26) is also the matrix of a PD or PSD hermitian form. The converse of this statement is also valid, as may easily be demonstrated by pre- and post-multiplying (26) by $(I - S^{*T})^{-1}$ and $(I - S)^{-1}$ respectively.

The necessary and sufficient conditions for the realizability of a network with an impedance matrix may therefore be stated in terms of the scattering matrix as follows:

Theorem 2

All linear passive non-reciprocal networks which have an impedance matrix must possess a scattering matrix which satisfies the requirement that $I - S^{*T}S$ be the matrix of a PD or PSD hermitian form. Further if a scattering matrix satisfies this requirement and a Z matrix with complex number elements exists based on (25), then a lumped positive network which has the specified scattering matrix and contains only conventional circuit elements and gyrators can be constructed.

The case of a lossless network is of special importance. Such a network has a matrix $Z_H = 0$, so that for no dissipative elements (26) becomes

$$S^{*T}S = I \text{ (lossless case)}. \quad (27)$$

The impedance matrix of a network with a unitary scattering matrix is skew-hermitian. Further, if the scattering matrix is real and unitary the impedance matrix is real, skew-symmetric, and realizable with gyrators only, and the technique described in the previous section for an all-gyrator network applies. On the other hand, if the impedance matrix is *purely imaginary but non-reciprocal* its hermitian part cannot be PD or PSD, hence such a matrix is *not* physically realizable.

The necessary and sufficient conditions for the realizability of a network in terms of its scattering matrix have all been premised on the existence of an impedance matrix. These conditions also are valid even when neither the impedance nor the admittance matrix exists. A method of proving the sufficiency¹⁹ of the requirements on the scattering matrix given above when no impedance matrix exists is to show that it is always possible to remove unity gyrators from a network without an impedance matrix so as to create a residual network. This residual network still satisfies the condition that $(I - S^{*T}S)$ be the matrix of a PD or PSD hermitian form but in addition possesses an impedance matrix.

¹⁹ Necessity is easily proved, since it is readily shown (see reference 17) without recourse to Z that dissipated network power is $V_i^{*T}(I - S^{*T}S)V_i$, where V_i is the column matrix of incident voltages at the network ports. Thus, for non-negative power it is necessary that $I - S^{*T}S$ be the matrix of a PD or PSD hermitian form.

The proof is given below.

A matrix Q is formed from a prescribed scattering matrix.

$$Q = I - S^*TS. \tag{28}$$

Q is an hermitian matrix and is the matrix of a positive definite (PD) or positive semi-definite (PSD) hermitian form. Further, it is presumed that S has no corresponding impedance matrix. That is, in the transformation

$$Z = 2[I - S]^{-1} - I \tag{29}$$

the matrix $I - S$ is singular.

The characteristic equation of S may be written^{9,16}

$$\det [S - \lambda I] = 0, \tag{30}$$

where "det" means "determinant of," and λ is a scalar eigenvalue.

The singular nature of $I - S$ may be expressed by stating that one of the eigenvalues of S is unity. A method of altering the given network to remove this eigenvalue will now be presented.

Suppose a unit gyrator is removed from port 1 of the unknown network with scattering matrix S . The gyrator has scattering matrix

$$\begin{bmatrix} 0 & -1 \\ 1 & 0 \end{bmatrix}.$$

The relation between incident voltages and the reflected voltage at port 1 of the original S matrix is:

$$v_{r1} = s_{11}v_{i1} + s_{12}v_{i2} + \dots + s_{1n}v_{in}. \tag{31}$$

The incident and reflected voltages at port 1 of the new network \bar{v}_{i1} , \bar{v}_{r1} are equal, respectively, to the reflected and incident voltage v_{r2g} , v_{i2g} at the output port of the gyrator,

$$\bar{v}_{r1} = \bar{v}_{i2g} \tag{32a}$$

$$\bar{v}_{i1} = \bar{v}_{r2g} \tag{32b}$$

and from the gyrator scattering matrix

$$v_{i2g} = -v_{r1} = \bar{v}_{r1} \tag{33a}$$

$$v_{r2g} = v_{i1} = \bar{v}_{i1}. \tag{33b}$$

Therefore (31) becomes

$$\bar{v}_{r1} = -v_{r1} = -s_{11}\bar{v}_{i1} - s_{12}v_{i2} - s_{1n}v_{in}. \tag{34}$$

The residual network with gyrator removed therefore has scattering matrix

$$\begin{bmatrix} -s_{11} & -s_{12} & -s_{13} & \dots & -s_{1n} \\ s_{21} & s_{22} & s_{23} & \dots & s_{2n} \\ \vdots & & & & \\ s_{n1} & s_{n2} & \dots & \dots & s_{nn} \end{bmatrix}$$

where s_{ij} is the general coefficient of the original matrix. Observe that the removal of the unit gyrator from port 1 has changed the signs of all the elements in row 1 of S .

In a similar fashion removal of a unit gyrator from port j changes all the signs in row j of S . This process is therefore capable of giving a new scattering matrix \bar{S} related to the original one S by

$$\bar{S} = \Lambda_k S, \tag{35a}$$

where the matrix Λ_k is nonsingular and has only diagonal elements. These are individually restricted to values ± 1 .

$$\Lambda_k = \begin{bmatrix} a_{11} & 0 & 0 & \dots \\ 0 & a_{21} & 0 & \dots \\ 0 & 0 & a_{33} & \dots \\ \vdots & & & \vdots \\ 0 & 0 & \dots & a_{nn} \end{bmatrix}. \tag{35b}$$

Note that

$$a_{jj} = \pm 1, \quad a_{ij} = 0 \quad i \neq j \tag{35c}$$

$$\Lambda_k^{-1} = \Lambda_k. \tag{36}$$

The hermitian matrix Q for the new network is

$$\begin{aligned} \bar{Q} &= I - \bar{S}^*T\bar{S} \\ &= I - S^*T\Lambda_k\Lambda_k S \end{aligned}$$

and by (36) $\Lambda_k\Lambda_k = I$, so that

$$\bar{Q} = Q. \tag{37}$$

In other words, removing gyrators from the unknown network as described results in a new network with a \bar{Q} matrix which is the same as Q and hence is PD or PSD if this was the character of the original Q matrix.

It will now be shown that it is always possible to choose $a\Lambda_k$ matrix to give a nonsingular $I - S$ matrix. To do this it will be proved that the set of all possible matrixes $\Lambda_k S$ cannot have a common eigenvalue.²⁰

Suppose that the $\Lambda_k S$ have a common eigenvalue λ_0 . Then for every possible Λ_k (If Λ_k has n rows, there are 2^n Λ_k matrixes):

$$\det [\Lambda_k S - \lambda_0 I] = 0_{k=1,2,\dots,2^n}. \tag{38}$$

This can be written as a set of 2^n linear homogeneous equations, one for each of the Λ_k . Each of these equations can be written as a sum of 2^n terms, with each term a product of one of the 2^n principal minors of S and some power of λ_0 .

These terms can be regarded as the unknowns of the homogeneous set. One of the terms is $\det S$ (the only n th order principal minor) times λ_0^0 , and one of the terms is λ_0^n (here the zeroth order principal minor, unity, multiplies λ_0^n). Since multiplying any number of rows of a square matrix by minus one changes the signs of exactly half the principal minors, each equation of the homogeneous set just described, when compared to

²⁰ The proof of this statement is due to H. Kurss of the Microwave Res. Inst., Polytechnic Inst. of Brooklyn, Brooklyn, N.Y.

any other equation in the set, has exactly half the signs changed. Thus the homogeneous set of equations has a coefficient matrix in which every term is ± 1 , and half the signs of the elements in any row are different from corresponding elements in any other row. The product of any two rows is therefore zero. Consider the linear dependence of the rows $\alpha_1, \alpha_2, \dots$ of this coefficient matrix:

$$C_1\alpha_1 + C_2\alpha_2 + \dots + C_{2n}\alpha_{2n} = 0. \tag{39}$$

If this equation is multiplied by the column matrix α_j^T all terms except the j th are zero and

$$C_j\alpha_j\alpha_j^T = 0, \tag{40}$$

and since $\alpha_j\alpha_j^T$ is 2^n (the number of elements in α_j) the only solution of (39) is $C_1=C_2=\dots=C_{2n}=0$. Therefore, the homogeneous set of equations is linearly independent and the only solution is that each term (a power of λ_0 times a principal minor) is zero. In particular, the term

$$\lambda_0^n = 0, \tag{41}$$

so that the only possible common eigenvalue to the set of matrixes $\Lambda_n \times S$ is $\lambda_0=0$. Accordingly, at least one of these equations lacks the eigenvalue unity. (If the admittance matrix were being considered the same proof would be used to show that the eigenvalue -1 can be eliminated).

It has therefore been shown that the a matrix $\bar{S}=\Lambda_K S$ can be found which has an impedance matrix. Further, \bar{S} has a \bar{Q} matrix which is PD or PSD and therefore by Theorem 2 the matrix \bar{S} can be realized by a physical network. The final network for S is formed by augmenting the network for \bar{S} with the gyrators that were removed in order to make $I-\bar{S}$ nonsingular.

A final theorem for the general realizability of a linear, passive, lumped non-reciprocal n -port may therefore be stated.

Theorem 3

The necessary and sufficient condition that a linear, passive network (definitions 1 and 2) be physically realizable as a lumped positive network (definition 3) at any single frequency is that the normalized scattering matrix with complex number elements, satisfies the requirement that $I-S^{*T}S$ be the matrix of a PD or PSD hermitian form. This implies that if a scattering matrix satisfies this requirement the network can always be constructed with conventional circuit elements and gyrators.

EXTENSION TO LINEAR ACTIVE CIRCUITS

The general realizability theorems of the previous sections, which were established for passive networks at any single frequency, can easily be extended to cover the case of active circuits. The proof of Theorem 1 for passive circuits required that Z_H be the matrix of a PD

or PSD hermitian form. If this is not the case, the canonical form of Fig. 3 will merely contain a number of negative resistors,²¹ but synthesis process is unchanged, so the following general theorem may be stated.

Theorem 4

Any open-circuit impedance matrix with complex number elements whose hermitian part is not PD or PSD can be represented in a canonical network form. The network elements need only be restricted to conventional types with the addition of gyrators and negative resistors.

A theorem similar to Theorem 4 and of the form of Theorem 3 applies to a network which has no impedance or admittance matrix, and whose scattering matrix does not satisfy the requirement that $I-S^{*T}S$ be the matrix of a PD or PSD hermitian form.

The significance of the above general theorem, which is a generalization of results given by Shekel,^{22,23} is that any linear vacuum tube or transistor circuit with an arbitrary number of ports has an equivalent canonical form at any frequency which employs only ordinary reciprocal elements, gyrators, and negative resistors.

Recent advances indicate that the last two elements may eventually be realized as solid-state devices; the former as a negative resistance diode,²⁴ the latter as a Hall effect element.^{6,7}

EXAMPLE—SYNTHESIS OF A TWO-PORT

Suppose the prescribed impedance matrix is:

$$Z = \begin{bmatrix} r_{11} + jx_{11} & r_{12} + jx_{12} \\ r_{21} + jx_{21} & r_{22} + jx_{22} \end{bmatrix}. \tag{42}$$

Then

$$\begin{aligned} Z_H &= \begin{bmatrix} r_{11} & \frac{r_{12}+r_{21}}{2} + \frac{x_{12}-x_{21}}{2} \\ \frac{r_{12}+r_{21}}{2} - j\frac{x_{12}-x_{21}}{2} & r_{22} \end{bmatrix} \\ &= \begin{bmatrix} r_{11} & r'_{12} + jx'_{12} \\ r'_{12} - jx'_{12} & r_{22} \end{bmatrix} \end{aligned} \tag{43}$$

and

$$Z_S = \begin{bmatrix} ix_{11} & \frac{r_{12}-r_{21}}{2} + j\frac{x_{12}+x_{21}}{2} \\ -\frac{r_{12}-r_{21}}{2} + j\frac{x_{12}+x_{21}}{2} & jx_{22} \end{bmatrix}$$

²¹ The number of negative resistor elements is equal to $\frac{1}{2}$ the rank minus the signature of Z_H .

²² J. Shekel, "The gyrator as a 3-terminal element," Proc. I.R.E., vol. 41, pp. 1014-1016; August, 1953.

²³ J. Shekel, "Reciprocity relations in active 3-terminal networks," Proc. I.R.E., vol. 42, pp. 1268-1270; August, 1954.

²⁴ W. Shockley, "Negative resistance arising from transit time in semi-conductor diodes," Bell Sys. Tech. Jour., vol. 33, pp. 799-826; July, 1954.

$$= \begin{bmatrix} jx_{11} & r'_{12} + jx'_{12} \\ -r'_{12} + jx'_{12} & jx_{22} \end{bmatrix}. \quad (44)$$

Diagonalization of Z_H is achieved with

$$U = \begin{bmatrix} 1 & 0 \\ -\frac{1}{r_{22}}(r'_{12} - jx'_{12}) & 1 \end{bmatrix} \quad (45)$$

to give

$$\begin{aligned} \bar{Z}_H = U^* Z_H U &= \begin{bmatrix} \frac{r_{11}r_{22} - (r'_{12} + x'_{12})^2}{r_{22}} & 0 \\ 0 & r_{22} \end{bmatrix} \\ &= \begin{bmatrix} r_a & 0 \\ 0 & r_b \end{bmatrix}. \end{aligned} \quad (46)$$

Thus the constants of the complex ideal transformer [(18)] as obtained from (45) are:

$$|\beta| = \frac{1}{r_{22}} \sqrt{r'_{12}^2 + x'_{12}^2} \quad (47)$$

$$\phi = \tan^{-1} \frac{-x'_{12}}{r'_{12}}. \quad (48)$$

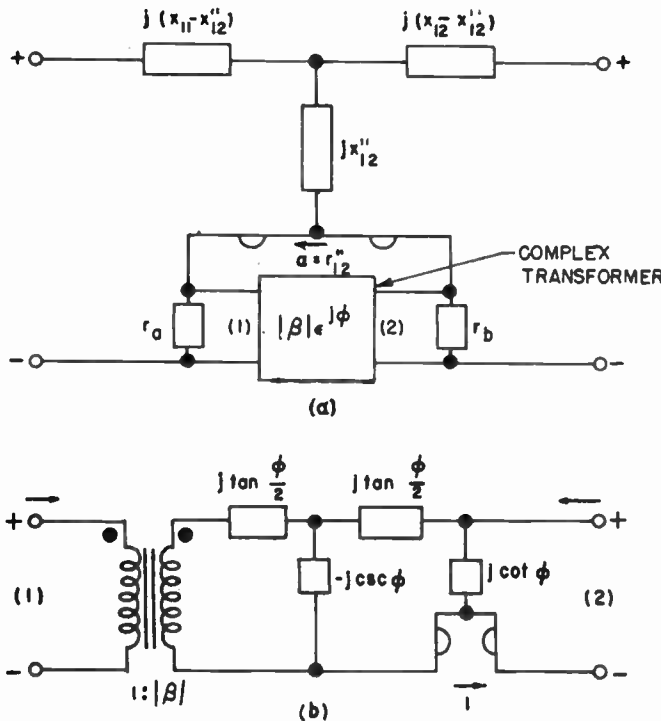

Fig. 5—Equivalent circuit for non-reciprocal two-port. (a) General equivalent circuit for two-port. (b) Complex transformer, $|\beta|e^{j\phi}$.

The equivalent circuit is shown in Fig. 5(a). The complex transformer circuit may be realized in the form of Fig. 4, or a circuit with one less gyrator, as shown in Fig. 5(b), may be used. A total number of two gyrators are needed to realize Z in the form of Fig. 5.

The values of the two resistors in the equivalent circuit are the diagonal elements of (46). If Z_H is the matrix of a PD or PSD form they are both positive; otherwise one or both may be negative.

NETWORK PROPERTIES IN THE FREQUENCY DOMAIN

If a network is linear and the total energy absorbed is non-negative for any impressed complex frequency (except at singular points) $p = \sigma + j\omega$, $\sigma \geq 0$, then it can be shown that (a) $Q(\omega) = I - S^{*T}(p)S(p)$ is the matrix of a PD or PSD hermitian form for all $p = \sigma + j\omega$, $\sigma \geq 0$. Further, (b) the element functions of the scattering matrix $S(p)$ must be real when p is real. If $S(p)$ has element functions which are single valued and only possess poles and isolated essential singularities, then condition (a) is sufficient to give: (c) Element functions of $S(p)$ are analytic in the region of the p plane, $\sigma > 0$. This covers a variety of circuits, including networks containing both linear non-reciprocal elements and finite lengths of transmission line with a finite number of discontinuities. If infinite lines and infinite numbers of discontinuities are to be permitted then the element functions of $S(p)$ may contain branch points or possibly non-isolated essential singularities, and condition (c) may not be deduced from condition (a).

Raisbeck²⁵ has shown that in the most general case the elements of the impedance matrix $Z(p)$ are analytic in the region $\sigma > 0$ if the proviso is added that the network has no response before excitation is applied. It appears that condition (c) may be derived by using a similar derivation in terms of scattering parameters. Conditions (a), (b), (c) therefore define any linear network which absorbs only positive energy at complex frequencies in the right half p plane, and has no response before the application of a signal. *This includes networks which possess no impedance or admittance matrix.*

In a recent important paper Oono and Yasuura²⁶ have shown that if the elements of $S(p)$ are rational functions and conditions (a) and (b) are satisfied, then the matrix $S(p)$ may always be realized as a lumped positive network (definition 3). The special case of synthesis with lossless, lumped, positive elements has also been considered and discussed by Tellegen,^{27,28} and Bélévitch.²⁹

²⁵ G. Raisbeck, "Definition of passive linear networks in terms of time and energy," *Jour. Appl. Phys.*, vol. 25, pp. 1510-1914; December, 1954.

²⁶ Y. Oono and K. Yasuura, "Synthesis of finite passive 2 n-terminal networks with prescribed scattering matrixes," *Ann. Telecommun.*, vol. 9; March, April, May, 1954. Also "Memoirs of the Faculty of Engineering," Kyushu Univ., vol. XIV, pp. 125-177; 1954.

²⁷ B. D. H. Tellegen, "Synthesis of passive resistanceless 4-poles that may violate the reciprocity relation," *Philips Res. Rep.*, vol. 3, pp. 321-337; October, 1948.

²⁸ B. D. H. Tellegen, "Complementary note on the synthesis of passive resistanceless 4-poles," *Philips Res. Rept.*, vol. 4, pp. 336-369; October, 1949.

²⁹ V. Bélévitch, "Fundamental results and outstanding problems of network synthesis," *Tijdschr. ned Radiogenoot.*, vol. 18, pp. 33-51; January, 1953.

Design of Parallel-*T* Resistance-Capacitance Networks*

YOSIRO OONOT†

The following paper was referred to the PROCEEDINGS by the Professional Group on Circuit Theory and the Editor of its TRANSACTIONS, W. H. Huggins. Their courtesy and cooperation are gratefully acknowledged.—*The Editor*

Summary—This paper deals with parallel-*T* resistance-capacitance networks which, for a source of finite resistance and a resistance load, have transfer characteristics symmetrical with respect to the resonant frequency. It is shown that there exists a network with the minimum loss for a prescribed frequency discrimination. Formulas are presented for the design of such a network.

INTRODUCTION

THE PARALLEL-*T* rc network, which serves for the elimination of a given frequency, has been of considerable interest in recent years, and a number of papers are available on its theory and application. However, the methods of design seem to have been restricted by the assumption of zero-source resistance and infinite-load resistance, or the assumption of the symmetrical form of the network. The method presented in this paper is free from such restrictions. The design procedure is quite simple and yields a network of frequency-symmetrical transfer characteristic with the minimum loss for a prescribed frequency discrimination.

THEORY

Consider a parallel-*T* network having a source resistance r_1 ($\neq 0$) and a load resistance r_2 , as shown in Fig. 1. In general the transfer voltage ratio E_2/E_1 is represented by a cubic rational fraction of frequency.

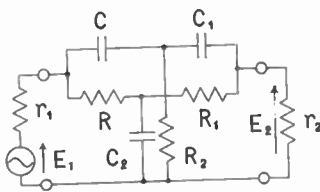

Fig. 1—Parallel-*T* rc network.

However, it can be shown that a quadratic fraction is needed for the transfer characteristic symmetrical with respect to the resonant frequency, i.e. the frequency of infinite attenuation, and the condition for the quadratic rational fraction can be obtained as

$$R_1/R = C/C_1. \tag{1}$$

* Original manuscript received by the IRE, November 18, 1954; revised manuscript received, January 17, 1955. The design formulas were published in the Tech. Rep. of the Kyushu University, vol. 26, pp. 138-140; October, 1953 (in Japanese). An application was shown by F. Irie in the same journal, vol. 25, pp. 118-122; March, 1953 (in Japanese).

† Kyushu University, Hukuoka, Japan.

Assume, therefore,

$$R_1 = kR, \quad C_1 = C/k. \tag{2}$$

Then, Stanton's¹ general expressions for the network components are reduced as

$$R_2 = Rk/\mu^2(1 + k), \quad C_2 = C(1 + k)/\mu^2k, \tag{3}$$

where

$$\mu = 2\pi f_0 RC, \tag{4}$$

f_0 being the resonant frequency. Thus the network can be specified by R , k , μ , and f_0 . The transfer characteristic is calculated as

$$\frac{E_2}{E_1} = \frac{p^2 + 1}{Fp^2 + Gp + H}, \tag{5}$$

where

$$F = (1 + \mu^2)(1 + k) \frac{r_1}{kR} + \left(1 + \frac{r_1}{r_2}\right) \tag{6}$$

$$G = \frac{1}{\mu} (1 + \mu^2)(1 + k) \left(\frac{1}{k} + \frac{r_1}{r_2} + \frac{r_1}{kR}\right) + \frac{1}{\mu} (1 + k) \frac{R}{r_2} \tag{7}$$

$$H = (1 + k) \frac{R}{r_2} + \left(1 + \frac{r_1}{r_2}\right) \tag{8}$$

and

$$p = jf/f_0, \tag{9}$$

f being the frequency. Should the response be symmetrical with respect to the resonant frequency, i.e.,

$$\left. \frac{E_2}{E_1} \right|_p = \left. \frac{E_2}{E_1} \right|_{1/p}, \tag{10}$$

the equation

$$F = H \tag{11}$$

is obtained, or, by (6) and (8),

$$(1 + \mu^2)r_1/kR = R/r_2. \tag{12}$$

¹ L. Stanton, "Theory and application of parallel-*T* resistance-capacitance frequency-selective networks," PROC. I.R.E., vol. 34, pp. 447-456; July, 1946.

Putting

$$r_2 = n^{-1}r_1 \tag{13}$$

$$R = xr_1, \tag{14}$$

the condition (12) is rewritten as

$$\mu^2 = nkx^2 - 1. \tag{15}$$

Substitution of (15) in (6), (7), and (8) reduces (5) to

$$\frac{E_2}{E_1} = \frac{1}{M} \frac{p^2 + 1}{p^2 + \Delta p + 1} \tag{16}$$

$$= \frac{1}{M} \frac{1}{1 + \Delta \frac{p}{p^2 + 1}}, \tag{17}$$

where

$$M = 1 + n + (1 + k)nx \tag{18}$$

$$\Delta = \frac{1}{M\mu} (1 + k)(nkx + x + 2)nx. \tag{19}$$

The vector diagram of (17) is obviously a circle of diameter $1/M$ in the complex E_2/E_1 -plane.² Since

$$\frac{1}{M} = \left. \frac{E_2}{E_1} \right|_{p=0} = \left. \frac{E_2}{E_1} \right|_{p=\infty}, \tag{20}$$

M represents the loss at the extreme frequencies. Let f_1 and $f_2(>f_1)$ be the frequencies for which

$$E_2/E_1 = M^{-1}/\sqrt{2}. \tag{21}$$

Then, it is easily found that

$$f_1 f_2 = f_0^2 \tag{22}$$

$$\Delta = (f_2 - f_1)/f_0. \tag{23}$$

Thus, Δ represents the bandwidth. The roots of the denominator of (16) must be distinct, real, and negative by the well-known property of rc networks.³ Hence

$$\Delta > 2. \tag{24}$$

It will later be shown that a network can be designed for any prescribed value of $\Delta > 2$ irrespective of the values of r_1 and r_2 .

If M and Δ are prescribed, the values of k , x , and μ can be calculated by (15), (18), and (19); but it is desirable to determine a network yielding the minimum Δ for a prescribed M or the minimum M for a prescribed Δ . Assume M is prescribed. From (18), k is written as

$$k = (M - 1 - n - nx)/nx. \tag{25}$$

By substitution, (15) and (19) become respectively

$$\mu^2 = -nx^2 + (M - 1 - n)x - 1 \tag{26}$$

² A. Wolf, "Note on the parallel- T resistance-capacitance network," *Proc. I.R.E.*, vol. 34, p. 659; September, 1946.

L. G. Cowles, "The parallel- T resistance-capacitance network," *Proc. I.R.E.*, vol. 40, pp. 1712-1716; December, 1952. (In these papers, A or Q respectively represents $\Delta/4$ or Δ^{-1} .)

³ W. Cauer, "Theorie der linearen Wechselstromschaltungen," Becker und Erler, Leipzig, Ger., vol. 1; 1941.

E. A. Guillemin, "Communication Networks," John Wiley and Sons, New York, N. Y., vol. 2; 1935.

$$\Delta = \frac{M - 1 - n}{M} \frac{(1 - n)x + M + 1 - n}{\sqrt{-nx^2 + (M - 1 - n)x - 1}}. \tag{27}$$

It can be shown that Δ has a positive minimum value and μ^2 is positive for some positive value of x , if and only if

$$M > (1 + \sqrt{n})^2. \tag{28}$$

The value of x for which Δ is minimum is found from $d\Delta/dx = 0$ to be

$$x = \frac{M^2 - 2nM + (1 - n)^2}{M(1 + n) - (1 - n)^2}. \tag{29}$$

The minimum value of Δ is given by

$$\Delta = 2 \frac{M - (1 + n)}{\sqrt{M^2 - 2(1 + n)M + (1 - n)^2}}. \tag{30}$$

It can further be shown that, by solving (30) for M , the minimum value of M for a prescribed $\Delta (> 2)$ is obtainable as

$$M = 1 + n + 2\sqrt{n} \frac{\Delta}{\sqrt{\Delta^2 - 4}}. \tag{31}$$

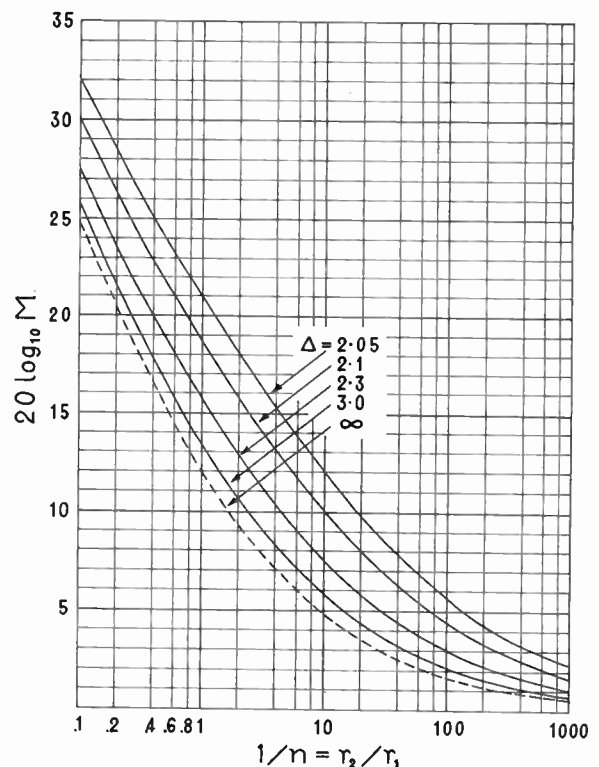

Fig. 2—Minimized loss at the extreme frequencies.

The relations (30) and (31) are shown in Fig. 2. The values of k and μ are determined by (25) and (15). Taking (31) into consideration, the formulas are stated as follows:

$$x = \alpha/\beta \tag{32}$$

$$k = \gamma/\alpha \tag{33}$$

$$\mu = \sqrt{nkx^2 - 1}, \tag{34}$$

where

$$\left. \begin{aligned}
 \alpha &= M^2 - 2nM + (1 - n)^2 \\
 &= 2n \frac{\Delta^2 + 4}{\Delta^2 - 4} + 4\sqrt{n} \frac{\Delta}{\sqrt{\Delta^2 - 4}} + 2 \\
 \beta &= M(1 + n) - (1 - n)^2 \\
 &= 4n + 2\sqrt{n}(1 + n) \frac{\Delta}{\sqrt{\Delta^2 - 4}} \\
 \gamma &= \frac{1}{n} [M^2 - 2M + (1 - n)^2] \\
 &= 2 \frac{\Delta^2 + 4}{\Delta^2 - 4} + 4\sqrt{n} \frac{\Delta}{\sqrt{\Delta^2 - 4}} + 2n
 \end{aligned} \right\} \quad (35)$$

It is remarked, in passing, that if Δ increases from 2, k monotonously changes from $1/n$ to 1. Finally, an example for $n=0.01$ is added. Cowles' method⁴ that employs

⁴ Cowles, *loc. cit.*

networks with $k=1$ leads to $M=1.29$ or $20 \log_{10} M=2.21$ and $\Delta=3.56$, the values fixed for $n=0.01$. For $M=1.29$, however, $\Delta=2.86$ is obtained from (30) using $k=2.45$ determined by (33). Moreover, if a slightly greater M is allowed, further improvement in discrimination can easily be secured as clearly seen in Fig. 2.

DESIGN PROCEDURE

A parallel- T network shown in Fig. 1 can easily be designed so as to have the transfer characteristic (16) [cf. (9)] for a source resistance $r_1(\neq 0)$ and a load resistance r_2 . By referring to Fig. 2, suitable Δ or M is prescribed for n of (13). The minimum M or Δ is then obtained by (31) or (30) respectively. It must be noted that the restriction (24) or (28) is placed on Δ or M respectively. The values of x , k , and μ are next determined by (32), (33), and (34) respectively. Then the network elements are obtained by (14), (4), (2), and (3).

IRE Standards on Television: Definitions of Television Signal Measurement Terms, 1955*

COMMITTEE PERSONNEL

Video Techniques Committee 1952-1955

W. J. POCH, *Chairman*, 52-55

A. J. BARACKET, *Vice-Chairman*, 52-54

J. L. JONES, *Vice-Chairman*, 54-55

S. W. Athey	K. B. Benson	S. Doba, Jr.	R. E. Graham	L. L. Lewis
A. J. Baracket	R. W. Clark	V. J. Duke	J. R. Hefe	R. T. Petruzzelli
J. H. Battison	E. M. Coan	G. L. Fredendall	J. L. Jones	C. G. Pierce
E. E. Benham	J. R. DeBaun	R. L. Garman	J. E. Keister	B. F. Tyson
		H. E. Weppler		

Standard Committee 1954-1955

E. WEBER, *Chairman*

M. W. BALDWIN, JR., *Vice-Chairman*

R. F. SHEA, *Vice-Chairman*

L. G. CUMMING, *Vice-Chairman*

K. E. Anspach	P. S. Carter	V. M. Graham	A. A. MacDonald	W. J. Poch
J. Avins	P. S. Christaldi	R. A. Hackbusch	W. P. Mason	R. Serrell
B. B. Bauer	A. G. Clavier	P. J. Herbst	Wayne Mason	R. E. Shelby
W. R. Bennett	W. J. Dodds	A. G. Jensen	D. E. Maxwell	N. Smith
J. G. Brainerd	J. E. Eiselein	J. G. Kreer, Jr.	H. R. Mimno	P. H. Smith
H. Burkhard	A. W. Friend	E. A. Laport	C. H. Page	J. E. Ward

Definitions Co-ordinator

M. W. BALDWIN, JR.

* Reprints of this Standard, 55 IRE 23.S1, may be purchased while available from the Institute of Radio Engineers, 1 East 79 Street, New York 21, N. Y., at \$1.00 per copy. A 20 per cent discount will be allowed for 100 or more copies mailed to one address.

Back Porch. That portion of a *Composite Picture Signal* which lies between the trailing edge of a horizontal sync pulse and the trailing edge of the corresponding blanking pulse.

Note: The *Color Burst*, if present, is not considered part of the *Back Porch*.

Black Compression (Black Saturation). The reduction in gain applied to a *Picture Signal* at those *Levels* corresponding to dark areas in a picture with respect to the gain at that *Level* corresponding to the mid-range light value in the picture.

Note 1: The gain referred to in the definition is for a signal amplitude small in comparison with the total peak-to-peak *Picture Signal* involved. A quantitative evaluation of this effect can be obtained by a measurement of *Differential Gain*.

Note 2: The over-all effect of *Black Compression* is to reduce contrast in the low lights of the picture as seen on a monitor.

Black Level. That *Level* of the *Picture Signal* corresponding to the maximum limit of *Black Peaks*.

Black Peak. A peak excursion of the *Picture Signal* in the black direction.

Blanked Picture Signal. The signal resulting from blanking a *Picture Signal*.

Note: Adding *Sync Signal* to the *Blanked Picture Signal* forms the *Composite Picture Signal*.

Blanking Level. That *Level* of a *Composite Picture Signal* which separates the range containing picture information from the range containing synchronizing information.

Note: The *Setup* region is regarded as picture information.

Blanking Signal. A wave constituted of recurrent pulses, related in time to the scanning process, used to effect blanking.

Note: In television, this signal is composed of pulses at line and field frequencies, which usually originate in a central sync generator and are combined with the *Picture Signal* at the pickup equipment in order to form the *Blanked Picture Signal*. The addition of *Sync Signal* completes the *Composite Picture Signal*.

The blanking portion of the *Composite Picture Signal* is intended primarily to make the return trace on a picture tube invisible. The same blanking pulses or others of somewhat shorter duration are usually used to blank the pickup device also.

Composite Picture Signal. The signal which results from combining a *Blanked Picture Signal* with the *Sync Signal*.

Compression (in Television). The reduction in gain at one *Level* of a *Picture Signal* with respect to the gain at another *Level* of the same signal.

Note 1: See also *Black Compression* and *White Compression*.

Note 2: The gain referred to in the definition is for a signal amplitude small in comparison with the total peak-to-peak *Picture Signal* involved. A quantitative evaluation of this effect can be obtained by a measurement of *Differential Gain*.

Differential Gain (in Television). In a video transmission system, the difference in the gain of the system in decibels for a small high-frequency sinewave signal at two stated *Levels* of a low-frequency signal on which it is superimposed.

Note 1: In this definition, *Level* is used in its second meaning as defined in this list.

Note 2: The two frequencies must be specified.

Differential Phase (in Television). In a video transmission system, the difference in phase shift through the system for a small high-frequency sinewave signal at two stated *Levels* of a low-frequency signal on which it is superimposed.

Note 1: In this definition, *Level* is used in its second meaning as defined in this list.

Note 2: The two frequencies must be specified.

Driving Signals (in Television). Signals that time the scanning at the pickup point.

Note: Two kinds of driving signals are usually available from a central sync generator. One is composed of *Pulses* at *Line Frequency* and the other is composed of *Pulses* at *Field Frequency*.

Equalizing Pulses. *Pulses* at twice the *Line Frequency*, occurring just before and just after the vertical synchronizing *Pulses*.

Note: The *Equalizing Pulses* minimize the effect of line-frequency pulses on the interlace.

Field (in Television). One of the two (or more) equal parts into which a *Frame* is divided in *Interlaced Scanning*.

Field Frequency. The product of *Frame Frequency* multiplied by the number of *Fields* contained in one *Frame*.

Frame. The total area, occupied by the picture, which is scanned while the *Picture Signal* is not blanked.

Frame Frequency. The number of times per second that the *Frame* is scanned.

Front Porch. That portion of a *Composite Picture Signal* which lies between the leading edge of the horizontal blanking *Pulse* and the leading edge of the corresponding sync *Pulse*.

Interlaced Scanning. A scanning process in which the distance from center to center of successively scanned lines is two or more times the nominal line width, and in which the adjacent lines belong to different *Fields*.

Leading Edge. The major portion of the rise of a *Pulse*.

Leading Edge Pulse Time. The time at which the instantaneous amplitude first reaches a stated fraction of the *Peak Pulse Amplitude*.

Level (in Television). 1. Signal amplitude measured in accordance with specified techniques.

Note: The recommended method is described in the IRE Standards on Methods of Measurement of Television Signal Levels published in the PROCEEDINGS, Vol. 38, May, 1950.

2. A specified position on an amplitude scale applied to a signal waveform.

Note: This definition is consistent with the use of the term in such definitions as *Reference White Level* and *Reference Black Level*.

Line Frequency. The number of times per second that a fixed vertical line in the picture is crossed in one direction by the scanning spot. Scanning during vertical return intervals is counted.

Peak Pulse Amplitude. The maximum absolute peak value of the *Pulse* excluding those portions considered to be unwanted, such as spikes.

Note: Where such exclusions are made, it is desirable that the amplitude chosen be illustrated pictorially.

Picture Signal. The signal resulting from the scanning process.

Polarity of Picture Signal. The sense of the potential of a portion of the signal representing a dark area of a scene relative to the potential of a portion of the signal representing a light area. Polarity is stated as "black negative" or "black positive."

Pulse. A variation of a quantity whose value is normally constant; this variation is characterized by a rise and a decay, and has a finite duration.

Note 1: The word "Pulse" normally refers to a variation in time; when the variation is in some other dimension, it shall be so specified, such as "space pulse."

Note 2: This definition is broad so that it covers almost any transient phenomenon. The only features common to all *Pulses* are rise, finite duration, and decay. It is necessary that the rise, duration, and decay be of a quantity that is constant (not necessarily zero) for some time before the pulse and has the same constant value for some time afterwards. The quantity has a normally constant value and is perturbed during the *Pulse*. No relative time scale can be assigned.

Pulse Decay Time. The interval of time required for the trailing edge of a *Pulse* to decay from 90 per cent to 10 per cent of the *Peak Pulse Amplitude*.

Pulse Droop. A distortion of an otherwise essentially flat-topped rectangular *Pulse* characterized by a decline of the *Pulse* top.

Pulse Duration. The time interval between the first and last instants at which the instantaneous amplitude

reaches a stated fraction of the *Peak Pulse Amplitude*.

Pulse Rise Time. The interval of time required for the leading edge of a *Pulse* to rise from 10 per cent to 90 per cent of the *Peak Pulse Amplitude*.

Pulse Tilt. A distortion of an otherwise essentially flat-topped rectangular *Pulse* characterized by either a decline or a rise of the *Pulse* top.

Pulse Width—Deprecated. See *Pulse Duration*.

Reference Black Level. The *Picture Signal Level* corresponding to a specified maximum limit for *Black Peaks*.

Reference White Level. The *Picture Signal Level* corresponding to a specified maximum limit for *White Peaks*.

Setup. In television, the ratio between *Reference Black Level* and *Reference White Level*, both measured from *Blanking Level*. It is usually expressed in per cent.

Space Pattern. A geometrical pattern appearing on a test chart designed for the measurement of geometric distortion.

Note: The RETMA Ball Chart is a specific example of a *Space Pattern*.

Synchronizing (in Television). Maintaining two or more scanning processes in phase.

Sync Compression. The reduction in gain applied to the *Sync Signal* over any part of its amplitude range with respect to the gain at a specified reference level.

Note 1: The gain referred to in the definition is for a signal amplitude small in comparison with the total peak-to-peak *Composite Picture Signal* involved. A quantitative evaluation of this effect can be obtained by a measurement of *Differential Gain*.

Note 2: Frequently the gain at the *Level* of the peaks of sync pulses is reduced with respect to the gain at the *Levels* near the base of the sync pulses. Under some conditions, the gain over the entire *Sync Signal* region of the *Composite Picture Signal* may be reduced with respect to the gain in the region of the *Picture Signal*.

Sync Level. The *Level* of the peaks of the *Sync Signal*.

Sync Signal (*Synchronizing Signal*). The signal employed for the synchronizing of scanning.

Note: In television, this signal is composed of *Pulses* at rates related to the line and field frequencies.

The waveform specified by the U. S. Monochrome Standards is shown in Figure 12 of the IRE Standards on Television: Methods of Testing Television Receivers, 1948.

The signal usually originates in a central sync generator and is added to the combination of *Picture Signal* and *Blanking Signal*, comprising the output signal from the pickup equipment, to form the *Composite Picture Signal*. In a television receiver, this signal is normally

separated from the *Picture Signal* and is used to synchronize the deflection generators.

Time Pattern. A picture tube presentation of horizontal and vertical lines or dot rows generated by two stable frequency sources operating at multiples of the line and field frequencies.

Trailing Edge. The major portion of the decay of a *Pulse*.

Video. A term pertaining to the bandwidth and spectrum position of the signal resulting from television scanning.

Note: In current usage, *Video* means a bandwidth in the order of megacycles, and a spectrum position that goes with a dc carrier.

White Compression (*White Saturation*). The reduction in gain applied to a *Picture Signal* at those *Levels* corresponding to light areas in a picture with respect to the gain at that *Level* corresponding to the mid-range light value in the picture.

Note 1: The gain referred to in the definition is for a signal amplitude small in comparison with the total peak-to-peak *Picture Signal* involved. A quantitative evaluation of this effect can be obtained by a measurement of *Differential Gain*.

Note 2: The overall effect of *White Compression* is to reduce contrast in the highlights of the picture as seen on a monitor.

White Peak. A peak excursion of the *Picture Signal* in the white direction.

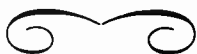

Correspondence

A New System of Logarithmic Units*

The letter by R. V. L. Hartley on this subject¹ prompts the following comments. Mr. Hartley does present an interesting dissertation on logarithmic units and some present or proposed uses thereof. However, it seems to leave the reader very much confused as to practical application of the basic ideas set forth.

The logarithmic unit is a valuable tool in both theoretical and practical work. Its value lies in its basic simplicity of structure and application. Let us be careful about proposing additional systems and nomenclature that confuse rather than simplify.

An outstanding example of what should be avoided, like the plague, is the unfortunate choice of a special series of Preferred Numbers (R15M) for nominal values of resistors used in the electronics art today.² We should look with considerable scepticism and disfavor on any new logarithmic system and nomenclature that is incompatible with what has been used successfully, in the scientific and engineering worlds, for the past century or so. This is not a reactionary viewpoint. It is a very practical one.

In studying a question such as the one under discussion, it often is helpful to refer to earlier books on the subject. It sometimes appears that those earlier authors were less burdened with detail and therefore had

their minds clearer for the fundamentals. In "Transmission Networks and Wave Filters," by T. E. Shea (D. Van Nostrand Co., Inc., 1929), appear the passages quoted below:

"For expressing the magnitude of a ratio, there are two important logarithmic units. One is the decibel (db), which may be called the common logarithmic unit. It was formerly called the transmission unit (TU). The other is the neper (nep), which may be called the natural logarithmic unit."

"Two powers are said to differ by one bel, or ten decibels, when one of them is ten times as large as the other."

"Two voltages, or currents, differ by one neper when one of them is e times as large as the other ($e=2.71828$). It is implied that the impedances with which the respective voltages or currents are associated in their circuit are identical."

"Both of the units, i.e., decibels and nepers have the character of pure numerics, having no dimensions."

These excerpts are quoted to show how well the problem was understood and stated, some 25 years ago, and also how confused the art was—as between decibels and nepers—even at that time.

While recent discussions are not in any fundamental conflict with the above, they certainly are more confusing. It may be a good form of mental gymnastics to refer to a distance of 5 kilometers by such a round-about expression as "the logarithm of a length of 5 km would be $\log 5 + \log 1,000 + \log L$." Since when, though, has it been mathematically correct to speak of the "logarithm of a length"?

What is wrong with stating a length of 5 kilometers simply as 5 kilometers, 5 km, or 5×10^3 meters? That is straightforward and simple. If someone wishes to use the numeric 5 or 5,000 in an involved mathematical computation, he need merely look up and use the logarithm of said number. Why confuse

everyone, when the accepted way is so simple?

It would appear that Mr. Hartley has carried his logic to an illogical and impractical extreme.

There is no need to go back to the meter every time we wish to express a length in centimeters or in kilometers. The metric system of nomenclature already provides a system of designating ratios. Nor should we refer to the basic yard or foot whenever we wish to express a length in inches or rods or miles. Where values are too small or too large to conveniently express in conventional units, we have the 5×10^{12} nomenclature.

The logarithmic unit has a very definite place in certain types of engineering work, where it is necessary to think primarily in terms of ratios rather than of arithmetical increments. However, where the thinking necessarily must be in terms of absolute values, or of arithmetical increments, it would appear that the use of logarithmic units should be avoided.

As regards the term "decilog," specific suggestions have been presented in letters appearing in the October 1954 and January 1955 issues of *Electrical Engineering* (AIEE). The comments by Mr. E. Oosterling seem to be particularly deserving of serious study.

Mathematical concepts and terminology, for general engineering use, should clarify rather than confuse. Let us, therefore, be careful that new proposals will help rather than hinder us in our work.

J. B. MOORE
66 Broad Street
New York 4, N. Y.

* Received by the IRE, January 26, 1955.

¹ Proc. I.R.E., vol. 43, pp. 97-98; January, 1955.

² J. B. Moore, "Preferred numbers," Proc. I.R.E., vol. 39, p. 1572; December, 1951.

A Design Philosophy for Man-Machine Control Systems*

In the above paper¹ a significant contribution is made to control systems employing men and machines. The pertinent points include the conclusions that the simpler the tasks presented to the human operator, the more precise and less variable become his responses, and that the optimal man-machine control system performance is obtained when the system is designed such that the human need act only as a simple amplifier.

For certain functions, however, such as for safety and for simplification of the machine, the human must be included. As W. Ley points out, nowhere else can one obtain so versatile a machine-control system in a package weighing less than two hundred pounds! As is pointed out in the article, the weight reduction achieved in using a human in cases where the operator tracks targets optically is considerable.

But suppose we go back through the paper and substitute the words "higher-order mammal" or "animal" for the words "human" or "man." How many of the conclusions remain valid? It would appear that most of them do. The implications of this substitution, if valid, could be tremendous. Some animals can be taught relatively easily to perform such complex control functions as riding a bicycle, balancing a ball, or making simple choices involving judgment. Why not train them to zero a cross pointer indicator or track a cursor onto a target? Simple fail-safe techniques could ensure that animal perversity does not turn against the user.

In systems being contemplated today, where the nonexpendability of the human is a limiting factor and where completely automatic systems would be too bulky because of the complexity of machine equivalents of animal functions, the utilization of an animal-machine system may very well provide a solution.

The moral implications in the humane use of animals should be carefully weighed against the possible greater good to humanity.

MAX HOBERMAN
11 Godwin Ave.
Fair Lawn, N. J.

* Received by the IRE, December 20, 1954.

¹ H. P. Birmingham and F. V. Taylor, *Proc. I.R.E.*, vol. 42, pp. 1748-1758; December, 1954.

VHF Field Strength Far Beyond the Radio Horizon*

Diffraction theory, applied to the propagation of radio waves over a smooth earth in the earth's lower atmosphere, assuming homogeneous refractive index conditions, yields an exponential decrease of field strength with distance for the region beyond the earth's bulge. It has been established, however, that median field strengths deep within the diffraction region far exceed the predicted values throughout the 7.5 meter

to 7.5 centimeter range.¹ A detailed knowledge of the rate of decrease of such field strengths with distance is helpful in distinguishing between the various theories advanced to explain their presence; it is also needed to assess both any possibility of their being used to extend communication range and the interference likely to be caused on co-channel circuits. Measurements of 1.4 meter wavelength transmissions to a distance of 420 statute miles are reported here.

A most direct method for measuring the distance loss is to move a receiver rapidly along a radial path outwards from a high-power transmitter. For this purpose Megaw² used a shipborne receiver in his North Sea measurements and Gerks³ a truck and an aircraft. Employing an aircraft has an inherent advantage in that it is possible to sample the field over great distances in a relatively short time, thus minimizing any diurnal changes; additionally, the influence of local ground conditions upon the effective antenna pattern is lessened and any abrupt spatial field strength changes may be noted.

An airborne receiver was used to measure the horizontally polarized field strength of a 220 mc pulsed transmitter having a large effective radiated power. The flight path was out over the North Atlantic Ocean eastward from the vicinity of Boston, Mass. Careful navigation and piloting permitted the use of directive antenna arrays, and maintenance of a 500-foot altitude enabled the radio horizon to be passed within a short distance from the transmitter. Both of these measures contributed toward the ability to record signals over a large distance in the extra-diffraction region. Two flights along the same path were made on successive days in February, 1954 and the points graphed in Fig. 1 are the averages of all valid data re-

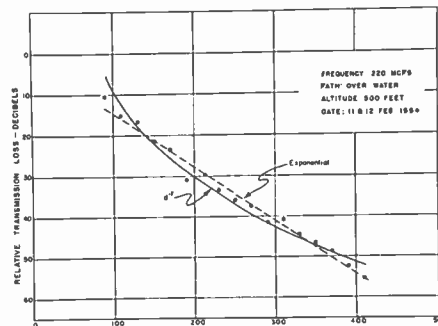

Fig. 1—Statute miles.

corded within every 20-mile interval beyond the influence of the trans-horizon diffraction field. On an absolute scale, the received power is about 70 db below free space at 250 miles. The weather was very cold and the air turbulent. Little surface ducting would be expected under such conditions, and no evidence of abnormal backscatter from the sea surface was noted at the transmitting site.

¹ K. Bullington, "Radio transmission beyond the horizon in the 40-4,000 mc band," *Proc. I.R.E.*, vol. 41, pp. 132-135; January, 1953.

² E. C. S. Megaw, "Scattering of electromagnetic waves by atmospheric turbulence," *Nature*, vol. 166, p. 1100; December 30, 1950.

³ I. H. Gerks, "Propagation at 412 Megacycles from a high-power transmitter," *Proc. I.R.E.*, vol. 39, pp. 1374-1382; November, 1951.

There is a difference, perhaps significant, between these results and those of Megaw² on 10 cm: the 1.4 meter field strength decreases less rapidly with distance. With reservations prompted by the different seasons and locations for the two experiments, the increased attenuation expected at the shorter wavelength because of atmospheric gaseous absorption, and possible loss of antenna gain at 10 cm, it appears that a wavelength dependence may be indicated.⁴

A number of predictions of the expected attenuation-distance law have been made for distances far beyond the radio horizon. Use of the most recently measured atmospheric refractive index data by Gordon,⁵ in a modification of the Booker-Gordon⁶ scattering theory, indicates a d^{-7} relationship for received power. Carroll's⁷ tropospheric dielectric layer model predicts an essentially exponential loss of some 0.19 db per mile. Bullington,¹ in an examination of many point-to-point measurements, concludes that a d^{-8} law yields a good fit.

Here, if a d^{-n} relationship is assumed, a value of $n=7$ appears to fit the data reasonably well. However, assuming an exponential decay law, a least squares curve also fits the data well and indicates a decrease of some 0.13 db per statute mile. Clearly, a distinction between an inverse distance law and an exponential law cannot definitely be made on the basis of these data. Measurements out to appreciably greater distances at low altitudes are required, and it is hoped that equipment now under construction will give data to make the distinction possible.

Numerous individuals contributed in making these measurements, especially L. A. Ames, J. A. Frazier, and P. Newman, all of AFRCR.

T. F. ROGERS
Air Force Cambridge Research Center
Cambridge 39, Mass.

⁴ A summary of VHF and UHF point-to-point measurements for various distances lately presented by J. Herbstreit (I.R.E. National convention, 1954; also personal communication). Compare more closely with our measurements than with Megaw's in this respect.

⁵ W. E. Gordon, "Radio scattering in the troposphere," *Proc. I.R.E.*, vol. 43, pp. 23-28; January, 1955.

⁶ H. G. Booker and W. E. Gordon, "A theory of radio scattering in the troposphere," *Proc. I.R.E.*, vol. 38, pp. 401-412; April, 1950.

⁷ T. J. Carroll and R. M. Ring, "Important Modes in the Troposphere Treated as a Linearly Graded Layer of Dielectric," *Proc. Conf. on Radio Meteorology*, Univ. of Texas, Austin, Texas, no. 9-12; (1953); T. J. Carroll and R. M. Ring, *Lincoln Laboratory Report no. 38*; February, 1954.

Temperature Dependence of the Microwave Properties of Ferrites in Waveguide*

The microwave properties of ferrites in waveguide depend upon several parameters, one of the most important of which is the temperature of the ferrites. A study of this dependence has been conducted using several ferrite cylinders. This letter reports on the preliminary results derived from this study and contains data obtained at 9,600 mc on Ferramic A-106 in 0.937-inch I.D.

* Received by the IRE, December 17, 1954. This work has been supported by the U. S. Navy, Bureau of Ships, Contract No. N0bsr 63312.

* Received by the IRE, November 29, 1954.

waveguide with a static magnetic field (H_a) applied parallel to the direction of propagation.

The observed changes in the microwave properties of ferrites as a function of temperature are the result of three effects: (1) effects due to changes in magnetization of ferrites; (2) temperature modified waveguide effects, and (3) changes in the dielectric loss. The effects due to changes in magnetization can, in general, be explained in terms of the existing theory of ferrimagnetism. The temperature-modified waveguide effects are very complicated and have not yet been fully explained. However, changes due to temperature in the ϵ and μ of the ferrite change the mode configuration in the ferrite loaded guide, and these, in turn, result in changes in rotation, axial ratio, etc. Changes in dielectric loss with temperature occur as in most dielectric materials.

The following general explanation may be given of the temperature effects in ferrites at microwave frequencies. It must be modified by the waveguide effects as in the case of the infinite medium, plane wave theory of ferrite propagation. The modification will be very small for large ratios of waveguide diameters to ferrite diameters. The changes in the rotation of plane of polarization (Fig. 1) of the emergent ellip-

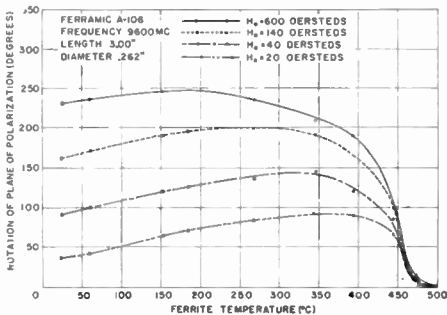

Fig. 1—Temperature dependence of the rotation of plane of polarization in Ferramic A-106, with applied magnetic field as parameter.

tically polarized wave are a result of the changes in the effective permeabilities as seen by the circularly polarized components of the wave. The rotation of plane of polarization of a pencil rod of ferrite in circular waveguide can be approximated by the following equation:¹

$$\theta = \frac{\omega l}{2c} (\epsilon)^{1/2} \{ (\mu_-)^{1/2} - (\mu_+)^{1/2} \}, \quad (1)$$

where:

- θ = rotation of plane of polarization.
- l = length of ferrite sample.
- ω = angular frequency of incident microwave energy.
- ϵ = dielectric constant of ferrite (consider dielectric losses negligible).
- c = velocity of light in free space.
- μ_+ = real part of the complex effective permeability seen by positive circularly polarized component of the wave.

¹ J. H. Rowen, "Ferrites in microwave applications," *Bell Sys. Tech. Jour.*, vol. 32, pp. 1333-1369; November, 1953.

μ_- = real part of the complex effective permeability seen by negative circularly polarized component of the wave.

When, at 500 degrees C., the ferrite loses its ferromagnetic properties, μ_- approximately equals μ_+ and the rotation of plane of polarization approaches zero. At any temperature less than the Curie temperature, the difference in the effective permeabilities seen by the two circularly polarized components of the wave will be greater than zero and a resulting rotation of plane of polarization will occur.

The increase in rotation (Fig. 1) occurs as a result of the increase in magnetization of the ferrite medium with increasing temperature; this is due to the decrease in crystal anisotropy and magnetostriction of the ferrite. The ultimate decrease in rotation can be explained in terms of the changes which occur in the net magnetization of the ferrite as the temperature is increased.² Both of these effects are quite complicated and will be treated in a later article.

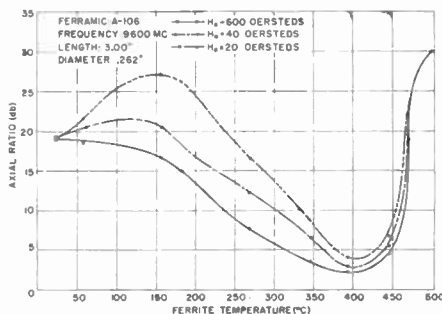

Fig. 2—Temperature dependence of the axial ratio in Ferramic A-106, with applied magnetic field as parameter.

The change in axial ratio with temperature (Fig. 2) is due to the large difference in the imaginary component of the complex effective permeabilities as seen by the circularly polarized components of the wave. The axial ratio of a ferrite in circular waveguide can be defined in terms of voltage as follows:¹

$$AR = 20 \log \frac{|E_+| + |E_-|}{|E_+| - |E_-|}, \quad (2)$$

where:

- E_+ = voltage amplitude of the positive circularly polarized component of the wave.
- E_- = voltage amplitude of the negative circularly polarized component of the wave.

A finite axial ratio is a result of the differential attenuation of the circularly polarized components of the wave. As the temperature of the ferrite approaches the Curie temperature, the ferrite absorption loss increases and the absolute values of E_+ and E_- decrease. At the Curie temperature, the circularly polarized components of the wave see the same effective permeability, and the differ-

² J. L. Salpeter, "Developments in sintered magnetic materials," *Proc. I.R.E.*, vol. 42, pp. 514-526; March, 1954.

ential attenuation approaches zero. Since both E_+ and E_- and hence the sum, have a small but finite value, and the difference approaches zero, the axial ratio approaches infinity.

The magnetic losses in a ferrite are determined by the values of the imaginary components of the tensor permeability. These components are dependent upon the magnetization of the ferrite. Since, at the Curie temperature, the magnetization approaches zero the magnetic losses become negligible. Therefore, the large increase in ferrite absorption loss in region near 500 degrees C. (Fig. 3) can be attributed to di-

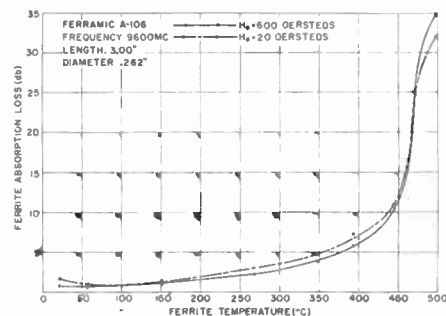

Fig. 3—Temperature dependence of the ferrite absorption loss in Ferramic A-106, with applied magnetic field as parameter.

electric losses in ferrite. Since a ferrite is a semiconducting material, its losses would be expected to increase with temperature as do the losses in most other semiconductors.

It should be noted that the large value of absorption loss actually made it difficult to make measurements of axial ratio near 500 degrees C. since this required measurements of microwave power more than 60 db below the input microwave power level of approximately 25 mw.

Additional measurements at 500 degrees C. of ferrite absorption loss, using frequency as a parameter, showed that the ferrite absorption loss increases as the frequency is increased from 8,500 to 9,600 mc; this is a reversal of the frequency behavior of the ferrite absorption loss at 23 degrees C. Hence, at some temperature between 23 degrees C. and 500 degrees C., the ferrite absorption loss should be practically independent of frequency for this ferrite diameter and waveguide size.

The Curie temperature of Ferramic A-106 has been reported by its manufacturer to be 300 degrees C. Their definition of Curie temperature is that temperature at which the value of initial permeability equals the initial permeability at ambient temperature (25 degrees C.). The measurement is made at a frequency of 1 mc.

In addition to Ferramic A-106, the temperature dependence of the microwave properties of several other ferrites, including Ferramic R-1 (formerly 1331), have been studied. These ferrites have temperature characteristics similar to those reported on Ferramic A-106. A discussion of the temperature effects observed on other ferrites will be reported in a forthcoming article.

B. J. DUNCAN and L. SWERN
Sperry Gyroscope Co.
Great Neck, New York

Notes on Hybrid Coding*

The term "hybrid coding" refers to coding and decoding procedures which serve to transmit and receive digital information, but in which the amplitudes of the signals received is utilized to minimize errors.

Silverman and Balser¹ have treated a hybrid coding procedure suggested by Wagner in which a single additional parity check binit added to a word serves to detect a single error which is ascribed to the most doubtful binit of the word received.

When forming hybrid codes involving more than one parity check, two alternate procedures may be followed:

The first is applicable to n -error correcting $n+1$ -error detecting digital codes, and consists in ascribing $n+1$ detected errors to the $n+1$ most doubtful bins received. The code obtained by this procedure for the case $n=1$ has been treated mathematically by Silverman and Balser² who have shown it to be more efficient than purely digital codes, beyond certain word lengths. The Silverman and Balser code has the advantage of being mathematically tractable, but is open to the criticism that the words reconstructed may not form part of the code. These cases have been correctly reckoned as error cases by the authors of this code, but the nonutilization of the recipient's knowledge that the reconstructed words could not have been sent underlines the circumstance that a compromise has been made with efficiency, for the sake of mathematical tractability. A logical extension of this first hybrid code could consist in correcting more than $n+1$ bins when the word received has a greater than $n+1$ distance to all words of the code.

The second procedure is applicable to any digital code, and consists in computing from the amplitudes of the bins received the *a posteriori* probabilities with which the various code words could have been sent, and selecting the word for which this probability is the greatest. Thus, if positive or negative pulses are utilized to transmit one of mn -binit words: $a_{11}, a_{12}, a_{1n}; \dots; a_{m1}, a_{m2}, \dots, a_{mn}$; (all a 's = ± 1), and if the gaussian noise contaminated pulse amplitudes received are: x_1, x_2, \dots, x_n , a simple application of Bayes' rule indicates that the relative probability that the k th word was sent is proportional to $\exp 2C[a_{k1}x_1 + \dots + a_{kn}x_n]$ (C =square of the pulse amplitude to mean square noise amplitude ratio), and the word for which the bracket is maximum should be selected as the word most likely sent.

The difference between the optimal hybrid code just described and a strictly digital code, and the difference between this optimal hybrid code and the Silverman and Balser code, can be highlighted with a few simple examples.

For instance, if a 5-binit code is utilized which consists of the 4 words with minimum distance 3: 1, 1, 1, 1, 1; -1, -1, -1, 1, 1; -1, 1, 1, -1, -1; and 1, -1, -1, -1, -1,

* Received by the IRE, January 2, 1955.

¹ R. A. Silverman and M. Balser, "Coding for constant-data-rate systems—part I. A new error-correcting code," *Proc. I.R.E.*, vol. 42, pp. 1428-1435; September, 1954.

² R. A. Silverman and M. Balser, "Coding for constant-data-rate systems," *Trans. I.R.E.*, PGIT-4, pp. 50-63; September, 1954.

and if the relative pulse amplitudes of a received word are: 1, -1, 1, 1, -3, the digital code leaves it unassigned between the first and the fourth word, whereas the optimal hybrid code assigns it to the fourth word. If the received word is: 1, 1, 1, 1, -3, the digital code assigns it to the first word, whereas the optimal hybrid code assigns it to the third word, which implies the correction of two bins. If a parity check is added to the code, and the received word is -6, -2, -1, 2, -6, 1, the Silverman and Balser code corrects it into the nonexisting code word -1, -1, 1, 1, -1, -1, the least 2-binit correction producing a code word (least straight sum or least sum of the squares, other possible extensions of the Silverman and Balser code) would give the second word, whereas the optimal hybrid code assigns it to the third word, which implies the correction of four bins. Lastly, if the parity-checked word received is 2, -2, 2, -1, 1, -1, its distance 3 to all code words makes it completely ambiguous digitally, but the correction of the three most doubtful bins, which can be made in accordance with the extension of the Silverman and Balser code mentioned earlier, will give the same result as the optimal hybrid code.

It will be noted that the 1-error correcting Wagner code treated by Silverman and Balser constitutes a particular case of both the Silverman and Balser code, and the optimal hybrid code, described here: if a simple parity check is utilized, the correction of the most doubtful binit corresponds automatically to the selection of the word sent which maximizes the bracket written above. It will be noted further that the optimal hybrid code always leads to a decision as to the word most likely sent, while the digital code on which it is based may lead to the same decision, or to a different decision having a lower *a posteriori* probability, or may remain indecisive. For these reasons, the optimal hybrid code will be always more efficient than the digital code on which it is grafted, or than the Silverman and Balser code.

It can be surmised that the most efficient optimal hybrid codes will be those grafted on the most efficient digital codes, but the task of treating these codes mathematically does not appear to be inconsiderable.

M. J. E. GOLAY
Sig. Corps Engrg. Lab.
Ft. Monmouth, N.J.

Rebuttal³

Dr. Golay observes (as have others) that Wagner-type "codes" are not codes ("digital codes" in the letter), but rather detection schemes. This point, which we did not emphasize in Part I of our paper is made clear in Part II, already submitted to the PROCEEDINGS. What Dr. Golay designates as an "optimum hybrid code" may be recognized as the familiar minimum-probability-of-error detector, or ideal detector.

The virtue of the Wagner-type codes is their simplicity of operation and comparative ease of implementation. However, it is

gratifying that the simple Wagner code turns out to be a minimum-probability-of-error detector. A minimum-probability-of-error detector exists in theory for any embedding of message points in a larger space. We are aware that the other codes we introduced are not minimum-probability-of-error codes and therefore obviously make more errors than the latter. On the other hand, as already pointed out, they are mathematically tractable and operationally feasible.

M. BALSER and R. A. SILVERMAN
Lincoln Laboratory
Mass. Inst. Tech.
Lexington, Mass.

Synthesis Techniques*

In the July, 1954 issue of the PROCEEDINGS OF THE I.R.E.,¹ G. L. Matthaei discusses methods for synthesizing driving-point impedances of the form

$$F(p) = \frac{gp^2 + ap + b}{p^2 + ep + d},$$

where $F(p)$ is positive-real. This letter presents an additional class of functions that is more general than Matthaei's *Type C Realization* and does not require Bott-Duffin. The *Type C Realization* is limited to functions that conform to

$$gd + b \leq ae, \quad (1)$$

whereas the method presented below applies to any function that satisfies the condition

$$|gd - b| \leq ae. \quad (2)$$

The synthesis technique is the following:²

(a) If $g \geq b/d$

$$\text{let } F(p) = \frac{b}{d} \frac{p^2 + d}{p^2 + ep + d} + \frac{\left(g - \frac{b}{d}\right) p^2 + ap}{p^2 + ep + d}. \quad (3)$$

(b) If $g \leq b/d$

$$\text{let } F(p) = \frac{g(p^2 + d)}{p^2 + ep + d} + \frac{ap + (b - gd)}{p^2 + ep + d}. \quad (4)$$

Each of the functions on the right-hand side of (3) and (4) are positive-real if (2) is satisfied.

Example:

$$F(p) = \frac{p^2 + 3p + 7}{p^2 + 2p + 1}$$

$$b/d = 7, \quad g = 1.$$

Thus, $g < b/d$ and the application of (4) yields

* Received by the IRE, November 26, 1954.

¹ "Some techniques for network synthesis," vol. 42, pp. 1126-1137.

² R. H. Pantell, "New Methods of Driving-Point and Transfer Function Synthesis," Tech. Rep. No. 76, Stanford Univ., Stanford, Calif.; July, 1954.

$$F(p) = \frac{p^2 + 1}{p^2 + 2p + 1} + \frac{3p + 6}{p^2 + 2p + 1}$$

The realization is shown in Fig. 1.

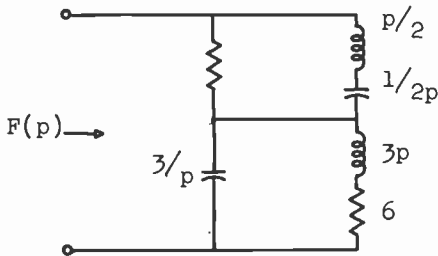

Fig. 1—Realization of $F(p) = \frac{p^2 + 3p + 7}{p^2 + 2p + 1}$.

The synthesis technique is a result of work done with the support of the U. S. Army, U. S. Air Force, and U. S. Navy.

R. H. PANTELL
Elect. Engng. Dept.
Stanford University
Stanford, Calif.

Rebuttal³

Both Dr. Pantell of Stanford University and Dr. E. S. Kuh of Bell Telephone Laboratories, independently, have called my attention to the method of realization which Dr. Pantell has presented in his helpful letter. The *Type C Realization* that they propose, clearly, is much broader in its application than the one that I proposed.

Concerning the same paper, in my discussion of *Type D Realization*, an important situation which I overlooked was that if $Im[F'(j\omega_1) < 0]$, at the frequency $j\omega_1$ where $Re[F'(j\omega_1)] = 0$ then $F'(p)$ should be inverted before applying the expansion process described. Also, Dr. L. Weinberg has mentioned to me that the Bott and Duffin procedure, as applied to the *Type D* case, need not involve the solution of a third degree equation, a fact which cancels a contrary impression contained in my paper.

G. L. MATTHAEI
Div. of Elect. Engng.
University of California
Berkeley, Calif.

³ Received by the IRE, December 27, 1954.

Diversity Combining*

Recently published^{1,2} discussions of diversity combining methods seem to skip over a very important characteristic of the original system and circuits^{3,4} for diversity combination of short-wave signals from spaced antennas.

* Received by the IRE, December 8, 1954.

¹ Leonard R. Kahn, "Ratio squarer," *Proc. I.R.E.*, vol. 42, p. 1704; November, 1954.

² J. E. Boughtwood, "Telegraph terminal AN/FGC-29 circuit design aspects," *Communication and Electronics, Trans. AIEE*, no. 15, p. 531; November, 1954.

³ H. H. Beverage and H. O. Peterson, "Diversity receiving system of RCA Communications, Inc. for radiotelegraphy," *Proc. I.R.E.*, vol. 19, pp. 531-561; April, 1931.

⁴ H. O. Peterson, H. H. Beverage, and J. B. Moore, "Diversity telephone receiving system of RCA Communications, Inc.," *Proc. I.R.E.*, vol. 19, pp. 562-584; April, 1931.

This characteristic is the inherent voltage regulation of the system comprising the diode rectifiers, of the individual radio receivers, and their common load resistor. The result is that the rectified output from the receiver delivering the stronger signal, at the moment, gradually biases the diodes and thus acts to further reduce the contribution from the receiver or receivers supplying a weaker signal.

It would appear that this gradual action rather effectively accomplishes the stated purpose of so-called ratio squarer systems.

Another point made in the recent discussion cited^{1,2} which could stand further clarification is the statement to the effect that rectified signal voltages add arithmetically, but rectified noise voltages in the same circuit add in the rms manner. A further explanation of this action would seem to be in order.

J. B. MOORE
66 Broad Street
New York 4, N. Y.

Rebuttal⁵

I appreciate very much J. B. Moore's comments on the Ratio Squarer,¹ especially in view of his pioneering work in the diversity reception field.

We seem to be in some disagreement as to Mr. Moore's first point that common load diversity systems "rather effectively accomplishes the stated purpose of the so-called 'Ratio Squarer' system," because one of the main design criteria for common load diversity systems is and has been sharp selection. The Ratio Squarer law indicates that, for optimum signal-to-noise ratios, sharp selection does not optimize the signal-to-noise ratio. In order to emphasize the fact that the sharp selection criterion has been accepted for diversity reception, I wish to quote from some authoritative papers.

Mr. Moore states the goal of sharp selection as follows: "the object being to insure that the utilized output signal will at any and every instant be derived either wholly or chiefly from the antenna at which the best signal-to-noise exists at that instant."⁶ It should be mentioned in passing that in addition to diversity reception, Mr. Moore discussed in this paper his error-proof Code System, which is so widely used in the communications field.

In June, 1947, another authority in this field, Walter Lyons, in discussing criteria for diversity receiver design, stated that, "A very important feature in the sound design of diversity receivers, particularly those for telephone and on/off telegraph reception, is the use of diode switching for automatically switching out all receivers of the group except the one which is temporarily receiving the highest signal voltage, and, ordinarily, the best signal-to-noise ratio."⁷ Also, in this same article, Mr. Lyons, in describing frequency shift diversity re-

ceivers, states, "The requirement is that one and only one signal contribute to the output load at any given time with the ability for very rapid switching when an interchange occurs."⁷

Davey and Matte state, "The ideal diversity selection circuit theoretically should give a signal-to-noise characteristic identical to that of a single channel under the signal-to-noise condition corresponding to the signal of the best momentary reception."⁸

It appears evident from the above statements by these leaders in the theory of diversity reception, that sharp selection is presently one of the important goals of diversity systems. The Ratio Squarer law, analyzed in our November correspondence, indicates that the weaker signals may be used to improve the resultant signal-to-noise ratio and therefore indicates that use of the sharp selection criterion does not result in optimum signal-to-noise ratios.

I would like to make the following comments in answer to the question raised by Mr. Moore as to how we arrived at the conclusion that the rectified signal voltages add linearly but the rectified noise voltages add in a root-mean-square fashion. Disregarding multipath delay distortion, which we may do for normal commercial keying speeds (below say 150 words per minute), the keying pulses from the individual diversity receivers should be in phase. However, the noise superimposed upon these pulses should be random in nature and therefore may be statistically added according to a root-mean-square summation.

I would like to take this opportunity to clarify a problem raised in one of the articles describing a follow-up design of my system.⁹ It was there mentioned that a "3-db signal-to-noise improvement" over conventional diversity systems was achieved in the two receiver ratio squarer diversity system. Actually this 3 db improvement for the two receiver version only occurs when the two signals are exactly equal in amplitude. At other times, the improvement is less but at all times the signal-to-noise ratio is equal or greater than that obtained from the conventional diversity systems. This signal-to-noise improvement has resulted in an appreciable improvement in measured error count over the best of the conventional systems which was measured in these tests, the common limiter system.⁸⁻¹⁰ Further improvement over normal diversity reception can be achieved by using three or four or more receiver diversity. Improvement of 4.7 db is achieved for the three receiver diversity and 6 db for the four-receiver diversity at equal signal instants over the conventional three- and four-receiver diversity systems.

L. R. KAHN
Kahn Res. Labs.
22 Pine Street
Freeport, L. I., N. Y.

⁸ J. R. Davey and A. L. Matte, "Frequency shift telegraphy-radio and wire applications," *Bell Sys. Tech. Jour.*, vol. 27, pp. 265-304; April, 1948; also *Trans. AIEE*, vol. 66, pp. 479-493; 1947.

⁹ J. E. Boughtwood and C. H. Cramer, "Military carrier telegraph equipment," *Electronics*, vol. 27, p. 196; October, 1954.

¹⁰ L. R. Kahn, "Analysis of a limiter as a variable-gain device," *Elec. Engrg.*, vol. 72, pp. 1106-1109; December, 1953.

⁵ Received by the IRE, January 14, 1955.

⁶ J. B. Moore, "Fading effects at high frequencies," *Electronics*, vol. 17, pp. 100-106; October, 1944.

⁷ W. Lyons, "Criteria for diversity receiver design," *RCA Rev.*, pp. 373-378; June, 1947.

“Large Reduction of VHF Transmission Loss and Fading by the Presence of a Mountain Obstacle in Beyond-Line-of-Sight Paths”*.1

A study of Fig. 1 in this paper and the Mt. Fairweather calculations indicates that the authors misinterpreted the “four-ray” expression of Schelleng, Burrows and Ferrell.² It appears that the phase terms ζ_1 , ζ_2 , ζ_3 and ζ_4 in this expression were taken to be equal to $k(TM+MR)$, $k(T'M+MR)$, $k(TM+MR')$ and $k(T'M+MR')$ respectively instead of kTR , $kT'R$, kTR' and $kT'R'$ respectively, where $k=2\pi/\lambda$, λ being the wavelength. This erroneous interpretation is also contained in the analysis by Matsuo which was referred to by the authors of this paper.

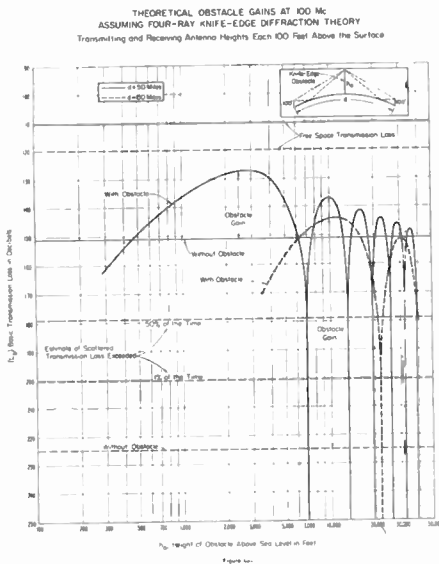

Fig. 1—The Mt. Fairweather circuit.

Revised “four-ray” calculations in terms of the previously published parameters for the Mt. Fairweather circuit predict a transmission loss 50 db in excess of the free-space transmission loss. Since smooth-earth diffraction theory predicts a loss of 105 db relative to free space,³ it follows that the revised theoretical value of the “obstacle gain” is 55 db, which is 25 db less than the previously predicted value and 18 db less than the measured value. A number of explanations can be advanced to account for this discrepancy between theory and experiment:

1. It is possible that the effect of the terrain between the terminals and the ob-

struction is not adequately approximated by simple image theory.

2. Even though the spherical earth divergence factors are each approximately equal to 0.99, the assumption of effective reflection coefficients equal to -1 may not be valid.
3. A limitation of the theory is that the shape and electromagnetic properties of obstructions are not taken into consideration.
4. Knife-edge diffraction theory, assuming an equivalent horizontal knife-edge at the maximum elevation determined by the vertical profile, may not be applicable to the analysis of this circuit. With reference to Fig. 1, it can be seen that there are several high peaks in the immediate vicinity of the direct path between the terminals.⁴ (The distances in brackets are the horizontal distances from the peaks to the vertical plane containing the terminals.)
5. Spatial variations in the radiation characteristics of the antennas are not taken into account in the Schelleng, Burrows and Ferrell expression; the realization of free-space antenna gains is assumed.

It seems worthwhile to point out that the Schelleng, Burrows and Ferrell expression can be rewritten in a form which is more amenable to interpretation and calculations. It is noted that the value of $\pi\pi^2/2$ appropriate to each term is the Fresnel approximation for the difference, in radians at the wavelength under consideration, between the path via M and the direct path; for example, $(\pi v_1^2/2) = k(TM+MR-TR)$. Consequently, the phase corrected Schelleng, Burrows and Ferrell expression can be written as follows:

$$\frac{E}{E_0} = \exp \frac{j\pi v_1^2}{2} \left[\begin{array}{l} C_1 \exp j\phi_1 + C_2 K_1 \\ \cdot \exp j(\phi_2 - \psi_1 - \phi_1) \\ + C_3 K_2 \exp j(\phi_3 + \psi_2 - \phi_2) \\ + C_4 K_1 K_2 \\ \cdot \exp j(\phi_4 + \psi_1 + \psi_2 - \phi_1 - \phi_2) \end{array} \right], \quad (1)$$

where:

$$\psi_1 = k(T'M - TM), \quad (2a)$$

$$\psi_2 = k(MR' - MR), \quad (2b)$$

and the remaining symbols are as defined.² The form of (1) suggests that it is convenient to regard C and f as being the magnitude and phase, respectively, of a complex diffraction coefficient, just as K and $-\phi$ can be regarded as the magnitude and phase of a complex reflection coefficient; the remaining terms in (1) represent the path-phase dif-

ferences at M between the direct and reflected rays. From a study of Figs. 20 and 21 of Schelleng, Burrows and Ferrell paper, it is concluded that negligible error may result from the use of average values for C and f when the effective height of the obstruction is considerably greater than the distance between each antenna and its image. Subject to this assumption, the magnitude of E/E_0 is given approximately by:

$$\left| \frac{E}{E_0} \right| \approx \bar{C} \left| 1 + K_1 \exp j(\psi_1 - \phi_1) \right| \cdot \left| 1 + K_2 \exp j(\psi_2 - \phi_2) \right|. \quad (3)$$

(The reduced form of (3) for the special case of an obstruction above a plane earth with a reflection coefficient of -1 has been given by Bullington.⁵)

The revised calculations for the Mt. Fairweather circuit were based on (3), since it was found that the greatest difference between the various values of $f(v)$ was less than 0.1 degrees, and since the smallest value of $C(v)$ exceeded 99 per cent of the largest value. The methods of Kerr⁶ were used to determine the values of ψ_1 and ψ_2 . (As in the authors paper,¹ the effective radius of the earth was taken to be 4/3 times the true radius.) Expressed in decibels, the second and third factors were found to be -12 db and -8 db respectively. The first factor was evaluated by means of the convenient nomogram due to Bullington;⁷ the assumed height of the knife-edge contained a correction to compensate for the curvature of the earth. In decibels, this factor was found to be equal to -30 db.

The writer is indebted to the authors of this paper for a stimulating exchange of correspondence. In addition, it is a pleasure to acknowledge valuable discussions with J. W. Herbstreit during a recent visit to Boulder, Colo.

J. H. CRYSDALE
Radio Physics Lab.
Defence Research Bd.
Ottawa, Can.

Rebuttal⁸

The authors of the subject paper have enjoyed the very stimulating exchange of correspondence which resulted in the presentation of the preceding discussion. It is believed that the discussion has made clear to all concerned the correct interpretation of the results of Schelleng, Burrows and Ferrell to the mountain obstacle problem. Accordingly, Fig. 1 in our original paper has been redrawn. It is to be noted that the curves now show only one cusp per “lobe” rather than the three in the original figure. Also minimum transmission loss for correspond-

* Received by the IRE, November 1, 1954.
¹ F. H. Dickson, J. J. Egli, J. W. Herbstreit, and G. S. Wickizer, PROC. I.R.E., vol. 41, pp. 967-969; August, 1953.

² J. C. Schelleng, C. R. Burrows, and E. B. Ferrell, “Ultra-short-wave propagation,” PROC. I.R.E., vol. 21, pp. 427-463 (see p. 450); March, 1933. In order that the phase of this expression be correct, the right-hand side must be multiplied by $\exp(-j\phi)$. This phase correction is immaterial, of course, for magnitude calculations.

³ K. Bullington, “Radio propagation at frequencies above 30 megacycles,” PROC. I.R.E., vol. 35, pp. 1122-1136; October, 1947. (See Figs. 1, 4 and 5.)

⁴ Additional topography was taken from the “Alsek River” and “Juneau-Atlin” topographical sheets published by the Dept. of Mines and Technical Surveys, Ottawa, Can. (It is of interest to note that “four-ray” calculations assuming a horizontal knife-edge through the peak of Mt. Fairweather predict an “obstacle gain” only 9 db less than the experimental value; the increased diffraction loss is more than compensated by the increased effective antenna directivities.)

⁵ “Radio Wave Propagation; Consolidated Summary Technical Report of the Committee on Propagation of the National Defence Research Committee,” Academic Press, New York, N. Y., p. 69; 1949.

⁶ D. E. Kerr, “Propagation of Short Radio Waves,” McGraw-Hill Book Co., New York, N. Y., 1st ed., pp. 113-123; 1951.

⁷ Bullington, *loc. cit.*, Fig. 8.

⁸ Received by the IRE, January 27, 1955.

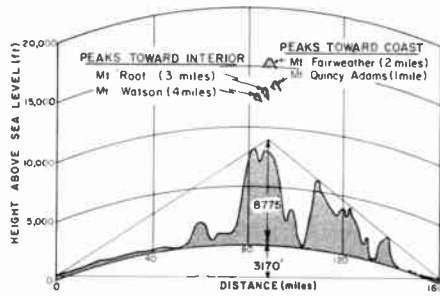

Fig. 1

ing "lobes" occur with somewhat higher obstacle heights than previously indicated. Minimum transmission loss occurs when all of the four indicated paths are in phase.

F. H. DICKSON, J. J. EGLI,
J. W. HERBSTREIT, and G. S. WICKIZER
by J. W. HERBSTREIT
Chief, Tropospheric Prop. Res. Sec.
Radio Prop. Engrg. Div.
National Bureau of Standards
Boulder, Colo.

Scattering of Electromagnetic Waves by Wires and Plates*

In the above paper¹ a method utilizing a combination of rigorous theory and rough approximation was presented for calculating the field scattered by a wire. The effort towards a simplified procedure is an admirable one, but in the course of the procedure a portion of the current on the wire and consequent scattered field was omitted.

Dr. Weber used transmission-line analogies to derive his approximate current distribution function, $\phi(z)$. Because of the unfortunate choice of the scalar potential difference between points on each half of the wire and the current, i.e., balanced transmission-line parameters, he could not take into account the unbalanced or antisymmetric currents which exist on the structure. The author should have been aware of the existence of these currents, especially in view of his reference to Tai's paper,² where they have been considered.

Since the correct zeroth-order receiving current distribution is well known to be of the form³

$$I = I_s + I_a;$$

where I_s , the symmetric current, is that given in Dr. Weber's paper with

$$k_1 = k \quad \text{and}$$

$$I_s = jI_c \frac{\sin kz \sin(kl \cos \theta') - \sin kl \sin(kz \cos \theta')}{\tan kl [\cos(kl \cos \theta') - \cos kl]}$$

the erroneous derivation, equations (22) through (26), is unnecessary. Utilizing the correct zeroth-order distribution in (20),

it is seen that the last bracket in equation (28) should have the following terms added inside it:

$$-\frac{1}{\tan kl} \left\{ \sin(kl \cos \theta') \left(\frac{\cos(kl \cos \theta) \cos \theta \sin kl - \cos kl \sin(kl \cos \theta)}{\sin^2 \theta} \right) \right. \\ \left. + \frac{\sin kl}{2} \left(\frac{\sin kl(\cos \theta + \cos \theta')}{\cos \theta + \cos \theta'} + \frac{\sin kl(\cos \theta - \cos \theta')}{\cos \theta' - \cos \theta} \right) \right\}.$$

In addition, (28) should be multiplied by j .

It is seen that I_a may be neglected only for normal incidence or normal observation, $\theta' = \pi/2$ or $\theta = \pi/2$ respectively. Fortunately the numerical results given in the paper are for $\theta = \theta' = \pi/2$.

In addition, Dr. Weber has chosen a controversial piece of experimental data with which to compare his results.⁴ He is therefore not justified in referring to his method as yielding "precise" results. It is an engineering approximation which gives only the correct order of magnitude and no more.

D. B. BRICK
Cruft Lab., Harvard University,
Cambridge 38, Mass.

Rebuttal⁵

Dr. Brick's suggestion appears to have merit for improving the accuracy of a portion of my paper¹ over part of the range for which validity is claimed. This is welcome. Some of his criticism may be a result of his having overlooked certain statements in the paper.

A given approximation method which is applied to a problem gives a unique zeroth-order solution. Different approximation methods applied to the same problem give, in general, different zeroth-order solutions. Dr. Brick's expression for the current is based on a mathematical approximation while that used in the paper is based on a physical approximation. It is unreasonable to say that the mathematical approximation is correct and the physical approximation is erroneous. In the light of work which has been done since the paper was completed, his approximation appears to be better.

The paper dealt with several subjects and contained twenty-nine equations. Some are precise, and others are not. Eq. (20) is a general formulation of the problem of scattering by wires. This is believed to be precise. Following this, transmission line analogies are used to obtain a current distribution function which is then applied to scattering by short wires. It is stated on page 87 of the paper that the transmission line analogies give "good results in certain cases." On page 88 these analogies are referred to as "rough approximations" and on page 89, in the conclusion, the entire procedure is referred to as "reasonably accurate." The term precise was used when comparing the back-scattering cross section (29) with that given by Tai.² This expression is believed to be precise⁶

over the range for which validity was claimed. Since Tai did not give an expression corresponding to (28) it should have been

clear from the other quoted remarks that precision was not claimed for everything in the paper. Dr. Brick is correct in referring to (28) as an unprecise engineering solution.

Eq. (25) gives a current distribution function based on the physical approximation that a short antenna is in some respects like a balanced transmission line. It is interesting that the physical approximation gives results close to the mathematical approximations over a considerable part of the range (short wires of length < 0.8 wavelength) for which validity is claimed. For very short wires comparison of the term which Dr. Brick adds with the terms already present shows that the relative contribution to the electric field varies as length over wavelength squared. The correction is then very small for all angles of incidence. This is a consequence of the fact that for very short wires the symmetric current gives rise to dipole radiation while the antisymmetric current gives rise to quadrupole radiation. For very short wires, then, neglect of the antisymmetric current amounts to neglect of the quadrupole radiation in comparison with the dipole radiation. As the wire length increases to a half wavelength and the foregoing considerations no longer apply, the antisymmetric current contribution is again zero for all angles because of the factor $\tan kl$ in the denominator of Dr. Brick's expression. For radiation which is either normally incident or normally scattered the antisymmetric contribution is zero for wires of all lengths as noted by Dr. Brick. The cases for which the antisymmetric contribution might be appreciable are scattering from long wires and certain cases of scattering from short wires. For long wires the correction may indeed be dominant. This was known and long wires were excluded from the discussion in the paper. For these reasons it appears that addition of more terms to the already monstrous expression (28) helps matters only for a part of the range of antenna lengths and angles of incidence and observation with which the paper is concerned. Nonetheless the addition seems to be a useful one. It may also extend the results to regions (long wires) for which validity was not claimed.

A more accurate (and more complex) method of taking the antisymmetric currents into account is to multiply Dr. Brick's expressions by a factor which can be calculated from the results of Tai's paper.²

There are typographical errors in the paper. The minus 1 should be deleted from the middle of (14b) and the last theta in the numerator of expression (28) should be primed.

J. WEBER
Professor of Elec. Engrg.
Univ. of Maryland
College Park, Md.

* Received by the IRE, February 4, 1955.

¹ J. Weber, Proc. I.R.E., vol. 43, pp. 82-89; January, 1955.

² C. T. Tai, "Electromagnetic back-scattering from cylindrical wires," *Jour Appl. Phys.*, vol. 23, pp. 909-916; August, 1952.

³ R. W. P. King, "Theory of Linear Antennas," Chapter 4. (To be published by the Harvard University Press.)

⁴ S. H. Dike and D. D. King, "Discussion on: The absorption gain and back scattering cross section of the cylindrical antenna," Proc. I.R.E., vol. 41, pp. 926-934; July, 1953.

⁵ Received by the IRE, February 23, 1955.

⁶ The balanced line approximation would be expected to be best at normal incidence, for several reasons. This is why (28) gives precise results for the back-scattering cross section, for short wires.

Contributors

J. T. Bolljahn (A'43-SM'53) was born in Oakland, California in 1918. He received the B.S. and Ph.D. degrees from the University of California in 1941 and 1950, respectively. From August, 1941, until January, 1946, he was employed by the Naval Research Laboratory in Washington, D. C. From February, 1946, until September, 1949, Dr. Bolljahn was a member of the staff of the University of California



J. T. BOLLJAHN

Antenna Laboratory.

Dr. Bolljahn joined the staff of the Stanford Research Institute in September, 1949, and his present position is laboratory manager of the Antenna Systems Laboratory.

He is a member of Sigma Xi, Tau Beta Pi and Eta Kappa Nu.



H. J. Carlin (SM'50) was born in New York, N. Y., in 1917. He attended Columbia University, receiving the B.S. degree in 1938, and the M.S. degree in 1940. In 1947 he was awarded the D.E.E. degree from Polytechnic Institute of Brooklyn.



H. J. CARLIN

Dr. Carlin was with Westinghouse from 1940 to 1945. In the latter part of 1945, he joined the Polytechnic Institute of Brooklyn, where he now holds the position of research professor and is a member of the executive committee which directs the activities of the Microwave Research Institute. His major work has been in the fields of microwave devices and network theory.

He is a member of the AIEE, AAAS, Tau Beta Pi, Sigma Xi, and Eta Kappa Nu.



E. P. Felch (A'32-M'42-SM'43-F'54) was born in Madison, N. J., on January 10, 1909. He graduated from Dartmouth College in 1929 with the A.B. degree in physics. He has been with Bell Telephone Laboratories since 1929.



E. P. FELCH

From 1930 until 1940, Mr. Felch was concerned with the development of electronic measuring apparatus. During World War II he was responsible for super-
development and application engineering of

Airborne Magnetometers and Magnetic Ordnance. Subsequently, he resumed responsibility for development of electronic measuring apparatus and the new Bell System Primary Standard of Frequency. Since 1953, he has been Military Systems Development Engineer, engaged in development of digital data transmission systems employing transistors.

He is a member of AIEE and the American Physical Society.



T. E. Firlie (S'52-A'53) was born on July 4, 1926, in Berlin, Germany. From 1946 to 1948 he was sound engineer at "RIAS" (Radio In The U. S. Sector Berlin). After coming to the United States he attended Los Angeles City College and the University of California at Los Angeles, receiving his B.S. degree in applied physics from U.C.L.A. in 1952.



T. E. FIRLIE

Mr. Firlie joined the Hughes Research and Development Laboratories as a member of the technical staff and is engaged in semiconductor research with the semiconductor laboratory. He was awarded a Hughes Cooperative Fellowship for the Master of Science degree in 1953 and received his M.S. in applied physics in January, 1955, from U.C.L.A.

Mr. Firlie is a member of the American Physical Society and Sigma Pi Sigma.



N. H. Fletcher was born in Armidale, Australia, in 1930. He attended New England University College (University of Sydney) and received a B.Sc. degree in 1952 with the University Medal in Physics. He came to Harvard University in 1952 on a Fulbright Travel Grant and the Frank Knox Memorial Fellowship, gained his M.A. degree in 1953, and is now working towards a Ph.D. in solid state physics, under the traineeship plan of the Australian Commonwealth Scientific and Industrial Research Organization.



N. H. FLETCHER

Mr. Fletcher joined the staff of Transistor Products, Inc., in 1953 and is now assistant director of the Development Division, working principally in the design of power transistors.

Mr. Fletcher joined the staff of Transistor Products, Inc., in 1953 and is now assistant director of the Development Division, working principally in the design of power transistors.

J. V. N. Granger (S'42-A'45-M'46-SM'51) was born in Marion, Iowa. He received the B.A. degree from Cornell College in 1941, and the M.S. and Ph.D. degrees from Harvard University in 1942 and 1948, respectively. During World War II he worked with the Radio Research Laboratory and American-British Laboratory of Harvard University, and served in the capacity of technical observer with the U. S. Air Force in Europe.



J. V. N. GRANGER

Since 1949 Dr. Granger has been with the Stanford Research Institute, where he is assistant director of engineering research and manager of the Radio Systems Laboratory.

He is a member of the Board of Directors of the National Conference on Aeronautical Electronics. In 1952 he was named "The Outstanding Young Electrical Engineer" by Eta Kappa Nu.



J. O. Israel (A'46-M'46-SM'52) was born on April 17, 1906, in Washington, D. C. He received the B.S. degree in electrical engineering from Lafayette College in 1927, and the M.S. degree from Yale University in 1930.



J. O. ISRAEL

Since 1928 Mr. Israel has been a member of the technical staff of Bell Telephone Laboratories, where he spent a number of years in network development. During World War II he participated in the development of the Magnetic Airborne Detector for anti-submarine service.

He is a member of the American Association for the Advancement of Science.



H. M. Joseph (A'42-SM'53) was born in Pittsburgh, Pa., on July 11, 1913. He received the B.S. degree in electrical engineering in 1937 and the M.E.E. degree in 1938 from the City College of the City of New York.



H. M. JOSEPH

After graduation, Mr. Joseph became a technical examiner for the U. S. Civil Service Commission. In 1939 he transferred to the U. S. Navy Department Bureau of Ships. From 1945 to 1947, Mr. Joseph was engaged

in the development of electronic instruments for the Underwater Explosions Research Group at the Norfolk Naval Shipyard. He continued in electronic instrumentation at the National Bureau of Standards from 1947 to 1954. While at NBS, Mr. Joseph led such projects as the Electronic Currency Counter. Mr. Joseph joined ACF Electronics early in 1954, as a project engineer in the instrumentation department.

Mr. Joseph is a member of the AIEE and AAAS.



M. Karnaugh was born in New York, N. Y., on October 4, 1924. He received the B.S. degree in physics from the City College of New York in 1948 and the M.S. and Ph.D. degrees in physics from Yale University in 1950 and 1952, respectively.



M. KARNAUGH

Department.

Dr. Karnaugh is a member of Phi Beta Kappa, Sigma Xi, and the American Physical Society.



L. S. G. Kovásznyai (M'53-SM'53) was born on April 14, 1918, in Budapest, Hungary. He attended the Royal Institute of Technology in Budapest, receiving the Dipl. Ing. degree in 1941 and the Ph.D. degree in physics in 1943.



L.S.G. KOVÁSZNAY

After the war, he was awarded a British Council Scholarship and spent a year at the Cavendish Laboratory, Cambridge University, England.

In 1947 he joined the staff of Johns Hop-

kins University as a research associate. In 1948 he became an assistant professor and in 1950 an associate professor. He is now professor of aeronautics and his time is divided between advance graduate teaching and research.

Besides his academic activities, Dr. Kovásznyai has been active as consultant both to government organizations and industry, such as the National Bureau of Standards, National Advisory Committee for Aeronautics, Ballistics Research Laboratory, and General Electric Co.

Dr. Kovásznyai is a member of the Institute of the Aeronautical Sciences and of Sigma Xi.



M. E. McMahon (S'48-A'51) was born in Lodi, Calif., on November 25, 1924. He received the B.S. and M.S. degrees at the University of California at Berkeley in 1950 and 1951, respectively.

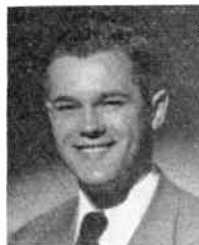

M. E. MCMAHON

From 1950 to 1951, he worked on an ONR-AEC cosmic ray project. He was employed by the semiconductor division of the Hughes Aircraft Co. from August, 1951 to August, 1954, and is now with Pacific Semiconductors, Inc.

Mr. McMahon is a member of Tau Beta Pi, Eta Kappa Nu, Sigma Xi and RESA.



Y. Oono was born on January 6, 1920, in Hukuoka, Japan. He received the B.E. degree from Kyushu University, Japan, in 1941, and the Doctor of Engineering degree from the same university in 1948.



Y. OONO

Since 1947, Mr. Oono has been an assistant professor of Communications Engineering at the Kyushu University which is located in Hukuoka, Japan.

J. A. Pierce (SM'45-F'47) was born in Spokane, Wash., on December 11, 1907. He received the B.A. degree in physics from the University of Maine.



J. A. PIERCE

From 1934 to 1941, he was engaged in research, primarily on the physics of the ionosphere, at Cruft Laboratory at Harvard University.

From 1941 through 1945, he was a member of the Radiation Laboratory of the Massachusetts Institute of Technology,

where he assisted in the development of the Loran system. He is now a Senior Research Fellow at Cruft Laboratory working in the field of radio propagation.

Mr. Pierce holds the President's Certificate of Merit, the Navigation Award, and the Morris Liebmann Prize. He is a Fellow of the American Association for the Advancement of Science and the American Academy of Arts and Sciences.



J. F. Roach was born on May 13, 1916, in Malta, Mont. From 1941 to 1946 he was with the U. S. Signal Corps. He has



J. F. ROACH

been associated with the Hughes Aircraft Co., since receiving the B.S. degree in engineering from U.C.L.A. in 1949. He has been concerned primarily with electronic control and test equipment for the production of semiconductor devices and is now working on special circuit design for digital controls.



For a photograph and biography of J. L. Stewart, see page 1572 of the October, 1954 issue of the PROCEEDINGS OF THE IRE.



40,000 ATTEND IRE'S GREATEST CONVENTION SHOW

Highlights of Papers and Show



Above—The New DuMont Inconumerator can, in one second, count up to one million objects of varying shapes and sizes. Here, the device is operated by DuMont engineer, H. P. Mansberg who, with Carl Berkley, supervised Inconumerator's design and construction.

Below—Electronic gun, by Teletronic Devices, Inc., conceals a radio transmitter in its handle. The sound effects device will electronically produce a gun shot by remote control.



Above—At a symposium on space stations, C. B. Ruckstuhl, Jr., Bendix Aviation, discussed the tiny three-channel telemetering transmitter, in his hand, which is mounted in the head of the experimental rocket at left to transmit course and space data back to earth. It will withstand a force of 32,000 g at take-off.

Right—Automatic Component Assembly System model built for Army Signal Corps by G.E.'s Electronics Division, is being developed as an industrial preparedness measure, and will be completed late this summer.



Above—Tiny storage battery weighing one-sixth of an ounce is, according to Yardney Electric Corporation, the world's smallest. Here it is compared with one of the largest single-cell units made.

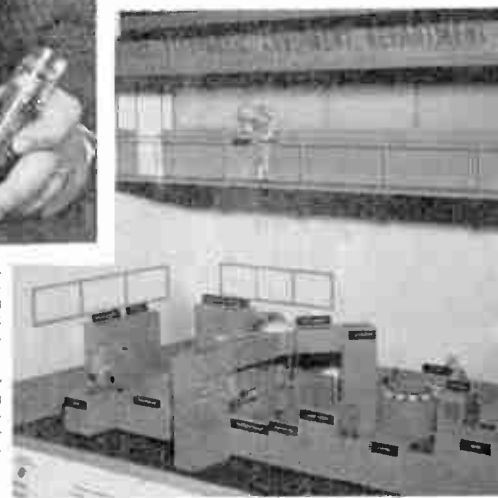

Below—Philco Corporation executives, Leslie J. Woods, Vice-President, Director of Research and Engineering, left, and James D. McLean, Vice-President, Government and Industrial Division, examine the latest in small, high-speed transistorized computers.



Below—The developmental RCA Tricolor Vidicon camera tube, which generates simultaneously, the red, green and blue signals of color TV, shown compared with the black-and-white Image Orthicon camera tube (on the table) now in general use. Vidicon performs functions usually requiring three separate tubes.



CONVENTION FEATURES AND SYMPOSIUMS



Above—Among those attending the Spurious Radiation Symposium were (left to right) E. M. Webster, FCC; W. R. G. Baker, General Electric; Axel Jensen, Bell Laboratories; A. V. Loughren, Hazeltine; Ralph Bown, Bell Laboratories; F. C. W. Browne, Canadian Department of Transport; Edward Allen, FCC; E. S. White, Warwick Manufacturing Company; and E. E. Coffey, Canadian Department of Transport.



Above—Color TV Symposium speakers (left to right): Oscar Reed, Lewis Winner, Robert E. Shelby, Frank Uzel, Jr., J. R. Popkin, H. A. S. Gibas, W. L. Hughes, and J. H. Ladd.



Above—Hostesses and guests at the Ladies' Tea are (left to right): Mrs. Wallace L. Cassell and Mrs. John D. Ryder. Mrs. William R. Hewlett pours.



Above—Ted Hunter, Editor of the IRE Student Quarterly, delivered a talk on the need for papers to aid students in selecting a special sphere for their engineering talents.



Above—Mrs. James W. McRae pours for the wives of conventioners at the Ladies' Tea which was held in the new IRE Headquarters at 5 East 79th Street in New York City.

Below—Panoramic view of the four-acre Radio Engineering Show held at the Kingsbridge Armory and Kingsbridge Palace. Concerns from all over the country provided seven hundred and four vitally interesting electronics exhibits. At this largest show in the Convention's history, many new products and processes were displayed.



IRE BANQUET AND ANNUAL MEETING



Above—Head table at Banquet. Front row: Award winner: Harald T. Friis, Arthur V. Loughren, B. D. Smith, Jr., William Shockley who acted as spokesman for Fellows, Bernard Salsberg and Harold B. Law. Second row: Stuart L. Bailey, Vice-Chairman of National Convention; John R. Pierce, Editor; W. R. G. Baker Treasurer; Maj. Gen. George I. Back, Chief Signal Officer, U. S. Army; Gen. Charles L. Bolte, Vice Chief of Staff, U. S. Army and Guest Speaker; James W. McRae, Toastmaster and Senior Past President (inset); John D. Ryder, President; Franz Tank, Vice President; Capt. Gordon L. Caswell, Acting Director of Naval Communications; Maj. Gen. Gordon A. Blake, Director of U. S. Air Force Communications; William R. Hewlett, Junior Past President Alfred N. Goldsmith, Editor Emeritus; George W. Bailey, Chairman of National Convention.



Above—Guests of honor (left to right) at the Banquet were Maj. Gen. George I. Back, John D. Ryder, Gen. C. L. Bolte, Maj. Gen. G. A. Blake and Capt. G. L. Caswell.



Right—The 1955 IRE Award winners (left to right) A. V. Loughren, Speaker William Shockley, who delivered the speech of acceptance on behalf of the Fellows; Bernard Salsberg, B. D. Smith and Harald B. Law.



Above—New IRE President, John D. Ryder receives gavel of office from William R. Hewlett, as he assumes the Chairmanship of the Annual Meeting.



Left—Franz Tank, Vice-President of the IRE and Docteur ès Sciences Techniques Honoris Causa of the Ecole Polytechnique de l'Université de Lausanne, came from Switzerland for the Convention.



Above—Harald Friis receives the Medal of Honor at the Banquet for "... his contributions in the expansion of the useful spectrum of radio frequencies, and for ... leadership ... to young engineers."

Below—William R. Hewlett (at podium) delivers the opening address at the Annual Meeting before turning over the IRE Presidency to his 1955 successor, John D. Ryder. Seated at the table are (left to right): T. A. Hunter, Franz Tank, John D. Ryder, Arthur V. Loughren, W. R. G. Baker and George W. Bailey.



IRE News and Radio Notes

ENGLAND HONORS R. KOMPNER

Rudolf Kompner, a member of Bell Laboratories' Research in High Frequency and Electronics Department, has been designated by the Physical Society of England as the 1955 recipient of its Duddell Medal. The medal, one of the highest honors bestowed by Britain's physicists, will be presented in London next autumn. Mr. Kompner will receive the award in recognition of his work in England during World War II on the traveling wave tube.

His work was related to the field of microwave repeater development and, in December 1951, Mr. Kompner joined the Laboratories to continue his research on vacuum tubes, particularly those used in the microwave region.

The Duddell Medal was established as a memorial to W. Duddell, a British physicist who contributed to developments in telephony and telegraphy, and who died in 1917. Other recipients have included Hans Geiger, E. O. Lawrence, and F. W. Aston.

COMPONENTS HANDBOOK PLANNED

The U. S. Air Force, through Wright Air Development Center, has signed a contract with the Technical Writing Service of McGraw-Hill Book Company for the publication of a complete and up-to-date *Components Handbook*.

This is part of the campaign to secure reliability in military equipment and aims to provide designing engineers with information which will enable them to select, specify and use component parts.

Compiling the *Components Handbook* will be a three-year project of the Air Force, Army and Navy. Keith Henney, IRE Fellow and editor of the projected handbook, welcomes correspondence from design engineers on information they might contribute. Mr. Henney's address is McGraw-Hill Publishing Company, 330 West 42 Street, New York City.

TWENTY-FOUR ORGANIZATIONS TO PARTICIPATE IN COMING NUCLEAR CONGRESS IN CLEVELAND, OHIO

Engineers Joint Council has announced that 24 organizations with a total membership of 250,000 will participate in the Nuclear Engineering and Science Congress in Cleveland December 12-17, 1955. To date, 183 titles have been submitted covering the entire present range of peace time applications of atomic energy.

Emphasis will be on the industrial possibilities of atomic energy. In addition to scientific and engineering phases, attention will be centered on management problems, and in many instances the papers will be the first public discussion of certain nuclear developments.

Thorndike Saville, Dean of Engineering at New York University, is President of Engineers Joint Council. EJC is composed of eight major national engineering organizations with a total membership of 170,000. John R. Dunning is Chairman of the General Committee on Nuclear Engineering and Science and is Dean of Engineering at Columbia University. Donald L. Katz, who is the Chairman of the Chemical and Metallurgical Engineering departments at the University of Michigan, is Chairman of the Program Committee of the Congress. Barnett F. Dodge, of Yale University, is President of the American Institute of Chemical Engineers, sponsor of the Atomic Exposition to be held in connection with the Congress.

"ELECTRONIC COMPONENTS SYMPOSIUM" MAY BE OBTAINED FROM IRE

The 1954 *Electronic Components Symposium Proceedings* are available at \$4.50 per copy. Those interested in obtaining *The Proceedings* may write to IRE Headquarters, 5 East 79 Street, New York 21, N. Y.

Transistor Conference National Committee Members



IRE-AIEE-U. of Pa. Transistor Conference was held in Philadelphia February 17 and 18. Nineteen papers were presented to nearly 700 circuit engineers. Members of the National Committee are (front row, left to right) N. Johnson, R. S. Gardner, H. E. Tompkins, J. G. Brainerd. (Back row) D. G. Fink, L. H. Good, W. H. Forster.

Calendar of Coming Events

Semiconductor Symposium, Electrochemical Society, Cincinnati, Ohio, May 2-5

National Aeronautical Electronics Conference, Biltmore Hotel, Dayton, Ohio, May 9-11

IRE-AIEE-IAS-ISA National Telemetering Conference, Hotel Morrison, Chicago, Ill., May 18-20

AFCEA Global Communications Convention, N. Y. City, May 19-21

IRE-AIEE-RETMA-WCEMA Electronic Components Conference, Hotel Ambassador, Los Angeles, Calif., May 26-27

IRE-AIEE Symposium on Electronic Materials and Components, U. of Pa., Philadelphia, Pa., June 2-3

American Society for Engineering Education Annual Meeting, Pennsylvania State University, State College, Pennsylvania, June 20-24

URSI-U. of Michigan International Symposium on Electromagnetic Wave Theory, University of Michigan, Ann Arbor, Mich., June 20-25

Ohio State U. and Wright Air Development Center Radome Symposium, Columbus, O., June 27-29

URSI Symposium on Solar Eclipses and the Ionosphere, Royal Society, Burlington House, London, England, August 22-24

Association for Computing Machinery, Annual Meeting, Moore School of Electrical Engineering, University of Pennsylvania, September 14-16

RETMA Automation Symposium, University of Pennsylvania, Philadelphia, Pa., September 19-20

International Analogy Computation Meeting, Société Belge des Ingénieurs des Télécommunications et d'Electronique, Brussels, Belgium, September 27-October 1

IRE-AIEE Conference on Industrial Electronics, Rackham Memorial Building, Detroit, Michigan, September 28-29

Second International Automation Exposition, Chicago Navy Pier, Chicago, Illinois, November 14-17

WASHINGTON PLAYED HOST FOR LINEAR PROGRAMMING SYMPOSIUM HELD IN JANUARY

Over 350 mathematicians, economists, and scientists attended the Symposium on Linear Programming in Washington, D. C., January 27-29, under the auspices of the National Bureau of Standards and the Directorate of Management Analysis of the U. S. Air Force. The sessions, which were sponsored by the Office of Scientific Research of the Air Research and Development Command, were held in the Pentagon on January 27 and at NBS on the remaining days.

The symposium included 26 lectures dealing with all phases of current research in linear programming. In addition, one hour expository addresses were given by: Walter Jacobs, U.S.A.F., on military applications; Alan J. Hoffman, NBS, on computation procedures; Paul Samuelson, Massachusetts Institute of Technology, on economic theory; Albert W. Tucker, Princeton University, on linear inequalities; and George B. Dantzig, Rand Corporation, on future prospects. Stefan Vajda, Admiralty Research Laboratory, England, delivered a special address on linear programming activities in Great Britain.

JUNE DEADLINE FOR NEC PAPERS

The National Electronics Conference invites authors to submit papers for the conference which will be held October 3-5 at the Hotel Sherman in Chicago. Papers should be sent to Gunnar Hok, Electrical Engineering Department, University of Michigan, Ann Arbor, Michigan. Deadline for submission of abstracts will be late May or early June and September will be the deadline for final manuscripts for the PROCEEDINGS.

AUGUST SYMPOSIUM, "SOLAR ECLIPSES AND THE IONOSPHERE," TO BE HELD IN LONDON BY URSI

A symposium, "Solar Eclipses and the Ionosphere," will be held in the rooms of the Royal Society, Burlington House, London, August 22-24. Topics to be discussed include: Ionospheric and Other Geophysical Eclipse Phenomena, Recent Ionospheric Eclipse Results, Ionospheric Processes—Ion Production and Recombination, Sources of Ionising Radiation, and Radio Astronomical Eclipse Observations.

Contributors include S. Chapman, H. S. W. Massey, J. A. Ratcliffe, M. Nicolet, J. Bartels, L. V. Berkner, D. R. Bates, J. Sayers, R. P. Lejay, K. Weekes, C. W. Allen, W. R. Piggott, C. M. Minnis.

The Proceedings of the Symposium will be published as a Special Report by the International Union of Scientific Radio (URSI). Those wishing to attend the symposium or to submit contributions are invited to communicate with: Dr. W. J. G. Beynon, Mixed Commission on the Ionosphere, Department of Physics, University College, Swansea, U. K.

REGION SIX HOLDS EXECUTIVE COMMITTEE MEETING IN DALLAS

Region Six held its Executive Committee Meeting in Dallas on February 11, during the Seventh Annual Southwestern Conference and Electronics Show, at the Baker Hotel. Durward J. Tucker, Director for Region Six, presided. All Sections of Region Six had representatives at the meeting with exception of Denver, Colorado.

Highlights included the formal authorization of a Southwestern I.R.E. Conference Organization, to guide future Southwestern Conferences. This organization will be made up of section representatives from Dallas, Houston, San Antonio, Tulsa, and the newly elected Section, Oklahoma City, which will sponsor the Southwestern Conference next February in Oklahoma City.



Durward J. Tucker, Director of Region Six, and Archie W. Straiton, Professor at the University of Texas.

The Executive Committee elected John A. Green to serve as Industry Representative on the Board of Directors of the Conference Organization. K. V. Newton, Chairman of the Kansas City Section, was appointed by Mr. Tucker to serve as Assistant Director for Region Six, and John A. Green was appointed to serve as Secretary of the Executive Committee for the next two-year period. George Bailey, Executive Secretary of the I.R.E., Archie W. Straiton and A. Earl Cullum, Jr., former Directors, were among those attending the meeting.

WAYNE U. HAS SUMMER COURSES

Wayne University is offering summer courses in Electronic Computers, Business and Engineering Applications, Automatic Data Processing, Mathematical Programming of Management Problems, Numerical Methods and Advanced Programming Techniques. Besides the Wayne staff, experts in the respective fields will conduct lectures, discussions and workshops. Representative business and engineering problems will be programmed for Wayne's UDEC as well as for several other commercially available machines.

Electronic Computers, Business and Engineering Applications, June 6-11, will survey automatic computers, their applications, the organization, and components. The ideas and methods relating to programming and coding of problems for automatic computers also will be considered, starting

from first principles. A detailed study of elementary engineering and business applications will be made in separate groups. For daily workshop periods, the students will be divided into small teams with a leader to prepare sample problems for machine solution and to run them on UDEC, the laboratory's digital computer.

The emphasis in Automatic Data Processing, June 13-18, will be on the survey of data processing units and systems and on suitable techniques in the programming and coding of advanced data processing problems. Also included will be a study of the common accounting areas from the point of view of mechanization with electronic devices. These cover such activities as payroll, billing, inventories, and general and cost accounting. An additional feature will be an intensive study of the applications in banking, insurance, utilities, merchandising, and manufacturing. Flow charting of information in data processing, actual programming of sample areas, and demonstrations on UDEC will be included in the workshop period.

A thorough presentation will be made in Mathematical Programming of Management Problems, June 20-25, of the basic techniques involved in linear programming. Also, game theory, dynamic programming, input-output analysis, and statistical techniques applicable to the field of management decision will be considered. Applications will be discussed which relate to the scheduling of distribution, production, and control of inventory; case histories and current research also will be examined. The construction of various mathematical models will be considered, and the use of approximation and exact methods of solution will be studied. Since knowledge of advanced mathematics will not be assumed, additional lectures will be provided in the basic mathematical concepts and methods involved.

Numerical Methods and Advanced Programming Techniques, June 27-July 2, will consist of two related topics. A section on numerical methods will cover the solution of ordinary and partial differential equations, integral equations, algebraic systems and matrices, approximation theory, and special mathematical topics. Emphasis will be placed on mathematical formulation of engineering and scientific problems, the analysis of error, and the feasibility of solutions of large systems. A. H. Taub, University of Illinois; A. S. Householder, Oak Ridge National Laboratory; David Young, University of Maryland; and others will constitute the instructional staff. A section on advanced programming techniques will study automatic and minimum access programming, design of subroutines, floating point and multiple precision arithmetic, speed coding, and test programming for marginal performance and detection of error.

Individuals may register for any one of the four courses since each constitutes a separate, though related, instructional unit. E. P. Little will be in charge of the first two weeks and Saul Rosen of the last weeks of the program. Final program, daily schedule of lectures, and other information may be obtained from A. W. Jacobson, Computation Laboratory, Wayne University, Detroit 1, Michigan.

SCHEDULE OF SESSIONS SET FOR AUTUMN AUTOMATION SYMPOSIUM IN PHILADELPHIA

The RETMA Engineering Department has released the tentative schedule of sessions to be held during the fall Automation Symposium. The two-day meeting, under RETMA sponsorship, will cover "Electronics for Automation and Automation for Electronics." The symposium has been set for Sept. 19 and 20 at Irvine Auditorium, University of Pennsylvania in Philadelphia. Registration fee will be \$3 and provision will be announced at a later date for advance registrations.

The planning committee, in selecting papers for the symposium, will consider those covering not only automation in the electronics field but also in unrelated industries such as automobiles and chemicals. Such subjects as automatic inventory and warehouse systems; factory and office routines, and education and management aspects of automation as a whole will be covered also.

Following is the tentative program for the symposium and the chairmen of the five sessions: September 19: Session I—Chairman, J. Harrington, United Shoe Machinery Corporation; *Mechanization for Electronic Assembly*. Session II—Chairman, D. Griffin; *Data Sensing, Processing and Utilization*. Session III—Chairman, W. R. G. Baker, General Electric Company; *Panel discussion—topic not determined*. September 20: Session IV—Chairman, D. Cottle, General Electric Company; *Automation for Low Volume Production*. Session V—Chairman, W. Hannahs, Automatic Production Research; *Redesign for Automation for Components and Products*.

BELGIAN PHYSICAL SOCIETY ELECTS OFFICERS FOR THIS YEAR

The annual general meeting of the Société Belge de Physique, held on February 19, elected the following officers: President, Professor P. Swings (Liège); Vice-Presidents, Professor W. De Keyser (Ghent), Professor J. Delfosse (Louvain), and Professor G. A. Homes (Brussels); Secretary General, Dr. M. C. Désirant.

HUNTER DESCRIBES STUDENT QUARTERLY AIMS TO CONVENTION

At the Annual Meeting held recently during the opening of the IRE Convention, Ted Hunter, Editor of the *Student Quarterly*, gave a brief summary of the results of this first year of publication.

Material on experiences in industry of recent graduates, on job opportunities as discussed by Professional Group Chairmen, and on various related jobs (sales engineering, teaching, consulting engineering) proved to be most popular with the student membership, Mr. Hunter said. IRE members were asked to provide the Editor with manuscripts on these subjects. Mr. Hunter concluded by showing slides of some of the illustrations and cartoons which have appeared in the *Quarterly*.

PROFESSIONAL GROUP NEWS

NEW CHAPTERS APPROVED

At a meeting on March 1 the Executive Committee approved five new chapters. They were: Audio, Dayton and Syracuse Chapters; Circuit Theory, Syracuse and Dallas-Fort Worth Chapters; Engineering Management, Syracuse Chapter.

OBITUARIES

William Charles Ellis, Chief Engineer for WFAA and WFAA-TV, radio and television services of the Dallas News, died recently.



W. C. ELLIS

Mr. Ellis studied electrical engineering at Montana State School of Mines, Butte, Montana. In 1924 he entered the Merchant Marine as radio operator and in 1925 entered the broadcast engineering field with Station WFAA. He served with the Signal Corps during World War II and was assigned to the Psychological Warfare Branch. He installed and repaired broadcast radio installations for use by PWB throughout the Mediterranean Theatre, and was appointed Chief Engineer of PWB for the MTO in 1944.

Returning from service in 1946. Mr. Ellis was appointed Facilities Engineer for WFAA and in 1950 he was promoted to Chief Engineer.

Raymond Bryan Meyer, Head of the Communication Branch, Radio Division of the Naval Research Laboratory, Washington, D. C., died recently.



R. B. MEYER

He had been with the Naval Research Laboratory since it opened in 1923. Mr. Meyer held seven patents in the fields of frequency control and high-frequency signaling systems. He was a native of Watertown, Wisconsin, where he was born August 26, 1896. He graduated from the Watertown High School, and took special courses at the State Normal School, Whitewater, Wisconsin, as well as at George Washington University in Washington, D. C.

During World War I, Mr. Meyer served as a chief yeoman in the Navy. He joined the Aircraft Radio Laboratories, Naval Air Station, Anacostia, D. C.; in 1919, as a radio engineer. In 1923, this activity became part of the new Naval Research Laboratory, and Mr. Meyer transferred with it.

He was a member of the American Physical Society, and the United States Naval Institute.

Robert B. Jacques, former Technical Secretary of the IRE, died recently. Mr. Jacques received the B.E.E. degree from Ohio State University in 1942. From 1942 until 1944 he was engaged there in research on antennas and reflection cross-section measurements by means of radar. He then undertook a project to measure the space-wave radiation patterns of a number of Signal Corps antennas using techniques developed at Ohio State University.



R. B. JACQUES

In February, 1946, Mr. Jacques joined the IRE headquarter's staff as Technical Secretary. In September 1946 he returned to Ohio State, for television research. He then joined Sandia Corp. in Albuquerque, N. M. He was a member of the American Physical Society, Tau Beta Pi, Eta Kappa Nu.

TECHNICAL COMMITTEE NOTES

The **Feedback Control Systems** Committee met at the M.I.T. Faculty Club on February 8 with Chairman John Ward presiding. The proposed *Standards on Graphical and Letter Symbols for Feedback Control Systems* and the proposed *Standards on Terminology for Feedback Control Systems* were approved.

The **Recording and Reproducing** Committee met at IRE Headquarters on February 23. Chairman A. W. Friend presided. The following subcommittee reports were given: R. C. Moyer reported that the Magnetic Recording Subcommittee planned work on Magnetic Recording Induction Measurements and Pre-Recorded Tapes. Lincoln Thompson, Chairman of the Mechanical Recording Subcommittee, reported that his group will resume work on Standards for Calibrating Frequency Records. T. G. Veal, Chairman of the Optical Recording Subcommittee, stated that his group had studied work being done in the field of response characteristics and intermodulation distortion. It was noted that SMPTE was working in this field also. Dr. Friend reported that A. P. G. Peterson and the Subcommittee on Distortion were cooperating with two other subcommittees in the preparation of *Methods of Measurement of Harmonic Distortion*. F. A. Comerchi reported that the Subcommittee on Flutter, under the chairmanship of H. E. Roys, planned to revise *Standards on Sound Recording and Reproducing: Methods for Determining Flutter Content*.

The **Circuits** Committee met at IRE Headquarters on February 24 and W. R. Bennett presided. The definitions prepared by L. Weinberg's Subcommittee on Linear Lumped-Constant Passive Circuits were discussed. W. A. Lynch asked for comments on several proposed definitions prepared by his Subcommittee on Linear Active Circuits Including Networks with Feedback Servo-Mechanism.

The **Standards** Committee met at IRE Headquarters on February 10 with Chairman Ernst Weber presiding. Definitions of ASA Committee C42 (Group 70) were ap-

proved after Mr. Baldwin reported that the ASA Committee had accepted IRE suggestions regarding three of the definitions. Mr. Jensen reported that the Executive Committee had approved the new IRE Technical Committee on Radio Frequency Interference with R. F. Shea as chairman. The committee will be activated after approval by the Board of Directors. The committee discussed plans for IRE representation at the IEC meeting to be held in

London in June. Two Standards were approved for publication in the PROCEEDINGS: *IRE Standards on Television: Definitions of Television Signal Measurement Terms, 1955* (55 IRE 23. S1) and *IRE Standards on Television: Definitions of Color Terms, 1955* (55 IRE 22. S1).

The **Navigation Aids** Committee met at IRE Headquarters on February 11 with H. R. Mimno presiding. The committee discussed the possibilities of cooperation with

CAA and RTCA in preparing measurement techniques pertaining to ILS systems. Members of the committee were asked to review the recently published *Navigation Aids Definitions* and to consider the possibility of preparing measurement procedures relating to the defined quantities.

The committee discussed the proposed *Standards of Direction Finder Measurements* which had been prepared by E. D. Blodgett's subcommittee.

Professional Groups

Aeronautical & Navigational Electronics—*Chairman*, Edgar A. Post, Navigational Aides, United Air Lines, Operations Base, Stapleton Field, Denver 7, Colo.

Antennas & Propagation—*Chairman*, Deimer C. Ports, Jansky & Bailey, 1339 Wisconsin Ave., N.W., Washington 7, D. C.

Audio—*Chairman*, W. E. Kock, Bell Tel. Labs., Murray Hill, N. J.

Automatic Control—*Chairman*, Robert B. Wilcox, Raytheon Manufacturing Co., 148 California St., Newton 58, Mass.

Broadcast & Television Receivers—*Chairman*, W. P. Boothroyd, Philco Corp., Philadelphia 34, Pa.

Broadcast Transmission Systems—*Chairman*, Lewis Winner, Bryan Davis Publishing Co., 52 Vanderbilt Ave., New York 17, N. Y.

Circuit Theory—*Chairman*, Dr. Chester H. Page, National Bureau of Standards, Connecticut Ave., Washington 25, D. C.

Communications Systems—*Chairman*, Col. J. Z. Millar, Western Union Telegraph

Co., Room 833, 60 Hudson Street, New York 13, N. Y.

Component Parts—*Chairman*, Floyd A. Paul, Reliability Bendix Development Lab., 116 W. Olive Avenue, Burbank, Calif.

Electron Devices—*Chairman*, George Espersen, Microwave Tube Section, Philips Labs., Irvington-on-Hudson, N. Y.

Electronic Computers—*Chairman*, Harry T. Larson, Ramo-Woodridge Corp., 8820 Bellanca Ave., Los Angeles 45, Calif.

Engineering Management—*Chairman*, C. J. Breitwieser, Lear, Inc., 3171 S. Bundy Drive, Los Angeles 34, Calif.

Industrial Electronics—*Chairman*, George P. Bosonworth, Engrg. Lab., Firestone Tire & Rubber Co., Akron 17, Ohio

Information Theory—*Chairman*, Louis A. DeRosa, Federal Telecommunications Lab., Inc., 500 Washington Avenue, Nutley, N. J.

Instrumentation—*Chairman*, Robert L. Sinck, Consolidated Engrg. Corp., 300 N., Sierra Madre Villa, Pasadena, Calif.

Medical Electronics—*Chairman*, Dr. Julia F. Herrick, Inst. of Experimental Medicine, Mayo Found., Rochester, Minn.

Microwave Theory & Tech.—*Chairman*, William M. Mumford, Bell Telephone Labs., Whippany, N. J.

Nuclear Science—*Chairman*, Dr. Donald H. Loughridge, Dean of Engineering, Northwestern Tech. Inst., Evanston, Ill.

Reliability and Quality Control—*Chairman*, Leon Bass, Jet Engine Dept., General Elec. Co., Cincinnati 15, Ohio

Production Techniques—*Chairman*, R. R. Batcher, 240-02—42nd Ave., Douglaston, L. I., N. Y.

Telemetry & Remote Control—*Chairman*, Martin V. Kiebert, Jr., Convair, P.O. Box 1011, Pomona, Calif.

Ultrasonics Engineering—*Chairman*, Amor L. Lane, 706 Chillum Road, Hyattsville, Md.

Vehicle Communications—*Chairman*, W. A. Shipman, Columbia Gas Systems Service Corp., 120 East 41st St., New York 17, N. Y.

Sections*

Akron (4)—K. F. Sibila, 1745—13 Street, Cuyahoga Falls, Ohio; C. O. Lambert, 1144 Roslyn Ave., Akron 20, Ohio

Albuquerque-Los Alamos (7)—T. F. Marker, 3133—40 St., Sandia Base, Albuquerque, N. Mex.; T. G. Banks, Jr., 1124 Monroe St., S.E., Albuquerque, N. Mex.

Atlanta (3)—D. L. Finn, School of Elec. Engr'g, Georgia Inst. of Technology, Atlanta, Georgia; P. C. Toole, 605 Morning-side Drive, Marietta, Georgia

Baltimore (3)—C. D. Pierson, Jr., Broadview Apts. 1126, 116 West University Pkwy., Baltimore 10, Md.; M. I. Jacob, 1505 Tredegar Avenue, Catonsville 28, Maryland

Beaumont-Port Arthur (6)—L. C. Stockard, 1390 Lucas Drive, Beaumont, Texas; John Petkovsek, Jr., 4390 El Paso Ave., Beaumont, Texas

Binghamton (1)—N. S. Lawrence, Johnson's Corners, R.D. 1, Harpursville, New York; O. T. Ling, 100 Henry St., Binghamton, N. Y.

Boston (1)—A. J. Pote, Lincoln Laboratory, Massachusetts Institute of Technology, Lexington 73, Mass.; T. P. Cheatham, Jr.,

Hosmer Street, Marlborough, Mass.

Buenos Aires—P. N. Guzzi, Cangallo 1286, Buenos Aires, Argentina; C. E. Sussenguth, Gral. Urquiza 1914, Florida F.C.N.G.B.M., Argentina

Buffalo-Niagara (1)—J. H. Doolittle, Goodrich Road, Clarence, N. Y.; W. L. Kinsell, 207 Ridgewood, Snyder, Buffalo 21, N. Y.

Cedar Rapids (5)—E. Pappenfus, 1101 30 St. Dr., S.E., Cedar Rapids, Iowa; E. L. Martin, 1119 23 St., S.E., Cedar Rapids, Iowa

Central Florida (2)—H. Scharla-Nielsen, Radiation Inc., P.O. Drawer 'Q', Melbourne, Fla.; G. F. Anderson, Radiation Inc. P.O. Box 'Q' Melbourne, Fla.

Chicago (5)—J. J. Gershon, DeVry Technical Institute, 4141 Belmont Ave., Chicago 41, Ill.; J. S. Brown, 9829 S. Hoyne Ave., Chicago 43, Ill.

Cincinnati (4)—R. A. Maher, 6133 Sunridge Drive, Cincinnati 24, Ohio; W. S. Alberts, 6533 Elwynne Drive, Silverton, Cincinnati 36, Ohio

Cleveland (4)—H. R. Mull, 4558 Silverdale Ave., North Olmsted, Ohio; W. G. Piwonka, 3121 Huntington Road, Cleveland 20, Ohio

Columbus (4)—R. W. Masters, 1633 Essex Road, Columbus 21, Ohio; T. E. Tice, 2214 Jervis Road, Columbus 21, Ohio

Connecticut Valley (1)—H. E. Rohloff, The Southern New England Telephone Company, 227 Church Street, New Haven, Conn.; B. R. Kamens, 45 Brooklawn Circle, New Haven 15, Conn.

Dallas-Fort Worth (6)—J. A. Green, 6815 Oriole Drive, Dallas 9, Texas; G. K. Teal, Texas Instruments Inc., 6000 Lemmon Ave., Dallas, Texas

Dayton (5)—A. B. Henderson, 801 Hathaway Road, Dayton 9, Ohio; N. L. Lashever, 849 N. Upland Ave., Dayton, Ohio

Denver (6)—R. E. Swanson, 1777 Kipling St., Denver 15, Colorado; Sydney Bedford, Jr., Mountain States Tel. and Tel. Company, Room 802, Denver, Colorado

Des Moines-Ames (5)—A. A. Read, 511 Northwestern Ave., Ames, Iowa; W. L. Hughes, Department of Electrical Engineering, Iowa State College, Ames, Iowa

Detroit (4)—N. D. Saigeon, 1544 Grant, Lincoln Park 25, Michigan; Archie L. Coates, 1022 E. Sixth Street, Royal Oak, Michigan

Elmira-Corning (1)—J. L. Sheldon, 179 Dodge Ave., Corning, N. Y.; J. P. Hocker, Pilot Plant No. 2, Corning Glass Works, Corning, N. Y.

El Paso (6)—J. F. Stuart, Box 991, El Paso, Texas; W. T. McGill, 7509 Mazatlan Road, El Paso, Texas

* Numerals in parentheses following Section designate Region number.

First name designates Chairman, second name Secretary.

Sections

- Emporium (4)**—E. H. Boden, R.D. 1, Emporium, Pa.; H. S. Hench, Jr., R.D. 2, Emporium, Pa.
- Evansville-Owensboro (5)**—A. P. Haase, 2230 St. James Ct., Owensboro, Kentucky; D. D. Micky, Jr., Engrg. Dept., General Electric Company, Owensboro, Ky.
- Fort Wayne (5)**—J. J. Iffland, 2603 Merivale St., Kirkwood Park, Ft. Wayne 8, Ind.; T. L. Slater, 1916 Eileen Drive, Waynedale, Ind.
- Hamilton (8)**—G. M. Cox, 154 Victoria St. S., Kitchener, Ont., Can.; A. L. Fromanger, Box 507, Ancaster, Ont., Can.
- Hawaii (7)**—G. W. Clark, Box 193, Lanikai, Oahu, T. H.; J. P. Sanders, Matsun Navigation Co., Box 899, Honolulu, T. H.
- Houston (6)**—W. J. Greer, Halliburton Oil Well & Cementing Co., 1628 Old Spanish Trail, Houston 25, Texas; R. S. Bush, 3818 Alberta Ave., Houston 21, Texas
- Huntsville (3)**—D. E. French, 1403 E. Clinton St., Huntsville, Ala.; T. L. Greenwood, 1709 LaGrande St., Huntsville, Ala.
- Indianapolis (5)**—J. T. Watson, 1515 Central Ave., Indianapolis 2, Ind.; M. J. Arvin, 4329 Fletcher Ave., Indianapolis 1, Ind.
- inyokern (7)**—G. D. Warr, 213-A Wasp Road, China Lake, Calif.; B. B. Jackson, 54-B Rowe Street, China Lake, Calif.
- Israel**—F. Ollendorf, Box 910, Hebrew Inst. Tech., Haifa, Israel; J. H. Halberstein, Box 1, Kiriath Mozkin, Israel
- Ithaca (1)**—Ben Warriner, Gen'l Elec. Co., Advanced Electronics Center, Cornell U., Ithaca, N. Y.; R. L. Wooley, 110 Cascadilla St., Ithaca, N. Y.
- Kansas City (6)**—K. V. Newton, Bendix Aviation Corporation, Box 1159, Kansas City 41, Mo.; Mrs. G. L. Curtis, Radio Industries, Inc., 1307 Central Ave., Kansas City 2, Kan.
- Little Rock (6)**—Raymond Beem, Route 3, Malvern, Ark.; D. L. Winn, 10 and Spring Streets, Little Rock, Ark.
- London (8)**—J. H. Blackwell, 863 Colborne St., London, Ont., Can.; J. D. B. Moore, 27 McClary Ave., London, Ont., Can.
- Long Island (2)**—W. F. Bailey, Hazeltine Corp., 58-25 Little Neck Pkwy., Little Neck, L. I., N. Y.; P. G. Hansel, Addison Lane, Greenvale, L. I., N. Y.
- Los Angeles (7)**—B. S. Angwin, 3300 Colby Ave., Los Angeles 34, Calif.; C. E. Rutherford, 209 S. Oakhurst Drive, Beverly Hills, Calif.
- Louisville (5)**—R. W. Mills, 1017 Eastern Parkway, Louisville 4, Ky.; L. A. Miller, 314 Republic Building, Louisville 2, Ky.
- Miami (3)**—C. S. Clemans, Station WSWN, Belle Glade, Florida; H. F. Bernard, 3670 S.W. 9th Terrace, Miami 34, Florida
- Milwaukee (5)**—W. E. Watts, 2224 N. 70 St., Wauwatosa 13, Wis.; W. A. Van Zealand, 4510 N. 45 St., Milwaukee 16, Wis.
- Montreal (8)**—R. W. Cooke, 18 Muir Road, Senneville, Que., Canada; F. H. Margolick, Canadian Marconi Company, 2442 Trenton Ave., Montreal, Que., Canada
- New Orleans (6)**—L. J. N. DuTreil, 202 Homedale Ave., New Orleans, La.; J. A. Cronvich, Dept. of Electrical Engineering, Tulane University, New Orleans 18, La.
- New York (2)**—A. B. Giordano, 85-99 Livingston Street, Brooklyn 2, N. Y.; H. S. Renne, Radio-Electronic Engr., 366 Madison Ave., New York 17, N. Y.
- North Carolina-Virginia (3)**—James C. Mace, 1616 Jefferson Park Ave., Charlottesville, Va.; Allen L. Comstock, 1404 Hampton Dr., Newport News, Va.
- Northern New Jersey (2)**—F. A. Polkinghorn, 63 Monroe Pl., Bloomfield, N. J.; B. G. Griffith, 127 Park Ave., Verona, N. J.
- Oklahoma City (6)**—G. W. Holt, 4420 N.W. 19 Blvd., Oklahoma City 7, Okla.; W. E. Lucey, 1348 Kinkaid Ave., Oklahoma City, Okla.
- Omaha-Lincoln (5)**—M. L. McGowan, 5544 Mason St., Omaha 6, Neb.; C. W. Rook, Dept. Elec. Engineering, University of Nebraska, Lincoln 8, Neb.
- Ottawa (8)**—W. A. Cumming, Radio & Elec. Engrg. Division, National Research Council, Ottawa, Ont., Canada; C. F. Patten-son, 3 Braemar, Ottawa 2, Ont., Canada
- Philadelphia (3)**—S. C. Spielman, Philco Corp., 4700 Wissahickon Ave., Philadelphia 44, Pa.; M. S. Corrington, 12 E. Cottage Ave., Haddonfield, N. J.
- Phoenix (7)**—P. W. Sokoloff, 1113 E. Oregon Ave., Phoenix, Ariz.; E. Eberhard, 30 E. Colter St., Phoenix 43, Ariz.
- Pittsburgh (4)**—F. C. Alexander, Jr., 2824 Mt. Royal Blvd. & Sutter Road, Glenshaw, Pa.; K. A. Taylor, Bell Telephone Company of Pennsylvania, 416 Seventh Ave., Pittsburgh 19, Pa.
- Portland (7)**—Howard Vollum, 1000 N.W. Skyline Blvd., Portland, Oregon; R. R. Pooley, Radio Station KPOJ, Box 31, Portland 7, Oregon
- Princeton (2)**—Jerome Kurshan, RCA Laboratories, Princeton, N. J.; J. L. Potter, Rutgers University, New Brunswick, N. J.
- Rochester (1)**—Allan Holstrom, 551 Spencer Road, Rochester 9, N. Y.; W. F. Bellor, 186 Dorsey Road, Rochester 16, N. Y.
- Rome-Utica (1)**—Harry Davis, 716 Cherry Street, Rome, N. Y.; M. V. Ratynski, Rome Air Development Center, Box 266, Griffiss Air Force Base, Rome, N. Y.
- Sacramento (7)**—I. L. Dutton, 5980 N. Haven Dr., North Highlands, Calif.; E. Berger, 3421 58 St., Sacramento 20, Calif.
- St. Louis (6)**—F. A. Fillmore, 5758 Itaska St., St. Louis 9, Mo.; C. Eftthim, 1016 Louisville Ave., St. Louis 10, Mo.
- Salt Lake City (7)**—M. E. Van Valkenburg, Dept. of Elec. Engr'g, U. of Utah, Salt Lake City 1, Utah; A. L. Gunderson, 3906 Parkview Dr., Salt Lake City, Utah
- San Antonio (6)**—C. M. Crain, Engineering Bldg. 149, U. of Texas, Austin 12, Texas; W. H. Hartwig, Dept. of Elec. Engr'g., U. of Texas, Austin 12, Texas
- San Diego (7)**—F. X. Byrnes, 1759 Beryl St., San Diego 9, Calif.; R. T. Silberman, 4635 Edgeware Rd., San Diego 16, Calif.
- San Francisco (7)**—A. J. Morris, 1827 Cordilleras Road, Redwood City, Calif.; J. S. McCullough, 1791 Willow Street, San Jose 25, Calif.
- Schenectady (1)**—R. E. Anderson, 638 Brandywine Ave., Schenectady, N. Y.; J. S. Hickey, Jr., General Electric Company, Research Lab., Schenectady, N. Y.
- Seattle (7)**—A. E. Harrison, Dept. of Electrical Engineering, University of Washington, Seattle 5, Wash.; R. H. Hoglund, 1825 E. Lynn Street, Seattle 2, Wash.
- Syracuse (1)**—W. H. Hall, General Electric Company, Syracuse, N. Y.; M. A. Johnson, R.D. 1, Totman Road, East Syracuse, N. Y.
- Toledo (4)**—L. S. Rynder, 140 Rockingham Street, Toledo 10, Ohio; L. R. Klopfenstein, Portage, Ohio
- Toronto (8)**—E. L. Palin, 2137 Bayview Ave., Willowdale, Toronto, Ont., Canada; F. J. Heath, 830 Lansdowne Ave., Toronto, Ont., Canada
- Tulsa (6)**—C. F. Hadley, 1356 East 45 Place, Tulsa 15, Okla.; L. H. Hooker, 4064 East 22 Place, Tulsa 5, Okla.
- Twin Cities (5)**—F. S. Hird, Northwestern Bell Telephone Company, 224 S. Fifth Street, Minneapolis, Minn.; J. L. Hill, 25—17th Avenue N.E., North St. Paul 9, Minn.
- Vancouver (8)**—Miles Green, Northwest Telephone Company, 2226 W. Tenth Ave., Vancouver, B. C., Canada; J. S. Gray, 4069 West 13 Ave., Vancouver, B. C., Canada
- Washington (3)**—T. B. Jacobs, General Electric Company, 777—14 Street, N.W. Washington, D. C.; R. I. Cole, 2208 Valley Circle, Alexandria, Va.
- Williamsport (4)**—J. E. Snook, 1629 Warren Ave., Williamsport, Pa.; F. T. Henry, 1345 Pennsylvania Ave., Williamsport, Pa.
- Winnipeg (8)**—H. Haakonsen, U. of Manitoba, Dept. Elec. Engr'g., Fort Garry, Man., Can.; G. R. Wallace, 400 Smithfield Ave., Winnipeg, Man., Can.

Subsections

- Amarillo-Lubbock (6)**—R. B. Spear, 510 E. Hill St., Brownfield, Texas; J. B. Joiner, 2621—30 Street, Lubbock, Texas
- Berkshire County (1)**—S. C. Leonard, Cheshire, Mass.; W. E. Neubert, 21 Highlawn Dr., Pittsfield, Mass.
- Buenaventura (7)**—E. C. Sternke, Route 2, Box 122, Camarillo, Calif.; Oliver LaPlant, 325 North "J" Street, Oxnard, Calif.
- Centre County (4)**—C. P. Bastuscheck, 1026 South Atherton Street, State College, Pennsylvania
- Charleston (6)**—W. L. Schachte, 152 Grove Street, Charleston 22, South Carolina, A. Jonas, 21 Madden Drive, Dorchester Terrace, Charleston Heights, South Carolina
- East Bay (7)**—J. L. Corl, 622 Rincon Road, Richmond 11, Calif.; R. D. Ogg, 48 Arlington Ave., Berkeley 8, Calif.

Erie (4)—R. S. Page, 1224 Idaho Ave., Erie 10, Pennsylvania; R. H. Tuznik, 905 E. 25 Street, Erie, Pennsylvania
Lancaster (3)—G. W. Scott, Jr., Research Labs., Armstrong Cork Co., Lancaster, Pa.; G. E. Mandell, 522 E. King St., Lancaster, Pa.
Mid-Hudson (2)—E. J. Breiding, 54 S. Grand Ave., Poughkeepsie, N. Y.; E. S. Wilson, I.B.M. Corporation, Engineering Lab., Poughkeepsie, N. Y.
Monmouth (2)—W. M. Goodall, Bell Telephone Labs., Box 107, Red Bank, N. J.;

A. H. Ross, 923 Broad St., Shrewsbury, N. J.
Northwest Florida (6)—K. L. Huntley, Mary Esther, Florida; G. C. Jones, 12 N. Okaloosa Road, Fort Walton Beach, Florida
Orange Belt (7)—B. F. Husten, Naval Ord. Lab., Corona, Calif.; T. A. Mayeda, 3659 Monroe Street, Riverside, Calif.
Palo Alto (7)—J. V. Granger, 320 Encinal Ave., Menlo Park, Calif.; W. B. Wholey, 342 Verano Drive, Los Altos, Calif.
Pasadena (7)—To be elected.

Richland (7)—I. M. Jacobs, 1322 Birch, Richland, Washington; W. G. Spear, 1519 McPherson, Richland, Washington
Tucson (7)—W. V. Record, 4511 E. Ninth Street, Tucson, Arizona; A. J. Bersbach, 5326 E. Seventh Street, Tucson, Arizona
USAFIT (5)—L. A. Yarbrough, Box 3001, USAFIT, Wright-Patterson AFB, Ohio; J. J. Gallagher, Box 3482 USAFIT, Wright-Patterson AFB, Ohio
Wichita (5)—H. G. Swift, 1642 South Main, Wichita, Kansas; V. N. Johnson, 1652 S. Edgemoor, Wichita 17, Kansas

Abstracts of Transactions of the I.R.E.

The following issues of "Transactions" have recently been published, and are now available from the Institute of Radio Engineers, Inc., 1 East 79th Street, New York 21, N. Y. at the following prices. The contents of each issue and, where available, abstracts of technical papers are given below.

Sponsoring Group	Publication	Group Members	IRE Members	Non-Members*
Antennas and Propagation	Vol. AP-3, No. 2	\$1.60	\$2.40	\$4.80
Broadcast Transmission Systems	PGBTS-1	\$2.50	\$3.75	\$7.50
Circuit Theory	Vol. CT-2, No. 1	\$2.70	\$4.05	\$8.10
Electron Devices	Vol. ED-2, No. 1	\$1.80	\$2.70	\$5.40

* Public libraries and colleges may purchase copies at IRE Member rates.

ANTENNAS AND PROPAGATION

VOL. AP-3, No. 2, APRIL, 1955

News and Views

Synthesis of Radio Signals on Overwater Paths—A. H. LaGrove, A. W. Straiton, and H. W. Smith

The fluctuations of radio signals at microwave frequencies on overwater paths are explained on the basis of a periodic rise and fall of the water level. From this study, it is seen that the variations in the radio signal strength will contain the frequency of the water-level cycles and also the second and third harmonics of the water-level cycles.

This same model predicts that the cross-correlation function of the fluctuations of the radio signal at two vertically-spaced antennas will drop from unity to zero as the separation distance is changed from zero to one-half of a lobe width of a height-gain interference pattern.

Although the model assumes reflection from a plane surface, the results of the study successfully explain most of the features of the observed fluctuations of the radio signals on two overwater paths.

A Nonresonant Endfire Array for VHF and UHF—W. A. Dunning

A new type of endfire array is described which has moderate bandwidth in the vhf and uhf ranges. Two types of arrays are dealt with; one, an unbalanced type fed with a coaxial line, which was studied primarily to test the theory of operation of the antenna; the other, a balanced type fed with unshielded twin-line which was developed as a receiving antenna for vhf television. This latter antenna has a gain varying from 6 db to 10 db above a dipole over a 50

per cent frequency range, and produces a voltage standing wave ratio of not greater than 2.5 to 1 on 300-ohm twin lead.

Radio Transmission Loss Versus Distance and Antenna Height at 100 Megacycles—P. L. Rice and E. T. Daniel

This report describes curves of transmission loss vs distance and antenna height derived from an analysis of approximately 159,000 hourly median field-strength observations between 90 and 110 mc. These observations extend over a period of several years and are distributed geographically over the whole United States. The curves contained in this report are believed to be more precise for engineering use than the FCC Ad Hoc Committee curves published in 1949.

Spacing-Error Analysis of the Eight-Element Two-Phase Adcock Direction Finders—D. N. Travers

In the design of a modern high-frequency radio direction finder utilizing the Adcock principle, the sensitivity and spacing error limitations of the conventional four-element array requires the use of several arrays in order to cover a large portion of the frequency spectrum. An eight-element array is described which has an operating frequency range considerably greater than that of the familiar Adcock, while still maintaining the simplicity of two-phase goniometer azimuth scanning. Spacing error curves are plotted and an optimum design is selected. It is shown that element spacing values greater than one wavelength are possible, and that frequency coverage is sufficiently great to render considerations other than spacing error the limiting factors.

The End Correction for a Coaxial Line When Driving an Antenna over a Ground Screen—Ronald King

Theoretical and experimental results obtained by Hartig for the end correction for a coaxial line when driving an antenna over a

ground screen are corrected. Improved theoretical and experimental curves of the quantity $-C_T/bc_0$ are obtained, where $-C_T$ is the lumped negative capacitance required as end correction, c_0 is the capacitance per unit length of the coaxial line, and b is the inner radius of the outer conductor of the line.

The Shielding of Radio Waves by Conductive Coatings—E. L. Hill

A theory is given of the shielding of radio waves by the conducting coatings which are placed over the cockpit dome and windows of an airplane. At low and medium frequencies the shielding arises primarily from the quasi-electrostatic charges which are induced on the surface, the effects of which increase strongly with decreasing frequency. At higher frequencies the shielding from this source diminishes in importance while that from the induced eddy currents increases in effectiveness.

VHF Auroral and Sporadic-E Propagation from Cedar Rapids, Iowa, to Ithaca, New York—Rolf Dyce

A 50-mc transmitter operating continuously at Cedar Rapids, to the west of Ithaca, has been monitored for more than two years, using a northward-pointing antenna intended to reduce signals from the west due to E-scatter and bursts due to meteors. Associated with visible auroral activity, enhanced signals are heard, having a very rapid fading rate, characteristic of auroral propagation previously described. Continuous recordings are made on an Esterline-Angus chart moving 6 inches per hour. Much stronger sporadic-E signals are observed occasionally entering the sidelobes of the receiving antenna, but can usually be distinguished from auroral propagation by the appearance of the trace or by the clarity of the beat frequency. This method of identification and separation is thought to be effective because each mode of propagation has its own diurnal and seasonal variations agreeing with characteristics found previously by other workers.

Endfire Slot Antennas—B. T. Stephenson and C. H. Walter

The conditions for endfire radiation from a traveling-wave slot are discussed. These are that the phase velocity of the traveling wave be equal to or less than the velocity of light in free space and that the aperture be excited with a strong longitudinal component of electric field. Practical ways of achieving these conditions are mentioned and an approximate analysis based on partially dielectric-filled waveguide theory is used to determine the aperture fields as a function of the antenna geometry.

Far-field pattern characteristics are discussed. It is found that the actual pattern may differ considerably from that predicted by simple theory. This is attributed primarily to two things, a finite ground plane and the discontinuity produced by the abrupt aperture opening. Two practical discontinuity mini-

mizers are described. The ground plane effect is analyzed by applying Huygens Principle, and a simple procedure is described for determining the first-order effect.

The problem of obtaining pencil-beam radiation in the horizontal (plane of the ground plane) pattern is solved quite simply by using wide-aperture antennas which can be made to operate satisfactorily over better than a 2:1 band. The efficiency and vswr of a practical antenna, with sidelobes in the horizontal pattern at least 20 db down have been measured over a 2:1 band. The efficiency varied from 65 per cent at the high-frequency end of the band to 55 per cent at the low end. The vswr was less than 1.4 over the band.

BROADCAST TRANSMISSION SYSTEMS

PGBTS-1, MARCH, 1955

Audio in TV Broadcasting—R. D. Chipp
A Fifteen-Kilowatt Beam Power Tube for UHF Service—W. P. Bennett

A new beam power tetrode for operation at frequencies up to 1000 mc is described. Although this type is specifically suited to meet the stringent requirements of television broadcast service, experience indicates its particular usefulness in generating higher powers at frequencies above approximately 200 mc.

This device is unique in that it is believed to be the first power tube designed specifically to operate as a grid-driven amplifier at frequencies as high as 1000 mc. A combination of features has made satisfactory grid-driven performance with its attendant low drive requirements a reality. A centrally located anode is surrounded by an array of unit tetrode electron-optical systems in a cylindrically symmetrical inverted electrode structure. The geometry of each tetrode unit is similar to that of the well-known beam power tube family. Effective internal by-pass capacitors are provided in the screen-grid-to cathode circuit. The arrangement of electrode supports and conducting leads provides isolated input and output circuits without common current paths. This arrangement, in conjunction with a very low plate-to-control-grid capacitance, results in a virtual elimination of feedback effects. As a consequence, neutralization is unnecessary.

Thoriated-tungsten cathodes and ceramic insulators are included among other noteworthy features. Characteristics of the tube are presented, along with data showing performance in the UHF television and 200-to-400 mc bands. Circuits for use at 900 Mc are described. Suitability for the transmission of color television signals is discussed.

A Novel UHF Television High-Power-Amplifier System—L. L. Koros

A novel type of power amplifier, especially developed for high-power UHF monochrome and color television transmitters, is described in this paper. The amplifier applies the type-6448 beam-power tubes for class-B service up to 15 KW peak of sync output with an amplification factor of 15 at 6 megacycles bandwidth (.5 decibel points) and, for class-C service with a power amplification factor of 30. The amplifier design is applied in the RCA TTU-12A transmitter.

This is the first time that such high power-outputs were obtained with grid-controlled tubes at UHF frequencies. The plate-cavity construction used for this high power-output is unconventional. It is believed that the cavity design which is described in connection with the type-6448 beam power tube can also be adapted to other, higher powered UHF tubes which may follow in the future.

An open-circuited half-wavelength plate-cavity is used which substantially consists of

one high-impedance and one low-impedance quarter-wavelength section. No conventional load-coupling element is used; the output transmission line is directly connected to the power-tube plate through a dc blocking condenser. The grid circuit operates in three-quarter-wavelength mode.

Achieving One Megawatt ERP in the UHF-TV Band—F. J. Bias and R. F. Stone

The alternatives are described for achieving one megawatt Effective Radiated Power in the UHF-TV band. The new G-E 45 KW and 23 KW transmitters are described. The different high power antenna approaches are discussed. Steps towards converting existing 1 KW and G-E KW stations are explained in detail.

Equipment Operating Characteristics for Color Television—C. E. Page

The Special Application of the Cathode-Ray Oscillograph in Television Broadcast Operation—R. W. Deichert and M. G. Scheraga

Chromacoder Colorcasting—C. G. Lloyd
Intercity B-W and Color Television Transmission—J. M. Barstow

Intercity television transmission is accomplished by both wire and microwave systems which have been described in some detail in other publications. The transmission of color signals as compared to monochrome signals over the systems places an added burden on them in three ways: (1) smaller amplitude distortions in the region of 3.6 mc, the color subcarrier frequency, are required; (2) interference in the region of the color subcarrier is more important than with monochrome transmission; and (3) a new requirement is added, namely, a differential phase requirement. Experience has shown that the added requirements can be met by the systems by provision of additional equalization measures. Increased maintenance and operating effort is also required to care for the more precise lineup adjustments.

Television Satellite Systems—C. B. Plummer

UHF Satellite Transmitter-Receiver Design and Operation—L. Katz and T. B. Friedman

A UHF satellite installation is described. Average field strength improvements of nearly 23 db were obtained in a deep shadow area at Waterbury, Connecticut. 80 db of straight RF amplification was used in conjunction with high gain receiving and transmitting antennas on a frequency of 700 Mc/S.

The Engineering Aspects of a UHF Booster Installation—J. Epstein

The object of this project was to examine the use of a booster to fill in the area inadequately covered by the primary station. A complete booster equipment including antennas and amplifier was installed and field tested at Vicksburg, Mississippi, 35 miles distant from the primary station WJTV, Channel 25, Jackson, Mississippi.

The measurements and observations of the performance of the booster at Vicksburg successfully demonstrate the feasibility of this method in covering a low-signal area. The project is further confirmation that a good engineering estimate of the ERP required to establish a given grade of service can be made once the topography of the given area is known.

The performance obtained with components of the booster system indicate that there are no major technical difficulties present with the approach used.

A Report on UHF Satellite Operation—J. R. Whitworth

CIRCUIT THEORY

VOL. CT-2, No. 1, MARCH, 1955

Editorial
Four Methods for the Analysis of Time-Variable Circuits—L. A. Pipes

This paper is an expository presentation of four distinct mathematical methods that have been found useful in the analysis of time-varying electric circuits. The methods presented are: (1) The use of the classical theory of differential equations in the analysis of time-varying circuits; (2) matrix methods of analysis; (3) approximate solution of time-varying circuit problems by the B.W.K. approximation; (4) Laplace transform and integral equation methods of solution. The various mathematical techniques presented are illustrated by applications to time-varying circuits of practical importance.

Analysis of Time-Dependent Linear Networks—J. Brodin

A network of linear time-dependent multi-poles is regarded as a set of relationships between a set of linear operators. A calculus for such operators is developed and its correlation with various modes of combination of multi-poles is indicated. Inequality-like formulas for partially ordered set of operators are given and the convergence of operator series is considered. Applications are made to the stability of time-dependent networks and to the error analysis of linear simulators.

Steady-State Transmission through Networks Containing Periodically Operated Switches—W. R. Bennett

A formal method is developed for calculating the steady state response of a lumped-constant linear network in which any number of arbitrarily located switches are opened and closed at uniformly separated instants of time.

A Time-Variable Transform and Its Application to Spectral Analysis—A. A. Gerlach

The concept of a time-variable transform which maps a function in the time domain into a function in a generalized domain is defined and exploited in a formal manner. Since the time-variable transform involves an integral only over finite limits a number of relations are derived which are unique with time-variable transforms. These relations throw some light on the notion of time-varying spectrum and have a number of applications that will be presented in subsequent papers.

Properties of Impulsive Responses and Green's Function—K. S. Miller

The definitions and interrelations among such concepts as system function, impulsive response, one-sided Green's function, weighting function and classical Green's function are discussed for linear varying-parameter networks. Various additional properties of these functions are also derived. Both the mathematical and engineering approach are used and compared.

Application of Complex Symbolism to Linear Variable Networks—A. P. Bolle

In this article the author shows that it is possible to make use of complex symbolism for linear variable networks. Special attention is paid to networks containing one linear variable inductance. The understanding of the properties and the operation of linear variable networks (for instance magnetic, dielectric or resistance modulators) is greatly enhanced by the use of the theory developed in this paper. This is shown for a magnetic modulator, for which the energy amplification is computed and the possible instabilities are considered.

Resonance Phenomena in Time-Varying Circuits—M. C. Herrero

This paper describes the results of a study of the sweeping-filter problem and its application to a panoramic receiver. A system transfer function is defined as the ration of the filter output to input when both are varying exponentially with time. A solution for this transfer function yields the desired information directly. A comparison is made between the sweeping filter case and the so-called "gliding-tone problem" in panoramic receivers of the sweeping-local-oscillator type. Both cases are similar in quasi-steady state. The behavior of

the system output with increasing sweeping frequency in the gliding-tone problem is such that the peak of the solution decreases with increasing sweeping frequency and instability cannot occur, whereas in the sweeping filter the peak magnitude is almost constant and, under appropriate conditions, instability may appear. Various types of parametric excitation are compared and physical interpretation of the behavior is presented, as well as the differences in the mathematical behavior of the system differential equations.

Effect of Rectifier Capacitances on the Conversion Loss of Ring Modulators—V. Belevitch

The effect of rectifier capacitances on the input to side-band conversion loss of a ring modulator operating between purely resistive source and load is investigated theoretically, all other effects being neglected, so that the modulator is considered as an ideal commutator with parasitic capacitances across its both terminal pairs. This problem of variable network theory is solved by a method already described by the author in a paper dealing with the same effects in a Cowan (shunt-type) modulator, but the derivation has been further simplified. The results for Cowan and ring modulators are identical and are expressed in terms of an equivalent frequency (intermediate between signal and side-band frequencies) at which the same capacitance would produce an identical loss in a network without frequency translation. It is also shown that a mismatch of the modulator (higher impedance at the low frequency side and lower impedance at the high frequency side) can never decrease the conversion loss. Known experimental evidence is shown to confirm the theory.

An Application of Analog Computers to the Statistical Analysis of Time-Variable Networks—J. H. Laming, Jr., and R. H. Battin

A method is devised for the calculation of the RMS response of variable coefficient linear systems for stationary random inputs whose autocorrelation functions are known. The original linear system is preceded by a "shaping filter" which is designed to produce the proper input signal for the system when the filter input is a purely random process ("white noise"). If $W(t, \tau)$ is the weighting function for the overall system including the filter, it can be shown that the required mean-squared response is given by

$$\int_{-\infty}^t W(t, \tau)^2 d\tau.$$

Physically, $W(t, \tau)$ represents the response of the over-all system at time t to a unit impulse at time τ . By replacing the system under study by a modified system, it is found to be possible by simulator techniques to generate a weighting function continuously as a function of τ for fixed t . It is thus possible to evaluate the mean-squared response by one test, for a particular t , rather than by a family of such tests. This affords a certain saving in time even when a number of values of t are to be considered. When only one t is of interest, however, the simplification is of considerable value. The simulation of the modified system is found to be extremely simple and can be accomplished immediately from the simulation of the original system.

The Response of Linear Networks to Suddenly Applied Stationary Random Noise—D. G. Lampard

This paper is concerned with some of the statistical properties of the output currents of a very simple time-varying linear circuit the input of which is a stationary time series. This circuit consists of the tandem combination of a switch and a bank of fixed linear networks, such that the stationary input is suddenly applied to the fixed linear networks at time $t=0$. Expressions are obtained for the time-dependents correlation functions and power spectra of the output currents and an integral equation for the autocorrelation function of the stationary input

is derived. Using this solution as a basis a new method is proposed for measuring such autocorrelation functions. For the special case in which the input has a Gaussian probability distribution, the joint probability distribution for the filter output currents is derived. Under this same condition, the joint probability distribution for a filter output current and its time derivative is found and from this result the probability that the filter output current has a zero in the interval $t, t+dt$ is obtained.

Frequency Memory in Multi-Mode Oscillators—W. A. Edson

This paper is intended to give an over-all picture of the present status of frequency-memory systems which utilize multi-mode oscillators that can oscillate at any one of several discrete frequencies. Such an oscillator will continue indefinitely to generate one of these frequencies unless turned off or subjected to a strong signal near one of the other possible frequencies in which case it will shift to that frequency. In this way, it remembers the last frequency to which it was subjected. As a minimum requirement, the system must have gain and phase properties such that oscillation is possible at each of the desired frequencies. However, if no further precaution is taken, the system will probably be inoperative because oscillation occurs at only one or two preferred frequencies or simultaneously at several frequencies. Various factors are discussed which must be considered in the design of the circuit so that single-frequency oscillation may be secured at each of the design frequencies. Typical oscillators are described which will remember any one of several hundred frequencies and which operate in any frequency range from the audible to microwave. As it is possible to perform addition, counting, and related operations with such oscillators, it is believed that these devices may prove valuable in computing machines based on digital, analog and mixed methods.

A Mathematical Analysis of a Series Circuit Containing Periodically Varying Resistance—L. A. Pipes

This paper presents a mathematical analysis of a general series circuit composed of a constant inductance and capacitance in series with a periodically-varying resistance. Three special cases are considered: (1) the response of the circuit to a constant applied electromotive force. (2) The response of the circuit to an applied alternating electromotive force. (3) The free oscillations of the circuit when the oscillations are sustained by the periodic variation of the resistance. The method of Brillouin, Wentzel and Kramers and that of the Laplace transformation is used to effect the solution of the differential equation of the circuit.

Comment on the Paper "A Mathematical Analysis of a Series Circuit Containing Periodically Varying Resistance"—H. Robbins

A Practical Method of Designing RC Active Filters—R. P. Sallen and E. L. Key

In the frequency range below about 30 cps, the dissipation factors of available inductors are generally too large to permit the practical design of inductance-capacitance (LC) or resistance-inductance-capacitance (RLC) filter networks. The circuits described in the following pages were developed and collected to provide an alternative method of realizing sharp cutoff filters at very low frequencies. In many cases the active elements can be simple cathode-follower circuits that have stable gain, low output impedance and a large dynamic range.

The Potential Analog Applied to the Synthesis of Stagger-Tuned Filters—H. A. Wheeler

A class of frequency selectors has a single pass band covered by multiple resonances. These may develop oscillating peaks (Tcheby-

cheff), merging peaks (Butterworth) or submerging peaks. The general case is formulated in terms of a semi-elliptic array of poles on the complex frequency plane, transformed to a circular array and then to a single pole by simple mapping formulas typical of two-dimensional potential problems. The attenuation formula is then written by inspection, bypassing the usual reliance on abstract mathematical tools such as the complex roots of unity and the Tchebycheff polynomials. Design formulas for oscillating peaks are organized in terms of the three performance parameters and the number of resonances and are mapped on a simple chart. The properties of all resonances are thereby determined for embodiment in a stagger-tuned amplifier or other network.

Resistance-Capacitance Filter Networks with Single-Component Frequency Control—W. K. Clothier

A short analysis is given of several bridge and ladder networks in which the rejection frequency is controlled by means of single components. Variable capacitors or resistors are used for frequency control in the bridge networks, and variable resistance or capacitance potential dividers in the ladder networks. The bridge networks have a relatively small useful range of continuous frequency control, whereas the ladder networks, by suitable design, may be used for ranges up to about 10 to 1. Response curves are given for a typical ladder filter with a 4 to 1 frequency range.

**Reviews
Correspondence
News**

ELECTRON DEVICES

VOL. ED-2, NO. 1, JANUARY, 1955

Correlation between Induced Grid Noise and Tube Noise—J. R. Stahmann

The correlated and uncorrelated parts of the induced grid noise of a triode can be measured by plotting the equivalent saturated diode current of a tuned stage as a function of its input capacity after neutralizing the anode-grid capacitance. Measurement results on 6AC7, 7AF7, and 6V6 tubes are presented. The large uncorrelated part found with the 6V6, which has a relatively large grid-cathode distance, indicates that the uncorrelated part cannot be explained by a breakdown of the Llewellyn-Peterson theory at close grid-cathode spacings. The large uncorrelated part may be explained by considering the tube as made up of a large number of small independent diodes in parallel. The per cent of correlation increases when the grid is made more negative since the spread in electron paths is reduced. The noise figure of a stage cannot be improved by detuning if the correlated part is small.

Propagation in Linear Arrays of Parallel Wires—J. R. Pierce

Karp has used in a millimeter-wave backward-wave oscillator a circuit in which an array of wires bridges a channel in a metal block, and in which there is a central bar or ridge close to the wires. A spatial harmonic of the field interacts with the electrons. The use of a central channel instead of a central bar gives a circuit for which the fundamental is a backward wave.

The phase constants and impedances of such circuits are calculated approximately.

Some Properties and Circuit Applications of Composite Junction Transistors—A. R. Pearlman

It is shown that by connecting together the collectors of two junction transistors and joining the emitter of one to the base of the other the free emitter and base connections, together with the common collectors, constitute

the three terminals of a composite transistor device with an equivalent alpha of $1 - (1 - \alpha_1)(1 - \alpha_2)$. Curves and numerical examples are used to show the device and circuit properties and to relate them to device and circuit parameters. It is demonstrated that amplifiers with input resistances of 10^8 ohms can be readily constructed with two conventional junction transistors. Applications as amplifiers and voltage followers are discussed. It is shown that the circuit behavior of composite transistors can be very similar to that of vacuum-tubes. Multiple composite power transistors using three or more junction transistors are described.

A Theory of Determining the Dynamic Sensitivity of Cathode-Ray Tubes at Very High Frequencies by Means of Fourier Transforms—E. Folke Bolinder

Fourier transforms have been used in a theory of determining the dynamic sensitivity of cathode-ray tubes at very high frequencies. The exposition of the theory is facilitated by means of analogous conditions in the theory of inhomogeneous transmission lines recently presented. Thus, for instance, the simplest case with parallel plates neglecting stray fields and exit displacement is analogous to the exponential line. The method of determining the dynamic sensitivity of a cathode-ray tube having various forms of its plates is presented. Finally the problem of constructing a cathode-ray tube having an optimized sensitivity curve is discussed.

Junction Diodes—Features and Applications—Frank Finnegan

Raytheon has done considerable work developing germanium and silicon junction diodes for use where low forward impedance, increased mechanical stability, more uniform electrical characteristics, better service reliability, and longer shelf-life are important. The silicon junction diodes are especially good where maximum temperature stability and extremely low saturation currents are desired.

The diffused junction type, the small area gold-bonded germanium, the aluminum-bonded silicon and the low-noise grown junction types are discussed in some detail. A grown junction silicon diode having a peak inverse voltage in excess of 2000 volts is described.

Optimum design of circuits which are useful in UHF and VHF television, computer, and other equipment is discussed. Factors influencing frequency response, noise figure and reverse transient response time are explained.

Recent Developments in Power Transistors—H. T. Mooers

Power transistors capable of providing five watts output are now in production. Because these units are relatively nonlinear in their characteristics, large-signal graphical analysis of their behavior is necessary. To facilitate this, the static characteristics of the grounded base, grounded emitter, and grounded collector circuits are presented for several temperatures. Since power transistors are seldom driven with a high-impedance source, the input voltages must be known as well as the input currents. These characteristics are drawn to indicate both simultaneously on one chart.

The power that must be removed from the junction of these transistors requires that the mounting for the transistor be thermally adequate to remove the heat without allowing the temperature of the junction to exceed its critical value. The temperature power relationship is discussed and the theoretical size requirements for a heat dissipator are shown for free air convection and forced convection.

Recent Developments in Silicon Fusion Transistors—R. A. Gudmundsen, W. P. Waters, A. L. Wannlund, and W. V. Wright

Development effort has been put on fused junction silicon transistors rather than grown junction transistors since this type of unit lends itself readily to mass production techniques. The mechanism of the fused junction is discussed in terms of both tin-silicon fusions and gold-silicon fusions.

A micro optical light probe technique for measuring the lifetime of injected carriers in the fabricated device is discussed.

Because of lifetime degradation in the bulk material when making high temperature tin-silicon fusions, reasonable alphas are obtained only by resorting to base thicknesses less than 0.001 inch. With such a thin base thickness a phenomenon called "punch through" is encountered in which the collector depletion region traverses the base region and affects an emitter to collector short at low collector voltages.

Surface recombination velocity for the silicon surfaces of experimental units are high, around 5,000 cm/sec. This and other problems limit the alpha of present units but solutions to these problems are forthcoming.

Books

Transistors: Theory and Applications by Abraham Coblenz and Harry L. Owens

Published (1955) by McGraw-Hill Book Company, Inc., 330 West 42 St., New York, N. Y. 270 pages + 12 page index + xv pages. Illustrated. $9\frac{1}{2} \times 6\frac{1}{2}$ \$6.00.

This book is an outgrowth of a series of articles published by the authors in *Electronics* during 1953 and 1954. It has been written primarily for the engineer or technician with no previous experience in semiconductors and touches briefly almost every aspect of the art from a short history of transistors to manufacturing techniques.

Most of the material is presented in non-mathematical descriptive terms. One exception is the analysis of the use of the small-signal equivalent circuit in predicting the performance of two transistors in cascade. All of the useful arrangements are discussed and the results are presented in concise tabular form.

The authors consider the invention of the transistor a major scientific achievement and go so far as to imply that the transistor as such is only the first of many semiconductor devices which will open a new era in the field of electronics. Despite the reference to applications in the title, they have omitted discussions of the many practical uses to which transistors have already been experimentally applied, such as amplifiers and oscillators in radios, hearing aids, television sets, and switching elements in computers. Such applications may be of minor importance relative to those which will come in the

future. Still, to the newcomer in the field, the description of such devices would help explain the authors' statement about the importance of semiconductors in general.

The book contains no diagrams of practical transistor circuits. It would seem that material on biasing problems, temperature stabilization, and interstage coupling networks would be at least as interesting and useful to the reader as the chapter on manufacturing techniques.

Despite the above reservations, the book should prove both an interesting and informative general introduction to the semiconductor field.

R. D. LOHMAN and G. B. HERZOG
David Sarnoff Research Center
Princeton, N. J.

RECENT BOOKS

Cattell, Jaques, ed., *American Men of Science*, Vol. I, *Physical Sciences*. A biographical directory. R. R. Bowker Company, New York, N. Y. \$20.00.

Chaundy, T. W., Barrett, P. R., and Batey, Charles, *The Printing of Mathematics*. Oxford University Press, 114 Fifth Ave., New York 11, N. Y. \$4.80.

Kiver, Milton S., *Television Simplified*. D. van Nostrand Co., Inc., 250 Fourth Ave., New York 3, N. Y. \$6.75.

Lawden, Derek F., *Mathematics of Engineering Systems*. John Wiley and Sons, Inc., 440 Fifth Ave., New York 15, N. Y. \$5.75.

Most Often Needed Television Servicing Information, 1955, M. N. Beitman, compiler. Supreme Publications, Highland Park, Ill. 3.00.

Proceedings of the National Electronics Conference: Vol. 10. Contains all the technical papers and luncheon addresses of the 1954 conference and a cumulative index of all technical papers presented during the ten year life of the conference. National Electronics Conference, 84 E. Randolph Street, Chicago 1, Ill.

Publications From the Institute. A list of all unclassified periodical publications, books, reviews and technical reports by the MIT faculty, departments, laboratories and the Technology Press for the year ending July 1, 1954. Office of Publications, MIT, Cambridge 39, Mass. \$50.50.

Radio Amateur's Handbook, by the Headquarters Staff of the American Radio Relay League. The Rumford Press, Concord, New Hampshire. \$3.00.

Reddick, H. W. and Millar, F. H., *Advanced Mathematics for Engineers*. John Wiley and Sons, Inc., 440 Fifth Ave., New York 15, N. Y. \$6.50.

Thermionic Valves 1904-1954: The First Fifty Years. The Institution of Electrical Engineers, Savoy Place, London W.C. 2, England. 9s. Od.

Tsien, H. S., *Engineering Cybernetics*. McGraw-Hill Book Co., Inc., 330 W. 42 St., New York, N. Y. \$7.00.

Abstracts and References

Compiled by the Radio Research Organization of the Department of Scientific and Industrial Research, London, England, and Published by Arrangement with that Department and the *Wireless Engineer*, London, England

NOTE: The Institute of Radio Engineers does not have available copies of the publications mentioned in these pages, nor does it have reprints of the articles abstracted. Correspondence regarding these articles and requests for their procurement should be addressed to the individual publications, not to the IRE.

Acoustics and Audio Frequencies.....	643
Antennas and Transmission Lines.....	643
Automatic Computers.....	645
Circuits and Circuit Elements.....	645
General Physics.....	647
Geophysical and Extraterrestrial Phenomena.....	648
Location and Aids to Navigation.....	650
Materials and Subsidiary Techniques.....	650
Mathematics.....	652
Measurements and Test Gear.....	652
Other Applications of Radio and Electronics.....	653
Propagation of Waves.....	654
Reception.....	654
Stations and Communication Systems.....	654
Subsidiary Apparatus.....	655
Television and Phototelegraphy.....	655
Transmission.....	656
Tubes and Thermionics.....	656

The Index to the Abstracts and References published in the PROC. IRE from February, 1954 through January, 1955 is published by the PROC. IRE, April, 1955, Part II. It is also published by *Wireless Engineer* and included in the March, 1955 issue of that journal. Included with the Index is a selected list of journals scanned for abstracting with publishers' addresses.

The number in heavy type at the upper left of each Abstract is its Universal Decimal Classification number and is not to be confused with the Decimal Classification used by the United States National Bureau of Standards. The number in heavy type at the top right is the serial number of the Abstract. DC numbers marked with a dagger (†) must be regarded as provisional.

U.D.C. CHANGES

In anticipation of a new edition of the Universal Decimal Classification Abridged English Edition (BS 1000 A), certain changes in U.D.C. numbers will be made in this and subsequent issues. The new numbers used will be:

Radio astronomy: 523.16
 Ultrasonics: 534 subdivisions with the special analytical subdivision -8 attached.
 Sound recording and reproducing: 534.85
 Electroacoustic problems, transduction, etc.: 534.86.

ACOUSTICS AND AUDIO FREQUENCIES

534.1-14: 621.395.61 904
Investigation of the Suitability of Ferrites for Application in Underwater Transducers—H. Thiede. (*Acustica*, vol. 4, no. 5, pp. 532-536; 1954. In German.) Measured efficiencies and resonance frequencies are tabulated for the relatively few NiZn specimens found under test to be satisfactory for underwater operation. Ferrite materials for acoustic purposes require uniform elastic properties which present-day manufacturing technique does not as yet provide.

534.1-8: 621.395.61/.62 905
Condenser Transmitters and Microphones with Solid Dielectric for Airborne Ultrasonics—W. Kuhl, G. R. Schodder and F. K. Schröder. (*Acustica*, vol. 4, no. 5, pp. 519-532; 1954.) Various radiator and microphone systems were tested, but the desirability of choosing a system that could be used as a reversible transducer in reciprocity calibrations limited the choice to one type. This had a backing plate with grooves whose width is equal to that of the intervening rails and is half the depth, and a metallized styroflex foil diaphragm 10 μ thick. This combination gave a linear relation between transducer current and sound pressure. The microphone frequency response varied only by about

6 db over the range 0.2-100 kc. Calibration procedure and errors are discussed. In this connection some measurements were made of the absorption of sound in air at humidities of 0.72 per cent and 1.04 per cent by weight, over the range 20-100 kc.

534.232:533.7 906
Sound Radiation from Vibrating Solids treated by the Kinetic Theory of Gases—V. Gavreau and A. Calaora. [*Compt. Rend. Acad. Sci. (Paris)*, vol. 239, pp. 1272-1274; November 15, 1954.] The velocity of particles close to the vibrating surface differs from that of the surface itself. Formulas are derived for the intensity of the sound radiated by a piston on the basis of the energy communicated to the gas molecules striking it. Numerical evaluation for the case of air leads to a value of radiated intensity only 87.6 per cent of that obtained assuming the gas to be a continuous fluid. This result has been verified by means of radiation pressure measurements.

534.614-8: 539.16 907
Measurement of Velocity of Ultrasonic Waves in Liquids using Radioactive Indicators—T. T. Ouang. (*Jour. Phys. Radium*, vol. 15, p. 697; October, 1954.) Nodes of standing waves in liquids containing very small quantities of radioactive material are detected by means of a counter or photographic film. Radioactive elements suitable for this purpose are mentioned.

534.85 908
Congress on Sound Recording—Paris 1954—(*Onde élect.*, vol. 34, pp. 725-811; October, 1954.) The text is given of a further selection of the papers presented. See also 2560 of 1954 (Houlgate).

621.395.62.089.6 909
The Subjective Free-Field Calibration of an External Telephone Receiver by the Equal-Loudness Method—J. Pritchett. (*Acustica*, vol. 4, no. 5, pp. 544-546; 1954.)

621.395.623.7 910
Some Aspects of the Non-Linear Distortion of Loudspeakers—C. Bordone. (*Acustica*, vol. 4, no. 5, pp. 563-566; 1954.) Frequency response and nonlinear distortion measurements on three loudspeakers of 2-, 4- and 6-w power respectively are reported and discussed. The nonlinear distortion, which is least along the loudspeaker axis, can be as large as 15 per cent for certain directions. A comparison of loudspeaker characteristics measured in an anechoic chamber and in a "living room" shows that distortion is nearly always greater in the second case, and that the nonuniformity of the directivity pattern is much more pronounced.

ANTENNAS AND TRANSMISSION LINES

621.315.2 911
The Sarrebourg-Sarreguemines 60-Channel Star Quad Cable—L. Parcé. (*Câbles &*

Trans., vol. 8, pp. 325-340; October, 1954.) Report on the specifications for and testing of the cable, with descriptions of the test gear used.

621.315.2 912
Study of Impedance Uniformity of Spliced Symmetric-Pair Cables—H. Pech. (*Câbles & Trans.*, vol. 8, pp. 341-350; October, 1954.) A formula is derived relating the cable irregularities measured on factory lengths, and the irregularities not to be exceeded after splicing.

621.315.212:621.3.018.78 913
Distortion of Cos² Pulses in Transmission over a Coaxial Pair—P. J. M. Clavier. (*Câbles & Trans.*, vol. 8, pp. 351-356; October, 1954.) The response of a cable of length l may be expressed in terms of the response of an arbitrary unit length by changing the time scale by a factor proportional to l^2 . This principle is applied to obtain graphs showing distortion for various cable lengths. Expressions for the highest useful test frequency and the corresponding pulse duration are derived in terms of l . Compensation is also discussed.

621.372.029.64 914
Radial Line Discontinuities—J. R. Whinnery and D. C. Stinson. (PROC. I.R.E., vol. 43, pp. 46-51; January, 1955.) Curves are presented showing the equivalent shunt capacitance for various types of discontinuity.

621.372.2+621.372.87:621.317.3.029.6 915
The Multiple-Short-Circuit Plunger Technique for the Determination of the Transformation Properties of Lossless 2n-Terminal Networks between Homogeneous Transmission Lines—Lueg. (See 1095.)

621.372.5:621.396.67.029.55 916
The Transport of Energy to the Aerials at S.W. Long-Range Stations—W. Berndt. (*Telefunken Ztg.* vol. 27, pp. 104-113 and 163-171; July and September, 1954.) Requirements at medium- and high-power stations are reviewed, a table showing the range of impedance for balanced and unbalanced feeder lines and antenna types. Design problems and the suitable application of the following devices are discussed in some detail: (a) selector switch devices, which include arrangements for connecting ten different transmitters to any ten of 20 antennas, (b) switches for reversing the direction of radiation, (c) the five most important types of coaxial and wire feeders, (d) common-antenna working, (e) impedance-transforming devices of the exponential, $\lambda/4$ -section, and stub types, (f) balun devices.

621.372.8 917
The Propagation of Transient Electromagnetic Signals in Waveguides—A. Rubinowicz. (*Acta Phys. Polonica*, vol. 13, no. 2, pp. 115-133; 1954. In German.) The propagation of a monochromatic TE-wave disturbance in considered, commencing at a given instant. If the

wavelength is less than the mode cut-off wavelength, a wave is propagated in two parts, the precursor transient and the main signal. The precursor signal travels with the free-space velocity for the medium filling the guide, the main signal with the group velocity. The field intensities for both parts of the signal are obtained in terms of series involving Bessel functions and asymptotic approximation. Energy relations in the wave are considered, and extensions of the results are mentioned.

621.372.8 918

A Distributed Electrical Analog for Waveguides of Arbitrary Cross Section—P. R. Clement and W. C. Johnson. (Proc. I.R.E., vol. 43, pp. 89–92; January, 1955.) "The characteristics of uniform waveguides of arbitrary cross section can be studied experimentally by using a two-dimensional transmission line, operating in resonance in its principal mode, as an analog. The model is simple, inexpensive, and quite accurate even for cross sections which have sharp corners. The theory is presented, measurement techniques are discussed, and experimental results are compared with the theoretical values for rectangular and ridged waveguides."

621.372.8 919

An Introduction to the Principles of Waveguide Transmission: Part 2—Attenuation, Amplification and Measurement—C. F. Floyd and W. A. Rawlinson. (P. O. Elec. Eng. Jour., vol. 47, part 3, pp. 153–158; October, 1954.) Processes associated with the detection of the waves are described. Part 1: 18 of February.

621.372.8 920

Interpretation of the Effect of an Insulating Film on the Attenuation of the H_{10} Wave in a Waveguide with Circular Cross-section—M. Cotte. (Cables & Trans., vol. 8, pp. 357–361; October, 1954.) Analysis shows and experiment confirms that a thin dielectric film on the walls may considerably increase attenuation by reducing the reflecting power of the metal and hence, as in the analogous optical case, facilitating transmission into the metal. If a varnish is used, it should be a very thin layer having low permittivity.

621.372.8 921

Theory of a Waveguide containing a Spiral, Partly Filled with a Dielectric—W. P. Schestopalov. (NachrTech., vol. 4, pp. 425–430; October, 1954.) German translation of 2884 of 1953.

621.372.8 922

Dispersion Characteristic of Sectionalized [disk-loaded] Waveguide—N. H. Sovetov. (Zh. Tekh. Fiz., vol. 24, pp. 1907–1909; October, 1954.) A comparison is made between calculated and experimentally determined phase-velocity dispersion characteristics of circular waveguides with disks of radius $b = 58.5$ mm, disk-aperture-radius $a = 15$ mm, and disk-spacing $d = 10$ mm, at wavelengths near 14.5 cm. Calculated curves are also given for waveguides with $b/a = 2, 3, \text{ or } 5$, and $(b-a)$ in the range $1.2 - 5.2\lambda$.

621.372.8 923

Excitation of Non-ideal Radio Waveguides—V. A. Il'in. [Compt. Rend. Acad. Sci. (URSS), vol. 98, pp. 925–928; October 21, 1954.] Solutions are obtained by the method developed by Samarski and Tikhonov (Zh. Tekh. Fiz., vol. 17, pp. 1283–1296; November, 1947, and 3335 of 1948) and used by Il'in (17 of February). The zero-order approximation, i.e. the solution of the ideal case, can be used within the "radius of action" which, in the case of a Cu waveguide operating at 10 cm λ , is about 10 m. The presence of angularities has a negligible effect on the character of energy losses in the waveguide.

621.372.8 924

Coupling of Two Waveguides of Similar Cross-Sections—B. Z. Katsenelenbaum. (Zh.

Tekh. Fiz., vol. 24, pp. 1892–1906; October, 1954.) A theoretical treatment.

621.372.8:538.221 925

Electromagnetic Waves in Rectangular Waveguide filled with Magnetized Ferrite—A. L. Mikaelyan. [Compt. Rend. Acad. Sci. (URSS), vol. 98, pp. 941–944; October 21, 1954.] Solutions are obtained for the equations of wave propagation for transverse magnetization of the ferrite.

621.372.8:621.376.3 926

Harmonic Distortion in Waveguides with Sinusoidal Frequency Modulation—L. Robin. [Compt. Rend. Acad. Sci. (Paris), vol. 239, pp. 1279–1280; November 15, 1954.] A formula involving Bessel functions is derived for the harmonic distortion with FM for a guide with perfectly conducting walls and arbitrary cross section. Notation and theory developed previously (1282 of 1953) are adapted. Numerical calculation for a round guide of radius 3.825 cm and length 3 km, using a carrier frequency of 35 kmc, a modulation frequency of 7.5 mc and a modulation index of 1.5, indicates that the harmonic distortion is low.

621.372.8:621.384.622.2 927

Experimental Study of Waveguide with [internal] Helix for Linear Accelerator for Heavy Particles: Phase Velocity—A. Septier. [Compt. Rend. Acad. Sci. (Paris), vol. 239, pp. 1367–1369; November 22, 1954.] Measurements of guide wavelength were made on a section of the guide terminated by reflectors at both ends, so as to become a resonator. The arrangements studied were (a) bare helix, (b) shielded helix, (c) helix held by three radial plexiglass supports, (d) use of three supports occupying greater volume. Curves of phase velocity as a function of frequency show the retarding effect of these arrangements.

621.372.8:621.384.622.2 928

Experimental Study of Waveguide with [internal] Helix for Linear Proton Accelerator: Shunt Impedance—A. Septier. [Compt. Rend. Acad. Sci. (Paris), vol. 239, pp. 1476–1478; November 29, 1954.] An investigation is made of the influence of the insulating helix supports on the Q value and shunt impedance of the guide. The results are compared with theoretical predictions.

621.396.67 929

An Application of Sommerfeld's Complex-Order Wave Functions to Antenna Theory—C. H. Papas. (Jour. Math. Phys., vol. 33, pp. 269–275; October, 1954.) Analysis is presented for an antenna comprising a coaxial line whose inner conductor is terminated by a hemispherical boss while the outer conductor is provided with an infinite flange. An accurate expression is derived for the admittance, involving functions which have not yet been tabulated.

621.396.67 930

Scattering of Electromagnetic Waves by Wires and Plates—J. Weber. (Proc. I.R.E., vol. 43, pp. 82–89; January, 1955.) A theoretical treatment with particular reference to the wave polarization changes produced. An approximate solution is obtained for scattering from a rectangular plate. The center-driven wire and the wire as a receiving antenna are treated. A method based on the scattering properties is indicated for measuring the input impedance of the center-driven wire. Expressions obtained for the scattered field and back-scattering cross section of the wire with sinusoidal current distribution are reasonably accurate for antenna lengths up to nearly a wavelength.

621.396.67 931

Current Distribution along a Cylindrical Radiator—P. Poincelot. [Compt. Rend. Acad. Sci. (Paris), vol. 239, pp. 1365–1367; November 22, 1954.] An error in the analysis presented previously (2119 of 1952) is corrected;

a solution is derived in the form of an infinite system of linear algebraic equations.

621.396.67 932

Distribution of Current along a Cylindrical Transmitting Aerial—P. Poincelot. [Compt. Rend. Acad. Sci. (Paris), vol. 239, pp. 1472–1474; November 29, 1954.] Continuation of analysis presented previously (931 above). Convergent expressions are obtained for the coefficients of the Fourier series representing the distribution.

621.396.67.029.45 933

Considerations in the Design of Aerials for Radiotelegraphy Transmissions in the Very-Low-Frequency Range—P. Bouvier. (Ann. Radiolect., vol. 9, pp. 342–351; October, 1954.) Description of the design and construction of the antenna system at Jim Creek, Washington [821 of 1953 (Hobart)] stressing the factors justifying the project and making comparison with earlier high-power lf antenna systems.

621.396.673 934

The Folded Ground Plane—J. C. Belcher. (Short Wave Mag., vol. 12, pp. 432–434; October, 1954. Correction, *ibid.*, vol. 12, p. 560; December, 1954.) A brief discussion of the earthed vertical folded antenna. The advantages include high input impedance, large bandwidth, low height ($\lambda/4$) and simple mechanical construction.

621.396.674.1.029.51 935

Ferromagnetic Loop Aerials—J. S. Belrose. (Wireless Eng., vol. 32, pp. 41–46; February, 1955.) Design of antennas for the frequency range 80–200 kc is discussed from the point of view of obtaining the best possible signal/noise ratio. Results are reported of experiments with loop antennas using ferroxcube rod or tube cores. For a receiver bandwidth of 100 cps a sensitivity of $1 \mu\text{v/m}$ with a signal/noise ratio of 10 db is shown to be possible.

621.396.677 936

Plane Aerials with Small Side Lobes—G. F. Koch. (Fernmeldetechn. Z., vol. 7, pp. 498–509; October, 1954.) "Angle attenuation" rather than magnitude of side lobes is chosen as the criterion for assessing polar diagrams of antennas for radio links. Simple diffraction theory indicates that rhombic apertures and those bounded by exponential, cosine, cosine-squared and cosine-cubed curves have better directivity than the usual square or circular apertures. Nonuniform as well as uniform aperture illumination is considered. Experimental results support the theory.

621.396.677 937

Newly Developed Directive Aerials for Decimetre and Centimetre Wavelengths—K. O. Schmidt. (Fernmeldetechn. Z., vol. 7, pp. 495–497; October, 1954.) A short survey; general formulas applicable to any form of directive antenna are presented.

621.396.677 938

Wide-Band Directive Aerials for Wavelengths below 20 cm—W. Stöhr. (Fernmeldetechn. Z., vol. 7, pp. 510–515; October, 1954.) The performances of various types of parabolic-reflector and lens antennas in the 2-, 4- and 6-kmc bands are compared, the most important data being tabulated. The preferred arrangement is a parabolic-sector reflector with large Horn primary radiator; the direction of illumination is perpendicular or nearly perpendicular to the paraboloid axis, and the side of the horn comes right up to meet the edge of the reflector. The long horn is advantageous from the point of view of matching.

621.396.677.3 939

Design of Linear Arrays giving Optimum Radiation Pattern—S. Herscovici. (Ann. Radiolect., vol. 9, pp. 352–359; October, 1954.) Duhamel's procedure (2225 of 1953) is reviewed and a simple matrix method is described for evaluating the excitation coefficients; this

is particularly advantageous when the number of elements is large. See also 331 of 1954 (Stegen).

621.396.677.3.029.6 940
Beaming Electric Waves by Director Plates
 —G. von Trentini. (*Z. angew. Phys.*, vol. 6, pp. 462-470; October, 1954.) Antenna systems with high gain (up to about 17.5 db) for the 3-10-km frequency range are considered theoretically and several experimental arrangements are described. The beaming of the waves from a dipole or waveguide radiator is obtained by a series of parallel plates normal to the direction of propagation and parallel to the electric vector, spaced at about $\lambda/2$. Both diffraction and reflection effects take place. The method can also be applied at lower frequencies, where perforated plates or wire mesh can be used in preference to the more strongly frequency-dependent Yagi director antenna systems.

621.396.677.45.029.63 941
High-Gain Side-Firing Helical Antennas—H. G. Smith. [*Trans. AIEE*, Part I, *Commun. and Elec.*, vol. 73, pp. 135-138; May, 1954. *Digest, Elec. Eng. (N.Y.)*, vol. 73, p. 896; October, 1954.] A helical side-firing antenna for the 500-1,000-mc range comprises a coil on a coaxial conducting cylindrical mast. Within a range of power gain (G) from 5 to 10, relative to a dipole, the required helix-mast spacing (S) is given by $S = \lambda/G$ for a helical conductor diameter of $\lambda/100$, turn length 2λ , and pitch $\lambda/2$. A coaxial stack of five such bays, excited in phase, produces a power gain of about 25 and a main-beam half-power width of 2 degrees.

AUTOMATIC COMPUTERS

681.142 942
Relay Time-Division Multiplier—G. A. Korn and T. M. Korn. (*Rev. Sci. Instr.*, vol. 25, pp. 977-982; October, 1954.) A simple tubeless multiplier for use in analog computers is described.

681.142 943
Three-Dimensional Analogue Computer—[*Engineer (London)*, vol. 198, pp. 532-533; October 15, 1954.] The Tridac is an electronic-hydraulic machine developed for the Royal Aircraft Establishment for solving problems in radar and guided-missile operation. It occupies 6,000 feet² of floor space, uses 8,000 tubes and consumes 650 kw under peak conditions. Individual mathematical operations are performed with an error >0.1 per cent of full scale. The basic analog quantity is a dc voltage and the basic element is a dc amplifier with a gain of the order of 60,000, stabilized by association with an ac amplifier.

681.142:512.831 944
The Calculation of the Latent Roots and Vectors of Matrices on the Pilot Model of the A.C.E.—J. H. Wilkinson. (*Proc. Camb. Phil. Soc.*, vol. 50, pp. 536-566; October, 1954.)

681.142:621.37 945
Resistance-Network Analogues with Unequal Meshes or Subdivided Meshes—G. Liebmann. (*Brit. Jour. Appl. Phys.*, vol. 5, pp. 362-366; October, 1954.) "A general method for deriving the finite difference approximations to the partial differential equation $\text{div } K \text{ grad } U = g$, which is solved by resistance-network analogues, is applied to find the resistance values and the currents which have to be fed in for (x, y) - and (r, z) -networks with unequal mesh sizes. Two ways of subdividing a network into finer meshes in the ratio 1:2 are then given, and a network subdivision in the ratio 2:5 is described. Experimental tests have shown that these subdivisions introduce negligible errors into the measured field distributions."

681.142:621.373.1 946
A Phonic-Wheel Generator for Position Indication in Digital-Computer Magnetic

Drum Storage—D. R. Quedsted and A. D. Booth. (*Jour. Sci. Instr.*, vol. 31, pp. 357-360; October, 1954.) The design is discussed of a variable-reluctance phonic-wheel generator for frequencies above 20 kc. The final form comprises a rotating slotted disk and polarizing permanent magnet placed centrally between two pickup heads. Pickup output as high as 5 mv/turn has been attained. The system has been adopted in the A.P.E.(X).C.-type computer [1184 of 1951 (Booth)].

681.142:621.395.625.3 947
Calculation of the Magnetic Field in the Ferromagnetic Layer of a Magnetic Drum—O. Karlqvist. [*Kungl. Tek. Högsk. Handl. (Stockholm)*, no. 86, 28 pp.; 1954.] The variation of the field with permeability, air gap, layer thickness and other factors is investigated, assuming the ferromagnetic layer to be of low-permeability spinel material. While the problem is nonlinear, the linear approximation is satisfactory in some cases. Numerical computations are presented for the drum used in the Swedish computer "Besk."

CIRCUITS AND CIRCUIT ELEMENTS

621.3.016.35 948
Extension of the Generalized-Phase-Diagram Method for Studying the Stability of Linear Systems—P. Lefèvre. (*Rev. gén. Élect.*, vol. 63, pp. 619-640; October, 1954.) Extension of work reported previously [3127 of 1949 (Demontvignier and Lefèvre)]. A rule for interpreting the phase diagram leading to a simpler method of application is described. The damping necessary to ensure stability is investigated by a graphical method; an analytical method is developed using a characteristic algebraic equation with real coefficients.

621.3.049.7 949
Automatic Production for Electronics—W. H. Hannahs. (*Elec. Mfg.*, vol. 54, pp. 116-124; July, 1954.) A review of the techniques and design factors.

621.3.066.6 950
The Influence of Electrical Current on the Contact between Metals—F. P. Bowden and J. B. P. Williamson. [*Research (London)*, vol. 7, pp. S53-S55; October, 1954.] Experiments are reported in which two blocks of gold were pressed together in such a way as to localize contact in a single region, and current pulses were passed whose duration was chosen in relation to the time constants of the contact so as to produce the effect of a continuous current. The constriction resistance between the blocks was measured before and after passage of a pulse; from these values the changes in the contact area were calculated. The results indicate that below a critical value of current the contact area is unchanged, but above this current value the contact area is increased by passage of current.

621.314.22 951
A Versatile Output Transformer for Surge Generators—J. D. Harmer and J. R. Howells. (*Electronic Eng.*, vol. 27, pp. 22-23; January, 1955.) Description of a tapped toroidal transformer designed to match the generator to a wide range of values of load impedance without altering the form of the surge.

621.316.726.078.3:621.317.7.029.64 952
Microwave Discriminator: Part I—Stabilization of [oscillator for] Test Bench—R. Fanguin and G. Raouf. (*Jour. Phys. Radium*, vol. 15, pp. 133A-138A; October, 1954.) A discriminator for stabilizing a reflex klystron operating at 10 kmc is discussed. A small portion of the klystron output is applied to a cavity resonator, and the sum and difference of the resonator response and the incident signal are used, after detection and amplification, to provide the control voltage for the klystron reflector electrode.

621.316.727:621.373.4 953
Closed-Loop Automatic Phase Control—P. F. Ordung, J. E. Gibson and B. J. Shinn. [*Trans. AIEE*, Part I, *Commun. and Elec.*, vol. 73, pp. 375-381; 1954. *Digest, Elec. Eng. (N.Y.)*, vol. 73, p. 915; October, 1954.] The method described of designing a phase control system for an oscillator is based on an application of techniques of servomechanism analysis.

621.318.4 954
Wafer-Coil Development for Inductive Components—A. Zack and T. Wroblewski. (*Sylvania Tech.*, vol. 7, pp. 99-102; October, 1954.) The automatic production of coils made of insulated metal foil, instead of wire, is described. The roll of foil is sliced into thin wafers which can be connected in series to obtain the required inductance. Physical and electrical characteristics are similar to those of wire-wound coils. Closer spacing of turns is possible than with printed-circuit techniques.

621.318.435.3 955
Transductors with Four-Limbed Cores—A. G. Milnes. (*Proc. IEE*, Part II, vol. 101, pp. 554-558; October, 1954.) "Transductors with four-limbed cores have characteristics which differ from those of conventional transductors in their symmetry with respect to control-current changes. Such transductors are suitable for increasing the sensitivity of non-polarized relays and may be operated by either dc or ac signals. The suppression of response to negative signals is also possible with four-limbed transductors, and this may be used to reduce swamping effects in push-pull magnetic amplifiers subjected to large signal inputs."

621.318.57 956
Accurate Linear Bidirectional Diode Gates—J. Millman and T. H. Puckett. (*Proc. I.R.E.*, vol. 43, pp. 29-37; January, 1955.) Discussion of switching circuits to be controlled by af square-wave voltages, with gates of several milliseconds. Bridge arrangements of two, four and six diodes are described. Operating factors considered include amplitude of control voltage, gain, constancy of gain/signal characteristic, backward leakage through the diodes, and effects of unbalance. Series, parallel and series-parallel combinations are illustrated; the use of a series-parallel arrangement of gates for processing radar data is described.

621.319.4:537.224 957
The Capacity and Field of a Split Cylindrical Condenser when the Conductors Differ in Length—H. J. Peake and N. Davy. (*Brit. Jour. Appl. Phys.*, vol. 5, pp. 371-373; October, 1954.) The transformation $z = b \cdot \text{dn}(Kw/U)$, using the usual notation of Jacobian elliptic functions, gives the complex potential at any point in the z plane, for the case of a plate of width $2b\epsilon$, raised to a potential U , symmetrically placed between two semi-infinite plates at zero potential at distance $2b$ apart. From this, the field and the capacitance $K'/K\pi$ of the system are obtained by the method of inversion. By comparing the results with those of a previous paper (655 of April), two algebraic identities for the elliptic integrals K and K' are obtained.

621.319.4:537.311.33 958
The Charging and Discharging of Nonlinear Capacitors—J. R. Macdonald and M. K. Brachman. (*Proc. I.R.E.*, vol. 43, pp. 71-78; January, 1955.) Capacitors with semiconductor, photoconductor or electrolytic dielectrics involving space charge polarization [1024 of 1954 (Macdonald)] are discussed and a formula is derived for the C/V characteristic. The charging and discharging processes in such a capacitor are compared with those for a capacitor in which C is an increasing exponential function of V . The time variation of the differential capacitance of the space-charge type during charging and discharging is investigated and is compared with the behavior of a linear

capacitor exhibiting a distribution of relaxation times.

621.372 959
The Relation between Time- and Frequency-Functions with Practical Examples of the Calculation of the Transient Response of Linear Transmission Systems—V. Fetzter. (*Arch. elekt. Übertragung*, vol. 8, pp. 163–172; April, 1954.)

621.372 960
The Practical Calculation of Transient Response for Arbitrary Attenuation and Phase Distortion—V. Fetzter. (*Arch. elekt. Übertragung*, vol. 8, pp. 467–477; October, 1954.) Phase characteristic is determined from a given attenuation/frequency curve by Bode's method. The locus of the complex transfer coefficient is approximated by Fourier series. The calculated coefficients are used to evaluate the response function (see 959 above) for the case of (a) unit-pulse and (b) unit-step input. As an example the transfer functions are determined for three different IF amplifier characteristics in a PPM receiver. The accuracy of the method in giving the general shape of the transient response curve is verified using Samulon's method (1856 of 1951). An appendix contains formulas for calculating the Fourier coefficients required and tables of the functions $\sin x/x$ and $\int_0^x \sin u/u$ applying in cases (a) and (b) respectively.

621.372.4 961
Equivalence of Two-Terminal Networks—K. H. R. Weber and I. Schlegel. (*Nachr. Tech.*, vol. 4, pp. 430–433; October, 1954.) Simple procedure is indicated for synthesizing or recognizing equivalent two-terminal networks containing three or more circuit elements.

621.372.5 962
Comment on "Networks Terminated in Resistance at Both Input and Output"—L. Weinberg. (*Proc. I.R.E.*, vol. 43, p. 98; January, 1955.) Theory presented previously for RLC lattice networks (3535 of 1953 and 1332 of 1954) is supplemented by indicating a method for obtaining R or RC terminations. See also *Convention Record I.R.E.*, part 2, pp. 90–95; 1954.

621.372.5 963
Displacement of the Zeros of the Impedance $Z(p)$ due to Incremental Variations in the Network Elements—A. Papoulis. (*Proc. I.R.E.*, vol. 43, pp. 79–82; January, 1955.) A method is presented for evaluating errors introduced in the analysis of LC networks by assuming that the elements are purely reactive.

621.372.5 964
Response Characteristics of a Linear System with Third-Order Transfer Function—S. Barabaschi and E. Gatti. (*Alta Frequenza*, vol. 23, pp. 211–231; October, 1954.) The rise time and delay time of a low-pass system on application of a step-function input are calculated using Elmore's formulas (653 of 1949). Conditions for minimizing these times are determined for functions with three poles and two zeros. The pulse transformer is treated as a numerical example; the calculations are supported by experimental results, as long as consideration is restricted to no-overshoot conditions.

621.372.5:621.396 965
Radio-Frequency Phase-Difference Networks: a New Approach to Polyphase Selectivity—G. B. Madella. (*Proc. I.R.E.*, vol. 43, pp. 102–103; January, 1955.) Comment on 1910 of 1954 (Cifuentes and Villard).

621.372.512.24 966
Forced Oscillations in Nonlinear Systems with Two Degrees of Freedom—D. Graffi. (*R. C. Acad. naz. Lincei*, vol. 16, pp. 176–180; February, 1954.) Analysis is given leading to the establishment of criteria for the stability

of oscillations in LCR circuits coupled by mutual inductance.

621.372.54 967
Image Parameters of Filters with One or Two Cut-Off Frequencies and Notes on the Decomposition of the Transfer Coefficient—J. E. Colin. (*Cables & Trans.*, vol. 8, pp. 277–288; October, 1954.) A table is given of formulas for the image transfer coefficients and image impedances of high-pass, band-pass and band-stop filters. Methods of expressing the transfer coefficient as the sum of the transfer coefficients of the basic sections are explained, though the band-stop case cannot be included. The filters are considered to be without loss and without mutual inductance.

621.372.54 968
Narrow-Band Filter composed of RC Quadrupoles—H. Wittke and K. Stambke. (*Funk u. Ton*, vol. 8, pp. 530–536; October, 1954.) The design of filter circuits for very low frequencies is discussed. Oscillograms illustrate the suppression of noise superposed on a 5-cps signal. For theory of RC quadrupoles see also 1627 of 1953 (Krstel).

621.372.54 969
Transient Operation of Low-Pass and High-Pass Lattice Filters—M. L. D'Atri. (*Alta Frequenza*, vol. 23, pp. 232–254; October, 1954.) An expression is derived for the admittance of the lattice filter terminated by its characteristic impedance functions. Using a new inverse transformation method, the unit-step response of some low-pass filters and the unit-function response of some high pass filters is determined. A simple method is indicated for determining the response to an arbitrary voltage.

621.372.54:621.372.8 970
Direct-coupled Waveguide Filters—H. Scheffelowitz. (*Ericsson Tech.*, vol. 10, no. 2, pp. 253–296; 1954.) Filters are considered of the type comprising chains of cavity resonators with a common iris separating adjacent cavities. Design methods based respectively on (a) impedance considerations, (b) wave matrixes, and (c) equivalence between the waveguide filter and the lumped-element filter are described for determining the susceptance of the irises and their separation. Theory is given for the case of mismatching, and formulas are derived for parallel and cascade couplings. A four-channel branching system for frequencies ranging from 4.76 to 4.96 kmc is described.

621.372.56.029.6:621.318.134 971
Ferrite Attenuators in Helices—J. A. Rich and S. E. Webber. (*Proc. I.R.E.*, vol. 43, pp. 100–101; January, 1955.) Directional attenuation has been observed using a Ni-Zn-ferrite cylinder fitting closely round a helix. Attenuation/frequency curves are shown for two values of axial magnetic field, and attenuation/magnetic-field curves are shown for frequencies of 1.8, 2.4 and 3 kmc. The directional effect is considerably higher than indicated by elementary theory; the reason for the discrepancy is discussed.

621.372.8:621.318.134:538.614 972
Ferrite Phase Shifters in Rectangular Wave Guide—B. Lax, K. J. Button and L. M. Roth. (*Jour. Appl. Phys.*, vol. 25, pp. 1413–1421; November, 1954.) Propagation theory is developed for a nonreciprocal device with asymmetrical arrangement, as described by Kales et al. (2040 of 1954), losses in the ferrite being neglected. The dependence of the phase shift on the thickness of the ferrite slab, on the degree of asymmetry, and on the intensity of the transverse magnetic field, is investigated. The field configuration in the guide is shown diagrammatically for some special cases. A modification with two symmetrically arranged ferrite slabs and antiparallel magnetic fields is also discussed.

621.373.421.13 973
Design of "Aperiodic" Oscillator Circuit with Inductive Quartz Crystal—H. Awender and K. Sann. (*Funk u. Ton*, vol. 8, pp. 520–529; October, 1954.) The discussion is illustrated by a numerical example of an oscillator using a Type-EF80 tube and suitable in the 50–800-kc or 0.8–20-mc band. See also 2892 of 1954.

621.373.52:621.311.6 974
A New Self-Excited Square-Wave Transistor Power Oscillator—G. C. Uchirin and W. O. Taylor. (*Proc. I.R.E.*, vol. 43, p. 99; January, 1955.) The basic circuit uses a push-pull arrangement of power transistors in conjunction with a transformer consisting of a center-tapped primary, center-tapped feedback, and output winding, and a single dc source. An explanation of the operation and oscillograms of waveforms obtained are presented. Good efficiency is obtained over a frequency range 15 cps–8 kc; the range has been extended up to 20 kc with reduced efficiency. Application to conversion of power from lvdc to hvdc is discussed.

621.375.2+621.373.42 975
Class-C Amplifier and Oscillator Design—L. T. Apps. (*Electronic Eng.*, vol. 27, pp. 30–32; January, 1955.) Charts are presented for simplifying the design procedure, using a method based on that of Terman and Roake (*Proc. I.R.E.*, vol. 24, p. 620; 1936.)

621.375.2 976
Mixing Pre-amplifier—F. J. Davis and P. W. Reinhardt. (*Rev. Sci. Instr.*, vol. 25, p. 1024; October, 1954.) A circuit for mixing signals from several photocells has diodes connected in the grid circuits of the separate input tubes so as to avoid signal attenuation which would otherwise result from the parallel arrangement of these tubes.

621.375.2:621.385.029.6 977
Traveling-Wave Tube System having Multiplied Gain—F. R. Arams. (*Proc. I. R.E.*, vol. 43, p. 102; January, 1955.) Advantage is taken of the wide frequency band of traveling-wave tubes to obtain increased gain by heterodyning the output to a different frequency and then feeding it to the tube again. The system is useful in microwave relay stations where it is in any case necessary to change the carrier frequency to prevent feedback from the transmitting antenna to the receiving antenna.

621.375.2.029.3 978
Gramophone and Microphone Pre-amplifier—P. J. Baxandall. (*Wireless World*, vol. 61, pp. 8–14 and 91–94; January and February, 1955.) The equipment is designed primarily for use with the 10-w amplifier described previously (1328 of 1948). Separate input stages and gain controls for gramophone and microphone channels are followed by a mixing circuit. The full output of 4v rms can be obtained with harmonic distortion ≤ 0.1 per cent for sinusoidal inputs ranging from 1 mv to about 50 mv with microphone and from 20 mv to 1v with gramophone.

621.375.2.029.4 979
The Use of Double Triodes in High-Gain Low-Frequency Amplifiers—R. G. Wylie. (*Jour. Sci. Instr.*, vol. 31, pp. 382–383; October, 1954.) "The type of amplifier stage employing a double triode is described in which one triode section provides a high dynamic load resistance for the plate circuit of the other. . . . An amplifier utilizing three such stages and possessing a gain of the order of 10^6 is described."

621.375.2.029.4:535.23.08-1 980
Infrared-Spectrophotometer Amplifier—M. N. Markov. (*Zh. Tekh. Fiz.*, vol. 24, pp. 1867–1875; October, 1954.) An amplifier for use with a low-impedance bolometer is described with complete circuit diagram. The amplifier input

is of the order of 2×10^{-9} v at a frequency of 9 cps, corresponding to a power input of 6×10^{-8} w; the over-all amplification is $\sim 3.5 \times 10^9$. The methods used to reduce noise, tube microphony, etc., are discussed.

621.375.226 981

On the Integral Width of Cascaded Tuned Amplifiers—K. M. van Vliet, J. Blok and C. Ris. (*Physica*, vol. 20, pp. 762-766; October, 1954.) "A formula is derived by which the overall integral bandwidth B of an amplifier containing a number of noninductively coupled LC circuits is expressed in the effective quality factors Q_i of the separate resonance circuits. The quantity B can also be expressed in the integral widths B_i of the separate circuits; for two or three stages very simple relations are found."

621.375.227 982

A New Circuit for balancing the Characteristics of Pairs of Valves—R. E. Aitchison. [*Nature (London)*, vol. 174, p. 704; October 9, 1954.] Both static and dynamic characteristics of a pair of tubes are balanced by adjusting the heater voltages by means of a potentiometer of a few ohms resistance in series with the heater supply circuit.

621.375.3 983

Derivative Controlled Magnetic Amplifiers—A. D. Schnitzler. [*Elec. Eng., (N.Y.)*, vol. 73, p. 1021; November, 1954.] Summary of paper published in *Trans. AIEE*, Part I, *Communication and Electronics*, 1954. A two-stage circuit for a low level fast-response unit is described. The first stage acts as derivative amplifier, amplifying average increments of signal voltage per half cycle of power supply voltage. The second stage acts as integrator, amplifying and summing the output voltage of the first stage. If the negative feedback applied to the first stage is delayed, e.g., by a low-pass filter, the total time constant of a system incorporating the amplifier can be effectively reduced.

621.375.3 984

Magnetic Amplifiers with Inductive D.C. Load—H. F. Storm. [*Elec. Eng., (N.Y.)*, vol. 73, p. 1007; November, 1954.] Summary of paper published in *Trans. AIEE*, Part I, *Communication and Electronics*, 1954. The instability region in the control characteristic curve is discussed, and a method of avoiding operation in this region suggested.

621.375.3:621.316.7 985

Characteristics of Magnetic Amplifiers for Industrial Use—R. G. Beadle and B. P. Chausse. [*Elec. Eng., (N.Y.)*, vol. 73, pp. 1023-1027; November, 1954.] A specification for standard units suitable for regulator applications is drawn up. The relative importance of the advantages and disadvantages of magnetic amplifiers is considered in detail for (a) pre-amplifiers, (b) limited-range regulators, (c) motor field current regulators, (d) Ward-Leonard drives. Hf amplifiers have a faster response than other types but at extra expense and with added complication.

621.375.3.024 986

Pulse Relaxation Amplifier: a Low-Level D.C. Magnetic Amplifier—R. E. Morgan and J. B. McFerran. [*Trans. AIEE*, Part I, *Communication and Electronics*, vol. 73, pp. 245-249; 1954. *Elec. Eng., (N.Y.)*, vol. 73, pp. 909-913; October, 1954.] The principles of operation are explained. Linear amplification can be obtained for an input signal of 10^{-11} w in a 4-stage amplifier delivering an output of 10^{-6} w. Variation of the temperature between -70 degrees C. and $+140$ degrees C. and of the supply voltage by ± 30 per cent resulted in a maximum zero drift of less than 10^{-16} w over a two-week period. The gain varied by 10 per cent for a 10 per cent change of the supply frequency.

621.375.4:621.314.63 987

Diode Amplifier—(*Tech. News Bull. Nat. Bur. Stand.*, vol. 38, pp. 145-148; October, 1954.) Outline of the properties and applications of amplifiers based on the reverse transient phenomenon associated with the high degree of carrier storage in Ge and Si junction diodes. The frequency of the power supply must not be less than that of the modulating signal. Such amplifiers can be used as pulse repeaters, in flip-flop circuits, or as wide-band flat-response amplifiers. Faster operation can be obtained with Si than with Ge diodes.

GENERAL PHYSICS

53.081.4 988

A New System of Logarithmic Units—R. V. L. Hartley. (*Proc. I.R.E.*, vol. 43, pp. 97-98; January, 1955.) A general discussion of the subject treated by Green (81 of February).

534.2+538.566 989

Correlation of Amplitude and Phase Fluctuations in Wave Propagation in a Statistically Inhomogeneous Medium—L. A. Chernov. [*Compt. Rend. Acad. Sci. (URSS)*, vol. 98, pp. 953-956; October 21, 1954. In Russian.] The cases considered are (a) the correlation of fluctuations of amplitude and phase at a single receiving point and (b) the correlation of amplitude or phase fluctuations at different receiving points. In the case of large-sized inhomogeneities the correlation between the amplitude or phase fluctuations extends over a range of the same order as the correlation between the random inhomogeneities of the medium itself.

537.2 990

Surface Distributions of Fixed Charges and Poynting Vector in a System of Permanent Volume Currents—É. Durand. [*Compt. Rend. Acad. Sci. (Paris)*, vol. 239, pp. 1276-1278; November 15, 1954.] Theoretical study of conditions in a hollow cylindrical conductor.

537.226:537.529 991

Present State of Theory of Electric Breakdown in Solid Dielectrics—V. A. Chuenkov. (*Unspekhi fiz. Nauk*, vol. 54, pp. 185-230; October, 1954.) A survey. The theory of the first stage of dielectric breakdown, the loss of electric strength, can probably be given best in terms of a kinetic equation for electrons in a solid. The effective cross sections of ionization for low-energy electrons, the probability of scattering of medium-energy electrons by the vibrating lattice and the effective cross section of recombination must be determined. The theory of the second stage, the actual breakdown, has not, as yet, been given. It is suggested that the cause of the breakdown could be connected with processes leading to the production of a shock wave analogous to that occurring in the breakdown of gases at high pressures. 66 references include over 30 to Russian literature.

537.525 992

Mechanism of H.F. Discharge between Plane Plates—F. Schneider. (*Z. angew. Phys.*, vol. 6, pp. 456-462; October, 1954.) The problem is considered using the Schottky diffusion theory of the positive column with a term added to take account of the hf character of the discharge. Measurements show that the electron temperature is higher than in a dc discharge under similar conditions. A theory is proposed which explains the dependence of the running potential on frequency.

537.525:538.69 993

Effect of Secondary Electrons on Ignition of H. F. Discharges—F. Kossel and K. Krebs. (*Z. Phys.*, vol. 139, pp. 189-196; October 16, 1954.) Initiation of discharges between parallel electrodes in inert gases was investigated at pressures of 10^{-6} -1 Torr using a frequency of 1.27×10^9 cps and magnetic fields up to 900 G. Two effects due to a transverse magnetic field

were observed: (a) decrease of breakdown potential, and (b) suppression of a glow discharge. The former is due to the "cyclotron effect"; the maximum reduction of 54 per cent occurred at a field strength $H = 2\pi fm/e$ where f is the frequency of the electric field. The latter is shown to be due to prevention of the secondary-electron resonance effect observed in a longitudinal magnetic field and noted by Farnsworth in his work on the secondary-electron multiplier.

537.525:621.318.57.029.6 994

Effect of Moving Striations on Microwave Conductivity of a Coaxial Discharge—H. L. Steele, Jr., and P. J. Walsh. (*Jour. Appl. Phys.*, vol. 25, pp. 1435-1436; November, 1954.) Experiments were made with a discharge tube arranged so that part of the discharge path fills a gap along the inner conductor of a coaxial line. The results indicate a marked variation of the microwave conductivity as striations move past the gap. The effect may be strong enough to use for switching purposes.

537.533:537.534.8 995

Electron Emission from Metals under High-Energy Hydrogen Ion Bombardment—B. Aarset, R. W. Cloud and J. G. Trump. (*Jour. Appl. Phys.*, vol. 25, pp. 1365-1368; November, 1954.)

537.533.1:621.385.029.6+621.384.622.2 996

Method of Measurement of the Velocity of High-Energy Electrons—M. Papouar. [*Compt. Rend. Acad. Sci. (Paris)*, vol. 239, pp. 1194-1196; November 8, 1954.] Formulas relating the beam voltage to the oscillation frequency in carcinotrons and loaded-waveguide linear accelerators are used to determine the electron velocity; the only apparatus required is a wavemeter together with a small line. Velocities approaching that of light are treated; relativity effects are taken into account.

537.533.8 997

The Similarity Law of Secondary Emission—J. L. H. Jonker. (*Philips Res. Rep.*, vol. 9, pp. 391-402; October, 1954.) Measurements were made of the secondary-emission yield factor for a number of materials under carefully controlled conditions, particularly with respect to clean target surface. Results then agreed well with the experimentally obtained universal curve (2197 of 1952), a formula for which is also given.

537.533.8 998

Determination of the Proportion of Reflected Electrons in the Secondary-Electron Emission from Copper and Gold—F. Speer. (*Z. Phys.*, vol. 139, pp. 226-238; October 16, 1954.) An experimental determination is reported. The retarding-field method of Gobrecht and Speer (3581 of 1953) was used, with primary potentials of 200-3,000 v, and the secondary-electron yield was corrected for the space-charge effect. At a primary potential of 1,000 v and a retarding potential of 40 v, the percentages of reflected electrons in the total secondary-electron yield are 35 ± 5 per cent and 38 ± 4 per cent for Au and Cu, respectively; at 3,000 v the percentages are 47 ± 6 per cent and 43 ± 5 per cent respectively. The results are presented graphically and are tabulated.

537.56:538.6 999

Galvomagetic and Thermomagnetic Effects in a Plasma—A. A. Ware. (*Proc. Phys. Soc.*, vol. 67, pp. 869-880; October 1, 1954.)

537.582 1000

Experimental Determination of the Energy Distribution of Thermoelectron Beams—H. Boersch. (*Z. Phys.*, vol. 139, pp. 115-146; October 16, 1954.) An investigation using the Lenard retarding-field method is reported. This method gave results accurate to within 0.004 ev for electron energies in the range 20-60 kev. Results indicate that a Maxwell dis-

- tribution occurs only at low beam currents and densities. No direct dependence was found on cathode temperature, space charge at the cathode or control potential; a dependence was observed on current density and to a lesser degree on current intensity. Deviations from Maxwell's distribution could not be attributed to errors in calculation, collisions with the residual gas, spectrometer effect of the emitter, transverse resistances of cathode, or local anomalies of the work function; positive results were obtained by relating the electron energy distribution to longitudinal space-charge oscillations produced by the shot effect. Shifts of the energy distribution are due to changes in the work function and the development of a potential barrier near the cathode.
- 538.221** **1001**
Deduction of Magnetic Interaction in s - d -Exchange Model of Ferromagnetic Metal—E. A. Turov. [*Compt. Rend. Acad. Sci. (URSS)*, vol. 98, pp. 945-948; October 21, 1954.]
- 538.221:538.652** **1002**
Quantum Theory of Magnetostriction of Ferromagnetic Single Crystals—A. A. Gusev. [*Compt. Rend. Acad. Sci. (URSS)*, vol. 98, pp. 749-752; October 11, 1954. In Russian.] Theory is developed for crystals with hexagonal or cubic symmetry at low temperatures. Results indicate that magnetostriction is connected with the magnetic interaction of electrons, and also give the temperature dependence of magnetostriction constants in the case investigated.
- 538.313** **1003**
The Perfectly Conducting Ring subjected to High-Frequency Currents and Magnetic Fields—H. Buchholz. (*Arch. elekt. Übertragung*, vol. 8, pp. 427-435; October, 1954.) Detailed analysis of the interaction of current and field for a ring of circular cross section, (a) with current flowing in a conductor along its axis, (b) carrying a hf current induced by a field in the ring aperture and (c) in an alternating field due to a coaxial current ring. Explicit formulas are derived for the complex impedance of the ring in cases (a) and (b). Functions are tabulated for calculating energy losses in case (c).
- 538.56:530.145** **1004**
A Derivation of Maxwell's Equations for a Vacuum by means of an Energy-Quantum Model—H. Zuhrt. (*Arch. elekt. Übertragung*, vol. 8, pp. 447-456; October, 1954.) Propagation phenomena such as interference and diffraction can be explained by means of quantum theory if the energy quanta are assumed to have finite volume. The magnitude of this volume is estimated from consideration of the energy received by a dipole in a 300-mc field of strength 100 $\mu\text{v}/\text{m}$.
- 538.566** **1005**
Theory of the Trentini Absorption Grid—W. Franz. (*Z. angew. Phys.*, vol. 6, pp. 449-456; October, 1954.) Exact theory is developed for absorption of a normally incident em wave by a loaded grid placed near and parallel to a conducting surface. The case when a dielectric intermediate layer is present is also considered. See also 204 of 1950, and 3483 of 1953 (Trentini).
- 538.566:535.43** **1006**
Scattering from Dielectric-Coated Spheres in the Region of the First Resonance—H. Scharfman. (*Jour. Appl. Phys.*, vol. 25, pp. 1352-1356; November, 1954.) Calculations based on methods developed previously [e.g. 1259 of 1952 (Aden and Kerker)] indicate that a dielectric-coated conducting sphere can be made to have a greater scattering cross section than an uncoated conducting sphere of the same over-all diameter. This was confirmed experimentally using technique described by Scharfman and King (2310 of 1954). Results of calculations and measurements are shown graphically. A physical interpretation is presented.
- 538.566:537.533:621.372.8** **1007**
Electromagnetic Wave Propagation in Bounded Electron Beams—P. Parzen. (*Quart. Appl. Math.*, vol. 12, pp. 309-312; October, 1954.) Maxwell's equations in appropriate form are solved subject to boundary conditions chosen in accordance with a particular uniqueness theorem, which is proved. Modes of propagation in a waveguide completely filled with an electron beam are determined.
- 538.569.4** **1008**
A Simple High-Temperature Microwave Spectrograph—P. A. Tate and M. W. P. Strandberg. (*Rev. Sci. Instr.*, vol. 25, pp. 956-958; October, 1954.) Equipment for operation in the frequency range 600 degrees-1,000 degrees C. is described, based on the Stark modulation effect.
- 539.23:535.393** **1009**
Determination of Thickness and Optical Constants of "Thin" Films—C. v. Fragstein. (*Z. Phys.*, vol. 139, pp. 163-174; October 16, 1954.) Theory is given relating the thickness and optical constants of very thin (<70Å) metallic films deposited on glass to the reflected and transmitted light intensities. Wolter's theory (*Z. Phys.*, vol. 105, nos. 5/6, pp. 269-308; 1937) is discussed.
- 53.08** **1010**
The Physics of Experimental Method. [Book Review]—H. J. J. Braddick. Publishers: Chapman & Hall, London, Eng.; 1954, 404 pp., 35s. [*Nature (London)*, vol. 174, pp. 712-713; October 16, 1954.] The statistical interpretation and mathematical manipulation of experimental results and the natural limits of measurement are treated. Electrical measurements, electronic devices and vacuum techniques are among subjects selected for discussion; examples of appropriate instrument technology are included.
- GEOPHYSICAL AND EXTRATERRESTRIAL PHENOMENA**
- 523.16** **1011**
Radio Astronomy—J. A. Roberts. [*Research (London)*, vol. 7, pp. 388-399; October, 1954.] A survey of techniques and results.
- 523.16** **1012**
The Remnants of Supernovae as Radio Sources in the Galaxy—R. H. Brown. (*Observatory*, vol. 74, pp. 185-194; October, 1954.) A critical survey is presented of recent work on the sources of galactic radio emission at meter wavelengths. Observations indicate that remnants of supernovae may account for some of the sources and radio emission may be due to collisions of gas at high velocities. Results of flux density calculations at 100 mc are tabulated.
- 523.16** **1013**
Novae and Radio Noise—G. Larsson-Leander. (*Observatory*, vol. 74, pp. 219-220; October, 1954.) Calculations show that rf radiation generated when two nova shells are merging should be observable in the early stages.
- 523.16:523.72** **1014**
An Analysis of Bursts of Solar Radio Emission and their Association with Solar and Terrestrial Phenomena—R. D. Davies. (*Mon. Not. Roy. Astr. Soc.*, vol. 114, no. 1, pp. 74-92; 1954.) "Solar radio emission records on seven frequencies in the range 60 to 10,000 mc were studied over a period of 18 months. The analysis, which includes a number of histograms, shows that many of the properties of bursts change with frequency. A study of the time delay between bursts on different frequencies revealed that 3,000 mc bursts often occur first; a simultaneous up and down movement of ionized material from the level of zero refractive index at that frequency is postulated. It is found that bursts were more frequent than flares, fadeouts and crochets and that they
- almost always accompanied these effects. The commencement of bursts appears to be simultaneous with that of flares and crochets but precedes that of fadeouts by about two minutes. In addition, there is a rough correlation between the intensity of bursts, flares, fadeouts and crochets."
- 523.16:537.562:538.561** **1015**
Charge Segregation occurring with Streaming in Ionized Gases, and Cosmic R.F. Radiation—R. W. Larenz. (*Naturwiss.*, vol. 41, pp. 470-471; October, 1954.) A discussion of the extent to which space-charge fluctuations can occur in a plasma which is neutral as a whole. Formulas are derived for the ion and electron concentrations as functions of time and space for the quasi-stationary one-dimensional case. It is suggested that rf radiation is related to the oscillations excited with comparable amplitude by both ionic and electronic components of the plasma.
- 523.5:061.3** **1016**
A Symposium on Meteor Physics at Jodrell Bank—T. R. Kaiser. (*Observatory*, vol. 74, pp. 195-208; October, 1954.) Report of the symposium held in July, 1954, at which 38 papers were presented. These include several on radio-echo investigations, ionization and excitation, and one paper on a possible mechanism of production of galactic radiation.
- 523.5:621.396.96** **1017**
Theory of the Meteor Height Distribution obtained from Radio-Echo Observations: Part 1—Shower Meteors. Part 2—Sporadic Meteors—T. R. Kaiser. (*Mon. Not. Roy. Astr. Soc.*, vol. 114, no. 1, pp. 39-62; 1954.)
- 523.74/.75** **1018**
Distribution of Coronal Flares as a Function of Latitude during the Course of the Solar Cycle—M. Trellis. [*Compt. Rend. Acad. Sci. (Paris)*, vol. 239, pp. 1119-1121; November 3, 1954.] Distributions consistent with the commencement of the new sunspot cycle have been observed.
- 523.746** **1019**
Notes on the Sunspot Cycle—C. N. Anderson. (*Jour. Geophys. Res.*, vol. 59, pp. 455-461; December, 1954.) Analysis of a long series of sunspot cycles based on a 169-year period and illustrating the negligible gravitational effect of the planets.
- 550.3:517.512.2** **1020**
Practical Methods of Harmonic Analysis for Geophysical Problems—R. P. Kane. (*Proc. Indian Acad. Sci. A.*, vol. 39, pp. 117-126; March, 1954.) Use of Fourier series for resolving the diurnal variations of geophysical elements is discussed. Rapid methods of analysis based on 12-ordinate and 24-ordinate schemes are described.
- 550.384:523.78** **1021**
Magnetic Observations at Quetta during the Total Solar Eclipse of June 30—S. A. A. Kazmi. [*Nature (London)*, vol. 174, p. 706; October 9, 1954.]
- 550.385** **1022**
An Intuitive Description of the Chapman-Ferraro Theory of the Initial Phase of a Magnetic Storm—T. Nagata. (*Jour. Geophys. Res.*, vol. 59, pp. 467-470; December, 1954.) The main mathematical results of the theory are derived from a simple consideration of the dynamic characteristics of a stream of ionized particles in a magnetic field.
- 550.385** **1023**
Transients of Magnetographs and Instantaneous Values from Recordings—S. L. Malurkar. (*Proc. Nat. Inst. Sci. India*, vol. 20, pp. 567-569; September/October, 1954.)
- 551.510.41** **1024**
Relation between Atmospheric Ozone and Storms—A. Vassy. [*Compt. Rend. Acad. Sci.*

(Paris), vol. 239, pp. 1309-1311; November, 1954.] Comparison of records indicates that the ozone concentration increases during storm times; the increase occurs suddenly, on the average $3\frac{1}{2}$ hours before the first discharge.

551.510.5 1025
Measurement of Atmospheric Humidity up to 35 Kilometers—C. J. Brasefield. (*Jour. Met.*, vol. 11, pp. 412-416; October, 1954.)

551.510.5:523.5:621.396.96 1026
Scale Heights and Pressures in the Upper Atmosphere from Radio-Echo Observations of Meteors—S. Evans. (*Mon. Not. Roy. Astr. Soc.*, vol. 114, no. 1, pp. 63-73; 1954.) Methods are described for determining pressure and scale height in the altitude range 88-100 km, making use of theory developed by Kaiser (1017 above).

551.510.52:535.325 1027
Notes on the Atmospheric Refractive Index in Canada from Aircraft Meteorological Soundings—A. S. G. Grant. (*Trans. Amer. Geophys. Union*, vol. 35, pp. 508-510; June, 1954.) Values of the n refractive index calculated from soundings made in connection with a shoran survey are compared with standard values.

551.510.534 1028
The Latitudinal and Seasonal Variations of the Absorption of Solar Radiation by Ozone—J. Pressman. (*Jour. Geophys. Res.*, vol. 59, pp. 485-498; December, 1954.) Calculations indicate that the length of day and the solar altitude factor are sufficient to give the major features of the ozone solar absorption.

551.510.535 1029
Short-Period Variations in the Ionosphere—Y. Nakata. [*Jour. Radio Res. Labs (Japan)*, vol. 1, pp. 1-82; March, 1954.] A comprehensive review is presented of methods and results of ionospheric research. Short-period fluctuations are discussed in relation to theories of layer formation.

551.510.535 1030
Procedures used to improve the Quality of Ionospheric Data—S. C. Gladden. (*Trans. Amer. Geophys. Union*, vol. 35, pp. 398-404; June, 1954.) Data from 21 field stations are regularly dealt with by the Ionospheric Data Quality Control Group of the Upper Atmosphere Research Section at the C.R.P.L. An outline is given of the procedures used, with special reference to the detection of errors.

551.510.535 1031
Statistical Analysis of "150-km" Echo—D. D. Chaffee, Jr. (*Jour. Geophys. Res.*, vol. 59, pp. 549-550; December, 1954.) Further investigation of the 150-kc echo from above the normal nighttime E layer [724 of 1954 (Lindquist)]. An analysis of $h'f_i$ data for the period January, 1951 to July, 1953 indicates definite peaks in the percentage duration of these echoes at the equinoxes and a positive 27-day recurrence tendency. No definite correlation has been found with sunspot numbers, magnetic-storm data or E_s .

551.510.535 1032
Electron Densities in the Ionosphere—J. C. Seddon. (*Jour. Geophys. Res.*, vol. 59, pp. 463-466; December, 1954.) A fresh interpretation of data obtained from rocket measurements (403 of 1954), based on a breakdown in the independence of propagation of the magneto-ionic components of a cw signal transmitted from the rocket, gives an electron density curve in agreement with $P'f$ records.

551.510.535 1033
Continuous Electron Density Measurements up to 200 km—J. C. Seddon, A. D. Pickar and J. E. Jackson. (*Jour. Geophys. Res.*, vol. 59, pp. 513-524; December, 1954.) Electron distribution at altitudes from 84 to 200 km was determined accurately from measurements made during a rocket flight at 1,000 h MST on

May 7, 1954 (f_0F_2 4.8 mc). Using $P'f$ records, the electron density curve was extrapolated to the F_2 maximum (2.9×10^6 electrons/cm³ at 288 km). Density increased rapidly between 91 and 101 km. In the 170-200-km region densities were in general 5-10 per cent lower than the F_1 maximum (2.1×10^6 at 170 km). Slight gradient variations in the lower ionosphere are probably the major cause of large variations of F_2 -layer virtual height. Sporadic echoes are apparently due to partial reflections from high-gradient regions.

551.510.535 1034
Spread F over Washington—G. Reber. (*Jour. Geophys. Res.*, vol. 59, pp. 445-448; December, 1954.) Analysis of records for the period 1944-1953. Diurnal curves for seasons and years throughout this period are similar, with spread F occurring more frequently in winter than in summer and equinox values usually midway between those for summer and winter solstices. Sample data from six other stations show different characteristics; phenomena at Watheroo merit further study. See also 3213 of 1954.

551.510.535 1035
Atomic Nitrogen as a Constituent for Region F₁—A. P. Mitra. (*Indian Jour. Phys.*, vol. 28, pp. 269-284; June, 1954.) Three temperature/height models are considered, (a) the Nicolet-Mange model, (b) the possible upper limit of temperature/height gradient, and (c) an intermediate model. For these, particle concentration with height, the rate coefficient of reaction with height and the height and concentration of maximum ionization are critically discussed and computed. The level of maximum ionization produced by photo-ionization of atomic nitrogen lies between 150 and 200 km, depending on the model considered. The concentration of atomic nitrogen at the height at which diffusive separation takes place need not be assumed to be greater than $(1/10)n(N_2)$. Hence atomic nitrogen could contribute at least in part to the F_1 -layer ionization. The possibility of ionization of atomic oxygen at the third ionization potential is briefly discussed.

551.510.535 1036
A Consideration of the Electron Disappearance in the F₂ Layer of the Ionosphere—T. Yonezawa. [*Jour. Radio Res. Labs (Japan)*, vol. 1, pp. 1-62 and 4-111; March, 1954.] Factors influencing the electron concentration, and conventional theories of recombination and attachment are reviewed. Nocturnal diffusion can account for only a small variation of concentration, but its effect on the altitude of maximum concentration is not necessarily negligible. Statistical analysis indicates that the influence of pressure on the nocturnal variation of electron concentration is unexpectedly small, while that of temperature is large. Analysis of the monthly mean values indicates that attachment rather than recombination is the mechanism responsible for the electron disappearance. The influence of layer movements, though not large, is significant. Further evidence in favor of the attachment theory is obtained from consideration of f_0F_2 distribution and from a comparison of the nocturnal concentration variations at two sites. Theoretical considerations favor a process of electron removal in which collisions between atomic ions of oxygen and excited molecules of nitrogen produce molecular ions of nitrogen which in turn recombine with electrons.

551.510.535 1037
A Theoretical Investigation of the Ionospheric Electron Density Variation during a Solar Eclipse—O. E. H. Rydbeck and H. Wilhelmsson. (*Chalmers Tek. Höösk. Handl.*, no. 149, 22 pp; 1954.) The investigation reported previously by Rydbeck (3783 of 1945) is extended to the general case of $D \gg d$, where D is the apparent diameter of the moon and d that of the sun; a uniform distribution of radiation over the solar disk is assumed. Con-

venient formulas are derived for the minimum electron density and for the time of occurrence of the minimum. For a partial eclipse of magnitude M , an approximate expression is derived giving minimum electron density as a function of M with an error not greater than the experimental error of the average ionospheric sounding equipment.

551.510.535:551.594.21 1038
Thunderstorms and Sporadic-E Ionization of the Ionosphere—S. K. Mitra and M. R. Kundu. [*Nature (London)*, vol. 174, pp. 798-799; October 23, 1954.] A study was made of the increase of E_s ionization during severe squall-type storms which are a feature of the weather in Bengal in the premonsoon months March-May. The transmitter frequency was gradually increased as the squall approached, and the frequency fE_s at which the E_s echo disappeared was noted. The observations were repeated every four minutes. Results are shown graphically for two typical cases. Values of fE_s as high as 10 mc were observed, compared with the average no-storm value of 3.5-5 mc.

551.510.535:(98):621.396.11 1039
Geographic and Temporal Distribution of Polar Blackouts—V. Agy. (*Jour. Geophys. Res.*, vol. 59, pp. 499-512; December, 1954.) "Tabulations of hourly values of the ionospheric parameters for 18 northern-hemisphere stations have been used to derive diurnal variations in the occurrence of 'blackout' [no-echo] conditions. Contour plots are presented showing the diurnal average percentage of time during which blackout conditions prevailed, the amplitude of the diurnal variation, and the time of maximum frequency of occurrence. Changes in the contours with season and with magnetic activity are discussed."

551.510.535"1954":621.396.11 1040
Ionosphere Review, 1954—T. W. Bennington. (*Wireless World*, vol. 61, pp. 66-68; February, 1955.) Evidence indicates that the sunspot minimum had occurred before the end of 1954. The latest sunspot cycle exhibited the asymmetry characteristic of cycles with high maximum; the increasing phase lasted 39 months and the decreasing phase about 83 months. Smoothed sunspot-number and critical-frequency curves show close correlation. The increase of muf at sunspot maximum is greatest for winter day and least for winter night. Frequencies over 30 mc appear to have been usable for long-distance communication during four winters around the sunspot maximum.

551.594.2 1041
Upward Stepped Leaders from the Empire State Building—B. J. F. Schonland and D. J. Malan. (*Jour. Frank. Inst.*, vol. 258, pp. 271-275; October, 1954.) A new interpretation is presented of the observations reported by McEachron (971 of 1942).

551.594.21 1042
Observations on the Negatively-Charged Column in Thunderclouds—C. A. Hacking. (*Jour. Geophys. Res.*, vol. 59, pp. 449-453; December, 1954.)

551.594.5:621.396.11.029.55 1043
Doppler-Shifted Radio Echoes from Aurora—K. L. Bowles. (*Jour. Geophys. Res.*, vol. 59, pp. 553-555; December, 1954.) Note on the results of an experiment in which alternate pulsed and cw signals at 25.4 mc were transmitted northward from a 100-w transmitter. Signals recorded at a receiver 15 miles away with antenna beamed north showed a Doppler frequency shift upward or downward correlating respectively with homogeneous and rayed auroral forms. When a homogeneous arc breaks into a rayed structure both shifts may be recorded simultaneously.

551.594.6:621.396.11.029.45 1044
Very-Low-Frequency Noise Power from the Lightning Discharge—J. S. Barlow, G. W.

Frey, Jr, and J. B. Newman. (*Jour. Frank. Inst.*, vol. 258, pp. 187-203; September, 1954.) Present knowledge about the lightning-discharge mechanism is reviewed; particular attention is paid to the theory of Bruce and Golde (966 of 1942). Computed power spectra of (a) a nearby cloud-to-ground flash and (b) a distant daytime atmospheric are compared, taking propagation effects into account [232 of 1954 (Bowe)]. The results confirm the presence of a peak at about 10 kc in the spectra of the distant atmospherics. 46 references.

LOCATION AND AIDS TO NAVIGATION

621.396.932 1045
Problems of Direction-Finding on Ships at Frequencies in the Intermediate Band (1.5-3.5 Mc/s)—A. Troost. (*Telefunken Ztg.*, vol. 27, pp. 149-155; September, 1954.) Resonant structures aboard ship are sources of considerable error at these frequencies. The effects are considered in some detail. Mounting a small crossed-loop antenna as high as possible on the ship reduces errors considerably, but errors can be suppressed if the sources are located by measurements while the ship is in harbor.

621.396.933.1 1046
Radio Compass for Airlines—(*Elec. Jour.*, vol. 153, p. 1043; October 1, 1954.) Description of the automatic direction finder Type AD7092C, which includes tunable sense amplifiers to overcome intermodulation problems encountered in areas with numbers of broadcasting stations close together. Bearing accuracy is within ± 2 degrees. The weight of the equipment is 15.3 pounds.

621.396.96 1047
Radar Experiments in the Port of Hamburg—W. A. Krause. (*Telefunken Ztg.*, vol. 27, pp. 132-138; September, 1954.) Experiments were carried out using Type-31 3-cm Decca equipment to determine the required number and location of transmitters to provide a radar map of the port approaches on a 1:10,000 scale, and of the port itself on 1:5,000. One main and two subsidiary unattended stations should suffice in each case.

621.396.96:551.578.1 1048
C-Band Weather Radar—(*Electronic Eng.*, vol. 27, pp. 20-21; January, 1955.) An investigation made at McGill University [2951 of 1954 (Hitschfeld and Marshall)] led to the choice of the C band (5.5 cm), in preference to the X and S bands, for aircraft weather-radar equipment. Tests have been made by United Air Lines of an equipment designed to penetrate 60-mm/h rainfall to a depth of 15 miles; satisfactory results were obtained. PPI presentations corresponding to various phases of storms are reproduced.

621.396.96:621.396.6.002.2 1049
New Techniques for Fabrication of Airborne Electronic Equipment—R. K. F. Scal. (*Proc. I.R.E.*, vol. 43, pp. 4-11; January, 1955.) Developments of miniaturization techniques at the National Bureau of Standards have been reported previously [307 of 1951 (Henry et al.)]. An account is now given of the development of radar equipment, to have a life of 2,000 h and to operate at altitudes $>50,000$ feet and at temperatures between -65 degrees and $+55$ degrees C. The various units are easily removable, and include a mixer-duplexer incorporating a plug-in waveguide flange and socket. The internal connections are made by a three-dimensional arrangement of processed (e.g. printed) plates. A closed air-cooling system is provided. The total weight is 55 pounds. Some tests on the equipment are reported.

MATERIALS AND SUBSIDIARY TECHNIQUES

535.5 1050
The Electronic Clean-Up of Gases in Sealed-Off Vacuum Systems—R. N. Bloomer and M. E. Haine. (*Vacuum*, vol. 3, pp. 128-

135; April, 1953.) An experimental investigation is reported. Typical log-pressure/time clean-up curves show two linear portions; in portion A the pumping speed is a few $\text{cm}^3/\text{second}$ and is proportional to the ionizing electron current, in portion B pumping speed is independent of current above a few tens of microamperes, but the speed is only about a twentieth as great. The cleaned-up gas is held by the glass walls, particularly in the vicinity of the electrode structure.

533.5:531.738 1051
The Experimental Determination of the Speed of a Vacuum Pump and of Components of a Vacuum System—C. W. Oatley. (*Brit. Jour. Appl. Phys.*, vol. 5, pp. 358-362; October, 1954.) For pressure equilibrium in a vessel, the rate a at which air leaks in is equal to the speed b of the pump in series with the exhaust aperture. Keeping a constant and measuring pressure at various fixed exhaust aperture sizes, b can be simply determined by a graphical method. An ionization gauge was used in the experiment. The interchangeable aperture device is described.

533.58 1052
Production of Very High Vacua with the Aid of Getters—S. Wagener. (*Z. angew. Phys.*, vol. 6, pp. 433-442; October, 1954.) A summary is presented of experimental results in the production of vacua down to pressures of the order of 10^{-9} mm Hg. See also 3566 of 1954 and back references.

537.224:621.396.822 1053
Electrical Noise Pulses from Polarized Dielectrics—N. P. Baumann and G. G. Wiseman. (*Jour. Appl. Phys.*, vol. 25, pp. 1391-1394; November, 1954.) Measurements on carnauba-wax and polyvinyl-acetate electrets are reported; the noise-pulse rate was observed as the electrets were heated. The noise appears to be associated with the decay of volume polarization rather than with real surface charge. The total charge associated with the noise pulses from the carnauba-wax type is at least 5 per cent of the maximum electret charge.

537.226.2:539.13 1054
Influence of Molecular Shape on the Dielectric Constant of Polar Liquids—F. Buckley and A. A. Maryott. (*Jour. Res. Nat. Bur. Stand.*, vol. 53, pp. 229-244; October, 1954.)

537.227:[546.431.824-31+546.42.824-31] 1055
Ferroelectric Properties of Solid Solutions in the System Barium-Titanate/Strontium-Titanate—G. A. Smolenski and K. I. Rozgachev. (*Zh. Tekh. Fiz.*, vol. 24, pp. 1751-1760; October, 1954.) Results are reported of an experimental investigation on specimens containing up to 95 per cent molar of SrTiO_3 . The dielectric-constant/temperature characteristics of the specimens, determined at 1 kc and at 740 kc, exhibit a maximum whose value increases from about 7,500 for pure BaTiO_3 up to about 15,000 for a 60 per cent SrTiO_3 solution, decreasing again at higher concentrations of SrTiO_3 . The temperatures at which these maxima occur decrease from about 120 degrees C. for pure BaTiO_3 to about -200 degrees C. for 90 per cent SrTiO_3 . Spontaneous polarization is a minimum in 30-40 per cent SrTiO_3 solutions. Phase transitions, the effect of applying a constant electric field, and spontaneous electrostriction were also investigated. Results are presented graphically.

537.227:546.431.824-31:621.315.612.4 1056
Dielectric Bodies in Metal-Stannate Barium-Titanate Binary Systems—W. W. Coffeen. (*Jour. Amer. Ceram. Soc.*, vol. 37, pp. 480-489; October 1, 1954.) Ceramic and dielectric properties of bodies composed of BaTiO_3 plus the stannates of Mg, Pb, Bi, Zn, Ni, Cu, Cd, Co, Mn, and Fe, and of bodies in the system tin-oxide- BaTiO_3 , have been investigated. Results of measurements on 80 specimens are tabulated and presented graphically.

537.311.31:548.0.546.3-1 1057
Electronic Structure of Primary Solid Solutions in Metals—J. Friedel. (*Advances Phys.*, vol. 3, pp. 446-507; October, 1954.) A study of the structure of alloys in which an impurity element is present in quantities so small that its atoms are dispersed in the matrix of the main element and only weak interaction occurs. The main problem examined is the effect on the conduction electrons of a metal when a localized charge is introduced in an interstitial or substitutional position. Two different approximations corresponding respectively to the molecular and atomic orbitals are derived; the former is more useful for studying fast electrons and properties related to Fermi level while the latter may be better for computing energies of dissolution.

537.311.33 1058
New Semiconductors—R. W. Douglas and C. H. L. Goodman. (*G.E.C. Jour.*, vol. 21, pp. 215-220; October, 1954.) The qualities required of materials for use in crystal tubes are discussed. Materials with covalent-ionic type of bonding are capable of providing both the high charge-carrier mobility and the relatively high energy-gap value required. "Substitute diamond" type structures are the simplest having such bonding; ternary compounds of chalcopyrite structure and quaternary compounds of stannite structure are described.

537.311.33 1059
A General Asymptotic Solution of Reaction Equations Common in Solid-State Chemistry—G. Brouwer. (*Philips Res. Rep.*, vol. 9, pp. 366-376; October, 1954.) Simple approximate solutions are given of equations derived by Kröger et al. (*Z. Phys. Chem.*, vol. 203, p. 1; 1954.) for the incorporation of vacancies into a semiconductor.

537.311.33 1060
Electronic Equilibrium of Illuminated Semiconductors—G. Wlérick. (*Jour. Phys. Radium*, vol. 15, pp. 667-676; October, 1954.) The effect of illumination is explained by introducing two quasi-Fermi levels, for the free electrons and holes respectively; the forbidden band is effectively narrowed by an amount equal to the difference between these levels. Three modes of action of the illumination are considered: (a) ionization of impurity centers; (b) production of band-to-band transitions; (c) combination of (a) and (b). Various possible transition processes from temperature-controlled to illumination-controlled equilibrium are discussed. For specimens containing a large number of impurity centers only feebly ionized when not illuminated, the photoconductive properties may be the same for both (a) and (b) types of action.

537.311.33 1061
Method of determining the Parameters of a Semiconductor—F. G. Bass and I. M. Tsidil'kovski. (*Zh. Tekh. Fiz.*, vol. 24, pp. 1834-1836; October, 1954.) A method is discussed for determining the carrier mobility u and the parameter n , defined by the equation $l = l_0(T)^n$ where l is the mean free path of the carrier and is a function of temperature T , and v is the carrier velocity. Formulas are given for the Hall effect, the longitudinal and transverse Nernst-Ettinghausen effects and two new longitudinal-transverse galvanomagnetic and thermomagnetic effects, in terms of functions of n and of (uH/c) , where H is the applied magnetic field and c is the velocity of light. The new effects occur when the direction of a magnetic field applied in the XZ plane makes an angle $\theta = \pi/2$ with the current flowing along the X axis; the electric field produced is in the direction of the Z axis and is independent of the sign of H . An experimental check, which is not described, gave values of u and n obtained from measurements of the Hall effect and of the new effects in agreement with previously published results.

- 537.311.33 1062
The Photomagnetolectric Effect in Semiconductors under Sinusoidal Conditions. Application to the Measurement of Minority-Carrier Lifetime—J. Grosvalet. (*Ann. Radioélect.*, vol. 9, pp. 360–365; October, 1954.) Considering a thick specimen illuminated by a sinusoidally modulated light source, the expression $\tan 2\phi = \omega\tau$ is derived relating the minority-carrier lifetime τ to the phase angle ϕ between the two voltages due to photoconductive and photomagnetolectric effects. Using a measurement method based on that described by Aigrain (139 of February) with modulation frequencies of 0.1, 0.3, 1.5 and 3 kc, this expression is applied to determine τ in the range 1 ms–10 μ s. Correction curves are given for measurements on samples <5 mm thick.
- 537.311.33 1063
Theory of Internal Field Emission in Cubic Crystals—J. Homilius and W. Franz. (*Z. Naturf.*, vol. 9a, pp. 205–210; March, 1954.) Conditions for field-emission breakdown in face-centered and in space-centered crystals are derived, using theory related to that of McAfee et al. (164 of 1952). The directional variation of breakdown field strength is at least 20 per cent. The formulas are used to examine the particular conditions for PbS, PbTe, Si and Ge.
- 537.311.33:536.21 1064
Correlation of Thermal Conductivity of Semiconductors with Electron Mobility—A. V. Ioffe and A. F. Ioffe. (*Zh. Tekh. Fiz.*, vol. 24, pp. 1910–1911; October, 1954.) Comment on 2968 of 1954 (Goldsmid). A table is given of corrected calculated values of thermal conductivities of C, Si, Ge, PbS, and Te, and of the mean free paths of phonons and electrons, together with experimental results.
- 537.311.33:536.21 1065
Effect of Admixtures on Thermal Conductivity of Semiconductors—A. V. Ioffe and A. F. Ioffe. [*Compt. Rend. Acad. Sci. (URSS)*, vol. 98, pp. 757–759; October 11, 1954. In Russian.] The expression for thermal conductivity derived by means of the kinetic theory is modified to take account of the greater number of collisions and the shorter mean free path of phonons when admixtures are present in the lattice. Calculations of the thermal conductivity in the case of various amounts of PbSe admixture in PbTe, Sb in Ge, and Si in Ge, give results in good agreement with experiment.
- 537.311.33:538.66 1066
Change of Thermal Conductivity of Semiconductors in Magnetic Field—Kh. I. Amirkhanov, A. Z. Daibov and V. P. Zhuze. [*Compt. Rend. Acad. Sci. (URSS)*, vol. 98, pp. 557–560; October 1, 1954. In Russian.] The transverse Righi-Leduc effect was investigated experimentally. No change of thermal conductivity was observed in Te, MoS₂, Bi₂Te₃ and PbTe in transverse magnetic fields up to 11,000 oersted, indicating that the Righi-Leduc effect amounted to less than 0.2 per cent; the thermal resistivity of Bi and HgSe increased with field strength. The results agree with theory.
- 537.311.33:546.28 1067
On the Production of Pure Silicon—K. Ono and T. Matsushima. (*Sci. Rep. Res. Inst. Tohoku Univ.*, Ser. A, vol. 6, pp. 477–496; October, 1954.) Investigations on the production of pure Si by the reduction of SiCl₄ with Zn are described.
- 537.311.33:546.28 1068
Diffusion of Boron and Phosphorus into Silicon—C. S. Fuller and J. A. Ditzenberger. (*Jour. Appl. Phys.*, vol. 25, pp. 1439–1440; November, 1954.) Methods of producing large-area *p-n* junctions by diffusing B or P into Si are briefly described.
- 537.311.33:[546.289+546.681] 1069
Germanium and Gallium and their Applications—A. R. Powell. [*Nature (London)*, vol. 174, pp. 627–629; October 2, 1954.] Report of papers presented at the British Association meeting in September, 1954, describing the occurrence of Ge and Ga in British minerals and their extraction from flue dust, problems in the analysis of the raw materials and finished products, and scientific and industrial applications of Ge.
- 537.311.33:546.289 1070
The Transistor: Part 3—Material Aspects: the Production of Transistor Grade Germanium—E. A. Speight and J. I. Carasso. (*P.O. Elec. Engrs. Jour.*, vol. 47, part 3, pp. 166–169; October, 1954.) Part 2: 296 of February (Roberts). An error in part 2 is noted.
- 537.311.33:546.3–1.46.86:539.23 1071
Investigation of Films of Variable Composition in the System Mg-Sb—I. V. Mochan. [*Compt. Rend. Acad. Sci. (URSS)*, vol. 98, pp. 579–582; October 1, 1954. In Russian.] An experimental investigation is reported of the dependence of electrical conductivity of Mg-Sb films on the Sb content. The conductivity drops sharply by a factor of several powers of ten at a concentration of Sb which varies from about 97 per cent Sb in vacuo to about 80 per cent Sb after six days exposure to air. The photoeffect cut-off at about 0.8 μ indicates that the changes are probably due to an increase of the Mg₃Sb₂ component in the film after exposure to air, and not to oxidation.
- 537.311.33:[546.48.241.1+546.682.241.1] 1072
Experimental Evidence of the Semiconductor Nature of the Compounds CdTe and In₂Te₃—J. Appel. (*Z. Naturf.*, vol. 9a, pp. 265–267; March, 1954.) Measurements were made of the conductivity of polycrystalline specimens over the range from room temperature to 900 degrees K for In₂Te₃ and to 1,100 degrees K for CdTe. Practical details are given of the preparation of the specimens and of the test set-up. Results are shown graphically; several activation levels are distinguished and their significance discussed.
- 537.311.33:546.682.86 1073
Optical and Photo-Electrical Properties of Indium Antimonide—D. G. Avery, D. W. Goodwin, W. D. Lawson and T. S. Moss. (*Proc. Phys. Soc.*, vol. 67, pp. 761–767; October 1, 1954.) "Measurements have been made of the refractive index and absorption index of InSb by reflection methods with polarized radiation. Extensive studies of absorption constant have been made by direct transmission measurements. Both photovoltaic and photoconductive effects have been observed in InSb. At room temperature the photosensitivity extends to approximately 7.5 μ , a considerably longer wavelength than for any other known material."
- 537.311.33:546.682.86 1074
The Interpretation of the Properties of Indium Antimonide—T. S. Moss. (*Proc. Phys. Soc.*, vol. 67, pp. 775–782; October 1, 1954.) Results of measurements by Avery et al. (1073 above) are analyzed and precise values are determined for the position and temperature dependence of the optical absorption edge. The variation of the position of the absorption edge with impurity concentration is explained by the very low effective mass of the conduction electrons, which is estimated by three methods to be about 0.03 of the free electron mass.
- 537.311.33:546.811–17 1075
Formation of Compact Pieces of Grey Tin—L. J. Groen. [*Nature (London)*, vol. 174, p. 836; October 30, 1954.] Experiments are reported which indicate that the presence of mercury encourages the transformation of ordinary tin into grey tin. Pieces measuring several centimeters in length and 0.5 cm in thickness have been obtained.
- 537.311.33:546.811–17 1076
Germanium-Stabilized Gray Tin—A. W. Ewald. (*Jour. Appl. Phys.*, vol. 25, pp. 1436–1437; November, 1954.) Experiments indicate that grey tin containing 0.75 per cent Ge does not appreciably revert to the metallic state unless the temperature is above 60 degrees C.
- 538.221 1077
The ΔE -Effect, Young's Modulus, and Magnetic Properties in Ferromagnetic Nickel-Copper Alloys—M. Yamamoto. (*Sci. Rep. Res. Inst. Tohoku Univ.*, Ser. A, vol. 6, pp. 446–457; October, 1954.) Measurements made at ordinary temperatures on alloys containing up to about 35 per cent Cu are reported, using magnetostrictive-oscillation and ballistic methods.
- 538.221 1078
On a New Anomaly in the Alloys of Nickel and Cobalt: Part 2—The Cause for the Effect of Magnetic Anneal—H. Masumoto, H. Saito and T. Shioya. (*Sci. Rep. Res. Inst. Tohoku Univ.*, Ser. A, vol. 6, pp. 462–468; October, 1954.) Results of experiments indicate that the magnetic annealing effect produced by treating the specimen in a comparatively weak field, and manifested in the rectangular hysteresis curve, is more marked in wire specimens than in ring specimens. The effect is observed over the temperature range between the magnetic transformation point and about 400 degrees, being most marked at about 650 degrees for an alloy containing 65 per cent Co. From measurements of magnetization at high temperatures with the specimens treated in various ways, it is concluded that the effect may be connected with plastic flow due to magnetostriction.
- 538.221:669.14.018.583 1079
Improvement of Magnetic Characteristics of Transformer Iron by means of Electrochemical Processing—S. Ya. Grilikhes. (*Zh. Tekh. Fiz.*, vol. 24, pp. 1786–1787; October, 1954.) Improvements obtained are (a) a 10–15 per cent increase of the permeability and (b) a 10 per cent decrease in hysteresis losses.
- 539.234:546.121.3:548.7 1080
Structure of Thin Films of Alkali Halides evaporated on to Single-Crystal Substrata—H. Lüdemann. (*Z. Naturf.*, vol. 9a, pp. 252–259; March, 1954.)
- 546.86:548.7 1081
Structure of Amorphous Antimony—H. Richter, H. Berkheimer and G. Breiting. (*Z. Naturf.*, vol. 9a, pp. 236–252; March, 1954.)
- 621.315.612.4:546.431.824–31 1082
Properties and Applications of Dielectrics containing Barium Titanate—H. Lennartz. (*Funk u. Ton*, vol. 8, pp. 537–548; October, 1954.) The physical properties and engineering applications in capacitors, transducers, dielectric amplifiers and modulators are surveyed. 45 references.
- 621.315.612.6 1083
Pressed and Sintered Glass Powder Shapes—W. H. McKnight. (*Materials and Methods*, vol. 40, pp. 94–96; October, 1954.) Cold-working technique is described for forming intricately shaped glass parts from powdered material. The sintered material is opaque and has essentially the same electrical properties as the original glass. An advantage as regards use for electrode mounts in evacuated tubes is the absence of trapped gas bubbles.
- 621.315.616 1084
Some Data on Recently Developed Insulating Materials—H. Nigg. (*Bull. schweiz. elektrotech. Ver.*, vol. 45, pp. 923–928; October 30, 1954. In French.) Properties of silicone rubbers, solid and cellular polyethylene, teflon and hostafion are reported briefly.
- 621.315.616 1085
Properties of Plasticizers and their Relation to Electrical Compounding—J. J. Morris and

W. J. Canavan. [*Elec. Eng. (N.Y.)*, vol. 73, pp. 1018-1020; November, 1954.]

621.318.2:621.317.7 1086
High-Coercive-Force Permanent-Magnet Materials and their Application—T. O. Paine and L. I. Mendelsohn. [*Elec. Eng. (N.Y.)*, vol. 73, pp. 891-895; October, 1954.] A brief review of materials and their application in moving-coil instruments is given. 18 references.

666.1.037.5:546.821+546.831 1087
The Glass-Sealing Properties of Titanium and Zirconium—H. Rawson and E. P. Denton. (*Brit. Jour. Appl. Phys.*, vol. 5, pp. 352-353; October, 1954.) "Titanium and zirconium may be sealed to standard sealing glasses without the need for any special sealing techniques, to give strong vacuum-tight seals with low stresses in the glass. If a flame-sealing method is used it is necessary to keep the sealing time as brief as possible, since the expansion characteristics of both metals change appreciably on prolonged heating in air."

MATHEMATICS

517.942.9 1088
The Meaning of the Vector Laplacian—H. K. Farr, P. Moon and D. E. Spencer. (*Jour. Frank. Inst.*, vol. 258, pp. 213-216; September, 1954.) Comment on 1844 of 1954 and authors' reply.

518.61 1089
A String-Net Analog for the Numerical Solution of the Equations of Laplace and Poisson—P. L. Tea. (*Jour. Frank. Inst.*, vol. 258, pp. 287-303; October, 1954.) The string-net surface for a given problem is the same as that obtained by the relaxation method, but is determined more easily.

519.2 1090
The Statistics of Scaled Random Events—R. O. Davies and J. W. Leech. (*Proc. Camb. Phil. Soc.*, vol. 50, part 4, pp. 575-580; October, 1954.) "When independent random events are scaled down by a factor n , the number of counts in a given time interval no longer obeys the Poisson Law. The correct distribution function is derived together with its moment-generating function and explicit formulas ($n=2, 4$) for the first four moments about the mean. The theory is in agreement with experiments carried out with a scale-of-four counter. A more general treatment is given and is applied to find the variance for all even values of n ."

517 1091
Les Fonctions Orthogonales dans les Problèmes aux Limites de la Physique Mathématique. [Book Review]—T. Vogel. Publishers: Editions du Centre National de la Recherche Scientifique, Paris, France; 1953, 192 pp., 1200 fr. [*Nature (London)*, vol. 174, p. 668; October 9, 1954.] Chapters of this monograph are devoted to (a) general properties of orthogonal functions and differential systems including perturbed systems, (b) particular closed series, e.g. Fourier, and (c) applications to particular problems including those involving the wave equation with boundary conditions.

MEASUREMENTS AND TEST GEAR

621.314.7.001.4 1092
Testing Point-Contact Transistors for Pulse Applications—R. L. Wooley. [*Elec. Eng. (N.Y.)*, vol. 73, pp. 981-987; November, 1954.] A set of dc, static and dynamic parameters is chosen that suffices to define transistor switching action in each of the three operating regions [652 of 1953 (Anderson)]. Dc measurements include (a) reverse emitter and collector resistance, (b) reverse collector current, (c) base resistance, (d) saturation collector voltage and (e) dc gain. Static measurements of the V_E/I_E and V_C/I_C characteristics with I_C and I_E as the respective parameters are required. Dynamic measurements include (a) current-gain/emitter-current characteristic, (b) frequency response, either as a current-gain/fre-

quency characteristic or by a pulse method. Measurement methods are specified and necessary precautions are noted. A table of typical measurement results and specifications is also given.

621.317.1:519.282 1093
Instrumental Drift—W. J. Youden. (*Science*, vol. 120, pp. 627-631; October 22, 1954.) A scheme of measurement is described by means of which the errors due to the drift of the measuring instrument can be determined by statistical analysis of the observed readings. References to more detailed discussions of analysis and design of experiments are given.

621.317.3:621.396.722 1094
Banbury Radio Measuring Station—P. N. Parker and G. Gregory. (*P.O. Elec. Eng. Jour.*, vol. 47, part 3, pp. 143-147; October, 1954.) Account of the equipment and work of this Post Office station, whose main function is to collect information on reception conditions in relation to the international planning of radio services.

621.317.3.029.6:[621.372.2+621.372.87] 1095
The Multiple-Short-Circuit Plunger Technique for the Determination of the Transformation Properties of Lossless $2n$ -Terminal Networks between Homogeneous Transmission Lines—H. Lueg. (*Arch. elekt. Übertragung*, vol. 8, pp. 457-466 and 513-522; October and November, 1954.) The method described by Weissfloch (2850 of 1954) and applied to six-terminal waveguide junctions (322 of March) is extended to $2n$ -terminal junctions, for which case it is possible, when the initial positions of the $n-1$ short circuits are suitably chosen, to adjust them simultaneously so that the voltage node on the input line moves according to a prescribed curve. Input impedance can be determined directly for any given terminating impedance. The conditions under which the method is applicable are defined in terms of the number of discontinuities passed through in moving the $n/1$ short-circuits over a distance $\lambda/2$ towards the junction. A detailed description is given of the method applied for a lossless eight-terminal junction. For junctions of higher order Stein's reduction method (1673 of 1954) can be applied in conjunction with the double and triple short-circuit techniques described.

621.317.335.3 1096
Errors Occurring in the Measurement of Dielectric Constant—R. F. Field. (*ASTM Bull.*, no. 201, p. 30; October, 1954.) Discussion of the accuracies attainable using the guard-electrode, micrometer-electrode or wire-connector methods to eliminate errors due to the finite extent of the specimen.

621.317.335.3.029.64 1097
Quick Method of Calculation of Complex Dielectric Constant at Centimetre Wavelengths (Method using Rod Samples)—S. Le Montagner, J. Le Bot, S. Chauvin and R. Haye. [*Compt. Rend. Acad. Sci. (Paris)* vol. 239, pp. 1474-1476; November 29, 1954.] Nomograms are discussed for use with the method of measurement described previously (2067 of 1953).

621.317.337+621.317.411]:621.3.042.12 1098
Measurement of Quality Factors of Inductor Cores—C. Stewart. [*Elec. Eng. (N.Y.)*, vol. 73, p. 1017; November, 1954.] Summary of paper published in *Trans. AIEE*, Part I, *Communication and Electronics*, 1954. If two coils having negligible winding capacitance are wound on a ring-shaped core the permeability and Q can be determined from mutual-impedance measurements. The materials considered have low loss and are used at low flux densities. A new bridge circuit not including inductors was designed to avoid the limitations of standard bridge circuits.

621.317.341 1099
The Measurement of Speech Level—J. N. Shearme and D. L. Richards. (*P.O. Elec. Eng.*

Jour., vol. 47, part 3, pp. 159-161; October, 1954.) Measurement difficulties due to the fragmentary nature of speech in telephone conversations are discussed. An instrument for laboratory use which eliminates observer errors has a "pointer-function" circuit replacing the usual moving-coil meter and giving an output which is the electrical counterpart of the meter deflection. This output is connected to a potential divider having 12 outputs at 1-db intervals, each of these being connected to a pulse trigger.

621.317.352:621.372.8 1100
Experimental Study of Circular Waveguides using the TE₀₁ Mode in the Vicinity of 25000 Mc/s—G. Comte and J. M. Paris. (*Câbles & Trans.*, vol. 8, pp. 311-324; October, 1954.) Continuation of 1068 of 1953 (Comte and Ponthus). Descriptions are given of test equipment and of attenuation measurements on short sections (a) for varying guide diameter, and (b) for various treatments of the internal surface. Resonance measurements on medium-length straight and curved guides were also made. Results were in satisfactory agreement with theory; in particular Jouguet's formula (948 of 1949) was verified. Electrolytic polishing gives results in best accord with theory.

621.317.4 1101
A New Electrodynamic Method of measuring Magnetic Fields—S. K. D. Roy. (*Indian Jour. Phys.*, vol. 28, pp. 183-190; April, 1954.) The method is based on measuring the maximum couple exerted on a small current-carrying coil suspended in the field.

621.317.7:621.372.5.012 1102
An Electronic Nyquist Diagram Plotter—J. L. Douce. (*Electronic Eng.*, vol. 27, pp. 32-34; January, 1955.) A unit incorporating 16 pentodes and 15 diodes is described, by means of which the gain of a network is found from a pair of voltages representing respectively the in-phase and out-of-phase components. A cro display is provided. A frequency range from about 1 cps to about 10 kc can be covered.

621.317.7.085.4.089.6 1103
The Calibration of Circular Scales and Precision Polygons—A. H. Cook. (*Brit. Jour. Appl. Phys.*, vol. 5, pp. 367-371; October, 1954.)

621.317.725:621.314.67 1104
Shunt-Diode Rectifier in Voltage Measurement—M. G. Scroggie. (*Wireless Eng.*, vol. 32, pp. 53-60; February, 1955.) Analysis indicates that the reduction of rectification efficiency due to series source resistance is the same for the simple shunt-diode arrangement as for the series-diode arrangement. This is supported by experimental evidence. The effect of the source resistance is reduced by augmenting the diode resistance. The effect of including RC filters is also discussed.

621.317.725.089.6 1105
Determination of the D.C./A.C. Transfer Error of an Electrostatic Voltmeter—W. E. Smith and W. K. Clothier. (*Proc. IEE*, Part II, vol. 101, pp. 465-469; October, 1954.)

621.317.729 1106
Equipotential Plotting Table—E. B. Dahlin. (*Rev. Sci. Instr.*, vol. 25, pp. 951-953; October, 1954.) Description of equipment using the electrolytic properties of ordinary paper with painted-on graphite electrodes to which a direct voltage of 1 kv is applied. Using an electrode spacing of about 30 cm, a desired equipotential line can be located accurately to within 0.1 mm.

621.317.733 1107
The Bridged-T Element as a Measurement Bridge—W. Herzog. (*Arch. elekt. Übertragung*, vol. 8, pp. 436-438; October, 1954.) Basic theory of the system is given and methods of measuring inductance and of determining the effective capacitance of a resistor are outlined. Advantages of the circuit are (a) input and

output may be directly earthed; (b) wide range of adjustment, e.g. in measuring inductance $L \propto 1/C^3$ where C is the capacitance in each of the T -network arms.

621.317.733 1108
Workshop RC Bridge—D. T. Gilling. (*Wireless World*, vol. 61, pp. 80–82; February, 1955.) Details are given of an instrument incorporating a 1-kc source, a bridge indicator comprising two-tube amplifier and meter, and a leakage indicator for testing electrolytic capacitors.

621.317.733:621.385.032.216 1109
A Bridge for the Measurement of Cathode Impedance—R. M. Matheson and L. S. Nergaard. (*RCA Rev.*, vol. 15, pp. 485–505; December, 1954.) Details are given of a simple bridge in which the impedance of an unknown diode is compared with that of a standard diode, on the basis of an equivalent diode circuit comprising emf in series with parallel R and C in the cathode lead. Results obtained over a considerable period of use are discussed. The method does not distinguish between the impedance of the oxide coating and that of the interface

621.317.733.029.64:621.317.335 1110
Microwave Interferometer—S. K. Chatterjee, C. Rama Bai and P. R. Shenoy. (*Jour. Indian Inst. Sci.*, section B, vol. 36, pp. 172–192; October, 1954.) Description of the design and operation of a two-beam interferometer for studying the properties of dielectrics at $\lambda = 3.2$ cm. The instrument is essentially a bridge, one arm consisting of a free-space path into which the sample is inserted. Microwave power from a klystron, modulated with a 1-kc square wave, is projected on to the sample from a horn, and the transmitted power is received by a second horn and combined in a hybrid junction with a fraction of the input transmitted by waveguide. A crystal detector records the energy minima and maxima as the receiving horn is displaced along its axis. Results of measurements on some solid insulating materials are reported. Diffraction effects are discussed in relation to sample size.

621.317.755:621.383.2 1111
Photoelectric Comparator for Measuring Oscillograms—H. B. Phillips. (*Rev. Sci. Instr.*, vol. 25, 971–976; October, 1954.) The center line of a waveform photographed from a cro trace is located accurately and rapidly by means of a balancing arrangement involving an optical beam splitter and two photocells.

621.317.755.029.6 1112
New System for Feeding a Pulse Oscillograph—I. S. Stekol'nikov, A. Ya. Inkov and A. M. Chernushenko. [*Compt. Rend. Acad. Sci. (URSS)*, vol. 98, pp. 969–972; October, 1954. In Russian.] A hv power-supply circuit for a high-speed cathode-ray oscilloscope is described. Square pulses of amplitude ~ 7 kv are produced in an LC ladder network by means of a "trigatron" tube. The pulse voltage is stepped up to ~ 40 kv by a bifilar autotransformer, the two windings of which also serve as leads for the heater supply. The cathode voltage is thus kept at -40 kv for about $1 \mu s$, less negative voltages for the anodes being provided by use of a potential divider between cathode and earth. Traces obtained with 150-mc and 3-kmc signals are shown. In the latter case the writing speed is about 340,000 km.

621.317.761.029.3 1113
An Audio-Frequency Meter—P. G. M. Dawe and J. A. Deutsch. (*Electronic Eng.*, vol. 27, pp. 2–6; January, 1955.) The instrument described was designed for investigating frequency variations of the human voice, and produces a direct voltage proportional to input frequency. A square wave of input frequency is used to fix the voltage attained by a pair of capacitors, the operating principle being similar to that used by Barker and Connor (221 of 1954) and Andrew and Roberts (817 of April).

The output actuates a pen recorder. Frequency ranges of 90–180 and 180–360 cps are covered.

621.373:621.387 1114
A Low-Frequency Pulse-Train Generator—J. E. Flood and J. B. Warman. (*Electronic Eng.*, vol. 27, pp. 13–16; January, 1955.) The pulse generator uses multi-cathode gas-filled counter tubes to produce pulses whose make-to-break ratio can be adjusted between 1:99 and 99:1 in steps of one per cent with an accuracy within one part per thousand. The pulse repetition frequency covers the range 5 to 50 cps with an accuracy determined entirely by the external oscillator used to drive the pulse generator. The pulses can be sent continuously or in trains of from 1 to 11 pulses.

621.397.62.001.4 1115
Measurements on Television Receivers: Part 6—Measurements of Linearity, Sensitivity and Selectivity in the Video and Sound Channels—O. Macek. (*Arch. Tech. Messen.*, no. 225, pp. 235–238; October, 1954.) Part 5: 567 of March.

53.08 1116
The Physics of Experimental Method. [Book Review]—Braddick. (See 1010.)

OTHER APPLICATIONS OF RADIO AND ELECTRONICS

550.837 1117
Direct Electromagnetic Effect of Alternating Radiators in Homogeneous Ground—A. Belluigi. (*Ann. Geofis.*, vol. 7, pp. 415–440; July, 1954.) Theory relevant to geophysical prospecting is developed. It is deduced that at very low frequencies the field strength must be increased and the propagation velocity of the em waves must be reduced to the order of magnitude of the velocity of seismic waves.

620.179:534.321.9 1118
Ultrasonic Thickness Gauging on Ships' Plates—(*Elec. Jour.*, vol. 153, pp. 1281–1283; October 22, 1954.) Description of Dawes Type 1101 portable gauge for measuring wall thickness where only one side is accessible. It incorporates a computing mechanism, so that once the calibrating ring has been set to the velocity of sound in the material under test, the wall thickness is read off directly.

621.316.7 1119
Sampled-Data Processing for Feedback Control—A. R. Bergen and J. R. Ragazzini. [*Elec. Eng. (N.Y.)*, vol. 73, p. 980; November, 1954.] Summary of paper published in *Trans. AIEE*, Part II, *Applications and Industry*, 1954.

621.317.39.029.6:621.372.413 1120
A Method of using Microwaves for measuring Small Displacements, and a Torque-Meter using this Principle—N. C. de V. Enslin. (*Proc. IEE*, Part II, vol. 101, pp. 522–528; October, 1954. Discussion, pp. 535–540.) Methods based on the relation between the resonance frequency and the dimensions of a cavity are described.

621.384.611 1121
Orbital Periods in the Microtron—H. F. Kaiser. (*Rev. Sci. Instr.*, vol. 25, pp. 1025–1026; October, 1954.)

621.384.612:621.373.4 1122
The Radio-Frequency System of the Birmingham Proton Synchrotron—L. U. Hibbard. (*Jour. Sci. Instr.*, vol. 31, pp. 363–371; October, 1954.) In this system the frequency is varied from 330 kc to 9.3 mc in 1 second by means of a servo-controlled beat-frequency oscillator, and is made to track the rising magnetic field with an error not greater than ± 0.1 per cent at the beginning and ± 1 per cent at the end of a cycle. The rf potential applied to the cees is 240 v rms.

621.384.62 1123
Recent Developments in Van de Graaff

Generators—W. D. Allen. (*Instrum. Practice*, vol. 8, pp. 872–879; October, 1954.) Problems involved in the vacuum-tube development are considered; ion sources, stabilization and beam ducting are also discussed.

621.384.622.1 1124
Simple Theoretical Model for studying the Motion of Ions in a Linear Accelerator—M. Y. Bernard. (*Jour. Phys. Radium*, vol. 15, pp. 121A–132A; October, 1954.)

621.384.622.2:621.372.8 1125
Experimental Study of Waveguide with [internal] Helix for Linear Proton Accelerator: Shunt Impedance—Septier. (See 928.)

621.384.622.2:621.372.8 1126
Experimental Study of Waveguide with [internal] Helix for Linear Accelerator for Heavy Particles: Phase Velocity—Septier. (See 927.)

621.385.833 1127
Some Types of Electrostatic Immersion Objective with High Magnification—A. Septier. (*Ann. Radioélect.*, vol. 9, pp. 374–410; October, 1954.) Detailed experimental and theoretical study of design and operating conditions.

621.385.833 1128
Distortion in Electron Lens—M. L. De and D. K. Saha. (*Indian Jour. Phys.*, vol. 28, pp. 263–268; June, 1954.) A modification of Hiller's method (3381 of 1946) of measuring the amount of distortion in different zones of the image field at low magnifications is explained. Distortion is plotted against radial distance from the optic axis. The magnification was also measured, and the coefficient of distortion computed graphically.

621.387.424 1129
Behaviour of Geiger-Müller Counters with External Graphiting when dealing with High Counts—D. Blanc. (*Jour. Phys. Radium*, vol. 15, pp. 693–694; October, 1954.)

621.387.424 1130
Production of Oscillations in Halogen-Quenched G.M. Counters—D. H. Le Croissette. (*Rev. Sci. Instr.*, vol. 25, p. 1023; October, 1954.)

621.396.9:621.315.232 1131
Apparatus for locating Buried Cables and identifying Individual Cables in Common Ducts—K. Buchmann. (*Bull. schweiz. elektrotech. Ver.*, vol. 45, pp. 838–841; October 2, 1954.) The em field of a 300–1,000-cps signal applied between the core of the cable to be identified and earth is detected by means of a search coil followed by a simple If amplifier. A 50-ma current in the cable can be detected at distances up to 5–10 m, and the position of the cable can be determined by taking bearings at several points as in hf direction finding.

77:537.22 1132
"Electrofax" Direct Electrophotographic Printing on Paper—C. J. Young and H. G. Greig. (*RCA Rev.*, vol. 15, pp. 469–484; December, 1954.) Electrofax paper is ordinary paper with a thin coating of ZnO in a resin binder. It is sensitized by placing a negative es charge on the coating in the dark, e.g. by ion transfer from a corona discharge. On exposure, the charge is lost in the exposed areas and retained in the masked area. The image is developed by applying a pigmented resin powder carrying a positive charge. The process can be used to make enlargements. Spectral response of the paper and details of the various steps in the procedure are discussed.

621.387.464:535.37 1133
Scintillation Counters. [Book Review]—J. B. Birks. Publishers: Pergamon Press, London, Eng.; 1953, 148 pp., 21s. [*Nature (London)*, vol. 174, p. 810; October 30, 1954.] The book gives a summary of recent work and

a picture of the present state of technique. The longest single chapter is devoted to organic crystalline phosphors.

PROPAGATION OF WAVES

538.566 1134

On Linearly Polarized Electromagnetic Waves of Arbitrary Form—A. Nisbet and E. Wolf. (*Proc. Camb. Phil. Soc.*, vol. 50, part 4, pp. 614-622; October, 1954.) "Two simple laws connecting the amplitude and phase functions of a monochromatic electromagnetic wave of arbitrary form are derived, holding in the case when one of the field vectors is linearly polarized. The first is a generalized Fermat's principle which enables determination of the phase when the amplitude is known; the second expresses the propagation of the (vector) amplitude along the curves orthogonal to the cophasal surfaces. Some other general properties of linearly polarized fields are also discussed, and illustrative examples are given."

538.566:538.63:537.56 1135

Deduction of Appleton's Ionospheric Double-Refraction Formula from the Non-Maxwellian Magneto-ionic Theory. Conditions and Range of Validity—R. Jancel and T. Kahan. (*Jour. Phys. Radium*, vol. 15, pp. 696-697; October, 1954.) The double-refraction formula is deduced from theory presented previously (3196 of 1954 and back references.)

621.396.11 1136

Radio Scattering in the Troposphere—W. E. Gordon. (*Proc. I.R.E.*, vol. 43, pp. 23-28; January, 1955.) Theory presented previously [1757 of 1950 (Booker and Gordon)] is modified in the light of subsequent observations of turbulence in the troposphere, as indicated by fluctuations of refractive index, and is applied to the investigation of radio fading problems. Required spacing of diversity receivers is deduced from the scattering volume. An upper limit is found for the size of an antenna to be able to yield its full theoretical gain in the presence of scattering. An estimate is made of the frequency bandwidth over which radio signals will be correlated at a single receiving site well beyond the radio horizon.

621.396.11 1137

Observation of Scatter Echoes on High-Power Pulsed Transmissions—S. N. Mitra and V. C. Iyengar. (*Indian Jour. Phys.*, vol. 28, pp. 147-166; April, 1954.) Report of observations made at Delhi during November, 1950 and May-June, 1951, mainly at 21.7 mc, using a 100-kw pulsed directional transmitter. Six types of scatter pattern are distinguished, a graph showing the relation of each type to total path and angle of incidence. Statistical analysis of observations shows that the most frequently occurring scatter pattern involved propagation via the E layer and scattering at the ground. Night and day ranges differed by about 100 km. Using directional antennas, the main ground scatter source was located in the mountainous area of the N. W. Frontier province.

621.396.11 1138

Oblique-Incidence Pulse Transmission—J. W. Cox and K. Davies. (*Wireless Eng.*, vol. 32, pp. 35-41; February, 1955.) A report is given of observations of transmissions over the 2,360-km path between Ottawa and Saskatoon, made during the summer of 1949. Each station was provided with a transmitter and receiver continuously and independently variable over the frequency range 2-25 mc. 10-kw pulses of 50- μ s duration were transmitted at the rate of 25 per second. In the first set of experiments the two transmitters kept on the same frequency, changing once per minute by 100-kc steps. In the second set of experiments, one transmitter while the other was varied. Records obtained during quiet and during disturbed conditions are reproduced, showing N-type echoes, scatter propagation at frequencies

about the muf and spread echoes. No departures from reciprocal conditions were observed. Millington's oblique-incidence theory was verified by converting vertical-incidence $h'f$ records to equivalent oblique-incidence records and comparing these with observations. The Sellmeyer dispersion formula was found to be more accurate than the Lorentz formula for calculating muf.

621.396.11:551.510.535 1139

A Reciprocity Theorem on the Propagation of Radio Waves via the Ionosphere—K. G. Budden. (*Proc. Camb. Phil. Soc.*, vol. 50, part 4, pp. 604-613; October, 1954.) It is proved that, for a horizontally stratified ionosphere and for a transmission path in the magnetic meridian, the reciprocity theorem for electrical systems applies (a) when the transmitting and receiving antennas both radiate or receive waves whose electric vector is in the plane of incidence, and (b) when both antennas radiate or receive waves whose electric vector is horizontal. If the electric vector radiated or received is horizontal for one antenna and in the plane of incidence for the other, then there is reciprocity in signal amplitude, but the phase changes for transmission in the two directions differ by 180 degrees. These results are valid for any law of variation of electron density and collision frequency with height. They are based on a "full-wave" theory, and therefore apply to all frequencies. They are unaffected if the path includes multiple reflexions, and if allowance is made for the curvature of the earth.

621.396.11.029.45:551.594.6 1140

Very-Low Frequency Noise Power from the Lightning Discharge—Barlow, Frey, and Newman. (*See* 1044.)

621.396.11.029.55 1141

Observed Diurnal Variations in Frequencies and Signal Qualities between New York and Central Europe—J. H. Nelson. (*RCA Rev.*, vol. 15, pp. 602-606; December, 1954.) Data on the highest and lowest frequencies received at New York during the badly disturbed month of November, 1953 are shown in charts for five different times during the day, the optimum working frequency predicted by the C.R.P.L. being shown for comparison. Consideration of these charts and corresponding ones covering a period of four years indicates that during ionospheric storms the optimum frequencies tend to be below predicted values, while during ionosphere calm periods the optimum frequencies tend to be above predicted values. For satisfactory operation, the communication engineer needs four staggered frequencies for each day, with additional frequencies to take account of yearly and eleven-yearly ionosphere variations.

621.396.11.029.55:551.594.5 1142

Doppler-Shifted Radio Echoes from Auroras—Bowles. (*See* 1043.)

621.396.812.3:621.317.087 1143

Peak Amplitude Recorder for Investigation on Fading—S. C. Mazumder and S. N. Mitra. (*Indian Jour. Phys.*, vol. 28, pp. 251-255; June, 1954.) The recorder includes a conventional gating circuit, so that any particular echo in the pulse echo train can be selected, and its amplitude recorded. Circuit diagrams are given, and operation is discussed.

RECEPTION

621.396.62+621.397.62:061.4 1144

26th Swiss Radio and Television Exhibition [August 1954]—(*Bull. schweiz. elektrotech. Ver.*, vol. 45, p. 862; October 2, 1954.) A brief account is given of the main trends noted in domestic radio and television receiver design.

621.396.62:621.396.822 1145

Spectral Response of a Quadratic Device to Non-Gaussian Noise—T. A. Magness. (*Jour. Appl. Phys.*, vol. 25, pp. 1357-1365; November,

1954.) A method of computation based on a fourth-order moment P of the input noise is discussed, P being a function of three independent time delays. The difference between the value of P for a non-Gaussian noise and that for a Gaussian noise with the same frequency range is expressed as a function P_1 whose Fourier transform, Q_1 , a function of three frequencies, is capable of interpretation in terms of nonlinear correlations between noise components at different frequencies. A specialization of Q_1 leads to E , a function of two frequencies, which is a measure of the correlation between the squares of the envelopes associated with those frequencies. "Several networks involving quadratic nonlinear elements are examined to illustrate the theory. It is shown that while the function P makes it possible to compute the complete spectral response of the network, the function E (together with the spectrum of the input) is sufficient in order to find the spectral density at zero frequency. Finally, for three examples of non-Gaussian processes, the corresponding P_1 , Q_1 and E functions are computed."

621.396.82:621.376.3 1146

Frequency-Modulation Interference Rejection with Narrow-Band Limiters—E. J. Baghdady. (*Proc. I.R.E.*, vol. 43, pp. 51-61; January, 1955.) A theoretical investigation is made of the minimum values of limiter and discriminator bandwidth required in a FM receiver to enable the weaker of two incoming signals to be suppressed. The values found are considerably lower than those given by Arguimbau and Granlund (734 of 1950). The possibility is discussed of reducing the discriminator bandwidth requirement to that of the IF stage by cascading bandpass filters.

621.396.823+621.397.823 1147

Ignition Interference at Frequencies below 100 Mc/s: the Mechanism of its Production—Newell. (*See* 1187.)

621.396.828:[621.396.44:621.315.052.63 1148

Radio Transmission on 230- and 400-kV Lines—B. G. Rathman, S. Parding and C. A. Enstrom. [*Trans. AIEE*, Part III, *Power Apparatus and Systems*, vol. 73, pp. 1037-1040; August, 1954. *Digest, Elec. Eng. (N.Y.)*, vol. 73, p. 1022; November, 1954.] Radio interference from lv lines in Sweden was suppressed by transmitting programs directly over the interfering lines. A graph shows signal-level/distance for a transmitter output power of 2×125 w and a frequency of 182 kc. A formula is given for computing the output power required to keep the signal level at least 35 db above the interference level over any required distance.

STATIONS AND COMMUNICATION SYSTEMS

621.376.5 1149

Spectra of Modulated Pulse Trains—A. Sabbatini. (*Alla Frequenza*, vol. 23, pp. 255-277; October, 1954.) Analysis is presented first for trains of unmodulated pulses; the spectrum consists of one of more Fourier series. It is not possible to make an accurate determination of the spectrum of the modulated pulses directly from that of the unmodulated pulses by considering the modulation to be applied to the individual components. The spectrum resulting from modulation by a single sinusoidal signal comprises a double infinite series of lines; the frequency band is not widened, but the lines are more closely spaced, with corresponding reduction of intensity.

621.39.001.11 1150

Coding to achieve Markov Type Redundancy—J. E. Flanagan. (*Jour. Math. Phys.*, vol. 33, pp. 258-268; October, 1954.)

621.39.001.11:519.272.1 1151

On the Concept of an Instantaneous Power Spectrum, and its Relationship to the Autocorrelation Function—C. H. M. Turner. (*Jour.*

Appl. Phys., vol. 25, pp. 1347-1351; November, 1954.) The expression derived by Page (2326 of 1952) to represent instantaneous power spectra is compared with other possible representations obtained by assuming different observers starting their observations at different times; the results differ by complementary functions. A "running autocorrelation function" is defined; Page's instantaneous power spectrum is equal to the Fourier transform of the time rate of change of this function.

621.395.44 1152

48-Channel-Current Network for Denmark—J. D. Christensen and A. Hillestrøm. [*Tele-teknik (Copenhagen)*, vol. 5, pp. 283-341; October, 1954.]

621.396:621.372.5 1153

Radio-Frequency Phase-Difference Networks: a New Approach to Polyphase Selectivity—G. B. Madella. (Proc. I.R.E., vol. 43, pp. 102-103; January, 1955.) Comment on 1910 of 1954 (Cifuentes and Villard).

621.396.1 1154

International Frequency Allocations and their Effects on Industry—J. M. Dobbyn. (Proc. IRE, Australia, vol. 15, pp. 276-284; November, 1954.) "Following a brief review of the history of international radio conferences, the important factors governing the allocation of channels by the Provisional Frequency Board, the Extraordinary Administrative Radio Conference of 1951 and Region 3 are discussed. The effects of the required frequency changes on the radio industry are examined."

621.396.43:621.396.65 1155

Radio Beam Links with Large Transmission Capacity—W. Klein. (*Tech. Mitt. schweiz. Telegr.-Teleph Verw.*, vol. 32, pp. 381-397; October 1, 1954. In German.) The recognition on the one hand of a physical limit for the beam concentration, and on the other hand of an economic limit for the size of the antenna, leads to a choice of wavelength giving a best compromise under ideal propagation conditions. In practice the choice is influenced also by fading conditions and by the power of the available tubes. The influence of the ground and of the troposphere on propagation is discussed qualitatively. Various transmission systems are compared, including pcm systems; network planning considerations are closely similar for them all.

621.396.44:621.315.052.63:621.396.828 1156

Radio Transmission on 230- and 400-kV Lines—Rathsman, Parding and Enstrom. (See 1148.)

621.396.63 1157

Automatic Alarm Device for CONELRAD Radio Alerting—R. B. Carey. [*Elec. Eng. (N.Y.)*, vol. 73, pp. 963-965; November, 1954.] A device for use in conjunction with a broadcast receiver. A part of the receiver IF voltage is rectified and used as positive bias to overcome a fixed negative bias on a pentode tube. Any interruption of the signal, whether due to an alert or to a failure in the alarm or receiver circuit, results in an alarm indication.

621.396.722:621.317.3 1158

Banbury Radio Measuring Station—Parker and Gregory. (See 1094.)

621.396.931 1159

Technical Planning of a Swiss Mobile Telephone Network—E. Wey. (*Tech. Mitt. schweiz. Telegr.-Teleph Verw.*, vol. 32, pp. 398-405; October 1, 1954. In French and German.) Experimentally determined field-strength distributions of transmitters at Chasseral and Säntis are used as basis for planning the system. The calling method, the ultimate capacity of the system, and the design of suitable super-regenerative receivers are discussed.

621.396.932 1160

U.S.W. Radio for Pilotage, Harbour and

Coastal Services—Mailandt. (*Telefunken Ztg.*, vol. 27, pp. 138-144; September, 1954.) Radio communication facilities and equipment provided for pilots are discussed in general terms from the user's point of view. Duplex operation is preferred.

SUBSIDIARY APPARATUS

621-526 1161

An Equalizing Network for Carrier-Type Feedback Control Systems—C. H. Looney. (Proc. I.R.E., vol. 43, pp. 20-22; January, 1955.) "The analysis of an active, high (ω), RLC circuit shows that it permits lag compensation of carrier-type feedback control systems through direct operation on the system actuating signal. The use of this circuit in an instrument type velocity servo reduces the steady state error by a factor of at least 30."

621-526 1162

The Minimum-Moment-of-Error-Squared Criterion: a New Performance Criterion for Servo Mechanisms—J. H. Westcott. (Proc. IEE, Part II, vol. 101, pp. 471-480; October, 1954. Discussion, pp. 488-492.)

621-526 1163

The Behaviour of a Remote-Position-Control Servo Mechanism with Hard-Spring Non-Linear Characteristics—J. C. West and P. N. Nikiforuk. (Proc. IEE, Part II, vol. 101, pp. 481-488; October, 1954. Discussion, pp. 488-492.)

621.311.6:537.311.33:[539.16+535.215 1164

Radioactive and Photoelectric p - n Junction Power Sources—W. G. Pfann and W. van Roosbroeck. (*Jour. Appl. Phys.*, vol. 25, pp. 1422-1434; November, 1954.) "An electrical power source can be made by exposing a p - n junction to radioactivity or light, so that the junction field separates electron-hole pairs produced by the radiation. Expressions for maximum power, optimum load resistance, and efficiency are derived from an equivalent circuit and rectification theory. Power and efficiency increase with source current I_0 of separated charges and zero-bias junction resistance. I_0 increases with energy and intensity of radiation, but is limited by self-absorption in the radioactive isotopes. Estimates of attainable power and efficiency for silicon cells are 3.10^{-3} watt cm^{-2} and 15 per cent for solar radiation, averaged, allowing for night, weather, and varying angle of incidence; and 3.10^{-4} watt cm^{-2} and 8 per cent, for beta radiation from Sr^{90} - Y^{90} of activity 32 Curie/g. However, lattice defects produced by Sr^{90} - Y^{90} beta radiation impair cell performance by increasing electron-hole recombination. A theoretical estimate of threshold energy for radiation damage in silicon is about 0.3 MeV, about half the experimental value reported for germanium. Avoiding radiation damage by annealing, by absorbers, and by use of less energetic isotopes is discussed. The Y^{90} beta spectrum is given; it is used in estimating damage rates in germanium, which are high, and efficiencies obtainable with absorbers, which are low. Theory and experiment are compared for Sr^{90} - Y^{90} cells of silicon and of germanium."

621.311.6:621.373.42 1165

An R.F. Source of Heater Power for Low-Level Audio-Frequency Amplifiers—L. Medina. (Proc. IRE, Australia, vol. 15, pp. 251-252; October, 1954.) Details are given of a simple and compact oscillator having a rated output of 6.3 v 0.45 a at 400 kc.

621.311.6:621.373.52 1166

A New Self-Excited Square-Wave Transistor Power Oscillator—Uchirin and Taylor. (See 974.)

621.311.6:621.383.5]:621.396.61:621.314.7 1167

Transmission by Sun Power Achieved—(Short Wave Mag., vol. 12, pp. 442-446; October, 1954.) Successful communication at

160-m μ over a distance of about 32 miles using a Se-photocell-powered transistor-transmitter is reported. The power unit, consisting of 16 photocells illuminated by sunlight, is described.

621.311.6:621.387 1168

Stabilized D.C. Supplies using Grid-Controlled Rectifiers—L. Knight. (*Electronic Eng.*, vol. 27, pp. 16-19; January, 1955.) Circuits using "magnitude-controlled" thyratrons are discussed; these are suitable for hv power supplies where the load is reasonably constant and the output voltage regulation is not required to be better than within about 1 per cent. A unit incorporating two Type-2D21 miniature thyratrons can supply 200 v at 150 ma.

621.314.67:621.387 1169

Wide-Range Operation of Grid-Controlled Rectifiers—D. H. McEwan. (*Electronic Eng.*, vol. 27, pp. 24-27; January, 1955.) "A method of controlling thyatron conduction over a wide range from a d.c. control signal is described and the steady-state characteristics of a d.c. power amplifier employing this method of control in a biphaser rectifier circuit are discussed and experimental results given."

621.316.722.1 1170

An Alternating-Voltage Stabilizer—D. J. R. Martin. (*Electronic Eng.*, vol. 27, pp. 35-37; January, 1955.) A unit designed to give an output of 240 v, varying by <0.2 per cent for line-voltage changes of $\pm 12\frac{1}{2}$ per cent, frequency changes of ± 4 per cent and load variations from 50 to 150 w, includes provision for correction of form factor by simultaneously stabilizing the rectified-mean and rms voltages.

621-526 1171

A Textbook of Servomechanisms. [Book Review]—J. C. West. Publishers: English Universities Press, 238 pp., 25 s. (*P.O. Elec. Eng. Jour.*, vol. 47, part 3, p. 158; October, 1954.)

TELEVISION AND PHOTOTELEGRAPHY

621.397.24:621.315.212 1172

Experimental Television Transmission over the Coaxial Cable between Amsterdam and Haarlem—L. F. Dert. (*Commun. News*, vol. 15, pp. 27-30; August, 1954.) Report of trials carried out during November, 1952, using British-made cable Type LC20 with teflothe dielectric, both cable and associated equipment having been designed originally for carrier-current telephony. The 5-mc bandwidth of the 625-line signals had to be reduced to fit the available channel; a carrier frequency of 1 mc was used with a main sideband of width 3.2 mc and a vestigial sideband of width 0.5 mc. A double modulation process was used. The received signal passed through two delay equalizers. Pictures of good quality were obtained.

621.397.241:621.397.6 1173

"Piped" Scanning Waveforms—E. J. Gargini. (*Wireless World*, vol. 61, pp. 83-87; February, 1955.) Account of a wired television distribution system in which receiver design is simplified by transferring as much circuitry as possible to the transmitter. Two rf carriers are transmitted, together with sound signals at speech-coil level. A 5.42-mc wave carries the picture information, and a 1-mc wave carries the scanning signals. Frame-scan and line-scan waveforms are respectively derived by passing the demodulated scanning signals through a low-pass and a high-pass filter. A circuit diagram is given of a 3-tube ac/dc receiver and a block diagram of the waveform generator at the transmitter. Under fault conditions and at the end of a program transmission a dc potential is transmitted to take all receivers out of circuit. Power levels are discussed in relation to field-test results.

621.397.26:621.396.65 1174

The Milan-Turin Television Radio Link—F. Vecchiacchi. (*Ricerca Sci.*, vol. 24, pp. 1978-

2007; October, 1954.) This two-way link operates in the 900-mc band with two different carrier frequencies. Horn antennas with parabolic reflectors give a gain >28 db. There is full visibility along each of the sections Turin/Trivero/Milan/Venice; the section lengths are 75, 87 and 77.5 km respectively. FM is used, with unity modulation index. The signal is repeated at the intermediate stations using simple frequency conversion with amplification at about 70 mc.

621.397.5:535.623 1175
Observer Adaptation Requirements in Color Photography and Color Television—R. M. Evans and W. L. Brewer. (*Jour. Soc. Mot. Pic. Tel. Eng.*, vol. 63, pp. 5-9; July, 1954. Discussion, p. 9.)

621.397.5:535.623 1176
Color Balance for Television—D. L. MacAdam. (PROC. I.R.E., vol. 43, pp. 11-14; January, 1955.) Consideration is given to problems introduced by the requirement that color rendering in the television picture should be independent of the type of illumination used at the transmitter and at the receiver. It is recommended that illumination having a color temperature of 4,000 degrees K should be used when testing the color balance of television receivers.

621.397.5:535.623 1177
Comment on "N.T.S.C. Signal Specifications for Color Television"—W. L. Brewer and J. H. Ladd. (PROC. I.R.E., vol. 43, p. 100; January, 1955.) Comment on 3369 of 1954 (Fink).

621.397.6 1178
Television Standards Conversion—H. A. Fairhurst. (*Wireless World*, vol. 61, pp. 53-54; February, 1955.) A brief sketch is given of a theoretically possible direct conversion method in which signal trains corresponding to selected picture lines at higher definition are stretched to the duration of the lower-definition lines. This is performed by feeding the signals to delay lines with capacity sufficient to hold the whole train, and switching the characteristics of the delay line so that the signal train emerges stretched. One possible way of producing a suitable delay line is to wind it on a closed ferrite core which can be saturated magnetically by means of an auxiliary winding.

621.397.6:621.372.552 1179
Cable Equalization for Television Studio Circuits—R. C. Kennedy. (*RCA Rev.*, vol. 15, pp. 581-601; December, 1954.) Design theory and application procedures are presented for both fixed and variable equalizers.

621.397.611.2 1180
The Performance of Television Transmitting Tubes with Stored Charges—D. D. Aksenov. (*Zh. Tekh. Fiz.*, vol. 24, pp. 1788-1797; October, 1954.) The mechanisms of processes occurring in stored-charge camera tubes, in particular the iconoscope, are discussed in relation to sensitivity limits and distortion of light values in the transmitted image.

621.397.62 1181
Practical Aspects of Multichannel and Multistandard Television Receivers—L. Chrétien and R. Aschen. (*TSF et TV*, vol. 30, pp. 314-319; October, 1954.) Synchronization problems and their solution are reviewed.

621.397.62 1182
Receiver for Three Standards—M. Venquier. (*Télévision*, no. 47, pp. 251-255; October, 1954.) Modernized version of an earlier design of 625-line-standard receiver (*Télévision*, no. 21, p. 45; February, 1952) for receiving Lille and the two Brussels transmissions. Design features are outlined and a circuit diagram is given with component values, coil data and operating voltages.

621.397.62+621.396.62]:061.4 1183
26th Swiss Radio and Television Exhibition [August, 1954]—(*Bull. Schweiz. elektrotech. Ver.*, vol. 45, p. 862; October 2, 1954.) A brief account is given of the main trends noted in domestic radio and television receiver design.

621.397.62.001.4 1184
Measurements on Television Receivers: Part 6—Measurements of Linearity, Sensitivity and Selectivity in the Video and Sound Channels—O. Macek. (*Arch. Tech. Messen*, no. 225, pp. 235-238; October, 1954.) Part 5: 567 of March.

621.397.7 1185
Monte Carlo Television Station—C. B. Bovill. (*Wireless World*, vol. 61, pp. 55; February, 1955.) Antennas of bat-wing type provide a main radiation lobe with a horizontal width of about 45 degrees covering the main Riviera; use is made of very small secondary lobes to cover some nearby towns. The effective radiated power on the vision frequency of 199.7 mc is 50 kw. The 819-line standard is used, the bandwidth being >10 mc. Modulation signals are conveyed over the two-mile path between studio and transmitter by a duplicated radio link operating at 4c mλ.

621.397.7:621.395.65 1186
The Use of Telephone Selector Switches on Television Circuits—H. D. M. Ellis and J. C. Taylor. (*BBC Quart.*, vol. 9, pp. 185-192; Autumn, 1954.) An account is given of equipment used at the BBC Lime Grove studios.

621.397.823+621.396.823 1187
Ignition Interference at Frequencies below 100 Mc/s: the Mechanism of its Production—G. F. Newell. (*BBC Quart.*, vol. 9, pp. 175-184; Autumn, 1954.) Results of measurements were in good agreement with the interference field strength spectrum calculated on the assumption that the ignition system acts as a loop antenna in free space carrying a uniform current. Screening of the ignition system was neglected. At all frequencies the radiated interference is proportional to the area enclosed by the ignition leads and the engine-block surface and to the voltage required to break down the sparking-plug and distributor gaps. At frequencies below 20 mc it is proportional to the capacitance across the secondary winding of the ignition coil; above 30 mc it is inversely proportional to the inductance of the ignition leads. The reduction of interference by use of the conventional resistor suppressors was also measured. Results are presented graphically.

TRANSMISSION

621.396.61.029.55:621.376.2:621.3.018.78 1188
Use of Negative Feedback in Independent-Sideband and Double-Sideband Transmitters—E. Oger. (*Ann. Radióelect.*, vol. 9, pp. 329-341; October, 1954.) An analysis of the basic causes of distortion and crosstalk in dsb and independent-sideband transmitters illustrates the importance of avoiding amplitude distortion particularly in the latter case. A negative-feedback arrangement used in 2-kw and 20-kw transmitters is described in which the waveforms at the transmitter output and the final-frequency-changer input are compared, after detection, to derive a correction voltage. The design of a phase-correction network for operation in the range 3.75-28 mc is discussed. Results of measurements on a transmitter with this feedback arrangement show an intermodulation ratio below -40 db up to a peak power of 20 kw for independent-sideband operation, and distortion level below -36 db for A3 operation at 86 per cent modulation.

TUBES AND THERMIONICS

621.314.63 1189
Surface Leakage Current in Rectifiers—M. Cutler and H. M. Bath. (*Jour. Appl. Phys.*, vol. 25, pp. 1440-1441; November, 1954.)

Theory based on a simple model is developed; the results obtained are supported by experimental observations on several semiconductor types of rectifier.

621.314.63 1190
The Variation of the Forward Characteristics of Junction Diodes with Temperature—J. S. Schaffner and R. F. Shea. (PROC. I.R.E., vol. 43, p. 101; January, 1955.) A typical value for the temperature variation of the forward voltage of a junction diode at constant current is -2mv degrees C.

621.314.63:546.289 1191
Reverse Saturation Current in One Type of $p-n$ -Junction Rectifier—J. Laplume. (*Compt. Rend. Acad. Sci. (Paris)*, vol. 239, pp. 1126-1128; November 3, 1954.) The type of rectifier considered is that described by Hall (834 of 1953), having donor and acceptor regions fused to opposite faces of a Ge disk. Analysis is presented to show that the contribution of surface recombination to the reverse saturation current is predominant if $2sr > R$, where s is the surface recombination velocity, τ the volume lifetime and R the radius of the disk.

621.314.7 1192
Effect of Base-Contact Overlap and Parasitic Capacities on Small-Signal Parameters of Junction Transistors—R. L. Pritchard. (PROC. I.R.E., vol. 43, pp. 38-40; January, 1955.) "In a grown-junction transistor in which the base connection consists of an alloy contact, overlap on emitter and/or collector regions may produce appreciable capacity between emitter-base and collector-base terminals. The effect of such overlap capacity upon measured small-signal parameters at high frequencies is described briefly for both grounded-base and grounded-emitter operation."

621.314.7 1193
Study of $P-N-P$ Alloy Junction Transistor from D.C. through Medium Frequencies—L. J. Giacoletto. (*RCA Rev.*, vol. 15, pp. 506-562; December, 1954.) The theoretical development of design equations for alloy-junction transistors is considered. Grown-junction-transistor theory [379 of 1950 (Shockley) and 3177 of 1951 (Shockley et al.)] is found to be applicable as long as the current density does not exceed a certain value. Base-lead resistance and collector shunt conductance are discussed. Measurements are reported on a transistor of the type described by Law et al. (876 of 1953); the results are in reasonably good agreement with those obtained from the theory.

621.314.7:537.311.33 1194
The Influence of Surface Recombination on the Current Gain of the Junction Transistor—J. Laplume. (*Compt. Rend. Acad. Sci. (Paris)*, vol. 239, pp. 1274-1276; November 15, 1954.) Analysis similar to that previously presented for a junction diode (1191 above) is developed for the transistor, assuming a model with a disk base of radius R , surface recombination velocity s , and volume lifetime τ . Formulas are derived from diffusion considerations for emitter and collector current and hence for the gain. The results indicate that surface recombination is again predominant when $2sr > R$. The theory can be readily extended to apply to steady-state ac conditions.

621.314.7:546.28 1195
Forming Point-Contact Silicon Transistors—H. Jacobs, F. A. Brand, W. Matthei and A. P. Ramsa. (*Jour. Appl. Phys.*, vol. 25, pp. 1406-1412; November, 1954.) Performance tests are reported on transistors with impurities introduced locally by the arcing technique previously described [1246 and 1607 of 1954 (Jacobs et al.)]. Voltage gains up to 75 and power gains between 15 and 60 are reported. Curves are shown of the variation of current gain with emitter current for various Si specimens. The current multiplication mechanism is discussed in the light of theory developed by Sittner (2366 of 1952).

- 621.314.7.001.4 1196
Testing Point-Contact Transistors for Pulse Applications—Wooley. (See 1092.)
- 621.314.7.012 1197
Small-Signal Parameters for Transistors—R. L. Pritchard. [*Elec. Eng. (N.Y.)*, vol. 73, pp. 902-905; October, 1954.] "The commonly used sets of parameters are discussed briefly and it is shown how the performance of the transistor can be determined with equal facility from any of the sets that may be provided."
- 621.385 1198
Practical Considerations in the Design of Low-Microphonic Tubes—T. M. Cunningham. (*RCA Rev.*, vol. 15, pp. 563-580; December, 1954.) "A definition of microphonism is given, and the modes of electrode movement which cause microphonic action are described. Various design methods used in the production of commercial receiving-type tubes to reduce microphonism are evaluated. In some cases, modification of existing designs to reduce the microphonic parasitic effect proves impractical because of other considerations."
- 621.385.029.6 1199
Valves for Input and Output Stages in the 4-kMc/s Band—H. Rothe. (*Fernmeldetechn. Z.*, vol. 7, pp. 532-539; October, 1954.) A comparison of the suitability of grid-controlled tubes, traveling-wave tubes and klystrons. Noise characteristics and power-handling capacity are considered.
- 621.386.029.6 1200
The Potentials in the Magnetron—Consequences in Design—K. Fritz. (*Fernmeldetechn. Z.*, vol. 7, pp. 528-531; October, 1954.) Energy relations are derived for the electrons; the form of the optimum electron path points to the desirability of segment arrangements other than circularly symmetrical. The magnetron mechanism is elucidated by analogy with an acoustic delay line. Special-purpose magnetrons designed in accordance with the theory are illustrated.
- 621.385.029.6 1201
Effect of Velocity Distribution on Traveling-Wave Tube Gain—D. A. Watkins and N. Rynn. (*Jour. Appl. Phys.*, vol. 25, pp. 1375-1379; November, 1954.) Application of theory developed previously (3289 of 1952). For a typical traveling-wave tube the thermal velocity distribution reduces the gain by <1 in 10^4 . For a tube using magnetic focusing and a high-perveance beam the velocity spread resulting from space charge lowers the gain by about 1 per cent.
- 621.385.029.6 1202
Beam Focusing by Periodic and Complementary Fields—K. K. N. Chang. (*Proc. I.R.E.*, vol. 43, pp. 62-71; January, 1955.) Theory of beam focusing in traveling-wave tubes by means of space-periodic magnetic or electrostatic fields is surveyed. An alternative method of focusing is proposed using complementary magnetic and electrostatic fields which need not necessarily be space-periodic; stable beams free from scalloping can be produced. The system is particularly useful for focusing in the accelerating region of the gun.
- 621.385.029.6:621.372.2 1203
Delay Lines with Periodic Structure in Travelling-Wave Valves—W. Kleen. (*Fernmeldetechn. Z.*, vol. 7, pp. 547-553; October, 1954.) See also 2375 of 1952 (Kleen and Ruppel).
- 621.385.029.6:621.372.2 1204
Investigation of Lines with Periodic Bar Structure: Part 2—A. Leblond and G. Mourier. (*Ann. Radioélect.*, vol. 9, pp. 311-328; October, 1954.) Theory developed in part 1 (3087 of 1954) is applied to the design of wide-band systems. The dispersion characteristics for certain comb-type and interdigital-type structures are determined. Study of the shape of the dispersion curve near the cut-off points illustrates the validity of the general expression for characteristic impedance. The physical significance of the "transverse-field" theory and its range of validity are discussed. The matching of an interdigital walled type of line to a coaxial system is treated by a method analogous to that used for determining the resonance frequencies of the interdigital magnetron (part 1). This method can be adapted for any type of bar structure.
- 621.385.029.63/.64 1205
Reflex Klystron for Grid Pulse Operation within the Frequency Range 2000-5000 Mc/s L. Torstenson. (*Ericsson Tech.*, vol. 10, no. 2, pp. 297-308; 1954.) The klystron described is designed to give an output of 1 w for pulsed operation and 100 mw for cw operation as a local oscillator; a spherical control grid in front of the cathode is used for the pulsed operation only. The external cavity has plunger tuning. Calculated values of output power as a function of frequency are compared with observed values.
- 621.385.029.63 1206
Low-Noise Travelling-Wave Valves—H. Schnitger and D. Weber. (*Fernmeldetechn. Z.*, vol. 7, pp. 540-546; October, 1954.) A design using only one pre-anode is described, with which a noise figure as low as 10.3 db can be achieved in conjunction with a gain of 27 db, operating at a wavelength of 16 cm, with 290 v on the helix and 95 v on the pre-anode and a magnetic focusing field of only 200 G. The importance of such simple designs for use at radio-link relay stations is indicated.
- 621.385.029.64 1207
The TL6, a Telefunken Travelling-Wave Valve for the Frequency Range around 4000 Mc/s—(*Telefunken Ztg.*, vol. 27, p. 187; September, 1954.) Designed for the output-amplifier stage of a dm- λ transmitter. The helix is held firmly in position by three ceramic rods fitting into two metallic caps.
- 621.385.029.64 1208
Theory of the Carcinotron—K. Pöschl. (*Fernmeldetechn. Z.*, vol. 7, pp. 558-561; October, 1954.) The starting current of the carcinotron oscillator is calculated on the basis of the linear theory of traveling-wave tubes, using appropriate boundary conditions.
- 621.385.029.64 1209
The Carcinotron, an Electrically Tuned Microwave Generator—W. Veith. (*Fernmeldetechn. Z.*, vol. 7, pp. 554-558; October, 1954.) The mechanism of production of the backward wave is explained. A tube is described in which a hollow beam is produced surrounding the helix and focused by a longitudinal magnetic field of strength 800 G. This construction enables the helix to be wound very uniformly and permits a gradual wide-band transition to a coaxial line at the cathode end. An external aquadag layer is provided at the collector end to attenuate unwanted waves. A helix with high coupling and relatively small tuning range was used in preference to one with low coupling and large range, to ease the requirements in relation to constancy of voltage and to provide greater power. Measurements of performance at 4 kmc are reported.
- 621.385.029.64:621.376.32 1210
Modulation Properties of the Reflex [klystron] Generator—J. Labus. (*Fernmeldetechn. Z.*, vol. 7, pp. 562-565; October, 1954.) Simple analysis indicates that good linearity of the frequency-modulation characteristic is achieved by suitably loading the klystron resonator. The distortion depends on the signal frequency shift and on the resonator Q but is practically independent of the oscillation mode. The frequency shift corresponding to half power and the maximum power reach their peak values at about the same value of the resonator Q . The slope of the modulation characteristic depends on the oscillation mode and on the Q . Experimental results are reported.
- 621.385.029.65 1211
Helix Millimeter-Wave Tube—W. V. Christensen and D. A. Watkins. (*Proc. I.R.E.*, vol. 43, pp. 93-96; January, 1955.) Development work on backward-wave oscillators with tape helices is reported. A tube is described in which a tungsten helix of length 1 inch, internal diameter 0.025 inch, and tape cross-section 0.002 inch by 0.005 inch is supported on quartz knife-edges so as to be able to dissipate its heat by direct conduction to the outside of the all-glass envelope. The output is taken by means of a helix-to-waveguide transition inside the envelope; this waveguide meets the glass wall at an angle and is continued by a further waveguide section outside the envelope. The cw power is >1 mw over the frequency range 50-67 kmc. Tuning is accomplished by varying the helix potential, which is 1680 v at 5 mm λ .
- 621.385.029.65 1212
Traveling-Wave Tube Experiments at Millimeter Wavelengths with a New, Easily Built, Space Harmonic Circuit—A. Karp. (*Proc. I.R.E.*, vol. 43, pp. 41-46; January, 1955.) Delay structures comprising ridged waveguides with transverse slots are discussed. For the small sizes necessary for operation at millimeter wavelengths the slotted structure is formed either by winding a grid or by photo-etching a thin metal sheet. The electron beam may flow on either or both sides of the slotted wall. Experiments with amplifier tubes and backward-wave oscillators are described. A spacing of about 55 slots/inch was used for amplification at 5 mm λ , with a 1-kv beam. The ratio of slot width to pitch passed through an optimum value between 0.3 and 0.5. A structure for a backward-wave oscillator was made by winding Au-coated Mo ribbon 0.001 inch thick and 0.0055 inch wide at 92 turns/inch on a Cu-plated Mo body. This tube was tunable from 57 to 61 kmc by varying the beam voltage from about 900 to 1,170 v.
- 621.385.032.21:621.3.018.75:537.581 1213
The Velocity Distribution of Electrons of Thermionic Emitters under Pulsed Operation: Part 2—Experimental Results and a Tentative Theoretical Explanation—C. G. J. Jansen, R. Loosjes and K. Compaan. (*Philips Res. Rep.*, vol. 9, pp. 241-258; August, 1954.) The velocity distribution of electrons emitted from cathodes with (BaSr)O and SrO coatings under square-pulse conditions shows a large dispersion, the spectra consisting of fairly discrete lines which gradually contract to a single line as dc is added. Coatings of BaO, ThO₂, and a mixture of (BaSr)O and Ni powder give a one-line spectrum, less sharp than that obtained with metallic cathodes. A detailed discussion is given of possible mechanisms accounting for these results. Part 1:2837 of 1953 (Jansen and Loosjes).
- 621.385.032.213 1214
Modern Thermionic Cathodes—N. D. Morgulis. (*Uspekhi fiz. Nauk.*, vol. 53, pp. 501-543; August, 1954.) A survey. Metallic cathodes are considered under (a) pure metal cathodes, and (b) metallic cathodes covered with monatomic films; nonmetallic cathode materials are grouped into (a) oxides of alkaline-earth metals, (b) chemical compounds of metals, and (c) mixed metal-ceramic systems. The properties are discussed mainly from the experimental point of view and theory is presented only briefly. Over 70 references.
- 621.385.032.216 1215
Spectral Dependence of Thermionic Emission with Activation from (Ba-Sr)O Cathodes over 0.6-3.5 eV Region—T. Hibi and K. Ishikawa. (*Phys. Rev.*, vol. 95, pp. 1183-1184; September, 1954.) Variation of the spectral dependence with activation observed previously (284 of 1953) is confirmed by more precise measurements using a monochromator.

- 621.385.032.216 1216
International Congress to mark the Fiftieth Anniversary of the Oxide Cathode—(*Le Vide*, vol. 9, pp. 3-93 and 100-211; May and July/September, 1954.) The text is given of the following papers presented at the congress:
- "Wehnelt's Discovery. Evolution of Ideas on the Thermionic Emission Mechanism of Oxide Cathodes,"—R. Warnecke (pp. 8-12).
- "The Work of the American Society for Testing Materials on Specifications and Standards for Oxide Cathodes,"—A. M. Bounds and T. H. Briggs (pp. 13-16).*
- "Wehnelt and his Work,"—C. Biguenet (p. 17).
- "Development of New Cathode Nickels with Improved Performance,"—A. M. Bounds, T. H. Briggs and C. D. Richard (pp. 18-21).*
- "Nickel in the Manufacture of Oxide Cathodes,"—J. Challansonnet (pp. 22-27).
- "Experimental Results on the Behaviour of Cathode Nickel heated in Vacuum,"—J. Richard (pp. 28-32).
- "Some Metallurgical Aspects of Nickel for Thermionic Cathodes,"—Nguyen Thien-Chi (pp. 33-41).
- "Premature Breaking of Very Thin Nickel Filaments with Additions of Aluminum and Magnesium as a result of Rapid Recrystallization with Grain Slipping,"—L. Piatti (p. 42).
- "Conditions for Precipitation of Carbonates and Crystal Structure,"—K. Amakasu, M. Fukase, E. Sekine, M. Takahashi, N. Noaki and S. Hirota (pp. 43-55).*
- "Dosage of Sodium in Alkaline-Earth Carbonates by γ Rays from Sodium 24,"—R. Gobin (pp. 56-57).
- "The Influence of the Physical and Chemical Properties of the Coating on the Emission from the Oxide Cathode,"—D. W. Wright (pp. 58-69).*
- "Results on the Emission from a Single Isotope,"—M. Berthaud (pp. 70-71).
- "Nitrocellulose as Binder in the Manufacture of Oxide Cathodes,"—Lhoste (pp. 72-74).
- "Production of Smooth Oxide-Cathode Surface by Spraying and Measurement of the Roughness,"—Y. Nakamura, S. Okada and Y. Kato (pp. 75-80).
- "Problems encountered in the Spray-Coating of Oxide Cathodes,"—J. Schweitzer (pp. 81-89).
- "A Simple Method of determining the Degree of Thermal Decomposition of Barium Carbonate in Vacuum,"—K. M. Yazawa (pp. 90-93).
- "The Nature of the Donors inside the Oxide Layers. Calculation of their Energy of Dissociation,"—J. Ortusi (pp. 100-105).
- "Use of the Radioactive Isotope for studying the Evolution of Strontium from Strontium Oxide under Electron Bombardment,"—S. Yoshida, N. Shibata, Y. Igarashi and H. Arata (pp. 106-108).*
- "Photoconductivity of BaO,"—M. Sakamoto (pp. 109-112).*
- "Study of Cathodoluminescence of (Ba, Sr)O,"—K. Noga and K. Nakamura (pp. 113-115).*
- "The Effect of Positive-Ion Bombardment on Oxide Cathodes,"—K. Takeya, T. Shirakawa and S. Takahashi (pp. 116-120).*
- "The Effects of Barium and Oxygen Vapours on the Spectral Dependence of Thermionic Emission from (Ba, Sr)O Cathodes,"—Hibi and Ishikawa (pp. 121-124).*
- "Migration of Impurities at the Nickel/Oxide Interface of Oxide Cathodes,"—G. A. Giger (pp. 125-128).
- "Abnormal Velocity Distribution of Electrons emitted by Pulsed Oxide Cathode,"—C. G. J. Jansen, R. Loosjes and K. Compaan (pp. 129-134).
- "Oscillographic Method for determining Work Function as a Function of Temperature,"—

- C. G. J. Jansen, R. Loosjes, J. J. Zaalberg van Zelst and G. A. Elings (pp. 135-138).
- "Measurement of Cathode Properties using Long Pulses,"—P. Sevin and M. Berthaud (pp. 139-147).
- "Measurements of Transverse Resistance of Oxide Cathodes,"—A. Kestelyn-Loebenstein (pp. 148-154).
- "On the Conductivity of Oxide Cathode Coatings,"—T. B. Tomlinson (pp. 155-160).*
- "Behaviour of Cathode Parasitic Impedance as a Function of Time and of Conditions of Use,"—P. Sainte-Beuve (pp. 161-165).
- "Development of Parasitic Impedance in Oxide Cathodes,"—A. Lieb (pp. 166-170).†
- "Experiments bearing on the Mobile-Donor Hypothesis in Oxide Cathodes,"—L. S. Nergaard (pp. 171-176).*
- "Films of Electron Micrographs of Hot Cathodes,"—E. Brüche (pp. 177-180).†
- "Investigation of Oxide Cathodes by Analysis of Electron Velocities in a Special Valve,"—O. Pfetscher and W. Veith. (pp. 181-187).†
- "Cathode-Characteristic Tracer,"—R. Echard (pp. 188-190).
- "On the Relations between Electron Emission, Conduction and Noise of Oxide-Coated Cathodes,"—J. Nakay, Y. Inuishi and Tsung-Che (pp. 191-199).*
- "Background Noise of Oxide Cathodes,"—J. Dalbert (pp. 200-202).
- "Flicker Effect at Microwave Frequencies,"—M. Musson-Genon (pp. 203-205).
- "Low-Frequency Fluctuations in the Conductivity of the Oxide-Coated Cathode,"—T. B. Tomlinson (pp. 206-211).*
- For a shortened version in German, of Warnecke's introductory paper, see *Elektrotech. Z., Edn A*, vol. 75, pp. 677-680; October 11, 1954.

621.385.032.216:533.583 1217

- Application of a Tracer to Cathode-Gettering and Gas-Adsorption Problems**—F. de Boer and W. F. Niklas. (*Brit. Jour. Appl. Phys.*, vol. 5, pp. 341-342; September, 1954.) The gettering effect of the heated oxide cathode in a cathode-ray tube of small volume was investigated by radioactivity measurements after introduction of the ^{14}C isotope. Results indicate that the cathode oxide layer has a specific gettering power about 500 times that of the stainless-steel gun components.

621.385.032.216:621.317.733 1218

- A Bridge for the Measurement of Cathode Impedance**—Matheson and Nergaard. (*See* 1109.)

621.385.2 1219

- Effect of Filament Voltage on the Plate Current of a Diode**—H. S. C. Chen. (*Jour. Appl. Phys.*, vol. 25, p. 1345; October, 1954.) Correction to paper noted in 3730 of 1954.

621.385.3 1220

- Triodes with Very Small Electrode Spacings**—F. W. Gundlach. (*Fernmeldetechn. Z.*, vol. 7, pp. 516-521; October, 1954.) The variation of the input conductance and noise factor of uhf disk-seal tubes due to the reflection of electrons from the space-charge potential minimum is shown by approximate calculations for the two limiting cases, (a) very large grid-cathode spacing, such that the potential minimum can be treated as a virtual cathode, and (b) very small spacing, such that no potential minimum occurs. The usual spacing in present-day tubes, about 10 μ , is between these two extremes, and the development of theory for this intermediate case is required.

621.385.3 1221

- The Input Admittance of Triodes**—W. Dahlke. (*Fernmeldetechn. Z.*, vol. 7, pp. 522-528; October, 1954.) In ordinary nonideal triodes the penetration of the anode field through the grid is nonuniform; as the grid potential is made more negative the emission from the cathode is suppressed first at regions where the

penetration is least. The input admittance is here calculated by summing the effects due to all the emitting regions; a new parameter called the "relative dispersion of the penetration factor" is introduced. Results of measurements indicate that this method of analysis explains previous discrepancies between observations and theory.

621.385.3.012 1222

- Static Characteristics of Non-ideal Triodes**—W. Dahlke. (*Telefunken Ztg.*, vol. 27, pp. 172-186; September, 1954.) The effect on the static characteristics of a tube with negative grid bias of fluctuations in penetration factor due to irregularities in the grid structure is considered, the approach being on the same lines as in earlier work (e.g. 2085 of 1952). The characteristics are computed and displayed in tables and graphs for various statistical distributions of the penetration-factor fluctuations. In general they are dependent only on permeance, and on the statistical mean and relative dispersion values of the penetration factor. The determination of these three factors by computation and by experiment is discussed and illustrated by examples. Agreement between the two methods is satisfactory, but could be improved if initial electron velocities were taken into account. *See* also 1221 above.

621.385.3.029.63/.64 1223

- A Triode Useful to 10000 Mc/s**—J. E. Beggs and N. T. Lavoo. (*Proc. I.R.E.*, vol. 43, pp. 15-19; January, 1955.) Tubes of very small size can be manufactured using low-loss quartz or ceramic insulating parts soft-soldered to copper parts during a high-temperature exhaust process. A description is given of the Type-L29 receiving tube, which is suitable for use in either distributed or lumped-constant circuits. It has a noise figure of 7 db at 1.2 kmc and is capable of giving an output of 40 mw at 10 kmc. A smaller version, Type L-31, and a commercial version, Type GL6299, are also mentioned.

621.385.3.029.63 1224

- U.H.F. Triodes**—W. J. Pohl and D. C. Rogers. (*Wireless Eng.*, vol. 32, pp. 47-52; February, 1955.) "The relationships between earthed-grid class C triode performance and electrode dimensions are outlined and combined with the factors concerning the safe operation of the grid. This leads to a simple design procedure which enables the rapid determination of the main electrode dimensions to satisfy given circuit requirements. The method is applicable to cases in which the maximum permissible grid dissipation can be estimated in terms of the grid dimensions. It applies particularly to disk-seal triodes in which at least one end of each grid wire is in intimate thermal contact with some well-cooled connector external to the valve, which enables a fairly accurate prediction of grid-wire-temperature distribution to be made."

621.385.5.012.3 1225

- The Use of Screen-to-Plate Transconductance in Multigrid Tube Circuit Design**—K. A. Pullen, Jr. [*Elec. Eng.*, (N.Y.), vol. 73, pp. 876-879; October, 1954.]

621.385.832+621.383 1226

- Electron Lens Raster Systems and their Application in Electron Image Storage Tubes**—M. Knoll. (*Z. angew. Phys.*, vol. 6, pp. 442-449; October, 1954.) Theory is presented of a system comprising a two-dimensional array of minute, identical lenses, and the application of the system in a direct-vision storage tube is described. For a similar report, in English, see Proceedings of the N.B.S. Semicentennial Symposium on Electron Physics, November 5-7, 1951, *N.B.S. Circular*, No. 527, pp. 329-336 and *ibid.*, pp. 339-342; March 17, 1954. (Knoll and Rudnick). Discussion on both papers, *ibid.*, pp. 343-344.

* English version included.

† German version included.

MATERIALS RESEARCH • ELECTRONIC COMPONENTS • PRECISION INSTRUMENTS • SYSTEMS ENGINEERING

Consulting service offered to industry in ultrasonic research and applications

No industrial organization need feel handicapped in utilizing the tremendous advances in the field of ultrasonics for its own problems through lack of specialized talents or facilities.

To meet the needs of firms seeking such assistance, the Vibro-Ceramics Corporation, Metuchen, N. J., is announcing a comprehensive consulting service in ultrasonics for industrial programs of any size or scope.

The advanced technological and research facilities now available at Vibro-Ceramics include ultrasonic attenuation analyzers, ultrasonic balances, generators, all types of transducers and an underwater sound laboratory for research in liquids.

Development work will be undertaken for the most part at its laboratories in Metuchen; corollary work such as pilot studies can be performed at the customer's location as necessary.

A large, capable research staff of theoretical physicists and engineers is now available to analyze problems, procedures, programs in cooperation with the customer, and design and construct ultrasonic production equipment.

At the present, Vibro-Ceramics is equipped to consider problems in four major fields:

- 1) ultrasonic processing for industry, including cleaning, emulsification, dispersion, agitation, drilling, soldering, and chemical effects of ultrasonics,
- 2) ultrasonic measuring and detection devices, including flow detection, process control, fluid or gas velocity measurement, depth indicators, and study of materials properties,
- 3) applications in medicine and biology, and
- 4) plastic deformation and fatigue in metals.

Vibro-Ceramics Corporation

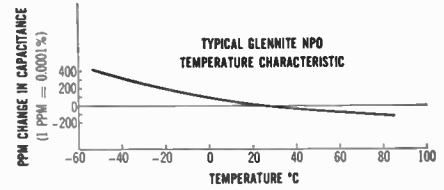

New high precision TC capacitor series; NPO ceramics controlled to ± 5 ppm/ $^{\circ}$ C

A new series of temperature compensating capacitors have been developed with the temperature coefficients precisely controlled to tolerances down to ± 5 ppm/ $^{\circ}$ C. Characterized by low loss and exceptionally high dielectric strength, these Glennite TC Capacitors enable more precise compensation for tuned circuit drift. They are available in voltage ratings of 150 V, 250 V and 500 V in all standard capacitance values.

Standard tolerances of ± 15 ppm/ $^{\circ}$ C are available to N 150, ± 30 ppm/ $^{\circ}$ C for higher coefficients. A continuous range from NPO to N5600 provides both standard and non-standard coefficients.

The new series includes an NPO with a true zero temperature coefficient specially designed for IF and other tuned stages. The Glennite NPO, with a slightly negative coefficient, is superior to mica as it efficiently counteracts drift without added compensation.

Glenco Corporation

New incremental capacitance bridge measures 0.0001% variations

The precise determination of low temperature coefficients of temperature compensating capacitors can now be achieved by the Glennite 1 MC Incremental Capacitance, Ratio Bridge, Model MS-1M. The unit has a working sensitivity of 1 ppm and detects the impact of a flash-light beam on a conventional NPO capacitor.

The bridge has a stability of better than 10 ppm/hr. and can measure capacitance variations as small as 0.00003 mmf. Operating range is 30 mmf to 1030 mmf, expandable by external padders or trimmers. A three terminal system eliminates stray capacitance variations to ground as sources of error, facilitating switching and multi-sample testing.

Reliability is assured by a modified standard bridge circuit which provides

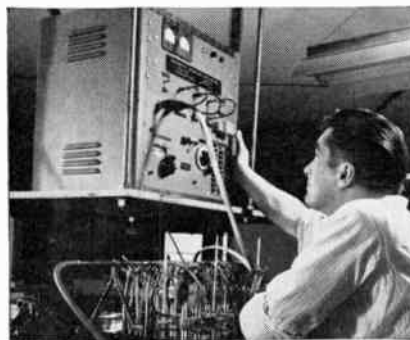

Glennite 1 MC Incremental Capacitance Ratio Bridge

a zero to 1.5% loss balance not found in resonance type systems; absolute accuracy is 0.5%. The unit, housed in a 22" x 21" x 15" cabinet, weighs 45 pounds.

Gulton Mfg. Corp.

Gulton Industries, Inc.

201 Durham Ave., Metuchen, New Jersey

- Put me on Gulton Abstracts mailing list
- Please send me additional information on:
 - Ultrasonic Consulting Services
 - Glennite Temperature Compensating Capacitors
 - Glennite Incremental Capacitance Bridge
 - Glennite Electromechanical and Electronic Instruments
 - Glennite Electronic Components

NAME _____

TITLE _____

COMPANY _____

ADDRESS _____

Published by
GULTON INDUSTRIES, INC.

Comprising: Gulton Mfg. Corp. • Glenco Corporation • Vibro-Ceramics Corporation
Greibach Instruments Corporation • Thermistor Corporation of America

News in X-Y Recording



(Continued from page 94A)

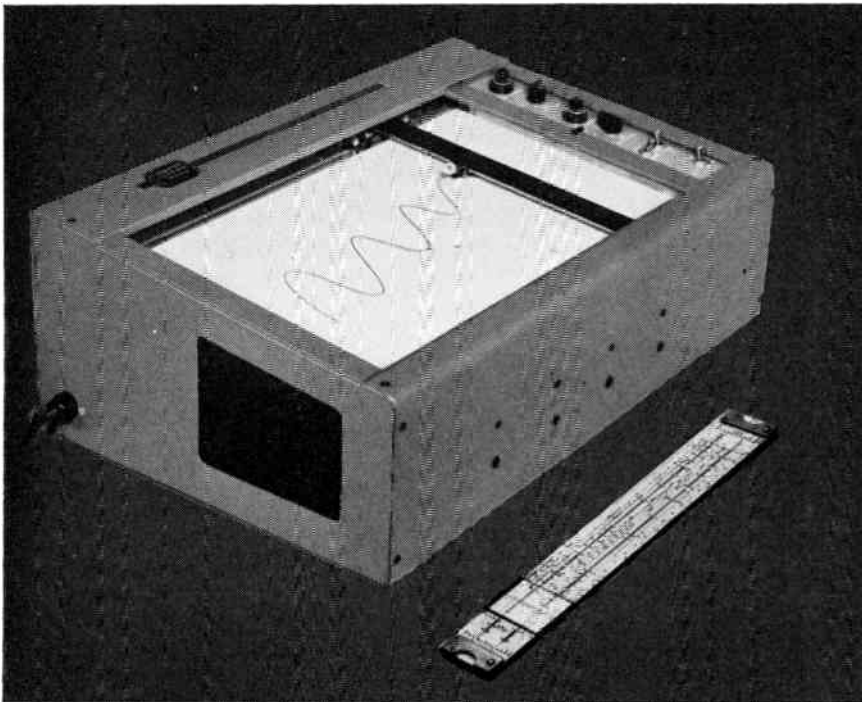

The new Variplotter Model 1100 Plotting Board

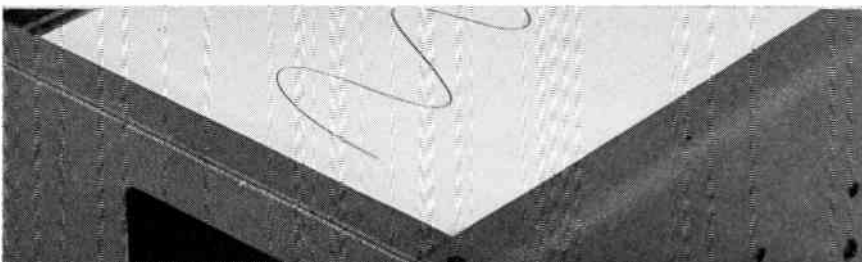

Including vacuum hold-down for plotting paper, finer accuracy, faster response

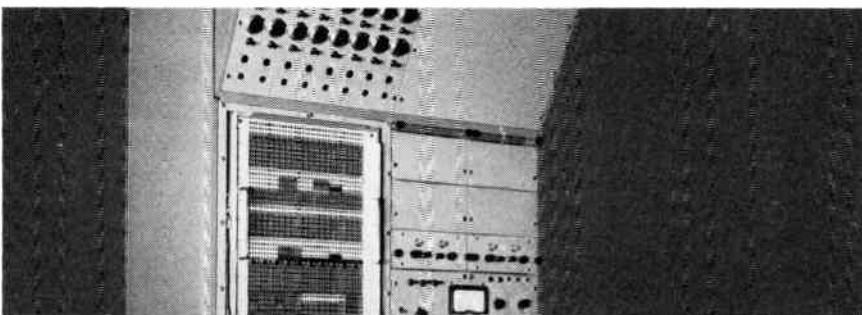

For use with Precision Analog Computing Equipment, Digital Systems, Instrumentation, etc.

Variplotter Model 1100 — Provides rapid (pen slews at approximately 20" per second) graphic recording of any data that can be reduced to electrical form. Same reliable accuracy as the well-known 205 series Variplotter. Ideal where compactness is essential without loss of speed or performance. Designed for use in recording computer outputs (as with EAI 16-31R pictured above), generating functions, or with additional equipment — for plotting digital information from punch cards or tape. For complete brochure write Department IR-7, Electronic Associates, Inc., Long Branch, New Jersey.



EAI SETS THE

P
PRECISION

A
ANALOG

C
COMPUTING

E
EQUIPMENT

LONG BRANCH, NEW JERSEY

- Farrior, J. S., Jr., 1920 Thornton Cir., Huntsville, Ala.
 Fawcett, G. M., Air Materiel Command Hq., RCAF Station, Rockcliffe, Ont., Canada
 Foulon, F., 547 N. Sierra Bonita Ave., Los Angeles 36, Calif.
 Froehlich, C., 5535 Netherland Ave., Riverdale 71, N. Y.
 Gardner, B. R., 1185 Oneida St., State College, Pa.
 Gillmer, A. H., 3557 McLaughlin Ave., Los Angeles 66, Calif.
 Globe, S., 6915—23 St., Hyattsville, Md.
 Goodman, H., 128 Front St., Mount Holly, N. J.
 Jacobs, Y., Apt. C-1, 310 Ryburn Ave., Dayton, Ohio
 Keener, E. L., 1113 Windsor Ave., Morgantown, W. Va.
 Lederman, A., 108 E. 91 St., New York 28, N. Y.
 Lomasney, J. M., 561 S. Elizabeth Dr., Lombard, Ill.
 Long, M. W., 251 Tenth St., N.W., Atlanta, Ga.
 Mack, M. C., 17 Charles Rd., North Linthicum, Md.
 MacDonald, D. L., Edmonton Transit System, 10330—84 Ave., Edmonton, Alta., Canada
 Manhart, R. A., 1105 E. Nutwood Ave., Fullerton, Calif.
 Mathews, W. E., 3309 Purdue Ave., Los Angeles 66, Calif.
 McComas, A. D., Falls Rd., Cockeysville, Md.
 Mueller, E. H., Box 1893 (c/o ARAMCO), Dhahran, Saudi Arabia
 Okun, A. M., 259 Hartford Ave., Kenmore 23, N. Y.
 Pridmore, T. C., Westinghouse Electric Corp., Bath, N. Y.
 Raymond, G. H., East St., Southington, Conn.
 Ritchey, N. B., 18 Whitson Rd., Huntington Station, L. I., N. Y.
 Smith, J. S., 302 Shaver Ave., North Syracuse, N. Y.
 Sonkin, S., Microwave Laboratory, Stanford University, Stanford, Calif.
 Stangl, F. P., 4617 E. Eastland St., Tucson, Ariz.
 Stelmak, J. P., Box 284, Westinghouse Electric Corp., Elmira, N. Y.
 Trautman, D. L., 3252 Grand View Blvd., Los Angeles 66, Calif.
 Uleman, T., 1 Gateway Center, Pittsburgh 22, Pa.
 Vogel, E., 1663 Greenway Blvd., Valley Stream, L. I., N. Y.

Admission to Senior Member

- Ament, W. S., 5083 Temple Hills Rd., Washington 22, D. C.
 Antul, J. J., 38 Standish Rd., Arlington, Mass.
 Blanchard, R. L., 223 Independence Dr., Chestnut Hill 67, Mass.
 Bonebreak, R. L., 815 Frederick Blvd., Akron 20, Ohio
 Braun, E. L., 10749 Sarah St., North Hollywood, Calif.
 Brearley, W. H., Jr., 407 Alexander Ave., Drexel Hill, Pa.
 Corson, D. E., 33 Browns Ter., Englewood, N. J.
 Dejaridin, G. L., Quai Claude Bernard 18, Lyon 7 (Rhone), France
 Dixon, L. W., 1808 S. Rogers, Bloomington, Ind.
 Elvy, M. T., 'Glenhurst,' 161, Cromwell Rd., Whitstable, Kent, England
 Esher, J. R., Jr., General Electric Co., Bldg. 37-419, Schenectady 5, N. Y.
 Groves, S. K., 1233—11 St., Tell City, Ind.
 Jackson, T. B., 6864 DeAnza Ave., Riverside, Calif.
 Kimes, R. A., American Machine & Foundry Co., 1085 Commonwealth Ave., Boston, Mass.
 Kramer, S. I., 539 Manatuck Blvd., Brightwaters, L. I., N. Y.
 Kulvik, E., Box 4060, A/S NERA, Oslo, Norway
 Krishnaji, Department of Physics, University of Allahabad, Allahabad-2, India

(Continued on page 101A)

Important developments in

COLOR TV Receiving Tubes

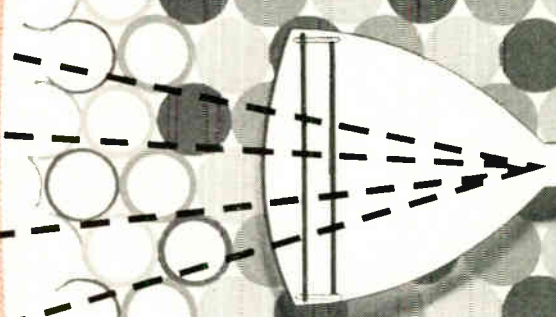
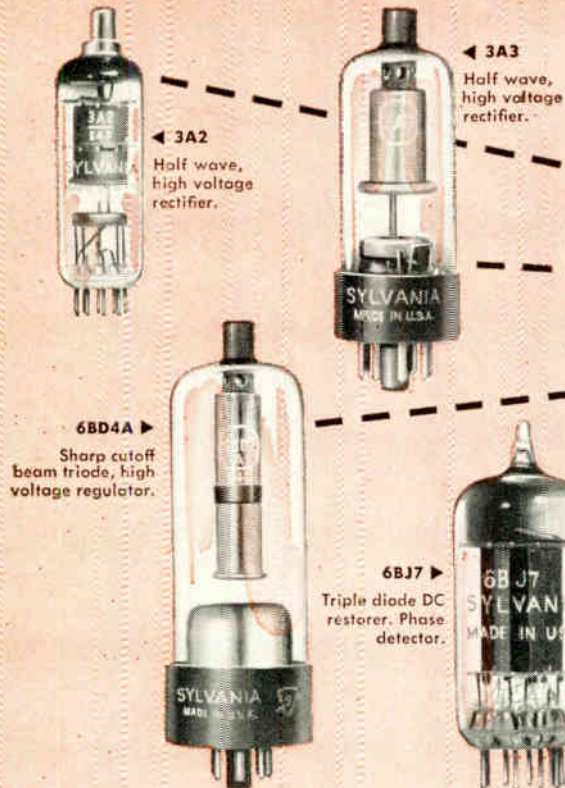

Expect them to keep coming from Sylvania

To make the color TV picture better as it gets bigger, Sylvania tube research, in close liaison with leading set designers, is busy developing and testing new tube types . . . designed especially for big-screen color TV.

Development of the 6BD4A to fill the need for a higher-rated voltage regulator is a typical example of Sylvania

pioneering in color TV receiving tubes.

These tubes, together with important Sylvania prototypes being offered to the industry today, will be color TV's "bread and butter" types tomorrow, and will be available from Sylvania in production quantities.

Expect Sylvania to supply your color TV picture tube requirements, too.



SYLVANIA

SYLVANIA ELECTRIC PRODUCTS INC.
1740 Broadway, New York 19, N. Y.
In Canada: Sylvania Electric (Canada) Ltd.,
University Tower Bldg., Montreal

LIGHTING • RADIO • ELECTRONICS • TELEVISION • ATOMIC ENERGY

Designed for



Application



**90900 Series
Cathode Ray Oscilloscopes**

The No. 90902, No. 90903 and No. 90905 Rack Panel Oscilloscopes, for two, three and five inch tubes, respectively, are inexpensive basic units comprising power supply, brilliancy and centering controls, safety features, magnetic shielding, switches, etc. As a transmitter monitor, no additional equipment or accessories are required. The well-known trapezoidal monitoring patterns are secured by feeding modulated carrier voltage from a pickup loop directly to vertical plates of the cathode ray tube and audio modulating voltage to horizontal plates. By the addition of such units as sweeps, pulse generators, amplifiers, servo sweeps, etc., all of which can be conveniently and neatly constructed on companion rack panels, the original basic 'scope unit may be expanded to serve any conceivable industrial or laboratory application.

**JAMES MILLEN
MFG. CO., INC.**

MAIN OFFICE AND FACTORY
**MALDEN
MASSACHUSETTS**



for all applications requiring
exceptionally high insulation
resistance and unusual
stability at high
temperature

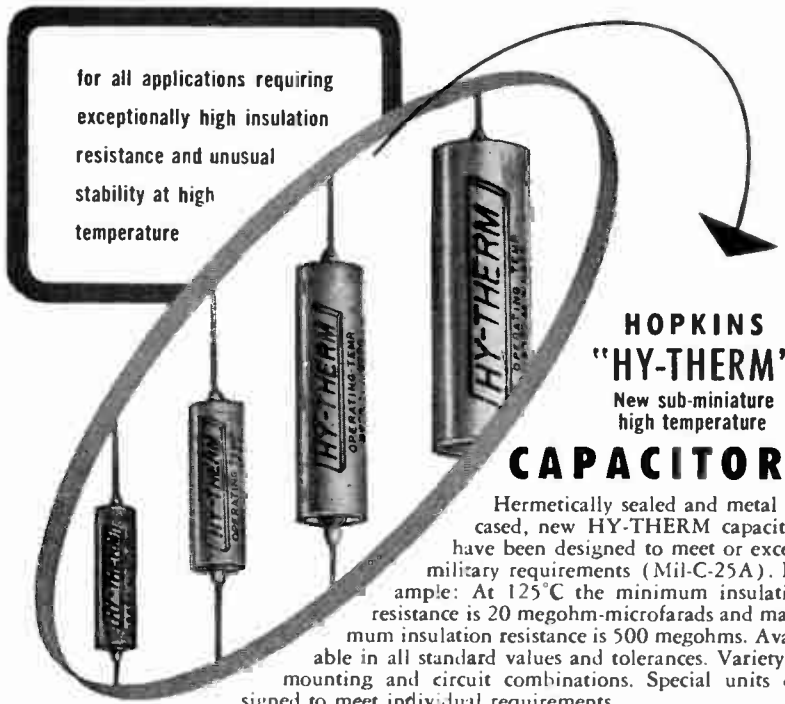

**HOPKINS
"HY-THERM"**
New sub-miniature
high temperature

CAPACITORS

Hermetically sealed and metal encased, new HY-THERM capacitors have been designed to meet or exceed military requirements (Mil-C-25A). Example: At 125°C the minimum insulation resistance is 20 megohm-microfarads and maximum insulation resistance is 500 megohms. Available in all standard values and tolerances. Variety of mounting and circuit combinations. Special units designed to meet individual requirements.

Have a special problem?
Write, wire or phone for
details, TODAY!



Catalog available

2082 Lincoln Ave., Altadena, Calif.,
SYcamore 8-1185 • Offices in
WASHINGTON, D.C. and DETROIT

**EXACTLY your type and size
in Spiral Wound PAPER TUBES**

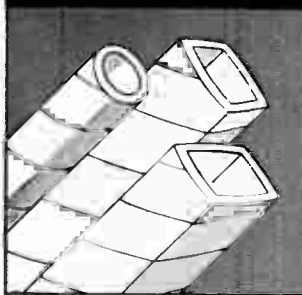

SQUARE, RECTANGULAR, ROUND

Standard-type PARAMOUNT paper tubes used for millions of coil forms and other applications. Hi-Dielectric. Hi-Strength. Kraft, Fish Paper, Red Rope, Acetate, or any combination wound on automatic machines. Any size from 1/2" to 30" long, from .450" to 25" I.P. Produced from wide range of stock arbors or specially engineered for you.

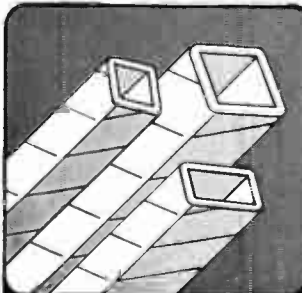

**NEW "PARAFORMED" TUBES
SQUARE OR RECTANGULAR**

Entirely new technique in tube making developed and perfected by PARAMOUNT. Perfectly flat side walls, sharp square inside corners, and very small radius on the four outside corners. Spiral wound, not die formed. No sharp outside edges to cut wire. No need for wedges to tighten winding on laminated core. Full rigidity and physical strength. Permits winding coils to closer tolerances. Allows faster automatic stacking of coils. Approved and used by leading manufacturers. *No extra cost!*

**PARAMOUNT
PAPER TUBE CORP.**

618 LAFAYETTE ST., FORT WAYNE, IND.

Standard of the Coil Winding Industry for Over 20 Years

WRITE ON COMPANY
LETTERHEAD FOR
STOCK ARBOR LIST
OF OVER 2000 SIZES



(Continued from page 98A)

- Leavitt, B. W., 25 Furrow La., Levittown, L. I., N. Y.
 Leopold, R., Lakeshore Dr., Oakland, N. J.
 Lerz, O. M., Jr., 25 Iowa Rd., Great Neck, L. I., N. Y.
 Liben, W., Schlumberger Well Surveying Corp., Houston, Tex.
 Lomax, S. E., Quelp Line, R.F.D. 1, Burlington, Ont., Canada
 Menzel, D. H., Harvard College Observatory, 60 Garden St., Cambridge 38, Mass.
 Muzquiz, G. C., Paseo de la Reforma 27, Depto. 305, Mexico, D. F., Mexico
 Schoke, J. A., 1777 Balsam Rd., Highland Park, Ill.
 Sen, H. K., 1024 E. Hyde Park Blvd., Inglewood 3, Calif.
 Thompson, R. J., Box 216, Griffiss AFB, Rome, N. Y.
 Watt, J. S., Box 2180, Research Center N-211A, Houston 1, Tex.
 Weise, R. W., 135 Bering Ave., Buffalo 23, N. Y.
 Williams, W. E., Jr., 9211 Mintwood St., Silver Spring, Md.

Transfer to Member

- Abilock, S., 1325-44 St., Brooklyn 19, N. Y.
 Ackley, E. H., 200 Seventh North St., Syracuse 8, N. Y.
 Aschbacher, S. J., Box 444, R.F.D. 1, Yellow Springs, Ohio
 Bach, H. M., 36 Woodmere Blvd., S., Woodmere, L. I., N. Y.
 Ba Hli, F., 327, U Wisara Rd., Rangoon, Burma
 Bailey, B., R.F.D. 1, Beech Hill, Concord, N. H.
 Barton, D. K., 620 Pomona Ave., Haddonfield, N. J.
 Benditzky, E., Box 1124, Haselton Branch, Rome, N. Y.
 Bennett, L. F., 451 Dovercourt Ave., Ottawa 3, Ont., Canada
 Blumenthal, L. J., 847 Highland Ave., Kenmore 23, N. Y.
 Bobrow, E. N., 95 Mayo Rd., Wellesley, Mass.
 Bodow, J., 82-33-165 St., Jamaica 32, L. I., N. Y.
 Bogart, R. M., 15 Rockmont Rd., Arlington 74, Mass.
 Boilen, I., 195 Front St., Brooklyn 1, N. Y.
 Bond, N. T., R.F.D. 1, Massena, N. Y.
 Bondy, M. F., 222 Glenhurst Ave., Tonawanda, N. Y.
 Bonney, H. W., 35-10-201 St., Bayside, L. I., N. Y.
 Booton, R. C., Massachusetts Institute of Technology, 77 Massachusetts Ave., Cambridge, Mass.
 Borgelt, W. E., 344 Bryn Mawr Rd., New Hyde Park, L. I., N. Y.
 Borgese, A. J., 2185-B Daisy La., Schenectady 9, N. Y.
 Bossler, F. B., 15 Delton St., Tonawanda, N. Y.
 Bostrom, R. C., 17 Longfellow Dr., Huntington Station, L. I., N. Y.
 Bowers, R. E., 2800 Caroline Ave., Schenectady, N. Y.
 Boxer, R., 1315 Schuyler St., Rome, N. Y.
 Bradshaw, D. B., 10 Rockview Rd., Milton, Mass.
 Branning, H. F., Magnolia Rd., R.F.D. 1, Endicott, N. Y.
 Brearley, H. C., Jr., Rm. 116, Bldg. 3, General Electric Co., Syracuse, N. Y.
 Breitzer, D. I., 30-06-29 St., Astoria, L. I., N. Y.
 Brennan, J. E., 30 Lawnview Dr., Braintree, Mass.
 Brenner, B., 121 S. Columbus Ave., Mt. Vernon, N. Y.
 Bresson, J., 545 Green Pl., Woodmere, L. I., N. Y.
 Brewer, L. F., 168 Ludlow St., Portland 5, Me.
 Bridgeman, T. H., 45 Hawthorne St., Brooklyn 25, N. Y.
 Briggs, R. S., 9 Puritan Rd., North Beverly, Mass.
 Brilmayer, E. W., 117-01 Park Lane, S., Kew Gardens 15, L. I., N. Y.

(Continued on page 102A)

Manufacturers of Specialty Rotating Equipment FANS • MOTORS • BLOWERS



Variable frequency blower for operation on 115 Volt single phase. Available with axial fan or centrifugal blower. A15BF-15-50 to 800 cycles—single winding available with axial fan or centrifugal blower. A15AB-2 — 50-60 cycle and 400 cycle operation single winding. A15CF10 — 50-60 and 320-1000 cycle operation dual winding.

A15BD-8—115 Volt 60 cycle Double Blower. 46 CFM at .28" static pressure.

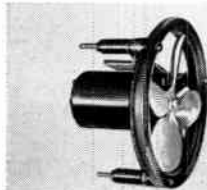
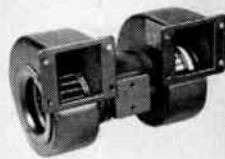

A15AD3—Axial blower unit for operation on 115 Volt 60 cycle single phase supply at 3300 RPM delivering 35 CFM at 0.2 S.P. This unit has special mounting bracket.

E Frame—Totally enclosed induction motor. 400 cycle 2, 4, 6 or 8 poles. 60 cycle 2 or 4 poles. 2-5/16" dia. H.P. up to 1/25 (up to 1/10 H.P. for axial vane blower application.)

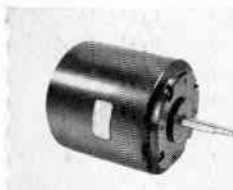

Synchronous Motors—Hysteresis or Reluctance type. 60 or 400 cycle. Available single or dual speeds.

B20B-7 — 115 Volt 60 cycle. 50 CFM at 1.5" static pressure. Metal housing, L type bracket. Also available in 400 cycle.



631 x 1—115 Volt, 60 cycle, 3450 RPM 100 CFM @ 2 1/2" water gauge. Fits in space 9 1/2" long, 8 3/4" wide, 7 3/4" high.

631 x 35—115 Volt, 60 cycle or 220 Volt, 60 cycle, 1 or 3 phase. 3450 RPM continuous duty, 250 CFM at 2 1/2" water gauge. Used in microwave generators, unattended repeater stations. Fits in space 13 1/2" long, 8 3/4" wide, 7 3/4" high.



The features of all AIR MARINE motors include Stainless steel thru-bolts, Rigid die-cast aluminum housings, and Riveted stator to insure Extra-Rigid Construction.

Positive bearing alignment and uniform air gap. Motors are protected against humidity and fungus growth — can be mounted in any position— are equipped with ball bearings using lubricants for high and low temperatures—meet all AN specifications.

The motors and blowers on this page are representative of the many varied models available. Detailed information specifications and performance data on all units available on request.



Showing comparison between our large and small blowers

Send for our new Catalog AM-60

Constantly developing to meet your exacting needs . . .

air-marine motors Inc.

369 Bayview Avenue
Amityville, L. I., N. Y.
AMityville 4-6122

West Coast Factory
2055 Pontius Avenue
Los Angeles 25, Calif.

UHF

... Ultra High Frequencies



**RADIO INTERFERENCE
and FIELD INTENSITY *
measuring equipment**

Stoddart NM-50A • 375mc to 1000mc

Commercial Equivalent of AN/URM-17

ULTRA-HIGH FREQUENCY OPERATION... Frequencies covered include UHF and color television assignments and Citizen's Band. Used by TV transmitter engineers for plotting antenna patterns, adjusting transmitters and measuring spurious radiation.

RECEIVING APPLICATIONS... Excellent for measuring local oscillator radiation, interference location, field intensity measurements for fringe reception conditions and antenna adjustment and design.

SLIDE-BACK CIRCUIT... This circuit enables the meter to measure the effect of the peak value of an interfering pulse, taking into account the shaping due to bandwidth.

QUASI-PEAK FUNCTION... An aid in measuring pulse-type interference, the Quasi-Peak function is just one of the many features of this specially designed, rugged unit, representing the ultimate in UHF radio interference-field intensity equipment.

ACCURATE CALIBRATION... Competent engineers "hand calibrate" each NM-50A unit. This data is presented in simplified chart form for easy reference.

SENSITIVITY... Published sensitivity figures are based on the use of the NM-50A with a simple dipole antenna or RF probe. However, the sensitivity of this fine instrument is limited only by the antenna used. The sensitivity of the NM-50A is better than ten microvolts across the 50 ohm input.

Stoddart RI-FI* Meters cover the frequency range 14kc to 1000mc

VLF
NM-10A, 14kc to 250kc
Commercial Equivalent of
AN/URM-6B. Very low frequen-
cies.

HF NM-20B, 150kc to 25mc
Commercial Equivalent of
AN/PRM-1A. Self-contained
batteries. A.C. supply optional.
Includes standard broadcast
band, radio range, WWV, and
communications frequencies.
Has BFO.

VHF
NM-30A, 20mc to 400mc
Commercial Equivalent of
AN/URM-47. Frequency range
includes FM and TV bands.

STODDART AIRCRAFT RADIO Co., Inc.
6644-C Santa Monica Blvd., Hollywood 38, California • Hollywood 4-9294



Membership

(Continued from page 101A)

- Brodhead, W. M., 131 Clarendon St., Boston 16, Mass.
- Bromley, J. E., 214 W. Court St., Rome, N. Y.
- Broster, G. S., 5 Maple St., Hingham, Mass.
- Broughton, W. G., Broadcast Equipment Sales, General Electric Co., Box 1122, Syracuse, N. Y.
- Brown, C. H., 30 Gloucester Rd., Westwood, Mass.
- Brown, R. W., 247-41—76 Ave., Bellerose 6, L. I., N. Y.
- Brown, S. R., 309 Pleasant Ave., North Syracuse, N. Y.
- Brown, W. C., 204 Conant Rd., Weston, Mass.
- Browning, E. A., 8 Stonleigh Rd., Worcester, Mass.
- Brownman, H. L., 576 Pontiac Rd., East Meadow, L. I., N. Y.
- Browning, S. D., 1 Edward Ct., Baldwin, L. I., N. Y.
- Brunette, G. E., Box 25, Lee Center, N. Y.
- Buckingham, W. D., 86 Post Ln., Southampton, L. I., N. Y.
- Buegler, R. J., 229 Sylvan Knoll Rd., Stamford, Conn.
- Burgoyne, C. L., 19 Rebecca Rd., Canton, Mass.
- Burnett, L. J., Jr., 115 Elm St., New Rochelle, N. Y.
- Burroughs, G., Corrigan La., Greenwich, Conn.
- Burrows, H. R., 114 Alpine Dr., Rochester 10, N. Y.
- Burton, W. E., 1038 Front St., Binghamton 96, N. Y.
- Burzycki, M., Box 732, Alfred, N. Y.
- Busch, W. R., 50 White Oak St., New Rochelle, N. Y.
- Bustaris, J. G., 80-105 Tryon Pl., Jamaica Estates, L. I., N. Y.
- Cade, P. J., 24 Ginn Rd., Winchester, Mass.
- Callahan, G. F., 160 Milford Dr., W., Syracuse, N. Y.
- Campbell, R. H., Jr., Minshall Estey Organ, Inc., Brattleboro, Vt.
- Camp, S. N., 1413 Terrace Blvd., New Hyde Park, L. I., N. Y.
- Canfora, A. E., 6501—17 Ave., Brooklyn 4, N. Y.
- Carlin, J., 51 Idell Rd., Valley Stream, L. I., N. Y.
- Carlisle, S. F., Jr., Elmsford, N. Y.
- Carlson, E. R., R.F.D. 2, Maple Rd., Clay, N. Y.
- Carmody, T. P., 17 Puritan Dr., Barrington, R. I.
- Carney, P. G., Box 110, Haselton Rd., Rome, N. Y.
- Case, C. C., Jr., 9 Beckett St., Hoosick Falls, N. Y.
- Caspers, G. E., Jr., Box 333, Lake Nebagamon, Wis.
- Casselberry, R. L., General Electric Co., Electronics Park, Syracuse, N. Y.
- Castillo, H. T., 3431 Hedgely Rd., Springfield, Ohio
- Castle, R. L., 35 High St., Topsfield, Mass.
- Castor, A. H., 91 Bay St., Manchester, N. H.
- Caulfield, J. T., 410 Sunrise Dr., M.R., Johnson City, N. Y.
- Caywood, R. W., 220 Woburn St., Reading, Mass.
- Cetrone, V. C., 21 William Ave., Glen Head, L. I., N. Y.
- Chaber, R. K., 245-11—80 Rd., Bellerose, L. I., N. Y.
- Chanitz, L., 226 W. Tremont Ave., New York 53, N. Y.
- Chase, R. L., Brookhaven National Laboratory, Bldg. T-126, Upton, L. I., N. Y.
- Chertok, S. L., 33 Concord Pkwy., Pittsfield, Mass.
- Chester, E. B., 132 Avon Rd., Tonawanda, N. Y.
- Chismark, A. H., 92 Fourth St., Troy, N. Y.
- Chittenden, K. M., 44 Ellery Rd., Waltham, Mass.
- Chivers, C. C., Product Service, 920 Erie Blvd., E., Syracuse, N. Y.
- Chun, H. H., 32 Cedar St., Marblehead, Mass.
- Chynoweth, W. R., 106 Stephens Pl., North Syracuse, N. Y.
- Ciaschini, W., 17 Elmview Ter., Pittsfield, Mass.
- Clapp, C. W., 114 Sacandaga Rd., Scotia 2, N. Y.
- Clapp, R. E., 2 Gray Gardens E., Cambridge 38, Mass.
- Clark, D. L., 52 Pierce Rd., Watertown 72, Mass.

(Continued on page 101A)

miniature and standard

Pulse Transformers

by Keystone

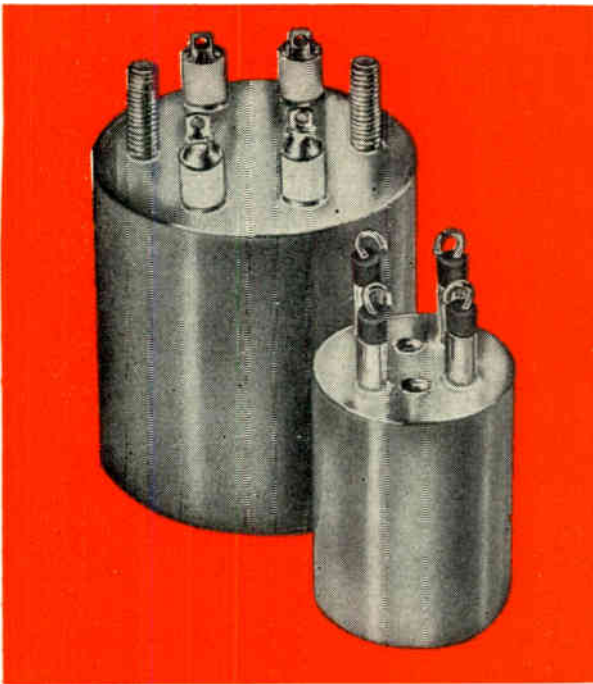

Design engineers and component manufacturers are constantly running into new problems requiring special pulse transformers.

Performance standards are higher for both military and commercial users. Rather than trying to make a standard unit stretch to do the job, more and more major component manufacturers are turning to Keystone custom-engineered pulse transformers. Keystone produces a wide variety of pulse transformers designed to meet your individual performance requirements with minimum size and weight.

Shown here are two typical Keystone units custom-engineered to meet specific requirements. The smaller one, model PT-175, is a line matching transformer. Pulse repetition rate is 1300 c.p.s., pulse duration is .1 to 1 microsecond, impedance is 75-1000 ohms. The unit is 1 3/8" high, has a diameter of 1", and weighs just 1.6 ounces. The larger unit is also a line matching transformer, model PT-403. It has a pulse repetition rate of 1500 c.p.s., pulse duration of .3 to 3 microseconds, and impedance of 100-2000 ohms. Diameter is 1 3/4", height is 1 7/8" and it weighs just 4 ounces. Both units are hermetically sealed, both meet applicable MIL specifications.



**write for new illustrated brochure,
"Modern Components"**

This new brochure describes and illustrates a wide variety of transformers and magnetic amplifiers produced to help you meet unusual and difficult specifications.

Write today for your copy.

If you are working on a particular problem involving a special pulse transformer—or if you would like to compare the performance of an individually-designed unit to the stock unit you are now using—contact the Engineering Department with an outline of your requirements. No obligation, of course.

keystone 
PRODUCTS COMPANY

904 23RD STREET UNION CITY 2, N. J.

TRAVELING-WAVE TUBES

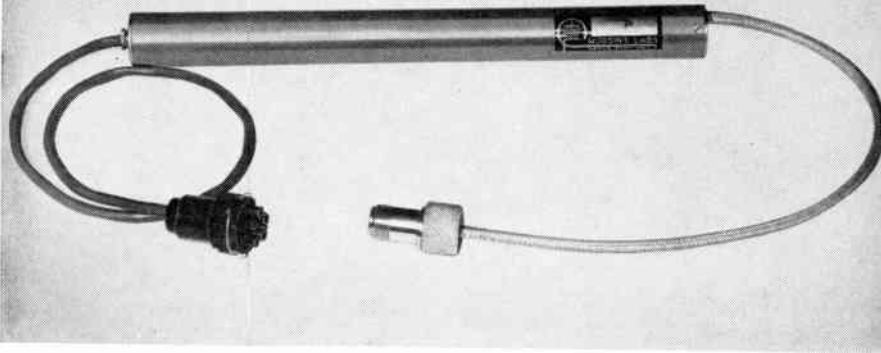

A backward-wave oscillator for X-Band application, the Huggins Type HIO-2B is voltage tuned from 7 to 14 kmc, requiring no mechanical adjustment. Producing medium power, it is readily adaptable to microwave frequency sweepers in automatic testing, and wideband receiving-transmitting uses.

GENERAL CHARACTERISTICS

frequency range	7 to 14 kmc
power output	10 dbm min (7.6-13.7 kmc) 4 dbm min (7.0-14.0 kmc)
helix voltage	300 to 3400 volts d-c
cathode current	12 ma
capsule length	10 7/8 in.
capsule diameter	1 in.
net weight	1 lb

X-Band (8.2 to 12.4 kmc)
Power 15 mw (approx)
Voltage 500 to 2000 v
(approx)



HUGGINS LABORATORIES

MENLO PARK 2

CALIFORNIA

STANDARD SIGNAL GENERATOR

MODEL
65-B
RANGE
75 KC
to
30 MC



Individually Calibrated Scale

- OUTPUT:** Continuously variable, .1 microvolt to 2.2 volts.
- OUTPUT IMPEDANCE:** 5 ohms to .2 volt, rising to 15 ohms at 2.2 volts.
- MODULATION:** From zero to 100%. 400 cycles, 1000 cycles and provision for external modulation. Built-in, low distortion modulating amplifier.
- POWER SUPPLY:** 117 volts, 50-60 cycles, AC.
- DIMENSIONS:** 11" high, 20" long, 10 1/4" deep, overall.
- WEIGHT:** Approximately 50 lbs.

Catalog on request

MANUFACTURERS OF
Standard Signal Generators
Pulse Generators
FM Signal Generators
Square Wave Generators
Vacuum Tube Voltmeters
UHF Radio Noise & Field Strength Meters
Capacity Bridges
Megohm Meters
Phase Sequence Indicators
Television and FM Test Equipment

MEASUREMENTS CORPORATION
BOONTON NEW JERSEY



(Continued from page 102A)

- Clark, F. E., 2 Farm Rd., Marlboro, Mass.
- Clark, N., Jr., 77 Prentice St., Waltham 54, Mass.
- Clark, S. C., Jr., General Electric Co., Rm. 337, Bldg. 22, Schenectady 5, N. Y.
- Cleary, E. P., 249 E. Manchester Rd., Syracuse 4, N. Y.
- Close, R. N., c/o Airborne Instruments Laboratory, 160 Old Country Rd., Mineola, L. I., N. Y.
- Coffey, W. N., Cornelia Ave., R.F.D. 1, Ballston Lake, N. Y.
- Cohen, A. B., 1325 Rosedale Ave., New York, N. Y.
- Cohen, A. L., 75-44—168 St., Flushing, L. I., N. Y.
- Cohen, D., 1664 Weeks Ave., New York 57, N. Y.
- Cohen, E., 67-14—108 St., Apt. 5C, Forest Hills, L. I., N. Y.
- Cohen, M., 508 Laurel St., Longmeadow 6, Mass.
- Cohen, S. B., 882 Bromton Dr., Westbury, L. I., N. Y.
- Cole, A. D., 75 Pitts St., Boston 14, Mass.
- Cole, B. R., 74 Oak Hill Dr., Arlington 74, Mass.
- Concelman, C. W., R.F.D. 4, Danbury, Conn.
- Davies, R. S., 6824 Chew Ave., Philadelphia 19, Pa.
- Day, W. J., 38 School St., Milton, Mass.
- Daykin, D. R., 1432 Arch Dr., Vestal, N. Y.
- Dayton, F. R., 6 Ambrose Ct., Baldwin, L. I., N. Y.
- De Agazio, E., Jr., 82 Oak St., Stoneham 80, Mass.
- Dean, C. M., 16 Oak Grove, Manchester, Conn.
- Dean, F. R., 267 High Rock St., Needham, Mass.
- Dean, W. N., 145 Tanners Pond Rd., Garden City, L. I., N. Y.
- De Bettencourt, J., 18 Sterling St., W. Newton 65, Mass.
- Decker, S. M., 125 White Rd., Mineola, L. I., N. Y.
- Dewey, C. S., 24 Florida St., Springfield 9, Mass.
- Diamond, J. M., 200 Columbia Hts., Brooklyn 1, N. Y.
- Dick, A. I., 67-11 Yellowstone Blvd., Forest Hills 75, L. I., N. Y.
- Dickinson, T. M., 901 Morgan Ave., Schenectady 9, N. Y.
- Dietz, H. G., 66-34 Selfridge St., Forest Hills, L. I., N. Y.
- Deitzler, R. P., 106 Baum Ave., North Syracuse, N. Y.
- Dillenback, G. V., Jr., Slingerlands, N. Y.
- Di Nozzi, A. D., 252 Broadway, Boston 11, Mass.
- Doellner, L. J., New City, N. Y.
- Donovan, L. N., 10028-105 St., Edmonton, Alta., Canada
- Drake, W. W., Jr., Raytheon Manufacturing Co., Waltham 54, Mass.
- Drisko, B. B., 160 Central St., Hingham, Mass.
- Dubin, L., Lambda Electronics Corp., 103-02 Northern Blvd., Corona 68, L. I., N. Y.
- Duckwald, C. S., Jr., 315 Terrace Rd., Schenectady 6, N. Y.
- Dudley, T. C., 6 Granite St., Foxboro, Mass.
- Duffy, D. P., 25 Poplar Pl., Glen Cove, L. I., N. Y.
- Duncan, N. L., 87 Goden St., Belmont 78, Mass.
- Dunefsky, M., 199-06—21 Ave., Whitestone 57, L. I., N. Y.
- Dunn, B. C., Jr., Commander Hotel, Cambridge 38, Mass.
- Dunnegan, T., Jr., 2154B Eastern Pkwy., Schenectady 9, N. Y.
- Durbin, E., 14 Hawthorne La., Valley Stream, L. I., N. Y.
- Dvorsky, A. L., 630 Buffalo St., Conneaut, Ohio
- Dwork, B. M., 25 Neillian Way, Bedford, Mass.
- Dyett, E. G., Jr., 385 Putnam Ave., Cambridge 39, Mass.
- Eachus, E. D., 105 Kristin Rd., N. Syracuse, N. Y.
- Edelberg, S., 7101 Shore Rd., Brooklyn 9, N. Y.
- Edmonston, A. S., 95 Hillside Ave., Wollaston, Mass.
- Edwards, L. C., 7 Fairview La., Randolph, Mass.
- Edwards, R. S., 27 Locust St., Garden City, L. I., N. Y.
- Eisaman, L. C., 58-25 Little Neck Pkwy., Little Neck, L. I., N. Y.

(Continued on page 108A)

cppe OFFERS HIGH QUALITY SYNCHROS

Consistently!

By Customer's Testing—
REJECTION RATE .00095

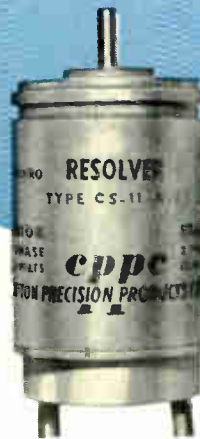

ACTUAL SIZE

Out of 9000 synchros recently supplied a customer for a single job, the rejection rate by his testing of some 20 characteristics was .095% on each test. Nearly 3/4 of the rejections were on minute differences of calibration measurements.

According to the customer, "this is far below rejection rates of 20% and 30% which we have experienced with regard to other sources of supply for like items."

A second customer reports that he has found CPCC synchros to have the next to the lowest rejection rate out of 500 suppliers. The only vendor having a lower rejection rate was a resistor manufacturer. (Names of both customers available on request.)

It costs no more to have the best! For highest consistent quality and accuracy, specify CPCC.

For full engineering information on size 10, 11, 15 and 22 synchros of virtually every type and available for 3 weeks or less delivery, write or phone, T. W. Shoop, Sales Mgr. Phone (Suburban Phila.) MADison 6-2101.

West Coast Rep. Wm. J. Enright, 988 Kensington Rd., Los Angeles. MUTual 6573.

Direct Export Sales inquiries to: Andrew S. Szucs, Inc., 50 Broad St., New York 4, N. Y.

LOOK TO CPCC FOR **cppe** SYNCHRO PROGRESS
CLIFTON PRECISION PRODUCTS COMPANY, INC.
CLIFTON HEIGHTS **PENNSYLVANIA**

23 Fields of Special Interest -

The 23 Professional Groups are listed below, together with a brief definition of each, the name of

ACTIVITIES

The IRE Professional Group has the responsibility of providing the individual with the advantages of a small, select society in the field of his specialization, with its own magazine, just as IRE provides him with the advantages of a large, general society. The advantages of the small society relate primarily to meetings and to publications. Specialized symposia may be arranged either to coincide with IRE Conventions or to occur where there are places of large activity in the field of interest.

The Group is concerned with the advancement of scientific engineering leading to increased professional standing in its field and serves to aid in promoting close cooperation and exchange of technical information among its members. It provides a forum for discussion and presentation of papers on subjects of mutual interest, and provides smaller, more compact Groups who may meet on the common basis of professional interests.

ORGANIZATION

The IRE Professional Group is established under a constitution within the framework of the IRE. The constitution defines the technical field of interest of the Group, establishes committee structures, describes broadly its functions and procedures, and fixes a minimum level of activity. The management of an IRE Professional Group is in the hands of its Administrative Committee, the officers and members of which are elected annually. The IRE provides financial assistance to the Groups in accordance with their activity and current needs.

PUBLICATIONS

Every Group publishes a magazine which is called TRANSACTIONS of the Professional Group, generally on a regular quarterly schedule. The TRANSACTIONS serve to preserve and disseminate the body of knowledge that constitutes the fields of interest of the Groups. All editions are distributed without additional cost to members who have paid the annual assessment.

The CONVENTION RECORD covering the sessions presented at the IRE National Convention is furnished without further charge to the members of Groups who have paid assessments.

MEMBERSHIP

IRE members of any grade are eligible for membership in the IRE Professional Groups and will receive all Group publications upon payment of the prescribed assessments. An IRE member may join as many Professional Groups as serve his interests and wishes.

To join IRE Professional Groups, indicate on the application coupon in the lower right-hand corner of the opposite page the Group or Groups you wish to join. Detach completed coupon and mail with your check for assessments to The Institute of Radio Engineers, 1 East 79th Street, New York 21, N.Y.

Aeronautical and Navigational Electronics

The application of electronics to operation and traffic control of aircraft and to navigation of all craft.

Mr. Edgar A. Post, Chairman, United Air Lines, Operations Base, Stapleton Field, Denver 7, Colo.
 Fee \$2. 13 Transactions, 4 Newsletters, *5, *6, *8, & *9, and *Vol. ANE-1, Nos. 1, 2, 3 and 4.

Antennas and Propagation

Technical advances in antennas and wave propagation theory and the utilization of techniques or products of this field.

Mr. Delmer C. Ports, Chairman, Jansky & Bailey, 1339 Wisconsin Ave., N.W., Washington 7, D.C.
 Fee \$4. 11 Transactions, 1 Newsletter, *4, *Vol. AP-1, Nos. 1, 2; *Vol. AP-2, Nos. 1-4; AP-3, No. 1-2.

Audio

Technology of communication at audio frequencies and of the audio portion of radio frequency systems, including acoustic terminations, recording and reproduction.

Mr. Winston E. Kock, Chairman, Bell Telephone Laboratories, Inc., Murray Hill, N.J.
 Fee \$2. 24 Transactions, 4 Newsletters. *5, *7, *10. *Vol. AU-1, Nos. 1-6; *Vol. AU-2, Nos. 1-5; Vol. AU-3, Nos. 1-2.

Automatic Control

The theory and application of automatic control techniques including feedback control systems.

Mr. Robert B. Wilcox, Chairman, Raytheon Mfg. Co., 148 California St., Newton 58, Mass.
 Fee \$2.

Broadcast & Television Receivers

The design and manufacture of broadcast and television receivers and components and activities related thereto.

Mr. Wilson P. Boothroyd, Chairman Philco Corporation, Tioga and "C" Sts. Philadelphia 32, Pa.
 Fee \$2. 9 Transactions. *1, *2, *3, *5, *6, *7, 8; BTR-1, No. 1.

Broadcast Transmission Systems

Broadcast transmission systems engineering, including the design and utilization of broadcast equipment.

Mr. Lewis Winner, Chairman, Bryan Davis Publishing Co., 52 Vanderbilt Avenue, New York 17, N.Y.
 Fee \$2. 1 Transaction, No. 1.

Circuit Theory

Design and theory of operation of circuits for use in radio and electronic equipment.

Dr. Chester H. Page, Chairman, National Bureau of Standards, Connecticut Avenue, Washington 25, D.C.
 Fee \$2. 7 Transactions. *1, *2, *Vol. CT-1, Nos. 1-4; CT-2, No. 1.

Communications Systems

Radio and wire telephone, telegraph and facsimile in marine, aeronautical, radio-relay, coaxial cable and fixed station services.

Col. J. Z. Millar, Chairman, Western Union Telegraph Co., Room 833, 60 Hudson St., New York 13, N.Y.
 Fee \$2. 4 Transactions, 5 Newsletters. *Vol. CS-1, No. 1; *Vol. CS-2, Nos. 1-2; CS-3, No. 1.

Component Parts

The characteristics, limitation, applications, development, performance and reliability of component parts.

Mr. Floyd A. Paul, Chairman, Bendix Development Lab., 116 W. Olive Ave., Burbank, Calif.
 Fee \$2. 3 Transactions. *PGCP-1-2-3.

Electron Devices

Electron devices, including particularly electron tubes and solid state devices.

Mr. George Espersen, Chairman, Phillips Labs., Inc., Irvington-on-Hudson, N.Y.
 Fee \$2. 9 Transactions, 3 Newsletters, 2 Technical Bulletins. *1, *2, *4, *Vol. ED-1, Nos. 1-4; ED-2, No. 1.

THE INSTITUTE OF RADIO

- IRE's 23 Professional Groups

the group chairman, and publications to date.

* Indicates publications still available.

<p>Electronic Computers</p> <p><i>Design and operation of electronic computers.</i></p> <p>Mr. Harry T. Larson, Chairman, Ramo-Wooldridge Corp., 8820 Belanca Ave., Los Angeles 45, Calif.</p> <p>Fee \$2. 13 Transactions, 5 Newsletters. *Vol. EC-2, Nos. 2-4; *Vol. EC-3, Nos. 1-4; EC-4, No. 1.</p>	<p>Engineering Management</p> <p><i>Engineering management and administration as applied to technical, industrial and educational activities in the field of electronics.</i></p> <p>Mr. C. J. Breitwieser, Chairman, Lear, Inc., 3171 S. Bundy Drive, Los Angeles 34, Calif.</p> <p>Fee \$1. 2 Transactions, 8 Newsletters. *1, *2.</p>	<p>Industrial Electronics</p> <p><i>Electronics pertaining to control, treatment and measurement, specifically in industrial processes.</i></p> <p>Mr. George P. Bosomworth, Chairman, Firestone Tire and Rubber Co., Akron 17, Ohio.</p> <p>Fee \$2. 2 Transactions, *PGIE-1-2.</p>
<p>Information Theory</p> <p><i>Information theory and its application in radio circuitry and systems.</i></p> <p>Mr. Louis A. DeRosa, Chairman, Federal Telecommunications Lab., Inc., 500 Washington Ave., Nutley, N.J.</p> <p>Fee \$2. 4 Transactions, 1 Newsletter. *2, *3, 4.</p>	<p>Instrumentation</p> <p><i>Measurements and instrumentation utilizing electronic techniques.</i></p> <p>Mr. Robert L. Sink, Chairman, Consolidated Engineering Corp., 300 N. Sierra Madre Villa, Pasadena, Calif.</p> <p>Fee \$1. 3 Transactions. *2, *3.</p>	<p>Medical Electronics</p> <p><i>The application of electronics engineering to the problems of the medical profession.</i></p> <p>Dr. Julia F. Herrick, Chairman, Mayo Foundation, Rochester, Minn.</p> <p>Fee \$1. 1 Transaction. 3 Newsletters. *1.</p>
<p>Microwave Theory and Techniques</p> <p><i>Microwave theory, microwave circuitry and techniques, microwave measurements and the generation and amplification of microwaves.</i></p> <p>Mr. William M. Mumford, Chairman, Bell Telephone Labs., Whippany, N.J.</p> <p>Fee \$2. 6 Transactions. *Vol. MTT-1, No. 2; *Vol. MTT-2, Nos. 1-3; MTT-3, No. 1.</p>	<p>Nuclear Science</p> <p><i>Application of electronic techniques and devices to the nuclear field.</i></p> <p>Dr. Donald H. Loughridge, Chairman, Northwestern Tech. Inst., Evanston, Ill.</p> <p>Fee \$2. 1 Transaction, 3 Newsletters.</p>	<p>Production Techniques</p> <p><i>New advances and materials applications for the improvement of production techniques, including automation techniques.</i></p> <p>Mr. R. R. Batcher, Chairman, 240-02 42nd Ave., Douglaston, L.I., N.Y.</p> <p>Fee \$1.</p>
<p>Radio Telemetry and Remote Control</p> <p><i>The control of devices and the measurement and recording of data from a remote point by radio.</i></p> <p>Mr. Martin V. Kiebert, Jr., Chairman, Convair, P.O. Box 1011, Pomona, Calif.</p> <p>Fee \$2. Transactions, Newsletter. 1-2.</p>	<p>Reliability and Quality Control</p> <p><i>Techniques of determining and controlling the quality of electronic parts and equipment during their manufacture.</i></p> <p>Mr. Leon Bass, Chairman, Jet Engine Department, General Electric Co., Cincinnati 15, Ohio</p> <p>Fee \$2. 4 Transactions, 1 Newsletter. *1, *2, *3, 4.</p>	<p>Ultrasonics Engineering</p> <p><i>Ultrasonic measurements and communications, including underwater sound, ultrasonic delay lines, and various chemical and industrial ultrasonic devices.</i></p> <p>Mr. Amor L. Lane, Chairman, 706 Chillum Road, Hyattsville, Md.</p> <p>Fee \$2. 2 Transactions, 4 Newsletters. *1, 2.</p>
<p>Vehicular Communications</p> <p><i>Communications problems in the field of land and mobile radio services, such as public safety, public utilities, railroads, commercial and transportation, etc.</i></p> <p>Mr. W. A. Shipman, Chairman, Columbia Gas Systems Service Corp., 120 East 41st St., New York 17, N.Y.</p> <p>Fee \$2. 4 Transactions, 2 Newsletters. *2, *3, *4.</p>	<p style="text-align: center;">USE THIS COUPON</p> <p style="text-align: right;">PG-5-55</p> <p>Miss Emily Sirjane IRE—1 East 79th St., New York 21, N.Y.</p> <p>Please enroll me for these IRE Professional Groups</p> <p>..... \$</p> <p>..... \$</p> <p>Name</p> <p>Address</p> <p>Place</p> <p>Please enclose remittance with this order.</p>	

ENGINEERS



1 East 79th Street, New York 21, N.Y.

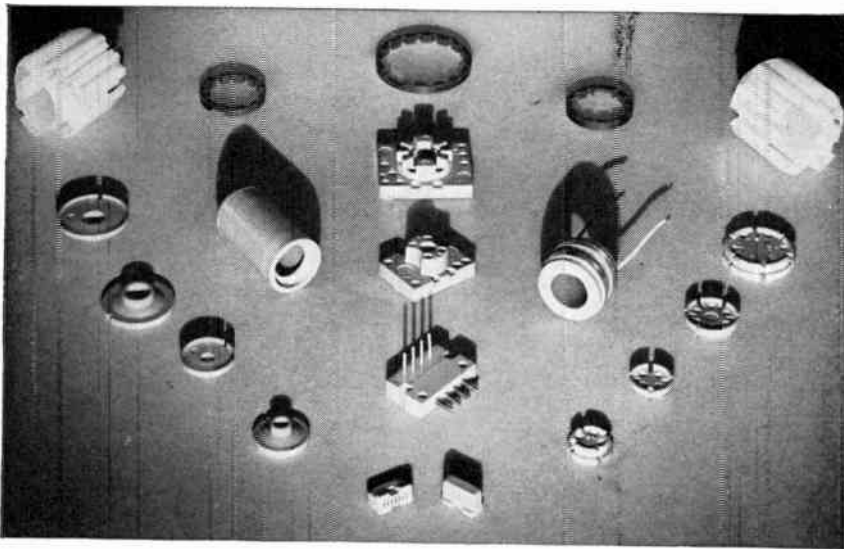

COME TO **EBY** for **SPECIALIZED MOLDING**

Results count! That's the story of the Eby molding service—the right combination of sound engineering, efficient equipment for both thermosetting and injection molding, metal parts fabrication and assembly if required—*plus* a lot of "savvy" in the production of close tolerance out-of-the-ordinary work.

Perhaps in the past you have thought of Eby only as a components manufacturer—it still is an important part of our business. However, the reputation of Eby molding has spread through the industry, so that today Eby ingenuity and ability in molding is preferred by many—because it's specialized for the critical or difficult jobs that must be done right.

Come to Eby . . . first, in molding to your exact requirements.

HUGH H. **EBY** CO.

4702 Stenton Ave., Philadelphia 44, Pa.



(Continued from page 104A)

- Eisenberg, A. J., 284 Cedarhurst Ave., Cedarhurst, L. I., N. Y.
 Elderkin, C. J., 230 Cochran Pl., Valley Stream, L. I., N. Y.
 Elkins, R. A., 136 Edden La., North Syracuse, N. Y.
 Elliott, C. I., 24 Leicester Rd., Belmont 78, Mass.
 Elliott, J. O., 25 Oxford Rd., Massapequa, L. I., N. Y.
 Ellis, F. W., Servo Corporation of America, 2020 Jericho Tnpk., New Hyde Park, L. I., N. Y.
 Ellis, II, J., Jr., 3555 Lufberry Ave., Wantagh, L. I., N. Y.
 Ellis, L. W., Jr., 75 Thomas Rd., Westport, Conn.
 Engel, L., 129 Garden Dr., Albertson, L. I., N. Y.
 Eteson, D. C., 35 Farnum St., Worcester 9, Mass.
 Evans, R. E., 376 Mill Hill Rd., Southport, Conn.
 Faulkner, W. H., Jr., Tracer Laboratory, Inc., 130 High St., Boston 10, Mass.
 Federer, A. M., 1479 Cromwell Ave., New York 52, N. Y.
 Fiorello, E. A., 91 Dudley St., Medford 55, Mass.
 First, D., 69-31—226 St., Bayside 4, L. I., N. Y.
 Flaherty, J. M., 317 Marose Dr., Pittsburgh 35, Pa.
 Fogel, C. M., 161 Admiral Rd., Buffalo 16, N. Y.
 Fogg, G. E., Jr., Sylvania Electric Products, Inc., Seneca Falls, N. Y.
 Fountain, H. F., Durham Rd., R.F.D. 2, N. Madison, Conn.
 Fowler, C. A., Box 101, East Norwich, L. I., N. Y.
 Fraenckel, V. H., 3 Henry St., Scotia, N. Y.
 Fragola, C. F., 436 Locust Ave., Uniondale, L. I., N. Y.
 Francoeur, G. R., 87-31 Britton Ave., Elmhurst, L. I., N. Y.
 Fram, E. G., 155 Summer St., Framingham, Mass.
 Fredrick, A. H., Millwood Rd., R.F.D. 1, Mt. Kisco, N. Y.
 French, E. C., 344 Farmington Ave., Hartford 5, Conn.
 Frerking, H. W., 2015 Central Dr., S., East Meadow, L. I., N. Y.
 Freeman, O. S., Jr., 67-49G—192 La., Fresh Meadows, L. I., N. Y.
 Friebele, E. J., 40 Sunset Dr., Manhasset, L. I., N. Y.
 Friedman, O., 495 E. 178 St., New York 57, N. Y.
 Frirree, F. L., 108 Shady Hill Rd., Newton Highlands 61, Mass.
 Fuelling, P. W., Box 269, Mastic Beach, L. I., N. Y.
 Gabor, W. D., 32 Adams Ave., Norwalk, Conn.
 Gada, N., General Electric Supply Co., 145 N. Beacon St., Brighton 35, Mass.
 Garceau, L., Electro-Medico Laboratory, South Woodstock, Vt.
 Goldstein, I., 393 Broadway, Cambridge, Mass.
 Goldstein, M., 3602 Avenue J., Brooklyn, N. Y.
 Goodman, J., 420 Broadway, Massapequa Park, L. I., N. Y.
 Goodstein, J., 74 Riverdale Rd., Green Acres, Valley Stream, L. I., N. Y.
 Goodway, J. T., 64 Waterman Rd., Roslindale 31, Mass.
 Goodwin, A. R., General Electric Co., Electronics Park, Rec. Bldg. 5, Syracuse, N. Y.
 Goodwin, V. D., Sylvania Electric Products, Inc., Products Development Laboratory, 83-30 Kew Gardens Rd., Kew Gardens 15, L. I., N. Y.
 Gorczyk, E., 29 Diamond St., Brooklyn 22, N. Y.
 Gordon, T. M., Jr., Box 76, Brookfield, Conn.
 Goronin, A., 412 Schenck Ave., Brooklyn 7, N. Y.
 Gould, G. B., c/o Mackay Radio & Telegraph Co., Box 440, Brentwood, L. I., N. Y.
 Goulder, M. E., Sanders Associates, Inc., 137 Canal St., Nashua, N. H.
 Graef, R. L., 208 Westbury Ave., Mineola, L. I., N. Y.

(Continued on page 110A)

FOR YOUR AUTOMATION PROGRAM

VARIABLE RESISTORS FOR PRINTED CIRCUITS



Type UPM-45
 For TV preset control applications. Control mounts directly on printed circuit panel with no shaft extension through panel. Recessed screwdriver slot in front of control and 3/8" knurled shaft extension out back of control for finger adjustment. Terminals extend perpendicularly 7/32" from control's mounting surface.



Type U70 (Miniaturized)
 Threaded bushing mounting. Terminals extend perpendicularly 5/32" from control's mounting surface.

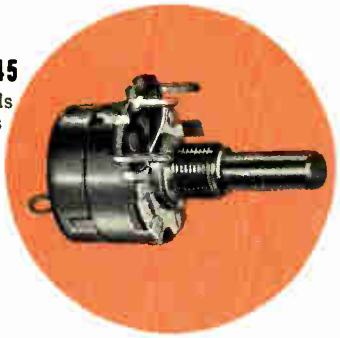

Type GC-U45
 Threaded bushing mounting. Terminals extend perpendicularly 7/32" from control's mounting surface. Available with or without associated switches.



Type YGC-B45
 Self-supporting snap-in bracket mounted control. Shaft center spaced 29/32" above printed circuit panel. Terminals extend 1-1/32" from control center.

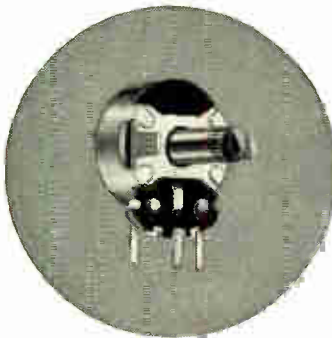

Type XP-45
 For TV preset control applications. Control mounts on chassis or supporting bracket by twisting two ears. Available in numerous shaft lengths and types.



Type XGC-45
 For applications using a mounting chassis to support printed circuit panel. Threaded bushing mounting.

VARIABLE RESISTORS FOR SOLDERLESS "WIRE-WRAP" CONNECTIONS

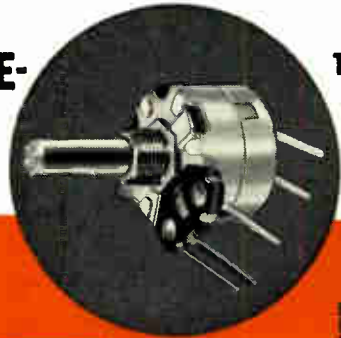

Type WGC-45
 Designed for solderless wire-wrapped connections with the use of present wire-wrapping tools. Available with or without switch and in single or dual construction.

The controls illustrated are typical constructions. CTS' years of engineering and technical experience makes available many other types for your automation needs.



CHICAGO TELEPHONE SUPPLY Corporation
 ELKHART • INDIANA
 FOUNDED 1894

EAST COAST OFFICE
 Henry E. Sanders
 130 North Broadway
 Camden 2, New Jersey
 Phone: Woodlawn 6-1628
 TWX No. Camden NJ 380
 Photo. Phone: Market 7-3129

SOUTHWESTERN U.S.A.
 John A. Green, Company
 5415 Oriole Drive
 P.O. Box 7234
 Dallas 9, Texas
 Phone: Dixon 9915

SOUTH AMERICA
 Jose Luis Pontar
 Buenos Aires, Argentina
 Montevideo, Uruguay
 Rio de Janeiro, Brazil
 Sao Paulo, Brazil

WEST COAST OFFICE
 Robert A. Stackhouse
 908 S. Robertson Blvd.
 Los Angeles 35, Calif.
 Phone: Crestview 4-3431
 TWX No. SEV H 7666

CANADIAN DIVISION
 C. C. Meredith & Co., Ltd.
 Streetsville, Ontario
 Phone: 310

OTHER EXPORT
 Sylvan Ginsbury
 8 West 40th Street
 New York 18, New York
 Phone: Pennsylvania 5-8239

The Exclusive Specialists in Precision Mass Production of Variable Resistors

Electronic Assembly 10/1964

for modern, profitable
automatic production...

...call on **KAHLE**

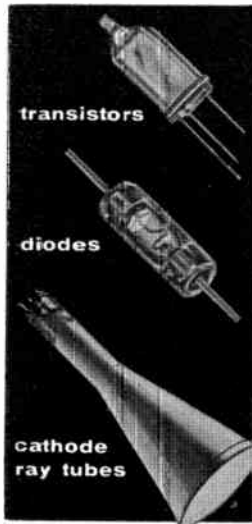

Write for information
on special experimental
and research services
offered by Kahle.

...world's leading
exclusive
manufacturer
of production
machinery for the
electronics field

If you're making (or plan to make) *diodes, transistors, sub-miniature, miniature, cathode ray tubes, or other electronic tubes or component parts*, take full advantage of Kahle's invaluable experience. With Kahle methods and "know-how" you're sure of getting exactly the right machinery to produce exactly what you want...accurately, dependably, profitably. For more than a quarter of a century the leaders in the electronics field have relied on Kahle for production machinery. Typical production steps automatically performed by Kahle equipment include sealing, bulb making, stem making, exhausting, grid winding, filament coil winding, lead wire welding.

Write today for additional details, equipment specifications, production data, and quotations.

Kahle ENGINEERING
COMPANY
1310 SEVENTH STREET • NORTH BERGEN, N.J.



(Continued from page 108A)

- Graham, R. C., R.F.D. 4, Rome, N. Y.
Graham, W., Fairchild, Wyandanch, L. I., N. Y.
Grahame, F. W., 1 Grove St., Fort Edward, N. Y.
Gray, J. S., 4069 W. 13 Ave., Vancouver 8, B. C., Canada
Gulack, J. G., 31-23 Grunstra Pl., Fair Lawn, N. J.
Harris, W. A., 48 Evergreen La., Haddonfield, N. J.
Jesurun, M. M., 609 Ritchie Ave., Silver Spring, Md.
Kaetel, H. C., 3145-A N. 48 St., Milwaukee 16, Wis.
Klein, A. L., Clausiusstr 48, Zurich 6, Switzerland
Kohn, E. B., 1944 W. Touhy, Chicago 26, Ill.
Kuhn, B. G., Box 399, RCAF Station, Ruckcliffe, Ont., Canada
Lakebrink, R. T., 36 Polk Dr., Huntsville, Ala.
Lang, G. R., 90 Ellington Dr., Wexford, Ont., Canada
Mentink, A. F., 2407 Fairview Ave., Cincinnati 19, Ohio
Miller, C. V., 4709 W. 75 St., Kansas City 15, Mo.
Mueller, E. L., 8012 Kimbark Ave., Chicago 19, Ill.
Myers, E. N., 245 E. Key Blvd., Oklahoma City 10, Okla.
Oberlies, J. L., 22 Sleepy La., Hicksville, L. I., N. Y.
Perrin, B. J., 3838 Grupe Ave., Akron 19, Ohio
Price, E. L., 3758 Cerritos Ave., Long Beach 7, Calif.
Robson, A. B., Jr., NAESU, Naval Rec. Sta., Washington 25, D. C.
Romanelli, P. A., 1563 West St., Utica 3, N. Y.
Schultek, L. R., 113 Rose La., Apt. 9D, Rome, N. Y.
Spilman, J. C., 34 Lakeshore Dr., Little Rock, Ark.
Spriggs, L. A., Jr., 155 Wellington Ave., Washington, Pa.
Thomas, E. C., 7280th Maint Group, Box 98, APO 30, New York, N. Y.
Tupman, L. M., 1118 Madeleine Cir., Cincinnati 31, Ohio
Usher, R., Box 46, St. Albert, Alta., Canada
Wood, F. P., Seattle University, Seattle 22, Wash.
Yamron, J., Massachusetts Institute of Technology, Instrumentation Laboratory, 68 Albany St., Cambridge 39, Mass.
Yunk, G. W., 2236 Kaelin Ave., Louisville 5, Ky.

Admission to Member

- Arndt, R. J., 8428 S. Carpenter St., Chicago 20, Ill.
Attali, G., 3602 Drummond, Houston, Tex.
Attridge, C. C., 215 Winding Way, Horseheads, N. Y.
Baranovsky, C., Argyle, Man., Canada
Barasch, H. P., 359 Glencove Ave., Carle Place, Hempstead, L. I., N. Y.
Bouvy, J. W., Box 374, Parris Island, S. C.
Bruce, C. R., c/o RCA, 589 E. Illinois, Chicago, Ill.
Coulter, H. N., Box 536, R.F.D. 1, Carmel, Calif.
Cutteridge, O. P. D., Electrical Engineering Department, College of Technology, Manchester 1, England
Daugherty, E. J., 919 Motter Ave., Frederick, Md.
Davis, C. W., 19500 Stagg, Reseda, Calif.
Davis, E. S., Hotel Belmont, Newark, N. J.
Douglas, A., Seafield, Wharf Lane, Radcliffe on Trent, Notts., England
Downing, G., #12, 11730B-127 St., Edmonton, Alta., Canada
Draper, C. A., 6315 Poppleton Ave., Omaha 6, Nebr.
Ducey, R. J., No. 8 Hangar, Airport, Edmonton, Alta., Canada
Evans, J. E., 1211 Atlantic Ave., Rochester 10, N. Y.
Fegely, W. D., 1905 Pine, Elkridge 27, Md.
Fithian, D. H., 1081 N. Los Robles Ave., Pasadena 6, Calif.
Flagler, R. H., 1210 E. 94, Seattle 5, Wash.
Goodwin, J. P., Jr., 907 N.E. Main St., College Park, Ga.

(Continued on page 112A)



PHASE DISPLAY EQUIPMENT

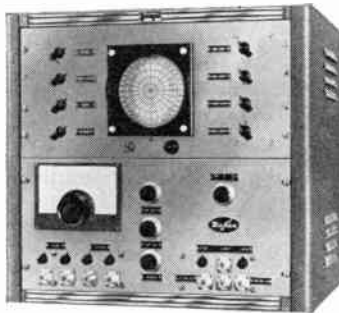

The PDE-1 displays the transfer function of any network, amplifier, or system as a polar plot of phase and amplitude, over the range of 100 kc to 10 mc. Sweep width is adjustable to 10 mc. Built-in marker generator. Ideal for transistor studies and measurements. Can be used in design and evaluation of feedback amplifiers and servo systems. Descriptive flyer forwarded on request.

Literature is available on our complete line of color television instruments for the studio, laboratory, and factory.

Wickes ENGINEERING AND CONSTRUCTION COMPANY
12TH STREET AND FERRY AVENUE ESTABLISHED 1920 CAMDEN 4, NEW JERSEY

**ARE YOU ASKED TO RECOMMEND
HIGH FIDELITY LOUD-
SPEAKER SYSTEMS?**

Then you will be interested in the corner horn types developed and licensed by Paul W. Klipsch and the units manufactured by Klipsch and Associates. Their performance is the closest approach to fidelity now available and the horns are adaptable to new advances in the art, if and when they are achieved.

Write for new literature on the Klipschorn and Shorthorn corner horn loudspeaker systems.

KLIPSCH & ASSOCIATES
Hope, Arkansas
Paul W. Klipsch, Owner-Manager; member
Acoustical Society of America, S.M., IRE.



**Goodness!
Such growth!**

During the past five years, the radio-electronic industry's spectacular growth has been paced by the increase of advertising pages in the annual IRE DIRECTORY.

In the 1949 edition, 158 advertisers took 133 pages. In the 1954 IRE DIRECTORY, the number of advertisers mushroomed to 501 and advertising pages numbered 358—an increase of 168% over the '49 edition.

The IRE DIRECTORY sells year 'round by serving over 35,000 IRE members who daily are developing and perfecting remarkable new devices. To sell ahead, put your product story before radio-electronic engineers who are planning ahead ... in the 1955 IRE DIRECTORY.

**Engineers are educated
to specify and buy.**

IRE DIRECTORY



Published by

The Institute of Radio Engineers

Adv. Dept., 1475 Broadway,
New York 36, N. Y. BRyant 9-7550

Bliley

CRYSTALS IN

AERONAUTICAL ELECTRONICS

Frequency control in guided missiles and in airborne communications requires an advanced degree of design and craftsmanship. That's why Bliley crystals, crystal ovens, and custom built oscillator assemblies are first choice for both prototypes and production. If you want it built better, call in Bliley.

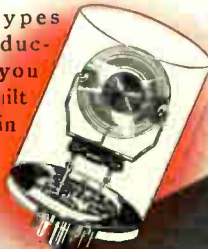

Bliley crystals fly with the famous "Matador" pilotless bomber built by the Martin Company, Baltimore.



BLILEY ELECTRIC COMPANY
UNION STATION BUILDING • ERIE, PENNSYLVANIA

Where accuracy is

VITAL!

You Can Depend On ARC Test Equipment



The Type H-14A Signal Generator has two uses: (1) It provides a sure and simple means of checking omnirange and localizer receivers in aircraft on the field, by sending out a continuous test identifying signal on hangar antenna. Tuned to this signal, individual pilots or whole squadrons can test their own equipment. The instrument permits voice transmission simultaneous with radio signal. (2) It is widely used for making quantitative measurements on the bench during receiver equipment maintenance.

The H-16 Standard Course Checker measures the accuracy of the indicated omni course in ARC's H-14A or other omni signal generator to better than 1/2 degree. It has a built-in method of checking its own precision.

Type H-12 Signal Generator (900-2100 mc) is equal to military TS-419/U, and provides a reliable source of CW or pulsed rf. Internal circuits provide for control of width, rate and delay of internally-generated pulses. Complete specifications furnished on request.

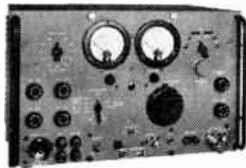

Type H-14A
Signal Generator



Type H-16
Standard Course Checker

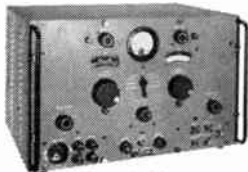

Type H-12
UHF Signal Generator

Dependable Airborne Electronic Equipment Since 1928

Aircraft Radio Corporation

BOONTON, NEW JERSEY

Omni Receivers • 900-2100 Mc Signal Generators • UHF and VHF Receivers and Transmitters • 8-Watt Audio Amplifiers • 10-Channel Isolation Amplifiers • LF Receivers and Loop Direction Finders



Membership

(Continued from page 110A)

- Gottlieb, E., 1532 Dwight Pl., New York 65, N. Y.
 Granger, F. P., Jr., 3021 Cortez, Garland, Tex.
 Greenberg, E., 99-63—66 Ave., Forest Hills, L. I., N. Y.
 Gunn, K. C. C., Old Road to 9 Acre Corner, Concord, Mass.
 Hariu, W. R., 3908 W. 54 St., Des Moines, Iowa
 Harrower, G. A., Bell Telephone Laboratories, Murray Hill, N. J.
 Hartel, B., Bell Telephone Laboratories, 204 Graham-Hopedale Rd., Burlington, N. C.
 Harter, W. R., 5469 Muddy Creek Rd., Cincinnati 32, Ohio
 Hase, A. M., 24 Armstrong Dr., R.F.D. 2, West Hill, Ont., Canada
 Hatchett, C., 1113 Pinedale Rd., Cocoa, Fla.
 Helms, C. M., Box 596, Kernersville, N. C.
 Henke, G. W., 95 Grand Ave., Freeport, L. I., N. Y.
 Hill, W. W., III, 4505C Dunland Rd., Baltimore 29, Md.
 Islam, M. N., Karachi Polytechnic Institute, Karachi, Pakistan
 Jeska, R. D., 9460 Louis Ave., Detroit 39, Mich.
 Kaprielian, Z. A., California Institute of Technology, Pasadena, Calif.
 Key, B. P., 1910—62 St., Lubbock, Tex.
 Knowles, C. H., 16-C Beech Spring Gardens, Summit, N. J.
 Knox, P. C., Westinghouse Air Arm Division, CES, Friendship International Airport, Baltimore 27, Md.
 Koch, G. E., 761 Los Altos Ave., Los Altos, Calif.
 Kotulak, J. J., Box 60, 3337th Technical Training Sq., Scott AFB, Ill.
 Kufluk, A., 216 Lakeshore Ave., Toronto 2, Ont., Canada
 Kunkel, B. M., 9 Park La., Darien, Conn.
 Lamb, R. W. H., Radio Station CFCN, 12 Ave. & Sixth St., E. Calgary, Alta., Canada
 Lambros, J. G., 1212 Tenth St., Apt. 7, Santa Monica, Calif.
 Lampard, D. G., Electrical Engineering Department, Columbia University, New York 27, N. Y.
 Lee, R. M., 5122 W. 123 St., Hawthorne, Calif.
 Mager, R. F., 811 Peru St., El Paso, Tex.
 Mahany, T. D., Jr., 19 Wrexham Ct., S., Tona-wanda, N. Y.
 Marx, A. C., 4656 N. Monticello Ave., Chicago 25, Ill.
 Mazziotti, F., Springwood Village, Apt. 5E, Hyde Park, N. Y.
 McKinney, R. C., 208 W. Avery St., Dallas, Tex.
 Miller, C. E., 42 Peters Pl., Red Bank, N. J.
 Molzahn, H. W., 141 Elgin Ave., Forest Park, Ill.
 Morris, C. R., 156 S. 52, Tacoma, Wash.
 Murphy, G. J., Electrical Engineering Department, University of Minnesota, Minneapolis, Minn.
 Musty, C. V., 1081 Los Robles Ave., Pasadena 6, Calif.
 Naylor, T. K., Rm. 20 C-002A, Massachusetts Institute of Technology, 77 Massachusetts Ave., Cambridge 39, Mass.
 Palmer, J. R., 324 Homan Ave., State College, Pa.
 Peterson, R. K., 37 A Thomas St., Harrisburg, Pa.
 Piantoni, G. L., 22 Central Ave., North Adams, Mass.
 Piloty, R., Technische Hochschule 21, Arcisstrabe, München, Germany
 Porterfield, C. P., The Method X Co., 3113 Forbes, Pittsburgh 30, Pa.
 Przybyl, R. P., 46 Greenfield, Clover Bank, Twn. Hamburg, N. Y.
 Quan, H. L., Box 1145, 638 Pico St., Ventura, Calif.
 Quell, C. H., 67 Bromleigh Rd., Stewart Manor, L. I., N. Y.
 Richardson, K. C., c/o Department 70, Bendix Radio, Greenspring & Smith Aves., Baltimore 9, Md.

(Continued on page 114A)

E-I*presents*

LINE OF HERMETICALLY SEALED

NEW

EXPANDED

*PATENTS
PENDING—
ALL RIGHTS
RESERVED**COMPRESSION
TYPE
END SEALS****FOR HERMETICALLY SEALING
CONDENSERS, RESISTORS AND
OTHER TUBULAR COMPONENTS**

E-I standardization now makes it possible to offer designers and engineers the economy of standard components in a wide selection of types and sizes. These rugged compression type end seals are available in a broad range of dimensions, in either flared tube or pierced terminals, with single or multiple lead terminations. Inquiries invited.

*-here's how***COMPRESSION
CONSTRUCTION
PROVIDES THE
TIME-PROVEN
LASTING SEALS**

In this exclusive E-I compression construction, the glass remains under constant compression and is therefore extremely strong. These seals possess extraordinary immunity to shock, vibration and pressure changes. For all practical purposes E-I Compression Seals are indestructible. No special skill is required to apply and assembly is rapid as all metal parts are tin dipped for easy soldering.

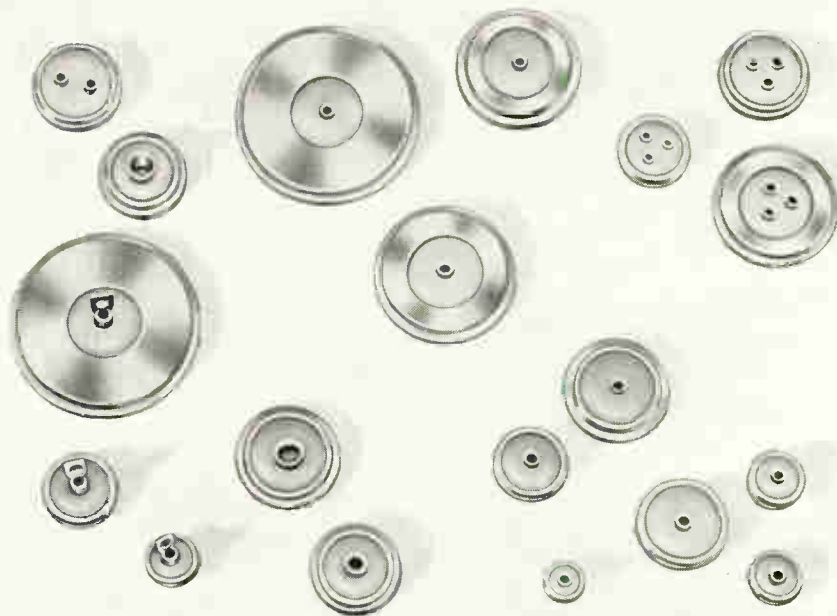

E-I Leadership—in the field of hermetic sealing assures dependability, economy and fast delivery . . . specify E-I for multiple headers, octal plug-ins, transistor bases and closures, sealed terminals, end seals and color coded terminals.

**ELECTRICAL INDUSTRIES**

Division of Amperex Electronics Corporation • 44 SUMMER AVENUE, NEWARK 4, NEW JERSEY

Improved Performance!

A versatile instrument... newly revised... for research and applications involving high repetition rates

MODEL B-2A PULSE GENERATOR

PULSE WIDTH: variable in 4 ranges from 1 μ s to 1.000 μ s

PULSE RISE TIME: .025 μ s

PULSE AMPLITUDE: 40 volts into 93 ohms

INTERNAL DELAYS: variable in 5 ranges from 0 to 10,000 μ s with respect to synchronizing pulse

INTERNAL REPETITION RATES: variable in 4 ranges from 10 cycles to 100 KC

SYNCHRONIZING PULSES: 5— independently available at separate output jacks



- High duty factors
- Can be triggered externally through Schmidt trigger input circuit
- Calibrating potentiometers are provided for each range

Write for complete data: our Bulletin I-B-2A

Rutherford ELECTRONICS CO. 3707 S. ROBERTSON BLVD. CULVER CITY, CALIFORNIA

NEW! MODULAR POWER SUPPLY MODEL 130

A new instrument offering outstanding versatility, the Model 130 MODULAR POWER SUPPLY, serves as an inexpensive power source with excellent stability and regulation. When limited power is required the Model 130 can be used singly and its small size has proved especially valuable. Higher output voltages are obtained by connecting several identical units in series. Units may be connected in parallel for greater output currents and if connected in series-parallel both higher voltages and greater currents are obtained. These interconnections are quickly and easily made on the rear of the units with connectors incorporated for this purpose.

SPECIFICATIONS:

OUTPUT: 145 to 310 Volts at 0-80 Milliampers.

REGULATION: Output voltage varies less than .1% with variation of power line voltage between 105 and 125 Volts and less than .2 Volt between no-load and full load conditions.

RIPPLE: Less than 2 Millivolts r.m.s.

OVERLOAD PROTECTION: Primary and high voltage secondary windings of the power transformer are protected by fuses.

POWER CONSUMPTION: Approx. 100 watts under full-load conditions from a 105 to 125 Volt, single-phase, AC power line.

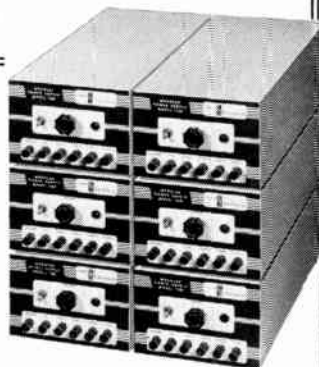

Illustration shows six MODULAR POWER SUPPLIES arranged for series-parallel connection

Write for Descriptive Literature

FURST ELECTRONICS, INC.
3326 W. Lawrence Ave., Chicago 25, Illinois



These manufacturers have invited PROCEEDINGS readers to write for literature and further technical information. Please mention your I.R.E. affiliation.

(Continued from page 16A)

even when aircraft voice transmission is unintelligible (signal-to-noise ratio -20db); No special equipment is needed in aircraft other than standard VHF transmission. Additional Remote Indicator heads may be used.

The complete system (Receiver-Indicator, Antenna, Mast and Cables) is available at a price less than one-half the cost of comparable systems, according to Olympic. Demonstrated in Washington, D. C. to members of the aviation industry, the unit was officially unveiled by Olympic at the IRE Convention.

Printed Circuit Audio Amplifier Assembly

A low-cost, compact printed-wired audio amplifier assembly is being offered by Photocircuits Corp., Glen Cove, L. I., N. Y. It measures 2½ wide x 4½ long x 1½ inches deep, exclusive of control shafts. This two-stage unit produces up to 2-watts output and can be used as an amplifier by itself, or incorporated into equipment as a sub-assembly.

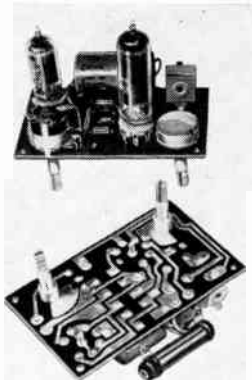

The amplifier is a complete unit, including volume and tone control, except for an output transformer which is usually mounted on the loudspeaker.

Frequency response is flat to 8,000 cps. Input voltage required is 0.2 volts. Power required at 115 volts, ac or dc, is 24 watts. A 12AT6 is used as a voltage amplifier driving a 50B5 power output tube. The power supply uses a selenium rectifier. Further information may be obtained by writing Photocircuits.

Stearns Elected President of WCEMA for 1955

The new President of the West Coast Electronic Manufacturers Association for 1955 is H. Myrl Stearns, executive vice-president and general manager of Varian Associates, Palo Alto, Calif. He was named by the Board of Directors to the post at their first 1955 meeting, held at the Fairmount Hotel in San Francisco January 14.

(Continued on page 118A)

YOU CAN RELY ON BUSS...

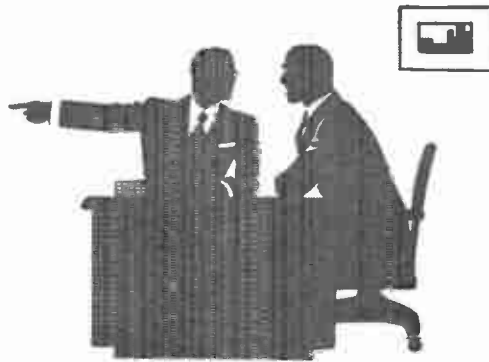

for Fuses of Unquestioned High Quality

Here's why—Millions upon millions of BUSS fuses have given dependable electrical protection in homes, on farms and in industries over the past 40 years, thus establishing the unquestioned high quality of BUSS fuses.

With a reputation like this, BUSS can't afford to take a chance with faulty fuses that could injure its business and yours.

That's why every BUSS fuse, normally used by the Electronic Industries, is tested in a sensitive electronic device that automatically rejects any fuse not correctly calibrated, properly constructed and right in all physical dimensions.

Fuses that give you double protection against loss of user goodwill are the result. Not only are users guarded against damaged equipment when there is trouble on the circuit, but they are also protected against irritating shut-downs caused by needless blows.

Then why not be sure your buying and stock records specify BUSS and FUSETRON fuses . . . you'll save time and trouble by using BUSS as the one source for all your fuse needs.

Makers of a complete line of fuses for home, farm, commercial, electronic and industrial use.

BUSSMANN MFG. CO.



Div. of McGraw
Electric Co.

IRE-555

University at Jefferson,
St. Louis 7, Mo.

another heppner first

NEW slip-on centering device

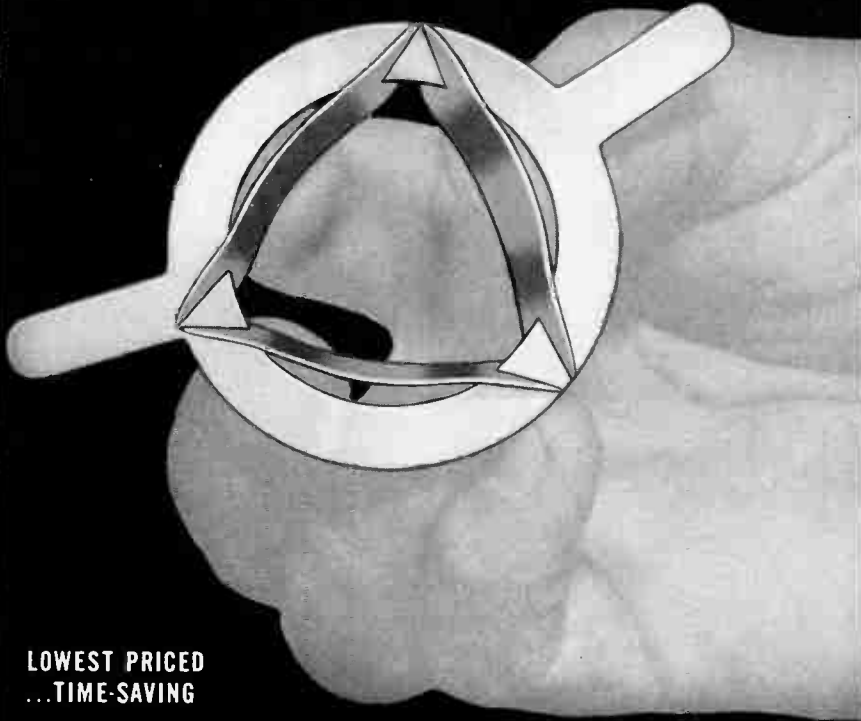

LOWEST PRICED
...TIME-SAVING

Just tilt open and slip on.

- For electrostatic TV tubes—all sizes.
- Saves valuable production time by new tilt-open slip-on design.
- 0-18 gauss max.
- Distortion-free beam assured by uniformity of field. Will not de-focus beam.
- 100% final inspection. Each unit tested in both open and closed position before shipment.

Lowest priced. Write for further information TODAY.

HEPPNER

MANUFACTURING COMPANY
ROUND LAKE, ILLINOIS

(50 Miles Northwest of Chicago)

Phone: 6-2161

Specialists in Electro-Magnetic Devices

OTHER HEPPNER PRODUCTS:

Ion Traps, Speakers, Flyback Transformers and Focomags.

REPRESENTATIVES:

WILLIAM I. DUNCAN, JR., 3451 N. 10th St., Philadelphia 40, Penna. · RALPH HAFFEY, R.R. 1, U.S. 27, Coldwater Rd., Ft. Wayne 8, Indiana · IRV. M. COCHRANE CO., 408 S. Alvarado St., Los Angeles, Calif. · JOHN J. KOPPLE, 60 E. 42nd St., New York 17, N. Y. · BEN H. TOLLEFSON, 144 Collingsworth Drive, Rochester 10, N. Y.



News-New Products

These manufacturers have invited PROCEEDINGS readers to write for literature and further technical information. Please mention your I.R.E. affiliation.

(Continued from page 116A)



A graduate of the University of Idaho, Stearns received a degree in electrical engineering from Stanford University in 1939. His first position was with Gilfillan Brothers in Los Angeles, which he held until joining Sperry Gyroscope Garden City Laboratories in 1941. It was at that time that Stearns first worked with the Varian Brothers in the early development of the klystron, which they had invented while research associates at Stanford.

Logical Gating Package

The 3C-PAC Gating Package, a new universal logical package has just been announced by Computer Control Co., 92 Broad St., Wellesley 57, Mass. These high-speed digital building blocks, operating at a 1 mc repetition rate, can be made to perform an endless variety of logical operations and computations. Logical systems are implemented by merely selecting the proper jumper connections.

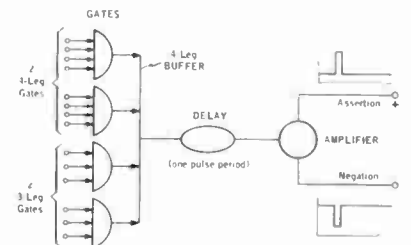

The 3C-PAC is useful for digital computation, control, and data handling. This single package can serve as a logical gating element or as a storage flip-flop. A flip-flop with input gating provisions and output driving capacity can be implemented with this one-tube package. A complete serial binary adder can be formed with two Gating Packages.

The gating package, shown symbolically in the illustration, consists of two 4-leg gates and two 3-leg gates joined by a 4-leg buffer, a lumped delay, and an amplifier that produces both positive and inverted pulse trains.

(Continued on page 120A)

SEVEN NEW INSTRUMENTS!

Seven more reasons for specifying



Type 219 STANDING WAVE DETECTOR. Supersedes 100 to 1000 mc/s slotted sections. VSWR and reflection coefficient angle may be read directly. Small size. Low in cost.

Type 858 "C" BAND SPECTRUM ANALYZER. New r-f head combined with standard PRD indicator unit for the 5100 to 5900 mc/s range. Direct reading frequency meter. Cutoff attenuator with very low backlash enables high precision.

Type 809 KLYSTRON POWER SUPPLY. Complete, well-regulated source of power for wide assortment of low voltage klystrons. Includes square wave and saw tooth modulation and provision for external modulation. Clamping tube makes it unnecessary to readjust reflector voltage when switching modulation. Low in cost.

Type 643 WAVEGUIDE THERMISTOR MOUNT. Provides broadband match over entire 8.2 to 12.4 kmc/s range for faster power measurements. No tuning required. Rugged, efficient, accurate. Ideal for pulsed power measurements. Other waveguide sizes.

Type 277 STANDING WAVE INDICATOR. Three scales, one expanded for low VSWR plus easy-to-read db scale. Three bandwidths. Thus faster, more accurate VSWR measurements. High sensitivity, low noise, and wide range of input levels. Inexpensive.

Type 504 HETERODYNE FREQUENCY METER. Measures frequency over the broad band of 100 to over 10,000 mc/s. Direct reading, hand calibrated dial for the heterodyne frequency oscillator eliminates calibration booklet. High sensitivity. Simple to use. Temperature-controlled crystal accuracy. Inexpensive.

Type 408 DIRECTIONAL COUPLER. High directivity, frequency insensitive, 10 db coupler for precision measurements in the 8.2 to 12.4 kmc/s band. Guaranteed directivity of over 40 db. Ideal for reflection measurements. Other waveguide sizes.

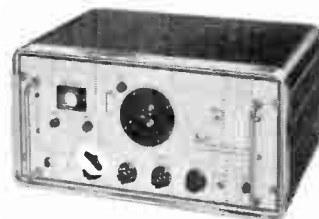

Request complete 1955
Catalog and Technical Bulletins
on these new instruments.

Polytechnic RESEARCH

& DEVELOPMENT CO., INC.

202 TILLARY STREET
BROOKLYN 1, N. Y.

Telephone:
ULster 2-6800

Midwest Sales Office:

1 SOUTH NORTHWEST HIGHWAY, PARK RIDGE, ILLINOIS — TALcot 3-3174

Western Sales Office:

741½ NORTH SEWARD STREET, HOLLYWOOD 38, CAL. — HOLLYwood 5-5287



you can depend on
SECON for
PRECISION WIRE & RIBBON
 if your product-need is here

PRECISION POTENTIOMETER WIRE

Bare and insulated. A complete range of precious metal potentiometer winding alloys from 37 ohms per circular mil foot to over 600 ohms per circular mil foot.

From initial selection of melt components through production and final completion, Secon puts a *complete metallurgical unit* at your service.

Tell us your wire and ribbon problems and we'll gladly submit prompt recommendations. Small quantity inquiries and orders specially invited. Write for pamphlet P-5.

- Fine Wire drawn to 0.0003" diameter
- Ribbon rolled to 0.0001" in thickness
- Electro-Plated Wire and Ribbon
- Special Solder
- Enameled and Insulated Wire
- Pirani Gauge Wire
- Electric Primer, Ignition Wire
- Galvanometer Suspension Strip
- Etched Wire
- Precision Potentiometer Wire
- Transistor Components
- Experimental Melts



SECON for wherever the element calls for PRECISION

SECON METALS CORPORATION
 7 Intervale Street, White Plains, New York
 White Plains 9-4757

There is Always One Leader in Every Field

BODNAR INDUSTRIES, Inc.

leads in the field of
PLASTIC LIGHTING PANELS AND DIALS

BECAUSE OF Quality • Uniformity • Performance
 Design & Layout "Know-How Service"
 Quantity Production Promptly

NEW YORK —19 Railroad Ave., New Rochelle (Home Office)

CALIFORNIA—4440 Lankershim Blvd., P.O. Box 264, North Hollywood

CANADA —44 Wellington St. E., Toronto

SPECIMEN PANEL MIL-P-7788 (AN-P-89) SENT ON LETTERHEAD REQUEST



AN/APR-4 LABORATORY RECEIVERS

Complete with all five Tuning Units, covering the range 38 to 4,000 Mc.; wideband discorne and other antennas, wavetraps, mobile accessories, 100 page technical manual, etc. Versatile, accurate, compact—the aristocrat of lab receivers in this range. Write for data sheet and quotations.

We have a large variety of other hard-to-get equipment, including microwave, aircraft, communications, radar, and laboratory electronics of all kinds. Quality standards maintained. Get our quotations!

NEW TS-13/AP X-BAND SIGNAL GENERATORS, with manual, \$575.00 . . . T-47A/ART-13 Transmitters, \$450.00 . . . H-P, Boonton, G-R, Measurements, and other standard items in stock; also nucleonic equipment.

ENGINEERING ASSOCIATES

434 PATTERSON ROAD

DAYTON 9, OHIO



These manufacturers have invited PROCEEDINGS readers to write for literature and further technical information. Please mention your I.R.E. affiliation.

(Continued from page 118A)

New Power Unilines

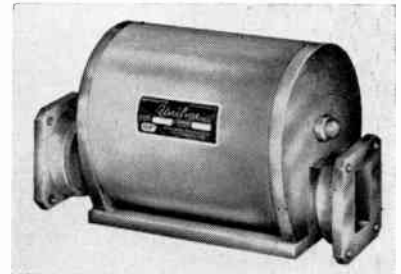

A new series of Uniline microwave load isolators capable of operation at peak powers up to 300 kw is announced by **Cascade Research Corp.**, 53 Victory Lane, Los Gatos, Calif. Like all Unilines, these new power models provide substantial load isolation with low VSWR and with negligible loss in transmitted microwave power. The increased power ratings are made possible by a design which maximizes cooling by conduction. Power Unilines utilize the resonant absorption properties of ferrites at microwave frequencies, the required transverse magnetic field being supplied by heavy permanent magnets which are an integral part of the assembly. No external power supply is required. Four new models are available: Model H16-17, 16-17 kmc, 100 kw peak, 100 watts average. Model H86-96, 8.6-9.6 kmc, 150 kw peak, 125 watts average. Model HL86-96, 8.6-9.6 kmc, 300 kw peak, 300 watts average. Model H28-32, 2.8-3.2 kmc, 150 kw peak, 150 watts average. Technical literature is available upon request.

Subminiature Toroid Winder

The EDC MidJet Toroid Winder is currently being manufactured by **Electro Devices Inc.**, 463 Commercial St., Boston, Mass., to produce coils of $\frac{3}{8}$ inch finished inside diameter.

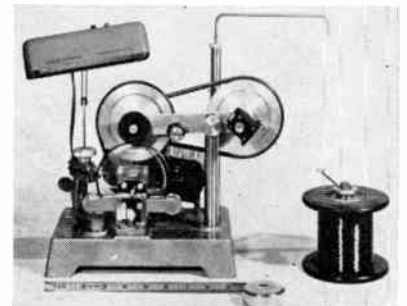

Based on an entirely different principle from that of any other toroid winder, the MidJet utilizes no sliders, accommodates #30 to #42 gauge wire, and winds closed magnetic cores of wound tape, stacked ring punchings, or molded powder at speeds ranging from 0 to 600 turns per minute. Turns are laid radially on 603

(Continued on page 122A)

Rugged New Mounting for MALLORY Tantalum Capacitors



ESPECIALLY DESIGNED for circuits that must withstand heavy shock and vibration is this latest version of the famous Mally XT Tantalum Capacitor.

The case has a sturdy threaded neck that fits through a keyed slot in the chassis. Lock washer and hex nut are supplied to give you an assembly that will withstand the most severe service. Mounting requires only seconds to complete . . . needs no strap or other hardware.

Next time you need capacitors for extreme-temperature, high-acceleration duty, plan to use these new Mally units. They come in a complete range of ratings and sizes up to 2 1/4" height. Write to Mally today for complete data.

MALLORY Tantalum Capacitors meet the toughest specifications

- Long life at temperatures up to 175° C. . . . can be supplied for use at 200° C.
- Low-temperature stability down to -55° C.
- Closer tolerances . . . only +50 per cent, when desired.
- Lower leakage currents than ever before.

Parts distributors in all major cities stock Mally standard components for your convenience.

Type TAW 
Subminiature Silverlytics*

*The smallest capacitor for its rating . . . 4 or 6 mfd. at 4 VDC. Only .145" in diameter, 3/8" long. Electrical characteristics comparable to larger capacitors. *Trade Mark*



CUT
YOUR COIL
PRODUCTION
COSTS
with
PRECISION COIL BOBBINS

Our special machinery and high production methods work in combination with rigid quality control to provide you with the finest in coil bobbins at lowest possible cost.

Your specifications are met to the most critical tolerances. Workmanship is precise and carefully inspected. You can order in quantity, in any size or shape, flanges of all types, and be sure of uniformity throughout. Only fine dielectric materials are used—kraft, fish paper, acetate, phenol impregnated or combinations.

With Precision Bobbins you eliminate rejects, waste, loss of time—get better coils at less cost. Prove it to yourself! Send specifications for samples. Ask for literature.

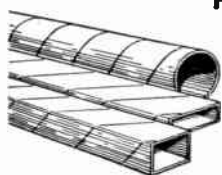

PRECISION LOW COST PAPER TUBES

Order in any length, size, shape, I.D. or O.D. and in any quantity. Precision Paper Tubes are crush resistant and light weight, with excellent dimensional stability. They are fabricated to the same high standards governing Precision Bobbins.

Send for samples and Arbor List of over 2000 sizes

Sales Representatives in:

New England:
Framingham, Massachusetts, Trinity 3-7091
Metropolitan New York, New Jersey:
Jersey City, New Jersey, Journal Square 4-3574
Upstate New York:
Syracuse, New York, Syracuse 4-2141
Northern Ohio, Western Pennsylvania:
Cleveland, Ohio, Atlantic 1-1060
Indiana, Southern Ohio:
Logansport, Indiana, Logansport 2555

Missouri, Southern Illinois, Iowa:
St. Louis, Missouri, Sterling 2318
Maryland:
Baltimore, Maryland, Plaza 2-3211
Philadelphia, Camden:
Philadelphia, Pa., Chestnut Hill 8-0282
California:
Pasadena, California, Sycamore 8-3919
Canada:
Montreal, Quebec, Canada, Walnut 0337



PRECISION PAPER TUBE CO.

2051 W. CHARLESTON ST.

CHICAGO 47, ILL.

Plant No. 2: 79 Chapel St., Hartford, Conn.



News-New Products

These manufacturers have invited PROCEEDINGS readers to write for literature and further technical information. Please mention your I.R.E. affiliation.

(Continued from page 120A)

degrees of core without reversing. Bank winding may be performed, however, to reduce distributed capacity of coil.

The EDC MidJet lends itself equally well to developmental laboratory work and to volume production of toroid coils. As a result of the new principle which involves winding off the inside of the shuttle, there is no kinking of wire and down-time is virtually eliminated.

For the latest brochure, write to Electro Devices, Inc.

High Power Terminations

New high power waveguide terminations manufactured by **The Narda Corp.**, 66 Main St., Mineola, N. Y., are an improved design which are capable of handling extremely high power without deteriorating under high temperatures.

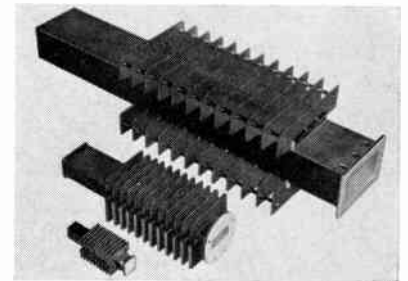

The loads are designed for operation over the entire waveguide band with an average vswr of approximately 1.05. Seven models cover the frequency range of 1120 to 1700 mc and 2600 to 18,000 mc. Each model covers a complete waveguide band. Typical average power ratings are 3500 watts at "S" Band and over 500 watts at X Band. Peak power ratings exceed the standard rated values for straight waveguide. All models may be pressurized for still higher power levels.

A new catalog entitled "Microwave and uhf Electronic Test Equipment" is now available from the firm on letterhead request.

New British Office for Narda Corp.

The Narda Corp. 66 Main St., Mineola, N. Y., announces the opening of a new branch office at 86 Holly Road, Uttoxeter, Staffordshire, England, to handle the sale of its line of microwave test equipment throughout the United Kingdom. This office is headed by Ronald Roberts, formerly of Hughes Aircraft Co.

Phase Display Equipment

The PDE-1 Phase Display Equipment, developed by **Wickes Engineering & Construction Co.**, 12th St. & Ferry Ave., Camden 4, N. J. displays the transfer function of any network, amplifier, or

(Continued on page 124A)

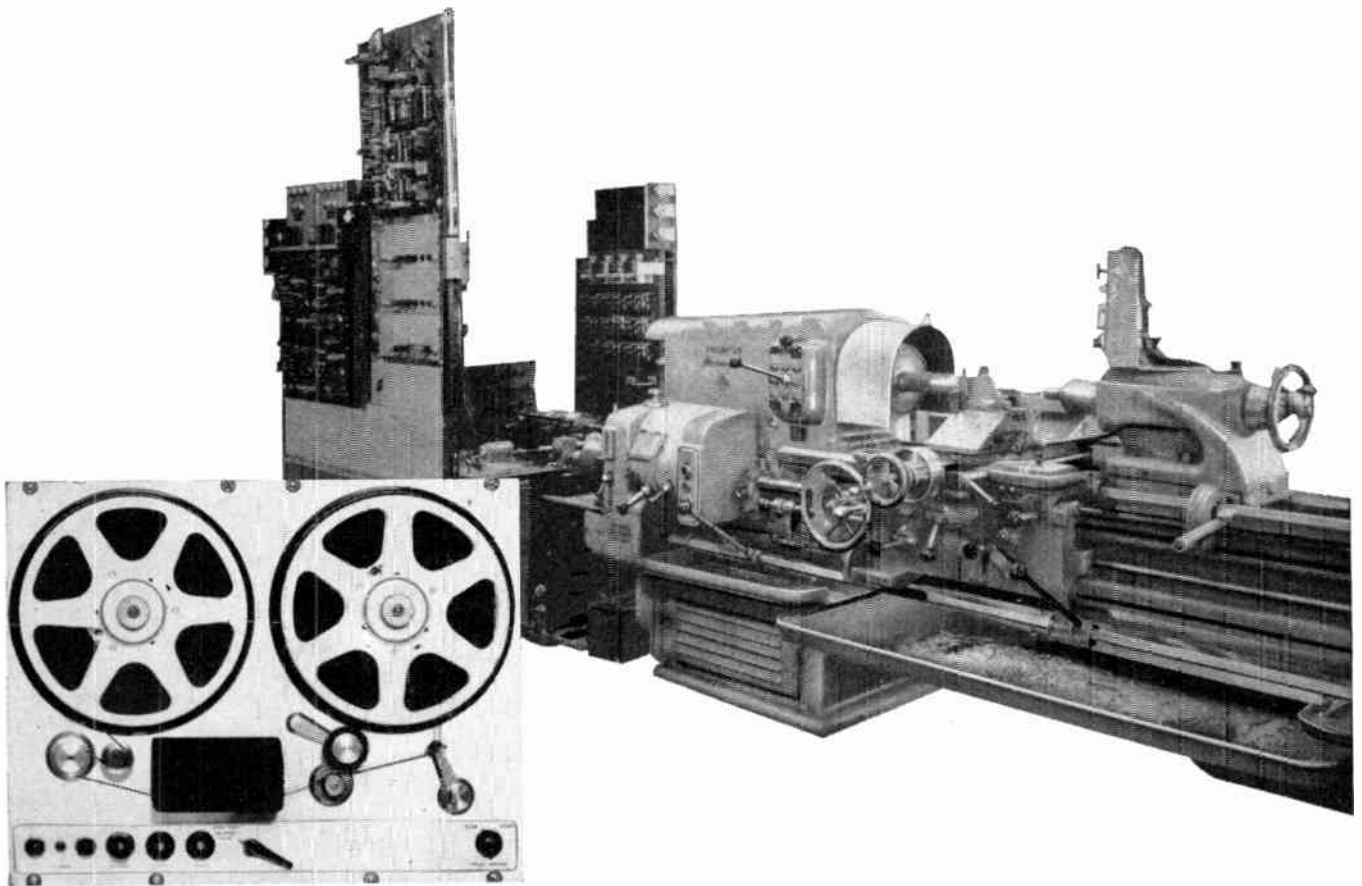

MAGNETIC TAPE CONTROLS MACHINES LIKE THIS

An **Ampex Magnetic Tape Recorder** programmed all operations of this 16" lathe. The Ampex machine was selected by General Electric, who designed and built the control system, to provide the "memory" which helped guide the machine flawlessly through the accurate motions involved in machining irregular parts. For each part to be manufactured, a skilled machinist made the first unit. The Ampex recorder "remembered" his motions and could thereafter direct the lathe in the manufacture of one part or a thousand — now or twenty years from now.

Other exacting work programs of drilling, jig boring, tapping, or gear cutting can be converted into electrical signals by existing tracer techniques . . . and permanently recorded on magnetic tape. The control system using the memory characteristics of this tape can give you an exact duplication of the original work sequence, again and again . . . wherever and whenever you want it. **Result:** machine tool setup time is shortened . . . print reading and "miking" times are reduced . . . operator errors and rejects are eliminated . . . and simultaneous operation of two or more feeds, on two or more machines is possible.

For Your Automation Needs: **Ampex Precision and Durability**

Ampex recorders retain precision even after thousands of hours of use. And they can be adapted to almost any automation need. Let our application engineers determine whether magnetic tape can provide a more efficient control system for your operation — or write for our 16-page bulletin on "Data Recording, Machine Control and Process Regulation."



Signature of Perfection in Magnetic Recorders

Contact your nearest Ampex representative or write — wire Dept. G-1896

AMPEX CORPORATION • 934 CHARTER STREET, REDWOOD CITY, CALIFORNIA

Branch Offices: New York; Chicago; Atlanta; San Francisco; College Park, Maryland (Washington D.C. area).
Distributors: Radio Shack, Boston; Bing Crosby Enterprises, Los Angeles; Southwestern Engineering & Equipment, Dallas and Houston; Canadian General Electric Company, Canada.

CONTINUOUS, DIRECT-READING

X-BAND VSWR MEASUREMENT

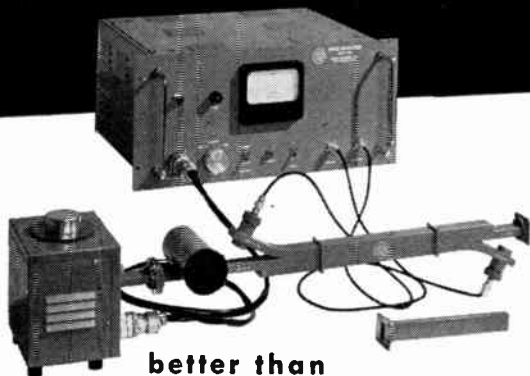

better than
2% overall accuracy!

For speedy and accurate VSWR measurements in laboratory or production use, the CTI Model 110B Measuring System reads directly, is continuously tunable from 8,500 to 9,600 mc.

SPECIFICATIONS

Two VSWR Ranges:	1.02 to 1.2; 1.2 to 2.5
Attenuation Scale:	0 to ∞; 1.5 db midscale
Waveguide Fitting	UG-39/U
Directional Couplers, directivity	over 40 db

COLOR TELEVISION INCORPORATED

SAN CARLOS 2, CALIFORNIA



SELF-GRIPPING • SELF-LOCKING

P-M NUT

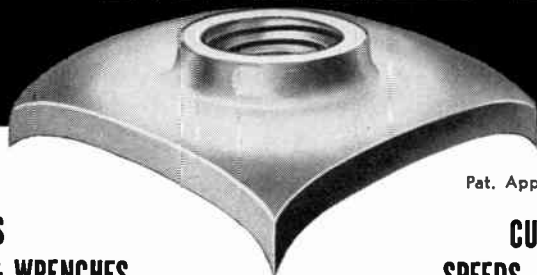

Pat. Applied For

**ELIMINATES
WASHERS & WRENCHES**

**CUTS COSTS
SPEEDS ASSEMBLY**

High-quality, low-cost nut is made of spring-tempered high carbon steel. Has cut threads and a flange with turned-down corners which bite into material to which applied. Spring flange is deflected during tightening for vibration-proof assembly. Used by leading manufacturers. Available in sizes 6-32 through 10-32. Other sizes in process.

P-M "ROLL FREE" DRAWN STEEL STUD

Low-cost "Roll Free" studs effect *unusual savings* over solid studs for most roller mounting. Smooth surface reduces friction for easier rolling, longer life. Standard sizes or to your specifications. For additional savings, ask us about pre-assembled studs and rollers.



Write for **FREE Literature and Samples**

Pat. Applied For

P-M Division
THE WATERBURY PRESSED METAL CO.

PLAIN STAMPINGS ★ PROGRESSIVE STAMPINGS ★ EYELETS
DRAWN SHELLS ★ SECONDARY OPERATIONS ★ ASSEMBLING

300 CHASE AVE. • WATERBURY 14, CONN.



News-New Products

These manufacturers have invited PROCEEDINGS readers to write for literature and further technical information. Please mention your I.R.E. affiliation.

(Continued from page 122A)

system as a simultaneous vector plot of amplitude response and phase shift. The equipment measures phase and amplitude distortion over the range of 100 kc to 10 mc.

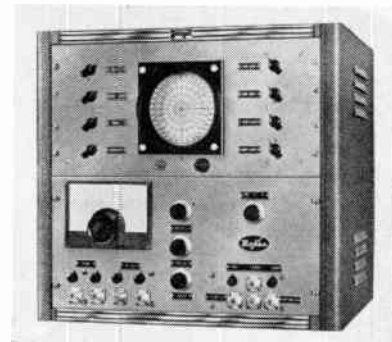

The network under test can have either lumped or distributed constants. Since the phase and amplitude components are displayed simultaneously, the PDE-1 is more precise and rapid than conventional methods. This feature is of particular value when comparing two supposedly identical networks, or when it is necessary to align simultaneously, phase and amplitude. The equipment is also of value in the design and evaluation of feedback amplifiers and servo systems.

The PDE-1 is suited to transistor studies and testing. Various parameters can be displayed, and the effects of varying currents through the transistor can be observed.

A built-in marker generator provides markers at 500-kc intervals, for Z-axis modulation of the display oscilloscope. A common time base controls the sweep oscillator, and provides horizontal sweep for the display oscilloscope eliminating external sync and phasing problems. Switching the circuits permit display of the "P" (in phase) component, the "Q" (quadrature) component, or simultaneous display of "P" and "Q" (polar plot).

The complete equipment includes an RS-2 Display Oscilloscope, and SD-1 Sweep Demodulator, and a cabinet rack, plus interconnecting cables.

Transistor Booklet for Hams

A new booklet, written especially for Radio Amateurs and Ham Operators, entitled "The Transistor and You" has just been published by the Electronics Division of Hydro-Aire, Inc., 3000 Winona Ave., Burbank, Calif., subsidiary of Crane Co.

The booklet will be distributed through electronics jobbers that carry the firm's new CQ-1 transistors, a low-cost unit of the junction type, designed for amateur and Ham applications. Copies may be obtained directly from the firm.

(Continued on page 158A)

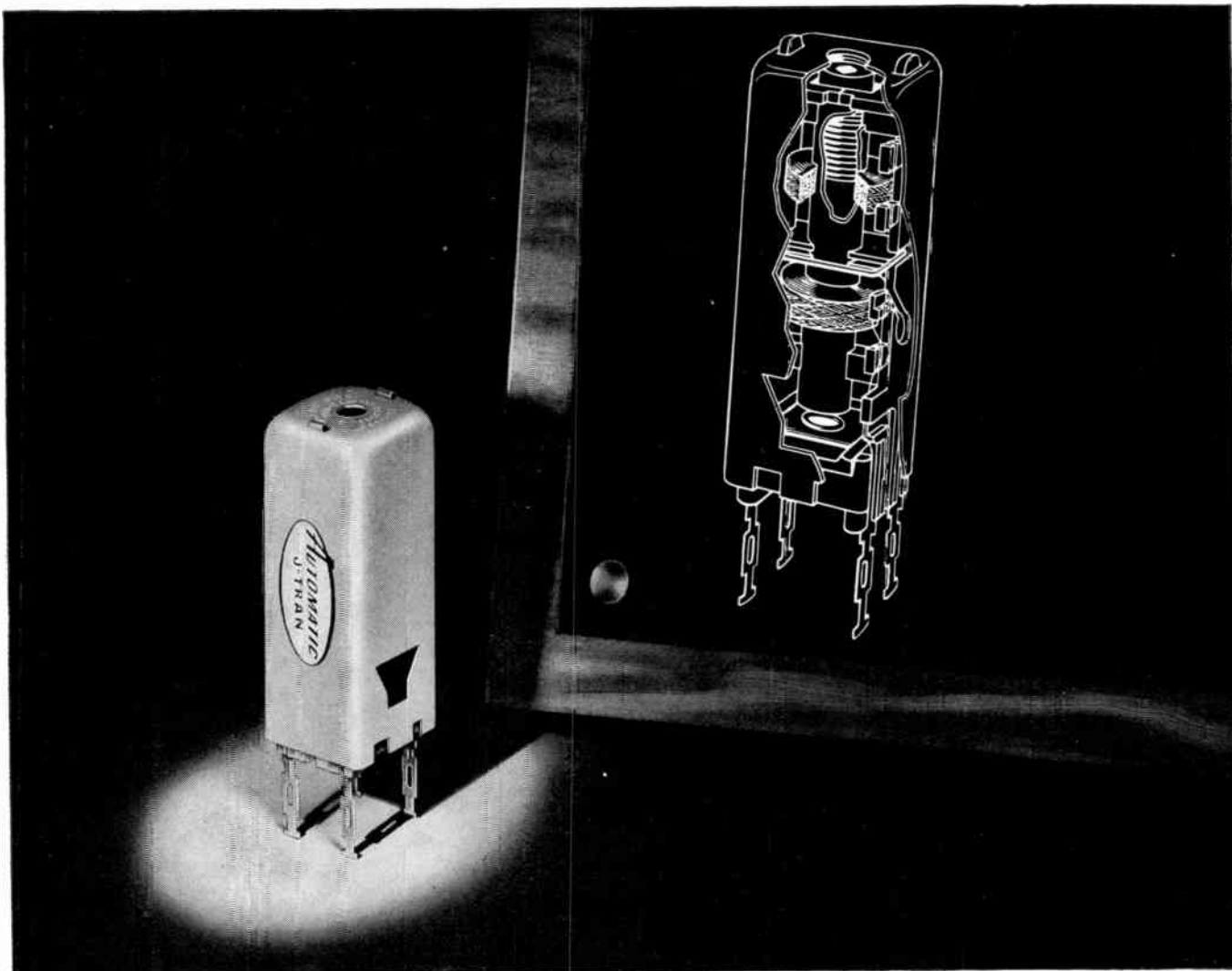

Only *AUTOMATIC* makes the J-TRAN®

3/4" I.F. Transformer for TV • 4.5 to 45 Megacycles

The J-Tran is the standard I.F. Transformer of the television industry. It is the smallest, lowest priced, I.F. Transformer of highest electrical performance — and you can get immediate deliveries! It is used as a Discriminator, Ratio Detector, Input Transformer, Interstage Transformer with traps, and Output Transformer for use with tube and crystal diodes. J-Trans are also made for 262 KC, 455 KC and 10.7 MC radio applications.

One of its many superior features is the hollow, supported, threaded, hexagonal core which permits either double or single ended tuning and allows great latitude in chassis organization. It is the only TV transformer with positive threading and controlled torque. It is supplied also with terminals for printed circuit chassis.

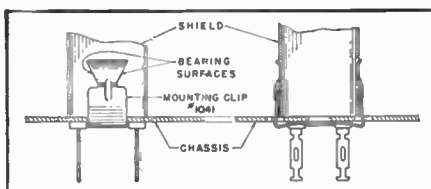

An outstanding mechanical advantage is the clip mounting method, which greatly reduces assembly time. This

method of mounting assures a permanent, non-oxidizing contact — so strong that a heavy chassis can be lifted by gripping only the J-Tran, without tearing the metal shell.

To become fully familiar with all the superiorities of the J-Tran for TV, write for a copy of the J-Tran* — K-Tran* Manual. It will be invaluable to you in your electronic designing.

*T.M. Reg. U.S. Pat. Off.

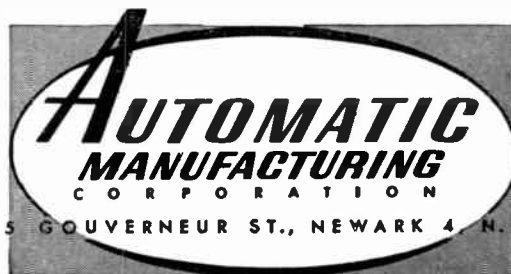

MASS PRODUCERS OF
ELECTRONIC COMPONENTS

Every part Automatic uses
... Automatic makes.

ENGINEERS AND



Your future measures up to your ability...
in these positions open now at RCA!

You'll find RCA opportunities in:

AVIATION ELECTRONICS
ELECTRON TUBES
COMPUTERS
MISSILE GUIDANCE
RADIO SYSTEMS

A whole new program of expansion at RCA—in Research, Systems, Design, Development and Manufacturing—opens a broad variety of permanent positions with all the features that appeal to the alert, creative engineer. These are opportunities with a future... available *today* for the man who wants to move ahead professionally with the world leader in electronics. They include work in fields of phenomenal growth. At the RCA engineering laboratories *listed in the chart on the right*, you'll find the kind of living and working conditions attractive to the professional man and his family.

Engineers and scientists find every important factor that stimulates creative

effort... including a quality and quantity of laboratory facilities unsurpassed in the electronics industry... and everyday association with men recognized at the top of their profession.

RCA's benefits add up to an impressive list of "extras." Among them: tuition for advanced study at recognized universities... a complete program of company-paid insurance for you and your family... a modern retirement program... relocation assistance available.

Your individual accomplishments and progress are recognized and rewarded through carefully planned advancement programs. Financially as well as professionally, you move ahead at RCA!

SCIENTISTS:

Check the chart below for openings in your field.

FIELDS OF ENGINEERING ACTIVITY	TYPE OF DEGREE AND YEARS OF EXPERIENCE PREFERRED											
	Electrical Engineers			Mechanical Engineers			Physical Science			Chemistry Ceramics Glass Technology Metallurgy		
	1-2	2-3	4+	1-2	2-3	4+	1-2	2-3	4+	1-2	2-3	4+
SYSTEMS <i>(Integration of theory, equipments, and environment to create and optimize major electronic concepts.)</i>												
AIRBORNE FIRE CONTROL			W							W		
DIGITAL DATA HANDLING DEVICES			C			C				C		
MISSILE GUIDANCE			M			M				M		
INERTIAL NAVIGATION			M			M				M		
COMMUNICATIONS			C O F							C O F		
		F							F			
DESIGN • DEVELOPMENT												
COLOR TV TUBES — Electron Optics— Instrumental Analysis— Solid States (Phosphors, High Temperature Phenomena, Photo Sensitive Materials and Glass to Metal Sealing)	L	L	L	L	L	L	L	L		L	L	L
RECEIVING TUBES — Circuitry— Life Test and Rating— Tube Testing— Thermionic Emission	H	H	H		H	H			H		H	H
MICROWAVE TUBES — Tube Development and Manufacture (Traveling Wave— Backward Wave)		H	H	H				H	H		H	H
GAS, POWER AND PHOTO TUBES — Photo Sensitive Devices— Glass to Metal Sealing	L	L	L	L	L			L	L		L	L
AVIATION ELECTRONICS — Radar— Computers— Servo Mechanisms— Shock and Vibration— Circuitry— Remote Control— Heat Transfer— Sub-Miniaturization— Automatic Flight— Design for Automation— Transistorization			M C F			M C F				M C F		
		F	F		F	F			F	F		
RADAR — Circuitry— Antenna Design— Servo Systems— Gear Trains— Intricate Mechanisms— Fire Control			M C F			M C F				M C F		
		F	F		F	F			F	F		
COMPUTERS — Systems— Advanced Development— Circuitry— Assembly Design— Mechanisms— Programming	C	C	M C F	C	C	M C F	C	C	C	M C F		
		F	F		F	F			F	F		
COMMUNICATIONS — Microwave— Aviation— Specialized Military Systems			M C F			M C F				M C F		
		F	F		F	F			F	F		
RADIO SYSTEMS — HF-VHF— Microwave— Propagation Analysis— Telephone, Telegraph Terminal Equipment		O	O F		O	O F			O	O F		
		F	F		F	F			F	F		
MISSILE GUIDANCE — Systems Planning and Design— Radar— Fire Control— Shock Problems— Servo Mechanisms			M F			M F				M F		
		F	F		F	F			F	F		
COMPONENTS — Transformers— Coils— TV Deflection Yokes (Color or Monochrome)— Resistors		C	C		C	C			C	C		
MACHINE DESIGN Mech. and Elec.— Automatic or Semi-Automatic Machines		H	H		H	H			H	H		

Location Code

- C—Camden, N. J.—in Greater Philadelphia near many suburban communities.
- F—Florida—on east central coast.
- H—Harrison, N. J.—just 18 minutes from downtown New York.

- L—Lancaster, Pa.—about an hour's drive west of Philadelphia.
- M—Moorestown, N. J.—quiet, attractive community close to Phila.
- O—Overseas—domestic and overseas locations.
- W—Waltham, Mass.—near the cultural center of Boston.

Please send resume of education and experience, with location preferred, to:



Mr. John R. Weld, Employment Manager
Dept. C-1E, Radio Corporation of America
30 Rockefeller Plaza
New York 20, N.Y.



RADIO CORPORATION OF AMERICA

Copyright 1955 Radio Corporation of America

Developers
of the
Corporal
Guided
Missile.



JET PROPULSION LABORATORY

CALIFORNIA
INSTITUTE OF
TECHNOLOGY

*Active in all phases
of electronics and physics
related to guided missiles
and jet propulsion.*

The nation's foremost guided-missile research and development facility, established in 1940, offers exceptional opportunity for engineers and research scientists in the fields of guidance and control, information theory, computers, electro-mechanical devices, instrumentation, and related aspects of electronic research. The Laboratory offers an ideal blend of academic and industrial environments and maintains a high level of technical competence. Attractive salaries are offered.

*A brochure describing
opportunities and activities
at the Laboratory will be
sent upon request.*

JET PROPULSION LABORATORY

California Institute of Technology
4800 OAK GROVE DR.,
PASADENA 3, CALIFORNIA



Positions Wanted

By Armed Forces Veterans

In order to give a reasonably equal opportunity to all applicants and to avoid overcrowding of the corresponding column, the following rules have been adopted:

The Institute publishes free of charge notices of positions wanted by I.R.E. members who are now in the Service or have received an honorable discharge. Such notices should not have more than five lines. They may be inserted only after a lapse of one month or more following a previous insertion and the maximum number of insertions is three per year. The Institute necessarily reserves the right to decline any announcement without assignment of reason.

MANUFACTURER'S REPRESENTATIVE

Wanted: High quality, low cost aeronautical products with a primary market in private aviation. WW II and Korean Emergency USNR veteran desires to act as manufacturer's representative. Address: Aeroconomy Agency, P. O. Box 1001, Schenectady, N. Y.

AUTOMATION ENGINEER

Experienced computer engineer desires affiliation at management level with firms concerned with automatic data, handling and automation. Consulting, developing, etc. Further information supplied on request. Box 806 W.

SALES ENGINEER

Five years experience in electronic sales, test engineering, quality control, Government inspection and procurement. Will receive BEE in June. Age 31. Desires sales, administrative or advertising position with electronic manufacturer. Prefer New York metropolitan area. Box 807 W.

ELECTRONIC ENGINEER— ADMINISTRATIVE

BSEE 1945, MS Eng. ADM. 1954, BSIE (lacks 12 hours). Age 32, married. Lt. USNR. 1 year Navy ETM, 1 year as electronic laboratory assistant. 15 years amateur radio. Last 8 years in nucleonic industry. 1 year electronic engineer, 1 year production manager, 2½ years factory manager, ¾ years controller. Desires position which utilizes this background. Box 808 W.

PATENT ENGINEER

BEE New York University 1949. In second year law school. 2 years radio transmitter, and 2½ years components and color TV design and development experience. 1st Lt. U.S. Signal Corps, Korean veteran. Age 25, married. Prefer position doing patent work in New York City area. Will consider out of town. Box 809 W.

BROADCAST ENGINEER

RCA graduate (with honors) desires position as broadcast engineer, anywhere. No experience, but capable, salary secondary. With a little help I can become a valuable engineer, just try me. Box 810 W.

(Continued on page 130A)

ENGINEERS

GROW

WITH THE NEW, EXPANDING
ELECTRONIC TUBE DIVISION OF
Westinghouse

in Elmira, New York

You'll have the opportunity to grow, professionally and financially, with this great company noted for its dynamic growth, and for its tangible recognition (based on merit) of the creative achievements of its engineers. And you will enjoy the uncrowded pleasant life in this vacation-land community.

Opportunities for:
DESIGN, DEVELOPMENT, and APPLICATION ENGINEERS: Receiving, image orthicon or vidicon tubes; solid state devices.

MICRO-WAVE TUBE DESIGN ENGINEERS: 2 or more years experience, for designing magnetrons, traveling-wave tubes, TR and ATR tubes, reference cavities, etc.

Above openings are for engineers and physicists with Bachelor's, Master's, or Doctor's degree. ALSO . . .

ELECTRICAL ENGINEERS, for Equipment Design: designing, costing & guiding construction of processing and testing equipment, e.g. atmosphere furnaces, electrical welders, induction heaters, X-ray seasoning & test units, wave-guide apparatus, transistor life test units.
MANUFACTURING ENGINEERS: Electrical & Mechanical Engineers, and Physicists, to work on micro-wave, image orthicon, & other tube types. Experience in these fields desirable.

Interviews in your area, or travel expenses paid for interviews in Elmira. Send resume:

WESTINGHOUSE ELECTRIC CORP.
Electronic Tube Div. Elmira, N.Y.

CONVAIR POMONA offers ENGINEERING OPPORTUNITIES

- ELECTRONICS
- DYNAMICS
- AERODYNAMICS
- THERMODYNAMICS

Guided Missiles



Employment Dept.
1675 West 5th St.
P. O. Box 1011, Pomona, Calif.



CONVAIR
A DIVISION OF
**GENERAL DYNAMICS
CORPORATION**
(POMONA)

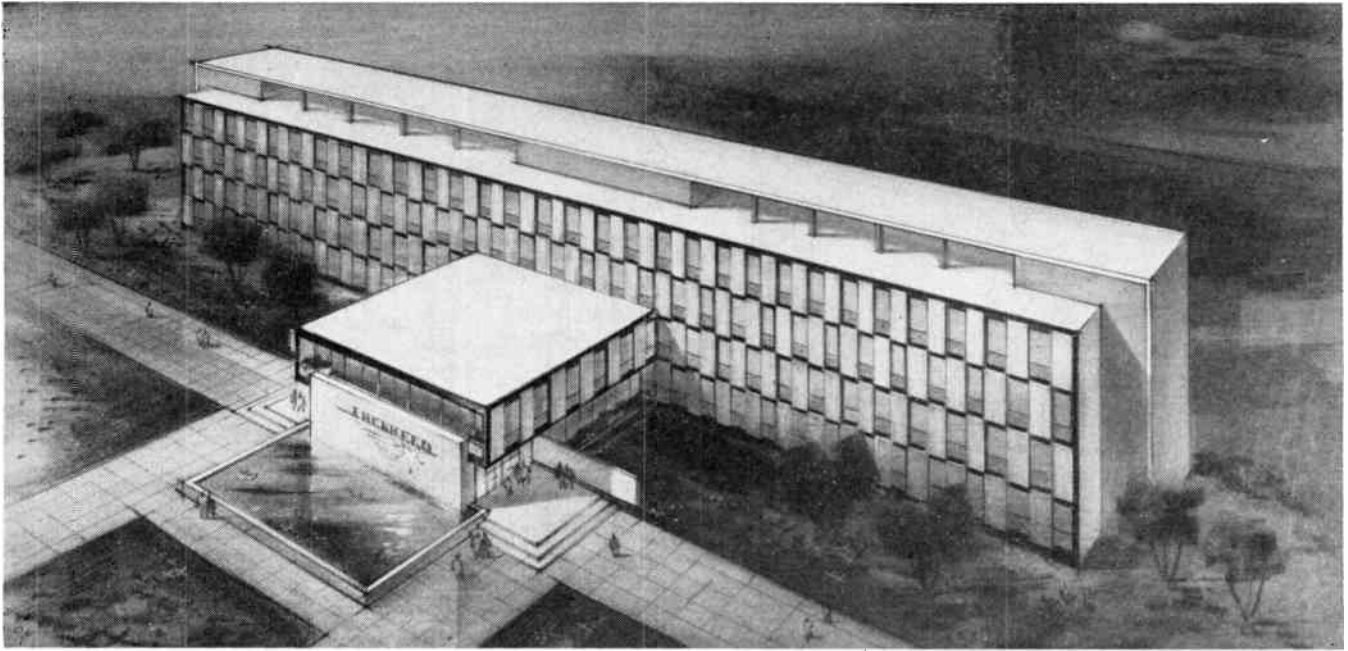

NEW MISSILE SYSTEMS RESEARCH LABORATORY RISES AT LOCKHEED

Scheduled for occupation this fall, Lockheed's new Missile Systems Research Laboratory is now well along in construction. First step in a \$10,000,000 research laboratory program, it is especially designed to provide the most modern facilities for meeting the complex problems of missile systems research and development.

Scientists and engineers able to contribute importantly to the technology of guided missiles are invited to write.

Lockheed MISSILE SYSTEMS DIVISION

research and engineering staff

National Conference on Aeronautical Electronics

May 9-11
Dayton, Ohio
Dayton-Biltmore Hotel
Telephone: Adams 2161

National Telemetry Conference

May 18-20
Chicago, Ill.
Morrison Hotel
Telephone: FRanklin 2-9600

C.T. Petrie and senior members of the technical staff will be available for consultation at both convention hotels.



Dr. E. H. Krause, Research Laboratory head (left), examines blueprints of the new laboratory with E. R. Quesada, Missile Systems Division vice president and general manager (center), and W. M. Hawkins, chief engineer, during ground-breaking ceremonies.

LOCKHEED AIRCRAFT CORPORATION • VAN NUYS • CALIFORNIA

ELECTRONIC ENGINEERS • PHYSICISTS • MATHEMATICIANS

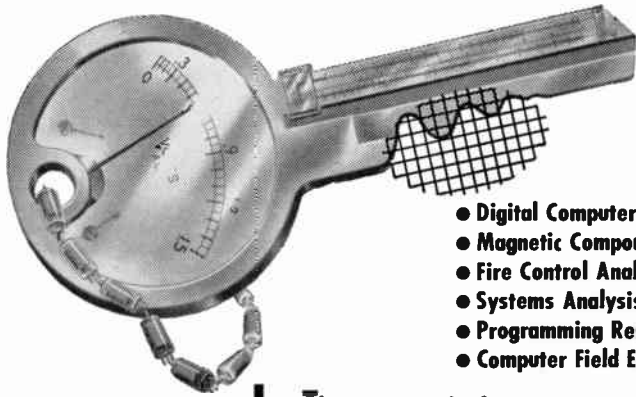

- Openings at all levels of experience.
- Training in digital techniques provided.
- Salaries commensurate with experience.
- Interview travel at our expense.
- Moving expenses paid for household goods.
- Liberal employee benefits.

The country's foremost computer development organization has permanent positions open in the above fields for qualified professional personnel. Opportunities for personal advancement and professional growth are exceptional in today's most rapidly expanding technological field.

HERE IS THE KEY TO YOUR FUTURE

... share in the satisfaction of contributing to the advancement of this important art.

Remington Rand

ENGINEERING RESEARCH ASSOCIATES DIVISION

1902 West Minnehaha • St. Paul W4, Minnesota

ELECTRONIC and ELECTROMECHANICAL ENGINEERS PERMANENT POSITIONS IN SOUTHERN CALIFORNIA

We are now staffing the new Electronics Laboratory of our Aeronautical Division in Anaheim, California.

Are you interested in a progressive and mature organization where these features are considered most important?

Professional atmosphere with considered attention to both individual and organizational growth.

Recognition of your special areas of interest and competence.

Selected projects requiring engineering ingenuity and advancement of the state of the art.

Consistent application of well considered administrative practices and effective engineering planning.

Selection of associates based on careful evaluation of qualifications with respect to long-range laboratory plan.

Subsystem research development work in these areas:

- RADIO AND RADAR SYSTEM APPLICATION
- MAGNETIC AMPLIFIER DEVELOPMENT AND APPLICATION
- TRANSISTOR AND TUBE CIRCUITRY
- ELECTROMECHANICAL CONTROLS AND ANALOGUE DEVICES

Candidates must have at least a B.S. in Electrical Engineering or Physics. Appointments are being made at Junior and Senior levels.

Write to Vernon Vogel
ROBERTSHAW-FULTON CONTROLS COMPANY
401 N. Manchester, Anaheim, California



Positions Wanted

By Armed Forces Veterans

(Continued from page 128A)

ENGINEER

MSEE 1952, 13 years experience with fire control equipment; 2½ years directing broad research, development, and testing program for radars, missiles, and electromechanical and electronic computers. Age 34, married. Desires managerial or organizational engineering work in New York or Los Angeles area. Box 819 W.

ADMINISTRATIVE ENGINEER

BSEE, LLB, Senior Member IRE, under 40. 6 years Signal Corps technical-administrative, 9 years research and manufacturing, extensive patent knowledge. Experienced in organizing and supervising group, personnel training, technical specification drafting, liaison. Desires supervisory position with coming research or manufacturing concern. Box 820 W.

ELECTRONICS ENGINEER

Striving, conscientious engineer for automation or missile development. BSEE 1951 III. Institute of Technology. 3 years experience in phono amplifiers, tape recording, multiplex communication in microwave. Box 822 W.

FIELD OR SALES ENGINEER

Experienced in electronics field engineering with diversified background in guided missile systems, test equipment and prototype electronics work. Retired Army Warrant Officer. Desires field or sales engineering position in Florida area. Box 823 W.

ENGINEER

2 years toward BEE degree. Age 27, married, 3 children. 1½ years Navy ETM 2 cl., WW II. 3 years field experience in radar and communication equipment. Presently engaged in flight simulator field. Desires any work permitting completion of studies toward degree. Box 824 W.

SALES—ADMINISTRATIVE ENGINEER

BSEE 1948. 7 years experience administrative engineering and military electronics equipment design in U.S. and abroad; present advancement too slow; age 34, married, 2 children; Tau Beta Pi; desires sales or administrative engineering electronics or allied field Southern California or Mediterranean area; present salary \$7700. Box 825 W.

PATENT ENGINEER

Professor engineering, Senior Member IRE; registered to practice before U.S. Patent Office; Available on part time basis because of change in employer's operations. Full time offer considered. Box 826 W.

ELECTRICAL ENGINEER

BSEE 1950. Experience in petroleum geophysics, broadcast, communications radio, military electronics. Interested in electronic design, development, test or field engineering. Location preference southwestern or southern area. Will carefully consider any offer. Box 827 W.

ENGINEER

BSEE 1951, I.I.T., Eta Kappa Nu. Age 25. 2 years experience in adapting power system analysis to digital computers. 2 years experience at White Sands in programming and in trouble shooting a large scale digital computer. Desires position involving logical design of computers. Box 838 W.

(Continued on page 134A)

EXPAND YOUR HORIZON!

ELECTRONIC ENGINEERS
ELECTRONIC PHYSICISTS

*Bendix Radio has new,
exceptional opportunities for advancement
while working on:*

**RADAR
MISSILE GUIDANCE
AIRBORNE COMMUNICATIONS
MOBILE COMMUNICATIONS
AUTO RADIO**

Expand the horizon of your future with Bendix Radio—a leader & pioneer in the electronics field, one that has the knowledge, strength and resources to stay out front during the competitive days ahead! Your part is EASY! Wire, phone, write . . . or send us a post card. Simply state your name, address and phone number, your education and experience. We'll carry the ball from there! All replies held in strictest confidence, and we guarantee speedy action!

*Address: Mr. L. H. Noggle
Dept. M
Bendix Radio
Baltimore 4, Md.
Phone: VAlley 3-2200*

Bendix Radio

DIVISION OF
BENDIX AVIATION
CORPORATION

Baltimore 4, Maryland

physicists and physical chemists

... with baccalaureate or advanced degrees and those with basic experience in these sciences now are offered an unusual opportunity to enter the new semiconductor field and at the same time become associated with General Motors.

The scope of the semiconductor field is virtually limitless, and our new permanent program is to explore wide areas of it and engage in research and development—starting with a power transistor suitable for automotive use and continuing on toward basic research and the development of semiconductor types suitable for military and other commercial uses. The work is independent of Government support.

The most up-to-date research facilities for this type of work are provided, with leadership by a physicist with an outstanding record in this field. You also obtain the advantages of being among the first to join this new and vital General Motors activity.

Location is the Midwest. Expenses for arranged interviews and relocation allowed. Unusual employe benefits of General Motors are included.

If you find this of interest or if you wish further information, write, wire or telephone Mr. H. J. Claypool, Executive Engineer, Delco Radio Division, General Motors Corporation, Kokomo, Indiana (phone 2-8211).

Delco Radio



DIVISION OF **GENERAL MOTORS**

CORNELL AERONAUTICAL LABORATORY NEEDS

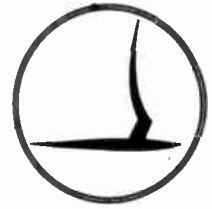

ELECTRONIC ENGINEERS

You can work in the stimulating atmosphere of an applied research and development laboratory where ideas are important, initiative is encouraged and associates are competent. The project areas listed below are typical of our extensive electronics interest; a complete list would include almost every branch of modern electronics.

We are interested in men of all levels with sound training, imagination and potential, regardless of their specialty. B.S. degree and experience required; advanced degree with experience to back it up is even better.

Communications

Dynamic Control Systems

Aircraft Instrumentation

Radar

Computers

Electrical Measurements

Varied Electronic Circuits

Servo-Mechanisms

Missile Guidance

Microwave

If you are interested in working at your maximum professional level in an organization that combines the most desirable elements of academic and industrial research and development, we invite you to communicate with our Employment Manager.

Hospitalization, surgery; group life, sickness, accident and retirement insurance is available with most of the cost paid by the Laboratory. Salaries are comparable with industry. Merit reviews occur semi-yearly assuring recognition of work well done and expediting advancement. Other personnel policies are very liberal, such as our self-sponsored internal research program. Graduate study at University of Buffalo is encouraged through generous tuition refund program.

CORNELL AERONAUTICAL LABORATORY

Buffalo 21, New York
wholly owned by Cornell University



pacing **canada's growth**
 creating **engineering opportunities**



ELECTRONICS SECTION CHIEF

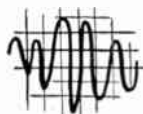

Responsible to the Chief Design Engineer for the design of all aircraft radio, radar and electronic installations and systems for a broad field of military aircraft. Candidates should have an engineering degree in Engineering Physics or Electrical Engineering and 12 years experience including 4 years in a senior supervisory capacity. Experience in the field of A.S.W. installations is desirable.

ELECTRONICS SUPERVISOR



To direct missile electronics design and development. Requires an Engineering Physics or Electrical Engineering degree, some graduate work in electronics preferred, with 8 to 10 years electronic design experience related to radar or fire control systems (including at least 3 years on guided missiles) and a strong background in systems analysis.

The future potential for those engineers who join Canadair is as apparent as the rapid industrial expansion now in progress in Canada itself.

Along with Convair and Electric Boat Company, Canadair is a division of General Dynamics Corporation, with the vast and varied facilities of each at its disposal toward the manufacture of military and commercial aircraft of all types.

On Canadair's engineering staff are men from all parts of the globe, contributing a wealth of new ideas and stimulating new thoughts on engineering practice.

The location is adjacent to a residential community where housing at moderate cost is readily available. The heart of historic Montreal is less than 6 miles away, and hunting, fishing and other outdoor recreations are near at hand. Generous relocation assistance will be given those who join the staff.

If you qualify for one of the positions listed above, please send a complete resume to E. H. Higgins, Chief Project Engineer, Dept. E-1. All replies will be held in strict confidence.



CANADAIR
LIMITED

P.O. Box 6087, Montreal, P.Q., Canada

ENGINEERS

Success Comes Early to Men of Talent

AT SYLVANIA

Here are challenging opportunities in a newly formed Division of a pioneer electronics firm for continued growth and responsible positions.

INVESTIGATE SYLVANIA'S OPPORTUNITIES NOW!

The following
CAREER POSITIONS
are now open

BOSTON Engineering Laboratory

Majors in E.E., M.E.,
Math, Physics. Research
& Development experience in—

- Countermeasures
- Systems Analysis
- Transistor Applications
- Noise Studies
- Antenna Res. & Dev.
- Systems Development
- Mechanical Design
- Miniaturization
- Digital Computer circuits & systems
- Circuit Design
- Shock & Vibration
- Technical Writing
- Missile Analysis

BUFFALO Engineering

Majors in E.E., M.E., or
Physics. Experience in
Product Design and Ad-
vanced Development in—

- Mechanical Design
- Shock & Vibration
- Subminiaturization
- Microwave Applications
- Pulse Techniques
- Servo Mechanisms
- F. M. Techniques
- Equipment Specifications
- Circuit Design
- Heat Transfer
- Systems Development
- Components
- Mechanization

INTERVIEW and RELOCATION EXPENSES will be paid by Sylvania

Sylvania provides financial support for advanced education as well as liberal insurance, pension and medical programs.

Please forward resume to:

Professional Placement Supervisor
SYLVANIA ELECTRIC PRODUCTS INC.
Thomas A. Tierney | Randall A. Kenyon
70 Forsyth Street | 175 Great Arrow Ave.
Boston, Mass. | Buffalo 7, N. Y.

SYLVANIA

ELECTRIC PRODUCTS INC.

Your inquiries will be answered
within two weeks.



Positions Wanted

By Armed Forces Veterans

(Continued from page 130A)

ELECTRONIC ENGINEER

BEE 1953. Age 25. 5 years electronic experience, including 2 years shop and testing, 1 year assistant project engineer on classified Navy project. 2 years as radio officer USAF. Being discharged from USAF in July. Desires responsible position in production or development. Box 839 W.

INSTRUCTOR

BSEE, MSEE. Age 29, married, 1 child. Graduate work in advanced electron tube circuits, network analysis and synthesis, and feedback systems. Mathematics minor. Licensed radio amateur. 1 year communications (R.F.) design and development; 1 year analogue computer circuit research and design; 3 years applied transistor research. Excellent references. Desires a full time teaching position in an institution that has an E.E. graduate school (PhD) with privilege of engaging in six semester hours per semester of graduate study. Available Sept. 1, 1955. Box 840 W.

ELECTRONICS SCIENTIST—INSTRUCTOR

Age 29, BS in mathematics, Summa cum Laude. Minor in physics, graduate work in mathematics for 2 years. University mathematics instructor for 3 years. 1st class radio-telephone license with radar endorsement. Air Force electronics instructor for 3 years. Excellent references. Desires position with definite possibility of advancement. Box 841 W.

(Continued on page 136A)

ELECTRONIC ENGINEERS

ADVANCE YOUR CAREER
WITH A LEADER IN
WESTERN ELECTRONICS

An expanding program of:

- research
- development
- production
- specialized military equipment
- advanced commercial design
- real creative challenge

Special receivers and transmitters, DF and DME, various instruments and Transistor applications—special devices. Studies in noise, radar, miniaturization and test equipment. Relocating expenses, good insurance plan, central location, steady advancement.

Send resume to L. D. Stearns
Engineering Employment Manager

Hoffman

LABORATORIES, INC.

(SUBSIDIARY OF HOFFMAN RADIO CORP.)

3761 S. HILL ST., LOS ANGELES,
CALIF.



Communications

Vital link between thought and action paces all military and industrial activity

RADIO COMMUNICATION, oldest of the electronic sciences, has long played an important role in the thought-action process; yet today it is being called upon for capabilities and performance characteristics far beyond those afforded by the present state of the art.

Such demands stem from the basic importance of advanced communication systems in maintaining American military superiority.

Recognizing this, The Ramo-Wooldridge Corporation is today engaged in research and development activities leading to the production of radio communications systems capable of providing the *information capacity, versatility, range, and reliability* necessary to insure maximum performance of our weapons systems.

And yet the challenge is not all military. It is inevitable that the application at Ramo-Wooldridge of these advanced modern theories and new techniques will lead to significant accomplishments in the field of commercial communications as well.

Engineers and physicists qualified to undertake advanced work in systems analysis and engineering, circuit development, transmitter and receiver engineering, modulator development, and propagation studies are invited to investigate the opportunities existing in HF and microwave communications, data transmission, facsimile, and allied fields, awaiting them at Ramo-Wooldridge.

The Ramo-Wooldridge Corporation

DEPT. P, 8820 BELLANCA AVENUE; LOS ANGELES 45, CALIFORNIA

ENGINEERS



Fulfill professional and personal objectives . . . with an outstanding firm in its field.

Challenging openings for experienced engineers with degrees or equivalent experience in:

- ELECTRICAL
- ELECTRONIC
- MECHANICAL

Research, Development, Design & Field Engineering on:

- Countermeasures
- Navigation Systems
- Guidance Systems
- Fire Control Radar Systems
- Beacons
- Electronic Installation
- Underwater Sound Systems
- Flight Simulators
- Antennas
- Magnetic Amplifiers
- Radar & Sonar Trainers
- Telemetry
- Communications Equipment
- Circuit Design

- DEVELOPMENT ENGINEERS
Junior & Senior
- FIELD ENGINEERS
(Local & Field Assignments)

WHAT STAVID OFFERS YOU



LOCATION:

On U.S. Highway 22, thirty miles (45 minutes) from New York City, near the beautiful Watchung Mountains, and within one hour's drive to the seashore. Enjoy all the advantages of the city, the mountains, and the seashore, as well as excellent schools, homes, churches and shopping facilities all conveniently located.

ENVIRONMENT:

One of the finest plants of its kind . . . spacious, modern, air-conditioned. Conducive to bringing out the best of your abilities!

ABOUT THE COMPANY:

Organized in 1945. Engaged in research, design and development for the Armed Services. The company has steadily progressed and grown since its inception, and now employs over 400. Positions are permanent, with opportunities for your development matching our own constant expansion.

ITS BENEFITS:

- Pension Plan
- Paid Vacations
- Group Life Insurance
- Education & Tuition Assistance
- Paid Holidays
- Other Group Insurances
- Paid Sick Leave
- Recreational programs: golf, softball, bowling, picnics, dances.

Interviews in Your Community by Appointment

Send resume, write or call for additional information.



STAVID ENGINEERING, INC.

U.S. Highway 22, Watchung, P.O. Plainfield, N.J. Plainfield 7-1600



Positions Wanted

By Armed Forces Veterans

(Continued from page 134A)

ENGINEER

BSEE June 1951, University of Missouri. 2 years in an aircraft joint project office, 18 months in testing, primarily in radar displays. Desires field service or overseas employment in construction or maintenance of communications, guidance or radar equipment. Single, 26. Can be released from service at anytime under AFR 36-22. Reply Lt. Thomas H. Magee, Box 7854, Wright-Patterson AFB, Ohio.

SECTION HEAD

BEE, MEE, Tau Beta Pi. Presently in charge of filter development section with cognizance over circuit design problems at VHF, UHF, and microwave frequencies. Experienced in project engineering and contract negotiation. Under 30, married. Desires responsible position anywhere in east. Box 842 W.

ELECTRICAL ENGINEER

Bs in Math. 1950, BEE 1954. IRE, AIEE, EIT (Ohio). Age 29, married, 1 child. 1 year experience with resistor components. Desires position in power or electronics field. Location Florida. Box 843 W.

COMPUTER ENGINEER

BEE, MSEE. 8 years extensive experience in analog computer field. Supervised large group of engineers in computer system and component design. Desires position of responsibility with opportunity for growth. Box 844 W.

(Continued on page 138A)

ENGINEERS

MICROWAVE

Development of microwave instruments & test equipment

ELECTRONIC

Development of electronic instruments

Precision instrument manufacturer requires men with good academic & practical background. At least 2-3 years design & development experience required. Should exhibit qualities of leadership, with the ability to meet & deal with people. Men who fill the bill will be substantially compensated.

POLYTECHNIC RESEARCH & DEVELOPMENT CO., INC.

202 Tillary St.
Brooklyn 1, New York

THE CHALLENGE OF CREATIVE ENGINEERING



At IBM, engineers are continually exploring the frontiers of man's knowledge in the expanding field of electronics.

Here, where the known meets the unknown, they are confronted every day with challenges that call for truly creative thinking—new ideas, new concepts, new applications.

In IBM's modern laboratories, engineers find the advanced facilities and, even more important, the atmosphere of freedom so vital to the search for knowledge and the stimulation of achievement.

If you are interested in this kind of engineering opportunity, and have the necessary background, we would like to have you visit our Poughkeepsie, N. Y., Laboratory. Here we can demonstrate—beyond the power of printed words—that IBM provides the environment and opportunity you have been seeking. We suggest that you write, outlining your interests, to William M. Hoyt, Room 2705, IBM, 590 Madison Avenue, New York 22, N.Y.

INTERNATIONAL BUSINESS MACHINES CORPORATION



A section of the
IBM Laboratory
in Poughkeepsie, N.Y.

IBM
TRADE-MARK

*World's
Largest Producer
of Data
Processing Machines*



Positions Open

The following positions of interest to I.R.E. members have been reported as open. Apply in writing, addressing reply to company mentioned or to Box No. . . .

The Institute reserves the right to refuse any announcement without giving a reason for the refusal.

PROCEEDINGS of the I.R.E.

1 East 79th St., New York 21, N.Y.

PROFESSOR—ELECTRICAL ENGINEERING

Professorial appointment at Brown University open for Electrical Engineer with established ability in teaching advanced research. Will have responsibility for organizing and directing theoretical and experimental research program in his fields of interest. Write to D. C. Drucker, Div. of Engineering, Brown University, Providence 12, R. I.

ELECTRONICS ENGINEER

The Civil Aeronautics Administration urgently needs electronics engineers who have had or who wish experience and training in electronics research and development. Salaries range from \$3410 to \$5940 per annum. Write or send application or Standard Form 57, which can be obtained at Post Office, to Personnel Officer, Civil Aeronautics Admn., Development of Evaluation Center, P. O. Box 5767, Indianapolis, Ind.

ENGINEERS IN ELECTRO-ACOUSTICS

ELECTRO-VOICE, Inc. has positions open for engineers with degrees in electrical engineering or physics. Positions are open for experienced men in speaker, microphone or phonograph pickup design and development for the recent graduates. Excellent future for the exceptional man. Write to Vice-President, Engineering, Electro-Voice, Inc., Buchanan, Michigan.

ENGINEER, CHEMIST OR PHYSICIST

Opening for research and product development in the field of semi-conductors and semi-conductor devices. Prefer direct experience with growth of silicon crystals and use of transistors. Also opening for research and product development of thermistors. Direct experience required. With a midwest manufacturer of electrical components. Capable of taking complete responsibility. Excellent working conditions in new laboratory. Reply in detail giving experience, training and salary desired. Box 801.

RADIO ENGINEERS

Consulting engineering firm requires senior and junior engineers for permanent staff positions. Experience in design and development of military radio and radar systems required. Work is of unusual interest and offers sound opportunities for advancement. Location mid-west. Salary open. Send summary of qualifications and background to Box 802.

RADIO ENGINEER

As technical consultant to large national trade association in two-way mobile and micro-wave radio fields. Also act as contact man with FCC and other associations on technical matters and frequency allocations. Location: Washington, D.C. Send complete details in first application. Salary \$600 per month. Reply Box 803.

(Continued on page 140A)

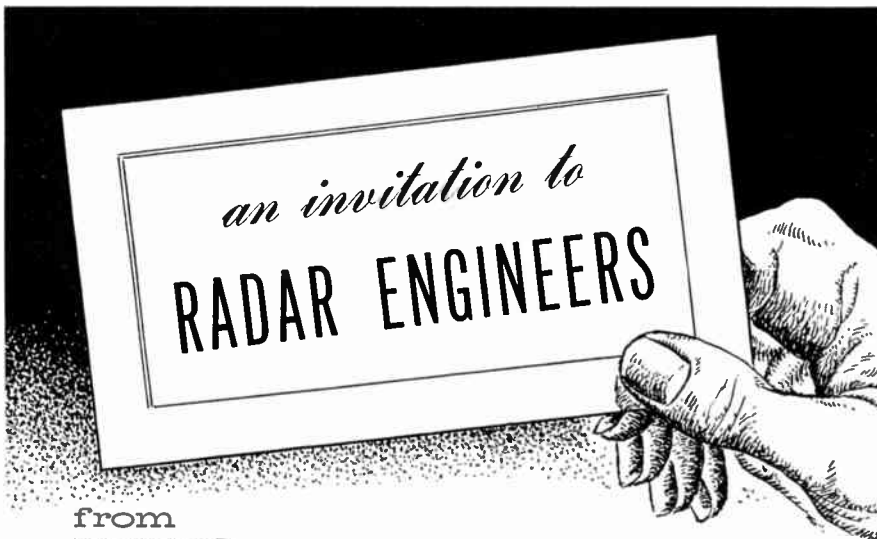

from
EMERSON ELECTRIC of St. Louis
AIRCRAFT ARMAMENT DIVISION

immediate openings on the highest technical level for
MICRO-WAVE and/or CIRCUIT DESIGN WORK

also immediate openings for
SERVO and COMPUTER ENGINEERS

where you'll work

- We're a national leader in armament and commercial projects, particularly in research, design and development of airborne fire control systems and guided missiles.
- We're a medium-sized company (5000 employees—300 armament engineers) where you're never "lost in the shuffle" but *rewarded and advanced* according to your abilities.
- We're located in one of St. Louis' nicer suburbs, within 5 to 15 minutes of new residential areas with attractive, moderately-priced homes.

the benefits you'll enjoy

- Graduate study program.
- Profit-sharing bonus and pension plan.
- Accident, life and health insurance.

Send complete resume, including salary requirements and phone number for local interview. St. Louis interview arranged at our expense. Write Engineering Personnel Manager.

Moving and Transportation Expenses Paid to St. Louis

EMERSON ELECTRIC
of St. Louis
8100 W. Florissant, St. Louis 21, Mo.

PHOTO-EMISSIVE EXPERIENCE

Old established firm manufacturing electronic tubes desires services of several engineers or physicists familiar with photo-emissive and photo-conductive devices. Firm is embarking on manufacture of pickup and storage tubes. Chance to get in at the start of a new operation. Location New England. State complete qualification, salary desired, citizenship status and references. Reply:

Box 810
INSTITUTE OF RADIO ENGINEERS
1 East 79th Street, New York 21, N.Y.



There's "growing room" for many kinds of engineers at Boeing

Boeing engineers are at the top in many fields, thanks in part to facilities like this wind tunnel. It is the most versatile privately owned one in the world.

Mechanical, electrical, civil and aeronautical engineers, mathematicians and applied physicists—all benefit from Boeing's insistence on engineering excellence. There are genuinely creative jobs at Boeing *right now*. Boeing engineers design equipment to the closest possible tolerances to "weigh nothing and take no space"—to do jobs that have never been done before, under great environmental handicaps of temperature, pressure and vibration. If this challenge interests you, then there's "growing room" for you on one of Boeing's airplane or guided missile "teams" in research, design or production.

As a result of long-range planning and solid growth, Boeing now employs nearly twice as many graduate engineers as at the peak of World War II. These members of aviation's most respected design and research group developed the B-47 and B-52 jet bombers, the IM-99 guided missile, and America's first jet tanker-transport. New and widely diversified projects are under way: supersonic flight, research in rocket, ram jet and nuclear propulsion, guided missile control, and much more.

Boeing engineers work with the most modern equipment, including electronic computers, chambers that simulate altitudes up to 100,000 feet, superb laboratories, and the multi-million-dollar new Flight Test Center.

With these advantages of facilities and opportunity for advancement, you can be sure of individual recognition at Boeing. Your achievements as a member of a tightly knit design or project "team" are recognized by regular merit reviews, and by Boeing's policy of promoting from within the organization.

- JOHN C. SANDERS, Staff Engineer—Personnel
- Boeing Airplane Co., Dept. G-21, Seattle 14, Wash.
- Please send further information for my analysis.
- I am interested in the advantages of a career with Boeing.

- Name _____
- University or college(s) _____ Degree(s) _____ Year(s) _____
- Address _____
- City _____ Zone _____ State _____

BOEING

Aviation leadership since 1916

SEATTLE, WASHINGTON WICHITA, KANSAS

ENGINEERS

ELECTRONIC

For work in the research & development of pulse circuitry, computing components and servo systems.

SYSTEMS (E.E.)

For work in the development of airborne navigational equipment.

The above positions require previous experience in allied fields.

MECHANICAL

2-3 years design experience on precision instruments.

DESIGNERS

ELECTRONIC ELECTRO-MECHANICAL MECHANICAL

1. Electronic or electrical packaging. Knowledge of subminiaturized techniques, for work associated with servos, amplifiers and computers.
2. Mechanical or electro-mechanical packaging of precision flight instruments.

The modern facilities and congenial atmosphere at Kollsman, designers of America's finest aircraft instruments, provide an environment conducive to truly creative work.

Please submit complete resumes to Employment Manager



kollsman INSTRUMENT CORPORATION

80-08 45th AVENUE, ELMHURST, NEW YORK • SUBSIDIARY OF *Standard* COIL PRODUCTS CO. INC.



Positions Open

(Continued from page 138A)

COMPONENTS APPLICATION ENGINEER

Wanted for an intriguing job. Essentials: knowledge of military electronics; an interest in a skill at writing technical information; freedom to travel; ability to communicate with other engineers; organizing power and punch. Opportunity: this job will make your reputation in an important phase of electronics. Location: New York City. Box 804.

TECHNICIAN

Position open. Community antenna system in growing community located in desirable valley southwest Oregon, needs technician capable adjusting RCA and Jerrold amplifier equipment. An excellent opportunity for the right man in an area with good schools, moderate climate, outstanding recreational inducements. Reply Umpqua TV, Inc. 1500 Harvard Ave., Roseburg, Oregon, giving qualifications, experience, etc.

SOLID STATE METALLURGIST

Experience in semi-conductors preferred; Ph.D level or equivalent. Salary will reflect applicant's ability, education and experience, and will satisfy the professional man. All replies confidential. Reply: P. O. Box 407, Waltham, Mass.

METALLURGIST—MATERIAL MAN

Experience in germanium essential, silicon experience in addition preferred. Good salary for competent man. All replies confidential. Reply: P. O. Box 407, Waltham 54, Mass.

ELECTRONICS ENGINEER

The U.S. Naval Postgraduate School has need for an electronic engineer in the computer laboratory for work with analog and digital computers. Opportunity to learn programming and coding and continue graduate studies. Electronics experience and mathematical interest necessary. Annual salary \$5,000 to \$6,940. Reply: Dept. of Mathematics and Mechanics, USNPS, Monterey, Calif.

POWER SUPPLY ENGINEERS

Graduate engineers with experience on tubeless regulated power supplies and magnetic amplifiers are needed. Write company complete resume, or phone Philip Diamond, President, Perkin Engineering Corp., 345 Kansas Street, El Segundo, Calif. ORegon 8-7215.

ELECTRICAL ENGINEERS

Electrical engineers with at least 3 years experience in the design or manufacture of electrical component parts. Several positions open for application work, involving the selection and use of microwave components, electron tubes, semi-conductors, wire and cable, small relays, etc. Contact G. K. Burnett, Sperry Gyroscope Co., Great Neck, N. Y.

ELECTRICAL ENGINEERS

Several years experience in the field of magnetic amplifiers and their applications. Must be able to assume full project responsibility and supervision. Real opportunity for exercise of initiative and advancement. Salary commensurate with education and experience. Send resume to Personnel Manager, Freed Transformer Co., Inc., 1718 Weirfield Street, Brooklyn 27, N. Y.

(Continued on page 142A)

DO YOU THINK CANADA HAS A BRIGHT FUTURE?

We are looking for a Car Radio Engineer who has the desire and ability to participate in the tremendous expansion that is predicted for our country in the years to come.

We are a medium-sized manufacturer of radio and television, noted for the quality and dependability of our products. Our salary levels compare favourably with others in the industry and we offer a complete employee benefit program plus a profit sharing plan.

We are located in Kitchener, a city of 50,000 in Southwestern Ontario about 100 miles from Buffalo, New York. Kitchener is noted for its cleanliness, and it offers adequate housing facilities at reasonable rates. Nowhere in the city are you more than ten minutes drive from work.

The man we are looking for should have university training and two or three years experience in car radio design. Some knowledge of transistors would be helpful.

Interviews can be arranged at your convenience and our expense. Send an outline of your background and experience in complete confidence to Dominion Electrohome Industries Limited, Kitchener, Ontario, Canada.

Lockheed antenna program offers wide range of assignments

Airborne Antenna Design is one of the fastest-growing areas of endeavor at Lockheed. Advanced development projects include work on stub, slot, reflector-type, horn and various dipole antennas.

These diverse antenna activities reflect the full scope of Lockheed's expanding development and production program. For with 13 models of aircraft already in production and the largest development program in the company's history underway, the work of Lockheed Antenna Designers covers virtually the entire spectrum of aircraft, commercial and military.

Lockheed's expanding antenna development has created a number of new positions on all levels for qualified antenna designers. Those interested are invited to write E. W. Des Lauriers, Dept. A-8-5.

Research Specialist Edward Lovick (right) discusses application of experimental slot antenna in the vertical stabilizer of a high-speed aircraft with Electronics Research Engineer Fred R. Zboril and Electronics Research Engineer Irving Alne.

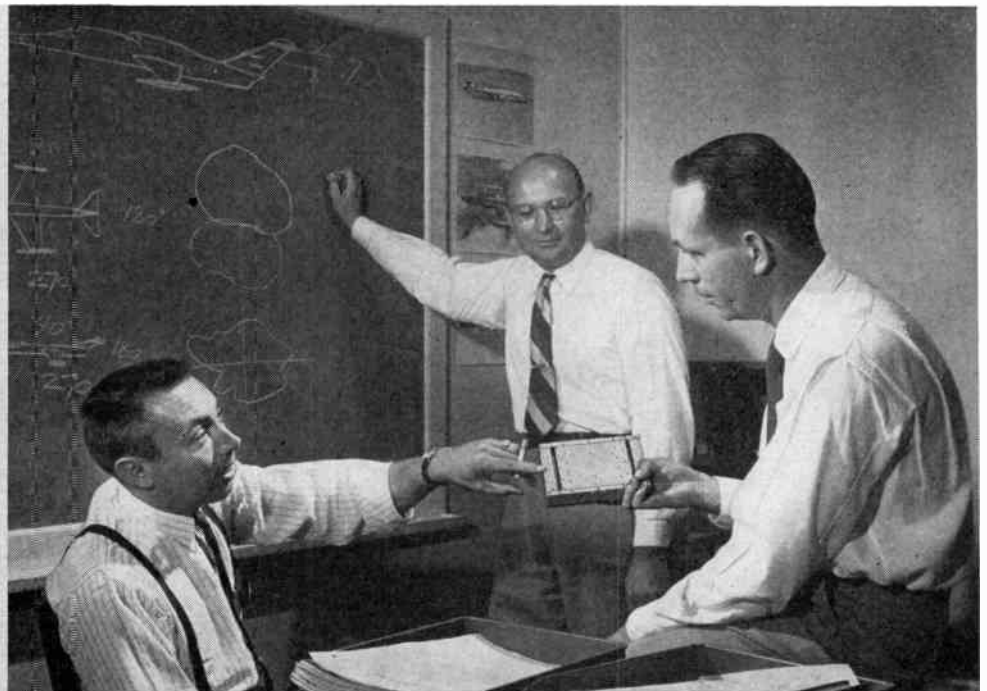

Lockheed increases engineers' salaries

Salaries, rate ranges and overtime benefits have been increased. In addition, employe benefits add up to approximately 14% of each engineer's salary in the form of insurance, retirement pension, etc.

Generous travel and moving allowances enable you and your family to join Lockheed at virtually no expense to yourself.

An address by Edward Lovick on "An Electronic Square-Rooter and Pattern Integrator for use with Antenna Range Systems" is available to interested engineers. Address inquiries to Mr. Lovick.

Lockheed AIRCRAFT CORPORATION

CALIFORNIA DIVISION • BURBANK **California**

**ELECTRONIC
ENGINEERS:**

**AT WESTINGHOUSE
AIR ARM...
EVEN THE SKY IS
NOT THE LIMIT!**

There's engineering adventure at Westinghouse Air Arm. It's the unlimited type of opportunity that challenges the most creative abilities and stimulates the imagination.

Your personal opportunity is unlimited at Westinghouse Air Arm, too. For income, working atmosphere, living conditions and employe benefits, you won't find a better position anywhere! There's a real future, too—because our business has a future and because our promotion and management development plan is progressive!

Openings exist for advanced development and design engineers in the fields of Radar, Fire Control, Missile Guidance, Computers, Autopilots, Bomber Defense, Field Service, Technical Writing.

We urge you to contact us today! We will forward by return mail an illustrated brochure about our operations and your place in them. Confidential interviews for qualified applicants will be quickly arranged.

TO APPLY—

Send letter outlining education and experience to—

EMPLOYMENT SUPERVISOR, DEPT. 142
WESTINGHOUSE ELECTRIC CORPORATION
2519 WILKENS AVENUE
BALTIMORE 3, MARYLAND



Positions Open

(Continued from page 140A)

ELECTRONIC ENGINEER

Excellent opportunities with expanding Radiation Instrument Development Group for recent graduates in E.E. or Physics and for engineers with 1-5 years' experience. Send resume and salary required to Tracerlab, Inc., Western Div., 2030 Wright Ave., Richmond 3, Calif.

PROFESSOR

Professorial position open on the faculty of the Dept. of Electrical Engineering of a mid-western university. Faculty rank and salary will be determined upon the qualifications of the applicant selected. Position starts in September 1955. A Ph.D. degree is desirable, but not necessary, if the applicant has a sufficiently strong research and publication record. Box 809.

SALES ENGINEER

We have an opening for a technical salesman, preferably with experience in the development and design of capacitors. Headquarters will be in Lee, Massachusetts. After a training period, the position will involve some travelling, principally in the east. The right man can expect an attractive fixed salary and expenses with an excellent opportunity for advancement. All inquiries will be treated in strictest confidence, and should be directed to the personal attention of Mr. Peter Schweitzer, Peter J. Schweitzer, Inc., 261 Madison Ave., New York 16, N.Y.

(Continued on page 144A)

**Electrical Engineers
and Physicists**

- Radar Simulation
- Advanced Circuitry
- Analog Computers
- Ballistics
- Mapping
- Telemetering

Senior and Junior Engineers

**A Job with
Good "Contacts"**

We offer you the opportunity to come in contact with an entire project, not with just a segment of the overall job. Here is your chance to join a firm with a future . . . to grow with us . . . to gain individual recognition by working closely with technical management. You will live and work in a delightful suburban community . . . associate with other top-notch engineers. If you are looking for a job with *good contacts*, write:

Industrial Research Laboratories

*Division of Aeronca Manufacturing Corp.
Dept. B-5, Hilltop and Frederick Rds.
Baltimore 28, Maryland*

“The World’s Most Promising Technological Revolution”

The Electronics industry is truly “the world’s most promising technological revolution.”

Even though it grew phenomenally during World War II, Electronics really came into its own following the war. By 1948, it had become a \$3,000,000,000 business, and was rapidly becoming a major industry.

Today, Electronics is a \$9,000,000,000 industry—counting television, radio, military electronics, commercial electronics, broadcasting, and related areas. There is every indication that by 1960 it will be a \$15 billion dollar industry and \$20 billion by 1964. And it will keep right on climbing.

No other major industry will grow that fast in the next decade.

The Armed Services, by far the largest customers of electronic products, spent an estimated \$145,000,000 in 1948 for electronic equipment for communications, navigation, gunnery systems, etc. Today, government electronic purchases amount to \$2,300,000,000 (or 6.3 per cent) of its total defense expenditures. Within the decade, this

may increase to 10 per cent of total government buying as the Armed Services become increasingly electronified. It is estimated that government electronic purchases will amount to over \$4,000,000,000 by 1964.

The potential volume in commercial and industrial electronics is unprecedented, especially in the field of computers, the heart of data processing, and “automation.” Sales of electronic equipment to commerce and industry amounted to \$1,000,000,000 in 1954, and the surface was barely scratched. This figure will more than double within the next ten years, for this area of electronics has a future limited only by one’s imagination.

The future of Electronics has no horizon. Many of the nearly 2,000 scientists and engineers throughout Sylvania are working on Electronics, constantly finding new and better ways to put Electronics to work. *They are keeping an eye to the future—assuring constant progress in the years ahead . . . “the world’s most promising technological revolution.”*

(Engineers: Sylvania has many opportunities in a wide range of defense projects. If you are not now engaged in defense work, you are invited to contact David W. Currier, Supervisor of Professional Placement, Sylvania Electric Products Inc., 1740 Broadway, New York 19, N. Y.)



SYLVANIA



Sylvania Electric Products Inc. • 1740 Broadway, New York 19, N. Y.

In Canada: Sylvania Electric (Canada) Ltd., University Tower Building, St. Catherine Street, Montreal, P. Q.

LIGHTING • RADIO • ELECTRONICS • TELEVISION • ATOMIC ENERGY

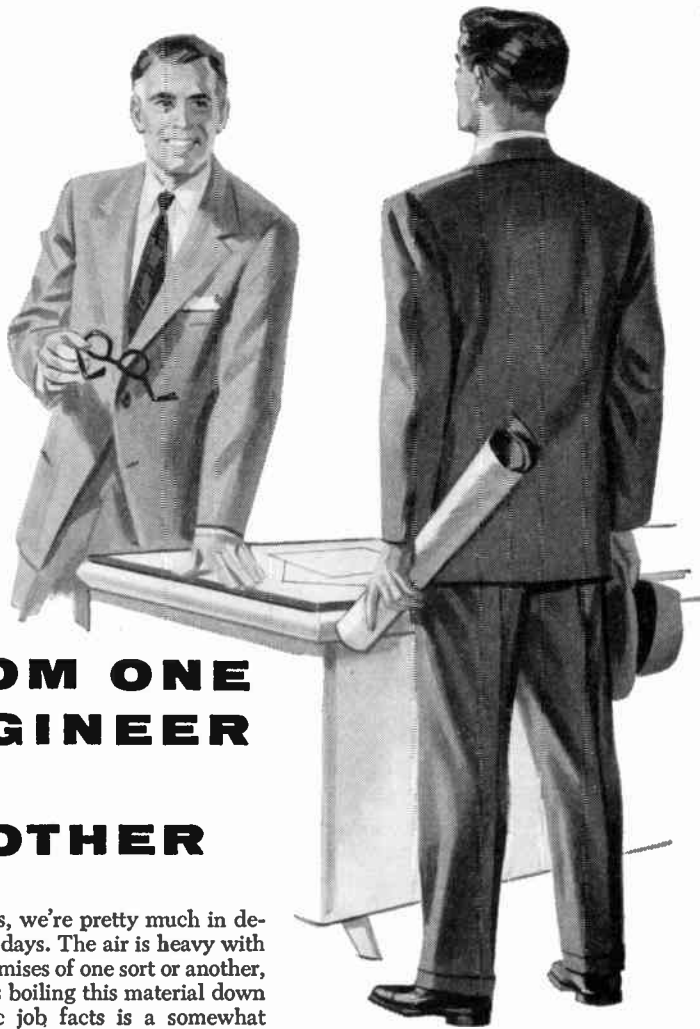

FROM ONE ENGINEER TO ANOTHER

As engineers, we're pretty much in demand these days. The air is heavy with glowing promises of one sort or another, and at times boiling this material down to the basic job facts is a somewhat complicated task. So I'm going to give it to you straight.

Link Aviation, Inc.—one of the subsidiaries of General Precision Equipment Corporation—has openings for engineers capable of independent activity, yet able to direct and coordinate the activities of others when necessary.

These men are needed in all phases of engineering activity—project engineering, production engineering and design—in the following fields: Advanced optics, analog computers, digital computers, radar simulation, pulse circuitry, mechanical design, electrical design. And they must be stimulated by the challenge of untried approaches, complex electronic or mechanical design problems, or new production techniques.

If you are one of these engineers, Link offers an unusual opportunity for professional growth to establish a solid, successful career while receiving generous employee benefits concurrently with raising your family in an ideal suburban environment.

For an interview or additional information, contact
WM. W. WOOD, JR.,
Vice President, Engineering



A SUBSIDIARY OF GENERAL PRECISION EQUIPMENT CORPORATION

Manufacturers of world-famous Link trainers and simulators (such as F3D, B-47, F-89, F2H-2, F2H-3) • simulated aircraft instruments • specialized computers • servo mechanisms • computer components • gear boxes • friction over-drive clutches • precision potentiometers • ratio voltmeters • phase angle meters • and other electronic devices



(Continued from page 142A)

ENGINEERS

Several positions for engineers are available involving the fields of electronics, instrumentation, mechanical engineering, etc. These positions are in the engineering field and are associated with various programs involving special devices, equipment and material for the military use. Salary ranges from approximately \$4200 to \$6000 per year. Education, training and experience will be the significant attributes in determining which position the candidate qualifies for. The above positions are available in upstate New York area and interested applicants should supply a resume of their experience to Box 811.

ELECTRONIC SALES ENGINEER

A growing group of electronic manufacturers' representatives serving in the southeast since 1924 requires an electronic sales engineer. Applicant should be married and be between the age of 30-35, willing to travel two-thirds of the time. Contacts cover industrials and distributors. Prospects for partnership interest to qualifying applicant. Send complete resume with photograph. Box 812.

PRODUCTION ENGINEER

Electronic engineer with production experience to supervise production and test personnel and to set up production and test facilities for small electronics manufacturer. Salary \$4000 to

(Continued on page 146A)

MIDWEST RESEARCH INSTITUTE

Kansas City, Missouri

*announces openings in industrial
Product and Process research*

**Attractive career appointments—
Income commensurate with ex-
perience—**

Completely new laboratories—

**Qualified Senior Electrical and Mechan-
ical Engineers and Physicists needed in
the following fields:**

Instrument and Machine Design
Electromechanical Apparatus
Automatic Control
Servomechanisms
Heat Transfer
Structural Analysis
Ordnance Development
Shock and Vibration
Aerodynamics

**IF you would like to live and work in a
growing progressive Heart-of-America
Community . . .**

**IF you would like to do both funda-
mental and applied research in a sci-
entifically minded atmosphere . . .**

**IF you have a sound technical back-
ground and practical working knowledge
gained in industry**

WRITE F. N. STEPHENS, Manager
Engineering Division
Midwest Research Institute
425 Volker Blvd.
Kansas City 10, Missouri

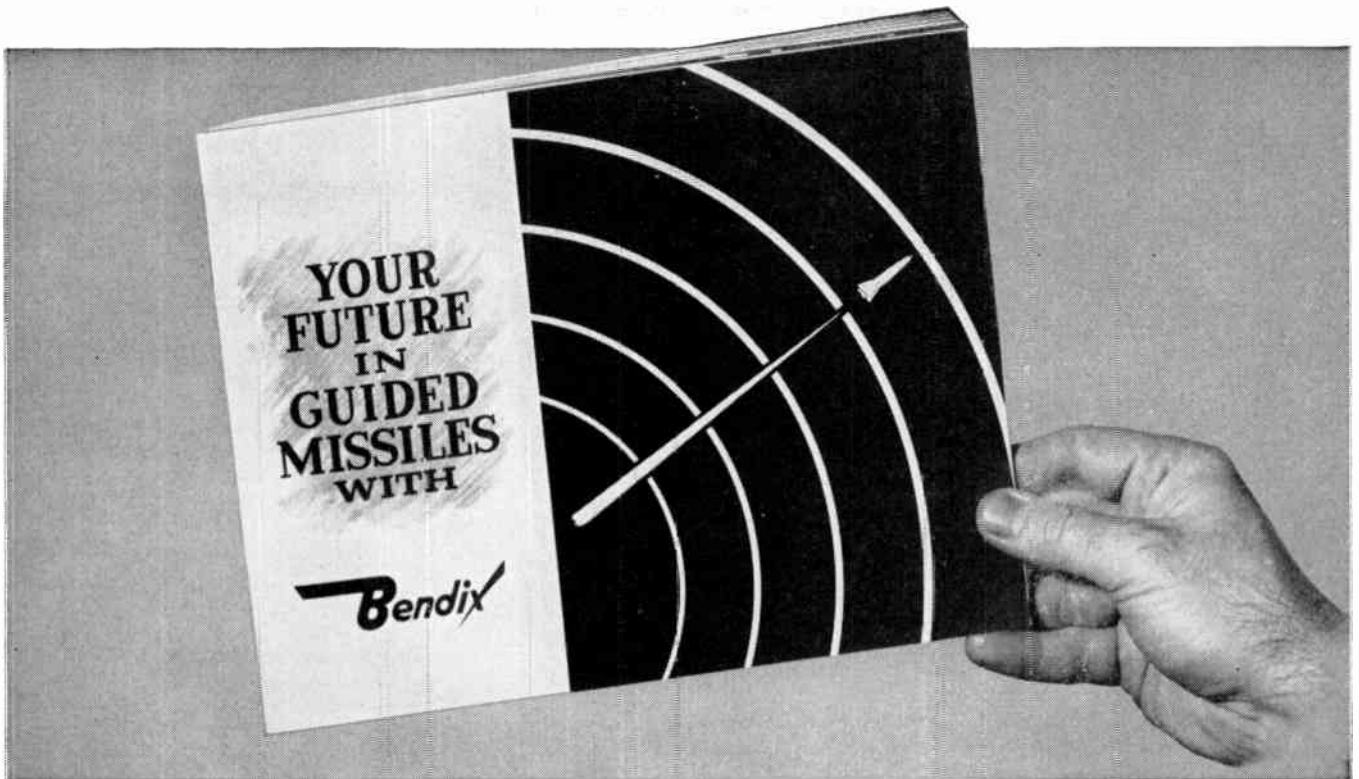

If you are interested in guided missiles this book will interest you. Here is one of the most complete guides to job opportunities in the guided missile field yet published. In this book, you will find not only a complete outline of the objectives and accomplishments of the Bendix Guided Missile Section, but also a detailed background of the functions of the various engineering groups such as system analysis, guidance, telemetering, steering intelligence, component evaluation, missile testing, environmental testing, test equipment design, reliability, propulsion, and other important engineering operations. Send for your free copy today.

23 challenging opportunities in the newest and fastest growing branch of the aviation industry are now open

Bendix job opportunities in guided missiles range from top senior engineers to assistant engineers, junior engineers, technicians, and a score of other assignments.

Qualified men are given real job responsibility with Bendix and grow with the development of what is not only the nation's most important weapon system, but a project that will undoubtedly lead to new and important long-range commercial applications.

And at Bendix you will be associated with top missile authorities and have at your command unexcelled engineering and manufacturing facilities.

If you are interested in a future in guided missiles, the first step is to fill out the coupon and mail it to us today.

Missile Section, Employment Department M
Bendix Products Division, Bendix Aviation Corporation
401 North Bendix Drive, South Bend, Indiana
**Please send me a copy of the book
"Your Future in Guided Missiles."**

Name _____

Address _____

City _____

State _____

Admiral

Increases ENGINEERING STAFF

Diversification at ADMIRAL is making itself felt in more and better engineering careers.

Real ability and originality can find new challenge and opportunity with a leader in electronic development and manufacturing.

Positions available for engineers with the following backgrounds:

★ MICROWAVE ENGINEERS

Experienced in UHF and SHF circuitry and components, with understanding of wave guides, cavities, and duplexers.

★ ELECTRONIC ENGINEERS

Junior and Senior engineers for television receiver circuit design. Experienced men also needed for V.H.F. and U.H.F. tuner work.

★ RADIO ENGINEERS

Duties involve designing household and portable radio receivers. FM and AM experience preferred.

★ MECHANICAL ENGINEERS

Electro-Mechanical designers. Assignments involve the design and layout of small mechanical devices at the development level.

★ COMMUNICATIONS ENGINEERS (MILITARY)

Applied development and design of radar and other specialized military systems.

★ AUTOMATION ENGINEERS

A special opportunity exists in the field of applying automation and printed circuit techniques in the above categories. Your imagination and engineering talents can be used in furthering this development.

Good starting salaries and working conditions with complete program of employee benefits. Opportunity for professional development with excellent facilities in Chicago area to carry on University graduate work while working full time.

• Send complete resume to Mr. Walter Wecker, Personnel Department, to get more information on these opportunities.

Admiral Corporation

3800 W. Cortland St.
Chicago 47, Illinois



Positions Open

(Continued from page 144A)

\$6000. Live in attractive small town with the opportunity of taking graduate work at the Pennsylvania State University. Reply to Community Engineering Corp., P. O. Box 824, State College, Penna.

ENGINEERS

Television receiver deflection systems engineers wanted. Development and product design. Both color and monochrome. Send resumes to Dept. RT-1, Technical Employment Office, General Electric Company, Electronics Park, Syracuse, N. Y.



Membership

(Continued from page 114A)

Buxbaum, S. J., Servlant Electronics Bldg., 142 Box 9, N.N.B., Norfolk, Va.

Carlyle, J. K., 15 College Cir., Stratford, N. J.

Carnevale, A. D., 4626 E. Douglas St., Tucson, Ariz.

Casey, K. T., 208 Hillcrest Manor Ct., Utica, N. Y.
Castro, S. J., 132-59 Maple Ave., Flushing 55, L. I., N. Y.

Caswell, J. R., 3253 Mountain View Ave., Los Angeles, Calif.

Cayouette, R. L., 65 Lexington Rd., Concord, Mass.

Cecala, J. A., 7008 Clinton Rd., Upper Darby, Pa.
Cerefin, D. C., 9577 TSU Det. 1, HQ, Co., W-5 Proving Ground, N. Mex.

Chambers, D. T., 112 Wagner St., Savannah, Ga.
Chong, C. F., 4225 Baltimore Ave., Philadelphia 4, Pa.

Clark, L. T., 70 Convair (Grants Lane), Fort Worth, Tex.

Clevenger, R. F., 15542 E. Goodhue St., Whittier, Calif.

Close, A. H., 12209-95 St., Edmonton, Alta., Canada

Comeau, E. A., 314 E. 82 St., New York 28, N. Y.
Constantinides, J. S., US 554661147, Det. 3, 9470 T.U., Fort Huachuca, Ariz.

Coutermash, L. E., 146 Dry Hill Rd., Norwalk, Conn.

Graycraft, H. T., 3947 N.E. Seventh Ave., Portland 12, Ore.

Cronin, J. F., Mechanic St., Barre, Mass.

Crowley, J. J., 1015 Poplar Dr., Falls Church, Va.
Davidson, J. K., 2803 Los Flores Blvd., Lynwood, Calif.

DePaola, G., 117-62 St., West New York, N. J.

De Pasquale, N. D., 2837 Robern Ave., Baltimore 14, Md.

Domingue, J. C., Box 297, Tombstone, Ariz.
Dorsett, J. E., 580 Freedom Ave., Portsmouth, Va.
Duda, E. M., 16607 James Couzens Hiwy., Detroit 21, Mich.

Duhamel, J. P., 6 Rue Alfred Molina, Bordeaux, France

Durocher, J. D., Jr., American Machine & Foundry Co., 11 Bruce Pl., Greenwich, Conn.

Duval, A. N., 1014 W. Inwood Dr., Arlington, Tex.
DuVal, C. N., R.F.D. 1, 44-P Linlier, Virginia Beach, Va.

Edwards, D. J., 2124-16 St., Lubbock, Tex.

Ellsworth, A. B., 1738 Yakona Rd., Towson 4, Md.

(Continued on page 150A)

DU MONT Instrument Division

needs additional high calibre
engineers for

Electronic Instrumentation
Missile Work
Test Equipment
Timing and Pulse Circuits
Video Circuits
Electro-Mechanical Devices
Recording Systems

for both commercial
and government output

Contact
Mr. George A. Kaye
Employment Manager

ALLEN B. DU MONT LABORATORIES, INC.

35 Market Street
East Paterson, New Jersey

ASSOCIATE OR ASSISTANT PROFESSOR

in fields of experimental physics and engineering to initiate and supervise research projects suitable for Masters and Doctors theses. Six hours weekly maximum teaching in graduate physics. If you like to deal with people as well as research problems, we have such an opening for a scientist 30 to 40 years of age with doctorate. Industrial research experience necessary. Opportunity for close association with industrial research laboratories, along with splendid opportunity to perform and publish original research. Academic title and salary according to ability and experience. Box 816, Institute of Radio Engineers, 1 East 79th Street, New York 21, N.Y.

UNIVAC

The FIRST Name

in Complete Electronic Computing Systems

As the UNIVAC takes its place in more and more industries, REMINGTON RAND has greatly expanded its research and development work in order to continue its leadership in electronic computing equipment.

There are many positions recently opened at all levels in all phases of research, design, development, and application of computing and allied equipment. Even though your training and experience may not be connected with computers, we are willing in many cases to provide the necessary training. Individual cases can be evaluated during interview.

- System Studies
- Logical Design
- New Components
- Solid State Physics
- Semi-conductors
- Magnetic Materials
- Storage Techniques
- Circuit Design
- Pulse Techniques
- Input-Output Devices
- Product Design
- Test Equipment Design
- Computer Development and Design
- High Speed Electro-Mechanical Devices
- System Test and Maintenance

The rapidly expanding engineering program has created many permanent positions paying excellent salaries. These positions offer personal challenges as well as outstanding opportunities for professional development. The possibilities for graduate study in this area are excellent and the company has a liberal plan for reimbursement of tuition expenses. Other company benefits include retirement and group insurance.

Replies Kept Strictly Confidential
FOR INTERVIEW, WRITE TO

Remington Rand

ECKERT-MAUCHLY DIVISION

2300 West Allegheny Ave.

Philadelphia 29, Pa.

ENGINEERS

Electronics

Component Application

Analogue Computer

Environmental Test

Senior Microwave Research

DOES YOUR CAREER INCLUDE THESE IMPORTANT FEATURES?

Provision for delightful living for the entire family. Westchester County, New York, site of General Precision Laboratory is famous throughout the U.S. for its high standard of living, the scenic beauty of its rolling hills, yet only an hour from New York City and its wealth of cultural, educational and recreational facilities.

A stable future. This is possible at GPL not only because it is engaged in work of a long-term nature, but also because of its association with the large and diversified parent organization, General Precision Equipment Corporation.

Growth and advancement. Because the group at GPL is small and closely integrated, recognition for outstanding work—and advancement—come quickly.

Men with interests in the above and related fields should submit resumes to Mr. Hollis F. Ware. Expenses will be paid for qualified applicants who are invited for interviews. We regret we can consider only U.S. citizens.

GENERAL PRECISION LABORATORY INCORPORATED

A subsidiary of General Precision Equipment Corporation
3 Bedford Road, Pleasantville, N.Y.

ELECTRONIC COMPUTER ENGINEER

Major national retail organization is seeking outstanding young digital computer engineer to head up research and installation activities involving merchandising applications of electronic data processing. Desirable background can include engineering and business school training, equipment design, programming, business systems analysis, punched card methods, operations research, and mathematical techniques. Excellent career opportunity for qualified individual.

Box 815

INSTITUTE OF RADIO ENGINEERS
1 East 79th St., New York 21, N.Y.

Vacancies exist at the Marine Physical Laboratory for men of originality with sound scientific background in Physics and Mathematics. The Marine Physical Laboratory of the Scripps Institution of Oceanography is a unit of the University of California.

The staff is small, the problems numerous and there is ample opportunity for the conduct of individual research in underwater acoustics, electronics, "noise" backgrounds and other fields falling under the wide classification of Marine Physics. Salaries are based on the University of California scales. Applications with statement of qualification should be addressed to: Director, Marine Physical Laboratory, San Diego 52, California.

Among important activities at Hughes is a program involving comprehensive testing and evaluation in connection with Hughes-developed radar fire control and navigation systems for latest type military all-weather interceptors.



Convair F-102 all-weather interceptor.

System Test Engineers

There is need on our Staff for qualified engineers who thoroughly understand this field of operation, and who have sufficient analytical and theoretical ability to define needed tests; outline test specifications; assess data derived from such tests, and present an evaluation of performance in report form.

Engineers who qualify in this area should have 1 a basic interest in the system concept and over-all operation of test procedures; 2 experience in operation, maintenance, "debugging," development, and evaluation testing of electronic systems, and knowledge of laboratory and flight test procedures and equipment; 3 understanding of basic circuit applications at all frequencies; 4 initiative to secure supporting information from obscure sources.

Hughes

RESEARCH AND DEVELOPMENT LABORATORIES

SCIENTIFIC AND ENGINEERING STAFF

Culver City, Los Angeles County, Calif.



ENGINEERS
PHYSICISTS

How SYLVANIA Can Help You in the Missiles Field thru its Stability and Diversity

Sylvania has established a Missile Systems Laboratory. New laboratory facilities are nearing completion. This 54 year old company, renowned for its consumer products, and supplying vital "heart" parts to other manufacturers, now brings its research, know-how, stability and diversity to the guided missiles field. Behind this important new Sylvania laboratory stands the versatility, drive and dedication that has seen Sylvania expand to 45 plants and 16 laboratories, while *doubling* its engineering staff and almost tripling sales in the past 6 years.

Permanent positions
are now open in these fields:

ANALYSIS & DESIGN OF
SEARCH RADAR SYSTEMS
ANTENNA THEORY & DESIGN
ANALYSIS OF MISSILE
GUIDANCE SYSTEMS
MATHEMATICAL ANALYSIS &
SYSTEM DESIGN OF FIRE CONTROL
& COMPUTER EQUIPMENT
INERTIAL GUIDANCE OR
INFRA-RED FOR DETECTION
& TRACKING
SERVO SYSTEM
DESIGN & ANALYSIS
AERODYNAMICS
PROPULSION
AIRCRAFT OR MISSILE
STRUCTURES

Relocation and interview expenses will be paid.

Please forward resume to:
Mr. Robert Koller
Supervisor of Professional Placement

missile systems laboratory

 **SYLVANIA**
ELECTRIC PRODUCTS INC.

151 Needham Street, Newton, Massachusetts
(A suburban location just 8 miles from downtown Boston)



Looking for NEW ELECTRONIC WORLDS to conquer?

Beyond the range of sight lies the vast potential of tomorrow's electronic world. How this new world will affect the scientist, surgeon, farmer, housewife, business man, can only be surmised. But the possibilities are inspiring. The world of the electron is infinite.

Wresting electronic secrets from Nature has been Farnsworth's sole function for over a quarter of a century. Expansive, aggressive diversification into new and challenging fields of activity, implemented by the addition of men with significant capacity for professional growth, marks the direction of the Company's progress. Association with an organization slated for continuing major success can lead to highly satisfying individual responsibility and awards, and result in a stimulating and fruitful career.

To scientists and engineers possessing the professional potential and who are looking ahead to new electronic worlds to conquer, Farnsworth offers worthwhile opportunities in these fields: Pulse Circuitry, Microwave Antennas, Information Theory, Infra-Red Systems and Devices, Mechanical Packaging, Receivers, Optics, Data Recording, Transistor Circuitry, Microwaves, Radar, Electronic Countermeasures, Operations Research, Missile Guidance and Control Systems and Test Equipment.



Address Inquiries to
FARNSWORTH ELECTRONICS CO.,
Technical Employment Dept.
Fort Wayne, Indiana

Creative Engineering Opportunities with Republic

Dynamics

Dynamics Engineer

A broad program involving analytical and experimental investigations of the complex dynamics problems associated with supersonic aircraft offers a real opportunity for young engineers with ability. You will gain invaluable experience under competent supervision to develop a professional background in such areas as servo-mechanisms, analogue computers, control system dynamics, non-linear mechanics and hydraulic system analysis. A program of laboratory investigations on actual systems in conjunction with analytical work, as well as a coordinated lecture program, offers an outstanding environment for rapid professional development. A degree in ME, AE or Physics with good Math background is preferred.

Research

Antenna Engineer

To conduct pattern studies, design prototype antennas and supervise flight tests of new antenna installations. College graduate in Physics, Math or E.E.

Electronic Instrumentation Engineer

Three to five years aircraft instrumentation experience required. Knowledge of transducers, amplifiers and recording equipment used in experimental research testing of hi-speed jet aircraft is essential. Knowledge of servo loop theory as applied to aircraft systems coupled with ability to properly instrument, record and analyze is desirable. Graduate with E.E. degree preferred.

Electronics Engineer

Familiar with airborne electronic equipment (communications, navigation I.F.F., Radar and Autopilots), preferably with 2 to 4 years aircraft experience. Should be a college graduate. Duties will include system investigations, establishing test procedures and conducting environmental tests on airborne electronic equipment and components.

Please address complete resume, outlining details of your technical background, to:

Mr. R. L. Bortner
Administrative Engineer



REPUBLIC AVIATION
FARMINGDALE, LONG ISLAND, NEW YORK



Membership

(Continued from page 146A)

- Emmer, T. L., 423 W. Vanderbilt Dr., Oak Ridge, Tenn.
- Erickson, T., 60-39—255 St., Little Neck, L. I., N. Y.
- Espejo C., G., All America Cables & Radio, Inc., Casilla 2336, Lima, Peru
- Ewanick, A. A., 219 Poplar St., Dickson, Pa.
- Faiz, V. N., Air Training Center, Karachi Air Port, Karachi, Pakistan
- Fathy, A. E. H., 44 Zaki Oaf St., Rod-El-Farag, Cairo, Egypt
- Ford, M. J., Box 334, R.F.D. 1, Atascosa, Tex.
- Fort, J. R., 735 Smalley Ave., Hayward, Calif.
- Franco, A., 3337 Student Sq., Box 558, Scott AFB, Ill.
- Frank, R. W., Lukko Sales Corp., 5024 Irving Park Rd., Chicago 41, Ill.
- Freeman, F. V. H., 625 Springer Ter., Los Altos, Calif.
- Garcia, G., 1025 Elkgrove Ave., Apt. 2, Venice, Calif.
- Gerlach, A. B., 9522, N. Kildare Ave., Skokie, Ill.
- Germain, L. V., 4080 Harvard Ave., Montreal 28, Que., Canada
- Gobeil, C. E., Officers Mess, RCAF Station, Trenton, Ont., Canada
- Gossman, R. G., 2590 Kensington Rd., East Meadow, L. I., N. Y.
- Gragg, J. W., Allied Electronics, Inc., Box 8008, Raleigh, N. C.
- Greco, N. A., 6 Cutler Farm Rd., Lexington 13 Mass.
- Grenier, C. A., NAESU, c/o Receiving Station, Washington, D. C.
- Griffey, D. E., 5124 Chase Ave., Skokie, Ill.
- Grossman, H., 3676 E. 147 St., Cleveland, Ohio
- Grubb, C. E., 1430 S. Oak, Arlington, Tex.
- Guill, G. M., Jr., 3802 Darlington Rd., S.W., Roanoke, Va.
- Hacker, P. S., 1803 Tower Rd., Glen Burnie, Md.
- Hahn, J., Pupin Cyclotron Laboratory, AEC, Columbia University, 538 W. 120 St., New York 27, N. Y.
- Harris, W. E., Jr., 86 Bank St., Red Bank, N. J.
- Hays, F. R., U. S. Radium Corp., Whippany, N. J.
- Hays, J. W., Box 298, Duncanville, Tex.
- Hinton, L. L., 2100 Oakwood Ave., Raleigh, N. C.
- Hoover, M. C., Electric Sorting Machine Co., 410—44 St., S.W., Grand Rapids 8, Mich.
- Horcher, A. P., 323 E. 83 St., New York 28, N. Y.
- Huber, C. A., 3337th T.T.S., Box 462, Scott AFB, Ill.
- Hunter, A. L., 913 Madeira Dr., N.E., Albuquerque, N. Mex.
- Hupp, C. E., 1637 Broadway, Melrose Park, Ill.
- Hurlbut, W. A., 1030 E. Helen, Tucson, Ariz.
- Jodon, F. R., 3000 Connecticut Ave., N.W., Suite 338, Washington 8, D. C.
- Johns, G. E., Box 33-H, R.F.D. 1, Rio Piedras, Puerto Rico
- Johnson, R. A., 7 Maxwell Ct., Mains Ave., Syracuse 7, N. Y.
- Jones, B. J., 19450 Marine View Dr., Seattle 66, Wash.
- Justice, R., Antenna Laboratory, Ohio State University, Columbus 10, Ohio
- Kemper, D. M., 1008 Fredrick, Venice, Calif.
- Kent, A. J., 29 Pine St., Bedford, Mass.
- Kerns, G. P., 114 Rose La., Rome, N. Y.
- Kilpatrick, H. B., 350 Sheridan Ct., Elmira, N. Y.
- King, G. J., 2804 Faber St., Redondo Beach, Calif.
- Kinney, D. D., Department 29, Hazeltine Electronics Corp., Little Neck Pkwy., Little Neck, L. I., N. Y.
- Kirkland, F. B., Philco Tech. Rep., 920th AC&W, APO 677, New York, N. Y.
- Klimberg, J., 2122 E. Sixth St., Tucson, Ariz.
- Koslov, S., Rm. 2-A 140, Bell Telephone Laboratories, Murray Hill, N. J.

(Continued on page 153A)

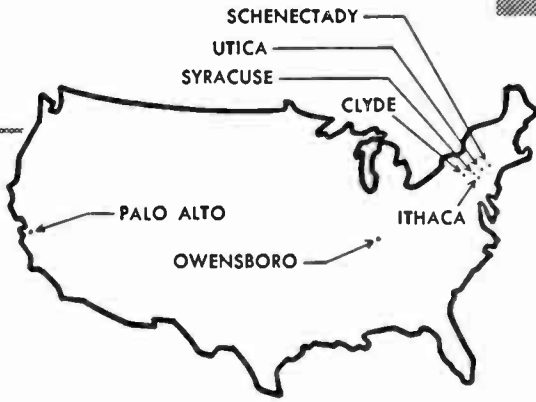

New
GENERAL ELECTRIC
*Opportunities
 Throughout the Country
 In Advanced Electronic
 Developments*

At General Electric plants and laboratories from New York to California, G.E. engineers are constantly planning new and revolutionary advances in the field of electronics.

And with each new development, they are broadening the scope and opening new challenges and new opportunities in this young and fast-growing field.

Thus, the opportunity is ever-increasing at General Electric. If you are interested in taking on new challenges... in working with the finest facilities... in growing along with this leader in industry, you are invited to apply now for positions open at Schenectady, Utica, Ithaca, Syracuse, and Clyde, New York; Owensboro, Kentucky; and Palo Alto, Calif.

ENGINEERS • PHYSICISTS

Positions available in the following fields:

Advanced Development, Design, Field Service and Technical Writing in connection with:

**MILITARY RADIO & RADAR • MULTIPLEX MICROWAVE
 MOBILE COMMUNICATION • COMMUNICATIONS
 ELECTRONIC COMPONENTS
 TELEVISION, TUBES & ANTENNAS**

Bachelor's or advanced degrees in Electrical or Mechanical Engineering, Physics, and experience in electronics industry necessary.

*Please send resume to:
 Dept. 5-5-P, Technical Personnel*



ELECTRONICS PARK, SYRACUSE, N. Y.

**PHYSICISTS
 RESEARCH ENGINEERS**

The Radiation Laboratory of The Johns Hopkins University provides unusual opportunities in a long range research and development program for experienced imaginative engineers and physicists. The men we seek are experts in fields of:

**SYSTEMS
 MICROWAVES
 CIRCUITRY**

The Laboratory offers challenging work in an atmosphere of scientific progress, encourages professional advancement and provides opportunity for advanced study in the University graduate schools. Congenial surroundings, excellent laboratory facilities, stimulating associations and, of course, liberal employee benefits.

Address inquiries to:

Radiation Laboratory
 The Johns Hopkins University
 Homewood Campus
 Baltimore 18, Maryland

ENGINEERS
 DESIGNERS-DRAFTSMEN
Electronic Mechanical

What's *NEW* at Melpar

NEW laboratories

NEW opportunities

NEW projects

Melpar has just opened its new plant at Falls Church, Virginia, in a beautiful suburban location. We have also moved to larger quarters at Watertown, Mass., and opened a new research department at Cambridge, Mass.

Melpar's continued expansion offers new career opportunities for individual growth and recognition. Men of vision and imagination who plan for the future are quick to sense the potential with this growing, dynamic organization.

Continued leadership in electronic research and development is reflected in our current group of projects with long-range military and industrial application.

- Network Theory
- Systems Evaluation
- Automation
- Microwave Technique
- UHF, VHF, or SHF Receivers
- Analog Computers
- Digital Computers
- Magnetic Tape Handling Equipment
- Radar & Countermeasures
- Packaging Electronic Equipment
- Pulse Circuitry
- Microwave Filters
- Flight Simulators
- Servomechanisms
- Subminiaturization
- Electro-Mechanical Design
- Quality Control & Test Engineers

*For personal interview send resume to
 Technical Personnel Representative,*

melpar, inc.

Subsidiary of Westinghouse Air Brake Co.

3000 Arlington Blvd., Dept. IRE-17
 Falls Church, Virginia
 or 11 Galen St., Watertown, Mass.

MISSILE INSTRUMENTATION

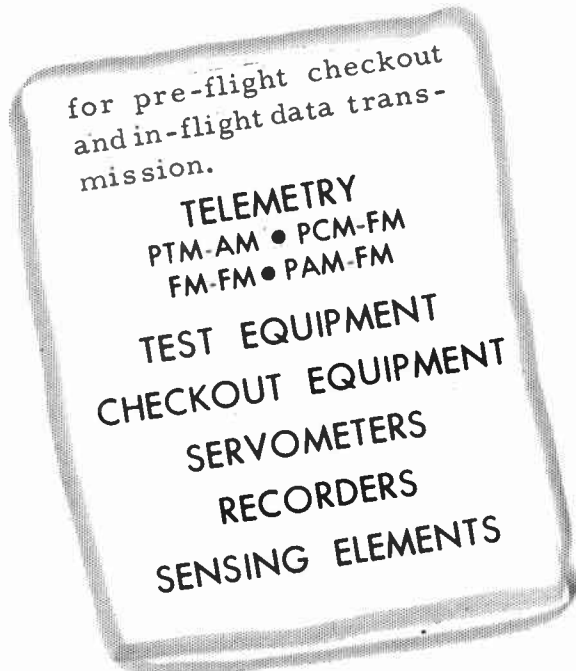
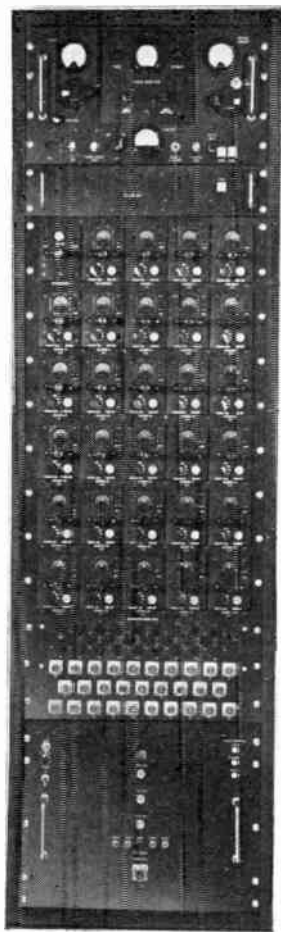

RADIATION Inc.

Melbourne, Fla.
Orlando, Fla.

Electronics • Avionics • Instrumentation

Digital Communication Engineers

with
experience
in
the
fields
of

Systems
Engineering
Miniaturization
Circuit
Development
Electromechanical
Development
Digital
Techniques

Long-Range Information Transmission

New advancements in the field of long-range information transmission are being made at Hughes with digital techniques.

Areas of Work

To further expand work in this area, Hughes Research and Development Laboratories are interested in people with experience in airborne communication systems, digital storage, low frequency measurements, modulation systems, miniaturized packaging, audio, IF and RF circuitry in the HF range, analog to digital—and other data conversion methods.

Scientific and Engineering Staff

Hughes

RESEARCH
AND DEVELOPMENT
LABORATORIES

CULVER
CITY,
LOS
ANGELES
COUNTY,
CALIFORNIA

Relocation of applicant must not cause
disruption of an urgent military project.

electronic engineers applied physicists

wanted to work in basic research and development for commercial and military applications.

You will find unusual opportunities for rapid advancement and professional growth as part of a team of recognized scientists and engineers.

Positions at
all levels available
for work in:

- Advance pulse circuits
- Digital system testing
- Magnetic core techniques
- Data conversion systems
- Electronic packaging
- Logical design
- Semi-conductor circuits
- Materials research

For personal interview,
send resume to

MAGNAVOX RESEARCH LABORATORIES*
2255 South Carmelina Avenue, Los Angeles 64, Calif.

*A DIVISION OF THE MAGNAVOX COMPANY

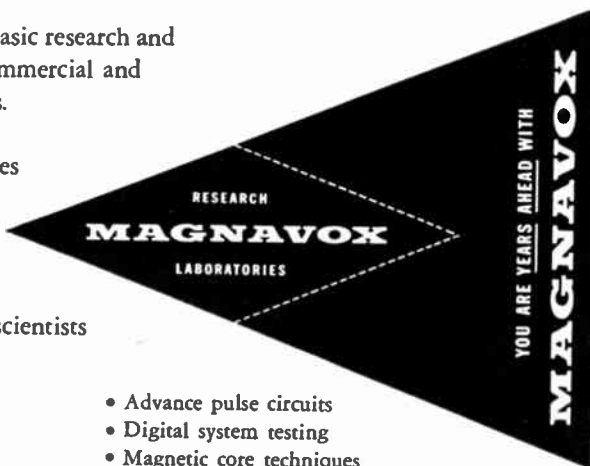

(Continued from page 150A)



- Kotter, A. S., 1410 N. Noble St., Chicago 22, Ill.
 Koulomzin, N. J., 38 Glen Byron Ave., Nyack, N. Y.
 Kroko, L. J., 10504 Shaker Blvd., Cleveland 4, Ohio
 Lauer, C. A., 251 School Rd., Kenmore 17, N. Y.
 Layden, O. P., 78 Borden St., Shrewsbury, N. J.
 Legler, H. E., 304 Miami St., Hiawatha, Kans.
 Lenz, W. K., Fifth AACS, I.O.M.Sq., APO 959, San Francisco, Calif.
 Lewicki, W. M., 259 Danbury Dr., Buffalo 25, N. Y.
 Lind, M. S., Electrical Engineering Department, Michigan College of Mining and Technology, Houghton, Mich.
 Lindsay, F. A., 18 Edgehill St., Princeton, N. J.
 Lindberg, R. W., Box 882, Prescott, Ariz.
 Landry, A. P., Box 636, Tombstone, Ariz.
 Lord, F. V., Box 54, Tarzana, Calif.
 Lovell, E., 2554 Prosser Ave., Los Angeles 64, Calif.
 Lowrie, G. M., 3404 Avenue G., Fort Worth 5, Tex.
 Lucas, H. B., 20 Ferry Ave., N., Fort Walton Beach, Fla.
 Mack, R. B., 29 Washington St., Beverly, Mass.
 Macomber, G. R., 401-C Hof Cir., Huntsville, Ala.
 Martin, A. L., II, Engineering and Technical Department, c/o BFS, Fort Huachuca, Ariz.
 Martin, G. B., Sr., Box 111, Erie St., Campbell Hall, N. Y.
 Matthews, C. I., 233 Shennecossett Pkwy., Groton, Conn.
 McDonald, M., 3955 Cortez Dr., Dallas 20, Tex.
 McGhee, R. B., 406-D Hof Cir., Huntsville, Ala.
 McPherson, R. T., 16247 Wyoming, Detroit 21, Mich.
 Mediatore, R. E., 44 Kingston Ct., New Hyde Park, L. I., N. Y.
 Meredith, C. J., Streetsville, Ont., Canada
 Mesecher, M. G., 114 Broad St., Matawan, N. J.
 Miller, L. F., 920 N. Market St., Frederick, Md.
 Miller, R. L., 100 Peck Ave., Syracuse 6, N. Y.
 Mitchell, J. L., 7133 Touchstone St., Houston 16, Tex.
 Moore, P. G., 1240 N. Foothill Blvd., Pasadena 8, Calif.
 Morell, C. S., 1127 Fourth St., S.E., Minneapolis 14, Minn.
 Muldowney, J. F., 1754 E. Cooke Rd., Columbus 11, Ohio
 Nichol, A. C., 8735-96 Ave., Edmonton, Alta., Canada
 Norgaard, A. K., Brondbyvestervej 13, Glostrup, Denmark
 Oddsson, I. G., 842 N. Euclid Ave., Oak Park, Ill.
 Oser, H., 1325 Park Ave., New York 28, N. Y.
 Pace, R. A., 1637 President St., Brooklyn 13, N. Y.
 Paul, C. A., 5303 Avenue H, Lubbock, Tex.
 Phelan, F. W., 6340 Cartridge St., Detroit 9, Mich.
 Pickus, L. C., 419 Clements Bridge Rd., Barrington, N. J.
 Pinol, D. G., 5154 W. 120 St., Hawthorne, Calif.
 Plumridge, R. F., 36 Livingston Rd., E. Hartford, Conn.
 Polkosnik, C. F., Jr., 10 Harrison St., Belleville 9, N. J.
 Poppelbaum, W. J., 164 Digital Computer Laboratory, University of Illinois, Urbana, Ill.
 Porcino, P. R., 215 Glen Ave., Scotia, N. Y.
 Potter, F. J., 1732 E. Montebello, Phoenix, Ariz.
 Pulliam, W. M., Jr., 1054 Center Ave., Norfolk 2, Va.
 Rabehl, W. C., Box 186, R.F.D. 7, Milwaukee 16, Wis.
 Rafeld, P. I., Reeves Instrument Corp., 215 E. 91 St., New York 28, N. Y.
 Reynolds, J. H., Jr., 4507 B St., S.E., Apt. 202, Washington 19, D. C.

(Continued on page 154A)

ALL AMERICAN CABLES & RADIO, INC. DOUGLAS AIRCRAFT CO. TRANS-CANADA AIR LINES
 CANADAIR LIMITED GLENN L. MARTIN COMPANY CANADIAN PACIFIC AIR LINES LTD. FLORIDA POWER & LIGHT CO.
 TRANS-WORLD AIRLINES These are just 15 of the many leading companies who upgrade their engineering and technical personnel with group training provided by CREI (founded 1927). CREI is seen each year at our IRE Convention Booth, and has advertised in this publication for 20 years. CREI's business is to help your business.
 BELL AIRCRAFT CORP. RADIO CORPORATION OF AMERICA
 PAN AMERICAN AIRWAYS (ATLANTIC DIV.) NATIONAL BROADCASTING CO.
 UNITED AIR LINES COLUMBIA BROADCASTING SYSTEM CANADIAN BROADCASTING CORP.

Shortage of Engineering Personnel?

We'll help you upgrade from within

TODAY'S recruiting efforts hardly help ease today's shortage. But, what about the future? The scarcity shows no signs of letting up.

We can help solve your *present* and *future* problems with CREI Group Training. This is the method many leading companies are using successfully to upgrade their engineering and technical personnel *from within*.

Among the group training enrollees with CREI are:

- 20% of the electronic staff of a leading aviation manufacturing company.
- More than 300 members of a leading airline's technical staff.
- Hundreds of others, employed by leading manufacturers and research laboratories. There are now approximately 10,000 active CREI students employed professionally in the electronics industry.

CREI's instruction material is prepared and administered in a personalized style by engineers who know how to teach and who know the requirements of the electronics industry.

Whether yours is a large company, or small, let us show you how CREI group training is working for others . . . how to set up a program that works . . . and how CREI can help you prepare for tomorrow's continuing shortages by "developing your own."

Write, or phone, directly to: E. A. Corey, Registrar.

Capitol Radio Engineering Institute



ECPD Accredited Technical Institute Curricula
 3224 16th Street, N.W., Dept. 185B
 Washington 10, D.C. HObar 2-1520

Electronic Engineers

A NEW CHALLENGING HORIZON!



- RELOCATION ALLOWANCES
- LIBERAL EMPLOYEE BENEFITS
- ADEQUATE HOUSING IN BEAUTIFUL SUBURBAN COUNTRY TYPE AREA
- TUITION REFUND PROGRAM (9 graduate schools in area of plant)
- MODERN PLANT WITH LATEST TECHNICAL FACILITIES
- ASSOCIATION WITH OUTSTANDING PROFESSIONAL PERSONNEL



Unusual opportunities for professional development and recognition

Sperry, a pioneer in many fields for 43 years takes another forward step in its consistent growth and expansion. You are invited to investigate these new openings.

Over 1500 employees have been associated with Sperry for more than 15 years . . . ample evidence of opportunity, good salaries, excellent benefits and fine working conditions that make for a bright future.

Digital Computer Engineers—Positions require familiarity with Digital to analogue data converters, Pulse circuits, Logical design, Sampled data system studies, Memory devices.

Electronic Engineers and Physicists—Interesting, Non-routine assignments in the fields of Radars, Missile test equipment, Microwave ferrites, Solid state devices, U.H.F. receivers and transmitters, Klystron and traveling wave tubes.

Interviews can be arranged on Saturday at our plant and may be arranged in your city.

SPERRY GYROSCOPE CO.

DIVISION OF THE SPERRY CORP.

Great Neck, Long Island, New York



Membership

(Continued from page 153A)

Richter, J. G., 28 St. Eleanora La., Yonkers, Crestwood, N. Y.

Roben, H., 733 Rose Dr., Midwest City 10, Okla.

Robertson, D. S., Department of Physical Sciences, Australian National University, Box 4, G.P.O., Canberra, Australia

Rocha, E., Box 558, Scott AFB, Belleville, Ill.

Runnalls, H. J., 7904—84 Ave., Edmonton, Alta., Canada

Rutstein, H. S., 5612 Belleville Ave., Baltimore 7, Md.

Rydstrom, H. F., 2247 R St., Washington 8, D. C.

Sampson, E. M., Rectifier Department, General Electric Co., 920 Western Ave., Lynn, Mass.

Saunders, W. K., 8505 Seven Locks Rd., Bethesda 14, Md.

Schroeder, R. K., 40 Highland Ave., Winchester, Mass.

Schweitzer, M. P., 261 Madison Ave., New York 16, N. Y.

Selby, S. L., 960 Newell Ave., Norfolk, Va.

Shurben, W. E., 140 N. Woodrow Blvd., Toronto 13, Ont., Canada

Simon, P. F., 52 Wall St., New York 5, N. Y.

Skinner, D. D., 132 Arch St., Verona, Pa.

Smith, E. D., 113 Lankin Blvd., Toronto, Ont., Canada

Smith, R. H., 1813 SESCO St., Arlington, Tex.

Smith, W. I., 335 Van Sant Dr., Palmyra, N. J.

Snyder, C. M., 324 Sedgewood Rd., Springfield, Delaware County, Pa.

Solimena, R., 5 De-Bosis, Ancona, Italy

Sorensen, H. D., 80 Via Natal, San Lorenzo, Cali.

Sorkin, C. S., 6600 Chew St., Philadelphia 19, Pa.

Sperling, R. D., 4627 E. 20 St., Tucson, Ariz.

Sprinkle, J. F., Nq. EADF-DM, c/o EAMEL, Stewart AFB, Newburgh, N. Y.

Stahl, W. D., 15 Third Ave., Atlantic Highlands, N. J.

Stetler, I. H., 35 Schoolhouse La., Poughkeepsie, N. Y.

Stott, W. R., 416 Seventh Ave., Pittsburgh 19, Pa.

Stumpp, C. M., Jr., 9470 TU, Det #6, c/o BFSD Fort Huachuca, Ariz.

Taylor, J. H., 5602 Willis Ave., Dallas 6, Tex.

Thompson, R. G., Metropolitan Life Insurance Co., Engineering Division Electrical Section, 1 Madison Ave., New York, N. Y.

Thumm, H. L., Jr., 3506 Bapaume Ave., Norfolk 9, Va.

Tomikawa, K. B., Box 226, R.F.D. 14, Baltimore 20, Md.

Trutter, J. A., 6704 Glenmore Dr., Falls Church, Va.

Turner, R. L., Jr., 114 E. Durham St., Philadelphia 19, Pa.

Van Buskirk, D., 4550 N. Kenmore Ave., Chicago 40, Ill.

Vaeth, J. G., 3 Lincoln Ave., Glen Head, L. I., N. Y.

Vasantharajan, M. N., Junior Engineer (Telecom), Electricity Department, Gunadhala, Via Bezwada, India

Von Wegern, F. C., 706 N. Oleander Dr., Fort Walton Beach, Fla.

Wagner, Z. G., 917 Beverly Dr., Solvay 9, N. Y.

Waite, G. F., 71 Ridgewood Ave., Glen Ridge, N. J.

Walton, J. S. V., 23-25 Beaver St., Rm. 601, New York 4, N. Y.

Warren, W. L., 4 E. Haverford Ave., R.F.D., Had-donfield, N. J.

Watts, H. T., Jr., 307 C. Hesse Ave., Apt. 928, Scott AFB, Ill.

Weekes, F. D., 1717 Riggs Pl., N.W., Washington, D. C.

Westervelt, J. C., 221 S. Harrison, East Orange, N. J.

Wheeler, A. J., 182 Temple Trailer Village, Alexandria, Va.

(Continued on page 156A)

Bendix

needs

ELECTRONIC ENGINEERS

in

SOUTHERN CALIFORNIA

Unusual engineering positions in Radar, Sonar and Telemetry are available at Pacific Division, Bendix Aviation Corporation in North Hollywood, California. These positions, which are directly associated with our long-range projects for industry and for defense, are available at all levels.

Please address inquiries to:

W. C. WALKER

Engineering Employment Manager

Pacific Division

Bendix Aviation Corporation

NORTH HOLLYWOOD, CALIF.

RAYTHEON

PROCESS ENGINEER

for

Cathode Sub-miniature Tubes

Excellent opportunity in Raytheon's expanding Cathode Sub-miniature Production Program for an engineer with experience in the manufacture of cathode sub-miniature type vacuum tubes. Minimum qualifications B.S. degree and three years experience in this field.

For appointment write to

G. W. Lewis,

Personnel Mgr.

Raytheon Mfg. Co.

55 Chapel St.,

Newton 58, Mass.

ELECTRONIC FIELD ENGINEERS

An outstanding opportunity awaits you in our nation-wide ELECTRONIC COMPUTER and DATA HANDLING SYSTEMS program

- **TRAINING** at our expense with full salary.
- **PERMANENT** installation assignment, perhaps in your own locality.
- **HOUSEHOLD** goods moved at our expense.
- **INSURANCE, PENSION** and other liberal employee benefits.
- **INTERVIEWS** arranged at our expense.

Send written résumé to:

REMINGTON RAND Inc.
ERA DIVISION
1902 W. Minnehaha
St. Paul W4, Minn.

TO THE FINE ENGINEERING MIND
SEEKING THE CHALLENGING PROJECTS IN

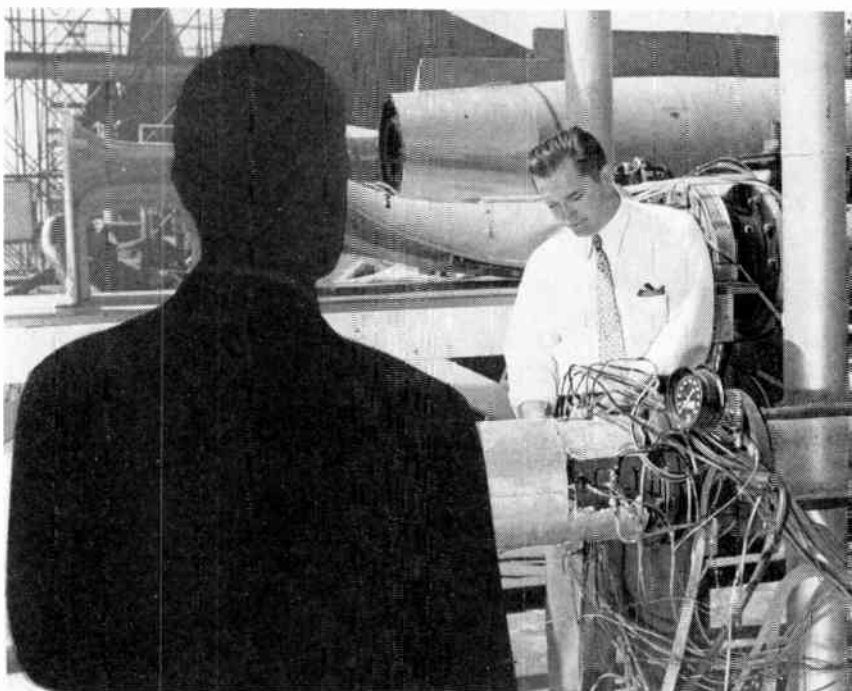

INSTRUMENTATION

INSTRUMENTATION ENGINEERS experienced in the development and design of static and flight test instrumentation systems are offered unusual career opportunities now at Convair in beautiful San Diego, California. These responsible engineering positions call for experience in one or more of the following areas: instrumentation systems planning and study; transducer design, selection, and application; airborne and ground-based telemetering equipment development and design; instrumentation systems installation design.

CONVAIR offers you an imaginative, explorative, energetic engineering department... truly the "engineer's" engineering department to challenge your mind, your skills, your abilities in solving the complex problems of vital, new, long-range programs. You will find salaries, facilities, engineering policies, educational opportunities and personal advantages excellent.

SMOG-FREE SAN DIEGO, lovely, cool city on the coast of Southern California, offers you and your family a wonderful, new way of life... a way of life judged by most as the Nation's finest for climate, natural beauty and easy (indoor-outdoor) living. Housing is plentiful and reasonable.

Generous travel allowances to engineers who are accepted. Write at once enclosing full resume to:

H. T. Brooks, Engineering Personnel, Dept. 805

CONVAIR

A Division of General Dynamics Corporation

3302 PACIFIC HIGHWAY

SAN DIEGO, CALIFORNIA



problem: gravity

Interested in it? So are we. For part of the advanced development program at Martin includes an overall search into the basic laws of the universe — probing the unknown in any field that relates to airborne systems.

Gravity is a personal problem to many creative engineers today: men who are lost in large engineering organizations; anchored to non-creative and futureless jobs. Ceiling Zero, Altitude Zero.

If you are one of those, you'd do well to look into the Martin story. For exciting new long-range developments have created many exceptional opportunities on projects of the highest priority and importance.

Contact J. M. Hollyday, Dept. P-5, The Glenn L. Martin Company, Baltimore 3, Maryland.

MARTIN
BALTIMORE · MARYLAND



(Continued from page 154A)

- Whitelaw, A. J., 16 Richmond Ave., La Grange, Ill.
 Whitley, J. E., Box 251, R.F.D. 2, Lynnhaven, Va.
 Williamson, H. S., 537 W. Rose La., Phoenix, Ariz.
 Wilson, H. S., 115-A Wall Worth Park Apts., Had-
 donfield, N. J.
 Wilson, H. J., 4324 Virginia Ave., Cincinnati 23,
 Ohio
 Winkler, S., 1222 N. Cambell Ave., Tucson, Ariz.
 Witter, F. L., Corning Glass Works, Leon St.,
 Bradford, Pa.
 Wong, R. B., 1522 Clay St., San Francisco 9, Calif.
 Woolett, R. S., U.S.N. Underwater Sound Labora-
 tory, New London, Conn.
 Worth, F. L., 6911 Firmament Ave., Van Nuys,
 Calif.
 Wright, W. C., 1652 Cape May Rd., Baltimore 21,
 Md.
 Yaeger, W. O., 488 Fairview Ave., Orange, N. J.
 Yates, Z., 1520 Chesapeake Ave., S. Norfolk, Va.
 Zadoff, S. A., 68-05—138 St., Flushing 67, L. I.,
 N. Y.
 Zeman, J. A., 3705 Hampton Rd., Pasadena 8,
 Calif.
 Zemenick, C. J., 14149 Viburnum Dr., Whittier,
 Calif.
 Zitren, J. B., 1600 Metropolitan Ave., New York
 62, N. Y.

Engineers

with experience in

computers
 microwave
 pulse techniques
 servo-mechanisms
 related circuit design

leading designers and manufact-
 urers of electronic instrumentation
 offer outstanding opportunity,
 top pay, moving allowance,
 benefits, plus the charm of san
 francisco living.

please send resume.

Berkeley *division*
 BECKMAN INSTRUMENTS INC.
 2200 WRIGHT AVE., RICHMOND 3, CALIF.



CIRCUIT ENGINEERS

Why Not Work in Vacationland?



One of the many advantages in working for Sanders Associates, Inc. is the site of the plant itself: Nashua in lovely New Hampshire, New England's most beautiful state. Less than one hour from both the White and Monadnock Mountains, with cool streams, crystal lakes, lush green foliage, Nashua's many natural recreational facilities abound. Or, if you prefer the surf and the sea, you're less than one hour from world-famous Hampton and Rye Beaches.

Of distinct advantage, too, is Sanders' working environment: the small, effective engineering groups working on a variety of projects, the balance of military and commercial work, the realistic management BY engineers FOR engineers make way for quick professional growth and personal advancement.

Noteworthy "firsts" developed at Sanders include printed "strip-line" plumbing, tape resistors, the world's smallest rate gyro. On the staff are some of the top electronics experts in America, and a good many of the most promising junior men — exceptional engineers with the "something extra" that makes the difference between competence and real talent.

To complement this fine team and to permit further expansion, Sanders is adding a few engineers with at least 3 to 5 years experience in missile guidance, pulse and doppler radar, microwave antenna, airborne navigation, printed circuit and component development.

If you are an exceptional engineer — have not only talent, but ambition and drive — Sanders can provide unusual opportunity. Address inquiries to Mr. J. I. Chesterley.



137 Canal St., Nashua, New Hampshire

ENGINEERS

The APPLIED PHYSICS LABORATORY OF THE JOHNS HOPKINS UNIVERSITY offers an exceptional opportunity for professional advancement in a well-established laboratory with a reputation for the encouragement of individual responsibility and self-direction. Our program of

GUIDED MISSILE
RESEARCH AND
DEVELOPMENT

provides such an opportunity for men qualified in:

ELECTRONIC CIRCUIT DESIGN AND ANALYSIS

DEVELOPMENT AND APPLICATION OF TRANSISTOR CIRCUITRY

SERVOMECHANISMS AND CONTROL SYSTEM ANALYSIS

ELECTRONIC EQUIPMENT PACKAGING INSTRUMENT DESIGN

MISSILE SYSTEMS DEVELOPMENT

FLIGHT TESTING

Please send your resume to
Professional Staff Appointments

APPLIED PHYSICS LABORATORY
THE JOHNS HOPKINS UNIVERSITY
8621 Georgia Avenue
Silver Spring, Maryland

ENGINEERS

● ELECTRONIC ● MECHANICAL

For progressive Chicago firm expanding in all types of research projects in military work. Positions also available for Lay-out detail and Design Draftsman.

Salary will be commensurate with ability and qualifications. All details will be treated strictly confidentially.

Address to:

HALLICRAFTERS COMPANY

4401 W. Fifth Avenue

Chicago 24, Illinois

**Personnel
Division**



SANDIA CORPORATION

invites you to compare

- ✓ **OPPORTUNITIES**
- ✓ **ADVANTAGES**

... with those of other research and development organizations. The "good" job is one in which you can be happy. You alone can decide the relative importance of such things as professional challenge of the work, promotion possibilities, work environment, job security, geographical location, climate, etc. In all these respects, Sandia Laboratory can meet the expectations of most engineers and scientists in the following fields —

- mechanical engineers
- electronics engineers
- electrical engineers
- physicists
- mathematicians
- aerodynamicists
- quality control engineers
- test engineers

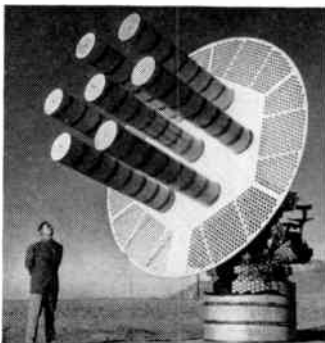

SANDIA CORPORATION, a subsidiary of the Western Electric Company, operates Sandia Laboratory under contract with the Atomic Energy Commission. Simply stated, Sandia's job is to build usable weapons around the explosive nuclear components developed at nearby Los Alamos Scientific Laboratory. Graduate engineers and scientists will find excellent opportunities in the fields of component development, systems engineering, applied research, testing and production.

COMPENSATION is competitive with that offered in other industry. Working conditions are excellent and employee benefits include liberal paid vacations, free group life insurance, sickness benefits and a generous contributory retirement plan. Opportunities for advancement in this young and growing laboratory are many.

SANDIA LABORATORY is located in Albuquerque — a modern, cosmopolitan city of 150,000, rich in cultural and recreational attractions and famous for its excellent year-around climate. Adequate housing is easily obtained. For descriptive literature giving more detailed information on Sandia Laboratory and its activities — or to make application for employment — please write:

PROFESSIONAL EMPLOYMENT DIVISION 1A1

SANDIA Corporation

SANDIA BASE • ALBUQUERQUE, NEW MEXICO



News-New Products

These manufacturers have invited PROCEEDINGS readers to write for literature and further technical information. Please mention your I.R.E. affiliation.

(Continued from page 124A)

AF Shift Terminal

The Model 812 is a new Audio Frequency Shift Terminal developed by **Radio Frequency Laboratories, Inc.**, Powerville Rd., Boonton 33, N. J., for use in the transmission and frequency multiplexing of telegraph, telemetering, and supervisory control signals. It may be used with one teleprinter for both sending and receiving with automatic break-in facilities or with two printers for simultaneous transmission and reception. Two or more Model 812 Terminals can be used in a space or frequency diversity system for reliable two-way radio transmission under severe fading conditions.



The equipment contains no relays and will operate at both slow and high speeds. Standard stock sets are available for maximum speeds of 100 (approximately 40 dot cycles) and 250 (approximately 100 dot cycles) words per minute. Sixteen (16) channels are available in the frequency range of 425 to 3100 cps. A 5½×19×16 inch chassis contains both the transmitter and receiver sections for one channel which includes the equipment and loop power supplies. The transmitter section includes a resistance stabilized frequency shift tone oscillator, amplifiers, and a 20 db transmitting filter. The receiver section includes a 40 db receiving filter, optional space or frequency diversity circuits, limiting amplifiers, discriminator, dc amplifier, optional mark-hold circuit, receiver output keying circuit and an automatic control circuit which permits sending and receiving with one printer without a manual send-receive switch. A test jack field is provided on the front panel.

For further information and descriptive literature, write to Radio Frequency Laboratories.

Low Cost Film Recording of TV Programs

A British firm has devised a system reported to cut in half the cost of making a film-recording of a television program. Other marked advantages over methods used so far are also claimed.

The company, **High-Definition Films Ltd.**, 24 Old Broad St., London W.C. 2, England, developed the new method, known as the High-Definition Electronic

(Continued on page 160A)

ENGINEERS

for immediate placement

ENGINEERING AT NCR:

1. Immediate, permanent positions in Mechanical and Electrical Engineering Divisions.
2. Engineering project work involving design and development of mechanical, electronic, electromechanical devices, and electronic data processing equipment in Business Machine applications.
3. Some experience in development, design, and application of high-speed, light-weight mechanisms of the intermittent motion type is desirable.
4. Openings also for Mechanical and Electrical personnel for writing technical and application literature describing newly-developed machines.
5. Ample training and indoctrination is available to all employees.

ACT AT ONCE—Send resume of your education and experience to: EMPLOYMENT DEPARTMENT, TECHNICAL PROCUREMENT SECTION

THE NATIONAL CASH REGISTER COMPANY

Dayton 9, Ohio

ELECTRICAL ENGINEERS
MECHANICAL ENGINEERS
ELECTRONIC ENGINEERS
MECHANICAL DRAFTSMEN

AS AN NCR ENGINEER you, with your family, will enjoy:

1. **UNLIMITED OPPORTUNITY** in the broad, ever-expanding field of Business Machine Engineering.
2. **AN EXCELLENT SALARY**, plus exceptional benefits of lifetime value for you and your family.
3. **A RECREATIONAL PROGRAM** for year-round enjoyment of the entire family including a new Country Club with 36 holes of golf, and a 166-acre park for outings with swimming, boating, and supervised play for the children.
4. **LIVING IN DAYTON . . .** considered one of the cleanest and most attractive cities in the Midwest with outstanding school facilities.
5. **YOUR WORK AT NCR** with its friendly, family atmosphere, with its employee morale at a very high level, and with people who, like yourself, have decided to build their professional future with NCR.

WAVE FILTER DESIGN ENGINEER

An excellent opportunity at the senior engineer level, with many job benefits.

Write to

E. A. Gentry

Personnel Manager

Clevite-Brush
Development Company

CLEVITE RESEARCH
CENTER

540 East 105th St.
Cleveland 8, Ohio

Division of
Clevite Corporation

ENGINEERS NEEDED FOR RESEARCH AND DEVELOPMENT POSITIONS IN THE

Design of electronic instrumentation for underwater ordnance, including high gain amplifiers, conventional filters, power amplifiers, oscillators and detectors in the ultrasonic range.

Analytical and experimental treatment of scientific research problems in the fields of hydrodynamics, acoustics, electronics, network theory, servo-mechanisms, mechanics, information theory and noise analysis including analogue and digital computations.

Design of transducers, fundamental problems in underwater acoustics involving transmission, attenuation, reflection, etc. Problems in sound control and noise reduction. Acoustical aspects of systems research including operations research and feasibility studies.

Opportunities for graduate study

Liberal Vacation Policies

Excellent Working Conditions

THE PENNSYLVANIA STATE UNIVERSITY
ORDNANCE RESEARCH LABORATORY
University Park, Pennsylvania

Send Resume to **ARNOLD ADDISON**, Personnel Director

We're Looking for People... Not Just Engineers

At ECA it's not only technical proficiency that counts. We're looking for more permanent staff members—imaginative, well-rounded, broad of outlook—men with varied interests.

We know they are uncommon. As a matter of fact, only one in twenty meets our standards. But we've found that these stay for good.

ECA's field—the science of automatic control—calls for an imaginative approach...and imagination can't exist in a vacuum. Ideas come easiest to men who are doing the work they enjoy, in a stimulating atmosphere.

In our flexible organization, the technical man must work with and through many other people. Human relations, in fact, may be the hardest part of his job. That's why we look for people, rather than just engineers.

What statisticians call "engineering turnover" is just about non-existent at ECA. The success of our established commercial products...the demand for our services in developing automatic controls, electronic business machines, computers...explain our growth with stability. Satisfaction from a job well done makes ECA a good place to work.

Please address inquiries to
Mr. W. F. Davis, Dept. 706



**ELECTRONICS
CORPORATION
OF AMERICA**

77 Broadway Cambridge 42, Mass.



(Continued from page 158A)

Picture Recording system. The final picture is photographed on standard 35 mm. motion-picture film from a specially developed kinescope tube.

The results of the HDF system, the company states, are so far in advance of normal kinescoping as to be indistinguishable from normal motion-picture film when transmitted.

In operation, a unique high-definition system of control maintains consistency in the final product and ensures exact matching between cameras. It operates by the continuous introduction of special calibrating signals into camera circuits, permitting continuous monitoring throughout the whole system. Calibrating signals provide a close check on film processing.

Special measuring apparatus developed at the company's laboratories is used to test the system at any stage from camera to record image. The whole system is on a closed circuit.

Sequential scanning is at 24 pictures per second. All fades, dissolves, cuts, superimpositions and process shots can be made during actual production, and dialogue, music and sound effects are all introduced at the same time.

The finished print, complete with sound, is available immediately after production on the floor, and the film can be broadcast on any TV system.

(Continued on page 163A)

FOR MAXIMUM RESULTS FIND YOUR BEST OPPORTUNITY AMONG OUR NO FEE POSITIONS

MISSILE, CHF. ENGR.	\$15-18,000
PROJECT ENGRS.	\$12-15,000
AVIATION ELECTRONICS	\$7-15,000
VACUUM DEPOSIT, SELENIUM	\$10-12,000
COMPUTER APPLIC. MGR.	\$13,000
COMPUTER ENGRS.	\$7-12,000
VIBRATIONS ENGRS.	\$10-12,000
MATHEMATICIANS	\$8-13,000
GOV'T. CONTR. ADMINS.	\$8,500
BRDCAST. & T.V. SALES	\$8,500
NAVY SALES ENGRS.	\$8,500
APPLICATIONS ENGRS.	\$9-12,000
ENGRG. EDITOR	\$9,000
TECH. WRITERS & ILLUSTR.	\$7-8,000
MANUFACTURING ENGRS.	\$6-8,000
RADIO SYSTEMS, Overseas	\$10,000
PHYSICISTS, All Fields	\$9-16,000
NUCLEAR ENGRS. & PHYS.	\$10-12,000
ROCKET ENGRS.	\$11,000
MECH. ENGRS., Proj.	\$12-14,000
SERVO-MECHANISMS	\$8-11,000
MACHINE DESIGN	\$7-10,000
TUBE DESIGN	\$8-14,000
RADAR SYSTEMS	\$7-14,000
COMMUN. SYSTEMS	\$8-14,000
INFORMATION THEORY	\$8-11,000
VHF & VHE	\$10-12,000
ANTENNA & WAVEGUIDE	\$8-12,000
METALLURGISTS	\$8-10,000
CERAMICS & GLASS	\$7-11,000
SYSTEMS ANALYSTS	\$8-13,000

OUR CLIENTS PAY INTERVIEWING AND MOVING EXPENSES AS WELL AS OUR FEE. PLEASE SEND 3 COPIES OF YOUR RESUME.

**GUILFORD
PERSONNEL SERVICE**

308 American Bldg. Box R-1D
Baltimore 2, Md. MUIberry 5-4340

MICROWAVE ENGINEERING

To
ENGINEERS
and
PHYSICISTS
qualified in this area...

The Microwave Laboratory at Hughes conducts fundamental research and long-range development in the field of microwave antennas and microwave electronics. New positions are now open in this area.

THE ANTENNA PROGRAM has to do with research on linear and two-dimensional arrays of slot radiators; transmission and radiation of surface-guided waves; very high resolution radar antennas; development and engineering of airborne communication, navigation, and fire control antennas.

THE MICROWAVE ELECTRONICS program is concerned with (1) basic research involving study of ferrites, and the discharge of gases at microwave frequencies, and (2) applied research and development involving microwave circuits, ferrite applications, microwave instrumentation, and circuits for developmental microwave vacuum tubes.

Scientific and Engineering Staff

HUGHES

**RESEARCH AND DEVELOPMENT
LABORATORIES**

Culver City, Los Angeles County, California

CHALLENGING CAREERS AT RAYTHEON

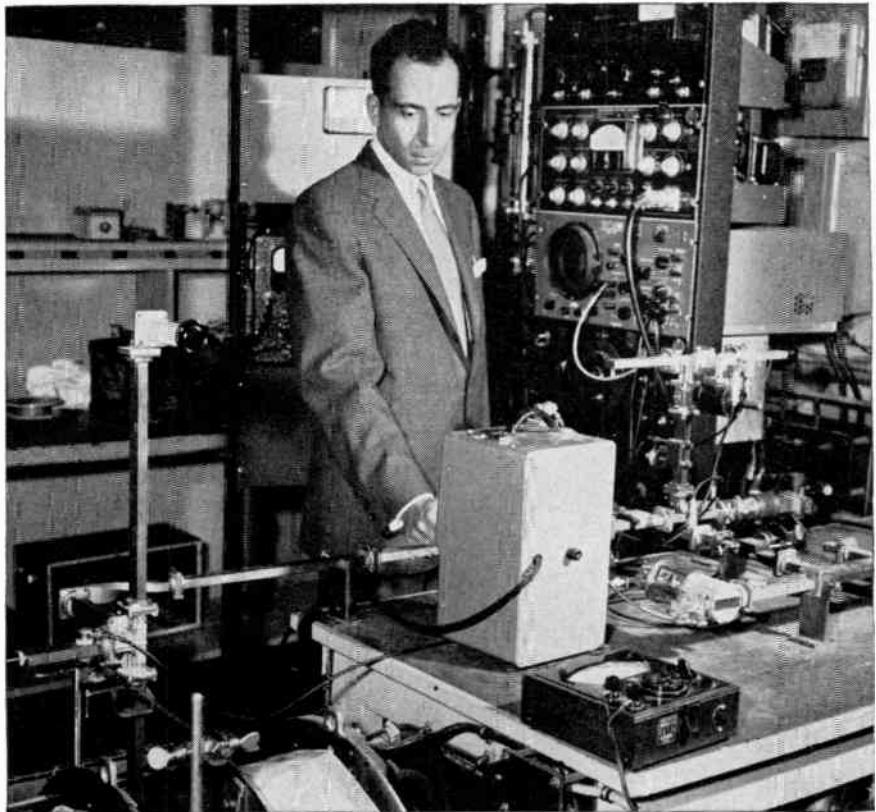

Studying ferromagnetic resonance. A cavity perturbation method is used, in which a ferrite specimen placed in a high Q microwave cavity changes cavity properties in accordance with electrical and magnetic properties of the material.

Looking for a good place to grow?

Advanced work on ferrites for microwave applications is being done in Raytheon's modern ceramic research facilities. Various types of gyrators, isolators, and other ferrite microwave devices have resulted from development work in the equipment systems and component development laboratories.

When you join Raytheon you work in an atmosphere of progress. Openings now for engineers, scientists in many areas including:

**microwave tubes • special purpose tubes • guided missiles
transistors • diodes • receiving tubes • TV receivers
radar • sonar • computers • ultrasonics
metallurgy • ceramics • communications systems
servomechanisms • control equipment • solid state physics**

Join a team where performance pays off. Please address inquiries to L. B. Landall, Professional Personnel Section.



RAYTHEON MANUFACTURING COMPANY

190 Willow St., Waltham 54, Mass.

Plants also located in California and Illinois

SPEED UP

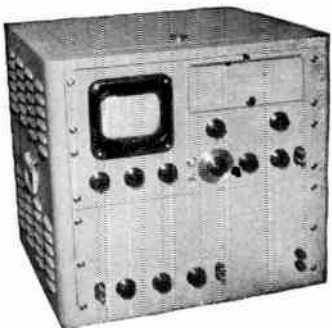

AUDIO WAVE FORM ANALYSIS

PANORAMIC SONIC ANALYZER LP-1

Many engineers find that Panoramic's LP-1 expedites their entire measurements program. LP-1 analyzes sound vibrations and electrical waveforms quickly, conveniently, accurately. Designed to eliminate the tedious problems commonly associated with audio waveforms analysis, the Panoramic technique provides valuable visual information in seconds!

- Visualizes frequency and amplitude of waveform components between 40 and 20,000 cps; magnifies small portions of spectrum for detailed analysis; displays easily photographed; scans spectrum in 1-second; analyzes changing and static phenomena.

It will pay you to investigate the many unique advantages of LP-1.

- **SPECIAL APPLICATIONS**
 - Investigations of closely spaced sound and vibration frequencies. Harmonic analysis of waveforms having low frequency fundamentals. Spectrum analysis requiring constant band width.
 - Panoramic's LP-1 offers scores of unique advantages; it will pay you to check their application to your problems.

WRITE TODAY for
Complete Specifications



Made by the makers of Panadaptor, Panalyzer, Panoramic Sonic Analyzer, and Panoramic Ultrasonic Analyzer

12 South Second Ave., Mount Vernon, N.Y.
Phone: MOUNT Vernon 4-3970

Does that new design call for a special transformer?

... One that's special in coil design or frequency response? Is insulation a problem? or weight? or size?

You may find the answer in our design department, staffed by engineers who are experienced not only in transformer design but also in the communications systems. They approach your problem with a knowledge of your over-all circuit requirements, and design a transformer that meets *all* your needs *exactly*.

And when the transformer has been proved, we have streamlined facilities to produce it in the quantity you need.

When you have a transformer problem, call on

CALEDONIA

ELECTRONICS AND TRANSFORMER CORPORATION

Dept. PI-5, Caledonia, N. Y.



Cosmic
CONDENSER SPECIALISTS SINCE 1923
ELECTROLYTIC & PAPER TUBULAR
CONDENSERS
For A.C., D.C. Sets - Phonographs etc.
COSMIC CONDENSER CO.
853 WHITTIER ST., BRONX
N. Y.

for

**performance
quality
price**

Phone — LU 9-3360

Teflon...*

*Trademark for DuPont tetrafluoroethylene resin.

INQUIRIES INVITED ON
TAPE • SHEET • ROD • TUBES

Molded and Machined Parts

O. J. Maigne Co.

321 PEARL STREET • NEW YORK 38, N. Y. • WORTH 2-1165



These manufacturers have invited PROCEEDINGS readers to write for literature and further technical information. Please mention your I.R.E. affiliation.

(Continued from page 160A)

Variable Delay Line Literature

The passive, jitter-free, continuously variable HELIDEL* delay line is the subject of Technical Paper 266, published by Helipot Corp., 916 Meridan Ave., South Pasadena, Calif., entitled *A Precise, Wide-band, Continuously Variable Delay Line*, the comprehensive paper was written by Norman W. Gaw, Jr., and David Silverman of Helipot Corp., and Melvin B. Kline of DuMont Laboratories.

Free copies may be obtained from Technical Information Service, Helipot.

*Reg. TM Helipot Corp.

Network Synthesizer

The NS-1 network synthesizer and universal laboratory filter designed by Wickes Engineering and Construction Co., 12th St., and Ferry Ave., Camden 4, N. J., for experimental circuits or systems evaluation, particularly in the television field. The equipment will synthesize any selectivity curve expressible by a Fourier cosine series, or any transient response function.

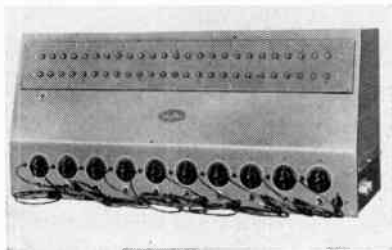

A 50-section delay line of special design permits rapid synthesis of any filter characteristic over the entire video range. An impedance matching circuit permits use of any input signal. Voltages are picked off the line by means of 10 cathode followers, each having an attenuator and polarity (algebraic sign) selector switch.

Any 10 voltages can be selected and combined, so that either 10 terms of a Fourier series can be obtained, or any 10-step approximation to a transient response function can be made. Voltages can be added in accordance with the harmonic analysis schedule of any selectivity curve. Synthesis can be in either the frequency or the time domain.

The NS-1 is used in the manner of a decade box. After the desired response is obtained, the necessary lumped constants for a permanent equivalent network are determined by simple measurements. The synthesizer can be retained as a permanent network when desired. The unit is stable so that the controls can be reset to repeat a desired network.

(Continued on page 165A)

THE MOSELEY AUTOGRAF trade mark X-Y RECORDER



MODEL 1, drum type, accepts 8½"x11" graph paper; traverses each axis in 1 second; has full scale ranges of 5 millivolts to 100 volts; zero set anywhere on the paper; portable, self-contained; available also as a curve follower for electrical read-out of drawn curves.

AUTOGRAF Recorders, **MODELS 1 and 2**, provide all the features needed for graphic recording of test data, point plotting, and curve following for readout purposes.

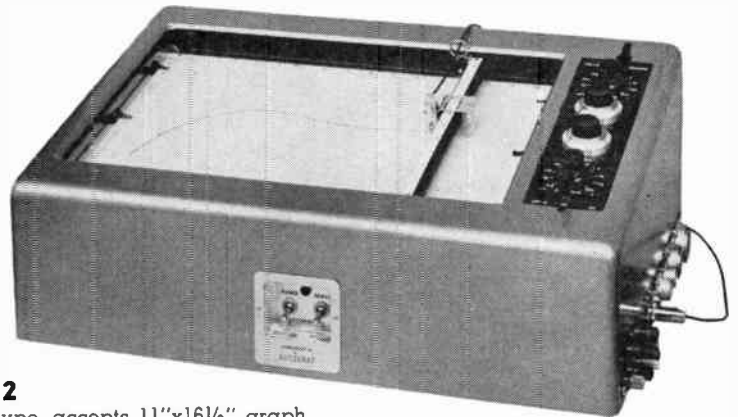

MODEL 2

Flat bed type, accepts 11"x16½" graph paper; same speeds, sensitivities and ranges as MODEL 1; zero set anywhere on paper plus one full scale length of zero-offset; inputs provided for analog recording, point plotting from digital sources, and curve following for computer or data reduction use.

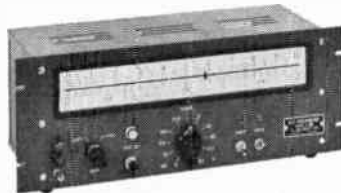

MODEL 20 DC VOLTMETER is a servo-actuated, fast, accurate and sensitive instrument. Has large, easy-to-read scale for general laboratory use where ranges from 3 millivolts to 300 volts are desired. For data handling it is furnished with a built-in Coleman digitizer and delivers digital output for operation of printers, typewriters, tape or card punches, etc.

MODEL 30 CARD TRANSLATOR converts information from punched cards into point form for automatic plotting. Handles up to 50 cards per minute, 10 to 200 counts per inch. Plugs directly into MODEL 2 recorder, controls both card reader and recorder for completely automatic operation.



MODEL 40 KEYBOARD provides a convenient means for plotting large amounts of tabular data in point-curve form. Self-contained voltage source together with full three column keyboard in both X and Y axes; unit plugs directly into MODEL 2 AUTOGRAF.

Bulletins describing these instruments are available and we'll be glad to send them to you. Write . . .

F. L. MOSELEY CO., 409 North Fair Oaks Avenue, Pasadena 3, California

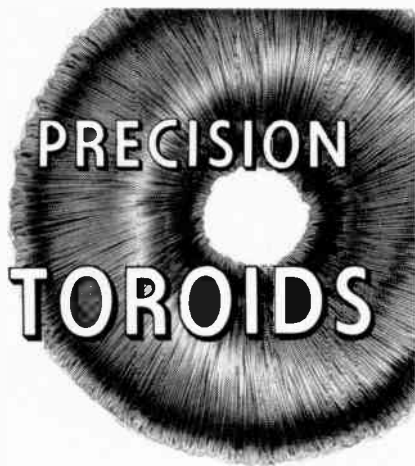

in less time with BOESCH TW-201!

Set up and start winding a new design in 30 seconds! Start winding the next coil in 5 seconds or less!

Coil sizes . . .
.218" I. D. through 5" O. D.!

Wire sizes . . .
#20 through #42 AWG!

Winding speeds . . .
through 600 RPM!

The BOESCH Semi-Automatic Coil Winding Machine lends itself ideally to both research and production. Write today for detailed information on the BOESCH TW-201 and other BOESCH winding machines.

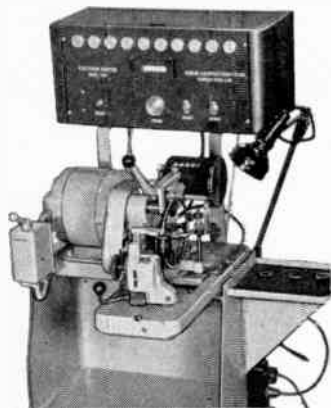

Model TW-201

Now — no licensing, no royalties required in the sale and use of BOESCH Machines



NEUTRON SOURCES



prepared by United States Radium Corporation have the following flux characteristics:

Radium-Beryllium 1.3×10^4 n/sec/mg
Polonium-Beryllium ... 0.26×10^4 n/sec/mg
Radium D-Beryllium ... 0.26×10^4 n/sec/mg



USR neutron sources are engineered to your specifications, thus the design of the capsule enables USR neutron sources to meet your special requirements.

In the relatively new field of

... activation analysis

USR neutron sources have enabled academic and industrial laboratories to utilize this new tool for the research investigator, offering trace element analysis — fast — accurate — in ranges never before envisioned.

One of the newest methods of determining geological strata characteristics is by radioactive

... oil well logging

which depends essentially on neutron bombardment of the structural materials encountered in underlying formations. USR high-activity neutron sources have effected such bombardment.

If you would like further information on USR neutron sources — write to Dept. P-5.

UNITED STATES RADIIUM CORPORATION

535 PEARL STREET, NEW YORK 7, N. Y.
Plants and Laboratories at: Bernardsville, N. J., Whippany, N. J.
Bloomsburg, Pa., N. Hollywood, Cal.

for service and lab. work

Heathkit PRINTED CIRCUIT OSCILLOSCOPE KIT FOR COLOR TV!

① Check the outstanding engineering design of this modern *printed circuit* Scope. Designed for color TV work, ideal for critical Laboratory applications. Frequency response essentially flat from 5 cycles to 5 Mc down only $1\frac{1}{2}$ db at 3.58 Mc (TV color burst sync frequency). Down only 5 db at 5 Mc. New sweep generator 20-500,000 cycles, 5 times the range usually offered. Will sync wave form display up to 5 Mc and better. Printed circuit boards stabilize performance specifications and cut assembly time in half. Formerly available only in costly Lab type Scope. Features horizontal trace expansion for observation of pulse detail — retrace blanking amplifier — voltage regulated power supply — 3 step frequency compensated vertical input — low capacity nylon bushings on panel terminals — plus a host of other fine features. Combines peak performance and fine engineering features with low kit cost!



MODEL
G-10
\$69.50
Shpg. Wt.
27 lbs.



MODEL
TS-4
\$49.50
Shpg. Wt.
16 lbs.

Heathkit TV SWEEP GENERATOR KIT ELECTRONIC SWEEP SYSTEM

② A new Heathkit sweep generator covering all frequencies encountered in TV service work (color or monochrome). FM frequencies too! 4 Mc — 220 Mc on fundamentals, harmonics up to 880 Mc. Smoothly controllable all-electronic sweep system. Nothing mechanical to vibrate or wear out. Crystal controlled 4.5 Mc fixed marker and separate variable marker 19-60 Mc on fundamentals and 57-180 Mc on calibrated harmonics. Plug-in crystal included. Blanking and phasing controls — automatic constant amplitude output circuit — efficient attenuation — maximum RF output well over .1 volt — vastly improved linearity. Easily your best buy in sweep generators.



WRITE FOR FREE CATALOG
...COMPLETE INFORMATION



News-New Products

These manufacturers have invited PROCEEDINGS readers to write for literature and further technical information. Please mention your I.R.E. affiliation.

(Continued from page 163A)

"L" Band Wavemeter

Amerac, Inc., Wenham, Mass., announces production of their Model 228 "L" Band Wavemeter, a co-axial line instrument covering the frequency range from 900 mc to 2400 mc, by transmission. The instrument features: high frequency stability through the temperature range 10°C to 40°C; accuracy of ± 0.02 per cent.



A counter-to-frequency graph is provided for accurate readings. As an optional feature, the lower portion of the cabinet contains a drawer with ring binder attached for the graph. Specifications for the Model 228 are as follows: type "N" constant impedance input connectors; BNC or UHF co-axial fitting for external video connection; power handling capability 1 mw to 1 watt (transmission); peak power is 25 watts (transmission); approximate loaded Q is 1000; cabinet is 15 inches wide, 9 $\frac{1}{2}$ inches deep, 7 $\frac{1}{2}$ inches high; net weight is 13 $\frac{1}{2}$ pounds. The unit is modified to meet customer's specific requirements.

Weber New D.C. Manager For Ampex

Paul J. Weber is the new Washington district manager of Ampex Corp. instrumentation division with offices in College Park, Md., according to an announcement by Robert Sackman, division manager.

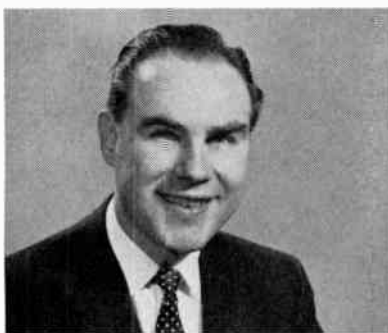

Weber also will supervise the instrumentation office located in Dayton, Ohio. With headquarters in Redwood City, Ampex Corp.'s instrumentation division markets tape recorders for such uses as data recording, machine tool control and process regulation.

(Continued on page 166A)



...an outstanding source
for all types printed circuit connectors

INTRODUCING NEW MINIATURE EC COAXIAL CONNECTOR

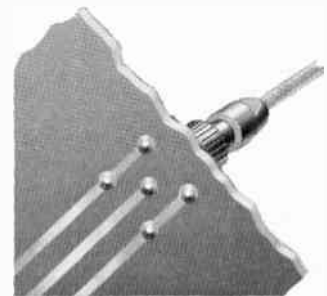
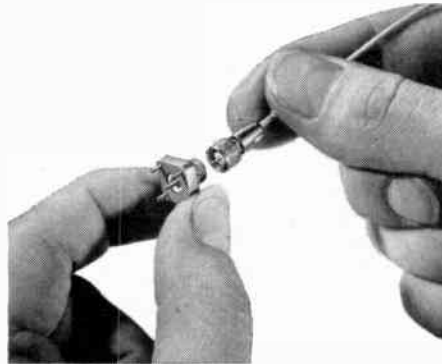

HHB Miniature EC Coaxial Connector in mounted position on card.

MORE THAN 75 PRINTED CIRCUIT CONNECTOR DESIGNS AVAILABLE

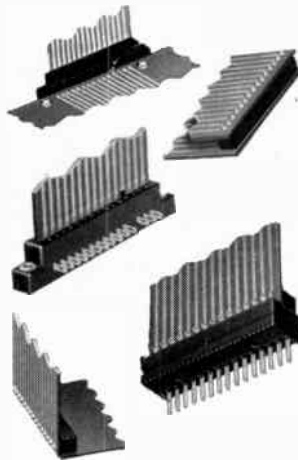

Every prospect and user of printed circuitry can rely upon the vast background of research and design-engineering experience of H. H. Buggie, Inc., regarding connectors for this specialized field. Since the introduction of printed and etched circuit methods, HHB personnel have worked closely with company engineers to develop connectors for special applications.

Today these designs include latest engineering advancements, such as the new HHB miniature connector for coaxial cable, featured above.

If you are a user of printed circuits, or contemplate the use of printed circuit designs in the future, H. H. Buggie, Inc., invites your inquiry regarding connector needs.

Write—for HHB EC Series Printed Circuit Connector bulletin.



Skilled in

- RESEARCH • DESIGN
- ENGINEERING • MANUFACTURING

of Electronic Components and Connectors
for Communications and Industry

H. H. BUGGIE, Inc.

726 STANTON STREET

TOLEDO 4, OHIO

Sales-Engineers in All Principal Cities



VARIABLE FREQUENCY GENERATORS

"THE STANDARD OF THE INDUSTRY"



MODEL 1435B

The Model 1435B Generator is another in the line of CML Variable Frequency power supplies that feature low distortion, excellent regulation and low dynamic output impedance.

At rated output of 2 K.V.A. into unity power factor load this unit has less than 3% total harmonic distortion and "no load-full load" regulation of better than 2% over the frequency range of 50-6000 cps.

For complete information about this and other CML generators covering the power range of 50 to 13000 VA and frequency ranges from 20 cps to 60 KC write for catalogue M.

COMMUNICATION MEASUREMENTS LABORATORY, INC.

350 LELAND AVE., PLAINFIELD, N.J.



News-Now Products

(Continued from page 165A)

Portable Microwave Relay For Color TV

New portable microwave relay equipment for transmission of color and monochrome TV programs has been announced by **Motorola Communications & Electronics, Inc.**, 4501 W. Augusta Blvd., Chicago 51, Ill. The equipment can be used for feeding TV signals into national networks, as well as for local "STL" applications. Both the transmitter and receiver are packaged into easy-to-carry units.



The equipment operates on "STL" and common carrier frequencies in the 6,000 to 7,000 mc range. Design features include provisions for balanced or unbalanced line operation, a receiver pre-selection filter which eliminates any possibility of adjacent microwave channel interference, a built-in modulation tester for rapid adjustment of system modulation and gain levels, and automatic alarm circuits for the transmitter and receiver.

Fixed station microwave TV relay equipment for color and monochrome transmissions is also available and can be used in conjunction with the portable microwave equipment. Fixed microwave RF equipment is mounted in an all-aluminum weatherproof housing and is designed for continuous operation.

Panel Meter Data

An Engineering Data Sheet just published by **International Instruments Inc.**, P. O. Box 2954, New Haven 15, Conn., describes and gives complete performance information on a new series of large Side Indicator Panel Meters. The new meters are said to save space and improve readability through the use of a bi-level scale. The scale length exceeds the American Standards Association's specification for conventional 4 1/2 inch meters and the panel area is less than 1/3 as much.

The Side Indicator Meters are described as having an initial accuracy of ± 2 per cent of full scale deflection on DC and ± 5 per cent on ac. The dc microammeter, milliammeter, and ammeter ranges are available from 50 μ a to 15 amperes; ac voltmeter ranges from 25 to 500 volts; dc from 50 mv to 500 volts. All meters are self-contained with external zero adjuster accessible from the front, in dustproof plastic cases.

(Continued on page 169A)

SPHERICAL MICROWAVE LENS

(Luneberg Type)

APPLICATIONS:

- Rapid Scanning and Tracking
- Wide Angle Volumetric Scanning
- Multiband Simultaneous Lobing
- Multidirection Simultaneous Lobing

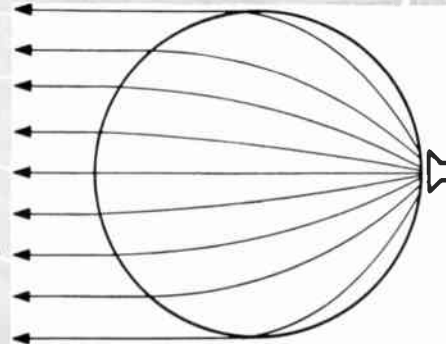
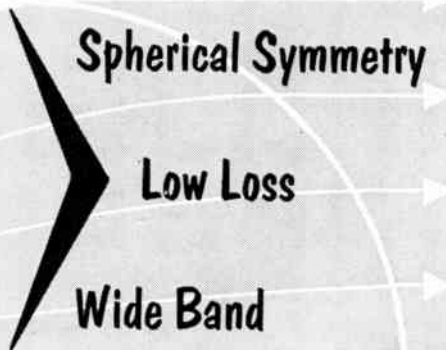

SCIENTIFIC ASSOCIATES, Inc.

engineering • development • manufacturing
580 Virginia Avenue, N.E. • Atlanta, Georgia

Two week delivery on lenses 1 and 2 feet in diameter.

**THIS TIME BE SURE
with
PEERLESS
Quality
Transformers**

For military requirements, insist on Peerless transformers for **QUALITY** design and **QUALITY** manufacture that insures constant **QUALITY** control.

Grade for grade, class for class, Peerless transformers exceed the MIL-T-27 requirements.

Peerless quality is **ECONOMICAL, UNIFORM, DEPENDABLE.**

THIS TIME have Peerless quote on your transformer requirements.

**PEERLESS
Electrical Products**

A Division of



9356 Santa Monica Blvd., Beverly Hills, Calif.
161 Sixth Avenue, New York 13, N.Y.

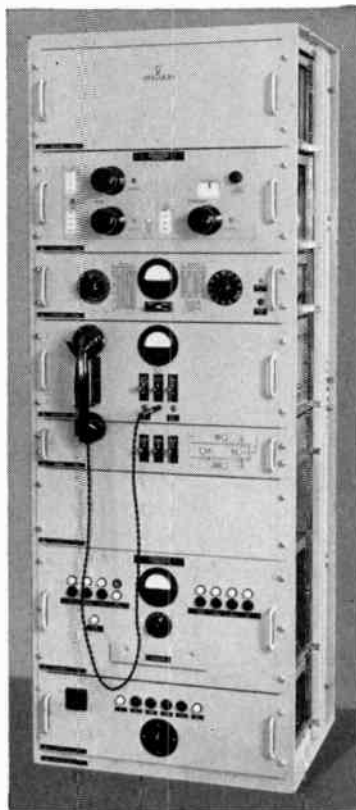

**24-CHANNEL PULSE-POSITION-MULTIPLEX RADIO
SYSTEM OF ADVANCED DESIGN**

This equipment provides 24 broad-band telephone channels in the frequency range 2450 to 2700 mc. with toll-grade transmission performance over very long systems. Full provision is made for branching, dropping and inserting channels, and elaborate fault-reporting and automatic changeover features are available. Transmitter has 5 watts average output power. Antennas, transmission line, 4-wire terminating, ringing and dialling sets and test equipment are available to form complete packaged systems of superb performance, reliability and quality.

A similar system is produced for the frequency band 235 to 328 mc.

Type PPM24/2500 Radio Bay is 22" wide by 18" deep by 64" high. The 24-channel multiplex bay has the same dimensions.

RADIO ENGINEERING PRODUCTS

1080 UNIVERSITY STREET, MONTREAL 3, CANADA

Telephone: UNiversity 6-6887

Cable Address: Radenpro, Montreal

MANUFACTURERS OF CARRIER-TELEGRAPH, CARRIER-TELEPHONE AND BROAD-BAND RADIO SYSTEMS

OUT OF THIS WORLD

**HEAR THE ACTUAL SOUNDS OF
— EARTHQUAKE
TREMORS***

A first recording — on LP

Shock waves of major & minor quakes from Madagascar, Hawaii, California, Mexico as received by tape-recording seismometer

*with cooperation of Dr. Hugo Benioff, CalTech Seismology Laboratory

**IONOSPHERIC swishes, whistlers,
tweeks; the dawn chorus**

Unexplained audio disturbances 50 to over 7,000 miles above the earth. Electromagnetic wave propagation in the audio range.

Manifestations of the L.R.O. Storey* phenomenon

Some recorded material suitable for sound spectrum analysis.

From recorded data collected & narrated by Prof. Millett Morgan, Dartmouth College

First Recording Ever Available

Provocative listening from recent research

12" High Fidelity LP (# 5012) -- 33 1/3 rpm only

*(Investigation of Whistling Atmospherics, Cambridge University Press, No. 908 Vol. 246 pp 113-141 9 July 1953)

COOK Laboratories

W 101 Second St., Stamford, Conn.

Please send "OUT OF THIS WORLD" to

At your dealer or send \$4.80 to

\$4.80 enclosed. (No C.O.D.)

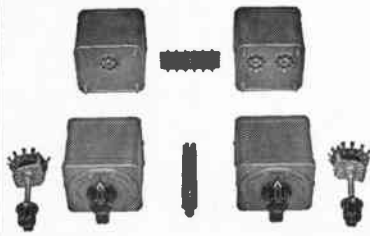

**simplify
custom
Installation**

The 4200 Sound Effects Filter and 4201 Program Equalizer are now available in component form, as illustrated, for the custom builder.

In addition to the flexibility of installation, all the features and characteristics of the standard models are retained.

The high and low sections of either model may be obtained separately. Complete wiring instructions included.

Send for Bulletin TB-4



Model 4200 Sound Effects Filter
(Send for Bulletin S)



Model 4201, Program Equalizer
(Send for Bulletin E)

Representatives in
Principal Cities

HYCOR
Company, Inc.

Subsidiary of International Resistance Company
11423 VANOWEN STREET
NORTH HOLLYWOOD 6, CALIF.

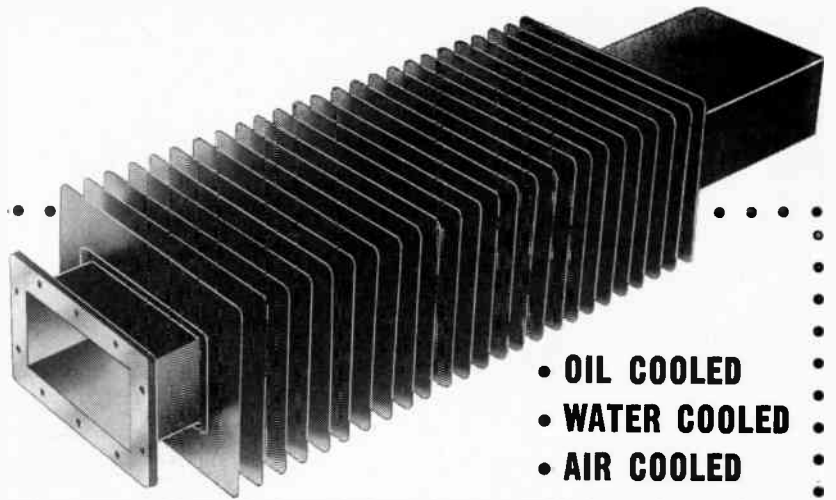

- OIL COOLED
- WATER COOLED
- AIR COOLED

NEW High Power DUMMY LOADS

WAVEGUIDE AND COAXIAL

- Coaxial Loads: up to 10 KW Average Power.
- Waveguide Loads: X-Band Loads up to 1000 Watts Average Power.
- S-Band Loads up to 4000 Watts Average Power.
- L-Band Loads up to 6000 Watts Average Power.

WRITE FOR NEW CATALOG AND QUOTATION ON SPECIAL DUMMY LOADS

ELECTRO IMPULSE Laboratory

200 RIVER STREET • RED BANK, N.J. • Phone: Red Bank 6-0404

SUBMINIATURE TRANSFORMER



Field tested—used with transistors by leading manufacturers in large quantities.

FRANK KESSLER CO.

41-45 47th St., Long Island City 4, N.Y.

Tel: Stillwell 4-0263

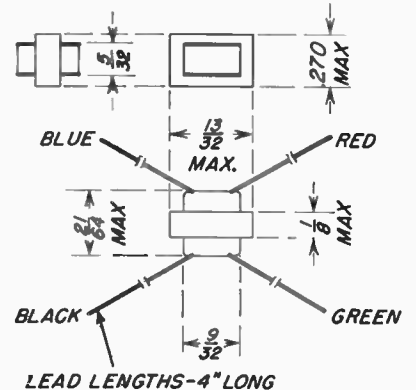

BERYLLIUM COPPER
Silvercote®

titanium

phosphor bronze

ALUMINUM

OTHER NON-FERROUS

Send for descriptive folder.



LITTLE FALLS ALLOYS Inc.
191 Caldwell Ave., Paterson 1, N.J.

Special Purpose **WIRE**

Consider WIRE and the importance of its function in your product. Whether a highly engineered application or a simple stapling purpose, your choice of the proper alloy or composition, temper and type of wire could mean success or failure during crucial test.

round • flat — square ■ half-round ▲

Precision gauges from 1/8 to .002.

SPRING WIRE — WIRE FOR INSTRUMENTS — ELECTRONICS. STRAND FOR WIRE ROPE AND BRAIDED APPLICATIONS — MANDREL WIRE — WIRE FOR FORMS — RIVETS — STAPLING



These manufacturers have invited PROCEEDINGS readers to write for literature and further technical information. Please mention your I.R.E. affiliation.

(Continued from page 166A)

Pulse Forming Network

A hermetically-sealed, high-power Pulse Forming Network that supplies power through a pulse transformer to magnetron and Klystron generators for industrial, electronic, radar, aircraft, missile, marine and scientific applications is available from **Luther Electronic Co.**, 5728 W. Washington Blvd., Los Angeles, Calif.

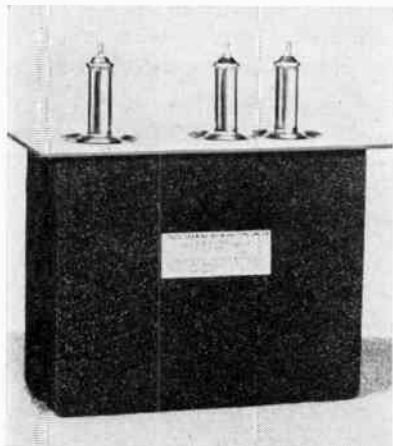

The network provides pulses of specific duration, voltage, amplitude and impedance in systems with characteristics of 5-100 kw, 2 ohms or more impedance, and pulse width from 0.1 microsecond.

The unit is designed to military specifications and is tested to Air Force standards for shock, vibration, high voltage, high altitude, salt spray and low temperature. The illustrated unit with paper dielectric and three terminals is used in an airborne radar system, and is 3½-inches wide, 6¾-inches deep, 8-inches long, and weighs 11 pounds. Charging voltage is 15 kv, duration of pulse is 0.5 and 2.4 microseconds. Repetition rate is 2000 pps and impedance is 50 ohms. Size, shape and weight may be varied to meet a wide range of requirements of voltage, impedance and pulse width.

Low Cost Relay

A small SPDT relay designed to sell in quantity for as little as 75 cents has been developed by **Sigma Instruments, Inc.**, 81 Pearl Street, So. Braintree, Boston 85, Mass.

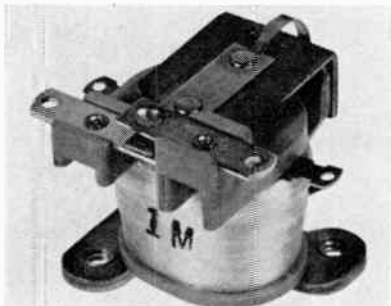

(Continued on page 171A)

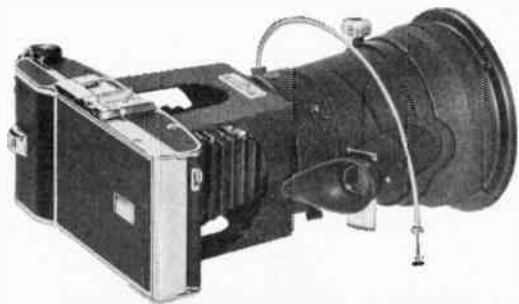

*in
sixty
seconds...*

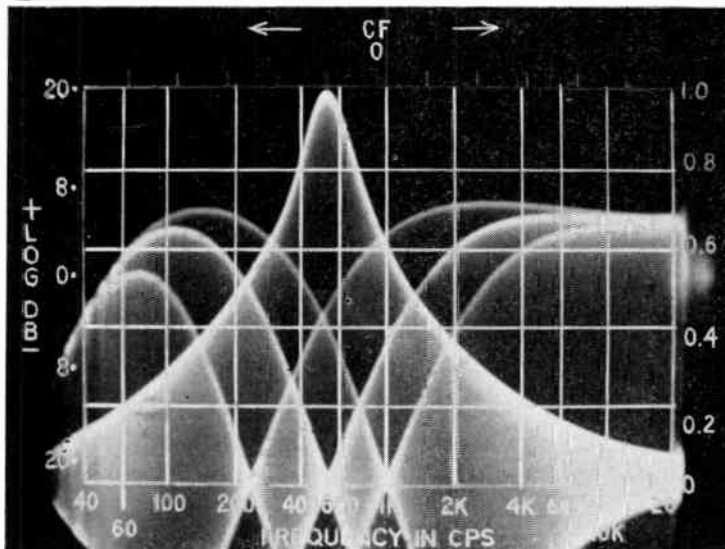

Performance evaluation of a Fischer electronic (low frequency—high frequency) filter; wave forms signify the following: Variable null marker to check points on response curve at 1 Kc, 2.2 Kc and 5.5 Kc. This is a log amplitude presentation where the frequency is multiplied by a factor of 10. Instrument used is SGI Sweep Generator; courtesy Panoramic Radio Products Corporation.

a full-size photo of any scope pattern for evaluation of transient phenomena!

This special Fairchild adaptation of the Polaroid-Land principle delivers a permanent, photographically accurate, full-size record of single transients or identical repetitive phenomena in 60 seconds after they appear on the C-R Tube. It is the only practical method to obtain a quick, permanent record of scope patterns like the one above. Because this photographic method is so fast, laboratory work can proceed continuously without interruptions or delays so usual where conventional film is used. The life size 3¼ x 4¼ in. image makes evaluation easy and accurate. Camera is automatically in focus when attached to the oscilloscope. Also provides for critical focusing adjustment where thick grids or filters are interposed between the tube face and camera hood.

For accurate records of continuously varying phenomena or single transients and stationary patterns on 35 mm. film, the Fairchild Oscillo-Record Camera is available. For more information, write Fairchild Camera and Instrument Corporation, 88-06 Van Wyck Expressway, Jamaica, New York, Department 120-23H.

FAIRCHILD

OSCILLOSCOPE RECORDING CAMERAS

TIC's New 800A

EXTENDED RANGE



VACUUM TUBE VOLTMETER*

A MEASUREMENT LABORATORY IN ONE
COMPACT INSTRUMENT

featuring

- Wider ranges of current, voltage and resistance
- High accuracy
- Portability
- Very high stability
- Wide frequency range
- Rugged construction

UNMATCHED IN RANGE

DC and AC Volts a full decade lower (0.1V to 1000V, full scales)

Resistance values a full decade lower and higher
(0.02 ohms to 5000 megohms)

Current values from 1 millimicroampere to 100 MA (full scales)

Write for FREE brochure and Laboratory Report No. 16

*Patents applied for

TECHNOLOGY INSTRUMENT CORP.

535 Main Street, Acton, Mass. Colonial 3-7711
West Coast Plant — Box 3941, No. Hollywood, Calif. POplar 5-8620

CRITICAL QUALITY CONTROL Means the Finest in Frequency Control in *Midland* CRYSTALS

Midland makes more frequency control crystals than anybody else. Millions are used in two-way communications throught the world.

Only a product of the highest quality rates that kind of demand. That's why you *know* your Midland crystal will do a completely dependable job for you.

The quality of Midland crystals is assured by exacting tests and controls through every step of processing. It's quality you can stake your life on — as our men in the armed forces and law enforcement do every day.

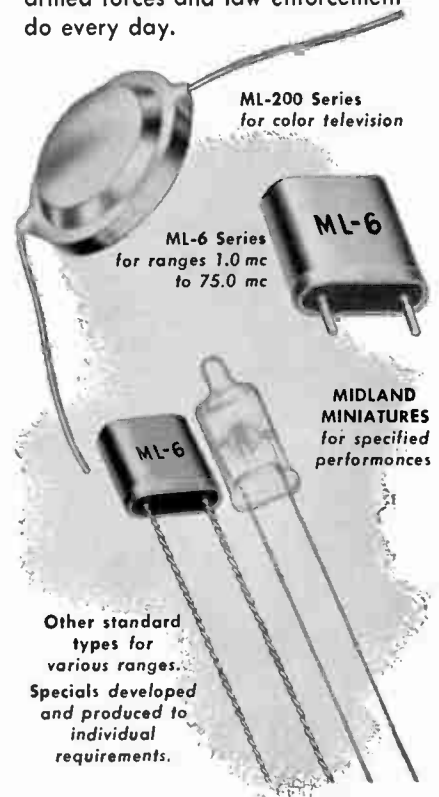

ML-200 Series
for color television

ML-6 Series
for ranges 1.0 mc
to 75.0 mc

MIDLAND
MINIATURES
for specified
performances

Other standard
types for
various ranges.
Specials developed
and produced to
individual
requirements.

Whatever your crystal need —
conventional or highly specialized...
when it has to be exactly right,
contact

Midland Manufacturing Co., Inc.
3155 Fiberglas Road • Kansas City, Kansas

WORLD'S LARGEST
PRODUCER OF QUARTZ CRYSTALS



News-New Products

These manufacturers have invited PROCEEDINGS readers to write for literature and further technical information. Please mention your I.R.E. affiliation.

(Continued from page 169A)

Tentative specifications of the Type 11F are: 50 milliwatts operate (24 ma in 9000 ohm coil); 1 ampere maximum contact load; up to 9000 ohm coil resistance; $1\frac{1}{2} \times 1\frac{1}{8} \times 1$ inches high maximum size; weight, 1 ounce.

Further data and information on price and delivery are available on request from Sigma Instruments, Inc.

Pulse Transformer



A new two-winding, Epoxy resin impregnated and hermetically sealed 75 microsecond pulse transformer with a rise time of 2 microseconds is offered by the Gudeman Company of California, Inc., 9200 Exposition Blvd., Los Angeles 34, Calif. The new units, H75-11, meet Mil-T-27, grade 1, class A test specifications. Operating Temperature range is from -70°C to 135°C . Size: $\frac{7}{8} \times \frac{1}{8} \times 1\frac{1}{8}$ inches exclusive of terminals and mounting flange.

Complete data is available from Donald H. Allen, at the firm.

Pressure Operated Potentiometer

Trans-Sonics, Inc., Bedford, Mass., announces the new Type 1100 Pressure-Operated Potentiometer for applications where the output voltage is to be a non-linear function of pressure.

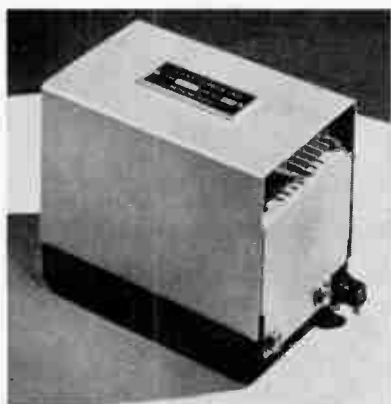

The instrument consists of a precision ruggedized pressure-operated potentiometer having taps and provision for resistance

(Continued on page 172A)

FOR SCIENCE and INDUSTRY

Electro-Pulse's NEWEST PULSE GENERATOR

- Operation to 330 KC
- Variable Duration and Delay
- Low Internal Impedance

LOW COST ...

HIGH PERFORMANCE



VARIABLE PULSE GENERATOR... Model 4120A

A truly wide-range laboratory-type unit — a basic instrument for pulse circuit test and development. Its versatility, compactness and simplicity of operation allow wide application in production and laboratory testing of: Computers... Telemetry... Television... Magnetics... Nuclear Research and Development... Radar... Navigational Systems.

- 33 CPS to 330 KC Rep. Rate • 1 to 100 μs Delay • .3 to 100 μs Pulse Width • At least 50 V Amplitude • .1 μs Rise Time • Blocking Oscillator Sync. Pulse • $3\frac{1}{2} \times 19$ " Standard Rack Panel • Complete with Regulated Power Supply

Write for Complete Data: Our Bulletin 4120A/I

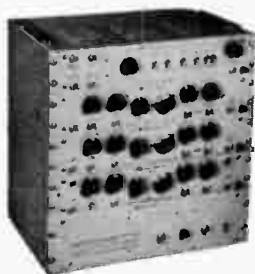

The Model 4120A Variable Pulse Generator is the latest addition to the Electro-Pulse line of pulse instrumentation which includes Analog and Digital Time Delay Generators, Pulse Oscillators and the 2100 series precision Pulse Generators

Model 2120A PULSE GENERATOR

Representatives in Major Cities

EP Electro-Pulse, Inc.

11811 MAJOR STREET, CULVER CITY, CALIFORNIA
Telephones: EXbrook 8-6764 and TEXas 0-8006

Idea to Reality...

Put WHEELER Microwave Experience to Work for You!

Wheeler Laboratories' outstanding achievements in better engineered microwave components for radio and radar place it in a unique position to handle your microwave needs.

Under the direction of Harold A. Wheeler, our competent engineering staff, with complete supporting facilities, is equipped to tackle your toughest design problem . . . and come up with positive results.

Submit your idea for immediate analysis, or arrange a meeting with our engineers. A brief summary of our work is available on request.



Members of the engineering staff discuss a problem in antenna design with Mr. Wheeler.



WHEELER
Laboratories, Inc.
122 Cutter Mill Road
Great Neck, N. Y.
HUnter 2-7876

Electrically Conductive Cloth

A New Engineering Material for Many Applications in Electronics

SUGGESTED USES: { RF SHIELDING
RADAR REFLECTION
MICROWAVE GASKETING
WARNING SYSTEMS
ATTENUATORS
STATIC DISCHARGE

Buy it by the yard and sew it to shape on any sewing machine. Or, have us sew it for you.

WRITE OR PHONE

Swift
INDUSTRIES, INC.
10 Love Lane, Hartford 1, Conn.
JACKSON 2-1181



News-New Products

These manufacturers have invited PROCEEDINGS readers to write for literature and further technical information. Please mention your I.R.E. affiliation.

(Continued from page 171A)

loading across the winding. The instrument mechanism operates in a hermetically-sealed evacuated container inside of the instrument case. A resistor board designed to accommodate loading resistors is external to the evacuated case and may be reached by removing the outside cover. This feature permits the user to select any desired voltage ratio versus pressure function by installing loading resistors on the instrument's terminal panel. The instrument can be made linear with respect to altitude, air speed, and many other aerodynamic functions.

The instrument is manufactured in compliance with MIL-E-5400, requirements for airborne electronic gear, and meets environmental requirements of MIL-E-5272. The instrument passes the vibration tests of MIL-E-5272, Paragraph 4.7.3.

Galvanometer

A series of shock resistant light beam galvanometers of exceptional compactness, with sensitivities up to 0.105 microamperes per millimeter division, has been developed by **Howell Instrument Co.**, 1106 Norwood, Fort Worth, Texas. They are available as completely housed galvanometer assemblies, with lamp and projection system included, ready for installation and use.



Originally developed to withstand shock and vibration encountered in field servicing and testing of jet aircraft, the Howell Galvanometer is suited to field work as well as for laboratory and industrial production testing services. Separately, the movement may be installed as an integral part of other industrial instrumentation in the fields of colorimetry and densitometry or for measurement of electrical potentials, conductivity, light flux or temperature (Wheatstone bridge or thermocouple).

Compactness is achieved, along with high sensitivity, through a folded light beam. The effective length of the light beam is 80 millimeters.

(Continued on page 175A)

TYPE **KARU** CAPACITANCE METER

Range: 0.5 uuf to 10 uf
Accuracy: $\pm 1\%$



TYPE **LARU** INDUCTANCE METER

Range: 0.1 uh to 1 h
Accuracy: $\pm 1\%$

**—EACH INSTRUMENT
PROVIDING A UNIQUE
COMBINATION OF**

- Wide range
- High Accuracy
- Direct reading
- Ease of operation

SPECIFICATIONS:

Type KARU Capacitance Meter

- Capacitance Range: 0.5 uuf to 10 uf—divided into 6 ranges: 0 to 100/1000 uuf/0.01/0.1/1/10 uf.
- Accuracy: $\pm 1\% \pm 5$ uuf.
- Measuring Frequency: 1.6 to 180 kc.
- Test Terminals: 2 knurled binding posts, one at ground potential.
- Tubes: 6SN7, 6H6.
- Power Supply: 110/125/150/220 volts ac, 40 to 60 cps, 10 va.
- Dimensions: 12" x 8 $\frac{3}{4}$ " x 8 $\frac{3}{4}$ ". Weight: 16 lbs.

Type LARU Inductance Meter

- Inductance Range: 0.1 uh to 1 h—divided into 7 ranges: 0.1 to 1/10/100 uh/1/10/100/1000 mh.
- Accuracy: $\pm 1\% \pm 0.01$ uh.
- Measuring Frequency: 2.2 kc to 4.7 mc.
- Resonance Frequency Measuring Range: 2.2 kc to 4.7 mc—divided into 7 ranges: 2.2-7/22/70/220 kc/ 0.7/2.2/4.7 mc.
- Accuracy: $\pm 0.5\%$.
- Test Terminals: 2 knurled binding posts, one at ground potential.
- Tubes: 6SN7, 6H6.
- Power Supply: 110/125/150/220 volts ac, 40 to 60 cps, 10 va.
- Dimensions: 12" x 8 $\frac{3}{4}$ " x 8 $\frac{3}{4}$ ". Weight: 16 lbs.

The KARU and LARU meters, manufactured by Rohde and Schwarz, will solve virtually all problems of capacitance and inductance measurements in the r-f field. Operating over exceptionally wide ranges, they provide accurate direct reading and require minimum skill and training.

Capacitance: KARU, by an application of the resonant circuit technique, measures from 0.5 uuf to 10 uf—covering the entire range of capacitors generally used—and with an accuracy of $\pm 1\%$.

Inductance: LARU covers the exceptionally wide range of 0.1 uh to 1 h, with an accuracy of $\pm 1\%$. It will also measure self-resonant frequency and distributed capacitance of inductors. Measurements can be made on components with Q as low as 1.

Both instruments are speedy and easy to operate—their direct reading scales are calibrated to give the result with no scale or multiplication factors to be considered. Six scales, controlled by the range selector switch, provide a total scale length of 54 inches.

Exclusive design features of KARU and LARU include: a novel revolving linear dial which eliminates metering errors... the range selector switch brings the appropriate scale into view... scale-factor errors are eliminated... positive action detent on the range selector switch... full protection from overload.

In measuring with KARU, the unknown capacitance is resonated with a built-in standard coil by means of the variable r-f oscillator, to which it is loosely coupled. The vacuum tube voltmeter reads the voltage across the standard coil. LARU similarly measures inductance, utilizing a standard capacitor in place of the standard coil.

These highly versatile instruments are compact, wholly reliable and completely self-contained. Each unit is provided with a recessed folding carrying handle and a removable protective cover.

For complete information, mail the attached coupon to Federal.



Federal

Telephone and Radio Company

A Division of INTERNATIONAL TELEPHONE AND TELEGRAPH CORPORATION
INSTRUMENT DIVISION
100 KINGSLAND ROAD, CLIFTON, N. J.

Federal Telephone and Radio Company
Instrument Division, Clifton, N. J.

Dept. S-437

Please send further information on the items checked:

- KARU Capacitance Meter LARU Inductance Meter
 Please send copy of your General Catalog.

Name _____ Title _____

Company _____

Address _____

City _____ Zone _____ State _____

ATR

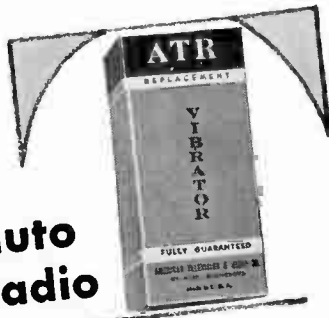

auto
radio

VIBRATORS

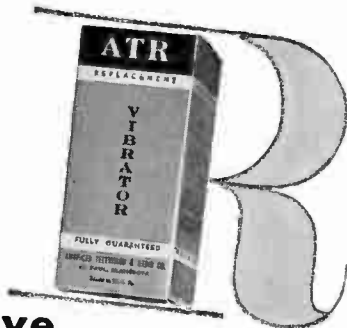

have
ceramic
stack spacers



A COMPLETE LINE OF VIBRATORS

Designed for Use in Standard Vibrator-Operated Auto Radio Receivers. Built with Precision Construction, featuring Ceramic Stack Spacers for Longer Lasting Life. Backed by more than 22 years of experience in Vibrator Design, Development, and Manufacturing.



- ✓ NEW MODELS
- ✓ NEW DESIGNS
- ✓ NEW LITERATURE

"A" Battery Eliminators,
DC-AC Inverters,
Auto Radio Vibrators

See your jobber or write factory

AMERICAN TELEVISION & RADIO CO.

Quality Products Since 1931
SAINT PAUL 1, MINNESOTA—U. S. A.

Send for this *Free* SAMPLE FOLDER...

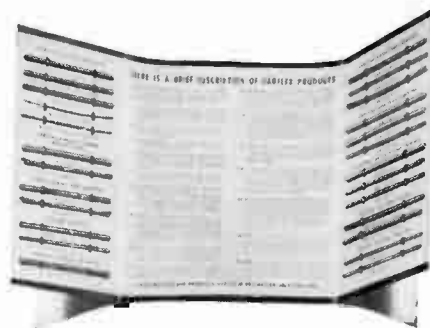

Contains 25 different test samples of high dielectric Insulating Tubing & Sleeving

Includes samples and descriptions of:
Varglas Silicone • Permafil-Impregnated Varglas Tubing • Varglas Tubing and Sleeving • Varglas Non-Fray Sleeving • Varflo Tubing and Sleeving • Varflex Cotton Tubing and Sleeving • Syntholvar Extruded Tubing

Write today!

VARFLEX CORP., 518 W. COURT ST., ROME, N.Y.

YOKE SPECIALISTS



- Military or special yokes and focus coils designed to *your* specifications.
- Production yokes for TV sets.

For your answer to yoke problems write Dr. Henry Marcy today.

syntronic

INSTRUMENTS, INC.

100 Industrial Road • Addison, Ill. • Phone: Terrace 4-6103

These manufacturers have invited PROCEEDINGS readers to write for literature and further technical information. Please mention your I.R.E. affiliation.

(Continued from page 172A)

Cooling Devices

A new brochure, *What We Make*, is now available from **Rotron Manufacturing Co.**, Woodstock, N. Y. This eight page unit describes in editorial and picture content the complete line of cooling devices for the electronics industry manufactured by this company as well as indicating applications in which these devices find use.

Sent free upon application by letter-head or publication inquiry card.

Reflectometer System

A fast accurate reflectometer system capable of wide range microwave impedance measurements has been developed by the **Hewlett-Packard Co.**, 395 Page Mill Rd., Palo Alto, Calif.

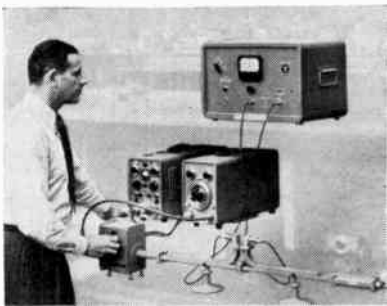

The system includes a new ratio meter, a 7 to 10 kmc swept-frequency oscillator, a power supply, and related crystal detectors and directional couplers. All have been developed specifically for use in the reflectometer system, although individually, components have additional uses.

Besides measurement of reflection coefficient or swr over a wide frequency range, the system makes possible direct and continuous swept-frequency oscilloscope presentation. It is said to be particularly applicable to fast production checking of reflection coefficient or swr, as well as useful in waveguide system alignment, checking of waveguide components, determining antenna and rotary joint performance and similar laboratory or production measurements. Single frequency measurements can be made with accuracies greater than possible with slotted lines. At present available for X-band operation only, the system will soon include components for operation at other microwave frequencies.

(Continued on page 177A)

Engineer using BURROUGHS PULSE UNITS loses no time designing test equipment

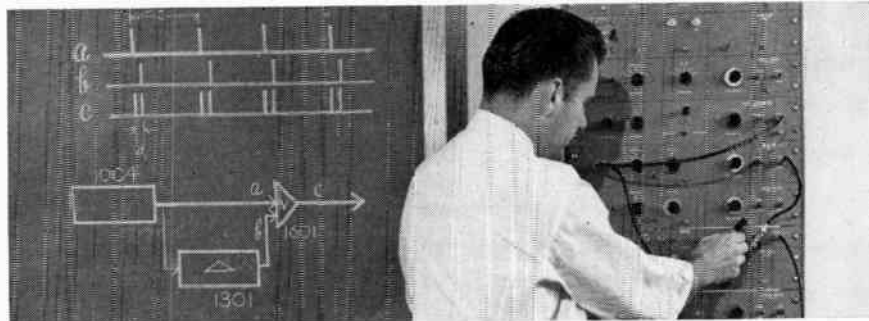

- 1. FAST SET-UP.** Engineer draws pulse sequence, then determines by block diagram how to connect his Burroughs Pulse Units. Usually this can be done in a matter of minutes.

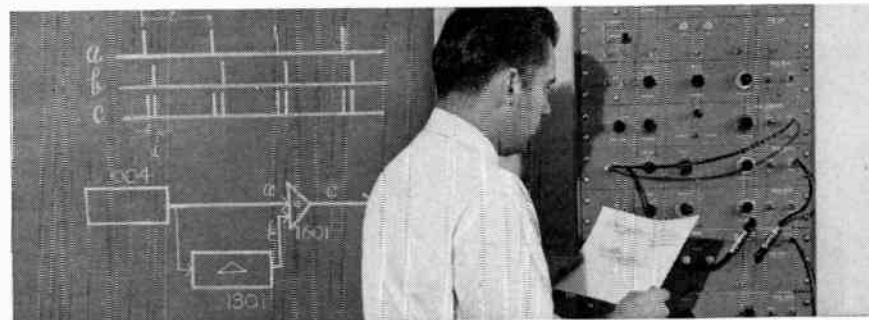

- 2. JOB COMPLETED.** No time lost. Because engineer spends no time designing test equipment, he can spend his full time on the real problem. This means he can do more, accomplish more.

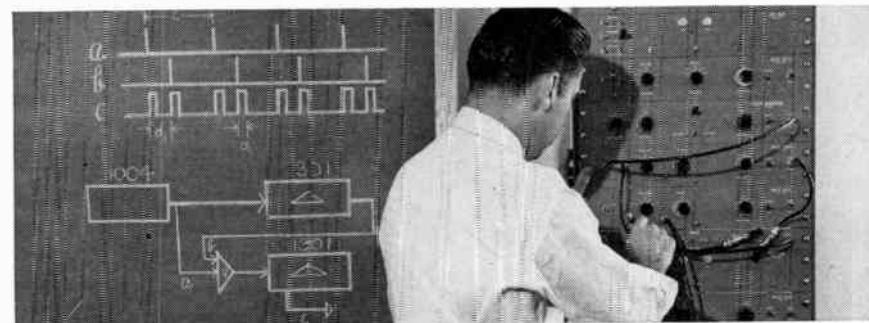

- 3. NEXT ASSIGNMENT.** Without losing time, engineer simply determines the block diagram needed to produce the next pulse sequence and sets up his Burroughs Pulse Units. He shifts quickly from one assignment to the next—saving considerable time otherwise needed to design and build special test equipment.

GET THE FACTS

Learn how you can make your time worth more. Burroughs Pulse Units save weeks of engineering, uncertainty, and considerable equipment cost. Can be used over and over again on different future projects. Immediate delivery from stock. Write for detailed brochure. *Burroughs Corporation, Electronic Instruments Division, Dept. 11-E, 1209 Vine St., Phila. 7, Pa.*

ELECTRONIC INSTRUMENTS DIVISION

FIRST IN PULSE HANDLING EQUIPMENT

CHICAGO

STANCOR

CONSERVATIVELY RATED INDUSTRIAL TRANSFORMERS

Typical units from the industry's largest and most complete line of transformers for electrical and electronic applications.

ISOLATION TRANSFORMERS



"KA" TYPE
tap switch, line cord
and output receptacle

Primary 125/115/105 Volts. Secondary 115 Volts-50/60 cycles

PART NO.	RATING WATTS	MOUNTING TYPE
P-6160	100	KA
P-6161	250	KA
P-6298	500	KA
P-6125	1000	FK
P-6123	1500	FK

STEP-DOWN ISOLATION



"FK" TYPE
ceramic insulated input
terminals, two output
receptacles

Primary 250/230/210 Volts. Secondary 115 Volts-50/60 cycles

PART NO.	RATING WATTS	MOUNTING TYPE
P-6383	100	KA
P-6385	250	KA
P-6387	500	KA
P-6389	1000	FK
P-6390	1500	FK

STEP-DOWN AUTOTRANSFORMERS



"K" TYPE
line cord on input, out-
put receptacle



"SD" TYPE
"Sealed-In-Steel" con-
struction. Line cord and
output receptacle

Primary 230 Volts. Secondary 115 Volts-50/60 cycles

PART NO.	RATING WATTS	MOUNTING TYPE
SD-50	50	SD
P-5062	80	K
SD-100	100	SD
P-5063	100	K
SD-150	150	SD
P-5064	150	K
SD-250	250	SD
P-5065	300	K
SD-500	500	SD
P-6141	500	K
SD-1000	1000	SD
P-6124	1000	FK

LINE ADJUSTING TRANSFORMERS



"PV" TYPE

Input voltage 65/75/90/100/115/130/145, output voltage 115:
with selector switch and output voltmeter

PART NO.	RATING WATTS	MOUNTING TYPE
PV6441	150	PV
PV6442	350	PV
PV6443	500	PV
PV6444	750	PV

Full lines of Control and Power Circuit Trans-
formers are also available from Chicago Standard



CHICAGO STANDARD TRANSFORMER CORPORATION

ADDISON AND ELSTON
CHICAGO 18, ILLINOIS

FREE CATALOGS listing these units, and
over 1000 other CHICAGO-STANCOR
transformers are available from your
CHICAGO STANDARD distributor or by
writing Chicago Standard Transformer
Corporation.

Export Sales: Roburn Agencies, Inc., 431 Greenwich St., New York 13, N. Y.

ENGINEERED

. . . through
EXPERIENCE

to Fit Your Needs

Station WOAY-TV is an ex-
ample of how TOWER'S engin-
eering and experience can solve
your unusual tower problems.
This 600 ft. tower supports an
83 ft. TV antenna, an FM anten-
na, an 8 ft. x 12 ft. Microwave
Passive Reflector, and serves as
an AM radiator. From coast to
coast you'll find installations
where TOWER'S "know how"
has paid off.

MICROWAVE TOWERS and REFLECTORS

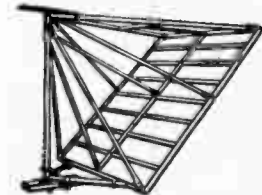

Pioneers in Microwave towers
and reflectors, TOWER Micro-
wave Passive Reflectors are
used by the U. S. Government,
Bell Telephone System and lead-
ing manufacturers. For strength,
dependability and service . . .
you can count on TOWER.

*Tower Fabricators
And Constructors
The World Over*

TOWER

Construction Co.
SIOUX CITY, IOWA



News-New Products

These manufacturers have invited PROCEEDINGS readers to write for literature and further technical information. Please mention your I.R.E. affiliation.

(Continued from page 175-1)

New Precision Resolver



A new size 15 boosterless resolver, Type 3D-2348, is now available from John Oster Manufacturing Co., Avionic Div., 1 Main St., Racine, Wis. No associated amplifiers and compensators are necessary because of the small variation in transformer ratio and phase shift with varying input voltage. Axis misalignment is ± 7 minutes and maximum angular error 0.12 per cent. Input voltage ranges from 0-16 v 400 cps. Input impedance is 740-79 Ω . The unit is available with terminal connectors and is designed for phase shifting and interchanging rectangular and polar coordinates in computer applications.

Phenolic Coil For Printed Circuitry

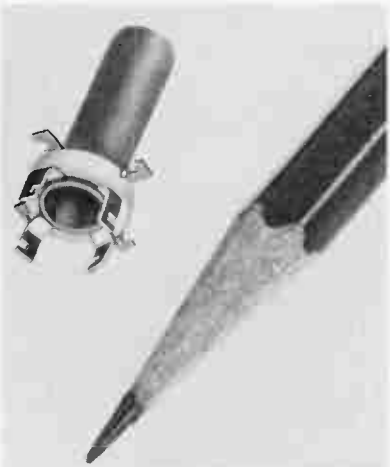

A new phenolic coil form type SPC for printed circuitry, available in two diameters with four terminals each, has just been announced by Cambridge Thermionic Corp., 445 Concord Ave., Cambridge 38, Mass. This coil form features a design which allows the unit to be dip soldered after mounting. This is available either as a form alone, or wound to the required specifications of the user. It comes complete with threaded slug. The terminal collar is securely fastened to the form. The unit mounts through four holes, as required by the number of terminals. When mounted, the smaller unit is $\frac{3}{4}$ inch high by 0.219 inch diameter, and the larger unit is $\frac{3}{4}$ inch by 0.285 inch diameter. Further specifications, application information and prices may be had by writing direct to the manufacturer.

(Continued on page 178A)

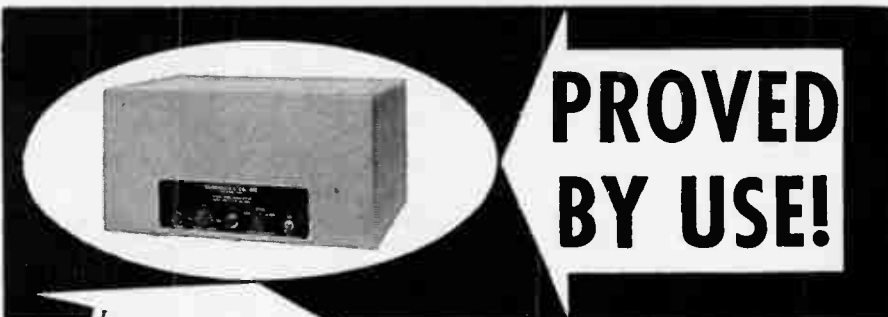

PROVED BY USE!

In the short time the Model 1001 Regulator has been on the market, more than 300 of the instruments have been sold, mainly for meter calibration applications and for use in standards laboratories.

As a result, it can now be said — and proved — that the Model 1001 gives hairsplitting precision with the rugged dependability of operation associated with voltage regulators of "ordinary" regulating accuracy!

0.01% regulation accuracy!

1000 VA capacity!

Sorensen Model 1001 electronic AC Voltage Regulator

specifications

Input	.95-130 VAC, 1 ϕ , 50-60 \sim
Output	110-120 VAC, adjustable
Load range	0-1000 VA
Regulation accuracy	$\pm 0.01\%$ against line and $\pm 0.01\%$ against load guaranteed at room temperature, for a resistive load, an input variation of $\pm 10\%$ and over a 2-to-1 load change. For all other conditions within the specifications the 1001 has a proportionate amount of accommodation.
Distortion	3% RMS maximum
P. F. range	0.95 leading to 0.7 lagging
Time constant	0.1 second
Tube complement	6SL7GT (1), 6L6GA (1), 5Y3GT (1), 2AS15 (1)

Even greater capacity with similar accuracy will be available this fall when the Sorensen Model 2501 Regulator — $\pm 0.01\%$ accuracy, 2500 VA capacity — goes into production.

general catalog available

AC VOLTAGE REGULATORS — 150VA to 15000VA capacities, 115 volt and 230 volt output, 400-cycle regulators, 3-phase regulators

FREQUENCY CHANGERS — 60 cycle and 400 cycle, accuracy to $\pm 0.01\%$

NOBATRONS — Regulated low-voltage, high-current DC sources

B-NOBATRONS — Regulated high-voltage, low-current B power supplies

NOBATRON-RANGERS — Wide-range variable DC sources

TUBELESS DC SUPPLIES — Magnetic amplifier supplies with various outputs and capacities

AIRBORNE FREQUENCY CHANGERS & INVERTERS, MILITARIZED REGULATORS, FILTERS, TRANSFORMERS, AND RELATED EQUIPMENT.

For your copy write Sorensen & Co., Inc., 375 Fairfield Avenue, Stamford, Conn. In Europe, Sorensen A.G., Gartenstrasse 26, Zurich 2, Switzerland.

SORENSEN

375 FAIRFIELD AVENUE, STAMFORD, CONN.

DIGITAL

PIG PRESET INTERVAL GENERATOR



EXACT DIGITAL SELECTION
 ●
NO CALIBRATION REQUIRED
 ●
SINGLE RANGE, 100,000 STEPS

The "PIG" will —

● **GENERATE DELAYS**

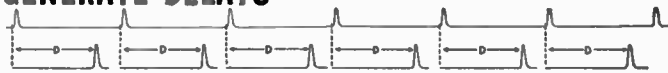

● **GENERATE PULSE BURSTS**



● **GENERATE VOLTAGE GATES**



● **MEASURE TIME INTERVALS**



● ● ● ● ●

- Internal 1 megacycle crystal oscillator time base
- Accepts any external time base up to 1 megacycle
- Fast reset—recycles in 50 microseconds
- Independent and simultaneous outputs
- Preset counter up to 1 megacycle

For complete information, write or call



POTTER INSTRUMENT COMPANY, INC.

115 Cutter Mill Road, Great Neck, N. Y.



News-New Products

These manufacturers have invited PROCEEDINGS readers to write for literature and further technical information. Please mention your I.R.E. affiliation.

(Continued from page 177A)

Sub-Miniature Potentiometers

Ace Electronics Associates, Potentiometer Div., 125 Rogers Ave., Somerville 44, Mass., has developed and tested a new Model 500 Aceptot.

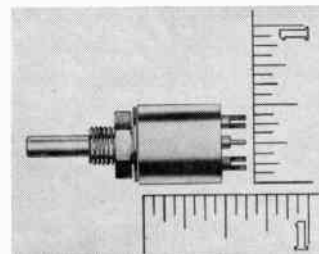

This sub-miniature wire wound precision potentiometer is $\frac{1}{8}$ inch in diameter, has a linearity of ± 3 per cent on standard models, and can be had in closer tolerances on special order.

Low dielectric constant and power factor are achieved through utilization of new materials and techniques. The component boasts low torque and is available in threaded bushing, servo, or tapped hole mounting.

"S" Band Wavemeter



Amerac, Inc., 116 Topsfield Rd., Wrentham, Mass., announces the design and production of an inexpensive "S" band wavemeter for the frequency range from 1800 mc to 3800 mc. The C&D wavemeter features a highly sensitive indication of resonance, with a control for setting the sensitivity of the instrument. Its micrometer extends outside the instrument, providing easy reading. It has a precision cavity assembly for accurate repeatable readings, with an anti-backlash device which gives further accuracy. All silver-plated parts are Rhodium flashed to minimize corrosion. The wavemeter has the

(Continued on page 180A)

Every

B-47 "STRATOJET"

Uses this Amplifier and Power Supply Rack . . . another
Servomechanisms'
"building block" system



This sub-system is another outstanding example of Servomechanisms' packaged function philosophy.

Consider the seven SA104H Servo Amplifiers used in this system. Servomechanisms has designed and produced over 40,000 of these amplifiers. All are 100% electrically and mechanically interchangeable. They are a USAF standard — designated Type A-1 — and as such are "shelf items" in supply depots throughout the world.

As a USAF standard, these amplifiers are used in many other systems in almost every modern fighter aircraft.

This demonstrates how Servomechanisms' packaged electronic functions have helped standardize and simplify fire control equipment—and why designers and users of control equipment specify Servomechanisms, Inc., for economy and reliability.

The reliability of Servomechanisms' equipment is directly traceable to the ease of maintenance inherent in the "building block" philosophy.

SERVOMECHANISMS
INC.
PACKAGED FUNCTIONAL COMPONENTS

EASTERN DIVISION . . . Post and Stewart Avenues, Westbury, N.Y.

WESTERN DIVISION . . . 12500 Aviation Boulevard, Hawthorne, Calif.

PROCEEDINGS OF THE I.R.E. May, 1955

179A

Lapp



ANTENNA STRAIN INSULATORS

• The largest of the porcelain rod insulators shown in the illustration develops 12,000 lb. strength. It is available, if specified, with rain shield and/or corona rings. All hardware is silicon aluminum alloy. Smaller units, in porcelain or steatite, are suited to lighter duty for strain or spreader use. Engineering and production facilities are also available for design and manufacture of units to almost any performance specification. Write for Bulletin 301, with complete description and specification data. Lapp Insulator Co., Inc., Radio Specialties Division, 250 Sumner St., Le Roy, N. Y.

Lapp



News-New Products

These manufacturers have invited PROCEEDINGS readers to write for literature and further technical information. Please mention your I.R.E. affiliation.

(Continued from page 178A)

following specifications: Accuracy (at 3260 mc is $\pm \frac{1}{2}$ mc; loaded Q is approximately 1000; ruggedized 50 microampere indicating instrument; rf detector is a selected type 1N21-B silicon diode; input connections are 2 type N jacks; overall size is 8 inches long, $7\frac{3}{4}$ inches wide, $2\frac{1}{4}$ inches deep; net weight is $2\frac{1}{2}$ pounds; price is \$225.00.

Pressure-Transient Recorder

In a new design utilizing interferometric optical principles, the new Model 216 Pressure-Transient Recorder developed by Beckman & Whitley, Inc., 963 E. San Carlos Ave., San Carlos, Calif., provides the capability of recording short-term pressure variations over a wide series of pressure ranges. The film record produced is suitable for rapid analysis and data reduction, a first approximation of pressure being available by the simple counting of the number of fringes.

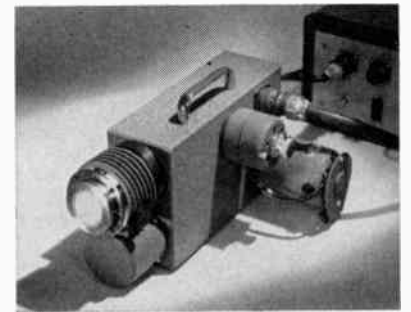

In application, the instrument can be utilized in three ways: exposed to free air manifestations, attached directly to a pressure vessel, or fed by a hydraulic line from the pressure source. Two units comprise the system: the combined transducer, optical system, and camera with 2-millisecond timing-pip system, housed in a case $15\frac{3}{4}$ by $9\frac{1}{2}$ by $7\frac{1}{4}$ inches and weighing 25 pounds; and the control unit (housed in a standard 19 inch rack unit 7 inches high and $8\frac{1}{2}$ inches deep, weighing 25 pounds) which can be located remotely from the transducer. Complete control is exercised from this point, including the camera drive motor, dynamic braking system, and the monochromatic light source which illuminates the transducer.

Since the instrument essentially measures the displacement of the transducer diaphragm, it is additionally adaptable for the measurement of any physical phenomena which can be translated into lineal motion, that is changing dimensions of a crystal under the action of a potential difference, magnetostriction effects on a body placed in a varying magnetic field, and other obvious possibilities.

Now—an entirely new kind of signal cable!

PHELPS DODGE SPIRAFIL COAXIAL CABLE

**with exceptional
Community Antenna System
characteristics**

PHELPS DODGE SPIRAFIL CABLE 3/8 70Ω

Spirafil coaxial signal cable was developed by Phelps Dodge as a companion cable to Styroflex coaxial cable. It is designed for specific use in applications where the precise Styroflex tape helix construction is not required.

This unique signal cable is made up of a solid copper center conductor, a solid polyethylene helix and an outer, tubular aluminum conductor.

Spirafil cable is particularly adaptable to use in community antenna systems. For this purpose, it has a number of outstanding features—*no radiation, low attenuation, excellent frequency response, uniform electrical properties over wide temperature variations and unlimited operating life.*

Spirafil cable is one of that select group

of cables assigned the highest life expectancy rating.

These special Spirafil characteristics, together with the economical cost of the cable, also make it suitable for certain applications in VHF, UHF and microwave communications circuits.

Spirafil cable is manufactured in 1000-foot, continuous lengths without joints. A Habirlene (polyethylene) jacket is supplied for protection against corrosion when the cable is to be installed in underground ducts, under water, or buried directly in the ground.

★ ★ ★

For special bulletin describing new Spirafil coaxial cable, write Dept. HF-1.

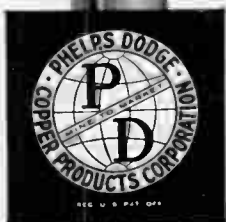

PHELPS DODGE COPPER PRODUCTS **CORPORATION**

40 WALL STREET, NEW YORK 5, N. Y.

PROFESSIONAL ENGINEERING CARDS

ALFRED W. BARBER LABORATORIES

Specializing in the Communications Field and
in Laboratory Equipment
Offices, Laboratory and Model Shop at:
32-44 Francis Lewis Blvd., Flushing, L.I., N.Y.
Telephone: Independence 3-3306

Edward J. Content, P.E. and Staff INTERNATIONAL RADIO CONSULTANTS

Pan American Radio Tangier Int'l Zone
Bldg., 16 Rue Delacroix Morocco
Specialized in the design, construction,
foreign, Electronic, projects, and advising
governments at Int'l Telecommunications
Union.

CROSBY LABORATORIES, INC.

MURRAY G. CROSBY & STAFF
RADIO-ELECTRONIC RESEARCH
DEVELOPMENT & ENGINEERING
COMMUNICATIONS, FM & TV
ROBBINS LANE
HICKSVILLE, NEW YORK
HICKSVILLE 3-3191

TRANSISTOR ENGINEERING

S. Moskowitz D. D. Grieg N. J. Gottfried
Product Transistorization. Complete service in
consulting, research, development, and produc-
tion on transistor circuitry, products and in-
strumentation.
c/o Electronic Research Associates, Inc.
87 East Centre Street, Nutley, N.J.
NUTLEY 2-5410

ELK ELECTRONIC LABORATORIES, INC.

Jack Rosenbaum
Specializing in design and development of
Test Equipment for the communications,
radar and allied fields.
333 West 52nd St., New York 19, PL-7-0520

JAMES EVANS

Consulting Physicist
"Specializing in Information Theory"
150-23 Horace Harding Boulevard
Flushing, N.Y. INdependence 1-4804

FREDERICK RESEARCH CORPORATION

Carl L. Frederick, D.Sc., President
Bethesda 14, Maryland • OLiver 4-5897
Engineering Research and Development, Eval-
uation, Technical Writing and Publishing—Elec-
tronic and Electro-mechanical Systems, Test
Equipment, Radio Interference, Instrumentation,
Controls.

PAUL GODLEY CO.

Consulting Radio Engineers
P.O. Box J, Upper Montclair, N.J.
Offs & Lab.: Great Notch, N.J.
Phone: Montclair 3-3000
Established 1926

GOVERNMENT CONTRACT LIAISON AND CONSULTANTS

GORDON ASSOCIATES, INC.
Specializing in Signal Corps Electronic Require-
ments, Technical Manuals, Tabular List of
Parts, Drawings
L. Gordon, Pres. P. Treston, Ch. Engr.
167 Broad Street Telephone
Red Bank, New Jersey Red Bank 6-2743

HIGHLAND ENGINEERING CO.

William R. Spittal & Staff
Specialize in Design and Development of
Transformers, Chokes, etc.
for the
Electronic, Industrial and Allied Fields.
Westbury, L.I., N.Y. WESTbury 7-2933

HOGAN LABORATORIES, INC.

John V. L. Hogan, Pres.
APPLIED RESEARCH, DEVELOPMENT,
ENGINEERING
Est. 1929. Electronics, Optics, Mechanisms,
Facsimile Communication, Digital Computers,
Electro-sensitive recording media, Instrumenta-
tion.
155 Perry Street, New York 14 CHelsea 2-7855

INTERFERENCE TESTING AND RESEARCH LABORATORY, INC.

Rexford Daniels E. T. Buxton P. B. Wilson
150 Causeway Street, Boston 14, Mass.
Lafayette 3-7826
Specializing in the design and testing of
equipment to meet Military and FCC specifica-
tions for radio interference.

LEONARD R. KAHN

Consultant in Communications and Electronics
Single-Sideband and Frequency-Shift Systems
Diversity Reception - Modulation Theory
Television Systems
Elizabeth Bldg., 22 Pine St., Freeport, L.I., N.Y.
Freeport 9-8800

George W. Baker, Pres. KIP ELECTRONICS CORPORATION

Electron tube consulting and design.
Research and development and preparation of
prototype electron tubes.
29 Holly Place,
Stamford, Connecticut
Phone 48-5328

Harry W. Houck Martial A. Honnell John M. van Beuren

RESEARCH ENGINEERS
Specialists in the Design and
Development of Electronic Test Instruments
c/o MEASUREMENTS CORP.
BOONTON, N.J.

L. J. CASTRIOTA M. WIND S. W. ROSENTHAL P. G. MARIOTTI

Microwave Consultants
Radio Frequency and Microwave Components
Cable—Waveguide—Coax
Dielectric Evaluation
Telephone G.P.O. Box 844
BOulevard 3-2096 Brooklyn 1, N.Y.

Olympic Radio & Television, Inc.

Radio—Electronics
Consulting—Research—Development
Environmental Tests Performed
for the Industry
B. Parzen — E. Bradburd
Olympic Building, Long Island City 1, N.Y.
Stillwell 4-6961

Be sure your firm is
listed in the 1955
IRE DIRECTORY
Use questionnaire on
following pages

EVERT M. OSTLUND Consulting Radio Engineer

Radio—Microwave
Communication—Control
Systems and Equipment
Planning, Research, Development
ANDOVER, NEW JERSEY
Tel.: Lake Mohawk 8635

N. G. Parke S. J. O'Neil Parke Mathematical Laboratories, Inc.

Specialists in engineering analysis and
computation in the fields of electronics and
aeronautics.
Independence Court • Concord, Massachusetts
Telephone Concord 827

PENN-EAST ENGINEERING CORPORATION

(Formerly—Atlantic Electronics Corp.
of Port Washington, N.Y.)
Designers of Industrial Controls
Gerald L. Tawney, Robert R. Sparacino,
Warren M. James, Richard C. Tawney
P.O. Box 240, Telephone Kutztown 2675

PICKARD AND BURNS, INC.

Consulting Electronic Engineers
Analysis and Evaluation of Radio Systems
Research, Development, Design and Production
of Special Electronic Equipment and Antennas.
240 Highland Ave. Needham 94, Mass.

SIDNEY PICKLES

Consulting Radio Engineer
Antennas & Transmission Lines
Phone: Post Office Box 643
Monterey 5-3379 MONTEREY, CALIFORNIA

RADIO SONIC CORP. ENGINEERS—QUALITY ASSURANCE

Testing, Processing
Electron Tubes, Semiconductors, Models, Produc-
tion Test Equipment, Antennas, Analyzers, Power
Supplies, Ultrasonics, Advanced Development
G. EMERSON PRAY, PRESIDENT
421 W. 54th St., New York 19, N.Y. PLaza 7-2798

Paul Rosenberg Associates

Consulting Physicists
100 STEVENS AVE. • MOUNT VERNON, NEW YORK
CABLE: PHYSICIST MOUNT VERNON 7-8040

M. D. Ercolino and Associates ANTENNA CONSULTANTS

Research and Development
Communication Arrays
Commercial and Amateur
FM and TV
c/o TELREX, INC. ASBURY PARK, N.J.
Phone Prospect 5-7252

WHEELER LABORATORIES, INC.

Radio and Electronics
Consulting — Research — Development
R-F Circuits — Lines — Antennas
Microwave Components—Test Equipment
Harold A. Wheeler and Engineering Staff
Great Neck, N.Y. HUNter 2-7876

IRE DIRECTORY QUESTIONNAIRE

Send to: Industry Research Div., Institute of Radio Engineers
1475 Broadway, 22nd Floor, New York 36, N.Y.

Date

Firm Name:

Phone No.

Address: City Zone State

Name of: Chief Engineer

Advertising Manager

3-55 Purchasing Agent

Method to be used by firms to indicate products manufactured or services rendered. Please read the entire questionnaire. Products are grouped beneath basic headings to facilitate location.

Do not check products that you do not manufacture for sale to the industry. Components manufactured for incorpora-

tion in your own end products (and not intended for sale) should not be listed, as this will only result in annoyance to you and the firms who make inquiries concerning product availability.

If, after a thorough examination of this form, you do not find a listing for your products, a short description and litera-

ture or catalogs that you have should be attached and returned to us.

After checking off the products, please fill in full data on your firm name and address, and mail the entire form to: Frank MacAloon, Industry Research Div., Institute of Radio Engineers, 1475 Broadway, New York 36, N.Y.

Industry Research Division Information Service

1. Communications

Audio—Broadcast Microwave—Radar

01 Aircraft & Airport Equip.

- 05 Airborne receivers
- 10 Airborne transmitters
- 15 Airport receivers
- 20 Airport transmitters
- 25 GCA equipment, etc.
- 30 VOR equip., complete

02 Amateur Equipment.

- 05 Receiving equipment
- 10 Transmitters

03 Antennas & Accessories.

- 05 AM broadcast transmitting
- 10 All-wave receiving
- 15 Amateur antennas, accessories & rotators
- 20 Dummy
- 25 FM broadcast transmitting
- 30 Microwave
- 35 Mobile
- 40 Radar reflectors
- 45 Rotators
- 50 Supporting towers
- 55 TV broadcast transmitting
- 60 TV multiple systems
- 65 Tower lighting equipment
- 70 Tower erection & maintenance service

04 Broadcast Receivers.

- 05 AM broadcast
- 10 AM shortwave
- 15 FM broadcast
- 20 TV broadcast — B & W
- 25 TV broadcast — Color
- 30 TV closed circuit

05 Broadcast Transmitters.

- 05 AM broadcast
- 10 FM broadcast
- 15 Relay broadcast & STL equip.
- 20 TV broadcast
- 25 TV closed circuit

06 Carrier Current Equipment

- 05 Complete terminal equip.
- 10 Installation & maintenance
- 15 Repeat & relay equip.

07 Emergency Communications Equipment.

- 05 Despatching equipment
- 10 Walkie-talkies

08 Facsimile Equipment.

- 05 Receiving equipment
- 10 Sensitized paper
- 15 Transmitting equipment

09 Industrial Sound Systems.

- 05 Complete systems
- 10 Installation & rental contractors

10 Marine Equipment.

- 05 Contract installers
- 10 Pleasure craft radiotelephones
- 15 Shipborne communications equip.

11 Mobile Equipment.

- 05 Central station receivers
- 10 Central station transmitters
- 15 Citizen radio
- 20 Mobile receivers
- 25 Mobile transmitters
- 30 Selective calling equipment

12 Monitor Equipment.

- 05 Frequency
- 10 Modulation
- 15 Remote control monitors
- 20 Video monitors

13 Radar-Microwave Receivers.

- 05 Microwave relay
- 10 Position indicators
- 15 Radar

14 Radar-Microwave Transmitters.

- 05 Microwave
- 10 Microwave relay
- 15 Radar

15 Recording Equipment.

- 05 Disk recorders
- 10 Embossing types of recorders
- 15 Magnetic tape recorders
- 20 Magnetic wire recorders

16 Studio Equipment.

- 05 Consoles & speech input equip.
- 10 TV cameras
- 15 TV camera control equipment
- 20 TV film projectors
- 25 TV studio lighting equipment
- 30 Turntables

17 Telegraph & Teleprinter Equipment.

- 05 Frequency shift converters
- 10 Frequency shift keys
- 15 Receivers
- 20 Transmitters

2. Components

18 Amplifiers.

- 05 DC amplifiers
- 10 Decade
- 15 Dynamic noise suppressors
- 20 Geophysical
- 25 Hearing Aid
- 30 High fidelity
- 35 IF amplifiers
- 40 Inter-coms
- 45 Magnetic
- 50 Microwave
- 55 Phono Pre-Amplifiers
- 60 Power
- 65 Public Address
- 70 RF amplifiers
- 75 Recording
- 80 Servo
- 85 Strain gage
- 88 TV amplifiers
- 90 TV boosters
- 92 Transistor
- 94 Ultrasonic
- 96 Wideband

19 Antenna Accessories.

- 05 Feeder line
- 10 Insulators
- 15 Lightning arrestors
- 20 Mounting hardware
- 25 Small towers

20 Attenuators.

- 05 Decade
- 10 Impedance matching
- 15 Microwave
- 20 Volume controlling

21 Batteries.

- 05 Dry batteries
- 10 Mercury batteries
- 15 Storage batteries—lead-acid
- 20 Storage batteries—nickel-alkali
- 25 Storage batteries—silver-zinc

22 Blowers & Cooling Fans.

- 05 Air wheels & housings
- 10 Complete blower assemblies
- 15 Fan blades

23 Cabinets, Consoles, & Enclosures.

- 05 Assembly enclosures
- 10 Metal cabinets
- 15 Metal relay rack panels
- 20 Moulded plastic cabinets
- 25 Wood cabinets

24 Capacitors: Fixed.

- 05 Ceramic
- 10 Decade
- 15 Electrolytic
- 20 Feed through
- 25 Fixed composition
- 30 Gas filled
- 35 Glass dielectric
- 40 High voltage
- 45 Metallized paper
- 50 Mica
- 55 Oil filled
- 60 Paper
- 65 Plastic insulated
- 70 Power factor
- 75 Precision air
- 80 Printed circuit
- 85 Pulse forming networks
- 90 Silvered mica
- 95 Tantalum
- 98 Vacuum

25 Capacitors: Variable.

- 05 Neutralizing
- 10 Precision variable
- 15 Temperature compensating
- 20 Trimmers, air
- 25 Trimmers, ceramic
- 30 Trimmers, glass
- 35 Trimmers, vacuum
- 40 Tuning

26 Chassis & Racks.

- 05 Aluminum chassis
- 10 Chassis slides
- 15 Racks, aging
- 20 Relay racks & cabinets
- 25 Steel chassis

27 Coils.

- 05 Audio frequency chokes
- 10 Deflection yokes
- 15 Filter
- 20 Flyback
- 25 Focusing coils
- 30 Power chokes
- 35 RF & IF chokes
- 40 Toroids
- 45 Tuning

28 Connectors.

- 05 AN & MIL standard types
- 10 Co-axial
- 15 Hermetically sealed
- 20 Microphone
- 25 Multiple circuit connectors
- 30 Power
- 35 Slip ring and commutating connectors
- 40 Sub-miniature
- 45 Waterproof

29 Converters.

- 05 AC to DC
- 10 DC to AC

- 15 Inverters
- 20 Rotary
- 25 Vibrators
- 30 Voltage

30 Cores.

- 05 Ceramic
- 10 Ferrites
- 15 Powdered metal
- 20 Tape wound
- 25 Toroids

31 Crystals & Accessories.

- 05 Crystal holders
- 10 Crystal ovens
- 15 Germanium
- 20 Oscillating quartz crystals
- 25 Piezo electric

32 Delay Lines.

- 05 Decade
- 10 Distributed constant
- 15 Distributed parameter
- 20 Lumped constant
- 25 Ultrasonic

33 Equalizers.

- 05 Dialogue equalizers
- 10 Line equalizers
- 15 Magnetic recording
- 20 Recording diameter equalizers
- 25 Sound effect equalizers

34 Filters.

- 05 Antenna
- 10 Band pass & band rejection
- 15 High pass
- 20 Loudspeaker dividing networks
- 25 Mechanical
- 30 Microwave
- 35 RF noise reduction
- 40 TV noise reduction
- 45 UHF & VHF
- 50 Variable band pass

35 Fuses & Fuse Holders.

- 05 Fuses
- 10 Fuse holders

36 Jacks, Jack Fields & Plugs.

- 05 Jacks
- 10 Jack fields
- 15 Patch cords
- 20 Plugs

37 Loudspeakers & Headphones.

- 05 Commercial grade loudspeakers
- 10 Headphones
- 15 High-frequency loudspeakers
- 20 Low-frequency loudspeakers
- 25 Wide-range, 2 & 3 way systems

38 Magnets.

- 05 Electro
- 10 Permanent

39 Meters (Indicating Instruments).

- 05 Ammeters
- 10 Elapsed time
- 15 Frequency indicating
- 20 Galvanometers
- 25 Micro-ammeters
- 30 Milli-ammeters
- 35 Voltmeters
- 40 Volume level, (DB & VU)
- 45 Wattmeters & watt hour meters

40 Microphones & Stands.

- 05 Carbon
- 10 Ceramic
- 15 Condenser
- 20 Crystal

- 25 Dynamic
- 30 Velocity
- 35 Microphone stands

41 Motors & Motor-Generators.

- 05 Blower & fan motors
- 10 Dynamotors
- 15 Frequency changers
- 20 Motor-generators
- 25 Phonograph
- 30 Servo
- 35 Synchronous motors
- 40 Timing motors

42 Phonographs, Pick-ups, Record Changers, etc.

- 05 Pick-ups—crystal
- 10 Pick-ups—dynamic
- 15 Pick-ups—magnetic
- 20 Pick-ups—reluctance
- 25 Playback arms
- 30 Record changers
- 35 Record players
- 40 Styli-diamond
- 45 Styli-metallic
- 50 Styli-sapphire
- 55 Tape phonographs & playback equipment

43 Pilot Lights & Assemblies.

- 05 Brackets, jewels, mounts, sockets
- 10 Incandescent lights
- 15 Neon lights

44 Power Supplies.

- 05 High voltage, (kilovolt)
- 10 Klystron
- 15 Low voltage
- 20 Medium voltage
- 25 Microwave
- 30 Primary power sources, fuel-engine driven
- 35 Transistor
- 40 Voltage regulated power sources

45 Printed Circuits.

- 05 Etched or screened prewired chassis
- 10 Printed electronic assemblies
- 15 Solder dipped prewired chassis

46 Recording Accessories.

- 05 Blank disks
- 10 Cutting heads
- 15 Cutting styli
- 20 Magnetic recording, playback & erase heads
- 25 Magnetic recording tape-acetate base
- 30 Magnetic recording tape-paper base
- 35 Magnetic recording wire
- 40 Stylus resharpening
- 45 Suction pumps & equipment
- 50 Tape splicing equipment

47 Rectifiers.

- 05 Copper oxide
- 10 Germanium
- 15 Selenium diodes
- 20 Selenium stacks
- 25 Silicon

48 Rectifiers, Vacuum Tube.

- 05 Grid controlled
- 10 Mercury vapor
- 15 Receiving
- 20 Transmitting

49 Relays.

- 05 Co-axial
- 10 D'Arsonval
- 15 Differential
- 20 Frequency selective

- 25 Hermetically sealed
- 30 Impulse
- 35 Keying
- 40 Latching
- 45 Mercury contact
- 50 Polarized
- 55 Power control & overload
- 60 Sensitive
- 65 Stepping
- 70 Sub-miniature
- 75 Telephone
- 80 Time delay

50 Resistors.

- 05 Carbon fixed, moulded
- 10 Carbon, variable
- 15 Deposited carbon
- 20 Potentiometers
- 25 Precision film
- 30 Printed circuit
- 35 Rheostats
- 40 Thermistors
- 45 Vacuum sealed
- 50 Very high megohm
- 55 Wirewound, fixed
- 60 Wirewound, variable
- 65 Wirewound, precision

51 Semi-Conductors.

- 05 Germanium diodes
- 10 Transistors, junction
- 15 Transistors, point contact

52 Sockets.

- 05 Capacitor, plug-in sockets
- 10 Crystal
- 15 Diode
- 20 Receiving tube
- 25 Transistor
- 30 Transmitting tube
- 35 UL approved industrial types

53 Switches & Contacts.

- 05 Band
- 10 Coaxial
- 15 Contacts
- 20 Foot
- 25 Key
- 30 Mercury
- 35 Momentary contact
- 40 Power
- 45 Precision snap-acting
- 50 Rotary
- 55 Slide
- 60 Solenoids
- 65 Spring-return
- 70 Tap
- 75 Thermally operated
- 80 Toggle & push button

54 Thermostats.

- 05 Bellows
- 10 Bimetal
- 15 Hermetically sealed

55 Transformers.

- 05 Audio
- 10 Current limiting
- 15 400 cps
- 20 Geophysical
- 25 Hermetically sealed
- 30 Horizontal output & flyback
- 35 Intermediate frequency
- 40 Isolation
- 45 Power components
- 50 Precision matched
- 55 Pulse
- 60 Radio Frequency
- 65 Saturable
- 70 TV deflection
- 75 TV impedance matching
- 80 Toroidal
- 85 Ultrasonic
- 90 Variable
- 95 Voltage regulating

Transistors, See: 51

56 Tuners.

- 05 AM tuners
- 10 FM tuners
- 15 Klystron
- 20 Microwave
- 25 TV tuners
- 30 UHF & VHF

57 Vacuum Tubes, Receiving.

- 05 Cathode-ray & TV picture
- 10 Miniature
- 15 Standard types, glass & metal
- 20 Sub-miniature

58 Vacuum Tubes, Special Purpose.

- 05 Electrometer tubes
- 10 Geiger-Mueller
- 15 Phototubes
- 20 Pirani tubes
- 25 Thyratrons
- 30 Voltage regulators & ballasts
- 35 X-Ray

59 Vacuum Tubes, Transmitting.

- 05 ATR & TR types
- 10 Air-cooled power tubes
- 15 Iconoscopes
- 20 Image orthicons
- 25 Klystrons
- 30 Magnetrons
- 35 Monoscope tubes
- 40 Traveling wave
- 45 Water-cooled power tubes

60 Vibration Controls.

- 05 Vibration & shock mounts
- 10 Isolation pads

61 Voltage Regulators.

- 05 Automatic
- 10 Manually operated
- 15 Varistors

62 Waveguides & Accessories.

- 05 Couplings
- 10 Flexible waveguides
- 15 Hybrid junctions
- 20 Rigid waveguides
- 25 Sampling lines, reflectors, etc.
- 30 Switches
- 35 Transmission lines

3. Controls—Instruments—Test Equipment

63 Audio Frequency Test Equipment.

- 05 Beat frequency oscillators
- 10 Distortion & noise analyzers
- 15 Intermodulation meters
- 20 Output power meters
- 25 RC oscillators
- 30 Spectrum analyzers
- 35 Square wave generators
- 40 Telegraph test
- 45 Voltmeters-audio frequency

64 Automatic Control Equip.

- 05 Burglar-alarm & protective systems
- 10 Combustion & smoke- nuisance controls
- 15 Electronic remote controls
- 20 Photo electric
- 25 Positioning equipment
- 30 Production control, counting & sorting equipment
- 35 Qualitative controls
- 40 Quantitative controls
- 45 Vacuum controls
- 50 Variable speed controls

65 Computers & Counters.

- 05 Analog to digital converters
- 10 Computers, analog
- 15 Computers, digital
- 20 Counters, continuous
- 25 Counters, pre-set
- 30 Data reduction equipment
- 35 Drums, magnetic
- 40 Electronic calculators

66 General Laboratory Equipment & Supplies.

- 05 Atmospheric test chambers
- 10 Chemicals
- 15 General laboratory equipment
- 20 RF shielding materials
- 25 Shielded enclosures

67 General Test Equipment.

- 05 Accelerometers
- 10 Bridges, capacitance
- 15 Bridges, impedance
- 20 Bridges, inductance
- 25 Bridges, resistance
- 30 Crystal testers
- 35 Decades, capacitance
- 40 Decades, inductance
- 45 Decades, resistance
- 50 Diode testers
- 55 Insulation testers
- 60 Multimeters
- 65 Null indicators
- 70 Ohm & megohm meters
- 72 Pyrometers
- 74 Spectrometers
- 76 Strain gauges
- 78 Stroboscopes
- 80 Transistor testers
- 82 Ultrasonic generators
- 84 Ultrasonic testers
- 86 Vacuum tube testers
- 88 Vacuum tube voltmeters
- 90 Vibration analyzers

68 Geophysical Apparatus.

- 05 Complete exploration equipment
- 10 Control equipment
- 15 Microphones
- 20 Recording galvanometers

69 Graphic Recorders.

- 05 Charts & papers
- 10 Ink writing
- 15 Inkless types
- 20 Fixed speed types
- 25 Variable speed types

70 Induction Heating Equip.

- 05 Brazing, soldering & welding
- 10 Di-electric heating
- 15 Induction heating

71 Laboratory Standards of Frequency & Time.

- 05 Elapsed time measuring equip.
- 10 Primary standards of frequency
- 15 Primary standards of time
- 20 Secondary standards of frequency
- 25 Secondary standards of time
- 30 Tuning forks

72 Medical Equipment.

- 05 Cardiographs
- 10 Diathermy
- 15 Electronic cauterizing
- 20 Electro-encephalographs
- 25 Stimulators

73 Microwave & Radar Test Equipment.

- 05 Bolometers
- 10 Frequency meters
- 15 Marker generators
- 20 Oscillators
- 25 Pulse generators
- 30 Slotted lines & measuring accessories

- 35 SWR meters
- 40 Time delay generators
- 45 Wavemeters

74 Nuclear Equipment.

- 05 Dosimeters
- 10 Ionization chambers
- 15 Pulse count integrators
- 20 Radiation detectors
- 25 Scalers
- 30 Survey meters

75 Oscilloscopes—Cathode-Ray.

- 05 General purpose
- 10 Oscilloscope cameras
- 15 Oscillosynchrosopes
- 20 Recording oscillographs
- 25 Special UHF & pulse analysis equipment

76 Radio Frequency Test Equipment.

- 05 Field strength meters
- 10 Impedance & admittance meters
- 15 Marker generators
- 20 Multi-vibrators
- 25 Oscillators
- 30 Phase meters
- 35 "Q" meters
- 40 RF power output meters
- 45 Signal generators, AM
- 50 Signal generators, FM
- 55 Sweep generators

77 Servo-Mechanisms.

- 05 Controls
- 10 Gears, gear-trains, etc.
- 15 Servo amplifiers
- 20 Servo motors & generators

78 Telemetry Equipment.

- 05 Data recorders
- 10 Data storage mechanisms
- 15 FM/FM modulators

79 Television Test Equipment.

- 05 Synchronizing generators
- 10 TV calibrators
- 15 TV marker generators
- 20 TV signal generators
- 25 TV sweep generators

4. Materials & Services

80 Cable & Wire.

- 05 Aluminum
- 10 Co-axial cables
- 15 Copper, bare
- 20 Enamel coated
- 25 Low-loss, high-frequency types
- 30 Magnet wire
- 35 Precious & rare metals wire
- 40 Pre-formed wire harnesses
- 45 Rubber insulated
- 50 Shielded
- 55 Synthetic insulated
- 60 Wire mesh
- 65 Woven wire braid

81 Ceramics.

- 05 Coil forms
- 10 Custom fabrication
- 15 Insulators
- 20 Proprietary forms

82 Consulting Engineers.

- 05 Acoustical
- 10 Electrical
- 15 Electronic
- 20 Mechanical
- 25 Radio
- 30 Television

83 Core Materials.

- 05 Laminations
- 10 Metallic powders

84 Fabricators & Services.

- 05 Contract fabrication & assembly
- 10 Electro-plating
- 15 Embedment
- 20 Fungus & moisture proofing
- 25 Hardening & heat-treating
- 30 Hermetic sealing service
- 35 Metal stamping & spinning
- 40 Packaging
- 45 Plastic fabricators
- 50 Plastic molders

85 Gasses & Vapors.

- 05 Acetylene
- 10 Argon
- 15 Hydrogen
- 20 Krypton
- 25 Neon
- 30 Oxygen
- 35 Xenon

86 Hardware & Findings.

- 03 Adhesive labels & tapes
- 06 Brushes, motor
- 09 Bushings & bearings
- 12 Cable clips
- 15 Cans
- 18 Dials & dial assemblies
- 21 Fasteners
- 24 Flexible shafts
- 27 Gaskets
- 30 Grilles
- 33 Grommets
- 36 Lacing cord & tape
- 39 Machine screw products
- 42 Markers & tags
- 45 Nameplates
- 48 Paper preforms, for coil foundations
- 51 Retaining rings
- 54 Rivets
- 57 Screws, nuts & washers
- 60 Springs
- 63 Strain reliefs
- 66 Terminal boards & straps
- 69 Terminals, rivet or stud
- 72 Terminals, wire end
- 75 Test clips

87 Hermetic Seals.

- 05 Ceramic to metal seals
- 10 Complete headers
- 15 Glass to metal seals

88 Insulating Materials.

- 05 Cambric sheeting
- 10 Cambric tubing
- 15 Ceramic
- 20 Cotton tapes
- 25 Fiberglas tapes
- 30 Fiberglas tubing
- 35 Glass bonded mica
- 38 Paper
- 40 Plastic
- 45 RF shielding materials
- 50 Rubber
- 55 Synthetics

89 Laboratories & Custom Builders.

- 05 Individual item builders
- 10 Pilot run plants
- 15 Research & development labs.
- 20 Testing & certifying organizations

90 Lacquers, Paints, Compounds & Waxes.

- 05 Coil dope
- 10 Conducting paint
- 15 Finishing & protecting lacquer
- 20 Fungus preventatives

- 25 Moisture proofing
- 28 Phosphors
- 30 Sealing & potting compounds
- 35 Silicones

91 Machinery & Tools.

- 05 Aluminizers
- 10 Coil winding machines
- 15 Dehydrators
- 20 General production machinery & tools
- 25 Marking & engraving machines
- 30 Soldering irons & guns
- 35 Vacuum tube machinery
- 40 Vacuum pumps
- 45 Vibration exciters
- 50 Welders & brazers

92 Metals.

- 05 Alloys
- 10 Copper
- 15 Ferrous
- 20 Non-ferrous, excluding copper
- 25 Powdered
- 30 Precious & rare

93 Moulded Products.

- 05 Insulators
- 10 Knobs & parts
- 15 Proprietary mouldings

94 Plastics.

- 05 Extrusions
- 10 Raw powders
- 15 Rods
- 20 Sheets
- 25 Tubes

95 Solder.

- 05 Acid core
- 10 Fluxes
- 15 Plain
- 20 Precious metal
- 25 Pre-forms
- 30 Rosin core

96 Vacuum Tube Parts.

- 05 Anodes
- 10 Envelopes, glass
- 15 Envelopes, metal
- 20 Getters
- 25 Grids & grid wire
- 30 Guns & gun parts
- 32 Lead wires
- 35 Phosphors
- 40 Pins & Prongs
- 42 Shaft locks
- 45 Spacers & insulators
- 50 Stampings
- 55 Tube caps
- 60 Tube clamps
- 65 Tube shields
- 70 Tubing-cathode

Education & Publishing

97 Education.

- 05 Technical instruction — home study
- 10 Technical instruction — resident

98 Publishing.

- 05 Book publishers
- 10 Data sheet & manual preparation
- 15 Magazines

Distributional Functions

99 Distribution.

- 05 Export & import
- 10 Jobbers & wholesalers
- 15 Manufacturers representatives
- 20 Sales & service
- 25 Surplus dealers



ACCURACY AT A GLANCE

WITH THE NEW E-I

FOUR-DIGIT

VOLTMETER



MODEL DV40A

ELECTRO INSTRUMENTS' Model DV40A four-digit voltmeter combines in one convenient package all requirements for automatically measuring voltage with utmost reliability and accuracy. A precision instrument designed and built to the exacting requirements of telemetry, computing, data reduction, automatic testing, plus many other instrumentation and automation applications.

Only Electro Instruments offers all these outstanding advantages:

- Direct-reading, four-digit, in-line display of DC voltages from ± 0.001 to ± 999.9 .
- Accuracy within \pm one digit. Absolute calibration insured by nine internally-mounted standard cells.
- $\frac{3}{4}$ second average reading time.
- Completely automatic polarity indication and range switching.
- Machine-recording output for automatic operation of printers, electric typewriters, IBM punch equipment.
- Rugged unitized construction with highest quality components.

- Dependability attested by aircraft, industrial and government laboratories.
- Calibration, switching circuits and bridge resistors mounted in a sealed compartment for thermal isolation and dust prevention.

SPECIFICATIONS: Input impedance: 11 megohms. Calibration: 9 internally-mounted certified standard cells. Size: 7 x 19 x 16 in. (rack and panel mounting). Color: instrument grey. Weight: 35 pounds. Power: 115v., 60 cps ac, 50 w.

Precision

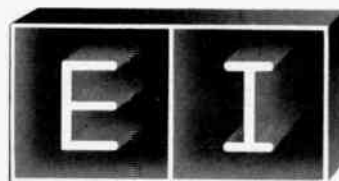

Instrumentation

ELECTRO INSTRUMENTS, INC.
3794 ROSECRANS ST. • SAN DIEGO 10, CALIF.

For complete information and specifications, write Dept. 20 for the new Bulletin 30.

ENGINEERING REPRESENTATIVES THROUGHOUT THE UNITED STATES AND CANADA

Electro Instruments' family of direct-reading, in-line instruments include 15 standard digital voltmeters for precision laboratory and production measurements, as well as digital

read-outs that provide unambiguous numerical indication for a variety of instrumentation applications. Complete literature, optional specifications available upon request.



A compact wide range VTVM-Ohmmeter for modern electronic circuit checking in the laboratory, on the production line and for general service-maintenance. Features include Peak-to-Peak voltage ranges which afford a new high in P-P reading accuracy of pulsed wave-forms in color or monochrome TV and similar applications.

**7 DISTINCTLY SEPARATE FUNCTIONS
40 SELECTED, WIDE-SPREAD RANGES**

- ▶ **6 TRUE-ZERO-CENTER DC VOLT RANGES:**
Constant 26 2/3 Megs input resistance.
0 ±1.2 ±6 ±12 ±60 ±300 ±1200 volts.
- ▶ **5 ELECTRONIC OHMMETER RANGES:**
0-1000-10,000 ohms. 0-1-100-1000 Megs.
- ▶ **6 PLUS and 6 MINUS DC VOLT RANGES:**
(Left-Hand-Zero) constant 13 1/2 Megohms input.
0-1.2-6-12-60-300-1200V.
- ▶ **6 HIGH IMPEDANCE RMS AC VOLT RANGES:**
0-1.2-6-12-60-300-1200 volts
Input Characteristics: Up to 60V Range -
3 Megs., 90 mmfd; 300 V Range - 1 Meg.,
70 mmfd; 1200V Range - 4 Megs., 67 mmfd.
- ▶ **6 HIGH IMPEDANCE P-P AC VOLT RANGES:**
0-3.2-16-32-160-800-3200 volts
Input Characteristics: Up to 160V Range -
6 Megs., 90 mmfd; 300V Range - 1 Meg.,
70 mmfd; 3200V Range - 4 Megs., 67 mmfd.
- ▶ **5 SPECIAL HIGH FREQUENCY PROBE RANGES:**
0-1.2-6-12-60-300 volts RMS.
(Requires optional PRECISION RF-10AHF Probe).
Probe input capacity: approximately 5 mmfd.
- **ONE UNIVERSAL COAX. AC-DC VTVM PROBE**
serves all functions other than HF ranges.
- **PEAK-TO-PEAK "RE-SET" PUSH-BUTTON** for
rapid "zero" return of special electronically
damped test circuit.
- **EXTRA-LARGE 5/16" RUGGED PACE METER.**
200 μA sensitivity ±2% accuracy.
- **1% MULTIPLIERS and SHUNTS.**

MODEL 88: complete with detachable AC
line cord, internal ohmmeter battery,
coaxial VTVM Probe and operating manual.
Size: 5 1/2 x 7 x 3 1/8". \$69.75 net

ACCESSORIES FOR THE MODEL 88
RF-10A HF vacuum tube probe \$14.40 net
TV-8 60 Kilovolt safety probe 14.75 net
ST-1 Snap-on foldaway tilt-stand 1.00 net

PRECISION APPARATUS CO., INC.

70-31 84th Street, Glendale 27, L. I., N. Y.
Export: 458 Broadway, New York 13, U. S. A.
Canada: Atlas Radio Corp., Ltd., 560 King St. W., Toronto 2E

**INDEX AND
DISPLAY ADVERTISERS**

Meetings with Exhibits 6A
News-New Products 10A
IRE People 48A
Industrial Engineering Notes 52A
Professional Group Meetings 72A
Section Meetings 86A
Membership 94A
Positions Wanted by Armed Forces
Veterans 128A
Positions Open 138A

DISPLAY ADVERTISERS

Admiral Corporation (Empl.) 146A
Advance Electronics Co. 189A
Aerovox Corporation 90A
Air Marine Motors, Inc. 101A
Airborne Instruments Laboratory, Inc. 26A
Aircraft Radio Corporation 112A
Airtron, Inc. 62A
Allen-Bradley Company 56A
Allied Radio Corporation 190A
Altec Lansing Corp., Peerless Div. 167A
American Lava Corporation 67A
American Phenolic Corporation 48A
American Television & Radio Co. 174A
American Time Products, Inc. 58A
Ampex Corporation 123A
Andrew Corporation 93A
Arnold Engineering Co. 40A
Assembly Products, Inc. 62A
Automatic Mfg. Corp. 125A

Ballantine Laboratories, Inc. 86A
Barber Labs., Alfred W. 182A
Bell Telephone Laboratories 4A
Bendix Aviation Corp., Eclipse-Pioneer Div. 74A
Bendix Aviation Corp., Guided Missile Section
(Empl.) 145A
Bendix Aviation Corp., Pacific Div. (Empl.) 154A
Bendix Aviation Corp., Radio Comm. Div.
(Empl.) 131A
Bendix Aviation Corp., Scintilla Div. 28A
Berkeley Div., Beckman Instruments, Inc.
(Empl.) 156A
Biley Electric Company 111A
Bodnar Industries, Inc. 120A
Boeing Airplane Company (Empl.) 139A
Boesch Manufacturing Co., Inc. 164A
Boonton Radio Corporation 37A
Buckbee Mears Company 28A
Buggie, Inc., H. H. 165A
Burrughs Corporation 175A
Bussmann Mfg. Co. 117A

California Electronics & Transformer Corp. 162A
California Inst. of Techn., Jet Prop. Lab.
(Empl.) 128A
Cambridge Thermionic Corp. 91A
Canadair Limited (Empl.) 133A
Cannon Electric Company 69A
Capitol Radio Engineering Institute 153A
Chatham Electronics Corp. 61A
Chicago Standard Transformer Corp. 176A
Chicago Telephone Supply Corp. 109A
Clare & Company, C. P. 30A
Clevite-Brush Development Co. (Empl.) 159A
Clifton Precision Products Co., Inc. 105A
Cohn Corporation, Sigmund 64A

**CONTINUOUSLY
VARIABLE
TIME DELAY**

PASSIVE NETWORKS

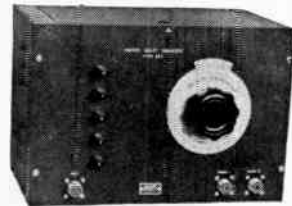

TYPE
2011
and
2012

- 5 × 10⁻¹⁰ Sec. Resolution Time.
- Passing signals of any wave form.
- No time jitter.

SPECIFICATIONS

TIME DELAY: Continuously variable 0 to 11
microseconds for Type 2011 and 0 to 16 micro-
seconds for Type 2012.

RISE TIME: Less than 10% of the time delay
at any point.

INPUT IMPEDANCE: 20 uuf shunted with 1
megohm direct.

ACCURACY OF TIME DELAY: Max. error
less than 10⁻⁶ second or 0.1% of the time
delay at any point with correction curve,
otherwise 1% of the time delay at any point.

PRICE: Type 2011, \$245; Type 2012, \$265.

**MINIATURE
CONTINUOUSLY
VARIABLE
TIME DELAY LINES**



TYPE 506

- 5 × 10⁻¹⁰ Sec. Resol. Time.
- Over 15 MC Bandwidth.
- For Phase Shift in Color TV.

10 Different models available with time
delays of 0 to 0.75 μs and impedance
of 180 ohms to 580 ohms. Price \$59.00
each.

STEP VARIABLE DELAY LINES:
Equal input and output impedance
available with max. delay of 2.2 μs to
10 μs.

Fixed delay lines and Tapped delay
lines to meet Jan. Speci-
fications.

WRITE FOR DATA!



**ADVANCE
ELECTRONICS CO., INC.**
451 HIGHLAND AVE. • PASSAIC, N.J.

DISPLAY ADVERTISERS

Collins Radio Co.	27A
Color Television, Inc.	124A
Communication Accessories Co.	89A
Communication Measurements Lab., Inc.	166A
Communication Products Co.	78A
Communications Equipment Co.	187A
Content, Edward J.	182A
Convair, Div. Gen. Dynamics Corp. (Empl.)	128A, 155A
Cook Laboratories	167A
Cornell Aeronautical Lab., Inc. (Empl.)	132A
Cornell-Dubilier Electric Co.	Cover 3
Cosmic Condenser Co.	162A
Crosby Laboratories, Inc.	182A
Crucible Steel Co. of America	21A

Dale Products, Inc.	114A
Daven Company	11A
Delco Radio Div., General Motors Corp. (Empl.)	132A
Dominion Electrohome Industries, Ltd. (Empl.)	140A
DuMont Laboratories, Allen B. (Empl.)	147A
DuMont Laboratories, Allen B.	65A

E S C Corporation	94A
Eby Co., Hugh H.	108A
Eitel-McCullough, Inc.	46A
Electrical Industries	113A
Electrical & Physical Instr. Corp.	66A
Electro-Impulse Laboratory	168A
Electro Instruments	188A
Electro Motive Mfg. Co., Inc.	57A
Electro-Pulse, Inc.	171A
Electronic Associates, Inc.	98A
Electronic Research Associates, Inc.	182A
Electronics Corp. of America (Empl.)	160A
Elk Electronic Labs., Inc.	182A
Emerson Electric Mfg. Co. (Empl.)	138A
Engineering Associates	120A
Engineering Research Associates (Empl.)	130A, 155A
Erie Resistor Corp.	92A
Evans, James	182A

Fairchild Camera & Instr. Corp.	169A
Farnsworth Electronics Co.	149A
Fast & Co., John E.	82A
Federal Telephone & Radio Co.	173A
Ford Instrument Co.	84A
Frederick & Assoc., Carl L.	70A
Frederick Research Corp.	182A
Freed Transformer Co., Inc.	75A
Frequency Standards	42A
Furst Electronics, Inc.	116A

Garde Manufacturing Co.	44A
General Aniline & Film Corp.	81A
General Electric Co. (Capacitor Sales)	47A
General Electric Co. (Empl.)	151A
General Electric Co., Tube Div.	32A & 33A
General Precision Lab., Inc. (Empl.)	148A
General Radio Co.	Cover 4
Godley Company, Paul	182A
Gordon Associates	182A
Guilford Personnel Service	160A
Gulton Industries, Inc.	97A

Hallcrafters Co. (Empl.)	157A
Heath Company	164A
Helipot Corp.	5A
Hepner Mfg. Co.	118A
Hewlett-Packard Company	8A & 9A, 24A & 25A
Highland Engineering Co.	182A
Hill Electronic Eng. & Mfg. Co.	20A
Hoffman Laboratories, Inc. (Empl.)	134A
Hogan Laboratories, Inc.	182A
Hopkins Engineering Co.	100A
Huggins Laboratories	104A
Hughes Aircraft Co.	83A
Hughes Research & Dev. Labs. (Empl.)	148A, 152A, 161A
Hycor Co., Inc.	168A
Hydro-Aire, Inc.	73A

THE LAST WORD IN AIRBORNE TELEMETRY

Universal Mounting Assembly

for simplified system planning and installation

The UNERAC (Universal Electronic Regulator, Amplifier and Calibrator) is a self-contained junction box for all elements of the transmitter system. It supplies or distributes all power, signal, calibration and transducer instrumentation voltages. Provides for transmitter deviation control, stepping relay circuits for 3 or 5 point calibration, and manual calibration.

The Universal Mount Section has mounting facilities for three RREP-type plug-in oscillators, plus necessary distribution and supply circuitry. Each building block section is constructed so that power is fed to the entire assembly, each section taking only that power required for its own oscillators and transducers.

Write for Technical Bulletin.

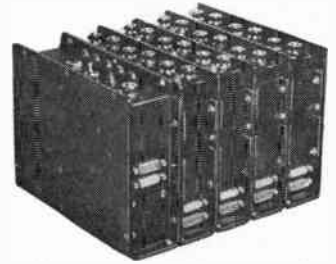

UNIVERSAL MOUNTING ASSEMBLY



TYPE 1401A UNERAC

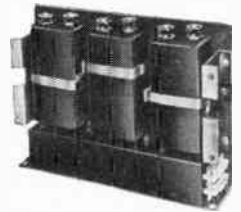

TYPE 1402A UNIVERSAL MOUNT



RAYMOND ROSEN ENGINEERING PRODUCTS, INC.

32nd & Walnut Streets • Philadelphia 4, Penna.
18166 Ventura Boulevard • Sherman Oaks, California

ALLIED

world's largest distributor of

ELECTRON TUBES FOR INDUSTRY

IMMEDIATE DELIVERY FROM STOCK

ALLIED stocks for quick shipment the world's largest distributor inventory of special-purpose electron tubes. We specialize in supplying the needs of industrial, broadcast, governmental and other users. To save time, effort and money—phone, wire or write to ALLIED for fast expert shipment.

Refer to your ALLIED Catalog for all electronic supplies. Write today for a FREE copy of the complete 308-page 1955 ALLIED Catalog.



Everything in Electronics from One Dependable Source

ALLIED RADIO

100 N. Western Ave.
Dept. 35-E-5, Chicago 80, Ill.

DISPLAY ADVERTISERS

Industrial Research Labs. (Empl.)142A
 Institute of Radio Engineers
38A, 39A, 106A & 107A, 183A-186A
 Interference Testing & Research Lab., Inc. ...182A
 International Business Machines Corp.137A
 International Electronic Research Corp.64A

Johns Hopkins Univ., Applied Physics Lab.
 (Empl.)157A
 Johns Hopkins Univ., Radiation Lab. (Empl.) 151A
 Jones Div., Howard B., Cinch Mfg. Corp.114A

Kahle Engineering Co.110A
 Kahn, Leonard R.182A
 Kay Electric Co.7A
 Kearfott Company, Inc.72A
 Kessler Co., Frank168A
 Keystone Products Co.103A
 Kip Electronics Corp.182A
 Klipsch & Associates110A
 Kollsman Instrument Corp.59A
 Kollsman Instrument Corp. (Empl.)140A

Laboratory for Electronics, Inc.50A & 51A
 Labscope, Inc.68A
 Lapp Insulator Co., Inc.180A
 Librascope, Inc.82A
 Link Aviation, Inc. (Empl.)144A
 Little Falls Alloys, Inc.168A
 Lockheed Aircraft Corp. (Empl.)129A, 141A

Magnavox Research Labs. (Empl.)152A
 Magnetics, Inc.29A
 Maigne Co., O. J.162A
 Mallory & Co., Inc., P. R.31A, 121A
 Marion Electrical Instrument Co.71A
 Martin Co., Glenn L. (Empl.)156A
 McColpin-Christie Corp.68A
 McCoy Electronics Co.70A
 Measurements Corp.104A, 182A
 Melpar, Inc. (Empl.)151A
 Microdot Div., Felts Corp.76A
 Microwave Consultants182A
 Midland Manufacturing Co., Inc.170A
 Midwest Research Institute (Empl.)144A
 Millen Mfg. Co., Inc., James100A
 Model Engineering & Mfg. Co., Inc.63A
 Moseley Co., F. L.163A
 Mueller Electric Co.60A
 Mycalex Corp. of America88A

N. R. K. Mfg. & Eng. Co.191A
 National Cash Register Co. (Empl.)159A
 New Jersey Electronics Corp.95A
 North Electric Mfg. Co.78A

Offner Electronics, Inc.2A
 Ohmite Mfg. Co.41A
 Olympic Radio & Television, Inc.182A
 Ordnance Research Laboratory, Pa. State
 Univ.159A
 Oster Mfg. Co., John36A
 Ostlund, Evert M.182A

Pacific Semiconductors, Inc.13A
 Panoramic Radio Products, Inc.162A
 Paramount Paper Tube Co.100A
 Park Nameplate Co.66A
 Parke Mathematical Labs, Inc.182A
 Penn-East Engineering Corp.182A
 Perkin Engineering Corp.6A
 Phelps Dodge Copper Products Corp.181A
 Pickard & Burns, Inc.182A
 Pickles, Sidney182A
 Polarad Electronics Corp.14A & 15A, 54A, 55A
 Polytechnic Research & Dev. Co., Inc.119A
 Polytechnic Research & Dev. Co., Inc. (Empl.) 136A
 Potter Instrument Co., Inc.178A
 Precision Apparatus Co., Inc.189A
 Precision Paper Tube Co.122A
 Pyramid Electric Company53A

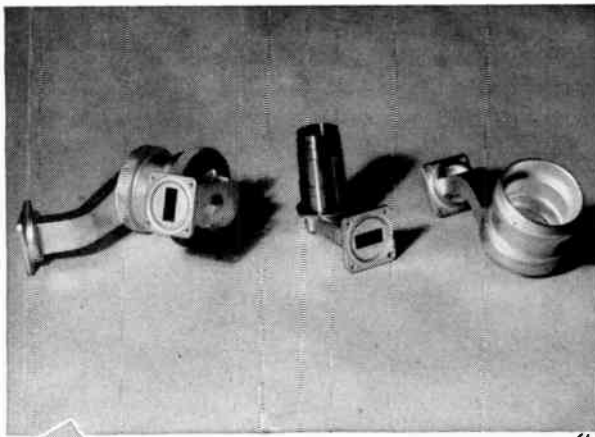

N.R.K. MFG. & ENGINEERING CO.

4601 W. Addison St., Chicago 41, Ill., Spring 7-2970

West Coast Representatives

TUBERGEN ASSOCIATES, 2232 W. 11th St., Los Angeles 6, Calif.

Microwave
 Assemblies,
 Radar Components,
 and Precision
 Instruments . . .
 manufactured and
 designed to your
 specifications.



NEW! VERSATILE!!

PUSH BUTTON SWITCH with Features Never Before Available

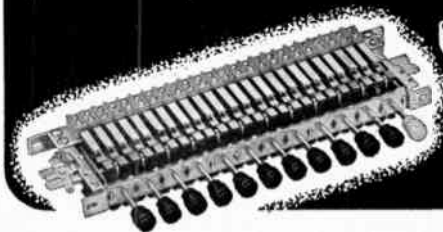

SWITCHCRAFT
 INC.
"MULTI-SWITCH"

**Easily Adapted
 to Individual Requirements**

NEW FEATURES

- Flexible tools—2 to 12 stations possible.
- Choice of mounting centers.
- Center to center between buttons— $\frac{5}{8}$ ".
- Plungers accept standard Push-On Buttons.
- Up to 4 stack switches can be operated by each button.
- Switches available with fine silver or welded cross bar Palladium contacts.

FUNCTIONS TO SUIT YOUR NEEDS

- Interlock. Actuating of a button automatically restores to normal, button previously actuated.
- Non-locking. Each button has momentary action.
- All-lock. Accumulative locking—all buttons restored to normal by actuating release button.
- All-lock and non-lock combination. Choice of functions.
- Interlock and non-lock combination. Various arrangements possible.

Be sure to check into the possibility of using the "Multi-Switch."
 Send details or write for Bulletin No. S-550.

SWITCHCRAFT
 INC.

1332 N. Halsted Street
 Chicago 22, Illinois

Canadian Representative
 Atlas Radio Corp., Ltd. 50 Wingold Avenue, Toronto, Canada

DISPLAY ADVERTISERS

Radiation, Inc.	152A
Radio Corp. of America (Empl.)	126A & 127A
Radio Corp. of America (Tube Dept.)	96A
Radio Engineering Products Limited	167A
Radio Materials Corp.	79A
Radio Receptor Co., Inc.	87A
Radio Sonic Corp.	182A
Ramo-Wooldridge Corp. (Empl.)	135A
Raytheon Mfg. Co. (Empl.)	154A, 161A
Raytheon Mfg. Co., Power Tube Div.	17A
Raytheon Mfg. Co., Special Purpose Tube Div.	18A & 19A, 23A
Remington Rand, Inc.	22A
Remington Rand, Inc., Eckert-Mauchly Div. (Empl.)	147A
Republic Aviation Corp.	150A
Robertshaw-Fulton Controls Co. (Empl.)	130A
Rosen Eng. Products, Inc., Raymond	190A
Rosenberg Associates, Paul	182A
Rutherford Electronics Co.	116A
Sanborn Company	77A
Sanders Associates, Inc. (Empl.)	157A
Sandia Corporation (Empl.)	158A
Sangamo Electric Co.	74A
Scientific Associates, Inc.	166A
Secor Metals Corp.	120A
Servomechanisms, Inc.	179A
Shallcross Mfg. Co.	76A
Shasta Div., Beckman Instruments, Inc.	52A
Sierra Electronics Corp.	44A
Sorensen & Company	177A
Speer Carbon Co.	45A
Sperry Gyroscope Co. (Empl.)	154A
Sprague Electric Company	1A, 3A
Stackpole Carbon Co.	35A
Stavid Engineering, Inc. (Empl.)	136A
Stoddart Aircraft Radio Co.	16A, 102A
Stupakoff Ceramic & Mfg. Co.	60A
Superior Tube Co.	115A
Swift Industries, Inc.	172A
Switchcraft, Inc.	191A
Sylvania Electric Products, Inc.	99A
Sylvania Electric Products, Inc. (Empl.)	134A, 143A, 149A
Synthane Corp.	12A
Syntronic Instruments, Inc.	174A
Technology Instrument Corp.	170A
Tektronix, Inc.	34A
Telrex, Inc.	182A
Texas Instruments, Inc.	43A
Tower Construction Co.	176A
Transradio, Ltd.	68A
Triad Transformer Corp.	54A
Triplett Electrical Instruments Co.	85A
Tru-Ohm Products Div., Model Eng.	63A
United States Gasket Co.	192A
United States Radium Corp.	164A
United Transformer Co.	Cover 2
University of Calif., Scripps Inst. of Oceanography	148A
Varflex Corporation	174A
Varian Associates	49A
Victoreen Instrument Co.	80A
Waterbury Pressed Metal Co.	124A
Waterman Products Co., Inc.	39A
Weckesser Co.	72A
Western Gold & Platinum Works	94A
Westinghouse Electric Corp. (Empl.)	128A, 142A
Wheeler Laboratories	172A, 182A
Wickes Engineering & Construction Co.	110A



“powder to part”

Quality Controlled Fluorocarbon Plastics

U.S.G. quality control extends through every operation in the fabrication and custom molding of parts from duPont TEFLON, Kellogg KEL-F and BAKELITE fluoroethene.

This quality control insures uniform electrical, chemical and physical characteristics of the highest quality. It also assures uniform density and dimensional stability permitting superior accuracy and dependability in the finished part.

Get the advantages of these fluorocarbon plastics at their best. Whether your requirements are for sheets, rods, tubing, tape, bars, cylinders, beading, electrical spaghetti, or parts extruded, molded or machined to your specifications . . . see U.S.G.

Write for Bulletin No. 300.

UNITED STATES GASKET COMPANY
Camden 1, New Jersey

USG

**FABRICATORS OF
FLUOROCARBONS & OTHER PLASTICS**

Representatives in principal cities throughout the world



New G-R Automatic Sweep

The G-R Automatic Sweep, consisting of the Type 1750-A Sweep Drive and the Type 1263-A Amplitude-Regulating Power Supply, represents a new approach to simplify measurements by automation.

The Type 1750-A Sweep Drive attaches to any knob, dial or shaft for automatic sweeping of oscillators, generators and other equipment. Sweep Arc, Speed, and Center Frequency are all continuously variable, even while the Sweep is in motion, and large percentage variations in frequency are possible. The Type 1263-A Amplitude Regulator insures constant amplitude as frequency is varied.

Ever changing oscilloscopic patterns produced with the aid of this equipment depict the effects of circuit changes with unequalled clarity. Laboratory measurements which normally take hours by point-by-point methods now may be accomplished in minutes.

In combination with G-R Unit Oscillators which cover the complete frequency range from 0.5 to 2000 Mc, a versatile and inexpensive system of Sweeping Signal Sources is available. The Sweep Drive can be coupled to either the vernier control for sweeping over moderate ranges or connected directly to the main shaft to take advantage of the extremely wide frequency ranges of G-R Unit Oscillators.



Unique  **Type 1750-A Sweep Drive . . . \$400**
**Adapts Existing Manually-operated
Equipment to Automatic Sweep Applications**

There are three independent electrical circuits: The Speed Control and limit switch circuit for the motor; the CRO deflection circuit; and the blanking circuit which eliminates the return trace and produces a base line for oscilloscope display.

- ★ **Wide Range of Speeds**—0.5 to 5 cps reciprocating motion
- ★ **Sweep Arc**—adjustable from 30° to 300°—permits large fractional variations in frequency
- ★ **Universal Coupling System**—four adjustable spider-like arms readily attach to knobs and dials, 1" to 4" diameter and shafts 1/4" and 3/8"—shaft height also adjustable
- ★ **Completely Adjustable Center-Position Control**
- ★ **Rated Maximum Torque**—24 oz.-in.
- ★ **Limit Switch**—disconnects and brakes motor if pre-set limits of shaft travel are accidentally exceeded.
- ★ **CRO Sweep Voltage Supplied**—mechanically tied to movement of swept shaft, permitting oscillator calibration to be transferred to CRO screen.

NEW Type 1263-A Amplitude Regulating Power Supply . . . \$250

To get the full benefit from a sweep-type presentation, amplitude variation with frequency must be minimized. The new Type 1263 Regulating Power Supply has been especially developed for automatic-sweep applications and will hold output voltage constant to within 2%, independent of frequency.

This instrument is for use with Oscillators whose outputs can be controlled by varying plate voltage applied. D-C potential developed by an auxiliary rectifier at the oscillator output is compared with a d-c reference potential within the regulator—the correction applied to the oscillator plate supply minimizes the difference.

- ★ **Plate Voltage Supplied**—0-250 volts at 25 ma as required by oscillator to maintain pre-set output level (with 105-125 or 210-250 line volts)
- ★ **Heater Voltage Supplied**—6 volts d-c at 0.5 amperes at 115/230 volt line
- ★ **R-F Output Regulation Control**—permits r-f level to be set from 0.2 to 2 volts
- ★ **Response Time**—plate current changed at 3 ma per millisecond or faster
- ★ **Output Meter**—built-in d-c VTVM calibrated in r-f output

WE SELL DIRECT—Prices are net, FOB Cambridge or West Concord, Mass.

GENERAL RADIO Company

275 Massachusetts Avenue, Cambridge 39, Massachusetts, U.S.A.

50 West Street NEW YORK 6
8055 13th St., Silver Spring, Md. WASHINGTON, D. C.
920 S. Michigan Avenue CHICAGO 5
1000 N. Seward Street LOS ANGELES 38

World Radio History



1915-1955

40 Years of Pioneering

in Electronics



THE POWER OF THE PRESS

Printed Circuitry is the development that's revolutionizing the electronics industry... and we at C-D are proud of the part we're playing in this "giant step" of progress.

Whatever your product...from television and tape recorders to hearing aids, radar or rockets... C-D's Printed Wiring Division offers printed circuitry designed specifically for you. Write for Brochure PRT 255 to Cornell-Dubilier Electric Corp., South Plainfield, New Jersey.

consistently dependable



CORNELL-DUBILIER CAPACITORS

Plants in South Plainfield, N. J.; New Bedford, Worcester and Cambridge, Mass.; Providence and Hope Valley, R. I.; Indianapolis, Ind.; Sanford and Fuquay Springs, N. C.; Venice, Calif.; Subsidiaries: The Radiart Corporation, Cleveland, O. and Cornell-Dubilier Electric International Corp.

THERE ARE MORE C-D CAPACITORS IN USE TODAY THAN ANY OTHER MAKE



