

SEPTEMBER · 1953

Proceedings



of the I · R · E

A Journal of Communications and Electronic Engineering

SLED TESTER

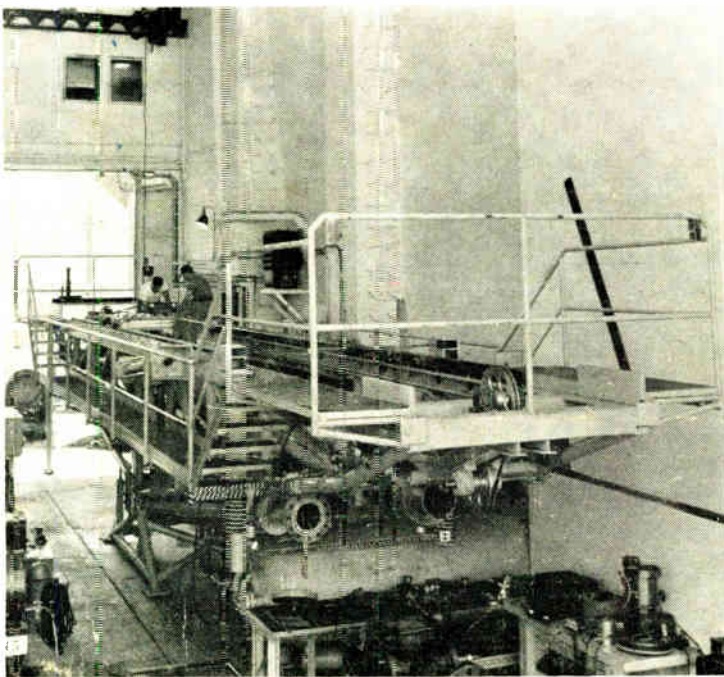

Northrop Aircraft, Inc.

This sled tester is one of several types of environmental testing devices used to determine the reliability of electronic components under simulated flight conditions.

Volume 41

Number 9

IN THIS ISSUE

Development of IRE Professional Groups
Common-Collector Transistor Amplifier
Piezoelectric Vibrator Measurements
Mismatch Errors in Microwave Power Measurements
Phase-Bistable Transistor Circuit
Junction Transistor Amplifiers
Graphical Spectrum Analyzer
RLC Lattice Networks
Signal Flow Graphs
Study of Nonlinear Devices
Direct-Viewing Memory Tube
Radiation Conductance of Slots
Metallic Delay Media
Radio-Ray Path in Ionosphere
Abstracts and References

TABLE OF CONTENTS INDICATED BY BLACK-AND-WHITE MARGIN, FOLLOWS PAGE 64A

The Institute of Radio Engineers

World Radio History



MINIATURE COMPONENTS FROM STOCK...

SUBOUNCER UNITS

FOR HEARING AIDS...VEST POCKET RADIOS...MIDGET DEVICES

UTC Sub-Ouncer units fulfill an essential requirement for miniaturized components having relatively high efficiency and wide frequency response. Through the use of special nickel iron core materials and winding methods, these miniature units have performance and dependability characteristics far superior to any other comparable items.

They are ideal for hearing aids, miniature radios, and other types of miniature electronic equipment. The coils employ automatic layer windings of double Formex wire... in a molded Nylon bobbin. All insulation is of cellulose acetate. Four inch color coded flexible leads are employed, securely anchored mechanically. No mounting facilities are provided, since this would preclude maximum flexibility in location. Units are vacuum impregnated and double (water proof) sealed. The curves below indicate the excellent frequency response available. Alternate curves are shown to indicate operating characteristics in various typical applications.

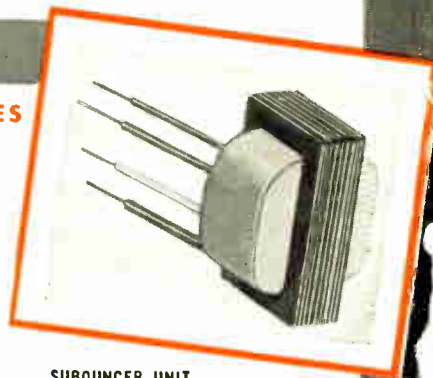

SUBOUNCER UNIT

Dimensions...9/16" x 5/8" x 7/8"
Weight......03 lb.

Type	Application	Level	Pri. Imp.	D.C. in Pri.	Sec. Imp.	Pri. Res.	Sec. Res.	List Price
*S0-1	Input	+ 4 V.U	200 50	0	250,000 62,500	16	2650	\$ 1.00
S0-2	Interstage/3:1	+ 4 V.U	10,000	0	90,000	225	1850	1.50
*S0-3	Plate to Line	+ 20 V.U.	10,000 25,000	3 mil. 1.5 mil.	200 500	1300	30	0.50
S0-4	Output	+ 20 V.U.	30,000	1.0 mil.	50	1800	4.3	0.50
S0-5	Reactor 50 HY at 1 mil D.C.							1.50
S0-6	Output	+ 20 V.U	100,000	.5 mil.	60	3250	3.8	1.50

*Impedance ratio is fixed, 1250:1 for S0-1, 1:50 for S0-3. Any impedance between the values shown may be employed.

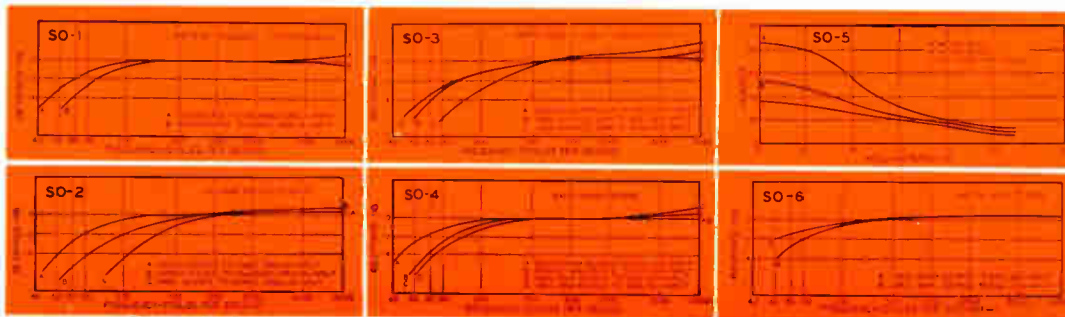

SUB-SUBOUNCER UNITS

FOR HEARING AIDS AND ULTRA-MINIATURE EQUIPMENT

UTC Sub-SubOuncer units have exceptionally high efficiency and frequency range in their ultra-miniature size. This has been effected through the use of specially selected Hiperm-Alloy core material and special winding methods. The constructional details are identical to those of the Sub-Ouncer units described above. The curves below show actual characteristics under typical conditions of application.

Type	Application	Level	Pri. Imp.	D.C. in Pri.	Sec. Imp.	Pri. Res.	Sec. Res.	List Price
*SS0-1	Input	+ 4 V.U.	200 50	0	250,000 62,500	13.5	3700	\$6.50
SS0-2	Interstage/3:1	+ 4 V.U.	10,000	0	90,000	750	3250	6.50
*SS0-3	Plate to Line	+ 20 V.U.	10,000 25,000	3 mil. 1.5 mil.	200 500	2600	35	6.50
SS0-4	Output	+ 20 V.U.	30,000	1.0 mil.	50	2875	4.6	6.50
SS0-5	Reactor 50 HY at 1 mil. D.C.							5.50
SS0-6	Output	+ 20 V.U.	100,000	.5 mil.	60	4700	3.3	6.50

*Impedance ratio is fixed, 1250:1 for SS0-1, 1:50 for SS0-3. Any impedance between the values shown may be employed.

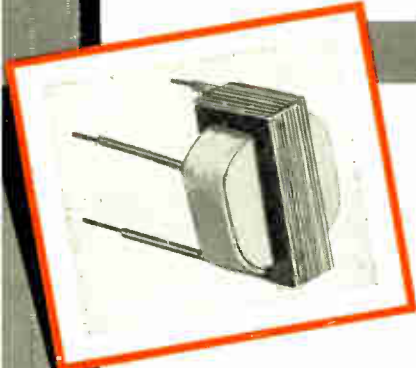
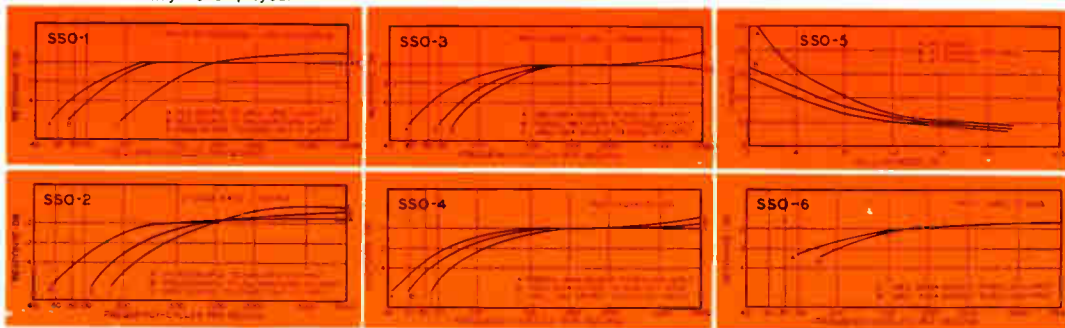

SUB-SUBOUNCER UNIT

Dimensions...7/16" x 3/4" x 5/8"
Weight......02 lb.

United Transformer Co.

150 VARICK STREET

NEW YORK 13, N. Y.

EXPORT DIVISION: 13 EAST 40th STREET, NEW YORK 16, N. Y.

CABLES: "ARLAB"

DURAMEG[®]

ACCURATE WIREWOUND RESISTORS

ABOVE AND BEYOND MIL-R-93A SPECIFICATIONS



DURAMEG wattage ratings are based on full rated dissipation at 105° ambient. These ratings are from 4 to 5 times the 85°C MIL ratings for the best of conventional resistors.

DURAMEG Resistors pioneered and proved new performance records for reliable, high-accuracy wire-wound resistors. They're molded under high pressure and temperature in mineral-filled, dense phenolic—impervious to moisture—for positive protection against electrolysis failure. They'll even withstand the salt water immersion cycling for characteristic A in the former specification JAN-R-93. Installations require no secondary insulation for mounting. Yes, they're also tough and resistant to high mechanical damage.

The long-term stability of Durameg Resistors offers a new scope of performance to equipment

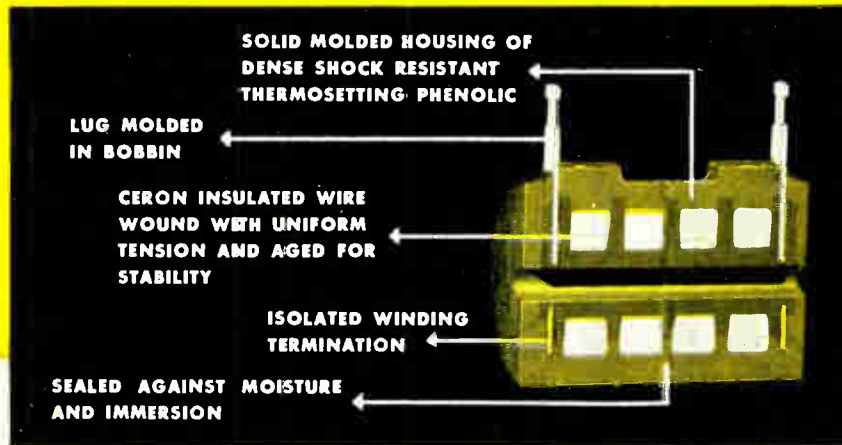

designers who must consider initial resistance tolerance of resistors as well as shifts in value with repeated thermal cycling and with age. With Durameg stability, you can design now for permanent peak performance!

Duramegs are the first accurate resistors that operate up to a hot spot temperature of 150°C as against the usual 105°C limit—made possible with Sprague's patented ceramic-insulated Ceron resistance wire. The unique combination of Ceron wire, Durameg molding technic and aging treatment, permits dissipation of full rated wattage at 105°C—the same temperature at which MIL ratings prescribe zero % dissipation!

DURAMEG Resistors are now available for commercial applications in dimensions identical to MIL styles. We will be glad to send you complete data upon request. * * * * *



WRITE, WIRE OR PHONE FOR
ENGINEERING BULLETIN 120

SPRAGUE ELECTRIC COMPANY
235 Marshall Street, North Adams, Mass.

SPRAGUE

PIONEERS IN ELECTRIC AND ELECTRONIC DEVELOPMENT

By the Push of a Button!

...in just 0.8 seconds your contact is made...

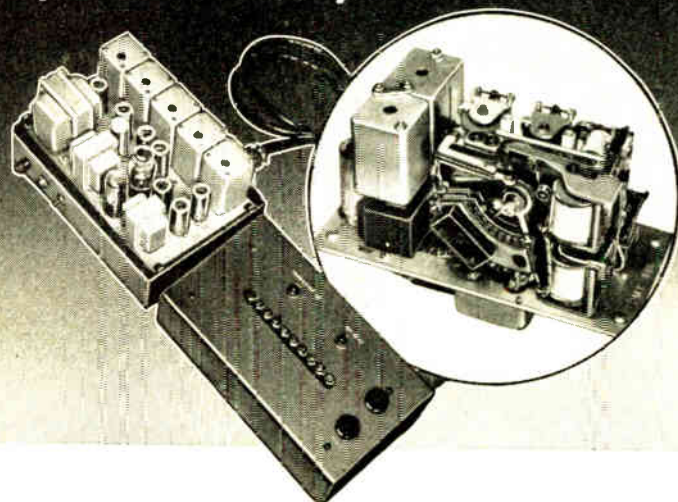

**...WHEN YOU ADD HAMMARLUND
Selective Calling Equipment
to Mobile 2-Way Radio Systems
...AND it means**

PRIVACY...QUIETNESS...CONVENIENCE

Privacy, speed, quietness and convenience become an accepted part of day-in-day-out operations of 2-way radio systems used to control large fleets of emergency service or commercial vehicles, or distant fixed stations, when Hammarlund Selective Calling Equipment is added.

By the push of a button the dispatcher selects within 0.8 seconds the vehicle, remote station, or group of receivers which he wants to contact. Only the *selected* operator or group of operators can receive the call.

If a radio operator is away from

his station when a call comes in, an indicator light will be turned on to show he was called while absent. For police and other emergency vehicles the horn or other alarm can be remotely activated to summon drivers whose work has taken them from the immediate vicinity of their cars.

Write today to the Hammarlund Manufacturing Company for descriptive information about this selective calling equipment that was engineered to produce new benefits for you from your 2-way radio system.

 **HAMMARLUND**

HAMMARLUND MANUFACTURING CO., INC.
460 WEST 34th ST. • NEW YORK 1, N. Y.

Meetings with Exhibits

● As a service both to Members and the industry, we will endeavor to record in this column each month those meetings of IRE, its sections and professional groups which include exhibits.

△

September 21, 22, 23, 24 & 25, 1953

Eighth National Instrument Conference and Exhibit. Hotel Sherman, Chicago, Ill.

Exhibits: Richard Rimbach, 921 Ridge Ave., Pittsburgh 12, Pa.

△

September 28, 29 & 30, 1953

National Electronic Conference Hotel Sherman, Chicago.

Exhibits: Orville Thompson, c/o De-Forrest's Training Inc., 2735 N. Ashland Ave., Chicago 14, Ill.

△

October 14, 15, 16 & 17

1953 Audio Fair Hotel New Yorker, New York City

Exhibits: Harry N. Reizes, 67 W. 44 St., New York, N.Y.

△

November 13, 14, 1953

Annual Electronics Conference Hotel President, Kansas City, Missouri

Exhibits: D. L. Welborn, 1400 Chestnut St., Kansas City 27, Missouri

△

February 4, 5 & 6, 1954

Sixth Southwestern I.R.E. Conference & Electronics Show, Tulsa, Oklahoma

△

March 22, 23, 24 & 25, 1954

Radio Engineering Show and I.R.E. National Convention, New York City. Exhibits at Kingsbridge Armory and headquarters hotel Waldorf Astoria. Direct connections by subway and by private express busses.

Exhibits Manager: Wm. C. Copp, 1475 Broadway, New York 36, N.Y.

△

Note on Professional Group Meetings: Some of the Professional Groups conduct meetings at which there are exhibits. Working committeemen on these groups are asked to send advance data to this column for publicity information. You may address these notices to the Advertising Department, and of course listings are free to IRE Professional Groups.



Every single one of 'em relies on

RAYTHEON



All the Portable Transmitter-Receiver Units, Military and Commercial, Employ RAYTHEON Filamentary Subminiature Tubes for

low battery power
constantly dependable performance
extreme durability for rough service
maximum compactness — flat for better packing
uniform quality and availability

Raytheon has unsurpassed engineering and production resources for the making of Subminiatures — has made millions of them over the past fifteen years.

Raytheon Filamentary Subminiatures will be found in all the major manufacturers' portable units, among them:

BENDIX
CLARK
GENERAL ELECTRIC
HALLICRAFTERS
INDUSTRIAL RADIO

LINK
MOTOROLA
RADIO SPECIALTIES
U. S. AIR FORCE AN/URC-4
U. S. ARMY AN/PRC-6,8,9 and 10

RAYTHEON

RAYTHEON MANUFACTURING COMPANY

Receiving Tube Division — for application information visit

Newton, Mass. Bigelow 4-7500 • Chicago, Ill. National 2-7776 • New York, N.Y. WHinead 3-4980 • Los Angeles, Calif. Richmond 7-3524

RAYTHEON MAKES ALL THESE:

RELIABLE SUBMINIATURE AND MINIATURE TUBES • SEMICONDUCTOR DIODES AND TRANSISTORS • NUCLEAR TUBES • MICROWAVE TUBES • RECEIVING AND PICTURE TUBES

PROCEEDINGS OF THE I.R.E. September, 1953, Vol. 41, No. 9. Published monthly by the Institute of Radio Engineers, Inc., at 1 East 79 Street, New York 21, N.Y. Price per copy: members of the Institute of Radio Engineers \$1.00; non-members \$2.25. Yearly subscription price: to members \$9.00; to non-members in United States, Canada and U.S. Possessions \$18.00; to non-members in foreign countries \$19.00. Entered as second class matter, October 26, 1927, at the post office at Menasha, Wisconsin, under the act of March 3, 1879. Acceptance for mailing at a special rate of postage is provided for in the act of February 28, 1925, embodied in Paragraph 4, Section 412, P. L. and R., authorized October 26, 1927.

Table of Contents will be found following page 64A

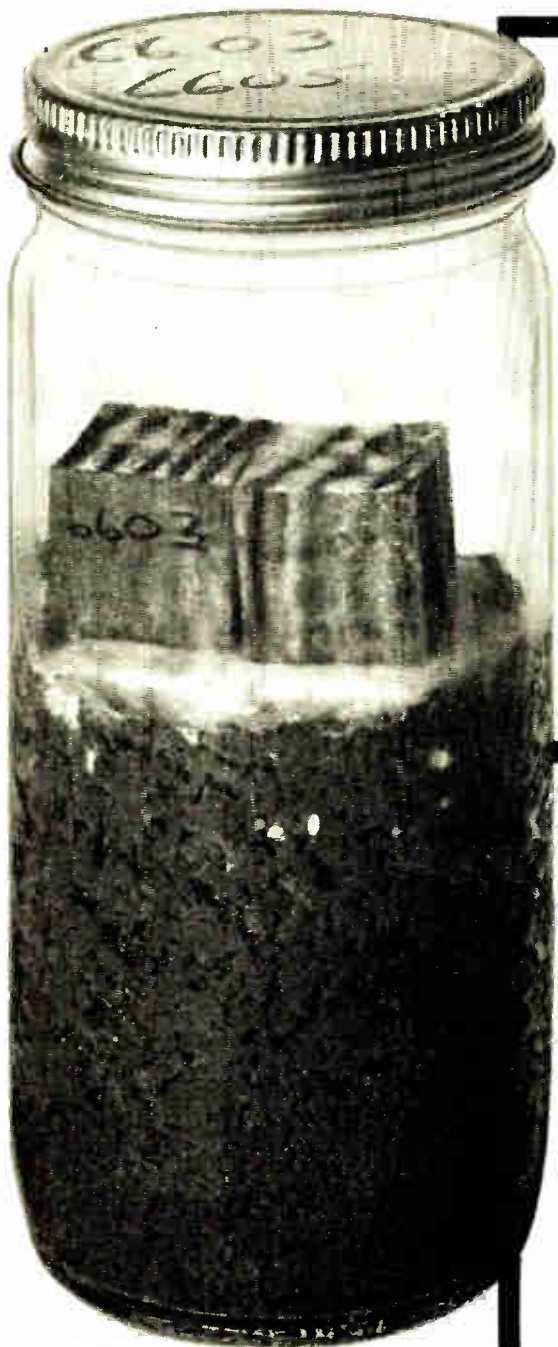

THIS BOTTLE TURNS SEVEN YEARS INTO SEVEN MONTHS

◀ *Test blocks of pole wood are fed to destructive fungi in bottles like this at Bell Laboratories. Wood rests on soil which controls moisture conditions and promotes fungus growth. Test speeds search for better preservatives.*

This year the Bell System is putting 800,000 new telephone poles into service. How effectively are they preserved against fungus attack and decay?

Once the only way to check a preservative was to plant treated wood specimens outdoors, then wait and see—for seven years at least. Now, with a new test devised in Bell Telephone Laboratories most of the answer can be obtained in seven months.

Cubes of wood are treated with preservatives, then enclosed in bottles with fungus of the most destructive kind, under temperature and humidity conditions that accelerate fungus activity. Success—or failure—of fungus attack on cubes soon reveals the best ways to preserve poles.

The new test has helped show how poles can be economically preserved for many years. It is another example of how Bell Telephone Laboratories works to keep down the cost of your telephone service.

A boring is taken from a pole section to see how far preservative has penetrated. For poles to last, it must penetrate deeply and be retained for a long time.



BELL TELEPHONE LABORATORIES

There are many opportunities for creative scientists and engineers at Bell Telephone Laboratories. For details see our advertisement on page 132A

THE

IDEAL SOURCE OF
D-C VOLTAGE FROM
A-C LINES

VARICELL

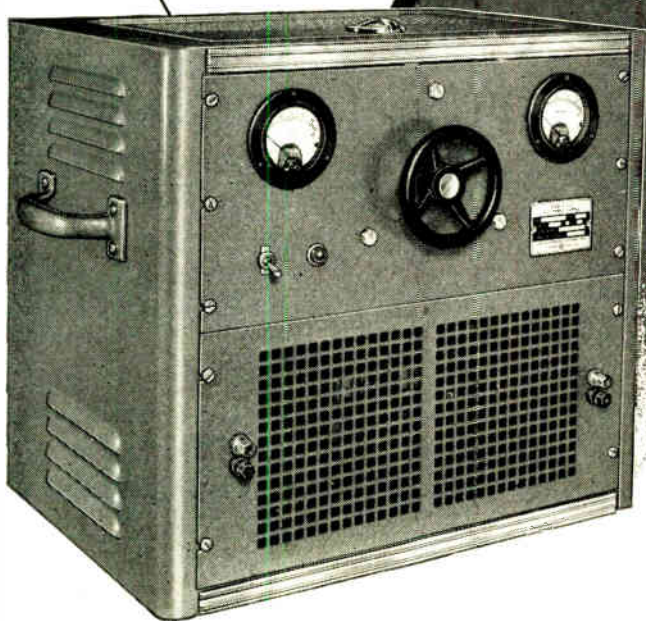

STABILIZED and REGULATED

Output voltage is unaffected by changes in the magnitude of a-c line voltage or output load current. Stabilization and regulation is ± 0.25 volts. R.M.S. ripple voltage is less than 0.1 volts.

ADJUSTABLE OUTPUT SETTINGS

Any desired output of d-c voltage from 0 to 30 volts is achieved by simply rotating the handwheel on the front panel.

CONVENIENT, EASY TO USE

The VARICELL is operated by simply plugging into any handy a-c voltage source supplying a nominal 115 volts, 60 cycles, 1 phase. The load is connected to either of the two pairs of SUPERIOR 5-WAY Binding Posts. The assembly is energized by an "On-Off" switch. A voltmeter visually identifies the output voltage at the binding posts. An ammeter shows the output load current.

ENGINEERS, LABORATORY TECHNICIANS, PRODUCTION TEST MEN and ALL OTHERS WORKING WITH LOW D-C VOLTAGES . . . get complete information now on the VARICELL. Use coupon below to get your copy of Bulletin V1051.



THE SUPERIOR ELECTRIC COMPANY
1109 Mae Avenue, Bristol, Connecticut

Please send my free copy of Bulletin V1051 describing the VARICELL.

THE SUPERIOR ELECTRIC CO.
BRISTOL, CONNECTICUT



NAME _____
POSITION _____
COMPANY _____
CO. ADDRESS _____
CITY _____ ZONE _____ STATE _____

marion
 advancement
 in instrument
 design

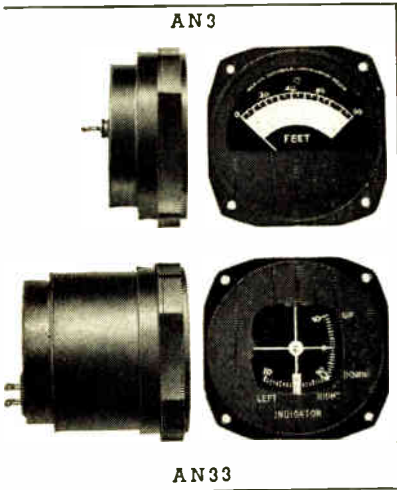
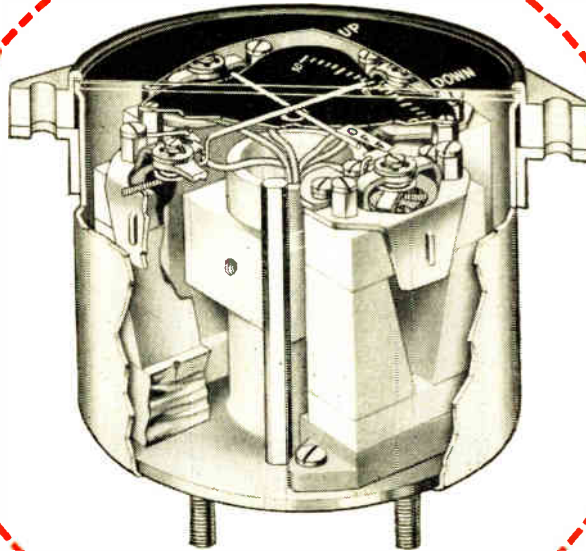

SETTING NEW DESIGN STANDARDS FOR AIRCRAFT INSTRUMENTS

Marion Electrical Instrument Company now makes available a line of aircraft instruments embodying proven Marion instrument features and incorporating new Marion developments. The result is single and multiple element aircraft types of greater durability and accuracy, incorporating a new single seal construction which isolates the glass-to-metal seal from mounting stresses and reduces thermal shock stresses. These instruments meet Army-Navy Aeronautical Design Standard AND 10401 requirements for 2 3/4" dial instruments. Applications of the new Marion AN Series include ammeters, voltmeters, radio navigational types (such as omni-range and ILS) and temperature indicators.

The single element Marion Model AN3 is completely ruggedized (per MIL-M-10304) including internal shock mount.

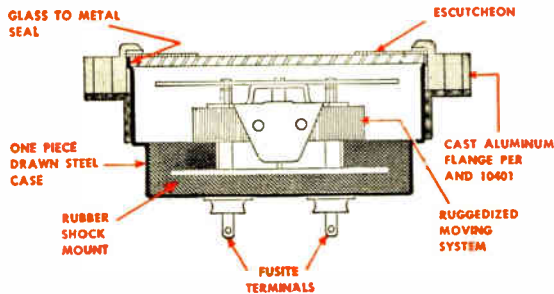

SERIES AN3

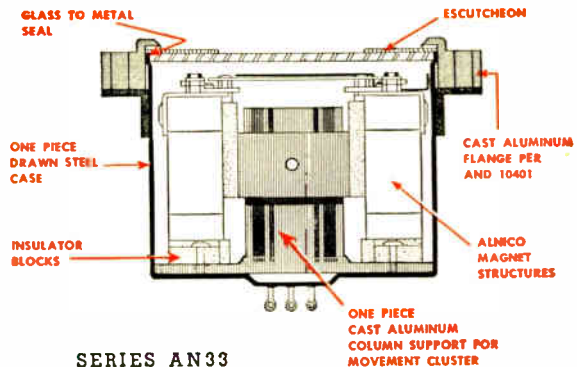

SERIES AN33

Marion AN33 Series provides for instruments incorporating two, three or four Marion ruggedized movements. An unique one piece base and column support provides greater rigidity and more precise alignment of the elements. All wiring passes directly through the center of this column to terminal connections. Accessories such as multiplier resistors and bridge networks where required are contained in an extension cap which is attached to the base of the instrument. The series consists of two element (Model AN32E), three element (Model AN33E), and four element (Model AN34E) types.

In both the Marion AN3 and AN33 Series the one piece drawn steel case is single-seal (glass-to-metal) hermetically sealed to the glass window, making the instruments impervious to the most severe of environmental hazards. A cast aluminum flange retains the escutcheon and provides for panel mounting (per AND 10401).

These Marion aircraft instruments represent another application of "Advancement In Instrument Design" to a critical instrument requirement.
 Marion Electrical Instrument Company, 407 Canal Street, Manchester, New Hampshire.



Reg. U. S. Pat. Off



marion meters

MANUFACTURERS OF RUGGEDIZED AND "REGULAR" METERS AND RELATED PRODUCTS

Copyright 1953 Marion Elec. Instr. Co.

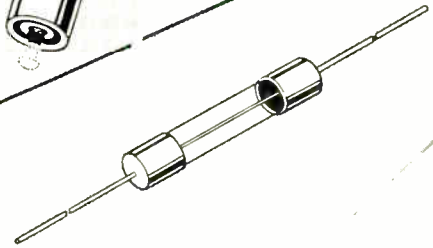
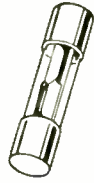
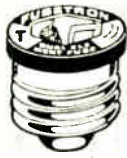

Avoid Fuse Confusion

Standardize on **BUSS** for *every*

protection need in TELEVISION • RADIO • RADAR • INSTRUMENTS • CONTROLS • AVIONICS

BUSS is the one dependable source for any fuse you need: standard type, dual-element (slow-blowing), renewable and one-time types...in sizes from 1/500 amp. up.

To make sure the highest standards of quality are maintained, every BUSS fuse is electronically tested. A sensitive testing device automatically rejects any fuse that is not correctly calibrated, or not right in all physical dimensions.

For Help in Finding the Right Fuse...

the BUSS Fuse Laboratories are at your service to assist you in selecting the fuse that will suit your needs best... if possible, a fuse that is available from local wholesalers' stocks.

PLUS a complete line of fuse clips, blocks and holders....

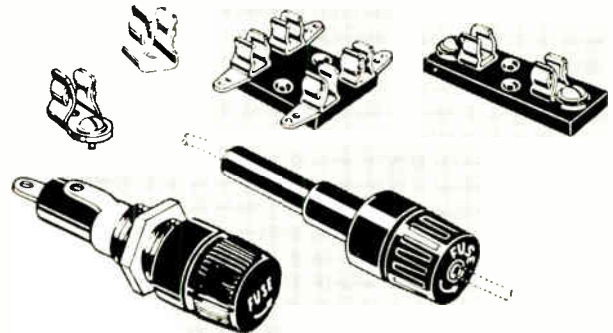

FOR MORE INFORMATION — *Mail this Coupon Today.*

BUSSMANN Mfg. Co. (Division of McGraw Electric Co.)
University at Jetterson, St. Louis 7, Mo.

Please send me bulletin SFB containing facts on BUSS small dimension fuses and fuse holders.

Name _____

Title _____

Company _____

Address _____

City & Zone _____ State _____ IRE-953

BUSSMANN MFG. CO., Division McGraw Electric Company
University at Jetterson St. Louis 7, Mo.

DuMont features Eimac Klystrons In 5 kilowatt UHF-TV Transmitters

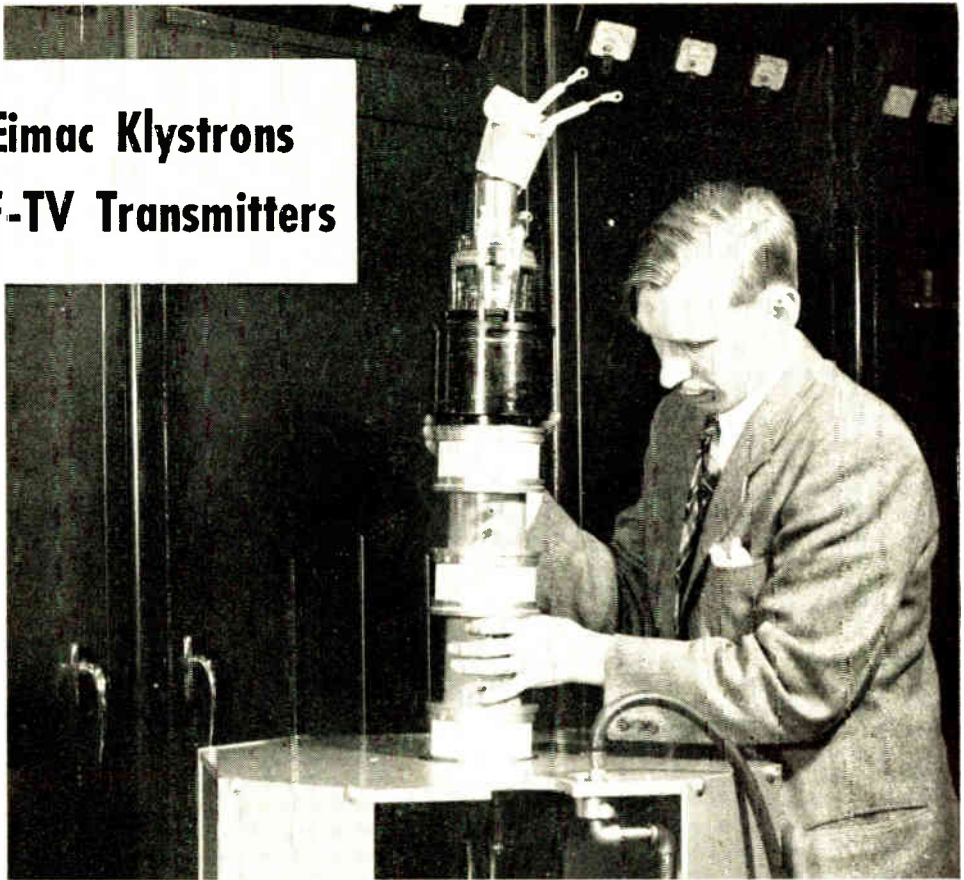

W. H. Sayer, DuMont research engineer, places Eimac klystron in RF section of DuMont 5kw transmitter.

DuMont combines the latest in electronic design and engineering techniques in its new, up-to-the-minute five kilowatt UHF-TV transmitters. With Eimac klystrons as final amplifiers, DuMont utilizes the only tubes that offer all these features for high-power UHF-TV—1) Low initial cost and operating

economy 2) Light weight 3) Reserve power for long life in typical operation 4) High power gain of 20 db. or more 5) Three tubes to cover the spectrum 6) Convenient external tuning makes efficient and accurate circuit alignment possible.

EIMAC TUBES IN DRIVER AND FINAL STAGES

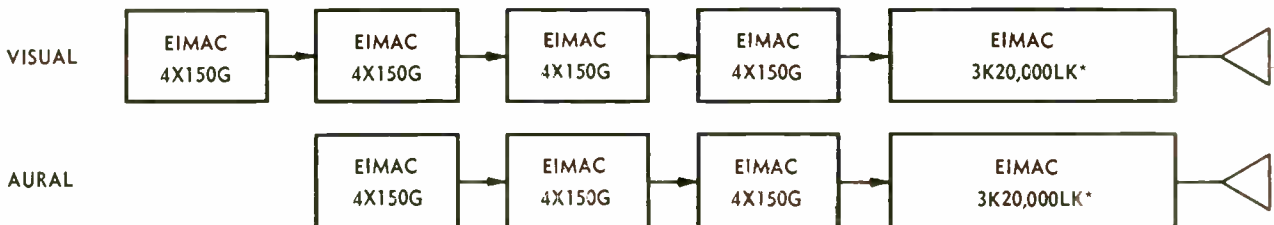

For further information about Eimac klystrons write our Application Engineering department.



*3K20,000LA channels 14-32
*3K20,000LF channels 33-55
*3K20,000LK channels 56-83

EITEL - McCULLOUGH, INC.
SAN BRUNO, CALIFORNIA

Export Agents: Frazer & Hansen, 301 Clay St., San Francisco, California

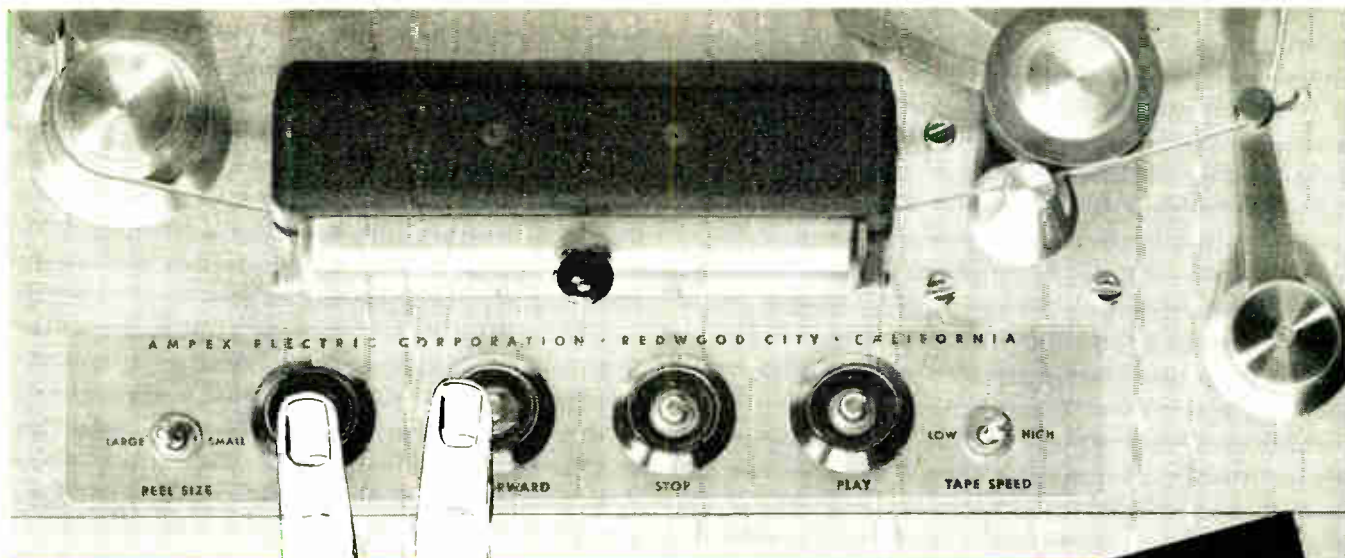

these pushbuttons are fast on cues...

They're the controls on the new AMPEX 350 Tape Recorder

Their quick, positive action will give station operators a new "sureness" with tape. Cueing is exact; editing is faster; fumbling is out. Remote control is available too. Responsiveness has always been a part of the *Ampex Standard of Excellence*—but now it is better than ever, making the AMPEX 350 truly the **NEWEST OF THE BEST**.

● **STARTING WITH A SPLIT SYLLABLE**

From pressing of the start button to stable tape motion takes 1/10th second. Tape can be backed off from starting cues as little as one to two inches. Precise starts become routine. Reliability is supreme.

● **STOPPING WITHIN TWO INCHES**

Even at 15 inches per second, the tape stops within less than two inches after the button is pressed. Band type brakes give positive stops; no drift or tape spillage can occur.

● **EASIER CUEING AND EDITING**

The Model 350 can be shuttled rapidly between fast forward and rewind without stopping. Cues for starting, editing or dubbing are speedily located. And for convenient editing, the capstan drives on the "pull side" of the heads.

● **ADJUSTMENT FOR REEL SIZES**

A new switch selects proper tape tension either for 10½-inch NARTB reels or for 5 or 7-inch plastic FMA reels. Proper tension means longer tape life, more accurate timing and truer performance.



AMPEX MODEL 350
The new slant puts all controls within easy reach of any operator, tall or short.

Recorders from \$975; Model 350 from \$1095; Reproducers from \$495. For further information write today to Dept. G-1279A



IF YOU PLAN FOR TOMORROW,
BUY AN AMPEX TODAY

934 CHARTER STREET, REDWOOD CITY, CALIFORNIA
Distributors in principal cities; distribution in Canada by Canadian General Electric Company

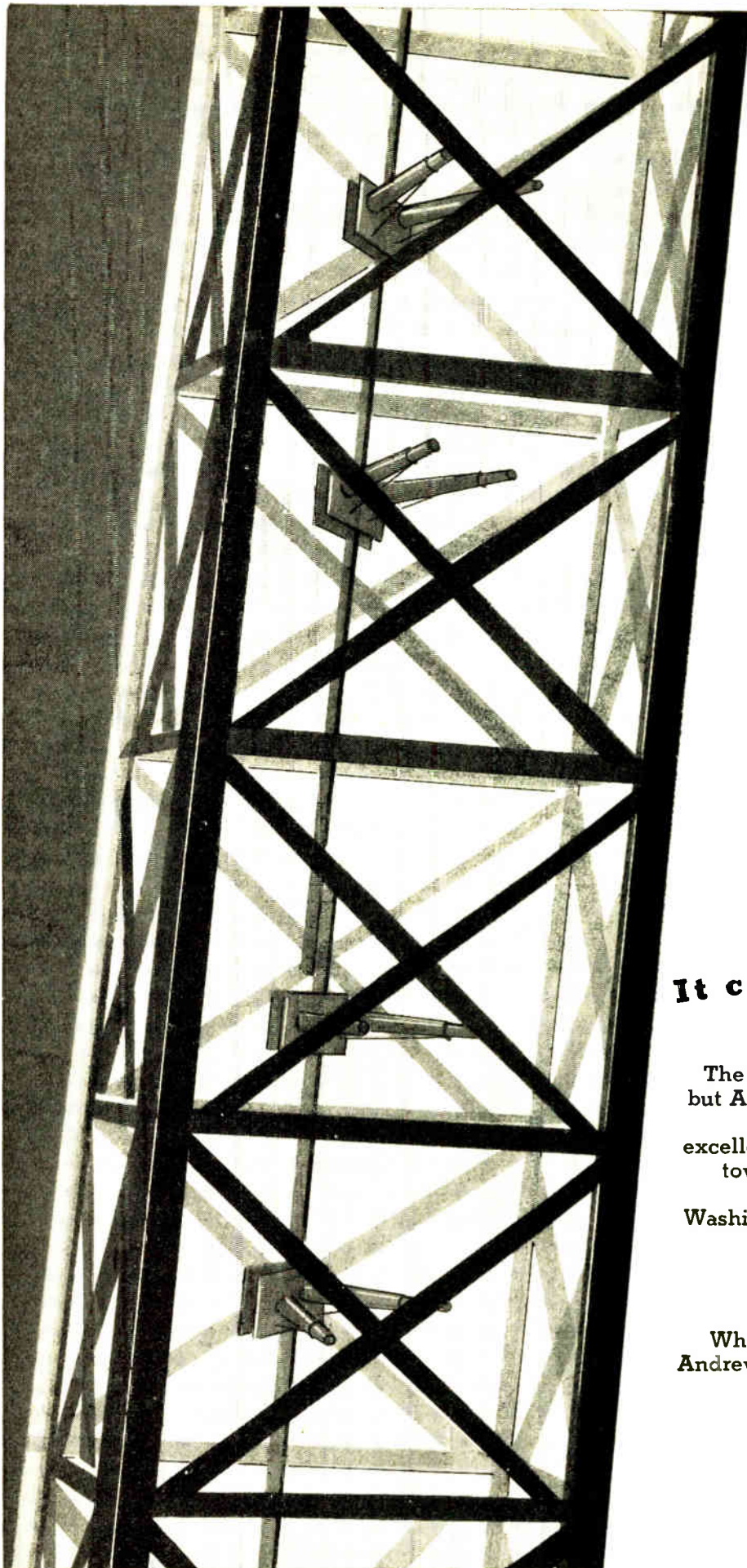

It couldn't be done?

The books said it couldn't be done—
but Andrew engineers went ahead and
designed an antenna that gives
excellent coverage mounted *inside* the
tower! This ingenious development
enabled station WTOP in
Washington, DC to use their television
tower for FM too—and so save
thousands of dollars.

Whatever your problem in antennas
Andrew ingenuity will find the answer.
Be sure to consult us.

Andrew
CORPORATION

363 EAST 75TH STREET, CHICAGO 19

RMC

DISCAPS

TYPE C

REPLACE TUBULAR CERAMIC and MICA CONDENSERS AT LOWER COST!

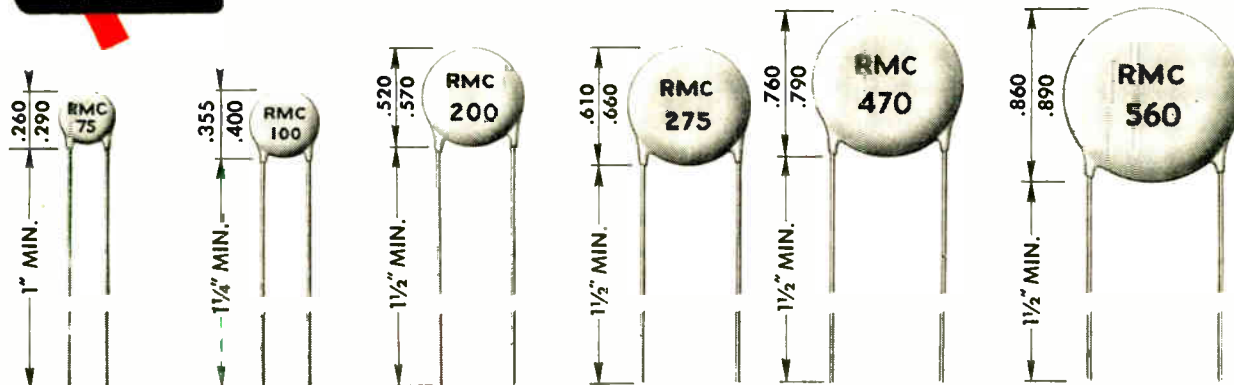

TC	1/4 Dia.	5/16 Dia.	1/2 Dia.	5/8 Dia.	3/4 Dia.	7/8 Dia.
P-100	1- 3 MMF	4- 9 MMF	10- 30 MMF	—	—	—
NPO	2- 12	13- 27	28- 60	61- 75 MMF	76-100 MMF	101-150 MMF
N- 33	2- 15	16- 27	28- 60	61- 75	76-100	101-150
N- 80	2- 15	16- 27	28- 60	61- 75	76-120	121-150
N- 150	2- 15	16- 30	31- 60	61- 75	76-140	141-150
N- 220	3- 15	16- 30	31- 75	76-100	101-150	151-190
N- 330	3- 15	16- 30	31- 75	76-100	101-150	151-190
N- 470	3- 20	21- 40	41- 80	80-120	121-200	201-240
N- 750	5- 25	26- 56	57-150	151-200	201-280	281-350
N-1400	15- 50	51-100	101-200	200-250	251-330	331-560
N-2200	47- 75	76-120	121-200	201-275	276-470	471-560

RMC Type C temperature compensating DISCAPS are available in a wide range of capacities in temperature coefficients between P-100 and N-2200. Featuring smaller size, lower self inductance, and greater dielectric strength, Type C DISCAPS assure trouble-free performance on VHF or UHF applications. Rated at 1000 working volts, DISCAPS provide a high safety factor.

Today, practically all major television and electronic manufacturers use DISCAPS. They combine many electrical and mechanical advantages with a lower initial price permitting substantial production cost reductions.

If you have a design problem requiring a standard or special type of ceramic capacitor our engineers are at your service.

SPECIFICATIONS:

POWER FACTOR: Less than .1% at 1 megacycle

WORKING VOLTAGE: 1000 V.D.C.

TEST VOLTAGE (FLASH): 2000 V.D.C.

CODING: Capacity, tolerance and TC stamped on disc

INSULATION: Durez phenolic-vacuum waxed

INITIAL LEAKAGE RESISTANCE: Guaranteed higher than 7500 megohms

AFTER HUMIDITY LEAKAGE RESISTANCE: Guaranteed higher than 1000 megohms

LEADS: No. 22 tinned copper (.026 dia.)

TOLERANCES: ±5% ±10% ±20%

These capacitors conform to the RTMA specification for Class 1 ceramic condensers.

The capacity of these condensers will not change under voltage.

SEND FOR SAMPLES AND TECHNICAL DATA

DISCAP
CERAMIC
CONDENSERS



RADIO MATERIALS CORPORATION

GENERAL OFFICE: 3325 N. California Ave., Chicago 18, Ill.

FACTORIES AT CHICAGO, ILL. AND ATTICA, IND.

DISTRIBUTORS: Contact Jobber Sales Co., 146 Broadway, Paterson 1, N. J.

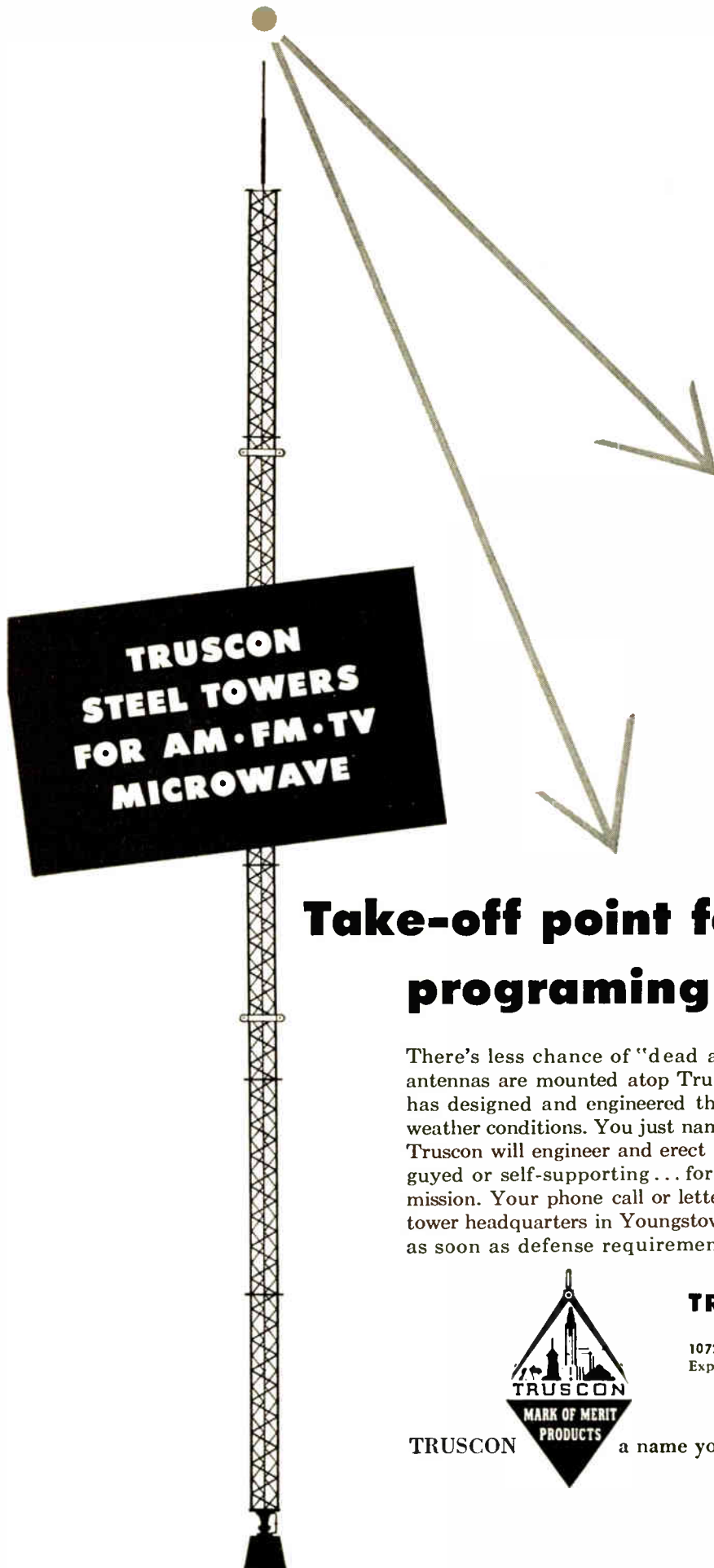

**TRUSCON
STEEL TOWERS
FOR AM·FM·TV
MICROWAVE**

Take-off point for dependable programming . . .

There's less chance of "dead air" costing you listeners when your antennas are mounted atop Truscon towers. Truscon knows towers — has designed and engineered them to stand strong and tall under all weather conditions. You just name the height your antenna must reach; Truscon will engineer and erect the tower you need . . . tall or small . . . guyed or self-supporting . . . for AM, FM, TV, or Microwave transmission. Your phone call or letter to any Truscon district office—or to tower headquarters in Youngstown—will get your tower program going as soon as defense requirements allow.



TRUSCON

a name you can build on

TRUSCON® STEEL DIVISION

REPUBLIC STEEL CORPORATION

1072 ALBERT STREET • YOUNGSTOWN 1, OHIO

Export Department: Chrysler Bldg., New York 17, N. Y.

How to measure the depth of D. Jones' locker

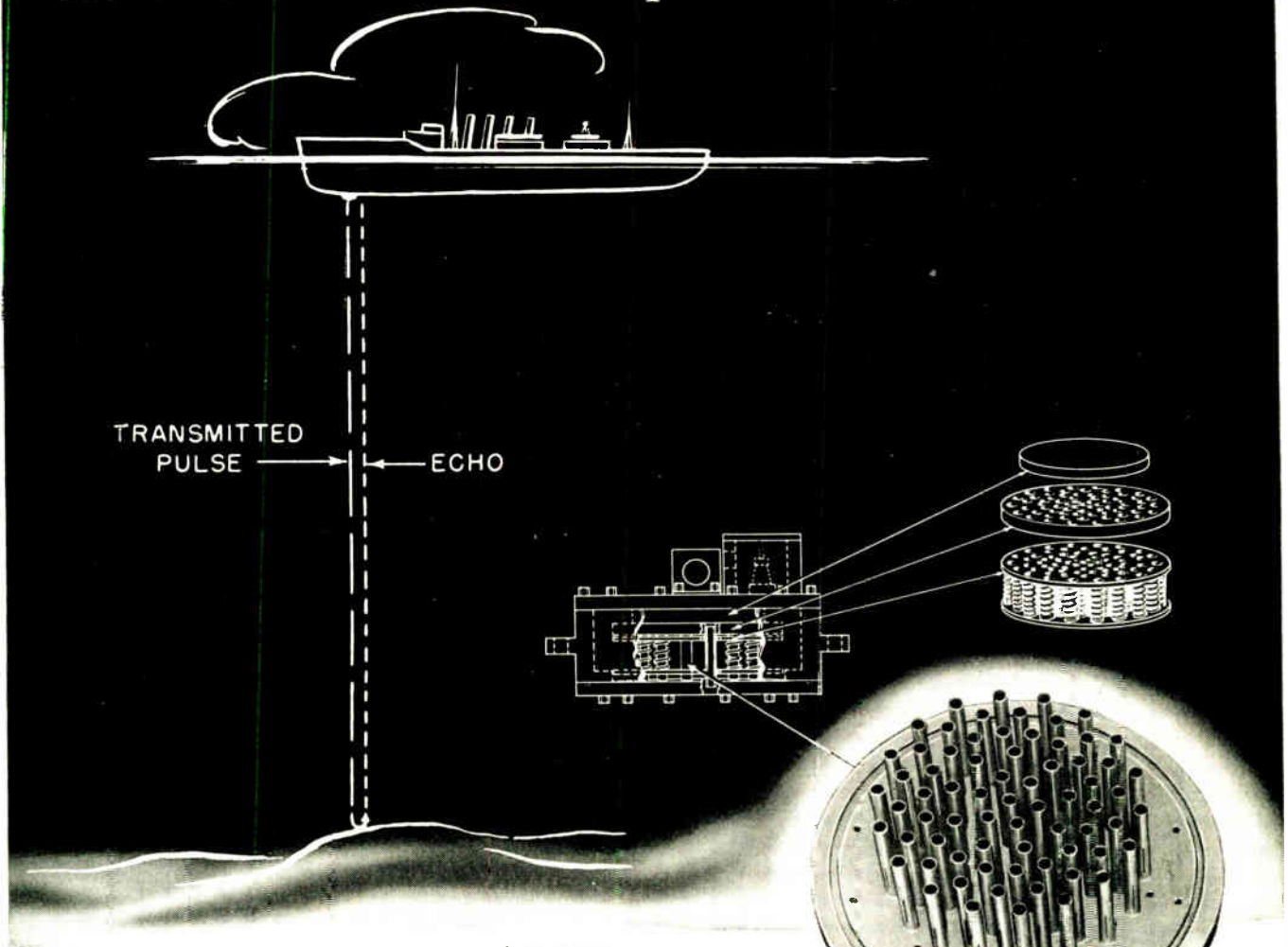

Best insurance against running aground is sonar . . . echo sounding equipment.

RCA Victor Division of Radio Corporation of America uses the phenomenon of magnetostriction to send and receive supersonic pulses and so determine the distance to a submerged object on the ocean's floor.

Magnetostriction—the familiar “Joule Effect” of your textbook days—is the ability of a ferromagnetic metal to change dimensions when magnetized. The metal of RCA echo sounding equipment is Superior Grade “A” nickel tubing.

70 pieces of Superior seamless nickel tubing, cold drawn to $\frac{3}{8}$ " O.D. x .020" wall thickness and cut to $\frac{1}{4}$ of the wave length of the alternating current signal, are soldered to a plate. Each length is enclosed by a coil.

Energizing the coil with alternating current, the tube expands and contracts, creating a piston effect on plate and diaphragm, sending out a supersonic wave. Likewise, reception of the echo wave by the diaphragm again causes the nickel tubes to pulsate and induce a current in the coil.

RCA Victor looks to Superior for accuracy and uniformity of analysis, precision drawing and cutting in large quantities. For cathodes, anodes, or tubing specialties, and tubing technology—ask Superior. Superior Tube Company, 2506 Germantown Avenue, Norristown, Pa.



Seamless Nickel Anode. Flattened one end. .500" O.D. x .025" Wall x 1.625" long.



Seamless Nickel Cathode. Round, flanged one end. .070" / .072" I.D. x .0025" Wall. .295" long.



Lockseam* Nickel Cathode. Round, tabbed, single bead. .045" O.D. x .0021" Wall. 27 mm long.



Disc Cathode .121" O.D. .312" long.



All analyses .010" to $\frac{3}{4}$ " O.D.
Certain analyses in Light Walls up to $2\frac{1}{4}$ " O.D.

Many types of nickel cathodes—made in Lockseam* from nickel strip, disc cathodes, and a wide variety of anodes, grip cups and other tubular fabricated parts are available from Superior. For information and Free Bulletin, address Superior Tube Company, Electronics Division, 2500 Germantown Avenue, Norristown, Pa.

*Manufactured under U.S. Patents.

24 INCH ALUMINIZED SYLVANIA PICTURE TUBES



When the television industry has demanded picture tubes of finest performance, it has turned again and again to Sylvania . . . the recognized leader in quality picture tube production.

Now Sylvania once more meets the industry's demands . . . this time for a large-screen aluminumized tube. New mass production techniques and 50,000 square feet of specialized, new facilities, at Sylvania's great Seneca Falls, New York plant, assure unbeatable quality and immediate availability of the much-wanted type 24CP4A.

Thus once again the television industry finds Sylvania's know-how in quality mass production provides a new television picture tube by which all future standards may be set. For further information on the 24CP4A, see your Sylvania representative, or write to Sylvania Electric Products Inc., Dept. 3R-3008, 1740 Broadway, New York 19, N. Y.

SYLVANIA



**LIGHTING · RADIO
ELECTRONICS
TELEVISION**

In Canada: Sylvania Electric
(Canada) Ltd., University Tower Building
St. Catherine St., Montreal, P. Q.

Where **stability** is important

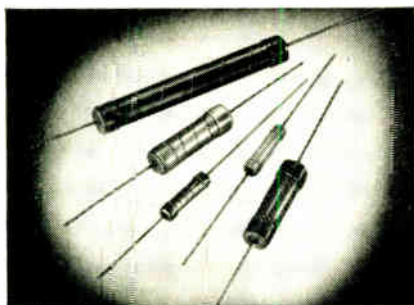
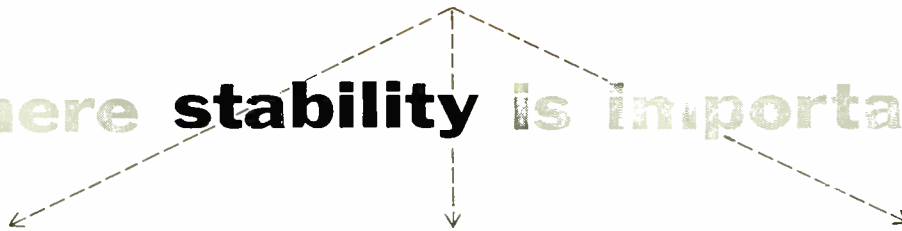

Corning Film-Type Resistors

With a film material that is entirely new for resistors, CORNING Film-Type Resistors afford a rugged unit with exceptional stability and capable of withstanding high ambient, high operating temperatures. (The film material is fired in at red heat to make integral contact with the heat-resistant glass base, forming a tough bond.)

CORNING Film-Type Resistors are available in two types: Type N with a resistance tolerance of 1% and capable of operating at ambient temperatures up to 140°C.; Type S with a normal resistance tolerance of 2% and capable of operating at ambient temperatures up to 200°C.

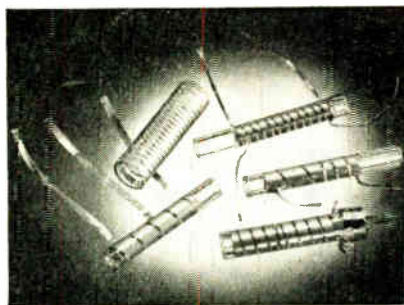

Corning Metallized Glass Inductances

The exceptionally high electrical stability and low temperature coefficient of CORNING Metallized Glass Inductances are the result of the integral contact of the fired-on metallizing with dimensionally stable glass coil forms. Drift is negligible, even under unusually variable ambient temperatures. High Q is inherent.

Whether you require uniform, variable or double pitch windings—fixed tuned, permeability tuned or permeability tuned inductance-trimmer combinations—we can meet your requirements exactly and to close tolerances.

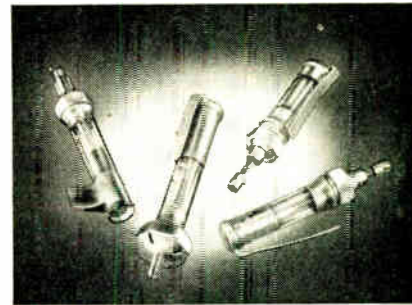

Corning Metallized Glass Midget Trimmer Capacitors

Since these components are produced by permanently bonding metal to tubes made of glass with practically zero temperature coefficients in the VHF range, capacity shift is negligible even with widely variable ambient temperatures.

CORNING Metallized Glass Midget Trimmer Capacitors are available in standard types from .3 to 12 u.u.f., or can be designed to meet your own particular needs. They are simple to solder, rugged and easy to tune critically. With direct traverse trimming, there is negligible capacity shift under vibration, and an absolutely smooth capacity curve.

► **Corning inductances, capacitors and resistors are mass produced on automatic machinery to close tolerances consistently duplicated from piece to piece. Our engineers will be glad to work with you on whatever design assistance you need. For complete information, use the coupon below.**

Corning Glass Works

New Products Division



Corning means research in Glass

CORNING GLASS WORKS, Dept. RE-9, Corning, N. Y.

Please send me information on:

- CORNING Metallized Glass Inductances, CORNING Film-Type Resistors
 CORNING Metallized Glass Trimmer Capacitors

Name..... Title.....

Company.....

Address.....

City..... Zone..... State.....

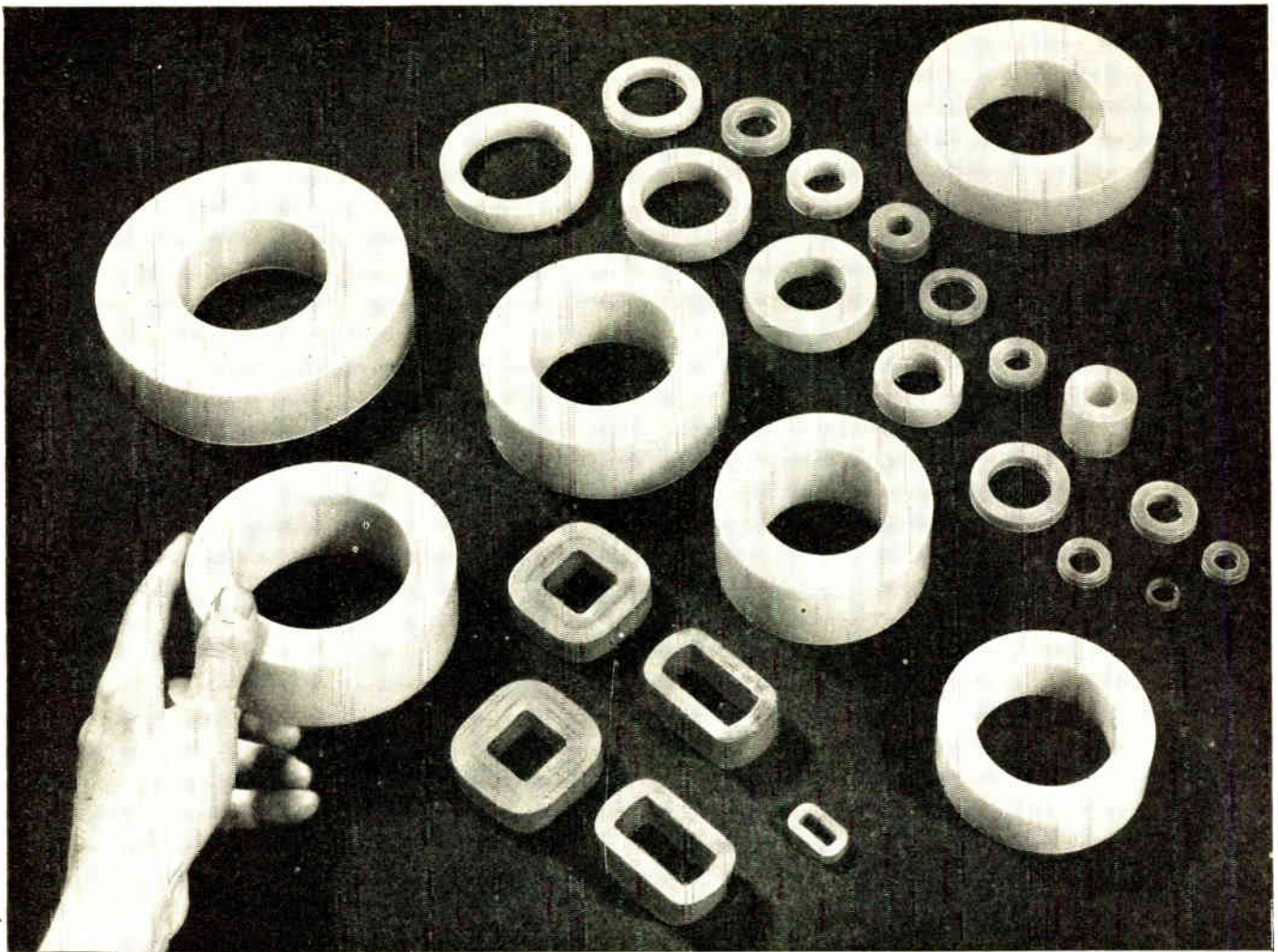

IN **TAPE-WOUND CORES** **JUST NAME YOUR REQUIREMENTS!**

RANGE OF MATERIALS

Depending upon the specific properties required by the application, Arnold Tape-Wound Cores are available made of DELTAMAX . . . 4-79 MO-PERMALLOY . . . SUPERMALLOY . . . MUMETAL . . . 4750 ELECTRICAL METAL . . . or SILECTRON (grain-oriented silicon steel).

RANGE OF SIZES

Practically any size Tape-Wound Core can be supplied, from a fraction of a gram to several hundred pounds in weight. Toroidal cores are made in twenty-two standard sizes with protective nylon cases. Special sizes of toroidal cores—and all cut cores, square or rectangular

cores—are manufactured to meet your individual requirements.

RANGE OF TYPES

In each of the magnetic materials named, Arnold Tape-Wound Cores are produced in the following standard tape thicknesses: .012", .008", .004", .002", .001", .0005", or .00025", as required.

Applications

Let us help with your problems of cores for Magnetic Amplifiers, Pulse Transformers, Current Transformers, Wide-Band Transformers, Non-Linear Retard Coils, Peaking Strips, Reactors, etc.

Address: **ENG. DEPT. P**

W&D 4613

THE ARNOLD ENGINEERING COMPANY
 SUBSIDIARY OF ALLEGHENY LUDLUM STEEL CORPORATION
 General Office & Plant: Marengo, Illinois
 DISTRICT SALES OFFICES . . . Boston: 200 Berkeley St.
 New York: 350 Fifth Ave. Los Angeles: 3450 Wilshire Blvd.



Designers—The right tube... find it with G.E.'s

NEW SPOT-RATING SERVICE ON THYRATRONS!



YOUR electronic circuit may require a control tube with special performance. Even General Electric's 36 thyratrons—largest choice in the industry—may not include a type whose published ratings are identical with the tube you need.

Here G. E.'s Thyatron Spot-rating Service takes over. Published tube ratings, such as those listed on this page, apply to *only one set of pre-established conditions*. Under different circuit conditions, a G-E thyatron's voltage or current capacity may be greater. For exam-

ple, if your peak voltage is less than 1250 v, Type GL-3C23 in practice may be found able to handle in excess of 1.5 amp current.

General Electric always is glad to recommend such possibilities, after study. You can have a thyatron that custom-fits your circuit—at the same time, one that's industry-tested for performance. You will save by installing a type already in large production!... With the list below as your guide, write pinpointing your thyatron needs! *General Electric Company, Tube Department, Schenectady 5, N. Y.*

FOR EVERY APPLICATION, A CHOICE OF **PROVED** G-E THYRATRONS!

Primary application and type number	Average amp	Peak amp	Peak volts, inverse	Primary application and type number	Average amp	Peak amp	Peak volts, inverse
MOTOR CONTROL				GL-393-A	1.5	6	1250
GL-C1J	1	8	700	FG-27-A	2.5	10	1000
GL-3C23	1.5	6	1250	GL-5728/FG-67	2.5	15	1000
GL-5720/FG-33 (3 electrodes)	2.5	15	1000	GL-5830/FG-41	12.5	75	10000
GL-5560/FG-95 (4 electrodes)	2.5	15	1000	HIGH CURRENT AMPLIFICATION			
GL-5544	3.2	40	1500	GL-5603	0.02	0.06	500
FG-172	6.4	40	2000	GL-2D21	0.1	0.5	1300
FG-105	6.4	40	2500	GL-5727 (special heater-cathode construction)	0.1	0.5	1300
GL-604A	6.4	77	500	GL-502-A (metal)	0.1	1	1300
GL-5545	6.4	80	1500	GL-2050 (glass)	0.1	1	1300
GL-414	12.5	100	2000	GL-627	0.64	2.5	2500
GL-5855	12.5	150	1500	GL-678	1.6	6	15000
WELDING CONTROL				FG-154	2.5	10	500
GL-5560/FG-95	0.5	30	1000	GL-5559/FG-57	2.5	15	1000
GL-5632 (gas)	2.5	30	1250	GL-672-A	3.2	40	2500
GL-601T (gas and mercury)	2.5	30	1250	MODULATOR SERVICE			
FG-172 (metal)	2.5	77	750	GL-6130	0.045	35	3000
FG-105 (glass)	2.5	77	750	GL-5948	1	1000	25000
	4	16	10000	SPECIAL APPLICATIONS			
REGULATED POWER SUPPLY				*GL-5062	(fuse tube)		200
FG-81-A (3 electrodes)	0.5	2	500	**GL-835 (2.5-v heater)	0.075	0.3	350
FG-98-A (4 electrodes)	0.5	2	500	**GL-884 (6.3-v heater)	0.075	0.3	350
FG-97	0.5	2	1000	*for electronic-blanket control **for oscilloscope sweep circuits			
GL-5557/FG-17	0.5	2	5000				



GENERAL ELECTRIC





Uniformity

**—batch to batch uniformity
that makes inspection unnecessary**

We have used every type of GA & F Carbonyl Iron Powder thus far produced. The overall quality and batch-to-batch uniformity of your products have always been gratifying to us. Because of this product dependability, we feel that incoming inspection of your powders is unnecessary.

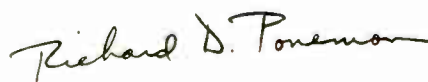

President
Pyroferric Company, Inc.
621 East 216th Street
New York 67, N. Y.

GA & F Carbonyl Iron Powders are used to produce cores for transformer and inductor coils—to increase Q values, to vary coil inductances, to reduce the size of coils, to confine stray fields and to increase transformer coupling factors.

These powders are microscopic, almost perfect spheres of extremely pure iron. They are today produced in eight carefully controlled types, ranging in average particle-size from three to twenty microns in diameter. The Carbonyl Process assures the quality and uniformity of each type.

We urge you to ask your core maker, your coil winder, your industrial designer, how GA & F Carbonyl Iron Powders can increase the efficiency and performance of the equipment or product you make, while reducing both the cost and the weight. We also invite inquiries for powders whose performance characteristics are different from those exhibited by any of our existing types.

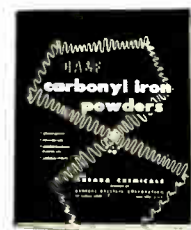

This 32-page book offers you the most comprehensive treatment yet given to the characteristics and applications of GA & F Carbonyl Iron Powders. 80% of the story is told with photomicrographs, diagrams, performance charts and tables. For your copy—without obligation—kindly address Department 58.

GA & F. CARBONYL IRON POWDERS



ANTARA. CHEMICALS

Division of **GENERAL DYESTUFF CORPORATION**

435 HUDSON STREET • NEW YORK 14, NEW YORK



INTERNAL

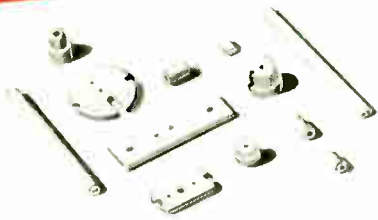

SUPPORTS AND INSULATORS
AlSiMag 393, 544, 548 Lava 1136, 1137
Anode · Cathode · Grid · Heater

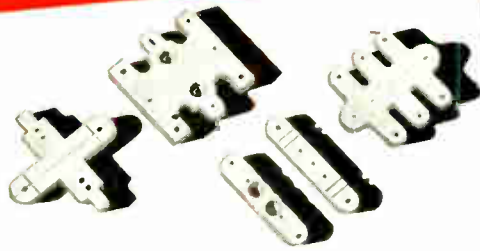

SPACERS
AlSiMag 393, 544, 548, 211-S
Lava 1136, 1137

For materials to match your
PERFORMANCE REQUIREMENTS

ALSiMAG[®] provides the
widest choice of
INSULATING COMPONENTS FOR ELECTRON TUBES
Lava and compositions of Alumina, Steatite or Forsterite

Progress on tube design depends to a great extent on the materials available for their construction. In AlSiMag you have the widest choice of materials to match your requirements. New materials are constantly being developed to meet specific problems.

The wide choice of AlSiMag ceramics permits you to balance your mechanical and dielectric requirements for your specific use.

TEST SAMPLES from our files sent free on request. SAMPLES to your blue print made at reasonable cost. BULLETIN NO. 537 "Internal Insulators for Electronic Tubes" sent on request.

52ND YEAR OF CERAMIC LEADERSHIP

AMERICAN LAVA CORPORATION

A Subsidiary of Minnesota Mining and Manufacturing Company

CHATTANOOGA 5, TENNESSEE

OFFICES: METROPOLITAN AREA: 671 Broad St., Newark, N. J., Mitchell 2-8159 • SYRACUSE, N. Y.: 330 Arlington Ave., Phone 76-5068 • CLEVELAND: 5012 Euclid Ave., Room 2007, Express 1-6685
NEW ENGLAND: 1374 Mass. Ave., Cambridge, Mass., Kirkland 7-4498 • PHILADELPHIA: 1649 N. Broad St., Stevenson 4-2823 • ST. LOUIS: 1123 Washington Ave., Garfield 4959
CHICAGO: 228 N. LaSalle St., Central 6-1721 • SOUTHWEST: John A. Green Co., 6815 Oriole Dr., Dallas 9, Dixon 9918 • LOS ANGELES: 5603 N. Huntington Dr., Capital 1-9114

EXTERNAL

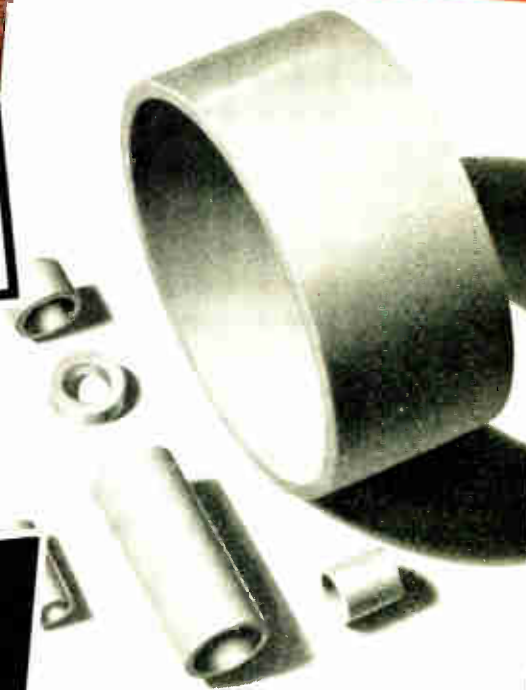

ENVELOPES
Precision ground internally and externally
AlSiMag 576, 243

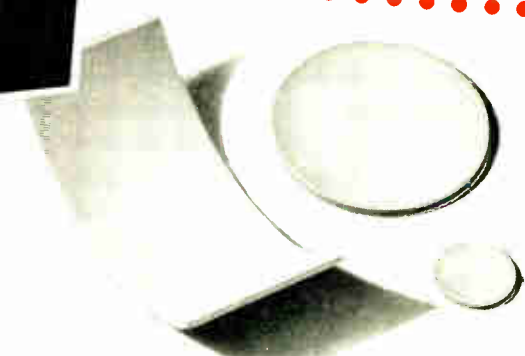

WINDOWS — Precision Ground
AlSiMag 576, 243

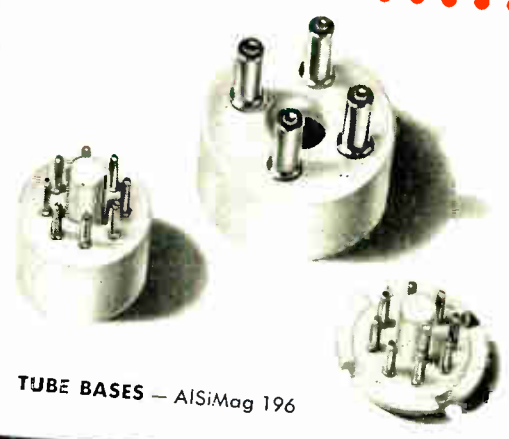

TUBE BASES — AlSiMag 196

A NEW CTS FAMILY

Of Variable Resistors

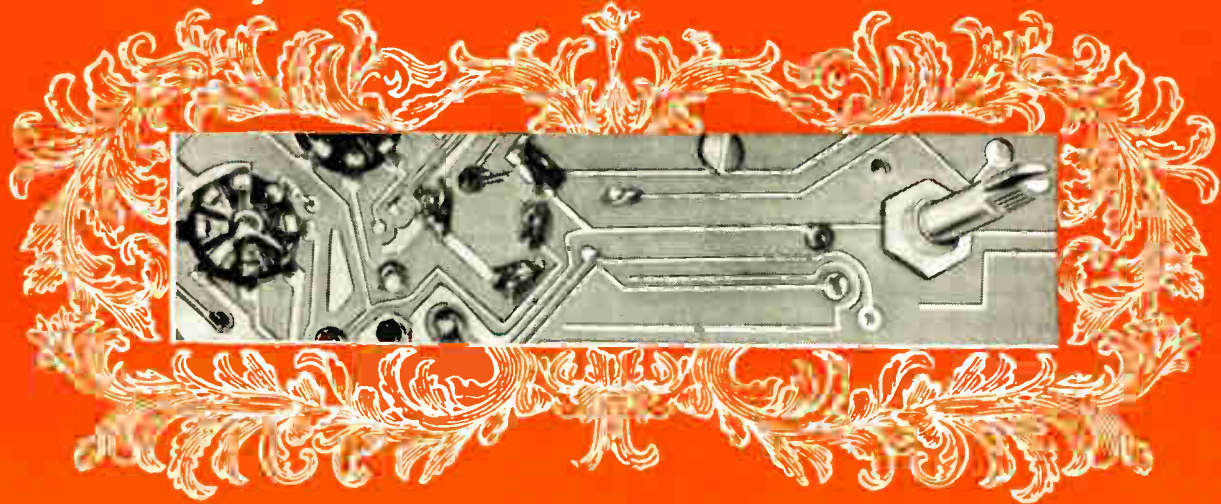

FOR PRINTED CIRCUIT APPLICATIONS

Note these unique design features:

- ① Protection against bending during handling is achieved by recessing each blade-type terminal in a notch in the bakelite base of the control.
- ② Valuable mounting space is conserved on the printed circuit panel by placing the terminals close in to the mounting bushing.
- ③ Adequate clearance for circuit paths is provided by ample spacing between terminals.
- ④ Available in *miniaturized* 3/4" diameter (U70) and in 1 1/16" diameter (U45, GC-U45, WF-U45).

For your printed circuit applications, CTS offers consultation without obligation.

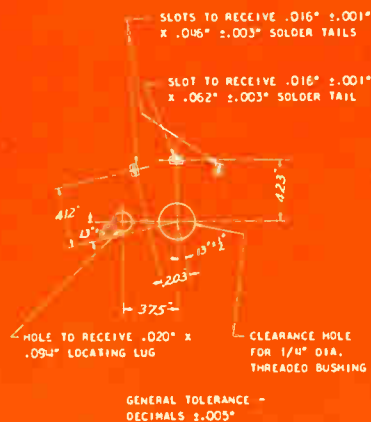

Ample spacing between printed circuit terminal openings for the miniature Type U70 series provides adequate clearance for circuit paths.

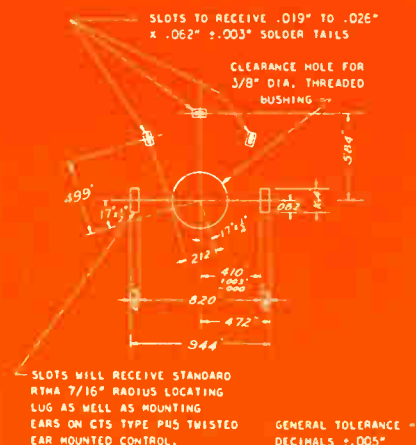

Ample spacing between printed circuit terminal openings for Types U45, GC-U45 and WF-U45 provides adequate clearance for circuit paths.

Type U70, 3/4" diameter *miniaturized* variable composition resistor with special printed circuit terminals. Wattage rating: .3 watt for resistances through 10,000 ohms, .2 watt with 350 volts maximum across end terminals for resistances over 10,000 ohms.



Type U45, 15/16" diameter, variable composition resistor with blade-type printed circuit terminals. Wattage rating: 1/2 watt for resistances through 10,000 ohms, 1/3 watt for resistances over 10,000 ohms through 100,000 ohms and 1/4 watt with 500 volts maximum across end terminals for resistances over 100,000 ohms.

Type GC-U45, 15/16" diameter, variable composition resistor with blade-type printed circuit terminals same as U45 except with attached SPST, 3 ampere, 125 volt "GC" type switch. Also available with type "WF", DPST, 3 ampere, 125 volt switch. (Variable resistor type WF-U45.)



CHICAGO TELEPHONE SUPPLY
Corporation

ELKHART • INDIANA

REPRESENTATIVES

Henry E. Sanders, McClatchy Bldg.
69th & Market St., Upper Darby, Penna.
Phone: Flanders 2-4420

W. S. Harmon Company, 1638 So. La Cienega Blvd.
Los Angeles 35, California • Phone: Bradshaw 2-3321

John A. Green Company, 6815 Oriole Drive
Dallas 9, Texas

IN CANADA

C. C. Meredith & Co., Ltd., Streetsville, Ontario

SOUTH AMERICA

Jose Luis Pontet
Buenos Aires, Argentina • Montevideo, Uruguay
Rio de Janeiro, Brazil • Sao Paulo, Brazil

OTHER EXPORT

Sylvan Ginsbury
8 West 40th Street, New York 18, N. Y.

Specialists in Precision Mass Production of Variable Resistors

World Radio History

RUBATEX *makes Rubber Behave!*

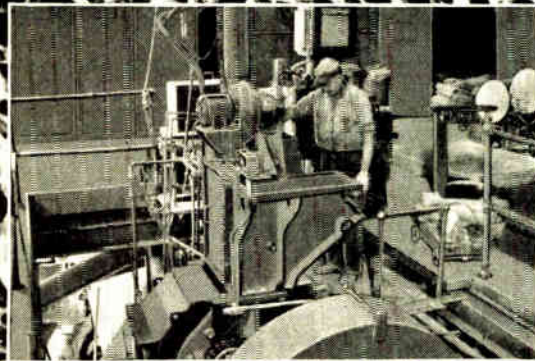

Compounding ingredients are blended with natural or synthetic rubber in Banbury mixers or on mixing mills for uniformity of cell structure.

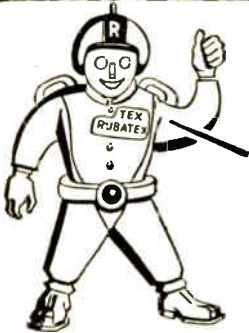
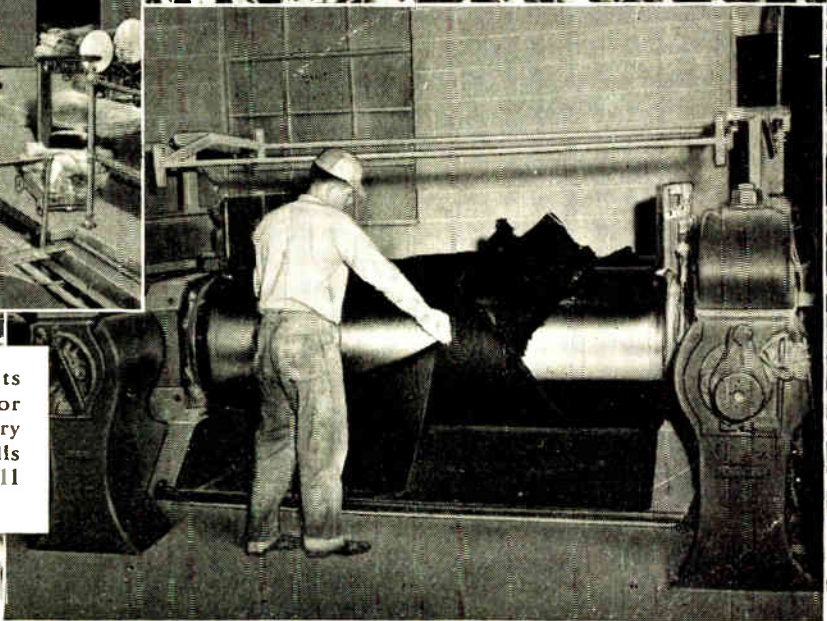

Closed cells are responsible for the structural strength and superior physical properties of Rubatex—not possessed by ordinary sponge rubber with open coarse cells which are wide open to oxygen and moisture.

Rubber has a stubborn "memory" and constantly strives to return to its original character. Rubatex temporarily knocks the "fight" out of rubber by blending it with specially developed compounding ingredients on mixing mills or in Banbury mixers to assure a uniformity of cell structure throughout.

When rubber regains its wind, Rubatex hits it again by blowing nitrogen under pressure into the precured sheets — forming millions of nitrogen-filled cells, permanently sealed with tough live rubber. Thus Rubatex reforms and transforms rubber into a material with a unique closed cellular structure that shuts out oxygen, heat, cold, moisture, dust and dirt . . . making RUBATEX far superior to other soft rubber materials for sealing, gasketing, cushioning, sound deadening, vibration isolation, and packaging applications.

In addition, RUBATEX is soft, pliable, easy to work with. It is available in natural and synthetic stocks in soft, medium, and firm form. Next time—check the advantages of RUBATEX first!

Send us details of your proposed applications and let us send you samples and recommendations. Write Dept IRE-9. Great American Industries, Inc., Rubatex Division, Bedford, Virginia.

FOR AIR THAT PROTECTS—USE RUBATEX

RUBATEX **CLOSED CELLULAR RUBBER**

RUBATEX AT WORK . .

AUTOMOTIVE & AIRCRAFT

- Arm rests
- Battery supports
- Lamp gaskets
- Heater core gaskets
- Cowl gaskets
- Window gaskets
- Fuel cell cushions
- Floor mats
- Anti-squeak pads

CONSTRUCTION

- Expansion joint seals
- Weather stripping

INDUSTRIAL

- Instrument gaskets
- Fatigue mats
- Low temperature insulation
- Dust-proof seals
- Moisture-proof seals
- Gasketing
- Vibration isolation
- Shock absorption

PACKAGING — Packing cushion for fragile goods and delicate scientific instruments.

REFRIGERATION — Gasketing for refrigerator and cold storage room doors.

SPORTING GOODS — "Air cushioning" padding for athletic equipment and apparel.

CONSUMER & HOUSEHOLD PRODUCTS

- Shoe innersoles
- Hearing aid "cushioning"
- Appliance gaskets
- Bath and kitchen mats

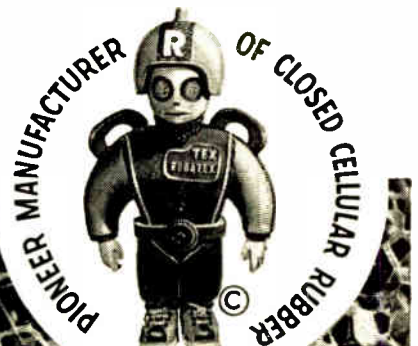

1 VARIABLE RESISTORS



Model 1 Radiohm[™]
Miniature



Model 2 Radiohm

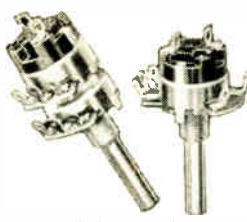

Model 2 Radiohm
(including JAN types)



Model 2 EXPRESS (†)
for immediate
production needs



Compentrol (†)
Infinitely variable
loudness control

2 SWITCHES



Series 20 Miniature
Phenolic or Steatite
Insulation



Standard Size
Phenolic or Steatite
Insulation

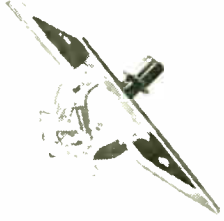

Lever Switch

FOR SALE!

These and 100,001 other electronic components for increased performance... by the industry's most experienced and No. 1 electronic component source

WHETHER you buy electronic components in small lots or by the carload — here's why it's good business to concentrate your five major electronic components problems with Centralab:

- Centrallab has pioneered more electronic "firsts" than any manufacturer in the field.
- Centralab Printed Electronic Circuits offer a new concept in reducing extra parts, assembly-time, errors and costs.
- Centralab ceramics are second to none—available in grade L5 and L6 Steatite.
- You can count on the production facilities of seven conveniently located plants.
- Continuous CRL product improvement.
- Unequaled engineering assistance for developing specific TV, FM, military and commercial electronic components.

Centralab electronic components are the result of more than 30 years' experience working in cooperation with manufacturers all over the world. For complete performance data and engineering specifications on products shown — check and mail the coupon.

†Trademark

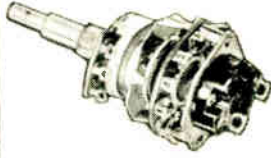

Series 30
Dual Concentric
Switches and/or Controls
Combinations



Tone Switch

3 CAPACITORS



BC Tubular TC Tubular

4 P.E.C.

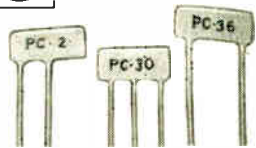

Miniature Resistor and
Resistor-Capacitor Units

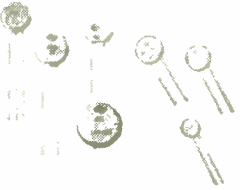

BC Discs TC Discs



TV HI-VO-KAPS[™]

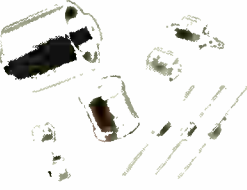

Transmitting Capacitors



Ceramic Trimmers



Standard Triode
Couplate[™]

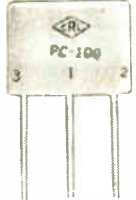

Vertical Integrator

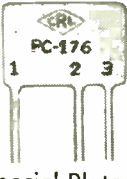

Special Plates
to suit manufacturer's
requirements



PC-30



PC-90

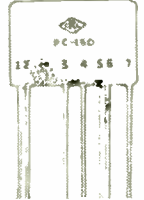

Audet[™]
Audio-detector plate

5 CERAMICS



Custom Ceramics
(Steatite, Centradite,
Zirconite.)

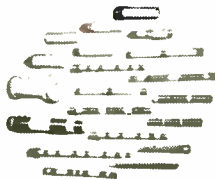

Metalized Ceramics

Centralab[®]

A Division of Globe-Union Inc.
920-I East Keefe Ave., Milwaukee 1, Wisconsin
In Canada, Box 208, Ajax, Canada

Please send me information on these Centralab products:

Controls Switches Capacitors
 Printed Electronic Circuits Ceramics

Name.....Title.....

Company.....

Address.....

City.....Zone.....State.....

HOW TO OFFER AIR SUPPORT when target is not seen



Our Aircraft



Enemy

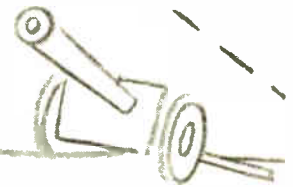

**...and FORD
was asked to find
the answer**

Friendly Troops



Blinding rain! Darkest night! Obscuring clouds! One of these conditions . . . or all three combined . . . deter planes from seeking out and destroying enemy strong points in support of friendly front line troops. That's why the Ford Instrument Company was called in by the Navy to design and build compact, airborne equipment to do this job.

This is typical of the problems that Ford has been given

by the Armed Forces since 1915. For from the vast engineering and production facilities of the Ford Instrument Company, come the mechanical, hydraulic, electro-mechanical, magnetic and electronic instruments that bring us our "tomorrows" today. Control problems of both Industry and the Military are Ford specialties.

You can see why a job with Ford Instrument offers young engineers a challenge. If you can qualify, there may be a spot for you in automatic control development at Ford. Write for brochure about products or job opportunities. State your preference.



FORD INSTRUMENT COMPANY
DIVISION OF THE SPERRY CORPORATION
31-10 Thomson Avenue, Long Island City 1, N. Y.

8

Telecomputing announces...

THE TELEDUCER

Automatically Records Voltage

In Decimal Digits

With 0.1% Accuracy



It offers these important advantages:

Provides 0.1% accuracy (1,000 counts full scale).

Provides for minimum full-scale input of 20 millivolts (20 microvolts per count).

Requires only 0.8 second or less for balancing.

Uses a simple bridge-balancing circuit.

Reads low voltage without DC Amplification.

Does not hunt or oscillate.

Presents visual reading of voltage on neon indicator bank.

Permits tabulated digital output when used with Program Unit and Electric Typewriter. (Digital recording in punched IBM cards or teletype tape available when used with suitable program units.)

Computing Service

Your computing and data reduction problems, large or small, can be handled quickly, efficiently by Telecomputing's staff. Time and cost estimates will be presented if you will send information defining your problem.

TELEDUCER Technical Bulletin 104 and Technical Bulletins 106 and 107, giving specifications on the Program Unit and Electric typewriter, will be mailed you upon request. Coupon below is for your convenience.

TELECOMPUTING

CORPORATION
BURBANK, CALIFORNIA

Mr. Preston W. Simms, Dept. IRE-9
Telecomputing Corporation, Burbank, California

Please send me Teleducer Bulletin 104.

Please send me Bulletins 106 and 107 on the Program Unit and Electric Typewriter.

Name _____

Company _____

Street Address _____

City and State _____

At Last! STANDARD COMPONENTS to mount your circuitry in vertical planes that SAVE SPACE... SAVE PRODUCTION COST... ARE NATURALS FOR PLUG-IN CONSTRUCTION

It's as simple as this —



ALDEN PRE-PUNCHED TERMINAL MOUNTING CARDS pre-cut to proper size for Alden 7-pin, 9-pin, 11-pin and 20-pin Plug-in Packages. Or in 3' strips for chassis — cut it off as you require.

ALDEN MINIATURE STAKING TERMINALS mount in any pattern on Terminal Mounting Cards. Ratchet slots hold elements for soldering without pliering or wrap-around.

ALDEN JUMPER STRIP stakes right under Terminals providing common circuit without soldering.

ALDEN CARD MOUNTING TUBE SOCKETS for miniature 7-pin and 9-pin and octal tubes.

ALDEN TERMINAL CARD MOUNTING SYSTEM

Take the above basic components, lay them out on full scale Planning Sheets found in



Alden Handbook. Following the Plan Sheet, Miniature Terminals and Tube Sockets stake into place on Card.

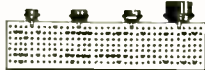

We can do it for you if you have volume production, so Cards come to you ready

to snap electronic elements and wiring into place for quick soldering.



Both sides can

be used for wiring



Your design and production are simplified. Wiring is an open, easy-to-work sub-assembly, so units can come through production independently or be easily subcontracted.

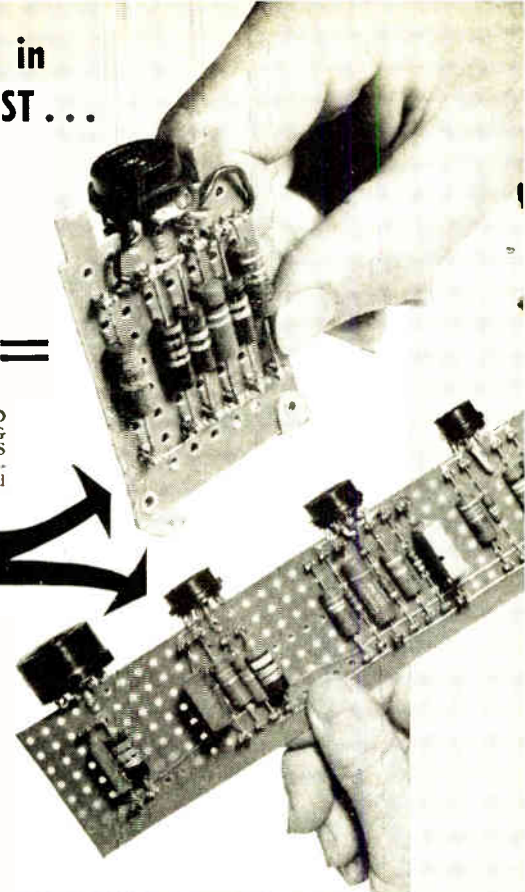

— and how beautifully these circuitry planes become plug-ins

4 SIZES OF PLUG-IN PACKAGES

Alden standard Bases, Lids, Handles, Cans, Sockets for 7, 9, 11 and 20-pin packages house Terminal Card Circuitry with tremendous flexibility for endless variety of open and shielded packages — making it easy and inexpensive to give your equipment reliability in service with instantly replaceable plug-ins for all sub-units.

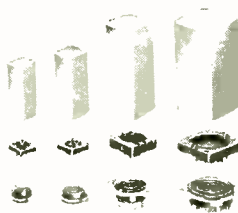

7-pin 9-pin 11-pin 20-pin
Package components and matching sockets.

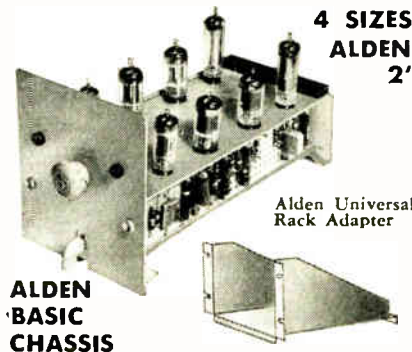

ALDEN BASIC CHASSIS

4 SIZES OF ALDEN BASIC CHASSIS 2", 4", 8", 17"

Your circuitry on Terminal Card strips snaps right into Alden Basic Chassis. Vertical mounting and hinged front panel give beautiful accessibility and space saving. Chassis can be plugged into Standard Racks, Alden Uni-Racks, Alden Portable Cases. Alden Rack Adapter mates Standard Rack to Chassis.



Plugged into Standard Racks



Plugged into Alden Uni-Racks



Plugged into Portable Cases



ALDEN PLUG-IN PACKAGE

— and how easy to assign to each plug-in unit a tiny tell-tale to spot trouble instantly



See how compact front panel easily mounts six tiny Alden Sensing Elements — specifically designed to tick the problem of having only a small amount of space. Assembled by simplest methods.



ALDEN MINI-TEST POINT JACK
For checking critical voltages from front of panel.



ALDEN "PAN-i-LITE"
Miniature indicator light with unbreakable 1-piece light-lens unit replaceable from front.



ALDEN "FUSE-LITE"
Fuse blows — Lite glows. Simply unscrew 1-piece light-lens unit and blown fuse comes out with it.

— and to organize circuitry for 1 point of check, with 30-second replacement

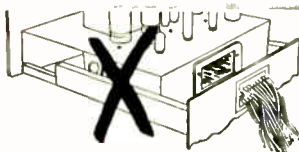

Alden's new concept in Rack-and-Panel Connectors, eliminates congested rats' nest of blind wiring and provides —

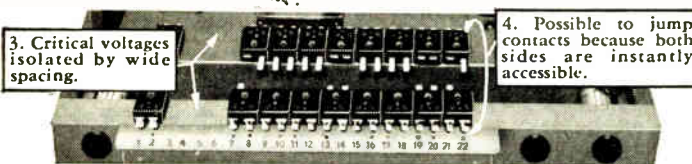

3. Critical voltages isolated by wide spacing.

4. Possible to jump contacts because both sides are instantly accessible.

1. Connectors are spread out in an orderly row, giving a accessible, identified by number and color-coding.

All you need is this Kit —

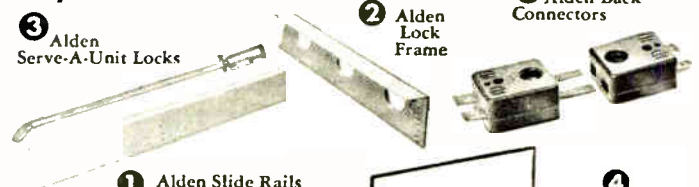

It's as simple as this —

Arrange Alden Side Rails (1) and Alden Lock Frame (2) to suit your chassis. Alden Serve-A-Unit Locks (3) mount in your chassis to engage pre-punched holes in Alden Lock Frame (2) to pilot, draw in, lock or eject.

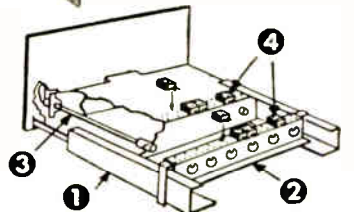

GET THE COMPLETE STORY — REQUEST "ALDEN HANDBOOK" — SENT FREE

ALDEN PRODUCTS CO. 121 N. Main St., Brockton 64, Mass.

NA-ALO

They're Here!

Corrosion-Resistant Pygmy Motor Generators

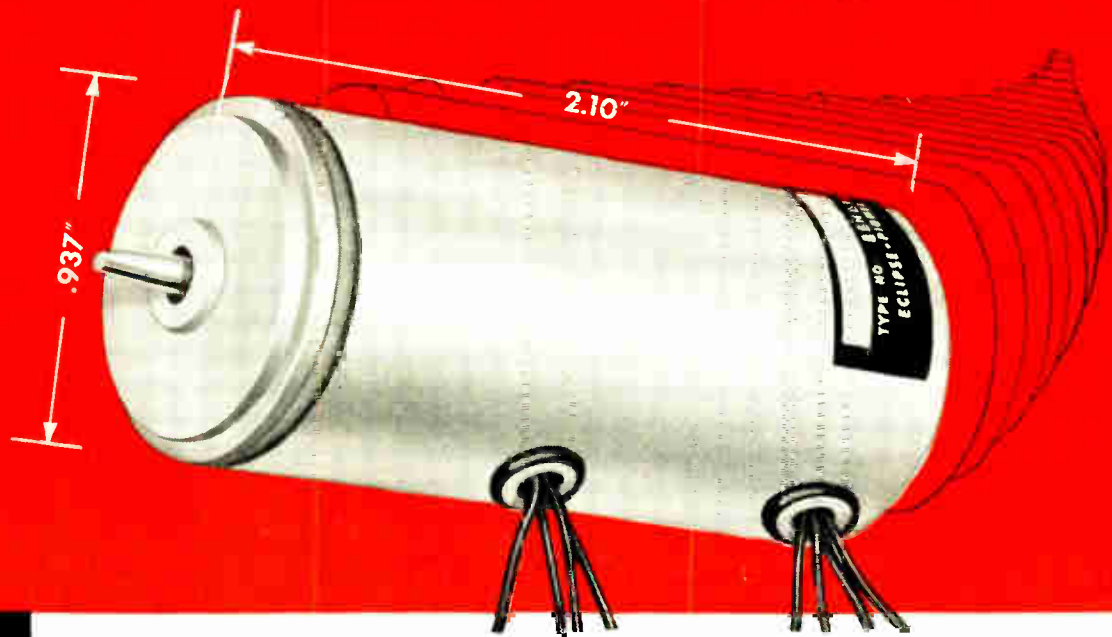

by *Eclipse-Pioneer*

TYPICAL ELECTRICAL CHARACTERISTICS

GENERATOR DATA

Linearity— $\frac{1}{2}$ of 1% to 4000 rpm
Output—300 mv/1000 rpm with
18 volt, 400 cycle excitation
Null—10 mv or less

MOTOR DATA

18 or 26 volt, 400 cycle, 2-
phase low inertia motor

For further information, write Department G.

ECLIPSE-PIONEER DIVISION OF ...

TETERBORO, N. J.

Export Sales: Bendix International Division
205 East 42nd St., New York 17, N. Y.

World Radio History



1,000,000 Capacitors . . .

and Not a Defective One in the Lot

(so a customer told us)

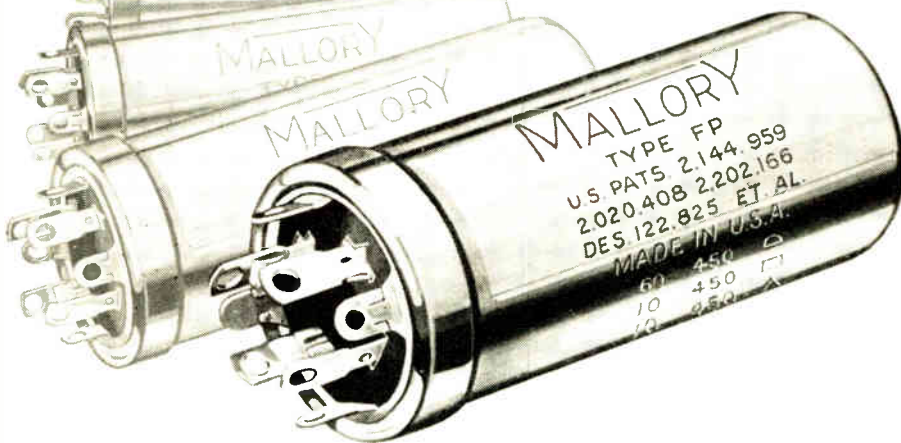

Whenever you have a problem involving capacitors or related circuits, get in touch with us. Our engineers will be glad to work with you. If you want complete data on any of the following types of capacitors, write us for literature.

Dry Electrolytic Capacitors
 Normal applications
 Temperature extremes
 Sub-miniature size

Paper Dielectric Capacitors
 Metal tubulars
 Bathtubs
 Noise suppression

A customer who buys Mallory Capacitors at the rate of a million or more per year, reported their records showed not a single field reject during the past twelve months.

Actually there may have been some defective units during that time. It hardly seems possible to make a million of anything with a perfect score.

But, the significant point is that this customer . . . like many others . . . has found by experience that the reject ratio on Mallory Capacitors is lower than that of any other supplier they deal with.

Unusual story? Not at all. This kind of dependability is the natural result of the exacting standards for manufacturing and quality control you find at Mallory. You are assured of absolute uniformity when you buy Mallory Capacitors . . . whether it is a hundred or a million.

Expect more . . . Get more from **MALLORY**

Parts distributors in all major cities stock Mallory standard components for your convenience

P. R. MALLORY & CO., Inc.
MALLORY

SERVING INDUSTRY WITH THESE PRODUCTS:
 Electromechanical—Resistors • Switches • Television Tuners • Vibrators
 Electrochemical—Capacitors • Rectifiers • Mercury Batteries
 Metallurgical—Contacts • Special Metals and Ceramics • Welding Materials

P. R. MALLORY & CO., INC., INDIANAPOLIS 6, INDIANA

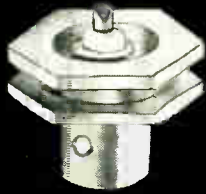

UG-569/U



UG-572/U



UG-643/U



UG-571/U



UG-573/U



UG-564/U



UG-565/U

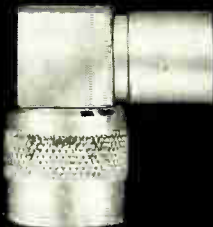

UG-567/U

CONNECTORS

by **KINGS**

C Series Connectors are a greatly improved mechanical and electrical type of co-axial connector. They are constant impedance and are designed for use with 50 ohm, middle size RF cables.

The C Series like every co-axial connector made by Kings is the result of constant research and development. Engineering ingenuity and precision manufacture have put "Connectors by Kings" in the front-line of communications equipment for industry and the armed services.

If you have a connector problem consult Kings. You'll be glad you called on Kings first.



KINGS *Electronics* CO., INC.

40 MARBLEDALE ROAD, TUCKAHOE, N. Y.

NEW

K-LOK*

DISC CERAMICONS

A Great Forward Development in

STABILITY

A Premium High Dielectric Constant Ceramic Capacitor

(PAT. APPLIED FOR)

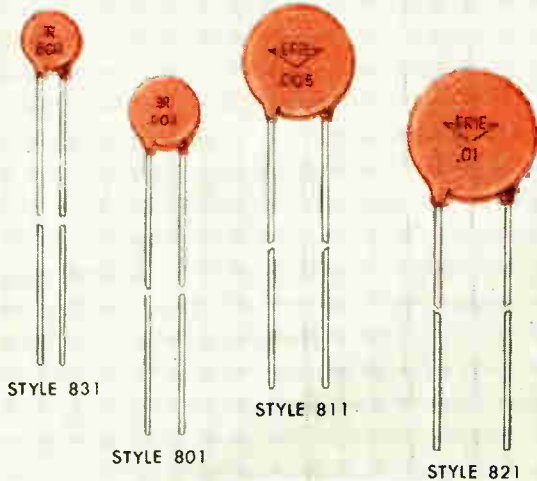

STYLE	CAPACITANCE RANGE—MMF
831	220-540
801	540-850
811	850-2500
821	2500-4500

Tolerances: $\pm 5\%$, $\pm 10\%$, $\pm 20\%$, GMV

ERIE takes pride in announcing this significant advance in ceramic capacitor design and application. K-LOK dielectric is the result of several years development activity having one planned objective — to produce premium performance characteristics in High-K ceramic capacitors.

In K-LOK we have achieved the enviable combination of high capacitance and really substantial stability under environmental extremes. The K-LOK is being produced and sold in addition to the standard line of ERIE Hi-K Ceramicons.

OTHER FEATURES TO BE NOTED ARE:

- Power Factor: 1% maximum
- Insulation Resistance: 10,000 megohms minimum
- Protective Insulation: Low loss phenolic dip for moisture seal and mechanical ruggedness
- ERIE K-LOK ceramic can be used on special order in supplying various high voltage disc capacitors and printed circuits

① FLAT TEMPERATURE CHARACTERISTIC

Greatest capacitance change from 25°C value:
 + 5%, - 5% from - 55°C to + 105°C
 + 5%, - 10% from - 55°C to + 125°C

② STABILITY WITH AGE

1% maximum capacitance decrease per decade of time.

③ LINEAR CIRCUIT OPERATION

Both voltage coefficient of capacitance and piezo-electric effect are low.

④ IMPROVED LIFE RATING:

up to 1000 VDCW 85°C
 up to 500 VDCW 125°C

Samples available on request

*TRADE MARK

ERIE components are stocked by leading electronic distributors everywhere.



ERIE RESISTOR CORPORATION . . . ELECTRONICS DIVISION

Main Offices: ERIE, PA.

Sales Offices: Cliffside, N. J. • Philadelphia, Pa. • Buffalo, N. Y. • Chicago, Ill.
 Detroit, Mich. • Cincinnati, Ohio • Los Angeles, Calif.

Factories: ERIE, PA. • LONDON, ENGLAND • TORONTO, CANADA

NOW

24 hour TAPE RECORDING *..NON-STOP!*

Records Every Word—TIMED TO THE MINUTE



Model D-24
Dual Channel

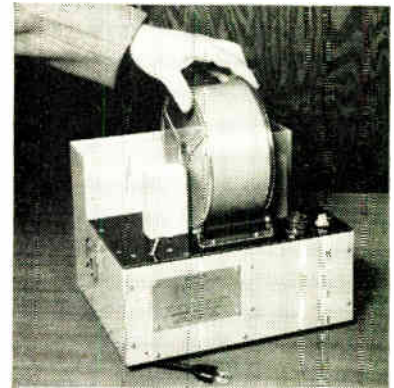

Erase the 24-hour tape in just 20 seconds — simply by rotating the reel in the SoundScriber Tape Demagnetizer!

NEW SoundScriber 24-hour Tape Recorder **INVALUABLE for Monitoring all Communications**

Continuous, uninterrupted, unattended magnetic tape recording for a full 24-hour day—with the time printed on the tape to indicate the exact minute of recording—that's the story of this new SoundScriber 24-Hour Tape Recorder, already proved in hundreds of military installations.

This new SoundScriber development is versatile, trouble-free, requires no attention during operation. It records a single channel, or dual channels simultaneously, from microphones, incoming lines, or a combination of both. Built-in speaker or accessory headphones allow instant "listening-in" while recording or playing back.

The 24-hour reel of tape, only seven inches in diameter, makes a complete, economical, permanent automatically timed record of a full day's communications . . . or is easily

erased for repeated re-use. Longer recording periods, almost unlimited in time, can be attained through simple modifications.

SoundScriber's unique mechanical design operates at approximately 1/60 the speed of conventional tape recorders —assures longer life and minimum service attention.

Contained in a sturdy aluminum carrying case, the SoundScriber 24-Hour Recorder operates from standard electrical outlets. The chassis is easily removed for mounting in conventional 19" rack.

The 24-Hour Recorder meets JAN specifications. It is now available for immediate delivery to commercial and other users.

Designed and produced
by the manufacturers of

Sound Scriber

D I C T A T I N G E Q U I P M E N T

TRADEMARK

MAIL COUPON TODAY FOR FURTHER INFORMATION

The SoundScriber Corporation
New Haven 4, Conn., USA

IRE-9

I want to know more about your 24-Hour Tape Recorder. Please send further data and sample of tape.

Name _____

Address _____ City _____

Kind of Business or Operation _____

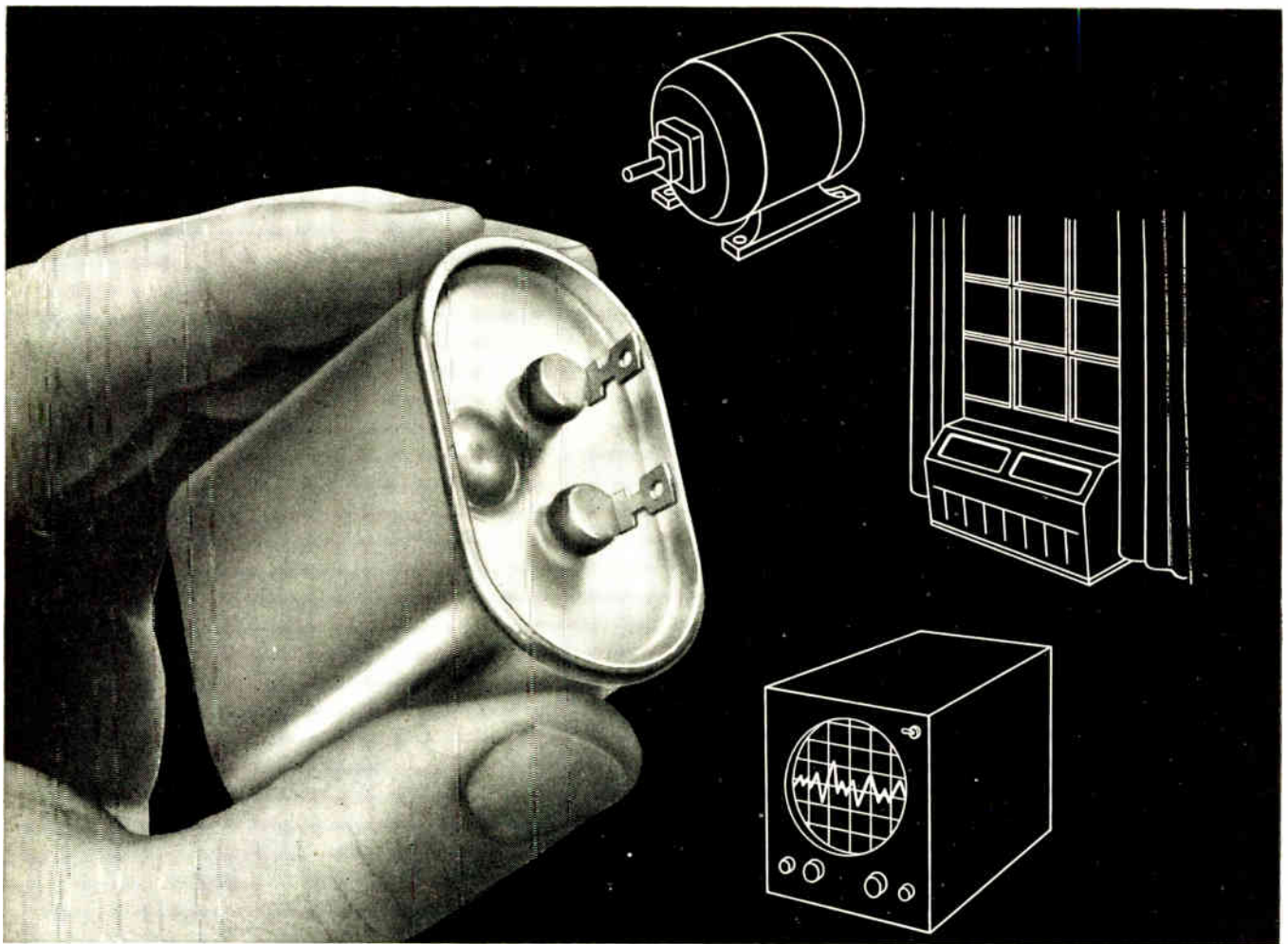

New oval-shaped General Electric capacitor saves space and weight in your electric equipment

If you're using fixed paper dielectric capacitors in case styles CP 53 and CP 70 it will pay you to consider General Electric drawn-oval units. These drawn-oval capacitors provide unsurpassed reliability combined with the important advantages of permitting smaller size, less weight and lower cost in the electric equipment you manufacture.

RATINGS range from 1 to 10 muf, 600 to 1500 volts dc, or 330 to 660 volts ac. Choice of mounting arrangements makes them ideally suited for air-conditioning units, electronic equipment, motors and controls or other applications where units capable of meeting all electrical and mechanical requirements of MIL-C-25A specs, except for case dimensions and markings, are desirable.

DOUBLE-ROLLED SEAM attaches cover to drawn-steel

case—producing a lighter, yet stronger capacitor. Actual savings in size and weight vary with case style and rating but can amount to as much as 30%. Depending upon case style and quantity ordered, prices average 10 to 20% lower than for rectangular capacitors.

MOUNTING VERSATILITY is provided by choice of three bracket styles for upright, inverted and side mounting to suit individual mounting requirements.

For more information on the new G-E drawn-oval capacitors, their ratings, dimensions and prices, contact your local G-E apparatus sales representative or write for Bulletin GEA-5777, General Electric Co., Section 442-10, Schenectady 5, N. Y.



You can put your confidence in—

GENERAL  ELECTRIC



Seal shown actual size

Look again!

See an individual sub-miniature hermetic seal with a barrel diameter of .100. We make others as small as .090. For the tiniest mounts in the world.

These glass-metal seals are particularly adaptable for rectifiers, hearing aids . . . for many other components that you may have thought couldn't be hermetically sealed because of their almost infinitesimal size.

Now, you know to what extremes of diminution HERMETIC can go to satisfy the requirements of industry and the Services. Above all, you should know that HERMETIC manufactures the largest line of hermetic seals available anywhere; the quality line that has attracted the greatest number of users because these are the only seals you can hot tin dip at 525° F. for easy assembly soldering, for a strain and fissure-free sealed part with

resistance of over 10,000 megohms. They will also withstand sub-zero conditions, swamp test, temperature cycling, high vacuum, high pressure, oils, compounds, chemicals, corrosion, salt water immersion and spray, and are available in RMA color code.

Seal illustrated is No. 1625-2; also available in .100 is No. 1625-1; and SK-2170-2 with barrel diameter of .090. New multi-header sub-miniatures may be had with a variety of terminations.

Write for information concerning your own problems and for a copy of our 32-page catalog.



Hermetic Seal Products Co.

29 South Sixth Street, Newark 7, New Jersey

F I R S T A N D F O R E M O S T I N M I N I A T U R I Z A T I O N

PROCEEDINGS OF THE I.R.E.

September, 1953

33A

CUT MANUFACTURING COSTS

With high quality Sylvania Tungsten and Chemical Products

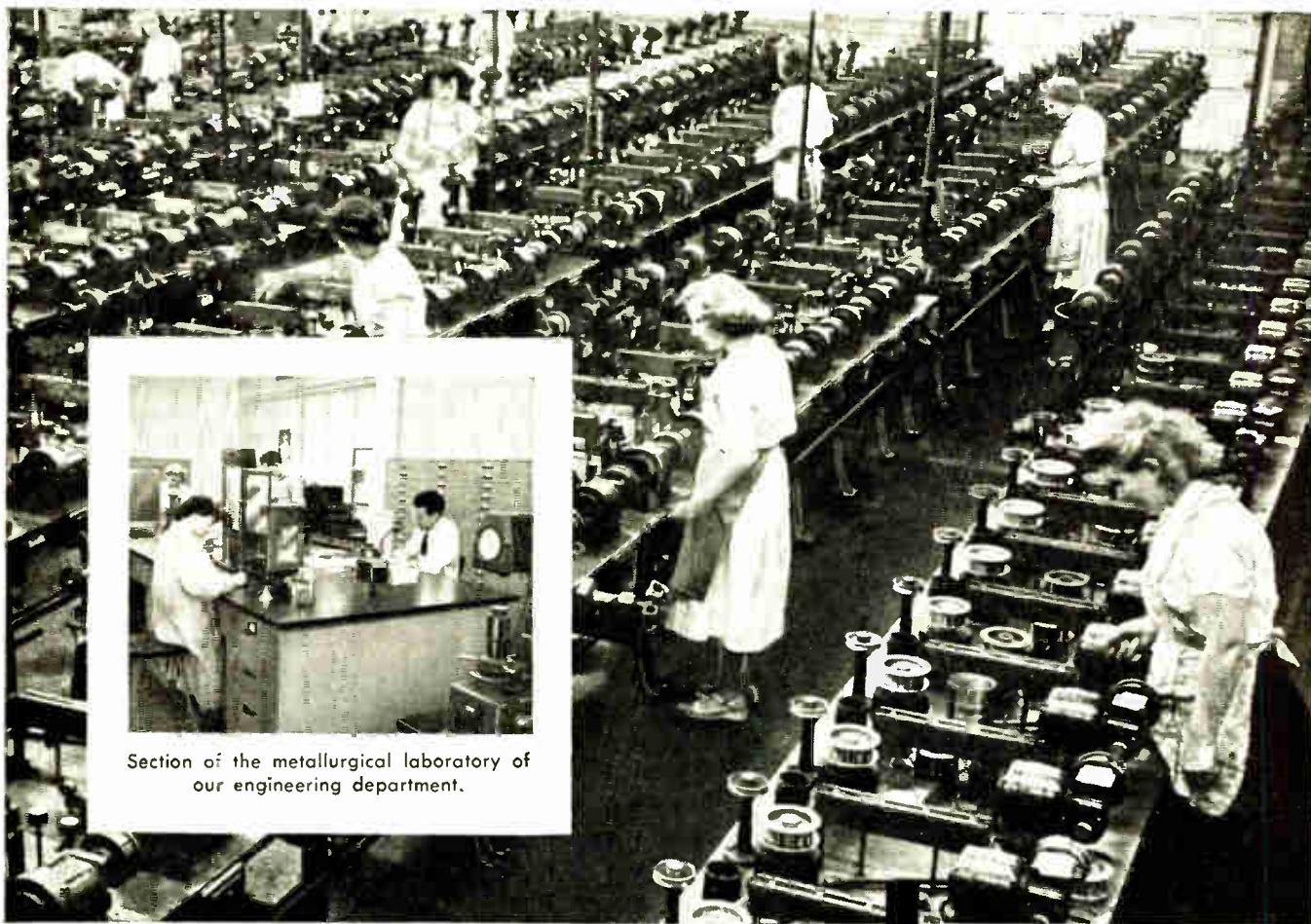

Section of the metallurgical laboratory of our engineering department.

General view of Sylvania tungsten wire drawing department at our Towanda, Pa. plant.

You take no chances—save time and money—when you use Sylvania tungsten and chemical products. Sylvania tungsten is quality controlled from ore to finished product, tested in the laboratory, in the field. Suppliers to all leading manufacturers in the radio and television industry, Sylvania offers you tungsten and chemical products that meet the highest standards of purity, precision, and uniformity.

To help you work out any special high quality product or solve your toughest manufacturing problems, Sylvania maintains large metallurgical and chemical laboratories. If it's a question of anything from a precision, custom-made tungsten component, a special high-purity phosphor, chemical or compound, to silicon or germanium for crystals, put it up to Sylvania. A note on your letterhead brings you full particulars. Address: Sylvania Electric Products Inc., Dept. 3T-4509, 1740 Broadway, New York 19, N. Y.

SYLVANIA

LIGHTING • RADIO • ELECTRONICS • TELEVISION

In Canada: Sylvania Electric (Canada) Ltd., University Tower Building, St. Catherine St., Montreal, P. Q.

Tungsten

Radio Heater and Grid Wire
Support Wire and Rod
Gold Plated Wire
Ground Seal Rod
Formed or Ground Parts
Cut and Bevelled Pieces
Hand Wound Coils

**Special High Purity
Chemicals and Compounds**
Potassium Silicate • Etching Inks
Carbonate Emission Coatings
Mica Spray Coatings
Basing Cements

Metal Powders
Silicon • Germanium
Phosphors
Cathode Ray Tube Phosphors



For over **20** years . . .

**A
GOOD PLACE
TO GET
GOOD
RESISTORS**

**JAN-R-11
TYPES**

Styles RC10, RC20,
RC21, RC30, RC31,
RC41, and RC42.

Write for Bulletin J2

$\frac{1}{2}$ -, 1-, and 2-watt fixed composition
types in all RTMA 5%, 10%, and 20%
preferred values.

. . . also automotive ignition suppression
and voltage regulation; fluorescent starting; protective
surge; and other special purpose types to your exact
specifications.



STACKPOLE

Electronic Components Division
STACKPOLE CARBON COMPANY
St. Marys, Penna.

for performance **ABOVE** and **BEYOND**
the usual standards . . .

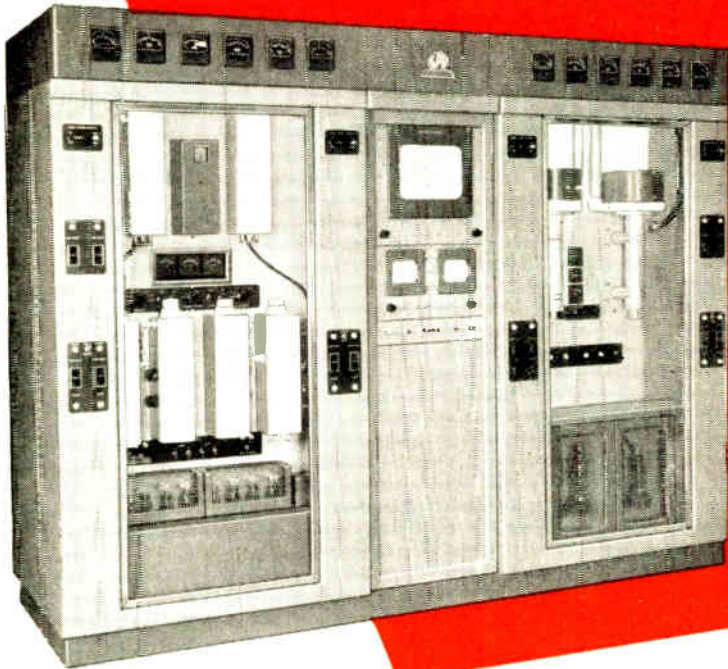

the **GPL**
Continental
UHF-TV
TRANSMITTER

■ Precision-built by the makers of the world's most powerful transmitting equipment—for the Voice of America—the GPL-Continental TV Transmitter offers quality and construction superior to accepted standards of today.

Exclusive "Frequilock" feature provides aural-visual frequency control of $4.5 \text{ mc} \pm 500$ cycles or better, even as high as 890 mc. No more intercarrier buzz! In addition to the console unit there is ample rack space for picture and waveform monitors. Transmitter controls may also be operated from the rack. With simplified power and

control circuits, manual controls are minimized.

It is designed for compactness and maximum accessibility. In addition, it is housed in unit-construction, frameless type cabinet in which cabinet members serve not only as equipment mounting panels, but also as an efficient duct system through which cooling air is circulated.

This 1 KW transmitter is arranged for ready expansion to greater output, or the exciter only may be operated as a small community station with 250 watts output.

Write for full details on the GPL-Continental PA-714 1 KW Transmitter

— "THE INDUSTRY'S LEADING LINE IN QUALITY, IN DESIGN" —



Check these features of the *Continental* 1 KW UHF Transmitter

- Maximum accessibility
- Simplified power and control circuits.
- Completely air-cooled.
- Space-conserving cabinet design — Transview styling.
- May be operated without console — plenty of rack space (63") in centrally located panel on transmitter for picture and waveform monitors.
- Single output tube operation for each power amplifier.
- Built-in VSWR metering — continuous power measurement.
- Exciter is a 250-watt transmitter for all UHF channels.
- Complete flexibility for future power increase.
- Features Continental's new "Frequency-lock"—new development in frequency control provides aural-visual frequency control of $4.5 \text{ mc} \pm 500$ cycles or better, even as high as 890 mc. No more intercarrier Buzz.
- Delivery of immediate orders in December, 1953.

GPL MEETS EVERY STATION REQUIREMENT WITH EQUIPMENT OF SUPERIOR QUALITY AND UTILITY



CAMERA CHAINS — Extremely compact, readily portable, built for combined studio and field use. Choice of major networks for their top live programs. Exclusive remote control features provide pan, tilt, iris and lens change from 1000 feet away.



PA-100-A TV PROJECTOR — A truly professional 16 mm projector to meet the continuous-service, minimum maintenance requirements of economical film telecasting. Ruggedly built, it provides crisp, bright pictures as well as high fidelity sound. Sound frequency response flat to 7000 cycles. Sound flutter kept at less than 0.25%. Adjustable tone controls compensate for poor sound films.



VIDEO RECORDERS — A complete high-quality TV recording System which produces standard 16 mm 24 frames per second film. Images are reproduced in negative or positive on emulsion 7373 or 7302 or equivalent. Finest picture resolution, high quality recorded sound.

General Precision Laboratory

INCORPORATED
PLEASANTVILLE NEW YORK



Export Department:
13 East 40th St., New York City
Cable address: Arlob

Cable address: Pnelob

TV Transmitters • TV Camera Chains • TV Film Chains • TV Field and Studio Equipment • Theatre TV Equipment



electronic wire and cables for standard and special applications

Whether your particular requirements are for standard or special application, choose *LENZ* for the *finest* in precision-manufactured electronic wire and cable.

GOVERNMENT PURPOSE RADIO AND INSTRUMENT HOOK-UP WIRE,

plastic or braided type, conforming to Government Specification JAN-C-76, etc., for radio and instruments. Solid or flexible conductors, in a variety of sizes and colors.



RADIO AND INSTRUMENT HOOK-UP WIRE,

Underwriters Approved, for 80° C., 90° C. and 105° C. temperature requirements. Plastic insulated, with or without braids.



RF CIRCUIT HOOK-UP AND LEAD WIRE

for VHF and UHF, AM, FM and TV high frequency circuits. LENZ Low-Loss RF wire, solid or stranded tinned copper conductors, braided, with color-coded insulation, waxed impregnation.



SHIELDED MULTIPLE CONDUCTOR CABLES

Conductors: Multiple—2 to 7 or more of flexible tinned copper. Insulation: extruded color-coded plastic. Closely braided tinned copper shield. For: Auto radio, indoor PA systems and sound recording equipment.



SHIELDED COTTON BRAIDED CABLES

Conductors: Multiple—2 to 7 or more of flexible tinned copper. Insulation: extruded color-coded plastic. Cable concentrically formed. Closely braided tinned copper shield plus brown overall cotton braid.



SPECIAL HARNESSES,

ords and cables, conforming to Government and civilian requirements.



SHIELDED JACKETED MICROPHONE CABLE

Conductors: Multiple—2 to 7 or more conductors of stranded tinned copper. Insulation: extruded color-coded plastic. Closely braided tinned copper shield. Tough, durable jacket overall.



JACKETED MICROPHONE CABLE

Conductors: Extra-flexible tinned copper. Polythene insulation. Shield: #36 tinned copper, closely braided, with tough durable jacket overall. Capacity per foot: 29MMF.



TINNED COPPER SHIELDING AND BONDING BRAIDS

Construction: #34 tinned copper braid, flattened to various widths. Bonding Braids conforming to Federal Spec. QQ-B-S75 or Air Force Spec. 94-40229.



PA AND INTERCOMMUNICATION CABLE

Conductors: #22 stranded tinned copper. Insulation: textile or plastic insulated conductors. Cable formed of Twisted Pairs, color-coded. Cotton braid or plastic jacket overall. Furnished in 2, 5, 7, 13 and 25 paired, or to specific requirements.



Lenz Electric Manufacturing Co.

1751 N. Western Ave., Chicago 47, Illinois

ords, cable and wire for radio ♦ p. a. ♦ test instruments ♦ component parts

Regardless of conditions— BLAW-KNOX CAN BUILD YOU A BETTER TV TOWER

Years of experience—more than four decades, in fact—have given Blaw-Knox the edge in designing, fabricating and erecting antenna towers for any purpose and any location. Blaw-Knox TV towers are on the job in widely separated geographical areas . . . in wide open fields, atop buildings in crowded cities and even grounded in salt water. Some have TV antennas already mounted—others have built-in provisions for TV when licenses are granted—all are heavily galvanized for longer life.

Whether you need a 100 ft. self-supporting structure or a 1000 ft. guyed tower to meet your requirements—whether for AM, FM, TV or Microwave—write or call today for capable engineering assistance with your plans.

BLAW-KNOX

BLAW-KNOX COMPANY
BLAW-KNOX EQUIPMENT
DIVISION
PITTSBURGH 22, PA.

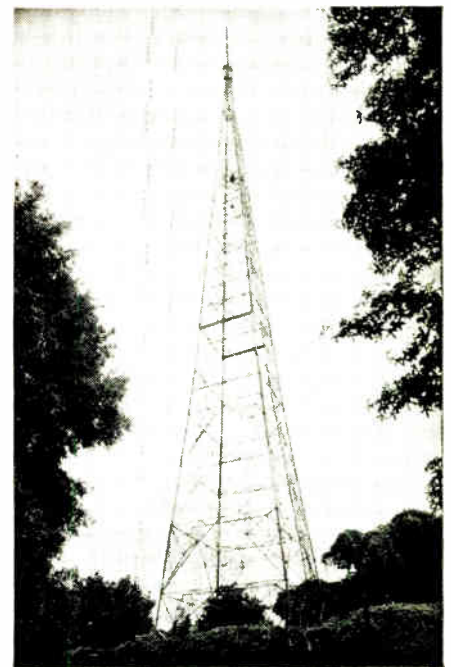
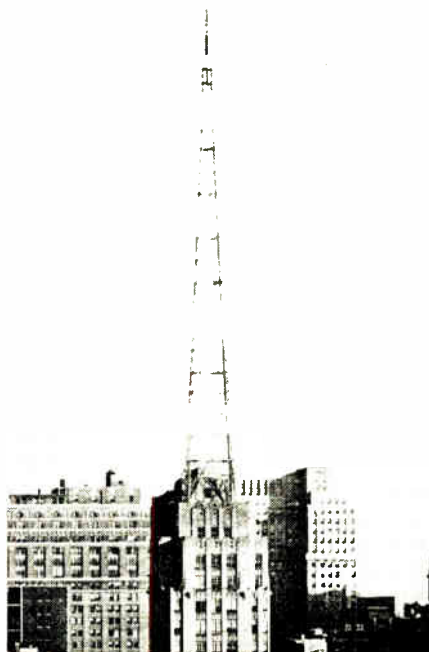
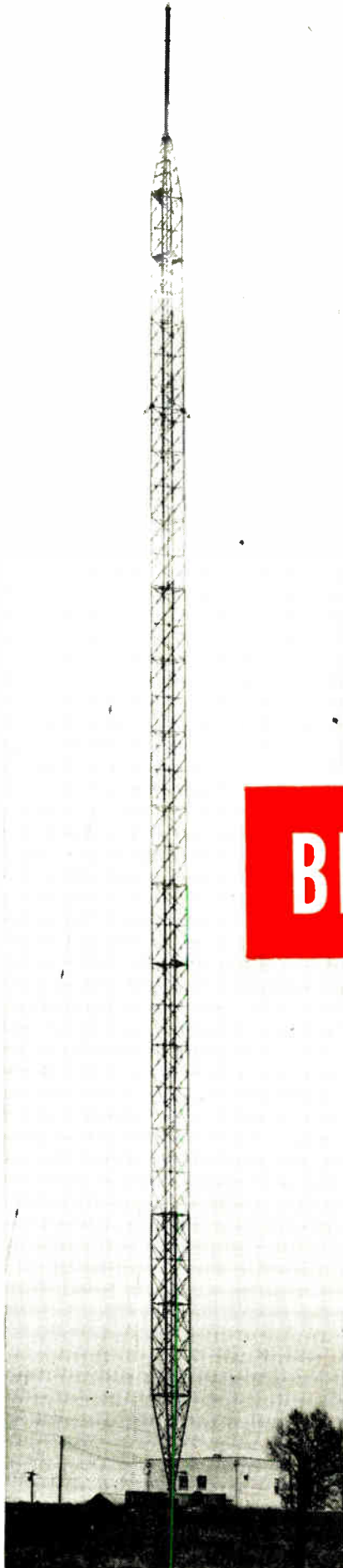



Filters

by **TRIAD**

Designed by Triad to meet exacting military requirements for airborne telemetering equipment, the tiny electric wave filter shown above actually contains eleven precision components: 2 toroidal inductors, 5 JAN-C-5 capacitors, and 4 precision wire-wound resistors. The resulting attenuation slope is over 50 decibels per octave.

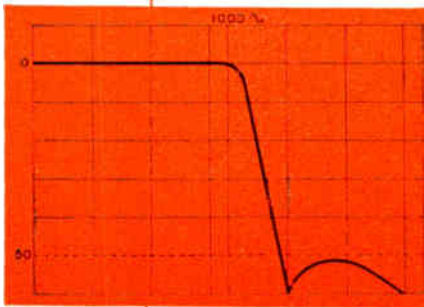

The same brilliant design and controlled manufacturing that goes into Triad's distinguished line of hermetically sealed military transformers is available to you for licking the toughest wave filter problems. Call Triad first!

For specifications and prices on Triad's general line of transformers, write for Catalog TR-53H



BALLANTINE

STILL THE FINEST IN ELECTRONIC VOLTMETERS



Ballantine Model 300

SENSITIVE ELECTRONIC VOLTMETER

Featuring a Logarithmic Voltage Scale and Uniform Decibel Scale

- Measures 1 millivolt to 100 volts over a frequency range from 10 to 150,000 cycles on a single logarithmic scale by means of a five decade range selector switch.
- Accuracy: 2% at any point on the scale over the ENTIRE RANGE.
- Input Impedance: $3\frac{1}{2}$ megohm shunted by 30 mmfds.
- Generous use of negative feedback assures customary Ballantine stability.
- Output jack and output control permit voltmeter to be used as a flat high gain (70DB) amplifier.
- Available accessories permit range to be extended up to 10,000 volts and down to 20 microvolts.
- Available Precision Shunt Resistors convert voltmeter to microammeter covering range from 1 to 1000 microamperes.

For additional information on this Voltmeter and Ballantine Battery Operated Voltmeters, Wide-Band Voltmeters, Peak to Peak Voltmeters, Decade Amplifiers, Inverters, Multipliers and Precision Shunt Resistors, write for catalog.

BALLANTINE LABORATORIES, INC.

102 Fanny Road, Boonton, N.J.



Why
Hughes Diodes
have set

**A
NEW
STANDARD
OF
RELIABILITY**

Reliability in a germanium diode is determined principally by permanent freedom from the two major causes of diode failure—moisture penetration of the diode envelope, and electrical instability under extreme operating conditions.

HUGHES GERMANIUM DIODES are designed to prevent such failures through two exclusive features:

1. Fusion Sealing—The glass-to-metal seal, proved in billions of vacuum tubes, is incorporated to full advantage in diode manufacture by the Hughes-developed process of fusion sealing at high temperature. The result is a rigid *one-piece* glass envelope making moisture penetration impossible.

2. 100% Testing—One hundred per cent testing insures the satisfactory operation of **HUGHES DIODES** under adverse conditions of moisture, temperature, vibra-

tion and severe shock. Hughes testing procedures *invite* instabilities to occur prior to shipment and assure rejection of every defective diode. Each **HUGHES DIODE** is humidity-cycled, temperature-cycled, JAN shock-tested, and electrically tested under vibration.

Reliability of **HUGHES DIODES** has been proved in airborne military electronic equipment for navigation, fire control and guided missiles. The same high standard required for these uses is your insurance against costly shutdowns, high maintenance expense and time losses.

Specify **HUGHES DIODES** wherever reliability is essential.

Fusion sealed in glass for electrical stability

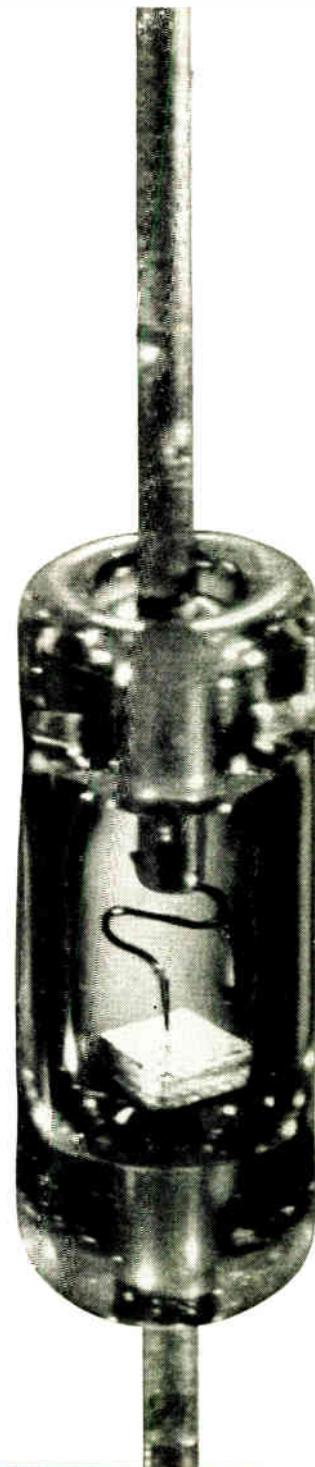

actual size

HUGHES GERMANIUM DIODE ELECTRICAL SPECIFICATIONS AT 25° C.					
Description	RTMA Type	Test Peak Inverse Voltage* (volts)	Maximum Inverse Working Voltage (volts)	Minimum Forward Current @ +1 v (ma)	Maximum Inverse Current (ma)
High Peak	1N55B	190	150	5.0	0.500 @ -150 v
	1N68A	130	100	3.0	0.625 @ -100 v
High Back Resistance	1N67A	100	80	4.0	0.005 @ -5 v; 0.050 @ -50 v
	1N99	100	80	10.0	0.005 @ -5 v; 0.050 @ -50 v
	1N100	100	80	20.0	0.005 @ -5 v; 0.050 @ -50 v
High Back Resistance	1N89	100	80	3.5	0.008 @ -5 v; 0.100 @ -50 v
	1N97	100	80	10.0	0.008 @ -5 v; 0.100 @ -50 v
	1N98	100	80	20.0	0.008 @ -5 v; 0.100 @ -50 v
High Back Resistance	1N116	75	60	5.0	0.100 @ -50 v
	1N117	75	60	10.0	0.100 @ -50 v
	1N118	75	60	20.0	0.100 @ -50 v
General Purpose	1N90	75	60	5.0	0.800 @ -50 v
	1N95	75	60	10.0	0.800 @ -50 v
	1N96	75	60	20.0	0.800 @ -50 v
JAN Types	1N126**	75	60	5.0	0.050 @ -10 v; 0.850 @ -50 v
	1N127†	125	100	3.0	0.025 @ -10 v; 0.300 @ -50 v
	1N128‡	50	40	3.0	0.010 @ -10 v

*That voltage at which dynamic resistance is zero under specified conditions. Each Hughes Diode is subjected to a voltage rising linearly at 90 volts per second.
 **Formerly 1N69A. †Formerly 1N70A. ‡Formerly 1N81A.

Semiconductor Sales Department
Hughes
 AIRCRAFT COMPANY
 CULVER CITY, CALIFORNIA
 Chicago New York City

Address inquiries to Dept. P'R

© 1953, H. A. C.

In addition to RTMA types, HUGHES DIODES are also supplied 100 per cent factory-tested to special customer specifications.



Type J Bradleyometer in single unit construction, without line switch

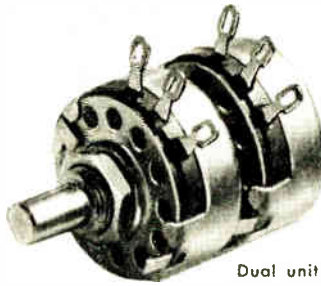

Dual unit

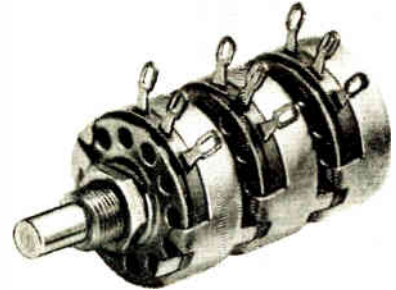

Type J Bradleyometer in triple unit construction

ADJUSTABLE RESISTORS and POTENTIOMETERS

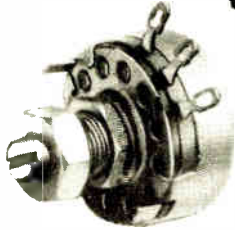

Type J Bradleyometer for screw driver adjustment with bushing shaft lock

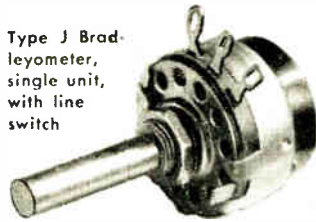

Type J Bradleyometer, single unit, with line switch

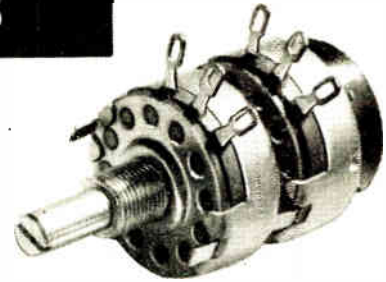

Type J Bradleyometer, of the dual type construction, with line switch

ANY RESISTANCE-ROTATION CURVE

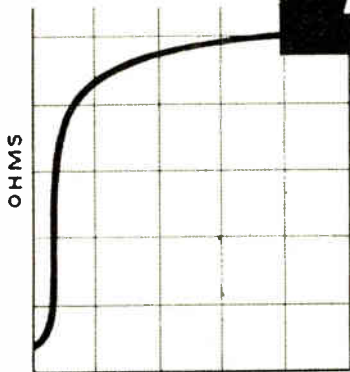

SHAFT ROTATION



During manufacture, the molded resistor can be varied in resistance throughout its circumference. After molding, it is unaffected by temperature or moisture.

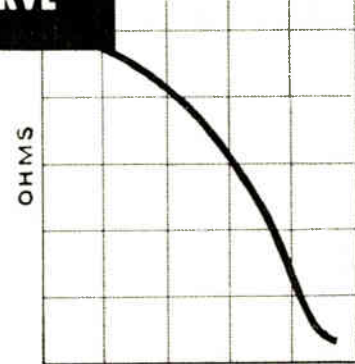

SHAFT ROTATION

QUALITY CONTROLS for CRITICAL CIRCUITS

If you need a potentiometer or adjustable resistor that is not affected by moisture, cold, or age, specify the Allen-Bradley Type J Bradleyometer. It is not a film or paint type resistor. The resistor can be built up to produce any form of resistance-rotation curve.

Allen-Bradley Co., 114 W. Greenfield Ave., Milwaukee 4, Wis.

After molding, the resistor is no longer affected by heat, cold, moisture, or age. There are no rivets, nor welded or soldered connections. The shaft, cover, faceplates, and other metal parts are made of corrosion resistant metal. Let us send you the latest Bradleyometer data.



ALLEN-BRADLEY

FIXED & ADJUSTABLE RADIO RESISTORS

Sold exclusively to manufacturers

QUALITY

of radio and electronic equipment



DIFFUSED JUNCTION GERMANIUM RECTIFIERS

ABSOLUTE MAXIMUM RATINGS — T-55 °C — RESISTIVE LOAD							
DIFFUSED JUNCTION RECTIFIER	1N91	1N92	1N93	1N94	1N151	1N152	1N153
RMS INPUT VOLTAGE (Volts)	—	—	—	130	35	70	105
PEAK INVERSE VOLTAGE* (Volts)	100	200	300	380	100	200	300
PEAK FORWARD CURRENT (Amps.)	0.47	0.31	0.25	1.57	1.57	1.57	1.57
D.C. OUTPUT CURRENT* (Ma.)	150	100	75	500	500	500	500
D.C. OUTPUT CURRENT—CAPACITIVE LOAD (Ma.)	—	—	—	350	350	350	350
D.C. SURGE CURRENT (Amps.)	25	25	25	25	25	25	25
FULL LOAD VOLTAGE DROP (volts peak)	0.5	0.5	0.5	0.7	0.7	0.7	0.7
LEAKAGE CURRENT (Ma., @ rated P.I.V.)	2.7	1.9	1.2	0.8	2.4	1.9	1.2
CONTINUOUS REVERSE WORKING VOLTAGE (Volts D.C.)	30	65	100	185	30	65	100
OPERATING FREQUENCY (Kc)	50	50	50	50	50	50	50
STORAGE TEMPERATURE (°C)	85	85	85	85	85	85	85

*Typical absolute maximum ratings. For other combinations refer to Fig. 1

- **VERY LOW LOSSES** when used for power supplies, battery chargers, filament supplies and switching circuits.
- **HERMETICALLY SEALED** against deteriorating elements. Glass-to-metal seals throughout.
- **MINIATURE SIZE** to facilitate use in all electronic equipments, yet heat losses are dissipated efficiently.
- **DESIGNED** to meet all military humidity tests and shock and vibration requirements.
- **MULTIPLE ARRANGEMENTS** can be made for full wave or bridge circuits up to tens of amperes. Send us your requirements—our engineers will furnish a complete recommendation.

Send for complete specifications: General Electric Co., Section 5293, Electronics Park, Syracuse, New York.

News FROM OUR ADVANCED DEVELOPMENT LABORATORIES

Silicon junction diodes have been successfully operated above 400°F (more than 200°C). This is hotter than the melting point of the lead-tin solder ordinarily used to wire these signal diodes into circuits.



GENERAL ELECTRIC

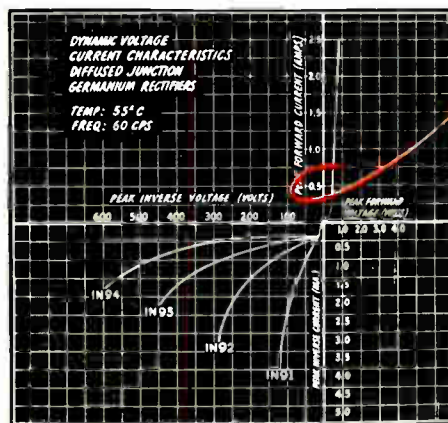

Note: THIS IS ONLY ONE OHM!

Fig. 1

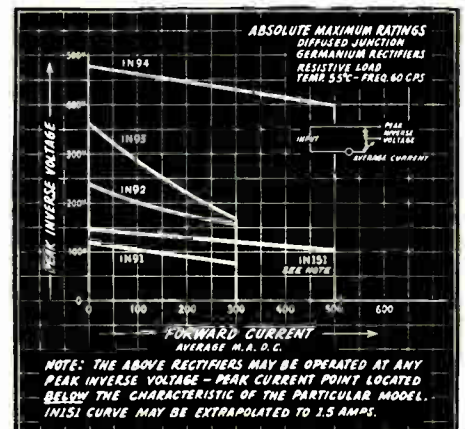



September 1953

Relay Rectifier-Suppressor

International Rectifier Corp., 1521 E. Grand Ave., El Segundo, Calif., has available two types of a new rectifier-suppressor for use with dc relays.

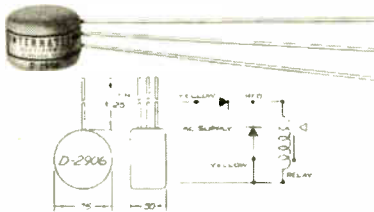

Type D-2906, shown in the photograph, is encapsulated within a thermo-setting plastic material offering complete protection in adverse environmental conditions such as moisture, fungus, salt spray, and corrosive vapors. This unit consists of two elements, one provides half wave rectification of the ac input and the other provides a path for current resulting from the collapse of the magnetic field of the relay coil during the non-conducting half-cycle. This arrangement provides chatter-free operation of the relay.

Type D-2906 measures $\frac{3}{4}$ inch in diameter and 1 inch long and is provided with three pigtail leads. The unit is rated 48 volts maximum input and 5 ma output in 100°C. It is an ideal unit for operation of 30 volt dc relays from an ac supply.

Hollow Shaft Differential

A hollow shaft differential of low inertia (0.0745 oz-in²), minimum backlash (0.10' maximum) and low weight (1 $\frac{1}{2}$ oz.) has recently been developed by Librascope, Inc., 1607 Flower St., Glendale, Calif., manufacturers of analog and digital computers, input-output devices, and components.

Designed for high accuracy in additive and subtractive operations, the mechanism will have primary application to angular or angular-velocity sums and differences, and sequence operations.



The versatility of the hollow shaft design permits the axial positioning of the differential or instrument disassembly. Shrink-on, safety-keyed side gears are available to your specifications. Built with precision ball bearing. The unit has an overall axial length of 1 $\frac{3}{16}$ inches and receives a $\frac{3}{16}$ diameter shaft.

These manufacturers have invited PROCEEDINGS readers to write for literature and further technical information. Please mention your I.R.E. affiliation.

Wideband DC Amplifier

A new wideband dc amplifier, Model 220, designed specifically to increase the sensitivity of cathode-ray oscilloscopes with extended low-frequency response has been developed by Furst Electronics, 3322 W. Lawrence Ave., Chicago 25, Ill. It can be used to extend the range of vacuum tube voltmeters, frequency analyzers and other instruments when unusually low frequencies are encountered.

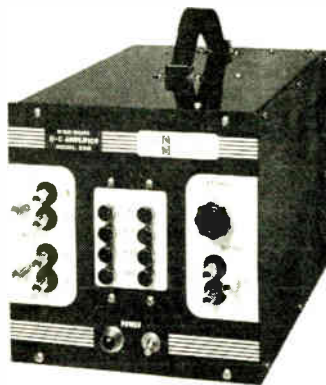

The amplifier uses push-pull amplification and a cross-coupled circuit achieves good stability and low drift. This circuit also provides good phase-inversion for equal results with balanced or unbalanced input signals. When two different signals are applied to the input terminals, the Model 220 acts as a differential amplifier. The difference between the signals appears push-pull at the output terminals.

Two sets of input terminals are provided. The terminals are connected directly to the input attenuators while connected through a pair of coupling condensers to the input posts.

The maximum gain of the amplifier is adjusted to approximately 100 and the input attenuators reduce this gain to approximately 10 and 1 (40 db, 20 db, 0 db). A fourth position on each attenuator grounds the grid of its input tube, a convenient feature when a single-ended signal is applied to one input terminal.

The output impedance of approximately 250 ohms single-ended and 120 ohms push-pull is sufficiently low to obtain a single-ended signal across a low impedance load without unbalancing the output. For this connection a third terminal connected to the ground is located near the push-pull output terminals.

UHF Coaxial Tuned Elements

Granco Products Inc., 36-17 20th Ave., Long Island City 5, N. Y., announces the availability of two types of uhf coaxial tuned elements. Model UHO is an oscilla-



tor element with a built-in 6 AF4 tube. Model UHR is a preselector element. Both models incorporate resonant cavity tuning which features a moving plunger permitting coverage of the entire UHF television band. All elements are completely wired and tested.

Boron Counters

Radiation Counter Labs., Inc., Skokie, Ill., manufacturer of neutron counters, has just complete a production run of what are believed to be the longest boron trifluoride counters ever made. These coun-

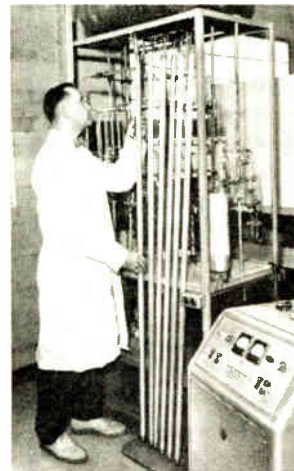

ters, measuring more than six feet in length, are of all aluminum construction. Another unique feature is that they are filled to 120 cm. Hg. of pressure with enriched boron trifluoride gas. Twenty-two of these six foot counters are being used in a group by a leading Southern university for maximum efficiency in detecting neutrons. Similar, but shorter, counters have been found to have a transit time of only one-half microsecond.

RCL has made neutron counters as small as $\frac{3}{4}$ inch in active length up to these elongated six footers. Neutron counters have been filled with as little as 10 cm of BF₃ to as high as 150 cm. Hg. by RCL.

For further information, write Dept. PF-7.

(Continued on page 96A)

**Vacuum Tube Voltmeter
Audio Oscillator
Equalization Filters**

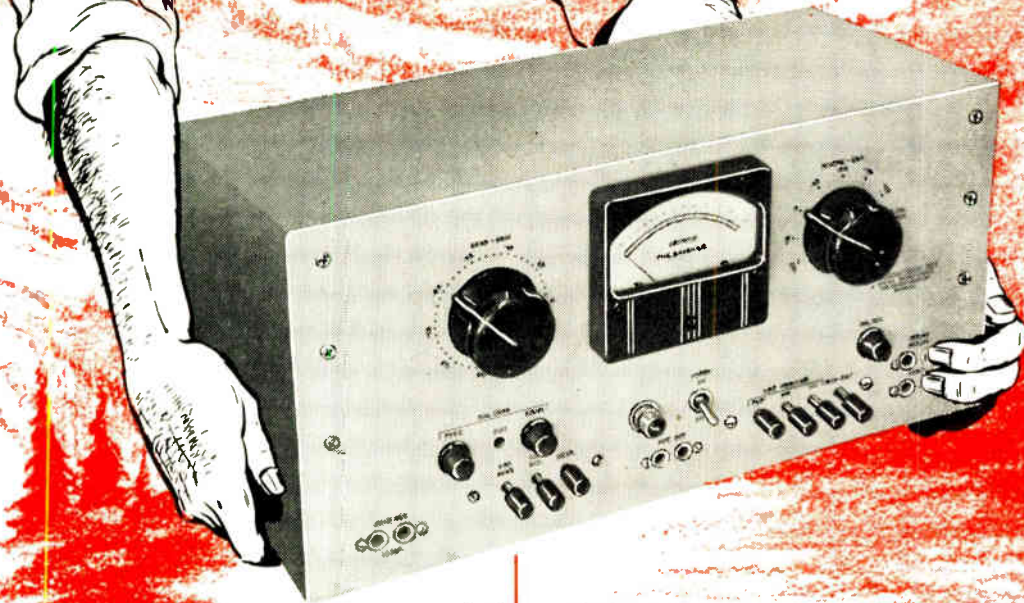

Three-in-one — Easily Portable

**DAVEN
TRANSMISSION
MEASURING SET
TYPE 12-A**

**For Measuring the
Characteristics
of Microwave
Relay Systems**



This unit provides the necessary information on transmission characteristics for the installation of terminal equipment, for the maintenance of terminal equipment, and for the field service of transmission lines and terminal equipment for microwave relay systems.

In one portable unit for efficient field use are combined the functions which normally would be performed by a separate Vacuum Tube Voltmeter, Audio Oscillator and Equalization Filters.

This unit has filters for providing response curves for accurate indication of 144, F1A or flat transmission lines. The 12-A also has provision for measurement of harmonic distortion and has its own self-contained low distortion 1000 cycle oscillator with variable amplitude.

The amplifier of the 12-A provides range levels from plus 20 to minus 80 DBM in calibrated steps of 10 Db. The associated meter is calibrated in 0.5 Db steps. The dynamic characteristics of the indicating meter are such that its response approximates the speed of appreciation of sounds by the ear.

This unit has line blocking capacitors for use across central battery and dial telephone lines.

Write for additional specific information and for catalog material.

THE **DAVEN** co.

195 Central Avenue
Newark 4, New Jersey

WORLD'S LARGEST MANUFACTURERS OF ATTENUATORS

mainstay of dependable transmission

FREQUENCY SHIFT COMMUNICATION

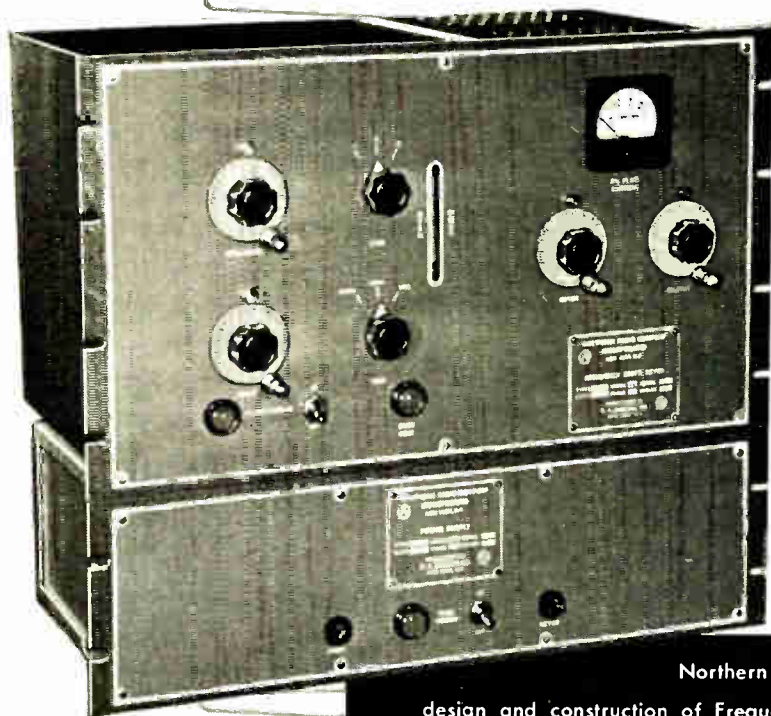

Whatever the system label — teleprinter, telegraph, facsimile, telephoto, radio-telephone, voice-carrier telegraph, or multiplexing of any of these — *dependability* is today's most vital communications requisite.

And, no matter what the form of message-handling intelligence, the proof is that Frequency Shift is the most dependable method of transmission.

Northern Radio has long specialized in the design and construction of Frequency Shift equipment of the types listed below. Their dependable performance for U.S. and Allied Commerce, Governments and Armed Forces all over the world has earned for Northern Radio a reputation for unquestioned leadership in communications engineering and precision manufacture.

Write for complete information.

- Frequency Shift Keyers
- Master Oscillators
- Diversity Receivers
- Frequency Shift Converters
- Multi-Channel Tone Systems
- Tone Keyers
- Demodulators
- Radio Multiplex Systems
- Monitors
- Tone Filters
- Line Amplifiers



NORTHERN RADIO COMPANY, inc.
147 WEST 22nd ST., NEW YORK 11, NEW YORK

Pace-Setters in Quality Communication Equipment

twenty times
tested!



TWICE SIZE →

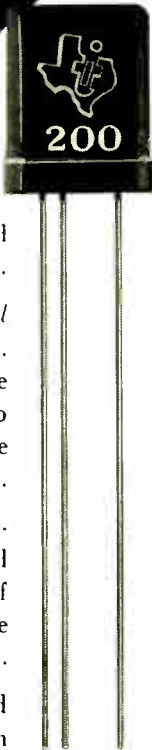

EVERY Texas Instruments grown junction and point contact transistor must pass more than 20 tests—in addition to continual visual checks—before it is granted the TI trademark and shipped to the user.

Texas Instruments inspects *all* transistors *all along* the manufacturing process.

This 100% inspection insures that the completed product will adhere closely to published specifications (see distribution curves at lower right).

All TI transistors have moisture-proof glass-to-metal hermetic sealing. And they are *all* aged a minimum of 24 hours at rated output as a positive operating double-check.

If you want transistors of this insured high quality, they are now available from Texas Instruments Incorporated. Write for new junction transistor bulletin DL-S 310.

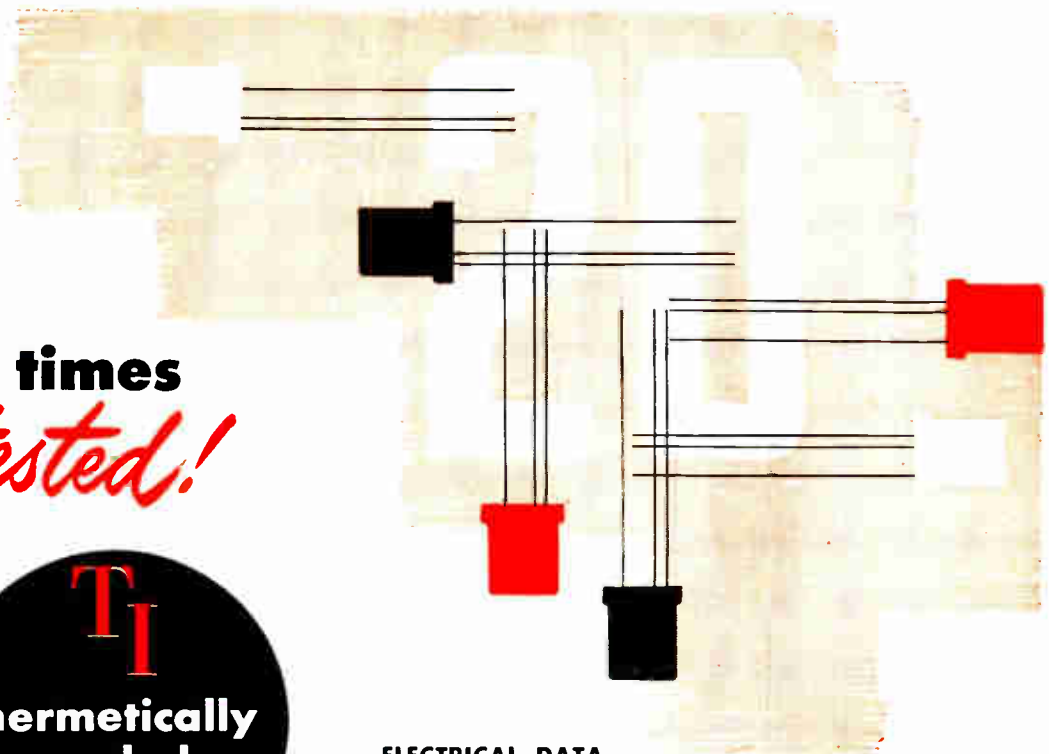

ELECTRICAL DATA

RATINGS, RECOMMENDED MAXIMUM:	n-p-n Junction	
	Type 200	Type 201
Collector Voltage	30 volts	30 volts
Collector Current	5 ma.	5 ma.
Collector Dissipation (at 30°C)	50 mw.	50 mw.
Ambient Temperature	50°C	50°C

AVERAGE CHARACTERISTICS (at 30°C):

Collector Voltage	5 volts	5 volts
Emitter Current	-1 ma.	-1 ma.
Collector Resistance (minimum)	0.2 megohms	0.4 megohms
Base Resistance	150 ohms	150 ohms
Emitter Resistance	30 ohms	30 ohms
Current Amplification Factor (minimum)	0.90	0.95
Collector Cut-Off Current	10 μ a	10 μ a
Collector Capacitance	12 μ fd.	12 μ fd.
Noise Factor (average value)	22 db.	22 db.

STATISTICAL DISTRIBUTION CURVES

Based on 250 Type 200 Transistors

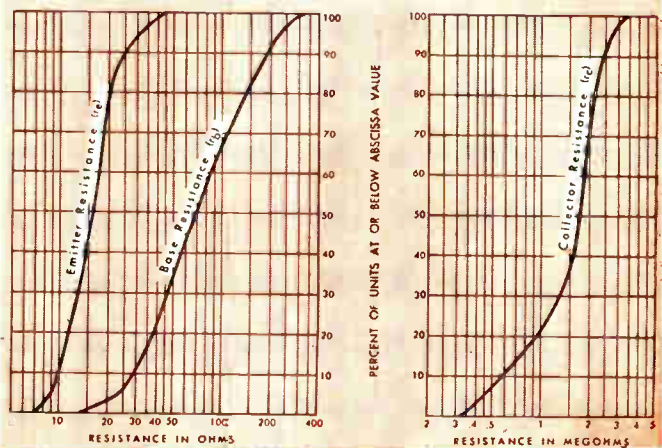

TEXAS INSTRUMENTS
INCORPORATED
6000 LEMMON AVENUE DALLAS 9, TEXAS



25% LESS WEIGHT!

castohm[®]

FIXED WIREWOUND POWER RESISTORS

... new homogeneous core and coating

- ✓ REDUCES SIZE AND WEIGHT
- ✓ ELIMINATES SHORTED TURNS



- 350°C hot spot operation
- Higher power dissipation with less weight, smaller diameters
- Higher maximum resistances
- Closer tolerances—to 1% (5% standard)
- Better heat conductivity
- Exceptional resistance to thermal shock

By eliminating the heavy ceramic core with the wire-bunching and shorted turns characteristic of vitreous enamel types, Shallcross has developed a radically new wirewound resistor that outperforms *all other* types of high temperature fixed power resistors. Through a unique process, the windings are imbedded in a special ceramic which forms an integral coating and core. Designed to MIL-R-10566 specifications, Castohms are destined to leave MIL-R-26A types far behind.

Find out how Castohms can reduce size and weight in your equipment - improve efficiency and reliability as well. Write, wire, or phone for details. Ask for Engineering Bulletin L-29.

SHALLCROSS MANUFACTURING CO.,
524 Pusey Avenue, Collingdale, Pa.

Shallcross

Designed to
MIL-R-10566
Specifications

R-30— 8 watts
R-33— 28 watts
R-37—125 watts
R-46—225 watts

Pick The Winner



PHOTO - BOSTON HERALD

PHOTO - BOSTON POST

THEY ALL STARTED EQUAL . . . BUT ONLY ONE WON!

Yes, they all started equal in this year's Boston 26-mile Marathon. But only Keizo Yamada **WON** in the record time of 2 hours, 18 minutes and 51 seconds. Why? Because he had the capacity to run farther faster.

ALL CAPACITORS START EQUAL, TOO

... but El-Menco Capacitors always win because they're *factually* tested at more than double their working voltage. You can know for sure that they have a wide margin of victory over the adverse conditions of any application.

So whether you pick the nidget CM-15 (2-525 mmf. cap) or the mighty CM-35 (5-10,000 mmf. cap), you're sure of a winner . . . in any military or civilian service.

Jobbers and distributors are requested to write for information to Arco Electronics, Inc., 103 Lafayette St., New York, N. Y. — Sole Agent for Jobbers and Distributors in U. S. and Canada.

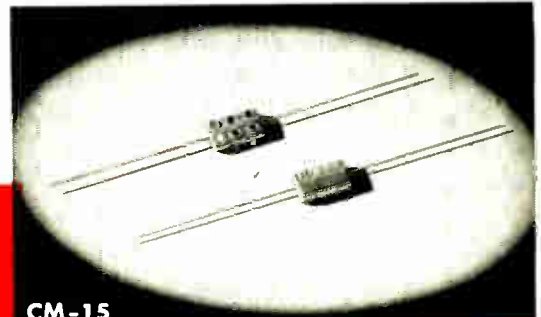

CM-15

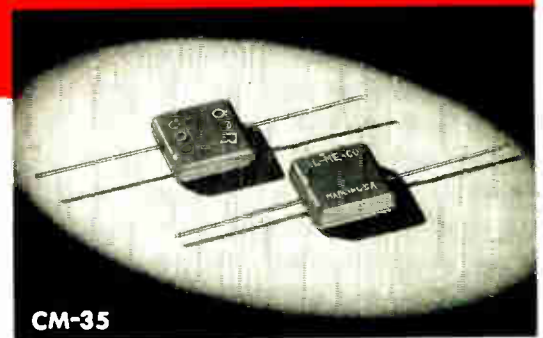

CM-35

WRITE FOR FREE SAMPLES
AND CATALOG ON YOUR
FIRM'S LETTERHEAD

MOLDED MICA **El-Menco** MICA TRIMMER
CAPACITORS

Foreign and Electronic Manufacturers Get Information Direct from our Export Dept. at Willimantic, Conn.
THE ELECTRO MOTIVE MFG. CO., INC. **WILLIMANTIC, CONNECTICUT**

SANBORN OSCILLOGRAPH RECORDING SYSTEMS HAVE MANY APPLICATIONS

Sanborn Recorders Help Speed Flight Design



SPERRY GYROSCOPE COMPANY

uses a two-channel Sanborn Recording System for basic research on their Zero Reader* Flight Director, a device which simplifies the manual control of aircraft. The Sanborn System shown above is recording the output of a flight simulator that solves Zero Reader equations.

* T. M. REG. U. S. PAT. OFF.

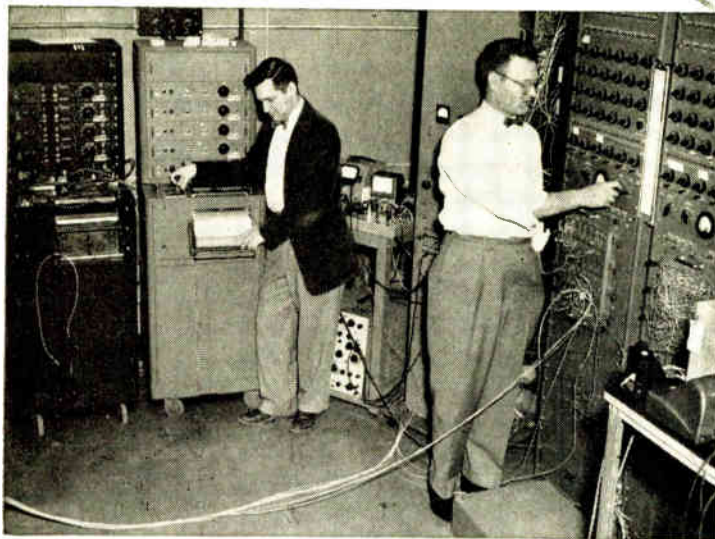

At **MCDONNELL AIRCRAFT CORPORATION** the movements of a guided missile are simulated by high-precision analog computers which in turn send *eight* different resultant electric signals into two Sanborn four-channel Recording Systems (left) for the graphic recording of the hypothetical results of the guided missile problem.



At DOUGLAS AIRCRAFT

COMPANY'S Flight Test Section, a Sanborn two-channel Recording System (shown removed from case for field operation) is used in conjunction with a telemeter radio link to record surface motion vibration in a flying aircraft while it is performing tests requiring continual monitoring. Recorded tracings provide the necessary permanent visual time history for comparison of the two events recorded and a study of their individual characteristics.

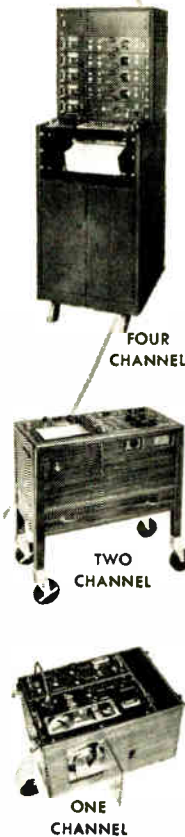

FOUR CHANNEL

TWO CHANNEL

ONE CHANNEL

How can Sanborn help you?

Sanborn one-, two-, and four-channel Recording Systems can provide an accurate and permanent graphic registration of almost any electrical phenomena whose frequency spectrum falls within the range of zero to 100 cycles per second. The availability and ready *interchangeability* of amplifiers and preamplifiers offer a wide range of use.

Records are traced by heated stylus on plastic coated strip-chart paper, and are in true rectangular coordinates. Other Sanborn advantages include: a high torque movement (200,000 dyne cms per cm deflection); built-in code and time markers; and a wide choice of paper speeds and channels.

Sanborn engineers will be pleased to make recommendations as to what type of equipment will best solve your recording problem. When writing, include the lower and upper limits and the frequency range of the phenomena to be recorded, and the type of transducer.

Ask for a copy of our "Applicability Folder" which presents a table of uses, complete performance data and specifications, brief descriptions of Sanborn Recording Systems and explanations of how their amplifiers may be readily interchanged.

SANBORN CO. INDUSTRIAL DIVISION
CAMBRIDGE 39, MASSACHUSETTS

for every plane...

GUARDIAN®

Interchangeable
APPROVED AIRCRAFT
RELAYS

standard spacing of mounting bracket holes enables you to meet new control specifications without changes in frame drawings . . .

The story is told—aircraft research, development and design engineers are sold on the new *interchangeability* feature of Guardian Aircraft Relays as *the only method of meeting changing control specifications without re-working frame drawings*. Standard spacing of mounting bracket holes is the “master key” to complete *interchangeability* of these highly reliable Guardian Aircraft Relays. Other bracket dimensions vary only between back plates and terminals on face plates.

Units range from S.P.S.T. (time delay available), to 4 P.D.T., with open-type mounting or sealed to MIL-R—6106 specifications. Many available to the new M.S. specifications. Weights range from 7.5 ounces to 20.8 ounces. Get complete *flexibility* of control at the design, modification and retrofit stages. Your copy of Bulletin 1 A-R tells how. Write.

NOTE THE PRECISE ALIGNMENT OF MOUNTING HOLES!



Interchangeable
10 Amp 4 P.D.T. 200 Ampere Solenoid Contactor

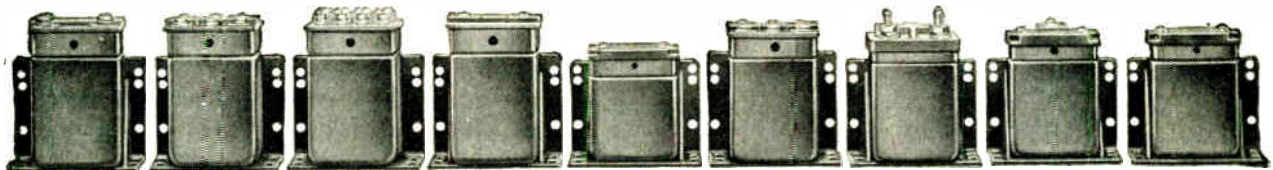

25 Amp S.P.D.T. 10 Amp 3 P.D.T. 10 Amp 4 P.D.T. 10 Amp S.P.D.T. 10 Amp 2 P.D.T. 10 Amp 3 P.C.T. 50 Amp S.P.D.T. 10 Amp 3 P.D.T. 10 Amp 2 P.D.T.

Specify from Guardian's complete range for every advantage of quick interchange!

GUARDIAN ELECTRIC
1628-K W. WALNUT STREET CHICAGO 12, ILLINOIS

A COMPLETE LINE OF RELAYS SERVING AMERICAN INDUSTRY



VARIAN ADDS

40,000 SQ FT

Klystron Headquarters



The New Varian Research and Administration Building

Continuing development and expansion of microwave-engineering applications for klystrons and other electron devices will be carried on in the newly-opened Palo Alto facilities of Varian Associates. This completes a greater than eight-fold growth for Varian in the five years since the formation of the company. Total extent of its several plants now exceeds 93,000 square feet. Size of the original staff has grown to 598. These people are all devoted to the goal of improving and expanding service to the electronic field—keeping Varian the first name in klystrons and related products. Since its discovery, Varian has pioneered in the new field of $n \cdot m \cdot r$ (nuclear magnetic resonance); has established the leading commercial laboratory for investigation and development of this penetrating technique; and has introduced instruments with broad new capabilities for exploring the characteristics of materials.

Field Engineering Representatives in 38 Cities throughout the World



VARIAN associates

PALO ALTO 2 • CALIFORNIA

First name in klystrons

PROCEEDINGS OF THE I.R.E. September, 1953

FREED

Instruments & Transformers

Famous
For

QUALITY • DEPENDABILITY • ACCURACY

FREED MILITARY PULSE TRANSFORMERS IN STOCK FOR IMMEDIATE DELIVERY

HERMETICALLY SEALED PULSE TRANSFORMERS for use in blocking oscillators, low level interstage coupling, and modulator outputs. Made in accordance with MIL-T-27 specifications. These pulse transformers are designed for maximum power, efficiency and optimum pulse performance. Balanced coil structures permit series or parallel connection of windings for turn ratios other than unity. Pulse characteristics, voltages and impedance levels will depend upon interconnections made.



No. 1030
Low Frequency
"Q" Indicator



No. 1020B
Megohmmeter



Decade
Inductors



No. 1040
Vacuum Tube Voltmeter



No. 1210
Null Detector &
Vacuum Tube Voltmeter



No. 1010
Comparison Bridge



No. 1110A
Incremental Inductance
Bridge



DM-12



DM-18



DM-8



DM-01

CATALOG NUMBER	APPLICATION	PULSE VOLTAGE KILOVOLTS	PULSE DURATION MICRO-SECONDS	DUTY RATIO	TEST VOLTAGE KV., RMS	CHARACTERISTIC IMPEDANCE OHMS	CASE SIZE
MPT-1	Blocking oscillator or interstage coupling	0.25/0.25/0.25	0.2-1.0	.004	0.7	250	DM-12
MPT-2	Blocking oscillator or interstage coupling	0.25/0.25	0.2-1.0	.004	0.7	250	DM-12
MPT-3	Blocking oscillator or interstage coupling	0.5/0.5/0.5	0.2-1.5	.002	1.0	250	DM-18
MPT-4	Blocking oscillator or interstage coupling	0.5/0.5	0.2-1.5	.002	1.0	250	DM-18
MPT-5	Blocking oscillator or interstage coupling	0.5/0.5/0.5	0.5-2.0	.002	1.0	500	DM-12
MPT-6	Blocking oscillator or interstage coupling	0.5/0.5/0.5	0.5-2.0	.002	1.0	500	DM-12
MPT-7	Blocking oscillator, interstage coupling or low power output	0.7/0.7/0.7	0.5-1.5	.002	1.5	200	DM-18
MPT-8	Blocking oscillator, interstage coupling or low power output	0.7/0.7	0.5-1.5	.002	1.5	200	DM-18
MPT-9	Blocking oscillator, interstage coupling or low power output	1.0/1.0/1.0	0.7-3.5	.002	2.0	200	DM-18
MPT-10	Blocking oscillator, interstage coupling or low power output	1.0/1.0	0.7-3.5	.002	2.0	200	DM-18
MPT-11	Blocking oscillator, interstage coupling or low power output	1.0/1.0/1.0	1.0-5.0	.002	2.0	500	DM-01
MPT-12	Blocking oscillator, interstage coupling or low power output	0.15/0.15 0.3/0.3	0.2-1.0	.004	0.7	700	DM-8

SEND FOR COMPLETE CATALOG OF
FREED INSTRUMENTS AND TRANSFORMERS

FREED TRANSFORMER CO., INC.

World Radio History
1720 WEIRFIELD ST. (RIDGWOOD) BROOKLYN 27, N.Y.

NOW

KEL-F* WIRE IN STRIPES

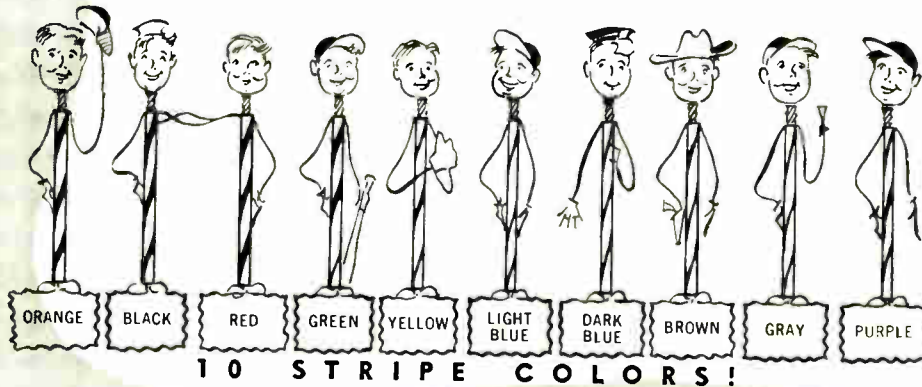

REX-KF[†] THE WONDER WIRE

(WITH KEL-F* INSULATION)

The Rex Corporation announces REX-KF Wire (Kel-F* insulated) with one, two, or three stripes in any combination of ten colors. Over 300 sharply distinguishing color codes are now easily available.

Striping removes the final obstacle to the broader use of wonderful trifluorochlorethylene insulation.

Write for full information on this remarkable advance in wire technology, and the story of REX-KF Wire, champion in every quality that makes wire good.

*T. M. of M. W. Kellogg Co.
 †T. M. of The Rex Corporation
 **Reg. U. S. Pat. Off

THE REX CORPORATION

Insulated Wire Specialties, Microwall Wire, Cast Plastics, Rexolite U. H. F.
 Insulating Materials, Rextrude** 105 Electrical Tubing and Custom Plastic Extrusions.

WEST ACTON, MASSACHUSETTS



VITREOUS ENAMELED RESISTORS

The resistor line which is specified by engineers employed by the nation's foremost manufacturers of original equipment.

DELIVERY

... two separate self-contained resistance plants guarantee prompt delivery.

QUALITY

... as the world's leading manufacturers of wire wound resistors, we assure you that only the finest engineering techniques and material are utilized.

PRICE

... our tremendous manufacturing capacity enables us to offer resistors in any quantity at exceptionally attractive prices.

ENGINEERING

... our factories include the most modern machine shops and engineering facilities. Our experienced engineering department is at your service to assist in designing any resistance unit to meet your requirements and to meet JAN Specifications.

We invite your inquiries.

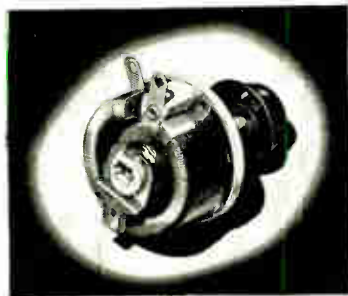
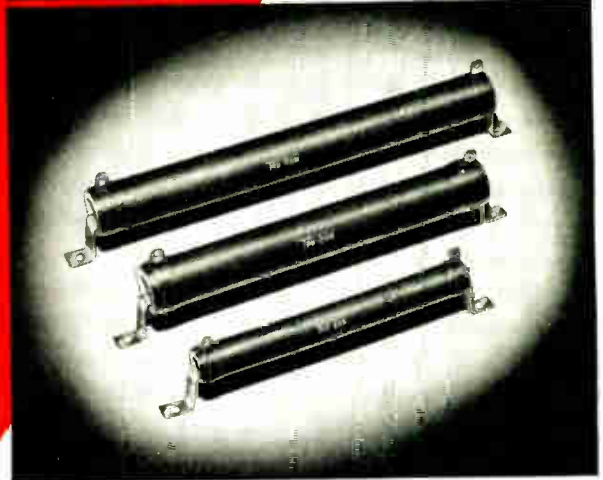
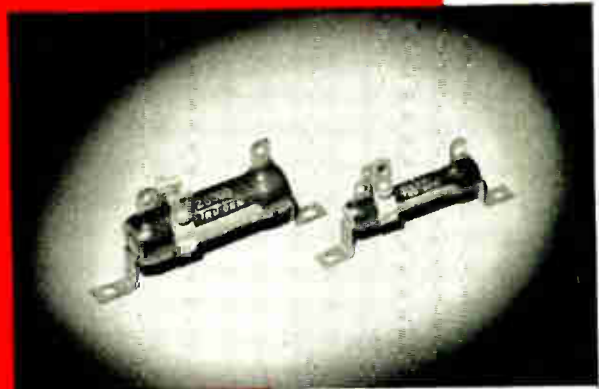

- 50 watt
- 75 watt
- 100 watt
- 150 watt



Power RHEOSTAT

... the practical rheostat in its most exacting form, with a compensating constant pressure contact brush ... designed to meet JAN Specifications. Write for complete technical literature.



PRODUCTS

Division of
Mogel Engineering
& Mfg., Inc.

General Sales Office: 2800 N. Milwaukee Avenue, Chicago 18, Ill.
Factory: Huntington, Indiana

MANUFACTURERS: Power Rheostats, Fixed Resistors, Adjustable Resistors, "E-Resistor" Resistors.



Our new multi-catalog complete with engineering data and illustrations, is your without obligation. WRITE TODAY!

Research tries the Unconventional

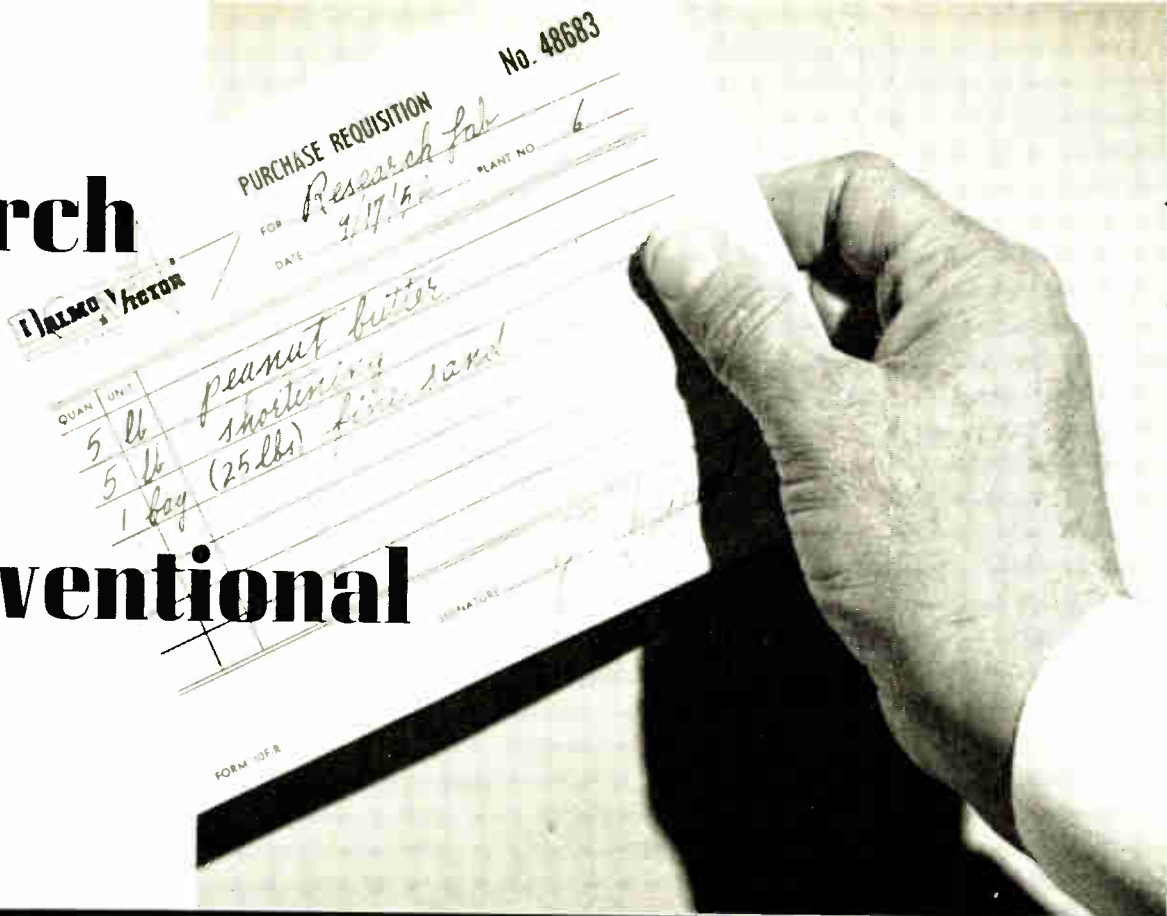

at **DALMO VICTOR**

One typical DV Development

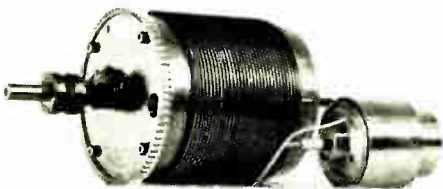

FLUID MAGNETIC CLUTCHES
Motion and its precision control are constant problems in radar antenna systems. For these requirements, one Dalmo Victor task group has evolved and engineered basic new types of fluid magnetic clutches, of which one example is illustrated.

Company purchasing personnel are sometimes amused by research department requisitions for all kinds of unexpected materials. Recently, a study of a wide variety of substances indicated that peanut butter, shortening and sand had ideal physical and electrical characteristics for a special antenna-loading problem at hand. So tests were made.

Dalmo Victor specialists never hesitate to explore unconventional channels of approach to engineering problems as well as the more customary ones. And, as a result, unusual ways are sometimes found for meeting difficult problems connected with development of complex, lightweight, electromechanical devices and the systems in which they operate.

DALMO VICTOR
SAN CARLOS · CALIFORNIA

DV

DOWN-TO-EARTH ELECTROMECHANICAL ENGINEERING

Distinguished Names
in Communications...

DU MONT



WELLS-GARDNER

... Put Their Confidence in
Midland CRYSTALS

**STEWART
SW
WARNER**

These names are synonyms for quality. The products they identify are famous for dependable, precision performance in every detail. These manufacturers must be sure that suppliers of every component have similar high-level reputations to uphold.

Emerson

The fact that the great names in communications rely on Midland Crystals is evidence enough that Midland Quality Control methods of crystal production insure completely reliable frequency control.

*Whatever your Crystal need, conventional or highly specialized,
When it has to be exactly right, contact*



Midland

MANUFACTURING COMPANY, INC.
3155 Fiberglas Road, Kansas City, Kansas

WORLD'S LARGEST PRODUCER OF QUARTZ CRYSTALS

WHATEVER THE SPECIFICATION
...LOOK TO *Ketay*
FOR SYNCHROS & SERVO MOTORS

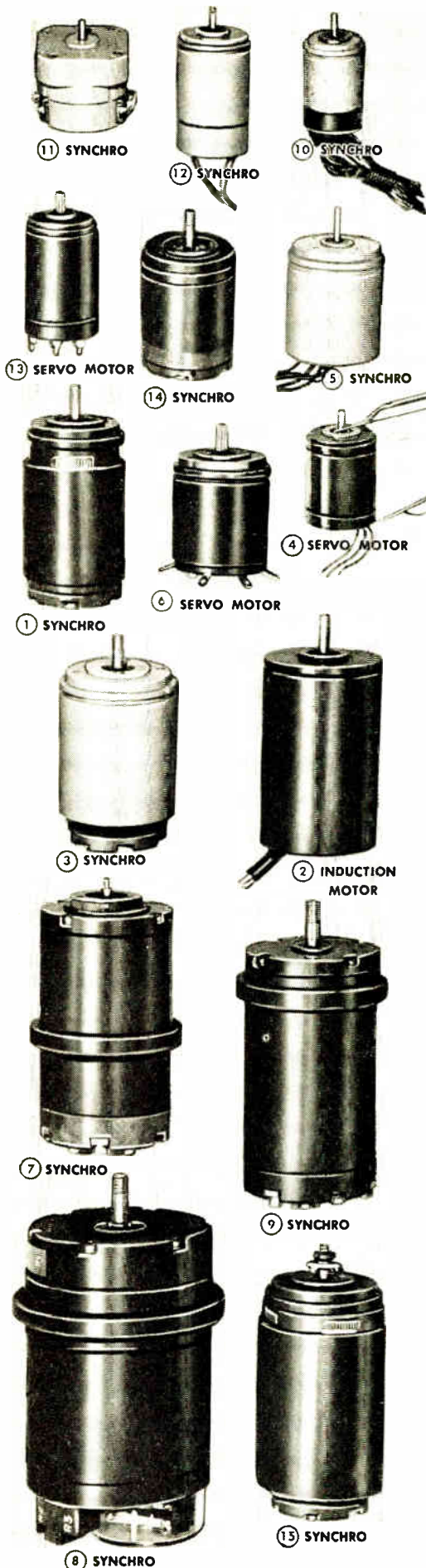

KETAY, the world's largest producer of government approved synchros, offers high precision rotary and instrument components for most every need. Industry, as well as suppliers to the Armed Forces, will find Ketay ready to solve their problems with a complete line of synchros, servos, magnetic amplifiers, computers and control systems.

If you are searching for a specific size or type... if availability is a problem... if engineering counsel is needed... Ketay can help. Why not join us for an exploratory discussion of your particular problem. Write today to Dept. A

WHATEVER THE NEED CHOOSE KETAY!

Available as listed

1. SYNCHRO, Size 16, O.D. 1.537", 115 V, 400 Cycles
(Transmitter, Receiver, Control Transformer)
2. INDUCTION MOTOR, O.D. 1.750", 3 phase 2 Pole, 115 V, 60 Cycles
3. SYNCHRO, Size 18, O.D. 1.750", 115 V, 400 and 60 Cycles
(Transmitter, Receiver, Differential, Control Transformer)
4. SERVO MOTOR, O.D. .937", 26V, 400 Cycles
5. SYNCHRO, O.D. 1.437", 14.4 V and 26 V, 400 Cycles
(Transmitter, Receiver, Resolver, Differential, Control Transformer)
6. SERVO MOTOR Mk 7, O.D. 1.437", 115 V, 400 Cycles
7. SYNCHRO, Type 1F or 1HC, O.D. 2.250" 115 V, 60 Cycles
(Receiver, Transmitter)
8. SYNCHRO, Size 31, O.D. 3.10", 115 V 400 and 60 Cycles
(Transmitter, Receiver, Differential, Control Transformer)
9. SYNCHRO, Size 23, O.D. 2.250", 26 V and 115 V 400 & 60 Cycles
(Transmitter, Receiver, Resolver, Differential, Control Transformer)
10. SYNCHRO, O.D. .937", 26 V, 400 Cycles
(Transmitter, Receiver, Resolver, Differential, Control Transformer)
11. LINEAR TYPE CONTROL TRANSFORMER, O.D. 1.625", 26 V, 400 Cycles
12. SYNCHRO, Size 11, O.D. 1.062", 26 V and 115 V, 400 Cycles
(Transmitter, Receiver, Resolver, Differential, Control Transformer)
13. SERVO MOTOR, O.D. 1.062", 115 V, 400 Cycles
14. SYNCHRO, Size 15, O.D. 1.437", 26 V and 115 V, 400 Cycles
(Transmitter, Receiver, Resolver, Differential, Control Transformer)
15. SYNCHRO, Size 19, O.D. 1.90", 115 V, 400 Cycles
(Transmitter, Receiver, Control Transmitter)

***Ketay* MANUFACTURING CORP.**
 555 Broadway, New York 12, N. Y.

PACIFIC DIVISION
 12833 Simms Ave., Hawthorne, California

DESIGN

DEVELOPMENT

MANUFACTURE ... of precision instruments,

components, and systems.

- KINETIX INSTRUMENT DIVISION
- RESEARCH & DEVELOPMENT DIVISION

THE MICROWAVE FERRITE DUO



THE UNIDIRECTIONAL TRANSMISSION LINE

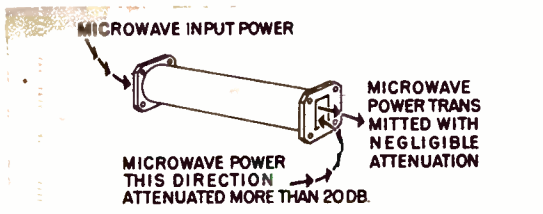

The Uniline section is a new development specifically designed for use in test measurements particularly where the impedance of the load is variable. For example, one of the several possible applications for the Uniline is as a replacement for the loss-type attenuator commonly used for isolation between source and load. In this instance, very substantial isolation is provided with negligible loss in transmitted power. Up to 100 times as much power is available for test purposes when the Uniline is used. The Uniline is a truly non-reciprocal transmission line element, not a directional coupler.

TECHNICAL SPECIFICATIONS

FREQ. RANGE: 8800-9600 or 9600-10,400 mcs.

WAVE GUIDE SIZE: $\frac{1}{2}$ " x 1" x $6\frac{1}{2}$ " long.

ATTENUATION, FORWARD DIRECTION: Less than 1 DB.

ATTENUATION, REVERSE DIRECTION: 20 DB. (Approx.)

VOLTAGE STANDING WAVE RATIO: 1.3:1, (or less) either direction.

Finished with standard flat flange unless otherwise specified.

Write for descriptive bulletins.

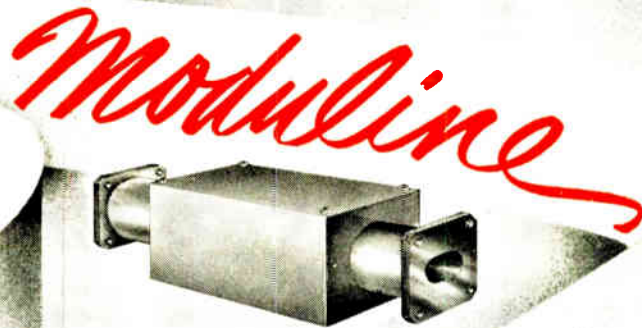

THE MICROWAVE AMPLITUDE MODULATOR

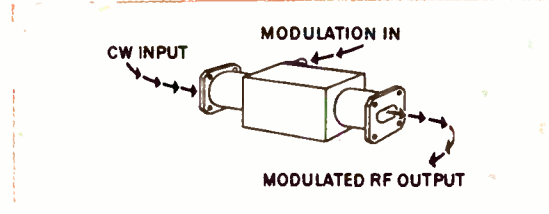

This new ferromagnetic resonance device is essentially a continuously variable microwave attenuator controlled by an applied magnetic field. Amplitude modulation of a CW microwave signal may be obtained by varying the magnitude of the magnetic field by means of an external modulating source. The moduline thus permits the microwave oscillator to be operated on a CW basis to eliminate undesirable frequency modulation and double moding frequently present when one of the klystron elements is directly modulated. The moduline also offers many possibilities as an electronically controlled microwave attenuator.

FREQ. RANGE: 8800-9600 or 9600-10,400 mcs.

WAVE GUIDE SIZE: $\frac{1}{2}$ " x 1" x 6.1" long.

INSERTION LOSS: Less than 1 DB.

PERCENT MODULATION: Zero to over 90%.

MODULATION FREQUENCY: Up to 3000 cps.

VOLTAGE STANDING WAVE RATIO: 1.4:1 or less.

MODULINE AUDIO DRIVER

Designed specifically as a convenient source of sine wave modulation input for the Moduline.

FREQUENCY RANGE: Continuously adjustable, 800 to 1200 cycles per second.

POWER OUTPUT: 100 ma., peak current into Moduline input. (impedance, 500 ohms at 1000 cps.)



CASCADE RESEARCH
CORPORATION

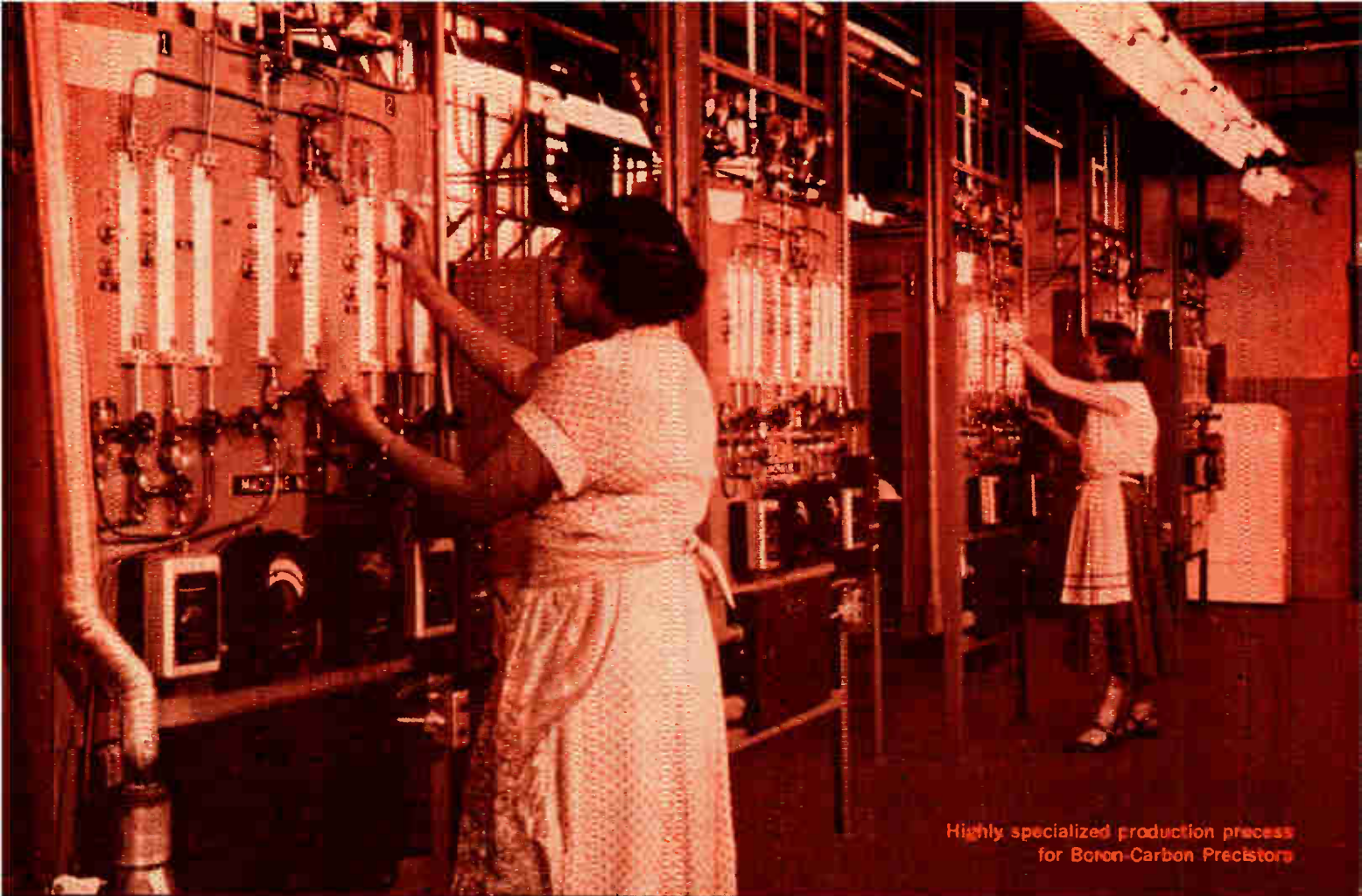

Highly specialized production process
for Boron-Carbon Precistors

ONLY FILM TYPE RESISTORS MEET HIGHER

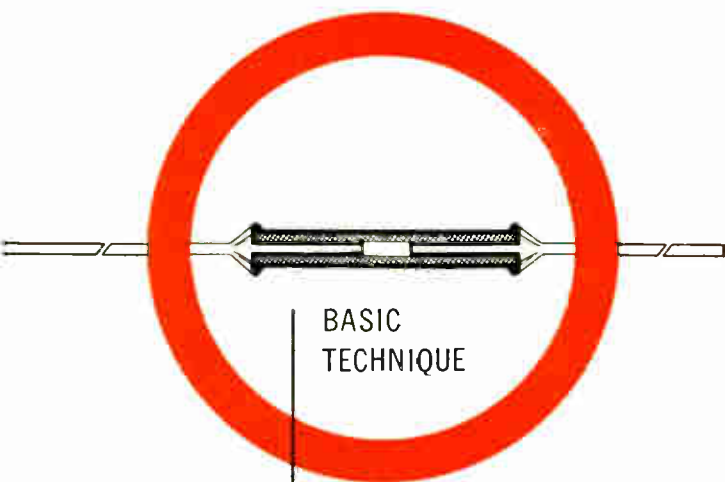

BASIC TECHNIQUE

A thin coating of pre-cured and stabilized resistance material is bonded to special glass or an inorganic core to form IRC's exclusive filament type element. This is in contrast to the carbon pill or slug principle of construction. Its uniformity and stability have proved superior since the earliest days of radio.

Advancing requirements of instrumentation, military electronics and television focus emphasis on greater stability for non-wire wound resistors. IRC believes its filament type construction offers the best answer to more exacting standards. For over 28 years the film type resistance element has proved its superior stability—even in today's newest IRC Boron-Carbon Precistor.

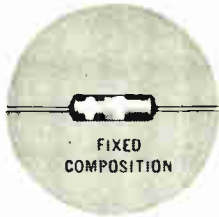

FIXED
COMPOSITION

high popularity—high stability

More IRC Filament Type BT Resistors are used in radio and TV sets than any other brand. They meet and beat JAN-R-11 specifications, and have been tested and approved by most producers of government equipment. Exceptionally stable—in $\frac{1}{8}$, $\frac{1}{2}$, 1 and 2 watts. Send coupon for Data Bulletin.

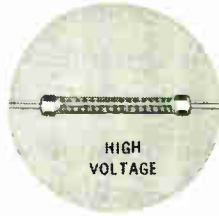

HIGH
VOLTAGE

high voltage—high stability

IRC Type MV High Voltage Resistors offer outstanding stability even in very high resistance values. Filament resistance coating in helical turns on ceramic tube provides a long, effective conducting path. 2 to 90 watts. Check the coupon for detailed information.



DEPOSITED
CARBON

high economy—high stability

Type DC Deposited Carbon Resistors combine accuracy and economy with high stability. Excellent where carbon compositions are unsuitable and wire wound precisions too large or expensive. Available in $\frac{1}{2}$, 1 and 2 watts. Use coupon for further facts.

STABILITY STANDARDS



BORON
CARBON

high accuracy—high stability

The ultimate in *stable* non-wire wound resistors. Type BOC Boron-Carbon Precistors conform to all requirements of MIL-R-10509A. Voltage coefficient less than 20 parts per million per volt. Extraordinary load life. $\frac{1}{2}$, 1 and 2 watts. Send for Bulletin.

Boron & Deposited Carbon Precistors • Power Resistors • Voltmeter Multipliers • Low Wattage Wire Wounds • Insulated Composition Resistors • Volume Controls •

Precision Wire Wounds • Ultra HF and Hi-Voltage Resistors • Low Value Capacitors • Selenium Rectifiers • Insulated Chokes • Hermetic Seal Terminals •



World Radio History

NEW
resistor



MOLDED
*boron-carbon
precistor*



Eliminates Possibility of End-Cap Trouble



Eliminates Danger of Mechanical Damage



Improved Electrical Characteristics

The new Type MBC $\frac{1}{2}$ watt, $\frac{1}{8}$ watt resistor offers the inherent superiority of a Boron-Carbon resistor plus the advantage of a fully insulated unit. Send coupon for full details.

INTERNATIONAL RESISTANCE CO.

405 N. Broad St., Philadelphia 8, Pa.

In Canada: International Resistance Co., Ltd., Toronto, Licensee

Send me full data on: DC Deposited Carbon; BT Insulated Filament Type Resistors; MV High Voltage Resistors; BOC Boron-Carbon Precistors; MBC Molded Boron-Carbon Precistors

Name _____

Title _____

Company _____

Address _____

City _____ Zone _____ State _____

- MORE UNIFORM CURRENT CONTROL
- SMALLER SIZE

WITH

OHMITE®

Taper-Wound

RHEOSTATS

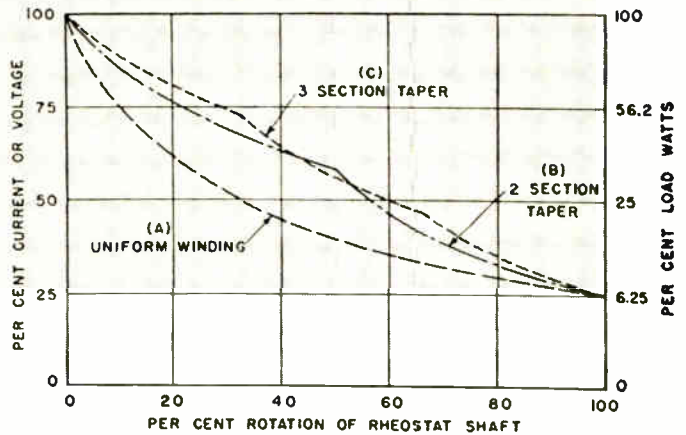
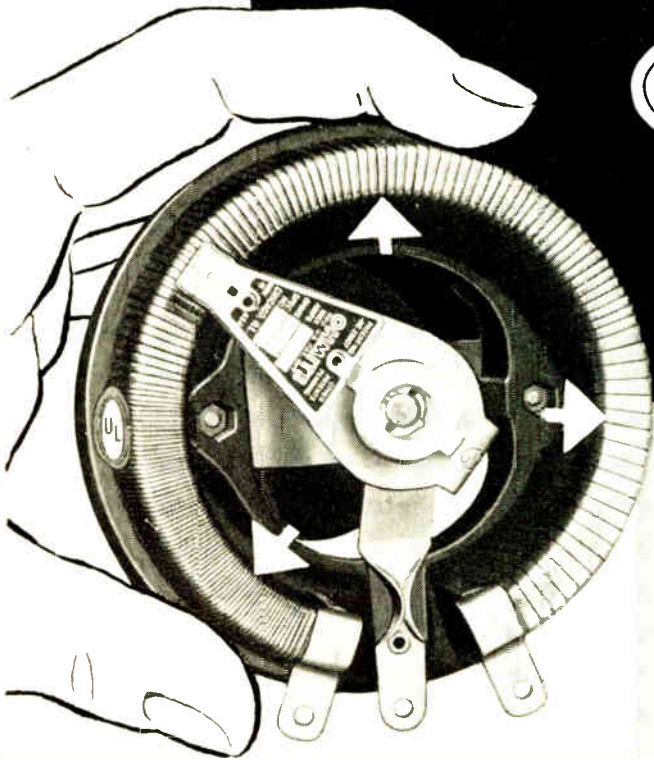

Rheostats are sometimes taper-wound to make possible the use of a smaller rheostat, provide more uniform control, permit special resistance-versus-rotation curves, or make possible the winding of higher resistance on a given size rheostat.

When rheostat windings are tapered, they are wound in two or more sections of diminishing wire or ribbon sizes. Since only the first turn of a rheostat carries the maximum current, succeeding turns can be wound with wire or ribbon of a smaller size. The sections are so smoothly joined that only the change in wire size tells where the sections connect.

As the above chart demonstrates, in a uniformly wound rheostat each degree of rotation adds a constant number of ohms to a constantly increasing number of ohms.

Hence, the current changes more slowly as the resistance is increased (Curve A). A tapered winding (Curves B and C), by increasing the number of ohms per degree of rotation as the total ohms in the circuit increase, makes the current curve more nearly linear.

Ohmite will design special tapered units to meet your requirements.

OHMITE MANUFACTURING CO., 3617 W. Howard St., Skokie, Ill. (Suburb of Chicago)

OHMITE

first IN RESISTANCE PRODUCTS

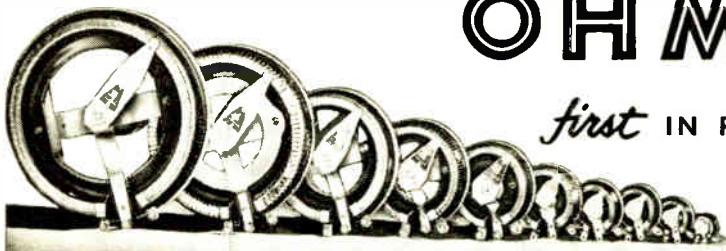

Write on Company Letter-head for Catalog and Engineering Manual No. 40.



New Ultra-Stable Microwave Oscillator

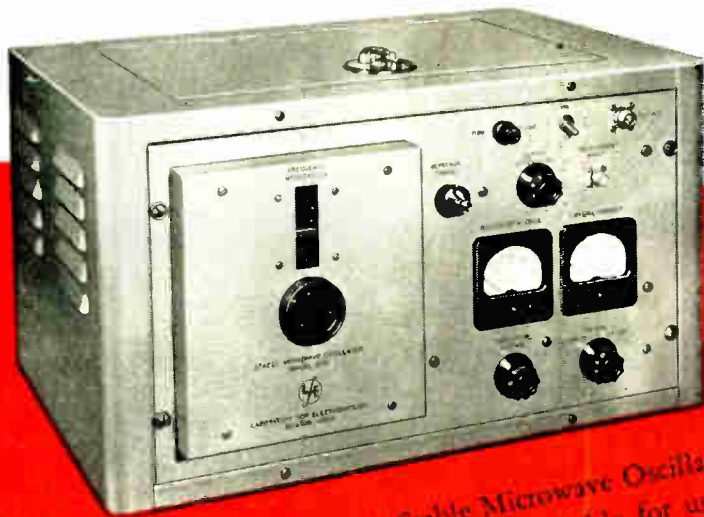

MODEL 803

Also Available: LFE Model 802 for ultra-stable microwave frequencies in the X-Band

The LFE Model 803 Stable Microwave Oscillator provides a source of highly stabilized microwave frequencies suitable for use as a local oscillator for microwave measurements, or in many other applications where a high degree of stability is required, such as Q measurements, SWR measurements and general narrow band design work. A dial accurately calibrated directly in frequency is an important feature. The main elements of the unit are a klystron oscillator, a stabilizing monitor loop which consists of a calibrated dual-mode reference cavity, a feedback amplifier and a self-contained power supply. Means are provided for modulating the oscillator.

Specifications

Frequency Coverage

2700 - 2950 Mc. - S-Band

Dial Calibration

Calibrated directly in frequency - 1 Mc. per division.

Frequency Stability

Short Term Deviation - less than one part in 10^8
Long Term Drift - less than 100 Kc./sec from original setting.

Modulation

Can be modulated 25% when stabilized; 100% modulation possible when stabilization is removed.

Attenuation

Attenuator provides 100 db. range of control.

Power Output

15 milliwatts.

Output Connector - Type N.

Power Consumption

150 watts.

Size

10 1/2" x 19" front panel, 14 1/2" deep, cabinet with rack mounting panel.

Weight

100 lbs.

For complete information, see your LFE engineering representative or write—



LABORATORY for ELECTRONICS, INC.

75-4 PITTS STREET • BOSTON 14, MASS.

PRECISION ELECTRONIC EQUIPMENT • OSCILLOSCOPES • MAGNETOMETERS • COMPUTERS • SOLID DELAY LINES

Now RCA-207E1 TANDEM 40-Mc IF AMPLIFIER

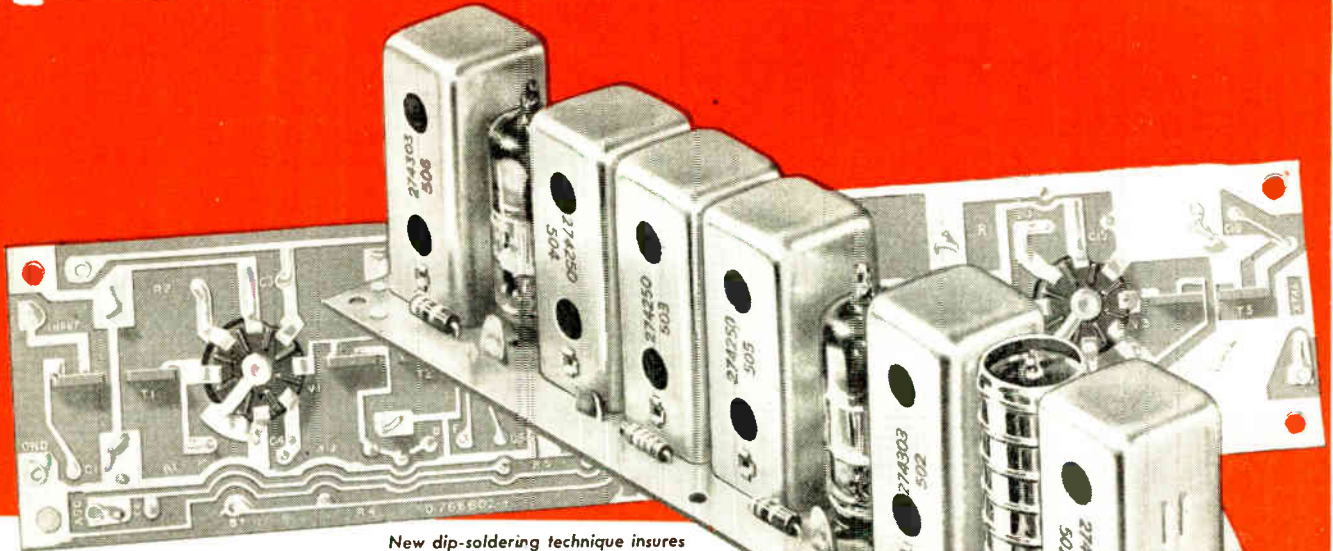

New dip-soldering technique insures uniform, high-quality connections

Compact "in-line" design utilizes photographic uniformity and accuracy of:

- ✓ PRINTED TRANSFORMERS
- ✓ PRINTED COILS
- ✓ PRINTED TRAPS
- ✓ PRINTED WIRING

Features:

- 41-25-Mc sound if
- 45-75-Mc picture if
- 40-uv sensitivity
- 4-Mc bandwidth
- 3 if stages, plus crystal detector
- No lead dress problems
- Requires chassis space of only 8 25/32" x 1 13/16"
- Excellent skirt selectivity

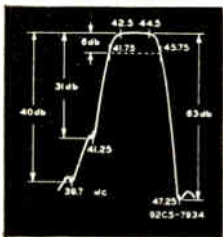

Overall response curve

Advantages:

- Pre-aligned and tested as a complete unit to save installation time
- Packaged intercarrier-sound if amplifier
- All tuning adjustments are above chassis
- All parts accurately positioned



RADIO CORPORATION of AMERICA
ELECTRONIC COMPONENTS HARRISON, N. J.

Also available:



RCA-209K1

Tunable RCA Printed-Circuit IF Transformers, Coils, and Traps

Ask for bulletin on RCA-209K1 through RCA-214K1

For full design advantages and technical data, write RCA, Commercial Engineering, Section 471R Or just call your nearest RCA field office:

(EAST) Humboldt 5-3900
415 S. 5th St., Harrison, N. J.

(MIDWEST) Whitehall 4-2900
589 E. Illinois St., Chicago, Ill.

(WEST) Madison 9-3671
420 S. San Pedro St., Los Angeles, California

BOARD OF DIRECTORS, 1953

- J. W. McRae
President
- S. R. Kantebet
Vice-President
- W. R. G. Baker
Treasurer
- Haraden Pratt
Secretary
- Alfred N. Goldsmith
Editor

I. S. Coggeshall
Senior Past President

D. B. Sinclair
Junior Past President

1953

- R. D. Bennett
G. H. Browning (R1)
W. H. Doherty
A. W. Graf (R5)
W. R. Hewlett
A. V. Loughren
R. L. Sink (R7)
G. R. Town
Irving Wolff (R3)

1953-1954

- J. T. Henderson (R8)
C. A. Priest (R4)
J. R. Ragazzini (R2)
J. D. Ryder
A. W. Straiton (R6)
Ernst Weber

1953-1955

- S. L. Bailey
B. E. Shackelford

●
Harold R. Zeamans
General Counsel

●
George W. Bailey
Executive Secretary

●
Laurence G. Cumming
Technical Secretary

Changes of address (with advance notice of fifteen days) and communications regarding subscriptions and payments should be mailed to the Secretary of the Institute, at 450 Ahnaip St., Menasha, Wisconsin, or 1 East 79 Street, New York 21, N. Y.

All rights of publication, including translation into foreign languages, are reserved by the Institute. Abstracts of papers with mention of their source may be printed. Requests for republication privileges should be addressed to The Institute of Radio Engineers.

PROCEEDINGS OF THE I.R.E.[®]

Published Monthly by

The Institute of Radio Engineers, Inc.

VOLUME 41

September, 1953

NUMBER 9

PROCEEDINGS OF THE I.R.E.

Floyd A. Paul, Chairman, Electronic Component Parts Professional Group.....	1090
Electronic Component Parts..... Floyd A. Paul and Wayne C. Irwin	1091
4660. The Development of Professional Groups and Chapters in the IRE..... L. C. Van Atta	1092
4661. The Common-Collector Transistor Amplifier at Carrier Frequencies..... F. R. Stansel	1096
4662. A Review of Methods for Measuring the Constants of Piezoelectric Vibrators..... Eduard A. Gerber	1103
4663. Mismatch Errors in Microwave Power Measurements..... R. W. Beatty and A. C. Macpherson	1112
4664. The Phase-Bistable Transistor Circuit..... R. H. Baker, Irwin L. Lebow, R. H. Rediker, I. S. Reed	1119
4665. Transient Analysis of Junction Transistor Amplifiers..... W. F. Chow and J. J. Suran	1125
4666. A Graphical Spectrum Analyzer for Pulse Series..... H. P. Raabe	1129
4667. RLC Lattice Networks..... Louis Weinberg	1139
4668. Feedback Theory—Some Properties of Signal Flow Graphs..... Samuel J. Mason	1144
4669. Measurements of Detector Output Spectra by Correlation Methods..... Louis Weinberg and L. G. Kraft	1157
4670. Direct-Viewing Memory Tube..... S. T. Smith and H. E. Brown	1167
4671. Correction to "Theory of AFC Synchronization"..... W. J. Gruen	1171
4672. Radiation Conductance of Axial and Transverse Slots in Cylinders of Elliptical Cross Section..... James Y. Wong	1172
4673. Microwave Measurements on Metallic Delay Media..... Seymour B. Cohn	1177
4674. The Calculation of the Path of a Radio-Ray in a Given Ionosphere..... A. H. De Voogt	1183
4675. Discussion on "Correlation and Linear Transforms" by Marcel J. E. Golay..... D. A. Bell and Marcel J. E. Golay	1187
Correspondence:	
4676. "Instantaneous Frequency"..... Julius J. Hupert	1188
4677. "How to Win Arguments"..... V. D. Landon	1188
4678. "Symmetrical Ridge Waveguides"..... Marshall H. Cohen and Robert E. Webster	1189
4679. "A Transistors in Trigger Circuits"..... S. Walter	1190
Contributors to PROCEEDINGS OF THE I.R.E.....	1191

INSTITUTE NEWS AND RADIO NOTES SECTION

Radio Fall Meeting Program.....	1193
Technical Committee Notes.....	1194
Professional Group News.....	1195
Transactions of the I.R.E.....	1196
IRE People.....	1197
Books:	
4680. "Radio and Radar Technique" by A. T. Starr..... Reviewed by Kerim Onder	1198
4681. "High Fidelity Simplified" by Harold D. Weiler..... Reviewed by Bruce P. Bogert	1198
4682. "Radio Operating Questions and Answers" by J. S. Hornung and Alexander McKenzie..... Reviewed by Alois W. Graf	1199
4683. "Electrodynamics" by Arnold Sommerfeld..... Reviewed by C. W. Carnahan	1199
4684. "Electron Tubes in Industry" by Keith Henney and James D. Fahnestock..... Reviewed by Harold A. Zahl	1199
4685. "Principles of Television Servicing" by Carter V. Rubinoff and Magdalena E. Wolbrecht..... Reviewed by John H. Battison	1199
Sections:	
4686. Abstracts and References.....	1200
Meetings with Exhibits..... 2A	Student Branch Meetings.... 82A
News—New Products..... 44A	Membership..... 82A
Industrial Engineering Notes 66A	Positions Open..... 130A
Section Meetings..... 80A	Positions Wanted..... 137A
Advertising Index.....	166A

EDITORIAL DEPARTMENT

Alfred N. Goldsmith
Editor

E. K. Gannett
Administrative Editor

Marita D. Sands
Assistant Editor

ADVERTISING DEPARTMENT

William C. Copp
Advertising Manager

Lillian Petranek
Assistant Advertising Manager

BOARD OF EDITORS

Alfred N. Goldsmith
Chairman

PAPERS REVIEW COMMITTEE

George F. Metcalf
Chairman

ADMINISTRATIVE COMMITTEE OF THE BOARD OF EDITORS

Alfred N. Goldsmith
Chairman



Reg. U. S. Pat. Off.

Responsibility for the contents of papers published in the PROCEEDINGS OF THE I.R.E. rests upon the authors. Statements made in papers are not binding on the Institute or its members.



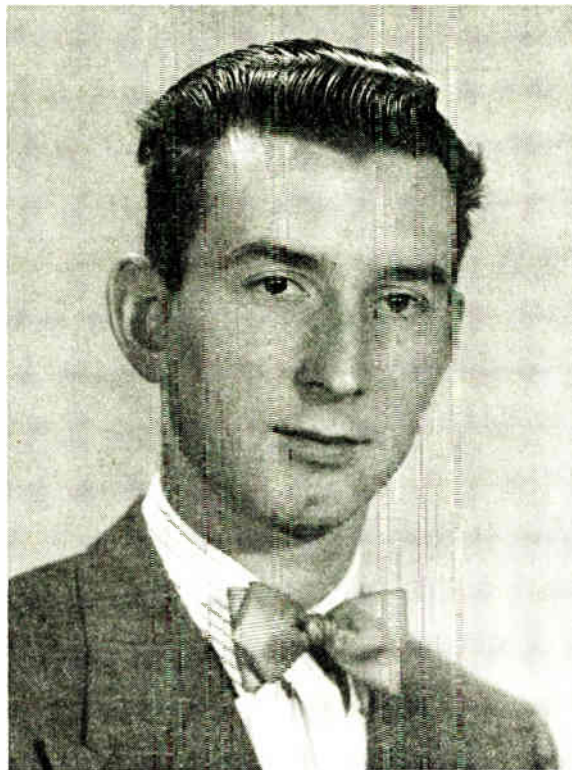

Floyd A. Paul

CHAIRMAN, ELECTRONIC COMPONENT PARTS PROFESSIONAL GROUP

F. A. Paul, first Chairman of the new Professional Group on Electronic Component Parts, was born on March 14, 1923, in Medford, Ore. He received the B.E. degree in electrical engineering in 1951 at the University of Southern California.

Mr. Paul founded the Radio Amateur's Club at the University, becoming its first president. He also worked on the carrier current station on campus, and was a graduate laboratory assistant in the speech clinic, working with audiometry equipment. From 1949 to 1951 Mr. Paul taught one year of calculus, mechanics, physics, drafting, and stress at Cal Aero Technical Institute, the other advanced electronics television, and radar theory at the Electronic Technical Institute in Los Angeles.

For the past two years Mr. Paul has worked at the California Institute of Technology Jet Propulsion Laboratory as a research engineer in the field of reliability and component parts. He was responsible for the scope of this work becoming all

inclusive in this new field. His work consisted of investigating, testing, evaluating, and disseminating component part information to all laboratory design and research engineers. He created local interest in the component parts field, and was instrumental in having local missile-parts engineers meet bi-monthly to discuss reliability and disseminate component part information.

In May of this year Mr. Paul joined Northrop Aircraft, Inc., Hawthorne, Calif., as supervisor of the electronic reliability section of the Special Weapons Division.

Mr. Paul was Secretary, and a member of the Final Steering Committee of the 1953 Electronic Components Symposium. He has published several technical articles, including "Characteristics of Deposited Carbon Resistors," and "Commercial, Ruggedized, and Premium Vacuum Tubes."

Mr. Paul became associated with the Institute as a Student in 1946, an Associate in 1950 and a Member in 1952.

Electronic Component Parts

FLOYD A. PAUL AND WAYNE C. IRWIN

A chain is no stronger than its weakest link. And when the chain is made of a multitude of intricately connected links of various degrees of strength and reliability, the previous aphorism becomes urgent and controlling.

Modern electronic equipment is indeed a complex chain of interrelated components. The dependability of each component thus determines the utility of the assembly. It was accordingly timely and appropriate that there be formed an IRE Professional Group on Electronic Parts.

Its purposes and plans are set forth in the following guest editorial, one of whose authors is the Chairman of this Group and is also Supervisor of the Reliability Section of Northrop Aircraft, Inc. at Hawthorne, California, and the other of whom is a research engineer in the same organization.—*The Editor*

A realistic policy toward the sharing of component parts data among research and development, and production organizations is long overdue. Channels for the exchange of test information have not kept pace with the growing need. Communication within all technical fields is essential if the state of the arts is to speed forward.

It has been estimated that the equivalent of seventy-five years of normal progress in electronic development has been achieved in the past fifteen years. The impetus for this accelerated advancement was the Government money poured into research and development programs. With the addition of new fields of interest, so limited in 1938, has come the need for visionary planning and studies of potential applications. In another ten years the most inclusive program now conceived will have become too restricted.

Nowhere is the need for development more acute than in the field of Component Parts. The primary limitation on the design of any system is the performance and reliability of the separate parts.

However, development cannot be done effectively without detailed knowledge of the performance of component parts in a multitude of environments. Accurate data must be compiled showing the effect of specific environmental and performance conditions upon each part. This information must then be channeled both to vendors and to equipment-design groups to ensure optimum usage. Because of the acute lack of this knowledge, engineering study in the Component Parts field has expanded to its present status.

The need for specialization in this work has been recognized by the IRE with its formation of the new "Electronic Component Parts" Professional Group. The Group is concerned with the characteristics, limitations, applications, development, performance, and reliability of component parts. It is expected that this Group will stimulate investigation and evaluation of present techniques and products.

One problem which can be overcome is the limited distribution of test results among companies and military contractors with a common aim. Each user of component parts now attempts his own evaluation of vendors' products, thereby throwing a heavy and unnecessary burden upon the nation's supply of technical personnel and laboratory facilities. This duplication of effort can be reduced by (1) recognizing that seldom is proprietary interest jeopardized by the sharing of test results and (2) the creation of new channels for quick and informal transmittal of these results.

The nature of this problem is known. Its military urgency is becoming understood. It is time that its solution was emphasized.

The Development of Professional Groups and Chapters in the IRE*

L. C. VAN ATTA†, FELLOW, IRE

CONCEPT OF PROFESSIONAL GROUPS

WE ARE CURRENTLY WITNESSING the creation of a number of professional societies within The Institute of Radio Engineers. Whereas this is proceeding as a bloodless revolution, we must expect much sweat and perhaps a few tears before it is complete. That the revolution is bloodless, is a credit to those who conceived of the Professional Group system; that the revolution achieves a maximum good, is the responsibility of every one of us. We must each of us know the facts about the Professional Groups in the IRE. We must understand the principles on which they are based and be familiar with the procedures by which they operate. We must each think about them in terms of our own needs for a specialized professional society and must act to insure that our needs are met.

The concept of Professional Groups was adopted in March 1948 to provide more adequately for the professional needs of specialized groups within the framework of the IRE. It had already been demonstrated in the field of American Physics that, on the one hand, a large undifferentiated society covering a wide field of interest cannot satisfy all its members, but that, on the other hand, several small societies in the same field are beset by excessive overhead and by resultant financial problems. In adopting the Professional Group principle, The Institute of Radio Engineers was attempting to realize a workable compromise directly: the Professional Groups were to care for their own specialized professional needs while IRE Headquarters provided guidance, coordination and generalized services.

The principal functions of each Professional Group Administrative Committee are to plan and conduct specialized symposia, to publish a Group Transactions with the objective of making it ultimately a regularly issued publication, to arrange for financial support of these undertakings, and to build up a large, well-informed Group membership. The IRE has committed itself to provide administrative, editorial, and financial assistance to the Group in performing these functions.

GROWTH OF PROFESSIONAL GROUPS

The Audio Group was formed in June, 1948, within three months of the adoption of the Professional Group principle. Since then Groups have been formed at a roughly linear rate of four per year to a present total

of 19 groups. Membership in the Groups has grown at an increasing rate to a present total of 27,456, for an average of more than 1,400 members per Group. Sixteen of the Groups are levying assessments from their members and 14,100 members have paid such assessments. Eleven Groups are publishing Transactions and to date 33 issues have appeared. Areas of specialized interest are indicated by the following list of the existing Professional Groups in order of their formation and with their present membership:

NAME	DATE OF FORMATION	MEMBERSHIP (as of 3-1-53)
1. Audio	6- 2-48	2,157
2. Broadcast Transmission Systems	7- 7-48	1,266
3. Antennas and Propagation	2- 1-49	1,738
4. Circuit Theory	4- 5-49	2,814
5. Nuclear Science	4- 5-49	1,410
6. Vehicular Communications	4- 5-49	719
7. Quality Control	7-12-49	758
8. Broadcast and TV Receivers	8- 9-49	1,444
9. Instrumentation	1-31-50	2,335
10. Radio Telemetry and Remote Control	6-12-50	1,418
11. Airborne Electronics	1- 9-51	1,172
12. Information Theory	5- 8-51	1,278
13. Industrious Electronics	5- 8-51	2,078
14. Engineering Management	6-12-51	1,606
15. Electron Devices	10- 9-51	910
16. Electronic Computers	10- 9-51	1,699
17. Microwave Theory & Techniques	3- 7-52	1,048
18. Medical Electronics	3- 7-52	688
19. Communications Systems	4- 8-52	918
		27,456

Present trends indicate that the Professional Groups will grow in number and in average size. However it does not follow that all Groups will necessarily be successful. Various criteria can be used to judge the success of a Professional Group: the effectiveness of its national symposia, its ability to assemble suitable material for a regularly issued Transactions, the number of paying members, or the amount of activity and interest stimulated within the Sections. Whatever criteria are applied, we may rest assured popular judgment will be made and the field will be left to those Groups that justify their existence. Groups may be terminated, may combine

* Decimal classification: R060. Original manuscript received by the Institute, March 1, 1953; revised manuscript received May 7, 1953.

† Hughes Aircraft Co., Culver City, Calif.

with others, or may modify their fields of interest. However, it seems improbable that the total number of Groups in the foreseeable future be less than it is today.

The Professional Group movement, even in its infancy, is having a tremendous impact on the IRE. A large amount of early publication is being accomplished in the relatively informal Transactions of the IRE. Headquarters facilities and staff have had to be expanded considerably to care for new clerical and publications needs. There has been a large increase in the total number of technical sessions, and the Technical Program Committees for the Conventions are depending ever more heavily on the Professional Groups for assistance in planning and arranging technical sessions.

These effects have been felt before the Groups have fully established themselves. Already Group symposia have been held apart from the national Conventions. Several of the Group Transactions may become recognized technical journals with separate editorial staffs. It seems likely that such developments will have important effects on IRE Conventions, on the Proceedings, on the Convention Record, and on general IRE policies.

If we look beyond the period of growing pains, we can anticipate that the Professional Group development will convert the IRE from a large, undifferentiated engineering society to a much larger complex of specialized engineering societies. We can expect the new organization not only to meet professional needs more precisely, but also to be more flexible in the face of future pressures of whatever kind.

RELATIONS OF THE PROFESSIONAL GROUPS

We must indeed attempt to understand the Professional Groups. Perhaps this can best be done by considering their relations to the individual, to the IRE, to other societies and particularly to the IRE Sections.

The Professional Group has the responsibility of providing the individual with the advantages of a small, select society in the field of his specialization, just as the parent organization provides him with the advantages of a large, general society. The advantages of the small society relate primarily to meetings and to publications. Specialized symposia may be arranged either to coincide with IRE Conventions or to occur at places where there is large activity in the field of interest. Publications of restricted circulation can be established to provide intensive coverage of a limited field. Arrangements for either meetings or publications are simplified by being partially separated from the general activity.

The Professional Group is established under a constitution within the framework of the IRE. The constitution defines the technical field of interest of the Group, establishes its committee structure, describes broadly its functions and procedures, and fixes a minimum level of activity. The Group Chairman reports periodically to the IRE Professional Groups Committee and accepts general policy guidance.

The IRE provides financial assistance to the Groups

in accordance with their activity and current needs. The Group depends upon the Headquarters Staff for assistance with records, publicity, and technical or other publications. The Group provides the IRE with expert assistance and decentralized control in arranging national symposia, reviewing papers, and coordinating Section activities in its field.

The Professional Group may arrange technical meetings in cooperation with other societies. These cooperative meetings have been quite successful in the past as the result of jointly sponsoring one meeting instead of permitting competing meetings. As an example, one series of meetings in San Diego on Antennas and Propagation profited from joint planning, sponsorship and support on the part of The Institute of Radio Engineers, International Scientific Radio Union, Research and Development Board, and the U. S. Navy Electronics Laboratory.

It is the relation of Professional Groups to the IRE Sections that is now receiving the most intensive development. Local participation by representatives of the Groups in Section affairs is following almost automatically on national Group participation in IRE affairs. Resultant problems are so numerous and potential advantages so great that the remainder of the article is devoted to this phase of Group development.

CONCEPT OF PROFESSIONAL GROUP CHAPTERS

Within the Section there is the same need for considering specialized professional interests as has already been recognized at the national level. In taking action to meet this need, local members of Professional Groups have the advantage of an existing framework for national coordination and exchange. It is necessary, however, to formalize relations between the Sections and Groups, and to define a connecting organizational unit, as follows:

A Chapter of a Professional Group is a duly established and recognized organizational unit of Section membership in technical association with the Professional Group.

The general purpose of a Chapter is to represent the professional interests of its Group members within a Section, to stimulate and conduct activities in the field of interest of the Group, and to coordinate these with the local activities of the Section and the national activities of the Group. The Chapter, a mutual concern of both Section and Group, is established by their joint action and must be provided with formal means for working directly with both.

Administration of a Chapter by a Section may be provided by making the Chapter Chairman a member of the Chapter Committee, Meetings and Papers Committee or Executive Committee of the Section. Formal contact with the associated Professional Group may be made in any suitable way such as: by making the Chapter Chairman a member of the Professional Group Ad-

ministrative Committee. The Chapter Chairman should maintain close liaison with the Professional Group committees on Membership, Papers Procurement and Publication.

The primary duty of a Chapter is to promote Section meetings in the field of interest of its associated Professional Group. Other essential duties of the Chapter consist of regular reporting to the Section and Group, of maintaining a certain minimum of representation at appropriate meetings of Section and Group committees, and of cooperating with Section and Group in local and national activities respectively. The minimum activity of the Chapter consists of the performance of these essential duties to the satisfaction of the Section and the Group.

Additional legitimate functions of the Chapter consist of 1) Arranging publicity and facilities for technical meetings of its sponsorship when these are not provided by the Section; 2) Conducting business meetings for planning Chapter activities and handling relations with its associated Professional Group; 3) Conducting membership drives for Chapter, Section, Group, or the IRE; and 4) Soliciting local papers for presentation at national Group symposia or IRE Conventions, or for publication in the PROCEEDINGS of the IRE or in the Group TRANSACTIONS.

The local activities of a Chapter are conducted as part of the Section program. These are approved by Section officers and supported financially by the Section. Any financial returns from such activities accrue to the Section. Within reasonable limits the Section provides publicity, space and facilities for Chapter-sponsored meetings or defrays their cost.

The national activities of a Chapter are conducted in collaboration with the Professional Group. Final decisions regarding national publicity, meeting space, and publication of papers for national symposia are the responsibility of the Administrative Committee of the Group. Any financial returns from national symposia sponsored by a Professional Group accrue to the Group fund at IRE Headquarters, and any costs are borne by this Group fund. The Chapter assists where practicable in plans and arrangements for Group symposia. It encourages its members to present papers at national Group symposia and to submit papers to the Group TRANSACTIONS. The Chapter Chairman keeps the Group Chairman informed of local activities and contributes to the NEWS LETTER of the Group.

BENEFITS FROM CHAPTERS

In the first place the Chapter provides the basis for recognizing and supporting efforts of Section members to provide for their own specialized professional needs. Beyond this, the creation of a Chapter in a Section results in distinct benefits to both the Section and the Professional Group.

The Chapters provide a means by which the Section can diversify and decentralize its organization to meet

the needs peculiar to its membership, i.e. the Chapters provide unit building blocks with which the Section organizational structure can be expanded in a variety of ways. With the help of its Chapters a Section can offer its members a greater variety of specialized technical programs more expertly arranged. To the extent that a Section better meets the professional needs of its membership, the Section will be more successful and its membership will be increased. Development of local interest will result also in increased Group and IRE membership.

The Chapter can assist the Professional Group with local arrangements for national symposia to be held in its Section. The Chapter can serve to channel important local technical work into Group or IRE symposia or publications. Chapter representatives can supply the Professional Group Chairman with information about local needs and with a reservoir of competent manpower for future service on the Administrative Committee.

As the mutual advantages of the Section-Group relationship through the agency of their Chapters get to be better appreciated, we can expect both Sections and Groups to make more systematic efforts to establish Chapters. We can expect as a result that the number of Chapters will increase very rapidly during the next few years. The Chapters therefore should play an increasing role in enriching the specialized professional activities in the Sections and in focusing national attention on outstanding technical accomplishments through the medium of the Professional Groups.

CHAPTER ESTABLISHMENT AND ORGANIZATION

The initiative in establishing a Chapter of a Professional Group in a Section may be taken by the Section Executive Committee, by the Professional Group Administrative Committee, or by IRE members in the Section with an interest in the field of the Professional Group. In any case the procedure is the same: a petition is prepared, circulated among Section members for signatures, and forwarded with the formal approval of the Section Executive Committee to the Technical Secretary, IRE Headquarters. The Technical Secretary then obtains approval from the Executive Committee of the Institute, records at IRE Headquarters the existence of the new Chapter, and so informs the Section Executive Committee.

The petition must contain the following information:

Name of Section

Name of Professional Group

Name of organizer (who becomes interim chairman pending election of regular chairman at a later organization meeting)

Signatures of at least 10 petitioners (who must be IRE members and must indicate on the petition either that they are members of the Professional Group involved or are prepared to become members if the petition is granted).

After receipt of information from the IRE Technical Secretary that the petition has been granted, the Chapter Organizer holds organization and election meetings and informs Section, Group and IRE Headquarters of the results. The Section Chairman informs the newly-elected Chapter Chairman of the reports expected from him and of the meetings which he or his delegate are invited to attend.

Chapters are added as they are petitioned by Section membership, and are terminated whenever they fall below the acceptable level of activity or effectiveness. The formal membership of a Chapter consists automatically of IRE members who are also members of both the Section and the Group. Attendance at Chapter meetings is not limited to Chapter members.

The organizational structure required for a Chapter depends upon its activities. A single officer can provide the formal representation to the Group and can perform additional limited functions, such as arranging for an occasional speaker at a Section Meeting. Normally a Chapter is more active in arranging meetings, conducting membership drives or soliciting papers, so that several officers are elected or appointed to its Administrative Committee as required.

ADJUSTMENT BY THE SECTION TO ITS CHAPTERS

To provide maximum service and encouragement to its Chapters and to capitalize most fully upon their activities, there are certain adjustments that the Section should make. If the Section contains several Chapters, or if the Executive Committee feels that the Section might with advantage support several Chapters, there should be established a Chapter Committee. This Committee would be charged with stimulating, guiding and coordinating Chapter activities; its Chairman would be a member of the section Executive Committee.

The Section should establish a Chapter Activities Fund to support Chapter activities and also to serve as a repository for funds collected as a result of same.

The Section should plan to have Chapters arrange for some of the technical programs of its regular meetings. In fact, in larger Sections, most of the technical meetings might be promoted by Chapters. A Section with several active Chapters may have to increase the number of meetings per year, but this should be considered to be a part of an expanded Section program. The Section should reexamine its meeting space and facilities and should insure that these are adequate to handle the expanded program.

The Section may find it necessary to increase the space in its Bulletin or meeting announcements to allow for the publicity required for Chapter activities. A monthly calendar of meeting dates and places might be added. In this connection a careful co-ordination of meeting dates should be effected. The date of issue of the Bulletin might have to be modified to assist in Chapter participation. Local reports on Chapter activities should be gathered together in one part of the Bulletin and a

copy of this part sent as early as possible to the Technical Secretary of the IRE for inclusion with similar material in a more general release by Headquarters.

STATUS OF THE CHAPTER MOVEMENT

Chapters on Audio existed in Boston and Milwaukee as early as the beginning of 1950. Whereas the Chapter movement is still so young that formal procedures are being established only now, there are already forty-eight Chapters in seventeen Sections of the IRE. Most active in this regard are the Los Angeles and Chicago Sections with twelve and eleven Chapters respectively. The Groups most active in establishing Chapters are Audio (10), Airborne Electronics (4), Broadcast Transmission Systems (4), Electronic Computers (4), and Vehicular Communications (4). Many more Chapters are in the process of formation, but those existing as of March 1, 1953 are tabulated below.

BY GROUPS

<i>Name of Group</i>	<i>No. of Chapters</i>	<i>Section Location</i>
Airborne Electronics	4	Baltimore, Dayton, Los Angeles, Philadelphia
Audio	10	Albuquerque (N.M. Sec.), Boston, Chicago, Cinn., Detroit, Kansas City, Milwaukee, Phila., Seattle, Los Angeles
Antennas and Propagation	2	Chicago, Los Angeles
Broadcast and TV Receivers	2	Chicago, Los Angeles
Broadcast Transmission Systems	4	Boston, Chicago, Kansas City, Los Angeles
Circuit Theory	2	Chicago, Los Angeles
Communications Systems	1	Washington, D. C.
Electron Devices	3	Emporium, Pa., Monmouth County, N. J. (N.Y. Sec.), Los Angeles
Electronic Computers	4	Los Angeles, Philadelphia, San Francisco, Washington
Engineering Management	2	Washington, Chicago
Industrial Electronics	1	Chicago
Information Theory	2	Albuquerque (N.M. Sec.), Los Angeles
Instrumentation	3	Chicago, Detroit, Los Angeles
Nuclear Science	2	Chicago, Oak Ridge, Tenn. (Atlanta Sec.)
Radio Telemetry and Remote Control	1	Los Angeles
Quality Control	1	Chicago
Vehicular Communications	4	Chicago, Detroit, Los Angeles, Washington

BY SECTIONS

<i>Name of Section</i>	<i>No. of Chapters</i>	<i>Groups</i>
Albuquerque (N.M. Sec.)	2	Information Theory, Audio
Los Angeles	12	Airborne Elec., Ant. and Prop., Audio, Broadcast and TV Rec., Broad. Tran. Sys., Circuit Theory, Elec. Devices, Elec. Computers, Vehicular Comms., Infor. Theory, Instru., Radio Tel. and Remote Control
San Francisco	1	Electronic Computers
Seattle	1	Audio
Baltimore	1	Airborne Electronics
Boston	2	Audio, Broadcast Transmission Systems
Emporium, Pa. Monmouth County, N. J. (N. Y. Sec.)	1	Electron Devices
	1	Electron Devices

	Sections, cont.	
Oak Ridge (Atlanta) Tenn.	1	Nuclear Science
Philadelphia	3	Elec. Computers, Air. Elec., Audio
Washington	4	Vehicular Comms., Engineering Mgt., Electronic Computers, Communications Systems
Chicago	11	Audio, Ant. and Prop., Broad. and TV Rec., Broad. Tran. Sys., Circuit Theory, Industrial Elec., Instru., Nuclear Science, Quality Con., Vehicular Comms., Engineering Mgt.
Cincinnati	1	Audio
Dayton	1	Airborne Electronics
Detroit	3	Audio, Instru., Vehicular Comms.

Kansas City	2	Audio, Broad. Tran. Sys.
Milwaukee	1	Audio

SECTION PG COORDINATORS

Chicago—A. A. Gerlach—Section Vice Chairman in charge of PG activities.
 Cleveland—Carl E. Smith—PG Coordinator.
 Dallas—William Rust, Jr., Regional Director—Region 6—PG Liaison.
 Kansas City—sub-section—David T. Geiser—PG Liaison.
 Los Angeles—Dr. Robert M. Ashby—Chairman, L. A. Section PG Committee.
 New York—S. Moskowitz—Chairman, Section Chapters Committee.
 Philadelphia—J. C. Brainerd—Section Vice Chairman in charge of PG activities.
 San Francisco—Dr. J. M. Pettit—PG Coordinator.

The Common-Collector Transistor Amplifier at Carrier Frequencies*

F. R. STANSEL†, SENIOR MEMBER, IRE

Summary—Expressions are derived for input resistance, output resistance and ratio of input to output voltage and current at low frequencies for transmission in both the base-to-emitter and the emitter-to-base directions. These expressions are extended to the carrier frequency range (up to approximately twice the alpha-cutoff frequency) by considering the effect of the variation of alpha with frequency, of collector capacitance and of load capacitance. Experimental evidence is presented which verifies the equations obtained.

INTRODUCTION

OF THE THREE fundamental transistor circuits, common-base, common-emitter and common-collector, only the common-collector circuit, or as it is sometimes called, the grounded-collector circuit, may have a high input impedance. This high input impedance, together with its approximately unity voltage amplification makes the common-collector transistor amplifier similar in both operation and use to the vacuum-tube cathode-follower circuit. Unlike the cathode-follower, the common-collector circuit is a bidirectional device capable of transmitting signals in either of two directions. There are also questions of stability in the use of common-collector transistor circuits which do not exist in vacuum-tube cathode-follower circuits.

The common-collector circuit has been discussed in a general way by previous writers^{1,2} It is the purpose here to extend these treatments and particularly to discuss the effects resulting from operating the common-collector amplifier at frequencies above the audio-fre-

quency range. In this article the low frequency equations for the input and output resistance and for the ratio of input to output voltage and current will be derived and their physical significance investigated. Following this the effect of frequency on transistor circuits will be touched upon and the basic principles cited will be applied to the low frequency equations previously derived. In the concluding portion of the article some experimental observations which verify the derived results will be given.

As previously mentioned, the common-collector circuit is bidirectional. Thus, the input may be either applied between the base and ground as shown in Fig. 1,

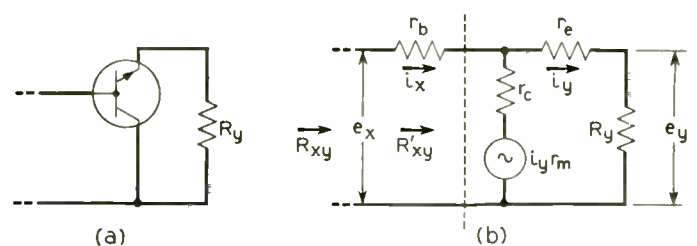

Fig. 1—Common-collector amplifier transmitting in the XY direction: (a) schematic, and (b) equivalent circuit.

or the input may be applied between the emitter and ground as shown in Fig. 2. The convention used in this article is to refer to the first connection (Fig. 1) as transmission in the XY direction and the second connection (Fig. 2) as transmission in the YX direction.

INPUT RESISTANCE— XY TRANSMISSION (OUTPUT RESISTANCE— YX TRANSMISSION)

The quantity R_{xy} as defined in Fig. 1 is both the input resistance of a common-collector amplifier when transmitting in the XY direction and the output resistance when transmitting in the YX direction. Wal-

* Decimal classification: R282.12. Original manuscript received by the Institute, December 16, 1952; revised manuscript received, May 19, 1953.

† Bell Telephone Laboratories, Murray Hill, N. J.

¹ R. M. Ryder and R. J. Kircher, "Some circuit aspects of the transistor," *Bell Sys. Tech. Jour.*, vol. 28, pp. 367-401; July, 1949.

² R. L. Wallace, Jr. and W. J. Pietenpol, "Some circuit properties and applications of NPN Transistors," *Proc. I.R.E.*, vol. 39, pp. 753-767; July 1951. Also *Bell Sys. Tech. Jour.*, vol. 30, pp. 530-563; July, 1951.

lace and Pietenpol² have given the value of this quantity. Using the notation of Fig. 1,

$$R_{xy} = r_b + \frac{r_c}{1 + (r_c - r_m)/(R_y + r_e)} \quad (1)$$

It is frequently desirable to express this relation in terms of the current amplification factor α which is defined as $[\partial i_c / \partial i_e]_e$ and is equal to:²

$$\alpha = \frac{r_m + r_b}{r_c + r_b} \quad (2)$$

By solving (2) for r_m and substituting in (1) the following is obtained:

$$R_{xy} = r_b + \frac{r_c}{1 + (r_c + r_b)(1 - \alpha)/(R_y + r_e)} \quad (3)$$

R_{xy} consists of the base resistance r_b in series with an equivalent resistance R'_{xy} equal to the second term of (3). Generally R'_{xy} is so large that the initial r_b term of (1) or (3) may be neglected and R_{xy} may be considered approximately equal to R'_{xy} .

By introducing the approximation $r_b \ll r_c$, valid for most transistors of both point contact and junction types (3) may be further simplified and becomes:

$$R_{xy} \cong R'_{xy} \cong \frac{r_c}{1 + r_c(1 - \alpha)/(R_y + r_e)} \quad (4)$$

which may be rearranged in the form:

$$\frac{1}{R'_{xy}} \cong \frac{1}{r_c} + \frac{1 - \alpha}{R_y + r_e} \quad (5)$$

This equation shows that the input resistance for XY transmission, neglecting the series resistance r_b , can be considered as composed of two resistors connected in

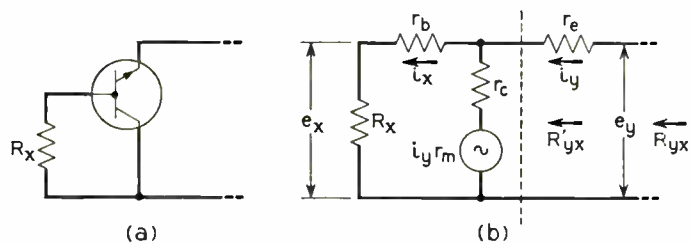

Fig. 2—Common-collector amplifier transmitting in the YX direction: (a) schematic, and (b) equivalent circuit.

parallel. One resistor is the collector resistance of the transistor r_c and the second is $(R_y + r_e)$ divided by $(1 - \alpha)$.

Consider the case of junction transistors. For this type r_c is quite large, often one or more megohms, so that the effect of this resistance is frequently of second order importance. α is generally only slightly less than unity so that $(1 - \alpha)$ is a small quantity and $(R_y + r_e)/(1 - \alpha)$ is large increasing in magnitude the nearer α is to unity. Therefore the input resistance of a common-collector amplifier using junction transistors is high and is determined largely by the load resistance and α but cannot exceed r_c .

Fig. 3 shows the value of R'_{xy}/r_c plotted as a function of $(R_y + r_e)/r_c$ for values of α found in both junction and point-contact transistors. Junction type transistors have values of α less than unity and the curves applicable are the solid lines in the center portion of the figure. Point-contact transistors, on the other hand, generally have values of α greater than unity and the curves applicable to these transistors are the dotted lines in the upper and lower portion of Fig. 3.

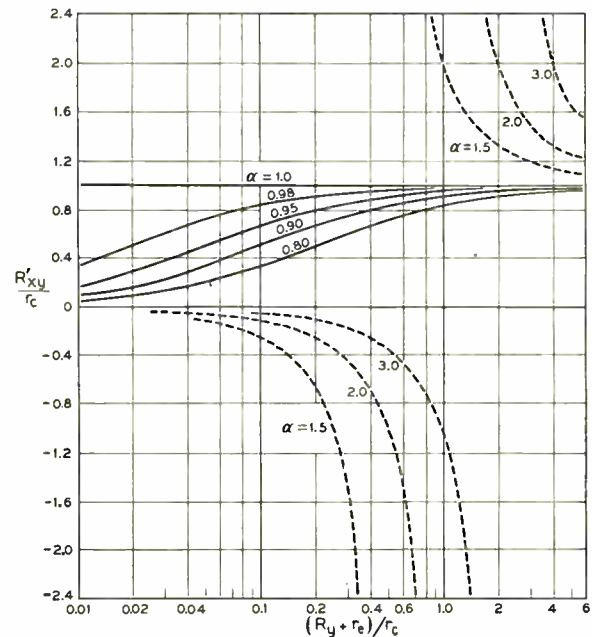

Fig. 3—Variation of input resistance as a function of load resistance— XY transmission.

For α greater than unity, the input resistance is more complicated and may under some conditions be negative. The quantity $1 - \alpha$ is negative so that R'_{xy} consists of a positive resistance r_c in parallel with a negative resistance $-(R_y + r_e)/(\alpha - 1)$. For very small values of R_y , less than the value given by the following expression,

$$R_y = r_b(\alpha - 1) - r_e \quad (6)$$

R_{xy} is positive. As R_y is increased, R_{xy} decreases, becoming zero at the value given in (6). For greater values R_{xy} is negative and increases in magnitude as R_y is increased until at the value,

$$R_y = (r_c + r_b)(\alpha - 1) - r_e \quad (7)$$

R_{xy} is infinite. For greater values of R_y , R_{xy} is positive, decreasing and approaching r_c asymptotically as R_y is increased. The corresponding variation of R'_{xy} is shown by the dotted curves of Fig. 3.

INPUT RESISTANCE— YX TRANSMISSION (OUTPUT RESISTANCE— XY TRANSMISSION)

The quantity R_{yx} as defined in Fig. 2 is both the input resistance of a common-collector amplifier when transmitting in the YX direction and the output resistance when transmitting in the XY direction. In the same manner as (3) its value is found to be,

$$R_{yx} = r_e + \frac{(1 - \alpha)(r_c + r_b)}{1 + r_c/(R_x + r_b)} \quad (8)$$

$$R_x = \frac{r_e - r_b(\alpha - 1)}{(\alpha - 1) - r_e/(r_c + r_b)} \quad (11)$$

As in the case at R_{xy} , R_{yx} consists of the emitter resistance r_e in series with an equivalent resistance R'_{yx} whose value is the second term of (8).

In contrast with R'_{xy} , R'_{yx} has a low value often of the same order as r_e and hence R'_{yx} is generally not a good approximation for R_{yx} .

Introducing the approximation $r_b \ll r_c$ the expression for R'_{yx} may be written in the form:

$$\frac{1}{R'_{yx}} \sim \frac{1}{(1 - \alpha)} \left[\frac{1}{r_c} + \frac{1}{R_x + r_b} \right], \quad (9)$$

thus indicating that R'_{yx} may be considered as two resistors $(1 - \alpha)r_c$ and $(1 - \alpha)(R_x + r_b)$ connected in parallel.

For many transistors the collector resistance r_c is high enough so that the first branch has little effect on the value of R'_{yx} and the following approximation is valid for the total input resistance:

$$R_{yx} \cong r_e + (1 - \alpha)(R_x + r_b) \quad (10)$$

The variation of the R'_{yx}/r_c as a function of $(R_x + r_b)/r_c$ is shown in Fig. 4. As in the previous case,

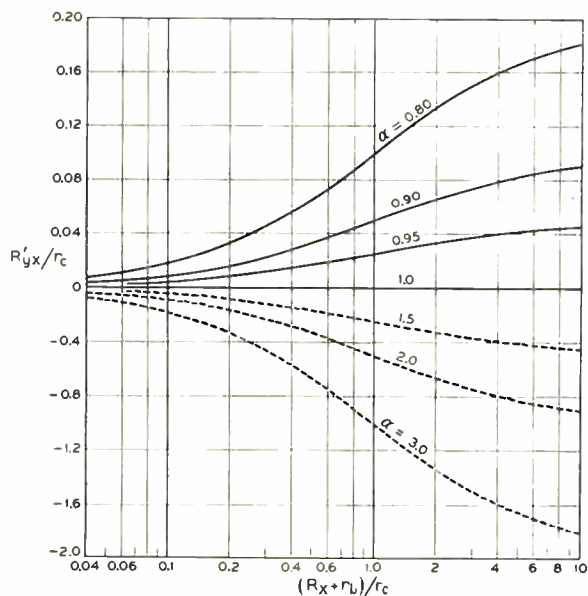

Fig. 4—Variation of input resistance as a function of load resistance —YX transmission. Note that scale for R'_{yx}/r_c is different for positive and negative values.

the curves applicable to junction transistors are shown in solid lines and the curves applicable to point-contact transistors are in dotted lines. Note that the curves applicable to junction transistors are plotted to a different scale of R'_{yx}/r_c than those applicable to point-contact transistors.

For α less than unity (junction transistors), R'_{yx} is always positive and increases as $(R_x + r_b)$ is increased with a limiting value of $(1 - \alpha)r_c$. For α greater than unity (point-contact transistors), R'_{yx} is always negative. The total input resistance R_{yx} is positive for values of R_x less than

for R_x equal to (11), R_{yx} is zero. For larger values of R_x , R_{yx} is negative, increasing in absolute magnitude as R_x increases and approaching the limiting value $-(\alpha - 1)r_c$. The corresponding variations of R'_{yx} are shown by the dotted lines in Fig. 4.

RATIO OF INPUT TO OUTPUT VOLTAGE AND CURRENT

These ratios may be found by solving the mesh equations for a common-collector transistor.¹ For XY transmission these ratios are:

$$\left[\frac{e_x}{e_y} \right]_{xy} = \frac{r_c + r_b}{r_c} \left(1 + \frac{r_b(1 - \alpha) + r_e}{R_y} \right) \quad (12)$$

$$\left[\frac{i_x}{i_y} \right]_{xy} = (1 - \alpha)(1 + r_b/r_c) + (R_y + r_e)/r_c. \quad (13)$$

For most transistors $r_b \ll r_c$ and $r_e \ll r_c$ so that the term outside the bracket in (12) and the $(1 + r_b/r_c)$ term in (13) are essentially unity. For large values of R_y the voltage ratio approaches unity while the current ratio is approximately:

$$\left[\frac{i_x}{i_y} \right]_{xy} \cong (1 - \alpha) + R_y/r_c. \quad (14)$$

For α less than unity (junction transistors), the output voltage and current are in phase with the input voltage and current for all values of R_y . For α greater than unity (point-contact transistors) the output voltage and current are in phase with the input voltage and current if R_y has a value greater than (7). If R_y is greater than (6) and less than (7) the input and output voltages are in phase and the input and output currents are 180° out of phase. If R_y has a value between zero and (6) the output voltage and current are 180° out of phase with the input voltage and current.

For YX transmission,

$$\left[\frac{e_y}{e_x} \right]_{yx} = 1 + \frac{r_b}{R_x} + \frac{r_e}{(r_c + r_b)(1 - \alpha)} \left[1 + \frac{r_c + r_b}{R_x} \right] \quad (15)$$

$$\left[\frac{i_y}{i_x} \right]_{yx} = \frac{1}{1 - \alpha} \left[1 + \frac{R_x}{r_c + r_b} \right] \quad (16)$$

if $r_b \ll r_c$ and $R_x \ll r_c$, (15) is approximately:

$$\left[\frac{e_y}{e_x} \right]_{yx} = 1 + \frac{r_b}{R_x} + \frac{r_e}{R_x(1 - \alpha)}. \quad (17)$$

For α less than unity (junction transistors) the output voltage and current are in phase with the input voltage and current for all values of R_x . For α greater than unity (point-contact transistors) the output voltage and current are 180° out of phase with the input voltage and current when R_x is less than the value given by (11).

For values of R_z greater than (11) the input and output voltages are in phase while the input and output currents are 180° out of phase.

EFFECT OF FREQUENCY

All of the preceding equations have assumed that the frequency is low. As the frequency is increased, four effects modify these equations. They are:

- (a) Variation of α both in magnitude and in phase with frequency.
- (b) Variation of r_e and r_b with frequency.
- (c) Effect of internal capacitance of the transistor particularly the capacitance shunted across r_c and the equivalent generator $i_y r_m$.
- (d) Effect of capacitance shunted across the load and generator resistances, that is, across R_x and R_y .

Ryder and Kircher¹ have discussed the frequency characteristic of α for point-contact transistors. Their observations were that the phase shift of α is "related to the amplitude in the same way as if the characteristic were that of a 'minimum phase' passive circuit." Based on these observations, D. E. Thomas³ has suggested that α can be represented by the equation:

$$\alpha = \frac{\alpha_0}{1 + j\Omega}, \tag{18}$$

in which α_0 is the value of α at low frequency, Ω is the ratio of the operating frequency to the cutoff frequency, f_e , and f_c the frequency at which the magnitude of α is $1/\sqrt{2}$ that of the low frequency value.

A more exact expression for α ,

$$\alpha = \alpha_0 \operatorname{sech} (j2.43\Omega)^{1/2}, \tag{19}$$

has been derived by Pritchard⁴ from the theoretical treatment of NP junctions by Shockley, Sparks and Teal.⁵ By expanding (18) into an infinite series it may be shown that (18) is a first approximation for (19). In an unpublished communication with the author, Pritchard has pointed out that while this approximation is quite good in magnitude, the difference being less than 0.1 db at 1.8 f_e , the agreement in phase is not so good. At the cutoff frequency f_c the two expressions differ by 13°. Hence on the basis of both theoretical considerations and experimental data which follows the use of the simpler expression (18) is justified at lower frequencies. At high frequencies a more complicated expression such as (19) may be required.

During the summer of 1952 the author made a series of measurements to determine whether (18) was accurate for junction type as well as point-contact transistors. Six grown junction NPN and two early experiment PNP alloy transistors were measured. In all cases the experimental results checked (18) within the limits of experimental error, generally closer than 0.1 db, up to

about twice the cutoff frequency. Above twice the cutoff frequency the measured loss in α was generally greater than the computed loss.

Recently the author has measured additional transistors including some PNP alloy units from several sources. In general most PNP alloy units measured recently have not followed (18) as closely as grown junction NPN units. Beyond the cutoff frequency most PNP alloy units have a tendency to decrease in α at a much faster rate than indicated by (18).

Cutoff frequency is effected by the operating point of the transistor. For grown junction NPN units the cutoff frequency increases with increasing collector voltage. In units checked cutoff frequency reached a maximum value at an emitter current between 0.5 and 2 ma. Cutoff frequency may also be affected by ambient temperature but this change is generally not large.

J. M. Early⁶ has shown that because of secondary effects the complete expression for r_e and r_b includes a correction factor which varies with frequency. The corresponding correction factors for r_e and α are negligible. These correction factors have not been introduced since in most cases these terms are small enough to be negligible. For a more exact treatment the effect of the variation of r_e and r_b with frequency must be considered.

GENERALIZED EQUIVALENT INPUT CIRCUIT—XY TRANSMISSION

The generalized form of R'_{xy} can be best expressed in the form of an admittance. This relation is obtained from (5) by substituting (18) for α , $G_y + j\omega C_y$ for $1/R_y$ and $g_c + j\omega c_c$ for $1/r_c$. Assuming $r_e \ll R_y$ and after some purely mathematical steps, the following equivalent input conductance and capacitance are obtained:

$$G'_{xy} \cong g_c + \frac{(1 - \alpha_0 + \Omega^2)G_y}{1 + \Omega^2} - \frac{2\pi f_c C_y \alpha_0 \Omega^2}{1 + \Omega^2} \tag{20}$$

$$C'_{xy} \cong c_c + \frac{\alpha_0 G_y}{2\pi f_c (1 + \Omega^2)} + \frac{(1 - \alpha_0 + \Omega^2)C_y}{1 + \Omega^2} \tag{21}$$

in which $\Omega = f/f_c$.⁷

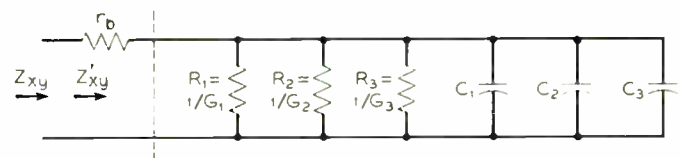

Fig. 5—Equivalent circuit for input impedance of common-collector amplifier. XY transmission.

The equivalent circuit which corresponds to (20) and (21) is shown in Fig. 5. It consists of three resistances

⁶ J. M. Early "Effects of space charge layer widening in junction transistors," Proc. I.R.E., vol. 40, pp. 1401-1406; November, 1952.

⁷ In deriving (20) and (21) it was assumed that the collector capacitance c_c shunts only r_c and not r_e and the equivalent generator $i_y r_m$ in series. The justification for this approximation is as follows. The effect of shunting r_e and $i_y r_m$ by c_c is equivalent to replacing r_e and r_m with $r_e \phi$ and $r_m \phi$ where $\phi = (1 - jQ_c)/(1 + Q_c^2)$ and $Q_c = \omega r_e c_c$. If in deriving α from r_m and r_e using (2) r_b is assumed negligible with respect to both r_m and r_e , the ϕ 's will cancel showing that α is not affected by the presence of c_c .

³ D. E. Thomas, "Transistor amplifier-cutoff frequency," Proc. I.R.E., vol. 40, pp. 1481-1483; November, 1952.

⁴ R. L. Pritchard, "Frequency variations of current-amplification factor for junction transistors," Proc. I.R.E., vol. 40, pp. 1476-1481; November, 1952.

⁵ W. Shockley, M. Sparks and G. K. Teal, "P-N Junction transistors," *Phy. Rev.*, vol. 83, pp. 151-162; July 1, 1951.

corresponding to the three terms of (20) and three capacitances corresponding to the three terms of (21) all connected in parallel. By adding the series impedance r_b the complete generalized equivalent circuit is obtained although as previously discussed this series term can generally be neglected.

A useful set of approximate values can be obtained from (20) and (21) by assuming that the Ω^2 term in $1 + \Omega^2$ and $1 - \alpha_0 + \Omega^2$ can be neglected. This approximation is valid up to 0.05 so 0.1 of the cutoff frequency and is useful in designing circuits in the frequency range up to 100 to 200 kilocycles. For this condition:

$$G'_{xy} \cong g_c + (1 - \alpha_0)G_y - 2\pi f_c C_y \alpha_0 \Omega^2 \quad (22)$$

$$C'_{xy} \cong c_c + \alpha_0 G_y / 2\pi f_c + (1 - \alpha_0)C_y \quad (23)$$

This approximation shows that at low frequencies both the input conductance and capacitance of a common-collector amplifier are nearly independent of frequency. The only frequency dependent term in (22) and (23) is the third term in (23) which can be minimized by making C_y small.

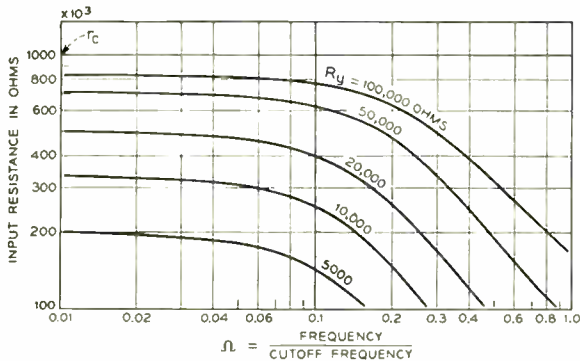

Fig. 6—Input resistance (XY transmission) for transistor having $\alpha_0 = 0.98$, $r_c = 1$ megohm, $f_c = 2$ megacycles and $c_c = 5$ mmf.

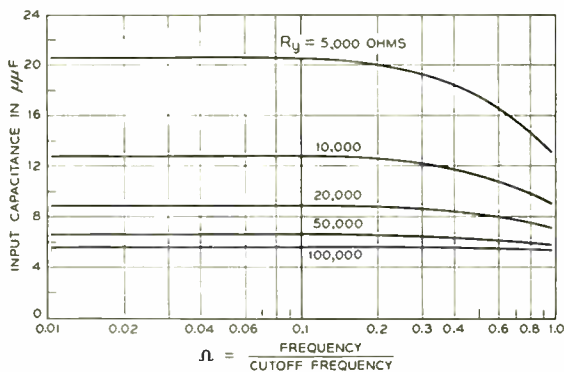

Fig. 7—Input capacitance (XY transmission) for same transistor as Fig. 6.

Figs. 6 and 7 are some illustrative curves for a common-collector amplifier using a junction transistor whose parameters are:

$$\begin{aligned} \alpha_0 &= 0.98 & f_c &= 2 \text{ megacycles} \\ r_c &= 1 \text{ megohm} & c_c &= 5 \text{ micromicrofarads.} \end{aligned}$$

In this amplifier C_y is assumed to be zero.

Fig. 6 shows the resistance component of the input impedance. As in the low frequency case, the input resistance increases as the load resistance is increased with an upper limit equal to r_c as determined by the first term in (20). Fig. 7 is the capacitance component of the input impedance which decreases as the load resistance is increased approaching c_c as a limiting value.

The effect of a capacitance shunted across the load resistance is given by the third term of both (20) and (22). Since this term has a negative sign, its effect is to decrease the input conductance or to increase the input resistance. Because of the Ω^2 term in the numerator this term has little effect at low frequencies but becomes of increasing importance as the frequency is increased. The magnitude of this term is directly proportional to C_y and if C_y is made large enough the magnitude of the third term will exceed the sum of the other two terms. For this condition the input conductance will have a negative value. Such negative conductance values have been measured experimentally.

When α_0 is greater than unity as in point-contact transistors both the second and third terms of (20) and (22) may be negative. This is a generalization of the negative resistance case previously discussed.

GENERALIZED EQUIVALENT INPUT CIRCUIT— YX TRANSMISSION

The generalized form of R'_{yx} , expressed as an admittance, may be found in the same manner as (20) and (21). The assumption that $r_b \ll R_x$ is also made. Because of the relative magnitudes of r_b and r_e this approximation is not as generally valid as in the previous case. The equivalent input conductance and capacitance for this case are:

$$G'_{yx} \cong \frac{(1 - \alpha_0 + \Omega^2)g_c}{(1 - \alpha_0)^2 + \Omega^2} + \frac{(1 - \alpha_0 + \Omega^2)G_x}{(1 - \alpha_0)^2 + \Omega^2} + \frac{2\pi f_c \Omega^2 \alpha_0 (c_c + C_x)}{(1 - \alpha_0)^2 + \Omega^2} \quad (24)$$

$$C'_{yx} \cong \frac{(1 - \alpha_0 + \Omega^2)(c_c + C_x)}{(1 - \alpha_0)^2 + \Omega^2} - \frac{\alpha_0 g_c}{2\pi f_c [(1 - \alpha_0)^2 + \Omega^2]} - \frac{\alpha_0 G_x}{2\pi f_c [(1 - \alpha_0)^2 + \Omega^2]} \quad (25)$$

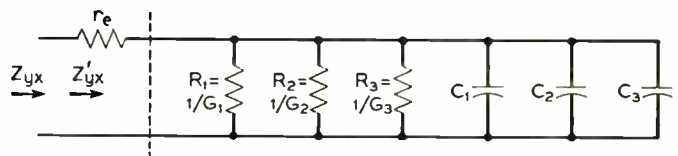

Fig. 8—Equivalent circuit for input impedance of common-collector amplifier. YX transmission.

The equivalent circuit corresponding to (24) and (25) is shown in Fig. 8. It consists of three resistances corresponding to the three terms of (24) and three ca-

capacitances corresponding to the three terms of (25) all connected in parallel. By adding the series impedance r_e the complete generalized circuit is obtained. In general, resistance values in Fig. 8 are lower than in Fig. 5, so it is often necessary to consider the effect of this series term.

Figs. 9 and 10 are illustrative curves computed for the same amplifier as used in Figs. 6 and 7. By compar-

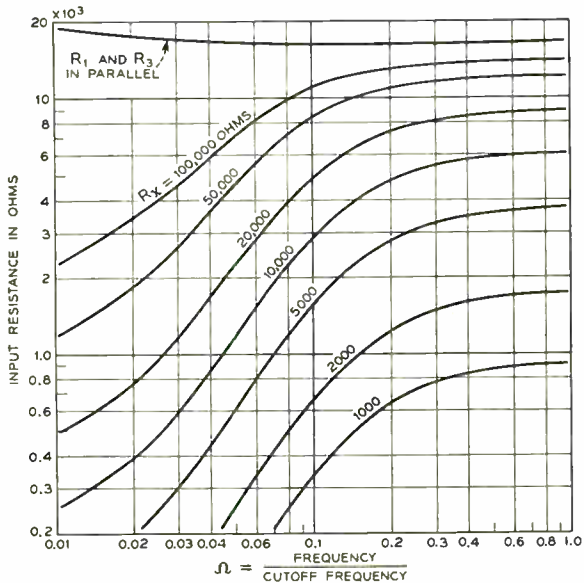

Fig. 9—Input resistance (YX transmission) for same transistor as Fig. 6.

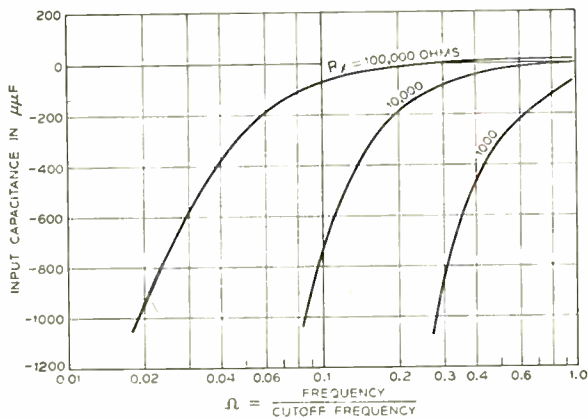

Fig. 10—Input capacitance (YX transmission) for same transistor as Fig. 6.

ing these two sets of curves it may be seen that these two impedances are in many ways the inverse of each other. The input resistance of XY transmission is high and nearly constant at low frequencies. As the frequency increases, this resistance decreases. In contrast, for YX transmission the input resistance is low and increases quite markedly with frequency at low frequencies. As the frequency increases, this resistance approaches an asymptotic value which is essentially R_x for low values of R_x . For higher values of R_x this asymptote is reduced in value by other two shunt resistances shown in Fig. 8.

The input capacitance for XY transmission is positive and nearly constant with frequency while the input capacitance for YX transmission may be negative and varies quite markedly with frequency.

EXPERIMENTAL OBSERVATIONS

A series of measurements were made to verify the foregoing mathematical treatment. The larger portion of these measurements was made using NPN junction transistors although some measurements were also made using point-contact and early experimental PNP alloy transistors. All observations checked computed results within the limits of experimental observations.

Fig. 11 shows the measured ratio of input to output voltage of a common-collector amplifier as a function of the load resistance. These measurements were made at

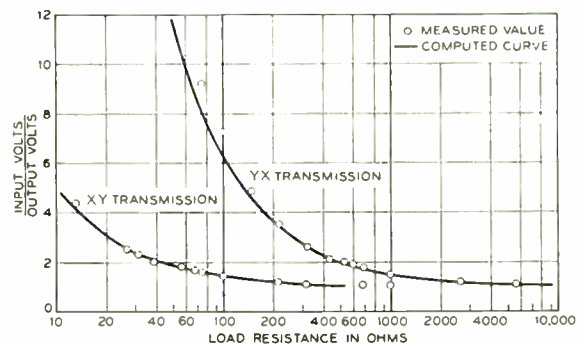

Fig. 11—Measured values of ratio of input to output voltage as function of load resistance. Output voltage = 0.005 volts; frequency = 30 kilocycles.

30 kilocycles using an NPN junction transistor with a constant output voltage of 0.005 volts. The two curves show the theoretical ratios for transmission in the XY and in the YX directions, computed using (12) and (15) respectively. Except for low values of load resistance, the measured values, as indicated on Fig. 11, check very closely the computed curve. For YX transmission there is a possibility some of the error was due to neglecting the effect of stray inductance in series with the load.

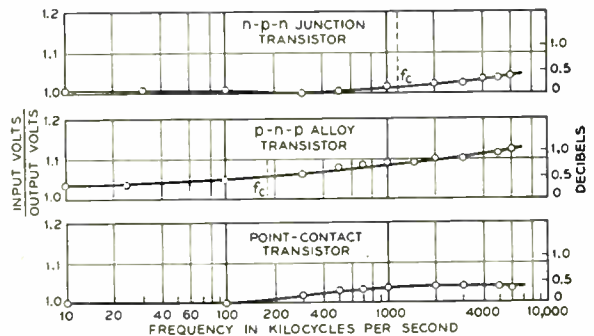

Fig. 12—Measured values of ratio of input to output voltage as function of frequency. XY transmission. $R_x = 5620$ ohms.

Fig. 12 shows the ratio of input to output voltage as a function of frequency for three transistors, a NPN junction transistor, an early experimental PNP alloy transistor and a point-contact transistor. These curves

were all taken transmitting in the *XY* direction and with a load of 5620 ohms. In all cases, the voltage ratio is very close to unity, increasing only slightly as the frequency increases. From 10 kilocycles up to the cutoff frequency the variation in voltage is in the order of a few tenths of a decibel.

Figs. 13 and 14 show a series of measurement of input admittance of a common-collector amplifier using a NPN junction transistor and a 10,000 ohm load resistance. These measurements were made using a pre-

Hence, as load capacitance is increased the input conductance should decrease and if the load capacitance is made large enough, it should be possible to obtain a negative input conductance. Fig. 13 shows that this decrease in conductance with increasing load capacitance was observed and for frequencies of 75 kc and above negative values of input conductance were measured.

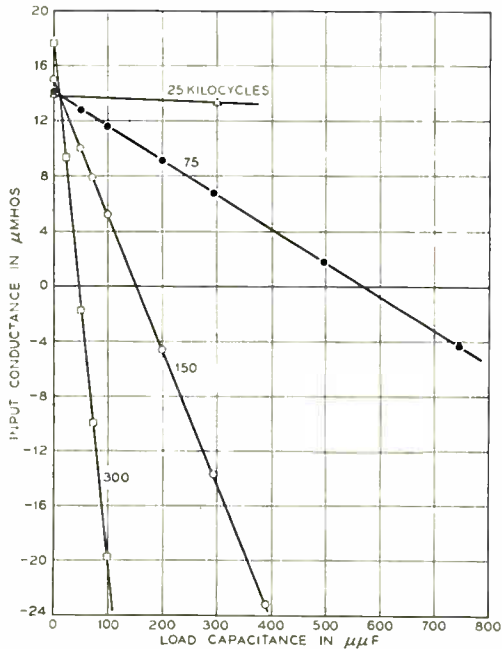

Fig. 13—Input conductance as a function of load capacitance. *XY* transmission. $R_v = 10,000$ ohms.

cision admittance bridge suitable for use at frequencies up to at least 500 kilocycles. According to (20) and (21), both the conductance and the capacitance components of the admittance are linearly related to the load capacitance. Fig. 13 shows observed values of input conductance and Fig. 14 observed values of input capacitance both as functions of load capacitance and at several frequencies. It will be noted that the predicted linear relation was observed.

In (20) it will be noted that the conductance term proportional to the load capacitance has a negative sign.

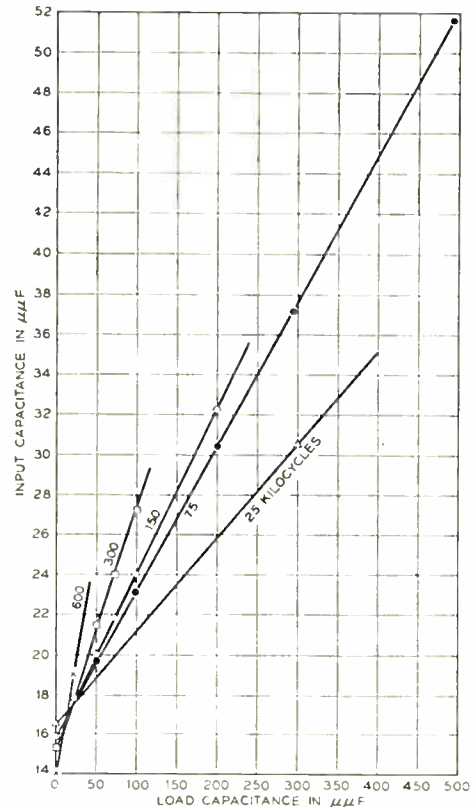

Fig. 14—Input capacitance as a function of load capacitance for same amplifier as Fig. 13

ACKNOWLEDGMENT

The writer wishes to acknowledge suggestions and helpful criticism from many of his associates at the Bell Telephone Laboratories. He particularly wishes to acknowledge assistance from R. E. Yaeger and E. K. Van Tassel in checking the derivation of these equations and in the preparation of this manuscript.



A Review of Methods for Measuring the Constants of Piezoelectric Vibrators*

EDUARD A. GERBER†, ASSOCIATE, IRE

Summary—The intent of the paper is to review all the known methods for measuring the constants of piezoelectric vibrators. The discussed methods are divided into two groups: routine measuring methods and laboratory measuring methods. The use of self-controlled oscillator circuits with the vibrators oscillating at their resonant frequency is recommended in the first group and the use of bridge circuits is recommended in the second group.

I. INTRODUCTION

A PIEZOELECTRIC VIBRATOR consists of a blank cut from piezoelectric material, usually in the form of a disk, slab, or ring, and with electrodes attached to, or supported near, the blank to excite one of its resonant frequencies. The piezoelectric vibrator can be represented in the vicinity of one of its resonant frequencies by its equivalent circuit, consisting of the series connection of an inductance, a capacitance, and a resistance, in parallel with a second capacitance. This simple network represents a resonant mode of the vibrator in all cases where the relative distance between resonant and antiresonant frequency is small in comparison with unity. Many methods are in use to measure the parameters of the equivalent circuit and their variations with temperature and pressure. It is the purpose of this paper to describe these methods, to discuss their advantages and disadvantages, and to recommend certain preferred methods. Future use of these methods by manufacturers and others concerned with the measurement of equivalent parameters will result in reliable and comparable results.

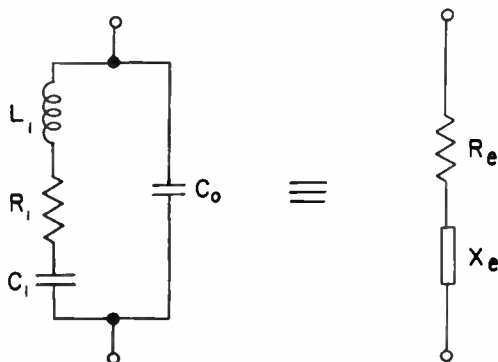

Fig. 1—Equivalent circuits of a piezoelectric vibrator.

II. PARAMETERS OF A PIEZOELECTRIC VIBRATOR

Fig. 1 shows the equivalent circuits of a piezoelectric vibrator. The four fundamental parameters L_1 , C_1 , R_1 , and C_0 determine the network completely; any other parameters, such as the resonant frequencies (or more

accurately, the characteristic frequencies, as they are called throughout this paper), the quality factor Q_1 and the capacitance ratio $r = C_0/C_1$ may be derived from them. The latter parameters, however, are of greatest practical importance in piezoelectric vibrators and methods for measuring them directly will also be considered in this paper. On the other hand, a measurement of the crystal resistance R_e under positive reactance conditions, as occurs in a Miller or Pierce circuit, is not considered to be fundamental and for this reason is omitted. Furthermore, it is not the purpose of this paper to give general frequency measuring methods which can be found elsewhere. Rather, the intent is to describe methods for exciting, in a proper way, the characteristic frequency to be measured.

For the purpose of defining the different characteristic frequencies, the impedance Z of the equivalent network, its resistive component R_e , its reactive component X_e , and the reactance X_1 of the $L_1C_1R_1$ branch are plotted as function of frequency in Fig. 2.¹ It must be mentioned that these curves do not represent a special piezoelectric vibrator; they have only qualitative

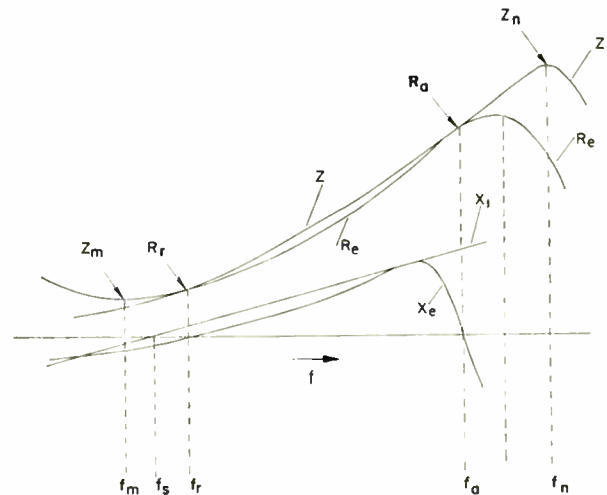

Fig. 2—Impedance Z , resistance R_e , reactance X_e , and series arm reactance X_1 of a piezoelectric vibrator as a function of frequency. Z_m and Z_n denote minimum and maximum impedance, R_e and R_a the impedances at zero phase angle. For the meaning of the different frequencies, see Table I.

character. To further enlighten the situation and, for reference later in the paper, the impedance and admittance circles of a piezoelectric vibrator are reproduced in Fig. 3. However, the circle representation of the impedance or admittance of a piezoelectric vibrator is valid only if, in the admittance diagram, the circle

* Decimal classification: R214.211. Original manuscript received by the Institute September 5, 1952.

† Signal Corps Engineering Laboratories, Fort Monmouth, N. J.

¹ W. G. Cady, "Piezoelectricity," McGraw-Hill Book Co., Inc., New York, N. Y., p. 374: 1946.

diameter is large in comparison with the change of ωC_0 in the resonance range, or if

$$r \ll Q_1^2 \tag{1}$$

which is the case in most vibrators. If this condition is not fulfilled, the admittance curve shows a cissoidal character.

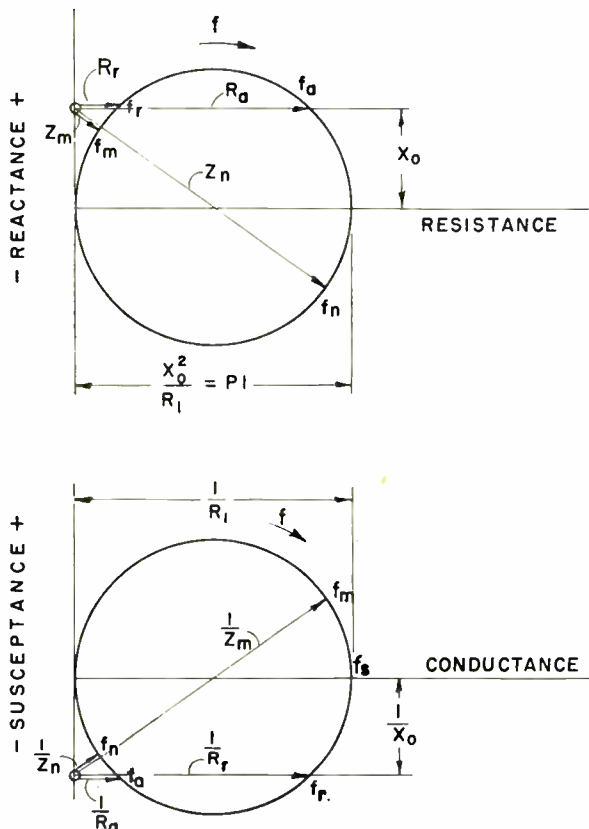

Fig. 3—Impedance and admittance diagram of a piezoelectric vibrator. The symbols conform with those used in Fig. 2.

The characteristic frequencies, as shown in Fig. 2, are explained in Table I. This table also gives formulas

TABLE I

Symbol	Condition	relative distance from f_s
f_s	series resonant frequency	
f_m	frequency at minimum Z	$[1 - (1+b)^{1/2}]C_1/4C_0$ (2)
f_r	resonant frequency ($X_e=0$)	$[1 - (1-b)^{1/2}]C_1/4C_0$ (3)
f_a	antiresonant frequency ($X_e=0$)	$[1 + (1-b)^{1/2}]C_1/4C_0$ (4)
f_n	frequency at maximum Z	$[1 + (1+b)^{1/2}]C_1/4C_0$ (5)

which may be useful in relating the different frequencies to the resonant frequency of the series arm f_s , called "series resonant frequency" in the following. These equations are derived under the assumption that (1) is in force, but they hold exactly even when R_1 is larger than X_0 . The parameter b represents the expression $(2R_1/X_0)^2$. In particular, if

$$b \ll 1 \tag{6}$$

as is the case in high quality quartz resonators, then to a very good approximation $f_s = f_m = f_r$, and $f_a = f_n$.

III. DIVISION OF MEASURING METHODS

This report is presented in such form that both research workers and manufacturers may readily choose applicable methods of measurement. Those engaged in research are concerned primarily with accuracy; manufacturers, however, must consider the needs of economy as governed by the speed with which operation can be performed. To comply with these different points of view, the paper will be divided into two main sections: Routine Measuring Methods and Laboratory Measuring Methods. All methods recommendable for routine measurements will be treated in the next section and the rest, applicable to laboratory use exclusively, will be discussed in a later section.

IV. ROUTINE MEASURING METHODS

A. Static Capacitance C_0

C_0 is usually determined in a capacitance bridge or in the Q -meter at a frequency low enough for the crystal vibrations to become immaterial. However in this case, the sum of C_0 and C_1 is actually measured as may be seen from Fig. 1. Should other resonant frequencies of the vibrator be present between the frequency used for determining C_0 and the resonant frequency under consideration, the C_1 values of the equivalent circuits of these other modes will also contribute to the low frequency capacitance. For precise results, therefore, C_0 should be measured above the resonance under consideration. In the case of bars in lengthwise vibration, for instance, an exact result is obtained using an alternating voltage of twice the fundamental frequency.² In the case of thickness vibrations, C_0 should be measured at frequencies above the highest resonances.

In the case of an AT-cut quartz vibrator, the "true" C_0 is only 0.7 per cent lower than C_0 measured below resonance and in most cases no correction is necessary. In the case of a vibrator with a large distance between resonant and antiresonant frequency, however, the difference between the true and the low-frequency C_0 may be much larger. For example, a barium titanate ceramic disk vibrating in its compressional thickness mode, has a true C_0 25 per cent lower than the low-frequency C_0 ;³ for Rochelle salt and potassium dihydrogen phosphate this percentage may be even larger.

B. Characteristic Frequencies

1. *Q-Meter Measurements:* According to George, Selby, and Scolnik,⁴ an unshielded coil is resonated in a Q -meter (such as manufactured by Boonton Radio Corp.) at a frequency near that of the vibrator. The piezoelectric vibrator is short-circuited by a small loop

² W. G. Cady, *loc. cit.*, p. 397.

³ W. P. Mason, "Piezoelectric Crystals and Their Application to Ultrasonics," D. Van Nostrand Co., Inc., New York, N. Y., p. 293; 1950.

⁴ W. D. George, M. C. Selby and R. Scolnik, "Precision measurement of electrical characteristics of quartz crystal units," *Proc. I.R.E.*, vol. 36, no. 9, pp. 1122-1132; September, 1948.

and placed near the low-voltage end of the coil, see Fig. 4. The Q -meter frequency is varied until a sharp dip indicates the frequency at minimum impedance of the circuit including the vibrator which is very close to f_s and f_r , if (6) is fulfilled and the other circuit parameters are chosen properly.

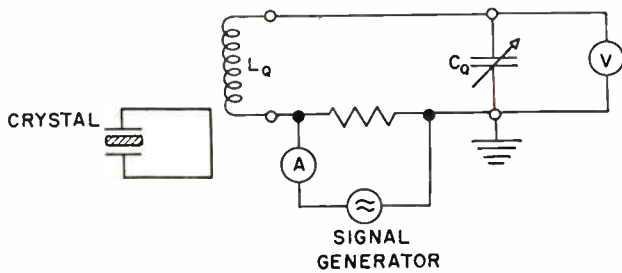

Fig. 4—Measurement of the characteristic frequency f_m (at minimum impedance) in the Q -meter.

Connecting the vibrator in parallel with the Q -meter coil, shown in Fig. 5, enables one to measure f_a . The rf generator within the Q -meter and the Q -meter tank circuit must be tuned successively in such a way that the instrument reading is at maximum with the crystal inserted and removed.

Because the frequency of the internal rf generator is not sufficiently constant for measurement on crystals, it is advisable to disconnect it and apply an external constant rf voltage directly across the coupling resistor in the Q -meter tank circuit.

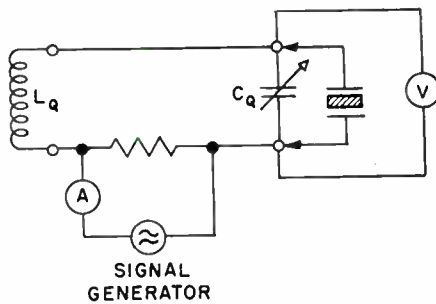

Fig. 5—Measurement of the characteristic frequency f_a (at maximum impedance) in the Q -meter.

The conservative estimate of accuracy is $\pm 1.5 \cdot 10^{-6}$ for the f_s measurement, and $\pm 2.5 \cdot 10^{-6}$ for the f_a measurement, according to George Selby and Scolnik.

2. *Filter Methods:* The simple measuring circuit described by Heegner,⁵ belongs to this category. It consists of a pick-up coil loosely coupled to a tunable oscillator, the crystal, a series thermo-element and, of course, appropriate frequency measuring equipment. A maximum current to the crystal corresponds closely to the minimum frequency f_m .

Another filter method is the so called "transmission method" shown in Fig. 6. The circuit consists of a tunable oscillator, a resistance network with the crystal, and a vacuum tube voltmeter or other detector. When the oscillator frequency is changed, a maximum reading

is observed which corresponds closely to the frequency f_m . If the values of the elements R and C of the transmission network are small, f_m is very close to f_s , the series resonant frequency and to f_r , the resonant frequency. If these conditions are not fulfilled, however, corrections must be applied to find f_s and f_r from the measured frequency value f_m . Koerner,⁶ who furnishes details of the transmission circuit in his paper, gives formulas for the frequency deviation due to the components R and C of the transmission network in Table I of his paper.

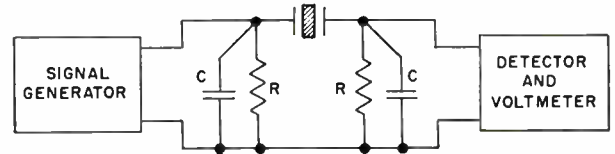

Fig. 6—Transmission measuring circuit.

A maximum reading of the voltmeter is obtained for f_s instead for f_m and, therefore, f_s may be measured directly if C_0 is antiresonated by an additional inductance L_0 shunting the crystal. The error in measuring f_s , in this case,⁶ is proportional to the relative deviation of $(L_0 C_0)^{-1/2}$ from ω_s and is zero, if $L_0 C_0$ is tuned exactly at ω_s . The accuracy of frequency measurement can be $1 \cdot 10^{-6}$ or better, depending upon the choice of network components and the application of the correction formulas.

3. *Antiresonance Method:* The circuit shown in Fig. 7 is able, according to Gerber,⁷ to measure the maximum impedance frequency f_n of a piezoelectric vibrator. This

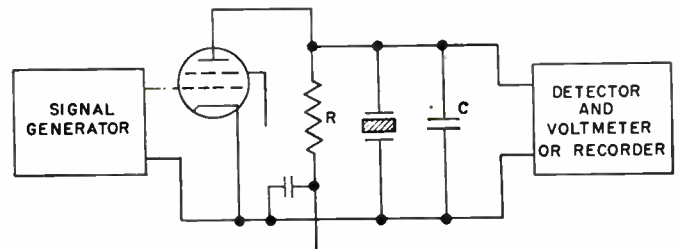

Fig. 7—Anti-resonance measuring circuit.

frequency corresponds to a maximum rf voltage across the crystal which is connected across the plate of an amplifier tube. If the reactance X of the capacitance C , which includes C_0 and the capacitance of the circuit, is large in comparison with R_1 , f_n is very close to f_a the antiresonance frequency of the vibrator. If the above condition is not fulfilled, a correction similar to that mentioned in paragraph IV-B-2 must be applied. It may readily be found by subtracting (4) from (5). The resistance R which includes the plate resistance of the tube and the input resistance of the detector influences the result only if it is comparable with R_1 . In this case, f_a may be found from

⁶ L. F. Koerner, "Progress in development of test oscillators for crystal units," Proc. I.R.E., vol. 39, no. 1, pp. 16-26; January, 1951.

⁷ E. A. Gerber, "Quartz-crystal measurement at 10 to 180 megacycles," Proc. I.R.E., vol. 40, no. 1, pp. 36-40; January, 1952.

⁵ K. Heegner, "Gekoppelte selbsterregte Kreise und Kristalloszillatoran," *Elek. Nach. Tech.*, vol. 15, no. 12, pp. 359-368; 1938.

$$\frac{f_n - f_a}{f_n} \approx \frac{C_1}{C_0} \left(\frac{R_1^2}{X^2} + \frac{R_1}{R} \right). \quad (7)$$

4. *Self-controlled Oscillator Circuits:* A disadvantage of all the methods described hitherto is the fact that a variable rf oscillator having the short-time stability of a crystal oscillator is needed. To avoid this disadvantage, circuits have been devised which utilize the crystal to be measured as the frequency controlling element in their amplification or feedback path. Three different circuits of this type are known and in use: the Crystal Impedance (CI) meter, the Butler circuit, and the Heegner circuit.

a. *The CI Meter:* This circuit was first devised by Heegner,⁵ and developed for practical use by the Frequency Control Branch, Signal Corps Engineering Laboratories.^{8,6} The basic circuit diagram is given in Fig. 8. Three units have been designed to cover the frequency range between 75 kc and 120 mc. The circuit

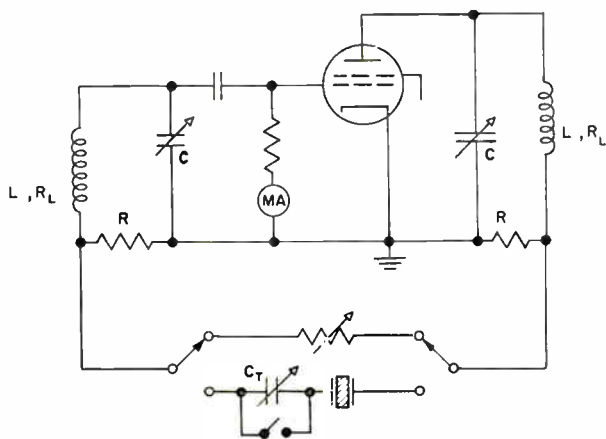

Fig. 8—Crystal impedance meter.

employs a well shielded pentode with tuned grid and plate circuits and a crystal network in the main feedback path which also contains a series capacitance C_T and substitution resistors. In operation, the crystal is switched into the circuit with C_T short circuited and the ganged LC circuits are tuned to obtain maximum grid current. To measure f_r , the crystal and the substitution resistor are alternately switched into the circuit. By adjusting the value of the substitution resistor and the LC tuning, the frequency and the grid current (which is a measure of the amplitude of vibration) may be set at values which do not change when either the crystal or the resistor is in the circuit. This adjustment permits measurement of f_r . Precaution must be taken that the substitution resistor has no phase angle, otherwise the frequency at zero reactance cannot be measured exactly.

Another method for measuring f_r in the CI meter, which does not need the substitution of a resistor, is described by Rosenthal and Peterson.⁹ They connect a

cathode-ray oscilloscope to the two terminals of the crystal network and observe the phase shift across it. The tuning of the LC circuits is changed until zero phase shift is observed. Unfortunately, this method of measuring the phase shift is not very accurate and the substitution method is preferable if exact results are desired. However, a high degree of accuracy can be obtained by using a sensitive phase indicator such as described by Laver.¹⁰ Phase changes of about ± 0.2 degree corresponding to a frequency error $\Delta f/f_r$ of $\pm 0.00174/Q_1$ can be measured. Measurement of f_s may be accomplished—as described in section IV-B-2—by antiresonating C_0 by an inductance shunting the crystal and by tuning LC for maximum grid current.

The accuracy of frequency measurement by the substitution method up to 15 mc as compared with bridge measurements is about $5 \cdot 10^{-6}$. For frequencies above 15 mc, the accuracy will decrease due to the increasing phase angles of the components, especially of the substitution resistor.

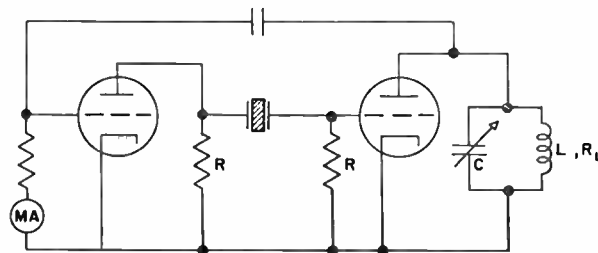

Fig. 9—Heegner circuit.

b. *The Heegner and Butler Circuits:* The Heegner circuit,^{11,6} shown in Fig. 9 is a two-tube oscillator with the crystal in a resistance network; the Butler circuit,^{12,13} shown in Fig. 10, is also a two-tube oscillator, consisting of a cathode follower and a grounded-grid amplifier which are connected by the crystal. The method of measuring is the same as that of the CI meter.

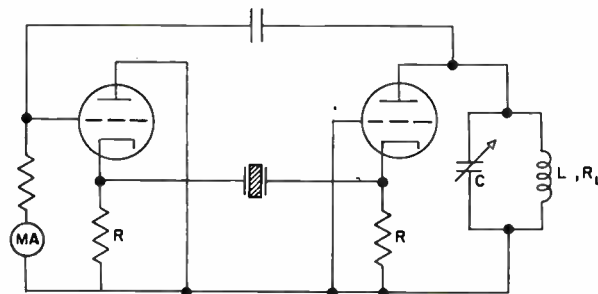

Fig. 10—Butler circuit.

5. *Comparison Between the Different Methods:* As has been mentioned previously, the great advantage of self-controlled oscillator circuits in comparison with all

¹⁰ F. J. M. Laver, "Crystal resonators as frequency standards," *Proc. IEE* (London), pt. III, vol. 97, no. 46, pp. 93-99; March, 1950.

¹¹ R. Bechmann, "On circuits for piezoelectric quartz oscillators and resonators for frequency stabilization and filters," *Telefunken-Hausmitteilungen*, no. 78; March, 1938.

¹² D. A. Venn, "Measuring vhf impedance of piezoelectric crystals at resonance," *Tel-Tech.*, pp. 44-46; March, 1950.

¹³ W. A. Edson, W. T. Chry and J. O. Hogg, Jr., Final Report on Contract No. W36-039 sc-36841 Georgia Institute of Technology, Atlanta, Ga., pp. 118-129; Dec., 1950.

⁸ A. C. Prichard and M. Bernstein, "Crystal impedance meters replace test sets," *Electronics*, vol. 26, pp. 176-180; May, 1953.

⁹ L. A. Rosenthal and T. A. Peterson, Jr., "Measurement of the series resonant resistance of a quartz crystal," *Rev. Sci. Instr.*, vol. 20, no. 6, pp. 426-429; June, 1949.

other described methods lies in the fact that no separate tunable oscillator is needed. Further f_s and f_r may be measured directly. Thus, the self-controlled oscillator method (section IV-B-4) is recommended for routine frequency measurements. Only if R_1 is too high to allow oscillations to start, is it necessary to use the transmission method (section IV-B-2) or the antiresonance method (section IV-B-3).

For comparing performance between the CI meter, the Heegner and the Butler circuits, it is desirable to know to what extent frequency is varied by mistuning the LC circuit. The expressions for the loop gain of the three oscillators are tabulated in column 2 of the Table II, assuming a high amplification factor of the tubes.

TABLE II

Loop Gain	Frequency change $\frac{\Delta\omega_s}{\omega_s}$ of the oscillator due to a detuning $\frac{\Delta\omega}{\omega}$ of the LC circuit
CI Meter $\frac{g_m L / C}{R_1 + 2R_L}$ (8)	$\frac{\Delta\omega}{\omega} \frac{Q}{Q_1} \left(1 + 2 \frac{R_L}{R_1} \right)$ (11)
Heegner Circuit $\frac{g_m^2 L R / C R_L}{(R_1 + 2R) / R}$ (9)	$\frac{\Delta\omega}{\omega} \frac{Q}{Q_1} \left(1 + 2 \frac{R}{R_1} \right)$ (12)
Butler Circuit $\frac{g_m^2 L R / C R_L}{(1 + g_m R)^2 \left(R_1 + \frac{2}{1 + g_m R} \right) / R}$ (10)	$\frac{\Delta\omega}{\omega} \frac{Q}{Q_1} \left(1 + 2 \frac{R}{R_1} \frac{1}{1 + g_m R} \right)$ (13)

g_m = transconductance; Q_1 Quality factor of the crystal; Q quality factor of the LC circuit; for other symbols see Figs. 8, 9, and 10.

To obtain the change of the oscillator frequency $\Delta\omega_s/\omega_s$ due to a detuning $\Delta\omega/\omega$ of the LC circuit, $R_1 (1 + 2jQ_1\Delta\omega_s/\omega_s)$ and $L/(CR_L)(1 + 2jQ\Delta\omega/\omega)$ are introduced instead of R_1 and L/CR_L in the loop gain expressions. If the imaginary part of these expressions is set equal to zero and the resulting equations are solved in terms of $\Delta\omega_s/\omega_s$, the results given in the third column of Table II are obtained. An inspection of these equations shows that the Heegner and Butler circuits are able to measure with somewhat greater accuracy frequency of low resistance crystals because R can be made low while R_L , the loss resistance of L , cannot be lowered below a certain amount. The CI meter and the Butler circuit will oscillate easier at higher frequencies due to a better matching of the plate circuit to a low-impedance crystal loop. This fact may be proven by using (8), (9), and (10). The Butler Circuit, however, has the disadvantage of higher capacitances across the two resistors R which introduce larger phase shifts and make its use difficult at high frequencies. The Heegner circuit, on the other hand, has a better matching to a high-impedance crystal loop which occurs at low frequencies. The CI meter is superior to the two other circuits in its rejection of harmonics created in the tubes because serious error will occur unless the har-

monics are eliminated from the substitution resistor. As a result of the above discussion, the CI meter is recommended for frequencies between 500 kc and 120 mc, and the Heegner circuit for frequencies below 500 kc.

C. Equivalent Parameters

1. Q-Meter Measurements: If the crystal is connected in series with the tank coil of the Q-meter, R_1 can be measured, according to George, Selby, and Scolnik,⁴ either by substitution of calibrated resistors or by determining the Q-degradation of the Q-meter tank in the usual way. This method, however, is not suitable for R_1 values higher than 10 ohms. The accuracy of the substitution method is ± 2.5 per cent.

Values of R_1 between 1,000 and 10,000 ohms, as well as values of the antiresonance resistance $R_a \approx X_0^2/R_1 \approx Z_n$ (as the impedance circle in Fig. 3 shows) between 5,000 and 5,000,000 ohms can be measured using the same tuning procedure as used for measuring f_s , R_a is evaluated either by measuring the Q-degradation in the usual way (formulas are given in Q-meter instruction book) or better by the substitution method. The accuracy of the R_a measurement is ± 5 per cent or better.

2. Transmission Method: The transmission circuit shown in Fig. 6 may be used for measuring R_1 by substituting known resistors in place of the crystal until the same output voltage is obtained. The remarks concerning the influence of R and C upon frequency are valid also for resistance measurements. The error in resistance is given by the following expression, if the substitution resistor is designated by R_{subst} :

$$\frac{R_{subst} - R_1}{R_1} = 4R\omega C_0(R\omega C - 2R_1\omega C_0). \quad (14)$$

If C_0 is antiresonated by a coil, R_1 may be measured with a very small error as shown by a graph in Koerner's paper.¹⁴ Thus by proper adjustment of its components, the transmission circuit may be designated for any specified accuracy of measurement. It is especially useful if the crystal to be measured will not vibrate in the series resonance oscillator circuits due to its high resistance or its high frequency.

Series connection of the vibrator with a capacitance C_T in the transmission circuit yields the possibility for measuring the capacitance ratio r and the series capacitance C_1 and, if R_1 is known, the quality factor Q_1 . For this purpose, measurement is made of the frequency difference Δf corresponding to maximum detector readings with C_T in the circuit and with C_T short circuited. Then C_1 and $r = C_0/C_1$ is obtained by

$$C_1 = 2(C_0 + C_T)\Delta f/f_s. \quad (15)$$

The use of this expression presumes that the transmission circuit is dimensioned in the proper way, according to the formulas given by Koerner.⁶

If R_1 is known, Q_1 may be calculated from C_1 and R_1 .

¹⁴ L. F. Koerner, *loc. cit.*, p. 24.

A direct routine measurement of Q_1 may be obtained by frequency modulating the rf generator and scanning the resonance curve of the vibrator. If the width of the resonance curve Δf is measured at $1/\sqrt{2}$ the amount of its height, then Q_1 has the value

$$Q_1 = f_s/\Delta f \cdot (R_1 + 2R)/R_1. \quad (16)$$

This method is valid only if the frequency is varied sufficiently slowly as shown by Hok.¹⁵

3. *Antiresonance Method:* This method, as Fig. 7 shows, is specially suited for measurement of the equivalent parameters of high frequency crystals because, in this case, the resistance R can be made higher than the maximum impedance of the vibrator.¹⁶ The principle of this method is to compare the maximum plate voltage e_{p1} across the vibrator with the plate voltage e_{p2} across a pure capacitive load C_L . Then the maximum impedance of the crystal is

$$|Z_n| = \frac{e_{p1}}{e_{p2}} \frac{1}{\omega C_L}, \quad (17)$$

and R_1 amounts to

$$R_1 = \frac{1}{\omega^2 C^2 |Z_n|} \frac{1}{1 - 1/\omega^2 C^2 |Z_n|^2} \quad (18)$$

where C is equal to the static capacitance C_0 plus the associated circuit capacitance C_T . Equation (18) reduces to the familiar expression for the Performance Index (PI).

$$R_1 = (\omega^2 C^2 PI)^{-1} \quad (19)$$

provided:

$$4R_1^2 \omega^2 C^2 \ll 1. \quad (20)$$

The latter resembles (6) but C_0 is replaced by $C = C_0 + C_T$. Q_1 may be measured as in the preceding paragraph, but no Q -degradation takes place, because $R \gg |Z_n|$. C_1 is measured by recording the resonance curve of the vibrator in the circuit and then recording a second resonance curve when the capacitance across the crystal has been increased by a known amount ΔC . The frequency difference Δf between the two curves gives a measure for C_1 , according to

$$C_1 = 2 \frac{\Delta f}{f_s} \frac{C}{\Delta C} (C + \Delta C). \quad (21)$$

If (20) is not fulfilled, corrections⁷ must be applied to (21).

4. *Self-Controlled Oscillator Circuits:* The procedure for measurement of f_r and f_s outlined in paragraph IV-B-4 applies also to the measurement of R_r and R_1 by the substitution method. A comparison by Prichard⁸ between the CI meter *TS-330/TSM*, frequency range 1 to 15 mc, and a general radio twin- T impedance meas-

uring circuit gives an agreement within 5 per cent for resistance values when using the built-in decade substitution resistor and within one per cent when the decade substitution resistor was replaced with a low-capacitance variable resistor. For measuring C_1 , a capacitance C_T is connected in series with the vibrator, (for instance as in Fig. 8) and the oscillator frequency change Δf is measured. C_1 is evaluated by using (15).

5. *Comparison Between the Different Methods:* As has been pointed out in paragraph IV-B-5, the self-controlled oscillator circuits are preferable for routine measurements because the frequency of oscillation is controlled by the vibrator itself. A comparison of these three circuits may be made by comparing the loop gains tabulated in Table II, column 2, noting the change resulting from variation of R_1 . It can be seen, as in the case of frequency measurements, the Heegner and Butler circuits are able to measure low resistances with somewhat greater accuracy due to the fact that R can be made low, while R_L cannot be lowered below a certain amount. All other remarks made regarding frequency measurement hold also for resistance measurements. Therefore, as previously stated: The CI meter is recommended for R_1 and C_1 measurements in the frequency range between 500 kc and 120 mc and the Heegner circuit in the frequency range below 500 kc. Above 120 mc, the use of the antiresonance method is recommended because it requires the application of fewer corrections than the other methods.

V. LABORATORY MEASURING METHODS

As mentioned in section III, all methods which are not suited for routine measurements are discussed under the above title. Routine measurement methods rarely yield the highest possible accuracy but, if adapted to the special condition of measurement and if the proper corrections are applied, all previous methods yield a degree of accuracy sufficient for laboratory use. This accuracy can be increased by making a larger number of measurements, by changing a parameter of the measuring device, and plotting a dependent crystal parameter against it. If the frequency of the driving oscillator is changed, for instance, the impedance of the vibrator at different frequencies can be measured and the impedance or admittance circle as shown in Fig. 3, can be plotted from which the equivalent parameters may be derived. George, Selby, and Scolnik⁴ measured PI in the Q -meter by the substitution method for different values of $C = C_0 + C_T$ and plotted it versus C on logarithmic paper, thus obtaining a straight line according to

$$\log PI = \log \frac{1}{\omega^2 R_1} - 2 \log C. \quad (22)$$

In a similar way, the difference Δf between the antiresonance frequency corresponding to C and f_s is plotted

$$\log \Delta f = \log \left(\frac{1}{2} f_s C_1\right) - \log C. \quad (23)$$

¹⁵ G. Hok, "Response of linear resonant systems to excitation of a frequency varying linearly with time," *Jour. Appl. Phys.*, vol. 19, no. 3, pp. 242-250; 1948.

¹⁶ E. A. Gerber, *loc. cit.*, p. 39, fig. 5.

R_1 and C_1 can be obtained with a high degree of accuracy from the straight lines representing (22) and (23).

Special laboratory measuring methods which are not likely to be applicable for routine measurement are discussed in the following without separation of frequency and R_1, C_1, Q_1 -measurements.

A. Crevasse Method

One of the oldest methods of measuring the equivalent parameters of a piezoelectric vibrator is the Crevasse method, first used by Cady¹⁷ and later by Dye¹⁷ in his very thorough investigation of the electric properties of the piezoelectric resonator. The circuit is

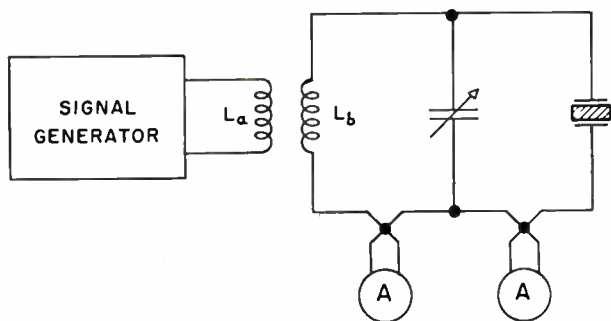

Fig. 11—Crevasse circuit.

shown in Fig. 11. If the frequency of the signal generator is changed slightly, the current in the inductance L_b and through the crystal is measured, or readings can be taken on a vacuum-tube voltmeter across the crystal. From these data, a complete resonance curve can be obtained and the crystal constants can be derived. The latter process, however, is rather complicated.

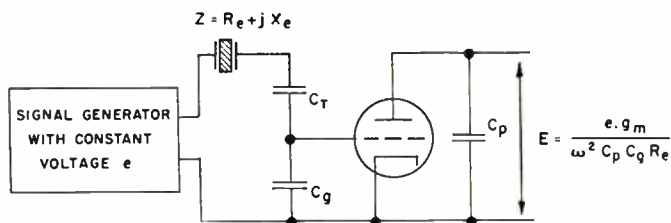

Fig. 12—The performance index (PI) meter circuit.

B. Performance Index (PI) Meter

The PI is the impedance of a piezoelectric vibrator when shunted with a condenser C_T at a frequency where the reactance of C_T is equal to the positive reactance of the crystal. PI has been defined by (19) where $C = C_0 + C_T$. The PI meter circuit^{18,6} in a simplified form is shown in Fig. 12. If the signal generator frequency is tuned for maximum voltage E , which corresponds to minimum impedance of the crystal, then the expression for PI is, if $C_T \ll C_0$:

$$PI = (\omega^2 C^2 R_1)^{-1} = (\omega^2 C_T^2 R_c)^{-1} = (E/e)(C_T C_0 / C_T^2 g_m). \tag{24}$$

Although the PI meter is designed primarily for a study of piezoelectric vibrators under positive reactance conditions, R_1 can be derived easily from (24). This equation, however is valid only if the condition (20) is fulfilled; otherwise, corrections must be applied which can be found in Heising's book.¹⁷ Readings may be taken for different values of C_T and straight lines be plotted according to (22) and (23) to increase accuracy.

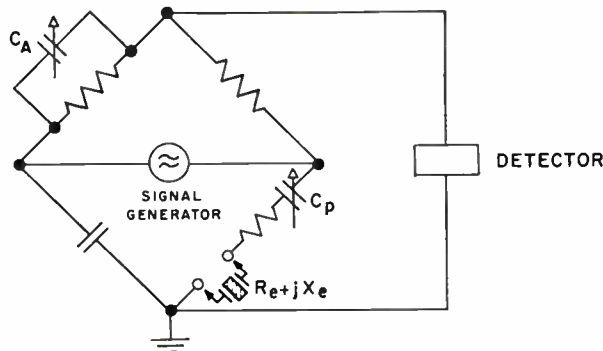

Fig. 13—Radio frequency bridge. R_e is balanced by C_A , X_e by C_p .

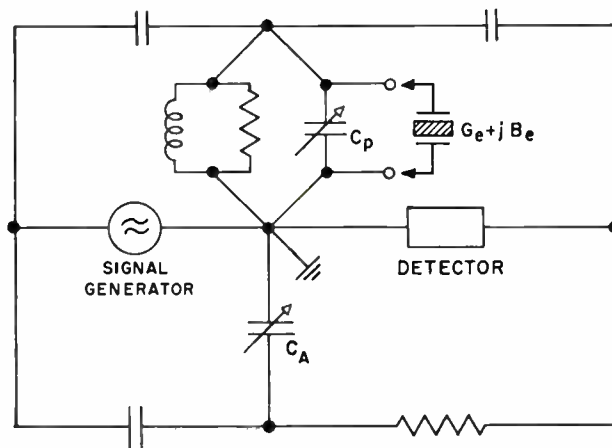

Fig. 14—Twin-T impedance measuring circuit. The conductance G_e is balanced by C_A , the susceptance B_e by C_p

C. Bridge Methods

1. Schering Bridges and Twin-T Impedance Measuring Circuit: Both types of circuits have been used extensively for precision measurement of the parameters of piezoelectric vibrators by George, Selby, and Scolnik,⁴ K. S. Van Dyke,¹⁹ and Lynch.²⁰ Figs. 13 and 14 show the schematic diagrams of a Schering type rf bridge and the twin-T circuit. The components of the unknown crystal impedance are determined from the difference in settings of capacitances C_A and C_p with the crystal short-circuited (rf bridge), removed (twin-T circuit),

¹⁹ K. S. Van Dyke, Second Semi-Annual Tech. Rep. on Contract no. W28-003-sc-1556, Wesleyan University, Middletown, Conn., pp. 7-50; July 9, 1946.

²⁰ A. C. Lynch, "Measurement of the equivalent electrical circuit of a piezoelectric crystal," *Proc. Phys. Soc. (London)*, sec. B, vol. 63, no. 365, pp. 323-331; May, 1950.

¹⁷ W. G. Cady, *loc. cit.*, p. 383.
¹⁸ R. A. Heising, "Quartz Crystals for Electrical Circuits," D. Van Nostrand Co., Inc., New York, N. Y., pp. 458-492; 1946.

and the crystal connected. Table III shows the frequency ranges and accuracy obtainable with two general radio bridges according to George and collaborators, and with the Schering bridge, used by Lynch.

TABLE III

Frequency Range	RF Bridge	Twin-T Circuit	Schering Bridge (Lynch)
		400 kc-60 mc	460 kc-40 mc
f_r	$\pm 1.5 \cdot 10^{-6}$		
f_a		$\pm 2.5 \cdot 10^{-6}$	
R_1	0-1000 ohms ± 0.1 ohm ± 1 per cent		
PI	0-1000 ohms ± 0.1 ohm ± 1.5 per cent	1,000-18,000 ohms ± 2.5 per cent	
C_1			0.0002-0.7 $\mu\mu\text{f}$ ± 0.1 per cent

According to the method adapted by Lynch, the susceptance $j\omega K$ of the $L_1C_1R_1$ branch of the equivalent network is measured at several frequencies around resonance and C_1 is calculated from these measurements. If only two frequencies f_1 and f_2 are used, which already give a good degree of approximation, C_1 is given by

$$C_1 = \frac{2(f_2 - f_1)}{f_s(1/K_1 - 1/K_2)} \quad (25)$$

To increase the accuracy of measurement, Van Dyke made measurements at a larger number of different frequencies. If the reciprocal of the square root of the conductance and the reciprocal of the susceptance of the $L_1C_1R_1$ branch of the crystal are plotted vs frequency, straight lines should be obtained except in a very narrow region at series resonance. If the first curve is plotted in square-root-ohms vs cycles-per-second and has a slope S_1 and the second curve in ohms vs cycles-per-second, having a negative slope S_2 then

$$\begin{aligned} R_1 &= (S_2/S_1)^2 \\ L_1 &= S_2/4\pi. \end{aligned} \quad (26)$$

If the curves deviate from a straight line, then holder losses or interfering modes are involved. Minor uniform curvature throughout the region of the resonance of interest may result from a secondary mode which is at some distance from the mode of interest, and may be corrected for by rectifying the line.

2. *Other Bridge Arrangements:* Rothauge and Hamburger²¹ have used a bridged T-network, as Fig. 15 shows. The network is balanced by adjusting the two capacitances C and the resistance R for minimum output. Then R_e and L_e are given by

$$\begin{aligned} R_e &= 1/R\omega^2C^2 \\ L_e &= 2/\omega^2C. \end{aligned} \quad (27)$$

To obtain the equivalent parameters of a vibrator, R_e and L_e are measured at different frequencies and the impedance or admittance circle may be drawn or conductance and susceptance may be plotted as described in the preceding paragraph. The authors claim an accuracy of 0.3 per cent for L_e and 2.3 per cent for R_e . An upper frequency limit for the measurements is given by the circuit capacitance across R .

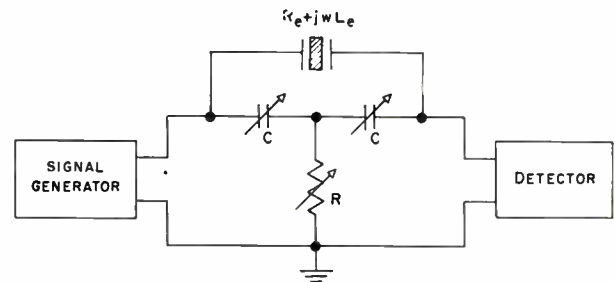

Fig. 15—Bridged T-network.

A differential bridge arrangement devised by Srivastava,²² is shown in Fig. 16. By balancing the bridge first at a frequency other than any resonant frequency and rebalancing it at f_s , this frequency and R_1 can be measured. Mendousse, Goodman and Cady,²³ used a type of bridge containing two fixed capacitors and a variable capacitor. The vibrator is connected in the

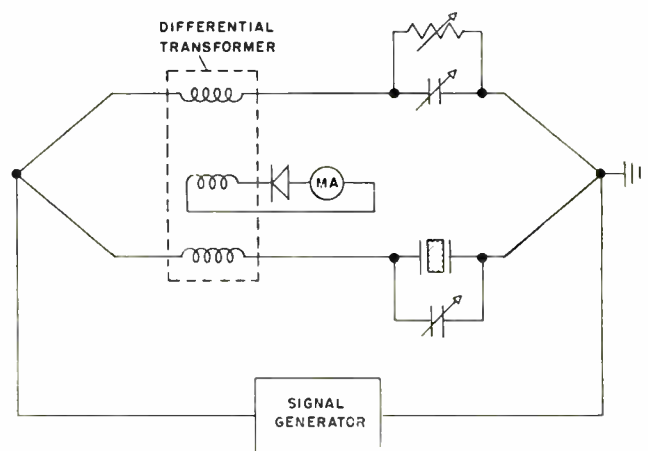

Fig. 16—Differential bridge.

fourth arm of the bridge. The static capacitance of the vibrator is balanced by the variable capacitor. The rectified output voltage of the bridge is observed, or recorded graphically, while the frequency is varied over the resonance range. From the recording, the Q of the vibrator can be obtained.

²² K. G. Srivastava, "A new and quick method for detection of piezoelectricity and measurement of the piezoelectric constants," *Indian Jour. Phys.*, vol. 25, no. 1, pp. 33-34; January, 1951.

²³ J. S. Mendousse, P. D. Goodman and W. G. Cady, "A Capacitance Bridge for High Frequencies," *Rev. Sci. Instr.*, vol. 21, no. 12, pp. 1002-1009; December, 1950.

²¹ C. H. Rothauge and F. Hamburger, "Measurement of the electrical characteristics of quartz crystal units by use of a bridged T-network," *Proc. I.R.E.*, vol. 38, no. 10, pp. 1213-1216; October, 1950.

D. Pauli's Method

Günther,²⁴ adapting a method due to Pauli, placed the vibrator in a secondary circuit together with a variable resistance R_T , as Fig. 17 shows. The ratio I_1/I_2 is measured at the frequency f_s for different values of R_T . The plot of I_1/I_2 versus R_T yields a straight line which cuts off the amount of $R_1(1 + \omega_s^2 C_0^2 R_1^2)^{-1/2}$ on the R -axis. Then r and C_1 are measured by observing the

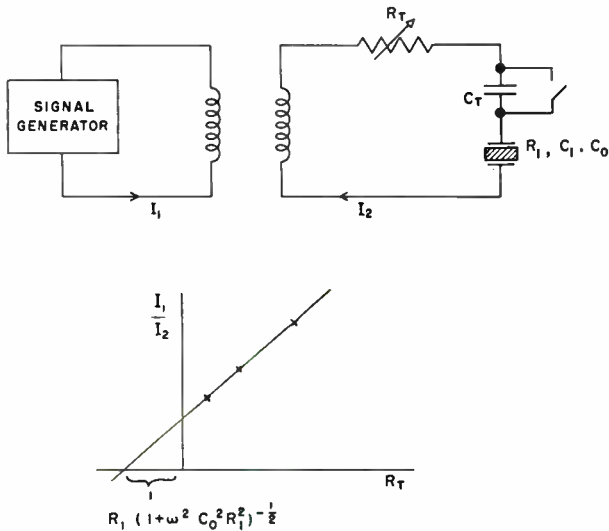

Fig. 17—Method of Pauli-Günther for measuring R_1 and C_1 .

frequency change due to an addition of C_T to the circuit and by using (15).

E. Decay Method

For a direct measurement of Q_1 , the decay method may be used as described by Van Dyke.²⁵ The vibrator to be measured is coupled very loosely to a signal generator and a radio receiver. One procedure is to tune the oscillator to the resonance of the crystal and then after the vibration of the latter has built up, suddenly short circuit the oscillator, leaving the vibration of the crystal to decay. The output of the receiver is connected across the vertical deflection plates of an oscilloscope, while the horizontal deflection is a linear sweep. The decay pattern is photographed and Q_1 calculated from the measured amplitude at the known sweep rate. The several computed values of Q_1 from different portions of a single decay agree to within approximately 2 per cent. The logarithmic decrement when the crystal is shunted by a known resistance is a linear function of this resistance. Constants of the equivalent network may be determined from the parameters of this linear relation.

An alternative procedure is to sweep the oscillator slowly through the crystal resonance, thus exciting the crystal and moving on so that the generator action of

²⁴ R. Günther, "Die elektrischen Ersatzgrößen von piezoelektrischen Kristallen und ihre Messung," *Hochfreq. und Elektroak.*, vol. 50, pp. 200-203; 1937.

²⁵ K. S. Van Dyke, Second Quart. Prog. Rep. Contract no. DA36-039 sc-73, Wesleyan U., Middletown, Conn., pp. 21, 22; July 1-Sept. 30, 1950.

the decaying crystal heterodynes with the former driver at its new frequency and the heterodyne tone can thus be followed in the decay. The photographic technique is the same as before.

F. Transmission Line Method

Bottom and coworkers²⁶ used a parallel wire transmission-line oscillator to measure L_1 and C_1 in the frequency range between 20 mc and 75 mc. The circuit diagram is shown in Fig. 18. If the shorting bar of the transmission line is adjusted to obtain crystal-controlled oscillations, then the reactance of the L_1 , C_1 , and R_1 arm of the crystal is given very nearly by

$$X_1 = Z_0 \tan \frac{\omega l}{c} / \left(\omega C_t Z_0 \tan \frac{\omega l}{c} - 1 \right), \quad (28)$$

where Z_0 is the characteristic impedance of the transmission line of length l , C_t is the total capacitance to the right of the crystal as shown in Fig. 18 including C_0 and tube and circuit capacitances, and c is the speed of light. C_t can be determined from the length l' of the transmission line which corresponds to the same frequency $\omega/2\pi$ but with the crystal removed and substituted by a capacitance equal to C_0 .

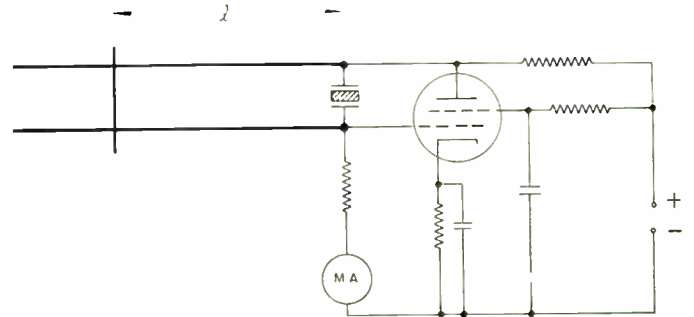

Fig. 18—Transmission-line reactance meter.

By evaluating X_1 at two or more frequencies, according to (28), it is possible, by means of simultaneous algebraic equations of the form

$$X_1 = \omega L_1 - 1/\omega C_1 \quad (29)$$

to solve for the value of L_1 and C_1 .

The accuracy of this method is believed to be better than 5 per cent. Its advantage lies in the fact that it is an absolute measurement, because L_1 and C_1 are measured in terms of length and time only.

G. Comparison Between the Different Methods

A method which allows one to measure the resistive and reactive components of a piezoelectric vibrator at different frequencies is the most desirable for precise measurements. For, as has been pointed out, the consistency of the data then can be checked easily and the equivalent parameters evaluated by plotting a diagram which should have, according to theory, a simple geometrical form like a circle or a straight line. Deviations

²⁶ V. F. Bottom and others, Sixth, Seventh and Eighth Quart. Rep., Contract no. DA36-039 sc-66, Colorado A & M College, Fort Collins, Col.; January, April and July, 1952.

from the simple diagram reveal the presence of additional parameters, such as holder losses or interfering modes which may otherwise be overlooked and may thus cause false results for the fundamental crystal parameters. The requirement stated at the beginning of this section can be met by using bridges or the Q -meter. However, null methods usually yield the higher accuracy, therefore, bridges are to be preferred which use capacitors only for balancing both the resistive and reactive (or the conductive and susceptive) components of the vibrator. Therefore Schering bridges like the general radio rf bridge and the twin-T impedance measuring circuit are recommended for precise laboratory measuring methods.

VI. DEPENDENCE OF EQUIVALENT PARAMETERS ON AMPLITUDE OF VIBRATION

It has been assumed in the foregoing chapters that the equivalent parameters are independent of the amplitude of vibration. But this is an approximation usually valid only for small amplitudes. The variation of the parameters with amplitude varies greatly with the type of vibrator. The amplitude is a function of the current through the vibrator or a function of the voltage across it, and affects both the resistance and frequency of the vibrator and is in addition to changes due to internal heating. Therefore, the current or the voltage level used at the measurement must be specified. Additionally, the difference between the measuring fre-

quency and f_s must be known, because the ratios amplitude/current and amplitude/voltage depend very much upon this difference. As has been pointed out by Gerber,²⁷ it is advisable to use current measurements for specifying the amplitude if frequencies in the neighborhood of f_r are involved, and voltage measurements, if measurements are made close to f_a . If these precautions are taken, the change of the mentioned voltage and current to amplitude relations with frequency are moderate and the influence of different values of R_1 upon amplitude is small.

It is advisable, however, to use the power dissipation in the vibrator as a measure of amplitude, if measurements are made at several different frequencies, because the ratio amplitude-power dissipation is independent of frequency.

VII. ACKNOWLEDGMENT

The author wishes to express his gratitude to A. C. Prichard and M. Bernstein for interesting discussions concerning the series resonance oscillator circuits, and to M. F. Timm for his aid in preparing the manuscript. Furthermore, the author is indebted to colleagues of the IRE Committee on Piezoelectric Crystals for many helpful suggestions.

²⁷ E. A. Gerber, "Amplitude of vibration in piezoelectric crystals," *Electronics*, vol. 24, no. 4, pp. 142, 204-218; April, 1951, and no. 9, p. 326; September, 1951.

Mismatch Errors in Microwave Power Measurements*

R. W. BEATTY†, MEMBER, IRE, AND A. C. MACPHERSON†

The following paper is published with the approval of the Tutorial Papers Subcommittee of the IRE Committee on Education.—*The Editor*

Summary—Expressions are derived for error due to mismatch when a UHF or microwave power meter is calibrated by comparison with a standard power meter. Three different methods are considered: (a) alternate connection to a stable power source, (b) the use of a microwave junction which simultaneously supplies power to the uncalibrated power meter and the standard power meter in a known ratio, (c) alternate connection to a microwave junction. The relative merits of the methods are discussed.

Expressions are derived for error due to mismatch when using a calibrated power meter in the following situations: (a) direct connection of power meter to power source, (b) reduction of power into the power meter by means of an attenuator, (c) reduction of power into the power meter by means of a directional coupler.

* Decimal classification: R245. Original manuscript received by the Institute, July 9, 1952; revised manuscript received April 20, 1953.

† National Bureau of Standards, Washington, D. C.

I. INTRODUCTION

THE EFFECTS of mismatch¹ have been recognized²⁻³ but are often neglected in the calibration and use of ultra-high frequency (UHF) and microwave power meters. Experience has shown that neglect of mismatch is not always justified and serious errors may occur. The magnitude of the error depends not

¹ A uniform section of UHF or microwave transmission line or waveguide is said to be matched when it is terminated in such a way that no net reflection of energy occurs. A termination which causes a net reflection of energy in the uniform section is termed a mismatch.

² C. G. Montgomery, "Technique of Microwave Measurements," McGraw-Hill Book Company, New York, N. Y., p. 130, 1944.

³ B. P. Hand and N. B. Schrock, "Power measurements from 10 to 12,400 megacycles," *Hewlett-Packard Journal* V. 2, no. 7-8; March-April, 1951.

only upon the degree of mismatch but also upon the properties of any power dividing or attenuating device which may be used.

For this reason, various circuit arrangements employed in the calibration and use of UHF and microwave power meters have been analyzed with regard to mismatch errors. Equations are given for the evaluation of these errors.

II. CALIBRATION OF POWER METERS

A. General Discussion

A power meter is calibrated by comparing its indicated power with the power it actually absorbs. Best accuracy of calibration is obtained by avoiding the use of secondary standards, attenuators or directional couplers and comparing the meter directly with a reference standard which may be a bolometric or calorimetric device. This may be done by alternate connection of the meter and the standard to a stable source or by the use of certain power splitting devices enabling simultaneous comparison, or by a combination of methods. Power splitting devices having a power ratio of unity have the advantage that geometric symmetry is possible, permitting precise mechanical construction which leads to a corresponding excellence of electrical symmetry.

The end result of a power meter calibration is often a correction factor f which is used to convert the meter reading R_M to the power P_M absorbed by the meter ($P_M = fR_M$). The correction factor f may be obtained in terms of observed quantities:

$$f = \frac{P_M}{R_M} = \left(\frac{P_M}{P_S}\right) \frac{P_S}{R_M} = (K) \frac{P_S}{R_M} \tag{1}$$

where P_S represents the power absorbed by the standard power measuring device. In the following methods of calibration, the power division ratio K is normally unity except as affected by mismatches and by deviations from ideal properties of the power dividers.

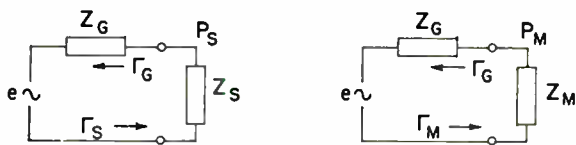

Fig. 1—Alternate connection to stable source.

B. Method 1—Alternate Connection to a Stable Power Source

The power meter and the standard are alternately connected to a stable generator as shown in Fig. 1. The generator output is padded to prevent the change in loading from affecting its amplitude or frequency. The ratio of the powers absorbed by the meter and the standard is⁴⁻⁵

⁴ The derivation is straightforward, remembering that $Z/Z_0 = 1 + \Gamma / 1 - \Gamma$.

⁵ It is evident that K_1 equals unity if $\Gamma_M = \Gamma_S$, a condition which may be recognized by a method described in "Accuracy with which two loads can be matched on a magic T," A. C. Macpherson and D. M. Kerns, *Electronics*, vol. 23, no. 9, p. 190; September 1950.

$$K_1 = \frac{P_M}{P_S} = \left| \frac{1 - \Gamma_G \Gamma_S}{1 - \Gamma_G \Gamma_M} \right|^2 \frac{1 - |\Gamma_M|^2}{1 - |\Gamma_S|^2} \tag{2}$$

where Γ_G , Γ_S , and Γ_M are the voltage reflection coefficients respectively of the generator, the standard, and the power meter, measured at the place of connection.

It is convenient to measure the voltage standing-wave ratio⁶ (VSWR or r) corresponding to the magnitude of Γ . Assuming that the worst phase combinations can exist in (2).

$$\frac{r_M (r_G r_S + 1)^2}{r_S (r_G + r_M)^2} \geq K_1 \geq \frac{r_M (r_G + r_S)^2}{r_S (r_G r_M + 1)^2} \tag{3}$$

In a specific example, if $r_G = 4.0$, $r_S = 1.05$, and $r_M = 1.25$, K_1 lies between 0.84 and 1.17, a mismatch error between -16 and +17 per cent if K_1 is erroneously taken to be unity.

The range of error can be reduced by "matching back" toward the generator, making Γ_G vanish. In this case, (2) becomes:

$$K_1' = \frac{1 - |\Gamma_M|^2}{1 - |\Gamma_S|^2} = \frac{r_M (r_S + 1)^2}{r_S (r_M + 1)^2} \tag{4}$$

With $r_S = 1.05$ and $r_M = 1.25$ as before, $K_1' = 0.99$, and the mismatch error is -1 per cent.

Caution must be used in attempts to further reduce the mismatch error by matching the power meter input. If an adjustable transformer is used for this purpose, the loss in the transformer itself will cause an error which cannot be readily evaluated. Only transformers with known loss can be safely used for this purpose.

C. Method 2—Comparison Using T-Junctions

1. Simultaneous Comparison: The generator is connected to the center arm (No. 3) of a symmetrical T-junction as shown in Fig. 2. The standard and the power meter are connected to the other two arms (arms 1 and 2, respectively).

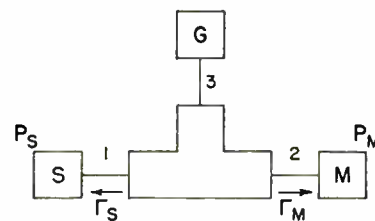

Fig. 2—T-junction comparison.

It can be shown that equal power will be delivered to the standard and the meter by a symmetrical T providing that their impedances are identical. A high degree of symmetry can be achieved by precise mechanical design and construction and by special techniques, such as electroforming. The degree of symmetry achieved may in some cases exceed the accuracy with which it can be measured. In the general case, however, in which asymmetry must be taken into account, the ratio of

⁶ $|\Gamma| = r - 1 / r + 1$.

powers absorbed by the meter and the standard is:⁷

$$K_2 = \frac{P_M}{P_S} = \left| \frac{S_{23}}{S_{13}} \right|^2 \cdot \frac{\left| 1 - \left(S_{11} - \frac{S_{13}}{S_{23}} S_{12} \right) \Gamma_S \right|^2}{\left| 1 - \left(S_{22} - \frac{S_{23}}{S_{13}} S_{12} \right) \Gamma_M \right|^2} \cdot \frac{1 - |\Gamma_M|^2}{1 - |\Gamma_S|^2} \quad (5)$$

The coefficients of the form $S_{m,n}$ are the scattering coefficients⁸ of the T . These scattering coefficients are either voltage reflection coefficients ($m=n$), or voltage transmission coefficients ($m \neq n$), and can be measured⁹ with a standing-wave machine.

It is possible to obtain the magnitudes of the coefficients in (5) from VSWR measurements and calculate the limits of K_2 as the phases are permitted to vary. Assuming that the T is symmetrical and lossless, K_2 lies between the limits:

$$r_M r_S \geq K_2 \geq \frac{1}{r_M r_S} \quad (6)$$

Specifically; if $r_S = 1.05$, and $r_M = 1.25$, K_2 lies between 0.76 and 1.31, an error between -24 and $+31$ per cent.

2. *Alternate Connection to T-Junction:* The generator is connected to the center arm (No. 3) of a T -junction as shown in Fig. 3. An uncalibrated power monitor is connected to one arm (No. 1) and the generator output is adjusted to maintain a constant indication of the monitor. The meter and the standard are alternately connected to the other arm (No. 2).

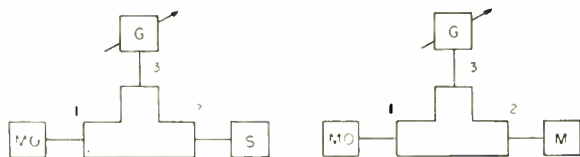

Fig. 3—Alternate connection to a T junction.

The ratio of powers absorbed by the meter and the standard from these conditions, applying (5), is

$$K_3 = \frac{P_M}{P_S} = \frac{P_M}{P_{MO}} \cdot \frac{P_{MO}}{P_S} = \left| \frac{1 - \left(S_{22} - \frac{S_{23}}{S_{13}} S_{12} \right) \Gamma_S \right|^2}{\left| 1 - \left(S_{22} - \frac{S_{23}}{S_{13}} S_{12} \right) \Gamma_M \right|^2} \cdot \frac{1 - |\Gamma_M|^2}{1 - |\Gamma_S|^2} \quad (7)$$

Comparison of this equation with (5) shows that the effect of asymmetry of the T has been reduced by this

method. In the case of a symmetrical lossless T , the limits of K_3 as determined from measurements of the magnitudes of the coefficients are the same as the limits of K_2 , as expressed in (6),

$$r_M r_S \geq K_3 \geq \frac{1}{r_M r_S} \quad (8)$$

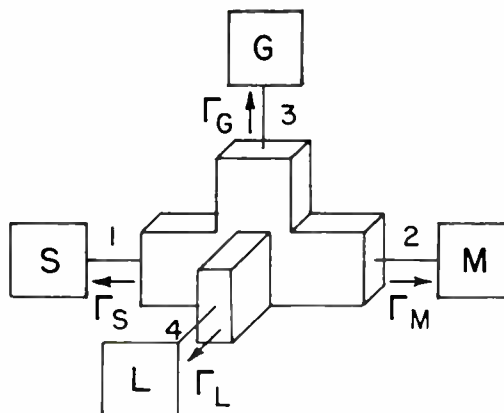

Fig. 4—Magic T comparison.

D. Method 3—Comparison Using Magic T

1. *Simultaneous Comparison:* The standard and the power meter are connected to the symmetrical arms (numbers 1 and 2, respectively) of a magic T ¹⁰ as shown in Fig. 4. A generator and a matched load are connected to the other arms (numbers 3 and 4, respectively). It can be shown that equal power will be delivered to the standard and the meter by a symmetrical magic T provided that their impedances are identical. But in the general case in which the asymmetry and mismatch are taken into account the ratio of powers absorbed by the meter and the standard is,¹¹

$$K_4 = \frac{P_M}{P_S} = \left| \frac{ab - cd \Gamma_L}{bg - df \Gamma_L \Gamma_M} \right|^2 \cdot \frac{1 - |\Gamma_M|^2}{1 - |\Gamma_S|^2} \quad (9)$$

where:

$$\begin{aligned} a &= S_{23}(1 - S_{11}\Gamma_S) + S_{12}S_{13}\Gamma_S \\ b &= S_{13}(1 - S_{44}\Gamma_L) + S_{14}S_{34}\Gamma_L \\ c &= S_{34}(1 - S_{11}\Gamma_S) + S_{13}S_{14}\Gamma_S \\ d &= S_{14}S_{23} - S_{13}S_{24} \\ f &= S_{12}S_{34} - S_{13}S_{24} \\ g &= S_{13}(1 - S_{22}\Gamma_M) + S_{12}S_{23}\Gamma_M \end{aligned}$$

The scattering coefficients of the magic T can be measured⁹ with a standing-wave machine or the ideal¹² values can be used if the losses in the T are sufficiently small, the internal matching is sufficiently good, and the mechanical construction is sufficiently precise.

¹⁰ A conventional waveguide magic T may be defined as a four-arm junction having the form shown in Fig. 4 which is symmetrical, lossless and matched looking in each arm.

¹¹ This equation follows from the scattering equations of a four-arm junction.

¹² See pp. 448-449 of reference of footnote 8.

⁷ This equation follows from the scattering equations of a three-arm junction.

⁸ C. G. Montgomery, R. H. Dicke, and E. M. Purcell, "Principles of Microwave Circuits," McGraw-Hill Book Company, New York, N. Y., pp. 146-151; 1948.

⁹ See Appendix.

If the four-arm junction is an ideal magic T having properly chosen reference planes, $S_{11} = S_{22} = S_{33} = S_{44} = S_{12} = S_{34} = 0$, and $S_{14} = -S_{24} = S_{13} = S_{23}$.

It is possible to simplify (9) in several ways. For example, if it is assumed that the load is perfectly matched ($\Gamma_L = 0$) (9) reduces to (5). If in addition some of the properties of an ideal magic T are substituted in this equation ($S_{11} = S_{22} = S_{12} = 0$, and $|S_{13}| = |S_{23}|$), it reduces to (4). A nomogram representing (4) is shown in Fig. 5.

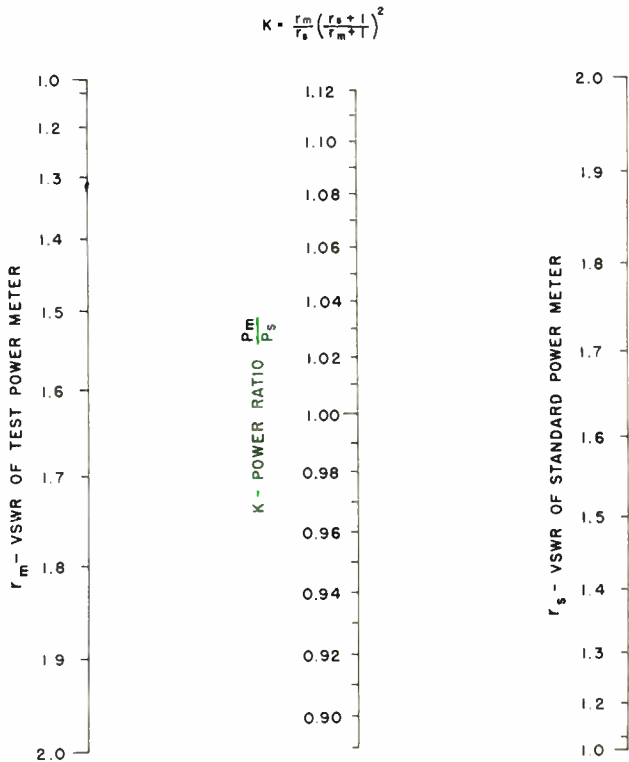

Fig. 5—Mismatch effect in the calibration of power meters.

2. *Alternate Connection to Magic T*: The generator and a load are connected to the symmetrical arms (numbers 3 and 4, respectively) of a magic T as shown in

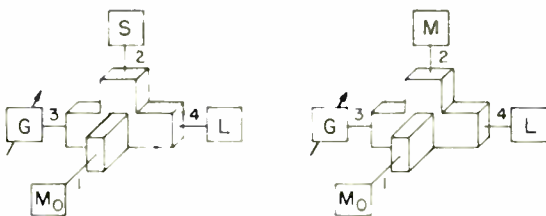

Fig. 6—Alternate connection to a magic T .

Fig. 6. An uncalibrated power monitor is connected to arm No. 1 and the meter and standard are alternately connected to arm No. 2. The generator output is adjusted to maintain a constant indication of the monitor. The ratio of powers absorbed by the meter and the standard is:

$$K_s = \frac{P_M}{P_S} = \frac{P_M}{P_{MO}} \cdot \frac{P_{MO}}{P_S}$$

$$K_s = \left| \frac{bg' - df\Gamma_L\Gamma_S}{bg - df\Gamma_L\Gamma_M} \right|^2 \cdot \frac{1 - |\Gamma_M|^2}{1 - |\Gamma_S|^2} \quad (10)$$

where:

$$b = S_{13}(1 - S_{44}\Gamma_L) + S_{14}S_{34}\Gamma_L$$

$$g' = S_{13}(1 - S_{22}\Gamma_S) + S_{12}S_{23}\Gamma_S$$

$$d = S_{14}S_{23} - S_{13}S_{24}$$

$$f = S_{12}S_{31} - S_{13}S_{24}$$

$$g = S_{13}(1 - S_{22}\Gamma_M) + S_{12}S_{23}\Gamma_M.$$

If the load is matched ($\Gamma_L = 0$), (10) reduces to (7). It is evident that the asymmetry effect is generally less in the alternate connection method than in the simultaneous comparison method. If the magic T is very nearly ideal, substitution of some of its properties ($S_{12} = S_{22} = 0$) into (7) reduces it to (4). For a perfect magic T ,

$$\frac{P_M}{P_S} = \frac{1 - |\Gamma_M|^2}{1 - |\Gamma_S|^2} = \frac{r_M}{r_S} \left(\frac{r_S + 1}{r_M + 1} \right)^2 \quad (4)$$

III. DISCUSSION OF CALIBRATION METHODS

A general discussion of all power meter calibration methods is beyond the scope of this paper. The methods described in the previous section have their advantages and limitations with regard to accuracy, flexibility, equipment requirements and speed and ease of measurement.

The alternate connection of the meter and the standard to the same generator is a simple and flexible method which can be employed with waveguide or coaxial line. No auxiliary power dividing equipment is required and the mismatch error is relatively small and can be easily evaluated from VSWR measurements if the generator is matched. The generator must remain stable in power output and frequency during the calibration and must be padded to prevent oscillator pulling caused by changes in loading.

The use of a power divider permits simultaneous comparison of the meter and the standard. This reduces the necessity for padding the oscillator and the stability requirements are not as great.

If the degree of symmetry is low, the mismatch and asymmetry error may be reduced by using the alternate connection method with a power monitor. The generator padding and stability requirements are increased and it is necessary to provide a smoothly adjustable generator output.

Symmetrical three-arm T 's are commercially available in waveguide and coaxial line. Because of the center conductor, the coaxial T involves additional difficulties of construction not encountered in the waveguide T . The mismatch error can be evaluated from measure-

ments of the parameters of the T . The range of mismatch error, even with a perfect T , is greater than that obtained by alternate connection of the meter and the standard to a matched generator.

Symmetrical waveguide magic T 's are commercially available but magic T 's or hybrid circuits in coaxial line are not readily obtainable. Carefully constructed waveguide magic T 's make excellent power dividers for power meter calibration, permitting simultaneous comparison with no more mismatch error than is encountered with alternate connection to a matched generator. If asymmetry is appreciable, it can be determined from measurements of the T parameters.

The effect of asymmetry can be reduced by using the alternate connection method with a power monitor.

A magic T can also be used to accurately compare two impedances.⁵ If one impedance is adjustable, the two can be made equal. Applying this principle to power meter calibration, the impedances of the meter and the standard can sometimes be made nearly equal, permitting a reduction in the mismatch error.

IV. USE OF POWER METERS

A. General Remarks

If the power to be measured is within the range of the power meter, a direct measurement can be made. If the power is greater, a calibrated device such as an attenuator or directional coupler is used in such a way that a known fraction of the power is measured by the power meter.

B. Direct Measurement

In the direct measurement of the power that a given generator will deliver to a given load, the power meter is simply substituted for the load. This is the same situation encountered in the alternate connection of two power meters to a stable source. If the meter and the load are nearly matched, it is often erroneously assumed that the power measured by the meter is the same as that delivered to the load. Assuming that the generator is well padded, the ratio of powers absorbed by the load and the power meter is given by (2) with an appropriate change in subscripts

$$K_6 = \frac{P_L}{P_M} = \left| \frac{1 - \Gamma_G \Gamma_M}{1 - \Gamma_G \Gamma_L} \right|^2 \frac{1 - |\Gamma_L|^2}{1 - |\Gamma_M|^2} \quad (11)$$

In this expression the reflection coefficients of the generator, meter, and load are designated as Γ_G , Γ_M , and Γ_L , respectively. If the power meter reading is assumed to be correct, it is multiplied by the factor K_6 to obtain the power that the generator will deliver to the load. It is apparent that (11) and (2) are of the same form and that the limits of K_6 are:

$$\frac{r_L}{r_M} \left(\frac{r_G + r_M}{r_G r_L + 1} \right)^2 \geq K_6 \geq \frac{r_L}{r_M} \left(\frac{r_G r_M + 1}{r_G + r_L} \right)^2 \quad (12)$$

In a specific example, taking $r_G=4.0$, $r_M=1.05$, and $r_L=1.25$, K_6 lies between 0.84 and 1.17, a mismatch error of between -16 and $+17$ per cent.

If the generator is matched, the mismatch error in the previous example is approximately -1 per cent.

C. Use of Calibrated Attenuator

If a calibrated attenuator is used to extend the range of power meter as shown in Fig. 7, the measured power is normally multiplied by the attenuator ratio to obtain the power available to the load. If the error of mismatch

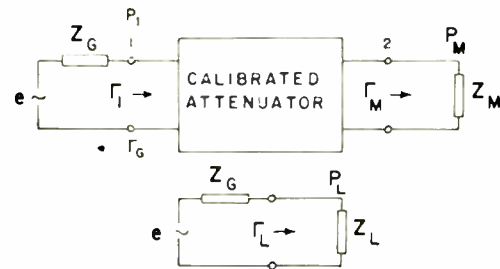

Fig. 7—Use of calibrated attenuator.

is taken into account, the previous result is multiplied by a correction factor K_7 to obtain the power delivered to the load when it is connected directly to the generator. The factor K_7 is given by:¹³

$$K_7 = \frac{P_L}{P_M R_A} = \left| \frac{1 - \Gamma_G \Gamma_1}{1 - \Gamma_G \Gamma_L} (1 - S_{22} \Gamma_M) \right|^2 \frac{1 - |\Gamma_L|^2}{1 - |\Gamma_M|^2} \quad (13)$$

In (13) the reflection coefficients of the generator, load, and meter are denoted by Γ_G , Γ_L , and Γ_M , respectively. The scattering coefficients of the attenuator are denoted by $S_{m,n}$ and Γ_1 represent the input voltage reflection coefficient of the attenuator with its output connected to the power meter. From the scattering equations for a two terminal-pair network,

$$\Gamma_1 = S_{11} + \frac{S_{12}^2 \Gamma_M}{1 - S_{22} \Gamma_M} \quad (14)$$

and the attenuation in decibels is:

$$A_T = 10 \log_{10} R_A = 10 \log_{10} \left| \frac{1}{S_{12}} \right|^2 \quad (15)$$

If only the VSWR's are measured corresponding to the reflection coefficients of (13), the limits of K_7 are:

$$4 \frac{r_L}{r_M} \left[\frac{(r_G r_1 + 1)(r_{22} r_M + 1)}{(r_G + r_L)(r_{22} + 1)(r_1 + 1)} \right]^2 \geq K_7 \geq 4 \frac{r_L}{r_M} \left[\frac{(r_G + r_1)(r_{22} + r_M)}{(r_G r_L + 1)(r_{22} + 1)(r_1 + 1)} \right]^2$$

In a specific example, taking $r_G=2.0$, $r_M=1.20$, $r_L=1.1$, $r_{22}=1.20$ and $r_1=1.25$, K_7 lies between 0.89 and 1.14, a mismatch error between -11 and $+14$ per cent.

¹³ This equation follows from (11) and the scattering equations of a two terminal-pair network.

If desired, the error may be evaluated by measuring the reflection coefficients appearing in (13). The measured value of Γ_1 may be checked by measuring the scattering coefficients of the attenuator and substituting in (14). Inspection of (14) and (15) shows that Γ_1 approximately equals S_{11} if the attenuation is large.

If the attenuator is reflection-free ($S_{11}=S_{22}=0$) (13) reduces to:

$$K_7' = \left| \frac{1 - \Gamma_G \Gamma_1}{1 - \Gamma_G \Gamma_L} \right|^2 \frac{1 - |\Gamma_L|^2}{1 - |\Gamma_M|^2} \quad (16)$$

and (14) reduces to:

$$\Gamma_1' = S_{12}^2 \Gamma_M. \quad (17)$$

In a specific example, taking $r_G = 2.0$, $r_M = 1.20$, $r_L = 1.1$, and $r_1 = 1.019$ (10 db attenuator), K_7' lies between 0.970 and 1.046, a mismatch error between -3 and +5 per cent.

If the generator is matched ($\Gamma_G = 0$), (16) reduces to:

$$K_7'' = \frac{1 - |\Gamma_L|^2}{1 - |\Gamma_M|^2} = \frac{r_L (r_M + 1)^2}{r_M (r_L + 1)^2}. \quad (18)$$

Assuming that $r_L = 1.1$ and $r_M = 1.20$, K_7'' equals 1.007, representing a mismatch error of less than 1 per cent.

D. Use of Directional Couplers

1. A directional coupler is often used to extend the range of power meters as shown in Figs. 8 and 9. In Fig. 8, the coupler is temporarily inserted between the generator and load and the power is measured with a power

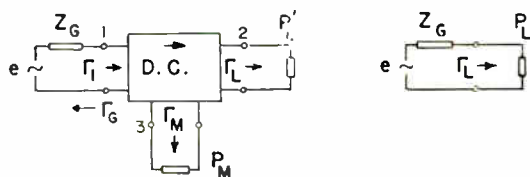

Fig. 8—Temporary insertion of directional coupler.

meter. The measured power is normally multiplied by the coupler ratio to obtain the power available to the load. If the effect of mismatch is taken into account, the previous result is multiplied by a correction factor K_8 to obtain the power delivered to the load when it is connected directly to the generator. The factor K_8 is given by:¹⁴

$$K_8 = \frac{P_L}{P_M R_{CO}} = \left| \frac{1 - \Gamma_G \Gamma_1}{1 - \Gamma_G \Gamma_L} \right|^2 \cdot |S_{13}|^2 \cdot \left| \frac{S_{12}(1 - S_{33}\Gamma_M) + S_{13}S_{23}\Gamma_M}{S_{23}(\Gamma_1 - S_{11}) + S_{12}S_{13}} \right|^2 \frac{1 - |\Gamma_L|^2}{1 - |\Gamma_M|^2}. \quad (19)$$

In (19) the reflection coefficients of the generator, meter, and load are denoted by Γ_G , Γ_M , and Γ_L , respectively. The input reflection coefficient of the directional coupler

¹⁴ The derivation of this equation is straightforward, starting from the scattering equations of a three-arm junction.

connected as shown in Fig. 8 is Γ_1 . The scattering coefficients of the coupler are designated by $S_{m,n}$. The coupling C , and directivity D , are defined in the usual manner:

$$\begin{cases} C = 10 \log_{10} R_{CO} = 10 \log_{10} \left| \frac{1}{S_{13}} \right|^2 \\ D = 10 \log_{10} \left| \frac{S_{13}}{S_{23}} \right|^2. \end{cases} \quad (20)$$

It can be shown by a solution of the scattering equations for a three-arm junction that the reflection coefficient Γ_1 is:

$$\Gamma_1 = S_{11} + \frac{S_{12}^2 \Gamma_L}{(1 - S_{22}\Gamma_L) - \frac{S_{13}(1 - S_{22}\Gamma_L) + S_{12}S_{23}\Gamma_L}{S_{12}(1 - S_{33}\Gamma_M) + S_{13}S_{23}\Gamma_M} S_{23}\Gamma_M} + \frac{S_{13}^2 \Gamma_M}{(1 - S_{33}\Gamma_M) - \frac{S_{12}(1 - S_{33}\Gamma_M) + S_{13}S_{23}\Gamma_M}{S_{13}(1 - S_{22}\Gamma_L) + S_{12}S_{23}\Gamma_L} S_{23}\Gamma_L}. \quad (21)$$

If the directional coupler can be considered to be perfect, having infinite directivity ($S_{23}=0$) and being reflection-free ($S_{11}=S_{22}=S_{33}=0$), the above equations simplify, (21) reducing to:

$$\Gamma_1' = S_{11} + S_{12}^2 \Gamma_L + S_{13}^2 \Gamma_M \quad (22)$$

and (19) reducing to (16). If in addition the generator is matched ($\Gamma_G = 0$) (18) applies.

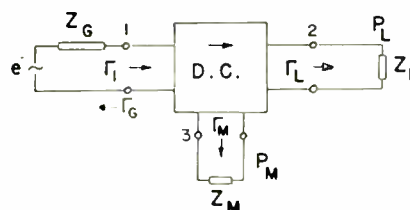

Fig. 9—Permanent installation of directional coupler.

2. A directional coupler is often permanently installed between the generator and the load as shown in Fig. 9. The power delivered to the load is normally obtained by multiplying the power meter reading by the coupler ratio. If mismatch is present, it is necessary to multiply this result by a correction factor K_9 . This factor is given by:¹⁵

$$K_9 = \frac{P_L}{P_M R_{CO}} = |S_{13}|^2 \left| \frac{S_{12}(1 - S_{33}\Gamma_M) + S_{13}S_{23}\Gamma_M}{S_{13}(1 - S_{22}\Gamma_L) + S_{12}S_{23}\Gamma_L} \right|^2 \frac{1 - |\Gamma_L|^2}{1 - |\Gamma_M|^2}. \quad (23)$$

Note that $K_9 = 1$ when $|\Gamma_L| = |\Gamma_M| = 0$, and $|S_{12}| = 1$. If the directional coupler can be considered to be perfect ($S_{11}=S_{22}=S_{33}=S_{23}=0$) and the coupling is loose ($S_{12}=1$), (23) reduces to (18).

¹⁵ The derivation is similar to that for (19).

In a specific example let $r_L=1.5$ and $r_M=1.25$. A directional coupler is used having a directivity of 25 decibels, a coupling of 20 decibels and reflections in each arm producing a VSWR less than 1.1. Assuming the worst phase conditions the limits of error calculated from (23) are approximately -8 and $+2$ per cent.

If the directional coupler is assumed to be perfect in the same example, the error calculated from (18) is approximately -3 per cent.

If these examples can be considered typical, it is evident that the simplified equation cannot be used to evaluate the mismatch error unless the directional coupler is very nearly perfect and the degree of mismatch is small.

ACKNOWLEDGMENT

The authors wish to thank Dr. David M. Kerns and the other readers who gave valuable criticism and suggestions.

APPENDIX

Measurement of Scattering Coefficients

A network having n -terminal pairs and a scattering matrix S is shown in Fig. 10. The scattering coefficients

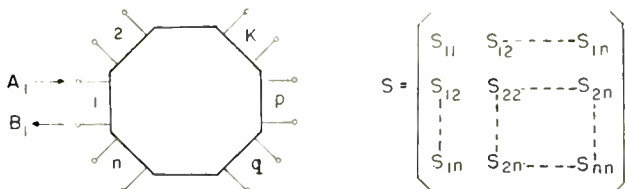

Fig. 10—Network having n -terminal pairs.

are of the general form $S_{p,q}$ where p and q are integers, each denoting a given terminal pair.

If $p=q=K$, the voltage reflection coefficient S_{KK} is measured at the K^{th} terminal pair with all other terminal pairs connected to reflection-free loads.

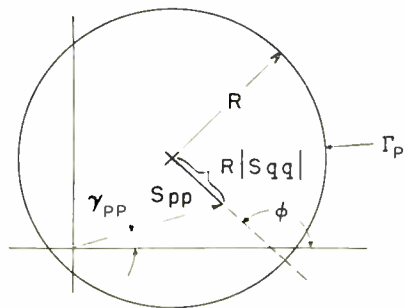

Fig. 11—Reflection coefficient circle.

If $p \neq q$, the voltage transmission coefficient S_{pq} is measured in the following way. The q^{th} terminal pair is connected to a variable reactance. All other terminal pairs with the exception of the p^{th} pair are connected to reflection-free loads. The input reflection coefficient Γ_p is measured for various reactances at q . The locus of the measured points is a circle as shown in Fig. 11. The magnitude and phase of S_{pq} are:

$$|S_{pq}|^2 = R\{1 - |S_{qq}|^2\} \tag{24}$$

$$\gamma_{pq} = \frac{1}{2}(\phi + \gamma_{qq}).$$

A short derivation follows:

If A and B denote the incident and reflected voltage waves at a pair of terminals p and q ,

$$\begin{cases} B_p = S_{pp}A_p + S_{pq}A_q \\ B_q = S_{pq}A_p + S_{qq}A_q. \end{cases} \tag{25}$$

Let

$$\frac{A_q}{B_q} = e^{j\theta}.$$

Then

$$\frac{A_q}{A_p} = \frac{S_{pq}}{e^{-j\theta} - S_{qq}} \tag{26}$$

and:

$$\Gamma_p = \frac{B_p}{A_p} = S_{pp} + S_{pq} \frac{A_q}{A_p} = S_{pp} + \frac{S_{pq}^2}{e^{-j\theta} - S_{qq}}. \tag{27}$$

A variation of θ represents a change in the reactance connected to terminal pair q . As shown in Fig. 12, the magnitude of the vector quantity $(\Gamma_p - S_{pp})$ goes through maximum and minimum values as θ changes.

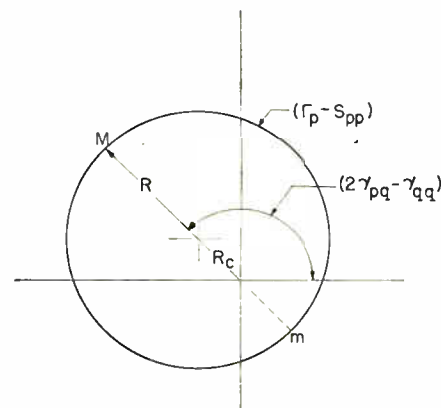

Fig. 12—Translated reflection coefficient circle.

At these points M and m ,

$$(\Gamma_p - S_{pp})_M = \frac{|S_{pq}|^2}{1 - |S_{qq}|} e^{j(2\gamma_{pq} - \gamma_{qq})} \tag{28}$$

$$(\Gamma_p - S_{pp})_m = \frac{|S_{pq}|^2}{1 + |S_{qq}|} e^{j(2\gamma_{pq} - \gamma_{qq} \pm \pi)}. \tag{29}$$

The radius of the circle is:

$$R = \frac{1}{2} \left[\frac{|S_{pq}|^2}{1 - |S_{qq}|} + \frac{|S_{pq}|^2}{1 + |S_{qq}|} \right] = \frac{|S_{pq}|^2}{1 - |S_{qq}|^2}. \tag{30}$$

The distance to the center of the circle is:

$$R_c = \frac{1}{2} \left[\frac{|S_{pq}|^2}{1 - |S_{qq}|} - \frac{|S_{pq}|^2}{1 + |S_{qq}|} \right] = \frac{|S_{pq}|^2}{1 - |S_{qq}|^2} |S_{qq}| = R |S_{qq}|. \quad (31)$$

Denoting the phase angle ($2\gamma_{pq} - \gamma_{qq}$) by ϕ , the diagram of Fig. 11 can be drawn.

An alternate method of measuring the scattering coefficients of an n -terminal pair network is as follows. Referring to Fig. 10, the scattering coefficients S_{pp} , S_{pq} , and S_{qq} are determined by terminating terminal pair q

in three different loads having voltage reflection coefficients Γ_{L1} , Γ_{L2} , and Γ_{L3} , and measuring the corresponding input voltage reflection coefficients Γ_1 , Γ_2 , and Γ_3 at terminal pair p with all other terminal pairs terminated in matched loads.

Solving the three equations for input voltage reflection coefficient of the form

$$\Gamma = S_{pp} + \frac{S_{pq}^2 \Gamma_L}{1 - S_{qq} \Gamma_L}, \quad (32)$$

the following expressions are obtained for the scattering coefficients.

$$S_{pp} = \frac{\Gamma_{L1} \Gamma_{L2} \Gamma_{L3} (\Gamma_1 - \Gamma_2) + \Gamma_{L2} \Gamma_{L3} \Gamma_1 (\Gamma_2 - \Gamma_3) + \Gamma_{L3} \Gamma_{L1} \Gamma_2 (\Gamma_3 - \Gamma_1)}{\Gamma_{L1} \Gamma_{L2} (\Gamma_1 - \Gamma_2) + \Gamma_{L2} \Gamma_{L3} (\Gamma_2 - \Gamma_3) + \Gamma_{L3} \Gamma_{L1} (\Gamma_3 - \Gamma_1)} \quad (33)$$

$$S_{qq} = - \frac{\Gamma_{L1} (\Gamma_2 - \Gamma_3) + \Gamma_{L2} (\Gamma_3 - \Gamma_1) + \Gamma_{L3} (\Gamma_1 - \Gamma_2)}{\Gamma_{L1} \Gamma_{L2} (\Gamma_1 - \Gamma_2) + \Gamma_{L2} \Gamma_{L3} (\Gamma_2 - \Gamma_3) + \Gamma_{L3} \Gamma_{L1} (\Gamma_3 - \Gamma_1)} \quad (34)$$

$$S_{pq}^2 = - \frac{(\Gamma_1 - \Gamma_2)(\Gamma_2 - \Gamma_3)(\Gamma_3 - \Gamma_1)(\Gamma_{L1} - \Gamma_{L2})(\Gamma_{L2} - \Gamma_{L3})(\Gamma_{L3} - \Gamma_{L1})}{[\Gamma_{L1} \Gamma_{L2} (\Gamma_1 - \Gamma_2) + \Gamma_{L2} \Gamma_{L3} (\Gamma_2 - \Gamma_3) + \Gamma_{L3} \Gamma_{L1} (\Gamma_3 - \Gamma_1)]^2} \quad (35)$$

The Phase-Bistable Transistor Circuit*

R. H. BAKER, MEMBER, IRE, IRWIN L. LEBOW, ROBERT H. REDIKER, AND I. S. REED†

Summary—A synchronized transistor switching circuit has been designed for use in computer applications. The circuit is phase bistable rather than amplitude bistable. The basic unit of the circuit is a commutating ring which is operated by clock pulses and which is sampled at one-half the repetition rate of the clock. An input pulse changes the *phase* of the ring with respect to the sample pulses. This is analogous to a change in the output *amplitude* of a conventional amplitude bistable device caused by introduction of an input pulse. The basic transistor circuit used is the one-shot multivibrator. The latter device has proved to be more reliable than any amplitude-bistable transistor circuit.

In section I are presented some features of a transistor switching circuit. Section II contains a simplified description of the phase-bistable circuit and its mode of operation. In section III is described the transistor circuitry, while in section IV some general applications to digital computers are discussed.

I. INTRODUCTION

IN THE DESIGN of transistor switching circuits one encounters certain difficulties which severely limit the apparent versatility of the point-contact transistor. If we connect the transistor in the circuit of Fig. 1(a), we obtain the familiar bilateral characteristic of

Fig. 1(b). Such a circuit may be made astable, monostable, or bistable by proper selection of the input load-line parameters, R_e and V_{ee} . Using the astable connection, we may design free-running multivibrators; with

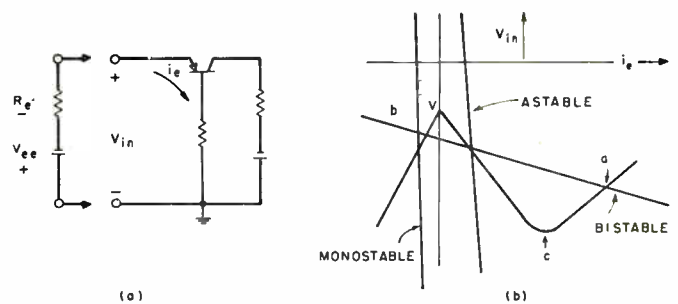

Fig. 1—Point contact transistor circuit and bilateral characteristic.

the monostable connection we may design regenerative pulse amplifiers and one-shot multivibrators; and with the bistable circuit it is possible to design flip-flops. Because of the “hole-storage” phenomenon,¹ the trigger pulse necessary to switch the circuit from its conducting state (point “a” of Fig. 1b) to its non-conducting state (point “b”) must be relatively wide. For most available

* Decimal classification: R282.12. Original manuscript received by the Institute, February 13, 1953. (The research reported herein was supported jointly by the Army, Navy and Air Force under contract with the Massachusetts Institute of Technology.)

† Massachusetts Institute of Technology, Cambridge, Mass.

¹ R. H. Baker, I. L. Lebow, and R. H. Rediker, to be published.

transistors, such as Western Electric type 1698, if point "a" is more than one volt from the valley point, point "c," pulses greater than $1 \mu\text{sec}$ in duration must be used. Since the valley-point voltage can only be stabilized to within 1 volt it must be concluded that the design of bistable circuits to operate at frequencies much above the kilocycle range is most difficult with the transistors presently available.²

We are thus led, at present, to the use of monostable and astable circuits, neither of which require external trigger pulses for switching from conducting to non-conducting states. A further advantage of these circuits over the bistable circuit is their relative independence upon being loaded. The effect of loading upon the input characteristic in Fig. 1(b) is to alter the shape of the curve in the positive current region while not affecting the negative current region. Hence, loading will alter the requirements for triggering "off" while not disturbing the requirements for triggering "on." It is evident from the above discussion that loading a bistable circuit may inhibit operation. Loading monostable or astable circuits may change the output pulse shape to some extent but will not, in general, seriously affect the circuit operation.

The phase-bistable circuit to be described in this paper is based upon a transistor one-shot multivibrator. In section II we describe the basic logic of the phase-bistable circuit. In section III we present the transistor circuitry employed in the device, together with a more complete description of the logic. Finally, in section IV some general computer principles, as applied to phase-bistable devices, are discussed.

II. THE PHASE-BISTABLE CIRCUIT

We present here the operation method of the phase-bistable circuit. The heart of the circuit is a commutating ring operated by a fixed-frequency clock. We show the block diagram of the commutating ring together with the sequence of operations in Fig. 2. The operation

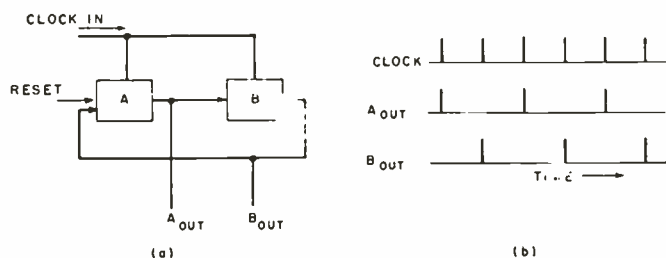

Fig. 2—Block diagram of the commutating ring and the sequence of operations.

of the circuit is as follows. Both A and B are sufficiently biased off to prevent the clock from firing either stage.

² R. H. Baker, I. L. Lebow, and R. H. Rediker, "A transistor switching circuit with stabilized valley point," *Tech. Memo. Lincoln Lab., Mass. Inst. Tech.*, July 22, 1952. This limitation does not apply to the more recently developed nonsaturating bistable circuits. For example, see A. W. Carlson, "A Transistor Flip-Flop With Two Stable Non-Saturated States," A. F. Cambridge Research Center Report; Dec. 1952.

A reset pulse is then applied to A in such a manner that enough bias is removed to allow the clock to trigger A . When A is triggered two things occur; first, the output pulse from A is applied to B and stored in B , allowing the second clock pulse to trigger B . Second, A is returned to its original biased state, preventing it from being triggered by the second clock pulse. Similarly, when B is triggered the output of B is stored in A while B reverts to its biased state so that the third clock pulse will trigger A and not B .

In order to sample the states of A and B , we observe the respective outputs with respect to a fixed-time base. The method of sampling is shown in the block diagram and timing diagram of Fig. 3. Here we show, in addition to the commutating ring, A and B , a sample pulse generator, and two gates, G_A and G_B . The sample pulse generator is simply a commutating ring, the output from one stage of which is a series of pulses at a repetition rate of one-half that of the clock generator. The reset pulse is applied simultaneously to A_S and A so that S and A are triggered by the same clock pulse. We

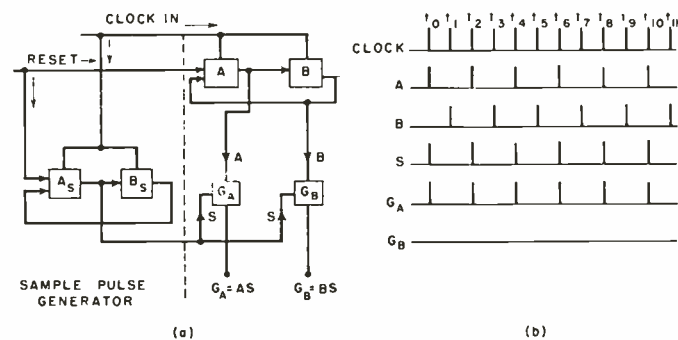

Fig. 3—Block and timing diagram showing method of sampling the states of A and B .

then gate the output of S with both A and B and observe a series of pulses at G_A and none at G_B . These outputs of the gates, G_A and G_B , represent the states of the system. According to the timing diagram of Fig. 3, we observe "ones" at G_A and "zeros" at G_B . Hence, we observe the state of the ring A - B by comparing its phase with that of the sample pulses.

If we inhibit one of the clock pulses going into the ring A - B we change the phase of A - B with respect to S . To prevent interference with the sampling procedure we always inhibit clock pulses not associated with sample pulses. The method by which count pulses occurring at random intervals accomplish this is shown in Fig. 4. The count pulse is synchronized to the clock by quantizing it to the output of B_S . Thus, in the timing diagram of Fig. 4 we see that a count pulse occurring between t_4 and t_5 is quantized to the succeeding pulse from B_S which occurs at time t_6 . This quantized count pulse inhibits the clock pulse occurring at t_6 and delays the triggering of B by one time interval. If we now observe the outputs of the gates G_A and G_B , we see that

following the inhibited clock pulse, G_A exhibits "zeros" while G_B exhibits "ones." In the same fashion a second count pulse will switch the ring $A-B$ to its original phase, causing G_A to read "ones" and G_B to read "zeros." The dotted lines appearing on the time scale of G_A and G_B in Fig. 4 represent the integrated outputs at the gates. It is evident that these correspond to the outputs of a conventional amplitude-bistable counter.

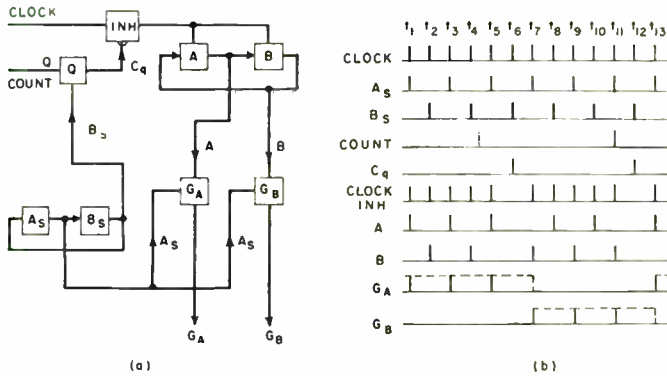

Fig. 4—Method of inhibiting clock pulses accomplished by count pulses occurring at random intervals.

As is demonstrated in section IV, the phase-bistable circuit may be employed as a general parallel counter. The maximum rate at which data may be processed is that of the sample pulses or one-half the clock frequency.

III. THE PHASE-BISTABLE CIRCUIT USING TRANSISTORS

A. Transistor Circuitry

1. *The One-Shot Multivibrator.* The basic transistor circuit used in each of the blocks in Fig. 4 is the one-shot multivibrator. In Fig. 5 we show the circuit diagram. The circuit of Fig. 5 is essentially that of Fig. 1 with a monostable load line. The discharge capacitor is connected between emitter and ground in series with a diode to maintain a high impedance input. Base stabilization has been employed to stabilize the triggering requirements. The output pulse widths obtained are 0.5–1 μ sec.

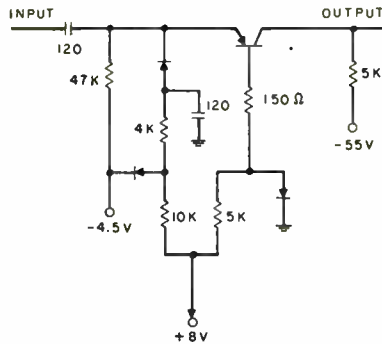

Fig. 5—Circuit diagram of the one-shot multivibrator.

2. *The Commutating Ring.* In Fig. 6(a) we show the circuit of the commutating ring. Both of the units are one-shot multivibrators similar to that of Fig. 5, except that triggering is accomplished by applying negative pulses to the base rather than positive pulses to the

emitter. Both emitters are biased sufficiently negative so that the clock pulses are incapable of triggering either stage. If, however, a positive reset pulse is applied, storage capacitor C_A becomes charged and the bias on stage A is effectively reduced. The succeeding clock pulse will then trigger stage A . When A is triggered, capacitor C_A becomes discharged, returning stage A to its original highly biased state. At the same time, the output pulse from A is applied to the storage capacitor of stage B . Hence, the next clock pulse will trigger stage B , C_B will be discharged, and C_A charged. Succeeding clock pulses will alternately trigger stages A and B .

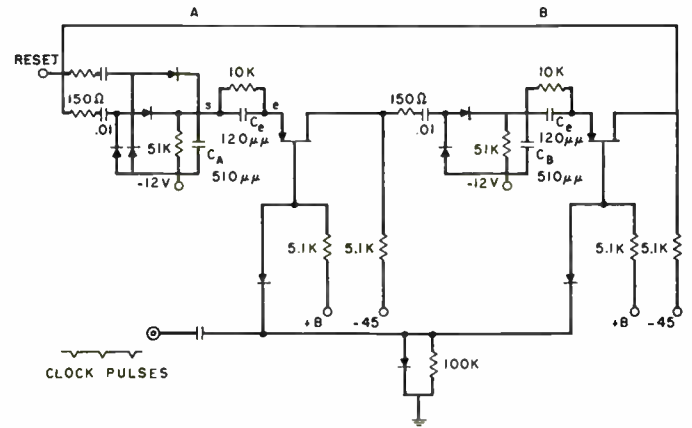

Fig. 6a—Circuit diagram of the commutating ring.

The detailed operation of the circuit is as follows, with reference to Fig. 6(b). Before application of the reset pulse both points e and s are at about -10 volts. A reset pulse then charges capacitor C_A , resulting in points e and s rising to about -3 volts. The next clock pulse triggers stage A , and its emitter voltage drops to about -13 volts in about 0.5μ sec when the transistor switches off. During this time, point s drops to about -8 volts.

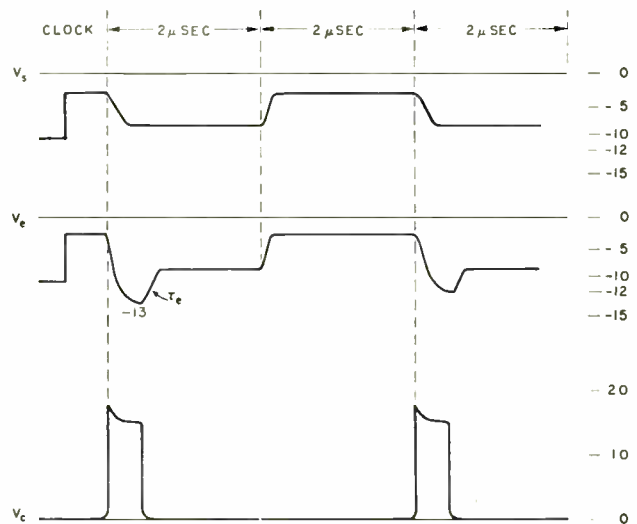

Fig. 6b—Detailed operation of the commutating-ring circuit.

The emitter then rises with a time constant of 1.2μ sec ($120 \mu\text{F} \times 10\text{K}$) until it reaches the voltage of point s (~ -8 volts). This latter voltage remains essentially

constant since the time constant at which C_A discharges is $\sim 25 \mu\text{sec}$; this is considerably greater than the period of the clock pulses ($2 \mu\text{sec}$). The second clock pulse is unable to overcome the bias on stage A but triggers stage B , the bias of which having been reduced by the output pulse from stage A .

3. *The Quantizer.* The quantizer circuit is identical to that of a single stage of the commutating ring. The pulse to be quantized is applied to the storage input while the quantizing pulses are applied to the base. Hence, referring to Fig. 4, there will be an output pulse from the quantizer at the time of a quantizing pulse immediately following a count pulse.

4. *The Inhibitor.* In Fig. 7 we show the inhibitor circuit. Again, the basic one-shot multivibrator is used. Clock pulses are applied to the emitter while the inhibit pulses are applied to the base. In the absence of an inhibit pulse, the clock pulses trigger the multivibrator. An inhibit pulse will raise the base potential to a value high enough to prevent the clock pulse from triggering

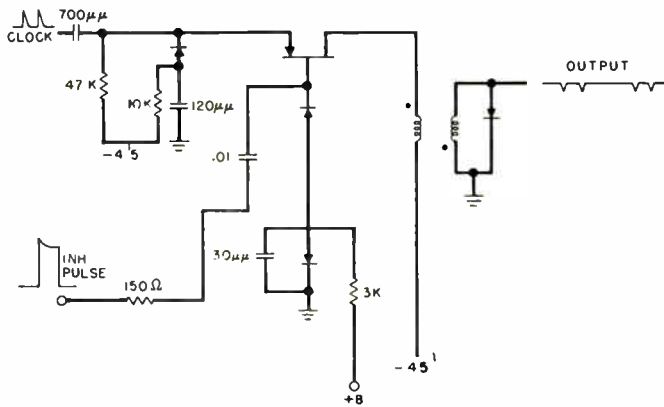

Fig. 7—The inhibitor circuit.

the circuit. Since we are dealing with a synchronous system the inhibit pulses are easily quantized and made of sufficient duration to completely cover the clock pulses. This insures positive inhibitor action.

5. *The Gate.* The gate is a conventional diode "and" gate the output of which is applied to a basic one-shot multivibrator used as a buffer stage.

B. A Two-Stage Binary Counter

In this section we combine the logic of section II with the circuitry of section IIIA to construct a two-stage binary counter operating at a clock frequency of 500 kc, and hence, with a maximum operating frequency of 250 kc. In Fig. 8 we show the block diagram, and in Fig. 9 the timing sequence. The difference between the first stage of Fig. 8 and the circuit of Fig. 4 is the method of quantizing the count pulses. In Fig. 4 the count pulses are quantized to the complement of the sample pulses. This is satisfactory from the logical point of view, but

impractical since it requires inhibition of a given clock pulse by a pulse which is created by the identical clock pulse. To obviate this difficulty we use the method of Fig. 8. The sample pulses themselves (not their comple-

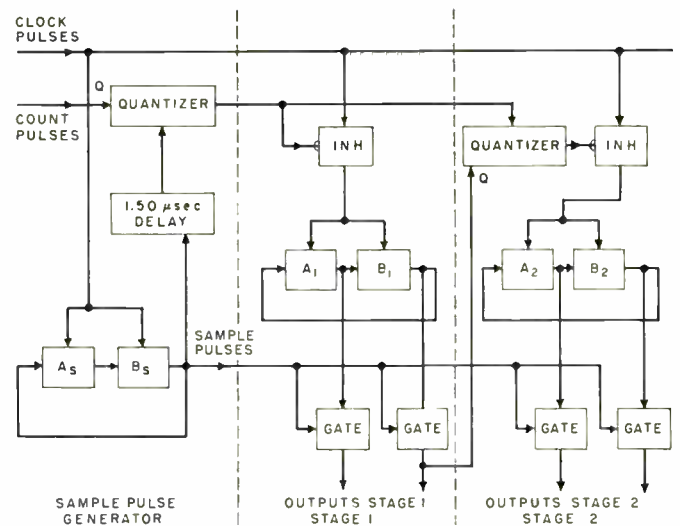

Fig. 8—Block diagram of the two-stage binary counter.

ment) are delayed by $1.50 \mu\text{sec}$ and used to quantize the count pulses. Hence, as we see from Fig. 9, the quantized count pulses begin $1.5 \mu\text{sec}$ after the clock pulses which formed them and end about $1 \mu\text{sec}$ later. Thus the

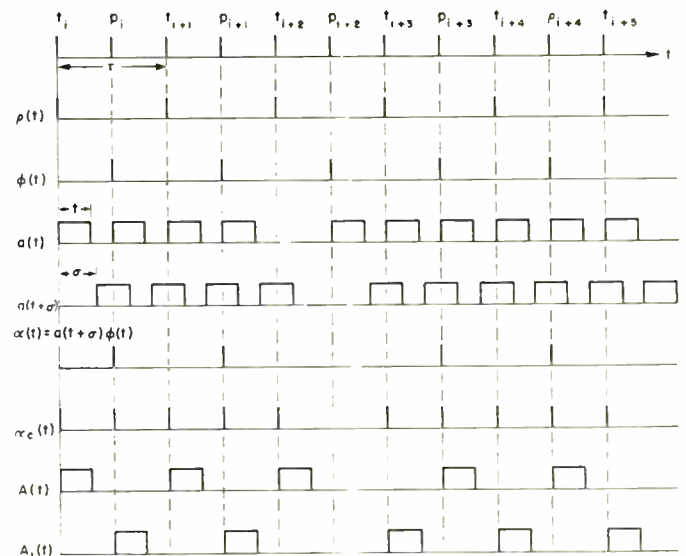

Fig. 9—The timing sequence of the two-stage binary counter.

quantized clock pulse covers the time of the sample pulses complement. This assures positive inhibitor action in the same time sequence as is shown in Fig. 4.

While every count pulse is applied to the inhibitor of the first stage, only alternate count pulses are applied

to the inhibitor of the second stage, as is required in a binary counter. As shown in Fig. 8, this is accomplished in the quantizer of the second stage. A count pulse will be applied to the second inhibitor only if pulses are present at the B_1 gate output. Since the B_1 gate output exhibits pulses only after alternate count pulses, the desired result is obtained.

As is seen in Fig. 8, a single counter stage consists of a commutating ring, two gates, an inhibitor, and a quantizer, each of which uses one transistor, making a total of six transistors per stage. The requirements on the transistors are quite small. Virtually any transistor having an α of 2, or greater, and a collector reverse resistance of 25K, or greater, is acceptable. The maximum operating frequencies (sample pulse frequencies) are 1 mc and 4 mc for transistor types 1698 and 1734, respectively.

IV. THE LOGICAL NATURE OF THE PHASE-BISTABLE CIRCUIT AND ITS APPLICATION TO DIGITAL COMPUTERS

The phase-bistable flip-flop, as described in the previous sections, can be used to replace the amplitude-bistable flip-flop in synchronous digital computers. To show this fact it is necessary to verify that, after proper symbolic interpretation of the inputs and outputs of the phase-bistable flip-flop and associated circuits, this device may be utilized to store one of the two symbols, 0 and 1, and its complement. Moreover, it is necessary that the state of the device may be changed as a function of its own and other states in synchronization with the phase-bistable flip-flop. For the purpose of generality, the specialized logic and notation described in the previous sections will not necessarily be adhered to.

From the standpoint of the symbolic action of the phase-bistable flip-flop, all pertinent voltage inputs and outputs may be regarded as having only two levels. Suppose the high level is denoted by 1 and the low level by 0; then each voltage under consideration is a two-valued or Boolean function $F(t)$ of the real parameter time, t .

TABLE I

$F(t)$	$G(t)$	$F'(t)$	$F(t)+G(t)$	$F(t)G(t)$	$F(t) \oplus G(t)$
0	0	1	0	0	0
0	1	1	1	0	1
1	0	0	1	0	1
1	1	0	1	1	0

Table I defines a unary and three binary operations of the Boolean functions, $F(t)$ and $G(t)$. In the terminology of logic or computing machinery, the product operation may be termed the "and," or gating operation; the sum $+$ is the "or," or mixing operation; and the sum \oplus is the exclusive "or," or binary sum operation. The prime

stands for negation or complementation. It may be shown that these operations are related to one another by the following identities:

$$\begin{aligned}
 F + G &= F \oplus G \oplus FG \\
 F' + G &= F'G + FG' \\
 F' &= F \oplus I \quad \text{and} \\
 F \oplus F &= 0.
 \end{aligned}
 \tag{1}$$

Electronically, the gating and mixing operations between Boolean functions may be performed by many well-known methods, utilizing unidirectional current elements.

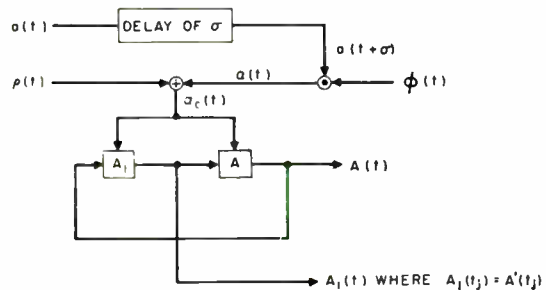

Fig. 10—Block diagram of the phase-bistable flip-flop.

Fig. 10 is a block diagram of the phase-bistable flip-flop with its pertinent inputs and outputs. Circles in the figure with a dot denote "and" gates and the circles with plus signs denote mixers, or "or" gates. Fig. 11 illustrates the timing diagram of the various inputs and outputs of the phase-bistable flip-flop.

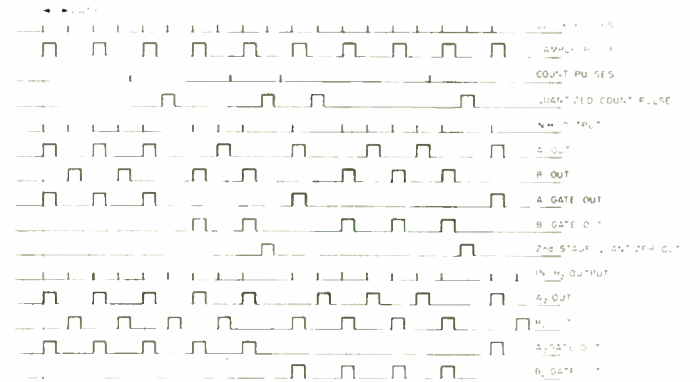

Fig. 11—Timing diagram of various inputs and outputs of the phase-bistable flip-flops.

The pulse function $\rho(t)$ is composed of read pulses at the discrete times t_j , and the pulse function $\phi(t)$ is composed of write pulses at the intermediate discrete times p_j . The rectangular wave input function $a(t)$ consists of a train of pulses of width ϵ with leading edges only at the times t_j and p_j ($j=0, 1, 2, \dots$). The pertinent information delivered by $a(t)$ occurs only within the time intervals $[t_j, t_j+\epsilon]$ or, more particularly, at the discrete time t_j since $a(t) = a(t_j)$ for t in the left closed interval $[t_j, t_j+\epsilon]$.

The function $a(t)$ is delayed or translated by the time σ in such a manner that the time points t_j are contained in the intervals $(t_j + \sigma, t_j + \epsilon + \sigma)$. In other words, the information pulses in the delayed input function $a(t + \sigma)$ overlap the nearest write pulses of $\phi(t)$.

The pulse function $a(t)$ is the product of $a(t + \sigma)$ and $\phi(t)$. An information pulse in $a(t + \sigma)$ allows a write pulse in $a(t)$ and the lack of an information pulse inhibits a write pulse to appear in $a(t)$. In other words, if $a(t_j) = I$, a write pulse occurs in $a(t)$ at time p_j , and if $a(t_j) = O$, no write pulse occurs in $a(t)$ at time p_j .

The pulse function $a_c(t)$ is $a(t)$ mixed with the read pulse function $\rho(t)$, or

$$a_c(t) = a(t) + \rho(t).$$

The action of $a_c(t)$ on the phase-bistable circuit is illustrated in Figs. 10 and 11. It is evident from Fig. 11 that if the time point t is in the interval $[t_j, t_j + \epsilon)$, that

$$A_1(t) = A'(t)$$

or, more particularly, at the discrete times t_j ,

$$A_1(t_j) = A'(t_j). \tag{2}$$

The state of the output of the phase-bistable flip-flop in the intervals $[t_j, t_j + \epsilon)$ is the pertinent state of the flip-flop, that is, the information to be read or to be used to control other phase-bistable flip-flops or itself. The action of the phase-bistable flip-flop at the pertinent discrete times t_j in terms of the input function is given in Table II.

TABLE II

$a(t_j)$	$A(t_j)$	$A(t_{j+1})$
O	O	I
O	I	O
I	O	O
I	I	I

By Table II and (2), one obtains

$$\begin{aligned} A(t_{j+1}) &= A(t_j)a(t_j) + A'(t_j)a'(t_j) \\ &= A(t_j) \oplus a'(t_j) \end{aligned} \tag{3}$$

as the time difference equation for the output function of the phase-bistable flip-flop in terms of the input function $a(t)$ at the discrete times t_j . By (1) equation (3) may be solved for $a(t_j)$, obtaining

$$\begin{aligned} a'(t_j) &= A(t_{j+1}) \oplus A(t_j) = \Delta A(t_j), \text{ or} \\ a(t_j) &= (\Delta A(t_j))'. \end{aligned} \tag{4}$$

Equation (3) with initial condition $A(t_0)$ may be called the change equation of the phase-bistable flip-flop at the discrete times t_j .

To illustrate a synthesis of computers using the phase-bistable flip-flop and its change equation (4), consider Table III, the table of desired operations for a clock counter having a cycle of three.

TABLE III

$A(t_j)$	$B(t_j)$	$A(t_{j+1})$	$B(t_{j+1})$	$\Delta A(t_j)$	$\Delta B(t_j)$
O	O	O	I	O	I
O	I	I	O	I	I
I	O	O	O	I	O
I	I	O	O	I	I

From the table and the rules of Boolean algebra,

$$\begin{aligned} \Delta A(t_j) &= A(t_j) + B(t_j) \\ \Delta B(t_j) &= A'(t_j) + B(t_j). \end{aligned} \tag{5}$$

From (2) and (5) the necessary inputs to two phase-bistable flip-flops to accomplish this purpose are

$$\begin{aligned} a(t) &= A_1(t)B_1(t) \\ b(t) &= A(t)B_1(t). \end{aligned} \tag{6}$$

The block diagram illustrating the design of this counter with respect to (6), is given in Fig. 12 where the large rectangles are assumed to contain everything in Fig. 10 except inputs and outputs. It should be noted that the output gates shown in Fig. 8 are only necessary in this counter when it is desirable to read the contents of the counter.

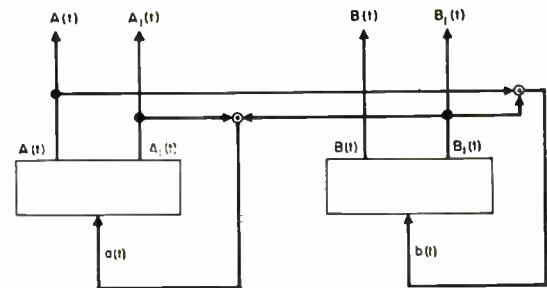

Fig. 12—Block diagram of a clock-counter design having a cycle of three.

From this example and the preceding analysis, it is evident that a large-scale digital computer may be constructed which utilizes only phase-bistable flip-flops as its bistable elements. This is true in particular due to the fact (6) is closely related to the change equation of the usual one-input vacuum tube flip-flop at its discrete change times t_i . This problem is discussed elsewhere.³⁻⁸

³ Garrett Birkhoff, "Lattice Theory," Am. Math. Society Coll. Pub.; 1948.

⁴ I. S. Reed, "Some Mathematical Remarks on the Boolean Machine," Tech. Report Lincoln Lab., Mass. Inst. Tech.; December 19, 1951.

⁵ I. S. Reed, "Boolean Function of a Real Variable and its Application to a Model of the Digital Computer and Discrete Probability" (forthcoming Lincoln Lab. Report, Mass. Inst. Tech.).

⁶ R. E. Sprague, "Techniques in the Design of Digital Computers," Assn. of Computing Machinery; March, 1951.

⁷ R. C. Jeffrey and I. S. Reed, "The Use of Boolean Algebra in Logical Design," Engineering Note E-458-1, Digital Computer Lab., Mass. Inst. Tech.; April 28, 1952.

⁸ R. C. Jeffrey and I. S. Reed, "Design of a Digital Computer by Boolean Algebra," Engineering Note E-462, Digital Computer Lab., Mass. Inst. Tech.; May 20, 1952.

Transient Analysis of Junction Transistor Amplifiers*

W. F. CHOW AND J. J. SURAN, ASSOCIATE, IRE

Summary—An analysis of the transient response of transistor amplifiers necessitates the consideration of transit-time effects. Transit-time phenomena may be represented by a transmission line in the equivalent circuit of a transistor. However, such an equivalent circuit would lead to unwieldy algebraic expressions in network analysis. This paper illustrates an approximation technique which results in simple Laplace transforms in the transient-response calculations for junction-transistor amplifiers. Theoretical results based upon this analysis are in good agreement with experiment.

INTRODUCTION

THE MAJOR SOURCES of transient behavior in transistor amplifiers are considerably different from those in vacuum-tube amplifiers. Vacuum-tubes, operating in a frequency region below the uhf band, are limited in their transfer characteristics by the existence of interelectrode capacitances. These capacitances are functions of the electrode geometry as well as the operating point of the tube. As the operation of the tube approaches the uhf region, transit-time effects will be encountered. Transit-time considerations will materially change the frequency and transient response analysis of vacuum-tube circuits. However, transit-time effects are negligible for most audio and radio frequency applications of vacuum tubes.

In a vacuum tube, electrons travel between the cathode and plate by virtue of an electric-field gradient. Evacuation of air in the space between the cathode and plate minimizes obstruction of the electron path. Modulation of the electric-field gradient causes a signal to appear in the plate circuit. In a transistor, however, carriers travel between the emitter and collector by virtue of a concentration, rather than electric-field, gradient. For *n-p-n* type transistors, the carriers are electrons and for *p-n-p* types, the carriers are holes. The paths of the carriers are through the base region of the transistor, and hence the carrier paths are obstructed by the atomic structure of the semiconductor and impurity materials which comprise the base layer. Modulation of the concentration gradient causes a signal to appear in the collector circuit.

Carriers move through the base of a transistor by a diffusion process and transit-time effects are of considerable importance even at low frequencies. In frequency and transient-response analysis, this fact constitutes the major difference between vacuum tubes and transistors. This paper will show how the transit-time phenomena in transistors may be taken into account in the equivalent circuit of the transistor, and how such an equivalent circuit may be simplified for practical transient-response calculations. Although the analysis

presented here has been restricted to junction transistors, it is applicable to point-contact types also, insofar as the latter approximate the junction units in fundamental physical behavior. The circuit analysis is further restricted to small-input signals, i.e. to transistors operating as linear (Class A) amplifiers.

DERIVATION OF THE EQUIVALENT CIRCUIT

If the effects of carrier transit in the base region of a transistor are completely neglected, the low-frequency ac equivalent circuit of the transistor may be represented by a *T*-network such as illustrated in Fig. 1(a).

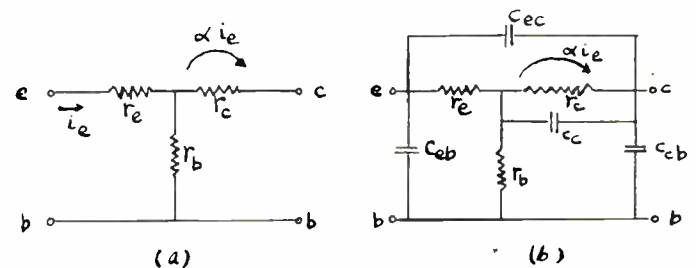

Fig. 1—AC equivalent circuit of a transistor neglecting diffusion effects of the carriers.

(The equivalent π configuration may also be used.) The circuit shown is for a grounded-base amplifier where r_e , r_b and r_c are the ac resistance of the emitter, base, and collector respectively. α is the current-amplification factor and i_e and i_c are, respectively, the emitter and collector currents. Still neglecting the effects of carrier diffusion through the base region, the circuit of Fig. 1(a) may be modified to include equivalent capacitances which result from the transistor geometry. Such an equivalent circuit is illustrated in Fig. 1(b) where C_{eb} , C_{ec} , C_{cb} are the emitter-base, emitter-collector and collector base capacitances respectively. C_c is the collector capacity, and is due to the high-resistance barrier between the base and collector regions. In currently-available junction transistors, the effects of the interterminal capacitances, C_{eb} , C_{ec} and C_{cb} are usually negligible compared to the effects of C_c and carrier diffusion. Consequently, the interterminal capacitances will be neglected in the ensuing analysis. The collector capacitance, C_c is a function of the collector voltage, but may be considered constant for a fixed operating point and for small-signal analysis.¹⁻³

¹ R. L. Wallace and W. J. Pietsenpol, "Some circuit properties and applications of *n-p-n* transistors," Proc. I.R.E., vol. 39, p. 753; July, 1951.

² J. S. Saby, "Fused impurity *p-n-p* junction transistors," Proc. I.R.E., vol. 40, p. 1359; Nov., 1952.

³ R. F. Shea et al., "Principles of Transistor Circuits," John Wiley and Sons, Inc., New York, N. Y.; to be published, 1953.

* Decimal classification: R282.12. Original manuscript received by the Institute, February 2, 1953. Presented at the 1953 IRE Convention, New York, N. Y.

† Electronics Laboratory, General Electric Co., Syracuse, N. Y.

In order that the equivalent circuit of Fig. 1(b) can be modified to include the transit-time effects of carrier movement through the base, a study of the basic-diffusion equation must be made. From the diffusion equation, it may be shown that the current amplification factor, α , is given by³⁻⁶

$$\alpha(j\omega) = \frac{i_c}{i_e}(j\omega) = \operatorname{sech} \frac{W}{L_m} \sqrt{1 + j\omega T_m} \quad (1)$$

where W is the width of the base region, L_m is the carrier-diffusion length and T_m is the carrier lifetime. A mathematical analogue to (1) is found in the current-transfer function of a distributed-parameter RC transmission line. Thus, from the transmission line transfer characteristic

$$\frac{i_o}{i_i}(j\omega) = \operatorname{sech} \sqrt{Y(j\omega)Z(j\omega)}, \quad (2)$$

it is apparent that the diffusion process in the base may be represented by a transmission-line equivalent circuit such as illustrated in Fig. 2. When the transmission-line

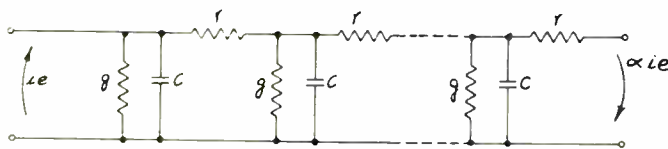

Fig. 2—Transmission-line analogue of (1).

analogue of the carrier-diffusion process is included in the equivalent circuit for the transistor, the circuit of Fig. 3 is obtained. This is the basic-equivalent circuit from which a simplified transient-analysis technique will be derived.

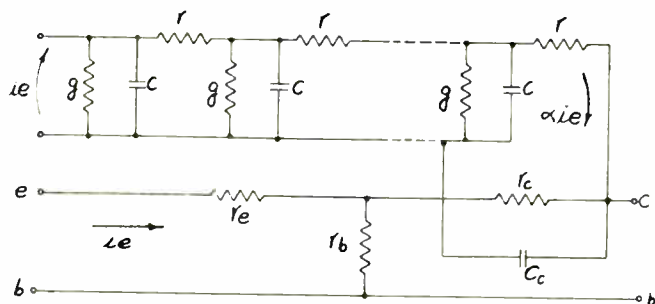

Fig. 3—Basic ac transistor-equivalent circuit.

It should be noted that (1) may be employed directly in the solution of transient-response problems whenever the effects of circuit elements external to the transistor can be neglected. In particular, this applies to transistor amplifiers having small load resistances.

⁴ W. Shockley, "Electrons and Holes in Semiconductors," D. Van Nostrand Co., Inc., New York, N. Y.; 1950.

⁵ W. Shockley, M. Sparks and G. K. Teal, "P-n junction transistors," *Phys. Rev.*, no. 83, Section IX, p. 161; 1951.

⁶ R. L. Pritchard, "Frequency variations of current-amplification factor for junction transistors," *Proc. I.R.E.*, vol. 40, p. 1476; Nov. 1952.

Equation 1 has been solved for a step in emitter current, but the results are sufficiently involved to require omission from this paper.⁷

The propagation of a pulse by a transmission line is characterized by two basic effects: dispersion and delay. Dispersion refers to the attenuation and phase shifting of certain frequency components in the transmitted signal by the selective character of the transmission line, and leads to a "spreading out" in time of the pulse wave front. Delay may be considered as due to the finite phase-velocity property of the transmission line, and is manifested by a time lag between the input and output signals. Both dispersion and delay are intrinsic properties of the transient response of transistor amplifiers. These properties may be treated separately by a circuit approximation to the transmission line analogue as shown in Fig. 2. For example, only one section of the line may be used to represent the dispersion effect, and the remainder of the line may be replaced by an ideal delay line to represent the delay property. The ideal delay line has the transfer characteristic

$$\frac{i_o}{i_i}(j\omega) = e^{-Kj\omega} \quad (3)$$

where K is the delay time (seconds). Using the approximate representation, the transmission line of Fig. 2 may be illustrated as indicated in Fig. 4. The current-

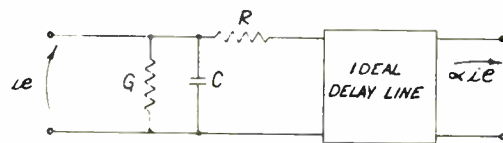

Fig. 4—Delay-line approximation of the transmission-line analogue shown in Fig. 2.

transfer function of this network is readily shown to be

$$\frac{i_o}{i_e}(j\omega) = \frac{1}{1 + GR} \frac{e^{-Kj\omega}}{1 + \frac{RC}{1 + GR}j\omega} \quad (4)$$

At very low frequencies ($\omega \rightarrow 0$), (4) approaches the value $1/(1 + GR)$, which will be denoted by α_0 , the low-frequency current amplification factor. The frequency at which the current ratio given by (4) is 3 db below α_0 is the α -cutoff frequency, f_{α_0} . The time-constant corresponding to f_{α_0} will be denoted by T_α . Equation 4 may, therefore, be written as

$$\frac{i_o}{i_e}(j\omega) = \alpha = \alpha_0 \left[\frac{e^{-Kj\omega}}{1 + j\omega T_\alpha} \right], \quad (5)$$

where

$$T_\alpha = \frac{1}{2\pi f_{\alpha_0}} \quad \text{and} \quad f_{\alpha_0} = \frac{1}{2\pi RC\alpha_0}$$

⁷ J. S. Schaffner and J. J. Suran, "Transient Response of the Grounded-Base Transistor Amplifier with Small-Load Impedance"; to be published.

For most junction transistors currently available, α_0 is very close to unity ($\alpha_0 > 0.9$). Hence, the conductance G in Fig. 4 is usually very close to zero (infinite resistance) and can be neglected in the equivalent circuit.

Using the delay-line approximation, the ac transistor-equivalent circuit illustrated in Fig. 3 is modified as shown in Fig. 5(a). Denoting the current ratio given

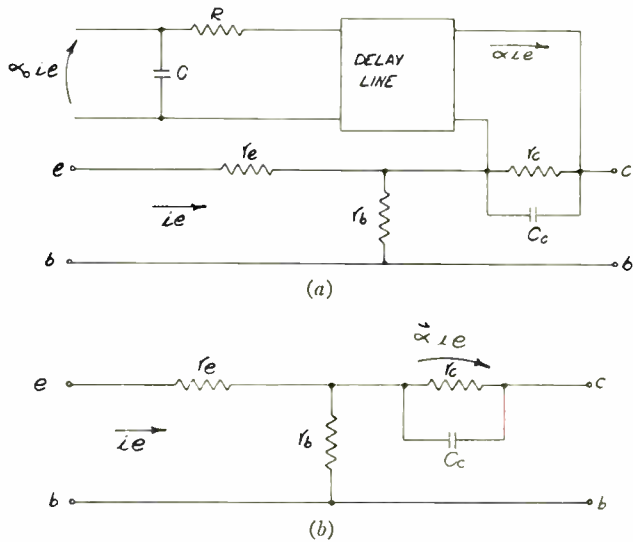

Fig. 5—AC delay-line approximate-equivalent circuit of the junction transistor.

by (5) as α , the equivalent circuit of Fig. 5(a) is redrawn as shown in Fig. 5(b). It is quite obvious that the circuit of Fig. 5 is a great deal simpler to deal with in circuit calculations than the transmission-line equivalent of Fig. 3. As will be borne out later, calculations based upon the delay-line approximate circuit are sufficiently close to experimental results to warrant the circuit's consideration in practical design problems.

FREQUENCY AND TRANSIENT RESPONSE CALCULATIONS

To illustrate the use of the equivalent circuit of Fig. 5 in transient-response calculations, consider the junction-transistor amplifier of Fig. 6(a). The voltage generator,

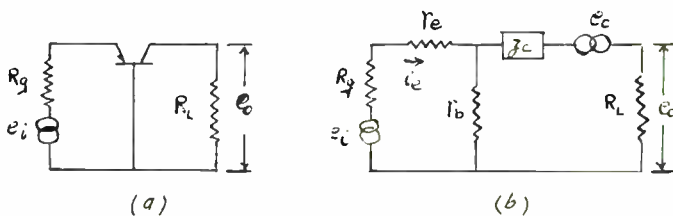

Fig. 6—AC circuit for grounded-base transistor amplifier.

of internal impedance R_g , generates a step voltage which is applied to the emitter of a grounded-base transistor amplifier terminated by a load resistance R_L . The voltage response, as measured across R_L will be determined from the equivalent circuit of Fig. 6(b). In Fig. 6(b), the current source αi_e of Fig. 5(b) has been converted to a voltage source, e_c , where

$$\vec{e}_c = \vec{\alpha} i_e Z_c \tag{6}$$

and Z_c is the parallel combination of r_c and C_c . Thus

$$Z_c = \frac{r_c}{1 + r_c C_c j\omega} = \frac{r_c}{1 + T_c j\omega} \tag{7}$$

The voltage transfer characteristic for the transistor amplifier circuit may be calculated from the Kirchhoff equations for the network of Fig. 6(b). In matrix form, these are

$$\begin{bmatrix} e_i \\ e_c \end{bmatrix} = \begin{bmatrix} (R_g + r_e + r_b) & (-r_b) \\ (-r_b) & (Z_c + R_L + r_b) \end{bmatrix} \begin{bmatrix} i_e \\ i_c \end{bmatrix} \tag{8}$$

When (8) is solved for i_c , it is found that the delay term $e^{-Kj\omega}$ appears in both the numerator and the denominator of the resulting expression. To simplify the transient calculation, it is desirable that the denominator of the transfer function be a polynomial in $(j\omega)$ and contain no $e^{-Kj\omega}$ term. This can be achieved if the delay term is expanded as

$$e^{-Kj\omega} = 1 - Kj\omega + \frac{(Kj\omega)^2}{2!} - \frac{(Kj\omega)^3}{3!} \dots \tag{9}$$

Since K is usually very small (of the order of $0.1 \mu s$ in junction transistors), all but the first three terms in (9) will be neglected. If this is done, the voltage-transfer function of the approximate equivalent circuit illustrated in Fig. 6(b) is given by

$$\frac{e_o}{e_i}(j\omega) = \frac{a_0 + a_1 j\omega + a_2 (j\omega)^2 + C_0 e^{-Kj\omega}}{b_0 + b_1 j\omega + b_2 (j\omega)^2} \tag{10}$$

The coefficient a_i, b_i, C_0 of (10) are, in terms of the circuit and transistor constants

$$a_0 = R_L r_b \tag{11a}$$

$$a_1 = R_L r_b (T_a + T_c) \tag{11b}$$

$$a_2 = R_L r_b T_a T_c \tag{11c}$$

$$C_0 = \alpha_0 R_L r_c \tag{11d}$$

$$b_0 = (R_g + r_e)(R_L + r_c + r_b) + r_b(R_L + r_c[1 - \alpha_0]) \tag{11e}$$

$$b_1 = (T_a + T_c)(r_b[R_g + r_e + R_L] + R_L[R_g + r_e]) + r_c T_a (r_b + r_e + R_g) + \alpha_0 K r_c r_b \tag{11f}$$

$$b_2 = T_a T_c [(R_g + r_e)(r_b + R_L) + R_L r_b] - \frac{1}{2} \alpha_0 r_c r_b K^2 \tag{11g}$$

An experimental transistor amplifier, of the type illustrated in Fig. 6, was built to test (10). As measured within an estimated accuracy margin of ± 20 per cent, the experimental circuit constants are as follows: $r_e = 30 \Omega, r_b = 200 \Omega, r_c = 600 K \Omega, \alpha_0 = 0.9, T_a = 10^{-6}$ sec., $T_c = 10^{-5}$ sec., $K = 0.5 \times 10^{-6}$ sec., $R_g = 50 \Omega, R_L = 10 K \Omega$. The voltage-transfer function derived experimentally is compared to that derived theoretically from (10) in Fig. 7. Since the bandwidth of the experimental curve is somewhat greater than the theoretical bandwidth, it may be expected that the theoretical transient-response

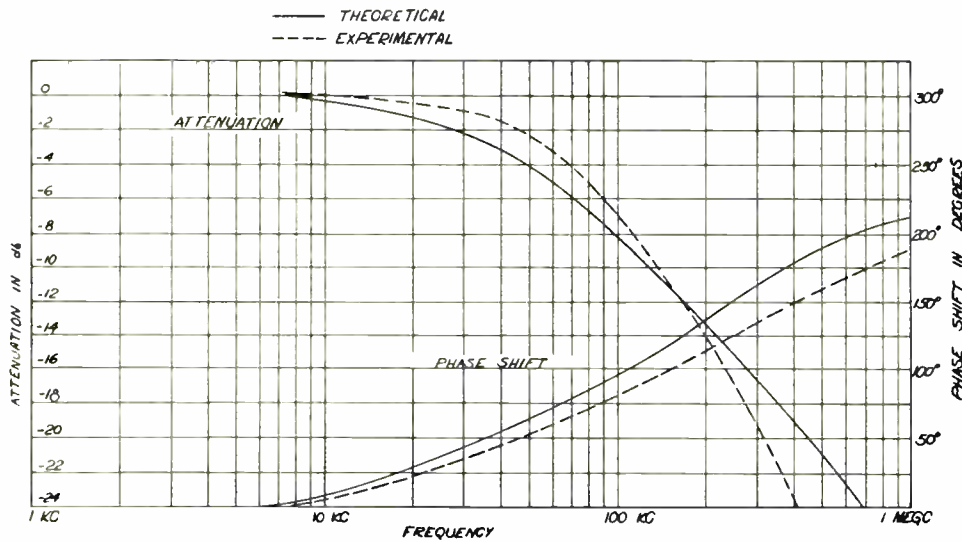

Fig. 7—Experimental and theoretical phase and attenuation characteristics.

calculation will lead to a conservative estimate of the physical response.

Transient-response analysis proceeds directly from (10). Assuming that the input voltage, e_i is a step function given by

$$e_i = \frac{1}{S}$$

where S is the Laplace operator (d/dt), (10) becomes, in terms of S

$$e_0(S) = \frac{a_0 + a_1S + a_2S^2}{S(b_0 + b_1S + b_2S^2)} + \frac{C_0e^{-KS}}{S(b_0 + b_1S + b_2S^2)} \quad (12)$$

The inverse transformation of the first term in (12) leads to a time function which is the approximate response of the equivalent circuit to the step input when the transistor is considered as a passive circuit, i.e., when \vec{e}_c is short-circuited. For good amplifiers, this term will be negligible. Inverse transformation of the second term in (12) results in

$$e_0(t) = \frac{C_0}{b_2A\Gamma} \left[1 + \frac{\Gamma e^{-A(t-K)} - Ae^{-\Gamma(t-K)}}{A - \Gamma} \right] \mu(t - K), \quad (13a)$$

where:

$$A, \Gamma = \frac{b_1}{2b_2} \mp \sqrt{\left(\frac{b_1}{2b_2}\right)^2 - \left(\frac{b_0}{b_2}\right)} \quad (13b)$$

Generally $\Gamma \gg A$; for this condition, (13a) becomes

$$e_0(t) = \frac{C_0}{b_2A\Gamma} [1 - e^{-A(t-K)}] \mu(t - K). \quad (14)$$

In (13a) and 14, $\mu(t - K)$ is a step function which is delayed in time, from the reference $t = 0$, by K seconds. Thus, the delay property of the transistor appears as a factor of the dispersion function, the latter being a

simple exponential in (14). Using (14), the theoretical transient response is compared to that obtained experimentally in Fig. 8. The same circuit and circuit constants are used here as were employed in the frequency-response calculations relating to (10). From (14), it is apparent that total rise time plus delay time T_R is

$$T_R = \frac{1}{A} + K. \quad (15)$$

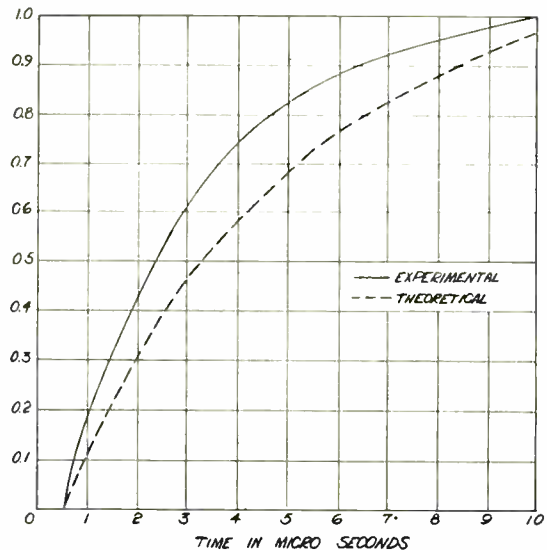

Fig. 8—Theoretical and experimental transient response.

Defining the response rise time, t_R , as simply $1/A$, Fig. 9 illustrates the variation of t_R with collector resistance, collector capacitance, μ , cut-off frequency and load resistance as calculated from (14). It should be cautioned that the curves illustrated in Fig. 9 are approximate relationships calculated for a specific case, and should therefore be referred to as indicative of trends rather than as references for universal calculations.

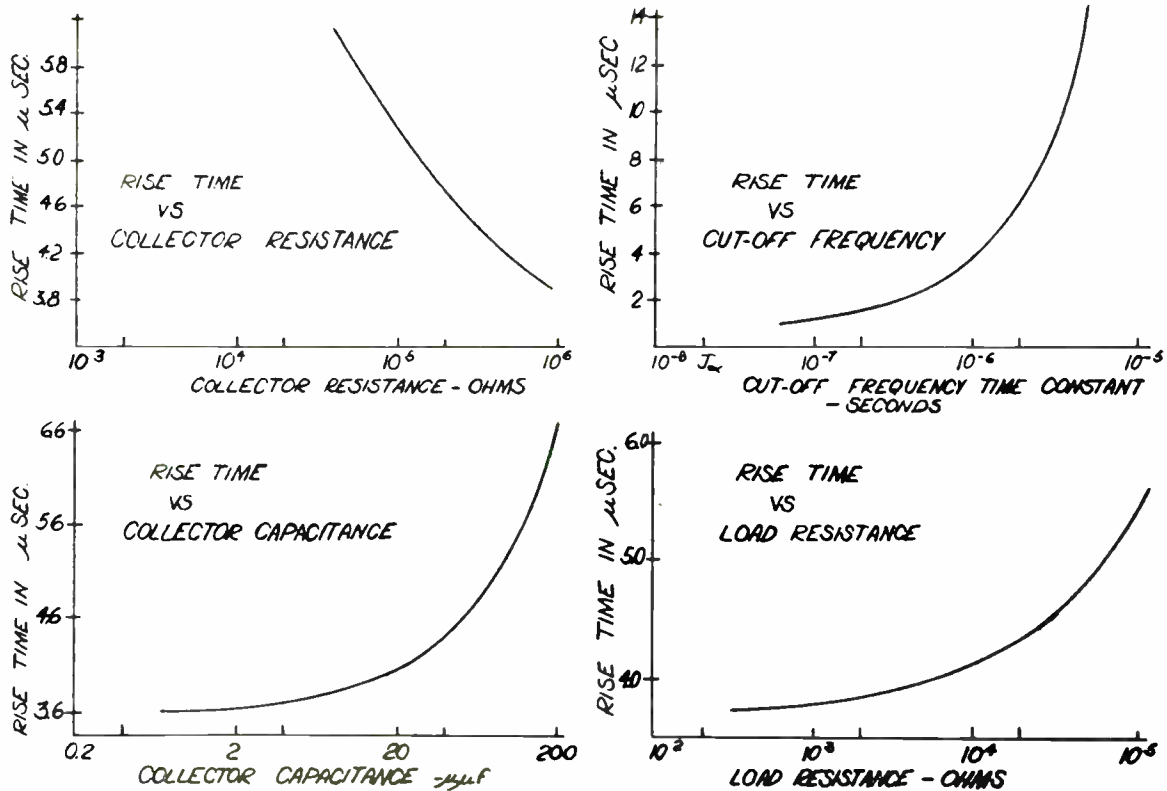

Fig. 9—Variation of rise time with several transistor parameters.

CONCLUSION

The equivalent circuit for a junction transistor may be modified by the inclusion of a transmission-line analogue for the representation of diffusion phenomena within the base region. Such an equivalent circuit may then be used for transient-response calculations. However, the resultant analysis would be so algebraically involved as to make the technique impractical for most design purposes. If the transmission line is replaced by a simple lumped-parameter R-C network in series with

an ideal delay line, an equivalent circuit will be obtained which is much more amenable to simple design calculations than transmission-line circuit. Calculations based on delay-line approximate circuit lead to conservative frequency-and-transient-response calculations. However, these are close enough to experimental results to justify design utility of delay-line equivalent circuit.

This work has been supported, wholly or in part, under Contract AF 33(600)-17793, which is sponsored jointly by the United States Air Force, Army and Navy.

A Graphical Spectrum Analyzer for Pulse Series*

H. P. RAABE†, ASSOCIATE, IRE

Summary—A general mathematical spectrum analysis of pulse series is discussed and applied to develop a slide-rule-type analyzer to give a pictorial presentation of the frequency spectrum. This method is very rapid and permits an overall evaluation of the spectrum. The analyzer, however, does not permit the determination of spectra for pulses having frequency modulation.

INTRODUCTION

IT IS THE PURPOSE of this paper to outline the theory, design, and use of a graphical spectrum analyzer which is similar to a slide rule and may be

used to determine the frequency spectra of infinite pulse series.

The computation of the frequency spectra for infinite pulse series requires many detailed calculations and familiarity with Fourier's Analysis. To make the work less difficult, some formula collections contain general formulas for different pulse shapes, so that the calculation of the spectral components is performed by ordinary algebra. However, in both cases, the evaluation takes time and lacks the advantage of pictorial presentation.

In order to develop a graphical method for analyzing various pulse shapes, it was necessary to set up a general problem in pulse-series spectra analysis to de-

* Decimal classification: R371.2. Original manuscript received by the Institute, July 21, 1952; revised manuscript received April 6, 1953.

† Aircraft Radiation Laboratory, Wright Air Development Center, Wright-Patterson Air Force Base, Dayton, Ohio.

termine the characteristics of the parameters. It was then necessary to determine the most suitable mechanical system which would satisfy the characteristics of the parameters and give adequate pictorial presentation of the spectra.

GENERAL MATHEMATICAL ANALYSIS

Fig. 1 shows the amplitude-time curve of a single pulse, $a_1(t)$. The pulse is characterized by the pulse shape and by a carrier. The pulse shape is defined by the envelope curve $a_0(t)$ for the positive amplitudes, while the carrier is defined by

$$c = c(t) = \cos(\omega_c t + \phi), \quad (1)$$

where $\omega_c = 2\pi f_c = 2\pi/T_c$ indicates the carrier frequency and $\phi = 2\pi u$ indicates the carrier-zero phase.

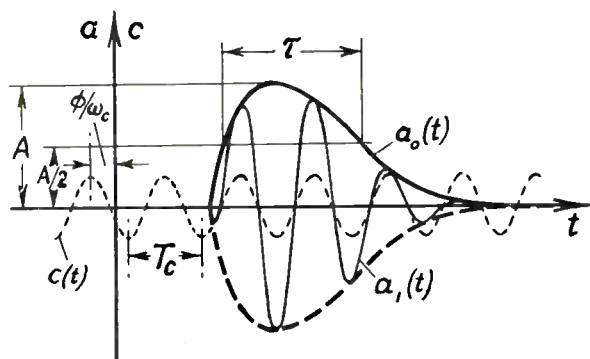

Fig. 1—The time function of a single pulse.

The pulse shape is arbitrary within the condition that the pulse area is finite, and that for any pulse shape two quantities can be defined: the absolute maximum amplitude A and the time difference τ between the first and last points in the pulse envelope having an amplitude $A/2$.

The spectrum of a single pulse is described by the Fourier inverse transformer

$$a_1(t) = \int_0^{\infty} [\alpha(\omega) \cos \omega t + \beta(\omega) \sin \omega t] d\omega. \quad (2)$$

The equation does not change when the spectrum is extended symmetrically over positive and negative frequencies and when $\alpha(\omega)$ is replaced by the even function $\alpha(\omega)/2$ and $\beta(\omega)$ is replaced by the odd function $\beta(\omega)/2$:

$$a_1(t) = \frac{1}{2} \int_{-\infty}^{\infty} [\alpha(\omega) \cos \omega t + \beta(\omega) \sin \omega t] d\omega. \quad (3)$$

The amplitude functions of the integral are defined by

$$\alpha(\omega) = \frac{1}{\pi} \int_{-\infty}^{\infty} a_1(t) \cos \omega t dt, \quad (4)$$

$$\beta(\omega) = \frac{1}{\pi} \int_{-\infty}^{\infty} a_1(t) \sin \omega t dt. \quad (5)$$

From the definition, above, it follows that

$$a_1(t) = a_0(t) \cdot c(t) = a_0(t) \cdot \cos(\omega_c t + \phi). \quad (6)$$

With this expression, (4) becomes

$$\alpha(\omega) = \frac{1}{2\pi} \int_{-\infty}^{\infty} a_0(t) \{ \cos [(\omega_c + \omega)t + \phi] + \cos [(\omega_c - \omega)t + \phi] \} dt. \quad (7)$$

This equation can be transformed into

$$\alpha(\omega) = \frac{1}{2\pi} \left\{ \cos \phi \int_{-\infty}^{\infty} a_0(t) [\cos(\omega_c + \omega)t + \cos(\omega_c - \omega)t] dt - \sin \phi \int_{-\infty}^{\infty} a_0(t) [\sin(\omega_c + \omega)t + \sin(\omega_c - \omega)t] dt \right\}. \quad (8)$$

Equation (5) can be developed in the same way, so that

$$\beta(\omega) = \frac{1}{2\pi} \left\{ \cos \phi \int_{-\infty}^{\infty} a_0(t) [\sin(\omega_c + \omega)t - \sin(\omega_c - \omega)t] dt + \sin \phi \int_{-\infty}^{\infty} a_0(t) [\cos(\omega_c + \omega)t - \cos(\omega_c - \omega)t] dt \right\}. \quad (9)$$

With (8) and (9) the Fourier integral according to (3) becomes

$$a_1(t) = \frac{1}{2\pi} \int_{-\infty}^{\infty} \frac{1}{2} \left\{ \cos \phi \int_{-\infty}^{\infty} a_0(t) [\cos(\omega_c + \omega)t + \cos(\omega_c - \omega)t] dt - \sin \phi \int_{-\infty}^{\infty} a_0(t) [\sin(\omega_c + \omega)t + \sin(\omega_c - \omega)t] dt \right\} \cos \omega t \cdot d\omega + \frac{1}{2\pi} \int_{-\infty}^{\infty} \frac{1}{2} \left\{ \cos \phi \int_{-\infty}^{\infty} a_0(t) [\sin(\omega_c + \omega)t - \sin(\omega_c - \omega)t] dt + \sin \phi \int_{-\infty}^{\infty} a_0(t) [\cos(\omega_c + \omega)t - \cos(\omega_c - \omega)t] dt \right\} \sin \omega t \cdot d\omega. \quad (10)$$

This equation is made up of two integrals over ω which are symmetrical with respect to $\omega=0$. This can be seen by assuming that the integration is first taken over $\omega < 0$. In this case the first trigonometrical terms within the square brackets would be equal to the second terms taken over $\omega > 0$ and vice versa. Therefore, the second set of terms can be substituted for the first set so that

$$a_1(t) = \frac{1}{2\pi} \int_{-\infty}^{\infty} \left[\cos \phi \int_{-\infty}^{\infty} a_0(t) \cos(\omega_c - \omega)t dt - \sin \phi \int_{-\infty}^{\infty} a_0(t) \sin(\omega_c - \omega)t dt \right] \cos \omega t \cdot d\omega$$

$$\begin{aligned}
 & - \frac{1}{2\pi} \int_{-\infty}^{\infty} \left[\cos \phi \int_{-\infty}^{\infty} a_0(t) \sin (\omega_c - \omega) t dt \right. \\
 & \left. + \sin \phi \int_{-\infty}^{\infty} a_0(t) \cos (\omega_c - \omega) t dt \right] \sin \omega t \cdot d\omega. \quad (11)
 \end{aligned}$$

By elementary transformation this equation becomes

$$\begin{aligned}
 a_1(t) = & \frac{1}{2\pi} \int_{-\infty}^{\infty} \left[(\cos \phi \cdot \cos \omega t - \sin \phi \cdot \sin \omega t) \right. \\
 & \cdot \int_{-\infty}^{\infty} a_0(t) \cos (\omega_c - \omega) t \cdot dt \\
 & - (\sin \phi \cdot \cos \omega t + \cos \phi \cdot \sin \omega t) \\
 & \left. \cdot \int_{-\infty}^{\infty} a_0(t) \sin (\omega_c - \omega) t \cdot dt \right] d\omega, \quad (12)
 \end{aligned}$$

and further

$$\begin{aligned}
 a_1(t) = & \frac{1}{2\pi} \int_{-\infty}^{\infty} \left[\cos (\omega t + \phi) \int_{-\infty}^{\infty} a_0(t) \cos (\omega - \omega_c) t \cdot dt \right. \\
 & \left. + \sin (\omega t + \phi) \int_{-\infty}^{\infty} a_0(t) \sin (\omega - \omega_c) t dt \right] d\omega. \quad (13)
 \end{aligned}$$

Regarding the integral of (7) and the corresponding equation for $\beta(\omega)$ it is evident that they mean an area of the dimension amplitude times time which varies with frequency. Therefore, the integral is proportional to the product $A \cdot \tau$. If the substitutes

$$t = \tau \cdot p \quad \text{and} \quad a_0(t) = A \cdot b_0(p) \quad (14)$$

are applied in (7), this equation becomes

$$\begin{aligned}
 \alpha(\omega) = & \frac{1}{2\pi} A \cdot \tau \int_{-\infty}^{\infty} b_0(p) \{ \cos [(\omega_c + \omega)\tau p + \phi] \\
 & + \cos [(\omega_c - \omega)\tau p + \phi] \} dp. \quad (15)
 \end{aligned}$$

In this equation $b_0(p)$ represents the function of the normalized pulse shape with the unit absolute-amplitude and the unit half-amplitude pulse length. Both units are dimensionless. Hence, the function $b_0(p)$ is identical for all rectangular, Gaussian and other pulses, respectively, and characterizes the pulse type. Also the integral term in (15) keeps the same value for all pulses of the same type, if $\omega_c \tau$ and $\omega \tau$ are of the same value.

Accordingly, (13) can be expressed as

$$\begin{aligned}
 a_1(t) = & A\tau \int_{-\infty}^{\infty} \left[\cos (\omega t + \phi) \right. \\
 & \cdot \int_{-\infty}^{\infty} \frac{1}{2\pi} b_0(p) \cos (\omega - \omega_c)\tau p \cdot dp \\
 & + \sin (\omega t + \phi) \\
 & \left. \cdot \int_{-\infty}^{\infty} \frac{1}{2\pi} b_0(p) \sin (\omega - \omega_c)\tau p \cdot dp \right] d\omega, \quad (16)
 \end{aligned}$$

where the two integrals over p are functions, y_c and y_s , of $(\omega - \omega_c)\tau$, which vary only with the pulse type, so that the equation can also be expressed as

$$a_1(t) = A\tau \int_{-\infty}^{\infty} [y_c \cos (\omega t + \phi) + y_s \sin (\omega t + \phi)] d\omega. \quad (17)$$

The two wave components of the amplitudes y_c and y_s can be combined in a single wave so that

$$\left. \begin{aligned}
 a_1(t) = & A\tau \int_{-\infty}^{\infty} y \cos (\omega t + \phi + \gamma) d\omega, \\
 \text{where} & \quad v = \sqrt{y_c^2 + y_s^2} \quad \text{and} \quad \gamma = \arctan \frac{y_c}{y_s}.
 \end{aligned} \right\} \quad (18)$$

If the pulse type is unchanged but the position of the pulse envelope in time is varied by an amount p_r , $b_0(p)$ as in (16) would become $b_0(p + p_r)$. Consequently, the integrals y_c and y_s would become functions of p_r . If these functions constitute a set of sine and cosine function of p_r , the envelope of the amplitude spectrum, y , would be independent of the position of the pulse. In order to prove that this is the case, it may be noted that the variation of the pulse envelope position results from two successive variations. In the first step the pulse as a whole is shifted in time by $t_v = \tau p_r$. This will not change y but it will increase the phase of the waves by ωt_v . In the second step the phase of the carrier is shifted back to the original position by the amount $-\omega_c t_v$. As ϕ indicates in (16), the carrier phase does not affect even the time integrals y_c and y_s . Therefore, it can be concluded that the spectrum envelope is independent of the position of the pulse envelope in time, but the time information is preserved in the phase of the spectral components.

It may be noted that the finite energy of a single pulse is distributed over the spectrum. This means that the amplitude of a wave of a particular frequency is infinitely small. The combined effect of a pulse series, in which every pulse differs by the time of occurrence and phase of the carrier relative to a carrier having zero amplitude and positive slope at the time equal to zero, can be described by superposition of the amplitudes with regard to phase. Since the amplitude curve is the same for all pulses, the factor of reinforcement can be obtained from the phase condition alone. For an infinite series of pulses, waves of discrete frequencies may result which have a finite amplitude.

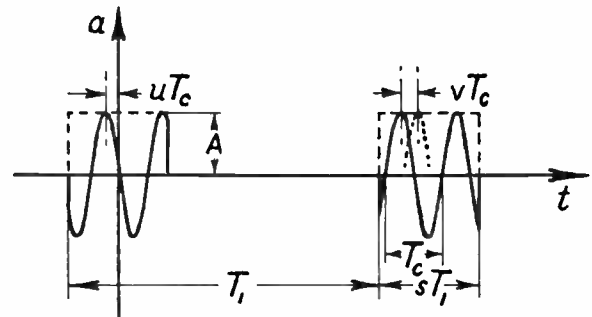

Fig. 2—Example of a pulse series.

If the pulses follow periodically in the distance T_1 and if the carrier phase proceeds from pulse to pulse by a constant phase change $2\pi v$ as Fig. 2 shows, the arguments of the pulses No. q and No. $(q+1)$ would be

$$\arg_q = \omega [t - (q - 1)T_1] + \phi + (q - 1)2\pi v, \quad (19)$$

$$\arg_{(q+1)} = \omega [t - qT_1] + \phi + q \cdot 2\pi v. \quad (20)$$

The difference of both is

$$\arg q - \arg_{(q+1)} = \omega T_1 - 2\pi v = \frac{\omega}{\omega_1} 2\pi - 2\pi v. \quad (21)$$

Since the difference does not depend on q , the reinforcement condition for the infinite series becomes

$$2\pi \frac{\omega}{\omega_1} - 2\pi v = 2\pi n, \quad n = 0, \quad \pm 1, \quad \pm 2 \dots \quad (22)$$

from which

$$\omega = (n + v)\omega_1. \quad (23)$$

This result means that a line spectrum takes the place of the continuous spectrum. The distance of the lines equals ω_1 while the first line ($n=0$) lies over $v\omega_1$.

For the infinite pulse series the complete equation can be stated similarly to (17). It is advantageous to replace τ by

$$\tau = sT_1 = \frac{2\pi s}{\omega_1} \quad (24)$$

where s is a dimensionless factor. In place of the frequency integral there is now a summation. Thus, the equation for infinite pulse series becomes

$$a(t) = As \sum_{n=-\infty}^{n=+\infty} \{ V_c \cdot \cos [(n + v)\omega_1 t + \phi] + V_s \cdot \sin [(n + v)\omega_1 t + \phi] \}. \quad (25)$$

The following conclusions can now be stated:

(a) Any pulse represents a carrier of the frequency ω_c , and the zero phase ϕ . The amplitude of the carrier is determined by some time function.

(b) The amplitude time function can be characterized by the absolute maximum amplitude A , the time difference between the extreme points of the amplitude $A/2$ and by the normalized pulse shape. The integral of this function must be finite.

(c) The normalized pulse shape represents a pulse type; e.g., rectangular pulse, Gaussian pulse, and so forth.

(d) A pulse series is made up of a periodical succession of pulses of the same type, absolute maximum, mean length and carrier frequency. The repetition time is T_1 so that the repetition frequency is defined by

$$\omega_1 = 2\pi f_1 = \frac{2\pi}{T_1}.$$

The carrier phase changes from pulse to pulse by the constant rate $2\pi v$. The mean pulse length is related to the repetition time by the quantity

$$s = \tau/T_1.$$

(e) The pulse series can be described by a discrete line spectrum. The frequencies of these are lines

$(n+v)\omega_1$, where $n=0, \pm 1, \pm 2 \dots$ represents the order of the line.

(f) The relative amplitude of the spectrum is determined by two different functions for the cosine and sine components and has the same shape for all pulses of the same type, when plotted against an $\omega \cdot s$ scale.

(g) The zero phase of the carrier appears as zero phase of all spectrum components.

(h) The amplitude function of the cosine components is an even function, while the amplitude function of the sine components is an odd one.

(i) The center of the amplitude functions is placed over the $\omega_0 \cdot s$ point.

(j) The absolute amplitude of the spectrum differs from the relative amplitude by the factors A and s .

The general analysis of repeated pulses shows that only two graphical elements are necessary in order to present the spectrum. The first element is the relative amplitude curve which covers all problems involving the same normalized-pulse shape. This means that for any normalized-pulse shape the proper relative-amplitude curve or spectrum envelope must be available. The second element is an array of lines which intersect the spectrum envelope and represent the distribution of contained frequencies. Both elements are shown in Fig. 3, which shows the line spectrum for the pulse described in Fig. 2. Therefore, the spectrum envelope belongs to a rectangular time envelope or pulse type. The lengths of the lines within the curve equal the relative amplitude of the indicated frequencies. However, in order to match all variations of s, ω_1, ω_c and v the separation of the lines as well as the position of the lines with respect to the envelope should be variable.

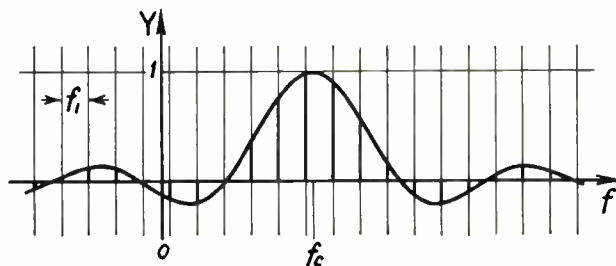

Fig. 3—Spectrum of the pulse series of Fig. 2 represented by a family of parallel lines and the envelope curve for rectangular pulses.

The variation of the separation of the lines can be provided by convergent lines if the envelope is moved towards the center of convergence or back. However, as long as the frequency scale is straight, the convergent lines will intersect this scale at different angles. This intersection can be made at right angles by a distorted envelope curve, so that the particular amplitude of a spectral line can be measured along the converging lines. But the second requirement provides the possibility of shifting the envelope across the lines. This means that the frequency scale should intersect the family of lines at a constant angle e.g., 90° . Therefore, the frequency

scale can no longer be a straight line. The only curve which can be shifted along its own path is the circle or, in general, a curve with constant radius of curvature, which includes the straight line.

Thus, two conditions have arisen which lead to two different solutions. The first condition means: the family of lines divides a circle into equal separations, while the second condition means: the family of lines intersects a circle at right angles. Since both conditions apply for any position of a circle, when moved towards the center of convergence, the family of curves consists of curves of the same shape, just displaced by a certain amount towards the center of convergence.

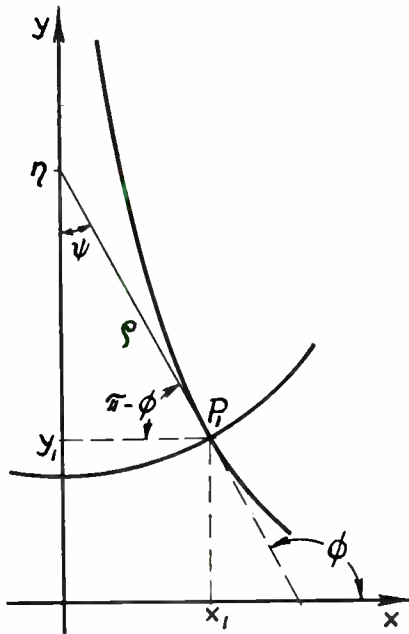

Fig. 4—A single line of a family of convergent lines.

Fig. 4 shows a single line of the family with the coordinates x and y and the circle with the radius ρ . The center of the circle lies at $x=0, y=\eta$. The first condition can be expressed by the differential equation

$$\frac{d\psi}{d\eta} = -K\psi \tag{26}$$

and means that any separation on the circle varies at a logarithmic rate. The integration of (26) leads to

$$\log_e \psi = -K\eta + \log_e C_c \tag{27}$$

or

$$\eta = \frac{1}{K} \log_e \frac{C_c}{\psi} \tag{28}$$

From the equation of the circle follows

$$y = \eta - \sqrt{\rho^2 - x^2}, \tag{29}$$

and

$$\psi = \arcsin \frac{x}{\rho} \tag{30}$$

With these expressions for y and ψ (28) becomes

$$y = \frac{1}{K} \left(\log_e \frac{C_c}{\arcsin \frac{x}{\rho}} \right) - \sqrt{\rho^2 - x^2} \tag{31}$$

and describes a curve which may be called logarithmic cycloid. The integration constant C_c has to fit the boundary condition for any particular line.

The second condition which provides the intersection angles of 90° means that the radius of the circle is tangent with the line. This can be expressed by the differential equation

$$\frac{dy}{dx} = \tan \phi = -\tan(\pi - \phi) = -\frac{\sqrt{\rho^2 - x^2}}{x} \tag{32}$$

The integral of (32) is

$$y = -\int \frac{\sqrt{\rho^2 - x^2}}{x} dx, \tag{33}$$

the solution of which is

$$y = \rho \left(\log_e C_t \frac{\rho + \sqrt{\rho^2 - x^2}}{|x|} \right) - \sqrt{\rho^2 - x^2} \tag{34}$$

and describes the tractrix.

For small x the logarithmic cycloid approaches the function

$$y = \frac{1}{K} \left(\log_e \frac{\rho C_c}{x} \right) - \rho, \tag{35}$$

while the tractrix approaches the function

$$y = \rho \left(\log_e \frac{2\rho C_t}{x} \right) - \rho. \tag{36}$$

If K and C_t are chosen as

$$K = 1/\rho \tag{37}$$

and

$$C_t = C_c/2 = C/2 \tag{38}$$

both (35) and (36) have the same form

$$y = \rho \left(\log_e \frac{\rho C}{x} \right) - \rho. \tag{39}$$

Fig. 5 presents the curves according to the three functions of (31), (34), and (39). They show that the tractrix and the logarithmic cycloid remain very close together up to $x=\rho/2$. Since an error with regard to the first condition requiring equal separations would cause a greater error in the amplitude of the spectral lines, the logarithmic cycloid is preferable.

As mentioned above, all logarithmic cycloids differ only by the integration constant C or by a certain displacement in the direction of the y axis which points to the center of convergence. On the other hand, all lines of the family differ by the $\arcsin x/\rho$. According to the first condition the equation can be stated

$$\arcsin \frac{x}{\rho} = \mu \cdot \beta_1, \quad \mu = 0, \pm 1, \pm 2, \dots \tag{40}$$

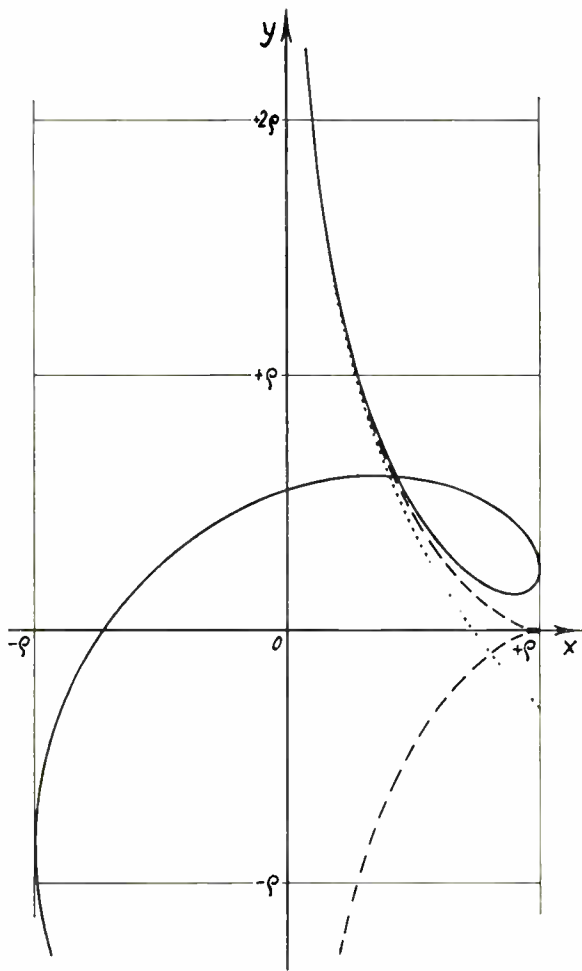

Fig. 5—Ordinary logarithmic curve (.....) as an approximation for the tractrix (---) and the logarithmic cycloid (—) at small values of x .

where μ indicates the order of the lines and β_1 is the distance between two adjacent lines measured on the circle. The line of the order 0 is a straight line which coincides with the y axis. This line means a displacement of $-\infty$. Therefore, it is necessary to relate the displacement to the line of the order 1. The displacement equals the difference of the value of y of any line for a constant x when $\arcsin x/\rho$ changes by the considered amount as Fig. 6 shows and

$$y_\mu = \rho \log_e \frac{C}{\beta} - \rho \log_e \frac{C}{\mu\beta} = \rho \log_e \mu, \quad \mu > 0 \quad (41)$$

expresses. Negative values of m indicate lines which are arranged symmetrical to the y axis. Thus, the whole family of lines can be described by the single equation

$$y_\mu = \rho \left(\log_e \frac{\mu C}{\arcsin \frac{x}{\rho}} \right) - \sqrt{\rho^2 - x^2}. \quad (42)$$

Since C determines only the position of the x axis it may have any arbitrary value, e.g.,

$$C = 1, \quad (43)$$

so that the final form of the family of lines becomes

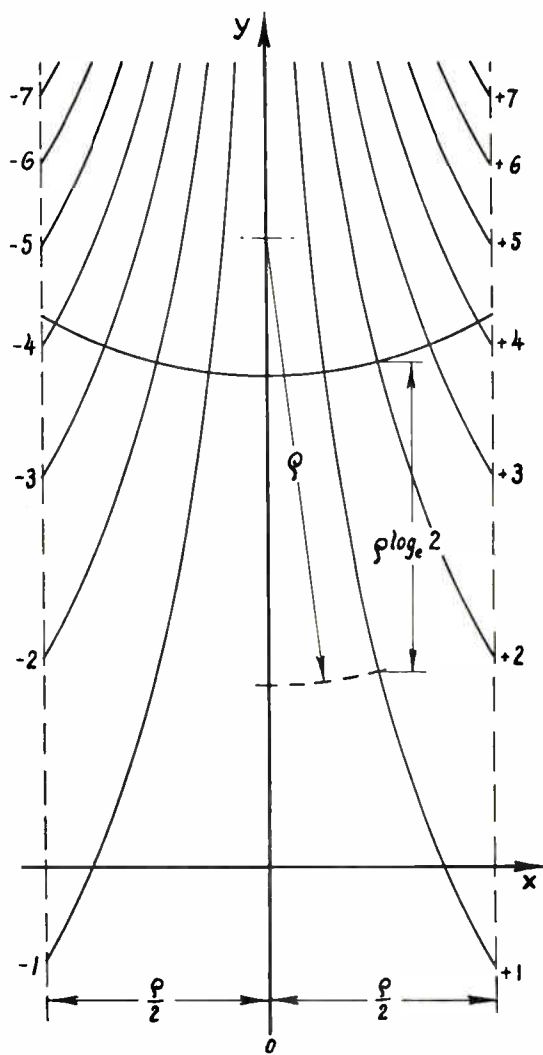

Fig. 6—The family of convergent logarithmic cycloids.

$$y_\mu = \rho \left(\log_e \frac{\mu}{\arcsin \frac{x}{\rho}} \right) - \sqrt{\rho^2 - x^2}. \quad (44)$$

In (44), which is plotted in Fig. 6, there is only one parameter, the radius of the circle ρ , which characterizes the family of lines.

PRACTICAL DESIGN OF THE ANALYZER

The practical design of an analyzer has to start with the choice of the radius, which limits the width of the chart carrying the lines. The next refers to the envelope. In the general case the envelope curve is extended over an infinite range. However, the amplitudes decrease and become negligible soon. Thereafter, a decision has to be made, up to what amplitude the envelope curve is of interest. From a pulse with a relatively slow decrease of the amplitudes, e.g., a rectangular pulse, the required frequency range can be obtained.

Now, the scale of the amplitude is subject to choice. Since the spectral lines have different curvatures an error can be expected which increases with the length of the used part of the lines or the greater the scale. As

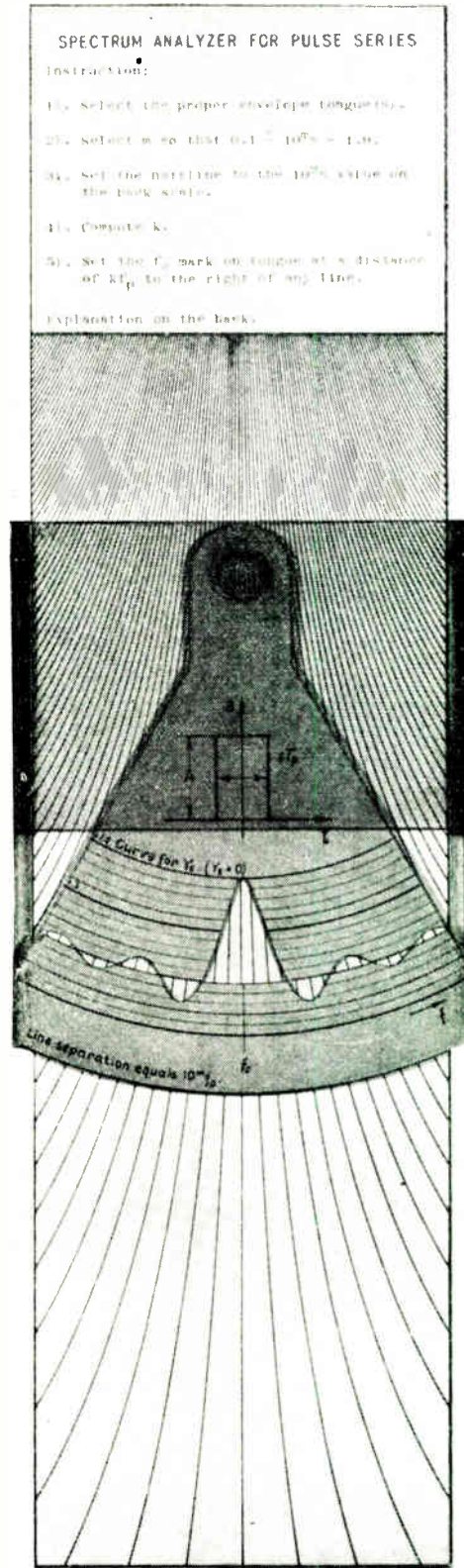
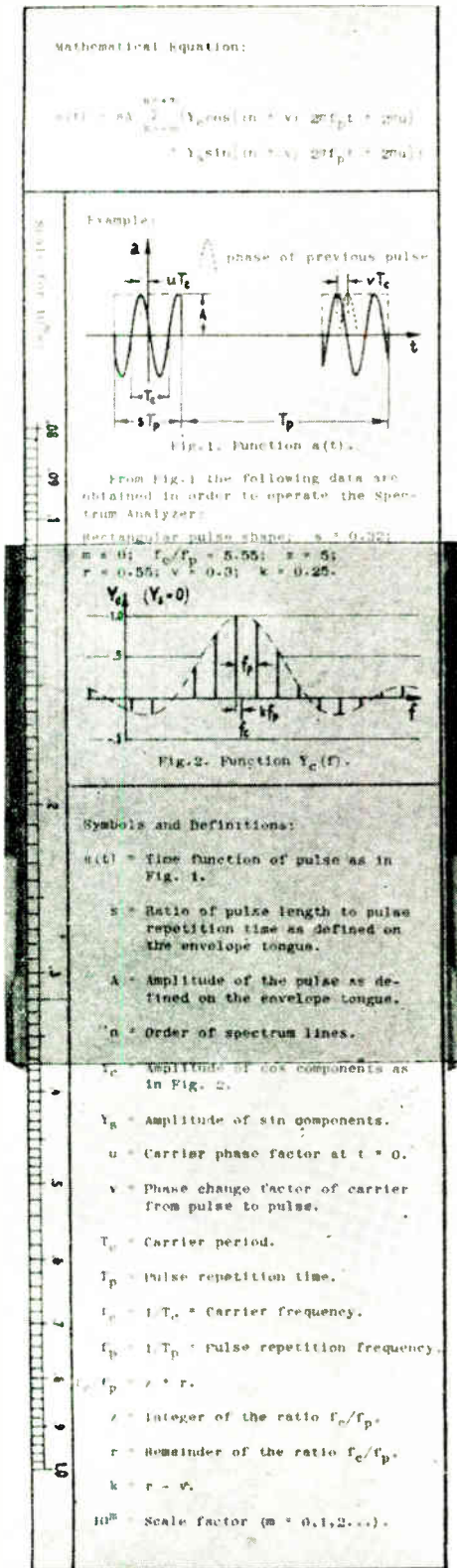

(a)

(b)

Fig. 7—The spectrum analyzer (a) back (b) front.

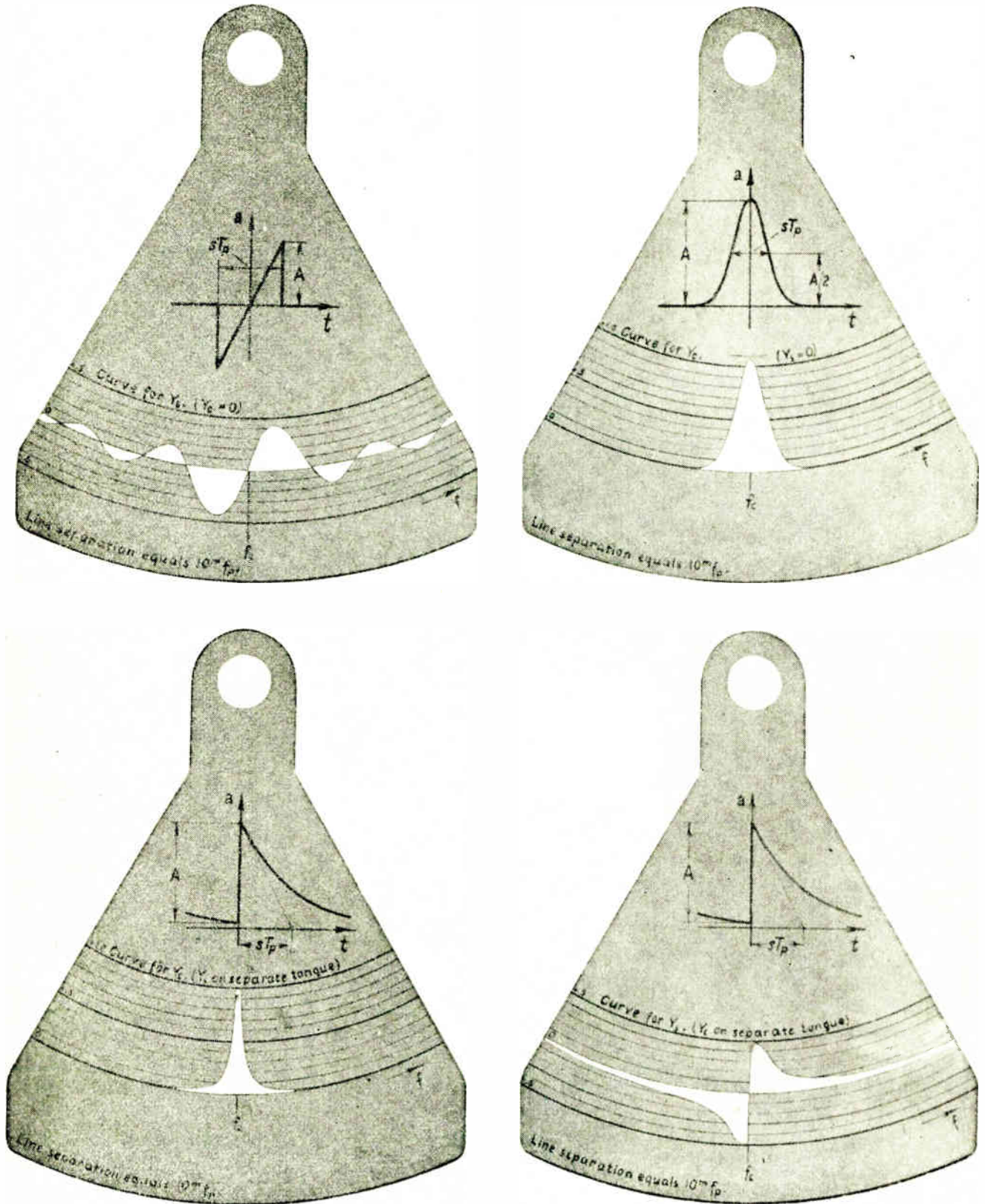

Fig. 8—A selection of envelope tongues.

long as the lines can be substituted by the radii of the circle, this error is negligible. However, a small scale would include a greater interpretation error due to the ability of the eye as well as a greater system error due to the inaccuracy of the construction. Therefore, a unit length greater than one fourth of the radius of the circle should not be used.

As mentioned, the sliding of the envelope curve towards the center of convergence means a logarithmic change of the values of s towards smaller amounts. It is not necessary to analyze pulse series with an s greater than unity. Thus, the chart carrying the line family can be limited on one side. For small values of s , of $1/100$ and below, the lines come so close together that it is impossible to draw them separately on a convenient-sized analyzer. Therefore, it is desirable to restrict the analyzer to one order of magnitude of the density of the lines. This means that all values of s between 0.1 and 1.0 can be used immediately. Smaller values have to be multiplied by a convenient scale factor, in order to obtain a value within the mentioned order of magnitude. E.g., the actual value $s=0.005$ should be multiplied by 100. Now, every line represents 100 lines which fill uniformly the space between two adjacent lines. The length of these lines can be estimated.

Fig. 7 is a photograph of a spectrum analyzer designed in accordance with the above. The left-hand picture shows the back of the analyzer carrying the defining mathematical equation; an example is described by tabulated description and the spectrum. The $10^m s$ scale is located on the left side, where 10^m is the scale factor chosen according to the problem. The slider carries a hairline which is set to $s=0.32$.

The right-hand picture shows the front of the analyzer with instructions, the family of lines, and the envelope tongue attached to the slider. The envelope tongue has been adjusted so that the f_c mark is set at a distance of 0.25 of the spacing between two lines to the right of the center line. This adjustment takes care of two facts. First, there is a fractional part of remainder rf_1 left from the ratio of the carrier frequency and the pulse repetition frequency. Second, there is a continuous phase increase equivalent to a frequency shift of vf_1 which makes the family of lines move up. Therefore the position of the f_c mark is determined by the difference $rf_1 - vf_1$ or by the amount kf_1 , whereby

$$k = r - v. \quad (45)$$

Fig. 8 shows further envelope tongues. The Z -type pulse is presented so that the pulse shape becomes an odd function. Therefore, the spectrum is made up of sine components only. The Z -type pulse envelope can be used to find the spectrum for an ordinary sawtooth wave since s becomes unity in this case.

Since the triangular wave is made up of the superimposition of a rectangular pulse and a Z -type pulse, the full spectrum of a triangular pulse can be obtained

from both tongues, so that the envelope of the rectangular pulse gives the cosine components, while the envelope of the Z -type pulse gives the sine components.

For technical application the Gaussian or bell-shaped pulse is very important, since it is, at once, the shortest pulse with the smallest frequency range.

The last example represents the exponential decay pulse. This pulse shape contains an even and an odd component so that two tongues are necessary to furnish the cosine components and the sine components separately.

Examples.

In the photograph of Fig. 7 the analyzer is set to the same problem as in Fig. 2 and 3. In agreement with the example, the envelope tongue for rectangular pulses has been selected and after setting the hairline to $s=0.32$ and the $10^m s$ scale, the factor k was simply computed as the difference of $r=0.55$, the remainder of the ratio of carrier frequency to pulse-repetition frequency, and $v=0.3$, the phase change factor of the carrier from pulse to pulse. Therefore, k becomes 0.25. According to the fifth point of the instruction the f_c mark on the tongue has been set to the right of the centerline at a distance of $0.25f_p$.

Now, the graph which appears under the envelope gives all information which is symbolized by the terms under the summation sign of the mathematical equation. The frequency scale is calibrated by the intersections with the family of lines while the f_c mark gives an absolute value to start from. In order to obtain the actual amounts in volts or amperes all lengths of the spectral lines have to be multiplied by the factor sA . Result may be in a table or presented in a graph.

This example was a simple one for there were no sine components contained, because the pulse could be presented over the time axis in such a way that the pulse shape became an even function.

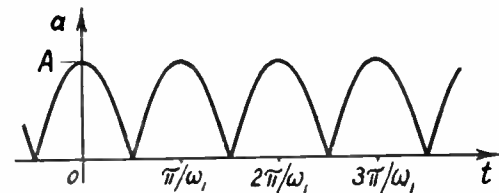

Fig. 9—Example of fullwave rectification.

Beside the general example which was given on the back of the analyzer, a particular case which shows the wide application may be analyzed. This example deals with the linear full wave rectification of a power supply circuit. The time function is presented in Fig. 9. This problem can be considered as a rectangular pulse series with a carrier frequency. The following data are assumed or result from the problem respectively:

$$f_c = 60 \text{ c/s}, f_p = 120 \text{ c/s}, A = 10 \text{ V}, s = 1.0 \text{ and } u = 0.$$

TABLE I

Rel. Ampl	$n =$	-4	-3	-2	-1	0	+1	+2	+3	+4
Y_c		+0.07	-0.09	+0.13	-0.21	+0.64	+0.64	-0.21	+0.13	-0.09
Y_s		0	0	0	0	0	0	0	0	0
Abs. Ampl.	$n =$	0	1	2	3	4				
$s \cdot Y_c$		+6.4	+4.3	-0.8	+0.4	-0.2				
$s \cdot Y_s$		0	0	0	0	0				

In order to adjust the analyzer the following five steps have to be undertaken:

- (1) Selection of the rectangular pulse envelope tongue.
- (2) Selection $m=0$ or $10^m=1$.
- (3) Setting the hairline of the slider to $10^m s = s = 1.0$.
- (4) Computation of $k=r-v$. Since $f_c/f_p = z+r = 0.5$, $z=0$, $r=0.5$. Furthermore $v=0$. Hence $k=0.5$.
- (5) Setting the f_c mark on tongue at a distance of $0.5 f_p$ to the right of the center line.

The resulting graph is shown in Fig. 10. The zero point of the frequency scale is indicated by an arrow. The spectrum can be preserved either as a series equation, graphically or in a numerical table. All three forms are presented. The series equation becomes

$$\begin{aligned}
 a(t) = & 1.10 \{ 0.64 \cdot \cos [(0+0)2\pi 120t] \\
 & + 0.64 \cdot \cos [(1+0)2\pi 120t] \\
 & - 0.21 \cdot \cos [(-1+0)2\pi 120t] \\
 & - 0.21 \cdot \cos [(2+0)2\pi 120t] \\
 & + 0.13 \cdot \cos [(-2+0)2\pi 120t] \\
 & + 0.13 \cdot \cos [(3+0)2\pi 120t] \\
 & - 0.09 \cdot \cos [(-3+0)2\pi 120t] \\
 & - 0.09 \cdot \cos [(4+0)2\pi 120t] \\
 & + 0.07 \cdot \cos [(-4+0)2\pi 120t] \} \quad (46) \\
 a(t) = & 6.4 + 4.3 \cdot \cos 2\pi 120t - 0.8 \cdot \cos 2\pi 240t \\
 & + 0.4 \cdot \cos 2\pi 360t - 0.2 \cdot \cos 2\pi 480t
 \end{aligned}$$

The graphical presentation of the spectrum is shown in Fig. 11, while the numerical table can be arranged as shown by Table I, above.

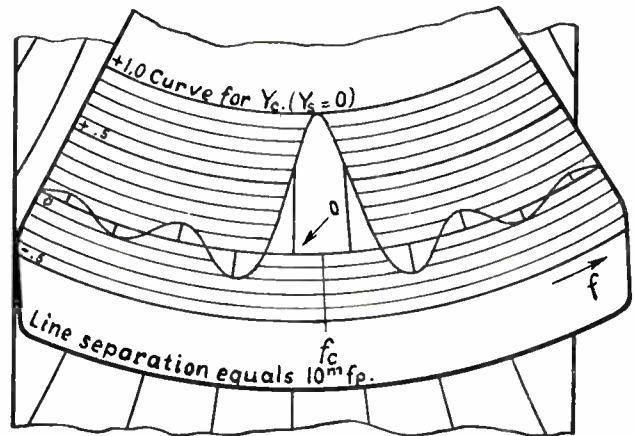

Fig. 10—Adjustment of the tongue for the example of Fig. 9.

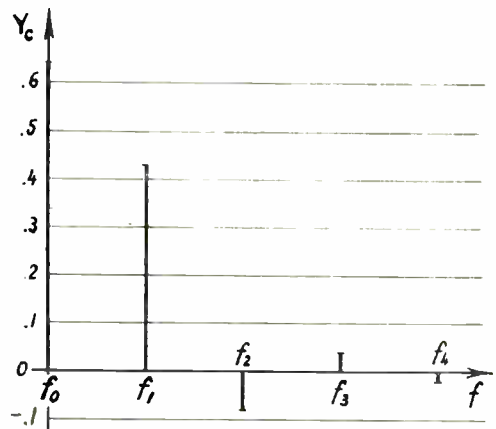
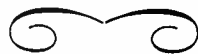

Fig. 11—Ordinary presentation of the spectrum of Fig. 10.

CONCLUSIONS

It is possible, by the use of a simple mechanical device similar to a slide rule, to present graphically the frequency spectra for an infinite series of pulses having amplitude modulation only. This method is very rapid and the pictorial presentation permits an overall evaluation of the frequency spectrum. There is, actually, no limitation to the variety of pulse types, though only a few examples are described. However, one exchangeable part of the slider must be prepared for any pulse type.



RLC Lattice Networks*

LOUIS WEINBERG†, MEMBER, IRE

Summary—A method is presented for the realization of a general transfer impedance as an open-circuited lattice. The method is a simple one based on a partial-fraction expansion of the given function. No restriction other than that of physical realizability is placed on the function to be realized; thus both minimum-phase and nonminimum-phase functions are realizable by this method. A part of the method allows control over the Q 's of the coils used in the final network. The achieved lattice has the significant features of requiring no mutual inductance and no perfect coils, that is, every inductance appears with an associated series resistance so that in building the network low- Q coils may be used.

INTRODUCTION

ANY GENERAL transfer impedance may be written within a multiplicative constant in the form

$$\begin{aligned} Z_{12} &= \frac{s^m + a_{m-1}s^{m-1} + \cdots + a_1s + a_0}{s^n + b_{n-1}s^{n-1} + \cdots + b_1s + b_0} \quad (n+1 \geq m) \\ &= \frac{(s-s_1)(s-s_3)\cdots(s-s_m)}{(s-s_2)(s-s_4)\cdots(s-s_n)} \\ &= \frac{p(s)}{q(s)} \\ &= E_2/I_1. \end{aligned} \quad (1)$$

If Z_{12} is to be realizable, it is necessary that $q(s)$ be a Hurwitz polynomial, that is, a polynomial with all its zeros in the left half-plane. For minimum-phase character of Z_{12} , $p(s)$ must also be of Hurwitz character; but the general nonminimum-phase function allows $p(s)$ to have zeros anywhere in the complex plane.

In this paper a method is presented for realizing a general minimum-phase or nonminimum-phase transfer impedance as the open-circuited lattice shown in Fig. 1. For such a lattice it may easily be shown that the open-circuit transfer impedance is given by the difference of two driving-point functions, namely,

$$Z_{12} = \frac{1}{2}(Z_b - Z_a). \quad (2)$$

The lattice achieved by the method presented here has simple arms requiring no mutual inductance and no pure inductances, that is, the procedure is so designed that every inductance appears with an associated series resistance. In addition, a measure of control over the Q 's of the coils is obtained.

The paper will be divided into three parts. First the

theoretical background for the problem is presented. The actual steps of the synthesis procedure comprise the second part, and in the final part an illustrative example is given.

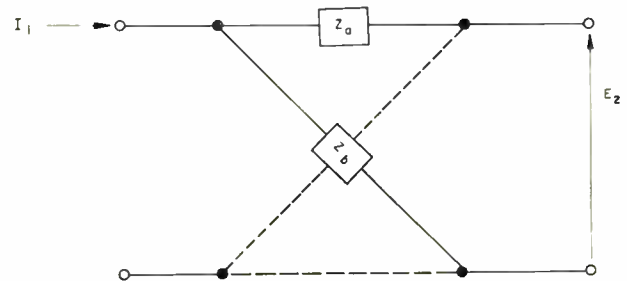

Fig. 1—Open-circuited lattice network with $Z_{12} = E_2/I_1 = \frac{1}{2}(Z_b - Z_a)$.

THEORETICAL DISCUSSION OF THE PROBLEM

For the driving-point functions of two-element kind networks the Foster method of synthesis can be successfully applied; that is, a partial-fraction expansion yields terms (conjugate poles taken in pairs) each of which is positive real and hence realizable almost by inspection. General RLC driving-point functions, however, introduce a complication in that they may have multiple order poles. It is found, furthermore, that the method of partial-fraction expansion breaks down for both the simple and higher order poles. If the original function is not positive real but, like a transfer function, is restricted only in that its poles must lie in the left half-plane, the statement about the partial-fraction expansion is of course true *a fortiori*. It is shown below, however, that it is possible to distribute the residues in the simple poles of a given Z_{12} so that the partial-fraction components of Z_a and Z_b are separately positive real. Though the procedure as applied to RC networks has been well known^{1,2} for a number of years, no one has yet shown its applicability to RLC networks.

To make the terms with multiple order poles positive real we apply a suggestion of Guillemin. To realize them as networks with lossy coils and no mutual inductance, we use the Bott and Duffin procedure (or, in certain special cases, the Brune method) plus a technique suggested by Darlington. Guillemin³ pointed out that the form of (2), namely, the *difference* of two positive real functions, allows sufficient resistance to be added to each impedance so that both become positive

* Decimal classification: R143. Original manuscript received by the Institute, January 30, 1953; revised manuscript received June 1, 1953. This paper is based on a chapter of Technical Report No. 201, Research Laboratory of Electronics, M.I.T. The research was conducted under the supervision of Dr. E. A. Guillemin and was supported in part by the Air Materiel Command, the Army Signal Corps, and the Office of Naval Research.

† Research Physicist, Hughes Aircraft Co., Culver City, Calif.

¹ E. A. Guillemin, "RC-Coupling Networks," M.I.T. Radiation Laboratory Report No. 43; October 11, 1944.

² J. L. Bower and P. F. Ordung, "The synthesis of resistor-capacitor networks," Proc. I.R.E., pp. 263-269; March, 1950.

³ Network Synthesis Seminar, Massachusetts Institute of Technology, Spring Term; 1951.

real. This reservoir of resistance, as Bode⁴ first demonstrated, is all that is necessary to make the partial-fraction terms of an RLC driving-point function separately realizable.

Simple poles are considered first. The condition for realizability of the partial-fraction components of a positive real function is specified in a form suitable for the procedure of this paper. The expansion contains two typical terms, one with a real pole and the other with a pair of complex poles. It can be shown^{5,6} if the terms are written in the alternate forms,

$$\begin{aligned}
 Z &= \frac{k_1}{s + \sigma_1 - j\omega_1} + \frac{\bar{k}_1}{s + \sigma_1 + j\omega_1} + \frac{k_2}{s + a} \\
 &= \frac{\alpha_1 + j\beta_1}{s + \sigma_1 - j\omega_1} + \frac{\alpha_1 - j\beta_1}{s + \sigma_1 + j\omega_1} + \frac{k_2}{s + a} \\
 &= \frac{2\alpha_1(s + \sigma_1 - \beta_1\omega_1/\alpha_1)}{s^2 + 2\sigma_1s + |s_1|^2} + \frac{k_2}{s + a} \quad (3) \\
 &= \frac{2\alpha_1(s + d_1)}{s^2 + 2\sigma_1s + |s_1|^2} + \frac{k_2}{s + a} \\
 &= z_1 + z_2,
 \end{aligned}$$

that the condition for realizability of the real pole is simply that k_2 be positive and that realizability for the pair of complex poles requires α_1 to be positive and

$$\frac{|\beta_1|}{\alpha_1} \leq \frac{\sigma_1}{\omega_1} \quad (4)$$

where σ_1 and ω_1 are defined as positive numbers. In words, (4) states that the condition for the existence of a positive real partial-fraction component z_1 is that α_1 be positive and the angle of the pole to the imaginary axis be greater than or equal to the angle of its residue. This is illustrated in Fig. 2, where angle $\phi = \tan^{-1}(\beta_1/\alpha_1)$ must be less than or equal to the angle $\delta = \tan^{-1}(\sigma_1/\omega_1)$, or the residue may lie anywhere in the cross hatched portion of the plane.

If the transfer function Z_{12} is expanded in partial fractions, it yields (where we have assumed a proper fraction, i.e., $n > m$, since the $M \geq N$ cases represent obvious extensions),

$$Z_{12} = \frac{p}{q} = \sum_{\mu=1}^n \frac{k_\mu}{s - s_\mu} \quad (5)$$

where n is the degree of q and

$$\begin{aligned}
 k_\mu &= \alpha_\mu + j\beta_\mu \\
 s_\mu &= -\sigma_\mu + j\omega_\mu \quad (6) \\
 &= |s_\mu| e^{j\psi_\mu}.
 \end{aligned}$$

If, in addition, we consider the unknown impedance arms as expanded into partial fractions,

$$\left. \begin{aligned}
 \frac{1}{2} Z_b &= \sum_{\mu=1}^n \frac{k_\mu^{(b)}}{s - s_\mu} \\
 \frac{1}{2} Z_a &= \sum_{\mu=1}^n \frac{k_\mu^{(a)}}{s - s_\mu}
 \end{aligned} \right\} \quad (7)$$

where

$$\left. \begin{aligned}
 k_\mu^{(b)} &= \alpha_\mu^{(b)} + j\beta_\mu^{(b)} = |k_\mu^{(b)}| e^{j\phi_\mu^{(b)}} \\
 k_\mu^{(a)} &= \alpha_\mu^{(a)} + j\beta_\mu^{(a)} = |k_\mu^{(a)}| e^{j\phi_\mu^{(a)}}
 \end{aligned} \right\} \quad (8)$$

then by substituting (5) and (7) in (2) and equating residues in like poles, we obtain,

$$k_\mu = k_\mu^{(b)} - k_\mu^{(a)} \quad (9)$$

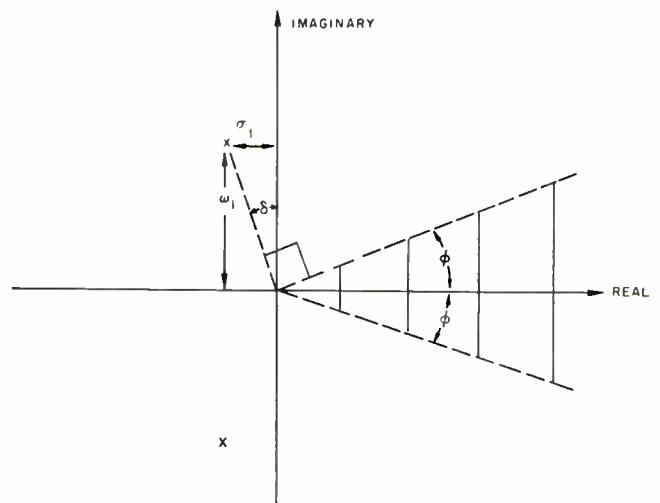

Fig. 2—Geometrical illustration of pole and residue relationship.

Since we now desire each partial-fraction term of (7) to be positive real, the discussion relating to (3) and (4) is applicable. If s_μ is real, k_μ is positive or negative real, and a simple distribution of the residues is

$$\left. \begin{aligned}
 k_\mu^{(b)} &= k_\mu; \quad k_\mu^{(a)} = 0, \quad \text{if } k_\mu > 0 \\
 k_\mu^{(b)} &= 0; \quad k_\mu^{(a)} = k_\mu, \quad \text{if } k_\mu < 0
 \end{aligned} \right\} \quad (10)$$

For complex poles, using the angles defined in (6) and (8), we may rewrite (4), the condition to be satisfied for Z_b and Z_a to have the desired realization, as

$$\left. \begin{aligned}
 |\phi_\mu^{(b)}| &\leq |\psi_\mu| - \frac{\pi}{2} \\
 |\phi_\mu^{(a)}| &\leq |\psi_\mu| - \frac{\pi}{2}
 \end{aligned} \right\} \quad (11)$$

It can easily be shown analytically that this condition can always be fulfilled; however, a geometrical proof⁷ is in this case quite simple and convincing, and it is therefore given below.

⁷ Geometrical form of proof due to W. H. Kautz.

⁴ H. W. Bode, "Network Analysis and Feedback Amplifier Design," D. Van Nostrand Co., New York, N. Y., 1945.

⁵ L. Weinberg, "New Synthesis Procedures for Realizing Transfer Functions of RLC and RC Networks," Technical Report No. 201, Research Laboratory of Electronics, M.I.T.; September, 1951.

⁶ L. Weinberg, "A General RLC Synthesis Procedure," Convention Record of the I.R.E.; 1953.

In Fig. 3 is shown the representation in the complex plane of (9), which makes it clear that what is necessary to satisfy (11) is a choice of point M that makes the angles of $k_{\mu}^{(a)}$ and $k_{\mu}^{(b)}$ as small as desired. It can be

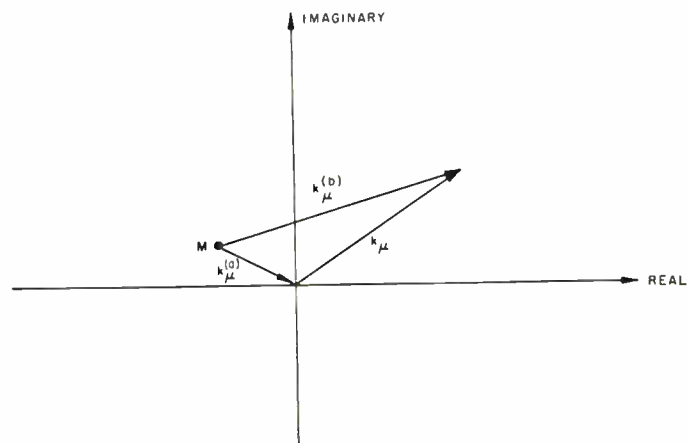

Fig. 3—Geometrical representation of $k_{\mu} = k_{\mu}^{(b)} - k_{\mu}^{(a)}$.

observed by inspection that the angles may be made arbitrarily small, but for a rigorous proof, we consider Fig. 4 for the three cases of α_{μ} positive, α_{μ} negative, and β_{μ} equal to zero. The construction is indicated in the figures where all angles marked with dimension lines are equal to $|\psi_{\mu}| - \pi/2$. Merely using the fact of the equality of alternate interior angles formed by a line intersecting parallel lines, we observe that at the apex of the crosshatched portion $|\phi_{\mu}^{(a)}| = |\phi_{\mu}^{(b)}| = |\psi_{\mu}| - \pi/2$, while along the lower (upper) boundary line, $\phi_{\mu}^{(b)}$ ($\phi_{\mu}^{(a)}$) remains constant and $\phi_{\mu}^{(a)}$ ($\phi_{\mu}^{(b)}$) changes. Inside the crosshatched area both angles decrease in magnitude. As for $|k_{\mu}^{(a)}|$ and $|k_{\mu}^{(b)}|$, their minimum values occur simultaneously at the apex of the crosshatched area if $|\psi_{\mu}| - \pi/2 \leq \pi/4$.

It is often of practical importance to control the Q 's of the coils used in the synthesis of the partial-fraction components. Each component, that is, a pair of complex poles, can be realized by the network in Fig. 5, so

$$z_{\mu} = \frac{2\alpha_{\mu}(s + \sigma_{\mu} - \beta_{\mu}\omega_{\mu}/\alpha_{\mu})}{s^2 + 2\sigma_{\mu}s + |s_{\mu}|^2} = \frac{2\alpha_{\mu}(s + d_{\mu})}{s^2 + 2\sigma_{\mu}s + |s_{\mu}|^2} \tag{12}$$

$$= \frac{\left(s + \frac{R_{\mu}}{L_{\mu}}\right)}{C_{\mu} \left[s^2 + \left(\frac{R_{\mu}}{L_{\mu}} + \frac{1}{R_{\mu}'C_{\mu}}\right)s + \frac{R_{\mu}}{L_{\mu}R_{\mu}'C_{\mu}} + \frac{1}{L_{\mu}C_{\mu}} \right]}$$

The pole closest to the j -axis will determine the minimum value of Q_{μ} that will satisfy every partial-fraction realization, where the definition is used

$$Q_{\mu} = \frac{\omega_{\mu}}{d_{\mu}} = \frac{\omega_{\mu}L_{\mu}}{R_{\mu}} \tag{13}$$

In order to use coils with as low Q as possible, it is

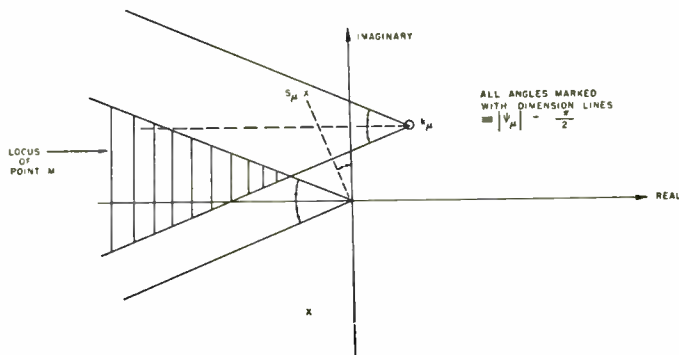

(a) Locus of M (crosshatched portion) for α_{μ} positive.

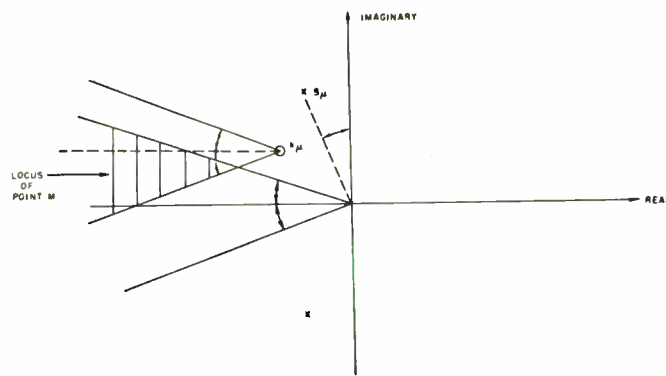

(b) Locus of M (crosshatched portion) for α_{μ} negative.

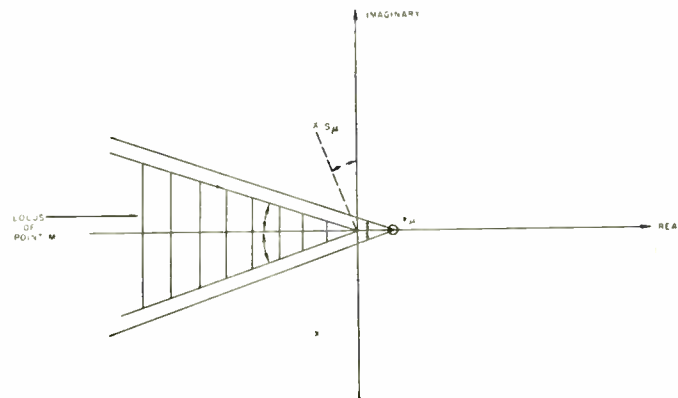

(c) Locus of M (crosshatched portion) for $\beta_{\mu} = 0$ and α_{μ} positive

Fig. 4—Locus of point M for satisfaction of (11), where all angles marked with dimension lines are $|\psi_{\mu}| - \pi/2$.

necessary that the value of d_{μ} be as close as possible to its maximum value $2\sigma_{\mu}$. This is brought about by causing $\phi_{\mu}^{(a)}$ and $\phi_{\mu}^{(b)}$ to be negative and of large magnitude. Since by definition

$$d_{\mu} = \sigma_{\mu} - \beta_{\mu}\omega_{\mu}/\alpha_{\mu}, \tag{14}$$

then

$$\frac{1}{Q_{\mu}} = \frac{d_{\mu}}{\omega_{\mu}} = \frac{\sigma_{\mu}}{\omega_{\mu}} - \frac{\beta_{\mu}}{\alpha_{\mu}} = \tan(|\psi_{\mu}| - \pi/2) - \tan \phi_{\mu}. \tag{15}$$

If we desire all Q_{μ} to be less than a given value Q_{\max} , then we must make $\phi_{\mu}^{(a)}$ and $\phi_{\mu}^{(b)}$ satisfy the relation for ϕ_{μ} given by

$$\tan \phi_\mu < \tan (|\psi_\mu| - \pi/2) - \frac{1}{Q_{\max}} \quad (16)$$

The above completes the treatment for first order poles. The technique providing for poles of multiple order is explained below.

Suppose that the given function possesses, in addition to simple poles, a pole of order t at the point s_1 , where s_1 is a negative real number. (Using a real pole to illustrate the procedure represents no loss in generality, since complex poles are handled similarly; it is understood, however, that as a first step conjugate poles of the same order are combined into one term.) Corresponding to this pole there will be t terms in the partial-fraction expansion. These combined into one fraction yield

$$\frac{k_{11}}{(s-s_1)^t} + \frac{k_{12}}{(s-s_1)^{t-1}} + \dots + \frac{k_{1t}}{(s-s_1)} = \frac{r(s)}{(s-s_1)^t} \quad (17)$$

In general this function will not be positive real. Even if it were, the realization as a driving-point impedance with lossy coils and no mutual inductance would not always be possible. To make such a form possible in all cases, we predistort the function,⁸ that is, we substitute $(s-d)$ for s , where d represents the desired R/L ratio. It is important to note that d must be less than the distance of the multiple order pole from the j -axis. The substitution yields a new function which can be written

$$P(s) = \frac{g(s)}{h(s)} = \frac{m_1 + n_1}{m_2 + n_2} \quad (18)$$

where m_1 and n_1 are defined respectively as the even and odd parts of the numerator, while m_2 and n_2 play the same roles for the denominator. The real part⁹ of $P(s)$ on the j -axis is given by $(m_1 m_2 - n_1 n_2) / (m_2^2 - n_2^2)$ evaluated at $s = j\omega$. In order for $P(s)$ to be positive real it is necessary and sufficient that its real part on the j -axis be non-negative for all ω . We need only differentiate $Re [P(j\omega)]$ with respect to ω in order to find its minimum values. No problem occurs if the smallest minimum is positive; the function is then positive real. However, when the smallest minimum is negative, the addition of a positive constant R , where R is equal to or greater than the magnitude of the minimum, makes the function positive real. This function is then identified as one of the components of $Z_b/2$, and R is the additional component of $Z_a/2$. The realization of $(P(s) + R)$ may now be carried out by the Bott and Duffin

method^{10,11} and the network obtained is then altered to correct for the predistortion: for every L a series combination of L and a resistance of Ld ohms is substituted, while every C is replaced by a parallel combination of C and a conductance of Cd mhos. It is thus evident that the network corresponding to the multiple order pole contains no mutual or ideal inductances.

It is useful to point out that in many cases the Brune procedure¹¹ is computationally simpler than the Bott and Duffin method and, more important, yields a simpler network *without mutual inductance*. Such cases are characterized by the fact that the even function $Re[P(j\omega)]$ has all its zeros occurring for real ω . When this characteristic is made to occur, then the Brune procedure becomes simply a continued-fraction expansion and the corresponding network a lossless one terminated in resistance. This case occurs, for example, when $(m_1 m_2 - n_1 n_2)$ equals a constant so that the real part has all its zeros at infinite ω .

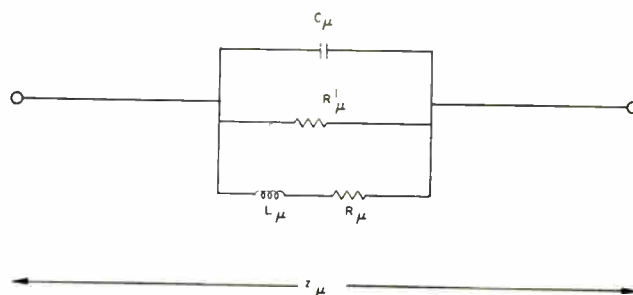

Fig. 5—Network realization of pair of complex conjugate poles where z_μ is given by (12).

STEPS IN THE SYNTHESIS PROCEDURE

The basic steps of the procedure may now be summarized as follows:

1. Expand the given transfer function in partial fractions.
2. Distribute the residues in the simple poles of Z_{12} to $Z_a/2$ and $Z_b/2$ in accordance with the discussion of the previous part. For the real poles, the distribution of (10) is used. For the complex poles calculate the angles $|\psi_\mu| - \pi/2 = \tan^{-1}(\sigma_\mu/\omega_\mu)$ and then find residues $k_\mu^{(a)}$ and $k_\mu^{(b)}$ by use of (9), at the same time satisfying the positive real condition given by (11). Or, more simply merely use (9) and the form of positive real condition given by (4), for which no angles need be calculated. A simple geometrical construction may often be helpful for this step.
3. For the simple poles realize the lattice arms in the Foster manner as simple series connections of canonic forms of networks. The RLC network of Fig. 5 corresponds to complex poles and a parallel RC combination is the canonic form for each of the real poles.

⁸ S. Darlington, "Synthesis of reactance four-poles," *Jour. Math. Phys.*, vol. 18, pp. 257-353; September, 1939.

⁹ E. A. Guillemin, "The Mathematics of Circuit Analysis," John Wiley and Sons, Inc., New York, N. Y.; 1949.

¹⁰ R. Bott and R. J. Duffin, *Jour. Appl. Phys.*, vol. 20, p. 816; August, 1949.

¹¹ E. A. Guillemin, "Summary of Modern Methods of Network Synthesis," *Advances in Electronics*, vol. 3, Academic Press, New York, N. Y.; 1951.

4. If multiple order poles occur, they are realized as outlined above and then added to the appropriate arms in series with the canonic forms corresponding to the simple poles.

The above completes the discussion of the synthesis procedure.

ILLUSTRATIVE EXAMPLE

It is desired to realize the following nonminimum-phase transfer impedance

$$Z_{12} = \frac{p}{q} = \frac{s^4 - 4s^3 + 7s^2 - 24s + 36}{(s^2 + 2s + 5)(s^2 + 4s + 13)(s + 4)}$$

as an open-circuited lattice. The partial-fraction expansion is of the form

$$Z_{12} = \frac{k_1}{s + 1 - j2} + \frac{k_2}{s + 2 - j3} + \text{conjugates} + \frac{k_3}{s + 4}$$

where the residues are given by

$$k_\mu = \left[\frac{(s - s_\mu)p}{q} \right]_{s=s_\mu}$$

It is a fairly tedious process to substitute a complex number in a high-degree polynomial. It is the writer's observation that many engineers still endure the tedium as inevitable. Since expansion in partial fractions is required of the student of synthesis quite often, we give below two methods for finding the value of a polynomial at a complex point; each of the methods is merely a simple application of the Remainder Theorem in algebra.

One procedure consists in using synthetic division to reduce the roots of the polynomial by an amount equal to the real part of the complex number. Then the imaginary part of the number is easily substituted into the transformed polynomial to yield the original polynomial evaluated for the total complex number. Thus in obtaining the numerator's contribution to the residue k_1 , we first perform synthetic division:

1	-4	7	-24	36		-1
	-1	5	-12	36		
1	-5	12	-36	72		
	-1	6	-18			
1	-6	18	-54			
	-1	7				
1	-7	25				
	-1					
1	-8					

The transformed polynomial is

$$s^4 - 8s^3 + 25s^2 - 54s + 72,$$

which yields, upon substitution of $s = j2$,

$$16 + j64 - 100 - j108 + 72 = -12 - j44.$$

This is the value of the numerator for the pole $s_1 = -1 + j2$. The denominator may be evaluated in the same way, or, since it is in factored form, it may be evaluated in a straightforward manner.

The second procedure requires the long division of the high-degree polynomial by the quadratic polynomial corresponding to a pair of complex conjugate roots, one of which is the point at which we wish to evaluate the polynomial of high degree. We obtain a linear term as a remainder, which, when evaluated at the desired point, yields the value of the original polynomial at this point. For example, in again evaluating k_1 ,

$$\begin{array}{r}
 s^2 - 6s + 14 \\
 s^2 + 2s + 5 \overline{) s^4 - 4s^3 + 7s^2 - 24s + 36} \\
 \underline{s^4 + 2s^3 + 5s^2} \\
 -6s^3 + 2s^2 - 24s \\
 \underline{-6s^3 - 12s^2 - 30s} \\
 14s^2 + 6s + 36 \\
 \underline{14s^2 + 28s + 70} \\
 -22s - 34
 \end{array}$$

The linear remainder, $(-22s - 34)$, evaluated at $s_1 = -1 + j2$, yields the same value as before, $(-12 - j44)$, as the value of the numerator polynomial.

If the reader compares these methods with some he may have used, e.g., substituting the s_1 in its magnitude-exponential angle form into the polynomial and then using trigonometric tables (giving many decimal places in order to maintain accuracy) to solve for the real and imaginary parts of each term, he will readily observe the economy of time and labor. The values of the residues are now

$$\begin{aligned}
 k_1 &= \alpha_1 + j\beta_1 = -0.05621 + j0.43491 \\
 k_2 &= \alpha_2 + j\beta_2 = -1.68047 + j0.20020 \\
 k_3 &= \alpha_3 = 4.47337.
 \end{aligned}$$

Using the above values and the ratios of the real to the imaginary part of each of the complex poles, we obtain values of $k_\mu^{(a)}$ and $k_\mu^{(b)}$ that satisfy the positive real requirement. They are

$$\begin{aligned}
 k_1^{(a)} &= 2.05621 - j0.93491 & k_1^{(b)} &= 2.00 - j0.50 \\
 k_2^{(a)} &= 4.68047 - j2.20020 & k_2^{(b)} &= 3.00 - j2.00 \\
 k_3^{(a)} &= 0 & k_3^{(b)} &= 4.47337.
 \end{aligned}$$

The lattice arms are therefore given by

$$Z_a = \frac{8.22484(s + 1.90935)}{s^2 + 2s + 5} + \frac{18.72188(s + 3.41024)}{s^2 + 4s + 13}$$

and

$$Z_b = \frac{8.00(s + 1.5)}{s^2 + 2s + 5} + \frac{12.00(s + 4)}{s^2 + 4s + 13} + \frac{4.47337}{s + 4}$$

Deriving the element values from the above, we finally obtain the lattice shown in Fig. 6. This lattice has the desired transfer impedance.

CONCLUSION

A simple method has been demonstrated for the realization of any minimum-phase or nonminimum-phase transfer impedance as an open-circuited lattice. The arms of the lattice are of a simple form and contain no mutual inductance. Any inductance used in the lattice always appears with an associated series resistance so that low-Q coils may be used in building the network. The procedure presented allows a measure of control over the Q's of the coils used in the final network.

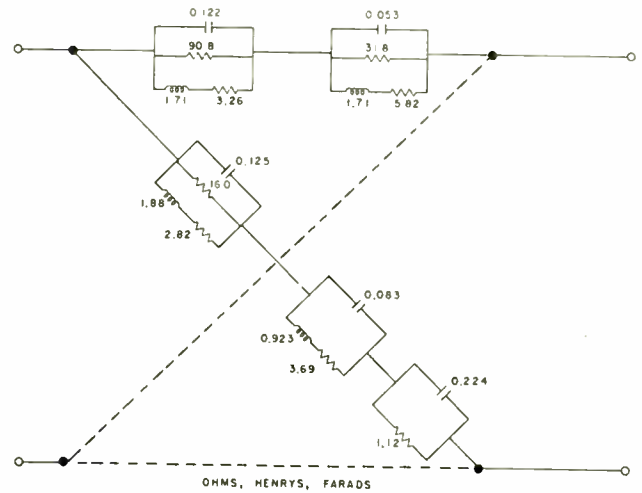

Fig. 6—Lattice obtained for illustrative example where $Z_{12} = p/q$.

FEEDBACK THEORY—Some Properties of Signal Flow Graphs*

SAMUEL J. MASON†, SENIOR MEMBER, IRE

The following paper appears through the courtesy and with the approval of the IRE Professional Group on Circuit Theory—*The Editor*.

Summary—The equations characterizing a systems problem may be expressed as a network of directed branches. (The block diagram of a servomechanism is a familiar example.) A study of the topological properties of such graphs leads to techniques which have proven useful, both for the discussion of the general theory of feedback and for the solution of practical analysis problems.

I. INTRODUCTION

A SIGNAL FLOW GRAPH is a network of directed branches which connect at nodes. Branch jk originates at node j and terminates upon node k ; its direction is indicated by an arrowhead. A simple flow graph is shown in Fig. 1(a). This particular graph contains nodes 1, 2, 3, and branches 12, 13, 23, 32, and 33. The flow graph may be interpreted as a signal transmission system in which each node is a tiny repeater station. The station receives signals via the incoming branches, combines the information in some manner, and then transmits the result along each outgoing branch. If the resulting signal at node j is called x_j , the

flow graph of Fig. 1(a) implies the existence of a set of explicit relationships

$$\begin{aligned} x_1 &= \text{a specified quantity or a parameter} \\ x_2 &= f_2(x_1, x_3) \\ x_3 &= f_3(x_1, x_2, x_3). \end{aligned} \tag{1}$$

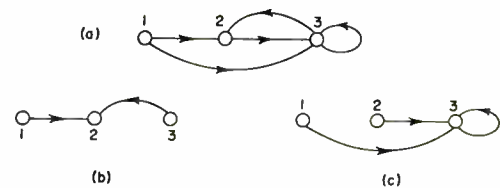

Fig. 1—Flow graphs.

The first equation alone would be represented as a single isolated node; whereas the second and third, each taken by itself, have the graphs shown in Fig. 1(b) and Fig. 1(c). The second equation, for example, states that signal x_2 is directly influenced by signals x_1 and x_3 , as indicated by the presence of branches 12 and 32 in the graph.

This report will be concerned with flow graph topology, which exposes the structure (Gestalt) of the associ-

* Decimal classification: R363.23. Original manuscript received by the Institute, September 5, 1952. This work has been supported in part by the Signal Corps, the Air Materiel Command, and the Office of Naval Research. The paper is based on a doctoral thesis in the Department of Electrical Engineering, M.I.T., 1951.

† Research Laboratory of Electronics, Massachusetts Institute of Technology, Cambridge, Mass.

ated functional relationships, and with the manipulative techniques by which flow graphs may be transformed or reduced, thereby solving or programming the solution of the accompanying equations. Specialization to linear flow graphs yields results which are useful for the discussion of the general theory of feedback in linear systems, as well as for the solution of practical linear analysis problems. Subsequent reports will deal with the formal matrix theory of flow graphs, with sensitivity and stability considerations, and with more detailed applications to practical problems. The purpose here is to present the fundamentals, together with simple illustrative examples of their use.

II. THE TOPOLOGY OF FLOW GRAPHS

Topology has to do with the form and structure of a geometrical entity but not with its precise shape or size. The topology of electrical networks, for example, is concerned with the interconnection pattern of the circuit elements but not with the characteristics of the elements themselves. Flow graphs differ from electrical network graphs in that their branches are directed. In accounting for branch directions it is necessary to take an entirely different line of approach from that adopted in electrical network topology.

A. Classification of paths, branches, and nodes

As a signal travels through some portion of a flow graph, traversing a number of successive branches in their indicated directions, it traces out a path. In Fig. 2, the sequences 1245, 2324, and 23445 constitute paths, as do many other combinations. In general, there may be many different paths originating at a designated node j and terminating upon node k , or there may be only one, or none. For example, no path from node 4 to node 2 appears in Fig. 2. If the nodes of a flow graph are numbered in a chosen order from 1 to n , then one may speak of a forward path as any path along which the sequence of node numbers is increasing, and a backward path as one along which the numbers decrease. An open path is one along which the same node is not encountered more than once. Forward and backward paths are evidently open.

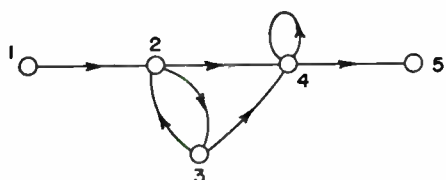

Fig. 2—A flow graph with three feedback branches and four cascade branches.

323) and 44. Multiple encirclements such as 23232 or 444 also constitute closed paths but these are topologically trivial. Notice that some paths, such as 12324, are neither open nor closed.

One may now classify the branches of a flow graph as either feedback or cascade branches. A feedback branch is one which appears in a feedback loop. All others are called cascade branches. Returning to Fig 2, it is seen that 23, 32, and 44 are the only feedback branches present. If each branch in a flow graph is imagined to be a one-way street, then a lost automobilist who obeys the law may drive through Feedback Street any number of times but he can traverse Cascade Boulevard only once as he wanders about in the graph.

The nodes in a flow graph are evidently susceptible to the same classification as branches; that is, a feedback node is one which enters a feedback loop. Two nodes or branches are said to be coupled if they lie in a common feedback loop. Any node not in a feedback loop is called a cascade node. Two special types of cascade nodes are of interest. These are sources and sinks. A source is a node from which one or more branches radiate but upon which no branches terminate. A sink is just the opposite, a node having incoming branches but no outgoing branches. Fig. 2 exhibits feedback nodes 2, 3, 4, a source 1, and a sink 5. It is possible, of course, for a cascade node to be neither a source nor a sink. The intermediate nodes in a simple chain of branches are examples.

B. Cascade graphs

A cascade graph is a flow graph containing only cascade branches. It is always possible to number the nodes of a cascade graph in a chosen sequence, called the order of flow, such that no backward paths exist. For proof of this, observe that a cascade graph must have at least one source node. Choose a source, number it one, and then remove it, together with all its radiating branches. This removal leaves a new cascade graph having, itself, at least one source. Again choose a source, number it two, and continue the process until only isolated nodes remain. These remaining nodes are the sinks of the original graph and they are numbered last. It is evident this procedure establishes an order of flow.

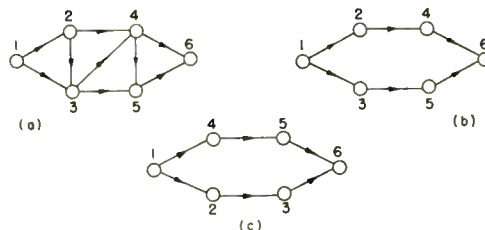

Fig. 3—Cascade graphs.

Any path which returns to its starting node is said to be closed. Feedback now enters directly into the discussion for the first time with the definition of a feedback loop as any set of branches which forms a closed path. The flow graph of Fig. 2 has closed paths 232 (or

Fig. 3 shows two simple cascade graphs whose nodes have been numbered in flow order. The numbering of graph 3(a) is unique, whereas other possibilities exist for graph 3(b); the scheme shown in graph 3(c) offers one example.

C. Feedback graphs

A feedback graph is a flow graph containing one or more feedback nodes. A feedback unit is defined as a flow graph in which every pair of nodes is coupled. It follows that a feedback unit contains only feedback nodes and branches. If all cascade branches are removed from a feedback graph, the remaining feedback branches form one or more separate feedback units which are said to be imbedded or contained in the original flow graph. The graph of Fig. 1, for example, contains the single unit shown in Fig. 4(a), whereas the two units shown in Fig. 4(b) and (c) are imbedded in the graph of Fig. 2.

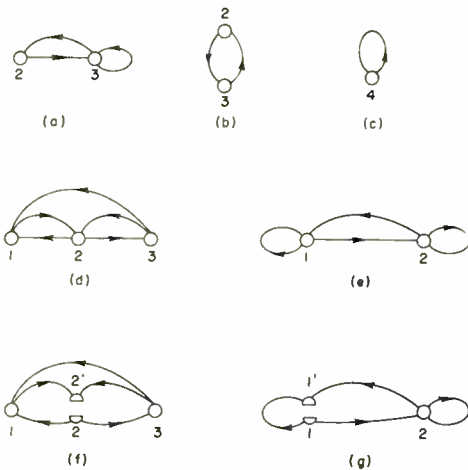

Fig. 4—Feedback units.

The units shown in Fig. 4(d) and (e) each possess three principal feedback loops. The number of loops, however, is not of great moment. A more important characteristic is a number called the index. Preparatory to its definition, let one introduce the operation of node-splitting, which separates a given node into a source and a sink. All branch tails appearing at the given node must, of course, go with the source and all branch noses with the sink. The result of splitting node 2 in Fig. 4(d) is shown in Fig. 4(f). Similarly, Fig. 4(g) shows node 1 of Fig. 4(e) in split form. The original node number may be retained for both parts of the split node, indicating the sink by a prime. Splitting effectively interrupts all paths passing through a given node and makes cascade branches of all branches connected to that node.

The index of a feedback unit can now be conveniently defined as the minimum number of node-splittings required to interrupt all feedback loops in the unit. For the determination of index, splitting a node is equivalent to removing that node, together with all its connecting branches.

The index of the graph in Fig. 4(d) is unity, since all feedback loops pass through node 2. Graph 4(e), on the other hand, is of index two.

D. The residue of a graph

A cascade graph represents a set of equations which may be solved by explicit operations alone. Fig. 5, for example, has the associated set

$$\begin{aligned} x_2 &= f_2(x_1) \\ x_3 &= f_3(x_1, x_2) \\ x_4 &= f_4(x_2, x_3). \end{aligned} \tag{2}$$

Given the value of the source x_1 , one obtains the value of x_4 by direct substitution

$$x_4 = f_4\{f_2(x_1), f_3[x_1, f_2(x_1)]\} = F_4(x_1). \tag{3}$$

In general, there may be s different sources. Once an order of flow is established, a knowledge of the source variables x_1, x_2, \dots, x_s fixes the value of x_{s+1} , since no backward paths from later nodes to x_{s+1} can exist. Similarly, with x_2, x_1, \dots, x_{s+1} known x_{s+2} is determined explicitly, and so on to the last node x_n . A cascade graph is immediately reducible, therefore, to a residual form in which only sources and sinks appear. The residual form of Fig. 5 is the single branch shown in Fig. 6(a), which represents (3). Had two sources and two sinks appeared in the original graph, the residual graph would have contained, at most, four branches, as indicated by Fig. 6(b).

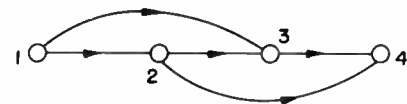

Fig. 5—A cascade graph.

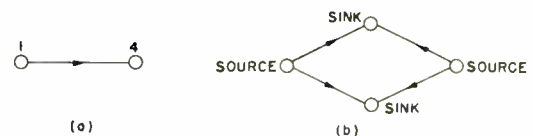

Fig. 6—Residual forms of a cascade graph.

Unlike those associated with a cascade graph, the equations of a feedback graph are not soluble by explicit operations. Consider the simple example shown in Fig. 1. An attempt to express x_3 as an explicit function of x_1 fails because of the closed chain of dependency between x_2 and x_3 . Elimination of x_2 from (1) by substitution yields

$$x_3 = f_3[x_1, f_2(x_1, x_3), x_3] = F_3(x_1, x_3). \tag{4}$$

Although a feedback graph cannot be reduced to sources and sinks by explicit means, certain superfluous nodes may be eliminated, leaving a minimum number of essential implicit relationships exposed.

In any contemplated process of graph reduction, the nodes to be retained in the new graph are called residual nodes. It is convenient to define a residual path as one which runs from a residual node to itself or to another

residual node, without passing through any residual nodes. The residual graph, or residue, has a branch jk if, and only if, the original graph has one or more residual paths from j to k . This completely defines the residue of any flow graph for a specified set of residual nodes.

We are interested here in a reduction which can be accomplished by explicit operations alone. The definition of index implies the existence of a set of index nodes, equal in number to the index of a graph, whose splitting interrupts all feedback loops in the graph. The set is not necessarily unique. Once a set of index nodes has been chosen, however, all other nodes except sources and sinks may be eliminated by direct substitution, leaving a residual graph in which only sources, sinks, and index nodes appear. Such a graph shall be called the index-residue of the original graph.

Fig. 7 shows a flow graph (a) and its index-residue (b). Residual nodes are blackened. Branch 25 in (b) accounts for the presence of residual paths 245 and 235 in (a). All paths from 2 to 6 in (a) pass through residual node 5. Hence graph 7(a) has no residual paths from 2 to 6, since a residual path, by definition, may not pass through a residual node. Accordingly, graph 7(b) has no branch 26. Fig. 7(c) illustrates an alternate choice of index nodes and Fig. 7(d) shows the resulting index-residue. Choice (a) is apparently advantageous in that it leads to a simpler residue.

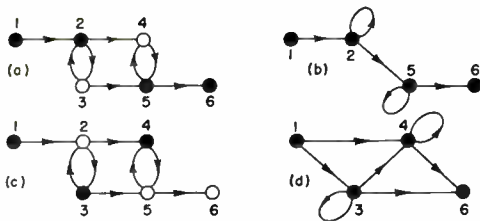

Fig. 7—Feedback graphs and their index-residues.

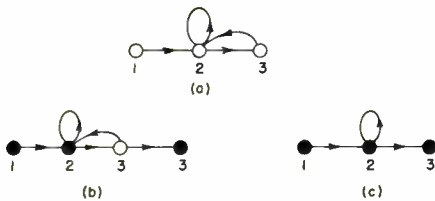

Fig. 8—Retention of a desired node as a sink.

A minor dilemma arises in the reduction process if one desires, for some reason, to preserve a node which is neither an index node nor a sink. In Fig. 8(a), for example, suppose that an eventual solution for x_3 in terms of x_1 is required. A node corresponding to variable x_3 must be retained in the residual graph. Apparently, no further reduction is possible. The simple device shown in Fig. 8(b) may be employed, however, to obtain the residue (c). The trick is to connect node 3 to a sink through a branch representing the equation $x_3 = x_3$. The original node 3 then disappears in the reduction, leaving the

desired value of x_3 available at the sink. This trick is simple but topologically nontrivial.

E. The condensation of a graph

The concept of an order of flow may be applied, in modified form, to a feedback graph as well as to a cascade graph. Consider the feedback graph in Fig. 9(a), which contains two feedback units. If each imbedded feedback unit is encircled and treated as a single supernode, then the graph condenses to the form shown in Fig. 9(b), where supernodes are indicated by squares. Since the condensation is a cascade structure, an order of flow prevails. Within each supernode the order is arbitrary, but we shall agree to number the internal nodes consecutively.

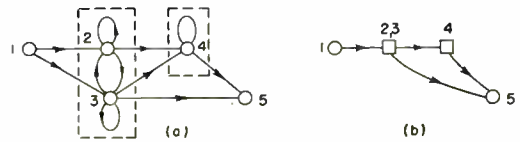

Fig. 9—The condensation of a flow graph.

The index-residue of a flow graph shows the minimum number of essential variables which cannot be eliminated from the associated equations by explicit operations. The condensation of the residue programs the solution for these variables. In Fig. 9(b), for example, the condensation directs us to specify the value of x_1 , to solve a pair of simultaneous equations for x_2 and x_3 , to solve a single equation for x_4 , and to compute x_5 explicitly. The complexity of the solution, without regard for the specific character of the mathematical operations involved, is indicated by the number of feedback units and the index of each, since the index of a feedback unit is the minimum number of simultaneous equations determining the variables in that unit.

Carrying the condensation one step further, the basic structural character of a given flow graph may be indicated by a simple listing of its nodes in the order of condensed signal flow, with residual nodes underlined and feedback units overlined. The sequence

$$\underline{1} \ \underline{2} \ \overline{3} \ \overline{4} \ \overline{5} \ \overline{6} \ \overline{7} \ \overline{8} \ \overline{9} \ \overline{10} \ 11 \ \underline{12}$$

for example, states that nodes 1 and 2 are sources, 7 and 11 are cascade nodes, and 12 is a sink. Also, nodes 3, 4, 5, 6 lie in a feedback unit of index two, having index nodes 4 and 5. Finally, nodes 8, 9, 10 comprise a later feedback unit of index one, 8 being the index node.

F. The inversion of a path

A single constraint or relationship among a number of variables appears topologically as a cascade graph containing one sink and one or more sources. Fig. 10(a) is an elementary example. At least in principle, nothing prevents the solving of the equation in Fig. 10(a) for one of the independent variables, say x_1 , to obtain the form shown in Fig. 10(b). In terms of the flow graph, it may be said, that branch 14 has been inverted.

By definition, the inversion of a branch is accomplished by interchanging the nose and tail of that branch and, in moving the nose, carrying along all other branch noses which touch it. The tails of other branches are left undisturbed. The inversion of a path is effected by inverting each of its branches.

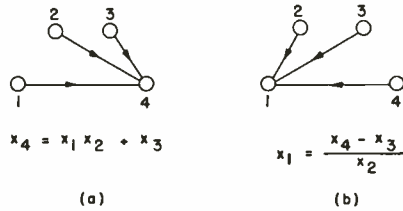

Fig. 10—Inversion of a branch.

Fig. 11 shows (a) a flow graph, (b) the inversion of an open path 1234, and (c) the inversion of a feedback loop 343. To obtain (c) from (a), for example, first change the directions of branches 34 and 43. Then grasp branch *p* by its nose and move the nose to node 4, leaving the tail where it is. Finally, the nose of branch *q* is shifted to node 3. Branches 12 and 32 are unchanged since they have properly minded their own business and kept their noses out of the path inversion. Topologically, the two parallel branches running from 4 to 3 are redundant. One such branch is sufficient to indicate the dependency of x_3 upon x_4 .

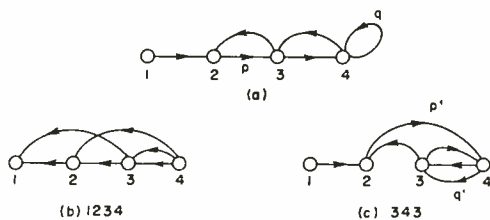

Fig. 11—Path inversions.

The inversion of an open path is significant only if that path starts from a source. Otherwise, two expressions are obtained for the same variable and two nodes with the same number would be needed in the graph. In addition, inversion is not applicable to a feedback loop which intersects itself. The reason is that two of the path branches would terminate upon a common node. Hence the inversion of one would move the other, thereby destroying the path to be inverted. Such paths as 234 and 23432 in Fig. 11(a), therefore, are not candidates for inversion.

The process of inversion, as might be expected, influences the topological properties of a flow graph. Of greatest interest here is the effect upon the index. Graphs (a), (b), and (c) of Fig. 11 have indices of two, zero, and one, respectively. In general, paths parallel to a given path contribute to the formation of feedback loops when the given path is inverted, and conversely.

Hence, should one wish to accomplish a reduction of index, he should choose for inversion a forward path having many attached backward paths but few parallel forward paths.

III. THE ALGEBRA OF LINEAR FLOW GRAPHS

A linear flow graph is one whose associated equations are linear. The basic linear flow graph is shown in Fig. 12. Quantities *a* and *b* are called the branch transmissions, or branch gains. Thinking of the flow graph as a signal transmission system, each branch may be associated with a unilateral amplifier or link. In traversing any branch the signal is multiplied, of course, by the gain of that branch. Each node acts as an adder and ideal repeater which sums the incoming signals algebraically and then transmits the resulting signal along each outgoing branch.

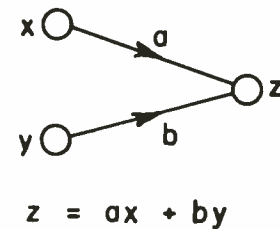

Fig. 12—The basic linear flow graph.

A. Elementary transformations

Fig. 13 illustrates certain elementary transformations or equivalences. The cascade transformation (a) eliminates a node, as does the start-to-mesh transformation (c), of which (a) is actually a special case. The parallel or multipath transformation (b) reduces the number of

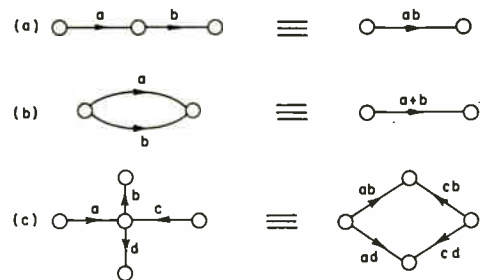

Fig. 13—Elementary transformations.

branches. These basic equivalences permit reduction to an index-residue and give, as a result of the process, the values of branch gains appearing in the residual graph. Fig. 14 offers an illustration. The residual nodes are the source 1, the sink 4, and the index node 2. Node 3 could be chosen instead of node 2, but this would lead to a more complicated residue. The star-to-mesh equivalence eliminates node 3 in graph 14(a) to give graph 14(b). The multipath transformation then yields the residue (c).

For more complicated structures the repeated use of many successive elementary transformations is tedious. Fortunately, it is possible under certain conditions to recognize the branch gains of a residue by direct inspection of the original diagram. In order to provide a sound basis for the more direct process, a path gain shall be defined as the product of the branch gains along that path. In addition, the residual gain G_{jk} is defined as the algebraic sum of the gains of all different residual paths from j to k . As defined previously, a residual path must not pass through any of the residual nodes which are to be retained in the new graph. It follows that each branch gain of the residue is equal to the corresponding residual gain G_{jk} of the original graph. Moreover, if the residual graph is an index-residue, then each G_{jk} is the gain of a cascade structure and contains only sums of products of the original branch gains. For index-residues, therefore, the gains G_{jk} are relatively easy to evaluate by inspection.

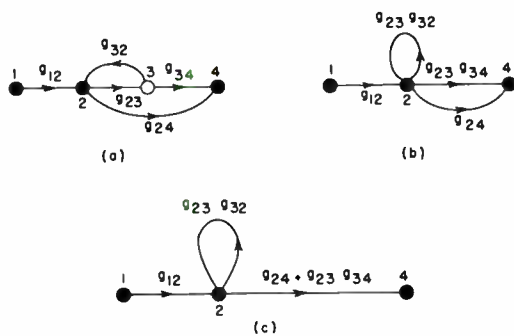

Fig. 14—Reduction to an index-residue by elementary transformations.

The feedback graph of Fig. 15(a), for example, has an index-residue (b) containing four branches. By inspection of the original graph, the residual gains are found to be

$$\begin{aligned}
 G_{13} &= g_{12}g_{23} \\
 G_{15} &= g_{12}g_{25} \\
 G_{33} &= g_{32}g_{23} + g_{34}g_{42}g_{23} + g_{34}g_{43} \\
 G_{35} &= g_{34}g_{45} + g_{32}g_{25} + g_{34}g_{42}g_{25}.
 \end{aligned}
 \tag{5}$$

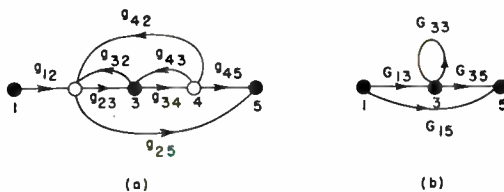

Fig. 15—Reduction to an index-residue by inspection.

Notice that there are three different residual paths from node 3 to itself and also from 3 to 5. Be very careful to account for all of them. There is only one residual path from 1 to 5, however, and this is 125. Path 12345, which

one might be tempted to include in G_{15} , is not residual, since it passes through node 3.

B. The effect of a self-loop

When a feedback graph is simplified to a residue containing only sources, sinks, and index nodes, one or more self-loops appear. The effect of a self-loop at any node upon the signal passing through that node may be studied in terms of Fig. 16(a). The signal existing at the central node is transmitted along the outgoing paths as indicated by the detached arrows. The signal returning via the self-loop is gx , where g is the branch gain of the self-loop. Since signals entering the node must add algebraically to give x , it follows that the external signal entering from the left must be $(1-g)x$. The node and self-loop, therefore, may be replaced by a single branch (b) whose gain is the reciprocal of $(1-g)$. When several branches connect at the node, as in Fig. 16(c), it is easy to see that the proper replacement is that shown in Fig. 16(d). Quantity g is usually referred to as the loop gain and $1-g$ is called the loop difference.

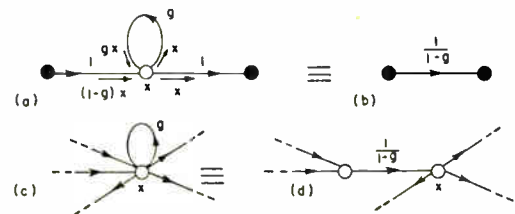

Fig. 16—Replacement of a self-loop by a branch.

Approaching the self-loop effect from another viewpoint, Fig. 16(b) may be treated as the residual form of Fig. 16(a). This is not, of course, an index-residue. The gain G of (b) is the sum of the gains of all residual paths from the source to the sink in (a). One path passes directly through the node, the second path traverses the loop once before leaving, the third path circles the loop twice, and so on. Hence the residual gain is given by the infinite geometrical series

$$G = 1 + g + g^2 + g^3 + \dots = \frac{1}{1-g}
 \tag{6}$$

which sums to the familiar result. The convergence of this series, for $|g| < 1$, poses no dilemma in view of the validity of analytic continuation. The result holds for all values of g except the singular point $g=1$, near which the transmission G becomes arbitrarily large.

The self-loop-to-branch transformation places in evidence the basic effect of feedback as a contribution to the denominator of an expression for the gain of a graph in terms of branch gains. In this algebra, feedback is associated with division or, more generally, with the inversion of a matrix whose determinant is not identically equal to unity.

C. The general index-residue of index one

If attention be restricted to a single source and a single sink, then the most general index-residue of index one, or first-index-residue, is that shown in Fig. 17(a). Other sources or sinks in the system may be considered separately, without loss of generality, since the system is linear and superposition applies. A knowledge of the self-loop-to-branch transformation enables one to write the (source to sink) gain of graph 17(a) by inspection. The gain is

$$G = d + \frac{bc}{1 - a} \quad (7)$$

When the total index of the graph is greater than one, as in Fig. 17(b), it is still a simple matter to find the gain, provided each imbedded feedback unit is only of first index. For graph 17(b)

$$G = g + \frac{ef}{1 - d} + \frac{bcf}{(1 - a)(1 - d)} \quad (8)$$

With practice, the gain of a graph such as that of Fig. 15(a) can be written at a glance, without bothering to make an actual sketch of the residue. The principal source of error lies in the possibility of overlooking a residual path.

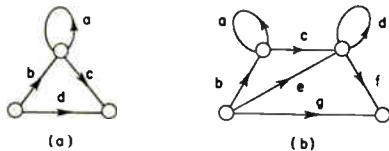

Fig. 17—Residues having first-index feedback units.

Of special interest is the theorem that if each feedback unit in a graph is a simple ring of branches, the gain of that graph is equal to the sum of the gains of all open paths from source to sink, each divided by the loop differences of feedback loops encountered by that path. For illustration, this theorem shall be applied to the graph shown in Fig. 18. There are nine different open paths from the source to the sink and each one makes contact with the feedback loop. The resulting gain is

$$G = \frac{ah + bdh + cgdh + aei + bdei + cgdei + aefj + bdefj + cj}{1 - defg} \quad (9)$$

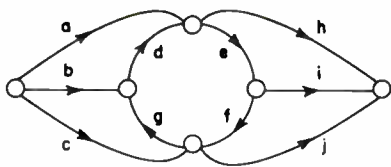

Fig. 18—A simple ring imbedded in a graph.

D. The general index-residue of index two

Again taking one source and one sink at a time, the most general second-index-residue shown in Fig. 19, will be considered.

Suppose that the self-loops are temporarily removed, leaving the simple imbedded ring shown in (b). Graph (b) exhibits five open paths from source to sink, namely *i*, *ab*, *cd*, *afd*, *ceb*; and the last four of these encounter the feedback loop *ef*. Hence the gain of graph (b) is

$$G = i + \frac{ab + cd + afd + ceb}{1 - ef} \quad (10)$$

Now, in order to account for the self-loops *g* and *h* in graph 19(a), each path gain appearing in (10) need only be divided by the loop difference (1-*g*) if that path passes through the upper node, and by (1-*h*) if it passes through the lower node. Paths *afb*, *ceb*, and *ef*, of course, pass through both nodes, and their gains must be divided by both loop differences. The resulting modification of (10) yields the gain of the general second-index-residue

$$G = i + \frac{\frac{ab}{1 - g} + \frac{cd}{1 - h} + \frac{afd + ceb}{(1 - g)(1 - h)}}{1 - \frac{ef}{(1 - g)(1 - h)}} \quad (11)$$

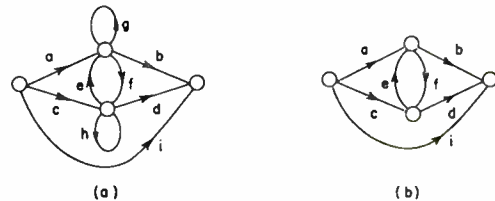

Fig. 19—The general second-index-residue with and without self-loops.

The derivation of this formula is important only as a demonstration of the power of the method. To find the source-to-sink gain of any graph whose feedback units are no worse than second index, we reduce to an index-residue; temporarily remove the self-loops; express the gain as the sum of open path gains, each divided by the loop differences of feedback loops touching that path; and modify the result to account for the original self-loops.

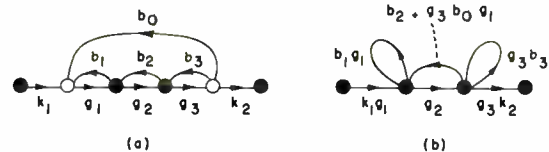

Fig. 20—A three-stage feedback amplifier diagram.

The importance of the method justifies a final example. Fig. 20(a) shows the feedback diagram of a three-stage amplifier having local feedback around each stage and external feedback around the entire amplifier. With the self-loops temporarily removed, the gain of the residue (b) is

$$G = \frac{k_1 g_1 g_2 g_3 k_2}{1 - g_2(b_2 + g_3 b_0 g_1)} \quad (12)$$

Since all paths appearing in (12) touch both index nodes, the actual gain of the amplifier is

$$G = \frac{k_1 k_2 g_1 g_2 g_3}{(1 - b_1 g_1)(1 - b_3 g_3)} \cdot \frac{1}{1 - \frac{g_2(b_2 + b_0 g_1 g_3)}{(1 - b_1 g_1)(1 - b_3 g_3)}} = \frac{k_1 k_2 g_1 g_2 g_3}{(1 - b_1 g_1)(1 - b_3 g_3) - g_2(b_2 + b_0 g_1 g_3)} \quad (13)$$

E. Graphs of higher index

The formal reduction process for an arbitrary feedback graph involves a cycle of two steps. First, reduction to an index-residue; and second, replacement of any one of the self-loops by its equivalent branch. Exactly *n* such cycles are required for reduction to cascade form, where *n* is the total index of the original graph. Transformation of more than one self-loop at a time is often convenient, even though this may increase the total number of self-loop transformations required in later steps. In practice, of course, the formal procedure should be modified to take advantage of the peculiarities of the structure being reduced. The process effectively ends when the index has been reduced to two, since the evaluation of gain by inspection of the index-residue then becomes tractable.

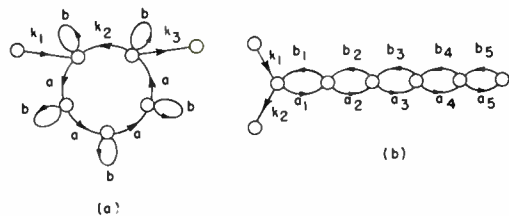

Fig. 21—Simple high-index structures.

Fig. 21 shows two graphs containing high-index feedback units. With the self-loops removed from the circular structure (a), the gain is equal to that of the single open forward path $k_1 a^4 k_3$ divided by the loop difference of the closed path $k_2 a^4$, and we have

$$G = \frac{k_1 a^4 k_3}{1 - k_2 a^4} \quad (14)$$

Since both paths pass through every index node, the reintroduction of the self-loops yields

$$G = \frac{k_1 a^4 k_3}{(1 - b)^5} = \frac{k_1 a^4 k_3}{(1 - b)^5 - k_2 a^4} \quad (15)$$

The feedback chain shown in Fig. 21(b) is of third index. Instead of reducing it to an index-residue, take advantage of the simplicity of the chain structure to write the gain by a more direct method. First, with the

last four loops of the chain removed, the gain is

$$G = \frac{k_1 k_2}{1 - a_1 b_1} \quad (16)$$

Now, the addition of loop $a_2 b_2$ modifies the path gain $a_1 b_1$ to give

$$G = \frac{k_1 k_2}{1 - \frac{a_1 b_1}{1 - a_2 b_2}} \quad (17)$$

Addition of the remaining elements leads to the continued fraction

$$G = \frac{k_1 k_2}{1 - \frac{a_1 b_1}{1 - \frac{a_2 b_2}{1 - \frac{a_3 b_3}{1 - \frac{a_4 b_4}{1 - a_5 b_5}}}}} \quad (18)$$

F. Loop gain and loop difference

Thus far loop gain has been spoken of only in connection with feedback units of the simple ring type. A more general concept of loop gain will now be introduced. The loop gain of a node shall be defined as the gain between the source and sink created by splitting that node. In terms of signal flow, the loop gain of a node is just the signal returned to that node per unit signal transmitted by that node. The loop difference of a node is by definition equal to one minus the loop gain of that node. The symbol *T* shall be used for loop gains and *D* for loop differences. In the graph of Fig. 22(a), for example, the loop gain of node 1 is equal to the gain from 1 to 1' in graph (b), which shows node 1 split into a source 1 and a sink 1'. By inspection

$$T_1 = a + \frac{bc}{1 - d} \quad D_1 = 1 - a - \frac{bc}{1 - d} \quad (19)$$

Another quantity of interest is the loop gain of a branch. Preparatory to its definition, replace the branch in question by an equivalent cascade of two branches, whose path gain is the same as the original branch gain.

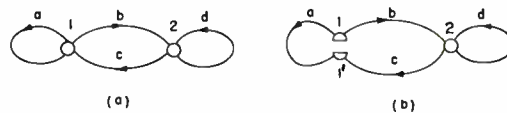

Fig. 22—The loop gain of a node.

This creates a new node, called an interior node of the branch. The loop gain of a branch may now be defined as the loop gain of an interior node of that branch. To find the loop gain of branch *b* in Fig. 22(a), for instance, first introduce an interior node 3 as shown in Fig. 23(a). The loop gain of branch *b* is the gain from 3 to 3' in (b),

$$T_{12}(\text{or } T_b) = \frac{bc}{(1 - a)(1 - d)} \quad (20)$$

The loop gain of a branch can be designated by either a single or double subscript, whichever is a more convenient specification of the branch. The double subscript is usually preferable, since it avoids confusion with the loop gain of a node. The loop gain of a given node (or branch) evidently involves only the gains of branches which are coupled to that node (or branch). Hence, in computing T , we need to consider only the feedback unit containing the node (or branch) of interest.

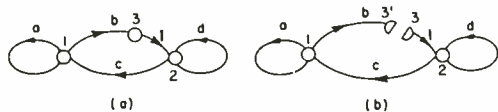

Fig. 23—The loop gain of a branch.

Having defined the loop gain of a node, the simple self-loop equivalence may be extended to a more general form which may be stated as follows. If an external signal x_0 is injected into node k of a flow graph, as shown in Fig. 24, the injection gain from the external source to node k is

$$G_k = \frac{x_k}{x_0} = \frac{1}{1 - T_k} = \frac{1}{D_k} \quad (21)$$

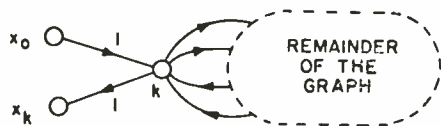

Fig. 24—Injection at node k .

The very nature of the reduction process for an arbitrary (finite) graph implies that the gain is a rational function of the branch gains. In other words, the gain can always be expressed as a fraction whose numerator and denominator are each algebraic sums of various branch gain products. Moreover, the gain G is a linear rational function of any one of the branch gains g . Thus

$$G = \frac{ag + b}{cg + d} \quad (22)$$

where quantities a, b, c, d are made up of other branch gains. To prove this, insert two new interior nodes into the specified branch g , as shown in Fig. 25(a) and (b), and then consider the residue (c), which contains only the source, the sink, and the two interior nodes. The gain of this residue evidently can be expressed as a linear rational function of g . It is also apparent that if branch g is directly connected to either the source or the sink, or to both, then the source-to-sink gain G is a linear function of the branch gain g , that is,

$$G = ag + b \quad (23)$$

where a and b depend upon other branch gains.

The foregoing results apply equally well to loop gains and loop differences, since T and D , by their definitions,

have the character of gains. Any loop difference D_k is a rational function of the branch gains, a linear rational function of any single branch gain, and a linear function of the gain of any branch connected directly to node k .

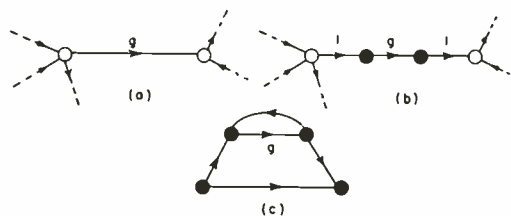

Fig. 25—The graph gain as a function of a particular branch gain.

We shall now derive an important fundamental property of loop differences which is of general interest. Consider an arbitrary graph containing nodes $1, 2, 3, \dots, n$, and let nodes $m+1, m+2, \dots, n-1, n$ be removed, together with their connecting branches, so that only nodes $1, 2, 3, \dots, m$ remain. Now suppose that the graph is reduced to a residue showing only nodes $m-1$, and m , as in Fig. 26. Branches a, b, c, d account

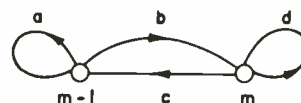

Fig. 26—A residue showing nodes $m-1$ and m .

for all coupling among nodes $1, 2, 3, \dots, m$ of the original graph. Sources and sinks may be ignored, of course, since only feedback branches are of interest in loop difference calculations. Define the partial loop difference D_k' as the loop difference of node k with only the first k nodes taken into account. By inspection of Fig. 26

$$D_m' = 1 - d - \frac{bc}{1 - a} \quad (24)$$

$$D_{m-1}' = 1 - a \quad (25)$$

and

$$D_{m-1}'D_m' = (1 - a)(1 - d) - bc. \quad (26)$$

If the numbers of nodes $m-1$ and m are interchanged in Fig. 26, then

$$D_m' = 1 - a - \frac{bc}{1 - d} \quad (27)$$

$$D_{m-1}' = 1 - d \quad (28)$$

and the product given in (26) is unaltered. Since this result holds for any value of m , and since a sequence may be transformed into any other sequence by repeated adjacent interchanges (1234 can become 4321, for example, by adjacent interchanges 1243, 2143, 2413, 4213, 4231, 4321), it follows that the product

$$\Delta_m' = D_1'D_2'D_3' \dots D_{m-1}'D_m' \quad (29)$$

is independent of the order in which the first m nodes are numbered. With all n nodes present, $D_n' = D_n$ and

$$\Delta = D_1'D_2'D_3' \dots D_{n-1}'D_n. \quad (30)$$

Quantity Δ , which shall be called the determinant of the graph, is invariant for any order of node numbering. Equation (30) shows that the determinant of any graph is the product of the determinants of its imbedded feedback units, and that the determinant of a cascade graph is unity.

The dependence of Δ upon the branch gains may be deduced as follows. Let g be any branch directly connected to node n , whence it follows that D_n is a linear function of branch gain g and that the partial loop differences D_k' are independent of g . Hence Δ is a linear function of g . Since the numbering of nodes is arbitrary, Δ must be a linear function of any given branch gain in the graph. The determinant Δ , therefore, is composed of an algebraic sum of products of branch gains, with no branch gain appearing more than once in a single product.

From (29) and (30) it follows that D_n is the ratio of Δ to Δ_{n-1}' . Since the node number is arbitrary,

$$D_k = \frac{\Delta}{\Delta_k} \tag{31}$$

where Δ_k is to be computed with node k removed. Once Δ is expressed in terms of branch gains, Δ_k may be found by nullifying the gains of branches connected to node k .

The introduction of an interior node into any branch leaves the value of Δ unaltered. To prove this the new node may be numbered zero, whence $D_0' = 1$ and the other partial loop differences are unchanged. It follows directly that the loop difference of any branch jk is given by

$$D_{jk} = \frac{\Delta}{\Delta_{jk}} \tag{32}$$

where Δ_{jk} is to be computed with branch jk removed, that is, with $g_{jk} = 0$.

Incidentally, by writing the linear equations associated with the flow graph and then evaluating the injection gain G_k by Kramer's rule (that is, by inverting the matrix of the equations), it is found from (21) and (31) that Δ is just the value of the determinant of these equations.

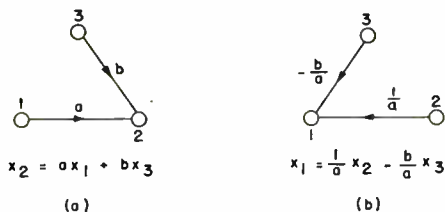

Fig. 27—Branch inversion in a linear graph.

G. Inverse gains

We have seen how the structure of a flow graph is altered by the inversion of a path. For linear graphs it is profitable to continue with an inquiry into the quantitative effects of inversion. Fig. 27(a) shows two branches which may be imagined to form part of a

larger graph. The signal entering node 2 via branch b is bx_3 . The contribution arriving from branch a , then, must be $x_2 - bx_3$, since the sum of these two contributions is equal to x_2 . Hence, given x_2 and x_3 , the required value of x_1 is that indicated by graph (b).

The general scheme is readily apparent and may be stated as follows. The inversion of any branch jk is accomplished by reversing that branch and inverting its gain, and shifting any other branch ik having the same nose location k to the new position ij and dividing its gain by the negative of the original branch gain g_{jk} .

For gain calculations, the usefulness of inversion lies in the fact that the inversion of a source-to-sink path yields a new graph whose source-to-sink gain is the inverse of the original source-to-sink gain. Since inversion may accomplish a reduction of index, the inverse gain may be much easier to find by inspection.

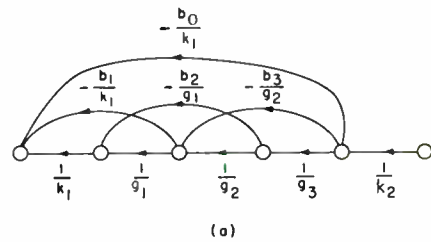

Fig. 28—The result of path inversion in Fig. 20(a).

For illustration, path $k_1g_1g_2g_3k_2$ shall be inverted in Fig. 20(a) to obtain the graph shown in Fig. 28. The new graph is a cascade structure of zero index. By inspection of the new graph, the inverse gain of the original graph is

$$\frac{1}{G} = \frac{1}{k_2} \left[\left(\frac{1}{g_3g_2} - \frac{b_3}{g_2} \right) \left(\frac{1}{g_1k_1} - \frac{b_1}{k_1} \right) - \frac{b_2}{g_3g_1k_1} - \frac{b_0}{k_1} \right] \tag{33}$$

Simplification yields

$$\frac{1}{G} = \frac{1}{k_1k_2} \left[\frac{1}{g_2} \left(\frac{1}{g_1} - b_1 \right) \left(\frac{1}{g_3} - b_3 \right) - \frac{b_2}{g_1g_3} - b_0 \right] \tag{34}$$

which proves to be identical with (13).

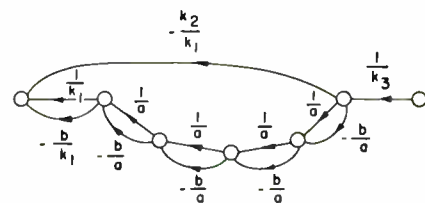

Fig. 29—The result of path inversion in Fig. 21(a).

A simpler example is offered by Fig. 21(a). Inversion of the open source-to-sink path gives the structure shown in Fig. 29. By inspection of the new graph, it is found

$$\begin{aligned} \frac{1}{G} &= \frac{1}{k_3} \left[\left(\frac{1}{a} - \frac{b}{a} \right)^4 \left(\frac{1}{k_1} - \frac{b}{k_1} \right) - \frac{k_2}{k_1} \right] \\ &= \frac{(1-b)^5}{k_1k_3a^4} - \frac{k_2}{k_1k_3} \end{aligned} \tag{35}$$

which checks (15).

II. Normalization

In the general analysis of an electrical network it is often convenient to alter the impedance level or the frequency scale by a suitable transformation of element values. A similar normalization sometimes proves useful for linear flow graph analysis. The self-evident normalization rule may be stated as follows. If each branch gain g_{jk} is multiplied by a scale factor f_{jk} , with the scale factors so chosen that the gains of all closed paths are unaltered, then the gain of the graph is multiplied by $f_{12}f_{23} \cdots f_{mn}$, where 1, 2, 3, \dots , m , n is any path from the source 1 to the sink n .

Fig. 30 illustrates a typical normalization. Graph (a) might represent a two-stage amplifier with isolation between the two stages, local feedback around each stage, and external feedback around both stages. The normalization shown in (b) brings out very clearly the fact that certain branch gains may be taken as unity without loss of generality.

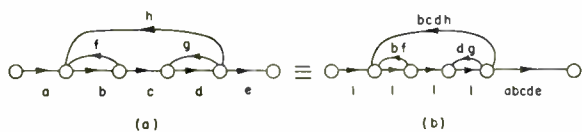

Fig. 30—Normalization.

IV. ILLUSTRATIVE APPLICATIONS OF FLOW GRAPH TECHNIQUES

The usefulness of flow graph techniques for the solution of practical analysis problems is limited by two factors: ability to represent the physical problem in the form of a suitable graph, and facility in manipulating the graph. The first factor has not yet been considered. It can be turned to now with the necessary background material at hand.

The process of constructing a graph is one of tracing a succession of causes and effects through the physical system. One variable is expressed as an explicit effect due to certain causes; they, in turn, are recognized as effects due to still other causes. In order to be associated with a single node, each variable must play a dependent role only once. A link in the chain of dependency is limited in extent only by one's perception of the problem. The formulation may be executed in a few complicated steps or it may be subdivided into a larger number of simple ones, depending upon one's judgment and knowledge of the particular system under consideration. No specific rules can be given for the best approach to an analysis problem. Therein lies the challenge and the possibility of an elegant solution. Whatever the approach, flow graphs offer a structural visualization of the interrelations among the chosen variables. It is quite possible, of course, to construct an incorrect graph, just as it is entirely possible to write a set of equations which do not properly represent the physical problem. The direct formulation of a flow graph from a physical problem, without actually writing the chosen equations, requires some practice before confidence is gained. It is hoped that the following examples, taken mostly from electronic circuit analysis, will be suggestive.

A. Voltage gain calculations

Fig. 31(a) shows the low-frequency linear incremental approximate model of a cathode follower. Suppose that we want to find the gain E_2/E_1 in terms of the circuit constants. By proceeding cautiously in small steps, the graph shown in Fig. 31(b) might be constructed. This graph states that $E_g = E_1 - E_2$, $E_g' = \mu E_g - E_2$, $I_p = E_g'/r_p$, and $E_2 = R_k I_p$. Alternatively, were one able to recognize at the outset the direct dependence of E_2 upon E_g , then graph 31(c) could have been sketched by inspection of the circuit. The more extensive one's powers of perception, the simpler the formulation. Powerful perception (or a familiarity with the cathode follower) would permit one to construct graph 31(d) directly from the network shown in Fig. 31(a). The reader is invited to evaluate the gains of graphs 31(b) and (c) by inspection, and compare them with (d).

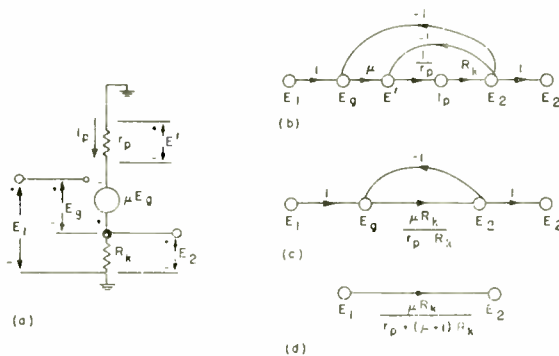

Fig. 31—Flow graphs for a cathode follower.

Another example is offered by the amplifier of Fig. 32(a). For convenience of illustration, the impedances and the transconductance have been given numerical values. In this circuit the grid voltage influences the output voltage both by transconductance action and by direct coupling through the grid-to-plate impedance. To avoid confusion between the actual voltage E_g and the factor E_g appearing in the transconductance current it is very helpful to designate one of them with a prime while setting up the graph. This distinction splits node E_g . It is a simple matter to complete the graph with a unity-gain branch representing the equation $E_g' = E_g$ which effectively rejoins the node.

The direct application of superposition, with voltage E_1 and current $5E_g'$ treated as independent electrical sources, each influencing the dependent quantities E_g and E_2 , leads to graph (b) of Fig. 32. The gain from E_g' to E_g for example, is the product of a transconductance 5, a current division ratio 4/9, and an impedance 2, as measured with $E_1 = 0$.

An alternative approach, actually equivalent to classical network formulation on the electrical-node-pair-voltage basis, gives graph 32(c). Here E_2 is expressed as a function of E_g and E_g' . In accordance with superposition, the gain from E_g' to E_2 must be computed with $E_g = 0$ (rather than $E_1 = 0$, as in the previous graph). Hence, in this particular calculation, the impedance presented to the current source does not include element 2.

The other independent electrical-node-pair voltage E_g is expressed in terms of E_1 and E_2 , as shown.

Graph 32(d), a third possibility, is actually the simplest and most elegant of the three. Responding to a certain physical appeal, express E_g in terms of the electrical sources, as in graph 32(b). Taking advantage

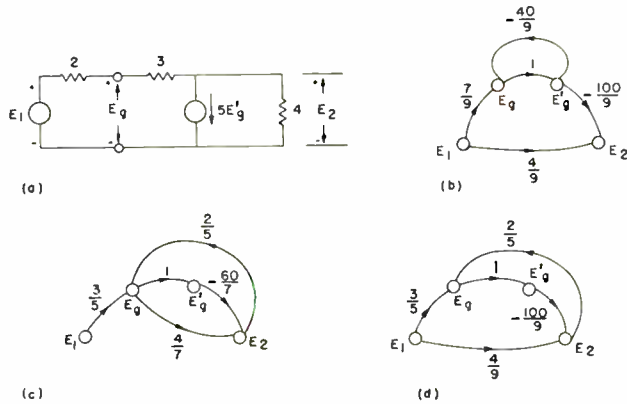

Fig. 32—An amplifier with grid-to-plate impedance.

of the fact that E_2 and $5E_g'$ are across the same electrical node-pair, formulate E_g in terms of E_1 and E_2 as in graph 32(c). This has topological appeal, since the resulting feedback loop touches both open paths from E_1 to E_2 . As a result, the graph gain is obtained as a simple function of the branch gains. The verification of graphs (b), (c), and (d) of Fig. 32 and the evaluation of their gains is suggested as an exercise for the reader. The answer is $-8/7$. If symbols are substituted for the numerical element values in the circuit, the suitability of the structure of Fig. 32(d) for this particular problem becomes more apparent.

present problem. Notice that the structure of Fig. 33(b) is obtainable directly from that of Fig. 32(b) by inversion of the source-to-sink branch.

The three gains of interest in Fig. 33(b) are

$$Z_0 = \left(\frac{E}{I} \right)_{Eg'=0} = \text{the impedance without feedback.} \quad (36)$$

$$T_{g'sc} = \left(\frac{E_g}{E_g'} \right)_{E=0} = \text{the short-circuit loop gain} = T_1. \quad (37)$$

$$T_{g'oc} = \left(\frac{E_g}{E_g'} \right)_{I=0} = \text{the open-circuit loop gain} = T_1 + T_2 \quad (38)$$

The terminal impedance is given by the graph gain

$$Z = \frac{Z_0}{1 - \frac{T_2}{1 - T_1}} = Z_0 \left(\frac{1 - T_1}{1 - T_1 - T_2} \right) \quad (39)$$

which may be identified as the well-known feedback formula

$$Z = Z_0 \left(\frac{1 - T_{g'sc}}{1 - T_{g'oc}} \right). \quad (40)$$

The conclusion is that flow graph methods provide a relatively uncluttered derivation of this classical result.

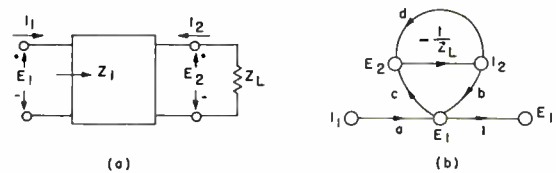

Fig. 34—The effect of load impedance upon input impedance.

Flow graph representation also brings out the similarities between feedback formulas for electronic circuits and compensation theorems for passive networks. Consider, for comparison, the determination of the input impedance of the circuit shown in Fig. 34(a).

Superposition tells us that the branch gains of the accompanying graph, Fig. 34(b), have the physical interpretations

$$Z_{1oc} = \left(\frac{E_1}{I_1} \right)_{I_2=0} = \text{open-circuit input impedance} = a. \quad (41)$$

$$Z_{2oc} = \left(\frac{E_2}{I_2} \right)_{I_1=0} = \text{open-circuit output impedance} = bc + d. \quad (42)$$

$$Z_{2sc} = \left(\frac{E_2}{I_2} \right)_{E_1=0} = \text{short-circuit output impedance} = d. \quad (43)$$

By analogy with the previous problem

$$Z_1 = Z_{1oc} \frac{1 + \frac{Z_{2sc}}{Z_L}}{1 + \frac{Z_{2oc}}{Z_L}} = Z_{1oc} \left(\frac{Z_L + Z_{2sc}}{Z_L + Z_{2oc}} \right). \quad (44)$$

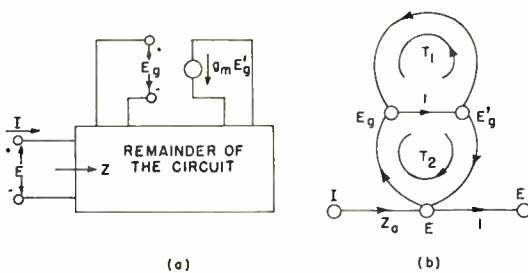

Fig. 33—The circuit and graph for terminal impedance formulation.

B. The impedance formula

Suppose that the input or output impedance Z of an electronic circuit is influenced by a certain tube transconductance in such a manner that the effect is not immediately obvious. To find Z one must introduce a set of variables and write the equations relating them. Choose the terminal current and voltage, I and $E = IZ$, together with the grid voltage E_g of the offending tube, as shown in Fig. 33(a). The graphical structure which naturally suggests itself, perhaps, is that of the previous problem, Fig. 32(b), with a source I and a sink E . Since E and I are located at the same pair of terminals, however, it is just as easy to express E_g in terms of E_g' and E , rather than E_g' and I . This choice gives graph (b) of Fig. 33, which is particularly convenient for the

C. A wave reflection problem

The transmission line shown in Fig. 35(a) has two shunt discontinuities spaced θ electrical radians apart. A voltage wave of complex amplitude A is incident upon the first discontinuity from the left. It is desired to find the resulting reflection B and the transmitted wave E . Let C, D, C', D' be the waves traveling in opposite directions just to the right of the first obstacle and just to the left of the second. In addition, let r and t denote the per unit reflection or transmission of a single discontinuity.

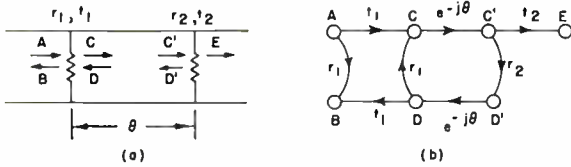

Fig. 35—Two discontinuities on a transmission line.

The accompanying graph 35(b) is self-explanatory. The only feedback loop present is the simple ring $CC'D'DC$. By inspection of this graph, the over-all reflection and transmission coefficients are

$$\frac{B}{A} = r_1 + \frac{t_1^2 r_2 e^{-j2\theta}}{1 - r_1 r_2 e^{-j2\theta}} \quad (45)$$

$$\frac{E}{A} = \frac{t_1 t_2 e^{-j\theta}}{1 - r_1 r_2 e^{-j2\theta}} \quad (46)$$

applies. By designing the incremental circuit for infinite gain, the transfer curve becomes vertical at point p , and the switching interval is made desirably small.

Assume for simplicity that the voltage divider feeding the second grid has a resistance much greater than R_1 (or let R_1 denote the combined parallel resistance). Now attempt to formulate E_1 in terms of E_0 and E_k by superposition. When $E_k = 0$, the ratio E_1/E_0 is simply the gain of a grounded-cathode stage. Similarly, with $E_0 = 0$, the first tube becomes a grounded-grid stage driven by E_k . This gives branches 01 and $k1$ in the flow graph shown in Fig. 36(d). Branches 12 and $k2$ follow the same pattern for the second tube. Now E_k can be formulated in a convenient manner. One possibility is the computation of the two tube currents $-I_1/R_1$ and $-I_2/R_2$, whose sum may be multiplied by R_k to obtain E_k , as shown.

The resulting graph is of index one, and either E_k or I_k may be taken as the index node. The index-residue would have the familiar form shown in Fig. 17(a). For infinite gain one need only specify that the loop gain of node E_k (or node I_k , or branch R_k) must be unity. By inspection of the graph, the three paths entering T_k are $k12k$, $k1k$, and $k2k$. Hence

$$T_k = R_k \left[\frac{k(\mu_1 + 1)\mu_2 R_1}{(r_{p1} + R_1)(r_{p2} + R_2)} - \frac{\mu_1 + 1}{r_{p1} + R_1} - \frac{\mu_2 + 1}{r_{p2} + R_2} \right] = 1. \quad (47)$$

It is a simple matter to solve (47) for the desired value of the voltage divider parameter k .

V. CONCLUDING REMARKS

The flow graph offers a visual structure, a universal graphical language, a common ground upon which causal relationships among a number of variables may be laid out and compared. From this viewpoint the similarity between two physical problems arises not from the arrangement of physical elements or the dimensions of the variables but rather from the structure of the set of relationships which we care to write.

The organization of the problem comes from within our minds and feedback is present only if we perceive a closed chain of dependency. The challenge facing us at the start of an analysis problem is to express the pertinent relationships as a meaningful and elegant flow graph. The topological properties of the graph may then be exploited in the manipulations and reductions leading to a solution.

ACKNOWLEDGMENT

The influence of H. W. Bode is clear and present in this paper, as will be obvious to anyone familiar with his work. The writer is particularly indebted to E. A. Guillemin and G. T. Coate, and also to J. B. Wiesner, W. K. Linvill, and W. H. Huggins, for many helpful ideas, criticisms, and encouragements.

D. A limiter design problem

Fig. 36(a) shows a vacuum-tube circuit commonly employed as a two-way limiter or level selector. The static transfer curve shown in Fig. 36(b) exhibits a high-gain central region limited on each side by cutoff. In the neighborhood of point p , where both tubes are conducting, the linear incremental circuit of Fig. 36(c)

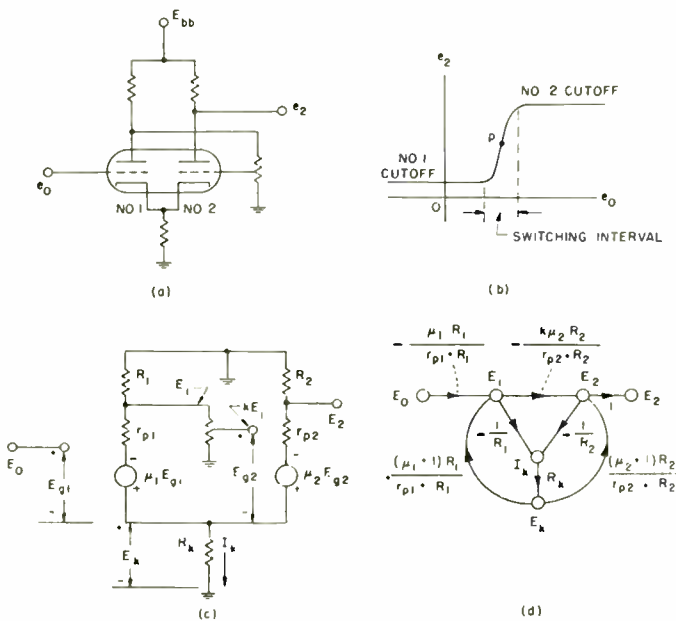

Fig. 36—A cathode-coupled limiter.

Measurements of Detector Output Spectra by Correlation Methods*

LOUIS WEINBERG†‡ AND L. G. KRAFT†, MEMBERS, IRE, 1953

Summary—The correlation technique is applied experimentally to determine the power density spectra of the output of two nonlinear devices, the linear and square-law rectifiers. Curves of the input and output autocorrelation functions obtained experimentally for inputs of filtered noise with and without a sine wave are compared with the theoretically calculated curves, and thus an experimental check on some known theoretical results is obtained.

INTRODUCTION

IN THE PAST DECADE much study has been directed to the mathematical analysis of random noise in communication systems.¹ Theoretical contributions pertinent to the work described in this report have been made by many investigators, among them Rice^{2,3} and Middleton^{4,5}. Rice's papers present a unified view of the basic methods of noise analysis for both linear and nonlinear circuits. Following his lead Middleton has solved a large number of nonlinear problems of practical importance.

The mathematical analysis is exceedingly complex. There exists, as a consequence, a considerable need for the development of experimental techniques by means of which the important statistical characteristics of random noise in electrical circuits can be determined. These techniques, once developed, can be used for checking existing theoretical results and for the solution of problems not yet susceptible to theoretical analysis. A method that has proved extremely useful in theoretical investigation is the correlation method. This method consists of first finding the autocorrelation function and then by a Fourier transformation of the function determining the power density spectrum.

There are available in the Research Laboratory of Electronics, M.I.T., an electronic digital correlator⁶ for

the experimental determination of correlation functions and machines like the electronic differential analyzer⁷ and the delay-line filter⁸ for accomplishing a Fourier transformation. The correlation method can thus be applied experimentally. Work in this direction was done in 1949 by Knudtson,⁹ whose experimental study was confined to linear circuits.

This report extends the range of experimental investigation by the correlation technique to include nonlinear devices, namely, the linear and square-law rectifiers. The first part presents a summary of the pertinent mathematical theory, particular attention being paid to the demonstration of a method which is applicable to the solution of nonlinear circuits. This is the characteristic-function method, in which the autocorrelation function is found through the intermediary of the characteristic function. The second part concerns itself with a discussion of the circuits and experimental technique and a presentation of the results obtained in the form of discrete points which are compared with the theoretically calculated curves.

PART I. PERTINENT STATISTICAL THEORY

A. Autocorrelation Function, Power Density Spectrum

An important statistical characteristic of a stationary random function such as a noise voltage is its autocorrelation function. If $f_1(t)$ represents the random function, the autocorrelation function $\phi_{11}(\tau)$ of $f_1(t)$ ¹⁰ is given by

$$\phi_{11}(\tau) = \lim_{T \rightarrow \infty} \frac{1}{2T} \int_{-T}^T f_1(t) f_1(t + \tau) dt. \quad (1)$$

It is often convenient in this report to make use of the normalized autocorrelation function defined as

$$\rho_{11}(\tau) = \frac{\phi_{11}(\tau)}{\phi_{11}(0)} = \frac{\lim_{T \rightarrow \infty} \frac{1}{2T} \int_{-T}^T f_1(t) f_1(t + \tau) dt}{\lim_{T \rightarrow \infty} \frac{1}{2T} \int_{-T}^T f_1^2(t) dt}. \quad (2)$$

* Decimal classification: R362. Original manuscript received by the Institute, September 17, 1952; revised manuscript received April 8, 1953. The research reported in this paper was supported in part by the Signal Corps, the Air Materiel Command, and the Office of Naval Research. The paper represents a condensation of "Experimental Study of Nonlinear Devices by Correlation Methods," Technical Report No. 178, Research Laboratory of Electronics, M.I.T., January, 1951.

† Research Laboratory of Electronics, Massachusetts Institute of Technology, Cambridge, Massachusetts.

‡ At present with Hughes Research and Development Laboratories, Culver City, California.

¹ D. B. Armstrong, "A Survey of the Theory of Random Noise; its Behavior in Electronic Circuits," Seminar Paper, Dept. of Elec. Eng. M.I.T. 1950.

² S. O. Rice, "Mathematical analysis of random noise," *B.S.T.J.*, vol. 23, pp. 282-332, 1944; 24, pp. 46-156.

³ S. O. Rice, "Statistical properties of a sine wave plus random noise," *B.S.T.J.*, vol. 27, pp. 109-157; 1948.

⁴ D. Middleton, "The response of biased, saturated linear and quadratic rectifiers to random noise," *Jour. App. Phys.*, vol. 17, no. 10, pp. 778-801; 1946.

⁵ D. Middleton, "Some general results in the theory of noise through nonlinear devices," *Quarterly of Applied Math.*, vol. 5, pp. 445-498; 1948.

⁶ H. E. Singleton, "A Digital Electronic Correlator," Technical Report No. 152, Research Laboratory of Electronics, M.I.T. 1950.

⁷ A. B. Macnee, "An Electronic Differential Analyzer," Technical Report No. 90, Research Laboratory of Electronics, M.I.T. 1948.

⁸ C. A. Stutt, "Experimental Study of Optimum Filters," Technical Report No. 182, Research Laboratory of Electronics, M.I.T. 1951.

⁹ N. Knudtson, "Experimental Study of Statistical Characteristics of Filtered Random Noise," Technical Report No. 115, Research Laboratory of Electronics, M.I.T. July 1949.

¹⁰ Y. W. Lee, "Application of Statistical Methods to Communication Problems," Technical Report No. 181, Research Laboratory of Electronics, M.I.T. September 1950.

An important use of the autocorrelation function resides in the fact that the power density spectrum $\Phi_{11}(\omega)$ can be directly obtained from it. Wiener's Theorem relates the two as a Fourier cosine-transform pair. Thus we may write

$$\Phi_{11}(\omega) = \frac{1}{2\pi} \int_{-\infty}^{\infty} \phi_{11}(\tau) \cos \omega\tau d\tau, \quad (3)$$

and

$$\phi_{11}(\tau) = \int_{-\infty}^{\infty} \Phi_{11}(\omega) \cos \omega\tau d\omega. \quad (4)$$

It can be shown¹⁰ that if $f_1(t)$ represents the input to a linear network and $f_2(t)$ the output, as shown in Fig. 1, then

$$\Phi_{22}(\omega) = |H(\omega)|^2 \Phi_{11}(\omega) \quad (5)$$

where $\Phi_{11}(\omega)$ and $\Phi_{22}(\omega)$ are the power density spectra of $f_1(t)$ and $f_2(t)$, respectively, and $H(\omega)$ represents the system function of the network. Of course, no such simple relationship exists for a nonlinear network.

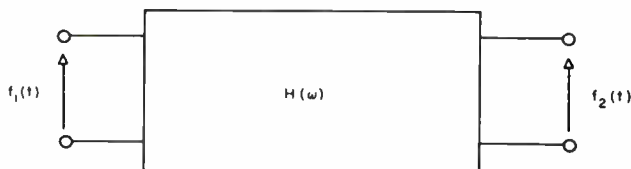

Fig. 1—Representation of linear network.

B. Characteristic Function: Probability Distribution Density, Ergodic Theorem, Moments

A statistical property that is extremely useful in the study of nonlinear circuits is the characteristic function. Preliminary to its definition, some basic definitions must be established. If $y(t)$ represents a stationary random variable and $p(y)dy$ is the probability that y lies between y and $y+dy$, then $p(y)$ is called the probability distribution density of the variable y . The average value of y , \bar{y} , is

$$\bar{y} = \int y p(y) dy, \quad (6)$$

the integral extending over the whole range of possible values of y . The Ergodic Theorem states that the average with respect to the time t of the stationary random variable $y(t)$ is equal to \bar{y} , and thus another method is provided for determining \bar{y} .

The average of a function of y is given in the same manner, so that

$$\overline{y^n} = \int y^n p(y) dy. \quad (7)$$

The averages evaluated by (7) are called the n th moments of the distribution $p(y)$.

Now the characteristic function can be defined. It is

a particular combination of the moments which gives the average value of e^{izy} , where z is a real variable. Letting $\psi(z)$ represent the characteristic function, we have

$$\begin{aligned} \psi(z) &\equiv \overline{e^{izy}} \\ &= \overline{\left[\sum_{n=0}^{\infty} \frac{(izy)^n}{n!} \right]} \\ &= \overline{\left[1 + \frac{izy}{1!} + \frac{(izy)^2}{2!} + \frac{(izy)^3}{3!} + \dots \right]} \\ &= 1 + iz\bar{y} + \frac{(iz)^2}{2!} \overline{y^2} + \frac{(iz)^3}{3!} \overline{y^3} + \dots \\ &= \sum_{n=0}^{\infty} \frac{(iz)^n}{n!} \overline{y^n}. \end{aligned} \quad (8)$$

But the average of e^{izy} is also given by

$$\overline{e^{izy}} = \int e^{izy} p(y) dy \quad (9)$$

where the integration is carried out for the complete range of values of y , so that we may place infinite limits on the above integral. The right-hand side of (9) we now recognize as an inverse Fourier transform; thus $p(y)$ is the Fourier transform of the characteristic function, and is therefore determined uniquely by

$$p(y) = \frac{1}{2\pi} \int_{-\infty}^{\infty} \psi(z) e^{-izy} dz. \quad (10)$$

Equation 10 represents the first important theorem on the characteristic function. A second important theorem derives from the following: if the characteristic functions of two independent random variables y and x are respectively $\psi(z)$ and $\xi(z)$, then the characteristic function $\zeta(z)$ of the distribution of the sum $y+x$ is given by the product; thus

$$\zeta(z) = \psi(z) \cdot \xi(z). \quad (11)$$

C. Contour Integral Representation of a Nonlinear Device

A useful, often essential artifice for solution of nonlinear problems is the representation of the transfer characteristic of the nonlinear portion of the circuit by a complex integral. For example, if a voltage V is applied to input of a nonlinear device, output current $I(V)$ may be written as an inverse Laplace transform^{2*}

$$I(V) \equiv L^{-1}[F(s)] \equiv \frac{1}{2\pi i} \int_C F(s) e^{sV} ds \quad (12)$$

where $F(s)$ is the direct transform,

$$F(s) \equiv L[I(V)] \equiv \int_0^{\infty} I(V) e^{-sV} dV \quad (13)$$

* Other transforms may also be used so that I need not be zero for negative V .

and C' is a Bromwich path parallel to the imaginary axis and to the right of all singularities.

The substitution $s = iu$ in (12) gives

$$I(V) = \frac{1}{2\pi} \int_C F(iu)e^{iuV} du \quad (14)$$

and changes the path of integration to one along the real axis from $-\infty$ to $+\infty$ with a downward indentation at the origin to avoid a pole or branch point.

D. Fundamental Formula of Characteristic-Function Method

We are now able to demonstrate Rice's derivation² of the fundamental formula of the characteristic-function method for obtaining the output autocorrelation function of nonlinear circuits. Writing (1) for the output current, we have

$$\phi_{22}(\tau) = \lim_{T \rightarrow \infty} \frac{1}{2T} \int_{-T}^T I(t)I(t + \tau) dt. \quad (15)$$

Substituting (14) and rearranging give

$$\phi_{22}(\tau) = \frac{1}{4\pi^2} \int_C F(iu) du \int_C F(iv) dv \cdot \lim_{T \rightarrow \infty} \frac{1}{2T} \int_{-T}^T \exp [iuV(t) + ivV(t + \tau)] dt. \quad (16)$$

The limit in the above equation is recognized as the characteristic function of the distribution of the sum of two random variables, $V(t)$ and $V(t + \tau)$. Denote this characteristic function by $g(u, v; \tau)$. Then,

$$\phi_{22}(\tau) = \frac{1}{4\pi^2} \int_C F(iu) du \int_C F(iv) g(u, v; \tau) dv \quad (17)$$

which is the fundamental formula of the characteristic-function method. To obtain the power density spectrum of the output current I , it is necessary to evaluate the above integral and its Fourier cosine transform,

$$\Phi_{22}(\omega) = \frac{1}{2\pi} \int_{-\infty}^{\infty} \phi_{22}(\tau) \cos \omega\tau d\tau. \quad (18)$$

PART II. EXPERIMENTAL STUDY

A. Circuit Details

A block diagram of the essential components used in the experimental procedure is shown in Fig. 2. White noise is by definition noise that has a uniform power-density spectrum over a frequency range that is large compared to the range of interest, which in this experiment is the filter bandwidth. The source of white noise employed a 6D4 gas triode as the primary noise generator.* Monitoring of the rectifier input and the rectifier bias voltages was accomplished by use of the thermocouple and d-c meters, respectively.

* Equipment designed by C A. Stutt. See ¹¹ for circuit diagram.

The band-pass filter, the amplifier, and the nonlinear element were incorporated in one chassis. From the circuit diagram in Fig. 3, it is seen that the filter is a simple RLC parallel-tuned circuit, whose Q may be varied in steps by use of the ganged switch. This switch varies both series and parallel resistance in order to provide approximately constant voltage across the tuned circuit for the different Q 's. Tapping the condenser of the tuned circuit serves the dual purpose of impedance transformation and voltage step-up.

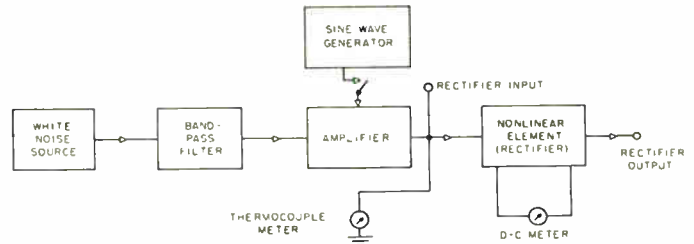

Fig. 2—Block-diagram representation of circuit.

After linear amplification of the filtered random noise by the first three tubes, the noise is fed to a cathode follower, which serves as a low internal resistance voltage source for the nonlinear element. The cathode resistances in the amplifier stages are unbypassed for increased linearity of amplification. When a noise plus sine-wave input was desired, an oscillator was connected through an appropriate RC combination to the plate of tube V-3.

The negative 150-volt connection to the resistance in the cathode-follower circuit is used to cancel the positive direct voltage developed across the cathode resistance. Thus the net direct voltage across the nonlinear element can be adjusted to give zero bias. For the linear rectifier a 9005 tube was found satisfactory. A series connection of eight 1N48 diodes and a 100-ohm resistor was substituted for the 9005 and its load resistance to provide an approximately square-law characteristic; a plot on log-log coordinates of the measured points of the characteristic is shown in Fig. 4. It is clear that the basic circuit of the experiment can be reduced to the one shown in Fig. 5, where switch "a" is considered closed for an input of noise alone.

B. Experimental Procedure

The resonant frequency of the band-pass filter was 23 kc/sec, and the sine-wave generator was set to this frequency. The linear and square-law rectifiers were studied by obtaining autocorrelation curves of the rectifier input and output for a number of Q -values of the resonant circuit and for an input of noise with and without a sine wave.

The autocorrelation function is recorded by the digital correlator in two forms. In one, a multiple pen Esterline-Angus Recorder records a number in binary-digital form for each τ -step. An example of such a record is shown in Fig. 6. The second form of recording is made

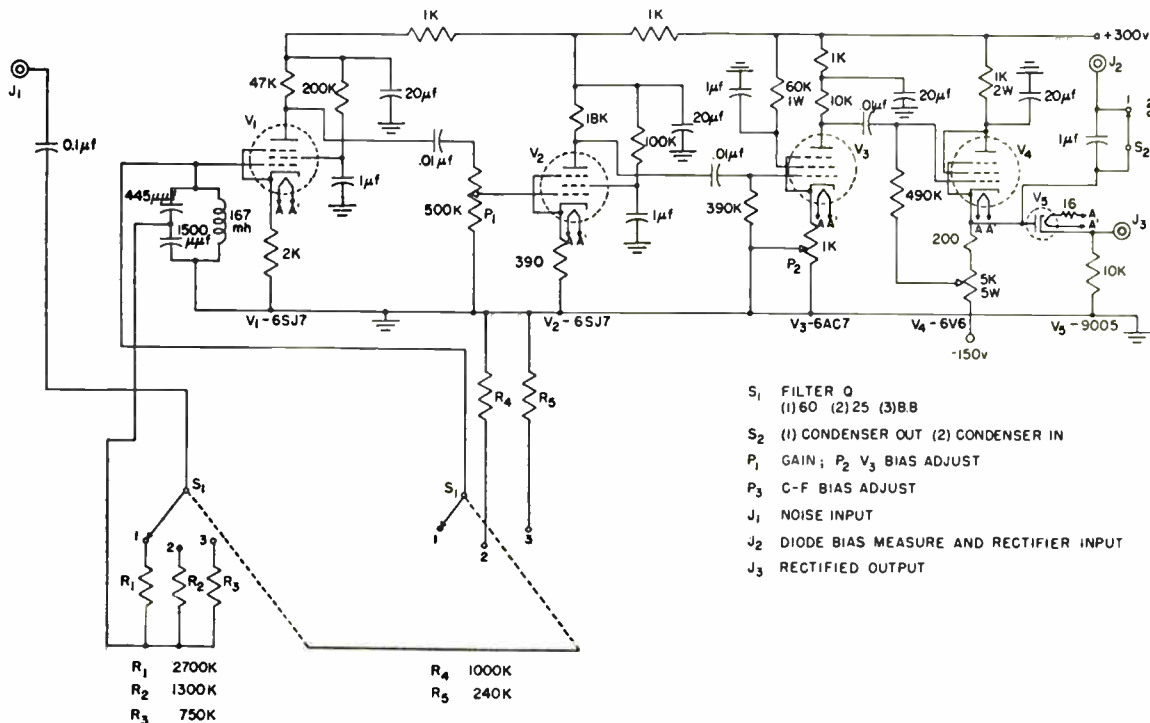

Fig. 3—Circuit diagram of amplifier including band-pass filter and nonlinear element.

by a General Electric Recording Microammeter; this record gives an immediate visual check on results. Some examples of the curves obtained by the second method of recording are shown by the photographs of Fig. 7.

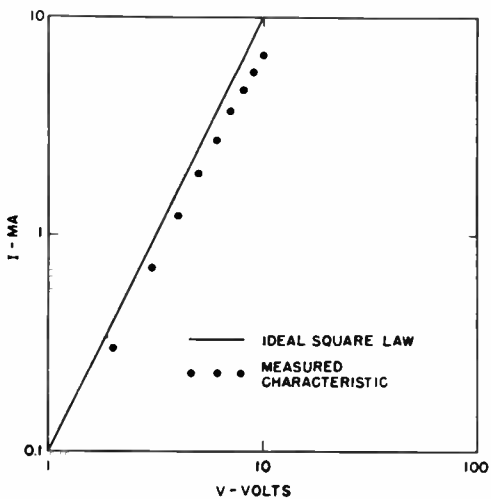

Fig. 4—Volt-ampere characteristic of square-law rectifier (log-log coordinates).

In obtaining each point of the correlation curve, the correlator obtains pairs of samples of the amplitude of the voltage waveform, multiplies the members of each pair and sums many such products. Approximately 31,000 pairs of samples were obtained over a period of about one minute of the signal for the curves of Fig. 7 with 2- μ sec spacing, and double this number of samples and period of signal for the 4- μ sec spacing of some of the other curves.

During the course of obtaining the correlation curves,

it became apparent that it was possible to alter the correlator itself to accomplish the rectification function of the 9005 tube or the 1N48 diodes. This was done by causing the number-generating part of the digital correlator to limit at the rectification level desired, that is, the high-speed counter of the number generator was arranged so that it stopped at the half-full level. This corresponds to biasing the rectifiers at zero voltage. In the

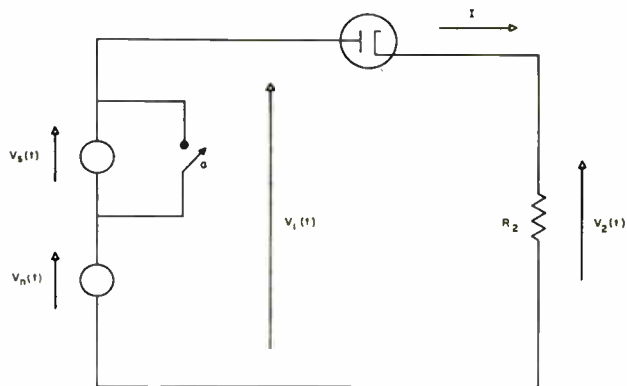

Fig. 5—Simplified circuit diagram with $V_n =$ filtered random noise of center frequency ω_0 , and $V_s = P \cos \omega_0 t$.

square-law case, the circuit of Fig. 8 produced “squaring” of the filtered noise while the correlator accomplished rectification. The output autocorrelation curves for the square-law rectifier with noise plus sine wave input were obtained in this manner.

C. Calculations from the Theory

To obtain the autocorrelation function of the input to the rectifier requires merely an application of linear

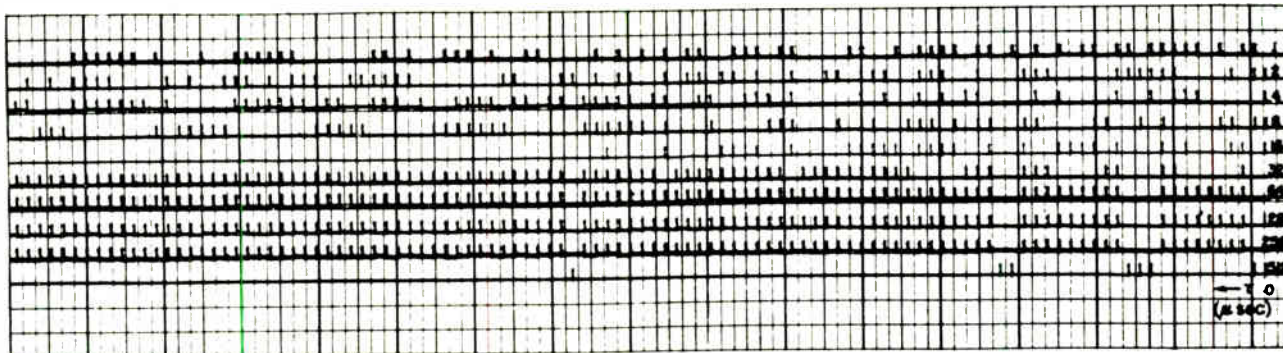

Fig. 6—Output autocorrelation function recorded in binary-digital form ($Q=8.8$, linear rectifier, noise input).

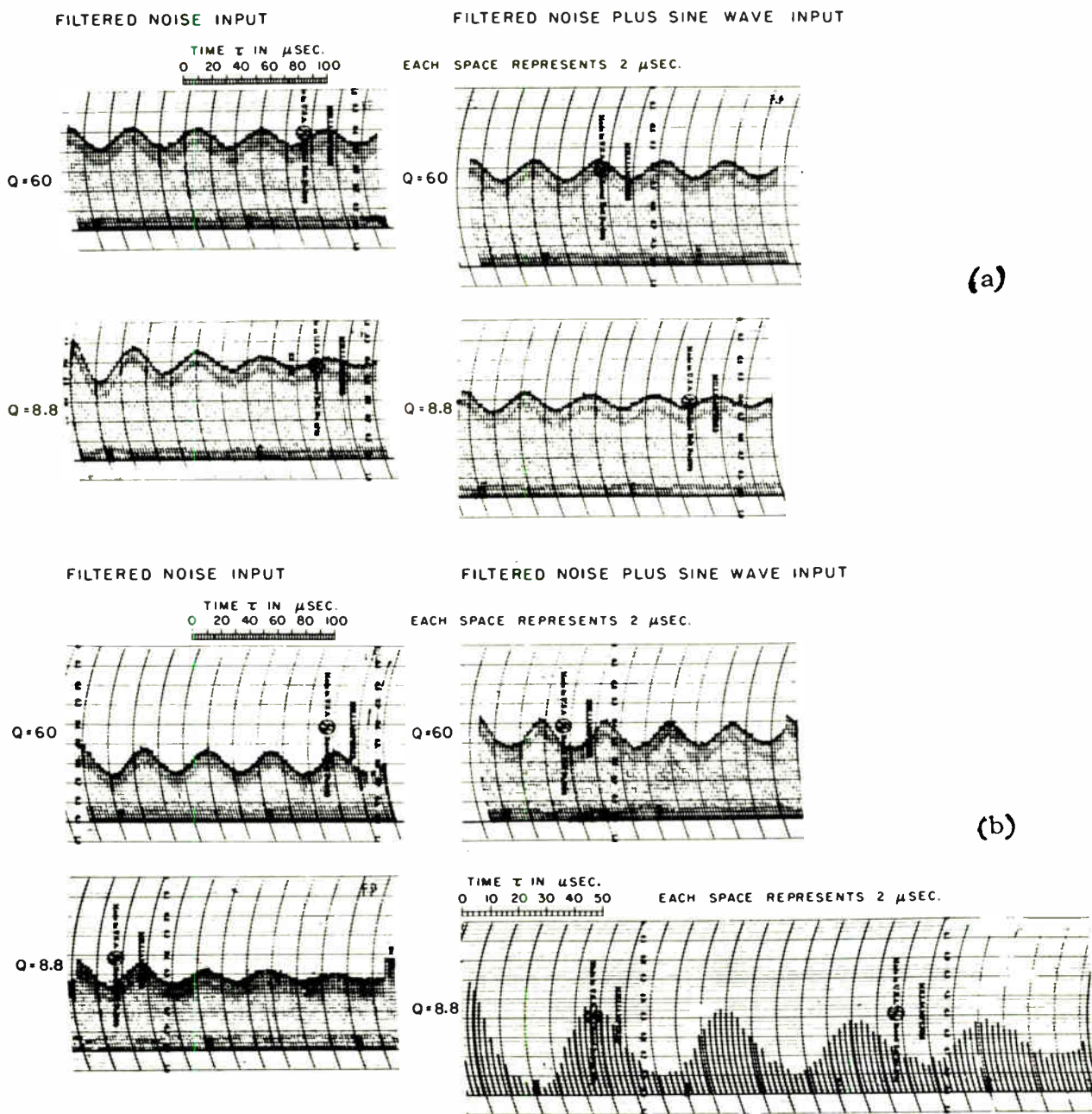

Fig. 7—Autocorrelation functions as recorded by correlator: (a) input autocorrelation functions, and (b) output auto correlation functions for linear rectifier.

theory. The filtered noise input to the rectifier, V_n , which is itself the output of the RLC band-pass filter

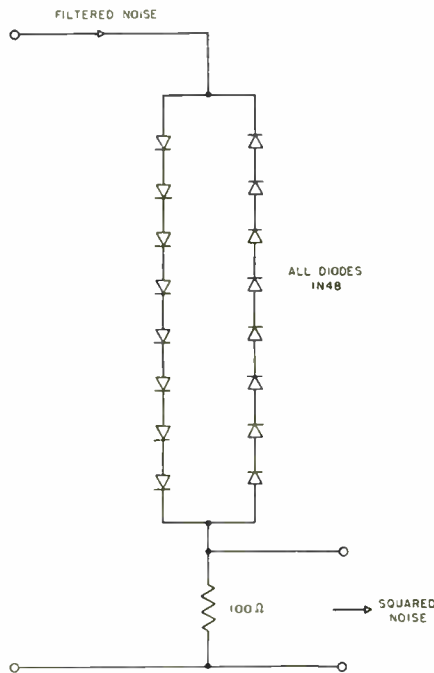

Fig. 8—Circuit for squaring input voltage.

with a white-noise input, has the normalized autocorrelation function¹¹

$$\rho_{nn}(\tau) = e^{-\omega_0|\tau|/2Q} \cos \omega_0\tau \quad (19)$$

where

$$Q = R/\omega_0L = R\omega_0C. \quad (20)$$

Since the autocorrelation function for the sinusoidal voltages, $V_s = P \cos \omega_0t$, is

$$\phi_{ss}(\tau) = \frac{P^2}{2} \cos \omega_0\tau, \quad (21)$$

the autocorrelation function for the total input, $V_n + V_s$, to the rectifier and load is

$$\begin{aligned} \phi_{11}(\tau) &= \phi_{nn}(\tau) + \phi_{ss}(\tau) \\ &= Ae^{-\omega_0|\tau|/2Q} \cos \omega_0\tau + \frac{P^2}{2} \cos \omega_0\tau. \end{aligned} \quad (22)$$

For the linear rectifier, where the output current is

$$I = \begin{cases} \alpha V & V \geq 0 \\ 0 & V < 0 \end{cases} \quad (23)$$

the Laplace Transform $F(s)$ is α/s^2 , so that $F(iu) = -\alpha/u^2$. Similarly, for a square-law rectifier with the characteristic

$$I = \begin{cases} \alpha V^2 & V \geq 0 \\ 0 & V < 0 \end{cases} \quad (24)$$

the transform is $F(iu) = 2\alpha i/u^3$.

Using the above, Rice² has obtained the autocorrelation for the output of a linear rectifier with a filtered noise input as

$$\begin{aligned} \phi_{22}(\tau) &= \frac{\alpha^2 \phi_{nn}(0)}{2\pi} \{ [1 - \rho_{nn}^2(\tau)]^{1/2} \\ &\quad + \rho_{nn}(\tau) \cos^{-1} [-\rho_{nn}(\tau)] \} \end{aligned} \quad (25)$$

where

$$\rho_{nn}(\tau) = \phi_{nn}(\tau)/\phi_{nn}(0) = e^{-\omega_0|\tau|/2Q} \cos(\omega_0\tau + 1/2Q) \quad (26)$$

and the arc cosine is taken between 0 and π .

For the square-law rectifier with a filtered noise input, the output autocorrelation function³ is

$$\begin{aligned} \phi_{22}(\tau) &= \frac{\alpha^2 \phi_{nn}(0)}{2\pi} \{ \cos^{-1} [-\rho_{nn}(\tau)] (1 + 2\rho_{nn}^2(\tau)) \\ &\quad + 3\rho_{nn}(\tau) (1 - \rho_{nn}^2(\tau))^{1/2} \}. \end{aligned} \quad (27)$$

When the rectifier input contains a sine wave in addition to the noise, Rice has shown²

$$\phi_{22}(\tau) = \sum_{m=0}^{\infty} \sum_{k=0}^{\infty} \frac{1}{k!} \phi_{nn}^k(\tau) h_{mk}^2 \epsilon_m \cos m\omega_0\tau \quad (28)$$

where $\epsilon_0 = 1$, $\epsilon_m = 2$ for $m \geq 1$. For the linear rectifier

$$\begin{aligned} h_{mk} &= \frac{\alpha \left(\frac{\phi_{nn}(0)}{2} \right)^{(1-k)/2} x^{m/2}}{2\Gamma\left(\frac{3-k-m}{2}\right) m!} \\ &\quad \cdot {}_1F_1\left(\frac{k+m-1}{2}; m+1; -x\right) \end{aligned} \quad (29)$$

and for the square-law rectifier

$$\begin{aligned} h_{mk} &= \frac{\alpha \left(\frac{\phi_{nn}(0)}{2} \right)^{(2-k)/2} x^{m/2}}{\Gamma\left(\frac{4-k-m}{2}\right) m!} \\ &\quad \cdot {}_1F_1\left(\frac{k+m-2}{2}; m+1; -x\right) \end{aligned} \quad (30)$$

where $x = \text{sine wave power/noise power} = P^2/2\phi_{nn}(0)$ and ${}_1F_1$ is the confluent hypergeometric function. Values of $x = 1/2$ and $x = 1$ were used in the experiment.

D. Experimental Results

Results for three different Q 's were obtained but it was considered sufficient for illustrative purposes to show the curves for only two of them. An example of the input autocorrelation curves obtained is shown in Fig. 9. The next four figures show the output autocorrelation functions, Figs. 10 and 11 applying to the linear rectifier and Figs. 12 and 13 to the square-law rectifier, for the respective inputs of noise with and without a sine wave. In order to effect a Fourier transformation by means of the electronic differential analyzer or the delay-line filter, it was necessary to obtain new auto-

¹¹ Y. W. Lee, and C. A. Stutt, "Statistical Prediction of Noise," Technical Report No. 129, Research Laboratory of Electronics, M.I.T. July 1949.

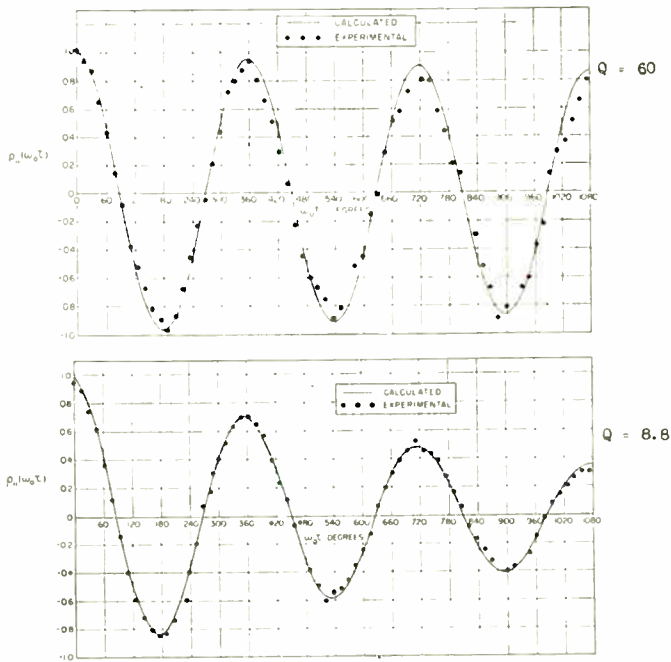

Fig. 9—Normalized input autocorrelation functions $\rho_{11}(\omega_0\tau)$ for filtered noise input.

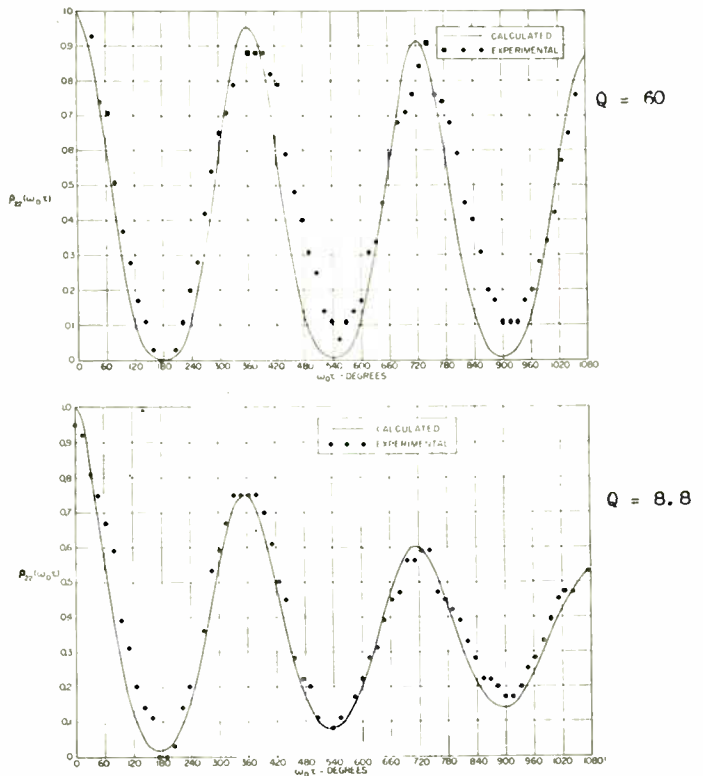

Fig. 10—Normalized output autocorrelation functions $\rho_{22}(\omega_0\tau)$ for linear rectifier with a filtered noise input.

correlation curves for a longer τ -range, specifically, a range in which the amplitude of the oscillations becomes negligible. These curves and their experimentally determined spectra are shown in Figs. 14 and 15.

The theoretically determined autocorrelation curves identified in Figs. 9 through 13 were plotted for a τ -range of 136 μ sec ($\omega_0\tau$ -range of 1080°). For convenience each theoretical curve is normalized with respect to its value at $\tau=0$. Presented on the same sheets with the theoretical plots are the discrete points obtained from the experimental data. When two sets of experimental data were obtained for one curve, the average was used. To plot the experimental points from the binary-digital data, it was necessary to perform a subtraction to obtain the zero level and a multiplication to obtain a good fit, as determined by visual inspection. An illustration of this procedure is the following: suppose we have obtained an exponentially damped cosine autocorrelation curve for $Q=60$, whose digital data show that the $\tau=0$ value is 154, the next maximum is 150, and the first minimum occurs at the half cycle and is 120. For the high- Q case the damping of the cosine is approximately linear for the first cycle so that the envelope would decrease to 152 at the half-cycle point. The zero value can then be obtained as $(152+120)/2=136$. This value is then subtracted from the number representing each point and the resulting values normalized for a good fit. Suppose, after inspection, it is felt that allowing the $\tau=0$ value to be 1 gives a good fit to the theoretical curve. Then,

$$(154 - 136)y = 1, y = \frac{1}{18} = 0.0556 \quad (31)$$

is the appropriate normalizing factor.

Figures 11 and 13 show output autocorrelation functions of rectified noise plus sine wave which take on negative values. The reason for this is that the d - c term in the series ($m=0, k=0$) of (28) has been omitted in the computation.

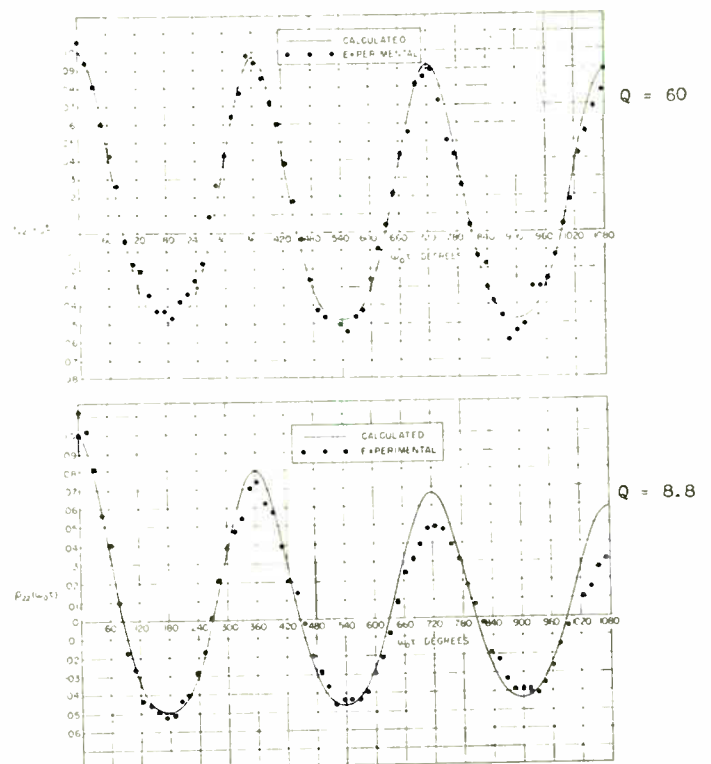

Fig. 11—Normalized output autocorrelation functions $\rho_{22}(\omega_0\tau)$ for linear rectifier with a filtered noise plus sine wave input, where x = sine wave power/noise power = 1.

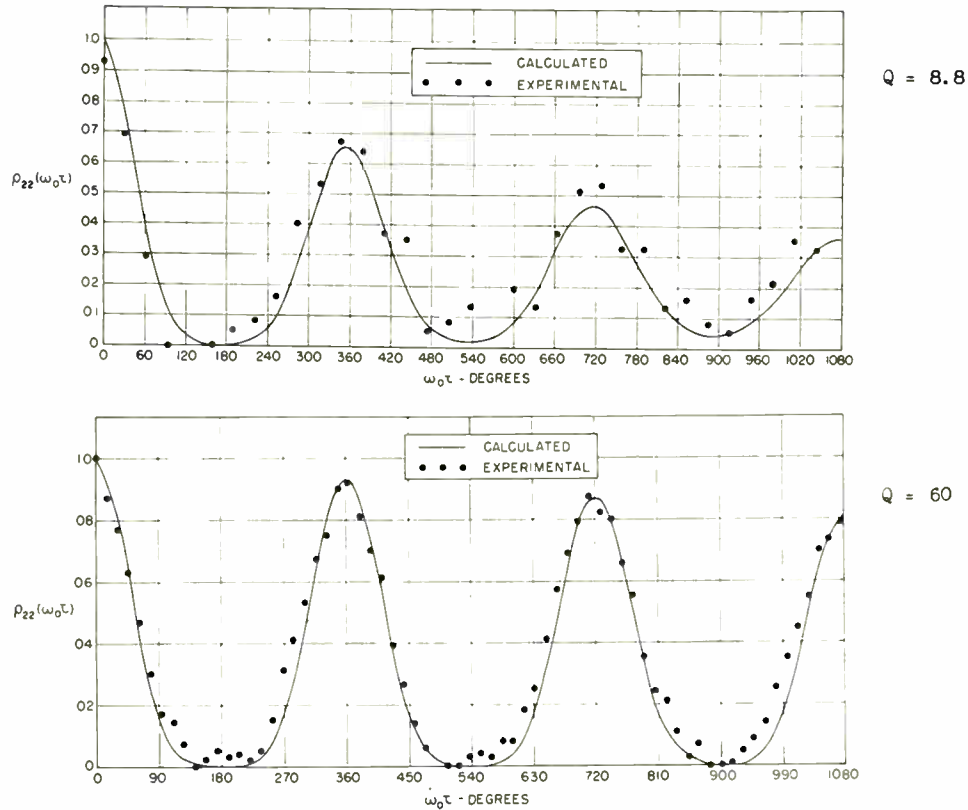

Fig. 12—Normalized output autocorrelation functions $\rho_{22}(\omega_0\tau)$ for square-law rectifier with filtered noise input.

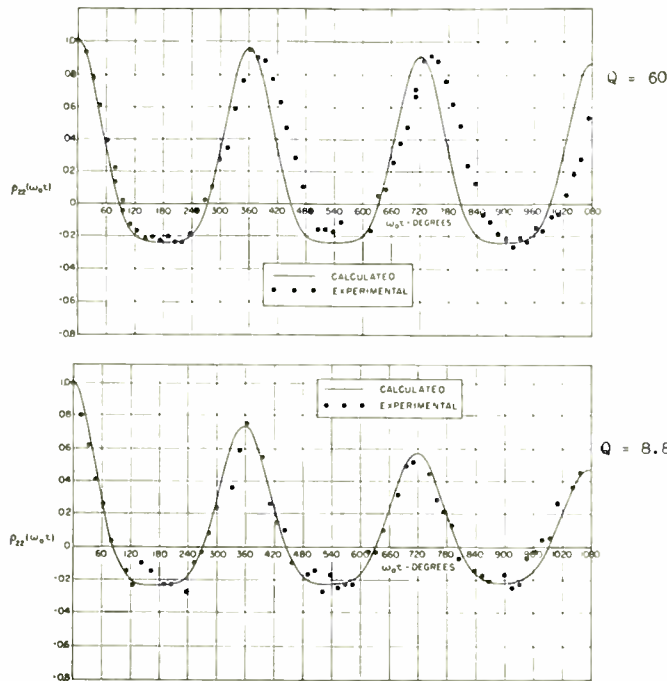

Fig. 13—Normalized output autocorrelation functions $\rho_{22}(\omega_0\tau)$ for square-law rectifier with filtered noise plus sine wave input, where $x = \text{sine wave power/noise power} = 1$.

level inserted by the correlator. For the case of large τ , where the samples are nearly independent, it can be shown that the ratio of the rms error (σ_e) to the variance (σ^2) of $f_1(t)$, the signal under study, is

$$\frac{\sigma_e}{\sigma^2} = \sqrt{\frac{1}{N} + \frac{2[D + \overline{f_1(t)}]^2}{N\sigma^2}} \quad (32)$$

where N = number of samples averaged
 $\overline{f_1(t)}$ = average of signal under study
 D = constant added to $f_1(t)$ by the correlator.

The quantities in the equation may be determined from the autocorrelation curve itself. For example, the autocorrelation curve shown in Fig. 14(a) was obtained with the number of samples $N = 31 \times 2^{11}$, and the values of σ^2 and $[D + \overline{f_1(t)}]^2$ may be obtained from the experimental data as

$$\begin{aligned} \sigma^2 &= 3.23 \times 2^{11} \\ [D + \overline{f_1(t)}]^2 &= 101.7 \times 2^{11} \end{aligned} \quad (33)$$

$$\therefore \sigma_e/\sigma^2 = 0.032.$$

Approximately one-third of the measured values might be expected to fall outside $\pm\sigma_e$ which equals ± 0.02 on the normalized curve shown. This agrees very well with the observed results.

There are errors other than that due to the finite number of samples. Causes of the most important errors

An error is to be expected due to the finite number of samples measured by the correlator. In general, such an error depends on the number of samples, the statistical properties of the signal measured, and the large d - c

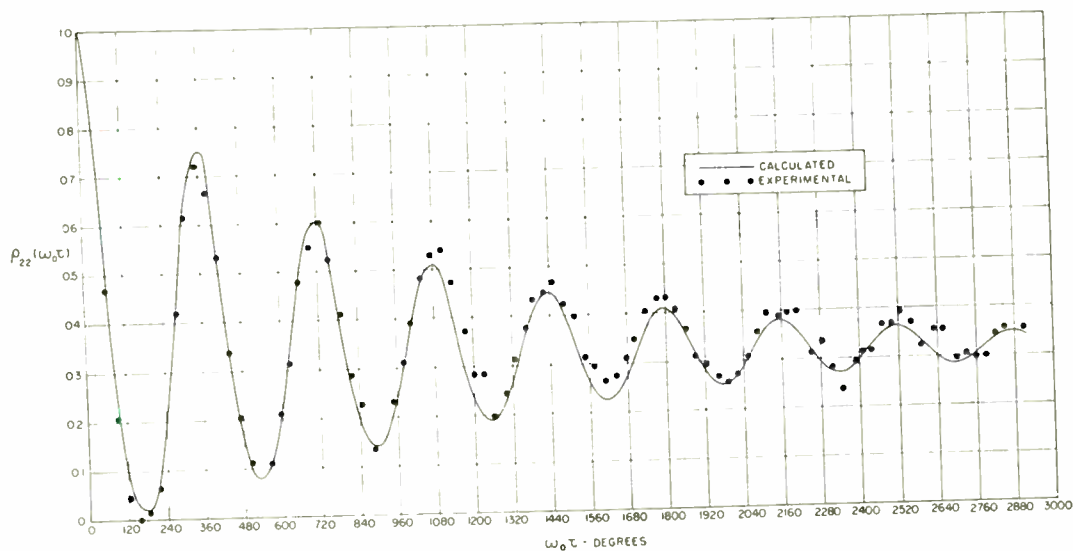

Fig. 14—Autocorrelation function and its associated power density spectrum. (a) Normalized output autocorrelation function $\rho_{22}(\omega_0\tau)$ for linear rectifier with filtered noise input and $Q=8.8$.

seemed to be:

1. amplitude drift in the sampling circuits of the correlator;
2. voltage drift in the power supplies used with the noise filtering and amplifying devices;
3. departure of the rectifiers from the idealized versions.

When a sine wave was added to the noise, additional errors were caused by:

4. amplitude drift in sine-wave generator;
5. synchronization of the sine-wave oscillator with the sampling frequency of the correlator.

In order to reduce errors of measurement in the sampling circuits of the correlator, a second compensator was added so that each channel of the machine is now compensated separately⁶. This was done after only a few of the tests for this report, and all curves which had already been obtained were discarded. The compensators act to keep the median value of the measured samples at a constant level, that is, they provide a correction in the number-generating circuits which tends to stabilize the median value of the binary numbers used in the digital parts of the machine. The effectiveness of the compensators depends on the statistical properties of the input signal, signals with a well defined median value being handled best. For the results in this report, the effects of drift originally present in the measuring portions of the correlator were reduced to negligible values compared with errors due to other causes. Some of the curves, when inspected closely, will indicate the magnitude of the drifts still present.

Changes in the power supply voltages and the signal levels from the noise and sine-wave generators were made small by constant monitoring and manual adjustment. A few minor circuit modifications were made to reduce the effects of such changes.

The departure of the rectifiers from ideal is an unavoidable part of the experimental method. However, the use of the correlator itself to perform the rectifying function of the diodes, as mentioned above, is a way of decreasing the errors introduced. Since results obtained using either the diodes or the correlator agree well with the theoretical curves, such errors do not seem to have been important.

The effects of synchronization of the input voltage periodicities with the sampling period of the correlator are of importance. The correlator obtains samples of the input signal and multiplies each sample by a second sample taken a time τ later. The products of a great number of sample pairs are added together to obtain one value of the correlation curve before shifting to a new value of τ . If the sampling takes place in synchronism with a periodic input signal, it can be seen that the first samples will always have the same value (depending only on the phase of sampling). Likewise, the samples obtained τ seconds later will be constant for any one value of τ , and will depend on the phase of the input signal at which the second sample is being taken.

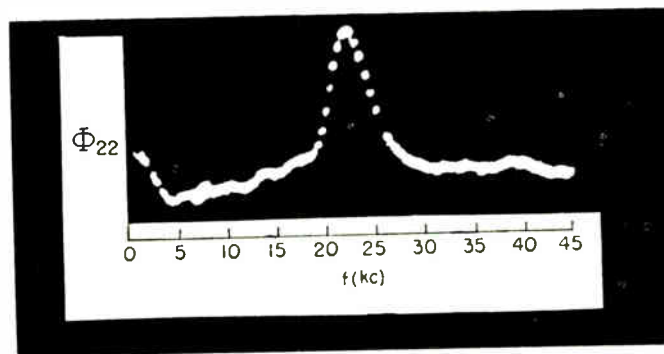

Fig. 14(b)—The zeroth and first spectral regions of its power density spectrum as obtained on the electronic differential analyzer.

The result of multiplying the second sample by the first and adding many such products is the average value of the second sample multiplied by a large constant. As τ is changed, the average value for each corresponding phase is obtained and the output curve of the correlator then has the same shape as the periodic waveform at the input. This difficulty can be met by setting the frequency of the input signal at a value different from

The compensators produce a further difficulty when the input signal frequency is a harmonic of the sampling rate. Whenever the samples of input voltage obtained by the correlator have constant magnitude, the compensators will adjust the number-generating portions of the machine to produce the constant median number for the constant magnitude of sample. If the input samples change to another constant level, the com-

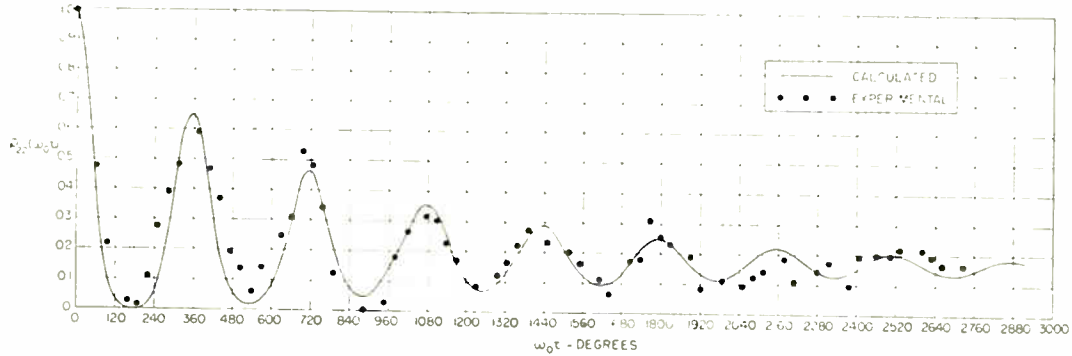

Fig. 15—Autocorrelation function and its associated power density spectrum. (a) Normalized output autocorrelation function for square-law rectifier with filtered noise input and $Q=8.8$.

any integral multiple of the sampling frequency. This was done during this experiment, and frequent observations made to correct the oscillator frequency for drifts.

compensators adjust again so that the same median number results, and no change appears in the correlation curve. Since the compensators make such an adjustment in a few seconds (time constant ≈ 4 sec), the input signal frequency should differ by a few cycles per second from any harmonic of the sampling rate. This effect was detected by observing the compensator voltages. When the signal frequency drifted near a harmonic of the sampling rate, these voltages would oscillate as the compensators followed the slow difference frequency.

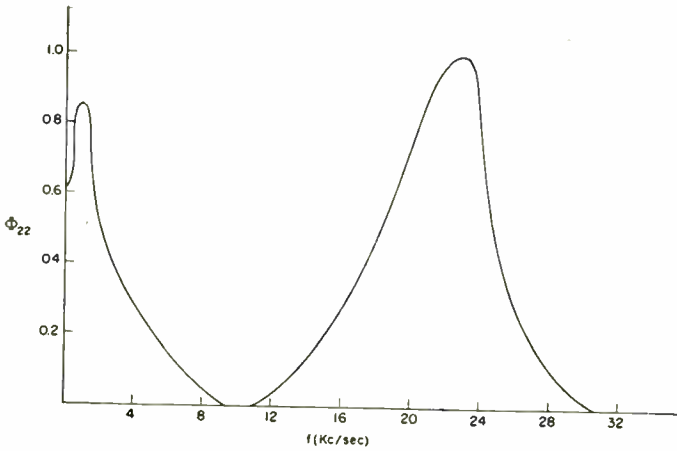

Fig. 15(b)—The zeroth and first spectral regions of its power density spectrum as obtained on delay-line filter.

It has been suggested that the inherent difficulty present in the correlator due to constant frequency of sampling may be avoided by sampling at random intervals. This appears to be an excellent suggestion for correlators designed for inputs of a periodic nature.

CONCLUSIONS

The autocorrelation method has been applied experimentally to the determination of power density spectra for the output of some nonlinear devices. The results for the autocorrelation functions have been compared with the theoretically calculated curves. It may be stated that an experimental check on some known theoretical results has been obtained, and it is hoped that the technique will be extended to the investigation of nonlinear problems that have not yet been solved analytically.

ACKNOWLEDGMENT

It is a pleasure to thank Professors Y. W. Lee and J. B. Wiesner for supervision of the work and Ilhan Uygur for his patient operation of the correlator.



Direct-Viewing Memory Tube*

S. T. SMITH†, SENIOR MEMBER, IRE, AND H. E. BROWN‡

Summary—The Haeff memory tube is modified by using a mesh-screen storage surface in combination with a relatively high-potential viewing screen. Electrons which pass through positive areas of the storage surface are therefore accelerated to produce an intensified image of the charge pattern. An image brightness of 70 fl has been demonstrated. Contrast, writing speed, resolution, persistence, and electrical output are discussed. Further development work is needed to produce more uniform storage screens, better electron guns, and to adapt the tubes for specific requirements.

INTRODUCTION

IN THE CONVENTIONAL cathode-ray tube, energy received by the luminescent screen is furnished by the focused electron beam which can supply energy to only one screen element at a time. When the pattern is retraced with sufficient frequency, the picture appears continuously luminescent due to the persistence effects of the luminescent material and the human eye.

In cathode-ray tubes providing true continuous luminescence, all screen elements contribute simultaneously to the brightness. Such tubes have the advantage of being able to supply more energy to the screen than contained in the writing beam, and are capable of preventing flicker at low frame rates. Tubes of this type consist of a large number of storage elements which control the flow of energy to the luminescent screen. A "writing" beam determines the degree of control of each storage element. Systems such as discrete insulator particles controlling photoemission,¹ secondary emission,² and thermionic emission,³ and the production of images of varying transparency by the dark-trace effect,⁴ heat effects,⁵ the attraction and orientation of small particles,⁶ double refraction in suitable substances,⁷ the electrostatic movement of small mechanical shutters,⁸ and

grid control of dielectric screens^{2-3,9-13} have been investigated. Difficulties with all of the above systems have so far been encountered, and to date the dark-trace effect is the only continuous-viewing method that has found useful applications.

In direct-viewing storage tubes employing grid control of dielectric screens, one of the problems is to prevent the reading, or "flood" beam electrons, and positive ions from discharging the storage elements. In tubes described by Knoll^{2,3} and Hergenrother^{10,11} the storage elements are charged sufficiently negative to repel all electrons. Although nearby high-potential collectors tend to suppress positive ions from reaching the storage surface, the persistence is still limited chiefly by positive ions.

An effective method of preventing the discharging effects of electrons, positive ions, and leakage of dielectric storage screens is to use the "holding" beam principle described in connection with the Haeff memory tube.¹⁴ The dielectric-coated mesh screen combined with a high-potential viewing plate can provide a bright image of the charge pattern. However, due to the bistable writing process, no halftones can be produced. In many applications, halftone images are not necessary, but several auxiliary modes of operation which produce halftone images will be discussed.

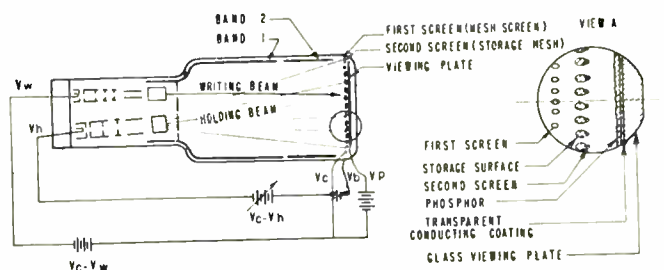

Fig. 1—Diagram of the direct-viewing memory tube.

DESCRIPTION OF THE TUBE

As shown in Fig. 1, the direct-viewing memory tube contains a focused writing gun together with a holding

* Decimal classification: R339. Original manuscript received by the Institute, September 30, 1952; revised manuscript received May 30, 1953.

† Hughes Research and Development Laboratories, Culver City, Calif.; formerly Naval Research Laboratory, Washington, D. C.

‡ Naval Research Laboratory, Washington, D. C.

¹ J. F. Adams, "The Krawinkel Image-Storing CR Tube," Fiat final report 1027, PB-78273; April, 1947. Also *Electronics*, vol. 21, pp. 132-134; May, 1948.

² M. Knoll and B. Kazan, "Storage Tubes," John Wiley and Sons, New York, N. Y., p. 69; 1952.

³ Evans Signal Laboratory Contract W36-039-SC44532 with RCA for a compact bright display tube.

⁴ T. Soller, M. A. Starr and G. E. Valley, Jr., "Cathode-Ray Tube Displays," Radiation Lab. Series, vol. 22, McGraw-Hill Book Company, New York, N. Y., pp. 664-705; 1948.

⁵ H. W. Leverenz, "Luminescence and tenebrescence as applied in radar," *RCA Rev.*, vol. 7, no. 2, p. 237; June, 1946.

⁶ J. S. Donald and D. B. Langmuir, "A type of light valve for television reproduction," *Proc. I.R.E.*, vol. 31, pp. 208-213; 1943.

⁷ J. L. Bird, British Patent No. 454,589.

⁸ V. K. Zworykin, British Patent No. 376,496.

⁹ H. Iams, U. S. Patent No. 2259507.

¹⁰ R. C. Hergenrother and B. C. Gardner, "The recording storage tube," *Proc. I.R.E.*, vol. 38, pp. 740-747; July, 1950.

¹¹ R. C. Hergenrother and A. S. Luftman, "Single-gun storage tube writes, reads, and erases," *Electronics*, vol. 26, pp. 126-130; March, 1953.

¹² M. Knoll and J. Randmer, "Ladungs-Bildspeicherrohren mit Speichergitter," *Archiv El. Übertragung*, vol. 4, pp. 238-246; 1950.

¹³ M. Knoll, "Steuerungswirkung eines geladenen Teilchens im Feld einer Sekundäremissionskathode," *Naturwiss.*, vol. 29, pp. 335-336; 1941.

¹⁴ A. V. Haeff, "A memory tube," *Electronics*, vol. 20, pp. 80-83; September, 1947.

gun which produces a spray of low-velocity electrons that flood the entire target. The target structure consists of a mesh collector screen, a second mesh screen with dielectric coating applied to the side exposed to the electron beams, and a viewing plate. The viewing plate has a transparent conducting coating (stannous chloride) deposited on the side towards the electron guns with a thin layer of phosphor applied over the conducting coating. Fig. 2 is a photograph of a completed tube.

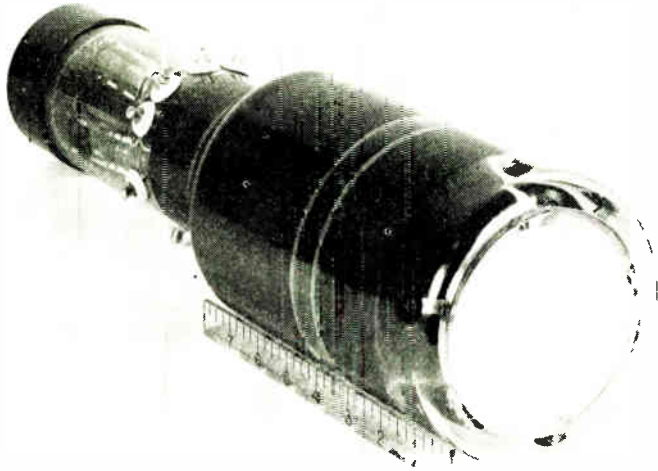

Fig. 2—Direct-viewing memory tube with electrostatically focused electron guns. Scale is in inches.

The stainless-steel screens consist of 165 wires-per-inch with a wire diameter of 0.0019 inch and are mounted on a 4-inch diameter frame in a taut condition. Before mounting, the screens are rolled flat to an average thickness of less than 0.002 inch. Zinc orthosilicate, ground to an average particle size of about one micron, has been found to be a suitable storage material. Fig. 3 is a photograph of a sprayed screen, which illustrates the uniformity of the storage surface and the relatively small reduction in open area of the mesh after spraying.

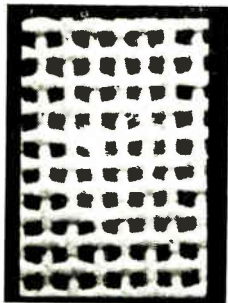

Fig. 3—Section of storage mesh with dielectric coating applied. (Magnification 22.)

Usual operation is to charge the entire storage surface negative by reducing the holding-beam bombarding velocity (power supply $V_c - V_h$, Fig. 1) to a value such that the secondary-emission ratio is less than unity. Un-

der this condition the storage surface accumulates electrons and charges negatively to the holding-beam cathode potential V_h . The holding-beam velocity is then returned to a higher value. When the focused writing beam of relatively high current and high velocity strikes the surface, it overrides the stabilizing effect of the holding beam and charges the bombarded area from cathode potential V_h to the positive equilibrium potential (a potential near the first-screen potential V_c). As the writing beam is moved from element to element of the storage surface, it leaves a trace of positive charge. The holding beam maintains positive elements at the positive equilibrium potential because electrons strike with a secondary-emission ratio greater than unity causing the storage surface to lose electrons and charge positively. Likewise, the holding beam maintains negative areas near cathode potential V_h since electrons strike these areas with low velocity where the secondary emission ratio is less than unity resulting in accumulation of electrons or negative charging.

IMAGE INTENSIFICATION

Electrons which penetrate the interstices of the storage mesh strike the viewing plate with high energy to produce a bright image. In order to obtain maximum brightness of the image, the viewing-plate potential and current density should be as high as possible. The viewing-plate potential is limited by field-emission effects and insulation breakdown. Field-emission effects, due chiefly to stray phosphor particles on the back side of the storage mesh, have been the most serious limitation. A considerable reduction of this difficulty has been achieved by cleaning loose particles from the backside of the storage mesh. It has been possible to operate with storage-mesh-to-viewing-plate potentials higher than 4,000 volts and spacings of 0.050 inch and greater.

In an experimental tube with 5,000 volts on the viewing plate illuminated over a circle of 7 cm diameter, and with 1.5 ma, total holding beam current, the light output at positively charged areas was measured to be 70 fl. This is sufficient brightness for viewing in a well-lighted room. In this case about 10 per cent of the holding-beam current was reaching the viewing plate. The stored image was stable over a long period of time.

IMAGE CONTRAST

Electrons from the holding beam reach the positive areas of the storage mesh with a velocity corresponding to a potential near the collector mesh potential; while at negative areas electrons approach at a velocity near zero. To obtain good contrast in the intensified image, the potential within the interstices of the mesh must be adjusted so that electrons approaching negative storage elements will be reflected; while electrons approaching positive surface elements will be allowed to penetrate.

The potential within the interstices is controlled by adjusting the potential V_b of the metal screen supporting the storage surface, as shown in Fig. 1.

Since the storage surface and the contrast-controlling metal surface, which Fig. 1 shows, are adjacent to each other, the application of a bias voltage V_b considerably different from the stable potentials of the storage surface results in a relatively wide range of potential distribution within the interstices of the mesh. A reasonably complete reflection of electrons at the negative areas can be achieved only if the maximum potential at the center of the hole of the mesh is near the potential of the holding-beam cathode. The presence of the positive electrodes nearby, that is, the collector and the viewing plate, tends to raise the potential at the holes; so that in order to reflect most electrons from the negative areas, it is necessary to use a biasing potential V_b approximately equal to the potential V_h of the holding-beam cathode. Fig. 4 illustrates the effectiveness of the screen biasing method for improving the contrast by showing a photograph of the direct-viewing screen for three different settings of the contrast-control potential V_b . It will be noted that the negative background is more visible near the center of the screen because the holding-beam electrons are striking at a nearly normal angle of incidence, and therefore a complete reflection of holding-beam electrons is more difficult.

A quantitative measure of contrast can be obtained by measuring the viewing-plate current, first when the storage surface is positively charged, and second when negatively charged. The ratio of these currents is a measure of contrast. The photograph of Fig. 4(a) represents a contrast ratio of about 3 near the center of the screen and greater than 5 near the edges. It appears that a contrast ratio of 5 or more over all parts of the storage surface would produce a satisfactory image for most purposes. The contrast ratio depends chiefly on the geometry of the storage mesh. It has been found that a dielectric coating with a thickness nearly equal to the spacing between wires produces better contrast than thinner coatings. Bulging coatings give slightly better contrast than slender coatings. Mesh screens that have been rolled flat provide larger contrast ratios than the use of round mesh screens. Changing the spacing between screens or between the storage mesh and the viewing plate has little effect on available contrast.

WRITING SPEED

The maximum writing speed depends upon the time it takes to charge the storage surface area under bombardment by the writing beam from the negative equilibrium V_h to a potential greater than the critical potential V_0 . If a constant charging current is assumed and the capacity of a storage element is estimated, then the time required to write a positive element is simply the time required to charge the capacity of the element to

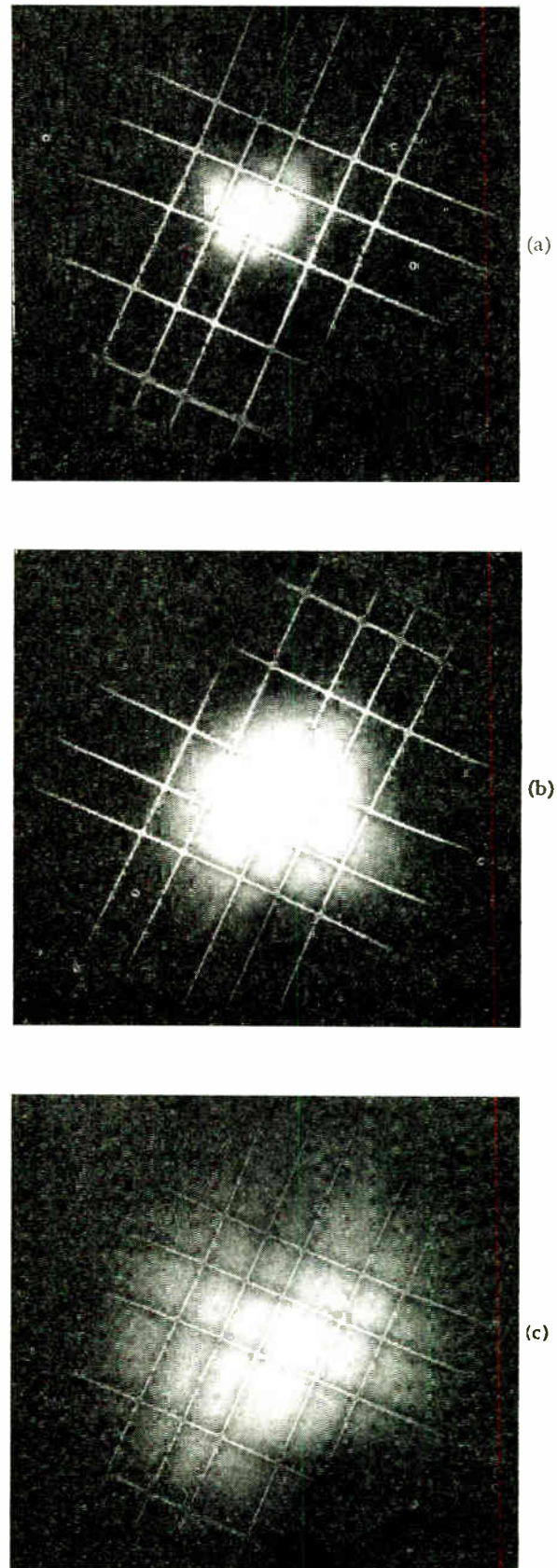

Fig. 4—Viewing-screen photographs of an early model of the direct-viewing memory tube with a negative background and five vertical and five horizontal positive lines written. Note appearance of the negative background for three different settings of the contrast control $V_b - V_n$. (a) 0 volts; (b) 100 volts; (c) 200 volts.

the potential V_0 . Maximum writing speed calculated in this manner shows reasonable agreement (within 20 per cent) of measured values.

Writing speeds of 37,000 cm/sec., have been measured with a writing beam of 1.1 mm and a current density of 1 ma/cm². An electron gun producing higher current densities would permit higher writing speeds.

RESOLUTION

At the present time the resolution is limited by the diameter of the writing beam. If electron guns producing beam diameters of less than 0.010 inch were used, then the coarseness of the mesh screens would begin to limit resolution. The best resolution has been obtained in a tube with a 3.5 inches diameter target where it is possible to write lines 0.015 inch wide and spaced only 0.006 inch apart.

The region of transition, or boundary, between positive and negative areas is less than 0.001 inch in width on the storage surface. The boundaries between positive and negative areas on the viewing plate are not as sharp as on the storage surface because of "Moire" interference effect of the two mesh screens and the focusing action of the grid wires. The boundaries on the viewing plate are estimated to be about 0.005 inch wide for experimental tubes with properly spaced viewing plates.

The focusing effect of the storage mesh noticeably reduces the available resolution when the spacing between the storage mesh and the viewing plate is large: Electrons penetrating the storage mesh at positive areas suffer a sidewise deflection within the interstices if they do not pass midway between the grid wires. As a consequence, the electrons converge to a crossover at some point behind the storage mesh. Beyond this crossover the electrons diverge rapidly. To avoid serious divergence and consequent loss of resolution because of the focusing effect of the mesh, the viewing-plate spacing is held to about 0.060 inch for unflattened mesh screens and 0.050 inch for flat mesh screens.

IMAGE PERSISTENCE

When the holding beam potential ($V_c - V_h$) is approximately twice the unity secondary-emission-ratio potential, stored patterns have been observed to persist for periods greater than one hour. Under such conditions the pattern is stable over a range of holding-beam current density from 1 to 200 $\mu\text{A}/\text{cm}^2$ and is not critically dependent on holding-beam potential.

When power is removed from the tube, the stored pattern will remain on the storage surface for at least two weeks. Therefore, the electrical leakage of the storage surface is small.

The complete stored pattern may be erased in a fraction of a second by lowering the holding-beam cathode

potential ($V_c - V_h$) to less than the unity secondary-emission-ratio potential so that the storage surface accumulates electrons and charges negatively. When the cathode potential is returned to its original value, storage surface has been erased and is again ready for use.

For some applications a limited rather than infinite persistence is desired. Limited persistence can be obtained by lowering the holding-beam potential ($V_c - V_h$) to a value somewhat lower than the stable potential. Under these conditions negative areas receive more current from the holding beam than positive areas. The unbalance of current causes the boundary between positive and negative areas to move toward positive areas. Positive areas thus appear to shrink, and the stored pattern gradually disappears.

Measurements of persistence have been obtained by writing a positive line or dot of known dimensions and measuring the time required for it to disappear. Persistence was found to be best expressed as the speed of the boundary movement toward positive areas. The speed of the boundary movement has been observed to be independent of the shape of the positive area, but depends in a complicated way on the holding-beam velocity, holding-beam current density, storage mesh bias potential, and angle of incidence of the holding beam. For example, the speed of the boundary movement near the center of the screen is about ten times the speed at the outer edges due chiefly to angle of incidence effects.

AUXILIARY MODES OF OPERATION

Two auxiliary methods of operation (a) and (b) are capable of reproducing halftones in stored images. Two others (c) and (d) provide good contrast, but no halftones. Each mode has been demonstrated experimentally.

(a) Dark lines of limited persistence can be written on a bright background in addition to writing brighter lines of infinite persistence on the same bright background. To accomplish this, the contrast bias potential V_b is made more positive to allow electrons from the holding beam to penetrate both positive and negative areas. The potential of the writing-beam cathode is adjusted approximately 50 volts more negative than the holding-beam cathode. Under this condition the storage element bombarded by the writing beam accumulates electrons and tends to charge in the negative direction to a potential equal to that of the writing-gun cathode. Electrons from the holding beam will not have sufficient energy to reach these highly negative areas which were charged by the writing beam. Since penetration of the storage mesh is suppressed in these areas, the trace of the writing beam (as seen on the viewing plate) appears dark on a relatively bright background. However, positive ions within the tube are attracted to the negative areas and cause the disappearance of the dark trace usually within 5 to 100 seconds, depending on the number

of positive ions, or pressure in the tube. Different degrees of darkness and thus halftone picture effects may be obtained either by modulation of the potential of the writing-gun cathode in accordance with the intensity of the picture elements, or with fast writing, by intensity modulation of the writing-beam current. A second writing beam with a much lower cathode potential can be used to trace positive lines which will remain bright indefinitely. Thus, one beam makes a dark trace which persists a relatively short time, while the other beam makes a bright trace which can be made to persist indefinitely.

(b) Another type of operation in which halftones can be achieved is to maintain the potential between the holding-gun cathode and first mesh screen near zero so that electrons from the holding beam approach the storage mesh with substantially zero velocity. The voltages are adjusted so that the electric field in the vicinity of the storage mesh is just sufficient to let electrons penetrate the storage mesh and reach the viewing plate. The writing-gun cathode is adjusted to a potential a few volts more negative than the holding-gun cathode so that the writing beam charges the elements of the storage surface negatively. The negatively charged elements of the storage surface prevent penetration of electrons through the storage screen, and those areas appear dark on a bright background as seen on the viewing plate. Different degrees of darkness can be obtained by varying the potential of the writing-beam cathode. As in the previous mode, the dark trace persists only a short time (5 to 100 seconds) because of the presence of positive ions.

Both of the preceding modes of operation suffer from two disadvantages: a) the persistence is not easily adjusted or controlled, and b) the display of dark signals on a bright background is not as desirable as bright signals on a dark background due to the diminished contrast.

(c) One method of operation which results in good contrast is the use of two holding beams. The first holding beam bombards the storage surface with a low-intensity beam and has its cathode at a potential a few volts lower than the cathode potential of the second

holding gun. Because of the lower potential of its cathode, the first holding beam charges all negative areas of the storage surface to a lower potential than obtained by the second holding gun. Consequently, electrons from the second holding beam do not have sufficient energy to reach negative areas of the storage surface. Thus, any electrons penetrating the storage surface at negative areas are due to the first low-intensity holding beam. However, those electrons penetrating at positive areas are the sum of the electrons from both holding-beam cathodes. By making the second holding-beam current much higher than the first, a bright image with good contrast results. The limit to ratio of currents in the two beams, and thus to contrast, is set by the fact that the positive areas tend to spread if the current in the second holding beam is made more than about three times the first holding-beam current.

(d) Instead of using two holding beams as described in the preceding paragraph, the contrast improvement can be obtained only with one holding beam by periodically pulsing the holding-beam cathode from one potential level to another. If the time of low potential state is about one-third that of the higher potential state, a good contrast is obtained.

CONCLUSIONS

It has been demonstrated that experimental direct-viewing memory tubes can produce bright images of the stored pattern. These tubes are also capable of generating electrical output signals and under special operating conditions can store and reproduce halftone images. However, further development work is needed to produce more uniform storage screens, better electron guns, and to adapt the tubes for specific requirements.

ACKNOWLEDGMENTS

A. V. Haeff directed this work and originated many of the ideas used in this investigation. Much assistance and cooperation were given by members of the Vacuum Tube Engineering Section of the Naval Research Laboratory, particularly D. E. Rudert, who showed great skill and patience in preparing the storage mesh screens.

CORRECTION

W. J. Gruen, author of the paper "Theory of AFC Synchronization" published in the August 1953 issue, has pointed out that the Greek letter ζ appeared incorrectly in place of the correct figure ρ in the following passage on page 1048. The passage should read: The pull-in range thus can be expressed analytically by the equation of the circle of curvature. If its radius is denoted by ρ , the circle is given by

$$\left(\frac{\omega_n}{K} - \rho\right)^2 + \left(\frac{\Delta\omega}{K}\right)^2 = \rho^2. \quad (45)$$

Hence, for $(\omega_n/K) \rightarrow 0$, the pull-in range of synchronization is approximately

$$|\Delta\omega_{\text{Pull-in}}|_{(\omega_n/K) \rightarrow 0} < \sqrt{2\rho\omega_n K - \omega_n^2} \cong \sqrt{2\rho\omega_n K}. \quad (46)$$

ρ can be interpreted as a constant of proportionality which depends on the particular design of the system, and which increases as the system gets closer to the theoretical limit of synchronization.

Radiation Conductance of Axial and Transverse Slots in Cylinders of Elliptical Cross Section*

JAMES Y. WONG†, ASSOCIATE, IRE

Summary—Expressions for the radiation field of axial and transverse slots in cylinders of elliptical cross-section are derived by a method based on diffraction theory and the principle of reciprocity. Radiation patterns of transverse slots and curves of radiation conductance are presented. It is shown that the radiation conductance is influenced considerably by the degree of curvature of the surface on which the slot is located.

I. INTRODUCTION

IN RECENT years while the slotted-circular-cylinder antenna has attracted the attention of many authors, relatively little work has been devoted to the analogous problem of the slotted-elliptic cylinder. Progress and development on this particular phase of the slotted-antenna problem has been limited, owing mainly to the lack of sufficient numerical tabulated values on elliptic "Mathieu" functions. Only recently has the development reached the stage whereby systematic numerical evaluation and application appeared feasible.

This paper is concerned with the radiation characteristics of axial and transverse slots in hollow metal cylinders of elliptical cross-section. The present analysis is an extension and application of the method used by P. S. Carter,¹ in which he obtained a solution to the problem of the electromagnetic fields of electric-dipole radiators in the vicinity of an infinitely long cylinder of circular cross-section. This method which is based on diffraction theory and the principle of reciprocity has also been employed by Sinclair² to obtain the patterns of antennas in the vicinity of cylinders of elliptical cross-section.

In addition to the radiation patterns, quantitative results for the radiation conductance of both axial and transverse slots are given in order to determine the variation in conductance with cylinders of different size and shape. It is shown that the radiation conductance of a transverse slot is influenced considerably by the

shape or ellipticity³ of the elliptic cylinder. This is equivalent to saying that the effect of curvature of the surface on which the slot is located plays an important role as far as the radiation conductance is concerned. Increased radiation is encountered for slots on thin cylinders; that is, the sharper the curvature of the surface, the greater is the radiation conductance. This important phenomenon can be regarded or termed "edge effect" and is a significant factor whenever slots are located on surfaces which are not plane.

II. METHOD OF ANALYSIS

In Carter's method, the radiation pattern of a dipole adjacent to an infinitely long cylinder is obtained as a receiving antenna instead of a transmitting antenna. The wave received from a distant dipole carrying a certain value of current will be essentially plane, and consequently such a plane wave can be expanded and expressed in terms of a sum of cylindrical waves. The presence of the cylinder produces secondary waves of amplitude, such that the sum of the primary and secondary tangential-electric fields vanish at the surface of the cylinder. The field at the dipole near the cylinder and hence the voltage at its terminals can therefore be determined. In accordance with the law of reciprocity, the position of voltage and current can be interchanged without altering the result. Then by applying the reciprocity theorem, an expression is obtained which gives the total radiation field from the dipole and cylinder.

This method is directly applicable in determining the far-zone field or radiation pattern of a short slot in a long cylinder of circular or elliptical cross-section. The electric-field distribution across the slot is replaced by its equivalent magnetic-current sheet. The problem is that of determining the pattern produced by a magnetic dipole adjacent to the cylinder. As the magnetic dipole is allowed to approach the surface of the cylinder, the effect of a slot in the cylinder is obtained.

Having obtained expressions for the far-zone fields produced by an elemental slot, it is possible to use these results to obtain the radiation from slots of finite length by carrying out the appropriate integration. Since only a knowledge of the far fields can be obtained by this approach, the method described furnishes information on

³ In engineering practice, the term ellipticity rather than eccentricity is more commonly used. It is defined as the ratio of the length of the semi-major axis of an ellipse to the length of the semi-minor axis. In this paper, it is denoted by the symbol a/b .

* Decimal classification: R326.611. Original manuscript received by the Institute, December 3, 1952; revised manuscript received February 19, 1953. This paper is in part a doctoral thesis, "Radiation of Slots in Elliptic Cylinders" submitted in partial fulfillment of the requirements for the degree of Doctor of Philosophy in Electrical Engineering in the Graduate College of the University of Illinois, 1952.

† Radio and Electrical Engineering Division, National Research Council, Ottawa, Canada. Formerly of Univ. of Illinois, Urbana, Ill.

¹ P. S. Carter, "Antenna arrays around cylinders," *PROC. I.R.E.*, vol. 31, pp. 671-693; December, 1943.

² G. Sinclair, "The patterns of antennas located near cylinders of elliptical cross section," *PROC. I.R.E.*, vol. 39, pp. 660-668; June, 1951.

only the real part of the terminal impedance; that is, only the radiation conductance of the slot can be determined.

Elliptic cylinder co-ordinates (u, v, z) are related to Cartesian co-ordinates (x, y, z) by the transformation

$$x + iy = c_0 \cosh(u + iv). \tag{1}$$

Expanding and equating real and imaginary parts, one obtains the equations of transformation

$$x = c_0 \cosh u \cos v \tag{2}$$

$$y = c_0 \sinh u \sin v \tag{3}$$

$$z = z \tag{4}$$

where $2c_0$ is the distance between the foci of the ellipse.

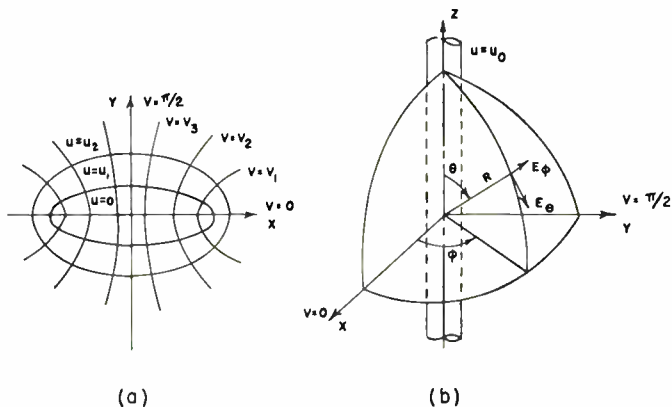

Fig. 1—Elliptic cylinder co-ordinate system.

Figs. 1(a) and (b) show the system of co-ordinates which is used. The elliptic cylinder is assumed to be infinitely long with its walls perfectly conducting and indefinitely thin. The longitudinal axis of the cylinder is taken as the z -axis of the co-ordinate system. Unless otherwise stated, notation and definitions of the elliptic-cylinder functions used in this paper are the same as those used in current practice.⁴ (See Appendix for a list of the definitions of elliptic cylinder functions.)

III. FAR-FIELD EXPRESSIONS OF SLOTS IN AN ELLIPTIC CYLINDER

(a) Axial Slot

Consider the distant source of plane waves to be produced by an elemental magnetic dipole of magnetic moment Kdl , where K is the magnitude of the magnetic current. The electric field of this incident plane wave polarized in the θ -direction as shown in Fig. 1(b) is expressed by

$$E = \frac{iKdl}{2\lambda R} \exp(ikR + i\omega t). \tag{5}$$

⁴J. A. Stratton, P. M. Morse, L. J. Chu and R. A. Hutner, "Elliptic Cylinder and Spheroidal Wave Functions," John Wiley and Sons, Inc., New York, N. Y.; pp. 53-61; 1941.

The mathematical analysis for the total diffracted field around the elliptic cylinder will not be given. The method is straightforward, and for a more complete account, the reader is referred to P. S. Carter¹ and G. Sinclair.² Having obtained the magnetic field at any arbitrary position (u, v, z) near the cylinder, it follows by application of the reciprocity theorem that the expression for the radiation field from an elemental slot located on the surface of the cylinder at (u_0, v, z) and excited by a voltage V is

$$E_\phi = \sin \theta \sqrt{2\pi} V \left(\frac{dl}{\lambda} \right) \frac{\exp(ikz \cos \theta)}{R} \sum_{m=0}^{\infty} i^m \left\{ \frac{Se_m(c, \cos v)}{N_m^e He_m^{(2)'}(c, \cosh u_0)} Se_m(c, \cos \phi) + \frac{So_m(c, \cos v)}{N_m^o Ho_m^{(2)'}(c, \cosh u_0)} So_m(c, \cos \phi) \right\}. \tag{6}$$

In (6), the primes on the functions $He_m^{(2)'}(c, \cosh u_0)$ and $Ho_m^{(2)'}(c, \cosh u_0)$ denote derivatives with respect to the variable u .

In order to obtain the radiation of a slot of finite length, it is simply necessary to integrate (6), taking into account the variation of the electric field along the length of the slot. Consider a slot of length l symmetrically located with respect to the $x-y$ plane as seen in Fig. 1(b). The field distribution in the slot is described by $V = V_0 g(z)$, where V_0 is the maximum value of the applied voltage across the slot, and $g(z)$ is an arbitrary function of z . This assumption is valid for narrow slots where the radiation pattern is independent of the distribution of electric field across the slot.

The resulting expression for the radiation field becomes

$$E_\phi = \frac{V_0 \sqrt{2\pi} \sin \theta}{\lambda R} \int_{-l/2}^{+l/2} g(z) \exp(ikz \cos \theta) dz \sum_{m=0}^{\infty} i^m \left\{ \frac{Se_m(c, \cos v)}{N_m^e He_m^{(2)'}(c, \cosh u_0)} Se_m(c, \cos \phi) + \frac{So_m(c, \cos v)}{N_m^o Ho_m^{(2)'}(c, \cosh u_0)} So_m(c, \cos \phi) \right\}. \tag{7}$$

By prescribing the function $g(z)$ it is possible to obtain (7) in closed form.

(b) Transverse Slot

In directions other than the horizontal plane, a transverse slot in an elliptic cylinder radiates waves having both θ and ϕ components of electric field. The method of approach follows in much the same manner as for an axial slot. The results of this evaluation are summarized below. For an elemental transverse slot located at (u_0, v, z) on an elliptic cylinder and excited by a voltage

V , the expressions for the far-zone electric-field components are

$$E_\theta = \frac{Vdl \exp (ikz \cos \theta - i\pi/2)}{\sqrt{2\pi} h_u R \sin \theta} \cdot \sum_{m=0}^{\infty} i^m \left\{ \frac{S e_m(c, \cos v)}{N_m^e H e_m^{(2)}(c, \cosh u_0)} S e_m(c, \cos \phi) + \frac{S o_m(c, \cos v)}{N_m^0 H o_m^{(2)}(c, \cosh u_0)} S o_m(c, \cos \phi) \right\} \quad (8)$$

$$E_\phi = \frac{Vdl \cos \theta \exp (ikz \cos \theta + i\pi/2)}{\sqrt{2\pi} h_v R \sin \theta} \cdot \sum_{m=0}^{\infty} i^m \left\{ \frac{S e_m'(c, \cos v)}{N_m^e H e_m^{(2)'}(c, \cosh u_0)} S e_m(c, \cos \phi) + \frac{S o_m'(c, \cos v)}{N_m^0 H o_m^{(2)'}(c, \cosh u_0)} S o_m(c, \cos \phi) \right\} \quad (9)$$

In (9) the prime on the functions $S e_m'(c, \cos v)$ and $S o_m'(c, \cos v)$ denote derivatives with respect to the variable v .

A more practical problem is the radiation of a transverse slot of finite length. This problem is somewhat more difficult than the case of a finite axial slot, because of the difficulty in carrying out the appropriate integration. However, if the function representing the variation of electric field along the slot is integrable, then it is possible to obtain an expression for the radiation in closed form. The problem will be restricted to a finite transverse slot symmetrically located about the major axis of the ellipse and situated at $z=0$ as shown in Fig. 2.

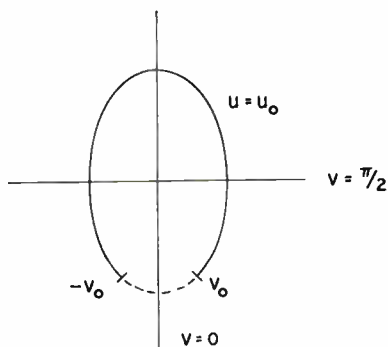

Fig. 2—Slot of angular length $2v_0$ located at $v=0$.

The variation of electric field along the slot is assumed to be represented by the function, $V = V_0 \xi(v)$ where $\xi(v)$ is an arbitrary function of v only.

By specifying $\xi(v)$ to be an even function of v and performing the appropriate integrations on (8) and (9), the resulting expressions for the radiation fields of a finite transverse slot of angular length $2v_0$ are

$$E_\theta = \frac{V_0 \exp (-i\pi/2)}{R \sin \theta} \sqrt{\frac{2}{\pi}} \cdot \sum_{m=0}^{\infty} i^m \frac{S e_m(c, \cos \phi)}{N_m^e H e_m^{(2)}(c, \cosh u_0)} \cdot \int_0^{v_0} \xi(v) S e_m(c, \cos v) dv, \quad (10)$$

$$E_\phi = \frac{V_0 \cos \theta \exp (i\pi/2)}{R \sin \theta} \sqrt{\frac{2}{\pi}} \cdot \sum_{m=0}^{\infty} i^m \frac{S o_m(c, \cos \phi)}{N_m^0 H o_m^{(2)'}(c, \cosh u_0)} \cdot \int_0^{v_0} \xi(v) S o_m'(c, \cos v) dv. \quad (11)$$

Calculated radiation patterns using (10) are shown in Fig. 3 for a short-transverse slot in cylinders of various size and shape. An arbitrary slot length of $\lambda/8$ is used throughout and the electric field distribution in the slot is assumed to be triangular. For the cylinders considered, it can be seen that the size and shape have relatively minor effect on the radiation pattern, the pattern remaining nearly cardioid in shape for all cases.

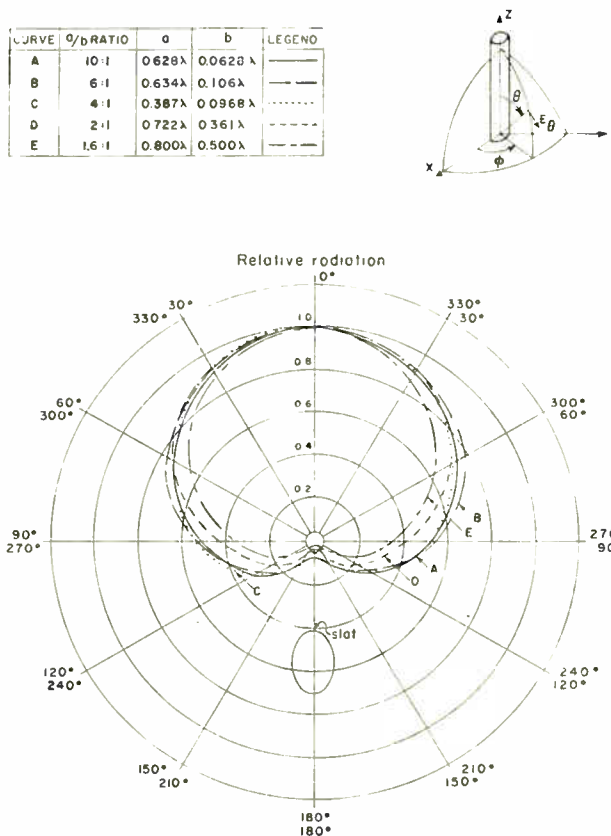

Fig. 3— E_θ field from $\lambda/8$ transverse slot in elliptic cylinder. Field in horizontal plane $\theta = \pi/2$.

IV. COMPUTATION OF THE RADIATION CONDUCTANCE

(a) Radiation Conductance of Short-Axial Slot

The radiation conductance G_θ of a slot is found by obtaining the total power radiated, and equating this power to the supplied power expressed in terms of G_θ . An expression for the radiation field has already been derived and the total-power flow can be obtained by integrating the Poynting vector over a spherical surface of radius R . The total-radiated power can be evaluated from a knowledge of the electric field through the relation

$$P = \frac{1}{\eta} \int_0^{2\pi} \int_0^\pi E_\phi E_\phi^* R^2 \sin \theta d\theta d\phi, \quad (12)$$

where E_ϕ^* is the conjugate of E_ϕ .

From the orthogonality property of the angular Mathieu functions, it is known that the following exist

$$\int_0^{2\pi} Se_i(c, \cos \phi) Se_j(c, \cos \phi) d\phi = \begin{cases} 0 & i \neq j \\ N_i e & i = j, \end{cases}$$

and

$$\int_0^{2\pi} Se_i(c, \cos \phi) So_j(c, \cos \phi) d\phi = 0 \quad \text{for all } i \text{ and } j.$$

A similar result exists for odd angular functions. Substituting the expression for E_ϕ into (12) and applying the orthogonality property, power radiated by the short-axial slot is

$$P = V^2 \left(\frac{dl}{\lambda}\right)^2 \frac{2\pi}{\eta} \int_0^\pi \sin^3 \theta \left\{ \sum_{m=0}^\infty \frac{(Se_m(c, \cos v))^2}{N_m e |He_m^{(2)'}(c, \cosh u_0)|^2} + \sum_{m=0}^\infty \frac{(So_m(c, \cos v))^2}{N_m^0 |Ho_m^{(2)'}(c, \cosh u_0)|^2} \right\} d\theta. \quad (13)$$

Since the expression above is an even function of θ with respect to $\theta = \pi/2$, the limits of the integral can be changed to 0 and $\pi/2$. The radiation conductance can be obtained immediately from (13) since it is defined as the ratio of the total power radiated to the square of the voltage supplied across the slot. Hence the expression for the radiation conductance of a short-axial slot located arbitrarily on the surface of an elliptic cylinder is

$$G_0 = \frac{4\pi}{\eta} \left(\frac{dl}{\lambda}\right)^2 \int_0^{\pi/2} \sin^3 \theta \left\{ \sum_{m=0}^\infty \frac{(Se_m(c, \cos v))^2}{N_m e |He_m^{(2)'}(c, \cosh u_0)|^2} + \sum_{m=0}^\infty \frac{(So_m(c, \cos v))^2}{N_m^0 |Ho_m^{(2)'}(c, \cosh u_0)|^2} \right\} d\theta. \quad (14)$$

The value of this integral cannot be determined analytically, but can be evaluated by a graphical integration method. A simplification of (14) results when the slot is located on the major axis of the ellipse. For this special case, it is known that

$$Se_m(c, \cos v) = 1 \quad \text{and} \quad So_m(c, \cos v) = 0.$$

Consequently

$$G_0 = \frac{4\pi}{\eta} \left(\frac{dl}{\lambda}\right)^2 \int_0^{\pi/2} \sum_{m=0}^\infty \frac{\sin^3 \theta}{N_m e |He_m^{(2)'}(c, \cosh u_0)|^2} d\theta. \quad (15)$$

For a practical, short, center-fed slot, the electric-field distribution in the slot is approximately triangular; that is, the electric field will be maximum at the midpoint and zero at the ends of the slot. This approximation will be valid for lengths less than about a quarter of a wavelength. The power radiated will be one-fourth of that radiated by a uniformly fed slot, and consequently the radiation conductance of a practical short slot will be just one-fourth of the value computed, using (14).

Quantitative results for the radiation conductance of an axial slot are shown in Figs. 4 and 5 on the assumption that the electric-field distribution along the slot is triangular. A cylinder having dimensions $a=0.387\lambda$, $b=0.0968\lambda$ was used in the computations, and Fig. 4 illustrates the effect of length of slot on the radiation

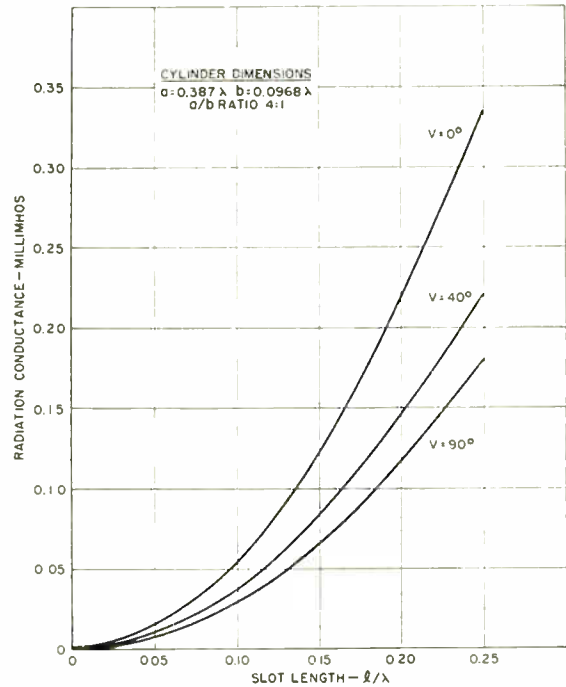

Fig. 4—Radiation conductance of axial slot in elliptical cylinder.

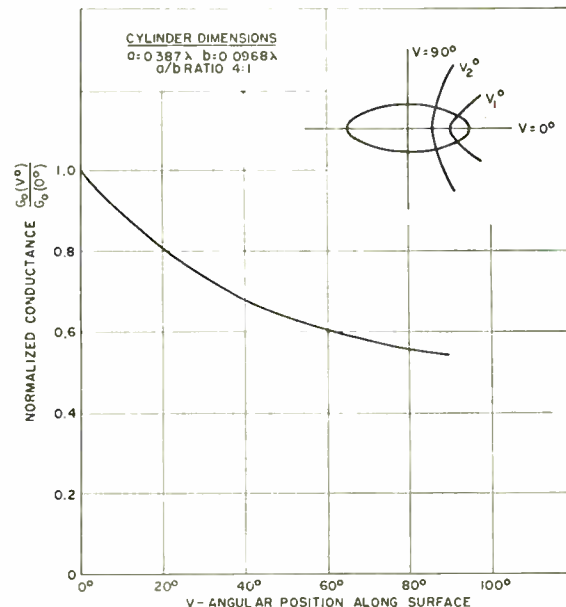

Fig. 5—Effect of position of axial slot on the radiation conductance.

conductance. Furthermore, the radiation conductance of an axial slot is a function of its position on the surface of the cylinder, and this effect is shown clearly in Fig. 5. The curve shows that maximum radiation is obtained for a slot located on the major axis and decreases in value as the distance from the major axis is increased.

(b) Radiation Conductance of Short-Transverse Slot

The determination of the radiation conductance of a transverse slot follows in precisely the same manner as that for an axial slot. The slot is assumed to be symmetrically located about the major axis of the elliptic cylinder, and that the electric-field distribution is assumed to be triangular. The total power radiated in terms of the electric-field components is

$$P = \frac{1}{\eta} \int_0^{2\pi} \int_0^\pi (E_\phi I_\phi^* + E_\theta I_\theta^*) R^2 \sin \theta d\theta d\phi.$$

The expression for the radiation conductance is found to be

$$G_0 = \frac{4}{\eta\pi} \int_0^{\pi/2} (P_\theta + P_\phi) d\theta. \tag{16}$$

The functions P_θ and P_ϕ are defined as

$$P_\theta = \sum_{m=0}^{\infty} \frac{(\widehat{S}e_m(c, \cos v_0))^2}{\sin \theta N_m^e |He_m^{(2)}(c, \cosh u_0)|^2}, \tag{17}$$

where

$$\widehat{S}e_m(c, \cos v_0) = \int_0^{v_0} Se_m(c, \cos v) dv = \sum_{n=0}^{\infty} D_n^m \frac{\sin nv_0}{n},$$

and

$$P_\phi = \sum_{m=0}^{\infty} \frac{\cos^2 \theta (So_m(c, \cos v_0))^2}{\sin \theta N_m^0 |Ho_m^{(2)'}(c, \cosh u_0)|^2}. \tag{18}$$

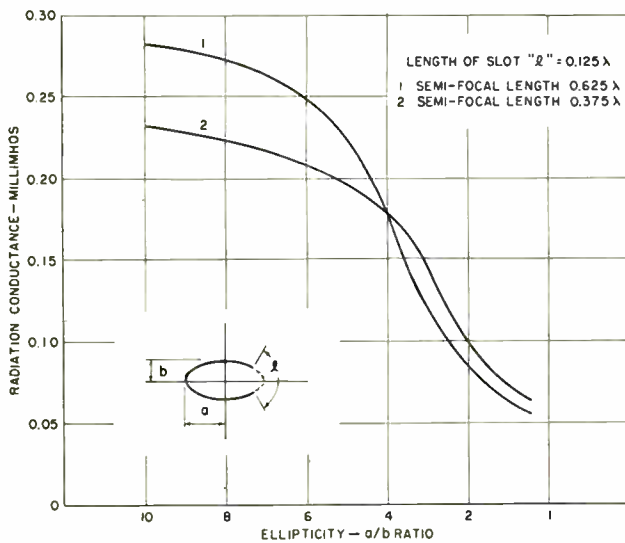

Fig. 6—Radiation conductance of cylinder of transverse slot in elliptical cylinder.

Since the electric-field distribution is assumed to be triangular, the radiation conductance of the slot is one-fourth the value computed using (16).

Quantitative results for the radiation conductance of transverse slots in cylinders of different sizes and ellipticities are presented in Figs. 6 and 7. Fig. 6 illustrates the effect of ellipticity of the cylinder on the radiation conductance, and it shows clearly that the radiation conductance is enhanced greatly for slots on thin

cylinders (large a/b ratios). Two values of semi-focal length are used in order to determine the effect of size of cylinder on the conductance as well as shape. In Fig. 7 the radiation conductance of a transverse slot is plotted as a function of the length of slot. Cylinders of three different shapes are considered, curves A, B and C corresponding to a/b ratios of 10, 4, and 1.6 respectively.

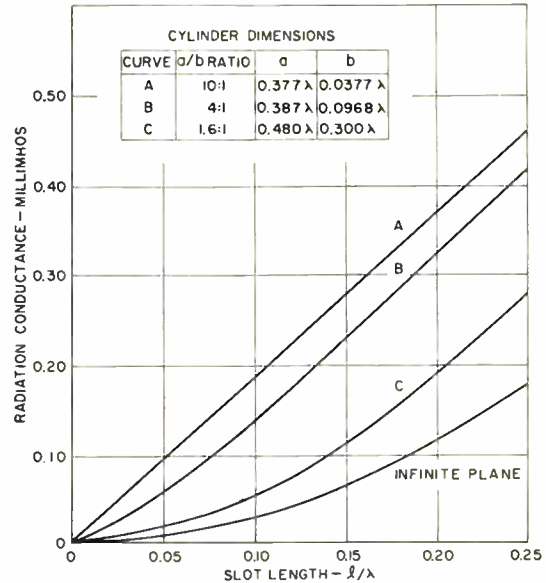

Fig. 7—Variation of conductance of transverse slot with slot length “ l .”

In order to gain a measure of the effect of curvature of the surface on the radiation conductance, the radiation conductance of a transverse slot in an elliptic cylinder is compared with a corresponding length of slot located in an infinite-plane conducting surface. The electric-field distribution is likewise assumed to be triangular, and further, the slot is assumed to be radiating on only one side. An approximate expression for the radiation conductance of a slot with these assumptions is $G_0 = (1/360) (l/\lambda)^2$ mhos. Fig. 8 illustrates the effect of the curvature of the surface on the radiation conductance and it is also observed that the shorter the length of the slot, the more pronounced is this effect. As an example, for a slot $\lambda/8$ long in a cylinder having dimensions $a=0.377\lambda$, $b=0.0377\lambda$, the radiation conductance is increased by a factor of about 5. For a shorter slot length of say, $\lambda/20$, the factor is increased to about 14.

V. CONCLUSIONS

Radiation patterns and curves of radiation conductance have been presented for axial and transverse slots in cylinders of elliptical cross section. The radiation conductance is shown to be influenced considerably by the degree of curvature of the surface on which the slot is located.

APPENDIX

Some definitions of the elliptic cylinder functions are listed on page 1177.

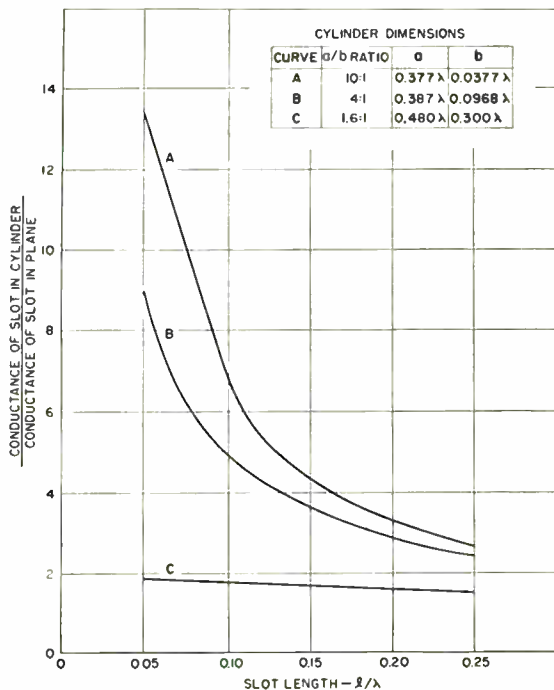

Fig. 8—Ratio of conductance of transverse slot in cylinder to conductance of slot in infinite plane.

Even angular Mathieu function

$$Se_m(c, \cos v) = \sum'_{n=0,1} D_n^m \cos nv,$$

where $c = c_0 k \sin \theta$, $k = 2\pi/\lambda$.

The prime on the summation denotes a summation over even values of n if m is even and over odd values of n if m is odd.

Odd angular Mathieu function

$$So_m(c, \cos v) = \sum'_{n=1,2} F_n^m \sin nv.$$

The conditions imposed upon the coefficients D_n^m and F_n^m are respectively

$$\sum'_{n=0} D_n^m = 1; \quad \sum'_{n=1} nF_n^m = 1.$$

Even radial Mathieu function

$$Ze_m(c, \cosh u) = \sqrt{\frac{\pi}{2}} \sum'_{n=0} i^{m-n} D_n^m Z_n(c \cosh u),$$

where $Z_n(c \cosh u)$ is any cylinder function.

Odd radial Mathieu function

$$Zo_m(c, \cosh u) = \tanh u \sqrt{\frac{\pi}{2}} \sum'_{n=1} i^{n-m} nF_n^m Z_n(c \cosh u).$$

The normalization factors N_m^e and N_m^o can be evaluated from the definitions

$$N_m^e = \pi \left\{ 2(D_0^m)^2 + \sum'_{n=2} (D_n^m)^2 \right\}$$

when m is even.

$$N_m^e = \pi \sum'_{n=1} (D_n^m)^2$$

when m is odd.

$$N_m^o = \pi \sum'_{n=1} (F_n^m)^2.$$

ACKNOWLEDGMENTS

The advice and encouragement of Dr. E. C. Jordan and the assistance received from the staff of the Antenna Laboratory, University of Illinois, are gratefully acknowledged.

Microwave Measurements on Metallic Delay Media*

SEYMOUR B. COHN†, SENIOR MEMBER, IRE

Summary—This paper presents rf index-of-refraction data for metallic delay-lens media containing square and circular obstacles. The equipment used in measuring this data is described, and the necessary correction formulas are given. The test specimens consisted of alternate layers of polyfoam spacers and thin polystyrene sheets imprinted with conducting obstacles. The data may be extended readily to other techniques of fabrication.

* Decimal classification: R310. Original manuscript received by the Institute, January 13, 1953. Presented 1953 IRE Convention, New York, N. Y. Work described here was performed at Sperry Gyroscope Co., part of a program of research under Contract No. W36-039-sc-38250 for Evans Signal Laboratory, U. S. Army Signal Corps. This paper is last of a series resulting from the research.

† Head of the Microwave Group of the Engineering Division, Stanford Research Institute. Prior to February, 1953, with the Sperry Gyroscope Co., as Research Engineer in the Microwave Instruments and Components Department.

INTRODUCTION

SYMMETRICAL ARRAYS of square or circular thin obstacles may be used in the design of metallic delay lenses where performance characteristics independent of the angle of polarization are desired. Approximate formulas have been given for thin-obstacle arrays,^{1,2} but rigorous solutions, having sufficient accuracy for practical design use, appear to be a virtual impossibility at the present time. Therefore, a measure-

¹ W. E. Kock, "Metallic delay lenses," *Bell Sys. Tech. Jour.*, vol. 27, p. 58; January, 1948.

² S. B. Cohn, "The electric and magnetic constants of metallic delay media containing obstacles of arbitrary shape and thickness," *Jour. Appl. Phys.*, vol. 22, p. 628; May 1951.

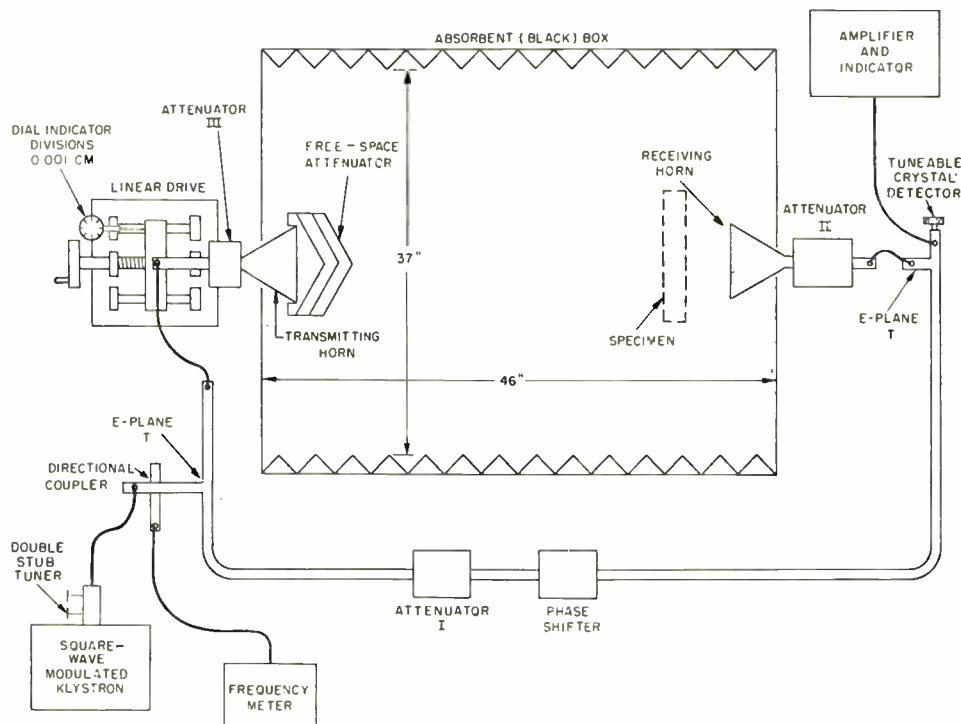

Fig. 1—Dielectric apparatus used for index-of-refraction measurements.

ment program described in this paper has been carried out on these arrays in order to provide accurate index-of-refraction data. The metal-strip array, on the other hand, is susceptible to precise analysis, but its use is limited to a single polarization. Formulas for the strip medium derived by various authors have been discussed and compared with measured data in another paper.³

The index of refraction of a delay medium is constant only at low frequencies, and increases more and more rapidly with frequency until an attenuating, or opaque, band is reached. The low-frequency index of refraction of square and circular-obstacle arrays has already been determined by an analog method utilizing an electrolytic tank.⁴ These data may be applied to the design of media whose obstacles and spacings are very small fractions of a wavelength. In the microwave range it is often more practical to make the obstacles and spacings relatively large, even though this necessitates operation in the region of varying index of refraction. The data presented in this paper cover this region, and make the design of such media possible.

MEASUREMENT TECHNIQUE

The measurement apparatus, shown schematically in Fig. 1, is of a type described in considerable detail by R. M. Redheffer.⁵ The frequency range of operation is 4,500 to 6,500 mc. Two paths are provided between the generator and the detector, one through free space and

the other through waveguide. The attenuators minimize interactions between the various elements, and provide a mean of amplitude adjustment. The paths are initially adjusted to produce signal cancellation at the detector, and then the dielectric sample is inserted and the transmitting horn moved by a measured amount in order to re-establish a signal minimum. If several sources of error to be considered later are neglected, the index of refraction of the sample may be calculated from

$$\eta_0 = 1 + \frac{\Delta + n\lambda}{D} \quad (1)$$

where Δ is the displacement of the transmitting horn toward the receiving horn after the sample is inserted, D is the sample thickness, n is zero or an integer, and λ is the free-space wavelength. The ambiguity in n may be resolved easily in all cases.

The measurement apparatus was checked in order to determine the importance of various sources of error. First, with no specimen present, the motion of the transmitter horn between successive minima was measured and found to agree with the free-space half wavelength within 0.2 per cent. Next, tests were made on a 12-inch-square slab of polystyrene 0.75 inches thick, and the data corrected for internal reflections by the method given by Redheffer.⁵ The results indicated that measurements on the index of refraction of metallic delay samples could be relied on within one per cent. In order to achieve this accuracy, it was found necessary to displace the sample horizontally and vertically by an amount such that the diffracted wavelets from opposite edges would arrive at the center of the receiving horn 180° out of phase. Also, to eliminate an error due to interaction between the specimen and the receiving

³ S. B. Cohn, "Experimental verification of the metal-strip delay-lens theory," *Jour. Appl. Phys.*, to be published in 1953.

⁴ S. B. Cohn, "Electrolytic-tank measurements for microwave metallic delay-lens media," *Jour. Appl. Phys.*, vol. 21, p. 674; July, 1950.

⁵ R. M. Redheffer, "Technique of Microwave Measurement," Radiation Laboratory Series, vol. 11, Chap. 10, McGraw-Hill Publishing Co., New York, N. Y.; 1947.

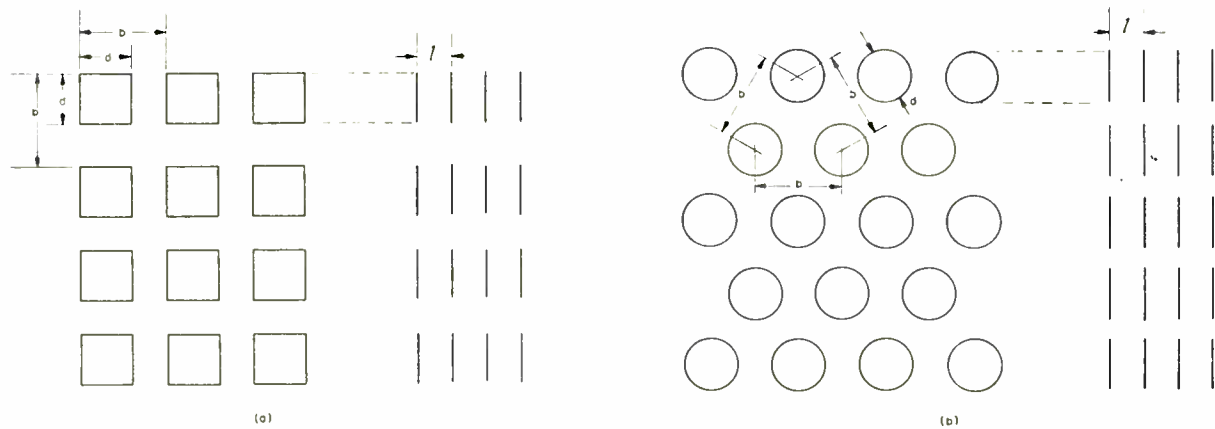

Fig. 2—The square and circular-obstacle media considered in this paper.

horn, it was necessary to average the measurements taken at two axial positions of the specimen separated by a quarter wavelength. These precautions were followed in all cases.

The delay specimens were 14 inches square and 5 inches thick. They consisted of alternate layers of polyfoam spacers and thin polystyrene sheets printed with conducting obstacles. The obstacle patterns, about 12 inches square, were applied by the silk-screen process with DuPont No. 4929 silver paint, which has been found to have very good microwave conductivity. The sheet thickness was 0.005 inches, the minimum usable without puckering. The assembly was held in rigid alignment by 3/4-inch polyfoam slabs in front and back, and by a lucite frame around the edges. The thickness from the first to last sheet of obstacles was in each case approximately 3.5 inches. The index-of-refraction data given in this paper were taken on five square-obstacle patterns and five circular-obstacle patterns as shown in Fig. 2, with various values of l . Other data were taken on rectangular obstacles, but being of limited interest, are not included here.

PHASE CORRECTIONS

In order to compute accurately the index of refraction from the measured transmission phase shift of the specimen, it is necessary to take account of two sources of phase-shift error. One is the phase angle of the transmission coefficient at each boundary between the specimen and air, and the other is the error caused by reflection interactions within the specimen. The first is peculiar to artificial dielectrics, since the phase angle of the transmission coefficient is completely negligible in molecular media. It arises from the discontinuity susceptance occurring at the surface of any array of uniform obstacles. The second phase error occurs in all dielectric media, but is intensified by the presence of a discontinuity susceptance. Formulas taking these effects into account will now be developed.

Assume a plane boundary between two semi-infinite media with normal incident and reflected plane waves in region I and a transmitted wave in region II, as shown

in Fig. 3(a). Let E_A , E_B , and E_C be the respective complex electric-field amplitudes of the three waves at the boundary. Then

$$r_1 = \frac{E_B}{E_A}, \quad t_1 = \frac{E_C}{E_A} = 1 + r_1 \quad (2)$$

where r_1 and t_1 are the reflection and transmission coefficients at the boundary. By applying transmission-line theory, one finds that r_1 and t_1 are given by

$$r_1 = \frac{Y_{01} - Y_{02} - jB_d}{Y_{01} + Y_{02} + jB_d} \quad (3)$$

$$t_1 = \frac{2Y_{01}}{Y_{01} + Y_{02} + jB_d} \quad (4)$$

where Y_{01} and Y_{02} are the characteristic wave admittances of the two media, and B_d is the shunt susceptance at the boundary.

In the case of a medium having parallel-plane surfaces, as shown in Fig. 3(b), the ratio of the electric-field amplitudes of the normal transmitted and incident waves is given by⁵

$$\frac{E_F}{E_A} = \frac{t_1 t_2 e^{-jk_d D}}{1 - r^2 e^{-j2k_d D}} \quad (5)$$

where k_d is equal to $2\pi/\lambda_d$, and λ_d is the wavelength in the delay medium. The other symbols are defined in Fig. 3(b). From (3) and (4) one obtains the following equations for r , t_1 and t_2 .

$$r = \frac{y_I - 1 - jB_d/Y_0}{y_I + 1 + jB_d/Y_0} \quad (6)$$

$$t_1 = t_2/y_I = \frac{2}{y_I + 1 + jB_d/Y_0} \quad (7)$$

where Y_0 is the characteristic impedance of free space, and $y_I = Y_I/Y_0$ is the normalized image impedance of the medium measured in an obstacle plane.

The phase lag between E_F and E_A is obtained from (5) by taking the negative of the angle in the complex

plane of the right-hand side. This phase shift is also equal to $kD + k\Delta + 2\pi n$ radians, where $k = 2\pi/\lambda$, λ is space wavelength, n is zero or an integer, and Δ is the horn displacement defined earlier. Hence

$$kD + k\Delta + 2\pi n = k_d D - \angle t_1 t_2 + \angle(1 - r^2 e^{-j2k_d D}) \text{ radians.} \quad (8)$$

The index of refraction of the medium is given by the ratio of the internal phase shift $k_d D$ to the phase shift kD in the same distance of free space. Therefore, with the aid of (1),

$$\eta = \eta_0 + \frac{\lambda \angle t_1 t_2}{2\pi D} - \frac{\lambda \angle(1 - r^2 e^{-j2k_d D})}{2\pi D}. \quad (9)$$

The second term on the right of the equal sign is the contribution of the transmission-coefficient phase angles, and the third term is the effect of reflection interaction.

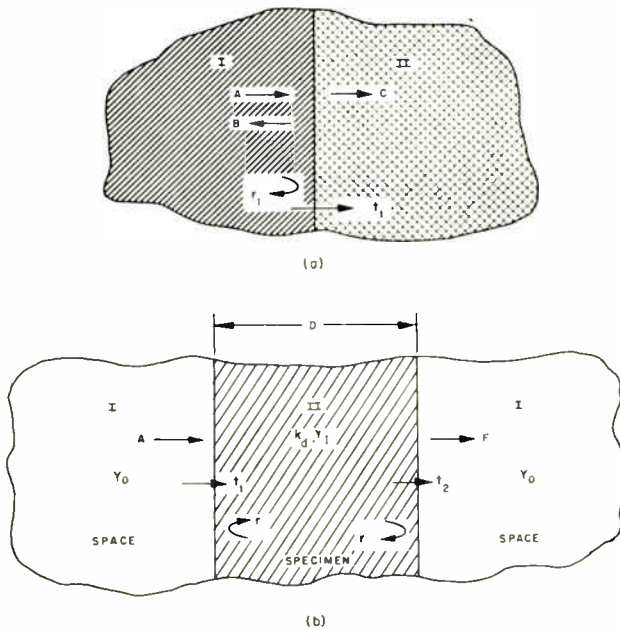

Fig. 3—Wave parameters at single and double boundaries between two media.

Let

$$\phi_{ts} = -\angle t_1 t_2 \text{ degrees} \quad (10)$$

$$\phi_r = \angle(1 - r^2 e^{-j2k_d D}) \text{ degrees,} \quad (11)$$

then the corrected index of refraction is

$$\eta = \eta_0 - \frac{\lambda \phi_{ts}}{360D} - \frac{\lambda \phi_r}{360D}. \quad (12)$$

For the delay-media samples $D/\lambda \approx 2$. Hence, in order to have the error in η due to errors in ϕ_{ts} and ϕ_r remain less than 0.015, the sum of these angles must be known to within 11° .

Substitution of (7) in (10) yields

$$\phi_{ts} = -\angle \left[\frac{4y_I}{\left[y_I + 1 + j \frac{B_d}{Y_0} \right]^2} \right]$$

$$= 2 \tan^{-1} \left[\frac{B_d/Y_0}{1 + y_I} \right]. \quad (13)$$

If now the surface obstacles are assumed equal to the internal obstacles, B_d will be one half of the susceptance B of an isolated sheet. In a typical case, ϕ_{ts} may be as large as 60° , and therefore cannot be neglected.

It is convenient to express ϕ_{ts} as follows

$$\phi_{ts} = \phi_t + \phi_{ts}', \quad (14)$$

where $\phi_t = \tan^{-1}(B/2Y_0)$, the major part of ϕ_{ts} , is the phase shift of a single sheet measured by the dielectrometer, and ϕ_{ts}' is a residual quantity given by

$$\phi_{ts}' = 2 \tan^{-1} \left[\frac{B/2Y_0}{1 + y_I} \right] - \tan^{-1} \frac{B}{2Y_0}. \quad (15)$$

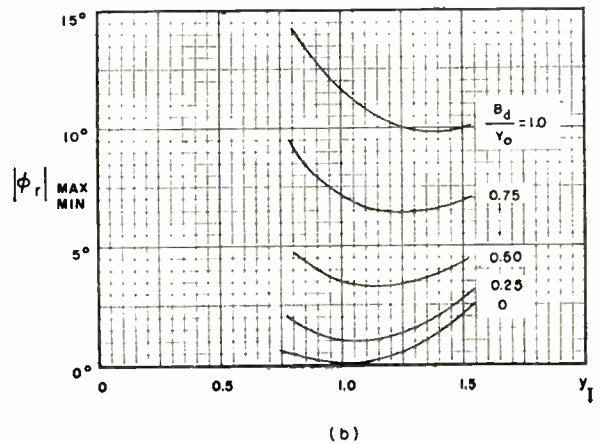
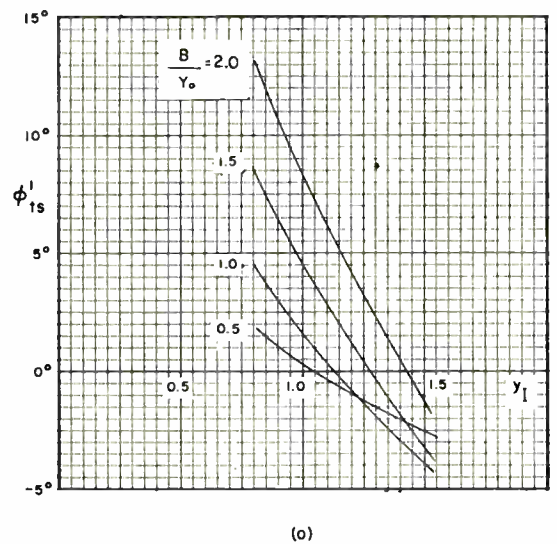

Fig. 4—Phase-shift errors. (a) Residual transmission-coefficient phase shift after subtracting phase shift of an isolated sheet, $B_d = B/2$; (b) Extreme values of phase-shift deviation due to internal reflections.

This is plotted in Fig. 4(a) as a function of B/Y_0 and y_I . Values of ϕ_{ts}' may be determined within a few degrees from measured values of B/Y_0 , and judicious estimates of y_I . The latter were obtained from the known y_I curves

for the metal-strip medium⁶ by matching the corresponding index of refraction curves.

The extreme values of ϕ_r may be deduced from (6) and (11) to be

$$(\phi_r)_{\max/\min} = \pm \sin^{-1} \left[\frac{(y_I - 1)^2 + (B_d/Y_0)^2}{(y_I + 1)^2 + (B_d/Y_0)^2} \right]. \quad (16)$$

This is plotted in Fig. 4(b) with B_d equal to $B/2$. It is seen that ϕ_r can be neglected for all but the largest values of B/Y_0 (which correspond to the largest obstacles tested). For the latter cases, B_d was reduced or eliminated by using smaller obstacles on the surfaces, thus reducing ϕ_r to negligible importance. This also reduced ϕ_{ts} , and its value was computed by (13) using the residual B_d and an estimate of y_I .

THE MEASURED DATA

Phase-shift measurements over the 4,500 to 6,500 mc range were first made on single sheets of obstacles, and then arrays of each pattern were tested over the frequency range with different spacer thicknesses. The index-of-refraction points were computed in the manner described above, and are plotted in Figs. 5 through 10.

The index-of-refraction values at $b/\lambda=0$ could not, of course, be measured by the dielectrometer, but were calculated from the electrolytic-tank values of $B\lambda/Y_0b$ already available.⁴ The following formula was used

$$\eta(0) = \sqrt{K_1} \sqrt{1 + \frac{b}{2\pi l} \left[\frac{B\lambda}{Y_0 b} + \delta \frac{B\lambda}{Y_0 b} \right]} \quad (17)$$

where K_1 is the dielectric constant of the polyfoam spacers, about 1.03, and $\delta(B\lambda/Y_0b)$ is the contribution of the polystyrene sheet. It has been found that for small sheet thicknesses the following formulas for the susceptance increment hold with good accuracy:

$$\delta \frac{B\lambda}{Y_0 b} = \frac{2\pi t}{b} \left\{ \frac{K}{K_1} \left[\frac{d/b}{1 - d/b} + 1 - \frac{d}{b} \right] - 1 \right\} \quad \text{for squares,} \quad (18)$$

$$\delta \frac{B\lambda}{Y_0 b} = \frac{2\pi t}{\sqrt{3} b} \left\{ \frac{K}{K_1} \left[\frac{1.77d/b}{1 - 0.886d/b} + \sqrt{3} - \frac{1.77d}{b} \right] - \sqrt{3} \right\} \quad \text{for circles,} \quad (19)$$

where K is the dielectric constant of polystyrene, about 2.5, t is the sheet thickness, and d and b are defined in Fig. 2. The points determined by (17), (18) and (19) are plotted in Figs. 5 through 10, and the resulting curves are seen to have the shape expected theoretically.

It must be remembered that the index-of-refraction data plotted in Figs. 5 through 10 apply only to the dielectric materials and dimensions utilized in the test specimens, and may be appreciably affected by altera-

tions of these parameters. However, it is possible to extend these data to other frequency bands, dielectric constants and sheet thicknesses, as shown below.

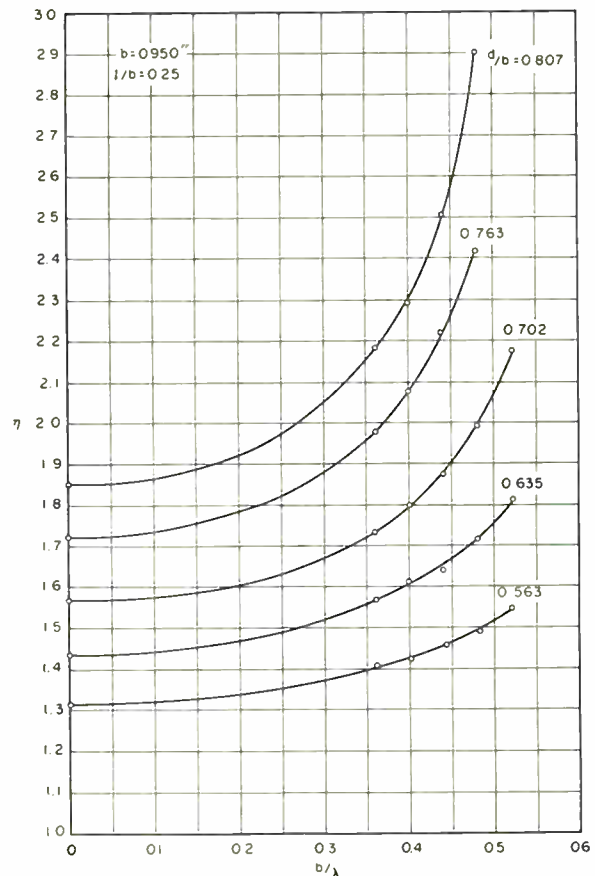

Fig. 5—Index of refraction of square obstacles on 0.005-inch polystyrene sheets spaced by polyfoam, $l/b=0.25$.

EXTENSION OF THE DATA

The graphical data may be used directly in other frequency ranges by scaling b , d , l and t proportional to λ , and using the same K and K_1 . If t/λ , K and K_1 are changed, the effect on the index of refraction may be determined as follows:

The only important effect of a thin dielectric sheet on the equivalent circuit of a printed obstacle pattern is to increase the shunt susceptance, B . Therefore, for small thicknesses, a change in t may be considered to have the same effect as a change in d/b , if in the two cases the total shunt susceptances are made identical. This conclusion justifies the following simple procedure for taking into account a change in sheet thickness. First, calculate $\eta(0)$ by (17), (18) and (19) for the particular d/b , l/b and dielectric sheet involved, assuming $K_1 = 1.03$. Then plot this point on the index-of-refraction graph for the same l/b . Finally, starting with this zero-frequency point, interpolate the new index-of-refraction curve between the adjacent curves on the graph. For example, if the starting point lies half way between two curves, then the remaining points will lie half way between these curves.

⁶ S. B. Cohn, "Analysis of the metal-strip delay structure for microwave lenses," *Jour. Appl. Phys.*, vol. 20, pp. 257-262 and p. 1011; March and October, 1949.

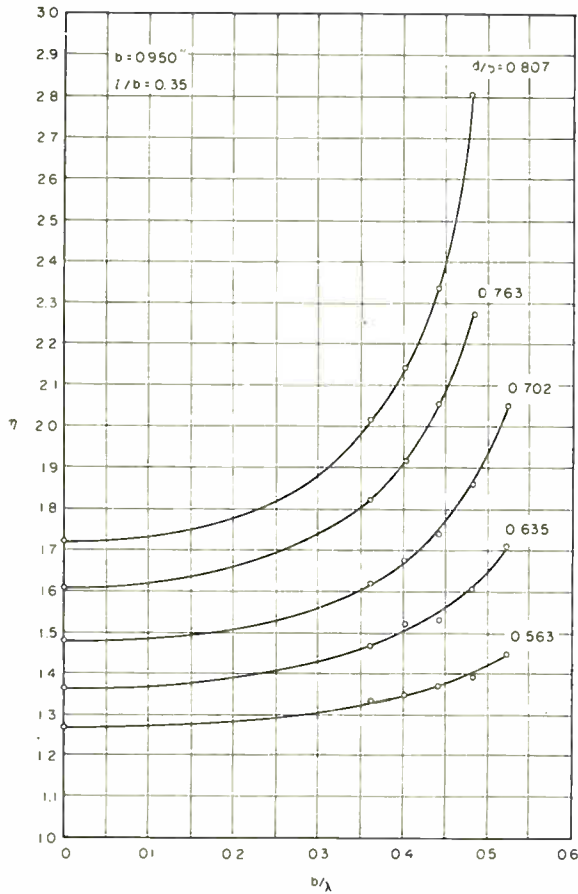

Fig. 6—Index of refraction of square obstacles on 0.005-inch polystyrene sheets spaced by polyfoam, $l/b=0.35$.

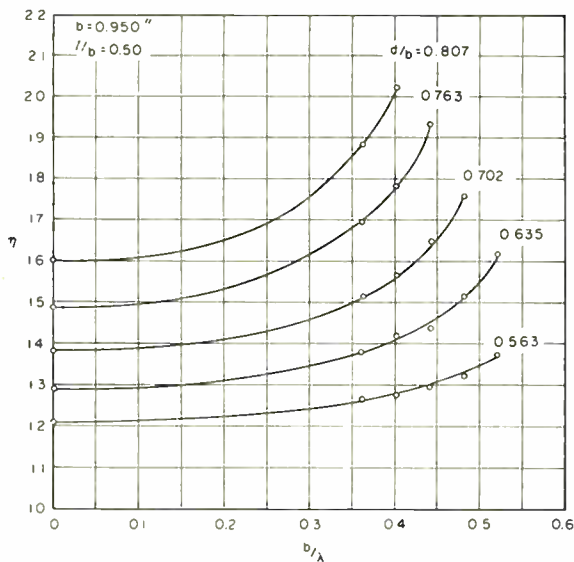

Fig. 7—Index of refraction of square obstacles on 0.005-inch polystyrene sheets spaced by polyfoam, $l/b=0.50$.

The above procedure assumes the dielectric constant K_1 of the spacers to be unchanged from 1.03. If K_1 is changed, the new index-of-refraction curve should then be corrected by the following general relationship for metallic-obstacle arrays embedded in a uniform medium of dielectric constant K_1 .

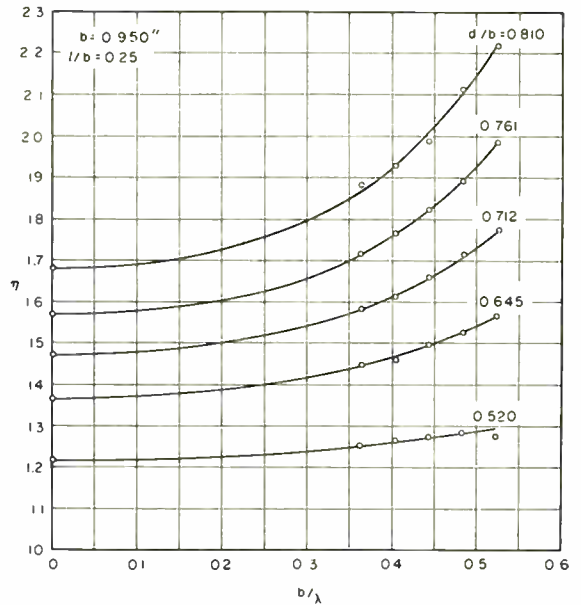

Fig. 8—Index of refraction of circular obstacles on 0.005-inch polystyrene sheets spaced by polyfoam, $l/b=0.25$.

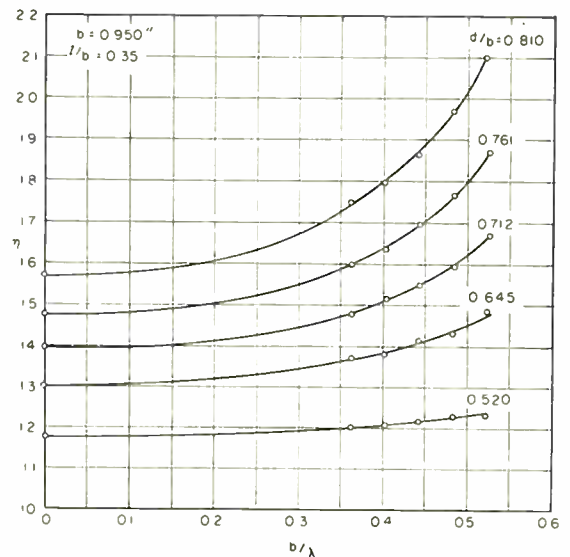

Fig. 9—Index of refraction of circular obstacles on 0.005-inch polystyrene sheets spaced by polyfoam, $l/b=0.35$.

$$\eta_1 = \frac{\eta}{\sqrt{K_1}} = N\left(\frac{b}{\lambda_1}\right) \tag{20}$$

η and η_1 are the indices of refraction relative respectively to air and to a medium K_1 , and λ_1 is the wavelength in K_1 . $N(b/\lambda_1)$ is independent of changes in K_1 if b/λ_1 is maintained constant. This relationship may be applied as follows: Let η be the index of refraction relative to air at frequency f for an obstacle array embedded in medium K_1 , and let η' and f' be the corresponding values for the same obstacle array embedded in K_1' . Then

$$\eta' = \eta \sqrt{\frac{K_1'}{K_1}}, \quad f' = f \sqrt{\frac{K_1'}{K_1}}. \tag{21}$$

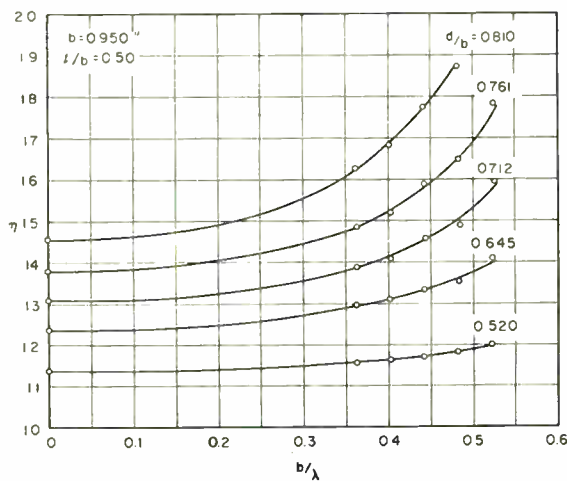

Fig. 10—Index of refraction of circular obstacles on 0.005-inch polystyrene sheets spaced by polyfoam, $l/b=0.50$.

By means of (21), a known curve of η versus f for one value of K_1 can be transformed into the appropriate curve for a second value of K_1 .

These methods of extending the original data have been applied to three different test pieces consisting of

foam spacers with obstacles printed directly on their surfaces (i.e., $t=0$). In two test pieces K_1 was 1.06, and in the third test piece K_1 was 1.19. A different obstacle pattern was used in each test piece. In all cases, excellent agreement was obtained between the directly-measured index-of-refraction curves and the curves obtained in the above-described manner.

CONCLUSION

It has been found that accurate r - f measurements of the index of refraction may be made on delay-medium samples of moderate size, if the various sources of error are carefully evaluated and taken into account. The graphical data presented in this paper is directly applicable only to the particular parameters involved, but may be extended easily by the method given in the text to cover a wide range of practical design possibilities.

ACKNOWLEDGMENT

The important contributions of Robert C. MacVeety to the development of the experimental technique and to the handling of the data are gratefully acknowledged.

The Calculation of the Path of a Radio-Ray in a Given Ionosphere*

A. H. DE VOOGT†, MEMBER, IRE

Summary—A third degree function is presented giving in a hypothetical way the electronic density in the ionosphere as a function of height or distance to the earthcenter: by inserting appropriate values of the constants, in accordance with measured values from ionospheric sounding stations, it is possible to arrive at any desired or proposed form of distribution (Chapman, Hacke^{1,2}), though there is no physical base for this third degree curve given in this paper. This function allows, after substitution, to calculate exactly, i.e., without any approximation, traveling-time, reached maximum height, and reached distance on the earth's surface of a radio-ray radiated at a given angle. Briefly, the calculation of the ray-path in an ionosphere based on measured values and heights of ionization-maxima at the ionospheric stations and based on arbitrarily selected values of gradients, is shown to be possible.

INTRODUCTION

ASSUMING NO INFLUENCE of the earth magnetic field nor of the collisional friction in the ionosphere and accepting horizontal layers with

no horizontal gradient, it is possible to arrive at formulas in differential form, for traveling time, distance, maximum height, etc., of a radio-ray. In fact these formulas embrace the theorems of Martyn and Breit and Tuve^{3,4} for a curved earth. In these formulas the refractive index as a function of height or of distance to the earth-center has to be introduced in such a way that the integrated form is algebraically solvable. It will be shown that a simple third degree equation may serve the purpose in the meantime giving an acceptable electronic-density curve. The form of this curve may be brought in close coincidence with any form of Chapman- or Hacke-distribution.¹ For the lower part of the ionosphere, the start is supposed to be made at 70 km height by a smooth curve, the tangent of which in the starting point is "vertical." The gradient of ionisation is increasing up to a certain point (see curves of Figs. 3 and 4) where a second hypothetical curve is introduced with constants differing from those of the first curve and with decreasing gradient up to a maximum of ionisation

* Decimal classification: R113.75. Original manuscript received by the Institute, October 21, 1952; revised manuscript received April 20, 1953.

† The Hague, 12, Kortenaerkade, Netherlands.

¹ J. E. Hacke, Proc. I.R.E., vol. 36, p. 724; 1948.

² John M. Kelso, Proc. I.R.E., vol. 38, p. 533; 1950.

³ D. F. Martyn, Proc. Phys. Soc., vol. 47, p. 323; 1935.

⁴ G. Breit and M. A. Tuve, Phys. Rev. II, vol. 28, p. 554; 1926.

which is reached with "vertical" tangent at a given height. Thus the *E*-layer-maximum is reached and now the process restarts in the same way until the *F*-layer maximum is reached. In total, four different third degree equations are used and the formulas, simple at the beginning of this calculation process, are very complicated towards the end though the mathematical part is simple. The numerical calculations are exceedingly cumbersome. In this paper only the simple start of the calculation is given in order to show the way of procedure and at the end the results of the calculations are given in a practical form and subsequently discussed. If the reader is interested in these calculations the author will be pleased to send a full account of the complete calculation on request (address: PTT-Radio-Service, Scheveningseweg 6, The Hague).

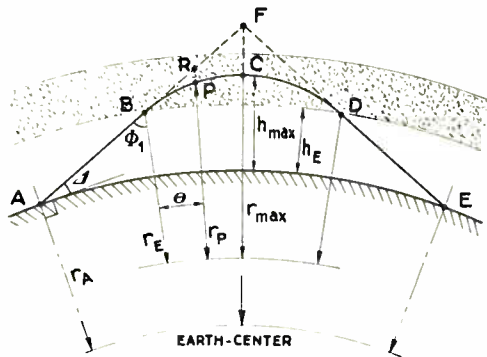

Fig. 1

I.

In Fig. 1 is presented the trajectory of a radio ray through the ionosphere from a point *A* to a point *E* on the earth's surface via *B*, *C* and *D*. Fig. 2 gives on an enlarged scale the situation between two successive points *P* and *Q* in the ionosphere very close together. Applying the law of Snellius for a curved earth and ionosphere and assuming the refractive-index to be *n*, the distance of the earth-center *r*, *r_E* the earth-center-distance of the lowest part of the ionosphere, the angle of incidence in an ionosphere layer *φ*, the group-velocity *v* and the velocity of light *c*, we have the basic equations:

$$\left. \begin{aligned} r_P n_P \sin \phi_P &= r_Q n_Q \sin \phi_Q = r_E \sin \phi_1 \\ n &= f(r) \\ v &= cn \end{aligned} \right\} \quad (1)$$

Simple mathematics (see remark at the end of the introduction) lead to the formulas:

$$dt = \frac{r dr}{c \sqrt{r^2 f^2(r) - r_E^2 \sin^2 \phi_1}} \quad (2)$$

$$d\theta = \frac{r_E \sin \phi_1 dr}{r \sqrt{r^2 f^2(r) - r_E^2 \sin^2 \phi_1}} \quad (3)$$

The traveling time for the ray from *B* to *E* and the earth-center-angles *θ* of the radius vector may be found

by integrating (2) and (3) under the condition that: *n=f(r)*, is a known function and that by substituting this function the integrals are solvable.

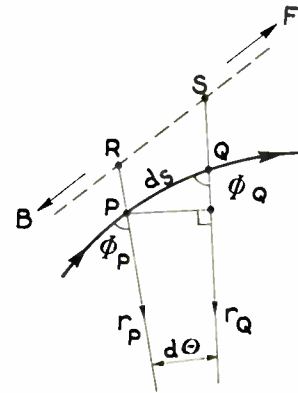

Fig. 2

Now it is well known that:

$$n^2 = 1 - kN \quad (4)$$

where *N* is the electronic density and

$$k = \frac{8.1}{f_{mc}^2} \quad (5)$$

if the frequency *f* is expressed in megacycles per second and *N* is the number of electrons per cm³ divided by 10³. Instead of assuming a function for *n* the author proposed in a former paper⁵ the use of the following function for *N*:

$$kN = a + \frac{b}{r} + \frac{g}{r^2}$$

where *a*, *b* and *g* are constants which may be found by boundary conditions. The final equation is accordingly:

$$n^2 = 1 - kN = 1 - \left(a + \frac{b}{r} + \frac{g}{r^2} \right) \quad (6)$$

For: *r=r_E*, *N* ought to be 0,

$$ar_E^2 + br_E + g = 0 \quad (7)$$

If the ionisation is starting smoothly at the point *B* (fig. 1) for *r=r_E*; *dN/dr* ought to be 0, thus:

$$r_E = \frac{-2g}{b}; \quad 4ag = b^2$$

and finally:

$$b = -2ar_E; \quad g = ar_E^2.$$

Equation (6) may now be written:

$$N = \frac{a}{k} \left(1 - \frac{r_E}{r} \right)^2 \quad (8)$$

The integration of (2) and (3) between *r=r_E* and *r=r_{max}* is not difficult; *r_{max}* is formed by using (1) for

⁵ A. H. De Voogt, *l'Onde Electrique*, vol. 30, No. 283, pp. 433-437; Oct. 1950.

$\phi = 90^\circ$ at the top of the ray:

$$n = \frac{r_E \sin \phi_1}{r_{\max}}$$

giving with (6) and (8)

$$r_{\max} = r_E \frac{a + \sqrt{\sin^2 \phi_1 + a \cos^2 \phi_1}}{a - 1} \quad (9)$$

The result, which will be sent on request to the reader, is a series of complicated formulas for the traveling time-intervals T_{AB} , T_{BC} , etc. and the earth-center angles θ_{AB} , θ_{BC} , etc.

II.

We have to consider now more accurately the hypothetical ionisation-curve defined by (6). In Fig. 3 the part of this 3rd degree-curve which is used to represent the ionisation of the lower ionosphere is given as a full-drawn line. (The parts for $r < r_E$ and $r > r_{m1}$ are not drawn, being unnecessary.)

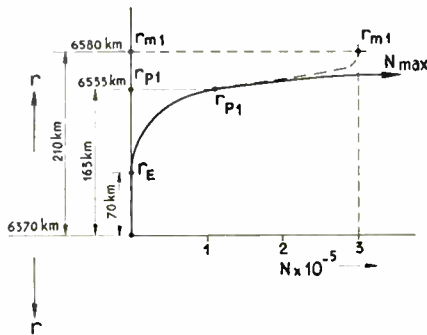

Fig. 3

The constants which define this particular curve are: $r_E = 70$ km and $a = 200$ for a frequency of 20 Mc/s. If another value of a is chosen the curvature of the ionisation-curve is changed.

The attention of the reader may now be drawn to the fact that it is quite possible to use the same procedure, and the same ionisation-curve for rays of different radio-frequencies. This will be clear after the following reasoning. The ionisation-formula is given by (5) which equation may be written with (8) in the form:

$$N = \frac{a}{k} \left(1 - \frac{r_E}{r} \right)^2 \quad (14)$$

Now by changing the frequency in: $k = 8.1/f_{mc}^2$, k changes into k' and by changing a in a proportional manner the quotient a/k remains unvariant and consequently the equation (14) will show unaltered constants for variable frequencies.

This means that the calculations are applicable to any desired frequency.

Now the next step in this process is to end the curve at a certain point r_p , and starting in r_p a new curve (dotted line in Fig. 3) of a type which is the reverse of the first curve.

This second curve is defined by the point r_{m1} , $N_{\max 1}$ and r_{p1} , N_{p1} . At the point of maximum ionisation r_{m1} the

tangent to the curve is again "vertical" and in r_{p1} both curves have the same tangent. The whole process may be repeated again for the next layer, the F -layer. Fig. 4 gives the curves. The formulas are still getting more complicated though not difficult to understand. (See remark at the end of the "Introduction.")

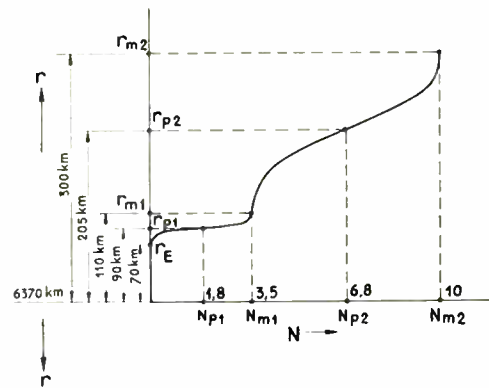

Fig. 4

As an example the constants for the complete E - and F -layer ionisation curve of Fig. 4 have been chosen as indicated in that drawing. The calculation has been completed for the frequencies of 1; 1.5; 2; 3; 4; 5; 6; 7; 10 and 20 Mc/s and for angles of radiation from zero to 90° . The critical angles for which the ray passes through the layer or remains parallel to it, or, the optimum θ -values for maximum and minimum distances on the earth surface, have been specially calculated.

In a simplified form Fig. 5 gives a summary of results. The horizontal axis is the earth surface taken to be a straight line; the indicated values of the distances are of course *calculated* according to the formulas of §I and §II for a *curved* earth. One unit of θ , represents a distance of 111 km on the earth surface.

The km-scale of height has been chosen in accordance with the horizontal scale so that the picture gives the real situation above the earth surface.

A complete series of drawings according to Fig. 5 for a number of ionospheric situations will be sent to the reader on request.

For the frequency of 20 mc the ray passes through the F -layer down to a radiation angle of $21^\circ 43'$. At this angle the ray follows the layer till infinity, the maximum height reached is 283 km; for a radiation angle of only $12'$ less the maximum height is reduced to 266 km and the ray reaches the earth at 2,630 km distance after 9.94 ms traveling time. At $\Delta = 17^\circ 31'$ a minimum distance is attained of 1,919 km (first skip-distance), at $\Delta = 12^\circ 26'$ the distance is again increasing reaching infinity (parallel to E -layer) at $11^\circ 21'$. At $11^\circ 19'$ the maximum height is 107 km, the distance 1,420, at $5^\circ 21' 30''$ there is again a minimum distance of 1,126 km (second skip-distance); at $\Delta = 0^\circ$, an angle not met in practice, the distance is: 2,228 km.

In Fig. 5 the same picture is given for 10 and 4 Mc/s on the same scale.

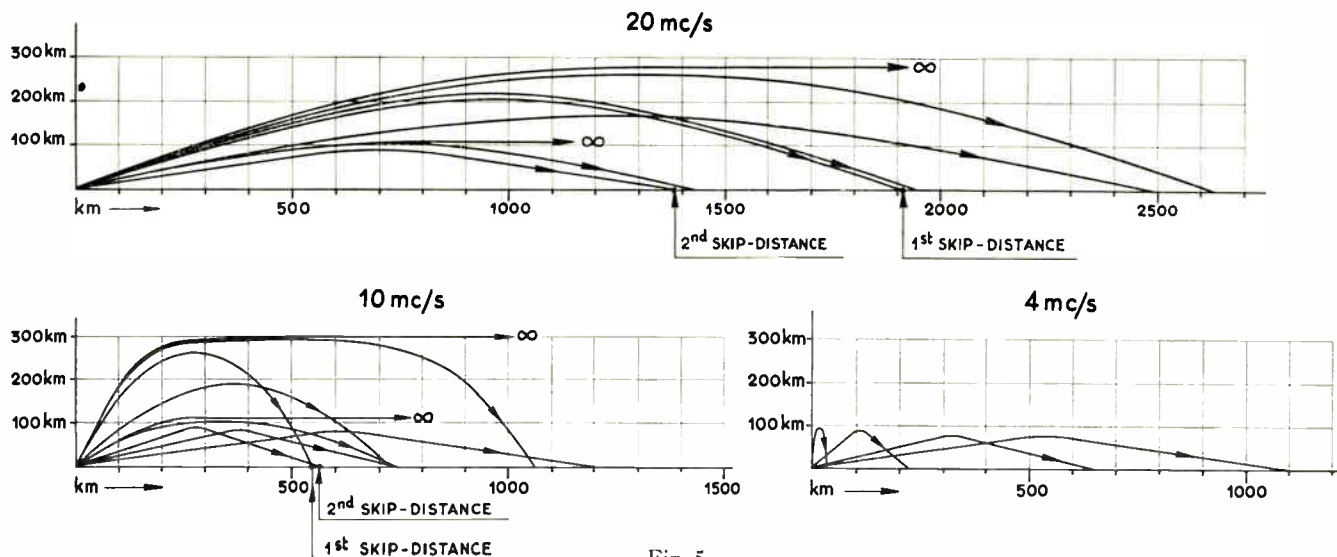

Fig. 5

For 10 Mc/s again two “infinity”-distances appear and two minimum skip-distances; for 4 Mc/s no such definite distances exist and the ray reaches a further point the more the radiation angle is lowered. In practice the radiation-angles for the 20 Mc/s in Fig. 5 are covered by normal directive aerials, for 10 and 4 Mc/s the angles above 30° are rather too high.

It will be clear to the reader that the same distance may be covered by rays with different radiation angle giving interference; the difference in time of arrival is known by the calculation-method mentioned above. In Fig. 5 (10 Mc/s) the point at 729 distance is reached by four rays with a time of traveling difference of approx. 0.3 m. sec. between each other.

CONCLUSION

The examples given in paragraph 3 make it clear that it is possible to calculate exactly the path of a radio-ray when the ionisation-curve is given in a form based on formula (6). Curves for vertical incidence giving real and virtual heights may be constructed in order to compare them with the ionograms of ionospheric-sounding stations. This work is now in progress at the section: “Ionosphere and Radio-Astronomy” of the Netherlands P.T.T. Service.

Furthermore it will be obvious to the reader that the system of calculating described here above is also applicable to an ionosphere with negative gradient, that is, for the upper part of each layer. Thus a complete ionosphere with one or more layers may be analysed and the angles θ (and ϕ) by which a ray which penetrates the ionosphere, passes through it and leaves the earth, may be calculated.

In the future for short waves (less than 10 meters) this feature will be of importance in order to find the corrections for the angles of arrival of rays coming from radiostars.

In the example given in Fig. 4 the E_{max} -ionisation has been taken on rather a high level (not often present in praxis). This is done with the object to demonstrate

the influence of the E-layer on F-layer-transmission. It is a simple matter to assume a weaker E-layer eventually with a negative gradient above the maximum.

Finally one may ask if the approximation of Fig. 4 based on formula (6) is justified. Writing (8) with a transformation of the variable r in h , the height above the earth ($r=r_E+h$), we obtain:

$$\begin{aligned}
 kN &= a \left(1 - \frac{r_E}{r} \right)^2 = a \left(1 - \frac{r_E}{r_E + h} \right)^2 \\
 &= a \left(\frac{r_E + h - r_E}{r_E + h} \right)^2 = a \frac{h^2}{(r_E + h)^2}
 \end{aligned}$$

and taking: $r_E+h \approx r_E$, because $r_E \gg h$, the final form is:

$$\frac{kr_E^2}{a} N = h^2$$

which equation represents a parabola.

The same argument holds good for the upper part of the curve from Fig. 3. The approximation is in fact an acceptable one.⁶

It is difficult to take in account the magnetic field on the earth and its influence on the refractive index and the splitting of the ray caused by it. In every point of the ray the position of the field is different. But it is a happy circumstance that for angles of radiation of 5° up to 30° which are used in common practice, the minimum value of the refractive index very seldom falls below 0.9, and the differences caused by the magnetic field may have a small influence.

By effectuating the above calculations for a series of assumed ionospheric conditions one is able to get a better impression of paths of radio-rays and of quantities involved in the ionospheric-radio-transmission.

ACKNOWLEDGMENT

The author wishes to express his gratitude to Mr. Steiner of Netherlands P.T.T. for valuable assistance he gave in making many complicated calculations.

⁶ J. A. Pierce, *Phys. Rev.*, vol. 71, pp. 698-706; May, 1947.

Discussion on

Correlation and Linear Transforms*

MARCEL J. E. GOLAY

D. A. Bell:¹ While supporting entirely Golay's view that correlation methods are unlikely to produce any unique advantage, I think that in terms of applications there is more to be said in their favour and also something to be said against both correlation methods and linear transforms.

The auto-correlation function (in relation to spectra) may be said to have been known to mathematicians since 1921² and perhaps to engineers since about 1945. Since it constitutes a fresh approach to an old problem, it would not be surprising if its general introduction to engineers did "spark the invention of new communication devices"—new *devices* but now new *results*. For example, the sine-wave detector described by Lee, Cheatham and Wiesner³ appears entirely equivalent in performance to a very narrow filter. But as a *device* it has engineering advantages when the equivalent bandwidth required is so very small. There is always an exact theoretical equivalence between a "time-plane" approach (e.g. correlation) and a "frequency-plane" approach (e.g. Fourier analysis), but this then leaves open the question of which device is actually easier to construct.

Golay is rightly critical of the correlation method for its abandonment of phase information, which is equivalent to adopting the least-square-error criterion *provided the noise is random and the signal characteristics are only available in a form which makes the signal "look like random noise."* With these conditions either a correlation detector or a Wiener filter would give least-square-error and ignore phase.

Now the reason for heading this note "Correlation and Linear Transforms" instead of "Correlation versus Linear Transforms" is that if phase information is available for either signal or noise we ought to (and we do in practice) scrap *both* correlation and linear-transform methods and use non-linear devices. It is non-linear devices, not linear-transform devices nor correlation devices, which in such cases are the basis of outstandingly useful devices like coherent detectors (homodyne, synchrodyne, etc.), noise-limiters, frequency-modulation, pulse-slicers, etc.

* Proc. I.R.E., vol. 41, p. 268; February, 1953.

¹ Department of Electrical Engineering, University of Birmingham, England.

² G. I. Taylor, "Diffusion by continuous movements," *Proc. Math. Soc.* (London), vol. 20, p. 196; 1922. Paper read in 1921, printed 1922.)

³ Y. W. Lee, T. P. Cheatham, Jr. and J. B. Wiesner, "Application of correlation analysis to the detection of periodic signals in noise," *Proc. I.R.E.*, vol. 38, p. 1165; October, 1950.

Marcel J. E. Golay:⁴ Bell makes a number of well taken comments, and the purpose of this response is to point out that apparent divergences between Bell's views and the writer's views, as expressed in his article, arise essentially from semantics.

In the first place one may well interpret Bell's stipulation as to results to consider that a new device yielding old results more efficiently or more simply than before does constitute an outstanding useful application. If practical problems exist in which the correlation function is the thing desired, a device performing the correlation calculations efficiently and with reasonably short samples would fall in the class thus defined. However, the existence of such problems is doubted. In the rather artificial problem of detecting a single, or possibly two weak spectral lines (Radio or Audio) submerged in noise, the autocorrelation function can be interpreted by an observer making a mental Fourier transform. The engineering view is taken here that the correlation concept should be a means to an end and as such, constitutes a useful analytic tool at best. As an end in itself, this concept belongs in the realm of mathematics and computing devices built for it belong in the class of mathematical aids. In these, efficiency can be sacrificed to ease construction. Sampling times can be tolerated which are considerably longer than would be acceptable in a computer designed for operational usefulness in a radar system and contrived so as to preserve much of the information content of received signals.

Bell's remarks about linear transforms and linear devices raise a question of definition. The writer has taken the view that non-linear devices multiplying (heterodyning) a received signal containing noise with a locally generated signal, produce a linear transform of the original, whereas non-linear devices multiplying a received signal by itself, perform a non-linear operation.⁵

D. A. Bell: The only point I wish to take up is the definition of "linear device." My criterion of a linear device is that it shall conform to the principle of superposition, i.e. the output produced by simultaneous application of two input signals must be equal to input. It is not at present apparent to me that Mr. Golay's view of the criterion of linearity is equivalent to this.

⁴ Chief Scientist, Squier Signal Laboratory, Fort Monmouth, N. J.

⁵ The writer would like to use this occasion to make a correction in the original manuscript. "The number 40,000 ($4n^2$) should be 30,000, and will be reduced to 27,500 if the C_j series appearing in (2) are replaced by $C_j^* = \sum_m a_m(\delta_{m+j} - \delta_{m-j})$, ($j > 0$), 5000 additional subtractions being required for this." *Proc. I.R.E.*, vol. 41, p. 270; February, 1953.

Correspondence

Instantaneous Frequency*

The letter contributed by J. Shekel published in the April 1953 issue of PROCEEDINGS OF THE I.R.E. raises some interesting issues.

Along, I am sure, with a fair proportion of communications engineers, I have derived in the past a great deal of practical use from the concept of "instantaneous frequency," which Shekel would like to see "banished forever from the dictionary of the communication engineer." "Banishing" would presumably have to start from I.R.E. **Standards on Modulation Systems** (1948) (pages 7 and 8) where such concepts as "Frequency Deviation," "Frequency Swing" and the contested "Instantaneous Frequency" are defined. Shekel's suggestion, if literally applied, certainly creates some practical difficulties. It would no doubt be considerably more difficult to explain "Frequency Deviation" as a "product of certain Bessel function argument and modulation frequency" to an engineering student than to do so using the present definition. Similarly, "Swept-frequency generator" (a useful instrument) would have to acquire a considerably more sophisticated name, and even the term "frequency modulation" would have to be abandoned, since "modulation" implies "variation" and something varying is logically expected to have an "instantaneous" value.

Without quibbling, however, about terminology, it is my opinion that "instantaneous frequency" is a useful concept, which can and should be defined rigorously, without the necessity of resorting to its "intuitive" interpretation.

Following Shekel's interesting observation about a real value not being uniquely defined as a real part of a complex value, I would like to suggest a definition of instantaneous frequency as:

$$\omega_{inst} \equiv \frac{d}{dt} \arg \sum_{k=1}^{k=m} A_k \exp j(\omega_k t + \phi_k) \quad (1)$$

where A_k , ω_k and ϕ_k are all constants assigned to the k -th spectral component of the described wave-shape.

I am sure the above would not constitute a new definition, but one which, if not clearly stated, is at least strongly implied in many papers making use of the concept of "instantaneous frequency," starting for example from the very basic treatment of frequency-modulation problems by Carson and Fry.¹

Thus, our real function of time might be represented by projections on the real axis of many time-dependent phasor sets, but we choose deliberately *only one* such set, namely:

$$f(t) = \operatorname{Re} \sum_{k=1}^{k=m} A_k \exp j(\omega_k t + \phi_k)$$

thus conveniently connecting the practical working concept of "instantaneous" frequency with the undoubtedly more significant physically concept of spectrum data.

* Received by the Institute, April 22, 1953.

¹ J. R. Carson and T. C. Fry, "Variable frequency electric circuit theory with application to the theory of frequency modulation," *Hell System Tech. Jour.*, vol. XVI, pp. 513-540; October 1937.

Shekel's (7) introduces another definition of instantaneous frequency which, as he says "might prove useful." It well might. But I do not see any reason why it should prove more useful than the definition already adopted, provided the conventional definition is adequately qualified in the light of Shekel's interesting observation.

After all, in a case of a strictly illustrative and utilitarian definition, the criterion of whether the definition is "right" or "wrong" does not apply.

The proper criterion is: "is the defined concept useful when its rigorous definition is judiciously applied?"

It is my feeling that the concept of "instantaneous frequency" treated as time-derivative of the argument of a properly defined phasor, is useful.

As for Shekel's statement that "many authors have already referred to this term as fallacious and misleading," the answer probably is that many terms improperly applied can be fallacious and misleading. On the other hand, a number of papers can probably be quoted where the concept of "instantaneous frequency" proved useful and illustrative (for example, the above-quoted paper by Carson and Fry, which I do not believe lost any actuality over the period of years). Unfortunately, I had no ready access to one of the references quoted by Shekel (Vaughan "Spectrum of a frequency modulated wave," *Wireless Eng.*, vol. 29, p. 217; Aug. 1952) but I have not found any sweeping statements regarding the concept of "instantaneous frequency" in the excellent paper by Harvey, Leifer and Marchand.² In my interpretation of the paper the only concern of the authors is to demonstrate that the "variable frequency" concept has in itself no energetic significance and to demonstrate by an ingenious device an illustrative correlation between this concept and the concept of spectral components.

JULIUS J. HUPERT
Physics Department
De Paul University
1036 Belden Ave.
Chicago 14, Illinois

² N. L. Harvey, M. Leifer and N. Marchand, "The component theory of calculating radio frequency spectra with special reference to frequency modulation," *Proc. I.R.E.*, vol. 39, p. 217; June 1951.

How to Win Arguments*

The first requirement in winning an argument is to start an argument. Fortunately this is one of the easiest parts of the process. For the benefit of the few who have trouble getting started, the following standard methods are listed:

1. Make a loud aggressive statement belittling your friend's favorite hobby.
2. Listen to your friend until he makes a positive statement of some sort. Contradict it flatly.
3. Make one or more bold positive statements of doubtful validity. The subject doesn't matter, but politics, the weather, hobbies and girls are favorites. Or a technical subject will do, provided neither you nor your friend are well versed in the specialty discussed.

nical subject will do, provided neither you nor your friend are well versed in the specialty discussed.

The Techniques of Argumentation The Circular Path

One of the favorite artifices of expert arguers is constant repetition. Perfect a pat argument of about a hundred words and repeat it time after time with as little variation as possible. This will wear your opponent down until he gives up in disgust.

The Break-in or Yeabut

Constant interruption is another favorite stratagem. To be most effective, listen intently until it appears that your opponent is about to make an effective point, then interrupt in a loud voice and go into your own routine. Break-ins should usually be preceded by "yeabut" whether you agree with any part of your opponent's argument or not.

The Crescendo

This is a contrivance which is very effective in the hands of a master craftsman. In executing this maneuver, proceed with your standard routine until your opponent sees fit to interrupt. When this occurs pay absolutely no attention to what he says other than to gradually increase the volume of your own voice. This subtle ruse is usually met by a similar crescendo on the part of the opponent. It is a sure sign of the expert to be able to shout back at your opponent so loudly and continuously as not to be able to hear a word he is saying.

The Stutter

A disadvantage of the crescendo is that while it obliterates your opponent's argument it does not succeed in getting your own argument heard. For this reason the stutter is preferred by many experts. The stutter consists in a loud repetition of the first syllable of your proposed commentary with or without the crescendo. As soon as your opponent realizes he is being drowned out he will usually subside and you can proceed. It is an awesome spectacle the way a truly great master of the art can alternate the stutter and the crescendo to beat down all opposition. The stutter is a particularly effective chisel enabling you to break-in on your opponent's routine.

The Use of Invective

A further help is a large vocabulary of sacrilegious words and phrases skillfully adapted to describe your opponent's intelligence and ancestors. While this expedient is very effective, its advocates find it desirable to have some acquaintance with the art of pugilism.

The Syllogism

To fall back on cold solid logic is a sign of weakness. It should never be indulged in unless you want to lose your reputation as a prize pain-in-the-neck.

V. D. Landon
RCA Laboratories
Princeton, N. J.

* Received by the Institute, June 5, 1953.

Symmetrical Ridge Waveguides*

In the course of an investigation of parameters affecting small cavity antennas, some of the properties of symmetrical ridge waveguides were studied. These included the cutoff frequency and the aperture impedance for the TE_{10} mode.^{1,2} More recently, the TE_{11} mode has been observed, and its cutoff frequency measured. These results are interesting, and it seems worthwhile to present a brief summary of them.

In the first group of measurements, six waveguides of the shape of Fig. 1 were constructed, with various ridge depths l . The actual models were bisected by an image plane (dashed line) to facilitate field probing and to eliminate asymmetrical modes. The image plane had a longitudinal slot at the

center of the guide, and the cutoff frequency and aperture impedance were determined by probing the field through this slot.

The cutoff frequency, f_c , as a function of l , is shown in Fig. 2. For $l=0$, $f_c=1477$ mc, the value for a 4-inch square waveguide.

* Received by the Institute, April 28, 1953.
¹ R. E. Webster, "Measurement of aperture impedance of metal-loaded waveguides terminated in a ground plane," Project Report 339-19, Antenna Laboratory, The Ohio State University Research Foundation, Columbus, Ohio; October 1, 1951.
² M. H. Cohen, "Aperture admittances and propagation constants of metal-loaded waveguides," Project Report 339-20, Antenna Laboratory, The Ohio State University Research Foundation, Columbus, Ohio; November 2, 1951.

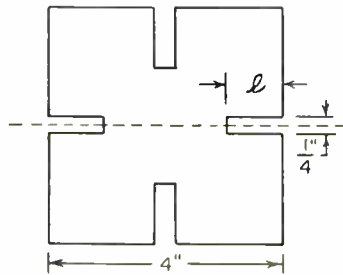

Fig. 1—Symmetrical ridge waveguide cross section.

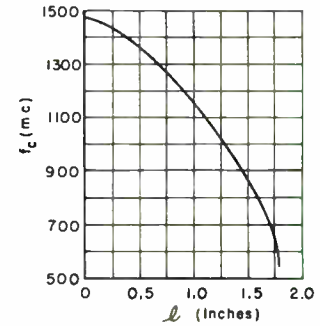

Fig. 2—Cutoff frequency vs. ridge depth.

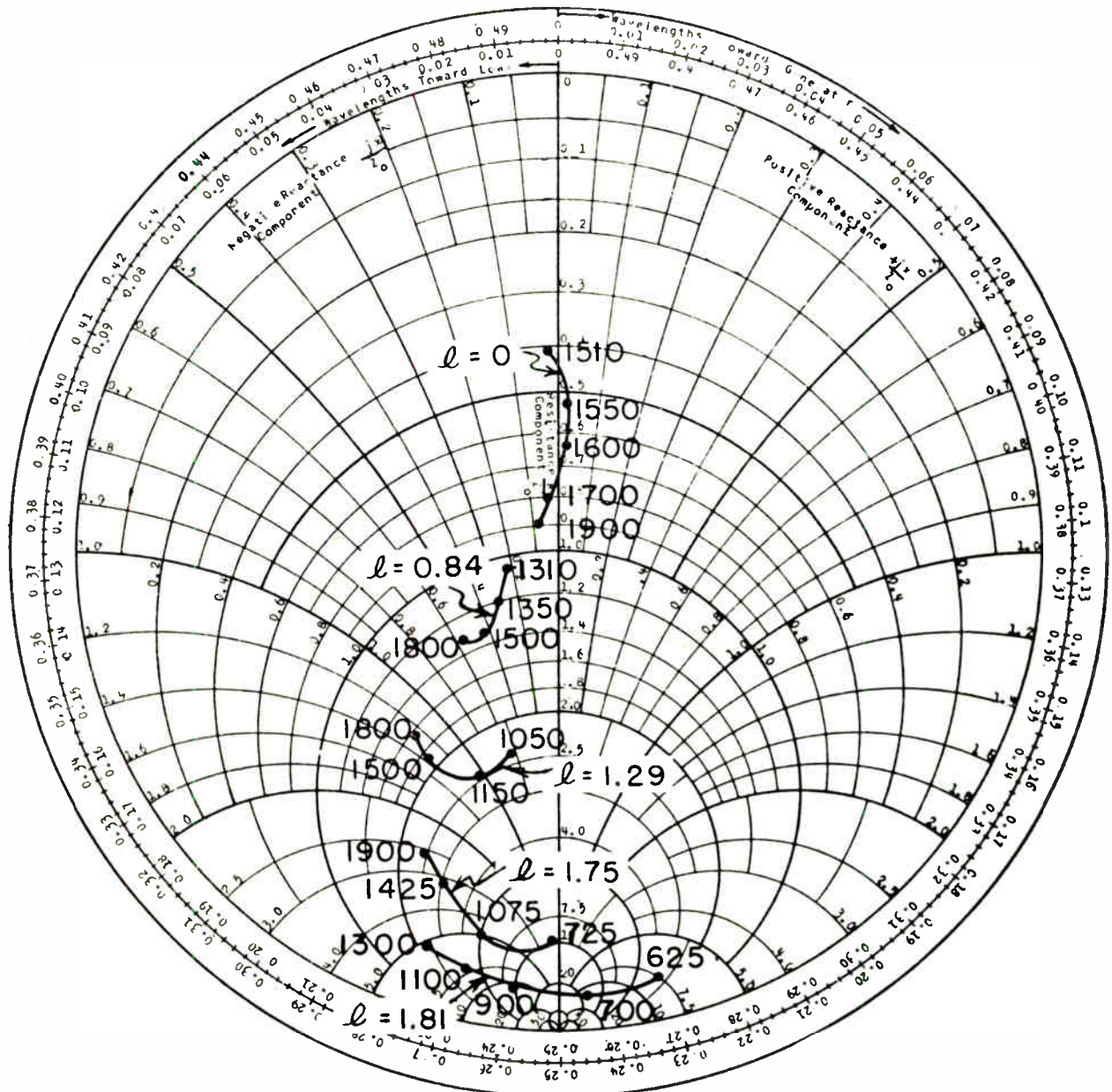

Fig. 3—Relative aperture impedance.

For the TE_{10} mode, f_c may be calculated approximately by the transverse resonance method. The equivalent transverse circuit from the center of the guide to one side consists of two discontinuity capacitors connecting three lengths of transmission line. The results obtained with this circuit are within 6% of the measured values.

The aperture impedance, relative to the transverse wave impedance of the TE_{10} mode, is shown in Fig. 3 for several values of l . In all cases the impedance has a relatively slow variation with frequency. It is comparable to that for a square waveguide with dielectric loading sufficient to reduce f_c by the same amount. The SWR , however, is slightly smaller in the latter case.

One complete (not bisected) waveguide has been built, with $l=1.29$ inches, and $f_c=990$ mc. for the TE_{10} mode. A section of it was made into a resonant cavity, and some resonances were found which were due to a waveguide mode having $f_c=1111$ mc. This mode must be asymmetrical because it was not observed with the bisected guides. It has tentatively been identified as the TE_{11} mode. The ratio of the cutoff frequencies of the TE_{11} and TE_{10} modes is 1.12, whereas the corresponding ratio for a square waveguide is 1.41. A high mode-separation is a much-valued property of ridge waveguides, but it does not exist in this case.

ACKNOWLEDGMENT

These remarks are based on works supported by Wright Air Development Center, Wright Patterson Air Force Base.

MARSHALL H. COHEN
ROBERT E. WEBSTER
Research Associates
Antenna Laboratory
Ohio State University Research Foundation
Columbus, Ohio

A Transistors in Trigger Circuits*

As a part of the course work in my final year at the Eidgenössische Technische Hochschule, Zürich, some N transistors were to be examined for use in trigger circuits.

In the literature three basic circuits are mentioned, using only one transistor. These are based upon the emitter, collector and base driving point resistances. However, a fourth design was developed, and will be described in the following.

The definitions of current and voltage directions to be used here for the equivalent T network of the transistor are the same as used by the Bell Telephone Laboratories.

To realize a trigger circuit, a backward amplification factor, greater than unity, is needed. Translated to transistor design this means that the current amplification factor has to be greater than one, and hence, only N transistors can be used as long as the trigger circuit is supposed to contain only one transistor.

Considering the equivalent circuit of the transistor (Fig. 1) the following equations are found (provided the base is unconnected):

$$V_{ce} + r_e I_e - r_c I_c - r_m I_e = 0$$

and

$$I_e = - I_c$$

the collector-emitter resistance is

$$R_{ce} = \frac{V_{ce}}{I_c} = r_e + r_c - r_m.$$

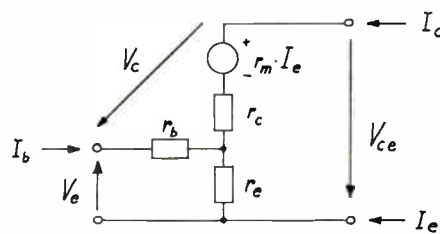

Fig. 1

As this current condition will be met in the trigger circuit, the negative $V_{ce}-I_c$ characteristic can be taken directly from the main transistor characteristics. However, special measurements would be preferable, due to the required accuracy at relatively small currents.

The negative $V_{ce}-I_c$ characteristic was also calculated, using the broken line method.

In Fig. 2 the complete trigger circuit is shown, and in Fig. 3 the measured negative $V_{ce}-I_c$ characteristic for the Bell transistor AP-1613.

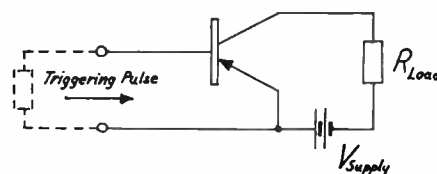

Fig. 2

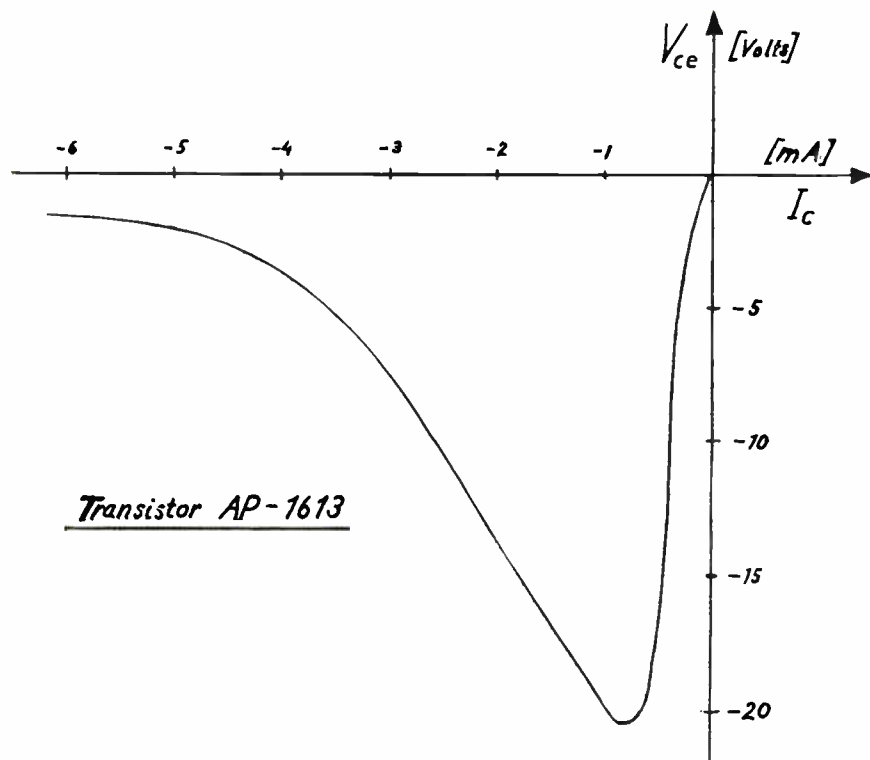

Fig. 3

The simplified condition for a negative resistance is therefore

$$r_c - r_m < 0 \quad \text{or} \quad \frac{r_m}{r_c} > 1.$$

This confirms that a current amplification factor >1 is required. From the equivalent circuit (Fig. 1) it is seen that

$$V_{ce} = V_e - V_c = V_c \quad \text{when} \quad I_c = - I_e.$$

The trigger was operated by sine-wave pulses in the frequency range up to 300 kc.

It is difficult to say anything certain about the properties of this transistor trigger design, as only one transistor was examined. However, the great simplicity of this transistor trigger circuit seems to be a very interesting and promising feature.

S. WALTER
Sorbyhaugen 1, Smestad
Oslo, Norway

* Received by the Institute, March 12, 1953.

Contributors to Proceedings of the I.R.E.

Richard H. Baker was born on February 15, 1928 in Dowagiac, Mich. He received the B.S. degree in Electrical Engineering from Texas A. and M. College in June 1949. Thereafter until June 1950 he worked at the Servomechanisms Laboratory of the Massachusetts Institute of Technology. Since September, 1950, he has been employed as a research engineer at the AF Cambridge Research Center, currently on loan to the Lincoln Laboratory, M.I.T. Mr. Baker received an M. S. degree in electronics from M.I.T. in June 1953.



RICHARD H. BAKER

For a photograph and biography of R. W. Beatty, see page 162 of the January, 1953 issue of the PROCEEDINGS OF THE I.R.E.

H. E. Brown was born on June 5, 1919, in Pellville, Kentucky. He received the B.S. degree in physics from Western Kentucky Teachers College in 1942 and has done graduate study at the University of Maryland. Since 1942, Mr. Brown has been associated with the Naval Research Lab. in Washington, D. C., where he has been engaged in research on storage and special tubes since 1947.



H. E. BROWN

Woo F. Chow was born in Shanghai, China, on June 7, 1923. After receiving the B.S. degree in Electrical Engineering from Ta Tung University in 1945, he joined the Chapin Power Company until he came to the United States in 1948. Mr. Chow received the M.S. degree in Electrical Engineering in 1949, and the Ph.D. in Electrical Engineering in 1952, both from the University of Minnesota, while he was serving as a teaching assistant. Dr. Chow joined General Electric Company in 1952. He is engaged in the development of transistor circuitry. Dr. Chow is a member of Eta Kappa Nu, and Sigma Xi.



W. F. CHOW

Dr. Chow joined General Electric Company in 1952. He is engaged in the development of transistor circuitry.

Dr. Chow is a member of Eta Kappa Nu, and Sigma Xi.

For a photograph and biography of SEYMOUR B. COHN, see page 1126 of the September, 1952 issue of the PROCEEDINGS OF THE I.R.E. In February, 1953, Dr. Cohn joined the Stanford Research Institute as Head of the Microwave Group of the Engineering Division.



A. H. DE VOOGT

Anthonet H. de Voogt was born May 1, 1892 in Amsterdam. He studied at the Technical High School in Delft and received, in 1915, the Electro-Technical Engineer degree. Since 1919 Mr. de Voogt has been in the Netherlands P.T.T. service, where he is now deputy-chief-director of General Affairs and Radio, and in charge of the Ionosphere and Radio-Astronomy section. Mr. de Voogt is Chairman of Commission 6J C.C.I.R. and Commission 5* of U.R.S.I.

Eduard A. Gerber (A'50) was born in Fuerth, Bavaria, Germany, on April 3, 1907. He received the Dipl. Phys. degree in 1930, and the Dr.-Ing. degree in 1934 from the Munich Technical University. In 1935 he joined the scientific staff of the Carl Zeiss Works, Jena, Germany, working on piezo-electric crystals. In 1946, he signed a contract with the U. S. Government for research work in the United States. Since that time he has been a consultant of the Signal Corps Engineering Laboratories, Fort Monmouth, N. J., for all matters of frequency control. Dr. Gerber is a member of the IRE Committee on Piezoelectric Crystals.



E. A. GERBER

L. G. Kraft, Jr., was born in Philadelphia, Pa., February 3, 1923. He received the B.S. degree from the University of Pennsylvania in 1944, and the S.M. degree in Electrical Engineering from Massachusetts Institute of Technology in 1949. He has been employed as an instructor at the M.I.T. Radar School and since 1949 as a research engineer at the Research Laboratory of Electronics and Lincoln Laboratory at Massachusetts Institute of Technology.



L. G. KRAFT, JR.

Lincoln Laboratory at Massachusetts Institute of Technology.

He is a member of Sigma Xi, Tau Beta Pi, and Eta Kappa Nu.

Irwin L. Lebow was born in Boston, Mass., on April 27, 1926. He attended the Massachusetts Institute of Technology for one year, served two years in the U. S. Navy and returned to M.I.T. in 1946, receiving the B.S. degree in physics in 1948 and the Ph.D. degree in physics in 1951. At M.I.T. he did research on high energy particles. Following graduation he joined the staff of M.I.T., Lincoln Laboratory, where he is currently engaged in research on transistor applications to digital computers. Dr. Lebow is an associate member of Sigma Xi and a member of A.P.S.



IRWIN L. LEBOW

Dr. Lebow is an associate member of Sigma Xi and a member of A.P.S.

Alan C. Macpherson was born in Washington, D. C. on December 24, 1920. He received the B.S. degree in Physics from the University of Maryland in 1943 and the M.A. degree in Physics from George Washington University in 1950. He served in the Army Signal Corps from 1943 to 1946, his duties including work on radar, proximity fuse production, and special purpose electronic tubes. In 1947 he joined the National Bureau of Standards where he has worked on precision measurements of power and impedance at microwave frequencies. Mr. Macpherson is a member of Sigma Pi Sigma.



A. C. MACPHERSON

Mr. Macpherson is a member of Sigma Pi Sigma.

Samuel J. Mason (SM'52) was born on June 16, 1921, in New York City, N. Y. He was graduated from Rutgers University, New Jersey, in 1942, with the B.S. degree in electrical engineering. Dr. Mason attended the Massachusetts Institute of Technology, Cambridge, Mass., from 1945 to 1951, receiving the M.S. degree in 1947 and the D.Sc. degree in 1952. From 1942 to 1945, Dr. Mason has been with the Radiation Laboratory of the Massachusetts Institute of Technology and from 1945 to 1952, in the Research Laboratory of Electronics of MIT.



S. J. MASON

From 1942 to 1945, Dr. Mason has been with the Radiation Laboratory of the Massachusetts Institute of Technology and from 1945 to 1952, in the Research Laboratory of Electronics of MIT.

Herbert P. Raabe (A'51) was born in Halle, Germany, on August 15, 1909. He received the Dipl. Ing. degree in 1936 and the



H. P. RAABE

Dr. Ing. degree in 1939, both from the Technical University of Berlin.

From 1936 to 1945, Dr. Raabe was employed in research and teaching in the communication technique department of the same university. From 1938 to 1945 he also conducted research work at the

Heinrich Hertz Institut für Schwingungsforschung.

From 1946 to 1947 Dr. Raabe was employed with the Bureau of Communication Technique in Berlin.

Since 1947 Dr. Raabe has been consultant at the Wright Air Development Center in Dayton, Ohio.



Robert H. Rediker was born in Brooklyn, N. Y. on June 7, 1924. He received the B.S. degree in Electrical Engineering in 1947 and the Ph.D. degree in Physics in 1950, from the



R. H. REDIKER

Massachusetts Institute of Technology. During 1950-51, Dr. Rediker was a research associate in cosmic rays in the physics department of M. I. T. In April 1951, he became a staff member of the Lincoln Lab.

In October, 1952, he joined the Physics Dept., Indiana University, returning in June, 1953, to the transistor device section of the Lincoln Laboratory.

Dr. Rediker is a member of the A. P. S. and Sigma Xi.



Irving S. Reed was born in Seattle, Wash. on November 12, 1923. He attended the University of Alaska for two years and graduated from the California Institute of Technology in 1944 with the B.S. degree. He received the Ph.D. degree in mathematics from the California Institute of Technology in 1949.



IRVING S. REED

From 1944 to 1946 Dr. Reed was in the U. S. Navy as an electronics technician. From 1947 to 1950 he worked for Northrop Aircraft, Inc., in Hawthorne, Calif., during which he contributed to the development of the Dida and Maddida computers. In 1950 Dr. Reed became one of the founding directors of the Computer Research Corp., and in October of 1951 he joined the Lincoln Laboratory of the Massachusetts Institute of Technology.

Dr. Reed is a member of the American

Mathematical Society, the Association for Computing Machinery, and Sigma Xi.



Sidney T. Smith (S'38-A'44-SM'53) was born on May 27, 1918, in Montezuma, Ga. He received the B.S. degree in electrical engineering from the Georgia Institute of Technology in 1939, and the D.Eng. degree from Yale University in 1942.



S. T. SMITH

From 1942 to 1952 Dr. Smith was employed by the Naval Research Lab. in Washington, D.C., doing investigative analysis of radar receivers and research

on storage and special tubes. In 1952 he joined the Hughes Research and Development Lab. and is a member of the Subpanel on Special Tubes of the Research and Development Board.

Dr. Smith is a member of the American Physical Society and RESA.



Frank R. Stansel (A'26-M'33-SM'43) was born in Raleigh, N. C., on August 7, 1904. He received the degree of B.S. in electrical engineering from Union College in 1926, and the M.E.E. and D.E.E. degrees from the Polytechnic Institute of Brooklyn in 1934 and 1941, respectively.



FRANK R. STANSEL

Since 1926 he has been employed as a member of the technical staff of the Bell Telephone Labs.

From 1926 to 1936 he was located at this organization's Whippany Radio Lab. developing high-power radio transmitters for broadcast and transoceanic service and special types of testing apparatus. In World War II he was a member of a group designing radar equipment.

During recent years Dr. Stansel has been located at the Murray Hill Branch of the Bell Telephone Labs., where he is engaged in the development of new types of carrier telephone systems.

Dr. Stansel is a member of the American Institute of Electrical Engineers, Eta Kappa Nu and Sigma Xi.



Jerome J. Suran was born in New York, N. Y. on January 11, 1926. After having served for three years with the U. S. Army during World War II, he received the B.S.E.E. degree from Columbia University in June, 1949, then continued graduate studies there and at the Illinois Institute of Technology.



J. J. SURAN

From 1949 to 1952 Mr. Suran was employed in control systems design and

development by J. W. Meaker and Company, and in the field of FM communications by Motorola, Inc.

In 1952 Mr. Suran joined the electronics laboratory of the General Electric Company.



For a photograph and biography of L. C. VAN ATTA see page 1739 of the December, 1952 issue of the PROCEEDINGS OF THE I.R.E.



Louis Weinberg (N'52) was born July 15, 1919, in Brooklyn, N.Y. He was graduated from Brooklyn College with an A.B. degree in 1941, and in 1947 received from Harvard University an M.S. in Engineering Sciences and Applied Physics. He then studied at the Massachusetts Institute of Technology, receiving the Sc.D. degree in Electrical Engineering in 1951.



LOUIS WEINBERG

From 1942 until 1943 Dr. Weinberg

worked for the Office of the Chief Signal Officer as Chief Radio Engineer in the Controlled Items Section. He left to join the Army Air Forces, where he remained until 1946, serving as a Radar and Electronics Officer, and as Technical Advisor to the American Embassy at The Hague, Netherlands. After having served in the Air Force, the four following years from 1947 to 1951, were spent as an instructor in the Department of Electrical Engineering at Massachusetts Institute of Technology.

Since leaving M.I.T., he has worked as a Research Physicist in the Systems Planning and Analysis Department of the Hughes Research and Development Laboratories. He is also a Lecturer in Engineering, University of California, Los Angeles.

Dr. Weinberg is Chairman of the Los Angeles Chapter of the IRE Circuit Theory Professional Group and is a member of Propylaea and Sigma Xi.



James Y. Wong (S'46-A'52) was born in Elm Creek, Manitoba, Canada, on November 21, 1926. He received the B.Sc. degree in electrical engineering from the University of Manitoba in 1944, the M.S. degree and Ph.D. degree in electrical engineering from the University of Illinois in 1949 and 1952 respectively.



JAMES Y. WONG

From 1950 to 1952 Dr. Wong was a research assistant at the University of Illinois' Antenna Laboratory, where he was engaged in aircraft antenna research. Since 1952 he has been a member of the antenna group of the Microwave Section, National Research Council, Ottawa, Canada, devoting his time to the field of microwave radar and to aircraft antenna problems.

In addition to his membership in IRE, Dr. Wong is also a member of Sigma Xi, Eta Kappa Nu and Pi Mu Epsilon.

Institute News and Radio Notes

OCTOBER URSI FALL MEETING

The USA National Committee of URSI is sponsoring a Fall Technical Meeting jointly with the IRE Professional Group on Antennas and Propagation and the Canadian National Committee of URSI. The meeting will be held at the National Research Council and the Defense Research Board, Ottawa, Canada, on October 5-8.

Technical sessions will begin on Tuesday, October 6. October 5 will be devoted to meetings of the USA National Committee and of the participating commissions.

The commissions and their chairmen are as follows: Commission 1—Radio Measurements and Standards, R. G. Fellers; Commission 3—Ionospheric Radio Propagation, L. V. Berkner; Commission 4—Terrestrial Radio Noise, F. H. Dickson; Commission 5—Radio Astronomy, J. P. Hagen; Commission 7—Electronics, J. R. Whinnery.

CORRECTION



C. K. BIRDSALL



G. R. BREWER

On page 937 of the July issue of PROCEEDINGS the photograph of G. R. Brewer appeared in the biography of C. K. Birdsall, and the photograph of C. K. Birdsall appeared in the biography of G. R. Brewer. The pictures are correctly identified above.

RADIO FALL MEETING

Following is the daily program of the Radio Fall Meeting to be held on October 26-28 at the King Edward Hotel in Toronto, Canada. It will be sponsored by the IRE and the Radio-Television Manufacturers Associations of the United States and Canada.

Monday Morning

Television Interference Symposium: W. R. G. Baker, presiding
(Sponsored by RTMA Engineering Dept.)

Monday Afternoon

Quality Control Session: J. R. Steen, presiding
(Sponsored by the IRE Professional Group on Quality Control)

Tuesday Morning

Television Session: I. J. Kaar, presiding
(Sponsored by the IRE Professional Group on Broadcast and Television Receivers)

Tuesday Afternoon

Television Session: D. D. Israel, presiding
(Sponsored by the IRE Professional Group on Broadcast and Television Receivers)

Tuesday Evening

Radio Fall Meeting Dinner
(Sponsored by the RTMA of Canada)

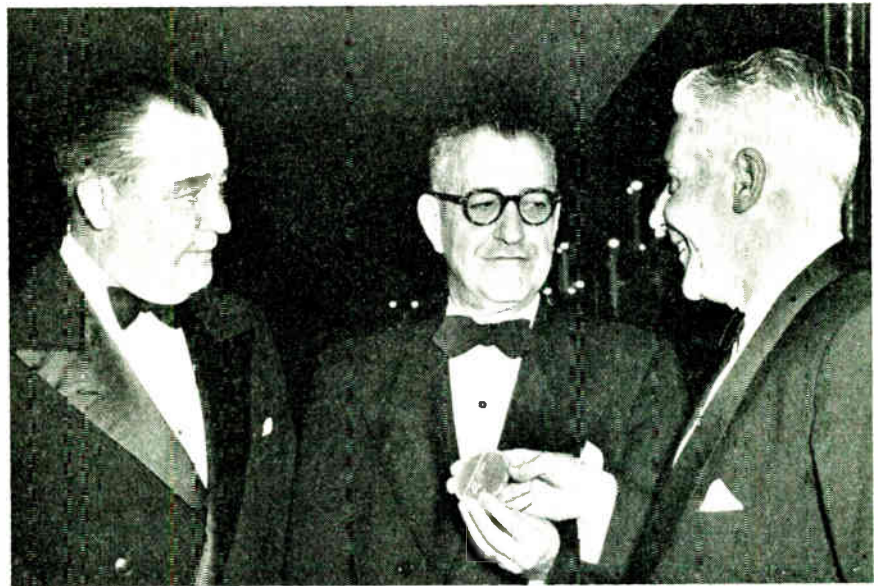

W. R. G. BAKER RECEIVING 1953 RTMA MEDAL OF HONOR

Dr. W. R. G. Baker, (center) vice president and general manager of General Electric Company's Electronics Division, receives the 1953 Medal of Honor awarded by Radio Television Manufacturers' Association at their 29th Annual Convention in Chicago. Presenting the medal is A. D. Piamondon, Jr., (right) president and chairman of the Board of RTMA. L. F. Muter, president of Muter Company and chairman of the RTMA Annual Awards Committee, waits to congratulate Dr. Baker. Dr. Baker is 1953 treasurer of the IRE.

Wednesday Morning

Electron Devices Session: L. S. Nergaard, presiding
(Sponsored by the IRE Professional Group on Electron Devices)

Wednesday Afternoon

Electron Devices Session: G. A. Esperson, presiding
(Sponsored by the IRE Professional Group on Electron Devices)

SAN ANTONIO CO-HOST TO RADIO METEOROLOGY CONFERENCE

The San Antonio Section will act as co-host with the Central Texas Branch of the American Meteorological Society to a conference on radio meteorology to be held at the University of Texas, Austin, November 9 through 12.

Sponsoring and participating organizations will include the Professional Group on Antennas and Propagation of the IRE, the American Meteorological Society, the Radar Weather Conference, and the National Commission II on Tropospheric Radio Propagation of the URSI and the Joint Commission on Radio Meteorology.

Members of the general conference committee are B. M. Fannin, J. C. Freeman, Jr., J. R. Gerhardt, C. W. Hostetter, Jr., K. H. Jehn, and A. W. Straiton. A special advisory steering committee includes the following representatives of the sponsoring organizations: L. G. Cumming, IRE; J. R. Gerhardt, University of Texas; W. E. Gordon, Cornell University; M. Katzin, Naval Research Laboratory; J. S. Marshall, McGill University; Newbern Smith, National Bureau of Standards; and K. C. Spengler, American Meteorological Society.

Calendar of COMING EVENTS

- Conference on Nuclear Engineering, University of California, Berkeley, September 9-11
- Joint Electron Tube Engineering Council General Conference, Atlantic City, N.J., September 16-18
- National Electronics Conference, Hotel Sherman, Chicago, Ill., September 23-30**
- URSI Fall Technical Meeting, Ottawa, Canada, October 5-8**
- Society Motion Picture & TV Engineers, 74th Semannual Convention, Hotel Statler, New York, N. Y., October 5-9
- American Society for Quality Control Mid-west Conference, Masonic Temple, Davenport, Iowa, October 8-9
- 1953 IRE-RTMA Radio Fall Meeting, King Edward Hotel, Toronto, Ont., October 26-28**
- Conference on Radio Meteorology, University of Texas, Austin, November 9-12
- IRE Kansas City Section Annual Electronics Conference, Hotel President, Kansas City, Mo., November 13 and 14**
- Joint IRE-AIEE 6th Annual Conference on Electronic Instrumentation in Medicine and Nucleonics, New York City, November 19-20**
- 1954 Sixth Southwestern IRE Conference and Electronics Show, Tulsa, Okla., February 4-6**

SECOND AUTHORS CALL FOR IRE NATIONAL CONVENTION

The deadline for acceptance of papers for the 1954 IRE National Convention is November 16. B. R. Lester, Chairman of the Technical Program Committee, requests prospective authors submit the following information: (1) name and address, (2) title of paper, (3) a 100-word abstract, and additional information up to 500 words (both in triplicate). Address all material to Mr. Lester at IRE Headquarters, 1 East 79 St., New York 21, N. Y.

TECHNICAL COMMITTEE NOTES

Under the chairmanship of A. G. Jensen the **Standards** Committee met on June 11 and completed consideration of the proposed waveguide terms. The 1st section of the standard was reviewed and adopted. Those sections reviewed at the February, April, and May Committee meetings are to be collated and the entire document submitted for Executive Committee approval at an early date. The committee's attention was directed by Mr. Jensen to the appointment of representatives from the various technical committees to the Annual Review Committee. He expressed the hope that the 1953 Chairman, J. Z. Millar, would have the complete co-operation of all technical committees. Speaking for Mr. Millar, who was unable to attend, R. R. Batcher emphasized the need for an early start this year, particularly if it is IRE's intent to publish the final report in the March 1954 issue of the *PROCEEDINGS*. A general discussion followed on improving the present procedure and expediting the work. It was suggested that in the future the Annual Review work be considered more or less a "continuous effort"; that it might become the responsibility of technical committee vice chairmen, or that a permanent office might be created in each committee to automatically handle the reviewing. Members concurred in the opinion that it should become one of the first duties of all chairmen on May 1 of each year to initiate work on the Annual Review. The motion was made and passed that effective May 1, 1954, each technical committee chairman is to designate a representative to the Annual Review Committee; that such a representative is to be considered as Chairman of the Annual Review Subcommittee of that committee. With reference to the ensuing year, it was agreed that the Technical Secretary is to circulate a letter to all chairmen requesting recommendations for appointment of technical representatives. Detailed instruction sheets in style, format, and so forth, will be mailed to appointees as soon as their names are made known. Resumes are to be in the hands of Mr. Millar by December 1. He in turn will attempt to get the material edited by January 15 for publication in the March 1954 *PROCEEDINGS*.

On June 5 the **Facsimile** Committee met under the chairmanship of Henry Burkhard. A revised mockup of the IRE Facsimile Test Chart was passed around for comments. A number of changes to the mockup were agreed upon. A. G. Cooley offered to undertake the first trial printing of the

chart by an offset process and have copies for submission at the next meeting. J. V. Hogan, Jr. and K. R. McConnell were appointed as a committee to work out all of the final details for this chart. The remainder of the meeting was spent in a review of the 1942 Definitions of Terms.

In the absence of P. C. Sordretto, R. E. Gray took the chair during the **Navigation Aids** meeting on June 22. Mr. Gray reported the first meeting of the Editorial Committee was held on June 3 at which time the 30 definitions listed under "A" were reviewed. The minutes of this meeting indicated that guidance from the main committee was required on the meaning of 13 of the terms. These were reviewed and specific recommendations made. The committee then turned its attention to reviewing the terms listed under "B." The committee modified a number of these terms. Further consideration of the main list was deferred until the September meeting. The rest of the meeting was devoted to proposals made by the Editorial Committee.

On June 10 the **Sound Recording and Reproducing** Committee convened under the chairmanship of A. W. Friend. H. E. Roys reported on the activities of the CCIR Task Group (19.4). Dr. Friend reported that R. M. Fraser, Chairman of Subcommittee 19.3 would not be able to attend the meeting but that his subcommittee is proceeding to consider recommendation of adoption of applicable standards already approved by SA/PTE. Lincoln Thompson, Chairman of Subcommittee 19.3, could not be present at the meeting but reported by telephone that his subcommittee has scheduled an early meeting to consider new data for presentation at the next meeting of the main committee. A. P. G. Peterson, Chairman of Subcommittee 19.1, reported that his group has revised 52 IRE 19.1 PS2/52 IRE 25.4 PS1, "Harmonic and Intermodulation Distortion Definitions and Procedures for Measurement" in accordance with the recent recommendations of the main committee. The committee then proceeded with a discussion of this document and some revisions were made. Dr. Peterson agreed to ask his Subcommittee to review R. E. Zenner's material dated February 9, 1951 on "Proposed Standards on Frequency Response of Recording-Reproducing Systems with Restive Terminations."

The **Symbols** Committee met on June 10 under the chairmanship of K. E. Anspach. IRE representation on various ASA Sectional Committees was reviewed to ensure adequate coverage of the Symbols field. Recommendations are to be made to the Standards Committee. A. F. Pomeroy requested a recommendation on what symbol should be shown under "bolometer" as recently added to the index of the ASA/IRE proposed Standard on Electrical Graphical Symbols now being prepared in prepublication form. The committee recommended that "bolometer" be omitted from the index as it could not determine on authoritative definition for the term under its modern usage and therefore the proper symbol could not be established. M. P. Robinson reported an unanimous vote to approve our use of

"pico" as a metric prefix for 10^{-12} with *p* or *P* as its abbreviation. This was approved and will be added to Table 1 in Standards on Abbreviations of Radio-Electronic Terms, 1951. It was agreed to continue Subcommittee 21.5 with existing personnel under the chairmanship of M. P. Robinson. Its scope will remain as "resolving problems in regard to single items suggested for standardization and questions involving application of standards." The Subcommittee on Semiconductors (21.2) will continue with C. D. Mitchell and its present personnel, and with the same scope indicated by its title.

A. C. Reynolds, Jr., reported on a meeting of his Subcommittee 21.3 held on May 19. It was agreed that this subcommittee should continue with its present personnel under the chairmanship of Mr. Reynolds and within the scope of "symbols and methods of functional representation of control, computing and switching equipment and processes." F. M. Bailey, Chairman of Subcommittee 21.4, reported on the last meeting of his subcommittee. The personnel of this committee will remain the same. K. E. Anspach will draft a proposed new scope for the Symbols Committee for letter ballot by the committee. H. P. Westman accepted the task of preparing the symbols section of the Annual Review. It was agreed that a subcommittee be set up to review the 1948 report on letter symbols.

On June 12 under the chairmanship of Newbern Smith, the **Wave Propagation** Committee convened. The scope of the committee was discussed and modifications made. The Chairman noted with regret the resignation of George Sinclair from the chairmanship of the Definitions Subcommittee. The committee unanimously agreed to ask him to remain a member of the committee. M. G. Morgan, T. Carroll and H. O. Peterson indicated their willingness to continue as Chairmen of Subcommittees on Ionospheric Propagation, Tropospheric Propagation and Standard Practices. The Committee agreed to change the name of Mr. Peterson's Subcommittee to "Standard Practices." H. G. Booker agreed to ask C. R. Burrows to remain as Chairman of the Radio Astronomy Committee. The Committee agreed to the formation of a new subcommittee on "Terrestrial Radio Noise." H. Dingar was recommended to serve as Chairman of the new committee. In regard to Annual Review Dr. Morgan and Dr. Carroll agreed to take charge of the Ionospheric Propagation and Tropospheric Propagation sections respectively, and Dr. Booker agreed to ask Dr. Burrows to handle the Radio Astronomy Section. A brief discussion was had on various definitions referred to the committee. The third draft of the "Proposed Standards on Wave Propagation: Methods of Measuring" was presented to the Committee for approval, with amendments agreed to by Mr. Peterson's Subcommittee in consultation with the Antennas and Wave Guides Committee. It was discussed and several additional amendments proposed and accepted by the committee. It was then approved as amended for submission to the Standards Committee as "Standards on Wave Propagation: Methods of Measuring Field Strength."

Professional Group News

ANNUAL BROADCAST CONFERENCE

The Professional Group on Broadcast Transmission Systems, Lewis Winner, Chairman, plan to hold their Annual Broadcast Conference during the first part of November. An all-day meeting will be held at the Franklin Institute in Philadelphia, Pa. The following subjects will be included: color television, three-dimensional TV, scanning systems, and general broadcasting problems.

BROADCAST TRANSMISSION SYSTEMS

The Boston Chapter of the Professional Group on Broadcast Transmission Systems met recently at the WBZ studio in Brighton, Mass. Sidney V. Stadig was the Chairman and R. E. Johnson, broadcast tube specialist with the Radio Corporation of America, Harrison, N. J., the speaker. Representatives of five radio stations were present to hear Mr. Johnson talk about "Getting the Most Out of Your Image Orthicon."

ELECTRONIC COMPUTERS

The Los Angeles Chapter of the Professional Group on Electronic Computers met recently at the University of California with W. F. Gunning as chairman. W. Farrand, North American Aviation Co., led a panel discussion on analog to digital, and digital to analog conversion. Members of the panel were A. J. Winter, Telecomputing Corp.; H. Burke, Consolidated Engineering Corp.; W. Shockeney, Hughes Aircraft; and W. F. Gunning, Rand Corporation. Each presented a conversion problem with which he was familiar. The panel proposed solutions to problems suggested by the audience also. At an earlier meeting in Royce Hall Dr. Nelson discussed commercial applications of digital computers; M. Mendelson, programming and tutorial; W. Martin, high-speed digital circuitry; E. Weiss, logical design; Dr. Wordemann, magnetic components; W. Melahn, advanced programming; Dr. Ware, random access memories; Dr. Rogers, analog arbitrary function generators; L. Beman, printed circuitry for computers; Dr. J. Salzer, digital computers in control systems. At their most recent meeting at the University S. Green was acting Chairman of the Group and Nicholas Metropolis of the Los Alamos National Laboratory the speaker. Mr. Metropolis gave a paper entitled "The Maniac Computer" in which he described the characteristics and operating experience of the Maniac computer at the Los Alamos Laboratory.

The San Francisco Chapter has been holding regular monthly meetings under the chairmanship of T. H. Meisling at Cory Hall of the University of California, Studio A of KNBC, and the Business School of Stanford University. Officers are: Chairman, T. H. Meisling, Vice-Chairman, J. W. Haanstra, Secretary-Treasurer, J. D. Noc.

The speakers were Willis Ware of the Rand Corp., L. C. Nofrey of the Radiation Laboratory of the University of California in

Berkeley, J. W. Haanstra of the IBM Corp., Lloyd Stowe of the Eckert Mauchly Division of Remington Rand, George Greene of Marchant Research, Inc., and John Luke of the Applied Science Division of the IBM Corp. Dr. Ware gave a paper entitled "A Computer Using Selectron Memories," and Mr. Nofrey gave one about "The UNIVAC System." Mr. Haanstra spoke about "Digital Data Recording in Engineering Application" and Mr. Stowe about the "Logic and Programming of the UNIVAC." Mr. Greene discussed "The MINIC, A Magnetic Drum Electronic Digital Computer" and Dr. Luke told about the "Organization and Applications of the IBM Card Programmed Calculator."

The Washington, D. C. Chapter met recently at the Pepco Auditorium with Vice Chairman D. H. Jacobs in charge. Speaker was D. H. Gridley of the Naval Research Laboratory. His paper was "The NAREC—A Progress Report on the Naval Research Laboratory Computer."

ENGINEERING MANAGEMENT

The Los Angeles Chapter of the Professional Group on Engineering Management held their two spring meetings at the IAS Building, and the Student Union Building of the University of Southern California with T. W. Jarmie as Chairman. At the earlier meeting E. F. King of the engineering department of the University of California in Los Angeles gave a paper entitled "Engineers and Education—A Pattern and A Prognosis." He analyzed the results of a personal survey of the use made by "successful" people in the United States of their engineering backgrounds. He presented several novel ideas which aroused the interest of the audience. There was general agreement that it was impossible to hire a graduate engineer possessing the qualifications needed, and that the engineering curriculum should emphasize the ability to express oneself in written and verbal form. Opinion was varied as to whether the Universities should provide a practical or theoretical background. At the later meeting, F. L. Graham, staff specialist at North American Aviation, gave a paper called "The Role of the Engineer—Supervisor In Human Relations," followed by a discussion with the audience. Although an engineer should have a knowledge and understanding of three things: himself, his relations to other human beings, and the physical world in which he lives, Mr. Graham observed that the engineer only has undisputed competence in knowledge of the physical world. He frequently lacks understanding and skills in the other things. He declared that experimental evidence has shown that improvements in these areas tends to maximize the human satisfactions of the professional engineer, and at the same time increase the productivity of any engineering group. He cited the results of recent social science research, and suggested several applications to engineering organizations of such research findings. Mr. Graham described the differences in group member behavior under democratic leadership as contrasted to autocratic

leadership. The democratic group member is more mature, co-operative, and hence more productive. He also shows more initiative and a greater sense of responsibility. In contrast, under autocratic leadership his behavior is characterized by dependency, irresponsibility, inability or failure to cooperate, and hostility. Hence there is a marked reduction in the opportunity to develop and mature professionally. Mr. Graham emphasized that democratic leadership is an acquired skill which often requires changes in an individual's attitude. For this, training is necessary, as is the acquisition of human relations techniques.

INDUSTRIAL ELECTRONICS

The Chicago Chapter of the Professional Group on Industrial Electronics met recently at the Western Society of Engineers Building with A. Crossley as Chairman. J. S. Solomon, research department head of Scioky Brothers, and W. Berkey, A. Crossley, and four others discussed "Electronics in Welding."

INFORMATION THEORY

The Los Angeles Chapter of the Professional Group on Information Theory met twice recently at the University of California in Los Angeles. Chairman of the meeting was R. R. Bennett. At the earlier meeting J. T. Culbertson of the Rand Corporation spoke about "Sense Data in Robots and Organisms." The speaker at the later meeting was J. C. Fletcher of the Hughes Research & Development Laboratories. His subject was "Applications of Information Theory to Electronic Guidance Systems." Officers for the coming year were elected and are: Chairman, R. R. Bennett; Secretary-Treasurer, D. B. Duncan; Program, E. Rechin and R. Canning; Symposia, H. Davis; Reader, E. Reich.

The New Mexico Chapter of the Professional Group on Information Theory held two meetings recently at Mitchell Hall of the University of New Mexico, Albuquerque, with Lt. Col. Yates Hill as Chairman. Bennett Basore, doctor with the Sandia Corporation, spoke about "Threshold Detection," and Lt. Col. L. V. Skinner, U. S. Air Force, gave a paper entitled "Autocorrelation Functions From the Probability Distributions. The following officers were elected for the coming year: Chairman, Bennett Basore; Program Chairman, Lt. Col. Yates Hill; Secretary, J. E. Gross.

NUCLEAR SCIENCE

The Chicago Chapter of the Professional Group on Nuclear Science met recently at the Western Society of Engineers Building with Bernard Schwartz as Chairman of the meeting. Speaker was Theodore Fields, assistant director of the radioisotope unit at the Hines Veteran Hospital and instructor of radiology at Northwestern University. His subject was "Crystal Counters."

QUALITY CONTROL

The Chicago Chapter of the Professional Group on Quality Control met recently at

the Western Society of Engineers Building with Robert Jersen, Chapter Vice President as Chairman. Three speakers contributed to the subject of the evening, "Proper Component Specifications." They were W. Zaricki, field engineer with the Gudeman Company; M. Wolff, quality control engineer with Chicago Transformer; and Harold May, quality control engineer with Motorola, Inc.

RADIO TELEMETRY AND REMOTE CONTROL

The Los Angeles Chapter of the Professional Group on Radio Telemetry and Remote Control met recently at the Institute of Aeronautical Sciences Building with W. Pickering as Chairman. A panel discussion was held on "The Telemetering Mechanical Commutator." Members of the panel were F. E. Bryan and W. A. Alberts of the Douglas Aircraft Company, Santa

Monica; F. N. Reynolds, Ralph M. Parsons Company, Pasadena; A. H. Nichols, Hughes Aircraft Company, Culver City; and R. R. Darden, Jr., Raytheon Manufacturing Company, Oxnard. J. R. Kauke, of the Applied Science Corporation of Princeton was the moderator. From now on meetings will be held separate from section meetings.

ULTRASONICS ENGINEERING

The newly formed Professional Group on Ultrasonics Engineering is co-sponsoring sessions on applications of ultrasonics engineering at the Acoustical Society Symposium being held in Cleveland October 15 to 17. The theme of this symposium is industrial applications of ultrasonics.

1953 ELECTRONIC COMPONENTS SYMPOSIUM PROCEEDINGS AVAILABLE

All papers presented during the 1953 Electronic Components Symposium held in Pasadena, Calif., under the joint sponsorship of the Radio-Television Manufacturers Association, the American Institute of Electrical Engineers, the West Coast Electronic Manufacturers' Association, and the IRE are now available in book form.

Thirty papers were presented during six sessions covering general component problems, environment and packaging, tubes and tube reliability, component reliability, resistors, capacitors and dielectrics, and devices and materials. Copies are \$4.50 each from the 1953 Electronic Components Symposium, Suite 1011, 621 South Hope St., Los Angeles 17, Calif.

Transactions of the IRE Professional Groups

Issues Recently Published

The following issues of TRANSACTIONS are now available from the Institute of Radio Engineers, Inc., 1 East 79 Street, New York 21, N. Y. Prices are indicated below, with a listing of the contents of each.

Correction on PGI-2, June, 1953

In the JUNE issue of the PROCEEDINGS the contents of PGI-2 published in June 1953 was inadvertently listed under PGI-1, May, 1953. PGI-1 was published in May 1952.

PGVC-3, June, 1953

(Third Annual Meeting, Professional Group on Vehicular Communications)

- Introductory Remarks on Mobile Channel Allocations, *F. T. Budelman*
- Frequency Economy in Mobile Radio Bands, *Kenneth Bullington*
- Technical Considerations Governing the Choice of Channel Spacing in Mobile Communication Bands, *D. M. Heller*
- Field Test of Split Channel 50 mc Systems, *W. M. Rust, Jr.*
- Operational Experience with a Split Channel 50 mc System, *J. S. Stover*
- Luncheon Address: Electronics—Promise and Reality, *W. R. G. Baker*
- Channel Spacing Considerations in the 154-174 mc Band, *H. E. Strauss*
- A Report on Channel-Splitting Demonstrations Conducted in Syracuse, *N. H. Shephard*
- Commercial Experience with 160 mc-20 kc Equipment, *D. E. Noble*
- Comparison of Mobile Radio Transmission at 150, 450, 900, and 3700 mc, *W. R. Young, Jr.*
- Concerning the Minimum Number of Resonators and the Minimum Unloaded Q Needed in a Filter, *Milton Dishal*
- High Frequency Crystal Units for Use in Selective Networks and Their Proposed Application in Filters Suitable for Mobile Radio Channel Selection, *D. F. Ciccollella and L. J. Labrie*
- FCC Rules and Their Enforcement in the Vehicular Services, *E. N. Singer*
- Dinner Address, *Haraden Pratt*

Sponsoring Group	Publication	Group Members	IRE Members	Non-Members*
Audio	Vol. AU-1, No. 3	\$0.80	\$1.20	\$2.40
Broadcast and Television Receivers	PGBTR-3	1.40	2.10	4.20
Electron Devices	PGED-3	0.70	1.05	2.10
Electronic Computers	Vol. EC-2, No. 2	0.90	1.35	2.70
Vehicular Communications	PGVC-3	3.00	4.50	9.00

* Public libraries and colleges can purchase copies at IRE Member rates.

Vol. Au-1, No. 3, May-June, 1953

Editorials

Report to PGA, *Marvin Camras*
Editorial Committee Reorganization, *D. W. Martin*

From Chapters

Cincinnati Chapter IRE-PGA, 1952-53

Technical Papers

Status of Military Research and Development in Acoustics and Audio, *P. J. Weber*
Loudspeaker Developments, *P. W. Klipsch*
Acoustic Damping for Loudspeakers, *B. B. Bauer*

PGA Institutional Listings

PGED-3, June, 1953

Amplification of Microwave Radiation by Substances Not in Thermal Equilibrium, *J. Weber*
Pulse Response of Junction Transistors, *N. H. Enestein and M. E. McMahon*
Factors Affecting Traveling-Wave Tube Power Capacity, *C. C. Culler and D. J. Brangaccio*

Correction

PGBTR-3, June, 1953

A Four-Point Message of Importance to All Members of the IRE Professional Group on Broadcast and Television Receivers, *D. D. Israel*
The Selection and Amplification of UHF Television Signals, *W. P. Boothroyd and John Waring*
The Design of Television Receivers Utilizing Non-Synchronous Power, *G. D. Hulst*
Approach to Mechanized Assembly of Electronic Equipment Applicable to TV Receivers, *R. F. Newton and L. K. Lee*
Optimum Utilization of the Radio Frequency Channel for Color Television, *R. D. Kell and A. C. Schroeder*
A Four-Gun Tube for Color Television Receivers, *J. L. Rennick and C. H. Heuer*
Transient Considerations in the NTSC Color System, *B. S. Parmet and L. M. Kaminsky*

Vol. EC-2, No. 2, June, 1953

Hidden Regenerative Loops in Electronic Analog Computers, *L. G. Walters*
Electrical Delay Lines for Digital Computer Applications, *J. R. Anderson*
Design of Triode Flip-Flops for Long-Term Stability, *J. O. Paivinen and I. L. Auerbach*
Contributors
Institutional Listings

JTAC REPORTS TO FCC ON MOBILE RADIO CHANNEL USE

The Joint Technical Advisory Committee has submitted to the Federal Communications Commission a comprehensive study dealing with the feasibility of reducing the separation between assignable frequencies in the land mobile radio services.

In 1951 JTAC had been requested by the FCC to answer five engineering questions about channel splitting. An industry subcommittee was set up under the chairmanship of F. T. Budelman, chairman of the IRE Professional Group on Vehicular Communications, and theoretical studies and laboratory and field tests begun. The report submitted to the FCC compiles the results of these tests and the conclusions reached by the subcommittee from them.

In concluding that channel splitting is feasible and that some gain in usage can result, the JTAC subcommittee points out that

"The use of narrower channel equipments is not by itself sufficient to obtain an appreciable increase in the number of usable channels in areas requiring a large number of channels. Sharing of channel assignments on a geographical basis, and efficient use of

assignments in the same area will gain more.

"The situation suggests that at present the difficulty is not so much a frequency shortage as it is an over-partitioning of the frequency spectrum. The rigid subdivision of the spectrum into government and non-government bands is one type of partitioning which is an obstacle in developing effective frequency utilization."

Commenting on channel-splitting in the 152-162 mc band, the report notes that a degradation of the order of 3 db in signal-to-noise ratio would have to be tolerated, but that

"It is the opinion of the committee that for many services this amount of degradation would be preferable to the alternatives of increased co-channel interference or lack of assignable channels."

The report presents two alternative plans for reducing the present 60-kc separation between channels in the 152-162 mc band. One plan is based on a 30-kc spacing, and the other on 40 kc in the same geographical area and 20 kc under adjacent-area conditions. The resulting increase in the number of assignable channels would range from 50 to a potential 200 per cent, depending on geographical considerations and on the plan chosen. "The increased cost for

split-channel equipment is estimated to be approximately 10-20 per cent above present-day equipment."

With reference to the 450-470 mc band, it was concluded that "the use of 100-kc channels should be continued," and that possible future "channel spacings less than 50 kc are not feasible." It was noted that these conclusions were reached by calculations without benefit of field experience, and that "before any definite plans are made in the 450-470-mc region, field test data must be compiled."

The type of modulation recommended for the land-mobile services was FM, similar in characteristics to that used in systems now operating in the vhf and uhf bands. The relative merits of FM/PM, AM, and SSB were considered and the latter two thought to be less suitable.

Multi-channel, broadband or rather co-ordinated, operation would give the largest number of useful channels in needy, congested areas. However, implementation of this method has unattractive or impractical aspects.

A copy of the 44-page report with appendix material is on file at the headquarters of the IRE, Radio-Television Manufacturers Association, and the Federal Communications Commission.

IRE People

James W. McRae (A'37-F'47), president of the Institute, and vice president of the Bell Telephone Laboratories, has been elected vice president of the Western Electric Co. and president of the Sandia Corp.



JAMES W. McRAE

Dr. McRae has been a vice president, in charge of systems development, since 1951. Associated with the Laboratories since 1937, his early work there included research on transoceanic radio transmitters and microwave techniques. After serving with the U. S. Army Signal Corps in World War II from 1942 to 1946, he returned to become director of radio projects and television research. He was associated with the New York-Boston radio-relay project before being appointed director of electronic and television research. In 1949 he was named director of apparatus development, subsequently becoming director of transmission development.

A native of Vancouver, B. C., Canada, Dr. McRae is a graduate of the University of British Columbia and received the Ph.D. degree from the California Institute of Technology in 1937. He then joined Bell Labs.

In the Signal Corps he co-ordinated development programs for airborne radar equipment and radar-counter measure devices, receiving the Legion of Merit for his work. He was later chief of the engineering

staff of the Engineering Laboratories at Bradley Beach, N. J., and subsequently became Deputy Director of the Engineering Division, attaining the rank of colonel.

As President of the Institute, Dr. McRae is Chairman of the Executive Committee, of which he has been a member since 1951. From 1946 through 1952 he was a member of the Board of Editors. He has served on the Awards Committee, the Policy Development Committee, the Tellers Committee, and the Board of Directors. In 1948 and 1949 he was Chairman of the New York Section.

Dr. McRae received honorary mention from Eta Kappa Nu as an outstanding electrical engineer in 1943. He is a member of the American Institute of Electrical Engineers and of Sigma Xi.



Raymond C. Allsop (SM'46) has been appointed to the Australian Broadcasting Control Board. The Board was constituted in 1949 by the Australian government to ensure the provision of broadcasting and television services, that adequate and comprehensive programs are given, and the technical equipment and operation of stations conform with approved standards.

Mr. Allsop was born on March 11, 1898, in Sydney, Australia. He began his career in broadcasting in 1913 as a student with the Shaw Wireless Co. of Sydney. He served as a wireless operator in the Royal Australian Naval Transport Service from 1916 to 1919, and in World War II was a Lt. Commander, serving as a design and production officer.

During the 1920's Mr. Allsop did design and manufacturing of sound-synchronized motion picture equipment and a radio phone transmitter. This transmitter later became the first broadcast station in Australia, 2BL, and he the chief engineer.



Peter M. Barzilaski (A'48), of the Material Laboratory of the New York Naval Shipyard, died recently.

Chief of the Electronics II Branch since 1947, Mr. Barzilaski joined the Laboratory in 1930. He served as an electronic consultant to the Bureau of Ships of the Navy after 1946.

Mr. Barzilaski was born on July 24, 1907 in Plymouth, Penn. He was graduated from Bucknell University with a B.S. degree in electrical engineering in 1929, and attended the graduate school of Brooklyn Polytechnic Institute.

After finishing his studies, Mr. Barzilaski spent a year as a student engineer in the radio engineering department of the Westinghouse Electric and Manufacturing Company. He obtained a professional engineering license in New York State in 1936.

Mr. Barzilaski was a member of the AIEE, the Acoustical Society of America, the Institute of Physics, and the Society of Naval Architects and Marine Engineers.

Books

Radio & Radar Technique by A. T. Starr

Published (1953) by Isaac Pitman & Sons, Ltd., London and Pitman Publishing Corporation, 2 West 45th Street, New York 36, N. Y. 791 pages +20-page index +xviii pages. 805 figures. 6½" X 9¼". \$15.00.

A vast amount of technical literature has been published since World War II recording the inventions and developments in radar and radio communication which have taken place during the last fifteen years or so. Notable of these are the proceedings of the Radiolocation (1946) and Radiocommunication (1947) Conventions published by the Institute of Electrical Engineers (England), the MIT Radiation Laboratory Series and articles in the PROCEEDINGS OF THE I.R.E. and other journals.

The radio engineer in need of specific information is confronted with a formidable task of first locating the relevant articles; then reading and digesting them. This can be a painful and time consuming venture when one considers the abundance of published material which is often presented in a long and highly elaborate fashion.

An attempt has been made to present in one volume a co-ordinated, comprehensive yet readable digest of information on modern radio and radar techniques. This is a tremendous job for only one author to undertake; but Dr. Starr is admirably qualified for this task as most readers will agree who have studied his previous textbook, "Electric Circuits & Wave Filters."

It must be pointed out that whatever the title may suggest, this book actually deals particularly with theoretical principles and problems relating to radar and microwave relay systems or UHF links. No application nor practical design information is given. The emphasis is on microwave radiation and propagation, antenna systems, noise and bandwidth, pulse techniques and circuit analysis.

The reader is expected to have a B.S. degree or its equivalent in radio engineering; but there is no reason why an intelligent reader with lesser qualifications should not derive some benefit from this book since the text is descriptive with *comparatively* little use of advanced mathematics where possible. The more rigorous mathematical analysis and other theoretical and specialized topics are relegated to the thirty appendices. By this expedient the author has succeeded in presenting difficult topics in a readable, yet accurate form.

In chapter 1 the various modulation systems, in particular pulse methods, speed of transmission, bandwidth, noise and other related topics are covered; but there is hardly any discussion of nonlinear or amplitude distortion. Pulse radar systems and the Doppler methods are also briefly described.

In chapter 2 the properties of electromagnetic waves, their propagation in space and in waveguides are described. The MKS system of units is used. Maxwell's equations are introduced but a more rigorous treatment of these and related topics are covered in several appendices. This chapter is a readable treatment of a difficult topic. The Smith chart is introduced.

Chapter 3 deals almost exclusively with

waveguides or microwave plumbing. Discontinuity in lines and waveguides are treated at some length. Mode transformers, directional couplers, resonators, filters, TR boxes, attenuators and other items are discussed but information on measurements is brief.

In chapter 4 uhf antennas, especially microwaves, are covered with emphasis on theory. Lens antenna and arrays, and such types as Eagle, Schwarzschild and Polyrod antennas are also described.

This chapter (5) deals especially with the behavior of vacuum tubes at uhf. Velocity modulation and traveling-wave tubes, as well as cavity magnetrons, are described at some length. Pulse operation of vacuum tubes is also covered.

Chapter 6 deals with the steady state behavior of linear networks. The complex frequency plane, mesh and nodal analysis, two terminal impedances, filters and equalizers are among many topics covered. There is a good treatment of negative feedback with discussion of stability criteria. Also, wide-band amplifiers and frequency modulation circuits are described, but these are very brief and sketchy in treatment with some omissions. There is no mention of the ratio and Braddy detectors.

Chapter 7 deals with the response of linear networks to repeated nonsemiooidal waves. Operational methods are introduced and the advantages of the Laplace Transform are stressed in the appendices devoted to these topics. Generation and amplification of the more common type of pulses and wave forms, time bases, dividers and counters, clamping, gating and bootstrap, and other circuits are described.

Of the thirty Appendices, seven are devoted to electromagnetic waves—their properties and transmission, Maxwell's equations, and other related topics. Fourier methods, vector analysis, operational analysis of circuits and Laplace Transform are covered in four. Noise, in circuits and in tubes, is well covered in Appendix 9; while noise in angle modulation as well as minimum S/N for visibility on ppi are each separately treated. Analysis of dc telegraphy, angle modulation, sampling and quantization, and velocity modulation are given in separate appendices. Topics like selective sideband transmission, the linear detector, low-pass filter and wave shape, space-charge effects and input amplifier valve circuits are also covered. Maximally-flat amplifiers, network theory and pulse amplifiers are further expanded in separate appendices.

A select bibliography is included at the end of each chapter and most of the appendices. The references are to British and American literature but some German, Dutch, and French sources are indicated in few cases.

The terminology is British—one reads "valves" for "vacuum tubes," "base" for "bias." This may reduce the usefulness of an otherwise good subject index for American readers. There is also an author index. When reference is made to standards (television signal), these are again to British practice.

Some of the drawings are rather small, and in some cases the lettering mentioned in the text were missing. Decimal numbering of the paragraphs makes frequent reference easy.

The subject matter is expertly treated but not uniformly. Some topics are so briefly mentioned that one wonders if any useful purpose has been served by devoting only a few lines to such an item as the "transistor." In a book published in 1953, one might expect to see more on semiconductors. Yet the author has found space for "The Evans Electro-selenium Cell" and has devoted a whole appendix to "Reflection Due to a Cylindrical Post." If one judges this book from its title and chapter headings alone, he is bound to be disappointed for not finding a better and more relevant outline of the subject matter. But if one remembers the true purpose of this book, it is safe to state that the author has done an admirable and gigantic task in presenting the theoretical principles and problems relating to uhf links in one volume.

KERIM ONDER

Panoramic Radio Products, Inc.
Mount Vernon, N. Y.

High Fidelity Simplified by Harold D. Weiler.

Published by John F. Rider Publisher, Inc., 480 Canal St., New York 13, N. Y. 208 pages. 104 illustrations. Size 5½ X 8½. Price: \$2.50.

"High Fidelity Simplified" is a readable little book explaining the high quality home music system to the music enthusiast. It considers, chapter by chapter, the components making up the high fidelity system, and thoroughly explains their functions in a rather easily understood way for the layman. The author's intention is to provide a guide for the prospective purchaser of high fidelity equipment and in this he is very successful. In addition, the book indicates the importance of maintaining a reasonable balance between cost and quality of the apparatus.

There are two chapters on acoustics as applied to the reproduction of music; chapters which treat in considerable detail loudspeakers, their enclosures, the amplifier, record players and tuners, care of records, assembly and housing of the complete system, and the tape recorder for the home user. A short index and a list of high fidelity component manufacturers ends the book. Perhaps more might have been said about the interconnecting wiring of the complete system, as the problems of grounding, hum pickup, and so forth, were not discussed for the benefit of those readers assembling their own system without technical help.

Although "High Fidelity Simplified" was written primarily for the reader with little or no technical background, it might be profitable reading for the technician and engineer interested in this field. The lay reader must be diligent, for a great deal of this information is discussed in a short space, but he will find the book a fine guide through the multitude of high fidelity components listed in the radio catalogues.

BRUCE P. BOGERT
Bell Telephone Laboratories
Murray Hill, N. J.

Books

Radio Operating Questions and Answers by J. S. Hornung and Alexander McKenzie

Published (1952) by McGraw-Hill Book Company, Inc., 330 W. 42 St. New York 36, N. Y. 486 pages+17-page index+53-page appendix+x pages. 129 figures. 5½×8½. \$6.00.

J. L. Hornung is chief engineer, Hopkins Engineering Company, Inc., Washington, D. C. Alexander A. McKenzie is associate editor, *Electronics* magazine, New York, N. Y.

The purpose of this book is to enable the reader to prepare for commercial radio operator examinations by using it in conjunction with the FCC "Study Guide and Reference Material for Commercial Radio Operator Examinations."

The present edition has a new approach as contrasted to the previous ten editions, and has been completely rewritten and re-edited. The book presents questions and answers in four primary classifications. These classifications are: radio laws, regulations and operating practices, general theory for transmitters and receivers, power supplies and special endorsements. Special endorsements cover aircraft, radio-telegraph, and ship-radar techniques. A 64-page appendix offers useful information in tables, symbols, and explanations.

In spite of an attempt in reorganizing the material to draft illustrations, circuit diagrams, and the material to an up-to-date standard, some discrepancies and errors still remain. Answer 3.282 states that Class-C amplifiers have operating efficiencies from fifty to sixty per cent, while Answer 3.107 says Class-C efficiency ranges between sixty and ninety-five per cent with the average around sixty-five per cent. Such differences in statements are apt to lead to confusion, and it is noted that in another instance some improvement could have been made in the answers relating to power factor, phase angle, and phase difference.

In spite of the differences or inaccuracies still remaining, the authors are to be commended for the improved rearrangement of material, which facilitates use of the book.

ALOIS W. GRAF
Patent Attorney
Chicago, Ill.

Electrodynamics by Arnold Sommerfeld

Published (1952) by Academic Press Inc., Publishers, 125 E. 23 St., New York 10, N. Y. 363 pages+7-page index+xiii pages. 48 figures. 9×6. \$6.80.

Arnold Sommerfeld is a lecturer at the University of Munich, Germany.

This excellent English translation by Dr. Edward Ramberg of Sommerfeld's lectures on electrodynamics comprises Volume III of "Lectures on Theoretical Physics."

It is not, in the usual sense, a textbook, but rather a philosophical derivation of classical electrodynamics, extending into the theory of relativity and the theory of the electron. The mathematical prowess demanded of the reader in the later parts of the book is considerable, and it should be regarded as good collateral reading for an advanced student of electrodynamics.

Parts I and II of the book should, on the other hand, be of considerable interest to radio engineers. Part I proceeds with Max-

well's equations as an axiomatic basis, expressed in vectorial integral form, rather than in co-ordinates and differential form, and develops the fundamentals of Maxwell's electrodynamics. Part II deals with the derivation of phenomena from the Maxwell equations, and considers what happens in static, stationary, quasistationary, and rapidly varying fields. The last condition leads to an extensive discussion of wave fields of cylindrical symmetry and to a general solution of the problem of waves on wires.

Part III is entitled, "Theory of Relativity and Electron Theory," and is probably the least profitable part of the book, as far as electronic scientists are concerned. Twenty years ago, when Professor Sommerfeld was using this material in his lectures, it was hoped that before too long, to quote Mason and Weaver, a "real electron theory of electricity would replace an electrical theory of the electron." To date, this has not been accomplished, and the electron remains more than ever the mysterious stranger in our midst. We know, for example, that electrons possess a definite spin and a magnetic moment that can only be defined in terms of quantum theory. As Sommerfeld remarks, it is indeed strange that practical electronics should have remained so long untouched by these fundamental facts and could get along with the notion of the charged point mass or the minute charged sphere.

Part IV deals principally with Maxwell's theory for moving media, following Minkowski's equations. The effects arising from dielectrics rotating in magnetic fields, the Rowland and Roentgen effects, as well as the field of unipolar induction are discussed.

Sets of problems of some profundity accompany each part; answers to these are given at the end of the book and constitute an interesting extension of the main discussion.

C. W. CARNAHAN
Sandia Base
Albuquerque, N. M.

Electron Tubes in Industry by Keith Henney and James D. Fahnestock

Published (1952) by McGraw-Hill Book Company, Inc., 330 West 42 St., New York 36, N. Y. 345 pages+8-page index+x pages. 234 figures. 6×9. \$6.00.

Keith Henney and James D. Fahnestock are associated with the magazine *Electronics*, New York, N. Y.

Although this book is a third edition, years have intervened since the last revision, and the current work required an almost complete re-write with new material available.

The authors' objective is one of providing industry engineers and technicians with enough fundamentals to appreciate the possibilities and limitations of electronic devices. The objective has been accomplished and, in fact, surpassed. The information presented and the simplicity in which the subjects are covered suggest it should have a large reader audience, including electronics students. For those interested in more advanced treatments of the subjects covered,

an excellent list of references accompanies each chapter. Also, throughout the entire book, the reader appreciates the clearness of the illustrations and the fine style in which the written material is presented.

The eleven chapters are named as follows: Basic Circuit Elements, Fundamentals of Tubes, Basic Tube Circuits, Rectifier and Power Supplies, Light-Sensitive Tubes, Thyatron Tube Circuits, Relays and Relay Circuits, Electronic Motor Control, Electronic Measurement and Control, Counters and Divider Circuits, High-Frequency Heating and Welding.

In summary, this book is an excellent, although quite elementary, treatment of a subject of continuously growing importance. Almost anyone interested in the applications of electronic devices will find it interesting, either to browse through quickly or to study in more detail, depending on the reader's particular proficiency in the electronics field.

HAROLD A. ZAHL
Signal Corps Eng., Labs.
Fort Monmouth, N. J.

Principles of Television Servicing by Carter V. Rubinoff and Magdalena E. Wolbrecht

Published (1953) by McGraw-Hill Book Company, Inc., 330 West 42 St., New York 36, N. Y. 542 pages+8-page index+10-page appendix+xv pages. 345 figures. 9×6. \$7.50.

Carter V. Rubinoff is dean and Magdalena E. Wolbrecht is former vice president of the American Television Laboratories, San Bernardino, Calif.

This is a book for the student of television servicing, not the engineer. It probably fulfills the needs of such an audience. The book is well organized and follows a logical presentation. In most cases the information is adjudged adequate. However, the first thing that struck this reviewer was the antiquity of the illustrations. Old equipment is shown in almost every technical illustration.

Although the dust jacket lists as two special features the latest information on field sequential color (obsolescent) and the new uhf television bands, only thirteen pages are devoted to these important topics. Yet the book is copyrighted in 1953. This is most unfortunate since at the time of going to press uhf television was actually in use in this country. The information on color TV is about three years old, nor is mention made of the dot sequential system or the current NTSC developmental work.

While it may be argued that the television serviceman may expect to be servicing a number of the earlier models of television sets, it hardly seems necessary to go back to the era of seven-inch receivers. This criticism applies particularly to the comparatively large amount of space devoted to projection-type receivers.

It is this reviewer's opinion that the book represents a dressed-up version of a television servicing course which might have been given at a trade school five years ago. There are many other books on television servicing on the market with more up-to-date information.

JOHN H. BATTISON
National Radio Institute
Washington, D. C.

Sections*

Chairman

R. M. Byrne
316 Melbourne Ave.
Akron, Ohio

L. E. French
107 Washington St. SE
Albuquerque, N. M.

S. R. Smith
278-12 St. N.E.
Atlanta, Ga.

G. R. White
Bendix Radio Div.
Towson 4, Md.

L. B. Cherry
1418 Central Dr.
Beaumont, Tex.

C. F. Maylott
41 River St.
Sidney, N. Y.

Beverly Dudley
Technology Review
Mass. Inst. Technology
Cambridge, Mass.

Luis M. Malvarez
Comandant Franco 390
Olivos—SCQBM
Buenos Aires, Arg.

R. R. Thalner
254 Rano St.
Buffalo, N. Y.

R. M. Mitchell
357 Garden Dr., S.E.
Cedar Rapids, Iowa

A. R. Beach
Louveridge Circle E.
Eau Gallie, Fla.

A. A. Gerlach
4020 Overhill Ave.
Chicago 34, Ill.

W. B. Shirk
6342 Hamilton Ave.
Cincinnati 24, Ohio

S. J. Begun
3405 Perkins Ave.
Cleveland 14, Ohio

C. B. Sloan
568 Arden Rd.
Columbus 2, Ohio

Eric Vaughan
657 Stafford Ave.
Bristol, Conn.

J. K. Godbey
Magnolia Petroleum Co.
Field Research Lab.
Box 900
Dallas, Tex.

A. H. Pettit
444 E. Peach Orchard Ave.
Dayton, Ohio

E. H. Forsman
3609 East 34 Ave.
Denver, Colo.

W. L. Cassell
Iowa State College
Ames, Iowa

F. W. Chapman
1756 Graefield Rd.
Birmingham, Mich.

H. F. Dart
923 Farnham St.
Elmira, N. Y.

Lt. Col. W. B. Sell
A.F.F. Bld. No. 4
Fort Bliss, Tex.

R. E. Neuber
130 Willonwood Center
Emporium, Pa.

B. H. Baldridge
R.R. 12 Kratzville Rd.
Evansville, Ind.

L. F. Mayle
The Magnavox Co.
Fort Wayne, Ind.

Secretary

AKRON (4) H. L. Flowers
2029—19 St.
Cuyahoga Falls, Ohio

ALBUQUERQUE-
LOS ALAMOS (7) R. K. Moore
2808 Mesa Linda Dr. NE
Albuquerque, N. M.

ATLANTA (6) D. L. Finn
School of Elec. Eng.
Georgia Inst. of Tech.
Atlanta, Ga.

BALTIMORE (3) C. F. Miller
Johns Hopkins U.
105 Md. Hall
Baltimore, Md.

BEAUMONT-
PORT ARTHUR (6) C. B. Trevey
2555 Pierce St.
Beaumont, Tex.

BINGHAMTON (4) Edward Klinko
27 Linden St.
Binghamton, N. Y.

BOSTON (1) H. A. Dorschug
Radio Station WEEI
182 Tremont St.
Boston 12, Mass.

BUENOS AIRES Alejandro Rojo
Transradio International
San Martin 379
Buenos Aires, Arg.

BUFFALO-
NIAGARA (4) D. P. Welch
859 Highland Ave.
Buffalo 23, N. Y.

CEDAR RAPIDS
(5) G. W. March
424 Liberty Dr.
Cedar Rapids, Iowa

CENTRAL,
FLORIDA (6) Hans Scharla-Nielsen
Radiation Inc. P.O. Dr. Q
Melbourne, Fla.

CHICAGO (5) W. E. Berkey
Westinghouse Electric
Merchandise Mart Plaza
Chicago 54, Ill.

CINCINNATI (5) W. W. Gulden
3272 Dayton Ave.
Cincinnati 11, Ohio

CLEVELAND (4) W. A. Howard
National Broadcasting Co.
815 Superior Ave.
Cleveland, Ohio

COLUMBUS (4) P. I. Pressel
599 Northridge Rd.
Columbus 14, Ohio

CONNECTICUT
VALLEY (1) P. F. Ordung
Dunham Lab. Yale Univ.
New Haven, Conn.

DALLAS-FORT
WORTH (6) M. W. Bullock
6805 Northwood Rd.
Dallas, Tex.

DAYTON (5) M. A. McLennan
304 Schenck Ave.
Dayton, Ohio

DENVER (5) P. H. Wright
1010 S. Franklin St.
Denver, Colo.

DES MOINES-
AMES (5) R. E. Price
1706 Franklin Ave.
Des Moines, Iowa

DETROIT (4) N. D. Saigeon
1544 Grant
Lincoln Park, Mich.

ELMIRA CORNING
(2) E. M. Guyer
Corning Glass Works
Corning, N. Y.

EL PASO (7) Harold Hopp
2404 Copper St.
El Paso, Tex.

EMPORIUM (4) E. H. Boden
Box 14
Emporium, Pa.

EVANSVILLE-
OWENSBORO (5) E. C. Gregory
1120 S.E. First St.
Evansville, Ind.

FORT WAYNE (5) Clifford Hardwick
2905 Chestnut St.
Fort Wayne, Ind.

Chairman

John Lucyk
77 Park Row S.
Hamilton, Ont.

I. G. Mercer
Box 1380 KHON
Honolulu, T. H.

K. O. Heintz
202 Humble Blvd.
Houston, Tex.

H. R. Wolff
5135 E. North St.
Indianapolis, Ind.

R. E. Lee
205A Entwistel St.
China Lake, Calif.

J. H. Van Horn
Telecom, Inc.
P. O. Box 5899
Kansas City, Mo.

W. F. Stewart
1219 Skyline Dr.
N. Little Rock, Ark.

G. A. Robitaille
19 McKinnon Pl.
London, Ont. Canada

Vincent Learned
2 Prescott St.
Garden City, L. I., N. Y.

E. F. King
3171 Federal Ave.
Los Angeles 34, Calif.

M. I. Schwalbe
Veterans Admin. Hosp.
Louisville 2, Ky.

Prof. F. B. Lucas
5340 Davis Rd., S.W.
South Miami 43, Fla.

H. J. Zwarra
722 N. Bdwy., Rm. 1103
Milwaukee, Wis.

D. A. Anderson
159 Sunnyside Ave. Lake-
side
Montreal 33, Que.

S. S. Shamis
11 Stanley Rd.
West Orange, N. J.

Prof. R. R. Wright
Dept. Elec. Eng.
Va. Polytechnic Inst.
Blacksburg, Va.

C. W. Mueller
Box 1082 c/o CAA
Oklahoma City, Okla.

V. H. Wight
1411 Nemaha St.
Lincoln 2, Neb.

J. A. Loutit
674 Melbourne Ave.
Ottawa, Ont., Canada

J. G. Brainerd
Moore School, U. of Penn.
Philadelphia 4, Pa.

A. M. Creighton, Jr.
2201 E. Osborn Rd.
Phoenix, Ariz.

J. H. Greenwood
530 Carleton Ho. WCAE
Pittsburgh, Pa.

G. C. Ellison, Jr.
11310 S.E. Market St.
Portland, Ore.

J. S. Donal, Jr.
RCA Labs.
Princeton, N. J.

Allan Holstrom
551 Spencer Rd.
Rochester, N. Y.

W. F. Koch
1340-33 St.
Sacramento, Calif.

E. F. O'Hare
8325 Delcrest Dr.
University City 24, Mo.

Secretary

HAMILTON (8) A. L. Fromanger
79 Park Row Ave. N
Hamilton, Ont. Canada

TERRITORY OF
HAWAII (7) M. S. Vittum
Box 43
Honolulu, T. H.

HOUSTON (6) E. W. Helken
Trans Tex. Airways,
Municipal Airport
Houston, Tex.

INDIANAPOLIS (5) J. T. Watson
1304 N. Delaware St.
Indianapolis, Ind.

INVOKERN (7) J. C. Keyes
704-A Kearsage
China Lake, Calif.

KANSAS CITY (5) Mrs. G. L. Curtis
Radio Industries, Inc.
1307 Central Ave.
Kansas City, Kan.

LITTLE ROCK (5) J. E. Wylie
2701 N. Pierce
Little Rock, Ark.

LONDON ONTARIO
(8) J. D. B. Moore
27 McClary Ave.
London, Ont., Canada

LONG ISLAND
(2) J. F. Bisby
160 Old Country Rd.
Mineola, L. I., N. Y.

LOS ANGELES (7) W. E. Peterson
4016 Via Cardelina, Palos
Verdes Estates, Calif.

LOUISVILLE (5) G. W. Yunk
2236 Kaelin Ave.
Louisville 5, Ky.

MIAMI (6) C. E. Rogers
717 Santander Ave.
Coral Gables 4, Fla.

MILWAUKEE (5) Alex Paalu
1334 N. 29 St.
Milwaukee, Wis.

MONTREAL,
QUEBEC (8) Sydney Bonnoville
Boaver Hall Hill
Montreal, P. Q., Canada

NEW YORK (2) A. C. Beck
Box 107
Red Bank, N. J.

NORTH
CAROLINA-
VIRGINIA (3) B. C. Dickerson
1716 Broadfield Rd.
Norfolk 3, Va.

OKLAHOMA CITY
(6) F. T. Pickets, III
1333 Chestnut Dr.
Oklahoma City, Okla.

OMAHA-LINCOLN
(5) M. L. McGowan
5544 Mason St.
Omaha 4, Neb.

OTTAWA,
ONTARIO (8) D. V. Carroll
Box 527
Ottawa, Ont., Canada

PHILADELPHIA
(3) C. R. Kraus
1835 Arch St.
Philadelphia 3, Pa.

PHOENIX (7) W. R. Saxon
301 W. Vernon Ave.
Phoenix, Ariz.

PITTSBURGH (4) J. H. Greenwood
530 Carleton House
Pittsburgh, Pa.

PORTLAND (7) R. W. Schmidt
1235 S.W. Freeman St.
Portland, Ore.

PRINCETON (3) G. S. Sziklai
Box 3
Princeton, N. J.

ROCHESTER (4) W. F. Bellor
186 Dorsey Rd.
Rochester, N. Y.

SACRAMENTO (7) H. C. Slater
1945 Bidwell Way
Sacramento, Calif.

ST. LOUIS (5) F. A. Fillmore
5758 Itasha St.
St. Louis, Mo.

* Numerals in parenthesis following Section designate Region number.

Sections

Chairman

Clayton Clark
710 N. First East St.
Logan, Utah

John Ohman
207 Windsor
San Antonio, Tex.

C. R. Moe
4669 E. Talmadge Dr.
San Diego, Calif.

J. R. Whinnery
U. of Cal. EE Dept.
Berkeley, Calif.

D. E. Norgaard
1908 Townsend Rd.
Schenectady, N. Y.

L. A. Traub
2816—31 Ave., N.
Seattle, Wash.

Richard F. Shea
225 Twin Hills Drive
Syracuse, N. Y.

R. G. Larson
2647 Scottwood Ave.
Toledo, Ohio

J. R. Bain
169 Kipling Ave. S.
P. O. 54
Toronto, Ont., Canada

C. E. Day
Geophysical Research
Corp.
2607 N. Boston Pl.
Tulsa, Okla.

O. W. Muckenhirn
EE Dept. U. of Minn.
Minneapolis, Minn.

A. H. Gregory
150 Robson St.
Vancouver, B. C. Canada

H. P. Meisinger
Hull & Old Courthouse
Rds.
Rt. 3, Vienna, Va.

R. C. Lepley
R.D. 2
Williamsport, Pa.

Secretary

J. S. Hooper
1936 Hubbard Ave.
Salt Lake City 5, Utah

Paul Tarradaychik
215 Christine Dr.
San Antonio, Tex.

F. X. Byrnes
1759 Beryl St.
San Diego, Calif.

A. J. Morris
812-11 Ave.
Redwood City, Calif.

R. L. Smith
Station WRGB
Schenectady, N. Y.

G. K. Barger
1229 9 Ave., W.
Seattle, Wash.

Major A. Johnson
162 Lincoln Ave.
Syracuse, N. Y.

R. E. Weeber
3141 Westchester
Toledo, Ohio

E. L. Palin
2139 Bayview Ave.
Toronto, Ont., Canada

C. S. Dunn
1926 S. Knoxville
Tulsa, Okla.

N. B. Coil
1664 Thomas Ave.
Saint Paul 4, Minn.

Miles Green
2226 W. 10th Ave.
Vancouver, B.C. Canada

H. I. Metz
Dept. of Commerce, CAA
Room 2094, T-4 Bldg.
Washington, D. C.

W. H. Bresce
818 Park Ave.
Williamsport, Pa.

Subsections

Chairman

R. F. Lee
2704-31 St.
Lubbock, Tex.

R. V. Higdon
1030 S. Atherton St.
State College, Pa.

F. G. McCoy
Rt. 4, Box 452-J
Charleston, S. C.

W. W. Salisbury
910 Mountain View Dr.
Lafayette, Calif.

Allen Davison
3422 Argyle Ave.
Eric, Pa.

J. R. Haeger
1107 Times Bldg.
Huntsville, Ala.

C. R. Burrows
116 Mitchell St.
Ithaca, N. Y.

G. F. Brett
326 E. Orange St.
Lancaster, Pa.

D. M. Saling
2 Baker St.
Poughkeepsie, N. Y.

O. D. Perkins
Signal Corps Eng. Labs.
Fort Monmouth, N. J.

G. P. McCouch
Aircraft Radio Corp.
Boonton, N. J.

W. M. Kidwell
1516 Laurel Ave.
Pomona, Calif.

H. M. Stearns
990 Varian St.
San Carlos, Calif.

J. H. Vogelman
404 W. Cedar St.
Rome, N. Y.

George Weiler
1429 E. Monroe
South Bend, Ind.

Capt. L. A. Yarbrough
3001 USAFIT
Wright-Patterson
Air Force Base, Ohio

H. G. Swift
Route 2
Derby, Kan.

John Greenaway
403 Tinniswood St.
Winnipeg, Canada

Secretary

AMARILLO-
LUBBOCK (6)
(Dallas-Ft. Worth)

CENTRE COUNTY
(4)
(Emporium)

CHARLESTON (6)
(Atlanta)

EAST BAY (7)
(Los Angeles)

ERIE (4)
(Buffalo-Niagara
Subsection)

HUNTSVILLE (6)
(Atlanta)

ITHACA (4)
(Syracuse
Subsection)

LANCASTER (3)
(Philadelphia)

MID-HUDSON (2)
(New York)

MONMOUTH (2)
(New York)

NORTHERN N. J.
(2)
(New York)

ORANGE BELT
(7)
(Los Angeles)

PALO ALTO (7)
(San Francisco)

ROME (4)
(Syracuse
Subsection)

SOUTH BEND (5)
(Chicago)

USAFIT

WICHITA
(Kansas City)

WINNIPEG (8)
(Toronto)

C. M. McKinney
3102 Oakmont
Austin, Tex.

W. L. Baker
1184 Oncida St.
State College, Pa.

C. B. Lax
Sergeant Jasper Apts.
Charleston, S. C.

J. M. Rosenberg
1134 Norwood Ave.
Oakland 10, Calif.

C. O. Brock
220 W. Rhett Ave.
Huntsville, Ala.

Benjamin Nichols
Franklin Hall, Cornell U.
Ithaca, N. Y.

M. B. Lemeshka
RCA New Holland Ave.
Conestoga, Pa.

E. A. Keller
Red Oaks Mill Rd.
R.D. 2
Poughkeepsie, N. Y.

Edward Massell
Box 433
Locust, N. J.

W. R. Thurston
923 Warren Parkway
Teaneck, N. J.

Eli Blutman
6814 Glacier Dr.
Riverside, Calif.

W. W. Harman
Elec. Research Lab.
Stanford U.
Stanford, Calif.

Fred Moskowitz
514 E. Bloomfield St.
Rome, N. Y.

A. R. O'Neil
WSBT-WSBT-TV
South Bend, Ind.

Lt. Col. R. D. Sather
Box 3344 USAFIT
Wright-Patterson
Force Base, Ohio

P. A. Bunyar
1328 N. Lorraine
Wichita, Kan.

R. M. Simister
179 Renfrew St.
Winnipeg, Canada

Professional Groups

AIRBORNE ELECTRONICS

Chairman

K. C. Black
Polytechnics Res. and Devel. Co.
Brooklyn, N. Y.

ANTENNAS AND PROPAGATION

P. S. Carter
RCA Labs
Rocky Point, L. I., N. Y.

AUDIO

Narvin Camras
Armour Research Foundation
Chicago, Ill.

BROADCAST AND TELEVISION

D. D. Israel
111 8 Ave., New York, N. Y.

RECEIVERS

Lewis Winner
52 Vanderbilt Ave., New York, N. Y.

BROADCAST TRANSMISSION

R. L. Dietzold
34 W. 11 St., New York, N. Y.

SYSTEMS

Col. John Hessel
Signal Corps Eng. Labs
Fort Monmouth, N. J.

CIRCUIT THEORY

Floyd A Paul
Northrop Aircraft, Inc.
Hawthorne, Calif.

COMMUNICATIONS SYSTEMS

L. S. Nergaard
RCA Labs, Princeton 5, N. J.

COMPONENT PARTS

John H. Howard
Burroughs Adding Machine Co.
Philadelphia, Pa.

ELECTRONIC DEVICES

Gen. T. C. Rives
General Electric Co.
Syracuse, N. Y.

ELECTRONIC COMPUTERS

Gen. T. C. Rives
General Electric Co.
Syracuse, N. Y.

ENGINEERING MANAGEMENT

Gen. T. C. Rives
General Electric Co.
Syracuse, N. Y.

INDUSTRIAL ELECTRONICS

Engene Mittlemann
549 W. Washington Blvd., Chicago, Ill.
Dr. William G. Fuller
Melpar, Inc., 452 Swann Ave.
Alexandria, Va.

INFORMATION THEORY

INSTRUMENTATION

MEDICAL ELECTRONICS

I. G. Easton
General Radio Co.
Cambridge, Mass.

MICROWAVE THEORY AND

TECHNIQUES

NUCLEAR SCIENCE

QUALITY CONTROL

RADIO TELEMETRY AND REMOTE

CONTROL

ULTRASONICS ENGINEERING

VEHICULAR COMMUNICATIONS

VEHICULAR COMMUNICATIONS

VEHICULAR COMMUNICATIONS

VEHICULAR COMMUNICATIONS

VEHICULAR COMMUNICATIONS

VEHICULAR COMMUNICATIONS

VEHICULAR COMMUNICATIONS

VEHICULAR COMMUNICATIONS

VEHICULAR COMMUNICATIONS

VEHICULAR COMMUNICATIONS

Abstracts and References

Compiled by the Radio Research Organization of the Department of Scientific and Industrial Research, London, England, and Published by Arrangement with that Department and the *Wireless Engineers*, London, England

NOTE: The Institute of Radio Engineers does not have available copies of the publications mentioned in these pages, nor does it have reprints of the articles abstracted. Correspondence regarding these articles and requests for their procurement should be addressed to the individual publications, not to the IRE.

Acoustics and Audio Frequencies.....	1202
Antennas and Transmission Lines.....	1203
Circuits and Circuit Elements.....	1203
General Physics.....	1206
Geophysical and Extraterrestrial Phenomena.....	1207
Location and Aids to Navigation.....	1208
Materials and Subsidiary Techniques.....	1208
Mathematics.....	1209
Measurements and Test Gear.....	1210
Other Applications of Radio and Electronics.....	1211
Propagation of Waves.....	1211
Reception.....	1212
Stations and Communication Systems.....	1212
Subsidiary Apparatus.....	1213
Television and Phototelegraphy.....	1213
Transmission.....	1214
Tubes and Thermionics.....	1215
Miscellaneous.....	1216

The number in heavy type at the upper left of each Abstract is its Universal Decimal Classification number and is not to be confused with the Decimal Classification used by the United States National Bureau of Standards. The number in heavy type at the top right is the serial number of the Abstract. DC numbers marked with a dagger (†) must be regarded as provisional.

ACOUSTICS AND AUDIO FREQUENCIES

534.213.4 2195

Theoretical Study of Vibratory Movements associated with Obstacles and Discontinuities—J. Guittard. (*Acustica*, vol. 3, pp. 22–32; 1953. In French.) Experimental results obtained with brass tubes excited by sound waves, using powder-pattern or manometric-capsule methods of observation, are analyzed mathematically.

534.231-13 2196

Second-Order Acoustic Fields: Relations between Energy and Intensity—J. J. Markham. (*Phys. Rev.*, vol. 89, pp. 972–977; March 1, 1953.) Explicit calculations, based on Airy's general solution for the propagation of an elastic disturbance in a one-dimensional gas, are made of the average energy density; and the average intensity of an acoustic wave. The front of the wave is shown to be a region of high density; it is followed by a region of lower density. This density variation seems to be a basic feature of a traveling wave in a gas and does not depend on the amplitude. (See also 2964 of 1952.)

534.321.9:534.61 2197

Sonde Method of Measuring the Ultrasonic Field Intensity—S. Morita. (*Jour. Phys. Soc. (Japan)*, vol. 7, pp. 214–219; March/April, 1952.) The probes used were spheres of sound-absorbing materials of diameter about 2 mm, containing thermistors of diameter 0.3–0.5 mm. From the experimental results together with theoretical considerations it is concluded that generation of heat takes place at the surface of any solid in an ultrasonic field, and that the wave has a cooling effect. The measurements were made mainly at a frequency of 450 kc.

534.321.9-14:534.6 2198

Measurements of Sound Absorption in Water and in Aqueous Solutions of Electro-

The index to the Abstracts and References published in the *PROC. I.R.E.*, from February, 1952 through January, 1953, is published by the *Wireless Engineer* and may be purchased for \$0.68 (including postage) from the Institute of Radio Engineers, 1 East 79th St., New York 21, N. Y. As supplies are limited, the publishers ask us to stress the need for early application for copies. Included with the Index is a selected list of journals scanned for abstracting, with publishers' addresses.

lytes—G. Kurtze and K. Tamm. (*Acustica*, vol. 3, pp. 33–48; 1953.) Four different techniques are described for measuring the absorption over different parts of the frequency range 4 kc–100 mc. The results are discussed in relation to theories about the properties of the liquids.

534.845.1 2199

Measurement of Sound-Absorption Coefficients—T. Vogel. (*Ann. Télécommun.*, vol. 8, pp. 93–96; March, 1953.) Various difficulties encountered in the measurement of room reverberation times and of absorption coefficients are briefly discussed. A simple method for absorption measurement is described in which observations are made of the stationary-wave system produced near the face of a large sample of the material under test by interaction of the reflected waves with incident plane waves, the measurements being made in a large echo-free room. Experimental results at 575 cps are compared with theoretical values derived on the basis of Rayleigh's theory.

534.846 2200

The Acoustics of the Royal Festival Hall, London—P. H. Parkin, W. A. Allen, H. J. Purkis and W. E. Scholes. (*Acustica*, vol. 3, pp. 1–21; 1953.) Continuation of investigations previously noted (Parkin, 567 of 1952). Comments made by listeners indicate that the "definition" is excellent, but that more "fullness of tone" is desirable for some types of music. Reverberation time is considered to be the only practical objective criterion; the value of the reverberation time for this hall when full is 1.5 seconds (at 500 cps), i.e. 0.2 second less than the optimum value given by Knudsen and Harris for a hall of this size. The "fullness" would probably be adequate if the reverberation time could be increased to 1.7 seconds or somewhat more.

621.395.612.451 2201

The Uniaxial Microphone—H. F. Olson, J. Preston and J. C. Bleazey. (*RCA Rev.*, vol. 14, pp. 47–63; March, 1953.) Modifications have been made to the ribbon microphone previously described (Olson and Preston, 2697 of 1950), to produce a microphone which is directional and blastproof. The latter object is achieved by associating baffles with the ribbon so as to attenuate the low frequencies. Theoretical and measured directional patterns are given and frequency response characteristics are shown.

621.395.616:621.317.39 2202

Measurement of the Mechanical Tension of Capacitor-Microphone Diaphragms—F. J. van Leeuwen. (*Electronica*, vol. 6, pp. 57–59; April 11, 1953.) Apparatus for measuring the diaphragm tension on the completely assembled microphone is described; its operation is based

on the increase of capacitance resulting from application of a direct biasing voltage. Measurement results indicate that dural and nickel-foil diaphragms are relatively satisfactory as regards maintenance of tension.

621.395.623.7 2203

Loudspeaker Baffles and Cabinets—J. A. Youngmark. (*Jour. Brit. IRE*, vol. 13, pp. 89–98; Feb. 1953.) Graphs of the frequency response of loudspeakers mounted in baffles of various shapes and sizes and in open-back and bass-reflex cabinets are shown and discussed. Main attention is given to bass-reflex cabinets and the triangular corner type which, used with a low-impedance source, has certain advantages over the flat "infinite" baffle. The general effect of a baffle on HF response is discussed and other design difficulties are briefly mentioned.

621.395.623.7.001.4 2204

Loudspeakers: Relations between Subjective and Objective Tests—F. H. Brittain. (*Jour. Brit. IRE*, vol. 13, pp. 105–109; Feb. 1953.) Objective testing unrelated to subjective experience is largely useless and can be very misleading, but objective tests made in an echo-free room can be satisfactorily correlated with subjective tests made in an ordinary living room. Hence pitch/loudness relations can be derived from frequency/intensity curves. Where a number of attributes are to be tested simultaneously, the subjective form of test is the only one possible.

621.395.625.3 2205

Notes on Wear of Magnetic Heads—G. A. del Valle and L. W. Ferber. (*Jour. Soc. Mot. Pic. & Telev. Eng.*, vol. 60, pp. 501–504; April 1953. Discussion pp. 505–506.) Wear due to the physical contact between the magnetic-head pole pieces and the magnetic coating on striped motion-picture film is discussed. Measurement methods and results obtained on R.C.A. record/reproduce heads are described.

621.395.625.3:771.53 2206

Manufacture of Magnetic Recording Materials—E. Schmidt and E. W. Franck. (*Jour. Soc. Mot. Pic. & Telev. Eng.*, vol. 60, pp. 453–462; April 1953.) An account is given of techniques used in manufacturing the coating and base materials, and in applying the coating. Problems involved in the production of film with a stripe of magnetic material are discussed.

621.396.625.3:771.53 2207

Commercial Experiences with Magna-Stripe—E. Schmidt. (*Jour. Soc. Mot. Pic. & Telev. Eng.*, vol. 60, pp. 463–467; April 1953. Discussion, pp. 468–469.) Problems involved in providing photographic film with a stripe of magnetic material are discussed. Proposed standards for locating the stripe are based on

data obtained from processing more than 2000 prints, of various types, with a "half" stripe (i.e. a stripe 0.050 in. wide, covering half the original photographic sound track).

621.395.625.3:771.53 2208
Magnetic Striping Techniques and Characteristics—B. L. Kaspin, A. Roberts, Jr., H. Robbins and R. L. Powers. (*Jour. Soc. Mot. Pic. & Telev. Eng.*, vol. 60, pp. 470-482; April 1953. Discussion, pp. 483-484.)

621.395.625.3:771.53 2209
Magnetic Striping of Photographic Film by the Laminating Process—A. H. Persoon. (*Jour. Soc. Mot. Pic. & Telev. Eng.*, vol. 60, pp. 485-488; April 1953. Discussion, pp. 489-490.)

621.395.625.3:771.53 2210
Magnetic Sound Tracks for Processed 16-mm Motion Picture Film—T. R. Dodell. (*Jour. Soc. Mot. Pic. & Telev. Eng.*, vol. 60, pp. 491-499; April 1953. Discussion pp. 499-500.)

621.395.625.6:537.228.3 2211
Sound-on-Film Recording using Electro-optic Crystal Techniques—R. Dressler and A. A. Chesnes. (*Jour. Soc. Mot. Pic. & Telev. Eng.*, vol. 60, pp. 205-216; March 1953. Discussion p. 216.) A modulator is described whose operation is based on the optical retardation produced by a crystal subjected to an electric field. ADP and KDP crystals are suitable. The electric field is applied parallel to the light beam, using transparent electrodes. Seventy-five percent modulation is obtained with a total system distortion of about 3.3%; the required driving voltage of 2 kV rms is derived from a standard audio amplifier through a matching transformer.

ANTENNAS AND TRANSMISSION LINES
 621.315.212 2212

Developments in High-Frequency Transmitter Cables—R. C. Mildner. (*Jour. Brit. IRE*, vol. 13, pp. 113-121; Feb. 1953.) Description of the mechanical and electrical characteristics of two types of coaxial cable with solid-wire inner conductor, for feeding the antennas of medium- and high-power transmitters. One has Al sheathing, the second is sheathed with Cu tape. Details of the range of accessories available are also given. The cables can be used for wavelengths down to the decimeter range.

621.392.621.396.67 2213
Losses in Aerial Feeders—F. Moyano Reina. (*Rev. Telecomun. (Madrid)*, vol. 9, pp. 10-13; March 1953.) A formula for the radiation resistance of two-wire transmission lines is developed; this is used to find the power loss due to radiation. A calculation is made for a two-wire 200-m antenna feeder with stearite separators; radiation losses are much less than other losses at 1 mc, and the total losses are less than for a good-quality coaxial cable with polystyrene insulation. Other advantages of the multi-wire line are its low cost and the ease with which it can be tested for standing waves.

621.392.21.029.64 2214
Microstrip—A New Transmission Technique for the Kilomegacycle Range—D. D. Grieg and H. F. Engelmann. (*Elec. Commun.*, vol. 30, pp. 26-35; March 1953.) (Reprint—see 621 of March.)

621.392.21.029.64 2215
Simplified Theory of Microstrip Transmission Systems—F. Assidourian and E. Rimai. (*Elec. Commun.*, vol. 30, pp. 36-45; March 1953.) (Reprint—see 622 of March.)

621.392.21.029.64:621.317.3 2216
Microstrip Components—J. A. Kostriza. (*Elec. Commun.*, vol. 30, pp. 46-54; March 1953.) (Reprint—see 623 of March.)

621.392.26 2217
A Compact Broad-Band Microwave-Wave Plate—A. J. Simmons. (*Proc. I.R.E.*, vol. 41,

p. 637; June 1953.) Correction to paper abstracted in 3348 of 1952.

621.392.26 2218
On the Transient Phenomena in the Wave Guide—N. Namiki and K. Horiuchi. (*Jour. Phys. Soc. (Japan)*, vol. 7, pp. 190-193; March/April 1952. Correction, *ibid.*, vol. 7, p. 652; Nov./Dec. 1952.) A theoretical investigation is made of wave distortion due to the variation of the phase velocity with frequency. The general formula is applied to examine the case when a sinusoidal oscillation is impressed at time $t=0$; initial oscillations of appreciable amplitude precede the signal front. Long-distance transmission could be affected by these transient phenomena.

621.392.26 2219
Uniform Designation of Waves in Waveguides—H. Meinke. (*Fernmelde- u. Z.*, vol. 6, pp. 101-103; March 1953.) The German Waveguide Standards issued in 1944 are discussed in relation to present-day usage in various countries.

621.392.26:537.226 2220
Shielded-Dielectric-Rod Waveguides—R. E. Beam and H. M. Wachowski. (*Trans. Amer. IEE*, vol. 70, pp. 874-880; 1951.) A dielectric rod surrounded by air and by a metal cylinder is termed a "shielded-dielectric-rod waveguide." Sets of curves are given showing (a) the value of λ/λ_0 for different ratios of cylinder and rod radii for the TM_{01} , TE_{01} and HE_{11} modes, (b) the relative field distributions within the cylinder for the same three modes.

621.392.5 2221
Transmission-Line Load Impedance for Maximum Efficiency—S. G. Lutz. (*Trans. Amer. IEE*, vol. 70, pp. 283-285; 1951.) (Full paper—see 2106 of 1951.)

621.392.67 2222
Theory of Straight Aerials—R. Gans and M. Bemporad. (*Arch. Elekt. Übertragung*, vol. 7, pp. 169-180; April 1953.) Free oscillations of the antenna are discussed briefly and conditions for reception and transmission are analyzed in detail. Hallén's theory is recapitulated, and a contradiction in his basic integral equation is cleared up. A new method is presented for solving the integral equation expressing the current distribution; this reduces the problem to the solution of a system of linear equations. The method enables any required degree of approximation to be attained and gives the solution in a form which enables particular properties of the antenna, e.g. the absorption area, to be calculated easily.

621.396.67 2223
Ground-Reflection Phase-Error Characteristics of a Vertical Antenna—H. Greenberg and D. R. Meierdiecks. (*Proc. NEC (Chicago)*, vol. 8, pp. 668-677; 1952.) Expressions for the phase error and amplitude factor are derived for the signal received from a vertical antenna fed at the base, the transmission being over ground of any given conductivity. Curves are given for the phase error and amplitude factor for an antenna about 60 ft. in height, (a) with base at ground level, (b) with base at a height of 100 ft., ground conductivities being taken as those of sea water, average earth and poorly conducting earth. Curves for the elevated antenna fitted with a counterpoise system of radius 500 ft. show a marked decrease of phase error with increase in amplitude. The transmission frequency is 1.7 mc in all cases considered.

621.396.67.029.63 2224
U.H.F. Mobile Antenna—E. F. Harris. (*Electronics*, vol. 26, pp. 181-183; May 1953.) Descriptions are given, with radiation patterns, of various arrangements of center-fed vertical arrays of stacked elements. Coaxial cable is used for the feeder and is bent to form the radiating elements and phasing sections of the

lower half of the array, the inner conductor being similarly treated for the upper half. A $\lambda/4$ isolating sleeve suppresses radiation from the line below the lowest $\lambda/2$ section. The whole array is moulded into a fiberglass supporting tube carried by a tubular metal mast. Such antenna systems cover wide frequency bands and should prove useful in the 450-470-mc band.

621.396.677 2225
Use of the Rhombic Aerial for Reception—H. Bohnenstengel. (*Fernmelde- u. Z.*, vol. 6, pp. 172-178; April 1953.) An investigation is made of the possibility of designing the rhombic antenna to pick up radiation polarized either in its own plane or in a perpendicular plane. To obtain uniform characteristic impedance a multiwire construction is desirable; details are given of the vertical spread required for a three-wire model. The requirements for the termination are studied by considering the antenna as a modified twin conductor. To be reflection-free, the terminating impedance must be complex, with an inductive component. Methods of measurement are indicated; measurements of voltage rather than resistance are required.

621.396.677 2226
An Experimental Investigation of the Corner-Reflector Antenna—E. F. Harris. (*Proc. I.R.E.*, vol. 41, pp. 645-651; June 1953.) Radiation patterns are shown for a dipole symmetrically located between two reflecting sheets including an angle θ . Results are given for values of θ from 30° to 270° and for spacings of 0.1λ to 3λ between the dipole and vertex.

621.396.677 2227
Optimum Patterns for Endfire Arrays—R. H. Duhamel. (*Proc. I.R.E.*, vol. 41, pp. 652-659; June 1953.) The methods of Dolph (2487 of 1946) and Riblet (2685 of 1947) for optimum design of the broadside array with an odd number of elements have been modified so that a common design procedure can be used. This procedure is extended to the endfire array with an odd number of elements. A comparison is made between the optimum design and other designs of endfire array.

621.396.677.012.12 2228
Analysis of Microwave-Antenna Side-Lobes—N. I. Korman, E. B. Herman and J. R. Ford. (*RCA Rev.*, vol. 14, p. 127; March 1953.) Correction to paper noted in 41 of January.

621.396.677.029.53 2229
Design and Performance Figures of a Medium-Wave Directional Aerial System—R. Becker. (*Elektrotech. Z.*, vol. 74, pp. 158-161; March 1, 1953.) Calculations are made of the heights, diameters and spacing of two vertical antennas for directional transmission on 506 m, and the components of the feeder system for obtaining the correct phase relation of the feed currents are determined. Good agreement was obtained between the observed and calculated radiation diagrams. (See also Eich, 222 of January.)

621.396.677.029.62 2230
Slotted-Cylinder Aerials with Horizontal Directivity—H. Bosse. (*Fernmelde- u. Z.*, vol. 6, pp. 123-127; March 1953.) Theory is developed to show that with a double-slotted cylinder of diameter $>0.2\lambda$ it is possible to obtain a horizontal diagram in which the forward radiation is much greater than the backward or the lateral radiation, without any null directions. For diameters $<0.2\lambda$, similar results can be obtained by providing dipoles in conjunction with a single-slotted cylinder. The calculations are confirmed by measurements.

CIRCUITS AND CIRCUIT ELEMENTS

538.652:[621.392.52+621.396.611] 2231
 Some Applications of Permanently Mag-

- netized Ferrite Magnetostrictive Resonators—W. van B. Roberts. (*RCA Rev.*, vol. 14, pp. 3-16; March 1953.) For frequencies up to about 1 mc, magnetostrictive resonators using ferrites are very much cheaper than crystal resonators. Toroidal magnetostrictive elements are discussed; by applying the biasing and driving fields in different directions, different modes of vibrations are obtained. A definition is given of the coefficient of coupling between driving coil and resonator, this coefficient affording an indication of the efficiency and being measurable with a Q meter. Applications of such devices as frequency-control elements in oscillator circuits and as components in various filter circuits are described.
- 621.3.015.7:621.387.4 2232
A Method Ensuring Stability and Equality of Channel Widths in a Pulse-Amplitude Analyzer—H. Guillon. (*Jour. Phys. Radium*, vol. 14, pp. 128-129; Feb. 1953.) The method is basically that of Wilkinson (1199 of 1950). Pulses of amplitudes between 5 and 50 V are accepted and bandwidth stability for 10-hour working periods is within $\pm 0.2\%$.
- 621.3.016.35 2233
The Generalized Transmission Matrix Stability Criterion—P. M. Honnell. (*Trans. Amer. IEE*, vol. 70, pp. 292-296; 1951. Discussion, pp. 296-298.) (Full paper—see 334 of 1952.)
- 621.3.016.34:621.396.615 2234
Generalization of the Nyquist-Diagram Method for Nonlinear Systems—A. Blaquière. (*Jour. Phys. Radium*, vol. 13, pp. 636-644; Dec. 1952.) Methods previously explained (1625 of June) are generalized to cover the case of oscillations represented by a nonlinear differential equation of any order.
- 621.314.22.015.7 2235
The Design of a Peaking Transformer—A. B. Thomas. (*Proc. IRE (Australia)*, vol. 14, pp. 55-57; March 1953.) The basic principles of the peaking transformer are outlined and the design of a transformer to produce 30-V pulses, of duration about 500 μ s, from a 100-V 50-cps input is discussed.
- 621.314.235.015.8 2236
Helical-Winding Slow-Wave Structures in Exponential-Line Pulse Transformers—J. Kukul and E. M. Williams. (*Proc. I.R.E.*, vol. 41, p. 669; June 1953.) A description is given of an experimental pulse transformer with integral hydrogen-thyratron pulse generator, suitable for use at the high impedance levels required in pulsed operation of magnetrons. The transformer has an outer cylindrical shell, the inner conductor consisting of a helix of constant diameter whose pitch decreases gradually from the thyratron end. Over-all length is 1.81 m, input impedance 290 Ω and output impedance 1590 Ω .
- 621.314.3† 2237
Steady-State Analysis of Self-Saturating Magnetic Amplifiers based on Linear Approximations of the Magnetization Curve—W. H. Esselman. (*Trans. Amer. IEE*, vol. 70, pp. 451-459; 1951.) A method is described for predicting the output currents of self-saturating magnetic amplifiers.
- 621.314.3† 2238
The Transient Response of Magnetic Amplifiers—Cases of Negligible Commutation—L. A. Finzi, D. P. Chandler and D. C. Beaumariage. (*Trans. Amer. IEE*, vol. 70, pp. 934-942; 1951. Discussion, p. 142.) (Full paper—summary noted in 926 of 1952.)
- 621.314.3:621.318.435 2239
A Saturable-Core Reference Source for Use with Magnetic Amplifiers—A. G. Milnes and T. V. Vernon. (*Jour. Sci. Instr.*, vol. 30, pp. 135-138; April 1953.)
- 621.314.7:621.392.5 2240
Terminology and Equations for Linear Active Four-Terminal Networks including Transistors—L. J. Giacoletto. (*RCA Rev.*, vol. 14, pp. 28-46; March 1953.) A general system of terminology is developed for linear active quadripoles, both nodal and loop analysis being presented. Definitions are given of current, voltage and power amplification factors, and the transformation equations are derived. The results are applied to a number of transistor circuits, the appropriate formulas being tabulated. Numerical examples are worked out.
- 621.316.541 2241
A Printed-Circuit Multiconductor Plug—W. D. Novak. (*Proc. NEC (Chicago)*, vol. 8, pp. 489-494; 1952. *Tele-Tech.*, vol. 12, pp. 64-66, 112; Jan. 1953.)
- 621.316.86:537.312.6 2242
Thermistor Production—W. T. Gibson. (*P.O. Elec. Eng. Jour.*, vol. 46, pp. 34-36; April, 1953.) Short illustrated account of the manufacture of bead-type and rod-type thermistors from powdered mixtures of the oxides Ni, Mn and Cu.
- 621.318.572 2243
A New Type of Waveguide Rotary Switch—D. G. Kiely. (*Jour. Brit. IRE*, vol. 13, pp. 100-103; Feb. 1953.) A high-speed waveguide switch is described which will connect two receivers or transmitters alternately to one antenna and which is particularly suitable for centimeter wavelengths. The performance of a model operating at 8 mm λ was satisfactory.
- 621.318.572 2244
Scale-of-Ten Counting Unit using Four Double Triodes—R. Wahl. (*Jour. Phys. Radium*, vol. 13, pp. 670-671; Dec. 1952.) Description of a scale-of-16 circuit converted to scale-of-ten operation by means of feedback from the fourth to the second stage, Ge crystals being used for the feedback coupling and for that between the first and second stage.
- 621.318.572:621.314.8 2245
A Transistor Reversible Binary Counter—R. L. Trent. (*Proc. NEC (Chicago)*, vol. 8, pp. 346-357; 1952.) (See 650 of March.)
- 621.319.4.029.5 2246
The Properties of Capacitors at High Frequencies—W. Hartmann. (*Bull. schweiz. elektrotech. Ver.*, vol. 44, pp. 258-262; March 21, 1953. In German.) The variations with frequency of the capacitance and loss angle of capacitors are deduced from the equivalent circuit, the frequencies considered ranging up to the television band. The self-resonance frequencies of paper, mica and ceramic capacitors, taking account of wire leads, are shown by curves. Other curves show the variation of loss angle with frequency.
- 621.392 2247
On Linear Electrical Networks—B. Gross. (*Ann. Acad. bras. Sci.*, vol. 24, pp. 443-447; Dec. 31, 1952.) Preliminary note of a method of analysis in terms of network admittance.
- 621.392.015.3 2248
The Calculation of Carrier-Frequency Transients—W. Händler and J. Peters. (*Fernmeldetechn. Z.*, vol. 6, pp. 179-188; April 1953.) By using function theory and the Laplace-transform method, exact calculations are made without introducing any assumptions regarding the phase response of the transmission system. Demodulation calculations by two methods are considered. As an example of use of the preferred method, a calculation of the carrier-frequency transients is made for the vestigial-sideband IF amplifier described by Zimmermann (2062 of 1952); a step voltage is used for modulation. In appendixes, the practical application of the residue theorem to transmission calculations is demonstrated, and a chart for plotting transients is presented.
- 621.392.4/.5 2249
Equivalent Circuits using Negative Two-Pole Elements—W. Klein. (*Arch. elekt. Übertragung*, vol. 7, pp. 198-201; April 1953.) Calculations for three-pole and multipole networks are simplified by substitution of equivalent circuits consisting only of two-pole elements, some of which have negative values.
- 621.392.4.012 2250
Loci of Complex Impedance and Admittance Functions—E. L. Michaels. (*Trans. Amer. IEE*, vol. 70, pp. 299-303; 1951.) (Full paper—see 2125 of 1951.)
- 621.392.43 2251
Impedance Matching with Transformer Sections—R. W. Klopfenstein. (*RCA Rev.*, vol. 14, pp. 64-71; March 1953.) An equivalent circuit for a transmission-line transformer section is discussed which allows considerable flexibility in design and enables end effects to be easily taken into account.
- 621.392.5 2252
On the Approximation Problem in Network Synthesis—A. D. Bresler. (*Proc. I.R.E.*, vol. 41, p. 644; June 1953.) Correction to paper abstracted in 660 of March.
- 621.392.5 2253
Networks for which Magnitude or Phase Angle of Input Impedance or Transfer Admittance remains Constant as Load Varies—R. S. Berkovitz. (*Trans. Amer. IRE*, vol. 70, pp. 286-291; 1951.) The conditions are determined that must be satisfied by a network at constant frequency to obtain a particular variation of input impedance or transfer admittance when the load changes in a specified way. Results are tabulated for ten special cases.
- 621.392.5 2254
The Parameters of a Four-Terminal Network—A. E. Ferguson. (*Aust. Jour. Appl. Sci.*, vol. 4, pp. 18-27; March 1953.) The method of analyzing quadripoles in terms of image impedances and a propagation constant is compared with the method based on the general circuit constants; the latter method, which can conveniently be treated by matrix algebra as described by Guertler (2440 of 1950) is preferred. The relation between the two sets of constants is examined and typical applications are illustrated.
- 621.392.5 2255
Note on the Iterated Network and its Application to Differentiators—H. L. Armstrong. (*Proc. I.R.E.*, vol. 41, p. 667; June 1953.) An alternative proof is given of the formula for a power of a matrix recently given by Pease (2457 of 1952).
- 621.392.5 2256
Use of Locus Diagrams to determine the Equalizing Action of Bridged-T Networks—E. Thinius. (*Fernmeldetechn. Z.*, vol. 6, pp. 109-115; March 1953.) Numerical examples are used to show the method of determining from the impedance diagram the variation with frequency of the attenuation and phase coefficients of bridged-T networks of different types.
- 621.392.5 2257
How to Design Notch Networks—C. J. Savant, Jr. (*Electronics*, vol. 26, pp. 188-191; May 1953.) Curves are given which simplify the design of capacitor-shunt or resistor-shunt bridged-T networks and of parallel-T networks of the infinite-attenuation RC type.
- 621.392.5 2258
Synthesis of Unbalanced RLC Networks—L. Weinberg. (*Proc. NEC (Chicago)*, vol. 8, pp. 598-608; 1952. *Jour. Appl. Phys.*, vol. 24, pp. 300-306; March 1953.) Each inductor of the network is assumed to have associated series resistance. The method of synthesis makes use of novel features, including (a) the breakdown of a Hurwitz polynomial into two

others, (b) application of a network theorem to division of the network into two parts and (c) a method of zero shifting with one pair of complex poles, (a) and (c) being discussed in appendixes. The network realizes a minimum-phase transfer function whose numerator and denominator are of degree not higher than the third and fourth respectively, and whose poles and zeroes may lie anywhere in the left half of the complex-frequency plane. Extension of the procedure to functions of higher degree is considered briefly.

621.392.5 2259

High-Characteristic-Impedance Distributed-Constant Delay Lines for Fractional-Microsecond Pulses—W. S. Carley and E. F. Seymour. (*Proc. NEC. (Chicago)*, vol. 8, pp. 787-798; 1952.) The delay lines described are pile wound with wire of 41-48 gauge (about 1500 turns/in.) on polystyrene rods previously coated with silver paint, slotted lengthwise at 10° intervals and then insulated with teflon tape prior to winding. A typical line, 10 in. in length and 0.2 in. in diameter, has a characteristic impedance of 5.6 k Ω , a delay of 3.7 μ s and an attenuation of the order of 0.3 db/ μ s. Pulse rise and fall times are about 0.1 μ s. Response curves for pulses of 0.3, 0.37, 0.6, 1.0 and 2.4 μ s duration are given. Characteristics of 5.6-k Ω and 10-k Ω lines are tabulated. (See also *Electronics*, vol. 26, pp. 188-192, 194; April 1953.)

621.392.5 2260

Phase and Group Delay—R. Krastel. (*Funk u. Ton.*, vol. 7, pp. 74-83; Feb. 1953.) Expressions for phase and group delay are obtained and the design of low-pass delay networks is considered, with illustrative numerical examples.

621.392.5:621.396.645 2261

Networks with Maximally Flat Delay—Kiyasu-Zem'iti, Nobuichi Ikeno and Sigeharu Yamada. (*Wireless Engr.*, vol. 30, pp. 158-159; June 1953.) (Comment on 3375 of 1952, Thomson.)

621.392.52 2262

Wiener's Theory of Linear Filtering—D. A. Bell. (*Wireless Engr.*, vol. 30, pp. 136-142; June 1953.) Wiener's theory (2465 of 1950) introduces the concept of the "optimum linear filter" for use when signal and noise occupy the same frequency band. This concept is examined without attempting to follow the complex mathematics of the original. The discussion is limited to the extreme cases of "zero-lag" and "infinite-lag" filters, which are appropriate respectively to telecommunication and automatic-control systems. A formula is derived for the transfer characteristic of the optimum filter for an input signal having the power spectrum $1/(1+\omega^2)$ with uniform random noise. For the zero-lag case the transfer characteristic is affected by consideration of phase/frequency variations; for the infinite-lag case it is not. For applications in which delay can be tolerated, the infinite-lag filter has the advantage of transmitting a much greater fraction of the input power. The applicability of "optimum" filters is discussed.

621.396.6 2263

Improved Components and Materials for Reliable Electronic Equipment—A. W. Rogers and B. A. Diebold. (*Elec. Mfg.*, vol. 48, pp. 114-119, 280; Nov. 1951.) Discussion of improvements in components and manufacturing techniques resulting from a U. S. Signal Corps research program.

621.396.6:061.4 2264

The National Radio-Components Exhibition, 1953—J. Roussseau. (*TSF et TV*, vol. 29, pp. 157-161, 189-195; April/May 1953.) Review of annual exhibition in Paris, with descriptions and illustrations of selected items. For other accounts see *Toute la Radio*, vol. 20, pp. 157-168; May 1953 and *Télévision*, No. 33, pp. 113-118; May 1953.

621.396.6:681.142 2265

Circuitry "Packages" for Electronic Computers—(*Tech. Bull. Nat. Bur. Stand.*, vol. 37, pp. 36-37; March 1953.) Short description of etched-circuit mass-produced units, $7 \times 3.5 \times 1$ in., with projecting pin connections. The basic unit comprises a transformer-coupled pulse amplifier using a Type-6AN5 miniature beam-tetrode and a number of Ge diodes. Four variants of the basic unit meet most computer-circuit requirements. A new computer including 800 such units is under construction. Test jacks facilitate location of defective units and of defective components of individual units.

621.396.611.1 2266

Electrical Oscillations: a Physical Approach to the Phenomena—A. W. Gillies. (*Wireless Engr.*, vol. 30, pp. 143-158; June 1953.) Phenomena occurring in oscillator circuits are explained in terms of modulation products. For an input signal of given form an analysis is made of the modulation products introduced by the curvature of the characteristic of a nonlinear resistor, the characteristic being represented to any required degree of accuracy by a polynomial. The operation of a negative-resistance oscillator including a nonlinear resistor is explained in terms of this analysis. In general the oscillation frequency deviates slightly downwards from the resonance frequency associated with the linear part of the circuit. Forced oscillations and synchronization are considered. A vector representation is developed for transient behavior and combined oscillations. For detailed mathematical discussion see 308 of 1950.

621.396.611.1 2267

The Response of a Tuned Circuit to a Ramp Function—M. S. Corrington. (*Proc. I.R.E.*, vol. 41, pp. 660-664; June 1953.) A ramp function is defined as one whose value increases linearly up to a certain point and then remains constant. Response curves are shown for a parallel-tuned LRC circuit subjected to (a) a linearly increasing driving force, (b) ramp voltages with various rise times. In each case curves are given for circuit Q values of 0.5, 1, 2, 4, 8 and ∞ .

621.396.611.1.012.1:512.942 2268

Three-Dimensional Locus Curves for Describing the Properties of Electrical Circuits—D. M. Tombs. (*Electrotech. Z.*, vol. 74, pp. 232-234; April 11, 1953.) In the Jahnke-Emde "Tafeln höherer Funktionen" (2826 of 1949) the Fresnel integral is shown by an isometric representation of a space curve. Prowse (2481 of 1948) has shown that the characteristics of an oscillatory circuit can be similarly represented by a three-dimensional locus curve whose projections on the three reference planes give respectively the usual circle diagram, a resonance curve, and an N-shaped susceptance diagram. Wire models, on similar lines, are described which show the relation between impedance and frequency, or between admittance and frequency, for some simple and coupled circuits.

621.396.611.21.029.45 2269

A New Quartz Oscillator for the Frequency Range 1-20 kc—A. Karolus. (*Electrotech. Z.*, vol. 74, pp. 136-140; March 1, 1952.) A quartz oscillator in the form of a tuning fork is described. Each prong carries four electrodes arranged according to the cut of the crystal and connected so that on application of a voltage via the spring suspensions the inner and outer halves of each prong are stressed in opposite directions. In air the Q factor is 2×10^4 , increasing to 10^5 at a pressure of a few mm Hg. With thermostatic control the frequency variation can be kept to within 1 part in 10^8 .

621.396.611.4 2270

Electromagnetic Field Expansions in Loss-Free Cavities Excited through Holes—T. Teichmann and E. P. Wigner. (*Jour. Appl.*

Phys., vol. 24, pp. 262-267; March 1953.) "The electromagnetic field in a loss-free cavity excited through holes cannot be completely expressed in terms of the short-circuit modes of the cavity satisfying the condition that the tangential component of the electric field is zero on the boundary of the cavity including the openings. For a complete expansion it is necessary to add an irrotational magnetic field, which contributes a term inversely proportional to the frequency, to the usual admittance matrix. If the cavity is presumed to include a reasonable portion of the guides feeding the openings, this irrotational component becomes almost diagonal."

621.396.615.018.751:621.317.755 2271

The Sawtooth Derivator—D. Admiraal. (*Electronic Appl. Bull.*, vol. 13, pp. 117-137; Aug./Sept. 1952.) The sawtooth derivator differs fundamentally from the conventional type of timebase generator in that the required waveform is derived from an arbitrary waveform which, in its turn, is derived from the signal applied to the CRO. In this way perfect synchronization is obtained. Various types of clipping and differentiating circuits are discussed and a description is given, with full circuit details, of practical equipment which functions entirely automatically and covers the frequency range 30 cps-15 kc without any switching operations.

621.396.615.029.62 2272

220-Mc/s Oscillator with a TBW-6/6000 or TBL-6/6000 Transmitting Valve—G. Mol. (*Electronic Appl. Bull.*, vol. 13, pp. 138-144; Aug.-Sept. 1952.) Details are given of the construction of a self-excited oscillator using either a water-cooled or an air-cooled high-power transmitting tube. Illustrations are given of the special anode-grid and cathode-grid circuit arrangements and of the method of coupling used for a water-cooled dummy load consisting of a $\lambda/4$ shorted coaxial line. The power dissipated in the load, about 3.25 kW, is estimated from the rise in temperature and rate of flow of the cooling water.

621.396.615.14:621.385.3 2273

A Mode of Oscillation of Conventional Triode Valves—G. Raoult and R. Turlier. (*Compt. Rend. Acad. Sci. (Paris)*, vol. 236, pp. 1007-1009; March 9, 1953.) Analysis shows that if certain conditions are satisfied UHF oscillations are possible in a triode tube designed for lower frequencies. This was verified for a Telefunken Type-LS180 triode, which is designed to oscillate on wavelengths down to about 50 cm. The tube has two grid and two anode terminals and to these a resonant 4-wire system was attached, with a 20-k Ω resistor and milliammeter connected between grid and earth. With an anode voltage of 500 V good oscillations on a wavelength of 11.4 cm were obtained, the mean oscillatory voltage on the grid being about 30 V and on the anode about 300 V. The calculated wavelength was about 11 cm.

621.396.615.17 2274

Stability in Negative-Feedback Time-Bases—A. B. Starks-Field. (*Electronic Eng.*, vol. 25, pp. 192-197; May 1953.) The term "double stroking" is applied to a condition in which alternate scanning strokes are dissimilar; this phenomenon is liable to occur during starting, and may continue indefinitely, in any timebase where the initiation of flyback depends on the conditions existing at the end of the scan and the flyback is maintained linear. The process is examined in detail for some typical circuits.

621.396.616:621.318.572 2275

Interesting Nonlinear Effects—R. S. MacKay. (*Jour. Appl. Phys.*, vol. 24, pp. 311-313; March 1953.) Experiments show that simple circuits comprising ordinary electric lamps together with iron-core transformer coils and

capacitors have properties similar to some multivibrators and ring circuits. Applications to switching, counting and delaying are indicated.

621.396.645.015.7:621.387 2276

The Gas-Filled Triode as Pulse-Amplifier Valve—E. Knoop. (*Z. angew. Phys.*, vol. 5, pp. 105–107; March 1953.) An experimental investigation is reported. Using a special circuit to avoid permanent ignition, a recovery time of 2 μ s can be attained with a He-filled Type-EC50 tube. For applied pulses of duration $>1 \mu$ s the operating threshold value of input voltage may be as low as 0.1 V; for shorter pulses the threshold is a few volts. As pulse width and height decreases, the build-up time for the discharge increases and the time delay of the amplified pulse is increased. The gas triode is thus only appropriate in the output stage of a pulse amplifier.

621.396.645.018.424 2277

Video Amplifiers with Extremely Large Bandwidth—F. J. Fischer. (*Electrotech. Z.*, vol. 74, pp. 131–133; March 1, 1953.) Practical designs of a cascade amplifier and one with distributed amplification are illustrated. Comparison of the two types shows certain advantages of the cascade type.

621.396.645.35 2278

A Direct-Voltage Amplifier for Voltages down to 10^{-9} V [from sources] having Low Internal Resistance—W. Kroeber. (*Naturwissenschaften*, vol. 40, p. 197; March 1953.) The low voltage threshold is achieved by using a crystal contact relay and Tesla transformer in the input circuit to convert the dc to ac for amplification.

621.396.645.35 2279

A Survey of the Limits in DC Amplification—C. M. Verhagen. (*Proc. I.R.E.*, vol. 41, pp. 615–630; June 1953.) The effect of a change of the cathode temperature of planar diodes and triodes is calculated and the possibility of compensating this temperature effect is discussed. The effect of anode-voltage changes is analyzed and some new compensating circuits are described which enable dynamic and in-phase balance to be obtained simultaneously with a single adjustment. For all balanced circuits the requirements as regards stability of the supply or auxiliary voltage are found to be nearly the same. Changes of tube constants with time are discussed. Investigation showed that the poorly defined position of the heater in the cathode sleeve of some tubes seriously limited their stability.

621.396.645.371.081.78 2280

Harmonic Distortion and Negative Feedback—R. O. Rowlands. (*Wireless Engr.*, vol. 30, pp. 133–135; June 1953.) An analysis is made which takes account of the production of harmonics of order higher than the second by the negative-feedback process. The usual formula for the reduction of distortion by application of negative feedback is accurate if the slope of the amplifier output-voltage/input-voltage curve does not vary appreciably over the working range. If a tube with a sharp cut-off is used and the input voltage is greater than the cut-off value, no reduction of distortion can be effected by negative feedback.

621.396.822:621.396:645:621.314.7 2281

Noise in Transistor Amplifiers—E. Keonjian and J. S. Schaffner. (*Proc. N.E.C. (Chicago)*, vol. 8, pp. 343–345; 1952.) (See 1288 of May.)

621.392.52 2282

Filter Design Data for Communication Engineers—J. H. Mole. [Book Review.] Publishers: E. and F. N. Spou, 252 pp., 63s; 1952. (*Elec. Eng.*, vol. 25, p. 221; May 1953.) A design procedure is outlined which permits rapid computation of the element values of the optimum Zobel filter having a given attenuation characteristic.

GENERAL PHYSICS

534.2:537.3 2283

The Acousto-Electric Effect—R. H. Parmenter. (*Phys. Rev.*, vol. 89, pp. 990–998; March 1, 1953.) Theoretical calculations indicate that an electric current should be generated in a crystal by the passage through it of an acoustic wave. In a metal, the electrons concerned are at the Fermi level; in an n -type semiconductor they are in the conduction band. Calculations for Na and for n -type Ge indicate that the predicted effect should be measurable.

535.37:537.228 2284

Initial Rise of Brightness of Electroluminescent Substances under the Action of an Alternating Field—F. Vigan. (*Compt. Rend. Acad. Sci. (Paris)*, vol. 236, pp. 1151–1153; March 16, 1953.) Observed phenomena can be explained on the assumption of excitation of luminescence centers by conduction-band electrons that have acquired sufficient energy. These electrons reach the conduction band from electron donor levels a few tenths of an electron-volt below and are then accelerated.

535.37:537.228 2285

Influence of Electric Fields on Luminescence—F. Matossi and S. Nudelman. (*Phys. Rev.*, vol. 89, pp. 660–661; Feb. 1, 1953.) Brief report of an investigation of the luminescence of a ZnS-Cu phosphor excited by near-ultraviolet radiation and subjected to alternating electric fields at frequencies up to 10 kc. The procedure used was similar to that of Destriau (110 of 1949).

535.37:537.228 2286

Effect of an Electric Field on a Continuously Excited Phosphor—F. Matossi. (*Naturwissenschaften*, vol. 50, pp. 239–240; April 1953.) When an alternating electric field is applied to a ZnS-Cu phosphor excited to steady-state luminescence, a momentary increase of luminescence is observed, with a subsequent drop and a slow change to a new steady state, a periodic intensity ripple, of double the field frequency, being superposed. Switching off the field generally results in a new momentary intensity with subsequent gradual return to the initial value. These effects are explained on the basis of theory given by Randall & Wilkins (1808 of 1946).

537.213+538.123:517.947.42 2287

Vector Potential Derivation from Scalar Potentials—J. J. Smith. (*Elec. Eng. (N.Y.)*, vol. 71, p. 802; Sept. 1952.) Digest of paper presented at AIEE District Meeting, May 1952. Definitions are given of vector potential; it is shown that vector potentials can be derived from the scalar potentials included in the Tables of Green's Functions (2360 below). Results are given for the field due to a thin rectangular sheet of magnetic material or a rectangular coil.

537.221 2288

Calculation of Contact Potentials—H. Dormont. (*Compt. Rend. Acad. Sci. (Paris)*, vol. 236, pp. 1009–1011; March 9, 1953.) A formula is derived for the contact potential between two metals from consideration of Fermi energy levels and surface thermal-electron flux.

537.221 2289

Contact Phenomena—H. Dormont. (*Compt. Rend. Acad. Sci. (Paris)*, vol. 236, pp. 1238–1240; March 23, 1953.) Continuation of investigation noted in 2286 above. If the two barrier layers have the same transparency, the usual formula for contact potential is found in terms of the constants of the Dushman-Richardson equation; if the two barrier layers have different transparencies, a correction term comes into play. Analysis indicates that by making sufficiently accurate measurements of contact potential it should be possible to separate emission-constant variation due to variation of

work function with temperature from that due to barrier transparency.

537.311.1:621.396.822 2290

Electrical Fluctuation Phenomena—H. Witt. (*Z. Phys.*, vol. 133, pp. 661–664; Dec. 2, 1952.) The possibility is discussed that fluctuation phenomena in insulating materials may have their origin in recombination fluctuations of the freed electrons with their positive residual charges, the recombination fluctuations being related to the statistical density fluctuations of the solid and being amplified by the mechanism of electronic conduction.

537.311.33 2291

Transistors: Theory and Applications: Part 3—Physical Properties of Electrons in Solids—A. Coblenz and H. L. Owens. (*Electronics*, vol. 26, pp. 162–165; May 1953.) Presents a concept of the electron that fits with generally accepted explanations of phenomena in semiconductor materials that are responsible for transistor action. (Part 2: 1957 of July.)

537.523.093 2292

Dependence of Direct Sparkover Voltage of Gaps on Humidity and Time—P. B. Jacob, Jr. and G. M. L. Sommerman. (*Trans. Amer. IEE*, vol. 70, pp. 921–924; 1951. Discussion, pp. 924–925.) A systematic investigation of humidity and time effects on the breakdown voltage for gaps using (a) spheres 12.5 cm in diameter, (b) standard rods, $\frac{1}{2}$ in. square section, with square edges. Results are shown graphically and discussed.

537.562:538.632 2293

General Expression for the Conductivity Tensor and for the Dielectric Tensor in an Ionized Medium. Various Applications: Hall Effect and Generalization of Langevin's Formula for Mobility—T. Kalan and R. Jancel. (*Compt. Rend. Acad. Sci. (Paris)*, vol. 236, pp. 1478–1481; April 13, 1953.) A calculation to a first order of approximation is made of the distribution function for electrons in an ionized gas exposed to crossed magnetic and electric fields. The rate of diffusion of the electrons is deduced and expressions are derived for the conductivity and dielectric tensors. In a later paper, the formulas obtained are to be discussed and compared with those established by Huxley (1266 of 1952).

538.061.3 2294

Washington Conference on Magnetism, 2nd–5th September 1952—(*Rev. Mod. Phys.*, vol. 25, 351 pp.; Jan. 1953.) The 66 papers presented at the conference are given in full, with reports of the discussions.

538.12 2295

The External Magnetic Field of a Single Thick Semi-Infinite Parallel Plate terminated by a Convex Semicircular Cylinder—N. Davy and N. H. Langton. (*Quart. Appl. Math.*, vol. 6, pp. 115–121; March 1953.)

538.3 2296

General Solutions of Maxwell's Equations—É. Durand. (*Compt. Rend. Acad. Sci. (Paris)*, vol. 236, pp. 1407–1409; April 8, 1953.) Expressions are derived which are sufficiently general to cover the case of charges or currents within the volume considered.

538.56:535.42 2297

Diffraction by a Thick Semi-Infinite Plate—D. S. Jones. (*Proc. Roy. Soc. A*, vol. 217, pp. 153–175; April 8, 1953.) A method of analysis based on that previously described (374 of February) is applied to the problem of the diffraction of a two-dimensional plane harmonic wave by a semi-infinite perfectly conducting plate of thickness d . Expressions are obtained for the distant field when d has any value, and the effects at the boundary of the shadow are deduced. Extension of the theory to the problem of diffraction by a thick plate of finite length is briefly discussed. The theory is

also extended to incident scalar waves whose direction of propagation does not lie in the plane perpendicular to the plate.

538.56:535.42 2298

The Diffraction of a Dipole Field by a Perfectly Conducting Half-Plane—T. B. A. Senior. (*Quart. Appl. Math.*, vol. 6, pp. 101-114; March 1953.) A method of analysis is developed which is valid for any orientation of the dipole; the dipole field is resolved into plane waves whose diffraction can be studied independently. The particular case of an electric dipole with its axis normal to the half-plane is investigated.

538.566:537.56 2299

Absorption in an Electron-Gas Mixture—H. Kober. (*Ann. Phys. (Lpz.)*, vol. 11, pp. 1-11; Oct. 10, 1952.) The influence of the collision damping on the polarization of an electron-gas mixture subjected to an alternating electric field is calculated using the kinetic theory of gases and assuming the simplest type of elastic collision. The nonlinear effect of the absorption is estimated to a first approximation; this nonlinearity is significant for long waves propagated in the ionosphere.

538.569.4 2300

Microwave Absorption Spectrum of ND₃—R. G. Nuckolls, L. J. Rueger and H. Lyons. (*Phys. Rev.*, vol. 89, p. 1101; March 1, 1953.) The frequencies of the main J, K sequence of inversion lines in the ND₃ absorption spectrum between 1.589 and 2.54 kmc, measured in a coaxial type of Stark cell, are tabulated together with values calculated from an NH₃-type formula.

538.613 2301

The Faraday Effect in Conductors and Semiconductors—A. Surduts. (*Compt. Rend. Acad. Sci. (Paris)*, vol. 236, pp. 1005-1007; March 9, 1953.) Analysis on classical lines is presented for the effect on a plane-polarized plane EM wave of an applied constant magnetic field in the direction of propagation. A formula for the rotation of the plane of polarization is derived which may possibly be checked experimentally.

538.691:537:122 2302

The Influence of Magnetic Impulses on the Kinetic Energy of Electrons—L. Kolodziejczyk. (*Compt. Rend. Acad. Sci. (Paris)*, vol. 236, pp. 1476-1478; April 13, 1953.) Analysis is presented showing that magnetic impulses, such as those caused by EM waves with discontinuities in the magnetic components, may produce variation of the kinetic energy of electrons and may contribute to the destruction of atomic structures.

539.211:537.533 2303

Surface Investigation of Metals and Nonmetals with Exo- and Photoelectrons—J. Kramer. (*Z. Phys.*, vol. 133, pp. 629-646; Dec. 2, 1952.) The term "exo-electrons" is applied to electrons emitted from a surface under excitation by light of sufficiently short wavelength, an exothermic process being involved. A description is given of the special Geiger-type needle counter used in the investigation, the light source with plexiglas lenses being built into the counter. Results obtained are shown graphically and discussed; they include curves showing (a) the decay of exo- and photoelectron emission from energy-treated Pt, stretched Al, and gypsum, and (b) temperature variation of exo-electron emission from gypsum, CaO, quartz and quinine sulphate subjected to various types of irradiation.

621.3.011.4:518.12 2304

Calculation of the Capacitance of a Circular Annulus by the Method of Subareas—T. J. Higgins and D. K. Reitan. (*Trans. Amer. IEE*, vol. 70, pp. 926-931; 1951. Discussion, pp. 931-933.) An approximation method is described and applied to the determination of the capacitance and charge distribution of a circu-

lar annulus and of a circular disk. The fourth approximations for the capacitance are in good agreement with the known exact values.

GEOPHYSICAL AND EXTRA-TERRESTRIAL PHENOMENA

523.746 2305

The Magnetic Field Strength in Sunspots—G. Thiessen. (*Naturwissenschaften*, vol. 40, pp. 218-219; April 1953.) Brief discussion of the validity of formulas developed by various investigators.

523.746 2306

The Sunspot Series—R. N. Bracewell. (*Nature (London)*, vol. 171, pp. 649-650; April 11, 1953.) Because of the lack of a truly periodic term in the sunspot-number series, predictions have so far been made on an empirical basis. A more satisfactory representation is obtained by plotting the numbers with reversed sign for alternate 11-year periods, to give a 22-year cycle with practically zero mean value. A significant degree of correlation is found between the slopes of adjacent flanks of the successive 11-year cycles.

550.384.3(99) 2307

Mean Magnetic Field and Secular Variation in Adelie Land from May 1951 to 1st January 1952—P. N. Mayaud. (*Compt. Rend. Acad. Sci. (Paris)*, vol. 236, pp. 954-956; March 2, 1953.)

551.510.535 2308

The Lower E and D Region of the Ionosphere as deduced from Long Radio Wave Measurements—R. J. Nertney. (*Jour. Atmos. Terr. Phys.*, vol. 3, pp. 92-107; Feb. 1953.) An ionosphere model is proposed which is in reasonable agreement with experimental data. During the day this locates the 16-kc reflection region in the tail of the D layer around 75 km height, the ionosphere-winds region in the nose of the later centered on 77 km, and a region of minimum ionization density between the D and E layers at about 80 km, with electron density of about 300 electrons/cm³.

551.510.535 2309

The Longitude Effect in the F Region—K. Rawer and C. M. Minnis. (*Jour. Atmos. Terr. Phys.*, vol. 3, pp. 123-124; Feb. 1953.) (Further discussion—see also Rawer, 1379 of 1951 and Minnis, 3081 of 1952.)

551.510.535 2310

Ionospheric Storms and the Geomagnetic Anomaly in the F₂ layer—E. V. Appleton and W. R. Piggott. (*Jour. Atmos. Terr. Phys.*, vol. 3, pp. 121-123; Feb. 1953.) Graphs are shown of (a) hourly values of the ratio of critical frequency on magnetically disturbed days to that on quiet days for Wakkanai during the winter, (b) hourly values of the ratio of critical frequency at Ottawa to that at Wakkanai during the winter. The shape of the graphs is similar, indicating that the geomagnetic distortion anomaly in the F₂ layer is such that it causes a minimum of critical frequency in the forenoon and a maximum in the afternoon. For Huancayo the principal anomaly is the abnormal maintenance of high fF₂ values after sunset.

551.510.535:551.55 2311

Travelling Disturbances in the Ionosphere: Diurnal Variation of Direction—G. H. Munro. (*Nature (London)*, vol. 171, pp. 693-694; April 18, 1953.) Since the publication of previous papers (2504 of 1950) observations of greater accuracy and extending over a greater part of the day have provided definite evidence of diurnal variation in the direction of horizontal movement. This is most marked in the month of June. A graph is given which shows the mean values of all directions observed for each hourly interval for all days of June in 1950, 1951 and 1952. A similar trend is noted in all three years, the direction of movement

changing from about 50° (E of N) at 0930 to 15° at 1430. Recent night observations suggest that there is consistently an E-W component of movement at night, in contrast with the consistent W-E component in the daytime.

551.510.535:551.55 2312

Moving Clouds of Ionisation in Region E of the Ionosphere—J. W. Findlay. (*Jour. Atmos. Terr. Phys.*, vol. 3, pp. 73-78; Feb. 1953.) During investigations of the phase path of 2.4-mc radio waves returned from the E layer (397 of 1952) some 110 echoes were observed which came from equivalent heights rather less than that of the E layer. Analysis supports the interpretation that the echoes came from ionization clouds moving with constant velocity in a horizontal direction. Histograms show that the velocities ranged between 20 and 150 m/s, that the most probable duration was 4-5 min and the most probable height 95-110 km. Echoes can apparently be detected only from clouds lying within a cone of semi-angle 6° from the observing point, the average horizontal dimension of the clouds being about 700 m.

551.510.535:551.55 2313

The Heights of Ionospheric Winds as measured at Long Radio Wavelengths—R. E. Jones, G. H. Millman and R. J. Nertney. (*Jour. Atmos. Terr. Phys.*, vol. 3, pp. 79-91; Feb. 1953.) The winds region is considered as constituting a "screen" capable of altering the phase and amplitude of a radio wave passing through it. The field pattern at the ground is assumed to be such that information on the phase change and absorption experienced by a wave passing through the "screen" can be obtained from it. It is also assumed that only the ordinary wave is observed, and that the region concerned is of the W.K.B. type. With these assumptions, theory is developed which, when applied to experimental data for 150-kc signals, gives the winds-region height as 74-77 km during the day and 83-100 km at night.

551.510.535:551.594.13:550.38 2314

Conductivity of the Ionosphere and Geomagnetic Tides—I. Lucas. (*Naturwissenschaften*, vol. 40, p. 239; April 1953.) The results of various investigations are summarized and discussed, with particular reference to effects observed near the geomagnetic equator.

551.510.535:621.396.812 2315

The Investigation of Ionospheric Absorption by a New Automatic Method: Part 2—Measurements on Oblique-Incidence Broadcast Signals—J. B. Jenkins. (*Elec. Eng.*, vol. 25, pp. 189-190; May 1953.) Apparatus similar to that described in Part 1 (1680 of June) is used for recording the strength of a signal received from a distant transmitter by reflection from the ionosphere. Comparison of the vertical-incidence records with simultaneously obtained oblique-incidence records is expected to facilitate the investigation of winds in the ionosphere.

551.578.1/.4:621.396.9 2316

Scattering and Attenuation by Non-spherical Atmospheric Particles—D. Atlas, M. Kerker and W. Hiltscfeld. (*Jour. Atmos. Terr. Phys.*, vol. 3, pp. 108-119; Feb. 1953.) Gans' theory of EM scattering and absorption by ellipsoids is applied to atmospheric particles. If these have preferred orientations, the amount of back-scattered energy depends on particle shape and on orientation of the particle relative to the incident beam. The effect is negligible in the case of snow. If the particles have random orientations, the observed scattering is independent of antenna orientation, but greater for ellipsoidal shape and for water particles than for ice. These theoretical considerations account well for known "melting-band" phenomena.

551.594.6:621.396.11 2317

Multiple Bursts of Signal in Long-Distance

Very-High-Frequency Propagation—Isted. (Sec 2419.)

LOCATION AND AIDS TO NAVIGATION

621.396.9:551.578.1/4 2318

Scattering and Attenuation by Non-spherical Atmospheric Particles—Atlas, Kerker and Hirschfeld. (Sec 2314.)

621.396.9:621.385.832 2319

A Quality Factor for Radar Cathode-Ray-Tube Presentation—A. F. Bischoff. (*Proc. NEC (Chicago)*, vol. 8, pp. 387–394; 1952.) A formula universally applicable to radar systems is derived which can be used to calculate a quality factor for the cr-tube display of a radar system. The quality factor expresses the effective brightness of the display in foot-lamberts. By converting to contrast ratio and referring to a family of empirical curves, perception time can be determined as a function of contrast ratio and cr-tube presentation size. Measurements on several modern radar equipments confirmed the value of this method of assessing their relative merits as regards display characteristics.

621.396.93:551.510.535 2320

A Problem of Radio Direction-Finding: Ionospheric Anisotropy—G. Elghozi. (*Ann. Télécommun.*, vol. 8, pp. 78–92; March 1953.) The theories of Booker (714 of 1950) and Al'pert (1032 of 1948) on the magneto-ionic effect are outlined and their formulas for the resulting lateral deviation of EM waves are compared. The methods of calculation involved are equivalent; if the results obtained are not the same, this may be due to differences between the values of the parameters occurring in the formula. These parameters include frequency, distance, azimuth of the initial plane of the wave, inclination of the geomagnetic field, value of the MUF. Their number precludes individual analysis. Several simple cases are, however, treated by Booker's method; the order of magnitude of the lateral deviations to be expected is determined and the conditions are found which the parameters must satisfy for the deviations to be appreciable.

621.396.932/.933 2321

Continuous-Indicating Loran—R. B. Williams, Jr. (*Proc. NEC (Chicago)*, vol. 8, pp. 365–375; 1952.) A description is given of a system in which the match of MF loran pulses in amplitude and in time difference, manually set up, is maintained over a very wide range of signal amplitudes. Each loran receiver of this modified type displays continuously a time-difference reading corresponding to a loran line of position, so that two such units determine the two lines of position necessary for a continuous navigational fix. Field tests have proved the system to be especially advantageous for use in aircraft.

621.396.932/.933].2 2322

Phase and Gain Stabilization in Matched-Channel Receivers—T. R. O'Meara and H. D. Webb. (*Proc. NEC (Chicago)*, vol. 8, pp. 376–386; 1952.) Factors leading to mismatch of gain and phase characteristics are discussed. Careful matching of components, use of low-impedance selective circuits, use of fixed-tuned amplifiers wherever feasible, and use of automatic phase-matching are recommended. (See also, Webb, 999 of 1952.)

MATERIALS AND SUBSIDIARY TECHNIQUES

533.5 2323

Gettering Process of Barium: Sorption Properties of Oxygen to Barium—T. Arizumi and S. Kotani. (*Jour. Phys. Soc. (Japan)*, vol. 7, pp. 300–307; May/June, 1952.)

535.215:546.431-31 2324

External Photoelectric Emission of Barium Oxide—K. Noga and S. Kawamura. (*Jour. Phys. Soc. (Japan)*, vol. 7, pp. 287–291;

May/June 1952.) Measurements were made of the photoelectric emission from sprayed coatings of BaO on Ni over a range of temperatures. The results are discussed in terms of energy levels.

535.37 2325

Interaction of Manganese Activator Ions in Zinc-Orthosilicate Phosphors—S. Larach and J. Turkevich. (*Phys. Rev.*, vol. 89, pp. 1060–1065; March 1, 1953.)

537.226 2326

Ferroelectricity in Oxides of Face-Centred Cubic Structure—W. R. Cook, Jr. and H. Jaffe. (*Phys. Rev.*, vol. 89, pp. 1297–1298; March 15, 1953.) A fluorite structure was previously (1374 of May) ascribed to $Cd_2Nb_2O_7$ and $Pb_2Nb_2O_7$. It is now confirmed that the structure of $Cd_2Nb_2O_7$ is face-centered cubic, with dimensions double those of the fluorite structure. A strictly cubic pattern of unit cell has been found for a lead niobate deficient in lead.

537.226 2327

Variational Methods for Periodic Lattices and Artificial Dielectrics—C. Flammer. (*Phys. Rev.*, vol. 89, p. 1298; March 15, 1953.)

537.226:621.3.029.64 2328

Wave-guide Measurements in the Microwave Region on Metal Powders Suspended in Paraffin Wax—J. M. Kelly, J. O. Stenoien and D. E. Isbell. (*Jour. Appl. Phys.*, vol. 24, pp. 258–262; March 1953.) Artificial dielectrics have been produced with refractive indices as high as 7.2 at a frequency of 9,364 mc, by embedding tiny flakes of conducting material in paraffin wax. When good conductors such as Cu and Al are used, the permeability is complex and the permittivity substantially real. The observed results are in agreement with the theoretical results of Lewin (2139 of 1947). To obtain low loss and high refractive index with powdered conductors, the particles must be very small and highly polarizable.

537.311.32 2329

The Electrical Conductivity of MgO Single Crystals at High Temperatures—A. Lempicki. (*Proc. Phys. Soc.*, vol. 66, pp. 281–283; April 1, 1953.) Measurements were made over the temperature range 300°–1500°K; the results are shown graphically. The energy gap between the full and conduction bands is found to be 4.6 eV, assuming that the conduction is electronic and intrinsic.

537.311.33 2330

Preliminary Data on the Relations between Lattice Defects and Debye R.F. Absorption in Iron Oxides—R. Freymann. (*Jour. Phys. Radium*, vol. 14, pp. 130–131; Feb. 1953.) At temperatures in the range 100°–273°K and frequency 1 mc, Fe_3O_4 - Fe_2O_3 mixtures are characterized by low absorption, FeO - Fe_3O_4 mixtures by high absorption.

537.311.33:537.312.8 2331

Theory of the Magneto-resistive Effect in Semiconductors—V. A. Johnson and W. J. Whitesell. (*Phys. Rev.*, vol. 89, pp. 941–947; March 1, 1953.) Calculation shows that when account is taken of the scattering of conduction electrons by impurity ions as well as by the lattice, the discrepancy between theoretical and experimental values of the magneto-resistive effect is increased. The calculated magnetic-field effects are very much greater for an intrinsic semiconductor than for an impurity semiconductor. The fractional changes in resistivity and Hall coefficient are calculated, for several different values of the electron/hole mobility ratio, as functions of a parameter involving magnetic field strength and temperature. Experimental values of the magnetic-field effect in intrinsic semiconductors at high temperatures are not available for comparison.

537.311.33:546.289 2332

Microwave Observation of the Collision

Frequency of Electrons in Germanium—T. S. Benedict and W. Shockley. (*Phys. Rev.*, vol. 89, pp. 1152–1153; March 1, 1953.) Measurements were made of the attenuation and phase shift resulting from the introduction of a sample of Ge into the rectangular waveguide of a 1.24-cm microwave bridge. From the results obtained on two samples, of different resistivities, the effective mass and relaxation time caused by collisions of the conduction electrons are found to be about 0.6 times the free-electron mass and $6.6 \times 10^{-15} T^{-1.5}$ seconds respectively, T being the absolute temperature.

537.311.33:546.289 2333

Radiative Transitions in Germanium—J. B. Gunn. (*Proc. Phys. Soc.*, vol. 66, pp. 330–331; April 1, 1953.) Experiments are described which demonstrate the occurrence of radiation due to recombination of injected minority carriers. Two similar n-type Ge filaments were used, one as radiation source and the other as photoconductive detector. Holes were injected into the source filament in pulses and were drawn along the filament by means of an applied field. On reversing the direction of this drift current, the detector output signal disappeared.

537.311.33:546.289 2334

The Temperature Dependence of Drift Mobility in Germanium—R. Lawrance. (*Phys. Rev.*, vol. 89, p. 1295; March 15, 1953.) The method previously described by Lawrance and Gibson (1379 of May) was used to measure the drift mobility of holes in single-crystal n-type Ge in the temperature range 100°–360°K. The method involves the use of a direct emitter voltage and a pulsed sweeping field. With decreasing temperature the drift mobility increases at first and then decreases rapidly when trapping occurs. The traps are apparently on the surface and may be completely filled and made ineffective by illuminating the specimen with light from a tungsten-filament lamp. The temperature variation of drift mobility is proportional to $T^{-2.3}$.

537.311.33:546.289:536.49 2335

Properties of Thermally Treated Germanium—L. Esaki. (*Phys. Rev.*, vol. 89, pp. 1026–1034; March 1, 1953.) A detailed account is given of investigations of the changes of the rectification characteristic, the resistivity, and the Hall coefficient of n-type single-crystal Ge samples subjected to various heat treatments.

537.311.33:621.396.822 2336

Contact Noise in Semiconductors—R. E. Burgess. (*Proc. Phys. Soc.*, vol. 66, pp. 334–335; April 1, 1953.) The result obtained by Macfarlane (910 of 1951) for the noise due to surface diffusion of ions into and out of strip-shaped patches is expressed in a simple closed form. For a circular patch the formula can also be expressed in closed form, on correction of an error in the original; but the noise-spectrum function then found differs from the approximate inverse-frequency form previously found.

537.32 2337

Thermoelectric Power for Very Small Differences of Temperature—J. Savornin and F. Savornin. (*Compt. Rend. Acad. Sci. (Paris)*, vol. 236, pp. 898–900; March 1, 1953.) Measurements of the thermoelectric power dE/dT of a sample of p-type Si at temperatures near 15°C, with progressively smaller values of dT , show that the values obtained are constant, even when dT is as low as 0.01°. This result differs from that of Sato for a semiconducting Bi-Sn alloy, for which dE/dT for a temperature difference of 0.5° was only 75% of the value for a difference of 3°.

537.533.8 2338

The Origin of Secondary-Emission Electrons—A. Lempicki. (*Proc. Phys. Soc.*, vol. 66, pp. 278–280; April 1, 1953.) Experiments were

made to determine the energy necessary to liberate secondary electrons, using a tube with a multiplier electrode coated with a mixture of BaO and MgO. The results indicate that the secondary electrons originate from the valence band and not from impurity centers.

538.221 2339

The Approach to Saturation in Dilute Ferro magnetics—A. D. Franklin and A. E. Berkowitz. (*Phys. Rev.*, vol. 89, p. 1171; March 15, 1953.) For mixtures containing more than about 60% of 2- μ iron powder, Néel's theory was found valid. With decrease of iron content below 60% the deviation from theory indicates that some other factor controls the approach to saturation.

538.221 2340

An Interpretation of the Magnetic Properties of some Iron-Oxide Powders: Part 2—W. P. Osmond. (*Proc. Phys. Soc.*, vol. 66, pp. 265-272; April 1, 1953.) The interpretation previously offered (2528 of 1952) is revised to take account of the probable cavities in the powder particles caused by loss of oxygen during the various transformations. Good quantitative agreement is found between theoretical and measured values of coercivity, the value depending only on shape anisotropy.

538.221 2341

Influence of the Magnetic Field on a Polymorphic Transformation in a Ferromagnetic Material—A. J. P. Meyer and P. Taglang. (*Jour. Phys. Radium*, vol. 14, pp. 82-84; Feb. 1953.)

538.221 2342

Quantum Theory of a Recently Suggested Cause of Ferromagnetism—G. Heber. (*Ann. Phys. (Lpz.)*, vol. 11, pp. 48-50; Oct. 10, 1952.) A discussion of the mechanism of interaction between the 4s and 3d electrons in ferromagnetic materials. (See also, Zecher, 2441 of 1951.)

538.221 2343

The Influence of Grain Size on Coercive Force—A. Mager. (*Ann. Phys. (Lpz.)*, vol. 11, pp. 15-16; Oct. 10, 1952.) A brief discussion based on a highly simplified model of the domain structure.

538.221:621.318.2 2344

The Preferred Direction in a Magnetically Hardened Permanent-Magnet Alloy—M. McCaig. (*Jour. Appl. Phys.*, vol. 24, p. 366; March, 1953.) Measurements are reported on columnar disks of alcomax III cut so that the columnar axis is along the diameter. In all cases the direction of easy magnetization lies between the hardening direction and the columnar axis.

538.222:[546.732-31 + 546.712-31] 2345

The Antiferromagnetic Properties of Mixed Cobalt and Manganese Oxides—G. E. Bacon, R. Street and R. H. Tredgold. (*Proc. Roy. Soc. A.*, vol. 217, pp. 252-261; April, 1953.)

538.652:538.221 2346

Magnetostriction in Alnico V—J. R. Ireland. (*Electronics*, vol. 26, pp. 234, 236; May, 1953.) The best magnetostrictive properties are obtained in alnico-5 by heat treatment followed by cooling at a controlled rate without application of a magnetic field. Subsequent drawing gives a slightly higher coercive force but reduces the magnetostrictive properties somewhat.

538.652:669.15.24-192 2347

Magnetic Crystal Anisotropy and Magnetostriction of Iron-Nickel Alloys—R. M. Bozorth and J. G. Walker. (*Phys. Rev.*, vol. 89, pp. 624-628; Feb. 1, 1953.) Measurements on a number of Fe-Ni alloys show that the cooling rate after annealing has a large effect on the anisotropy for alloys with compositions near FeNi₂, where atomic ordering occurs. There is a smaller effect on the magnetostriction. The

composition for highest initial and maximum permeabilities is nearly that for which the magnetostriction in the direction of easy magnetization is zero.

539.23 2348

Metallizing of Glass, Ceramic and Plastics Surfaces—R. J. Heritage and J. R. Balmer. (*Metallurgia (Manchester)*, vol. 47, pp. 171-174; April 1953.) Three techniques for depositing metal films are discussed, namely, reduction from aqueous solutions, reduction by heat and evaporation in a vacuum. Where necessary, the films can be subsequently thickened by electroplating. Various applications are indicated.

539.23:546.623-31 2349

Ionic Current and Film Growth of Thin Oxide Layers on Aluminum—A. Charlesby. (*Proc. Phys. Soc.*, vol. 66, pp. 317-329; April 1, 1953.)

546.289 2350

Elasticity and Thermal Expansion of Germanium between -195 and 275°C—M. E. Fine. (*Jour. Appl. Phys.*, vol. 24, pp. 338-340; March 1953.) The resonance frequencies of longitudinal and torsional vibrations in single-crystal Ge rods were measured. From these results and those of thermal-expansion measurements the Young's modulus and shear modulus were determined.

549.514.51 2351

Internal Friction of Quartz—G. A. Alers. (*Jour. Appl. Phys.*, vol. 24, pp. 324-331; March 1953.) The internal friction of quartz was investigated over the temperature range 200°-440°C by measuring the logarithmic decrement of a bar vibrating at its fundamental resonance frequency of 21 kc and at its second harmonic. The logarithmic-decrement/temperature curve obtained can be considered as a combination of two peaked curves, corresponding to relaxation effects and an exponential curve.

621.314.634 2352

Electron Multiplication in Hard Flows of Selenium Rectifiers—M. Tomura and Y. Abiko. (*Jour. Phys. Soc. (Japan)*, vol. 7, pp. 220-221; March/April 1952.)

621.315.61 2353

Properties of Insulating Materials—(*Elec. Times*, vol. 123, pp. 582-585; March 26, 1953.) Brief report, with list of papers, of the IEE Symposium. Recent work on solid and liquid insulants and researches on newly developed plastics were described.

621.315.61 2354

Silicone Resins in Insulation at Power Frequencies—W. J. Renwick and J. R. Reed. (*Engineer (London)*, vol. 195, pp. 471-473; March 27, 1953.) Shortened version of paper presented at the IEE Symposium on Insulating Materials. Tests indicate that these materials are satisfactory at working temperatures at least 50°C higher than those permissible for conventional insulants.

621.315.61 2355

The Newer Laminated Plastic Insulating Materials—A. N. Hawthorn and S. W. Mesent. (*Engineer (London)*, vol. 195, pp. 436-437; March 20, 1953.) Shortened version of paper presented at the IEE Symposium on Insulating Materials. Measurements are reported of the properties of various laminated plastics. Effects of prolonged exposure to high temperature and high humidity are investigated.

621.315.611.017.143 2356

A New Method of Representing the Dielectric Losses in a Solid Insulating Material—H. Bonifas. (*Rev. Gén. Elec.*, vol. 62, pp. 129-136; March 1953.) A satisfactory representation of the losses in the dielectric of a capacitor

is obtained by means of a resistor in series with the capacitor, with a second resistor in parallel with the combination. The loss factor of the capacitor is defined in terms of the two resistors; the corresponding vector diagrams are shown. The relative amounts of power dissipated in the two resistors are discussed and the optimum utilization of dielectric losses for dielectric heating is considered, with particular reference to the heating of a vitrifiable mixture and the gluing of wood.

621.318.4.042.15 2357

Moisture Aging of Powder-Core Toroids—E. J. Oelbermann, R. E. Skipper and W. J. Leiss. (*Electronics*, vol. 26, pp. 236, 242; May 1953.) Test results indicate that absorption of moisture into the powder core of certain toroids decreases the inductance, which recovers again on removal of the moisture by vacuum drying. Hermetic sealing is recommended.

666.1.037.5 + 621.3.032.52/53 2358

Hermetic Seals—R. O. McIntosh. (*Elec. Mfg.*, vol. 49, pp. 120-123, 334; April 1952.) Various types of seal, including glass-to-metal seals, are illustrated and discussed with special reference to their advantages and limitations.

669.245:621.385 2359

The Use of Nickel in Valves—K. Jackson and R. O. Jenkins. (*Elec. Eng.*, vol. 25, pp. 208-211; May 1953.) The general requirements for metals used in tube construction are discussed; Ni or a Ni alloy is found to satisfy these requirements in nearly all cases. The special requirements for use in cathodes, anodes, and grid and support wires are examined. Properties of Ni alloys used in tube components are listed.

535.215 2360

Photoconductivity in the Elements—T. S. Moss. (Book review.) Publishers: Butterworths Scientific Publications, 249 pp., 50s; 1952. (*Elec. Eng.*, vol. 25, p. 222; May 1953.) Results of theoretical and experimental research on photoconductivity are surveyed and the results of the author's own investigations on a particular group of elements are presented.

621.315.6 + 537.311.33 + 538.221 2361

Radio Research Special Report No. 25. Selected Problems in the Preparation, Properties and Application of Materials for Radio Purposes—[Book Notice.] Publishers: H. M. Stationery Office, London, 1952. (*Govt. Publ. (London)*, p. 25; March, 1953.)

MATHEMATICS

517.544.2 + 517.2 + 517.511(083.6) 2362

Tables of Green's Functions, Fourier Series, and Impulse Functions for Rectangular Co-ordinate Systems—J. J. Smith. (*Trans. Amer. IEE*, vol. 70, pp. 22-30; 1951.) Tables based on a previous paper (1025 of 1945) are given which materially reduce the work of solving partial differential equations encountered in problems of engineering and physics.

517.93 2363

Stability Investigation of the Nonlinear Periodic Oscillations—C. Hayashi. (*Jour. Appl. Phys.*, vol. 24, pp. 344-348; March 1953.)

519.242 2364

Interpolation in a Series of Correlated Observations—E. J. Williams and N. H. Kloot. (*Aust. Jour. Appl. Sci.*, vol. 4, pp. 1-17; March 1953.) Least-squares formulas are given for estimating the values of unmeasured members of a series from measurements of the alternate members; the series considered corresponds to a stationary random process, possibly with a linear trend. The applicability of three simple formulas, appropriate under different limiting conditions, is discussed; results obtained by applying different

estimation formulas to experimental data are compared.

681.142 **2365**
Fundamental Characteristics of Digital and Analog Units—J. M. Salzer. (*Proc. NEC (Chicago)*, vol. 8, pp. 621-628; 1952.)

681.142 **2366**
A Different Approach to Analog Computation—C. R. Bonnell. (*Proc. NEC (Chicago)*, vol. 8, pp. 629-635; 1952.) Theory and description of computers based on the balancing of torques applied to a shaft, the torques representing various parameters. (For a shorter account, see *Radio & Telev. News*, vol. 49, pp. 14-15, 31; May 1953.)

681.142 **2367**
Interconversion of Analog and Digital Data in Systems for Measurement and Control—B. Lippel. (*Proc. NEC (Chicago)*, vol. 8, pp. 636-646; 1952.)

681.142 **2368**
A Five-Channel Electronic Analog Correlator—M. J. Levin and J. F. Reintjes. (*Proc. NEC (Chicago)*, vol. 8, pp. 647-656; 1952.)

681.142 **2369**
A Diode-Bridge Limiter for Use with Electronic Analogue Computers—R. J. Medkoff and R. J. Parent. (*Trans. Amer. IEE*, vol. 70, pp. 913-916; 1951.) Description of a simple limiter, developed from the basic diode-bridge circuit, which provides an absolute limit and can be adjusted by means of a single control.

681.142 **2370**
A New Digital Computer—(*Elec. Eng.*, vol. 25, p. 201; May 1953.) Brief description of the "401" computer, built on the sub-unit principle.

681.142 **2371**
An Electronic Statistical Tabulator—R. M. Stewart, Jr. and A. R. Kassander, Jr. (*Proc. NEC (Chicago)*, vol. 8, pp. 657-667; 1952.)

681.142 **2372**
High-Speed Number Generator uses Magnetic Memory Matrices—An Wang. (*Electronics*, vol. 26, pp. 200, 204; May 1953.) Description of equipment for displaying numbers on the screen of a cr tube.

681.142 **2373**
The Input-Output System of the EDVAC—R. L. Snyder, Jr. (*Trans. Amer. IEE*, vol. 70, pp. 507-509; 1951.)

681.142:517.93 **2374**
Analog Computer Elements for Solving Nonlinear Differential Equations—C. A. Ludeke and C. L. Morrison. (*Jour. Appl. Phys.*, vol. 24, pp. 243-248; March 1953.)

681.142:621.314.7 **2375**
A Transistor Optical Position Encoder and Digit Register—H. G. Follingstad, J. N. Shive and R. E. Yaeger. (*Proc. NEC (Chicago)*, vol. 8, pp. 766-775; 1952.) (See 766 of March.)

681.142:621.318.57 **2376**
A Method of Gating for Parallel Computers—A. G. Ratz and V. G. Smith. (*Trans. Amer. IEE*, vol. 70, pp. 510-516; 1951.)

681.142:621.395.6 **2377**
Circuitry "Packages" for Electronic Computers—(See 2263.)

MEASUREMENTS AND TEST GEAR

621.3.018.41(083.74) **2378**
Developments in Frequency Synthesis—H. J. Finden. (*Elec. Eng.*, vol. 25, pp. 178-183; May 1953.) Extension of work noted in 2251 of 1944 and 1961 of 1950. Accurate frequencies in the range 1 kc-100 mc are obtained by combining in a mixer system the harmonics of a decade system of frequencies derived by division and multiplication from an internal

or external 100-kc frequency standard. The harmonics are selected in relation to the frequency to be synthesized so that unwanted mixer products can be filtered out.

621.3.018.41.029.426:621.3.087 **2379**
An Automatically Calibrated Electronic Frequency Recorder—W. E. Phillips. (*Proc. NEC (Chicago)*, vol. 8, pp. 781-786; 1952.) Description of equipment particularly suitable for industrial applications requiring maintenance of stable speeds over long periods. A pulsating voltage, either ac or dc, is developed by any convenient means and used to generate a succession of uniform positive voltage pulses whose average value, applied to a capacitor, is a measure of the original speed and is recorded on a Speedomax recorder whose calibration is checked automatically every 45 minutes. The frequency range covered is 10-130 cps.

621.3.087.6:[621-526:621.396.615 **2380**
A Servo System for Heterodyne Oscillators—T. Slonczewski. (*Trans. Amer. IEE*, vol. 70, pp. 1070-1072; 1951.) (Full paper—see 720 of 1952.)

621.3.087.6:621.3.015.7 **2381**
Test Set for Recording Impulses—L. J. Nijs. (*Elec. Commun.*, vol. 30, pp. 9-11; March 1953.) Description of portable equipment producing a record on waxed paper tape of two independent impulse inputs and a timing trace. A timing precision to within 2 ms is obtained, neglecting errors due to supply frequency deviations.

621.317.335:621.315.61 **2382**
On the New Method of Measuring Dielectric Constant and Loss Angles of Semiconductors—B. Ichijo. (*Jour. Appl. Phys.*, vol. 24, pp. 307-311; March 1953.) A description is given of the "double-resonant-circuit" method, which is useful for investigating poor insulators such as wood or textile containing much moisture. Measurement results are discussed.

621.317.335.3+621.317.41].029.64 **2383**
A Method of Measuring Dielectric Constant and Complex Permeability at Ultra-high Frequencies—A. Surduts. (*Compt. Rend. Acad. Sci. (Paris)*, vol. 236, pp. 900-902; March 2, 1953.) Detailed theory, with derivation of the formulas necessary for numerical calculation, is presented for a method in which the material to be tested completely fills a short portion of a waveguide matched to an UHF source. For measurements of the dielectric constant, the method is similar to that of Roberts and von Hippel (178 of 1947), the waveguide being short-circuited behind the material. For the permeability measurement, a matched section with the same characteristic impedance as that of the waveguide in front of the material, is used behind the material, an absorbing cone eliminating the reflected wave.

621.317.335.3:621.395.611.4 **2384**
Determination of the Dielectric Constants of Optically Uniaxial Crystals from the Spectrum of Natural Oscillations of Circular-Cylinder Cavity Resonators—E. Hafner. (*Arch. elekt. Übertragung*, vol. 7, pp. 181-190; April 1953.) An examination is made of the field pattern inside a resonator containing a disk of the crystal and the equations for the natural electric and magnetic modes (1623 of June) are discussed. Various methods are indicated for determining the two principal dielectric constants of the crystal from the geometry of the system when the particular mode of oscillation is known.

621.317.351:621.3.018.78 **2385**
Diagnosis of Distortion. The "Difference Diagram" and its Interpretation—E. R. Wigan. (*Wireless World*, vol. 59, pp. 261-266; June 1953.) The distorted output signal from equipment under test is passed through a network which subtracts the fundamental wave and

leaves only the distortion terms plus any hum or other circuit noise. This, after amplification, is applied to the y plates of a CRO. By suitable adjustment of the phase of the signal applied to the x plates, a curved line trace is obtained which is a representation of the circuit transfer characteristic with all its defects much magnified. By comparing this "difference diagram" with certain standard shapes, examples of which are given, the various sources of distortion in particular circuits can be recognized and corrective measures applied. Typical oscillograms are reproduced.

621.317.365 **2386**
Measuring Wavelength in Millimeters—J. R. Martin and C. F. Schunemann. (*Electronics*, vol. 26, pp. 184-187; May 1953.) Wavelength measurements were made on klystron and magnetron sources and on a Rigbi doublet of length 1 cm. Three methods were used: (a) diffraction-grating spectrometer; (b) Boltzmann interferometer; (c) Michelson interferometer. Details of the various components of the equipment used are described and measurement results are tabulated, with estimates of probable errors. The Michelson interferometer results are the most consistent and this system appears to be the most convenient of the three systems used. It can easily be extended to much shorter wavelengths than those now reported, which were of the order of 1.25 or 3 cm.

621.317.7:621.314.7:621.396.822 **2387**
Noise Analyzer for Transistor Production—R. F. Merrithew. (*Electronics*, vol. 26, pp. 136-137; May 1953.) Description, with full circuit details, of an instrument designed to measure transistor noise figures at a frequency of 1 kc and 1 cps bandwidth. Calibrated attenuators give the required noise figure directly.

621.317.7.029.64 **2388**
An Ultrahigh-Frequency Discriminator—G. Raoult and R. Fanguin. (*Compt. Rend. Acad. Sci. (Paris)*, vol. 236, pp. 1143-1145; March 16, 1953.) Description of frequency-stabilized equipment for measurements at 3-cm wavelength, based on well-known FM techniques. An error voltage is derived by means of a suitably coupled cavity resonator, magic-T junction and wide-band directional coupler and, after amplification, is applied to the klystron reflector.

621.317.715:537.324 **2389**
The Problem of Matching a Thermocouple to a Galvanometer—L. Geiling. (*Ann. Télécommun.*, vol. 8, pp. 103-112; March 1953.) Factors limiting the sensitivity of the combination of a thermocouple and galvanometer are discussed. A projected instrument is described, termed a thermogalvanometer, which may have advantages over the thermocouple-galvanometer combination.

621.317.715.5 **2390**
A Transformer-Coupled Resonance Galvanometer—H. G. Möller. (*Elektrotech. Z.*, vol. 74, pp. 150-151; March 1, 1953.) Description of a vibration galvanometer with bifilar-suspended coil, suitable for use with an ac bridge. The suspension can be adjusted to give high sensitivity at an appropriate frequency.

621.317.72.088.2 **2391**
Influence of the Ground on the Calibration and Use of V.H.F. Field-Intensity Meters—F. M. Greene. (*Proc. IRE (Australia)*, vol. 14, pp. 58-64; March 1953.) (Reprint—see 2284 of 1950.)

621.317.73:621.396.611.21 **2392**
Crystal Impedance Meters replace Test Sets—A. C. Prichard and M. Bernstein. (*Electronics*, vol. 26, pp. 176-180; May 1953.) Two impedance meters for testing crystal units have been developed in the U. S. Signal Corps engineering laboratories: (a) Type TS-537/TSM, covering the frequency range 75 kc-1.1 mc; (b) Type TS-330/TSM, covering the

range 1–15 mc. Each instrument can be used to test crystal units at resonance or at anti-resonance over a range of load capacitance from 12 μF to 120 μF . A projected test set, Type TS-68.3/TSM, is primarily intended for resonance measurements in the range 10–75 mc. A circuit diagram is given for the 1–15 mc instrument. The impedance meter is essentially a tuned-grid tuned-anode oscillator in which the crystal unit to be tested is connected in the main feedback path, so that it controls the oscillation frequency and amplitude. The crystal-unit parameters are determined by a substitution method, a resistor replacing the crystal unit and being adjusted so that the oscillation frequency and amplitude are the same when either the crystal unit or the resistor is in circuit. The other parameters of the crystal unit are then determined from formulas which are given in an appendix.

621.317.733.018.12 2393

Phase Bridge for Measurement and Display of Phase Distortions in Television Apparatus (Phasograph)—H. Fegert. (*Nachr. Tech.*, vol. 3, pp. 111–115; March 1953.) Design requirements for a universal, fully automatic phase bridge suitable for measurements on filters, amplifiers, cables, or quadrupoles of any kind, are discussed. A description is given of equipment of this type, with illustrations of its use for measuring the delay of a 2-stage band-pass filter.

621.317.735:621.315.21 2394

A New Cable-Fault Indicator—M. B. Williams and D. Brookes. (*P.O. Elec. Eng. Jour.*, vol. 46, pp. 13–18; April 1953.) Description of equipment which gives an alarm signal when the insulation resistance falls below a prescribed value.

621.317.742.029.64:621.315.212 2395

U.H.F. Cable Measuring Equipment—W. W. H. Clarke, J. L. Goldberg and J. D. S. Hincliffe. (*A.T.E. J.*, vol. 9, pp. 100–108; April 1953.) Description, with photographs, of equipment using a slotted coaxial-line unit, with tapered matching units, for the impedance measurements required for determination of coaxial-cable irregularities.

621.317.784:621.316.313 2396

A Thermocouple Audio-Frequency Wattmeter—J. D. Ryder and M. S. McVay. (*Proc. NEC (Chicago)*, vol. 8, pp. 725–729; 1952.) Theory and description of an instrument using thermocouples as the squaring and averaging elements. With careful design, operation is satisfactory in the range 50 cps–15 kc. See also *Radio & Telev. News*, vol. 49, pp. 6–7, 20; February 1953.

621.396.645.35:621.317.32 2397

Operation and Properties of a New Direct-Voltage Amplifier using W. Kroebel's Crystal Contact Breaker—G. Haas. (*Z. angew. Phys.*, vol. 5, pp. 107–116; March 1953.) An amplifier is discussed in which the direct-voltage input is converted to alternating voltage by means of the contact breaker previously described [Kroebel, 787 of March], damped trains of oscillations being set up in a CL input circuit. Design for high sensitivity with high input resistance is investigated theoretically and experimentally. The construction is described of an amplifier with input resistance > 1000 M Ω , with an operating threshold three times the value of the noise voltage corresponding to the 100-M Ω internal resistance of the source.

621.397.6.001.4 2398

Television Test Equipment—L. W. Mittelmann. (*Nachr. Tech.*, vol. 3, pp. 116–120; March 1953.) A translation from *Radiotekhnika, Moscow*, No. 6, pp. 48–60; 1951. Equipment is described, with block diagrams and some schematic circuit diagrams, suitable for adjustment of the frequency characteristics of wide band amplifiers in the range 0.1–20 mc,

for alignment of television receivers in the range 6–80 mc, and for pulse testing of television receivers, using pulse rise times down to 0.05 μs .

621.397.62.001.4 2399

Measurements on Television Receivers: Part I—General Survey—O. Macek. (*Arch. Tech. Messen*, No. 205, pp. 31–42; Feb. 1953.) Receiver circuits and the 625-line and 525-line standards are reviewed as a preliminary to the discussion of appropriate receiver tests.

621.317.7 2400

Electrical Measuring Instruments: Part I—C. V. Drysdale and A. C. Jolly, revised by G. F. Tagg. (Book Review.) Publishers: Chapman & Hall, 279 pp., 75s; 1952. (*Elec. Eng.*, vol. 25, p. 221; May 1953.) (Revised edition of a standard work.)

OTHER APPLICATIONS OF RADIO & ELECTRONICS

531.768:546.431.824.31 2401

A Ceramic Vibration Pick-Up—E. V. Carlson. (*Proc. NEC (Chicago)*, vol. 8, pp. 94–98; 1952.) *Radio & Telev. News*, vol. 49, pp. 8–9, 27; May 1953. The advantages resulting from the use of polarized multicrystal BaTiO₃ ceramic instead of Rochelle salt in vibration pickups are discussed. The construction of a BaTiO₃ unit is described and a practical reciprocity method of calibration, using three of the units, is illustrated by a numerical example.

534.1.08 2402

Vibration Measurements—D. S. Gordon and R. Winslade. (*Elec. Eng.*, vol. 25, pp. 216–217; May 1953.) Comment on 790 of March and author's reply.

534.321.9:623.896 2403

An Acoustic Liquid-Depth Recorder—C. E. Goodell. (*Proc. NEC (Chicago)*, vol. 8, pp. 776–780; 1952.) (See 1447 of May.)

534.321.9:659 2404

Some Metallurgical Applications of Ultrasonics—A. E. Crawford. (*Metallurgia (Manchester)*, vol. 47, pp. 109–113; March 1953.) The design of suitable generators is discussed and various applications, particularly in the foundry, are indicated.

548.0:537.228.1].001.8 2405

Piezoelectric Crystals as Sensing Elements of Pressure, Temperature, and Humidity—E. A. Roberts and P. Goldsmith. (*Trans. Amer. IEE*, vol. 70, pp. 968–972; 1951. (Full paper—see 1058 of 1952.)

621.317.033.7 2406

Pulse-Time Modulation Telemetering Systems for Rocket Application—J. T. Mengel. (*Trans. Amer. IEE*, vol. 70, pp. 599–605; 1951.) Design and operational data are presented for a 23-channel telemetry system with a peak pulse power of 1 kW, and for an improved 30-channel system with 4-kW peak pulse power.

621.384.6 2407

Elimination of the Effects of Faulty Alignment in the Strong-Focusing Cosmotron [proton synchrotron]—J. Seiden. (*Compt. Rend. Acad. Sci. (Paris)*, vol. 236, pp. 1145–1146; March 16, 1953.) Choice of suitable operating point will eliminate the particle loss involved in the design proposed by Courant *et al.* (1454 of May).

621.394.612 2408

A Focusing Method for Large Accelerators—T. Kitagaki. (*Phys. Rev.*, vol. 89, pp. 1161–1162; March 1, 1953.) Theory is given of a method similar to that described by Courant *et al.* (1454 of May). A system of alternate guiding magnets and focusing magnets is used, the latter of the quadrupole type and located in the linear portion of the orbit.

621.384.622.2 2409

A 3-4-MeV Linear Electron Accelerator—J. Vastel. (*Compt. Rend. Acad. Sci. (Paris)*, vol. 236, pp. 1343–1345; March 30, 1953.) Measurements are reported on a more powerful waveguide accelerator developed from the model previously described (2294 of 1952.)

621.384.622.2 2410

Dielectric Loading for Waveguide Linear Accelerators—G. T. Flesher and G. I. Cohn. (*Trans. Amer. IEE*, vol. 70, pp. 887–893; 1951.) Relations are determined between the electric accelerating field and the input power, guide dimensions, frequency and physical properties of the materials, for waveguide accelerating systems in which the loading takes the form of a coaxial dielectric cylinder, losses being taken into account.

621.385.833 2411

Electrostatic Lenses for Focusing High-Energy Particles: Calculation of Trajectories—M. Y. Bernard. (*Compt. Rend. Acad. Sci. (Paris)*, vol. 236, pp. 902–904; March 2, 1953.)

621.385.833 2412

Some Characteristics of a Low-Voltage Electron Immersion Objective—W. W. H. Clarke and L. Jacob. (*Proc. Phys. Soc.*, vol. 66, pp. 284–295; April 1, 1953.) Report on an experimental investigation of the beam characteristics for electron guns operated at voltages in the range 20–70V.

621.387.424 2413

The End Effects in Geiger Mueller Counters—R. Ito. (*Jour. Phys. Soc. (Japan)*, vol. 7, pp. 256–260; May/June 1952.)

621.395.61:621.317.083.7 2414

An Electromechanical Transducer—J. F. Engelberger and H. W. Kretsch. (*Trans. Amer. IEE*, vol. 70, pp. 213–216; 1951.) Description, with illustrations of its application, of a device suitable for converting mechanical and certain electrical quantities into corresponding electric currents, mainly for telemetry purposes. (See also Roper and Engelberger, 693 of 1948.)

PROPAGATION OF WAVES

538.566 2415

A Transient Magnetic Dipole Source in a Dissipative Medium—J. R. Wait. (*Jour. Appl. Phys.*, vol. 24, pp. 341–343; March 1953.) Formulas are derived for the electric field due to a small current-carrying loop immersed in a dissipative medium and energized by a step-function current. Approximate expressions for the magnetic-field components are also derived. The propagation of an EM pulse in sea water is discussed.

621.396.11 2416

Approximate Determination of the Range at the Earth's Surface between Radio Transmitter and Receiver Installations—O. Laaff. (*Fernmeldetechn. Z.*, vol. 6, pp. 169–171; April 1953.) A diagram is constructed which facilitates calculation of service range for the case where the received signal is a combination of the direct wave and that reflected from the earth with a reflection coefficient of -1 . A numerical example is worked out for a 5-kW television transmitter operating in the 200-mc frequency band.

621.396.11 2417

A Note on Wave Propagation through an Inhomogeneous Medium—G. A. Hufford. (*Jour. Appl. Phys.*, vol. 24, pp. 268–271; March 1953.) The problem of computing the EM field due to radiation from an antenna near the ground is considered. A modification of Kirchhoff's formula is suggested and an equation is derived from which, if certain integrals can be evaluated, an estimate can be made of the error in the usual approximate methods. The theory is applied to the equivalent

lent-earth's-radius model and to the flat-earth modified index model.

621.396.11:551.510.52 2418

Tropospheric Propagation: a Selective Guide to the Literature—(Proc. I.R.E., vol. 41, pp. 588–594; June 1953.) A paper prepared by a subcommittee of the IRE to assist radio engineers who have not specialized in tropospheric propagation but wish for information on specific problems relating thereto. 41 references.

621.396.11:551.510.535 2419

Ionosphere Conditions and Radio Weather—B. Beckmann. (*Flecktrotech. Z.*, vol. 74, pp. 125–129; March 1, 1953.) The effect of ionosphere conditions on radio propagation is related to the width of the frequency band between the lowest useful HF and the MUF, and the mean received field strength for a given path. The product of these two factors is expressed as a single number and can be represented for day-time and night-time conditions on a clock-face diagram, an increase in this number indicating an improvement in conditions. Examples are shown.

621.396.11:551.510.535 2420

The Reflection of Radio Waves from an Ionized Layer having both Vertical and Horizontal Ionization Gradients—R. P. W. Lewis. (*Proc. Phys. Soc.*, vol. 66, pp. 208–316; April 1, 1953.) Approximate transmission-path calculations are made, based on ray optics, neglecting effects due to the geomagnetic field and to ionospheric absorption, and considering only the case in which the plane of incidence contains the direction of the horizontal gradient. Two particular types of electron-density distribution are considered. The accuracy and limitations of the analysis are examined. Graphs are presented showing the dependence on angle of incidence of (a) angle of emergence, (b) increase in horizontal range due to the horizontal gradient, and (c) ratio of penetration frequencies with and without a horizontal gradient.

621.396.11:551.594.6 2421

Multiple Bursts of Signal in Long-Distance Very-High-Frequency Propagation—G. A. Issted. (*Nature (London)*, vol. 171, pp. 617–618; April 4, 1953.) Observations on 53.25-mc signals made at a distance of 330 miles from the transmitter showed, in addition to a slowly varying continuous signal, pairs of bursts having a time separation of 0.7–6 sec and trains of three or four bursts having a constant time separation. These have been found to follow a lightning flash. This suggests that the mechanism is a relatively local recurrent condition of the medium consequent upon a flash. Eckersley's whistlers (*Nature (London)*, vol. 122, p. 768; 1928) seem to be closely related phenomena.

621.396.11:621.396.67 2422

Ground-Reflection Phase-Error Characteristics of a Vertical Antenna—Greenberg and Meierdiercks. (See 2221.)

621.396.11.029.55 2423

Meteor Scatter: a Newly Discovered Means for Extended-Range Communication in the 15- and 20-Meter Bands—O. G. Villard, Jr. and A. M. Peterson. (*QST*, vol. 37, pp. 11–15, 126; April 1953.) (See Villard *et al.*, 2117 of July.)

621.396.11.029.6:551.510.535 2424

A Review of V.H.F. Ionospheric Propagation—M. G. Morgan. (Proc. I.R.E., vol. 41, pp. 582–587; June 1953.) A review, prepared by a subcommittee of the IRE, of the characteristics of ionospheric propagation which utilizes (a) regular F_2 ionization, (b) sporadic E ionization, (c) scattering from the regular ionization, (d) auroral ionization, (e) meteoric ionization. 67 references.

621.396.11.029.63 2425

An Experimental Study of Wave Propagation at 850 Mc/s—J. Epstein and D. W. Peterson. (Proc. I.R.E., vol. 41, pp. 595–611; June 1953.) A study was made of the effects of refraction, earth reflection, diffraction and attenuation on the effective range of an 850-mc transmitter. The results obtained enable a satisfactory estimate to be made of the service area of a transmitter from the theoretical free-space field strength, when diffraction effects and certain other factors based on experiment are taken into account.

621.396.812.3 2426

Statistical Analysis of Field-Strength Fluctuations in the First Fading Zone of the Swiss Broadcasting Stations since the Implementation of the Copenhagen Plan—C. Glinz. (*Tech. Mitt. schweiz. Telegr.-Teleph. Verw.*, vol. 31, pp. 106–114; April 1, 1953. In French and German.) Continuation of the work noted in 2716 of 1951, in which measurements were reported for operation at the frequencies allocated by the Lucerne Plan of 1934. For Beromünster and Sottens (frequencies changed from 556 to 529 kc and from 677 to 764 kc respectively) the new measurements show only small differences, while for Monte Ceneri (frequency changed from 1167 to 557 kc) the fading curve is completely changed and resembles that for Beromünster, thus confirming the preliminary report. Correlation with the sunspot cycle is not strong. The results cannot be clearly interpreted until night-time data for the ionosphere for medium frequencies are available.

RECEPTION

621.396.62.029.58:621.396.41:621.396.619.24

2427
Single-Sideband Multi-Channel Operation of Short-Wave Point-to-Point Radio Links: Part 3—An Independent-Sideband Short-Wave Radio Receiver—W. R. H. Lowry and W. N. Genna. (*P.O. Elec. Eng. Jour.*, vol. 46, pp. 19–24; April 1953.) The design, construction and performance are described of a receiver suitable for long-distance links operating in the range 4–30 mc, and designed for reception of the type of signal described in part 2 [Owen and Ewen, 2175 of July]. Response is uniform to within 2 db from 100 cps to 6 kc. The receiver closely approaches the limits of performance theoretically obtainable in respect of sensitivity, faithful reproduction, and freedom from avoidable interference.

621.396.621 2428

An Audio-Frequency Mixing System for Spaced Diversity Receivers—E. G. Hamer and D. W. Elson. (*Jour. Brit. IRE*, vol. 13, pp. 123–128; Feb. 1953.) The general principles of diversity reception are reviewed and a suitable method of combining the outputs of spaced receivers is described. The average noise level remains sensibly constant over the receiver band-width. If a noise sample is taken from the AF output of a receiver, at a frequency outside the speech-frequency band, the information from this sample can be used at the central station to control the output level of the satellite receiver. The combined output of all the receivers fluctuates only to a small extent. Equipment based on this principle and designed for a 3-channel mobile FM VHF service is described.

621.396.621:621.396.619.11/.13 2429

New Trends in A.M./F.M. Receiver Design—H. H. van Abbe, B. G. Dammers, J. Haantjes and A. G. W. Uitjens. (*Elec. Appl. Bull.*, vol. 12, pp. 209–229; Dec. 1951.) The special requirements of AM/FM receivers are discussed and a detailed description, with complete circuit diagram, is given of a receiver with five tubes (plus a rectifier) three of which are new types. Type EABC80 is a triode-diode triode, Type ECH81 a triode heptode and

Type EF85 a variable- μ high-slope pentode. Technical data for these tubes are tabulated.

621.396.621.029.6 2430

The Development of Circuit and Valves for U.S.W. Receivers—H. Rothe. (*Flecktrotech. Z.*, vol. 74, pp. 161–165; March 1, 1953.) A review of German practice in receiver design. Advantages of different detector, demodulator and mixer circuits are discussed, and details are given of tubes used, including a triode-diode triode for use as combined AM/FM detector and AF preamplifier.

621.396.622:621.396.822 2431

The Detection of a Sine Wave in Gaussian Noise—E. Reich and P. Swerling. (*Jour. Appl. Phys.*, vol. 24, pp. 289–296; March 1953.) An analysis is made to determine the "optimum" method of detecting a sine wave of known frequency and amplitude. The "optimum" method is defined as that which gives maximum probability of recognizing the presence of the sine wave, while the probability of falsely indicating the presence of a sine wave does not exceed a given value. When the noise has a uniform frequency distribution, all the relevant information is contained in the amplitude and phase of the Fourier transform of the received sample at the frequency of the sine wave. When the noise has an exponentially decaying autocorrelation function the values at the end points of the observed sample are also significant.

621.396.82 2432

Interference Evaluation by means of Different Noise Filters—E. Altrichter. (*Nachr. Tech.*, vol. 3, pp. 80–82; Feb. 1953.) An examination is made of the difference between the results obtained by using the 1934 and 1949 CCIR curves and the DIN-5045 curves for interference evaluation. Numerical results are given for the case of white noise.

621.396.823 2433

Radio Influence Tests in Field and Laboratory—500-kV Test Project of the American Gas and Electric Company—G. D. Lippert, W. E. Pakala, S. C. Bartlett and C. D. Fahrnkopf. (*Trans. Amer. IEE*, vol. 70, pp. 251–265; 1951. Discussion, pp. 265–269.) (Full paper—see 257 of 1952.)

STATIONS AND COMMUNICATION SYSTEMS

621.39.001.11 2434

New Problems and Methods in Communication Research. Report on the "Symposium on Applications of Communication Theory" held in London—W. Meyer-Eppeler. (*Arch. elekt. Übertragung*, vol. 7, pp. 201–206; April 1953.) General discussion of the research trends indicated. A list of the papers given is included. (See also *Fernmeldetechn. Z.*, vol. 6, pp. 189–190; April, 1953.)

621.391:621.396.619.16 2435

Recent Development in Communication Technique—C. W. Earp. (*Elec. Commun.*, vol. 30, pp. 61–70; March 1953.) (Reprint—see 2889 of 1952.)

621.396.4:621.395.44 2436

F.M. Telegraphy on Carrier-Current Telephone Lines—B. Vural. (*Tech. Mitt. schweiz. Telegr.-Teleph. Verw.*, vol. 31, pp. 89–106; April 1, 1953. In German.) An investigation was made of the possibility of establishing a multichannel frequency-shift telegraphy system using the frequency band 8–12 kc. A single channel was tested in the laboratory. The bandwidth required is greater than that for the tone-frequency system, but the signal/noise ratio is better and the system is relatively insensitive to variations of attenuation with frequency. Using for each channel two frequencies separated by 300 cps, the available band accommodates six channels.

- 621.395.44:621.315.052.63 2437
The Weser-Ems Power-Supply Carrier-Frequency Communication Network—E. Koch. (*A.E.G. Mitt.*, vol. 42, pp. 161-167; July/Aug. 1952.) The system described covers an area of 9600 km² and has 34 carrier-frequency terminals. Frequencies in the band 45-185 kc are used. Design of coupling capacitors and wide-band HF band-stop filters is discussed.
- 621.395.44:621.397.242 2438
Planning Fundamentals for Carrier-Frequency Cable Links for Communications—F. Bath and W. v. Werther. (*Fernmeldetech. Z.*, vol. 6, pp. 149-157; April 1953.) The various types of cable are described and the factors governing repeater spacing are indicated. The particular conditions for the transmission of radio and television programs in Germany are discussed; for the latter case, using the vestigial-sideband system with a carrier frequency of 1.056 mc, available power permits a repeater spacing of 9 km, the signal/noise level being satisfactory over a distance of 1000 km.
- 621.396.61/.62 2439
Citizen-Radio Class-A Equipment—R. L. Borhardt. (*Electronics*, vol. 26, pp. 166-169; May 1953.) A description is given of a FM transmitter and companion receiver for the 460-470-mc band allocated to the citizens' radio service. In the transmitter, the third harmonic of a crystal, about 19 mc, is multiplied by 24 to obtain the required frequency. A Type-2C39A tube, designed for use in grounded-grid cavity-type circuits and rated at 100-W maximum anode dissipation, is used as power amplifier with the low dissipation of 10 W to ensure long life. Special features of the receiver to achieve frequency stability are described. With high-gain aerials, mounted as high as possible, reliable communication has been realized within a radius of 30 miles, while ranges up to 57 miles have been recorded.
- 621.396.619(083.74) 2440
Standards on Modulation Systems: Definitions of Terms, 1953—(Proc. I.R.E., vol. 41, pp. 612-615; May 1953.) Standard 53 I.R.E. 211 S 1.
- 621.396.619.11/.13 2441
Modulation Problems—U. Kirschner. (*Funk u. Ton*, vol. 7, pp. 90-95; Feb. 1953.) Mathematical analysis by Fourier series and by Carson & Fry's method (464 of 1938) of oscillations, modulated in amplitude, phase or frequency.
- 621.396.619.16 2442
Note on Delta Modulation—(*Elec. Commun.*, vol. 30, pp. 71-74; March 1953.) A simple method of producing delta modulation is based on consideration of the fact that the process is equivalent to pulse-density modulation combined with quantization in time; a practical circuit is illustrated. An accurate method is described for calculating the distortion introduced by the quantization process; the formula obtained embodies the same law as that given by Libois (2330 of 1952).
- 621.396.619.16 2443
Pulse-Group Coding and Decoding by Passive Networks—R. F. Blake. (*Proc. NEC (Chicago)*, vol. 8, pp. 760-765; 1952.) Pulse coding and decoding processes which involve timing, gating, summation and coincidence detection, can be accomplished by passive networks consisting of delay lines, resistors and crystal matrices. The individual networks to accomplish the various operations, and their combination for coding and decoding, are discussed. The resulting units require no power or active elements other than the source of the pulse or code group. Preliminary tests of experimental coders and decoders showed them to be particularly suitable for many types of coded-pulse system.
- 621.396.65 2444
Israel Intercity V.H.F. Telecommunication Systems—L. C. Simpson. (*RCA Rev.*, vol. 14, pp. 100-124; March 1953.) Description of two 12-channel radiotelephone systems linking Jerusalem via Tel-Aviv with Haifa and operating in the 250-mc band. FM is used, with frequency multiplexing.
- 621.396.65:621.397.26 2445
Microwave Relay Link for Television—(See 2463.)
- 621.396.71 2446
Organization and Technical Arrangements of the Luchow Radio Station—H. Heuser. (*Fernmeldetech. Z.*, vol. 6, pp. 116-122; March 1953.) Description of one of the stations used by the West German Post Office for overseas radio telegraph and telephone services.
- 621.396.97 2447
The Future of Broadcasting—P. Adorian. (*Jour. Brit. IRE*, vol. 13, pp. 81-87; Feb. 1953.) It is suggested that the British broadcasting service might eventually comprise at least two sound and two television programs. Medium- and long-wave transmitters would provide the overseas services, while listeners in Britain would be catered for in the VHF or UHF bands or by wire relay. The advantages of FM in the VHF band are discussed.
- 621.396.1 2448
Radio Spectrum Conservation—Report of the U. S. Joint Technical Advisory Committee—(Book Review). Publishers: McGraw-Hill, New York, 221 pp.; 1952. (*Arch. elekt. Übertragung*, vol. 7, pp. 207-208; April 1953.) Factors affecting wavelength allocations are examined, and an "ideal plan" is worked out. Present-day allocations are critically discussed and practical methods of making the best use of the available frequency band are indicated.
- SUBSIDIARY APPARATUS**
- 621-526 2449
A Phase-Plane Approach to the Compensation of Saturating Servomechanisms—A. M. Hopkin. (*Trans. Amer. IEE*, vol. 70, pp. 631-639; 1951.)
- 621-526 2450
Network Synthesis by Graphical Methods for A.C. Servomechanisms—G. A. Bjornson. (*Trans. Amer. IEE*, vol. 70, pp. 619-625; 1951.) (Full paper—see 501 of 1952.)
- 621-526:621.3.016.352 2451
Calculation of the Attenuation in Filtered Oscillators—G. Cahen and J. Loeb. (*Ann. Télécommun.*, vol. 8, pp. 97-101; March 1953.) A hypothesis previously used is not required in defining the dynamic characteristics of a control system. A particular class of nonlinear servomechanisms is investigated and stability criteria are discussed. See also 972 of April, Cahen & Loeb; 1279 of May and 1624 of June, Cahen.
- 621-526:621.3.078 2452
Some Design Criteria for Automatic Controls—P. T. Nims. (*Trans. Amer. IEE*, vol. 70, pp. 606-611; 1951.) The design of control systems to give optimum response is discussed in terms of the area between the graphical representation of a step disturbance and the control response curve. This area, and a "weighted control area," can be calculated directly from the system parameters and enable the necessary control sensitivities to be determined for optimum response.
- 621-526:621.313.2-8 2453
Rotary Amplifiers in Servomechanisms—G. Lehmann. (*Elec. Commun.*, vol. 30, pp. 12-25; March 1953.) The rotary amplifier consists of a dc generator driven at constant speed. The properties of this machine as an amplifier are discussed. Use of this amplifier as power stage for a tube amplifier in servomechanisms is described.
- 621-526:621.392.5 2454
Effects of Carrier Shifts on Derivative Networks for A.C. Servomechanisms—G. M. Attura. (*Trans. Amer. IEE*, vol. 70, pp. 612-618; 1951.)
- 621-526:621.396.645.37 2455
A Note on the Design of Conditionally Stable Feedback Systems—P. Travers. (*Trans. Amer. IEE*, vol. 70, pp. 626-630; 1951.) Formulas are presented which relate parameters of the loop transfer function of a conditionally stable system to the relative stability of the system transfer function. The condition is determined for which the system bandwidth is a minimum when the loop transfer function is required to have a specified value at a particular frequency.
- 621.311.6 2456
Power Supplies for Transmitters—K. Brehm. (*A.E.G. Mitt.*, vol. 41, pp. 268-274; Sept./Oct. 1951.) Present-day equipment used for supplying power to small or large installations is described.
- 621.314.263 2457
Differential Analyzer Study of Harmonic Power Generation with Nonlinear Impedance Element—P. E. Russell and H. A. Peterson. (*Trans. Amer. IEE*, vol. 70, pp. 917-920; 1951.) (Full paper—See 812 of 1952.)
- 621.314.57 2458
A Gas-Tube Inverter with the Supply Voltage below the Breakdown Voltage—J. M. Cage and J. C. Schuder. (*Trans. Amer. IEE*, vol. 70, pp. 908-912; 1951.) Investigation of the operating characteristics of simple circuits using gas-discharge tubes working with direct voltages down to about 5 V.
- 621.314.634 2459
Development of 40-Volt Selenium-Rectifier Plates—J. T. Cataldo. (*Elec. Mfg.*, vol. 49, pp. 108-112, 330; May 1952.) Forward and reverse characteristics are given for recently developed 40-V Se rectifiers in a bridge circuit. Results of a 3500-hr life test showed a voltage drop of about 2%. The use of such plates effects a great reduction in weight compared with post-war 26-V plates.
- 621.316.722 2460
Voltage Stabilization—F. A. Benson. (*Elec. Eng.*, vol. 25, pp. 160-165 & 202-207; April/May 1953.) Review paper with 146 references. Results of the latest work on glow-discharge tubes are reported.
- 621.319.331 2461
A New Electrostatic Influence Machine—P. Jolivet. (*Rev. Gén. Élect.*, vol. 62, pp. 25-39; Jan. 1953.) Description of the principles of operation, the construction and performance of a rotary machine operating at atmospheric pressure and giving voltages up to 100 kV.
- TELEVISION AND PHOTOTELEGRAPHY**
- 621.397 2462
High-Speed Facsimile Equipment—(*Electronica*, vol. 6, pp. 61, 63; April 11, 1953.) Brief description of Philips equipment with a scanning speed of 40 mc, the width of the scanning line being $\frac{1}{2}$ mm. Reproduction at the receiver is on photographic film.
- 621.397.24/.26 2463
International Television: Radio and Cable 2000-Mile Network for the Coronation Transmissions—(*Wireless World*, vol. 59, pp. 274-275; June, 1953.) Sketch maps are given which show (a) the complete system of British television stations, (b) the radio-link system permitting re-radiation of the B.B.C. transmissions by stations in France, Holland and Western Germany.

- 621.397.242:621.395.44 2464
Planning Fundamentals for Carrier-Frequency Cable Links for Communications—Bath and v. Werther. (See 2436.)
- 621.397.26:621.396.65 2465
Microwave Relay Link for Television—(*Elec. Commun.*, vol. 30, pp. 3-8; March 1953.) This radio link in its present form operates in one direction only, to transmit television programs from Louisville, Kentucky, on the U. S. national network, to Nashville, Tennessee. Five repeater stations are incorporated, alternate stages using frequencies from the 2.008-2.025-kmc and 2.042-2.059-kmc channels respectively. The repeater antenna systems comprise vertically radiating paraboloids about 9 ft above ground, associated with plane wire-mesh reflectors at the top of a tower.
- 621.397.335:535.623/.624 2466
Synchronization in Color Television—D. G. Fink. (*Electronics*, vol. 26, pp. 170-175; May 1953.) Phase synchronization is a necessary and sufficient condition for proper operation of a television system, since the existence of a stationary phase relation implies frequency synchronism. Four types of phase synchronization which must be accomplished in a satisfactory color-television system are discussed. A table of the phase-synchronism requirements shows that the most difficult synchronization problem in color television is not that of color phase, but that of maintaining vertical scanning sufficiently precise to secure proper interlacing.
- 621.397.5:535.623].001.42 2467
Recommendations of the National Television System Committee for a Color Television Signal—A. V. Loughren. (*Jour. Soc. Mot. Pic. Telev. Eng.*, vol. 60, pp. 321-336; April 1953.) The original NTSC specification [Hirsch *et al.*, 1750 of 1952] is discussed, and the method of deriving the signal is described. Details are given of the signal specification as revised in February 1953, incorporating modifications made in the light of the preliminary field tests. (See also Fisher, 1822 of June and 2466 below.)
- 621.397.5:535.623].001.42 2468
Revised Specifications for Field Test of N.T.S.C. Compatible Color Television—W. R. G. Baker. (*Proc. I.R.E.*, vol. 41, pp. 666-667; June 1953.) Full text of the specifications approved by the NTSC in February 1953.
- 621.397.5:535.623:621.397.822 2469
Effects of Noise on N.T.S.C. Color Standards—C. H. Jones. (*Proc. NEC (Chicago)*, vol. 8, pp. 185-200; 1952.) To analyze the effect of noise on a color-television system, the concept of a color solid is used. One dimension is determined by the amplitude of the black-and-white modulation envelope. The other two dimensions in polar form consist of the magnitude and phase angle of the 3.9-mc color-subcarrier signal. The Munsell color solid specifies in an ideal way the visual relation existing among colors. To compare the NTSC solid with the ideal, contours of Munsell value (related to luminosity), hue and chroma (saturation) have been plotted. An examination of these contours shows what colors are most influenced by noise. The present NTSC system is found to be fairly good as regards the effect of noise on brightness and chromaticity. The signal/noise ratio for brightness would be slightly improved by using a gamma a little lower than 2.75. The chromaticity signal/noise ratio can be appreciably improved by adjustment of the amplitudes and phases of the three color components and by applying the gamma to the Y coefficient of the chromaticity portion of the signal.
- 621.397.5:778.5 2470
Television Recording—W. D. Kemp. (*Jour. Soc. Mot. Pic. Telev. Eng.*, vol. 60, pp. 367-384; April 1953.) Shortened version of paper noted in 847 of March.
- 621.397.6 2471
Television Standards Converter—(*Wireless World*, vol. 59, p. 273; June 1953.) A general description is given of the principles of operation of equipment used for converting the British 405-line coronation-broadcast signals to the continental 625-line standard at Breda, Holland. The operating principle is basically the same as that of the equipment used by the B.B.C. in 1952 for changing from French to British standards. The incoming picture is displayed on the 5-in. screen of a cr tube used as a flying-spot scanner. The scanning beam of the 625-line camera is arranged to "read" the picture at an approximately constant time interval behind the "writing" spot of the cr tube. The two scanning systems are locked together by synchronization methods, and spot wobbling is used to fill in the gaps in the 405-line picture, thus avoiding interference patterns appearing in the 625-line picture.
- 621.397.6.001.4 2472
Television Test Equipment—Mittelmann. (See 2396.)
- 621.397.62 2473
Adaptation of French Television Receivers for American TV Standards—P. Roques. (*TSF et TV*, vol. 29, pp. 84-87; March 1953.) Outline of alterations necessary for converting an 819-line receiver to 525-line operation.
- 621.397.62:535.88 2474
Special Problems in Television Large-Picture Installations—E. Schwartz. (*Funk u. Ton*, vol. 7, pp. 53-73; Feb. 1953.) (See 1168 of April.)
- 621.397.62:535.88 2475
The Fischer Large-Screen Projection System—E. Baumann. (*Jour. Soc. Mot. Pic. Telev. Eng.*, vol. 60, pp. 344-356; April 1953.) (Reprint—See 2350 of 1952.)
- 621.397.62:535.88:535.623 2476
Eidophor System of Theater Television—E. I. Sponable. (*Jour. Soc. Mot. Pic. Telev. Eng.*, vol. 60, pp. 337-343; April 1953.) Brief description of equipment installed in a New York theater, comprising eidophor equipment modified to give color pictures.
- 621.397.62:621.385.2:546.289 2477
The Germanium Diode as Video Detector—W. B. Whalley, C. Masucci and N. P. Salz. (*Proc. I.R.E.*, vol. 41, pp. 638-644; June 1953.) The Ge diode is particularly suitable for use as a video detector on account of its high forward conductance, low intrinsic capacitance and high back resistance, giving good wide-band operation. Methods of measuring the various characteristics are described and analysis of the operation of the crystal diode as a video detector is presented, the forward and back conductances being assumed constant over the operation range, loads with large and with small time constants being considered.
- 621.397.62:621.397.828 2478
Reducing Radiation from TV Receivers—P. S. Rand. (*Electronics*, vol. 26, pp. 130-135; May 1953.) Quantitative measurements of the radiation from a screened oscillator, simulating the local oscillator of a television receiver, show that complete suppression of radiation can be achieved if suitable methods of screening and filtering are used, particularly for power leads.
- 621.397.62.001.4 2479
Measurements on Television Receivers: Part 1—General Survey—O. Macek. (*Arch. Tech. Messen*, No. 205, pp. 41-42; Feb. 1953.) Receiver circuits and the 625-line and 525-line standards are reviewed as a preliminary to the discussion of appropriate receiver tests.
- 621.397.621.2:621.316.722.2 2480
Practical Considerations on Line Time Base Output Stages with Booster Circuit—C. J. Boers and A. G. W. Uitjens. (*Elec. Appl. Bull.*, vol. 12, pp. 137-151; Aug. 1951.) Simple relations are derived by means of which the numbers and ratio of turns, the voltages and the currents of the line-timebase output transformer can be calculated approximately. Various methods of feeding the heater of the booster diode are indicated. Practical examples are calculated.
- 621.397.621.2:621.316.729 2481
Flywheel Synchronization of Timebase Generators: Part 1—Flywheel Action of Resonant Circuits—P. A. Neeteson. (*Elec. Appl. Bull.*, vol. 12, pp. 154-171; Sept. 1951.) Detailed analysis of the response of a parallel resonant circuit to a series of periodic pulses of short duration.
- 621.397.621.2:621.316.729 2482
Flywheel Synchronization of Timebase Generators: Part 2—Automatic Phase Control—P. A. Neeteson. (*Elec. Appl. Bull.*, vol. 12, pp. 179-199; Oct./Nov. 1951.) Discussion of circuits in which synchronization is obtained by deriving a control voltage from the phase shift between the synchronizing signal and the relaxation voltage, the control voltage being then applied to the control grid of the tube in which the relaxation voltage is generated. Several practical circuits for a.p.h.c. are described and their operation is discussed. (Part 1: 2479 above.)

TRANSMISSION

- 621.396.61:621.396.619.11 2483
Output Analysis and Alignment Techniques for Phase-Rotation Single-Sideband Transmitters—O. Whitby and D. R. Scheuch. (*Trans. Amer. IEE*, vol. 70, pp. 209-212; 1951.) Discussion with reference to the type of transmitter described by Villard (893 of 1949). The two balanced modulators are driven by RF voltages in quadrature. AF modulating voltages, also in quadrature, are applied in push-pull to the tube grids of each modulator. The anode-current pulses of all the four Eimac Type 4-250A tubes used develop power in a common anode tank circuit. When properly operated, only one sideband is present in the output. Details of the alignment procedure are given, and a specially developed alignment indicator is described which consists essentially of a single-frequency test source of four quadrature AF modulating voltages and four gated phase-sensitive detectors, each one of which is assigned to the examination of one particular component in the detected output of the transmitter.
- 621.396.61.018.3 2484
The Output-Stage Harmonic Power radiated from the Transmitter Aerial—K. Freudenhammer. (*Fernmeldetechn. Z.*, vol. 6, pp. 158-164; April 1953.) For a given harmonic the power radiated is maximum when the antenna circuit resonates at this frequency as well as at the fundamental. A simple formula is derived for this case, in which the power is expressed in terms of the damping of the individual circuits between output tube and antenna, the ratio of harmonic to fundamental tube current and the ratio of harmonic to fundamental radiation resistance. Various types of coupling and antenna are compared from the point of view of obtaining the lowest possible radiation of harmonics.
- 621.396.615.141.2:621.396.619.11 2485
Measurements on an Amplitude-Modulated Injection-Locked U.H.F. Magnetron Transmitter—L. L. Koros. (*Proc. NEC (Chicago)*, vol. 8, pp. 395-406; 1952.) (See 1060 of April.)

- 621.396.619.11/.13 2486
The Spectral Differences between Amplitude- and Frequency-Modulated Oscillations—A. Raschkowitsch. (*Frequenz*, vol. 7, pp. 37-41; Feb. 1953.) Comparison is made between the frequency spectrum of the sidebands of FM oscillations with small frequency swing and that of AM oscillations with a square-law modulator characteristic. Discussion of the results of this comparison shows the necessity of using a large frequency swing, and that FM is particularly suitable for the USW band.
- 621.396.619.23:621.385.2 2487
Diode Modulators for Frequency Modulation—A. Raschkowitsch. (*Frequenz*, vol. 7, pp. 49-53; Feb. 1953.) The internal resistance of a diode decreases with increasing anode voltage, passes through a minimum value at about 7 V and then rises to a very high value at saturation. This property is utilized in a simple modulator in which the anode of a class-A control triode is connected direct to the cathode of the diode, with a capacitive connection to earth. Using only the straight portion of the triode characteristic, the diode internal resistance varies linearly with the modulation voltage applied to the grid of the triode, thus causing variation of diode current and FM of an oscillator capacitively coupled to the diode anode. Theory of the method is based on equivalent circuits. In a practical example, a frequency swing of ± 15 kc was obtained on an oscillator frequency of 10 mc.
- TUBES AND THERMIONICS**
- 537.525.92:537.533.7 2488
Space-Charge Waves in Electron Streams—J. Labus. (*Elektrotech. Z.*, vol. 74, pp. 129-130; March 1, 1953.) Two methods of calculating the phase constants of space-charge waves are discussed.
- 621.314.7 2489
Factors in the Design of Point-Contact Transistors—B. N. Slade. (*RCA Rev.*, vol. 14, pp. 17-27; March 1953.) The characteristics of point-contact transistors depend essentially on four factors, namely (a) the materials used for the point contacts, (b) the spacing of the point contacts, (c) the resistivity of the Ge, and (d) the electrical forming process. The design of transistors for use in RF amplifiers, oscillators and switching or counter circuits is discussed with reference to these factors. (See also Rose and Slade, 585 of February and 884 of March.)
- 621.314.7 2490
Interpretation of α -Values in p - n Junction Transistors—F. S. Goucher and M. B. Prince. (*Phys. Rev.*, vol. 89, pp. 651-653; Feb. 1, 1953.) Measurements of the current amplification factor were made for five n - p - n junction transistors and one p - n - p junction transistor. For all six samples, the results obtained by three different methods agreed within the limits of experimental error.
- 621.314.7 2491
Junction-Transistor Characteristics at Low and Medium Frequencies—L. J. Giacoletto. (*Proc. NEC (Chicago)*, vol. 8, pp. 321-329; 1952.) (*Tele-Tech.*, vol. 12, pp. 70-72, 125; March 1953.) The characteristics of junction-type transistors are reviewed and methods of measuring their parameters are described. The results of such measurements have pointed the way to constructional modifications permitting operation at frequencies >10 mc. (See also 644 of March.)
- 621.314.7 2492
Properties of Junction Transistors—K. D. Smith. (*Proc. NEC (Chicago)*, vol. 8, pp. 330-342; 1952.) Factors of importance in the design and application of n - p - n -junction transistors are discussed in detail and the relations of some of the design variables to the parameters of the equivalent circuit are considered. The results of measurements of various characteristics for the development type M1752 are shown graphically and new models designed for power dissipation of the order of 3 W are noted; a power gain of 26 db is obtained.
- 621.314.7 2493
Some Transient Properties of Transistors—H. G. Bassett and J. R. Tillman. (*Brit. Jour. Appl. Phys.*, vol. 4, pp. 116-117; April 1953.) Tests carried out on point-contact transistors of British manufacture show that the growth and decay of the collector current, in response to a rectangular pulse of emitter current, are roughly exponential after an initial delay of the order of 0.1 μ s, during which there is no response. If the collector current is saturated, or if the collector voltage, instead of being steadily applied, is pulsed on, during or after application of the pulse of emitter current, effects due to delayed carriers are strikingly exhibited.
- 621.383.27 2494
The Dark Current in Photomultipliers—N. Schaetti and W. Baumgartner. (*Z. angew. Math. Phys.*, vol. 4, pp. 159-160; March 15, 1953. In German.) Continuation of work noted in 1518 of May. Further measurements on Cs-Sb photocathodes provide evidence of photoconduction and crystal-phosphor effects as well as photo-emission.
- 621.385 2495
Change of Electron Temperature in an Electron Beam—H. M. Mott-Smith. (*Jour. Appl. Phys.*, vol. 24, pp. 249-255; March 1953.) The change in velocity distribution within a beam on issuing from an accelerating grid into a field-free space is calculated by direct integration of the Boltzmann equation. For electron densities and velocities typical of traveling-wave tubes and diodes, the effect of electron collisions is negligible, as is also the longitudinal component of the electron-gas pressure; the usual heat-conduction formulas of kinetic theory do not hold.
- 621.385:669.245 2496
The Use of Nickel in Valves—Jackson and Jenkins. (See 2357.)
- 621.385-71 2497
Basic Heat-Transfer Data in Electron Tube Operation—B. O. Buckland. (*Trans. Amer. IEE*, vol. 70, pp. 1079-1085; 1951.) (Full paper—see 1774 of 1952.)
- 621.385.029.6 2498
Low-Noise Traveling-Wave Tube—A. G. Peifer, P. Parzen and J. H. Bryant. (*Elec. Commun.*, vol. 30, p. 60; March 1953.) Correction to paper noted in 273 of January.
- 621.385.029.6 2499
Theory of the Large-Signal Behavior of Traveling-Wave Amplifiers—A. Nordsieck. (*Proc. I.R.E.*, vol. 41, pp. 630-637; June 1953.) Calculations are made of the amplification, output phase distortion and harmonic content for a traveling-wave tube operated beyond its linear range. Space-charge effects are neglected. The limiting efficiency and phase distortion are given for various values of the beam-to-circuit coupling factor and of the electron injection velocity. The relative harmonic content in the output is given for all harmonics up to the fifth. Nearly all the results are presented graphically.
- 621.385.029.63/.64 2500
Waves in an Electron Stream with General Admittance Walls—C. K. Birdsall and J. R. Whinnery. (*Jour. Appl. Phys.*, vol. 24, pp. 314-323; March 1953.) The influence of wall admittance on the operation of electron-stream tubes is investigated, using the method of field analysis. Values of gain and phase velocity are calculated for walls of arbitrary admittance. Design is facilitated by use of charts showing contours of the complex functions involved. Gain is zero for open or short circuit and for capacitive wall impedance, low for resistive-capacitive, higher for resistive and resistive-inductive, and highest for inductive walls. Results for the case of the resistive-capacitive wall were verified by experiments using a very thin glass tube coated on the inside with a layer of tin oxide. No immediate practical application is envisaged for the particular structures discussed.
- 621.385.029.63 2501
Measurements on a 10-W Helix-Type Traveling-Wave Valve for 15-cm Wavelength—H. Schnitger and D. Weber. (*Fernmelde- tech. Z.*, vol. 6, pp. 66-72; Feb. 1953.) The design and performance of a traveling-wave tube designed to give a power gain of 17 db at 2 kmc are described. Details are given of the helix construction, the capacitive coupling arrangement which simplifies tube changing, and the beam focusing system. The observed efficiency of about 20% is in fair agreement with theoretical calculations. Measurements have been made to determine the optimum distance between helix input and a graphite coating on the outside of the glass envelope for suppression of self oscillations.
- 621.385.029.63:621.396.619.23 2502
The Electron Coupler—A Developmental Tube for Amplitude Modulation and Power Control at Ultra-High Frequencies—C. L. Cuccia. (*RCA Rev.*, vol. 14, pp. 72-99; March 1953.) For another account see 2188 of July.
- 621.385.032.212 2503
Cold-Cathode Valves—H. L. von Gugelberg. (*Bull. schweiz. elektrotech. Ver.*, vol. 44 pp. 81-87; Feb. 7, 1953. In German.) Recent developments in voltage-stabilizer, relay, photo-flash and decade-counter tubes are reviewed.
- 621.385.032.216 2504
New Dispenser-Type Thermionic Cathode—R. Levi. (*Jour. Appl. Phys.*, vol. 24, p. 233; Feb. 1953.) Brief preliminary note about the "impregnated" cathode, a development of the "L" cathode previously described by Lemmens *et al.* (773 of 1951). Instead of using Ba and Sr carbonates contained in a cavity, the new cathode uses Ba aluminates dispersed within the pores of the W plug.
- 621.385.032.216 2505
The Effects of Oxygen on the Electrical Properties of Oxide Cathodes—A. A. Shepherd. (*Brit. Jour. Appl. Phys.*, vol. 4, pp. 70-75; March 1953.) Experiments on (Ba, Sr)O cathodes were made using mass-spectrometer and probe methods to examine the effects of oxygen poisoning on emission and conductivity. Results show that increased oxygen ion emission occurs during recovery and that most of this originates within the body of the coating. This supports the work of Metson (3588 of 1949). The conclusion is drawn that poisoning is mainly due to an increase in work function, this being caused by adsorption of oxygen on the interior crystal surfaces as well as on the outer coating. Results at all temperatures for emission and at high temperatures for conductivity support this. Conductivity results in general can be accounted for by the Loosjes-Vink conduction mechanism (491 of 1950) although this does not explain the discrepancy between cathode work function and high-temperature activation energy.
- 621.385.032.216:537.311.33 2506
The Interpretation of Nijboer Theory for BaO from the Viewpoint of Co-existence of Various Impurity Levels—S. Narita. (*Jour. Phys. Soc. (Japan)*, vol. 7, pp. 221-222; March/April 1952.)
- 621.385.032.216:621.397.62 2507
Cathode Interface Effects in TV Receiver

- Design**—F. M. Dukat and I. E. Levy. (*Electronics*, vol. 26, pp. 169-171; April 1953.) Undesirable effects, notably reduction of gain and deterioration of low-frequency response, due to the development of cathode-interface impedance are discussed. This resistance increases with decrease of cathode temperature and with decrease of cathode area. Relevant characteristics of some commercial tube types are tabulated and compared. The discussion applies also to car radio receivers, where trouble may occur when valves are operated at low heater voltages.
- 621.385.032.216.1:546.841.4-31** 2508
Thermionic Properties of Thoria—G. Mesnard. (*Le Vide*, vol. 7, pp. 1256-1261; Nov. 1952.) From results of measurements on the emission of thoria-coated tungsten filaments, the optimum working temperature is found to be between 1900° and 2000°K. The values of the constants A and ϕ in Richardson's equation corresponding to different activation treatments are determined. (See also 2730 of 1951.)
- 621.385.032.216.1:546.841.4-31** 2509
Changes with Time in Thoria-Coated Thermionic Cathodes—G. Mesnard. (*Le Vide*, vol. 8, pp. 1273-1279; Jan. 1953.) An investigation of emission variations which occur at fixed operating temperatures following activation treatment. Purely thermal effects and effects of current are distinguished. Temperature variations due to current in a tungsten filament with its central portion coated with thoria are tabulated. (See also 2506 above.)
- 621.385.032.216.1:546.841.4-31** 2510
Thoria Cathodes—G. Mesnard. (*Compt. Rend. Acad. Sci. (Paris)*, vol. 236, pp. 904-906; March 2, 1953.) Further experiments on thoria cathodes are described which show the existence of a considerable temperature gradient in the thoria coating. This gradient becomes much less after treatment at 1900-2000°K, owing to crystallization of the thoria. New measurements of the conductivity were made by using a very fine electrode in contact with the thoria surface, the second electrode being the W-wire support. The results are discussed in relation to previous investigations (504, 774 and 2730 of 1951). Thoria appears to be a semiconductor of n type.
- 621.385.2:537.525.92** 2511
Space-Charge-Limited Currents between Inclined Plane Electrodes. Approximate Solutions—H. F. Ivey. (*Jour. Appl. Phys.*, vol. 24, p. 227; Feb. 1953.) Simplified formulas are derived for the "pervance function" and "trajectory magnification factor" introduced in a previous paper (2384 of 1952).
- 621.385.2:546.289:621.397.62** 2512
The Germanium Diode as Video Detector—Whalley, Masucci and Salz. (See 2475.)
- 621.385.2:621.3.016.35** 2513
Measurements of Saturated-Diode Stability—V. H. Attree. (*Brit. Jour. Appl. Phys.*, vol. 4, pp. 114-116; April 1953.) Results are given of tests on Mazda Type-29C1 diodes run for 1000 hr at emission currents of 5 mA and 0.5 mA. The filament current, for a given emission, shows smaller variations than the voltage, and results at 0.5 mA are much better than at 5 mA emission. At 0.5 mA the filament current is constant to within 1 part in 500 over the 1000-hr period. Tests on a single Ferranti Type-GRD6 diode also show that for constant emission the filament current variations are very much less than those of the filament voltage.
- 621.385.2:[621.317.3+621.316.72]** 2514
Saturated-Diode Operation—H. L. Attree and V. H. Attree—(*Elec. Eng.*, vol. 25, p. 216; May, 1953.) Comment on 1197 of April and author's reply.
- 621.385.2.032.213.1** 2515
Approximate Formulas for the Saturation Current of Diodes with Tungsten Cathodes—Dzhakov. (*Zh. Tekh., Fiz.*, vol. 22, pp. 602-605; April 1952.)
- 621.385.3** 2516
Design Rules for Planar Triodes—W. Dahlke. (*Telefunken Ztg.*, vol. 26, pp. 54-60; Jan. 1953.) Charts are provided to facilitate the determination of the various dimensions of a planar triode for a specified slope of the characteristic and a specified operating current. Numerical calculations for the Telefunken pentode Type EF80, are in good agreement with measured values.
- 621.385.832:621.318.57** 2517
A Decimal Counter Electron Tube—D. L. Hollway. (*Jour. Phys. (Australia)*, vol. 6, pp. 96-115; March 1953.) A detailed description is given of the construction and operation of the counter tube noted in 2374 of 1950. A 4-tube counter is described capable of counting speeds from 70,000 to 180,000 second, depending on circuit conditions.
- 621.387:621.316.722:621.396.822** 2518
Peak-Noise Characteristics of some Glow-Discharge Tubes—H. Bache and F. A. Benson. (*Jour. Sci. Instr.*, vol. 30, pp. 124-126; April 1953.) Results of further measurements on voltage-regulator tubes, including miniature and also relatively-large-current tubes, are shown graphically. (See also 2930 and 2931 of 1952.)
- 621.387.004.15** 2519
Improving Gas-Tube Grid-Circuit Reliability—J. H. Burnett. (*Proc. NRC (Chicago)*, vol. 8, pp. 568-576; 1952. *Tele-Tech*, vol. 2, pp. 70-72, 175; April 1953. *Elec. Eng., N.Y.*, vol. 72, pp. 341-346; April 1953.) Several sources of noise in the grid circuits of thyatrons are discussed and practical methods of noise reduction to obtain improved performance are outlined.
- 621.396.615.141.2** 2520
The Turbator, a Single-Cavity Magnetron—F. Lüdi. (*Tijdschr. ned. Radiogenoot.*, vol. 18, pp. 89-103; March 1953. In German.) (See 2945 of 1950.)
- 621.396.615.141.2** 2521
Grid Magnetron delivers Modulated U.H.F. Output—P. L. Spencer. (*Electronics*, vol. 26, pp. 148-154; May 1953.) A highly stable magnetron is described which has a set of grid wires located in the gaps between the tips of the anode vanes. Details are given of a tube of this type which has a tuning range of ± 50 mc centred near 2.35 kmc and a CW power output of 50 W. Frequency stability, achieved through grid injection of signals from a crystal-controlled oscillator, should prove particularly advantageous in UHF television broadcasting, Doppler radar, and in subcarrier multiple-relay services. The grid provides an excellent means of injecting video modulation signals. Circuit diagrams, with component details, are given for a suitable video amplifier and modulator, and also for a generator, video amplifier and modulator for a subcarrier system, a cathode follower being used for grid drive of the magnetron.
- Classification**—O. C. Hilgenberg. (*Elektrotech. Z.*, vol. 74, pp. 205-207; April 1, 1953.) The general principles on which the UDC system is based are clearly explained and are illustrated by numerous examples
- 061.3:[55+621.396.11]** 2523
International Scientific Radio Union: Meeting in Sydney—R. L. Smith-Rose. (*Nature (London)*, vol. 171, pp. 628-631; April 1953.) A general account of the tenth general assembly of URSI, held during August 11-21, 1952, with summaries of the proceedings of the various Commissions.
- 061.3:[55+621.396.11]** 2524
Tenth General Assembly of URSI—(*Onde élect.*, vol. 33, pp. 127-190; March 1953.) An account is given of the organization and development of the Union, and reports are presented of the discussions of the individual commissions, dealing respectively with the following subjects: measurements, the troposphere and wave propagation, the ionosphere and wave propagation, atmospheric, radio astronomy, information theory, electronics.
- 061.4:[621.317.7+621.38]** 2525
Physical Society's Exhibition [1953]—(*Wireless Engr.*, vol. 30, pp. 124-129; May 1953.) Brief descriptions are given of a selection of the exhibits. (See also *Elec. Eng.*, vol. 25, pp. 212-215; May 1953.)
- 061.4:[621.396.6+621.317.7+621.38]** 2526
Components and Techniques. Survey of the RECMF and Physical Society's Exhibitions—(*Wireless World*, vol. 59, pp. 246-255; June 1953.) Short descriptions of selected exhibits, with lists of exhibitors in the sections dealing with components.
- 621.38/.39:47:** 2527
A Look at Russian Radio and Electronics—G. B. Devey. (*Proc. NRC (Chicago)*, vol. 8, pp. 358-364; 1952.) Some information is given on Russian technical literature, and also on the development of an ultrasonic microscope, research on semiconductors, and the use of ultrasonics to accelerate the action of H_2SO_4 in the surface cleaning of steel, with references to the Russian journals in which these developments are described.
- 621.396.001.891:41-41:** 2528
Radio Research in the British Commonwealth—(*Nature (London)*, vol. 171, pp. 683-684; April 18, 1953.) A short review of investigations in many Commonwealth countries of ionospheric conditions and propagation at various frequencies, RF noise measurements in the ranges 15-500 kc and 2-20 mc, study of meteors by radio methods, radio astronomy, standard-frequency transmissions, effects of terrain on radio propagation, forecasting of ionospheric storms and of radio propagation conditions, and comparison of forecasts with observations.
- 621.396.6** 2529
New Components—(*Rad. Tech. Dig. (France)*, vol. 7, pp. 29-37; 1953.) A brief survey of new radio and allied equipment on the French market.
- 621.396** 2530
The Radio Amateur's Handbook—[Book Review.] Publishers: American Radio Relay League, West Hartford, Conn., 30th edn, 800 pp., 1953. (*Electronics*, vol. 26, pp. 403-404; May 1953.)

MISCELLANEOUS

- 025.45** 2522
Meaning and Purpose of the Decimal

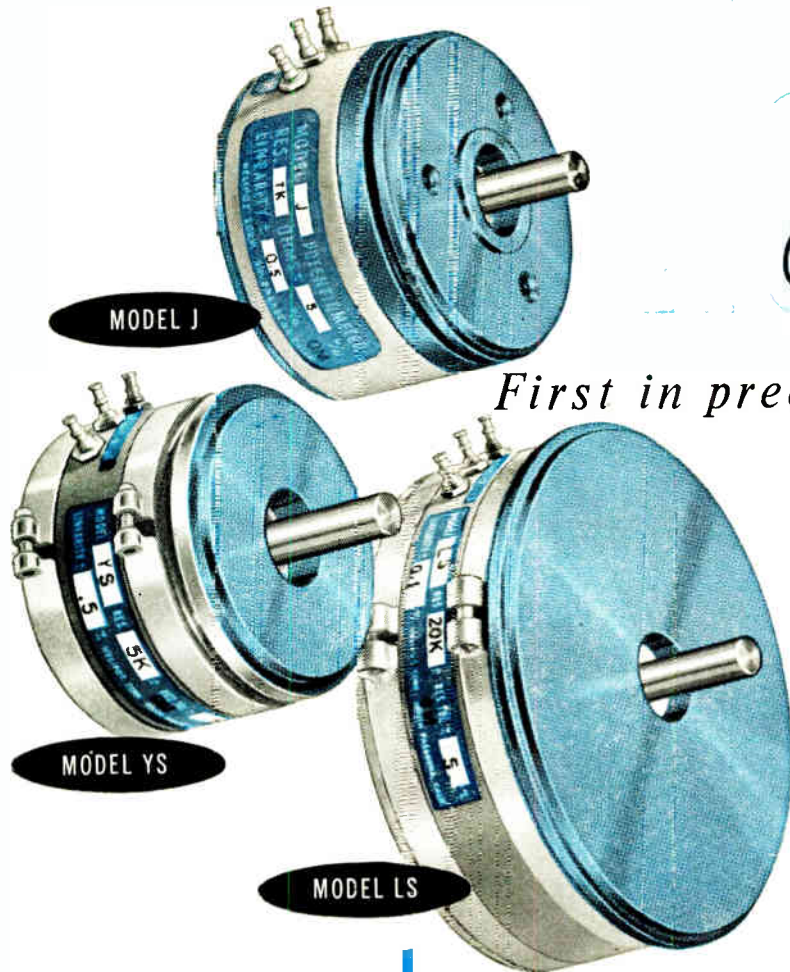

Single Turn

First in precision potentiometers

Here are three models of single turn, continuous rotation Helipot . . . each available from stock in a wide range of resistance values. All three feature the rugged dependability . . . the high degree of precision . . . the proven design characteristics . . . that you expect of every Helipot. Among their many features are the copper mandrel which effectively dissipates heat . . . the spot-welded connections (no pressure-type connections are used in any Helipot model) . . . the provision for easy, accurate phasing on the job . . . the wide choice of mounting styles, number of ganged sections, number of additional tap connections, etc. And like all Helipot models, they are available in variations to meet your exact specifications.

The versatility of these three series of single turn, continuous rotation Helipot makes them ideal for such uses as servo systems . . . analog computers . . . pH indication and control . . . level indication and control . . . telemetering circuits . . . color analysis and control . . . navigation aids . . . radar indicators . . . laboratory instruments, and many more. Your particular requirements will determine the model . . . the number of ganged sections . . . the number and placement of tap connections . . . the style of mounting . . . and other characteristics best suited to your needs.

Every Helipot series is available in variations to meet your exact specifications. Our engineering department will gladly give you every assistance . . . in adapting standard Helipot to your particular requirements . . . in building entirely new Helipot to meet your needs.

Design details subject to change without notice. Certified drawings available upon request.

Below is a Quick-Reference-Guide to the J, L, and Y Series Helipot. For complete information, write for Data File 906

	Model Y Series	Model J Series	Model L Series
Diam.	(a) 1 3/4"	2"	3"
Resist. Range	5-75,000 ohms (b)	50-50,000 ohms (b)	10-100,000 ohms (b)
Power Rating	3 watts	4 watts	5 watts
Active Elec. Rotation	354° ±1°	356° ±1°	358° ±1°
Coil Length	4.6"	5"	8.3"
Mounting	Y-Threaded Bushing. YS-Servo Flange, Sleeve Bearing. YSP-Servo Flange, Ball Bearing.	Threaded Bushing (Spec.). Servo Flange, Ball Bearing (Std.).	L-Threaded Bushing. LS-Servo Flange, Sleeve Bearing. LSP-Servo Flange, Ball Bearing.
Max. No. Ganged Sections (c)	14	8	8
Max. No. Tap Connections per Section (c)	17	21	33

- (a) Model Y Series Helipot are available in both linear and non-linear versions.
 (b) Higher or lower resistance values can be furnished on special order.
 (c) Sections can be ganged and tap connections added, during manufacture.

Helipot corporation

a division of BECKMAN INSTRUMENTS, INC.
 SOUTH PASADENA, CALIFORNIA

PLANTS AT SOUTH PASADENA, CALIFORNIA & MOUNTAINSIDE, NEW JERSEY
 ENGINEERING REPRESENTATIVES IN PRINCIPAL CITIES

NEW

Oscilloscope

TO SUCCEED THE POPULAR TYPE 514-D

THE Type 514-AD

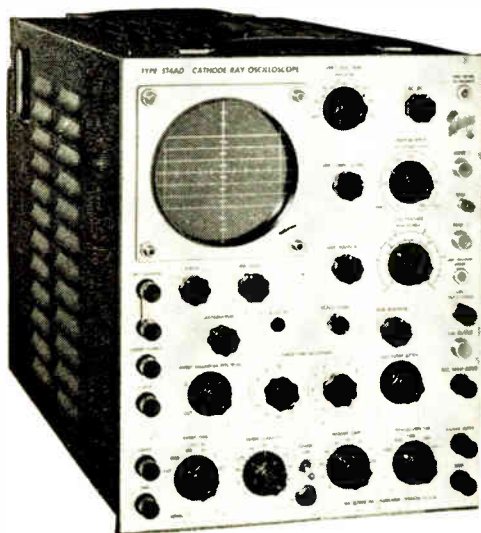

New Vertical Amplifier
6 cm undistorted vertical deflection

New Precision Flat-Faced
5" CRT—improved geometry and edge focus

New Variable Duty Cycle
Calibrator

New Sweep Amplifier

New Sweep Magnifier

New Direct-Coupled
Unblinking

With its many important new characteristics the Type 514-AD comes even closer to providing everything you need in a general-purpose laboratory oscilloscope. Excellent transient response, 10 mc bandwidth, 6 cm undistorted vertical deflection, and wide time base range increase the depth of investigation possible with this versatile new instrument. High quality design and construction assure long, trouble-free service.

Condensed Specifications

Vertical Amplifier

Risetime—0.04 μ sec
Bandwidth—dc to 10 mc
ac—2 cycles to 10 mc
Sensitivity—dc, 0.3 v/cm to 100 v/cm
ac, 0.03 v/cm to 100 v/cm
Signal Delay—0.25 μ sec
Calibrator—0 to 50 v square wave,
accurate within 3%, duty cycle
variable 2% to 98%

Time Base Range

0.1 μ sec/cm to 0.01 sec/cm,
continuously variable, accurate
within 5%
Single, triggered, or recurrent sweeps
5x sweep magnifier
3 kv Accelerating Potential
All dc voltages electronically regulated

Type 514-AD—\$950 • Type 514-A (without delay network) \$900

Prices f.o.b. Portland, Oregon

Write for complete specifications



TEKTRONIX, Inc.

P. O. Box 831B, Portland 7, Oregon • Cable: TEKTRONIX

Industrial Engineering Notes*

NEW FREQUENCY DEVIATION METER DEVELOPED BY BUREAU OF STANDARDS

The National Bureau of Standards has announced the development of a new and comparatively simple frequency deviation meter which reportedly indicates the deviations of a signal from a reference frequency to better than 0.5 per cent. The meter was developed by Norris Hekimian of the NBS Central Radio Propagation Laboratory. The Bureau has reported that the meter performs the same function as the "tuning eye" on some radio receivers but with enough precision to be used in the laboratory or as part of the production inspection procedure in a manufacturing operation. A report on the frequency deviation meter will appear in the July issue of the NBS Technical News Bulletin.

RTMA ACTIVITIES

At the 29th annual convention the Board of Directors approved a reorganization plan for submission to the membership and elected Director R. C. Sprague as Chairman and Glen McDaniel as temporary President pending the selection of a full-time paid president. The plan provides for two committees of the Board: a Radio-Television Industry Committee and an Electronics Industry Committee, and a change in the name of RTMA to the Radio-Electronics-Television Manufacturers Association. . . . The RTMA Engineering Department has recently made a Linearity Chart available for television studio use. This chart, prepared by the TR-4.4 Committee on Studio Facilities, permits an accurate adjustment of scanning circuit linearity for camera chains, and other checks in television studio maintenance. The chart is similar in size to the well-known Resolution Chart. In a smaller size it appears also in a "Standard on Electrical Performance Standards, Television Studio Facilities," now being printed. The large charts are available from the RTMA Headquarters in Washington at \$2.00 for a single copy and \$1.00 each for additional copies. . . . The Joint Technical Advisory Committee has submitted a report to the Federal Communications Commission on engineering questions relative to land mobile radio channel splitting. The questions were posed originally in July 1951 by Wayne Coy when he was Chairman of the FCC. In submitting the report to FCC Chairman R. H. Hyde, JTAC Chairman Ralph Bown pointed out that an industry subcommittee, headed by F. T. Budelman, has been working hard on the problems posed ever since they were submitted and has made both theoretical studies and laboratory and field tests. The report suggests two alternative plans for splitting to increase the number of nominal channels in the present 152-164 mc bands for land mobile service. Some suggestions for the 350-460 mc band also are made, along with detailed reasons why FM is preferred to other modulation methods for land mobile use. . . .

* The data on which these NOTES are based were selected by permission from *Industry Report* issue of June 22 and 29 and July 3 and 10, published by the Radio-Television Manufacturers Association, whose helpfulness is gratefully acknowledged.

(Continued on page 69A)

NOW!

for the first time Collins Precision Oscillators Are Available to Industry

YES, now you can get Collins precision oscillators long famous for their accuracy and stability, as complete packages for incorporation into your own designs. Collins oscillators give your transmitters, receivers, frequency standards, or test equipment superior stability and accurate linear dial calibration.

Collins permeability-tuned variable-frequency oscillators are sealed against atmospheric changes. Temperature compensated and mechanically stable.

Output frequency is essentially independent of environment.

Calibration is linear.

The following performance characteristics are for the 70E-12 — a typical Collins oscillator:

Frequency range, 1.955 - 2.955 mc.
Calibration accuracy, ± 750 cycles
Maximum warmup drift, 30 min.-2 hours, ± 125 cycles
RF Output, 0.5 - 2.0 v rms, 15 mmf load
Plate power, 150 v @ 12 ma
Heater power, 6.3 v @ 600 ma
Tubes, two 6BA6
Tuning rate, 100 kc/turn
Size, 2½" dia. x 6-1/16" high

Other oscillators are available as follows:

Type	Fundamental Frequency Range
70E-1	1.0-1.5 mc
70E-8	1.6-2.0 mc
70E-12	1.955-2.955 mc
70E-15	2.0-3.0 mc
70H-2	2.455-3.455 mc
70H-3	1.5-3.0 mc

For the latest electronic developments it's . . .

COLLINS RADIO CO., CEDAR RAPIDS, IOWA

11 W. 42nd St., NEW YORK 36

1930 Hi-Line Drive, DALLAS 2

2700 W. Olive Ave., BURBANK

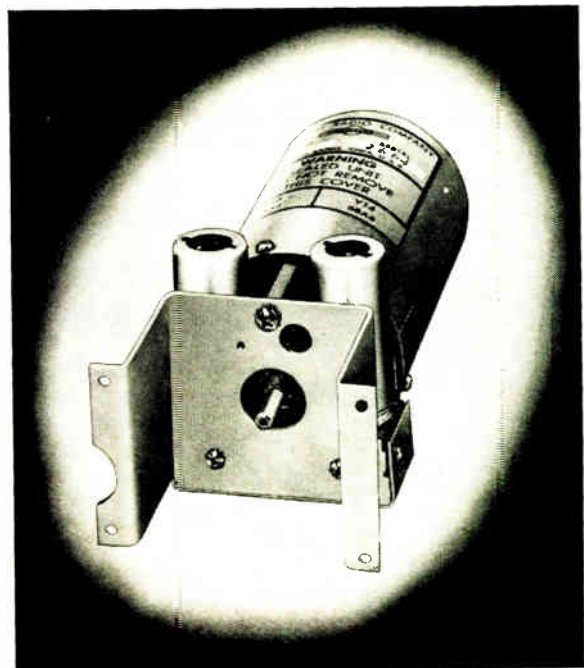

Type 70E-12 Collins oscillator.
A compact arrangement to fit your equipment.

A request on your company letterhead will bring complete information on the Collins line of oscillators for industry, plus quotations on engineering samples and production quantities.





ELECTRONIC TEST INSTRUMENTS

Read the



**... for up-to-the-minute news of
electronic developments, techniques
and instrumentation, sent regularly
without charge**

The *-hp-* Journal is an engineering periodical sent to you as another service of the Hewlett-Packard Company. It is written for engineers, by engineers. Typical papers discuss such subjects as:

- "Design notes on the RC Oscillator Circuit"**
- "Direct-Reading UHF Power Measurements"**
- "Good Practice in Slotted Line Measurements"**
- "New 100 kc Counter for Electronics and Industry"**

Articles also contain technical data, performance information and operating suggestions for *-hp-* test instruments. All issues are fully illustrated.

Write today for your free subscription

(Please give your title or position; or state if engineering student)

HEWLETT-PACKARD COMPANY

2784D PAGE MILL ROAD • PALO ALTO, CALIFORNIA, U.S.A.

SALES REPRESENTATIVES IN ALL PRINCIPAL AREAS

WORLD'S LARGEST EXCLUSIVE MANUFACTURER OF ELECTRONIC TEST INSTRUMENTS

Vacuum Tube Voltmeters - Audio Oscillators - Frequency Counters, Monitors and Standards - Audio, VHF, UHF and SHF Signal Generators - Square Wave Generators - FM and TV Broadcast Monitors - Wave and Distortion Analyzers - Slotted Lines - Tunable Bolometer Mounts - VHF Bridges - VHF Detectors - Microwave Test Equipment and Power Meters - Standing Wave Indicators - Low Pass Filters - Electronic Frequency Meters - Attenuators - Wide Band Amplifiers - Regulated Power Supplies - Electronic Tachometers - Voltage Dividers, Multipliers, Shunts - Accessories



Instruments for Complete Coverage

Industrial Engineering Notes

(Continued from page 66A)

"CELLULAR" ELECTRONICS CONSTRUCTION UNDER STUDY AT BUREAU OF STANDARDS

The National Bureau of Standards is currently investigating the problem of connecting components and tubes to printed circuit sheets. The Bureau has reported that a "cellular" assembly method proposed by P. J. Selgin of the NBS Engineering Electronics Laboratory has several interesting features which could prove advantageous in this field. In his approach to the problem, small three-contact molded blocks or cells, each containing one or two circuit elements—resistors, capacitors, inductors—are pressed against the etched circuit pattern by means of springs that are extensions of the tube socket contacts. No soldering is needed. This experimental technique is one of a number under study at the Bureau in a program, sponsored by the Navy Bureau of Aeronautics, for improving construction and maintenance of electronic equipment. A report of the "Cellular Electronic Construction" will appear in the August issue of the NBS Technical News Bulletin.

FCC ACTIONS

After considering petitions filed, including that of RTMA, the Federal Communications Commission finalized its Notice of Proposal Rule Making of Nov. 26, 1952, looking to amend Section 3.687(i)(1) of its Rules Governing Television Stations to specify, temporarily, that all emissions removed in frequency in excess of 3 mc above or below the respective channel edge shall be attenuated no less than 60 db below the visual transmitter power. Stations authorized prior to July 1 will have until July 1, 1954, to comply with this requirement but the Commission said it "believes it would be undesirable to permit additional stations to commence operation without adequate suppression of spurious emissions." The Commission, in finalizing its proposal, pointed out that this 60 db value is temporary and that, accordingly, stations should give consideration to the installation of equipment with greater attenuation than that now required. . . . The FCC also issued a Notice of Proposed Rule Making looking toward amending Section 19.3(b) of the Rules Governing the Citizens Radio Service to relax the spurious and harmonic radiation requirement by (a) providing a 40 db attenuation requirement for such emissions outside the 460-470 mc band for Class A and B station equipment operated with three watts or less, plate input power to the final radio stage, and (b) providing a less restrictive requirement of 30 db attenuation for such emissions for Class B station equipment, when operated at three watts or less, plate input power, in those cases where such radiation appears on frequencies allocated to Industrial, Scientific and Medical equipment. Interested persons may file comments on or before July 15, 1953. . . . The FCC has finalized that portion of its proposed rule-making amending Section

(Continued on page 72A)

Precision ATTENUATION to 3000 mc!

- VSWR less than 1.2 at all frequencies to 3000 mc.
- TURRET ATTENUATOR featuring "Pull - Turn - Push" action with 0, 10, 20, 30, 40, 50 DB steps.
- Accuracy $\pm .5$ DB, no correction charts necessary.
- 50 ohm coaxial circuit. Type N Connectors.

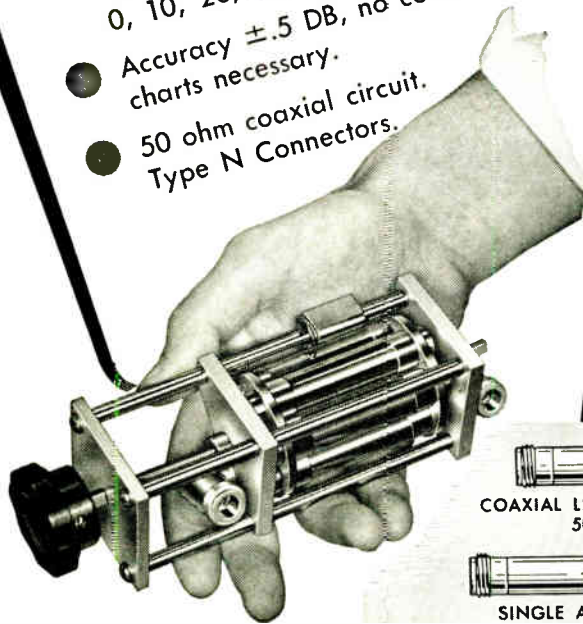

COAXIAL LINE TERMINATION
50 ohms

SINGLE ATTENUATOR PAD
50 ohms

VSWR ± 1.2 to 3000 mc.
One watt c.w. power dissipation

Inquiries are invited concerning single pads and turrets having other characteristics

STODDART AIRCRAFT RADIO CO., INC.

6644-C SANTA MONICA BLVD., HOLLYWOOD 38, CALIFORNIA
HOLLYWOOD 4-9294



At least one of your interests is now served by one of IRE's 21 Professional Groups

Each group publishes its own specialized papers in its *Transactions*, some annually, and some bi-monthly. The larger groups have organized local Chapters, and they also sponsor technical sessions at IRE Conventions.

Airborne Electronics (G 11)	Fee \$2
Antennas and Propagation (G 3)	Fee \$4
Audio (G 1)	Fee \$2
Broadcast & Television Receivers (G 8)	Fee \$2
Broadcast Transmission Systems (G 2)	Fee \$2
Circuit Theory (G 4)	Fee \$2
Communication Systems (G 19)	Fee \$2
Component Parts (G 21)	Fee to be set
Electron Devices (G 15)	Fee \$2
Electronic Computers (G 16)	Fee \$2
Engineering Management (G 14)	Fee \$1
Industrial Electronics (G 13)	Fee \$2
Information Theory (G 12)	Fee \$2
Instrumentation (G 9)	Fee \$1
Medical Electronics (G 19)	Fee \$1
Microwave Theory and Techniques (G 17)	Fee \$2
Nuclear Science (G 5)	Fee to be set
Quality Control (G 7)	Fee \$2
Radio Telemetry & Remote Control (G 10)	Fee \$1
Ultrasonics Engineering (G 20)	Fee to be set
Vehicular Communications (G 6)	Fee \$2

IRE Professional Groups are only open to those who are already members of the IRE. Copies of Professional Group *Transactions* are available to non-members at three times the cost-price to group members.



The Institute of Radio Engineers
1 East 79th Street, New York 21, N.Y.

USE THIS COUPON

Miss Emily Sirjane
IRE—1 East 79th St.
New York 21, N.Y.

PG 8 53

Please enroll me for these IRE Professional Groups

..... \$
 \$
 Name
 Address
 Place

Please enclose remittance with this order.

Professional Group on Aeronautical and Navigational Electronics

Although radio communications early became an essential factor in aircraft development, perhaps one of the most dramatic and specialized fields of present-day radio-electronic progress has been *airborne electronics*.

Partly due to the war-time secrecy necessary, the Professional Group on Airborne Electronics was the eleventh formed by IRE members. But, it is a particularly clean-cut example of the need for Professional Groups, and the value the groups can render to members. The problems presented called for a high degree of specialization—yet they were essentially *radio* techniques—from servomechanisms to radar, and from communications to computers and guided missiles.

The Dayton IRE Section introduced its own specialized conference on Airborne Electronics in 1946, which has now become the National Conference of the Group. This Conference publishes a very complete and printed "Proceedings" annually, in book form. The Group also publishes four *Transactions* and *Newsletters* a year in co-operation with the IRE Editorial Department, and it sponsors full technical sessions at other Conferences, and notably at the Annual IRE National Convention, the papers from which comprise a major share of Part I of the Convention Record.

The group has grown rapidly, and now has 1315 members in all parts of the country. It is developing some interesting local Chapters.

One very favorable outcome of the development of this Professional Group is that it is tending to accelerate the coordination between air frame design and electronic design in this field—to the obvious benefit of both. It has also drawn together into one Group, through practical engineering necessity, engineers working in sometimes widely separated fields: propagation theory, navigational aids, servomechanisms, etc.

W. R. G. Baker
Professional Group Chairman

SUPERIOR PERFORMANCE

On 3 Cycles to 20 Megacycles

The LA-239 C Oscilloscope

DATA

1. Wider Bandwidth: Complex waves from 5 Cycles to 15 Megacycles. Sine waves from 3 Cycles to 20 Megacycles.

2. Extended Sweep Frequencies: Linear from 10 Cycles to 20 Megacycles internally synchronized. Triggered sweep, from single random impulses to irregular pulse-intervals up to as high as 6 Megacycles.

3. Square Wave Response: Rise time 0.042 Microseconds; only 5% droop on flat-topped pulses as long as 30,000 Microseconds duration.

4. Greater Stability: Electronically regulated power supplies throughout to maintain accuracy and constant operation under varying line conditions or line surges. You can display surges on the line from which Model LA-239C is being powered without distortion of the trace!

5. Higher Signal Sensitivity: Maximum sensitivity without Probe: 10.4 millivolts. With Probe: 100 millivolts. (Maximum signals, 125 V. Peak and 450 V. Peak respectively.)

6. Timing Markers: Interval Markers of 0.2; 1; 5; 20; 100; 500; or 2,000 Microseconds may be superimposed on the trace for the accurate measurement of the time base.

7. Voltage Calibration: Signal amplitude is compared against a 1,000 cycle square wave (generated internally) the amplitude of which is controlled by a step-and-slide attenuator calibrated in peak volts. (A jack is provided to deliver 40V Peak for use in calibrating other instruments.)

8. Sweep Delay: Any portion of the sweep longer than a 10 Microsecond section may be expanded by 10:1 for detailed study of that portion of the signal.

9. Power Source: 110 to 130 V AC; from 50 to 1,000 cycles, 295 Watts. (Fused at 4 Amperes.)

10. Dimensions: In Bench Cabinet: 19½ in. Wide; 15¼ in. High; 16¾ in. Deep. In Rack Mounting (With cabinet removed to fit standard relay rack): 19½ in. Wide; 14 in. High.

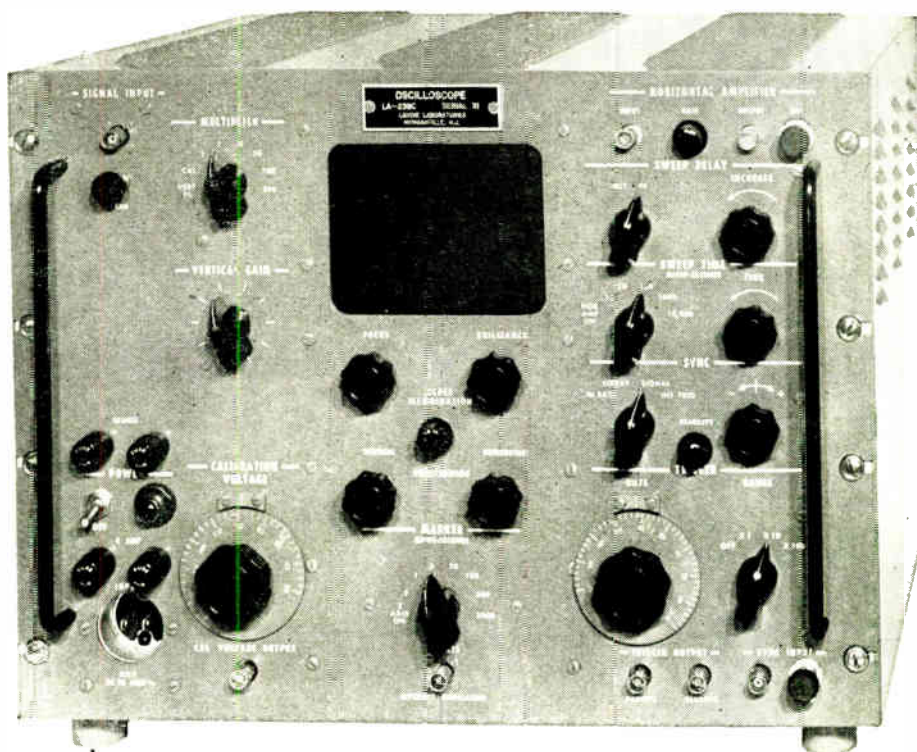

THE LAVOIE MODEL LA-239C has been designed to surpass the high performance of the TS-239A/UP, which has been the standard test oscilloscope for the Armed Services since its introduction. Model LA-239C is the result of a long period of research and development which has included the study of new tubes, new circuits, and new techniques. Rugged design has been combined with functional simplicity to produce an instrument as attractive as it is efficient.

To create a circuit that will produce a certain complex wave form, or study transients and pulse phenomena, no better precision instrument is available today.

Lavoie Laboratories take pride in offering this precision oscilloscope as the combination of engineering perfection and manufacturing skill.



Lavoie Laboratories, Inc.
MORGANVILLE, NEW JERSEY

DESIGNERS AND MANUFACTURERS OF ELECTRONIC EQUIPMENT

(Continued from page 69A)

9.446 of the Aeronautical Rules to enlarge the scope of service of aeronautical operational fixed stations, now authorized primarily for link or control circuits, to include other aeronautical fixed operations, effective July 31, 1953. The Commission also issued a Notice of Proposed Rule Making looking toward amending Parts 10, 11, and 16 of its Rules so as to effectuate the assignment of frequencies in the band 450-460 mc for use by the Public Safety Industrial and Land Transportation Radio Services. . . . RCA and its broadcasting subsidiary, NBC, has petitioned the FCC to adopt the NTSC color TV standards as the NTSC prepared to file its own petition immediately after its meeting July 21. In a 697-page petition, RCA and NBC stated that the RCA system, based on the NTSC standards, meets all the criteria established by the FCC for a satisfactory color television system and pointed out that color programs broadcast on these standards can be received in black-and-white on the millions of sets now in use without any adjustments or additions. Dr. W. R. G. Baker, Chairman of the NTSC, announced following an NTSC meeting recently in New York that all recent technical problems, including that of amateur band interference, had been resolved and that the NTSC would meet again on July 21 to finalize its work on the proposed color standards. Following this the NTSC will immediately file its petition with the FCC, he said. When the FCC adopts the proposed color standards, the petition states, RCA and NBC will: 1. expedite production of color receivers, tri-color tubes, and broadcasting and studio equipment for sale to the public, to television manufacturers and to broadcasters. 2. Commence broadcasting compatible color television programs which NBC will offer to commercial sponsors and its affiliated stations throughout the United States. (Already, 41 independent stations affiliated with NBC have agreed to a prompt start in broadcasting network color programs and others are planning to do the same.) Officials of the FCC had no formal comment on the RCA-NBC petition, but there were strong indications that the Commission would take no action on the RCA petition, other than perhaps to invite comment, until after it receives the petition of NTSC. Meanwhile, other manufacturers may file similar petitions, it was reported.

MOBILIZATION

President Eisenhower issued an Executive Order recently abolishing the Office of the Telecommunications Advisor to the President and vesting its activities in the Director of Defense Mobilization. The post of Telecommunications Advisor had been created by President Truman under Executive Order 10,297 in October 1951. Under the new order, all "records, property, personnel and funds held, used, employed, available, or to be made available in connection with the functions vested in the Telecommunications Advisor . . . shall be transferred, consonant with law, to the Office of Defense Mobilization."

(Continued on page 73A)

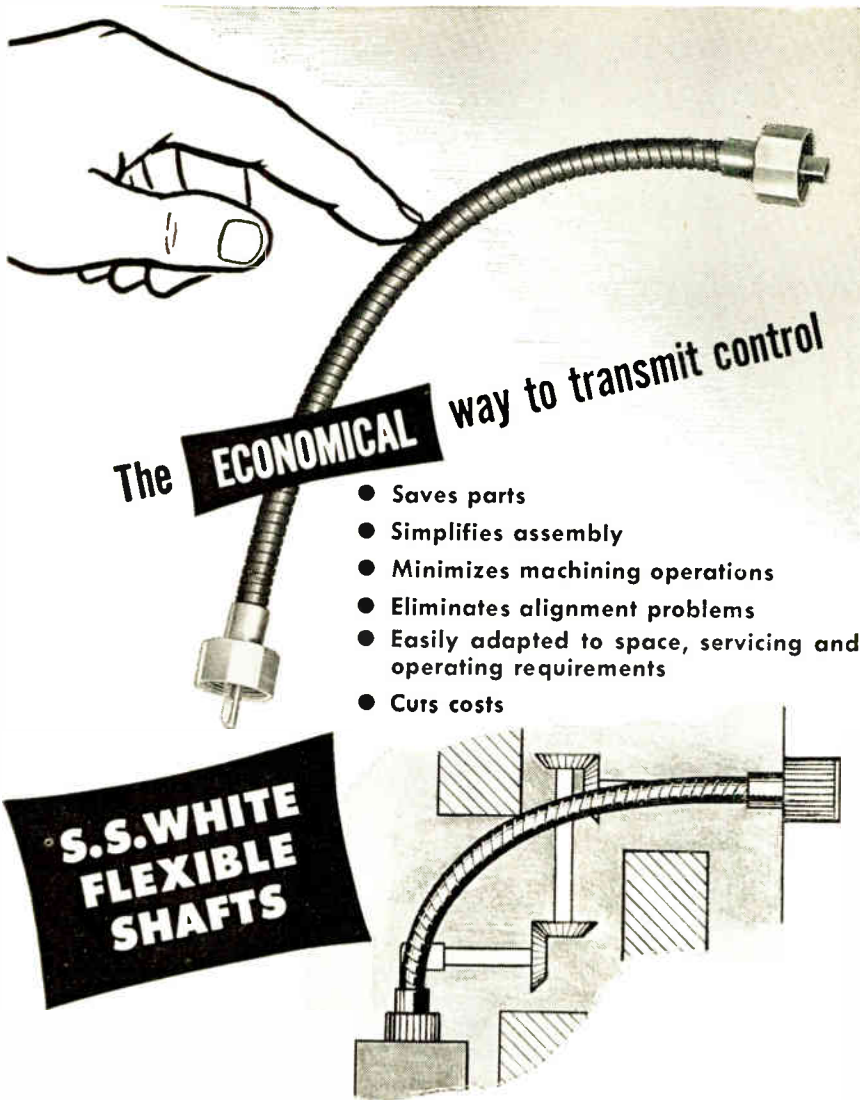

The **ECONOMICAL** way to transmit control

- Saves parts
- Simplifies assembly
- Minimizes machining operations
- Eliminates alignment problems
- Easily adapted to space, servicing and operating requirements
- Cuts costs

**S.S. WHITE
FLEXIBLE
SHAFTS**

It only takes a single S.S.White flexible shaft to provide an efficient, smooth operating control linkage between any two parts, regardless of curves, obstacles or distance. Compare this to the systems of belts and pulleys—universal joints—or solid shafts and bearings that might otherwise have to be used—systems that call for extra care in alignment, machining, and assembly time. The advantages are obvious and most important in electronic equipment design. With S.S.White flexible shafts you need fewer parts, can simplify assembly, and improve product performance at far less cost.

S.S.White remote control flexible shafts come in a large selection of sizes and characteristics to meet almost any control requirement. Let S.S.White engineers assist you in working out details. There's no obligation.

Write for the Flexible Shaft Handbook. This 256-page handbook has full details on flexible shaft selection and application. Copy sent free if requested on your business letterhead.



THE S.S. White INDUSTRIAL DIVISION
DENTAL MFG. CO.

Dept. G, 10 East 40th St.
NEW YORK 16, N. Y.

WESTERN DISTRICT OFFICE: Times Building, Long Beach, Calif.

Industrial Engineering Notes

(Continued from page 72A)

FEDERAL PERSONNEL

Raymond H. Folger, New York, was confirmed recently as Assistant Secretary of the Navy. President Eisenhower nominated Lewis L. Strauss, New York financier, to be Chairman of the Atomic Energy Commission, succeeding Gordon Dean, whose resignation was effective June 30. . . . Commissioner George E. Sterling, who took office on January 2, 1948, as a member of the FCC, recently celebrated his 30th year in government service. He entered the federal service as a radio inspector in the Bureau of Navigation, Department of Commerce, in 1923, later transferring to the Radio Division, Department of Commerce. In 1927, he moved to the Federal Radio Commission, following its organization, and in 1934 to the FCC when it replaced FRC.

NAVAL ORDNANCE LAB REPORT COVERS NEW MAGNETIC ALLOY

The Naval Ordnance Laboratory has released a report covering the "Fabrication and Properties of 16-Alfenol—a Non-Strategic Aluminum-Iron Alloy." The report includes information on the methods of fabricating 16-Alfenol, an aluminum-iron alloy containing 16 per cent aluminum, from cast slab to thin gage type and gives magnetic data from a limited number of heat-treated laminated cores. The material reportedly exerts extremely low anisotropy which "should be excellent for applications requiring nondirectional magnetic properties." Despite the low anisotropy of 16-Alfenol the BH loop is reported to be very rectangular, a property which has proven "beneficial in applications such as magnetic amplifier cores."

INDUSTRY STATISTICS

Television set production during the first five months of this year topped all previous January-May periods on record, according to a report issued recently by the RTMA Statistical Department. Radio Output for the period was more than 1.6 million sets above the same five months of 1952. During the first 21 weeks of this year, 3,309,757 television sets and 6,102,711 radios were manufactured, according to the report. In 1952, a total of 1,957,083 TV receivers and 4,469,432 radios were produced in the same period.

TELEVISION

The FCC ruled recently that theater television should be a common carrier operation on frequencies already allocated to the common carrier service and finds no necessity for a separate allocation for frequencies for theater television, thus concluding the proceedings by various organizations in the motion picture industry. . . . By agreement between the United States and Mexico, television channel assignments have been arranged. Twelve television channels between 50 and 216 mc along the border have been established, and within an area of 400 kilometers (250 miles) in width on either side of this border.

(Continued on page 74A)

BEST ALL-AROUND TESTER ON THE MARKET

USE IT FOR

- TV SETS
- RADIOS
- TRANSMITTERS
- BROADCASTING EQUIPMENT
- HOME APPLIANCES
- TWO-WAY RADIO COMMUNICATIONS SYSTEMS
- PHONE LINES
- AIR CONDITIONING SYSTEMS
- STARTER CONTROLS
- AUTO IGNITIONS, GENERATORS, BATTERIES
- MOVIE EQUIPMENT
- PANEL INSTRUMENTS
- TV CAMERAS
- AUTO LIGHTING SYSTEMS
- GENERATORS
- VOLTAGE SOURCES
- "HAM" RADIO EQUIPMENT
- CABLES
- CONNECTORS
- AUDIO FREQUENCY SOUND CURRENTS

and write for your complimentary copy of 1001 Uses for the Simpson Model 260 34 pages of uses.

RANGES

20 OHMS PER VOLT DC
1.0 OHMS PER VOLT AC
VOLTS AC AND DC: 2.5, 10, 40, 200, 1,000, 1,000
OUTPUT: 2.5, 10, 50, 250, 1,000
MILLIAMPERES, DC: 10, 100, 500
MICROAMPERES, DC: 100
AMPERES, DC: 10
DECIBELS (5 RANGES): -12 TO +55 DB
OHMS: 0-2000 (17 OHMS CENTER), 0-200,000 (1,200 OHMS CENTER), 0-20 MEGOHMS (120,000 OHMS CENTER)



Simpson
Model 260
VOLT-OMM-MILLIAMMETER

130.95 Dealer's net.

SIMPSON ELECTRIC COMPANY

2200 W. Range St., Chicago 44, Illinois U.S.A.

World Radio History

In Canada: Best-Simpson Ltd., London, Ont.

It pays to check **TEFLON*** for non-porosity

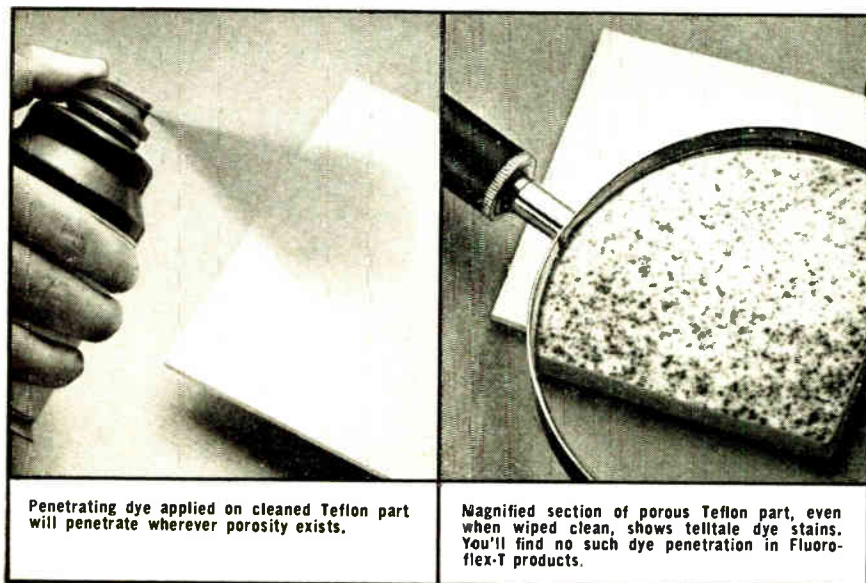

Penetrating dye applied on cleaned Teflon part will penetrate wherever porosity exists.

Magnified section of porous Teflon part, even when wiped clean, shows telltale dye stains. You'll find no such dye penetration in Fluoroflex-T products.

Assure dielectric stability in parts
by using non-porous **FLUOROFLEX®-T**

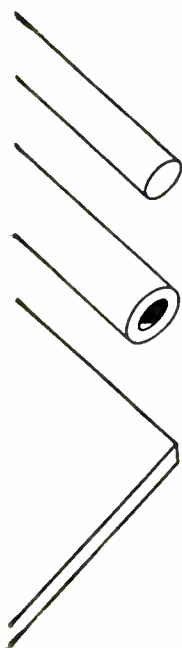

Porosity detracts from any insulating material — even from a virtually perfect UHF dielectric such as Teflon. How can you tell whether Teflon has porosity? By a penetrating colored dye test. Clean the part, apply dye, wipe off. When magnified, absorbed spots of dye can be plainly seen.

Put Fluoroflex-T products to the test and you won't find any penetration in either rod, tube, or sheet. For two reasons: (1) Teflon powder is extruded or molded on equipment especially designed to compact it to the critical density. This not only prevents porosity but also provides highest tensile strength. (2) Normal discolorations in Teflon are left unbleached to retain this optimum density.

That's why you can always count on Fluoroflex-T for electrical stability in severest use. Stress-relieved, it is also dimensionally stable and machines properly with minimum rejects. Write for Bulletin FT-19.

*DuPont trade mark for its tetrafluoroethylene resin.

© Resistoflex trade mark for products from fluorocarbon resins.

RESISTOFLEX corporation

Belleville 9, N. J.

SPECIALY ENGINEERED FLEXIBLE RESISTANT PRODUCTS FOR INDUSTRY

Industrial Engineering Notes

(Continued from page 73A)

All station assignments will have, through the agreement, an effective radiated power not in excess of 100 kw for channels 2, 3, 4, 5, and 6; and no more than 325 kw for channels 7, 8, 9, 10, 11, 12, and 13. A copy of the text of the agreement between the two countries can be obtained from the FCC by referring to memo No. 91303. . . .

For the purpose of aiding the FCC in processing TV applications, promoting the extension of TV service, and insuring that all persons have a fair and equal opportunity to apply for availability facilities, the FCC issued a Notice of Proposed Rule Making recently which would (1) require local advertising of all initial applications for new television stations, and (2) provide a cut-off of 30 days from the publication after which no competing applications would be accepted in opposition to the TV applications so advertised. An applicant for a new TV station would have to give public notice of his application by publishing that fact, at least once a week for two weeks immediately following his filing, in a local newspaper of general circulation in the community in which the requested TV channel has been assigned. No action would be taken for a 30-day period, and if no competing application is filed within that time and the applicant otherwise qualifies, his application would be eligible for a grant after the 30-day period. . . . The FCC released a public notice recently on the reception by television receivers of signals of amateurs operating in the 21 mc band. It was pointed out that on May 1, 1952, the Commission's transfer of the 21 mc band to the Amateur Radio Service was completed and that "in some instances interference to television broadcast reception may often be due to the fact that certain post-war television receivers now in use by the public use an intermediate frequency in the amateur 21 mc band." The FCC statement continued: "The Commission has carefully studied this problem and has determined that interference that may be received by television receivers which use an intermediate frequency in the amateur 21 mc band from amateur operation in that band is due principally to characteristics in the design of the television receivers. In many cases such interference can be cured by simple and inexpensive means. The Commission expects that amateur station licensees will cooperate with the owners of the receivers in determining the actual cause of interference to television reception appearing to result from amateur operation in the 21 mc band. Moreover, amateur licensees will be required to correct any of their operations contrary to Commission Rules which may contribute to the interference. The Commission cannot, however, hold amateur licensees operating in the 21 mc band responsible for remedying such interference if such amateurs are complying with all of the applicable rules and regulations of the Commission; this is in accordance with the policies already established with respect to other authorized services. Attention is also called to the fact that about 300 Television Interference (TVI)

(Continued on page 76A)

H-16 CHECKS the CHECKER

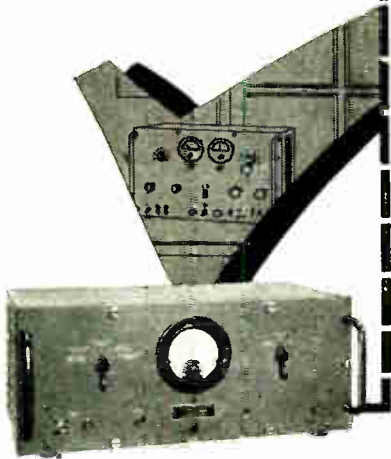

ARC Type H-16 **STANDARD COURSE-CHECKER**

For Omni Signal Generators

■ This newly developed instrument is a means for checking precisely the phase-accuracy of the modulation on VOR (Omnirange) Signal Generators. Now that the use of omnirange receivers and signal generators is so widespread, it is necessary to have a means of measuring the phase differences between the 30 cps envelope of the 9960 \pm 480 cps reference modulation, and of the 30 cps variable modulation when that difference is required to be 0, 15, 180 or 195 degrees.

■ An important feature of the H-16 is a built-in self-checking circuit to insure .1 degree accuracy. Errors may be read directly on a 3-inch meter, calibrated to read \pm 4 degrees.

Write for detailed specifications



Dependable Airborne
Electronic Equipment
Since 1928

Aircraft Radio Corporation
BOONTON NEW JERSEY

FASTER TUBE TESTING!

New New New

Now! fast testing in Plate Conductance with convenient ohms readings for leakage and shorts with the new Simpson Model 1000

- tests any tube—including 9 pin miniatures and subminiatures—for plate conductance. Dial shows percentage of rated plate conductance for more positive, accurate results.
- tests are made under conditions simulating actual use in radio, TV, hearing aids and other electronic circuits.
- gives you reliable short tests because the Simpson 1000 quickly and conveniently shows you the exact ohms values for inter-element leakage and tube shorts.
- Simpson's roll chart service makes a new roll chart available each year and complimentary roll chart supplements are provided at regular intervals.
- and—the Simpson 1000 is as handsome as it is useful. Front panel is finished in non-glare grey hammerloid. Rich burgundy carrying case looks like expensive luggage. Comes complete with Operator's Manual—all for only \$135.00, net.

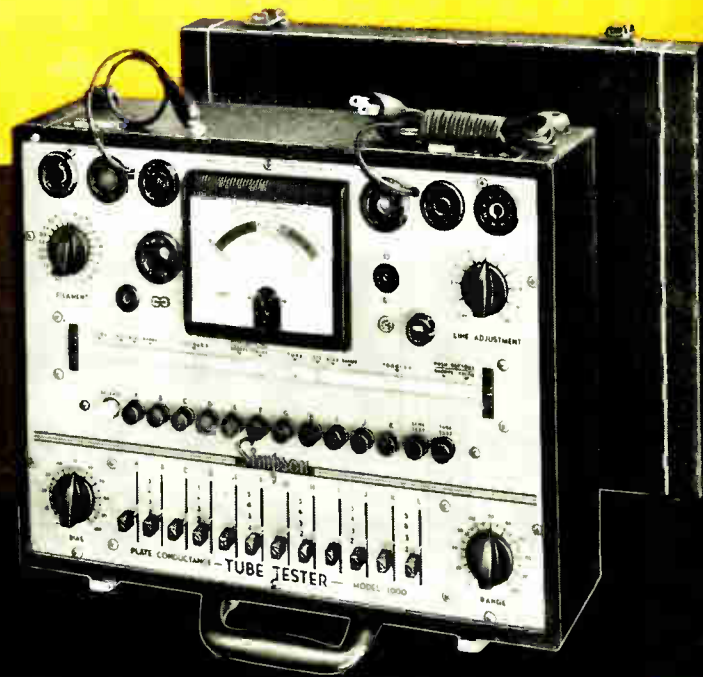

Simpson MODEL 1000

SEE IT AT YOUR PARTS JOBBER

SIMPSON ELECTRIC COMPANY

5200 West Kinzie Street, Chicago 44, Illinois
Estebrook 9-1121

World Radio Inc. IN CANADA: Bach-Simpson, Ltd., London, Ontario

(Continued from page 74A)

... Complete line of
Microwave Components
from magnetron to antenna...
designed and produced by experts-



WAVEGUIDE SWITCH

A complete line: compact, rugged, suitable for military usage; VSWR less than 1.10; crosstalk greater than 50 Db; operation 24 v. DC, 110 v. AC; may be specially designed to meet switching problems.



DUMMY LOADS

Designed for military field operation; built to meet all standard military vibrations and shock requirements. Capable of operating at extremely high average powers.

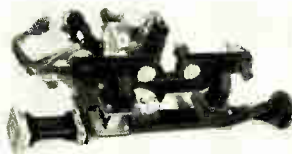

MIXER DUPLEXER

Precision-built to closest tolerances; completely tested. Designed to meet your basic requirements, or produced from your blueprints.



FLEXAGUIDE

Pressure-tight; rugged enough to meet roughest requirements; VSWR less than 1.10; attenuation equal to brass rigid guide.



COUPLERS

Complete series for all waveguide sizes. Flange combination, and waveguide or coaxial outputs. Designed to meet your particular problems.

For RIGID Waveguide Specify



Rigid Bends • Twists • Tapers • Crystal Mixers • Duplexers
Flanges • Magic Tees • Directional Couplers • Dummy Loads
Waveguide Switches • Coax Adaptors • Precision Castings
Waveguide Transformers • Quick Disconnect Clamps

For FLEXIBLE Waveguide Specify



Army and Navy Standard Waveguides
Flexible Twists • Bends • Tapers
Straight Sections • All Lengths and Sizes

Write for Catalogs

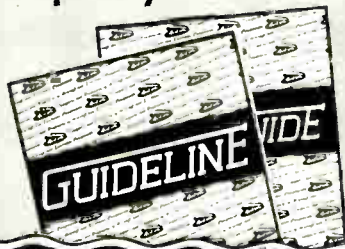

Airtron inc.
Linden, New Jersey

BRANCH OFFICES
DAYTON CHICAGO LOS ANGELES DALLAS
KANSAS CITY SEATTLE ALBUQUERQUE

Committees have already been formed in communities throughout the country to help deal with the television interference problem. These voluntary committees are composed of set owners, industry representatives and amateurs, and they have achieved encouraging results in their efforts to eliminate television interference. The Commission believes that these TVI committees will also prove helpful in solving any interference problems that may develop with respect to amateur operation in the amateur 21 mc band. . . . The FCC waived its rules recently to permit the testing of non-standard color television signals, in accordance with National Television System Committee specifications, over facilities of the National Broadcasting Co. network during the regular broadcast day, starting immediately and ending July 31, 1953. The operation is limited to non-commercial, sustaining programs. . . .

One year after the FCC again started processing applications for television stations, following the three and one-half year "freeze" on new grants, television was truly on its way to becoming a nationwide service. From July 1, 1952, when FCC again started processing applications, through July 1, 1953, the Commission approved construction permits for 381 commercial TV outlets. In addition, 18 non-commercial educational stations have received CPs, including one recently, of which KUTH, Houston, Tex. is in operation. Of the 381 commercial outlets authorized, six have returned their permits, leaving outstanding new commercial CPs at 375 on July 1. With the 108 stations which had been authorized before the freeze, the total number of stations with outstanding authorizations stood at 500 on July 1. Eight additional commercial outlets and one educational station have been approved since that time, bringing the current total to 509. As of July 10, every state in the Union, with the exception of Vermont, has outstanding permits for TV stations. In addition, outlets have been approved for Fairbanks, Alaska; San Juan, P. R., and Honolulu, T. H. Stations now are operating, or at least have received FCC approval to go on the air, in all states which have outstanding CPs, with the exception of Montana, New Hampshire and Wyoming. The present 509 outstanding authorizations for television stations are distributed throughout 302 U.S. cities, plus the three in our territories. The 500 stations authorized on July 1 were distributed as follows, according to a release from FCC:

State	VHF	UHF	Total	No. of Cities
Alabama	3	5	8	4
Arizona	8	0	8	4
Arkansas	2	3	5	3
California	24	9	33	17
Colorado	8	2	10	4
Connecticut	4	7	11	6
Delaware	1	1	2	2
D. of C.	4	0	4	1
Florida	9	3	12	9

(Continued on page 78A)

Star Performers in Every Category

E-I SEALED TERMINALS

Specify **E-I**

Compression Type Headers, Plug-In Headers, GS Series Multiple Headers, Custom Seals to Specification, Tubular End Seals, Color Coded Terminals, High Creepage Terminals

Whatever your need, E-I can supply a Sealed Termination that exceeds requirements at a cost no higher than competitive types of lesser dependability. Over 12 years of specialization, with research, development and manufacture devoted exclusively to Hermetically Sealed Terminations insures this extra dependability in every single item shipped by E-I. For outstanding performance, faster delivery, lowest unit cost, call, write or wire your requirements to E-I today. Hundreds of Standard types, with optional features are available plus custom designs to your exact specification.

PATENT PENDING
ALL RIGHTS RESERVED

E-I... YOUR HEADQUARTERS for every type of Hermetically Sealed Termination. Write today for illustrated literature.

DIVISION OF AMPEREX
ELECTRONIC CORPORATION



ELECTRICAL INDUSTRIES

44 SUMMER AVENUE, NEWARK 4, NEW JERSEY
EXPORT AGENTS
PHILIPS EXPORT CORP., 100 EAST 42nd STREET, NEW YORK 17, N. Y.

NOW!

UHF AND MICROWAVE MEASUREMENTS MADE EASY WITH THE PRESTO MICROWAVE SECONDARY FREQUENCY STANDARD

50-11,000 MC OUTPUT

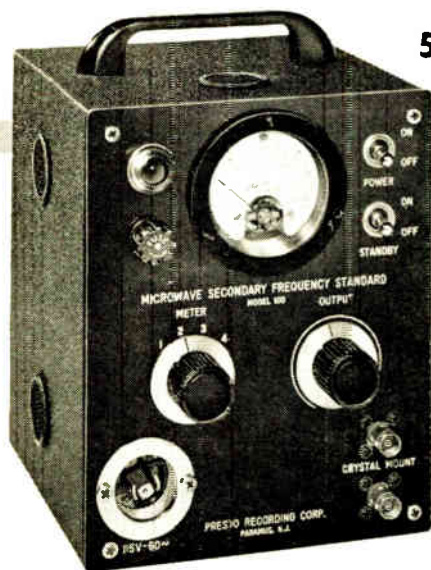

MODEL 100*

Price: \$265.00 f.o.b. factory

signals spaced every 100 and 200 mc over its complete frequency range, and a 50 mc marker output useful up to approximately 9,000 mc.

- No frequency tuning whatsoever.
- Markers every 50, 100, 200 mc.
- .005% accuracy over range.
- Lightweight and compact—8 1/2 lbs., 7 3/8" x 6" x 6 1/4".
- Military quality standard components used throughout.
- Low power consumption—60 watts.
- Operates from 115V—50-1750 cycle source.

USE IT

- To perform functions of expensive primary standards.
- To calibrate signal generators.
- To establish standard frequencies.
- To calibrate and align receivers.
- To radiate test signals for overall radar systems check.
- To provide markers for panoramic displays.

*Patent Applied For

PRESTO
RECORDING CORPORATION
PARAMUS, NEW JERSEY

SPECIALTY PRODUCTS DIVISION

Industrial Engineering Notes

(Continued from page 76A)

State	VHF	UHF	Total	No. of Cities
Georgia	6	3	9	7
Idaho	0	9	9	6
Illinois	8	11	19	12
Indiana	2	11	13	11
Iowa	4	4	8	6
Kansas	4	1	5	4
Kentucky	2	5	7	4
Louisiana	2	9	11	5
Maine	1	1	2	2
Maryland	3	3	6	3
Massachusetts	2	10	12	9
Michigan	7	12	19	13
Minnesota	7	2	9	6
Mississippi	1	4	5	4
Missouri	11	7	18	10
Montana	7	0	7	4
Nebraska	4	4	4	2
N. Hampshire	0	1	1	2
Nevada	2	0	2	1
New Jersey	1	5	6	4
New Mexico	6	0	6	4
New York	15	21	36	14
N. Carolina	3	8	11	9
N. Dakota	5	0	5	3
Ohio	12	15	27	13
Oregon	2	3	5	4
Oklahoma	3	4	7	4
Pennsylvania	9	25	34	19
Rhode Island	1	1	2	1
S. Carolina	2	5	7	5
S. Dakota	1	0	1	1
Tennessee	4	3	7	5
Texas	25	16	41	23
Utah	3	0	3	1
Virginia	5	7	12	10
Washington	7	2	9	5
W. Virginia	2	4	6	5
Wisconsin	3	7	10	7
Wyoming	2	0	2	2
Hawaii	3	0	3	1
Puerto Rico	1	0	1	1

During April and May the FCC approved construction permits for 41 new television stations, bringing the total at the end of May to 366. Special temporary authorizations were issued to 27 stations during the period, bringing the total on May 31 to 80. These were:

State and City	Permittee	Channel
Arizona Phoenix	Share-time, Maricopa BC and KOY BC	10
California Fresno	J. E. O'Neill	47
San Francisco	S. H. Patterson	32
Tulare	Sheldon Anderson	27
Connecticut Stamford	Stamford-Norwalk Television Corp.	27
Idaho Meridian	Boise Valley Broadcasters, Inc.	2
Illinois Rockford	Greater Rockford TV, Inc.	13
Indiana Ft Wayne	Northeastern Indiana BD Co., Inc.	33
Waterloo	Tri-States TV, Inc.	15
Iowa Cedar Rapids	American BD Stations, Inc.	2
Kentucky Richmond	Blue Grass TV Co.	60
Louisiana Alexandria	Barnet Benzner	62
New Orleans	Community TV Corp. CKG TV Co.	32 26
Michigan Cadillac	Sparton Broadcasting Co.	13
Minnesota Minneapolis-St. Paul	Share-time, Minn. TV Public Serv. Corp. & WMIN BC Co.	11

(Continued on page 80A)

PROOF of PERFORMANCE

Shure slender Gradient Microphones solve difficult acoustic problem

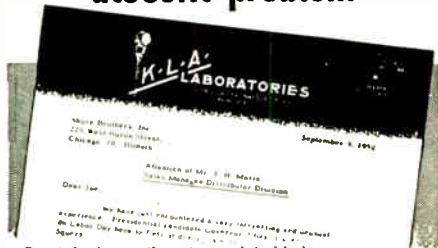

Read the interesting story printed below—as told by S. L. Almas, President of K-L-A LABORATORIES, INC., Detroit, Mich.

"We have just encountered a very interesting and unusual experience. Presidential candidate Governor Adlai Stevenson spoke on Labor Day here in Detroit during an open air meeting in Cadillac Square.

"The speech was televised coast to coast and T.V. engineers did not want a battery of microphones obscuring the speaker's face. We did not want ordinary broadcast microphones used that would cause feedback before sufficient signal was obtained to drive the public address system to the desired output.

"After due consideration, it was mutually agreed to use only two microphones for network T.V. - Radio - 5 Newsreels, two Tape Recorders, and Public Address System. We suggested two Shure Model #315 microphones, and these were used with excellent results. We received compliments galore.

"Congratulations for having designed a microphone to satisfy the demands of such varied fields of sound reproduction."



Former Governor Stevenson of Illinois, pictured as he addressed Detroit audience on Labor Day, during the 1952 presidential campaign.

"315"
GENERAL PURPOSE
LIST PRICE \$79.50

"300"
BROADCAST
LIST PRICE \$135.00

SHURE

Shure Patents Pending

SHURE BROTHERS, INC.
MICROPHONES AND ACOUSTIC DEVICES
225 W. Huron St. Chicago 10, Ill. Cable: SHUREMICRO

by every test



ATR is best!



ATR

AUTO RADIO VIBRATORS

Have Ceramic Stack Spacers

A COMPLETE LINE OF VIBRATORS

Designed for Use in Standard Vibrator-Operated Auto Radio Receivers. Built with Precision Construction, featuring Ceramic Stack Spacers for Longer Lasting Life. Backed by more than 22 years of experience in Vibrator Design, Development, and Manufacturing.

"A" Battery Eliminators, DC-AC Inverters, Auto Radio Vibrators

- ✓ NEW MODELS
- ✓ NEW DESIGNS
- ✓ NEW LITERATURE

ATR



See your jobber or write factory

AMERICAN TELEVISION & RADIO Co.

Quality Products Since 1931

SAINT PAUL 1, MINNESOTA—U. S. A.

American Beauty

makes perfect soldered connections for

SYLVANIA

RADIO and
TELEVISION SETS

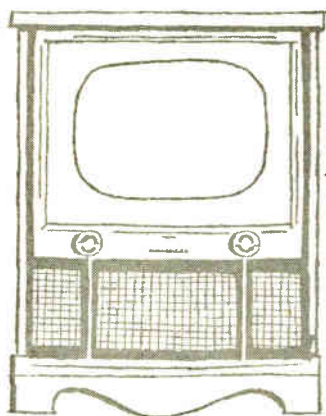

Pride of Brides for Three Generations, the famous American Beauty Electric Iron, made by the same specialists in electrical heating devices.



Build better with Solder...
Solder better with
American Beauty
Electric Soldering Irons—Since 1894

There are over 2,000 soldered connections in a good television receiver. Sylvania calls on American Beauty to help produce top quality products, maintain its reputation as a maker of expertly crafted receivers.

IN CHOOSING SOLDERING IRONS, look to the oldest, largest manufacturer in America. Look to **AMERICAN BEAUTY**, the Standard of Perfection on the world's production lines, and to these features that make **AMERICAN BEAUTY** the largest-selling of all soldering irons . . .

- **Nickel-coated, corrosion-resistant tips, easily and quickly replaced**
- **Super-flexible cord, American Beauty-made, reduces worker fatigue**
- **Heating element of chrome-nickel ribbon resistance wire**
- **Insulated with pure mica**
- **Built-in connection for ground wire**
- **Six models . . . from 50 to 550 watts**

A-106

AMERICAN ELECTRICAL HEATER COMPANY

DETROIT 2, MICHIGAN

Industrial Engineering Notes

(Continued from page 78A)

State and City	Permittee	Channel
<i>Missouri</i>		18
Cape Girardeau	KGMO Radio-TV Inc.	
St. Louis	St. Louis Educational TV Commission	
<i>Montana</i>		
Great Falls	The Montana Farmer Inc.	3
<i>New Hampshire</i>		
Keene	WKNE Corp.	45
<i>New Jersey</i>		
New Brunswick	Home News Publ. Co.	47
<i>New York</i>		
Albany	Hudson Valley BC Co.	41
Rochester	Genesee Valley TV	27
<i>Ohio</i>		
Cincinnati	Rounsaville-Clark TV Co.	54
Columbus	Ohio State U.	34
<i>Oklahoma</i>		
Miami	Miami TV Co.	58
<i>Oregon</i>		
Eugene	Eugene TV, Inc.	13
<i>Pennsylvania</i>		
Lancaster	H. C. Burke	21
Lewiston	Lewiston BC Co.	38
Pittsburgh	Metropolitan Pittsburgh Educational TV	13
<i>Rhode Island</i>		
Providence	New England TV Co. of R. I.	16
<i>South Carolina</i>		
Greenwood	Greenco Inc.	21
<i>Texas</i>		
Abilene	Reporter BC Co.	9
Harlingen	Magic Triangle Televisers, Inc.	4
Lubbock	Plains Radio BC Co.	5
<i>Virginia</i>		
Marion	Mountain Empire BC Corp.	50
<i>West Virginia</i>		
Wheeling	Tri-City BC Co.	7
<i>Wyoming</i>		
Casper	D. L. Hathaway	2
<i>Hawaii</i>		
Honolulu	American BC Stations Inc.	4



ALBUQUERQUE-LOS ALAMOS

"Patent Law," by Dr. Donald MacKenzie Sandia Corporation; April 24, 1953.

"The Neuro Calatone," by R. P. Matthews; "The Thermistor as an Amplitude Limiter Element," by M. J. Mattison, "Negative Resistance of Basalcontact Transistors; Development and Application of Transistor," by T. E. Stone and C. R. Kennedy; all Students, University of New Mexico; May 20, 1953.

Installation of new officers; June 26, 1953.

ATLANTA

"Extension of Television Coverage by Satellite Stations," by J. H. DeWitt, WSM and WSM-TV, Nashville, Tenn.; May 15, 1953.

"Remote Control of 10 K.W.F.M. Transmitter," by Ben Akerman, WGST, Atlanta; June 26, 1953.

BEAUMONT-PT. ARTHUR

"The Santa Fe Railway's Microwave Communication System," by J. L. Lee, GC & SF Railway Co.; July 20, 1953.

BINGHAMTON

Election of officers; June 25, 1953.

COLUMBUS

"Mountain Climbing Adventures," by E. M. Boone, Faculty, Ohio State University; June 16, 1953.

EMPORIUM

"Color Television Today," by Donald Fink, Philco Corporation; May 13, 1953.

"UHF Measurements and Techniques," by R. Bailey and J. W. Rush, General Electric; June 24 1953.

(Continued on page 81A)

SECTION MEETINGS

(Continued from page 80A)

HAWAII

"Underwater Sound," with equipment demonstrations, by D. L. Pang, U. S. Naval Shipyard; April 8, 1953.

Dinner meeting and nomination of officers; May 13, 1953.

"Cosmic Disturbance Studies made at Mt. Haleakala Observation Station," by Grote Reber, Research Corporation; June 10, 1953.

INYO KERN

"Magnetic Amplifiers," by O. J. M. Smith, Faculty, University of California, and Film, "And a Voice Shall be Heard"; June 22, 1953.

"Some Characteristics of Common Loud-speaker Enclosures," by J. S. Sherwin, Naval Ordnance Test Station; July 13, 1953.

PORTLAND

"The Physics of Music and Hearing," by W. E. Koch (by Tapescript), Bell Telephone Laboratories; "Practical Aspects of High Quality Tape Reproduction," by E. G. Swanson and Jack Hauser, Ampex Electric Corporation; April 14, 1953.

"Data Processing Systems for Computers," by R. L. Sink, Regional Director of Region 7; May 4, 1953.

"Transistors in Negative Impedance Circuits," by J. G. Linvill (by Tapescript), Bell Telephone Laboratories; May 21, 1953.

"Some Circuit Properties of Junction Transistors," by L. G. Schimpf, Bell Telephone Laboratories; June 23, 1953.

PRINCETON

"What Industrial Research Expects from Engineering Education," by Dr. D. H. Ewing, RCA Laboratories; April 23, 1953.

SACRAMENTO

"New Trends in Audio," by Louis Bourget, Civil Defense Communications Division; May 8, 1953.

"Some TV Studio Circuits and Practices," by Walter Berger, Station KXOA; June 26, 1953.

SAN FRANCISCO

"Semi-Conductor Electronics," by Dr. William Shockley, Bell Telephone Labs.; June 16, 1953.

TOLEDO

"Rocket Ship and Space Travel," by Prof. McClean, Ohio State University; Election of officers; June 17, 1953.

VANCOUVER

"Radio Slips by Announcers and TV in Canada," by Sam Ross, Station CKWX; June 19, 1953.

WILLIAMSPORT

"Color Television Today," by D. G. Fink, Philco Corporation; May 13, 1953.

SUBSECTIONS

CENTRE COUNTY

Noise Seminar Lecture #1 by Evan Johnson, Faculty, Pennsylvania State College; April 14, 1953.

Noise Seminar Lecture #2 by Mr. Loomis, of Haller, Raymond & Brown; April 23, 1953.

Noise Seminar Lecture #3 by Mr. Burnett, of Haller, Raymond & Brown; April 28, 1953.

Noise Seminar Lecture #4 by J. N. Warfield, Faculty, Pennsylvania State College; May 5, 1953.

"Nuclear Reactor at Pennsylvania State College," by Dr. W. M. Brezozala, Faculty, Pennsylvania State College; May 19, 1953.



Preformed Contact Finger Stock is an ideal electrical weather stripping around doors of equipment cabinets as well as being excellent for use with VHF and UHF circuitry. Silver plated, it comes in three widths— $1\frac{1}{2}$, $3\frac{1}{2}$ and $1\frac{7}{16}$ inches.

Variable vacuum capacitors come in three models, are lightweight, compact, eliminate the effects of dust and atmospheric conditions and have low inductance. Also available are eight types of fixed vacuum capacitors.

Air-system sockets, designed for Eimac tube types 4-400A, 4-1000A, 4X150A, and 4X150D, simplify cooling and assure adequate air-flow to various seals. The 4-400A socket can also be used with the 4-125A and 4-250A

radial-beam power tetrodes if desired.

HR heat dissipating connectors provide efficient heat transfer from the tube element and glass seal to the air while making electrical connections to plate and grid terminals. Precision machined from dural rod, HR connectors come in ten sizes to fit most of Eimac's internal anode tubes.

High Vacuum Rectifiers come in eight models, are instant heating, have radiation-cooled pyrovac* plates and can be operated in a variety of rectifying and voltage multiplying circuits. Also available are four types of mercury-vapor rectifiers.

* An Eimac trade name.

• For further information write our Application Engineering department

EITEL-McCULLOUGH, INC.
SAN BRUNO · CALIFORNIA
Export Agents: Frazar & Hansen, 301 Clay St., San Francisco, California



**Highly
Sensitive
Extremely
Stable**

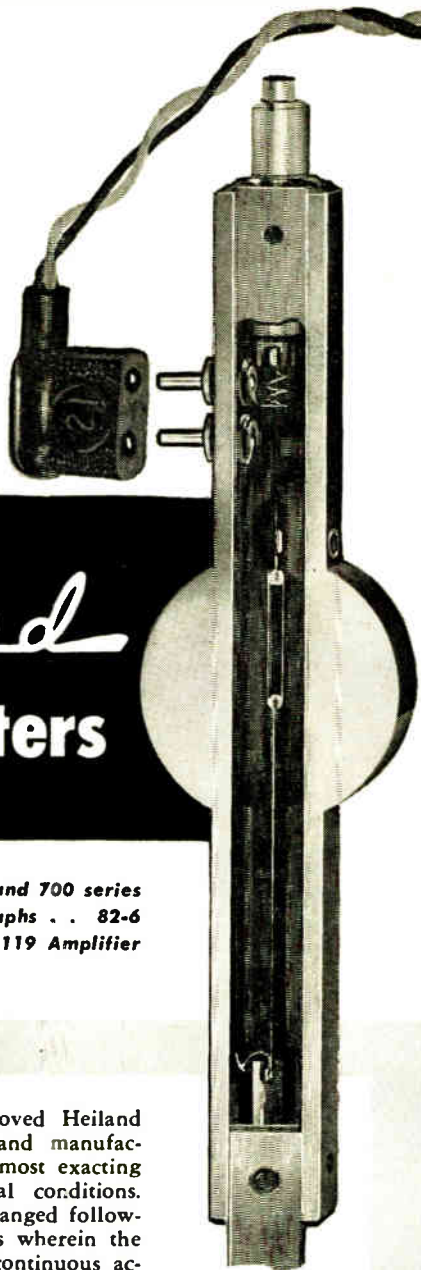

Heiland Galvanometers

For use with Models 401, 500 and 700 series
Heiland Recording Oscillographs . . . 82-6
Bridge Balance Units . . . Model 119 Amplifier
Systems.

These new and greatly improved Heiland Galvanometers are designed and manufactured to stand up under the most exacting operational and environmental conditions. All characteristics remain unchanged following prolonged production tests wherein the galvanometer is subjected to continuous accelerations in excess of 125g. Zero drift in most Heiland Galvanometer types will not exceed $.001^{\circ}/^{\circ}\text{F}$ even in unheated magnet blocks. A standard balance of $.010^{\circ}/\text{g}$ is supplied in all galvanometer types at no additional charge. Heiland Galvanometers are available in natural frequencies of 40 to 3300 cps. and sensitivities such that only a few microamperes provide full scale deflection. Heiland Galvanometers can be supplied in both electrically and fluid damped types. In the fluid damped types there is absolutely no loss of damping fluid due to "creep" or spilling regardless of temperature, altitude, position and acceleration in excess of 125g.

Other Features Include . . .

- Solid case construction
- Completely dustproof
- Rotational limit stop
- Improved connector terminal
- Horizontal and vertical adjustment is rapid and simple
- Investigate our exchange plan on this new and improved galvanometer

Write or wire for further details and catalog . . .

Heiland Research Corporation

130 EAST FIFTH AVENUE • DENVER 9, COLORADO

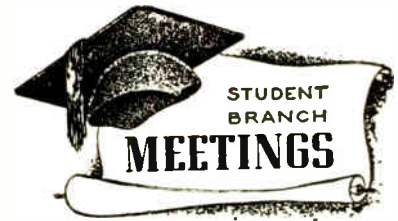

DREXEL INSTITUTE OF TECHNOLOGY,
IRE-AIEE BRANCH

"Transistors," by Frank Kiper, Philco Corporation; July 1, 1953.

NORTHEASTERN UNIVERSITY, IRE-AIEE BRANCH

Field trip to Salem Harbor Station, New England Power Company; July 10, 1953.

UNIVERSITY OF WASHINGTON, IRE-AIEE BRANCH

Film, "Atom Bomb Test at Bikini"; May 26, 1953.



The following transfers and admissions were approved and will be effective as of September 1, 1953:

Transfer to Senior Member

- Anderson, W. C., 56 Sound View Dr., Greenwich, Conn.
- Barron, F. E., 501 Old Farm Rd., Pittsburgh 34, Pa.
- Baumgartner, W. S., 616 S. Orange Ave., Monterey Park, Calif.
- Beers, R. A., 325 W. Graisbury Ave., Audubon 6, N. J.
- Bertie, C. E., 1828 Elizabeth Ave., Winston-Salem, N. C.
- Bliss, G. B., 603 N.W. 10 Ave., Gainesville, Fla.
- Bundy, R. C., Dept. 104, Hughes Aircraft Company, Tucson, Ariz.
- Burr, R. P., Hazeltine Corporation, 58-25 Little Neck Pkwy., Little Neck, L. I., N. Y.
- Coundjeris, A., 34-20-71 St., Jackson Heights, L. I., N. Y.
- Eckert, J. P., Jr., 2300 W. Allegheny Ave., Philadelphia 29, Pa.
- Etkin, H. A., 2 Midwood Lane, Levittown, Pa.
- Feldt, R., 875 W. 181 St., New York 33, N. Y.
- Forstall, E. L., 1500 Flat Rock Rd., Penn Valley, Narberth P.O., Pa.
- Gliniski, G., 14 Dunvegan Rd., Ottawa, Ont., Canada
- Goodman, R. M., 9355 Annapolis Rd., Philadelphia 14, Pa.
- Greene, H. A., Jr., 125 Alberta Ave., San Carlos, Calif.
- Greenwood, J. H., Radio Station WCAE, Inc., 530 Carlton House, Pittsburgh 19, Pa.
- Hansen, E. L., 224-04-93 Rd., Queens Village 8, L. I., N. Y.
- Herz, A. J., 22 W. Monroe St., Chicago 3, Ill.
- Huggins, R. A., Huggins Laboratories, 700 Hamilton Ave., Menlo Park, Calif.
- Hulick, H., Jr., Radio Station WPTF, Insurance Bldg., Raleigh, N. C.
- Husten, B. F., National Bureau of Standards, Corona, Calif.
- Katz, L., 1760 Silverlake Blvd., Los Angeles 26, Calif.
- Lane, C. R., 166 Green Hill Rd., Westwood, Mass.
- Latour, M. H., 1124 N.W. 14 Ave., Gainesville, Fla.
- Lybarger, S. F., 306 Beverly Rd., Pittsburgh 16, Pa.

(Continued on page 84A)

4 mmf/ft



AIR-SPACED ARTICULATED CO-AX CABLES

offer a unique combination of

- ✓ FRACTIONAL CAPACITANCE
- ✓ HIGH IMPEDANCE
- ✓ MINIMUM ATTENUATION
- ALONG WITH
- ✓ EXCEPTIONAL FLEXIBILITY
- ✓ LIGHT WEIGHT

38 STOCK TYPES

FOR ANY OF YOUR STANDARD OR SPECIAL APPLICATIONS

A few of the very low capacitance types are:

Type No.	Capacitance $\mu\text{f}/\text{ft}$	Impedance ohms	O.D.
C.44	4.1	252	1.03"
C.4	4.6	229	1.03"
C.33	4.8	220	0.64"
C.3	5.4	197	0.64"
C.22	5.5	184	0.44"
C.2	6.3	171	0.44"
C.II	6.3	173	0.36"
C.I	7.3	150	0.36"

WE ARE SPECIALLY ORGANIZED TO HANDLE DIRECT ORDERS OR ENQUIRIES FROM OVERSEAS
SPOT DELIVERIES FOR U.S.
BILLED IN DOLLARS—SETTLEMENT BY YOUR CHECK CABLE OR AIRMAIL TODAY

TRANSRADIO
LTD.
CONTRACTORS TO
H.M. GOVERNMENT

138A CROMWELL RD., LONDON, S.W.7
ENGLAND

CABLES: TRANSRAD LONDON

Specialists in Magnetic Materials

Standard Designs—Special Shapes



Permanent Magnets

Magnet Design—Bulletin 151. Written for the design engineer. Covers application, properties, design problems and testing of permanent magnets.

Standard Magnets—Catalog SM-1252. Complete data with dimensional drawings of standard magnets offered from stock for working models, small requirements, without special tooling.

Core Materials

Laminations—Bulletin L-752. Data on stamped silicon-iron laminations covering material applications, general specifications, typical value graphs. Also covers T & S OrthoSil oriented materials.

Wound Cores—Bulletin WC-353. New bulletin describing T & S Wound "C" and Toroidal Cores. Complete with specifications and value graphs.

Select the bulletin or catalog you need—write Thomas & Skinner today.



THOMAS & SKINNER Steel Products Company, Inc.

1125 EAST 23RD STREET, INDIANAPOLIS 7, IND.



Bulletin
151



Catalog
SM-1252



Bulletin
L-752



Bulletin
WC-353

Try Remler for Service-Tested
"Hard-to-Get" Components

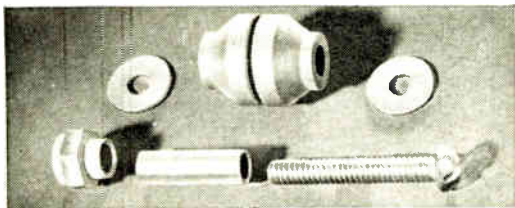

SILASTIC RUBBER SHOCK MOUNTS

① Ideal for sub-panel mounting. Isolates tubes from shock and vibration. Mount retains compliance from minus 70° to plus 480°F. Invaluable for military and airborne equipment.

Custom Components
Metal-plastic components designed and manufactured to order. Write for quotations specifying electrical and mechanical characteristics. Describe application. No obligation.

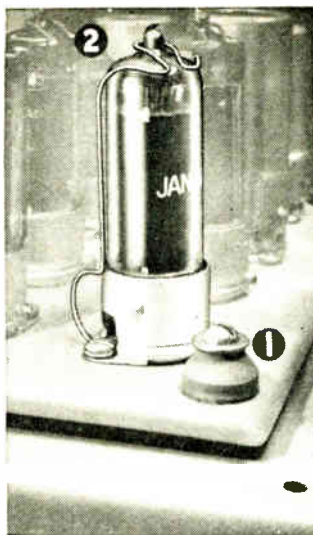

MINIATURE TUBE CLAMP

② Corrosion resistant. Holds miniatures in sockets under severe conditions of shock and vibration without restricting air circulation. Easy to insert and withdraw tubes. Three sizes.

Remler Company Ltd.
2101 Bryant St. San Francisco 10, Calif.

Remler

Since 1918 PIONEERS IN ELECTRONICS AND PLASTICS



(Continued from page 82A)

- MacGregor, W. R., 1707 H St., N.W., Washington 6, D. C.
- Martin, C. B., 508 S. Johnson Ave., Urbana, Ill.
- Mazur, D. G., 208 Modoc Lane, Washington 21, D. C.
- Menagh, F. H., Erie Railroad Company, Midland Bldg., Cleveland, Ohio
- McHoney, L. M., 2467 Hartland Ave., St. Louis 14, Mo.
- Meneley, C. A., 2340 19, Cuyahoga Falls, Ohio
- Murphy, E. J., 355 San Luis Ave., Los Altos, Calif.
- Oliver, B. M., 395 Page Mill Rd., Palo Alto, Calif.
- Price, R. L., 756 S. Highland Ave., Barrington, Ill.
- Ramberg, E. G., RCA Laboratories, Princeton, N. J.
- Rogers, S., Engineering Dept., Convair, San Diego 12, Calif.
- Samsky, B. S., Saratoga Industries, Box 422, Saratoga Springs, N. Y.
- Scillian, G. L., 11612 Georgia Ave., Silver Spring, Md.
- Smith, B. H., 1171 1/2 Grizzly Peak Blvd., Berkeley 8, Calif.
- Snedeker, M. L., 5300 Archmere Ave., Cleveland 9, Ohio
- Snyder, R. L., Jr., 270 Linden St., Moorestown N. J.
- Stanko, E., 209 Crest Ave., Haddon Heights, N. J.
- Talbott, E. P., 2210 Caples St., El Paso, Tex.
- Stuetzer, O. M., R.D. 1, Springfield, Ohio
- Thorp, W. E., 7371 W. 83 St., Los Angeles 45, Calif.
- von Trentini, G., 1790 Rosetti, Florida FCNGBM, Buenos Aires, Argentina
- Waddell, J. F., 3288 Sweet Dr., Lafayette, Calif.
- Wood, G. W., Defense Research Laboratory, Box 8029, Austin 12, Tex.

Admission to Senior Member

- Best, N. R., 2014 Wardman Rd., Washington 18 D. C.
- Castanias, J. E., 908 Neal Ave., Dayton 6, Ohio
- Collins, J. L., Statler Bldg., Boston 16, Mass.
- Cummins, J. W., 4 Chuckwagon Rd., Rolling Hills, Calif.
- Edwards, R., Box 66, Asbury Park, N. J.
- Egolf, R. S., 90 Eighth Ave., Brooklyn 15, N. Y.
- Kettler, A. H., RCA Victor Division, Bldg. 14 5, Camden, N. J.
- Lennert, F. G., Jr., 745 Evergreen St., Menlo Park, Calif.
- McFarland, J. E., Nassau Research & Development Associates, 66 Main St., Mineola, L. I., N. Y.
- Mengel, J. T., 9132 Bradford Rd., Silver Spring, Md.
- Olesky, S. S., 1627 S. Sherbourne Dr., Los Angeles 35, Calif.
- Rieh, E. S., 7 Pierce Ave., Wakefield, Mass.
- Richardson, H. L., Sylvania Electric Products, Inc., 1740 Broadway, New York 19, N. Y.
- Rockwell, G. O., Rm. 252-B, Humble Bldg., Houston 1, Tex.
- Rueger, L. J., Glenallen Ave., Silver Spring, Md.
- Selsted, W. T., 3960 Martin Dr., San Mateo, Calif.
- Straiton, J. W., 866 Leggett Dr., Abilene, Tex.
- Veley, H. N., 369 S. St. Marys St., St. Marys, Pa.
- Weiser, R. V., 253 S. Brady St., DuBois, Pa.
- Williams, M. A., 7816 Stewart Ave., Los Angeles 45, Calif.
- Wyman, J. H., Box 511, Laurel Ave., Middletown, N. J.

Transfer to Member

- Bartels, W. S., Lexington Park, Md.
- Bruna, R. F., R.D. 1, Box 36, Libertyville, Ill.
- Coelran, J. L., 2839 N. Tacoma St., Arlington 13, Va.
- Cormack, W. J., Jr., 419 Webster St., Cary, N. C.
- Corns, R. B., 517 Cole St., Raleigh, N. C.
- Crawford, E. W., 123 W. 74 St., New York 23, N. Y.

(Continued on page 86A)

NEW "PARAFORMED" SPIRAL WOUND PAPER TUBES

with **FLAT** SIDE WALLS

SMALL ROUNDED OUTSIDE CORNERS

SQUARE INSIDE CORNERS

ANY SIZE, SQUARE OR RECTANGULAR

DO YOU HAVE A SPACE PROBLEM?

Eliminates squeezing operation of finished coil and possibility of shorts due to fractured enamel insulation.

For the first time, a paper tube like this—developed and perfected by PARAMOUNT after years of research! No artificial heat or pressure is used in its manufacture—"PARAFORMING" takes place at the time of actual winding. No sharp outside edges to cut the wire during winding of coils. Has great rigidity and physical strength. Permits coil manufacturers to hold much closer tolerances. No need for wedges to tighten the winding on the laminated core. Coils can be automatically stacked much faster, too. The new "PARAFORMED" tubes are approved and used by leading manufacturers. And they cost no more!

Paramount PAPER TUBE CORP.

617 LAFAYETTE ST., FORT WAYNE 2, IND.
Standard of the Coil Winding Industry for Over 20 Years

WRITE ON COMPANY LETTERHEAD FOR STOCK ARBOR LIST OF OVER 2000 SIZES

Coincidence Detector, Type 1201B, another of the basic elements in Burroughs' line of "Unitized" Pulse Control Equipment.

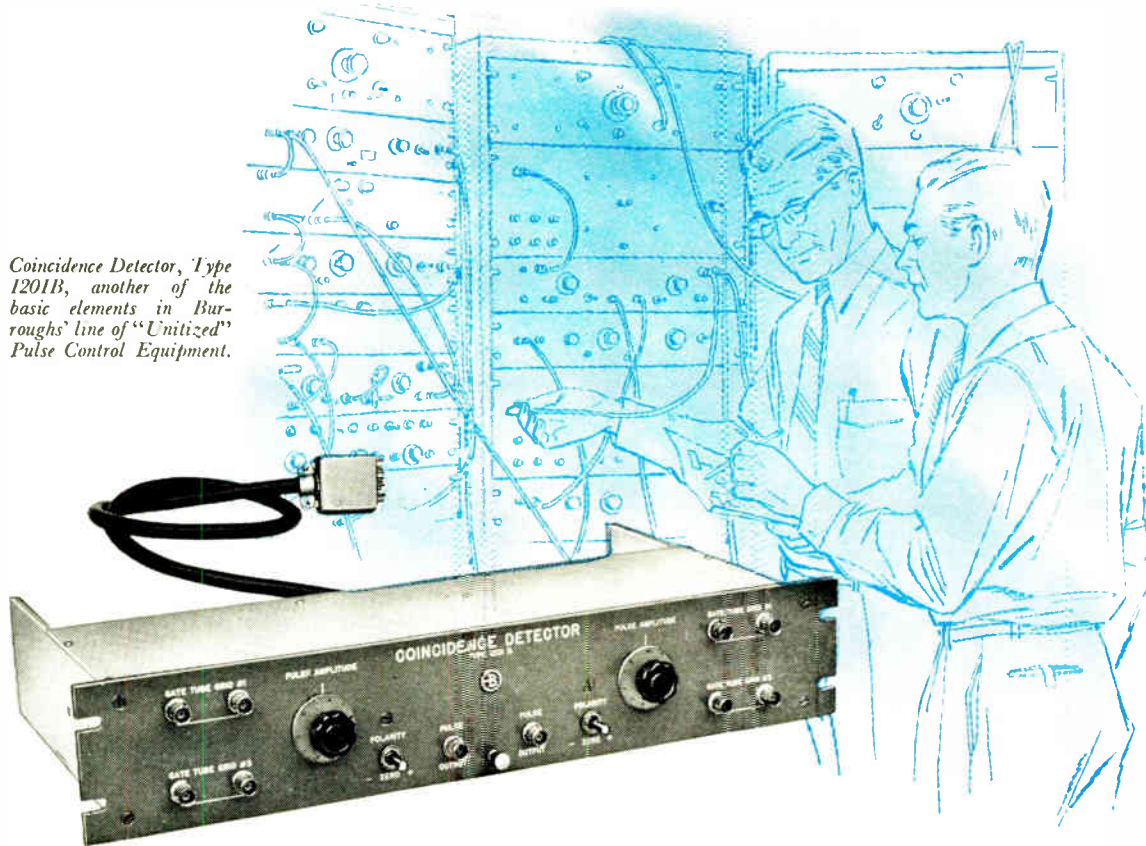

"Unitized" Pulse Control Equipment permits fast, easy readaptation of electronic test circuits

Speedy assembly of electronic testing equipment is one big advantage you gain when you use versatile Burroughs pulse control units . . . but there is another tremendous advantage that *only* "Unitized" equipment offers. Since each Burroughs unit performs just *one basic operation*—such as generating, counting, mixing, gating, or delay—it's easy to *reassemble* equipment for a *different* project when one set of electronic tests is completed. You simply make a block diagram of the new circuit needed and rearrange the cables to correspond to your diagram. This flexibility permits you to quickly perform tests which otherwise might require a very long time or not be undertaken at all.

SIMPLY "PLUG IN" BURROUGHS COINCIDENCE DETECTORS

Both of the coincidence detectors offered by Burroughs demonstrate the practical one-basic-function principle that makes Burroughs "Unitized" Pulse Control Equipment so suitable to your needs.

Burroughs Coincidence Detector, Type 1201B (shown here), is designed to detect coincidence between the output signal of a flip-flop and 0.1 microsecond pulses. Two inputs are provided for each unit. One accepts 0.1 microsecond pulses with

amplitudes of 12 volts or more. The other accepts the output of Burroughs Flip-Flop, Type 1101C or equivalent.

Burroughs "Unitized" pulse control assemblies have been in constant use for more than two years. Their proved dependability has led to their use by many leading electronic research organizations, including: Massachusetts Institute of Technology, Consolidated Engineering Corporation, The Catholic University of America and Magnetics Research Company.

For full information on Burroughs "Unitized" Pulse Control Equipment, write or call Department 14C, Electronic Instruments Division, Burroughs Corporation, 511 North Broad Street, Philadelphia 23, Pa.

PULSE GENERATORS
COINCIDENCE DETECTORS
PULSE DELAYS
FLIP-FLOPS
PULSE GATERS
CHANNEL SELECTORS
MIXERS

ELECTRONIC INSTRUMENTS DIVISION
Burroughs

THE BEST KNOWN NAME IN OFFICE MACHINES

CANNON PLUGS

get good reception

O SERIES

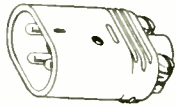

P SERIES

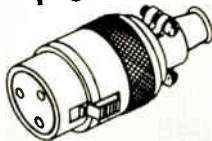

GB SERIES

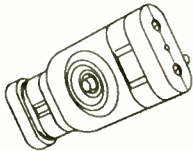

UA SERIES

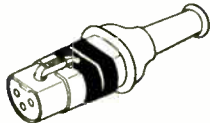

XL SERIES

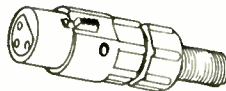

D SERIES

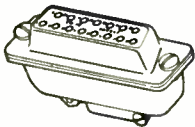

K SERIES



XKW-B1 SERIES

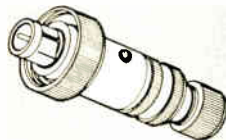

U SERIES



TELEPHONE RECORDER

K SERIES



TELEVISION

WRITE FOR
PRICE FOLDER
CPL-6

The high quality audio connectors shown above are available from all Cannon Franchised Distributors. In their great variety of sizes, shapes and contact arrangements there is no problem or technical requirement in the radio, sound, TV or related fields that cannot be met. Cannon plugs are standard on leading makes of audio equipment and microphones.

CANNON ELECTRIC

Since 1915



Factories in Los Angeles, Toronto, New Haven, Benton Harbor. Representatives in principal cities. Address inquiries to Cannon Electric Co., Dept. I-377, P.O. Box 75, Lincoln Heights Station, Los Angeles 31, Calif.



(Continued from page 84A)

- Davis, C. R., 2745 Morton Dr., Springfield, Ohio
DeMedeiros, L. A., Ave. Copacabana 1386, Apt. 802, Rio de Janeiro, Brazil
Detelemendy, J. A., 818 S. Kingshighway Blvd., St. Louis 10, Mo.
Duvall, G., 408 N. Greenwood Ave., Ft. Smith, Ark.
Egan, W. G., 107-56—113 St., Richmond Hill 19, N. Y.
Endres, R. O., 310 Pleasant Valley Ave., Moorestown, N. J.
Fromanger, A. L., 79 Park Row Ave., N., Hamilton, Ont., Canada
Gates, R. E., 40 Cedar St., Ajax, Ont., Canada
Harmon, W. R., Jr., 1068 W. Fourth St., Winston-Salem, N. C.
Irwin, R. P., 13 Coe Ave., Hillside 5, N. J.
Johnson, M. A., R.D. 1, Totman Rd., E. Syracuse, N. Y.
Kinnier, D., 131 Hewett Rd., Wyncote, Pa.
Kounalis, L. E., 7705 Rosemead Blvd., Rivera, Calif.
Lloyd, A. T., 1650 S. Huntington St., Pomona, Calif.
Maki, C. E., 3236C A St., Sandia Base, Albuquerque, N. Mex.
Neuer, A. G., 1609 W. North Ave., Chicago 22, Ill.
Mitchum, M. M., 1000 Lynwood Dr., Rolla, Mo.
Odell, A. C., R.D. 3, Box 370A, Orange, Tex.
O'Farrell, J. J., Jr., Westview Terr., R.D. 2, Red Oaks Mill, Poughkeepsie, N. Y.
Pearsall, S. H., Spring Valley Rd., Donelson, Tenn.
St. Vrain, W. E., 408 Par Lane, Kirkwood 22, Mo.
Schafitz, S. A., Willow Run Research Center, Group 4420, University of Michigan, Ypsilanti, Mich.
Skitek, G. G., 1210 Iowa St., Rolla, Mo.
Sprung, R. A., 84 Pangborn Pl., Hackensack, N. J.
Steiner, J. I., 3368 6/D Echeverria, Buenos Aires, Argentina
Talpey, T. E., Department of Electrical Engineering, University of Michigan, Ann Arbor, Mich.
Tipping, C. C., 266 Junipero St., Redwood City, Calif.
Woods, H. D., 232 N. Frederick, Burbank, Calif.
Zielinski, C. A., 1339 Wisconsin Ave., N.W., Washington, D. C.

Admission to Member

- Abu-Kandeel, A. A., Egyptian State Broadcasting, Abu-Zaabal, Cairo, Egypt
Affrunti, A. J., 350 S. Keeler Ave., Chicago 24, Ill.
Agerholm, M., 744 Ukiah Way, Upland, Calif.
Aldrich, D. F., 1030 Hoffman St., Elmira, N. Y.
Anfenger, E., 83 Englewood Ave., Brookline, Mass.
Arnold, C. E., 43 Collamore St., Milton 86, Mass.
Baker, D. A., 2305 Foster Ave., Baltimore 14, Md.
Ballew, H. W., 303 Brook Manor, Huntsville, Ala.
Barnette, L. A. M., 4801 Linden St., Bellaire, Tex.
Beckwith, J. E., 635 S. Flores St., San Antonio, Tex.
Blount, E. M., 318 S. Mill St., Plainfield, Ind.
Branker, H. E., 299 Meadowbrook Rd., N. Merrick, L. I., N. Y.
Brown, J. M., 924 Hardin St., Westfield, N. J.
Buchmeier, H. P. G., 238 Roslyn Rd., Winnipeg, Man., Canada
Caruth, J. L., 6902 Kennison St., Dallas, Tex.
Chamberlain, J. T., R.D. 3, Box 298, Gaithersburg, Md.
Cosentino, A. A., 661 E. 243 St., New York 70, N. Y.
Crouch, P. W., "Leusdon," 141 W. Town Lane, Bristol 4, England
Diamond, M., Rm. 603, 301 Vaughan St., Winnipeg, Man., Canada
Doshier, R. T., Jr., 1706 S. Farola Dr., Dallas, Tex.
Eddins, W. T., c/o Radiation, Inc., Melbourne, Fla.

(Continued on page 88A)

reality through research

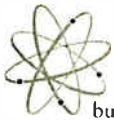

Now especially, in this age of push button and feed back controls, Potter & Brumfield relays, contactors and electro-mechanical actuators contribute greatly to the planning and production of better products. P & B offers today's designer reality through research . . . unlimited horizons for product development with many new versatile mechanisms specifically designed to meet his needs for . . .



miniaturization



Tiny SM relay typifies miniature design. Sealed version weighs less than an ounce; measures $\frac{3}{4}$ " x $1\frac{1}{8}$ "

ruggedization

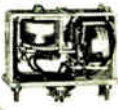

LK Series, electrical latch-electrical release relay, withstands 10-G vibration, 50-G shock.

sensitization



Ultra-sensitive SS relay provides operation with sensitivity range from 1 MW to 2W.

acclimatization



Hermetic sealing protects individual relays or multiple groups from dust, fumes, moisture, etc.

Your inquiries are invited. Write for new Catalog No. 122 illustrating relays for every application.

**Potter &
Brumfield**
PRINCETON, INDIANA

Export: 13 E. 40th St., N. Y., N. Y.
Sales Offices in Principal U. S. and
Canadian Cities

ATTENUATION HITS

New High!

IN NEW SHIELDED ENCLOSURE

Air-Conditioned • Portable • Weatherproof

Now! Attenuation of radio frequency energy higher than ever before . . . attenuation over the widest frequency range . . . attenuation beyond measure over 1 mc with present instruments.

All this becomes reality in the new RFI Shielded Enclosure. Built of heavy copper sheet panels—solid floors, solid walls, solid ceilings—this new enclosure shuts r-f interference in or out more effectively than any other type of structure. The reason? Patented Lindsay Construction—in which solid cop-

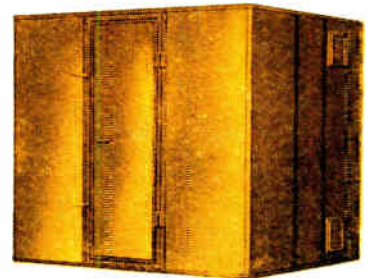

This unique construction also offers you the greatest strength-to-weight ratio. Superior rigidity enables you to mount the enclosure on a truck as a mobile unit. Or, carry it to a testing station. Unload it. And later move it to another location, all without disassembling.

Weatherproofed, RFI Shielded Enclosures can withstand the rigors of climates hot or cold, damp or dry. For warmer climates, they can be air-conditioned with units of any size.

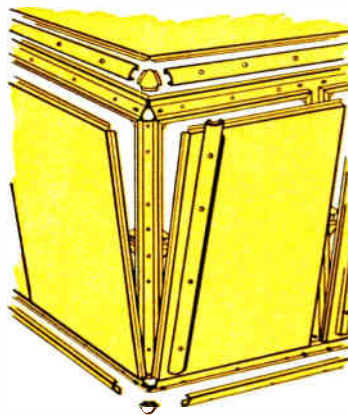

per panels are joined at rigid, copper-plated steel channels and tightly bolted together. Tensioners at the seams, further serve to stop any interference that might find its way through the almost leak-proof channel and panel joints.

The result is a revolutionary advancement in shielding effectiveness. An independent laboratory conservatively plotted it for 100 db from .15 mc to 1000 mc. Beyond that, to the limit of its testing apparatus.



Actually there's no end to the many advantages you'll find in this new type of shielded enclosure. Bulletin No. 2 gives most of the details. Write, wire, or phone for your copy now!



**RFI SHIELDED ENCLOSURES
CORPORATION**

3634 N. Lawrence Street • Philadelphia 40, Pa. • Phone: REgent 9-2537

"CASE" these Cabinets ... for QUALITY

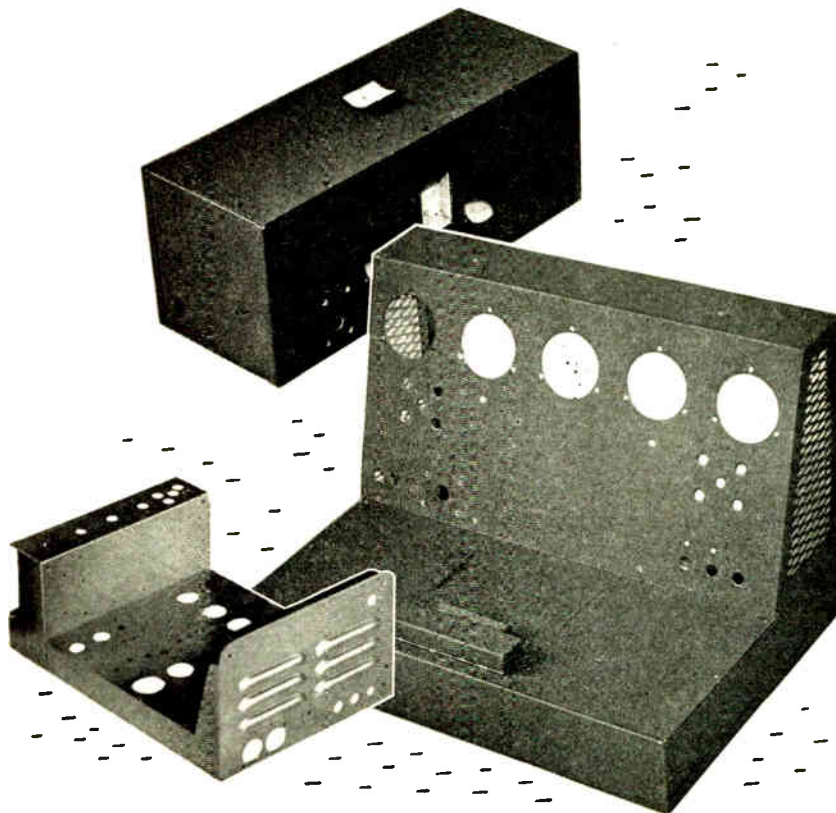

Inspect the fine detail and craftsmanship which stands out even in the photograph above. When Riester and Thesmacher handles your sheet metal job, your product is more efficiently housed—and at possibly lower cost. Submitting your blueprints to us will bring our prompt quotation—and the help you may need for improved sheet metal fabrication.

Aluminum Spot Welding • Heliarc Aluminum Welding

REPRESENTATIVES

Frank W. Taylor Co. P.O. Box 316, DeWitt, N.Y.	Paul R. Sturgeon 25 Huntington Ave., Boston 16, Mass.
Kenneth E. Hughes Co. 17 W. 60th St., New York 23, N.Y.	Samuel K. Macdonald, Inc. 1531 Spruce St., Philadelphia 2, Pa.
William E. McFadden 150 E. Broad St., Columbus 15, Ohio	



MANUFACTURERS
Special Steel Equipment
Metal Cases - Cabinets
CONTRACTORS
Sheet Metal
Building Products
**VENTILATION,
AIR CONDITIONING**

**THE
RIESTER & THESMACHER
COMPANY**
1526 W. 25TH ST. CHERRY 1-0154
CLEVELAND, OHIO



(Continued from page 86-A)

Eisner, W., Signal Division, Hq. USAREUR Com-
Z, APO 58, c/o PM, New York, N. Y.
Ewing, J. H., 6100 -18 Rd., N., Arlington, Va.
Frauman, C. L., 241 Leda Dr., Dallas, Tex.
Hawley, O. D., 1332 Claranette Ct., Owensboro,
Ky.
Henry, F. T., 1345 Pennsylvania Ave., Williams-
port, Pa.
Herbert, N. J., R.D. 1, Coopersburg, Pa.
Hicks, C. S., 209 Newburg Ave., Catonsville 28,
Md.
Joost, A. E., 192 Orchard Lane, Columbus 14,
Ohio
Jurgen, R. K., Sutton Publishing Company, 172 S.
Broadway, White Plains, N. Y.
Jurskis, A., 1313 W. Jerome St., Philadelphia 40,
Pa.
Ladd, J. H., Color Technology Division, Kodak
Park Bldg. 65, Rochester 4, N. Y.
Lawrence, S., 245 Hawthorne St., Brooklyn 25,
N. Y.
Lebail, P. E., 67 rue d'Amsterdam, Paris 8, France
Levy, J. E., 2607 Bellevue Dr., Bethesda 14, Md.
Lewis, G., c/o Loral Electronics Corp., 794 E. 140
St., New York 54, N. Y.
Lippincott, E. W., 411 W. Plum, Centuria, Wash.
Madill, C. L., 1138 Old Esquimalt Rd., Esquimalt,
B. C., Canada
Man, J. V., 109 S. Cicero Ave., Chicago, Ill.
Marsden, R. S., Jr., Research Department, Phillips
Petroleum Company, Bartlesville, Okla.
Mayer, D. B., 6710 McCallum St., Philadelphia 19,
Pa.
McCaughna, J. R., 226 E. Anapamu, Santa Bar-
bara, Calif.
McCullom, K. A., 270 Lunden Dr., Idaho Falls,
Idaho
Mundy, J. L., 1115 Normahill Dr., Pittsburgh 1,
Pa.
Muraehver, J., 151-153 Needham St., Newton,
Mass.
Pareseau, P. H., 65 Cutler St., Worcester 4, Mass.
Pokorny, J. J., 815 Grand Ave., Dayton, Ohio
Potter, B. W., 5328 N. Downey Ave., Long Beach
11, Calif.
Reese, I. C., 7221 Wyandotte St., Kansas City, Mo.
Reynolds, C. L., 1511 Linden Ave., Owensboro, Ky.
Rothschild, M., 50 S. Wall St., Avon, N. J.
Saylor, R. R., 6510 Alta Ave., Baltimore 5, Md.
Scholes, H. M., 1419 Raymundo Ave., Los Altos,
Calif.
Siedband, M. P., 2857 W. Coldspring Lane, Balti-
more 15, Md.
Siewers, S. S., R.D. 2, Box 680G, El Cajon, Calif.
Slawson, W. J., 9 Stuyvesant Oval, New York 9,
N. Y.
Smith, J. H., 6000 Lemmon Ave., Dallas, Tex.
Stein, D. R., 166-05 Highland Ave., Jamaica 32,
L. I., N. Y.
Strang, D. B., 117 Middlesex Rd., Waltham, Mass.
Thompson, D., Box 367, Blacksburg, Va.
Uyeda, Y., R.D. 5, Box 189, Lancaster, Pa.
Wallace, R. P., Mycalex Corporation of America,
Clifton Blvd., Clifton, N. J.
Weeks, R. M., 3210 Culver St., Dallas 10, Tex.
Wildermuth, J. R., 826 N. West St., Carlisle, Pa.
Winn, D. L., 114 E. Capitol, Little Rock, Ark.
Zelinger, F. F., 1816 N.W. 15, Oklahoma City, Okla.

The following elections to Associate were approved and are effective as of August 1, 1953:

Aller, J. C., 1153 W. Cedar, Oxnard, Calif.
Allott, A. J., 606 Brookside Ave., Wayne, Pa.
Bartel, W. B., 1220 Kolle Ave., S. Pasadena, Calif.
Beazley, W. H., Computing Devices of Canada,
Ottawa, Ont., Canada
Bee, R. E., 260-29-74 Ave., Glen Oaks, L. I.,
N. Y.

(Continued on page 90A)

**The Only
All Band**

**10 mc
to
21,000 mc**

**Direct Reading
Single Control**

SPECTRUM ANALYZER

Model LSA

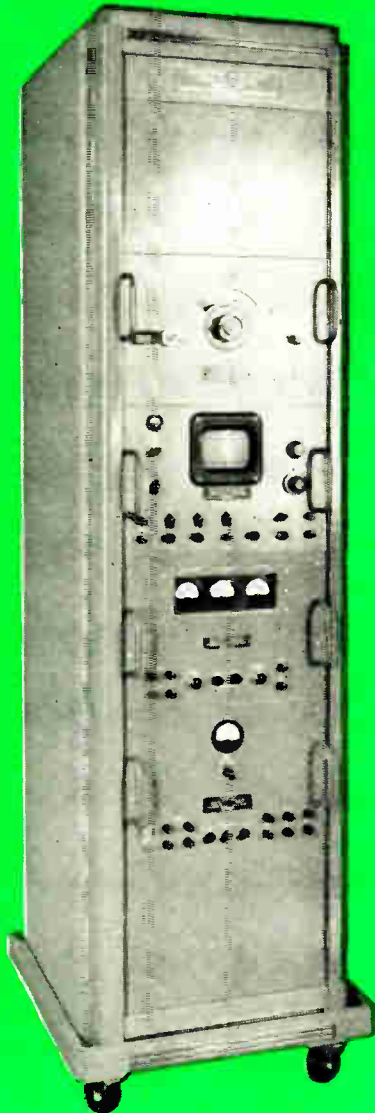

The Model LSA provides direct means of rapid, accurate measurement of spectral display of r. f. signals from 10 to 21,000 MCS

Saves Engineering Manhours

The Model LSA Spectrum Analyzer is Polarad's answer to rising engineering costs when high performance and economy are essential.

This unique engineering tool helps get results faster with fewer personnel and in less space. Because of its ultra simplicity, tremendous frequency coverage and remarkable instrumentation the Model LSA can handle almost any problem in the radio spectrum (10 mc to 21,000 mc) with the greatest of ease, reliability and accuracy.

How The Model LSA Cuts Production Costs

In the factory, Model LSA's simplicity of operation, direct reading and "GO-NO-GO" electronic display speeds production and cuts costs. Uniform quality and high performance of your complete equipment is assured by checking it with a Polarad Spectrum Analyzer.

Expensive personnel training programs are eliminated by the Model LSA, which often actually takes the place of the microwave specialist and frees engineers for other work. For further details contact your nearest Polarad representative or write direct to us.

FEATURES:

Frequency Range 10 mc-21,000 mc; 4 tuning heads
Accuracy Frequency Calibration—1%
Spectrum Display variable from 250 kc to 25 mc
Frequency Marker for measuring frequency differences of 0-25 mc
Broad Band R.F. Attenuators 10 mc-12,000 mc
Automatic Voltage selector for each tuning head
Single Dial Control
Direct Frequency Reading
Spectrum Displayed on 5" cathode ray tube

USES:

Examine pulse spectrum of magnetrons and klystrons
Measure noise and interference spectrum
Act as broad band receiver from 10 mc to 21,000 mc
Observe and measure harmonic frequency differences
Measure band width of microwave cavities
Calibrate microwave oscillators and preselectors

More Megacycles Per Dollar Than Any Other Instrument



Polarad Electronics Corporation

100 Metropolitan Avenue, Brooklyn 11, N. Y.

REPRESENTATIVES: Albuquerque • Atlanta • Boston • Chicago • Cleveland • Fort Worth • Kansas City • Los Angeles • New York • Ontario • Philadelphia • San Francisco • Seattle • Syracuse

the **Waterman**

SAR PULSESCOPE®

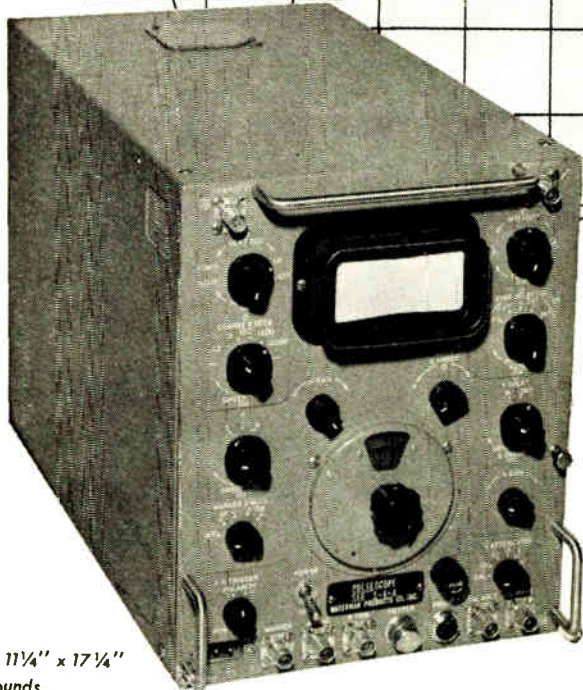

MODEL
S-4-A

Size:
9 1/8" x 11 1/4" x 17 1/4"
31.5 Pounds

ANOTHER EXAMPLE OF *Waterman* PIONEERING...

The SAR PULSESCOPE, model S-4-A, is the culmination of compactness, portability, and precision in a pulse measuring instrument for radar, TV and all electronic work. An optional delay of 0.55 microseconds assures entire observation of pulses. A pulse rise time of 0.035 microseconds is provided thru the video amplifier whose sensitivity is 0.5V p to p/inch. The response extends beyond 11 MC. A and S sweeps cover a continuous range from 1.2 to 12,000 microseconds. A directly calibrated dial permits R sweep delay readings of 3 to 10,000 microseconds in three ranges. In addition,

R sweeps are continuously variable from 2.4 to 24 microseconds; further expanding the oscilloscope's usefulness. Built-in crystal markers of 10 or 50 microseconds make its time measuring capabilities complete. The SAR PULSESCOPE can be supplied directly calibrated in yards for radar type measurements. Operation from 50 to 1000 c.p.s. at 115 volts widens the field application of the unit. Countless other outstanding features of the SAR PULSESCOPE round out its distinguished performance.

WATERMAN PRODUCTS CO., INC.

PHILADELPHIA 25, PA.

CABLE ADDRESS: POKETSCOPE

WATERMAN PRODUCTS INCLUDE

S-5-A LAB	<u>PULSESCOPE</u>
S-11-A INDUSTRIAL	<u>POCKETSCOPE</u> ®
S-12-B JANized	<u>RAKSCOPE</u> ®
S-14-A HIGH GAIN	<u>POCKETSCOPE</u>
S-14-B WIDE BAND	<u>POCKETSCOPE</u>
S-15-A TWIN TUBE	<u>POCKETSCOPE</u>

Also RAYONIC Cathode
Ray Tubes and Other
Associated Equipment



(Continued from page 88A)

- Benuing, G. L., 522 Madison, Fort Wayne, Ind.
 Biernson, G. A., Servomechanisms Laboratory,
 Massachusetts Institute of Technology,
 Cambridge, Mass.
 Bird, H. H., Hainesburg, N. J.
 Blake, R. F., 739 Hilltop Terr., S.E., Washington
 19, D. C.
 Blanchard, M. A., 4035 Prairie Ave., Brookfield,
 Ill.
 Bosch, C., The Electrona Corp., 1064-1070 Clinton,
 Irvington, N. J.
 Brittain, J. F., Hq. USAFE A-2, APO 633, c/o PM,
 New York, N. Y.
 Cantafio, L. J., RCA Victor, Bldg. 13-7, Sec. 581,
 Camden, N. J.
 Chase, R. J., 501 W. Bridge St., Streator, Ill.
 Cory, H. E., Air Prod. Res. Age. MCLAPRD-1,
 Bldg. 288, Area A, Wright-Patterson AFB,
 Ohio
 Collins, T. E., 1500 N. May St., Joliet, Ill.
 DiSciullo, E. V., 141 S. Munn Ave., East Orange,
 N. J.
 Drake, W. A., Y.M.C.A., 350 N. Garey, Pomona,
 Calif.
 Dratch, J. E., 4227 Belmar Ave., Baltimore, Md.
 Eddlemon, C. E., 166 W. North Ave., Chicago, Ill.
 Eldridge, G. C., Jr., 311 S. Princeton Ave., Wenonah,
 N. J.
 Emch, G. F., 1704 Cody Dr., Silver Spring, Md.
 Feldman, E. J., 6 Cherry St., Haverhill, Mass.
 Fine, A., 5062 Milton Ave., Arlington, Calif.
 Fisher, F. M., 270 Comstock, Buffalo, N. Y.
 Fisher, R. J., 2204 Glass Rd., N.E., Cedar Rapids,
 Iowa
 Gabel, J. F., 4127 W. Eddy St., Chicago 41, Ill.
 Gardoff, I. M., 5 Manor Dr., Newark, N. J.
 Girdardelli, L. R. L., Inst. Tecnol. De Aeronautica,
 Sao Jose Dos Campos, Sao Paulo, Brazil
 Glum, D. E., 7006 S. Maplewood Ave., Chicago,
 Ill.
 Gonsalves, L., 51 Jouvette St., New Bedford, Mass.
 Gracey, J. O., Box 775, Dickinson, Tex.
 Grausdin, P., 481 Simcoe St., Winnipeg, Man.,
 Canada
 Green, E. E., 285 Richmond Ave., Buffalo 22, N. Y.
 Haring, L. L., 18-48 Stein Way St., Long Island
 City, N. Y.
 Harris, F. D., 1833 Jefferson Pl., N.W., Washington,
 D. C.
 Heacock, R. L., 1385 N. Foothill Blvd., Pasadena,
 Calif.
 Henry, R. F., 17 George Court, Hasbrouck Heights,
 N. J.
 Hicks, R. L., 22 1/2 Lime St., Inglewood, Calif.
 Hood, R. T., National Research Council, Sussex
 St., Ottawa 2, Ont., Canada
 Huber, P. K., Phyl. Inst. Der. Univ., Klingelberg-
 strasse 82, Basel, Switzerland
 Jeffrey, R. C., Digital Computer Laboratory, 68
 Albany St., Cambridge 39, Mass.
 Johnston, D. L., 1336 W. Bryn Mawr, Chicago 40,
 Ill.
 Jones, H. T., 1025 Hebron Rd., Hendersonville,
 N. C.
 Jur, C. J., 3731 N. Sacramento Ave., Chicago, Ill.
 Kay, L., 51 Lee Gardens Apts., Bristol, Va.
 Kirshner, J. M., 727 Kennedy St., N.E., Washing-
 ton, D. C.
 Krackhardt, R. H., Barnes Hill Rd., Berlin, Mass.
 Kreager, C. R., 4930 E. State Blvd., Fort Wayne,
 Ind.
 Leedy, R. L. S., 70 Park St., Montclair, N. J.
 Leib, J. E., 2039 Venice, San Diego, Calif.
 Leitner, B. B., 10525 Wellworth Ave., Los Angeles,
 Calif.
 Licht, G. L., 2900 Clairmount Ave., Detroit, Mich.
 Longo, J. F., 63 Old Oak Ave., Cranston 9, R. I.
 Lubke, G. W., Box 7306, El Paso, Tex.
 Mabuchi, O., 38 Shimamachi, Nishikujo, Shimo-
 gyoku, Kyoto, Japan
 Madden, P. G., 222 N. George Mason Dr., Arling-
 ton, Va.
 (Continued on page 92A)

Here's the tube that gives **Wmca** **FREEDOM FROM ARC-OVERS—LOWER HUM!**



Federal's

F-892-R

with the Federal-developed
**DOUBLE HELICAL
 FILAMENT**

- Does away with bowing
- Greatly increases tube performance and life

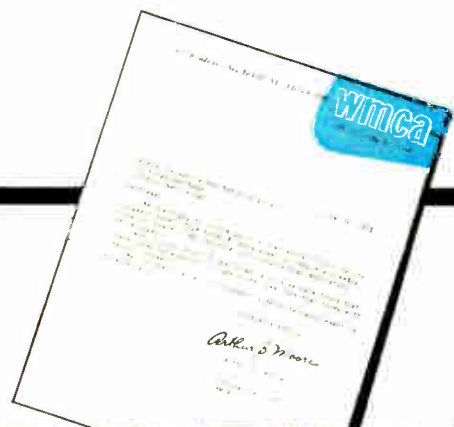

"... a definite improvement
 in tube design," says WMCA

Federal's Double Helical Filament – in Federal's F-892-R – has achieved an outstanding record of dependability at WMCA—America's Leading Independent Station, and First on New York's Dial.

WMCA reports that these tubes "have given us complete freedom from arc-overs in maintaining continuously high modulation percentages. Also, in our proof of performance runs we have found that these tubes have about 2 Volume Units lower hum than tubes with regular filaments."

Federal's F-892-R—wound through 360° for mechanical stability and carrying opposing electrical fields which provide improved electrical stability—definitely eliminate *bowing*—one of the primary causes of filament-to-grid shorts!

Sturdier, longer lasting and more economical, Federal's double helical filament tubes are the key to a new era of *performance quality* and *operating dependability* for 5 and 10 KW transmitters. Write for full information today, address Dept. K-337

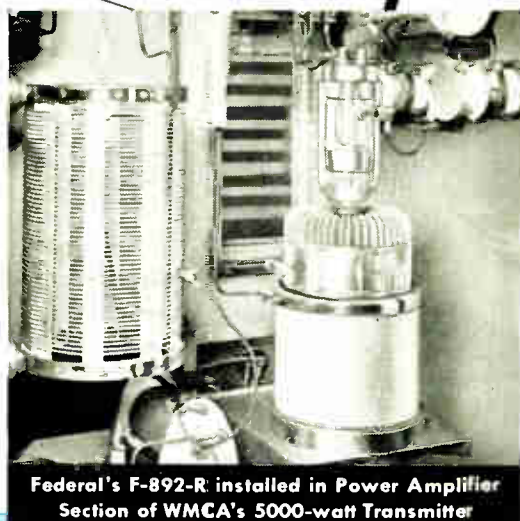

Federal's F-892-R installed in Power Amplifier Section of WMCA's 5000-watt Transmitter

"Federal always has made better tubes"



Federal Telephone and Radio Corporation

VACUUM TUBE DIVISION • 100 KINGSLAND ROAD, CLIFTON, N. J.

In Canada: Federal Electric Manufacturing Company, Ltd., Montreal, P. Q.
 Export Distributors: International Standard Electric Corp., 67 Broad St., N. Y.

Further Proof of

Getting to the bottom of things

... is most clearly demonstrated by what we are doing every hour of every day—year in and year out—to make a finer fixed CAPACITOR.

One of the many things you as users are interested in is the "LIFE OF THE CAPACITOR" under a multitude of operating conditions. We in the FAST organization have spared no expense to give you honest-to-goodness answers on this important factor in providing quality capacitors.

What follows is a summary of what we are doing to give you just that . . .

I: RESEARCH and DEVELOPMENT TESTS

A. AC and DC tests at various temperatures and voltages.

1—Investigation of Impregnants: (a) New impregnants AC—synthetic and natural oils. DC—oils, resins and waxes. (b) Studies of impurities and additives.

2—Investigation of electrode separators and electrode materials: (a) Modified kraft papers—low PF varieties and sundry densities. (b) Films—regenerated cellulose, polystyrene, teflon, "Mylar", etc.

3—Number of groups tested: AC; over 800 involving more than 8000 units. DC; over 3300 involving more than 70,000 units.

4—Duration of tests: AC; many have been continuously under test for over 6 years. DC; many have been continuously under test for over 10 years.

5—Voltage range of tests: AC; 70 to 2400 volts at 60 and 400 cycles. DC; 140 to 44,000 volts.

6—Temperature range of tests: AC; Room to 130°C. DC; -55°C to +150°C.

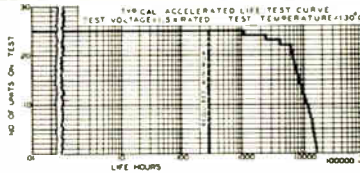

II: PRODUCTION TESTS

A. Alternating Current

1—Heat runs on production lots—ultimate surface temperature rise.

2—Ultimate life hours of current production (periodic tests run)

B. Direct Current

1—Civilian Production: (a) ultimate life hours of capacitors taken from current production. (These test runs comprise over 1600 groups involving more than 16,000 units)

(b) Ultimate life hours of capacitors after being stored in cartons from 1 to 24 months under normal variations in humidity and temperature. (These test runs comprise over 230 groups involving more than 2300 units)

2—Military Production: (a) Test to applicable specifications (Jan. C-25; Jan. C-91; U. S. Army 71-1667; Etc.)

(b) These test runs comprise over 3300 groups involving more than 19,000 capacitors.

Please note Carefully: at least 80% of the 115,300 capacitors included in the above tests were tested to destruction at voltages from 1/2 to 4 times rated and at maximum rated—or in excess of—operating temperatures. Many outside this group have not failed to date. Importantly too, this is a continuous policy of the company in sustaining our testing program throughout every day—year after year.

So with pardonable pride may we suggest **QUALITY CAPACITORS** is more than a "catchphrase" as applied to the FAST organization . . . and another link in the chain of **GETTING TO THE BOTTOM OF THINGS?**

* Du Pont trade-mark for Polyester Film

JOHN E. FAST & CO.

Capacitor Specialists For
Over A Third of A Century

North Pulaski Road, Chicago 41, Ill.

"WHEN YOU THINK OF CAPACITORS . . . THINK FAST"

Quality COMES FIRST

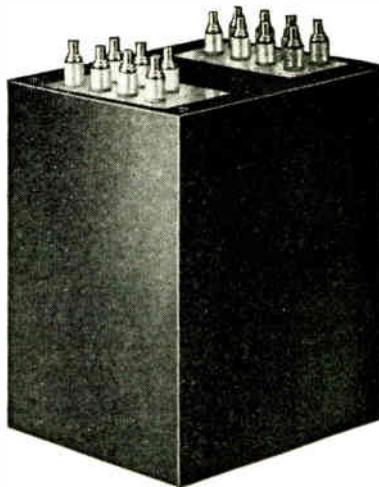
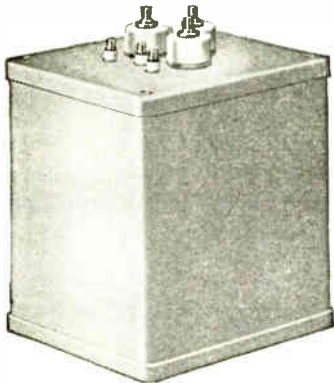

• If performance and long life are the primary factors in your application of transformers, then submit your specifications to Acme Electric. Quality comes first in every Acme Electric transformer.

ACME ELECTRIC CORPORATION

MAIN PLANT: 449 Water Street Cuba, N.Y.
West Coast Engineering Laboratories: 1375 W. Jefferson Blvd.,
Los Angeles, Calif.

In Canada: Acme Electric Corp. Ltd., 50 North Line Rd.,
Toronto, Ont.

Acme Electric

TRANSFORMERS



(Continued from page 90A)

- Manley, H. J., R.D. 1, Rentschler Sta., Belleville, Ill.
- McClary, D. A., 542 Rockwell St., Kent, Ohio
- McDaniel, D. Z., 535 S. D St., Oxnard, Calif.
- McLaughlin, T., Loral Electronics Corp., 794 E. 140 St., New York, N. Y.
- McLendon, J. T., Jr., Box 95, Hubert, N. C.
- Meinholdt, D. W., 6100 Overlook Dr., Dallas, Tex.
- Merlin, A. G., 362 Peninsula Blvd., Lyubrook, L. I., N. Y.
- Minozuma, F., 1163 Ohara-Michi, Meguro-Ku, Tokyo, Japan
- Moon, C. L., 1538 W. Latimer St., Tulsa, Okla.
- Moore, E. F., Bell Telephone Laboratories, Inc., Murray Hill, N. J.
- Muns, R. L., 175 Thacker, Des Plaines, Ill.
- O'Malley, M., 243 Bon Air Ave., Hatboro, Pa.
- Patera, A. F., 284 Edwards Pl., Yonkers, N. Y.
- Pankos, J. F., 1430 N. Hoyne Ave., Chicago, Ill.
- Pansch, H. J., 7490 Tech. Training Sq., APO 207, Box 61, c/o PM, New York, N. Y.
- Penmaraju, R. R., 12 Sreenivasa Iyyer St., West-mambalam, Madras, India
- Pesce, W. J., 255 Hill St., Waterbury 13, Conn.
- Phillips, A. H., 188-04—64 Ave., Fresh Meadows, L. I., N. Y.
- Phillips, C. C., III, 1005 Woodside Ave., Upland, Pa.
- Rager, D. M., Jr., 8603 Lindbergh Ave., Niagara Falls, N. Y.
- Rampel, G. G., 485 Gramatan Ave., Mt. Vernon, N. Y.
- Ryan, H. T., Capehart-Farnsworth Corp., Fort Wayne, Ind.
- Sartory, J. J., 89-16—117 St., Richmond Hill 18, L. I., N. Y.
- Seoggin, W. G., Jr., 2317 Lyon St., Raleigh, N. C.
- Segel, D. L., 815 Levering Ave., Los Angeles, Calif.
- Shlonsky, L., 80 Van Cortlandt Park, S., New York, N. Y.
- Simkins, R. S., 30 Amby Ave., Plainview, L. I., N. Y.
- Skinner, N. W., 144 Clyde St., Hampton, Va.
- Slator, S. L., 22 Seafort Ave., Sandymount, Dublin, Ireland
- Speck, R. W., 170 Langley Ave., Toronto, Ont., Canada
- Sternbach, S. J., 1013 Andover Rd., Baltimore 18, Md.
- Stoleson, H. N., 3 AAC'S I & M Sqdn., APO 863, c/o PM, New York, N. Y.
- Stufflebeam, C. E., 1333 N. Utica, Tulsa, Okla.
- Stuver, H. J., 3886 Lyceum Ave., Venice, Calif.
- Swink, J. E., 915 McKinley Ave., S. Norfolk, Va.
- Tindall, J. B., 2525 Balsam St., Suite 202, Vancouver, B. C., Canada
- Traver, J. W., 313 Hermosa Ave., Vallejo, Calif.
- Ulrich, W. J., 5 Clent Rd., Great Neck, L. I., N. Y.
- Vance, P. R., R.D. 2, Graybill Rd., Uniontown, Ohio
- Wears, L. R., 3008 Ferndale St., Kensington, Md.
- Windsor, R. N., 4 AAC'S, I & M Sqdn., APO 207, c/o PM, New York, N. Y.
- Wolaver, L. E., 408 Waneta Ave., Dayton 4, Ohio
- Wydro, W. S., 25 Mockorange Lane, Levittown, Pa.
- Zaabel, C. W., 2300 Armitage Ave., Chicago 18, Ill.
- Zuleeg, R., c/o Tippett, 4410 Knox Rd., College Park, Md.

33,000 IRE ENGINEERS

will receive the 1953
IRE Directory in
September

Midget with the giant brain

The Problem

To design and build a computer for airborne automatic control systems—with severe restrictions imposed on size, weight and operation under extreme environmental conditions; in short, a computer that would be small, simple, reliable, rugged—and easy to build and maintain.

AT HUGHES RESEARCH and Development Laboratories this problem was examined exhaustively, and it was concluded that a digital computer offered the best means for satisfying the requirements because of its ability to solve complex problems accurately and quickly.

Because the requirements of this application could not be met by existing digital computers, owing to their large size, the following developments were undertaken:

1. Simplification of the logical structure of the computer through the use of a mathematical theory of computer design based on Boolean algebra—but with retention of the operational versatility of a general-purpose computer.
2. Development of ingenious circuitry to utilize the new logical designs.

3. Achievement of minimum size by the use of subminiature techniques, including germanium diodes, subminiature tubes, and etched circuits.

4. Employment of unitized construction: plug-in units of flip-flop circuits and diode networks.

Need for subminiaturization, then, was a governing factor. Consequently, entire new techniques for making things not only vastly smaller, but at the same time easier to build and service, were developed by Hughes. This is a continuing process and there is indication of even more significant advancement in miniaturization for the future.

A major effort at Hughes is also devoted to adapting electronic digital computer techniques to business data processing and related applications—destined for far-reaching peacetime uses.



One of the subminiature switching circuits from the Hughes airborne electronic digital computer is examined by Dr. Eugene M. Grabbe (right), Associate Head, Computer Systems Department, Advanced Electronics Laboratory, and Phil A. Adamson of the Technical Staff.

For the convenience of those attending the NATIONAL ELECTRONICS CONFERENCE AND EXHIBITION, Chicago, September 28, 29, 30, 1953, members of our Technical Staff will be available for interviews at the Hotel Sherman. For appointment telephone DEarborn 2-5700.

ENGINEERS AND PHYSICISTS

Activities at Hughes in the computer field are creating some new positions in the Computer Systems Department. Experience in the design and application of electronic digital computers is desirable, but not essential. Engineers and physicists with backgrounds of component development or system engineering are invited to apply.

Assurance is required that the relocation of the applicant will not cause the disruption of an urgent military project.

ADDRESS: Scientific and Engineering Staff

Hughes
RESEARCH
AND DEVELOPMENT
LABORATORIES

Culver
City,
Los Angeles
County,
California



DESIGNER'S

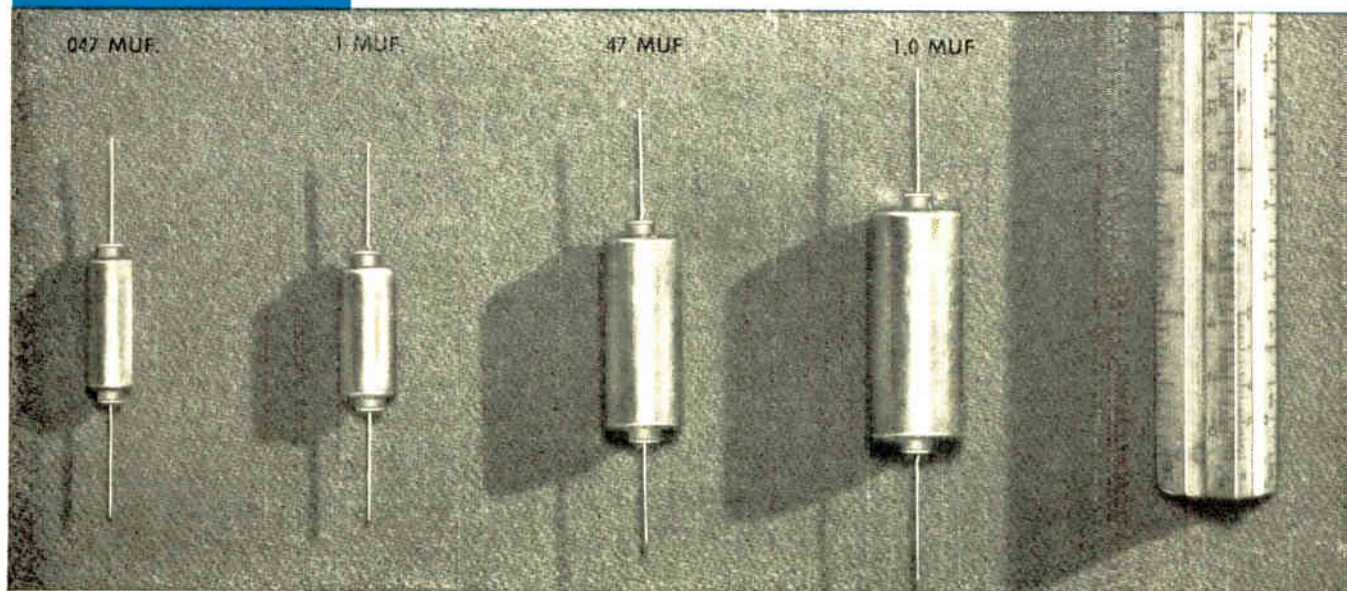

New metal-clad subminiature capacitors withstand extreme temperatures

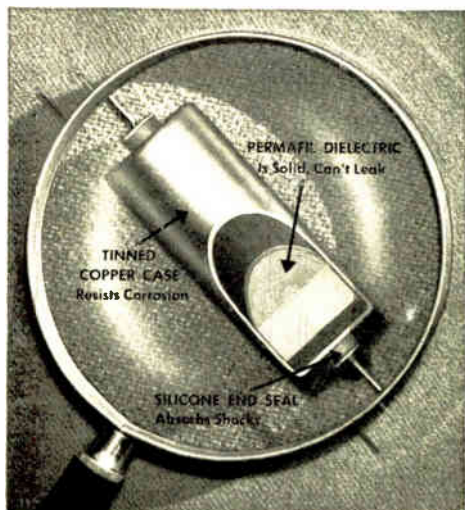

RUGGEDLY CONSTRUCTED G-E subminiature metal-clad capacitors meet all requirements of JAN-C-25 and the proposed MIL-C-25.

Permafil solid dielectric permits operation up to 125C without derating

Here's a complete new line of General Electric metal-clad subminiature capacitors designed to meet difficult operating conditions. Now you need no increase in capacitor size for applications with high working temperatures.

G. E.'s exclusive permafil solid dielectric eliminates the possibility of leakage without derating from -55°C to $+125^{\circ}\text{C}$ —and up to $+150^{\circ}\text{C}$ with proper derating. Silicone bushings give high shock resistance—both thermal and physical—and leads can be soldered right up to the bushing.

Muf ratings range from .001 to 1.0 muf in 100, 200, 400 and 600 volts d-c working. They can be operated at full voltage up to altitudes of 50,000 feet.

If you need even smaller capacitors, G.E. has introduced another line of new Pyranol* (liquid-filled) metal-clad capacitors. These are designed for operation from -55°C to $+85^{\circ}\text{C}$ without derating and offer the same electrical advantages as their permafil cousins. For further information on permafil capacitors, send for new Bulletin GEC-987.



DIGEST

TIMELY HIGHLIGHTS ON G-E COMPONENTS

Compact high-voltage components built for extra long service life

These G-E high-voltage components offer a continuous-service life for long periods under extreme temperatures and mechanical shocks. All are oil-filled and hermetically sealed to resist moisture, dirt and dust. For applications 5000 volts and higher, where corona must be held to a minimum, a wide range of ratings can be tailored to meet your needs. In your inquiry, please include all functional requirements, any physical limitations, and expected quantities. Contact your G-E Apparatus Sales representative for more information.



Rectifiers



Reactors



Transformers

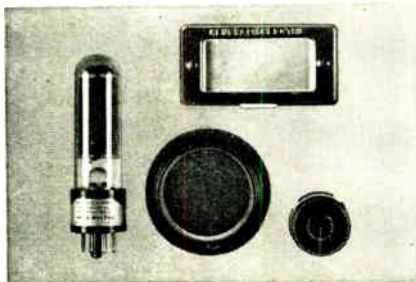

Detects, measures light accurately

G-E photovoltaic cells—for applications where electronic amplifiers are not practical—provide extra-high output with stability and long life in capturing light energy and converting it into electrical energy. This self-generating power plant can detect, measure, and control light—and can measure variations in colors. These G-E cells are available in a hermetically sealed series with standard mountings, and in a wide variety of mounted and unmounted sizes. See Bulletin GEC-690.



Speeds solution to field problems

The G-E analog field plotter offers a valuable aid to electronics equipment engineers in simplifying complex field studies. Problems in electrostatics, electromagnetics, and many other fields are rapidly solved with this sensitive, versatile plotting board and associated equipment. It needs only a low-voltage d-c supply, and is not affected by line-voltage variations. Explanation and instructions are covered in a 50-page manual accompanying plotter. For details, see Bulletin GEC-851.

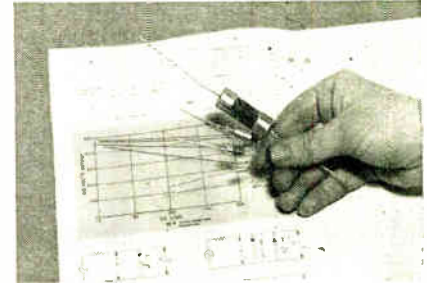

Cover wide temperature range

From -55°C through $+100^{\circ}\text{C}$ —that's the wide range covered by these new G-E miniature selenium rectifiers. Stacks—available for either lead or bracket mounting—have the same outstanding features as larger G-E selenium cells: long life, good regulation, high reverse resistance, and low heat rise. For protection, they are enclosed in either Textolite* tubes, or hermetically sealed in metal-clad casings. For more data, contact your G-E Apparatus Sales representative.



EQUIPMENT FOR ELECTRONICS MANUFACTURERS

Components

Meters, Instruments
Dynamotors
Capacitors
Transformers
Pulse-forming networks
Delay lines
Reactors
Thyrite*
Motor-generator sets
Inductrols
Resistors
Voltage stabilizers

Fractional-hp motors
Rectifiers
Timers
Indicating lights
Control switches
Generators
Selsyns
Relays
Amplidynes
Amplistats
Terminal boards
Push buttons
Photovoltaic cells
Glass bushings

Development and Production Equipment

Soldering irons
Resistance-welding control
Current-limited high-potential tester
Insulation testers
Vacuum-tube voltmeter
Photoelectric recorders
Demagnetizers

*Reg. Trade-mark of General Electric Co.

General Electric Company,
Apparatus Sales Division, Section A 667-26
Schenectady 5, New York

Please send me the following bulletins:

- for reference
 for immediate project
- GEC-690 Photovoltaic Cells
 GEC-851 Analog Field Plotter
 GEC-987 Permafil Capacitors

Name _____

Company _____

City _____ State _____



News—New Products

These manufacturers have invited PROCEEDINGS readers to write for literature and further technical information. Please mention your I.R.E. affiliation.

(Continued from page 44A)

3 Wire Type Snap-Action Switch

Control Products Inc., Sussex St., Harrison, N. J., announces production of a new type basic waterproof switch. The switch is a single pole, double throw, three wire type featuring sine curve design and miniature size.

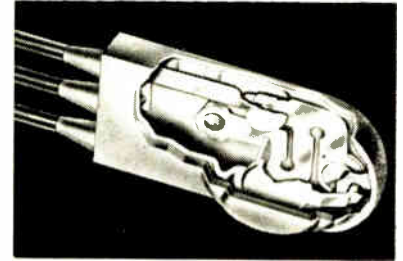

The CPI snap action mechanism is built around a beryllium copper spring fabricated in the shape of a sine curve. Switch is made in accordance with U. S. Army specification 60-977-2 Class B covering waterproof and corrosion resistance.

The basic switch mechanism is enclosed in a waterproof material and will operate without damage in temperatures ranging from -65°F to $+165^{\circ}\text{F}$. Electrical capacity is 20 amperes resistive, 28 volts dc, 10 amperes resistive, 110 volts ac.

Switches are also available in two wire types. All can be supplied with lead lengths made to specification. For complete data, detailed specifications and illustrated literature, readers are invited to write the manufacturer.

Brochure on Vacuum Impregnation

A revised edition of a 24-page brochure #760 on "Vacuum Impregnation" has just been released by F. J. Stokes Machine Co., 5500 Tabor Rd., Philadelphia 20, Pa.

The new publication describes in detail a wide range of applications for this versatile process by which voids in porous materials are filled with a desired impregnant after air and moisture have been evacuated. Among these uses are the sealing of metal castings against microporosity, the improvement of dielectric efficiency in electrical components and the plotting of transistors.

The enlarged range of Stokes equipment for vacuum impregnating is described and complete specifications for standard cylindrical and rectangular impregnating chambers, storage tanks, and vacuum pumping units are contained in the new booklet, Catalog No. 760.

Copies of the catalog may be obtained free on request to the Company.

(Continued on page 98A)

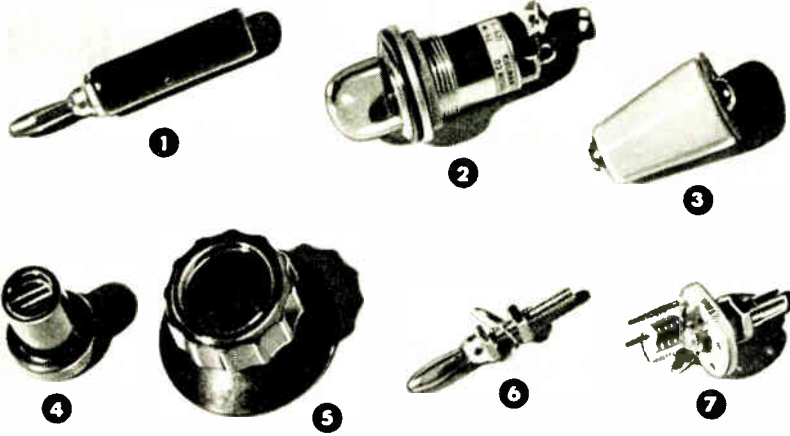

TIME AFTER TIME — ENGINEERS SPECIFY JOHNSON COMPONENTS

Looking for a miniature variable capacitor — a Steatite cone insulator — a beryllium contact nylon tip jack? JOHNSON has these and a large variety of other electronic components. Designed and manufactured to high standards, JOHNSON components are the choice of engineers time and time again.

1. Cat. No. 108-75 BB—"Banana Spring" plug, available with either red or black $1\frac{3}{8}$ " plastic handle. Nickel-silver springs, high grade nickel plated brass screw machine parts.

2. Cat. No. 147-1143—Wide angle, Lucite lens pilot light. Designed for applications utilizing low powered light sources yet requiring good visibility. $\frac{5}{8}$ " threaded Lucite jewel, mounting hole required $1\frac{1}{16}$ ", length behind panel $1\frac{1}{16}$ ". Single contact miniature bayonet socket, phenolic socket body, solder terminals. UL approved.

3. Cat. No. 135-501—Steatite cone insulator, grade L-4 or better. Threads tapped directly into ceramic. Furnished with machine screws, brass and cork cushion washers. $1\frac{1}{32}$ " height, including washer, $\frac{3}{4}$ " base, 8-32 hardware.

4. Cat. No. 116-214—Black phenolic instrument knob. Length $1\frac{3}{16}$ ", skirt diameter $\frac{3}{4}$ ", main body diameter $\frac{1}{2}$ ". Available for $\frac{1}{4}$ " or $\frac{3}{16}$ " shaft. Slotted head, equipped with set screw.

5. Cat. No. 116-261—Black phenolic skirted knob. 12 well defined flutes, $1\frac{3}{8}$ " diameter, $2\frac{1}{16}$ " skirt. Accurately centered brass insert for $\frac{1}{4}$ " shaft.

6. Cat. No. 108-75—"Banana Spring" plug. Furnished with beryllium copper spring on special order. Nickel, cadmium or silver plating if desired.

7. Cat. No. 160-104—Single section, miniature air variable capacitor. Panel area required, $\frac{5}{8}$ " wide by $\frac{3}{4}$ " high. Low inductance. Precision assembled plates. Split sleeve bearings. Beryllium copper tension spring contact for permanent alignment, constant torque and low inherent noise. Steatite insulation impregnated with DC-200. Single hole mounting bushing threaded $\frac{1}{4}$ -32 with flats to prevent turning. $\frac{3}{16}$ " shaft slotted for screwdriver adjustment. Plate spacing .017". Peak voltage rating, 1250.

For more complete information on all JOHNSON electronic components, write for your copy of General Products Catalog 973. Available upon request.



E. F. JOHNSON COMPANY

CAPACITORS, INDUCTORS, SOCKETS, INSULATORS, PLUGS, JACKS, DIALS, AND PILOT LIGHTS

204 SECOND AVENUE SOUTHWEST • WASECA, MINNESOTA

**New 800-2600 MCS
Frequency Meters
Lightweight-Portable
Units.. For Field and
Laboratory Use!**



Models
 FS-C-171-A 800-1200 MCS.
 FS-C-172-A 1200-1600 MCS.
 FS-C-173-A 1600-2250 MCS.
 FS-C-174-A 1700-2600 MCS.

The input circuit is a type N connector (JG-58,U) . . . The output is monitored by a 1N218 crystal and microammeter circuit with adjustable sensitivity control for varying input power levels. The output of the crystal may be obtained from pin jacks provided on the panel of the instrument. A switch is provided to change the output from the microammeter to the pin jacks.

ACCURACY

Better than .05% from 20°F to 120°F

SENSITIVITY

Usable indication with 1 milliwatt input
Adjustable for higher levels

INDICATOR 50 Microammeter

INPUT

50 Ohm Type N Connector

EXTERNAL DC OUTPUT

Pin Jacks

EXCURSION OF MICROMETER

One-half inch

MICROMETER SCALE

at 1000 Mc — 1 Division equals 290 KC

at 1400 Mc — 1 Division equals 350 KC

at 2000 Mc — 1 Division equals 450 KC

at 2600 Mc — 1 Division equals 555 KC

EXTERNAL SIZE 6½ x 9¾ x 7"

WEIGHT Four pounds

CAVITY UNITS AVAILABLE

Units consist of cavity body, micrometer control, crystal, suitable connectors and calibration chart. Write for specifications and prices.



frequency standards

P. O. Box 504,
Asbury Park, New Jersey

**LET ME
BRING YOU UP-TO-DATE
ON
"Lavite" FERRITE
COMPONENTS**

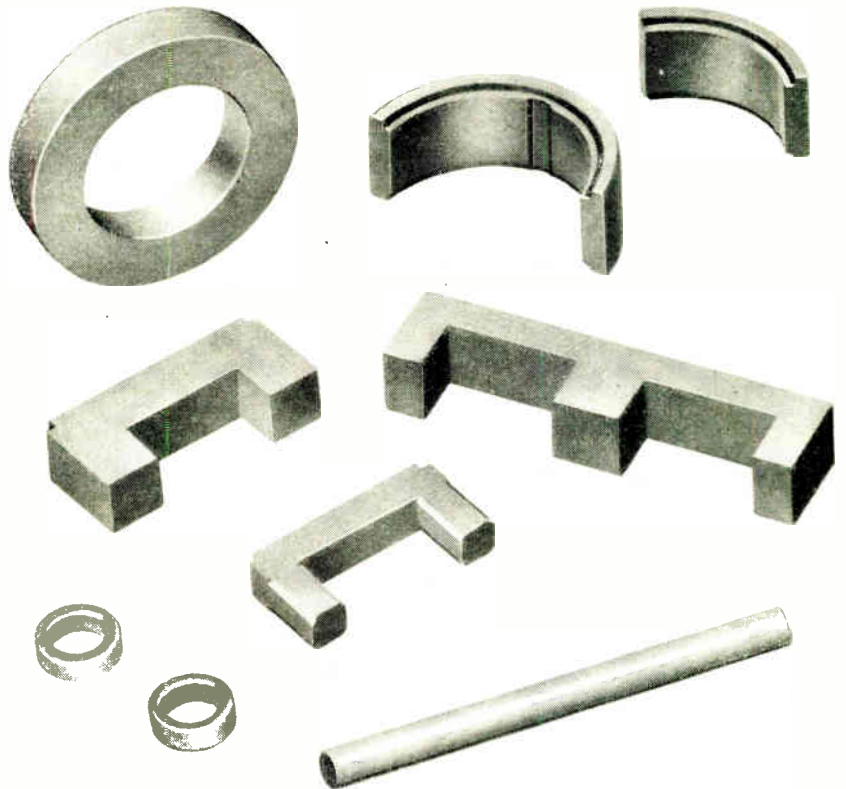

Let me first emphasize the essential difference between "Lavite" Ferrites and general Ferrites. When you use "Lavite" Ferrites, you first have all of the desirable basic advantages of this type of material. These advantages are many varieties in composition to better meet specific electrical properties that may be required as to high saturation, higher permeabilities, high Q and FM frequencies, low temperature coefficient, etc.

To this is added the plus value of:

1. Steward's private research and development,
2. Steward's modern and highly efficient facilities to produce your "Lavite" Ferrite components to greater accuracy in both material and size,
3. Interestingly low production costs of these parts, and
4. Prompt delivery.

And in addition to all this, you are invited to consult Steward engineers, without obligation, for scientific answers to your specific problems. Send me your specifications.

Ask for general characteristic data on all "Lavite" Technical Ceramics — ("Lavite" Steatite, "Lavite" Titanates, "Lavite" Ferrites, and others).



**D. M. STEWARD
MANUFACTURING CO.**

3605 Jerome Ave, Chattanooga, Tennessee.
Sales Offices in Principal Cities

News—New Products

These manufacturers have invited PROCEEDINGS readers to write for literature and further technical information. Please mention your I.R.E. affiliation.

(Continued from page 96A)

60-Position Switch

The space-and-weight-saving advantages of low-cost printed circuit techniques have been applied to a new 60-position rotary switch recently announced by the **Shallcross Manufacturing Co.**, 520 Pusey Ave., Collingdale, Pa.

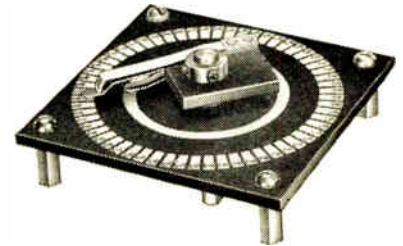

Stator contacts of the new switch are silver- and rhodium-plate copper printed on a paper-base phenolic deck 3 inches square. Connections are made to stator contacts through soldered eyelet terminals. The combination of printed contacts and eyelet terminals makes this switch light in weight, considering the number of contacts.

The switch features an isolated shaft and is designed for 4-point spacer mounting so that a number of these single pole units may be readily ganged. Contacts are arranged to make-before-break. Detent is optional on order.

Inquiries are invited regarding applications.

Digital Point Plotter

The new CCP Digital Point Plotter, recently announced by **California Computer Products**, 3927 W. Jefferson Blvd., Los Angeles 16, Calif., is a high-speed, low-cost digital point-by-point plotter developed primarily for preparing curves and graphs of data received from general-purpose digital computers.



It has an aluminum plotting drum 12 inches long and 6 inches in diameter, capable of producing 11×17 inch plots. Plotting resolution is 40 points per inch, with accuracy held to ± 0.025 inch. Plotting speed is 2 seconds per point. A variety of stylus-symbols may be selected by the user.

(Continued on page 100A)

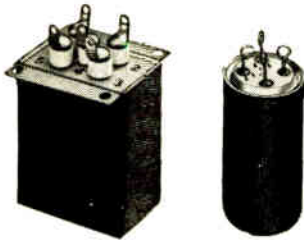

MINIATURE



MOLDED



CASED

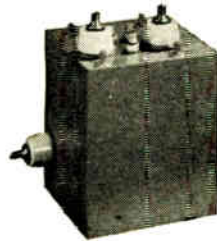

HERMETICALLY SEALED OIL-FILLED



A-LINE



T-LINE



TOROIDS

Kenyon
Standard
and Special
Transformers
engineered to
your requirements

INQUIRIES AND SPECIFICATIONS
RECEIVE PROMPT ATTENTION



Kenyon Transformer Co., Inc.
840 Barry St., New York 59

Microwave TEST COMPONENTS

PRD offers a complete line of test equipment for precise measurements in the Microwave region. This equipment, the finest obtainable anywhere, includes Frequency Measuring Devices, Signal Sources and Receivers, Attenuators and Terminations, Impedance Measurement and Transformation Devices, Detection and Power Measurement Equipment, Bolometers and Accessories.

**When you test,
use the best—**

PRD

QUALITY
DEPENDABILITY
ACCURACY

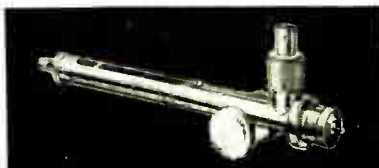

TYPE 250-A BROADBAND PROBE — Frequency range of 1 to 12.4 Kmc/s; two tuning knobs permit precise adjustment for maximum power transfer from the probe tip to the crystal or bolometer detector; third knob controls depth of probe tip insertion.

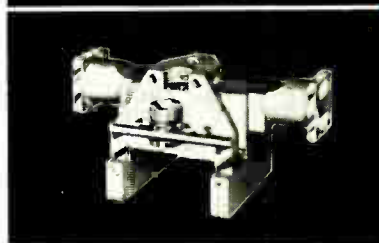

SLOTTED SECTIONS—The mechanical and electrical design of PRD slotted sections emphasizes these important features: Instrument accuracy assured indefinitely by virtue of three bearing carriage suspension to minimize wear; waveguide section machined from solid aluminum alloy stock, to avoid warpage no castings are used.

TYPE 275 VSWR AMPLIFIER — Featuring high gain; A.G.C. to maintain output constant for slow variation in r-f power source; low input noise level of 0.03 microvolts; wide VSWR ranges of 1:1.3, 1:3, 3:10, 10:30, and 30:100; greater accuracy because VSWR scale on meter is linear.

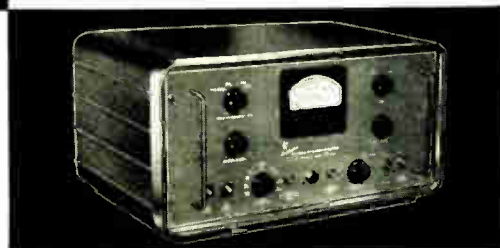

✓
**WRITE FOR
NEW CATALOG**
Address requests for your copy of the new catalog to Department R-9—no obligation.



Polytechnic **RESEARCH
& DEVELOPMENT COMPANY • Inc**



55 JOHNSON STREET, BROOKLYN 1, NEW YORK
WESTERN SALES OFFICE:
741½ NO. SEWARD ST., HOLLYWOOD 38, CALIF.

News—New Products

These manufacturers have invited PROCEEDINGS readers to write for literature and further technical information. Please mention your I.R.E. affiliation.

(Continued from page 98A)

An optional decimal keyboard is available for manual plotting and provision can be made to plot data from magnetic and paper tape or IBM card readers. Other features include automatic multiple curve plotting, simple accessible controls, arbitrary origin location, scale factor trim adjustment, typewriter ribbon ink supply, swing-out chassis rack for easy accessibility to component parts, plug-in components, cable drives for drum and carriage, sealed oil motors and gear trains, and a choice of type of digital input system.

Sliding Contacts or Brushes of Silver Graphite

New sliding contacts or brushes for servo mechanisms, radar antenna operating units, calculating machines, miniature motors and other applications has been announced by the Stackpole Carbon Co., St. Marys, Pa.



Stackpole claims their silver-graphite units feature extremely low contact resistance plus great resistance to welding for maximum contact efficiency. In addition, these units show life at minimum cost. Lowest radio noise levels are obtained by using these silver-graphite units against a silver ring. For ordinary uses however, a copper ring or commutator will suffice.

Available in sizes from 1/16 inch diameter upward, these contacts and brushes can be supplied with pure silver backing for spot welding or brazing directly to support arms or springs. They can also be furnished with copper backing, integral rivet, or other device to meet almost any mounting requirement. Units are supplied separately or factory-mounted to specification. They are made of silver with almost any desired percentage of graphite. Standard grades range from 5 per cent to 80 per cent graphite.

Plastic Toroids

After more than a year of development engineering, The Communication Accessories Co., Hickman Mills, Mo., has perfected a means of molding toroids in plastic. The mounting problems and fragility of the uncased toroid have been entirely eliminated, the manufacturer claims. Two types of brass bushings in the center of the toroid are available. One is threaded for a 6/32 screw, the other pro-

(Continued on page 102A)

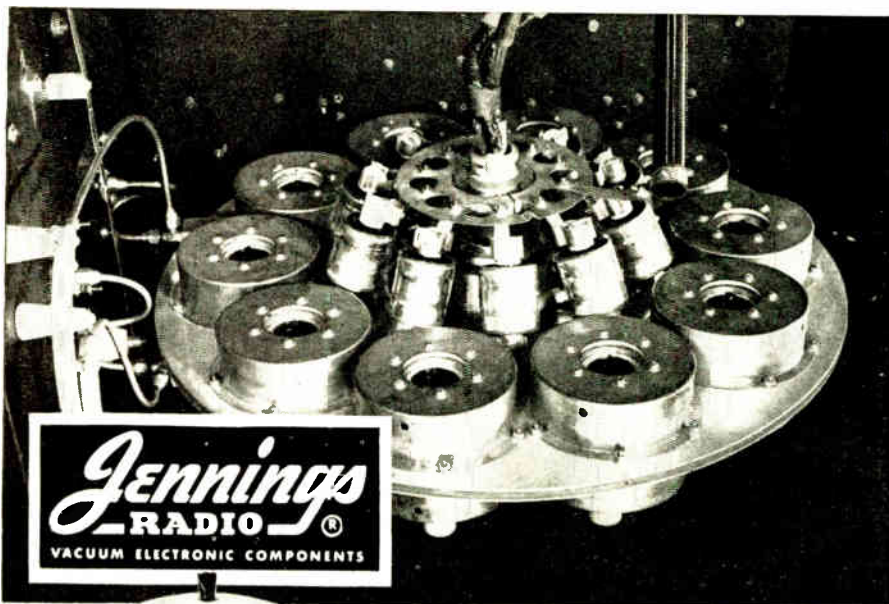

Jennings
—RADIO—
VACUUM ELECTRONIC COMPONENTS



TYPE MMC-1
2000 MMFD. 10 or 15 KV.
225 AMPS. R.M.S.



TYPE MC-1.
1000 MMFD. 10 or 15 KV.
100 AMPS. R.M.S.

**FOR INDUCTION
and
DIELECTRIC
HEATING
HIGHER CURRENT
RATINGS
LOWER INDUCTIVE
LOSSES**

Are offered by **JENNINGS NEW
COMPACTED VACUUM CAPACITORS.**

High current ratings because they are all-copper construction and have large contact surfaces for dissipating heat; low inductive losses because the vacuum dielectric permits a maximum amount of capacity at high voltages to be packed into an extremely small physical space. For example, an MMC-1, 2000 mmfd unit with a voltage rating of 10 KV and a current rating of 225 amperes has an over-all length of less than 5 inches. We believe this to be the shortest physical length yet devised for any type of capacitor

with the same capacity, voltage, and current ratings. With no dielectric to puncture, this vacuum capacitor is also self-healing after temporary overloads.

The oscillator shown above demonstrates how Jennings capacitors may be mounted in parallel in such a way that no parasitic suppressors are required. The large capacitors mounted between the conductor discs are MC-1, 1000 mmfd units used in the tank circuit. Above and below the conductor discs are mounted ten small JCS-1, 100 mmfd vacuum units used as grid and plate blocking capacitors.

Jennings also manufacture vacuum switches capable of repeatedly breaking the D.C. voltages and currents found in the oscillators of induction and dielectric heating units. The same switch may be used to provide extremely fast-acting overload protection for the D.C. power supply.

Write us for information regarding your own Capacitor problem.
Literature mailed on request.

**JENNINGS RADIO MANUFACTURING CORPORATION · 970 McLAUGHLIN AVE.
P.O. BOX 1278 · SAN JOSE 8, CALIFORNIA**

HICKOK

Model 209A



true VTVM and CAPACITANCE TESTER

- Large 9" meter.
- Measures wide ranges of capacitance, inductance, resistance, current, voltage, both AC and DC.
- Includes matched high frequency probe to make this laboratory instrument a TRUE VTVM.
- Write for technical details . . .

THE HICKOK ELECTRICAL INSTRUMENT CO.

10551 Dupont Ave., Cleveland 8, Ohio

QUALITY TRANSFORMERS



For Every Application in Military or Civilian Use

Designed and Built to the most exacting specifications by the originators of the famed FORM-FLEX

Aircraft Transformer Corp.

Manufacturers of Inductive Equipment
Long Branch, New Jersey
Long Branch 6-6250

Representatives located in principal cities throughout the country. Write for address of the one nearest you.

Your Reference Book on

- SOCKETS • PLUGS & CONNECTORS
- JACKS • TERMINAL STRIPS • RACK AND PANEL CONNECTORS • BINDING POSTS
- TERMINAL BLOCKS, KNOBS, STANDOFF INSULATORS • FUSE HOLDERS & FUSE BLOCKS

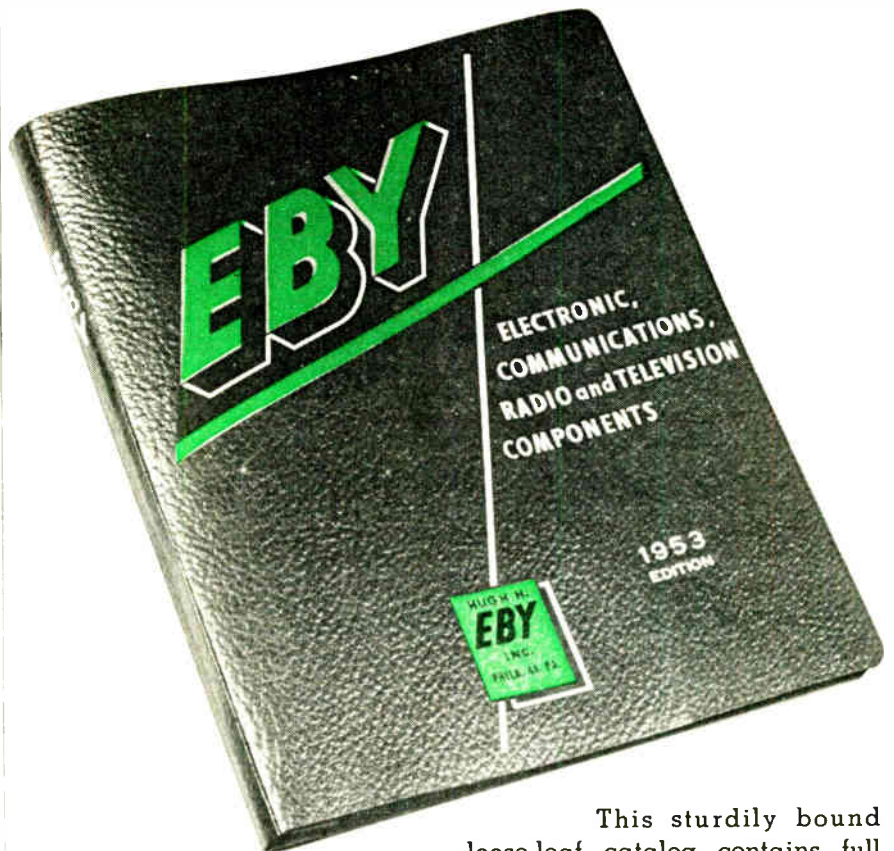

This sturdily bound loose-leaf catalog contains full details and specification data on the complete line of Eby components. A copy will be sent upon request on your company letterhead.

HUGH H. EBY INC.

4702 Stenton Avenue, Philadelphia 44, Pa.



*offers many
exclusive advantages
in..*

Receptacles & plugs

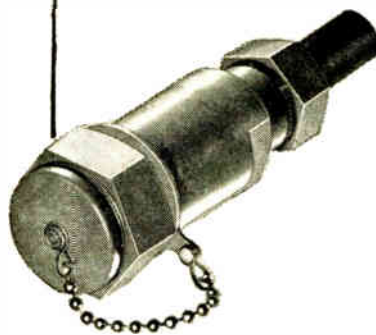
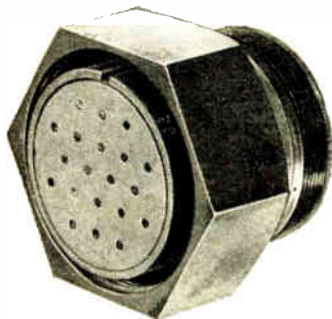
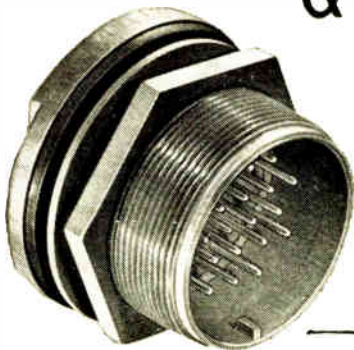

*Pressurized & Waterproof
RECEPTACLES*

*Cable Type
RECEPTACLE & PLUG*

Waterproof CAPS

*Special Waterproof
CABLE CLAMPS*

*High Voltage
RECEPTACLE & PLUG*

*Capacitor Type
RECEPTACLE*

New catalog literature is available on the outstanding, quality line of RECEPTACLES & PLUGS offered by HHB.

These quality parts are available in standard sizes, and arrangements, (AN types), or special arrangements to meet your requirements.

We invite inquiries . . . no obligations.

H. H. BUGGIE Inc.
TOLEDO 4, OHIO

Sales Engineers in All Principal Cities

*Skilled in Electronic Component Parts
RESEARCH • DESIGN
ENGINEERING
MANUFACTURING*

News—New Products

(Continued from page 100A)

vides a hole to clear a 6/32 hole. This center bushing keeps mounting pressure off the plastic and makes possible cleaner mountings. Complete uniformity of dimension is maintained by precision molds. The following toroids are available finished in this manner: Types 206, 848, 930, 671, 395 and 269.

Complete data are available by writing the company. Samples available on request.

Beta Gamma Counter

The Victoreen Instrument Co., 3800 Perkins Ave., Cleveland 14, Ohio, announces the availability of a new beta gamma counter tube.



The tube (Type 6306) is a bismuth cathode counter tube having efficiency six times greater than standard counter tubes on radioactive iodine and more than twice on radium.

This tube has the same thin aluminum wall as the 30 mg/cm² Victoreen Type 1B85. However, the bismuth screen liner effectively makes the 6306 a thick wall tube with many times the strength of the old style ribbed 1B85.

Very low cost of the 6306 makes it ideal for multiple tube applications such as cosmic research, area and process monitoring, aerial prospecting, and hand-and-foot monitoring. Uniformity of characteristics allows many tubes to be operated in parallel.

Electrical characteristics and dimensions of the 6306 are identical to those of the coaxial based 1B85. Operating voltage is 900 volts with a slope of 5 per cent per 100 volts over the 150 volt plateau.

Deposited Carbon Resistor

Erie Resistor Corp., Union Station Bldg., Erie, Pa., announces that they are in production on 1/2-watt deposited carbon precision resistors in values from 100 ohms to 1/2 megohm. Standard tolerances are 1, 2, and 5 per cent.

A feature of this stable pyrolytic resistor, designated as Style 155, is the one piece molded case. The thermo-setting molded insulation provides protection against humidity and also gives assurance against mechanical damage to the carbon film. Added insulating sleeving is not required on these units.

Erie Style 155 resistor is considerably smaller than corresponding non-insulated RX20 size with insulating sleeving. Actual size is 19/32 long by 3/16 inch diameter, and leads are axial #20 tinned copper wire.

Sold under the trade name "Hi-Stabe," these resistors meet test requirements of MIL-R-10509A.

(Continued on page 104A)



HIGH
Quality

CLEVELITE*

FOR BETTER COMPONENTS

Clevelite ensures satisfactory performance wherever high dielectric strength, low moisture absorption, mechanical strength, low loss and good machinability are of prime importance.

Clevelite is made in SEVEN GRADES . . . Time Tested!

GRADE	APPLICATION
E	Improved post-cure fabrication and stapling.
EX	Special grade for TV yoke sleeves.
EE	Improved general purpose.
EEX	Superior electrical and moisture absorption properties.
EEE	Critical electrical and high voltage application.
XAX	Special grade for government phenolic specifications.
SLF	Special for very thin wall tubing having less than .010 wall.

When you specify and use CLEVELITE you obtain
High Quality and Fine Service

*Send for our new Clevelite
Folder just off the press.*

WHY PAY MORE? For the best . . . Call CLEVELAND!

* Reg. U. S. Pat. Off.

The **CLEVELAND CONTAINER Co.**
6201 BARBERTON AVE. CLEVELAND 2, OHIO

PLANTS AND SALES OFFICES at Chicago, Detroit, Memphis, Plymouth, Wisc., Ogdensburg, N. Y., Jamesburg, N. J.
 ABRASIVE DIVISION at Cleveland, Ohio
 CANADIAN PLANT: The Cleveland Container, Canada, Ltd., Prescott, Ontario

REPRESENTATIVES
 NEW YORK AREA R. T. MURRAY, 604 CENTRAL AVE., EAST ORANGE, N. J.
 NEW ENGLAND R. S. PETTIGREW & CO., 62 LA SALLE RD., WEST HARTFORD, CONN.
 CHICAGO AREA PLASTIC TUBING SALES, 5215 N. RAVENSWOOD AVE., CHICAGO
 WEST COAST IRV. M. COCHRAN, CO., 408 S. ALVARADO ST., LOS ANGELES



PRESSURE INSTRUMENTS

Giannini instruments for low pressure measurement and control utilize precision potentiometer elements to translate pressure signals into proportional electrical signals (20-50 volts) requiring little or no amplification. Models are available with single or multiple outputs and can be linear with airspeed, altitude, pressure, or to natural or empirical functions. ■ Over twenty separate and distinct types of proven capsule-powered transducers and switches are obtainable for applications requiring precise measurements of absolute, differential, or gage pressures, in ranges from ± 0.5 psi diff. to 0-150 psi. ■ Instruments are available to operate under either normal military environmental conditions or under conditions of high acceleration, severe shock, and extreme vibration. *G. M. Giannini & Co. Inc. also manufactures a complete line of high pressure instruments. Write for catalog.*

MODEL 45176 illustrated 0-1 to 0-150 psi abs, diff., gage.
Size 2.63 in. dia. x 3 in. weight 15 oz. max.

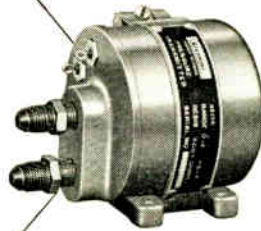

MODEL 45177

Up to 4 outputs and inputs in ranges 0-1 to 0-150 psi abs, diff. or gage. (Set of 2 model 45176).



MODEL 45154

Ranges 0-5 to 0-30 psi abs. Size 2.25 in. dia. x 2.48 in. weight 8 oz. max.



MODEL 45172

Ranges 0-10 to 0-30 psi abs, diff. or gage. Size 2.19 in. x 2.83 in. weight 15 oz. max.

Giannini

G. M. GIANNINI & CO., INC. • PASADENA 15, CALIF. • EAST ORANGE, NEW JERSEY

News—New Products

These manufacturers have invited PROCEEDINGS readers to write for literature and further technical information. Please mention your I.R.E. affiliation.

(Continued from page 102A)

Multi-Stylus Recorder

A new series of multi-stylus recorders (RX-30 series) which can record simultaneously on a large number of fixed styli across a chart $9\frac{1}{2}$ inches in width is being offered by **Hogan Laboratories, Inc.**, 155 Perry St., New York 14, N. Y. The recording medium used is FAXPAPER, a current-sensitive electrolytic recording paper. Because of its wide range half-tone characteristics, this paper makes possible the gathering of additional information in each marking channel by means of variable density recording techniques.

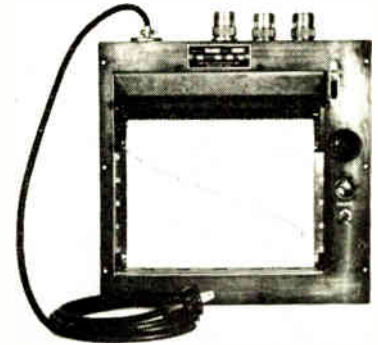

The recorder is supplied with a single, fixed, chart advance speed, but this speed can be chosen from several different speeds available, to best suit the use to which it may be put. The number of styli may also be varied to meet requirements.

An example of this series of recorders is the RX-30C (shown in illustration) which has thirty nine marking styli and a chart advance speed of 4 ips. A 400 foot roll of FAXPAPER will feed this recorder for twenty minutes of operating time. Re-loading is simple and requires no threading of the paper web.

RF Bridge

The Wayne Kerr Bridge (Type B601) now being distributed by **Marconi Instruments, Ltd.**, Dept. TI, 23 Beaver St., New York 4, N. Y., measures balance and unbalance complex impedances and the impedance between any pair of terminals in a three terminal network.

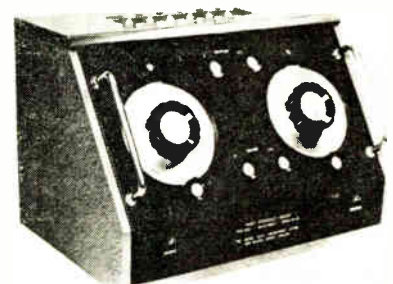

The Bridge employs the tapped-transformer principle and reads directly,
(Continued on page 106A)

PROCEEDINGS OF THE I.R.E. September, 1953

ANNOUNCING...

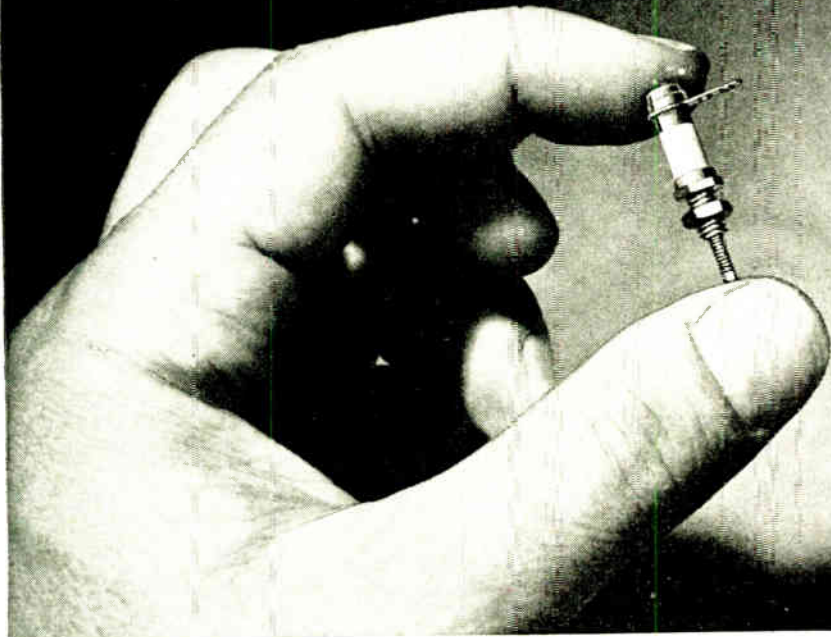

Shown approximately full size.

C.T.C.'s new CST-50 capacitor with greatly increased range, greater stability

Surpasses the range of capacitors many times larger in physical size.

The new CST-50 variable ceramic capacitor embodies a tunable* element of such unusual design it practically eliminates losses due to air dielectric. As a result, a large minimum to maximum capacity range (1.5 to 12 MMFD) is realized — despite the small physical size of the capacitor. This tunable* element is a spring-type, S-shaped tuning sleeve* which maintains constant maximum pressure against the inside wall of the ceramic form.

Other Design Features

The CST-50 stands only 19/32" high when mounted, is less than 1/4" in diameter and has an 8-32 threaded

mounting stud. The mounting stud is split so that the tuning sleeve* can be securely locked without causing an unwanted change in capacity. The tuning sleeve* is at ground potential. The CST-50 is provided with a ring terminal which has two soldering spaces.

All C.T.C. materials, methods and processes meet applicable government specifications. For further information on C.T.C. components and C.T.C.'s consulting service (available without extra charge) write us direct. Cambridge Thermionic Corporation, 456 Concord Avenue, Cambridge 38, Mass. West Coast manufacturers contact: E. V. Roberts, 5068 West Washington Blvd., Los Angeles and 988 Market St., San Francisco, California.



Exploded view of the CST-50 capacitor shows: (1) ring terminal with two soldering spaces; (2) metallized ceramic form; (3) spring-type S-shaped tuning sleeve*; (4) split mounting stud; (5) locking nut.

* Patent Applied For

CAMBRIDGE THERMIONIC CORPORATION

custom or standard . . . the guaranteed components

Write for Free Catalog #400 containing complete data on the entire CTC line.

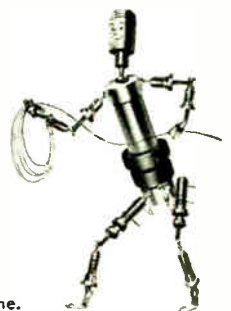

Peak Performance

from Amphenol Components



RF TYPE CONNECTORS



POLYETHYLENE CABLES

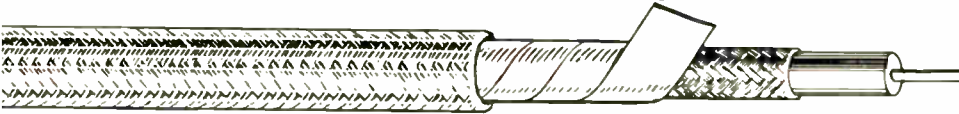

TEFLON CABLES

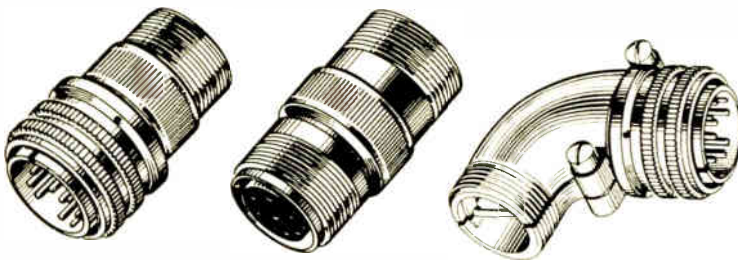

AN TYPE CONNECTORS

AMPHENOL RF CONNECTORS are available in Types BNC, BN, N, HN, C, LC, Push-On and UHF 83 series. Efficient in performance, they provide excellent impedance match with low loss. They are unmatched for quality linking of coaxial cables.

AMPHENOL CABLES are made with the finest materials—incorporate dielectrics of the new extreme temperature range plastics as well as standard plastics. Constant quality checking insures that each cable will perform up to the high AMPHENOL standards.

AMPHENOL AN CONNECTORS are manufactured in strict compliance with government specifications—have superb mechanical and electrical characteristics. AMPHENOL supplies the widest selection of AN's now available from a single source.

CATALOG B-2 is a general listing of all AMPHENOL products, including AN's, RF's, Cables, Sockets and other radio products. Listed are special literature and catalogs, to be ordered when more specific information is required.



AMERICAN PHENOLIC CORPORATION
chicago 50, illinois



News—New Products

These manufacturers have invited PROCEEDINGS readers to write for literature and further technical information. Please mention your I.R.E. affiliation.

(Continued from page 104A)

with an accuracy of ± 1 per cent, resistances from 10 ohms to 10 megohms, capacitances from 0.1 μf to 20,000 μf , and inductances from 0.5 μH to 0.05 H, in the frequency range 15 kc to 5 mc. There are no tubes or power requirements, the bridge being used with external signal generator and detector.

Particularly useful in antenna measurements, this instrument has found new application in the transistor and the non-linear ceramic fields. The bridge is one of the series covering the range from 15 kc to 250 mc.

Miniature Variable Speed Changers

Newly re-designed Series 3 variable speed changers with three different types of geared controls are now available from **Metron Instrument Co.**, 432 Lincoln St., Denver 3, Colo.

The output-shaft speed can be varied from $\frac{1}{3}$ th to 5 times the input-shaft speed by simply rotating the speed control shaft with either spur, miter or worm-gear remote controls.

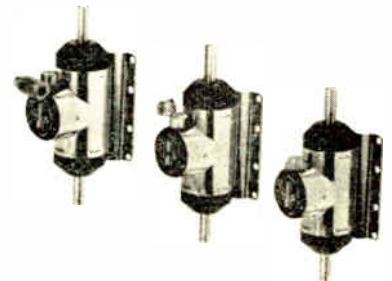

Small and lightweight (6 ounces), these units are suitable for remotely controlled applications in recorders, flow controls, regulators, scanning mechanisms, and so forth.

The spur-gear control (Type 31D) may be used where the control shaft and the remote control shaft are parallel. A choice of mating spur gears offers a wide selection of control speeds.

Where the control shaft and remote control shaft must be at right angles to one another, either the miter-gear control (Type 31E) or the worm-gear control (Type 31F) is recommended. The worm-gear control is advantageous where a small motor is used to drive the control shaft.

Any one of the three types may be converted to flexible shaft by removing the control gear.

Phenolic Terminal Blocks

Phenolic terminal blocks for electronic and communications equipment are now available from **Lenkurt Electric Co.**, County Rd., San Carlos, Calif. Four dif-

(Continued on page 107A)

News—New Products

These manufacturers have invited PROCEEDINGS information. Please mention your I.R.E. affiliation, readers to write for literature and further technical

(Continued from page 106A)

ferent arrangements are offered providing 40, 60, 80 or 100 pre-tinned, double-notched terminals fastened between phenolic strips. The terminal assembly is fastened to a base of the same material. Advantages provided by all phenolic block construction are good electrical characteristics, high structural stability, and low water absorption.

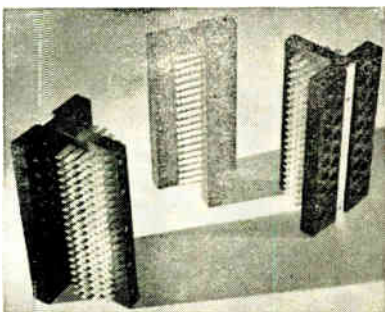

Specifications and prices for Lenkurt phenolic terminal blocks are given in new Lenkurt Bulletin B1-P2. Copies are available from the manufacturer.

Acetate Coil Bobbins

Acetate coil bobbins for rf and IF coils, relays, push-pull solenoids, switching, timing and reversing circuits, and other electronic applications requiring high insulation properties, are now available in any size, shape, I.D. or O.D., and in any quantity, from Precision Paper Tube Co., Dept. P17, 2051 W. Charleston St., Chicago 47, Ill.

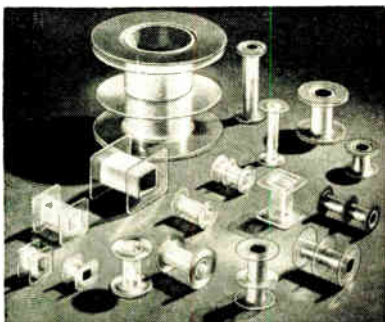

These bobbins can be supplied in all acetate construction, combination acetate and dielectric paper, and with vulcanized fiber or metal flanges. In the case of coil forms for relays, and so forth, where brass shading rings are employed to concentrate the magnetic field, acetate shields are used to insulate the coil from the ring. Used with dielectric paper, acetate provides increased insulation without sacrifice of the tensile strength of the base material.

These coil forms can be fitted with flanges to meet any specification, plain, slotted, punches, or fitted with terminal leads and embossed or recessed to fit any type of mounting.

(Continued on page 108A)

Peak Performance from Amphenol's 5 Plants

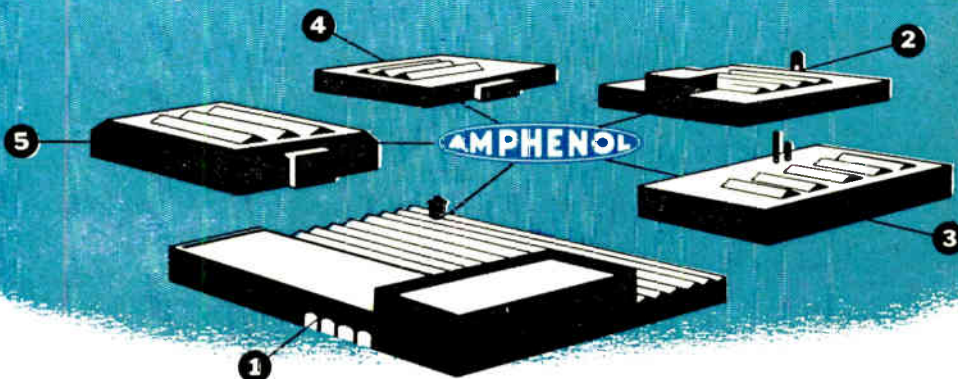

over 9,000 precision products for the electronics industry!

Products of the American electronics industry are becoming increasingly efficient, both in design and in function. The inventiveness of electronics seemingly knows no bounds and each day witnesses a new product, a new application, all requiring skill in manufacture—all reflecting the amazing advances made in electronics since the end of the war. Intricate new computers; radio equipment for atomics and for aircraft are not only complex in themselves, but in their component requirements issue a challenge to all who supply these vital parts.

To meet this challenge, to work with industry in the designing and supplying of quality components for new projects, the engineering versatility of AMPHENOL is dedicated. For AMPHENOL engineers have not only the thorough grounding and magnificent experience of working with the over 9,000 items presently in the AMPHENOL catalogs, but they are constantly alert to new ideas. Time and again they have been able to assist in the design of components for particular applications, many entirely new; often they have been able to adapt an existing AMPHENOL component to new specifications, at great saving of time and expense to the manufacturer. Whatever the need, let AMPHENOL assist you in your problems and *build, with you, to the future of electronics.*

AMERICAN PHENOLIC CORPORATION
chicago 50, illinois



VACUUM TUBE VOLTMETER

MODEL 62

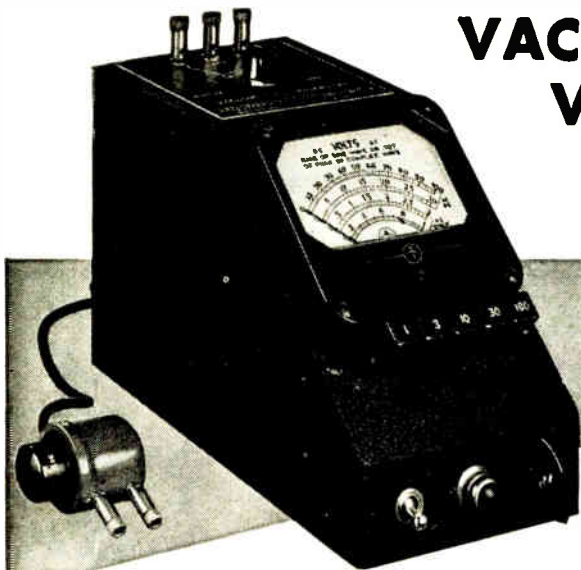

SPECIFICATIONS:

RANGE: Push button selection of five ranges—1, 3, 10, 30 and 100 volts a.c. or d.c.

ACCURACY: 2% of full scale. Useable from 50 cycles to 150 megacycles.

INDICATION: Linear for d.c. and calibrated to indicate r.m.s. values of a sine-wave or 71% of the peak value of a complex wave an a.c.

POWER SUPPLY: 115 volts, 40-60 cycles—no batteries.

DIMENSIONS: 4 1/4" wide, 6" high, and 8 1/2" deep.

WEIGHT: Approximately six pounds.

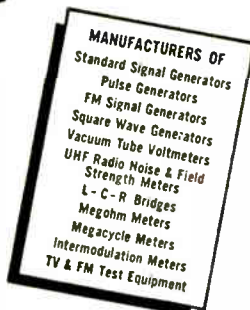

MEASUREMENTS CORPORATION
BOONTON NEW JERSEY

News—New Products

These manufacturers have invited PROCEEDINGS readers to write for literature and further technical information. Please mention your I.R.E. affiliation.

(Continued from page 107A)

Miniature Motors

Miniature totally enclosed, explosion proof, dc electric aircraft motors are now being produced in quantity by **Lear, Inc., Grand Rapids Div.**, 110 Ionia Ave., N.W., Grand Rapids 2, Mich. These motors are precision manufactured to yield the highest horsepower per pound ratio consistent with the reliability demanded of aircraft devices, according to Lear.

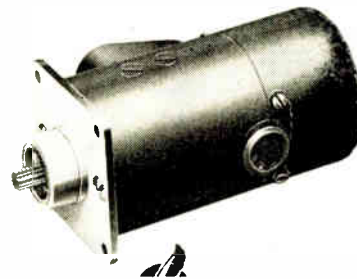

The motors may be used in any application which requires 5 to 45 watts output at speeds from 9,500 to 15,000 rpm. A maximum diameter of 1.572 inches and lengths of 2.69, 3.00, 3.38, and 3.88 are the outline dimensions of those currently in production.

Electro-magnetic brakes are incorporated as integral parts of these new units. Motors are available with or without thermal protectors. These 26 volt dc, intermittent duty motors are designed to meet the environmental and service requirements of Specification AN-M-40, and the new proposed MIL Specification for dc motors.

Motors are designed with single series, split series, tapped series, shunt, or compound windings. Output shafts to customer specifications are available with or without integral pinions. Standard or special mounting flanges may also be specified.

Overload Radiation Switch

A new overload radiation switch that provides protection against tube failure due to anode overheating has been announced by **Federal Telephone and Radio Corp.**, 100 Kingsland Rd., Clifton, N. J., associate of International Telephone and Telegraph Corporation.

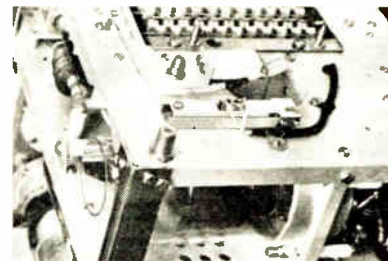

Designed to protect radiation-cooled transmitting tubes from damage caused by

(Continued on page 110A)

IT'S HARVEY FOR PROMPT "OFF-THE-SHELF" DELIVERY

Whether it's equipment, components or other electronic requirements, you will always find them in Harvey's extensive stocks, ready for immediate delivery to you anywhere.

WRITE
PHONE
or WIRE

Harvey's twenty-five years of service to the industry are your assurance of understanding 'know-how' and complete dependability.



Telephone
LUxemburg 2-1500

HARVEY
RADIO COMPANY, INC.
103 West 43rd St., New York 36, N. Y.

B&W Precise AUDIO TESTING

for designing, production checking,
research or "proof of performance"
FCC tests for broadcasters.

A low-distortion source of audio frequencies between 30 and 30,000 cycles. Self-contained power supply. Calibration accuracy $\pm 3\%$ of scale reading. Stability 1% or better. Frequency output flat within 1 db, 30 to 15,000 cycles.

MODEL 200 \$138



**AUDIO
OSCILLATOR**

For fundamentals from 30 to 15,000 cycles measuring harmonics to 45,000 cycles; as a volt and db meter from 30 to 45,000 cycles. Min. input for noise and distortion measurements .3 volts. Calibration: distortion measurements ± 5 db; voltage measurements $\pm 5\%$ of full scale at 1000 cycles.

MODEL 400 \$168



**DISTORTION
METER**

Combines RF detector and bridging transformer unit for use with any distortion meter. RF operating range: 400 kc to 30 mc. Single ended input impedance: 10,000 ohms. Bridging impedance: 6000 ohms with 1 db insertion loss. Frequency is flat from 20 to 50,000 cycles.

MODEL 404 \$85



**LINEAR
DETECTOR**

Speeds accurate analysis of audio circuits by providing a test signal for examining transient and frequency response . . . at a fraction of the cost of a square wave generator. Designed to be driven by an audio oscillator.

MODEL 250 \$10



**SINE WAVE
CLIPPER**

The instruments of laboratory accuracy

Bulletin PR-93 gives complete details

Barker & Williamson, Inc.

237 Fairfield Avenue • Upper Darby, Pa.

**HIGH
COMPRESSION
GLASS-TO-METAL
VACUUM
SEALS**

These are the only seals that
are hot tin dipped at 530°F.

MULTI-PIN HEADERS The new vacuum tight, HIGH COMPRESSION glass to metal seal makes CONSTANTIN HEADERS ideal for use in the manufacture of practically any product which demands a stabilized atmosphere, and protection from moisture. Ingenious seal engineering and flexible manufacturing methods permit numerous additional configurations and the adaptation of CONSTANTIN HEADERS to any requirement.

TRANSISTOR MOUNTS CONSTANTIN TRANSISTOR MOUNTS assure dependable, long-life transistor service for all types of electronic instruments. Glass-to-metal sealing allows the germanium block to be permanently sealed in a vacuum or inert gas. This prevents aging and gives lasting protection against variations due to moisture, dirt, and changing atmospheric or light conditions.

CONDENSER END SEALS Our complete line of special END SEALS assures a stabilized atmosphere thus making them especially adaptable to capacitors, filters, delay lines, and precision resistors. Special finishes available.

TERMINALS Constantin's extensive line of HIGH COMPRESSION TERMINALS are available in all combinations of hooks, eyes, tubes and pierced flats. Standard units of the complete line have test ratings from 1,000 to 15,000 volts R.M.S. and 5 to 25 amperes.

L.L. Constantin & Co.

MANUFACTURING ENGINEERS
Rt. 46 and Franklin Ave., Lodi, N. J.

Also manufacturers of—
MULTI-PIN CON PLUGS
CRYSTAL HOLDERS
VACUUM COATING EQUIPMENT



These compression seals are in addition to our regular and complete line of vacuum to metal glass seals.

News—New Products

These manufacturers have invited PROCEEDINGS readers to write for literature and further technical information. Please mention your I.R.E. affiliation.

(Continued from page 108A)

excessive plate dissipation, the switch will operate with any tube whose radiant energy density at the bulb surface is greater than one watt per square inch. Rugged and easy to install, the new device is resistant to shock and vibration, has positive snap action, and can be readily adjusted to the desired operating level. It is also capable of controlling sizable currents.

The switch differs from thermostats in that it is actuated by (direct) radiant energy and is essentially unaffected by ambient temperature changes. It shows no material change in characteristics over an ambient range of -20° to $+100^{\circ}\text{C}$. For detailed data contact the Component Sales Dept.

Two-Speed Precision Drive

The control of variable capacitors, inductances, slide wire potentiometers, wave-meters, and so forth, requires exact angular movements from 0° to 180° . The "Microdual," a two-speed precision rotary drive, designed to provide this precision without backlash is announced by **Transradio Ltd.**, 138 A Cromwell Rd., London, S.W. 7, England.

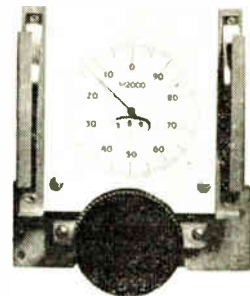

The main feature of this instrument, the manufacturer claims, is that it is possible by axial displacement of the control knob to select the desired speed ratio with no observable backlash on either range.

Helicoidal gearing is employed and the main drive is by split and spring-loaded gears with automatic take-up of any wear or play between the primary and secondary drives.

On all models the main dial is divided into 100 divisions equivalent to 180° ; this is accompanied by a separate decimal indicator. The indicator needle of the main dial, as well as of the decimal indicator, is permanently attached to the output shaft, giving a performance amounting to 100 per cent precision of reading. Ample torque on the center spindle is assured, the drive on the lower ratio is positive and the friction drive is used on the higher ratio where it is most effective.

The separation between successive markings on the decimal indicator can be as small as 5.4 minutes ($=1/2000 \times \text{Full Scale Deflection}$) and positioning to within 2.7 minutes is obtained.

(Continued on page 112A)

Saratoga Industries

STAR PERFORMANCE AS
MANUFACTURERS OF TRANSFORMERS,
REACTORS, FILTERS, TOROIDAL
COILS FOR THE ELECTRONICS INDUSTRY

Now in its ninth year of operation, Saratoga Industries, Inc. has built a solid reputation for the manufacture of precision windings. Approved for in-plant testing under MIL-T-27, Saratoga Industries, Inc. is also prepared to handle all types of commercial production. Saratoga engineers invite your inquiry to help solve your problems relating to reactors, transformers, filters and windings of all types.

SARATOGA INDUSTRIES, INC., SARATOGA SPRINGS, N. Y.

A NEW FAST 10mc SCALER (0.1 MICROSECOND RESOLUTION)



MODEL 410 SCALER

FEATURES:

1. **Resolving Time:** 0.1 μ sec.
2. **Maximum Continuous Rate:** 10^7 counts per second or 10 mc; no lower limit
3. **Interpolation:** Simple neon light indicators usually available only in slower Scalers
4. **Scale Factor:** Binary scale of 128 for maximum reliability

APPLICATIONS:

1. **Fast Nuclear Counting:** When used in conjunction with conventional slow Scalers (app. 10^5 counts per second); it extends their range to 10^7 counts per second
2. **High Frequency Measurements:** Extends range of 100kc frequency counting equipment up to 10 mc.
3. **Time Interval Measurements:** Allows time interval measurements to an accuracy of 0.1 μ sec.

ELECTRICAL AND PHYSICAL INSTRUMENT CORPORATION

DESIGN, DEVELOPMENT AND MANUFACTURE
ELECTRONIC AND ELECTRICAL DEVICES

Sales and Business Office
25 West 43rd Street
New York 36, N. Y.
Telephone: Longacre 4-2265

Engineering Division
42-19 27th Street
Long Island City 1, N. Y.
Telephone: Stillwell 4-6389

Write for Bulletin S-1

PRECISION INDEXING

up to
2400
PER HOUR

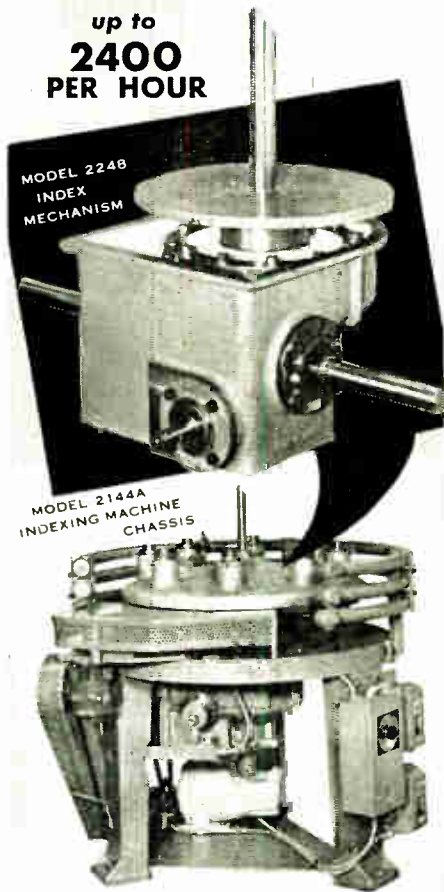

For the first time KAHLE makes available separately the index mechanism (Model 2248) with or without chassis (Model 2144A) which is capable of indexing at 2400 per hour! This is the heart of many famous machines whose ruggedness, precision and minimum maintenance requirements have made KAHLE a leader and name well known throughout the world in electronics and the glass industry.

KAHLE's more than 40 years of experience have perfected these units—used in the electronics and glass industries in such applications as annealing, fire polishing, sealing, etc.—which are offered for installation on your own tables or incorporated in your own machines. Index mechanisms are available with 8, 16, 24, 30, 32 and 48 positions.

Particulars about special features of the indexing chassis... Dual-Motor Drive, Timer-Index Control, Automatic Head Stop, Universal Head Receptacles, etc... will be given gladly.

Write KAHLE today for complete information.

Kahle ENGINEERING COMPANY

1312 SEVENTH STREET
NORTH BERGEN, N. J.

LABORATORY PROVEN

FAIRCHILD

Transistor Analyzer

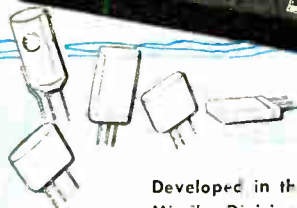

Developed in the Electronic Laboratories of the Fairchild Guided Missiles Division, the Fairchild Transistor Dynamic Analyzer incorporates in a single instrument all features necessary for testing transistor characteristics. During the past two years, this instrument has served as an essential tool in the Fairchild Laboratories for designing transistor circuits for use in missile guidance systems.

The Analyzer provides accurate and complete plots of static and dynamic characteristics of Transistors—point contact and junction. Its principles are basic, to meet future Transistor needs. Complete with all calibrating circuits built in—only external equipment, a standard DC oscilloscope.

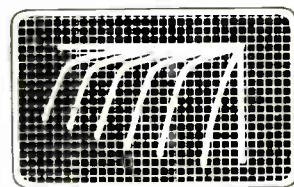
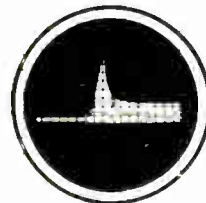

TYPICAL SCOPE PRESENTATIONS

Presents on the Scope: Alpha vs Emitter Current • Collector, Emitter and Transfer Characteristics • Collector Characteristics in Grounded Emitter Connection • Sweeping Technique Shows Up Anomalies • Complete families of curves obtainable in 10 incremental steps for each 5 ranges.



ENGINE AND AIRPLANE CORPORATION
FAIRCHILD

Guided Missiles Division

Wyandanch, L. I., N. Y.

Other Divisions: Aircraft Division, Hagerstown, Md. • Engine Division, Farmingdale, N. Y.

WRITE FOR DETAILED
TECHNICAL BULLETIN

News—New Products

These manufacturers have invited PROCEEDINGS readers to write for literature and further technical information. Please mention your I.R.E. affiliation.

(Continued from page 110A)

Cushion Jewel Mountings

A new cushion mounting for shock protection of jewel assemblies has been developed by **Richard H. Bird & Co., Inc.**, Waltham, Mass. The mount has a resilient cushion of silicone rubber which absorbs vibration and serious shocks which might otherwise put the assemblies out of alignment and cause additional damage to the jewel bearings.

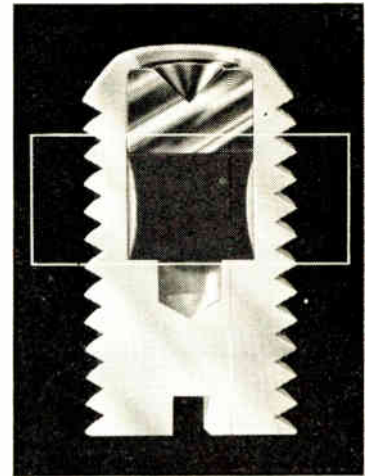

The cost of this shock protection is comparatively low, according to Bird, and the company can provide variable cushioning to suit the differing operating conditions. The silicone rubber withstands exposure to temperatures from -85°F to 325°F . This cushion mounting also eliminates the possibility of damage by inexperienced assembly-line operators, prevents loose assemblies and gives complete control of the jewel movement. These cushion-jewel bearings provide inexpensive shock-proofing for delicate instruments; and the more rugged, including meters of various types, have a longer life-expectancy free from need of readjustment.

VOR Signal Generator Tester

The type H-16, manufactured by **Aircraft Radio Corp.**, Boonton, N. J., provides a means of checking the phase-accuracy of the modulation on VOR (omni-range) signal generators.

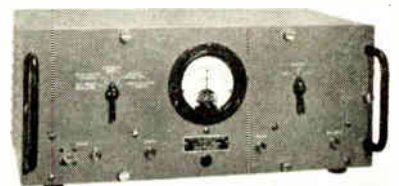

The Standard Course Checker will measure the phase differences between the 30-cps envelope of the 9960 ± 480 -cps reference modulation and of the 30-cps

(Continued on page 113A)

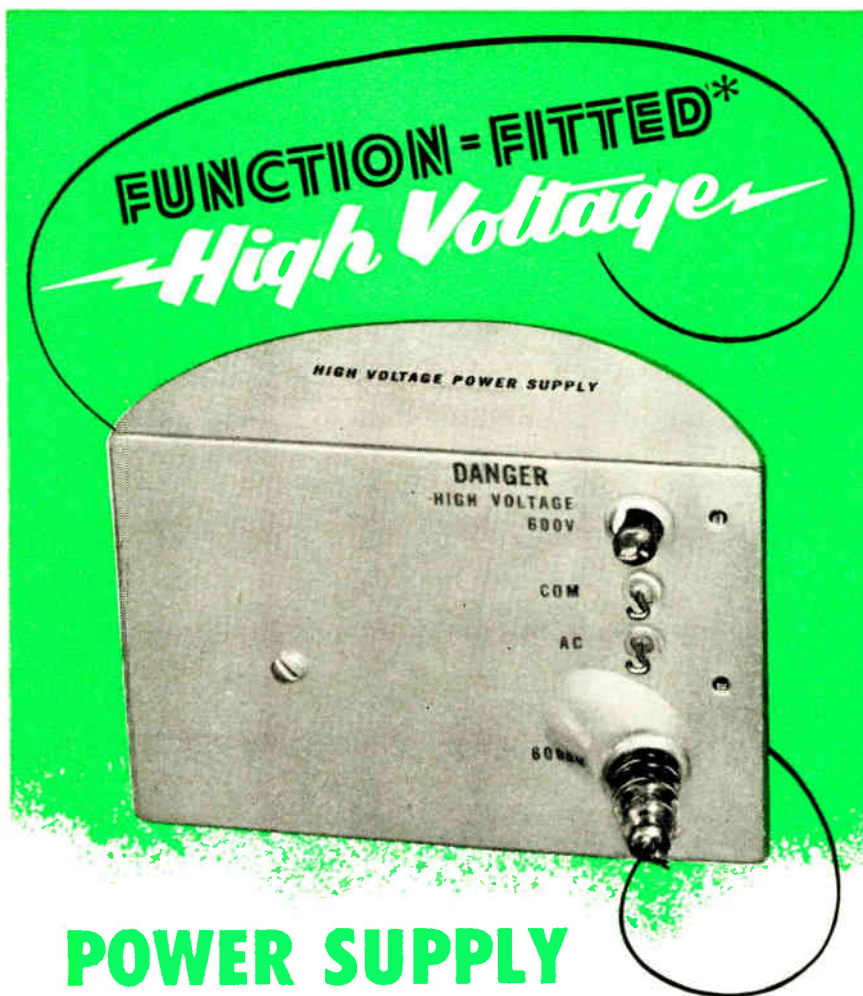

POWER SUPPLY

Eliminating all vacuum tubes, Acme Regulated Power Supplies provide extremely dependable, trouble-free, accurate, most economical service for industrial and laboratory purposes. Regulated by magnetic amplifiers.

Such units will give a minimum of 20,000 hours' continuous service. Available in variety of voltages and frequencies. Typical:

Here shown is Type S-730. **Input:** 100-120 v. AC; 380 to 420 cps. **Output:** 6000 v. DC $\pm 5\%$, with 100 microampere load; 600 v. DC tap; ripple voltage less than 120 v. peak-to-peak at 100 microampere load. **Temperature Range:** Designed to operate from -55°C to $+85^{\circ}\text{C}$, and at -55°C at 50,000 ft. altitude.

Potted Unit which eliminates altitude problems inherent in oil-filled designs. This particular unit does not include magnetic amplifier.

FUNCTION-FITTED TO YOUR NEEDS

Send us your power supply requirements. Acme either has a standard unit that will do, or will design and build a special unit for you. Literature on request.



AEROVOX CORPORATION

PASADENA, CALIF.

Hi-Q DIVISION
OLEAN, N. Y.

AEROVOX CORPORATION
NEW BEDFORD MASS.

In Canada: AEROVOX CANADA LTD., Hamilton, Ont. **JOBBER ADDRESS:** 740 Belleville Ave., New Bedford, Mass.
Export: 41 E. 42nd St., New York 17, N. Y. • Cable: AEROCAP, N. Y. •

News—New Products

These manufacturers have invited PROCEEDINGS readers to write for literature and further technical information. Please mention your I.R.E. affiliation.

(Continued from page 112A)

variable modulation. Easy to operate, the checker is readily portable for laboratory or field use.

A built-in self-checking circuit assures accuracy of the instrument. Prior to each measurement the H-16 is itself checked in a few seconds.

The H-16 checks the following courses: 0° "TO" (180° "FROM"), 180° "TO" (0° "FROM"), 15° "TO" (195° "FROM").

Amount and sense of error up to a maximum of 4° is indicated on the panel meter.

The instrument operates dependably under prolonged periods of high humidity and temperature. Measurements may be made almost immediately after tube warm-up.

Input power is 35 watts, 115 volts, 60 cps. Input voltage may vary 105 to 130 volts and frequency from 50 to 70 cps.

The instrument is 15 3/8 inches wide and weighs 11.77 pounds. The companion power supply unit weighs 5.3 pounds.

It is priced at \$398.00 f.o.b. Boonton, N. J. Detailed literature on request.

Crossbar Switch

A new type crossbar switch for multiple switching of audio and video circuits in computer systems, and many other applications, has been announced by James Cunningham, Son & Co., Inc., 13 Canal St., Rochester 8, N. Y.

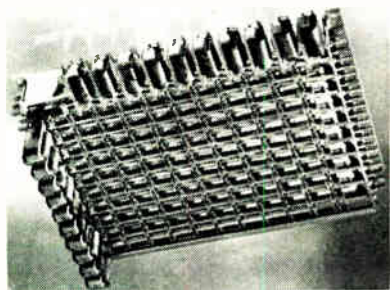

The switch is able to handle high frequency at a low crosstalk level. It is available with 4 or 10 link levels, and either 10 or 25 line levels. Each circuit may have up to three conductors.

Proper transmission is achieved at frequencies as high as 70 mc. Bridging capacitance between adjacent conductors is 15 μf . The crosstalk level between two circuits with common ground, and adjacent in both line and link levels, is down more than 65 db at 10 mc.

The 10x10 switch is 8 by 11 by 3 1/2 inches and weighs 10 pounds. It may be mounted in any position.

The switch functions by the action of electromagnets which set up and hold the connections. This operation is completed in less than 14 milliseconds, and release is effected in 2 milliseconds.

(Continued on page 114A)



ceramic capacitors





FUNCTION FITTED

*Not mere ceramic capacitors but units engineered to your circuitry, associated components and operational conditions.

Hi-Q specialists are ready to collaborate with your engineers for the ideal application.

... to your needs



These trimmers, stand-off capacitors and resistor-capacitor combinations are typical of Hi-Q special components developed largely to meet special needs. They suggest what Hi-Q specialists can accomplish in designing and producing ceramic units for any and all purposes.

Capacitor elements in Hi-Q special components meet all requirements as established by RTMA for Class 2 ceramic dielectric capacitors specifically suited for by-pass and coupling applications, or for frequency discriminating circuits where Q and stability of capacitance are not of major importance. Where Class 1 capacitors are required, Hi-Q specialists are again ready to study your most rigid specifications.



AEROVOX CORPORATION

OLEAN, N.Y. HILTI CERAMICS—WILKOR RESISTORS

AEROVOX CORPORATION
NEW BEDFORD, MASS.

ACME ELECTRONICS INC.
PASADENA 4, CALIF.

In Canada: AEROVOX CANADA LTD., Hamilton, Ont. JOBBER ADDRESS: 740 Belleville Ave., New Bedford, Mass.
Export: 41 E. 42nd St., New York 17, N. Y. Cable: AEROCAP, N. Y. ☐

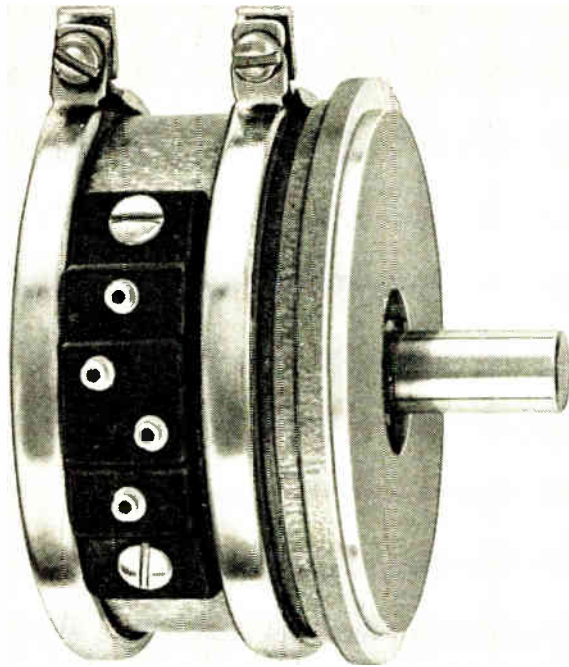

TYPE 756— Fairchild's latest single-turn PRECISION POTENTIOMETER

Gives you all these advantages...

- 1** Extremely low noise level and longer life with sustained high accuracy result from improved windings and wiper design. These improvements also permit higher rotational speeds with minimum of wear.
- 2** Higher resolution (0.05% at 2,000 turns) and close functional tolerances (linear $\pm 0.25\%$; non-linear 0.35% with 3:1 slope ratio in high resistance ranges) give higher point-to-point tracking qualities.
- 3** Standard electrical functional angle is 320 deg. nominal with ORV tolerance of $\pm 5\%$ in resistance range from 800 to 40,000 ohms. Electrical functional angle of 350 deg. nominal with ORV tolerance of $\pm 3\%$ in resistance ranges of 50 to 45,000 ohms can be supplied on special order.
- 4** Greater flexibility—For non-linear functions as many as 13 taps can be provided by adding extra terminal boards.
- 5** All the desirable qualities of the well-known Type 746 unit, including easy and more accurate phasing, ganging up to 20 units on a single shaft, all-metal precision-machined housing and shaft, low torque, etc., are included in the Type 756.

Full information about the entire line of Fairchild Precision Potentiometers, including specifications of the Type 756 unit and how we can help solve your potentiometer problems, is available for the asking. Write to *Potentiometer Division, Fairchild Camera and Instrument Corporation, Park Avenue, Hicksville, Long Island, New York, Department 140-39H1.*

FAIRCHILD
PRECISION POTENTIOMETERS

News—New Products

These manufacturers have invited PROCEEDINGS readers to write for literature and further technical information. Please mention your I.R.E. affiliation.

(Continued from page 113A)

Multi-Tester

Electronic Measurement Corp., 280 Lafayette St., New York, N. Y., has announced the addition of a new tube-battery-ohm capacity tester to their line of testing equipment. Model 207 features a large $7\frac{1}{2}$ inch meter for counter use. EMC

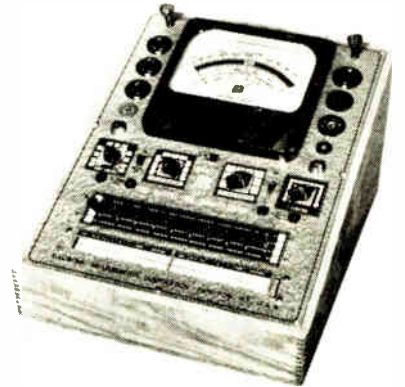

states that it is a durable, accurate instrument that gives direct readings for all tubes through the standard emission method of testing. Four-position lever type switches are used. It is housed in a portable oak carrying case with removable hinge cover. Model 207 C is priced at \$65.90; Model 207 P portable case with removable cover at \$69.90.

Germanium Diodes

Hermetically-sealed germanium diodes in production quantities are now available from **Hughes Aircraft Co., Semiconductor Sales Dept.**, Florence Ave., at Teale St., Culver City, Calif. Hughes subminiaturized diodes are supplied in 17 RTMA types, including three JAN approved diodes, as well as other types.



The glass-to-metal seal combats the major cause of diode failure, moisture penetration of the diode envelope. A new fusion sealing process is employed.

Other advantages include resistance to heat by avoiding materials that soften below 300°C, maximum space economy through subminiaturization, and wide range of electrical characteristics including high back resistance combined with high forward conductance. Each diode is humidity-cycled, temperature-cycled, JAN drop-tested, and electrically tested under vibration.

(Continued on page 116A)

WAVEGUIDE

Components

**TO SPECIFICATIONS
SINCE 1943**

- | | |
|----------------------------|----------|
| TEES | BENDS |
| MIXERS | RATRACES |
| DUPLEXERS | CAVITIES |
| ROTATING JOINTS | PADS |
| FILTERS | PHASERS |
| ATTENUATORS | FLANGES |
| ELECTRONIC ASSEMBLIES | |
| SPECIAL PURPOSE COMPONENTS | |

For the complete story on Premier's fully integrated engineering, production and testing facilities, write Dept. IRE today for our new brochure.



**PREMIER
INSTRUMENT CORP.**





52 West Houston Street
New York 12, N. Y.



GLASSCAPS

the Plastic Film Dielectric CAPACITORS

with all these advantages:

-  Glass Container Design
-  Smaller Volume
-  Easier To Mount
-  Hermetically Sealed
-  Lighter Weight

Write:
for our new
completely
illustrated
catalog
on your
company
letterhead

By selecting the proper plastic film dielectric, electrical characteristics are:

- HIGHEST VOLTAGE PER SIZE
- HIGHEST RESISTANCE
- LOWEST DIELECTRIC ABSORPTION
- HIGHEST STABILITY WITH LIFE
- LOWEST POWER FACTOR
- WIDE TEMPERATURE RANGE

Send us your specifications

Plastic Film Capacitors • High Voltage Power Supplies • Pulse Forming Networks



Plastic Capacitors, Inc.
2511 W. MOFFAT STREET, CHICAGO 47, ILLINOIS

News—New Products

These manufacturers have invited PROCEEDINGS readers to write for literature and further technical information. Please mention your I.R.E. affiliation.

(Continued from page 114A)

Connector Catalog

Buchanan Electrical Products Corp., Hillside, N. J., offers a new 16 page catalogue, number 53, which describes their complete line of solderless wire connectors and specialized electrical fittings. It contains illustrated descriptive information on "pres-SURE-connectors" for solderless



wire splicing and terminating, "Bushend" insulated bushings for electrical metallic conduit, "Snap-Action" plugs for temporary or permanent plugging of knockout holes in wire device boxes and other applications; also heavy duty molded terminal blocks in various styles, types, and sizes. Complete specifications, dimensional data, application instructions, and ordering information are given.

Binary Counter

Laboratory for Electronics, Inc., 75-4 Pitts St., Boston 14, Mass., is introducing a new magnetic 9-stage binary counter plug-in package that counts at rates up to 50 kc., and is a minimum element unit, 8x2x2 inches in size.

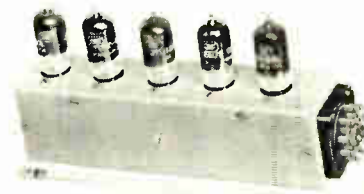

Among the advantages of the Model 1001 are low power requirements, wide tolerance on power supply variations, and minimum number of tubes.

Major applications of the Model 1001 Magnetic Binary Counter are those relating to pulse rate scaling and digital control systems. It can be applied to perform such functions as integration, addition, mul-

(Continued on page 118A)

Phil-trol
hermetically
sealed
relays
engineered
to your
requirements



DUST-PROOF
WEATHER-PROOF
VIBRATION-PROOF
DIRT-PROOF
MOISTURE-PROOF
OXIDATION-PROOF

Relays to meet all standard or armed services requirements

Phil-Trol Hermetically Sealed Relays are specially designed to meet the most rigid specifications and severe operating conditions. They have exceptionally high factors of safety and dependability. There are Phil-Trol Sealed Relays for most military, commercial or civilian aircraft applications. They are extremely compact, will withstand vibration, dust, dirt, moisture, oxidation and temperature changes.

Wiring diagrams are clearly printed on the enclosures and protected with a coat of clear lacquer.

Phil-Trol has complete engineering, production and testing facilities for hermetically sealed relays, all under one roof, making it possible to give faster delivery and higher quality on all your sealed relay requirements.

Let us help you plan efficient, money-saving applications of Phil-Trol Hermetically Sealed Relays for your requirements. Send the coupon below!

Phil-trol

IS THE REGISTERED TRADE MARK OF
PHILLIPS CONTROL CORP., JOLIET, ILLINOIS
OFFICES IN ALL PRINCIPAL CITIES

PHILLIPS CONTROL CORP., DEPT. PI, JOLIET, ILLINOIS
Please send me a free copy of the new Phil-Trol Relay and Actuator Catalog.

Name _____ Title _____

Company _____

Address _____

City _____ Zone _____ State _____

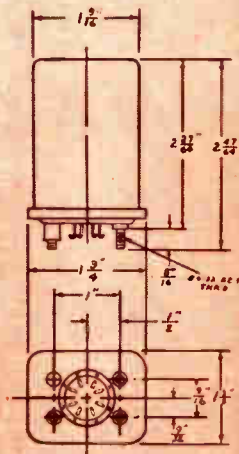

Continuous operation at exceptional temperature ranges

—up from +210°C (+410°F) to -90°C (-130°F) and below

EXTRUDED

TEFLON

HOOK-UP WIRE

EXTRUDED TEFLON (Tetrafluoroethylene) hook-up wire is organically capable of sustained operation from +210°C to -90°C with no appreciable decomposition. This wide range of operating efficiency continually opens new applications for **EXTRUDED TEFLON** — especially where constant stability under exceptional temperature conditions is required for long periods.

EXTRUDED TEFLON +210°C to -90°C is non-inflammable . . . is resistant to chemicals . . . has no known solvent.

Because of low electrical losses, **EXTRUDED TEFLON** is adaptable for high frequency use. It has very high volume and surface resistivity.

EXTRUDED TEFLON is available in thin wall and specified hook-up wire sizes, with shield or jacket, also as coaxial cable. Now available in 10 colors — black, brown, red, orange, yellow, green, blue, violet, gray, white. Samples available.

MAKE SUPRENANT YOUR HEAD-QUARTERS FOR ALL TECHNICAL HOOK-UP WIRE INFORMATION.

Suprenant MFG. CO.

199 Washington St. Boston 8, Mass. Plant—Clinton, Mass.
Engineered Wire and Cable for the Electronic and Aircraft Industries

SUB-MINIATURE PILOT LIGHTS

Approved for AIRCRAFT

AND IMPROVED IN IMPORTANT DETAILS

DIALCO

SUB-MINIATURE INDICATOR ASSEMBLIES

A great aid to your miniaturization program



ACTUAL SIZE

NON-DIMMING
No. 8-1930-621

MOUNT IN 15/32" HOLE
ALL LENS COLORS

Easy lamp replacement with any midget flanged base lamp types

Complete blackout or semi-blackout dimmer types



ACTUAL SIZE

MECHANICAL DIMMER
No. 11-1930-621

THESE ASSEMBLIES LOGICALLY REPLACE LAMPS NO. 319, 320, and 321

REPLACE WITH THIS



NOT THIS



OR THIS

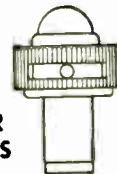

PLASTIC PLATE (EDGE) LIGHT ASSEMBLIES



ACTUAL SIZE

AIR FORCE and BUREAU of AERONAUTICS
MIL-L-7806 DRAWING MS-25010

DIALCO No. *TT-51* (Red filter-black top)
... or, No. *TT-51A*, complete with No. 327 Lamp

ALSO MADE with other filter colors and with *light-emitting top* (for indication)



ALL OF THE ASSEMBLIES ILLUSTRATED ACCOMMODATE LAMPS NOS. 327, 328, 330, and 331.
ANY ASSEMBLY AVAILABLE COMPLETE WITH LAMP
SAMPLES ON REQUEST — NO CHARGE

Foremost Manufacturer of Pilot Lights

DIALIGHT CORPORATION

60 STEWART AVENUE, BROOKLYN 37, N. Y.

HYACINTH 7-7600

© 1952

HYCOR

Telemetering Filters

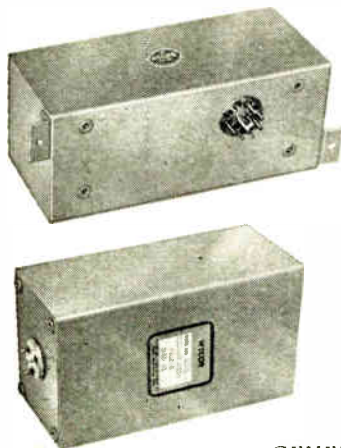

FEATURES . . .

- HYCOR telemetering filters have excellent characteristics due to the use of high "Q" toroid inductor elements. The filters may be used in low level circuits with negligible hum pickup resulting.
- In addition, only the finest capacitors are employed to assure stability.
- Available in standard RDB frequencies.

GENERAL SPECIFICATIONS
IMPEDANCE 500 500 OHMS

TYPE	BANDWIDTH	ATTENUATION	FREQUENCY RANGE	PRICE
1500	±7½%	-3 db or less	400 cps to 14.5 kc.	\$ 55.00
	±20%	-30 db or more		
4300	±7½%	-3 db or less	400 cps to 960 cps 1300 cps to 14.5 kc.	82.50
	±20%	-40 db or more		75.00
4000	±7½%	-3 db or less	400 cps to 960 cps 1300 cps to 14.5 kc.	105.00
	±15%	-45 db or more		
	±15%	-3 db or less	22 kc. to 70 kc.	95.00
	±28%	-45 db or more		

Other frequencies and impedances available on request

11423 VANOWEN ST., NORTH HOLLYWOOD, CALIFORNIA



SUnset 3-3860

Manufacturers of Precision Resistors, Toroid Inductors and Electric Wave Filters

REPRESENTATIVES:

Jack Beebe, 5707 W. Lake Street, Chicago, Illinois
 George E. Harris & Co., Box 3005, Municipal Airport, Wichita, Kansas
 Marvin E. Nulsen, 5376 E. Washington St., Indianapolis 19, Indiana
 Burlingame Associates, 103 Lafayette Street, New York City
 Canada: John R. Tilton, 1166-A Lake Shore Road, Long Branch, Ontario

For further information contact your nearest Hycor representative or write for Bulletin TF

News—New Products

These manufacturers have invited PROCEEDINGS readers to write for literature and further technical information. Please mention your I.R.E. affiliation.
 (Continued from page 116A)

tiplication and division when used in conjunction with other LFE plug-in packages.

Another new device is the Model 1002 Gating Unit Plug-In Package which is used in combination with the Model 1001 Magnetic Binary Counter to permit pulse multiplication and division, scale factoring, and other functions.

Laboratory for Electronics is also introducing the Magnetic Pulse Synchronizer Plug-in Package Model which synchronizes rates up to 50 kc. This unit provides a means for accepting pulses at random times and synchronizing them with pulses occurring at known times. The design is independent of tube types and input signal characteristics, and has a very low input power requirement.

Plug In Meter-Relay

The new Model 265 non-indicating meter-relay, produced by Assembly Products, Inc., Chagrin Falls, Ohio, has a balanced movement and self locking contacts. It is sealed in a metal can and can be furnished with either an octal plug connector or other type of sealed header. The jeweled movement is shock mounted.

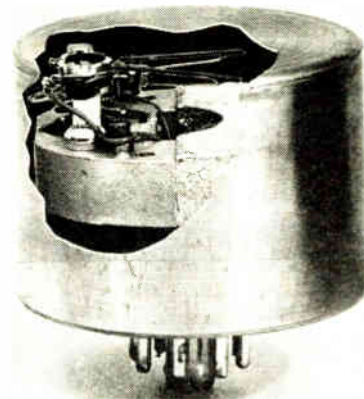

Sensitivity ranges are listed from 0.2 microamperes to 50 amperes, or 0.05 millivolts to 500 volts. Copper oxide or crystal diode rectifiers are used for ac operation. Rectifiers or rf thermocouples can be included inside the sealed case or they may be used externally.

Contacts lock in by a holding coil in the relay. They are released by breaking the circuit to the holding coil. Contacts are rated 5 to 25 dc milliamperes at 75 to 125 volts. The contact current energizes the holding coil. Contact arrangement is SPST or SPDT.

Accuracy is factory adjusted to within 3 per cent of the specified voltage or current. By adjusting circuit resistance the accuracy can be improved to within 1 per cent.

(Continued on page 120A)

for lacings that stay put!

GUDELACE

BRAIDED NYLON LACING TAPE*



Style 18 (Medium), 500 yd. spools, black or natural.



A New and Revolutionary Type of Lacing

- Saves time, saves money, greatly reduces the number of rejects
- Won't "bite through" insulation
- Won't cut wiremen's fingers or cause dermatitis
- Ties easier, ties tighter and cuts down on slipping of knots

Let GUDELACE answer your lacing problems.

Write for **FREE** samples and prices.

*Patent Pending.

GUDEBROD BROS. SILK CO., INC.

Electronics Division Dept. D

Main Office: 12 South 12th Street, Philadelphia 7, Pa.

225 West 34th Street, New York 1, N.Y.

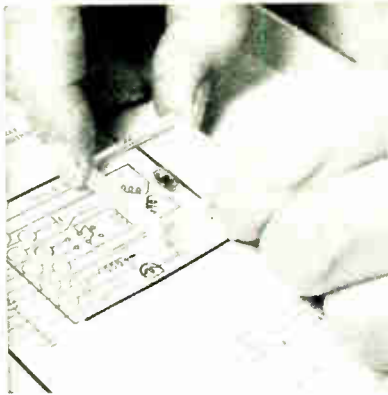

**DON'T DRAW IT!
—PRINT IT—**

- TRANSPARENT
- ASA Standard Symbols
- 27 Stamps Per Kit
- Large Selection
- Special Pads
- Opaque Ink
- Under \$30.00

John Griffin Company
2157 James Avenue
St. Paul 5, Minn.

The **RIGHT**
Coated Fabric
for **YOU**



Over the years, leading manufacturers have learned to rely upon APEX when selecting durable, fast colored, sales-improving fabrics for:

- PORTABLE PHONOGRAPHS
- PORTABLE RADIOS
- TAPE RECORDERS
- TV BOOSTERS
- SERVICING KITS
- ANTENNA ROTATOR CONTROL CABLES
- SERVICEMEN'S CARRYING CASES
- PORTABLE PA SYSTEMS
- PORTABLE TV SETS
- TEST INSTRUMENTS
- SOUND & PROJECTION EQUIPMENT
- INDUSTRIAL & MEDICAL EQUIPMENT

It will cost you nothing to let APEX specialists consider your problems.

APEX COATED FABRICS, Inc.

16 East 22nd St. N. Y. City 10

Phone: SPring 7-3140

For 27 years "The House of Service"

does your
problem
involve a

Strange twist?

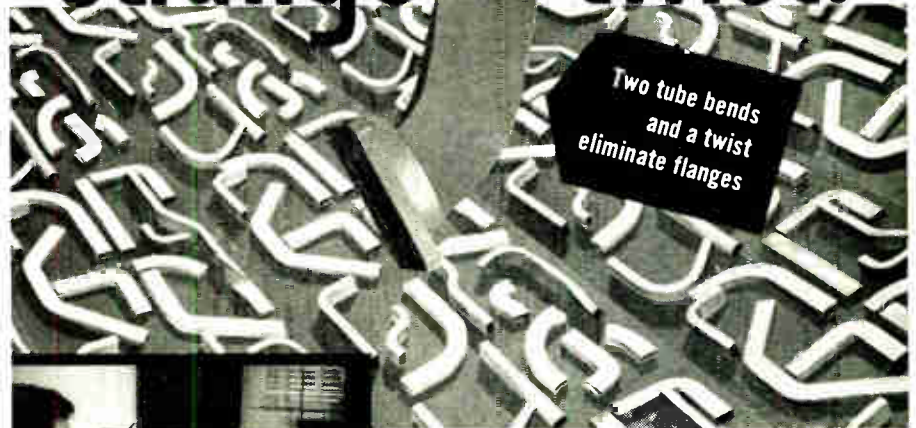

Two tube bends
and a twist
eliminate flanges



**MANUFACTURING
TO YOUR BLUEPRINTS
AND SPECIFICATIONS**

New tube bending techniques make it possible for Meridian Metal craftsmen to hold extremely close tolerances in continuous bends. By use of ingenious methods, exact conformity of all parts in a production run is obtained. Accurate control in every phase of manufacturing insures compliance with rigid dimensional requirements of wave guide components, resulting in excellent broadband operation.

**SMALL OR LARGE PRODUCTION WITH
LOW COST TOOLING**

Meridian Metalcraft, Inc. is equipped to manufacture in volume or to produce prototypes on a model shop basis. Our specialized metal craftsmen can often recommend design changes during the fabrication of prototypes for increased economy and efficiency if and when quantity production is desired.

MERIDIAN METALCRAFT, INC.
213 WEST WHITTIER BLVD., WHITTIER, CALIF.

MERIDIAN METAL *Craftsmanship*

FOR THE ELECTRONIC, RADAR AND TECHNICAL INDUSTRIES

In large scale production NOW!

American Electronic

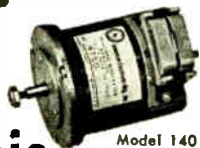

Model 140
**SYNCHRO
GENERATORS**



Model 141
**SYNCHRO CONTROL
TRANSFORMERS**

A pair with an established reputation.
The heart of modern two-speed systems.



Model 172
**SERVO CONTROL
MOTORS**
"Standard" in many modern
computers and controls.
Thousands in use

FEATURES

- Maximum accuracy, signal-to-noise ratio, range of linear operation.
- Minimum noise, size and friction.
- Total magnetic shielding.
- Internal winding or external network compensation.
- High temperature resistant models.
- Corrosion and fungus resistant.
- Complete line of "packaged" compensating isolation driver-amplifiers.
- Reliable delivery commitments.



American Electronic Mfg., Inc.
9503 W. Jefferson Blvd., Culver City, Calif.

AVAILABLE FOR IMMEDIATE DELIVERY!



Size 15
**UNIVERSAL-FREQUENCY
PRECISION RESOLVER**
Minimum noise, highest
accuracy. Basic to all
trigonometric operations.

Size 15
**UNIVERSAL-FREQUENCY
PRECISION POTENTIOMETER**
Continuous rotation,
induction type. Accuracy
comparable to resolver.

Model 171
**SERVO COMPUTING
TACHOMETER**

Companion to Model 172
Servomotor. Superior
linearity and signal-
to-noise ratio



READY FOR FALL DELIVERY:

Sizes 11 and 23 Induction Resolvers and Potentiometers • Sizes 11 and 15 Servo Control Motors and Computing Tachometers • Model 293 Brushless Potentiometers.

News—New Products

These manufacturers have invited PROCEEDINGS readers to write for literature and further technical information. Please mention your I.R.E. affiliation.

(Continued from page 118A)

24-Inch Rectangular Picture Tube

National Union Radio Corp., Hatboro, Pa., announces that it is now in production on a 24-inch rectangular picture tube which is being supplied to set manufacturers for the Fall line of TV sets.

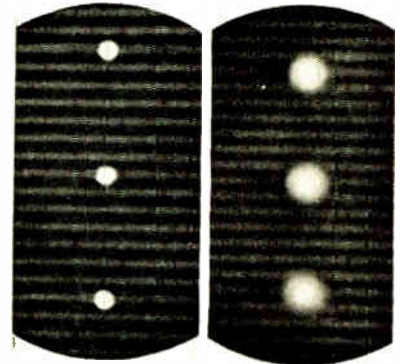

N.U.'s tube known as type 24C/VP4 is magnetically deflected and magnetically focussed and employs a tinted gray faceplate. Minimum over-all length is achieved through the use of a 90° deflection angle. Picture size is approximately 17½×21½ inches. The tube is rated for operation with second anode potentials up to 18 kilovolts. Typical operation calls for 300 volts on G2 and 17 kilovolts on the second anode.

The improvement in the spot size and reduction in the splash by use of a new gun is shown in the illustrated micro-photographs taken on a superior 21EP4A tube and on an average N.U. 24C/VP4 tube using the new design gun. Beam currents and second anode potentials are the same for both spots. It will be noted that even though the 24-inch tube has approximately 15 per cent greater raster height, the spot size is very much smaller than for the 21-inch tube. Further, it will be noticed that there is a much greater concentration of electrons in the smaller spot which is evidenced by the greater brilliancy of the spot.

Computer Memory Unit

Computer Control Co., 106 Concord Ave., Belmont 78, Mass., announces development of a memory unit, Model 3C1-384, composed of a solid acoustic delay line and associated circuitry. This unit is a complete package ready for installation in a computer. The design includes the entire memory circuit in one plug-in type chassis. Groups of these units are used in a computer to provide sufficient memory. A complete memory circuit can easily be removed for servicing and a spare unit plugged in to keep the computer operating.

(Continued on page 122A)

NEW! UHF TELEVISION Standard Signal Generator

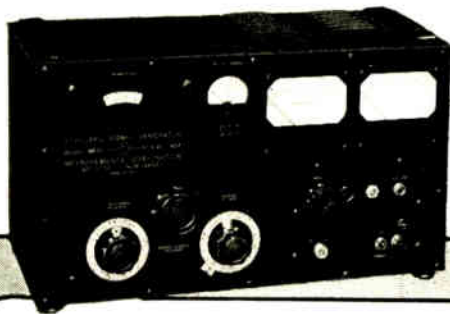

MODEL 84-TV
300—1000Mc.

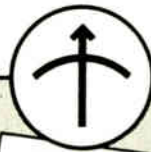

SPECIFICATIONS

FREQUENCY RANGE: 300-1000 megacycles.
OUTPUT: .1 Microvolt to 1 Volt, across 50 Ohms.
OUTPUT IMPEDANCE: 50 Ohms coaxial.
MODULATION: Internal 400 cycle, continuously variable from 0 to 30%. Provision for external modulation of 50 to 20,000 cycles.
LEAKAGE: Negligible.
SIZE: Overall Dimensions: 11¼ inches high, 19 inches wide, 11 inches deep.
WEIGHT: Approximately 40 pounds.
POWER: 115 volts, 60 cycles, 120 watts.

Write for complete details

MANUFACTURERS OF
Standard Signal Generators
Pulse Generators
FM Signal Generators
Square Wave Generators
TV Standard Signal Generators
Vacuum Tube Voltmeters
UHF Radio Noise & Field Strength Meters
Megacycle Meters
Intermodulation Meters
TV & FM Test Equipment

MEASUREMENTS CORPORATION
BOONTON NEW JERSEY





Top Service

IS ASSURED WHEN YOU ORDER YOUR

RAYTHEON TUBES

and JUNCTION TYPE TRANSISTORS

FROM

DALIS

Metropolitan New York's Foremost Electronic Distributor

Immediate Delivery From Stock



PHONE: Algonquin 5-3000

WRITE or WIRE: Dept. IND

TELETYPE: N. Y. 1-2482

H. L. DALIS INC.

WHOLESALE DISTRIBUTORS
ELECTRONIC EQUIPMENT

175 VARICK ST., NEW YORK 14

SERVING THE TRADE FOR OVER
A QUARTER CENTURY

world's largest Ion Trap maker
offers lowest priced Ion Trap
on the market

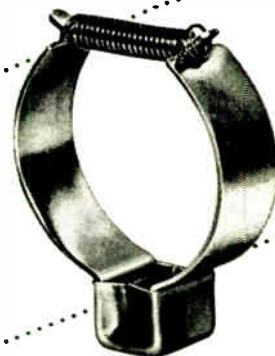

NEW SIMPLIFIED CONSTRUCTION

MODEL T-312. The new simplified steel construction lowers manufacturing costs by fully utilizing, for the first time, the Alnico permanent magnet's maximum efficiency. This makes Model T-312 the lowest priced ion trap on the market. Installs in only 2-3 seconds—just slip on.

FEATURES OF BOTH MODELS

STAYS PUT—No wobble; no shift during shipment; no realignment necessary when your TV set is installed in the home.

EASILY ADJUSTED—Slides more uniformly over tube's neck due to metal-to-glass contact.

STABILIZED AND TESTED on special equipment designed and used only by Heppner, each individual Heppner Ion Trap is guaranteed to meet your working requirements.

UNUSUALLY FAST DELIVERY.

LIGHTWEIGHT—Snap-On Model weighs only 1/2 ounce; Slip-On Model only 3/5 ounce. Will not harm tube's neck.

ALNICO P.M. USED—Retains magnetism indefinitely.

SNAP-ON ION TRAP

installs instantly—just snap on—stays put



MODEL E-437. Saves you expensive production manhours with EXCLUSIVE instant snap-on feature. Reduces your parts costs because priced below competition. Clamp-type construction of Hardened Spring Steel.

Heppner has built over 15,000,000 ion traps to date

Write today for further information on better ion traps at lower prices.

HEPPNER

MANUFACTURING COMPANY

Round Lake, Illinois (50 Miles Northwest of Chicago)
Phone: 6-2161

SPECIALISTS IN ELECTRO-MAGNETIC DEVICES

Representatives: **John J. Kopple**
60 E. 42nd St., New York 17, N.Y.

James C. Muggleworth
506 Richey Ave., W., Collingswood, N. J.

Ralph Haffey
2417 Kenwood Ave., Ft. Wayne 3, Indiana

Irv. M. Cochrane Co.
408 So. Alvarado St., Los Angeles, Calif.

now... RESINITE

brings you the
HIGHEST RESISTIVITY of any
RESINATED PRODUCT

Resinite Coil Forms are laboratory tested and field proven. Their operating characteristics— Volume resistivity . . . power factor . . . thermal properties . . . low moisture absorption . . . and resistance to voltage breakdown — represent a new achievement in basic components for electronic application.

Resinite Coil Forms are available with inside or outside threads, slotted, punched or embossed. Axial pressure in excess of 25 lbs. is accomplished through a special three row threaded design. Torque can be controlled to + or - 1 in. oz.

RESINITE CORPORATION

DIVISION OF PRECISION PAPER TUBE

2035G W. Charleston St., Chicago 47, Ill.
79 Chapel St., Hartford, Conn.

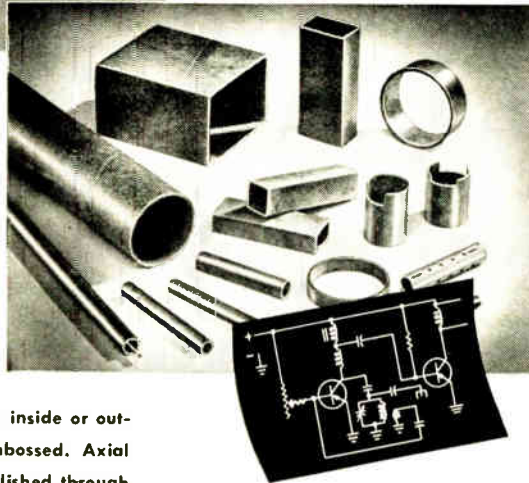

RESINITE 8104: for coil forms requiring very high dielectric properties under extreme humidity.

RESINITE "AC": for applications requiring very high dielectric strength. ELECTROLYTIC CORROSION IS IMPOSSIBLE.

RESINITE 104: for stamping, severe forming, fabricating.

Send today for full details and technical information.

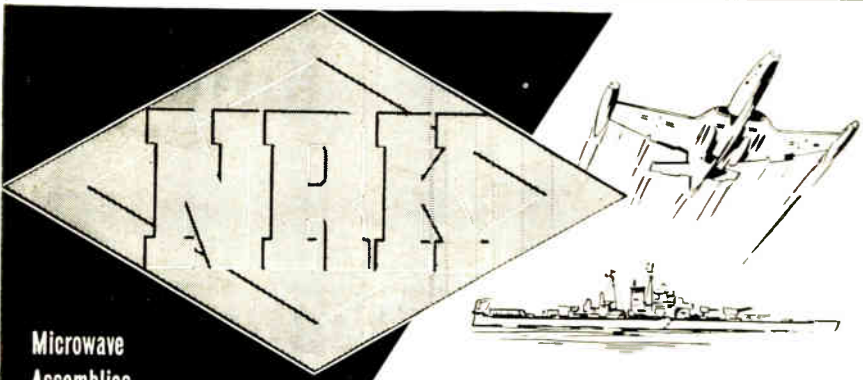

Microwave Assemblies, Radar Components, and Precision Instruments . . . manufactured to your Blueprints and Specifications.

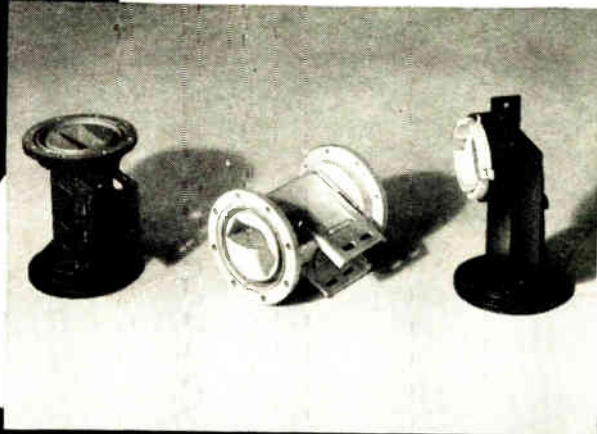

N.R.K. MFG. & ENGINEERING CO.

4601 WEST ADDISON STREET • CHICAGO 41, ILL. • SPing 7-2970

News—New Products

These manufacturers have invited PROCEEDINGS readers to write for literature and further technical information. Please mention your I.R.E. affiliation.

(Continued from page 120A)

The unit stores 384 bits at a pulse repetition rate of 1 Mc. A self-contained heating element and thermal control gives temperature stability to the quartz line. Inherent accuracy of delay control greatly exceeds design requirements. All germanium diodes are grouped in a single plug-in type sub-unit. All five tubes are 6AN5's operated 80 per cent below manufacturers design center.

The over-all dimensions of the plug-in chassis are $4\frac{1}{2} \times 5\frac{1}{2} \times 10$ inches. A self-contained filament transformer is optional. Input voltage requirement into write-erase gate is 10 volts. The reshaped output signal level is 15 volts into a 100 ohm impedance load. Carrier frequency is 20 mc. All circuits are degenerated, with reserve gain in the wide band IF amplifier. There is a gain control for initial adjustment of the IF stage. No tuning is necessary. Temperature coefficient of the quartz delay line is -123 parts per million per degree centigrade. The unit is especially fitted for airborne use and is insensitive to shock.

Plate Transformer

A new air cooled plate transformer has now been added to the line of heavy duty electronic components manufactured by **Magnatran, Inc.**, 246 Schyler Ave., Kearney, N. J. Its purpose is to furnish power to plate of rectifier tubes, which in turn supply high direct current voltage to all types of electronic equipment.

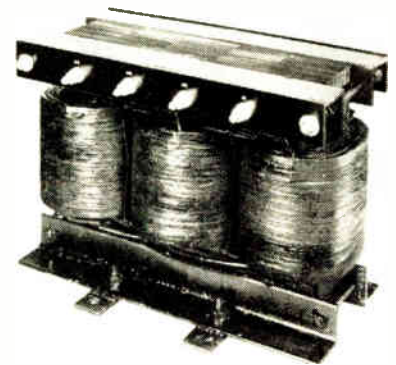

These transformers are conservatively designed for trouble-free life and to withstand abnormal impulse voltage encountered in rectifier service.

In addition to the open frame core and coil construction, all coils are layer wound with wire locked in place by means of special construction of the layers of insulation.

Entire unit is vacuum varnish impregnated and coated with several coats of baking varnish to make coils impervious to moisture.

Secondary leads are terminated with ceramic bushings, and primary leads are in screw terminals.

(Continued on page 124A)

C O N S T A N T

RESEARCH

and

DEVELOPMENT

HAS ENABLED US TO
PRODUCE ONE OF THE
FINEST COMPUTERS
AVAILABLE TODAY.



AMPLIFIER GROUP, TYPE 16-31C—provides 28 contact stabilized operational amplifiers for use as summers, differentiators, integrators, and inverters. Also in the cabinet are all necessary power supplies and a complete test panel.

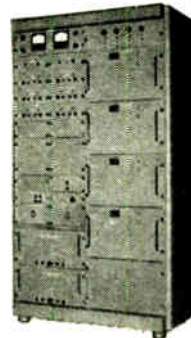

MULTIPLIER GROUP, TYPE 16-31L—is a servo-mechanical multiplier and incremental function generator. There are 20 channels, each of which is capable of multiplying four variables by a fifth.



RESOLVER GROUP, TYPE 16-31D—furnishes 4 resolving channels and 12 operational amplifiers. Each resolving channel may also be used for multiplying three variables by a fourth. Furnished complete with test panel, reference supplies, and power supplies.

CONTROL CONSOLE, TYPE 16-24E—Houses the grounded metal problem board and its bay, attenuators, initial condition potentiometers, networks, limiters, and all operating controls.

SERVO GROUP, TYPE 16-31P—For the operations of resolving and multiplying when used with external amplifiers. There are two resolving and four servo-multiplying channels. The equipment is furnished with test panel and power supplies.

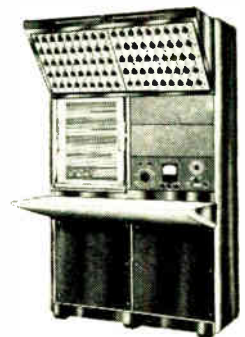

INQUIRE SALES DEPARTMENT
LONG BRANCH, NEW JERSEY

NEED INSTRUMENTS TO SOLVE ELECTRONIC PROBLEMS?...



RADA-SWEEP
Radar IF Amplifier
Alignment

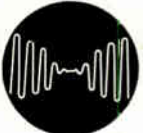

MEGA-MATCH
Measurement of
Reflection Coefficient



MEGA-PULSER
Transient Testing
Video Amplifiers



MARKA-SWEEP RF-P
TV Tuner Alignment

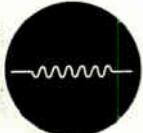

RADA-PULSER
Radar IF Transient
Testing



CALIBRATED
MEGA-SWEEP
Wide Range Sweeping
Oscillator
Single Dial Tuned

CONSULT THIS LATEST
64-PAGE
CATALOG



Write

FREE

KAY ELECTRIC CO.

4 MAPLE AVE.

PINE BROOK, N. J.

ALFAX UNIVERSAL RECORDING PAPER

For the first time there is available an indelible recording paper—ALFAX—that is NOT subject to humidity, temperature or capillary action problems usually associated with pen and ink or papers marked by arcing or heat.

ELECTRICITY IS THE INK THAT MARKS ALFAX

Alfax paper can be marked by current as low as one volt and is instantaneous, permanent and stable. Highly sensitive Alfax is capable of fourteen steps by simply varying the current through the paper.

Alfax is the only paper that is capable of high speed recording, stable before or after recording, is non-transferable, has low current consumption at high speeds, can record at high humidity over all temperature ranges, is smudge proof and nontoxic, widths from 14" to 72".

Alfax opens a whole new field of monitoring and recording of phenomena which never before have been done easily and cheaply.

THIS MONTH'S EXAMPLE

To find material defects in gun barrels a Govt. arsenal applied a helix recorder with Alfax paper that graphically recorded the inside of the barrel, instantly showing the exact information needed. No other recording medium was suited to this job.

Request Booklet—describe your problem

Alfax Paper & Engineering Co.

Alden Research Center,
Westboro, Mass.

ENGINEERING SERVICE TO
RECORDER MANUFACTURERS

News—New Products

These manufacturers have invited PROCEEDINGS readers to write for literature and further technical information. Please mention your I.R.E. affiliation.

(Continued from page 122A)

Pulse Generator

Wang Laboratories, 296 Columbus Ave., Boston 16, Mass., has developed the "Confluxer" for producing constant charge pulses. These pulses are triggered by the behavior of the input voltage to the device. Each pulse is produced when the instantaneous voltage of the input initially exceeds a fixed value. The device is then reset by the return of the voltage below the critical value.



The voltage-time product for each pulse is constant for any operating load. Since volt-seconds divided by ohms gives coulombs, the output for a given load resistance produces a constant charge per pulse. This pulse output can be integrated to obtain a voltage proportional to the frequency of the input. The device is used as a frequency meter, electronic tachometer, or as a digital to analog converter. It is also suitable for pulse generation, microsecond pulse generation from slowly varying input, and pulse amplitude discrimination. The output has a linearity of 0.2. Input waveform with a rise time as slow as 0.1 second still insures proper operation. The resolution time permits full charge per pulse if the pulses generated are more than 15 microseconds apart. The circuit is so independent of tube characteristics and aging effects, that a 12AU7 may be used satisfactorily in place of the intended 12AT7. Output pulse rating is 200 volt-microseconds. Normal operation gives a pulse voltage of approximately 3 microseconds. Minimum output load is 2,500 ohms. A minimum input of 10 volts is required.

Oscillogram Processor

Oscillographic records on any standard recording papers up to 12 inches in width may be completely processed and dried at speeds exceeding 10 feet per minute by the new 23-109 Oscillogram Processor, developed by Consolidated Engineering Corp., 300 N. Sierra Madre Villa, Pasadena 8, Calif. Processing is accomplished without darkroom facilities or an external water supply. Compact and portable it measures 17 inches wide, 31 inches long, 18 inches high.

(Continued on page 125A)

GLUTTONS for PUNISHMENT



CUSTOM CORD SETS

RUBBER... PLASTIC... NEOPRENE...

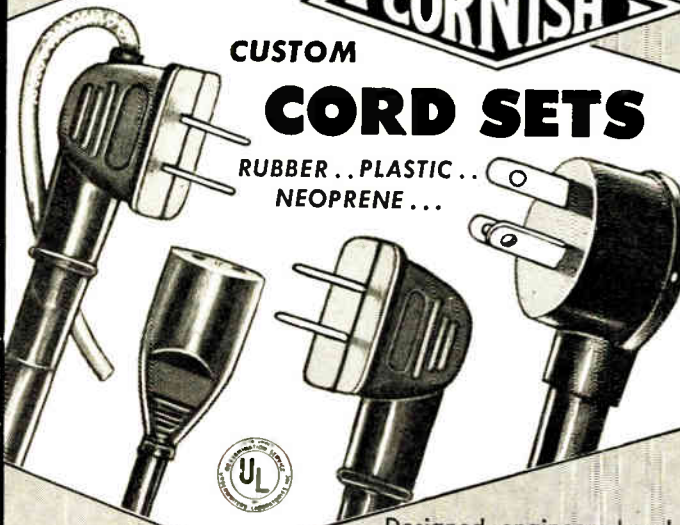

Also "NOFLAME-COR" The Television Hookup Wire

Designed, engineered and produced for YOUR products! For a delicate "walkie-talkie" or a huge arc welding unit... put your wire problems up to CORNISH experts!

MADE BY ENGINEERS FOR ENGINEERS

CORNISH WIRE CO., INC.

50 Church St. New York 7, N. Y.

There is Always One Leader in Every Field

BODNAR INDUSTRIES, Inc.

leads in the field of

TRANSILLUMINATED PLASTIC LIGHTING PLATES

BECAUSE OF Quality • Uniformity • Performance
Design & Layout "Know-How Service"
Quantity Production Promptly

NEW YORK —19 Railroad Ave., New Rochelle (Home Office)
TEXAS —Jefferson Tower Building, Dollos
CALIFORNIA—4440 Lonkershim Blvd., N. Hollywood
CANADA —313 Montreal Trust Bldg., 67 Yonge St., Toronto

SPECIMEN PANEL MIL-P-7788 (AN-P-89) SENT ON LETTERHEAD REQUEST

**Biggest
AUDIO
and
HI-FI
Event of
the Year!**

AUDIORAMA 1953

Presented by **THE AUDIO FAIR**

TIME:
Oct. 14, 15, 16, 17

PLACE:
Hotel New Yorker
New York City

Registration On
5th, 6th
and 7th Floors

The annual event in the Audio field of utmost interest to Government and Military Agencies, Broadcast Engineers, Recordists, Sound-On-Film Men, Hobbyists, High Fidelity Enthusiasts, and Distributors and Dealers of Audio and High Fidelity equipment. The AUDIO FAIR is the largest and most concentrated exhibition of Audio Equipment held under one roof! Every up-to-the-minute development will be represented, seen and heard.

SPONSORED BY **The General Public Is Invited to Attend** **NO ADMISSION CHARGE**

AUDIORAMA is presented by THE AUDIO FAIR
HARRY N. REIZES, Managing Director, 67 W. 44 St., N. Y.

News—New Products

These manufacturers have invited PROCEEDINGS readers to write for literature and further technical information. Please mention your I.R.E. affiliation.

(Continued from page 124A)

The latest chemical processes of Eastman Kodak Company are utilized. Instead of the conventional fixing bath, a stabilizer solution is used, eliminating the usual washing procedure necessary with standard photographic processing procedures. Elimination of the washing step lessens the time interval between the taking and observation of data.

The 250-foot capacity magazine of the 23-109 may be loaded in subdued light or a darkroom, depending upon the sensitivity of the record material being used. Spares are available so that several magazines may be loaded at one time. Operation of the processor requires no previous photographic experience or knowledge, nor is any complex threading involved in the loading.

Solutions are contained in stainless steel tanks and thermostatically maintained at 100°F to minimize ambient temperature effects. Cumulative footage which has been processed is shown on an indicator so that remaining solution life may be calculated. Drying-drum temperature is thermostatically controlled and may be adjusted by the operator for various humidity conditions, paper widths, and record materials.

The processor is constructed of stainless steel with chemical-proof controls and panels. Models are available for operation from 115 volt single-phase ac lines. No water-line connection is necessary.

Further information about the 23-109 may be obtained by writing for Bulletin CEC-1537.

Terminal Block Enclosure

To alleviate conditions of excess dust, and also for safety from shock to personnel, where terminal blocks carrying high voltages must be mounted near avenues of traffic, Curtis Development & Manufacturing Co., 3266 N. 33rd St., Milwaukee 16, Wis., has designed a metal enclosure.

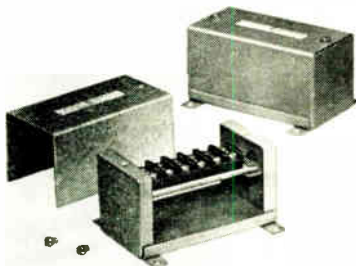

This new enclosure is said to come with either the Curtis "M" or the "MT" terminal blocks integrally mounted with from 1 to 14 terminals per block and enclosure. Cover is held in place by 2 screws, and when removed, leaves three sides of enclosure open for easy connecting of wires or circuits changes.

(Continued on page 126A)

Silic-O-Netic TIME DELAY RELAYS

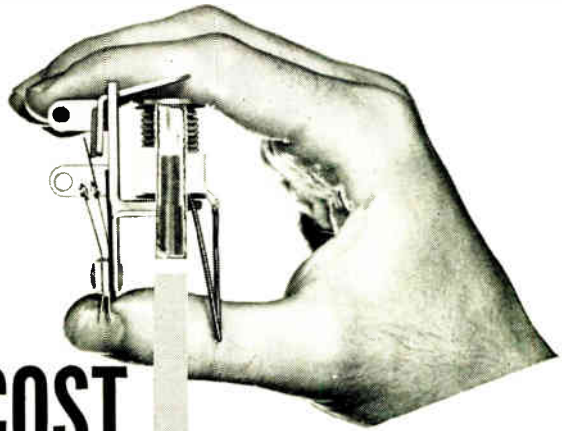

LOW COST
and
DEPENDABLE



Complete information is available upon request. Write for Bulletin 5001.

Better performance in a time delay relay for your products need not run your costs UP. The basic design of the new SILIC-O-NETIC Time Delay Relay lends itself to Heinemann high production techniques . . . creates savings that are passed on to you as LOWER unit costs.

SILIC-O-NETIC Relays provide other savings, too. As a load carrier in itself, it eliminates the need for a separate load relay. Being small in size, it reduces the overall size requirements of equipment with which it is used. SILIC-O-NETIC Time Delay Relays have only one moving part in the time element, which is hermetically sealed . . . and never requires attention.

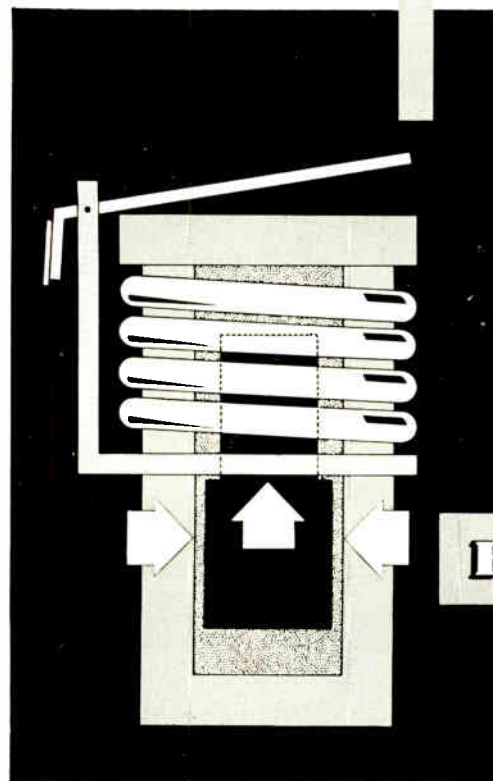

The SILIC-O-NETIC Time Delay Relay employs silicones . . . operates dependably on a hydraulic-magnetic operating principle regardless of position or frequency of operation. Overall size is only 1 1/8" x 2 1/2" x 3/4".

HEINEMANN

ELECTRIC COMPANY
154 Plum Street,
Trenton 2, N.J.

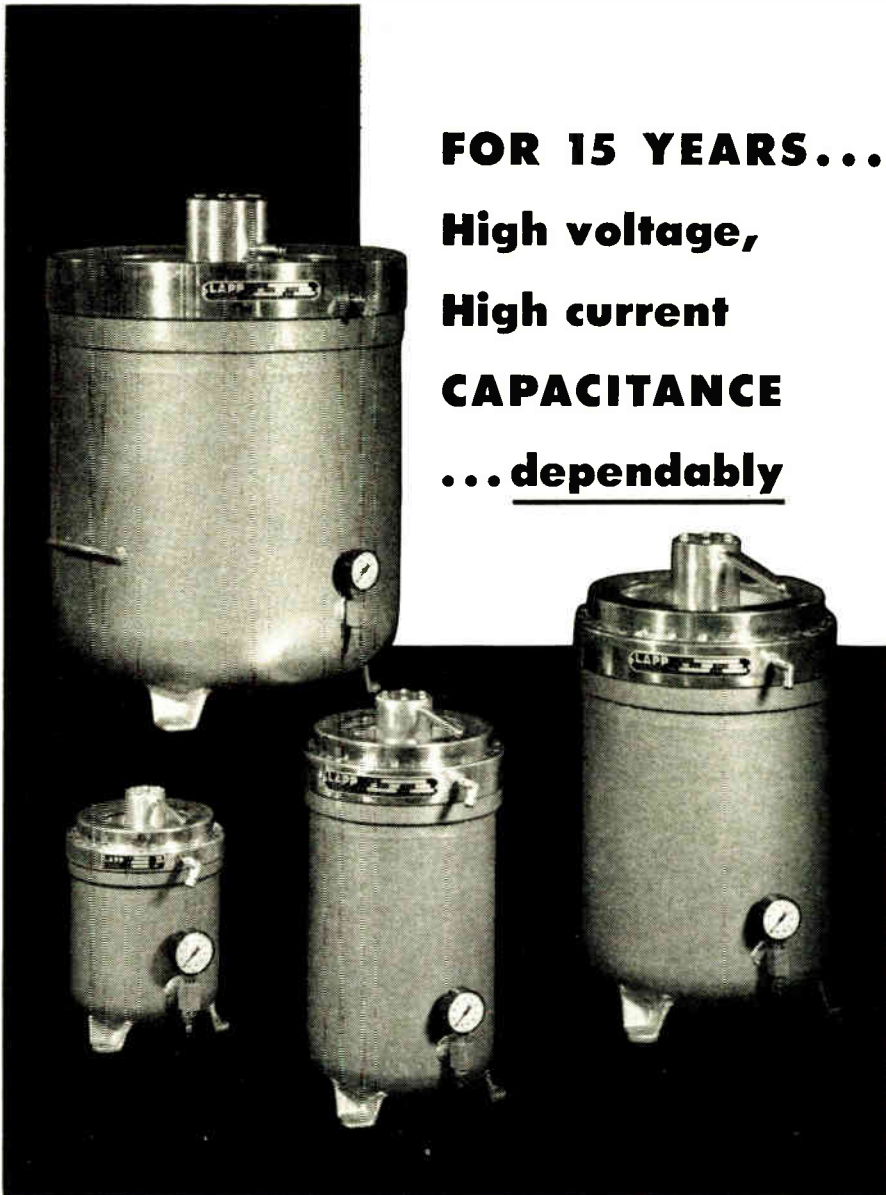

FOR 15 YEARS...
High voltage,
High current
CAPACITANCE
...dependably

● The record of more than 15 years service, in thousands of installations, proves the reliability of the Lapp Gas-Filled Condenser. For duty at high voltages and high currents this unit offers the advantages of extreme compactness . . . low loss . . . high safety factor . . . constant capacitance under temperature variation . . . grounded tuning shaft . . . and rugged sturdiness. Units available in fixed or variable capacitance . . . capacitances to 60,000 mmf; current ratings to 525 amps at 1 mc; voltages to 100 Kv peak. Write for Bulletin 302 with complete description and characteristics data. Lapp Insulator Co., Inc., Radio Specialties Division, 205 Sumner St., Le Roy, N. Y.



News—New Products

These manufacturers have invited PROCEEDINGS readers to write for literature and further technical information. Please mention your I.R.E. affiliation.

(Continued from page 125A)

Two standard $\frac{7}{8}$ inch diameter knock-outs are provided, one at each end of enclosure, to permit cable or wires to be fed in under the terminal block. Circuits can be coded for identification of wires.

Curtis Types "M" and "MT" terminal blocks, standardly furnished in this new enclosure, are conservatively rated at 300 volts, 15 amperes.

Manufacturer states that these new enclosures will only be available at present in minimum quantities of 100 units. Complete information may be had by writing to John Eschweiler at the Curtis Plant.

Non-Metallic Magnets

Commercial production of a ceramic permanent magnet material is now underway at the **Ferroxcube Corp. of America**, Saugerties, N. Y. The newly developed magnetic material, known as Magnadur, contains no nickel, cobalt, tungsten, chromium or other critical materials. This is expected to accelerate its use in many fields for which government allocations of critical materials are restricted.

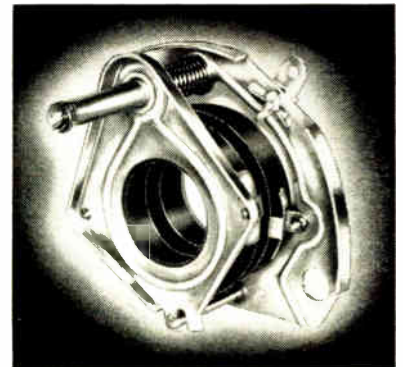

The magnets are made by a process of powder metallurgy from a mixture of barium and iron oxide, pressing or extruding the mixture in shape and sintering in furnaces at very high temperatures.

The initial development of this material was accomplished in Holland by N. V. Philips' Gloeilampenfabrieken, of Eindhoven. Magnadur has high coercive force and high resistance to demagnetization as well as magnetic stability. Its resistance permits the use of Magnadur magnets in the presence of high frequency fields without undesirable losses.

Initial production of the new material for the balance of 1953 will be concentrated on toroidal rings developed specifically for TV focusing magnets.

Ferroxcube Corp. Engineering Bulletin FC-6000 gives complete technical data as well as demagnetization and energy product curves for Magnadur permanent magnets. Copies may be obtained on letterhead request to the Ferroxcube Corp. of America, 235 Marshall St., North Adams, Mass.

(Continued on page 128A)

for high permeability applications

now — the first time
available . . .

PERFORMANCE GUARANTEED

TAPE WOUND CORES



ONLY MAGNETICS, INC.

offers Performance Guaranteed Tape Wound Cores. Guaranteed performance to specifications means truly economical production of high permeability magnetic devices in your plant . . . and controlled buying by your purchasing department. If you haven't investigated Performance-Guaranteed Tape Wound Cores, why not let us send you the complete story?

FACTORY CORE MATCHING

For applications in which closely matched characteristics are required, save time and money by using the Magnetics, Inc. factory core matching service.

free engineering design service for high permeability magnetic applications

Magnetics, Inc. engineering is second to none in the field of high permeability magnetics. Services are free to customers.

Write for full information

MAGNETICS, inc.

Specializing in High Permeability Magnetics

Dept. I-2 BUTLER, PA.

SERVOSCOPE®



Test analyzer for use in development and PRODUCTION of SERVOMECHANISMS and PROCESS CONTROLS. Measures FREQUENCY RESPONSE, PHASE SHIFT 0.1 to 20 CYCLES SINE WAVE, SQUARE WAVE, MODULATED CARRIER, 50 to 800 CYCLES.

SERVOBOARD

A FLEXIBLE SET of PRECISION mechanical parts for quickly coupling motors, synchros, potentiometers to form assemblies of Servo systems, regulators, computers.

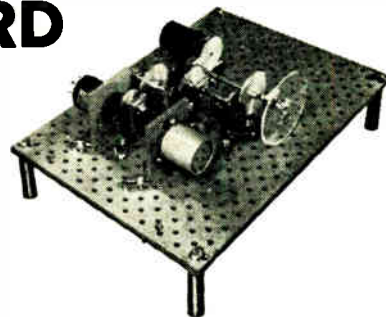

SERVO CORPORATION OF AMERICA

DEPT. IRE-9

NEW HYDE PARK, N.Y.

THE DISTINCTIVE NEW ER-225 SERIES RACKS by PAR-METAL

18" Deep, 22" Wide

offer you the greatest dollar-for-dollar value in the industry today!

Because only in the ER-225 will you find these unique features:

- ✓ Standard 43 1/4", 67 1/4", and 83 1/2" heights.
- ✓ New ribbed design corner trims, with new quick FRONT detachable fastenings.
- ✓ The door is stamped from one piece of steel and reinforced — with formed, clean, smooth, double thick edges.
- ✓ "Multitracks" available with closed or open intermediate sides for rack-to-rack wiring.
- ✓ Streamlined modern design; beautiful finish.

Planning an electronic product? Consult Par-Metal for

RACKS • CABINETS CHASSIS • PANELS

Remember, Par-Metal equipment is made by electronic specialists, not just a sheet metal shop.

Made by
Electronic
Specialists!



WRITE FOR CATALOG!

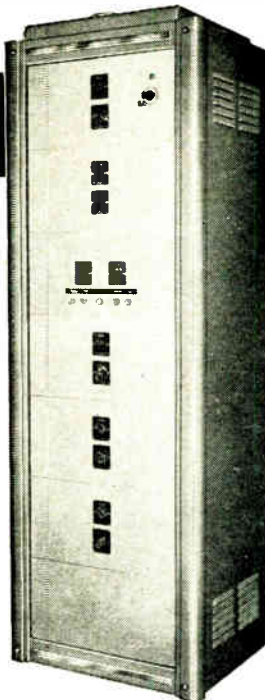

"MULTIRACKS"

These Racks may be assembled in multiple units as shown above. SHELVES available. Also ROLLER TRUCKS available for single racks or "Multitracks".

NO INCREASE IN COST!

The ER-225 is priced to compete with racks not having the equivalent features. Beyond doubt — it's the industry's greatest value.

The ER-225 Rack as used by the American Communications Corp., N. Y. C. 13.

PAR-METAL

PRODUCTS CORPORATION

32-62 — 49th ST., LONG ISLAND CITY 3, N. Y.

Tel.: Astoria 8-8905

Export Dept.: Roche International Corp.

13 East 40 Street, New York 16, N. Y.

NOW 

90° DEFLECTION YOKE

... an Accepted Standard of Major Manufacturers!

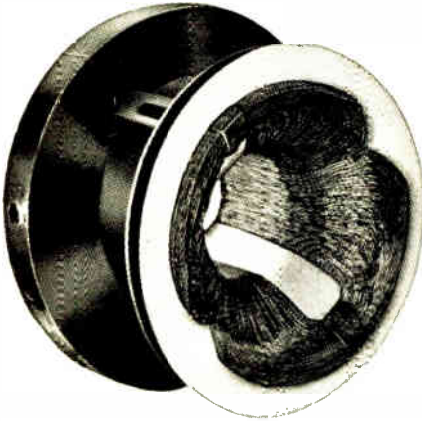

Yes, as leading TV manufacturers know . . . the DX 90° Deflection Yoke for 27" receivers gives the ultimate in performance and compactness. Enclosed in an Underwriters' Approved Tenite case, this yoke assures a sharp, full-screen focus without use of pin-cushion magnets. Ingeniously designed for mass production on special equipment, it provides the attractive price and top quality major manufacturers demand. We invite your inquiry.

DEFLECTION YOKES . . . TOROID COILS . . . CRYSTALS
I. F. TRANSFORMERS . . . R. F. COILS . . . DISCRIMINATORS
SPEAKERS . . . TV TUNERS . . . ION TRAPS . . . TRANSFORMERS



DX RADIO PRODUCTS CO.

GENERAL OFFICES: 2300 W. ARMITAGE AVE., CHICAGO 47, ILL.

AN/APR-4 LABORATORY RECEIVERS

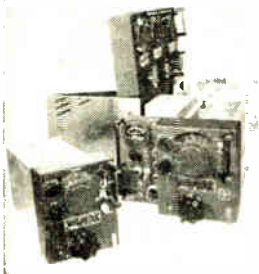

Complete with all five Tuning Units, covering the range 30 to 4,000 Mc.; wideband discone and other antennas, wavetraps, mobile accessories, 100 page technical manual, etc. Versatile, accurate, compact—the aristocrat of lab receivers in this range. Write for data sheet and quotations.

We have a large variety of other hard-to-get equipment, including microwave, aircraft, communications, radar; and laboratory electronics of all kinds. Quality standards maintained. Get our quotations!

We will buy any Electronic Material at top prices. SCHOOLS —unload your dusty surplus for cash or credit.

ENGINEERING ASSOCIATES

434 PATTERSON ROAD

DAYTON 9, OHIO

GEARS FOR ELECTRONIC AND SMALL ELECTRICAL MECHANICAL EQUIPMENT

MECHANICAL ASSEMBLIES



THE CUSTOM GEAR COMPANY

120 East Sample Street - - - South Bend 18, Indiana

News—New Products

These manufacturers have invited PROCEEDINGS readers to write for literature and further technical information. Please mention your I.R.E. affiliation.

(Continued from page 126A)

Aircraft Microvolt Signal Generator

A new aircraft microvolt signal generator is announced by Hickok Electrical Instrument Co., 10551 Dupont Ave., Cleveland 8, Ohio, for continuous coverage from 125 kc to 165 mc on fundamentals.



This generator, Model 292XAL, provides complete coverage of the aircraft band including all the necessary IF frequencies, and covers all rf frequencies with calibrated output. It can be externally modulated from 15 to 10,000 cps and measures both input and output of units under test.

The manufacturer claims that the unit maintains dependable and accurate frequency calibration, is free of wave distortion, and has no spurious signals in the output system. It embodies temperature compensation, self-contained crystal oscillator reference level, and is crystal controlled. Attenuator is especially designed to faithfully attenuate without frequency discrimination. Price is \$300.00.

Self Clearing Hydraulic Servo Valve

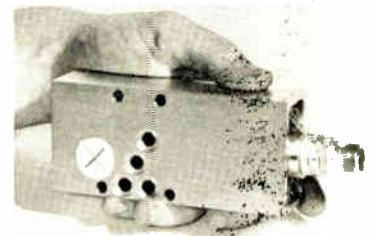

Sanders Associates, Inc., Nashua, N. H., announces the design and production of a low leakage, self-clearing hydraulic servo valve. It is a two-stage, four-way valve with internal mechanical feedback for the transformation of low-level electrical information into controlled hydraulic energy. The unit is completely sealed against magnetic particles and can be operated without oil filters. This trans-

(Continued on page 136A)

Four Transmitters in One



wilcox 99 Multi-Frequency Transmitter

- Up to four R.F. channels in 125-525 k/c, 2-20 m/c, 118-132 m/c frequency ranges.
- Power output 400 watts LF and HF, 250 watts VHF.
- Unusually easy to inspect and maintain.
- Single or simultaneous transmission for greater flexibility.
- Complete remote control operation.

Write today for complete specifications..

wilcox
ELECTRIC COMPANY, INC.

Fourteenth and Chestnut
Kansas City 27, Mo., U.S.A.

ELECTRONIC ENGINEERS

EE or ME degree, minimum 3 years' experience in research and development work involving microwave circuits and antennas, circuit development, servomechanisms, analogue computers or related equipment.

FIELD REPRESENTATIVES

A few openings for graduate engineers only with backgrounds similar to above. Continental U.S.A.

What You Can Expect at General Precision Laboratory

A progressive group of young, successful men, firmly established as designers and manufacturers of electronic equipment . . . a medium-sized staff in which you receive individual recognition . . . a policy of promotion-from-within that helps qualified men move ahead swiftly . . . a modern laboratory located in a pleasant suburban community ideal for family living.

Expenses will be paid for qualified applicants who come for interviews. Please submit complete resume to: Mr. H. F. Ware

GENERAL PRECISION LABORATORY

INCORPORATED

A Subsidiary of GENERAL PRECISION EQUIPMENT CORPORATION
63 BEDFORD ROAD, PLEASANTVILLE, NEW YORK



The following positions of interest to I.R.E. members have been reported as open. Apply in writing, addressing reply to company mentioned or to Box No. . . .

The Institute reserves the right to refuse any announcement without giving a reason for the refusal.

PROCEEDINGS of the I.R.E.
1 East 79th St., New York 21, N.Y.

ENGINEER

Engineer for acoustic and audio research laboratory of progressive manufacturer located in pleasant New York suburban area. Must have good background in loudspeakers, microphones, transducers and physics of moving systems. Challenging opportunity and attractive salary commensurate with experience and past achievements. Box 736.

TRANSFORMER DESIGNER

Minimum 2 years experience. Unusual opportunity for young man who wants to get ahead. Salary open. Box 738.

ASSISTANT PROFESSOR

Teaching position: Assistant Professor of electrical engineering starting September 1. Must teach electronics, ultra high frequency and introductory course in machinery. Master degree, twelve month employment, one month summer vacation. Write: K. F. Sibila, Head, Electrical Engineering Dept., The University of Akron, Akron 4, Ohio.

MARKETING MANAGER—ELECTRONIC EQUIPMENT

Full responsibility marketing and sale of industrial products. Must prove ability to develop and carry out marketing programs. Operate field sales force. Conduct market planning, research and promotion services. Build strong marketing team. Continue growing. Should have experience in electronics or allied industrial products. Selling and marketing or sales management. Location: Northeast section of U. S. Salary open. Send resume to Box 739.

CHIEF MECHANICAL ENGINEER

Qualified to direct Research and Development, as well as production of Precision Mechanisms in electronics field. A thorough knowledge of modern shop methods, as well as experience in planning and tooling, for production is essential. Engineers with experience in design of tape recorders will get preference. The Engineer who can qualify for above position, will be given opportunity to supervise the entire mechanical Engineering Division and will be responsible to top management only. Top salary. Progressive, old established company in N.Y. metropolitan area. Send complete detailed resume stating experience, education background and salary expected to S. Klein, Room 1002, 527 Fifth Ave., New York 17, N.Y. Replies will be held in strict confidence.

ENGINEER

Opening for qualified engineer with interests in field of resistor, rheostats, switches and allied components manufacture. Experience in design, selection of materials and production tooling required. Attractive working condition, excellent opportunity with medium sized progressive manufacturer. Please give full details of training and experience; state salary desired. Mail replies to Box 740.

(Continued on page 132A)

ENGINEERS & PHYSICISTS: what's simac*?

It's newer than radar, sonar, loran and TV
Its commercial uses are almost limitless
It's the fast-growing field in which Sperry ultrasonic equipment is paramount

IT'S
**SONIC
INSPECTION
MEASUREMENT
AND
CONTROL**

SIMAC, the most advanced method for non-destructive testing of metal and other materials.

RESEARCH PHYSICISTS ELECTRONIC ENGINEERS

Degree in physics, experienced in research on ultrasonics, wave motion in solids, sonar techniques, seismology or piezo-electric transducers.

Sperry Products, Inc. now offers you an opportunity to diversify your experience, to join an expanding, completely independent organization.

- Work for a smaller company in which your ability can be recognized quickly, your talents can thrive.
- Move your family to Danbury, Conn. in the foothills of the Berkshire Mountains, less than 2 hours drive from New York City. Moving expenses paid.

*Find out more about available positions:
send complete resume to W. J. Hatcher.*

SPERRY PRODUCTS, INC.
DANBURY CONNECTICUT
* trade mark

ENGINEERS:

**DOES YOUR
PRESENT JOB
GIVE YOU**

ALL THESE

RCA

CAREER

ADVANTAGES?

**POSITIONS NOW OPEN FOR
SENIOR DEVELOPMENT
AND DESIGN ENGINEERS:**

- ✓ ELECTRONIC . . .
- ✓ COMMUNICATIONS . . .
- ✓ MECHANICAL . . .
- ✓ COMPUTER . . .
- ✓ ELECTRON TUBE . . .

**PERSONAL INTERVIEWS ARRANGED
IN YOUR CITY.** A copy of our booklet
"Challenge and Opportunity," describing the role of the
engineer in RCA, will be mailed upon request. Please
send a complete resume of your education and
experience to:

MR. ROBERT E. McQUISTON, Manager
Specialized Employment Division, Dept. 2021
Radio Corporation of America
30 Rockefeller Plaza
New York 20, N.Y.

CHECK SHEET

Yes No

- PROFESSIONAL RECOGNITION AND PRESTIGE?
- ADVANCEMENT IN STATUS?
- SECURITY AND STABILITY?
- CHALLENGE AND OPPORTUNITY?
- HIGH SALARY SCALE AND OPPORTUNITIES
FOR PROMOTION?
- EXCELLENT SUBURBAN HOUSING AT
REASONABLE COST?
- FACILITIES FOR PROFESSIONAL
ADVANCEMENT?
- UNEXCELLED TECHNICAL AND LABORATORY
FACILITIES?
- ASSOCIATION WITH TOP SCIENTISTS?
- TUITION REFUND PLAN FOR ADVANCED STUDY?
- MILITARY OR COMMERCIAL OPPORTUNITY?
- MODERATE COST OF LIVING?
- MODERN RETIREMENT PLAN?
- COMPANY-PAID LIFE INSURANCE?
- COMPANY-PAID LIBERAL HOSPITAL, SURGICAL
AND DISABILITY PLAN (FAMILY BENEFITS)?
- LIBERAL VACATION PLAN?
- LIBERAL HOLIDAY SCHEDULE?
- PROFESSIONAL STATUS AND UTILIZATION OF
YOUR EDUCATION AND EXPERIENCE?



RADIO CORPORATION of AMERICA

Bell Telephone Laboratories

has career openings for experienced

electrical engineers
mechanical engineers
physicists

For work on Guided Missiles, Radar, Fire Control and Underwater Systems in New Jersey (20 miles from New York City).

The company that has pioneered many of the major developments in the fields of communications and electronics now offers you an opportunity to join its staff. Here you will gain invaluable experience and great satisfaction through the challenging diversified nature of the work. To qualify, you must be a college graduate (preferably not over 40 years of age) with related experience of the following types:

Systems Engineering

Analysis
Coordination
Evaluation
Planning
Studies

Systems Development

Fundamental Development
Circuit Design
Mechanical Design
Equipment Development
Field Testing

Write, giving full details of education and experience to:

BELL TELEPHONE LABORATORIES Inc.

Employment Director, Box 2, New York 14, N. Y.



(Continued from page 130A)

INSTRUMENTATION ELECTRONICS ENGINEER

As group leader for analytical instrument development laboratory. Should have a degree in electrical or electronics engineering with five years experience or advanced degree in lieu of part of this experience. Some past experience at bench work is a requirement. Successful applicant will do design work in conventional circuitry such as narrow band pass a.c. amplifiers; high gain stable d.c. amplifiers; stable d.c. power supplies; high and low power pulse networks; thyatron control circuits; application of fractional horsepower motors; servo systems; etc. Send resume with salary requirements to: Personnel Manager, Fisher Scientific Company, 717 Forbes Street, Pittsburgh 19, Pa.

ELECTRICAL ENGINEERS

A New York metropolitan organization is in need of Electrical Engineers to do research and development work. These men should have a minimum of two years experience in the fields of radar, television or high frequency communications. The work is primarily of a study nature. However, experience in circuit or system design is required as background to intelligently perform the analytical and theoretical work. Box 741.

ENGINEER

An Engineer with a degree in communications or electronics to work with a growing Sales Engineering Organization in the Southwest, selling complete line of component parts and test equipment. Production engineering experience desirable. Live in Dallas and travel in Oklahoma, Arkansas, Louisiana and Texas. Please submit a complete application stating educational background and past work experience. John A. Green Company, 6815 Oriole Drive, Dallas 9, Texas.

TECHNICAL WRITER

Experienced in preparation of instruction books, handbooks, operating and maintenance manuals for electronic equipment. Must be able to do editing and layout. Top salary. Progressive, old established company in N.Y. metropolitan area. Send complete detailed resume stating experience, educational background and salary expected. Replies will be held in strict confidence. Box 742.

MICROWAVE TUBE DESIGN

Senior Engineer or Physicist (M.S.-Ph.D.) with design experience in travelling wave tube field to organize and lead group to study and develop travelling wave tubes. Ideal location in Westchester County, New York. Excellent working conditions, full benefits, insurance, hospitalization, pension plan. Salary to \$10,000, depending on qualifications. Write Box 743.

COMMUNICATIONS ENGINEER

A small but established firm of consulting electronics engineers has an opening for a radio engineer with at least 2 years experience for the reduction of radio interference by test and redesign of electronic equipment. Address: Electro-Search, 4337 N. 5th St., Philadelphia 40, Pa.

Engineers & Physicists

- Mechanical Engineers
- Servo Engineers

- Electrical Engineers
- Chemists
- Physicists

The diversified research and development programs now in progress at
melpar, inc.
The Research Laboratory
of Westinghouse Air Brake Co. and its subsidiaries
offer excellent opportunities for
professional achievement to qualified men.



Write to Personnel Director,
MELPAR, INC.
Dept. G-3
452 Swann Avenue
Alexandria, Virginia
or 10 Potter St.,
Cambridge, Mass.

Call our representative Mr. E. M. Lane at the Sherman Hotel in CHICAGO during the National Electronics Conference Sept. 28-30

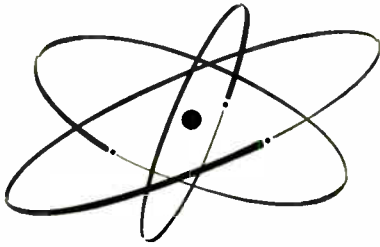

ELECTRONICS CAREERS

WITH

Martin

ATTRACTIVE OPPORTUNITIES

FOR

EXECUTIVE ENGINEERS and TECHNICAL SPECIALISTS

Openings for:

SYSTEMS ANALYSIS ENGINEER

RADAR UNIT SUPERVISOR

PROJECT ENGINEER

SUPERVISOR OF ELECTRONIC DEVELOPMENT

Our long range program of diversified electronic projects provides stimulating opportunities for professional growth.

Recognition and rapid advancement are our answer to today's engineering shortage.

Contact our representative at the National Electronics Conference, Hotel Sherman, Chicago, Illinois, September 28 to 30, 1953 or write

THE GLENN L. MARTIN CO.
TECHNICAL EMPLOYMENT
BALTIMORE 3, MD.

send for the most widely used Electronic Supply Guide

free →

ALLIED'S 268-PAGE 1954 CATALOG

SEND FOR IT

the World's largest Stocks of

ELECTRONIC SUPPLIES FOR INDUSTRY

Simplify and speed the purchasing of *all* your electronic supplies and equipment. Send your orders to us at ALLIED—the reliable one-supply-source for all your electronic needs. Depend on us for quick shipment from the world's largest stocks of special-purpose electron tubes, test instruments, audio equipment, electronic parts (transformers, capacitors, controls, etc.) and accessories—everything for industrial and communications application, for research, development, maintenance and production. Let our expert Industrial supply service save you time, effort and money. Send today for your FREE copy of the 1954 ALLIED Catalog—the *complete*, up-to-date guide to the world's largest stocks of Electronic Supplies for Industrial and Broadcast use.

NEW HOME OF ALLIED RADIO



ultra-modern facilities

TO SERVE YOU BEST

147,000 square feet of efficient floor space, utilizing latest conveyor and pneumatic equipment—devoted exclusively to the best service in Electronic Supply.

ALLIED RADIO

100 N. Western Ave., Dept 35-J-3
Chicago 80, Illinois

one complete dependable source for everything in electronics



**Engineers, physicists, designers, technicians—
Investigate the challenging
new opportunities in the guided missile industry**

**BENDIX OFFERS EXCELLENT POSITIONS
IN ITS WELL-ESTABLISHED
GUIDED MISSILE PROGRAM**

To men interested in the rapidly growing guided missile industry, an association with Bendix offers unusual advantages. For here at Bendix, guided missile work is not a side line, but a well-established program with over seven years of successful development and research backing up today's operations.

No finer engineering and production facilities are found anywhere in the industry, and the men responsible for the Bendix guided missile program are recognized leaders in their field. Job opportunities range from theoretical systems analysis, through product and test equipment design and development, to field test and flight evaluation.

OPENINGS IN:

- | | |
|---------------------|-------------------------|
| Aerodynamics | Hydraulics |
| Electronics | Mechanics |
| Microwaves | Servo Mechanisms |
| Dynamics | Structures |

LET'S DISCUSS OUR MUTUAL INTERESTS

Write:

Employment Dept. Bendix Products Division
Bendix Aviation Corporation, 401 Bendix Drive
South Bend 20, Indiana



**ELECTRONIC
ENGINEERS**

FOR DESIGN AND DEVELOPMENT WORK IN

- RADAR**
- COMPUTERS**
- TELEMETERING**
- DATA REDUCTION**
- SERVO MECHANISMS**
- DIGITAL TECHNIQUES**

A CHANCE TO GROW WITH A YOUNG PROGRESSIVE COMPANY, SALARIES AND ADVANCEMENT COMMENSURATE WITH ABILITY, LIBERAL VACATIONS, SICK LEAVE, EIGHT PAID HOLIDAYS, GROUP INSURANCE, EDUCATIONAL ASSISTANCE PROGRAM, EXCELLENT WORKING CONDITIONS. SEND RESUME OF EXPERIENCE AND EDUCATION WITH SALARY REQUIREMENTS AND AVAILABILITY DATE TO:

 **Electronic Engineering Company**
of California
100 SOUTH ALVARADO STREET
LOS ANGELES • 4 • CALIFORNIA

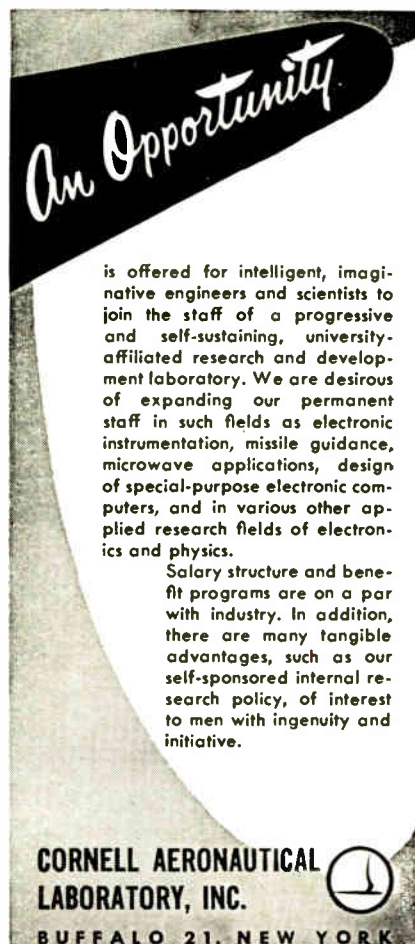

An Opportunity

is offered for intelligent, imaginative engineers and scientists to join the staff of a progressive and self-sustaining, university-affiliated research and development laboratory. We are desirous of expanding our permanent staff in such fields as electronic instrumentation, missile guidance, microwave applications, design of special-purpose electronic computers, and in various other applied research fields of electronics and physics.

Salary structure and benefit programs are on a par with industry. In addition, there are many tangible advantages, such as our self-sponsored internal research policy, of interest to men with ingenuity and initiative.

**CORNELL AERONAUTICAL
LABORATORY, INC.** 
BUFFALO 21, NEW YORK

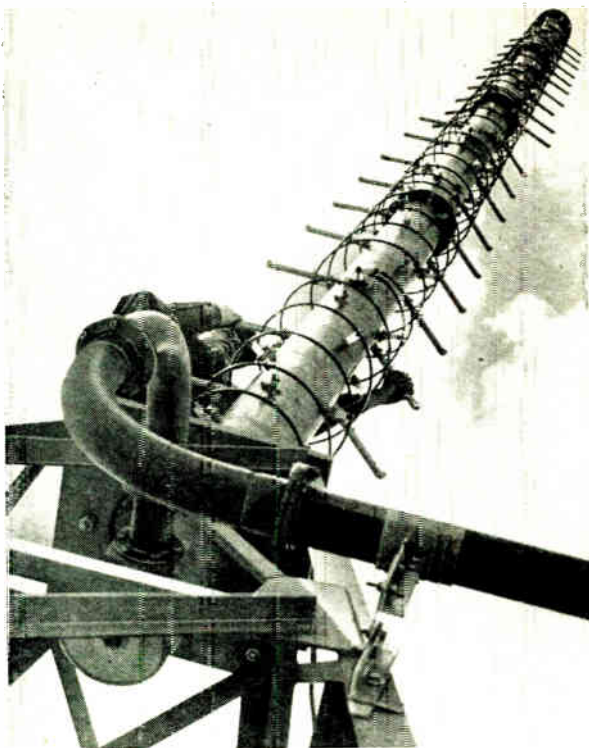

Typical of General Electric's pace-setting developments — this new type of television transmitting antenna that increases by 25 times the effective radiated power of the UHF station transmitter.

NEW DEVELOPMENTS BY GENERAL ELECTRIC ENGINEERS SHOW VERSATILITY OF ELECTRONICS

Again and again, General Electric engineers have pioneered the new developments in electronics.

This is no coincidence, for a number of important factors have made these achievements possible: the vast facilities provided by General Electric; the opportunity to apply the most creative thinking to challenging problems; the stimulating association with outstanding men in the profession; the strong sense of stability inherent in a General Electric job.

The same opportunities are open to engineers, physicists, chemists and metallurgists in the following fields: Advanced Development, Design, Field Service and Technical Writing in connection with:

MILITARY RADIO & RADAR
MOBILE COMMUNICATION
MULTIPLEX MICROWAVE
COMMUNICATIONS
ELECTRONIC COMPONENTS
TELEVISION, TUBES & ANTENNAS

Bachelor's or advanced degrees in Electrical or Mechanical Engineering, Physics, Metallurgy or Physical Chemistry and/or experience in electronics industry necessary.

Please send resume to:

GENERAL  ELECTRIC

Dept. 9-3-P, Technical Personnel
ELECTRONICS PARK Syracuse, N. Y.

ENGINEERS PHYSICISTS

TAKE INVENTORY OF YOUR
FUTURE

WHAT MAKES A GOOD JOB?

Check off the items in the following list that you look for in a good job.

- 1—Professional Recognition
- 2—Interesting work
- 3—Equitable salary
- 4—Recognition of ability
- 5—Security
- 6—Good future prospects
- 7—Reward for ideas
- 8—Good working conditions
- 9—Liberal benefit program
- 10—Family protection
- 11—Paid vacations and holidays

If you look for all of the above items and more, in a good job, it will be to your advantage to investigate the opportunities in Electronic Circuit Design and Specialized vacuum tube research and development at . . .

NATIONAL UNION RADIO CORP.
ELECTRONIC RESEARCH DIVISION
P. O. Box 352 Orange, New Jersey

PROGRESS WITH A LEADER
OFFERING
ADVANCED ENGINEERING POSITIONS
IN
NEW AIR CONDITIONED PLANT

microwave
engineers

Country Surroundings—
Big City Advantages
Add Up To An
Unlimited Future With

SYLVANIA'S ELECTRONICS DIVISION

A leader in the development and production of microwave components, Sylvania's expanding Electronics Division offers a few top microwave engineers an assured future.

Here, in New England's Greater Boston area, you will be next door to some of the country's most renowned technical centers of learning and research, yet you and your family will enjoy the serenity of country living.

ENGINEERING SPECIALIST

This is a top engineering staff position for a man who has the flair, ability and knowledge of a specialist who will be consultant of and assist as an expert in all divisional microwave programs and problems of our four plants. The position offers top-rank professional activity covering invention, research, development, production and application in the microwave field. Products involved include semi-conductor devices, TR and ATR tubes, magnetrons, klystrons, and travelling wave tubes. Requirements for this position include ad-

vanced engineering or physics degree, or equivalent, and at least 5 years of solid experience in the microwave field.

MICROWAVE SPECIALIST

For advanced microwave investigations, particularly related to silicon crystal development, applications and improved evaluation and testing. Requires sound background in electromagnetic theory, waveguide circuitry, microwave mixer operation. An engineering or physics degree and 1 to 5 years of microwave experience are desirable.

Please send complete resume to:

Mr. Robert L. Koller

Sylvania Electric Products Inc., Electronics Division
Woburn, Mass.

SYLVANIA



PRODUCTS

Speeding Electronic Progress

through crystal



research

This new JK G-12 is designed for ultra stable frequency control in applications such as frequency standards, timing and counting circuits, broadcast equipment and frequency monitors. Electrodes are deposited directly on the large, precision-made quartz plate shockmounted in an evacuated glass envelope. Frequency range 500 kc to 1500 kc. Crystal may be designed for a minimum temperature coefficient of from 0°C to 50°C or for temperature controlled operation at 60°C with a JKO7E-115V Oven. Approximate height above chassis, 2 3/4". Maximum diameter of octal base, 1 3/4". Consult us on specific applications.

JK STABILIZED G-12 CRYSTAL
For the "Difficult" 500 kc to 1500 kc Range



Tomorrow's Crystals



The increasing demand for ultra-stable frequency control to meet today's new requirements has necessitated a new approach to crystal design. Evacuated glass envelopes — for maximum protection and freedom from contamination — are a part of the new design of JK Crystals for the Critical. Consult us on your requirements for crystals of this advanced design.

**THE JAMES
KNIGHTS COMPANY,
SANDWICH, ILLINOIS**



News—New Products

These manufacturers have invited PROCEEDINGS readers to write for literature and further technical information. Please mention your I.R.E. affiliation.

(Continued from page 128A)

fer valve exerts a clearing force of up to 500 pounds in the first stage to remove sludge, dirt or metal particles that tend to jam the valve. Its frequency response is flat from 0 to 150 cps. It has a linear output up to 14 hp, with no external leakage and a zero signal leakage of only 60 cc/min. Power amplification is 5,000 with pressures up to 3,000 psi. Input power is less than 2 watts; input current is 15 ma; resolution is 0.03 per cent; time constant is 0.001 second. The valve is 1 5/16 x 2 7/16 x 5 1/2 inches with a volume of less than 18 cubic inches and has a flow of up to 12 GPM. It weighs less than 1 1/2 pounds. The lower flow models are correspondingly smaller and lighter. The life of the unit is at least 4 million cycles.

Aircraft Panel Meters

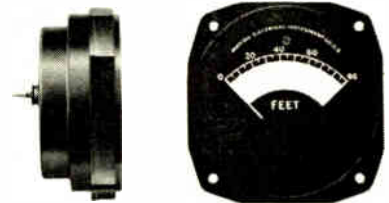

Marion Electrical Instrument Co., Manchester, N. H., announces the Marion Model AN3 instrument, a single-element aqnel mounted type, completely ruggedized per MIL-M-10304, including internal shock mounting. It meets Army-Navy aeronautical design standard and 10401 requirements for 2 1/2 inches dial instruments. In addition to the ruggedized D'Arsonval movement, the unit is (glass-to-metal) hermetically sealed. Applications include: ammeters, voltmeters, radio navigational types (such as omniranges and ILS) and temperature indicators.

Tower Bulletin

Blaw-Knox Co., Tower Dept., Farmers Bank Building, Pittsburgh 22, Pa., has published a new 20-page bulletin, No. 2417. This bulletin describes the AM, FM, Television, Microwave, Communications, and Radar towers built by the company. Various types of guyed and self-supporting towers are described.

A photograph of the Blaw-Knox testing frame is shown. By use of this frame, any combination of loads representing wind and antenna load can be applied to a tower. Actual deflection and twist can be measured, and tower tested to destruction if desired.

The RTMA standard specifications are given in the bulletin. These standards were adopted by Blaw-Knox and other leading tower manufacturers to avoid confusion.

Copies of the bulletin 2417 may be obtained by writing the company's Tower Department.

(Continued on page 138A)



Positions Wanted By Armed Forces Veterans

In order to give a reasonably equal opportunity to all applicants and to avoid overcrowding of the corresponding column, the following rules have been adopted:

The Institute publishes free of charge notices of positions wanted by I.R.E. members who are now in the Service or have received an honorable discharge. Such notices should not have more than five lines. They may be inserted only after a lapse of one month or more following a previous insertion and the maximum number of insertions is three per year. The Institute necessarily reserves the right to decline any announcement without assignment of reason.

ADMINISTRATIVE ENGINEER

BEE Purdue 1943, MS EE pending. Six years electronic production engineering, four years business management research company, government contracts. Age 33, family of three. Senior Member IRE. Box 654 W.

ELECTRONIC ENGINEER

Electronic design engineer with 3 years experience. Desires position as sales engineer in New York City area. BEE degree from New York University. Age 29. Box 655 W.

ELECTRONIC ENGINEER—RESEARCH

BSEE 1948 from large northeastern university. 8 years experience before graduation; 1 year industrial control, 4 years research in VHF, UHF and audio after graduation. Excellent background of theory and practical applications. Desires supervisory of small engineering group located in west or southwest. Box 657 W.

ELECTRONIC ENGINEER

BSEE electronics option, University of Kentucky; age 33, married, 2 children. U.S. Civil Service training field radio and frequency modulation; Army Signal Corps service, 3½ years mobile communications equipment. Presently engaged in UHF transmitter design-development. Resume upon request. Box 658 W.

ELECTRONIC ENGINEER

BS and MS in electronic engineering; age 26; married. 2½ years experience in electronics and microwaves, running the gamut of research to production and sales. Desires responsible position in development, manufacture or technical sales. Box 659 W.

PHYSICIST—ENGINEER

Physics graduate 1950. Over 8 years classified electro-mechanical design and production, Airborne radar installation and maintenance, test, carrier telephone and communications systems with supervisory and administrative experience. Desires responsible engineering administration position. Will relocate. Box 670 W.

SENIOR ENGINEER

Ten years project leadership; development of radar indicators, analogue computers, missile controls. Thoroughly familiar with circuit design below UHF, BSEE 1936, MEE 1949, DEE expected 1955. Desires work of non-military nature. Box 671 W.

ELECTRONIC ENGINEER

Electronic engineer seeks future in sales. Four years experience in varied phases of industry and complimentary education, (MEE

(Continued on page 139A)

KEEP CURRENT CONSTANT WITH VICTOREEN CURRENT REGULATOR TUBES

Replace that expensive regulating circuit with a single current regulator tube designed to closely regulate line or battery current—simply, efficiently, at minimum cost.

In-a-current-regulator tube an increase in current is automatically compensated for by increased resistance.

What About...

CURRENT RANGE . . . Many tube types available .025 to 6 amps. A.C. & D.C.

VOLTAGE DROP Varies 1 to 100 V depending on current, bulb size.

PHYSICAL SIZE Standard T-6, T-9 or ST-14 —octal or miniature base.

ENVIRONMENTAL CONDITIONS Reliable operation at extreme temperatures, humidity, altitude.

MIL SPECS . . . Type approved tubes available.

ELECTRICAL CHARACTERISTICS . . . TYPICAL TYPES

Type No.	Voltage (V)	Currents (Amps)
CR 80-20	20-60	.080
CR 140-20	20-35	.140
CR 200-20	20-40	.200
CR 350-5	5-12	.350
CR 600-4	4-10	.600
CR 800-4	4-10	.800
CR 900-4	4-11	.900
CRM 900-5	5-9	.900
CR 950-4	4-11	.950
CR 1635-5	5-9	1.635
CR 1700-2	2-4	1.700
CRM 1700-2	2-4	1.700
CR 3500-3	3-6	3.500
CR 4200-3	3-6	4.200

Write for further details—include specifications for your application

BETTER COMPONENTS MAKE BETTER INSTRUMENTS

The Victoreen Instrument Co.

3800 PERKINS AVENUE

CLEVELAND 14, OHIO

These manufacturers have invited PROCEEDINGS readers to write for literature and further technical information. Please mention your I.R.E. affiliation.

(Continued from page 136A)

ANOTHER BETTER TOOL...

for the ELECTRONIC ENGINEER and the RESEARCH SCIENTIST

A versatile instrument for research involving high repetition rates

MODEL B-2 PULSE GENERATOR

PULSE WIDTH: variable in 4 ranges from .2 μ s to 1,000 μ s
PULSE RISE TIME: .02 μ s
PULSE AMPLITUDE: \pm 80 volts open circuit
INTERNAL IMPEDANCE: 93 ohms
INTERNAL DELAYS: variable in 5 ranges from 0 to 10,000 μ s with respect to synchronizing pulse
INTERNAL REPETITION RATES: variable in 4 ranges from 10 cycles at 100 KC
SYNCHRONIZING PULSES: 5—independently available at separate output jacks

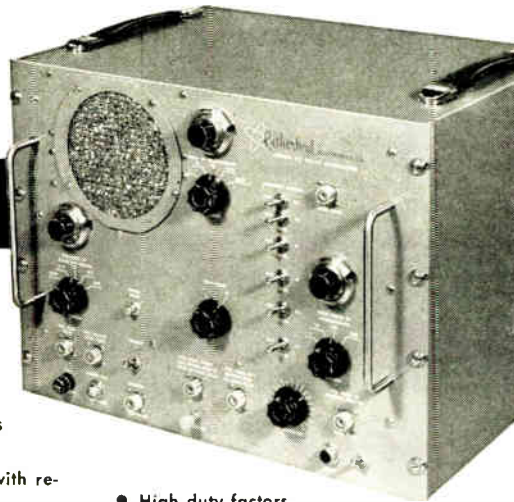

- High duty factors
- Can be triggered externally and for single pulse operation
- Calibrating potentiometers are provided for each range

Write for complete data: our Bulletin I-B-2

Rutherford ELECTRONICS CO. 3707 S. ROBERTSON BLVD.
CULVER CITY, CALIFORNIA

Sub-Miniature Blower

Sanders Associates, Inc., Nashua, N. H., announces production of the "Minicube" subminiature blower. This 1 inch cube, which weighs 1 ounce, includes the motor and blower housing and delivers 3 cubic feet of air per minute. It is designed for circulation of air and the cooling of electronic parts and equipment.



The unit can be mounted next to a component for spot cooling or anywhere else for general circulation of air. The rating of a component, such as a power resistor, can be increased by properly attaching a blower directly to the component. The "Minicube" can be used in hermetically sealed equipment for heat transfer to or from the case. Mounted on the inside the blower affords efficient heat transfer to the case. Mounted on the outside it can be used to remove heat from the case. The manufacturer claims the "Minicube" can replace large external blowers for cooking klystrons and magnetrons.

Standard models are available for operation over a temperature range of -55°C to $+85^{\circ}\text{C}$, with an expected life of 1,000 hours. Other models are also available for extremely wide temperature ranges. The "Minicube" utilizes an integral hysteresis-type synchronous motor turning at a speed of 24,000 rpm. Motors can be supplied for either 6.3 v, 3 watt, or 26 v, 4 watt, 400 cps operation. The motor is normally two-phase, but can be operated from a three-phase source or a single-phase source with a phase shifting capacitor.

Ball-&-Disk Integrator

A ball-&-disk type integrator has been developed and produced by **The Reflectone Corp.**, 1700 Summer St., Stamford, Conn.

The device is a high-precision, comparatively low-torque, speed changer for generating variable reversible speeds in a stepless fashion, using a minimum amount of space. It may be used for analog computers, servo mechanisms, and similar devices.

The unit weighs 17 ounces. At 750 rpm input speed to the disk (maximum recommended speed) the maximum output speed is 1,500 rpm. Output torque at this speed should not exceed 5 ounce inches.

(Continued on page 140A)

Saratoga Industries

STAR PERFORMANCE AS
MANUFACTURERS OF TRANSFORMERS,
REACTORS, FILTERS, TOROIDAL
COILS FOR THE ELECTRONICS INDUSTRY

Now in its ninth year of operation, Saratoga Industries, Inc. has built a solid reputation for the manufacture of precision windings. Approved for in-plant testing under MIL-T-27, Saratoga Industries, Inc. is also prepared to handle all types of commercial production. Saratoga engineers invite your inquiry to help solve your problems relating to reactors, transformers, filters and windings of all types.

SARATOGA INDUSTRIES, INC., SARATOGA SPRINGS, N. Y.

Positions Wanted

(Continued from page 137-A)

New York University 1953). Extremely advantageous and capable assistant to chief sales engineer. Available for metropolitan New York employment. Box 672 W.

ENGINEER

BSEE, MSEE, more than two additional years of graduate work in physics and electronics. Married, 1 child. Electronics officer USNR; 2 years teaching electronics; 4 years responsible research and development position in radar with emphasis on microwaves. Will locate anywhere. Box 673 W.

ELECTRONIC ENGINEER

BS physics, graduate work in E.E. and physics. Married, age 30. 6 years instructor radio and television school, covering courses in all phases of electronics. 2 years own television business. 3 years Army electronics instructor. Desires position with future in New York metropolitan area. Box 674 W.

ELECTRONIC ENGINEER

Five years supervision, instruction, design of TV broadcasting studio equipment and receivers, technical writing and proofreading. Eleven years experience in maintenance of electronic equipment. Interested in permanent position with future. Box 676 W.

ENGINEER

Under Graduate work in EE—55 credits. Graduate work in EE—60 credits. B.S. Physics 1943; 5½ years experience in basic electronic research, design and development; Supervisory experience. Age 32, married. Desire position in management, sales or supervisory capacity. Minimum salary \$9,000. N.Y., N.J., D.C. area preferred. Will consider others. Box 686 W.

SALES ENGINEER

Attention sales representatives and progressive firms in N.Y.C. and New England area! Will you buy this? B.S.E.E. 1949. 2 years electronic test equipment and 2 years microwave engineering; excellent health, 28 years old, married, neat appearance, pleasing personality. Seeking career position in sales. Can you match this? Box 688 W.

ENGINEER

EE Purdue 1941. Age 34. Six years civilian experience in unit substation, power and distribution transformer design. Six years in Navy as an electronics officer. Desire Midwest or Southwest location. Married, one child. Box 687 W.

MICROWAVE DESIGN ENGINEER

Master's Degree, Physics major, with solid background in design and test of components. Interested in responsible position with N.E. firm. Capable of administrative or sales duties also. Box 689 W.

JR. ELECTRONIC ENGINEER

Age 30. USN-ETMI/c. BEE (eves) due June 1954 from New York University. Experience: 4 yrs. T.V. repair; presently doing electronic research (2 yrs) for USN. Interested in design and/or development in New York area with a future. Box 690 W.

ENGINEER

Position in engineering sales or technical administration desired by Naval Reserve Officer returning to inactive status. Strong electronic and administrative background in research and development. Family man, permanent location essential, travel facilitated by private pilot license. Brochure sent upon request. Box 691 W.

(Continued on page 145A)

the pioneer
is the leader

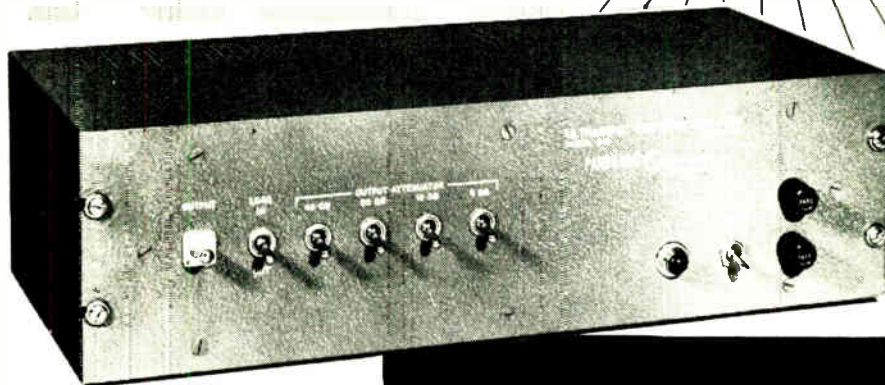

PANORAMIC MODEL G-3

For Research
Development
and Production
Test
Applications

Frequency Coverage:
2KC to 300KC

Center Frequency:
Variable and calibrated
between 2KC and 200KC

Sweepwidth:
Variable and calibrated
from 200KC down to 0KC.
Selected sweepwidth remains
constant as center frequency is
varied.

Amplitude Scale:
Linear or two decade log.
Amplitude range 50 db overall.

Sweep Rate:
6.7 c.p.s.

Voltage Output:
2.5 volts, flat to ± 1.5 db

**Internal Source
Impedance:**
60 ohms

Output Attenuation:
Toggle switch operated,
75 db with steps of 40 db,
20 db, 10 db and 5 db.

DIRECT READING ULTRASONIC RESPONSE INDICATOR

Used as an adjunct to the Model SB-7 Panoramic Ultrasonic Analyzer the G-3 permits simple rapid visual inspection of amplitude versus frequency characteristics of networks and devices between 2KC and 300KC.

The combination, a complete package, serves as a frequency sweep source and synchronous selective detector which insures indications of fundamental responses only.

Direct readings of frequency, amplitude, sweepwidth and center frequency are available from the calibrated dials and screen of the SB-7 Panoramic Ultrasonic Analyzer.

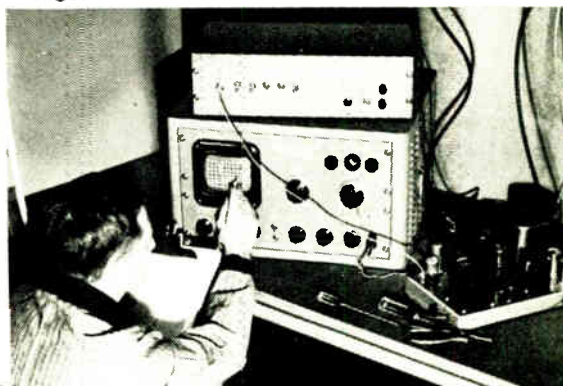

Our complete line of equipment will be demonstrated at the National Electronics Conference Booth #116.

Write for complete information, price and delivery.

12 SOUTH SECOND AVENUE • MOUNT VERNON, NEW YORK



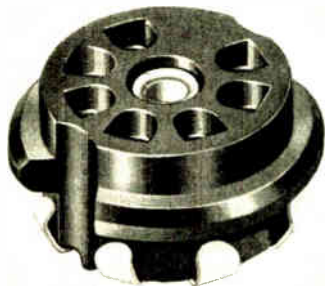

Illustrated here, is Elco Corporation's new 7-pin printed-circuit socket, which in addition to its electrical and mechanical efficiency and stability, incorporates many advantages never previously available. Aware for a long time of the growing importance of printed circuitry, Elco engineers have been busy in their laboratories on the development of sockets for practical commercial application of this new technique. And again, Elco introduces a quality product.

Positioning of the Elco printed circuit socket in the chassis is quick, easy, positive. No strains or stresses are transmitted to the chassis or to the socket insulator; yet electrical contact is excellent at all times. The improved contact design automatically centers tube pins in position; resulting in positive contact retention with low resistance, producing optimum circuit performance. Contacts are made of brass or phosphor bronze, cadmium plated or beryllium copper silver plated. Insulators are of general purpose phenolic or ceramic materials. These Elco sockets are also available with shield clamps. Complete technical data is yours upon request; as is full information concerning Elco's complete quality-line of tube-sockets, shields, and sensational new Varicon connectors.

For Catalog Sheets, Call GARfield 6-6620 or Write **ELCO Corp., 190 W. Glenwood, Phila. 40, Pa.**

News—New Products

These manufacturers have invited PROCEEDINGS readers to write for literature and further technical information. Please mention your I.R.E. affiliation.

(Continued from page 138A)

Picture-Tube Filter

Bennett Laboratories, Inc., 2790 Bay Road, Redwood City, Calif., in an effort to improve picture quality and remove viewing eyestrain by filtering out the blue and violet picture-tube radiation, has developed the new SafeTVision, a flexible plastic film which self-adheres directly to the picture tube face. The filter is available in three sizes to cover the picture-tube ranges to 17, to 21, and to 30 inches and listing, respectively, at \$4.95, \$7.95 and \$10.95.



Based on medical research into the symptoms and causes of television eyestrain, the filter corrects the spectral distribution of visible energy by providing a sharp cut-off for ultraviolet and a large reduction in the violet-blue peak which is characteristic of cathode-ray tube outputs. Since eyestrain results widely from the inability of human eyes to either focus or accommodate themselves to violet-blue radiations, elimination of these components produces a balanced non-fatiguing picture-tube image.

Rotary Shaft Seal

An improved rotary shaft seal which offers operating advantages in hand-operated electrical circuit and tuning mechanisms for radio and radar communication equipment for ships, aircraft, and mobile ground equipment, has been announced by **H. H. Buggie, Inc., 726 Stanton St., Toledo 4, Ohio.** Designated as Series 1100, the rotary shaft is valuable in connection with pressure, waterproofing, and moisture sealing panel-mounted shafts.

The firm claims that the design combines the flexibility and sealing quality of rubber, low frictional resistance of metal against bearing material, and the corrosion resistant quality of high-grade brass with miniature size. Shafts are one piece, eliminating back lash. No lubrication is required.

Three standard sizes are available. Modified designs can be developed to meet special requirements. Inquiries regarding special applications for pressure, or waterproofed, rotary shaft seals are invited.

(Continued on page 142A)

HERE IS THE ANSWER TO YOUR PROBLEM OF VARIABLE TIME DELAY!

MINIATURE CONTINUOUSLY VARIABLE-TYPE 506-507

- FAST RISE TIME
- EXCELLENT STABILITY
- HAIRLINE ACCURACY
- NO TIME JITTER
- SMALL SIZE
- LIGHT WEIGHT

SPECIFICATIONS

TYPE 506

TIME DELAY: Continuously variable from 0 to 3.25 microsecond.

RISE TIME: Less than 10% of time delay at any point.

CHARACTERISTIC IMPEDANCE: 190 ohms nominal.

ATTENUATION: Approximately zero below 10 mc, 0.5 at 15 mc, 1 at 20 mc, 1.8 at 30 mc.

PRICE: \$59.00

TYPE 507

TIME DELAY: Continuously variable from 0 to 0.8 microsecond.

RISE TIME: Less than 10% of time delay at any point.

CHARACTERISTIC IMPEDANCE: 580 ohms nominal.

ATTENUATION: Approximately zero below 3 mc, 0.5 at 8 mc, 1 at 15 mc.

PRICE: \$65.00.

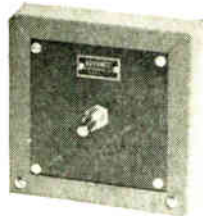

STEP VARIABLE-TYPE 601

SPECIFICATIONS

TIME DELAY: Variable in step of 0.2 microsecond up to 2.2 microsecond.

IMPEDANCE: 190 ohms nominal.

CUTOFF FREQUENCY: 0.2 mc nominal.

CONSTRUCTION: Lumped parameter.

OVERALL SIZE: 3" x 3" x 5".

PRICE: \$124.00.



WRITE FOR DATA!

ADVANCE ELECTRONICS CO.,

P. O. Box No. 394, Passaic, N. J.

Professional Cards

ALFRED W. BARBER LABORATORIES

Specializing in the Communications Field and
in Laboratory Equipment
Offices, Laboratory and Model Shop at:
32-44 Francis Lewis Blvd., Flushing, L.I., N.Y.
Telephone: Independence 3-3306

INTERNATIONAL RADIO CONSULTANTS

Pan American Radio Tangier
Bldg., 16 Rue Int'l Zone
Delacroix Morocco

Specialized in the design, construction, installation and operation of foreign Radio, Electronic, Communications and Acoustical projects, and representing and advising governments and other agencies at meetings of the International Telecommunications Union in local, regional and world wide affairs.

Edward J. Content, P.E. and Staff

CROSBY LABORATORIES, INC.

MURRAY G. CROSBY & STAFF
RADIO-ELECTRONIC RESEARCH
DEVELOPMENT & MANUFACTURING
COMMUNICATIONS, FM & TV
ROBBINS LANE
HICKSVILLE, NEW YORK
HICKSVILLE 3-3191

ELDICO OF NEW YORK, INC.

Donald J. S. Merten and Engineering Staff
Consultants on Interference Elimination
from Transmitters, Induction Heaters,
Diathermy, etc.

44-31 Douglaston Parkway, Douglaston, L.I., N.Y.
Bayside 9-8686

ELECTRO-METRIC INSTRUMENT CO.

A. Newton, Director of Eng.

Circuit analysis, design and development in the
fields of VHF, UHF tuners, TV receivers and
accessories, laboratory and test instrumentation.

241 Centre Street, New York 13, N.Y.
Canal 6-1337

Richard B. Schulz

Electro-Search

Radio-Interference Reduction;
Development of
Interference-Free Equipment,
Filters, Shielded Rooms

4337 N. 5th Street, Philadelphia 40, Pa.
Gladstone 5-5353

ELK ELECTRONIC LABORATORIES, INC.

Jack Rosenbaum

Specializing in design and development of
Test Equipment for the communications,
radar and allied fields

333 West 52nd St., New York 19, PL-7-0520

F-R MACHINE WORKS ELECTRONICS **FXR** X-RAY DIVISION

DESIGN - DEVELOPMENT - MANUFACTURE
Charles Zavales
44-14 Astoria Boulevard Long Island City 3 N.Y.
Phone Astoria 8-2800

(Continued on page 143A)

Synchro Control
Transformer
(Actual Size)



Geared
Servo Motor
(Actual Size)



Servo Motor-
Tachometer
Generator
(Actual Size)



KEARFOTT COMPONENTS INCLUDE:

Gyros, Servo Motors, Synchros, Servo and Magnetic Amplifiers, Tachometer Generators, Hermetic Rotary Seals, Aircraft Navigational Systems, and other high accuracy mechanical, electrical and electronic components.

**miniature
precision components
for high-performance**

Servo Systems

Developed and produced by Kearfott, these units exemplify accomplishments of creative engineering teamed with production skill providing performance values of accuracy, speed of response and reliability unique for their size. Advanced design techniques are typified by the unitized stator and housing construction, permitting line-bored relationship of stator and rotor. This makes practical the extremely close concentricity tolerances apparent in improved efficiency of the Servo Motors and the very high accuracy of the companion Synchro. A very rugged structure, stable under extremes of environmental exposure is also provided.

Conforms to Navy BuOrd Size II
(Maximum Diameter 1-1/16")

TECHNICAL INFORMATION

Synchro—Available as Control Transformer, Transmitter, Resolver, Differential, for 26 or 115 volt 400 cycle operation. Maximum error tolerance is 7 minutes of arc. The hardened pinion shaft may be used as a spline. Terminals for convenient installation and replacement are provided. Other synchros for 60 cycle operation may be obtained. (Basic Type R500).

Servo Motor—The Servo Motor (Basic Type R119) features a very high torque-to-inertia ratio. Motor input is 3.5 watts per phase at 115 volt 400 cycle. Available with high-impedance control winding for operation directly in plate circuit of an Amplifier. Integral precision gear train can be provided. Many other models available including Servo Motors for 60 cycle duty. (Basic Type R303).

Servo Motor-Generator—The motor described above is available with an integral high performance damping generator, providing an output signal of 1/2 volt per 1000 RPM over a 5500 RPM speed range. (Basic Type 420400).

Technical Bulletins on standard Kearfott products are available and will be sent on request. Your inquiries are invited for the development and production of special units for unusual applications. Write today for Bulletin #53 describing our products and facilities.

Kearfott

SINCE 1917

CREATIVE ENGINEERING
PRODUCTION ACHIEVEMENT

KEARFOTT COMPANY, INC., 1150 McBride Ave., Little Falls, N. J.
West Coast Office: 253 N. Vinado Ave., Pasadena, Calif.
A General Precision Equipment Corporation Subsidiary

Designed for



Application

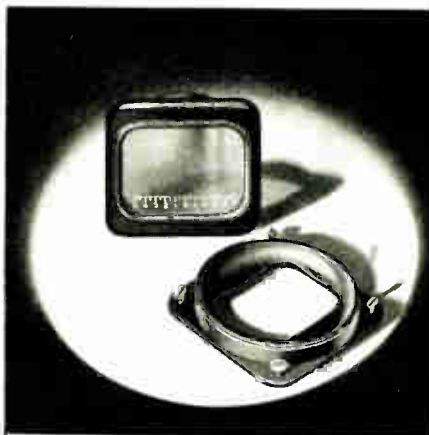

**The No. 80070 Series
of
Cathode Ray Tube Bezels**

The MILLEN "Designed for Application" line of plastic and cast aluminum panel bezels includes units for the 1", 2", 3" and 5" tubes. The 5" size is also available with a special neoprene cushion for the new flat faced tubes as well as the standard cushion. The finish on all types, either metal or plastic is a handsome flat black. The 2", 3" and 5" sizes include a green plexiglass filter. Mumetal and nicoloi shields are also available for all types of cathode ray tubes for use with any of these bezels.

**JAMES MILLEN
MFG. CO., INC.**

MAIN OFFICE AND FACTORY
**MALDEN
MASSACHUSETTS**



News—New Products

(Continued from page 140A)

New Oscillograph

A new seven-element automatic oscillograph for recording power system disturbances and photographically recording preselected magnitudes, wave shapes, and phase relations, has been announced by the **General Electric Co., Meter & Instrument Dept.**, Schenectady 5, N. Y.

The new oscillograph, G-E Type PM-15, has seven permanent-magnet, fluid-damped galvanometers with a separate shunt and resistor unit for adapting them to current or voltage measurements. Relays and controls are provided for starting the instrument automatically by over-current in $\frac{1}{2}$ cycle, and stopping it after a predetermined interval or after the fault has cleared.

The instrument features continuous monitoring and its unit subassembly construction permits simplified inspection and maintenance. A new photographic-type time recorder for establishing the date and time to-the-minute of each oscillogram is employed. A low-cost, flood-lighting type of light source simplifies replacement and eliminates adjustment of prisms and lens when replacing lamps.

Including the recorder, the oscillograph measures 16 inches wide, 23 $\frac{7}{8}$ inches high, and 10 $\frac{3}{4}$ inches deep. Net weight is 95 pounds.

The record chart is bromide paper, 4 $\frac{1}{2}$ inches wide by 200 feet long, and moves at a chart speed rate of 12 ips. Request bulletin GEC-396.

(Continued on page 145A)



TRANSFORMERS

" Fill Your Need to a "

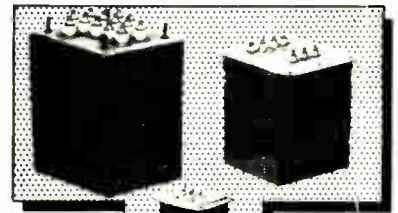

For
**INDUSTRIAL
AND
ELECTRONIC
EQUIPMENT**

**SAMPLE,
SHORT
and
LONG RUNS**

Let us
quote on your
specifications,
no obligation

Delivery
as
Promised!

DESIGNED TO COMMERCIAL AND
MILITARY SPECIFICATIONS
(MIL-T-27 and AN-E-19)

EPCO Products Inc.
2500 Atlantic Ave.
Brooklyn 7, New York

NOISE

in **RESISTOR
APPLICATIONS**

NOISE in resistors may be caused by many factors, but most often arises in the incomplete or tangential contact which exists among the carbon granules that make up a molded resistor. Noise also originates where the connector leads meet the body of the resistor.

Because **WELWYN High Stability Resistors** are formed by depositing a pure, homogeneous carbon film, and because the end-caps are machine-turned and bond-fitted to the body, and the terminal leads clenched into the end-caps, the conducting path presented to any current flow is as continuous as if through a solid conductor. The noise factor of **WELWYN Deposited Carbon Resistors** is only slightly above that predicted by the Johnson formula.

For further Information and
Test Data concerning ...

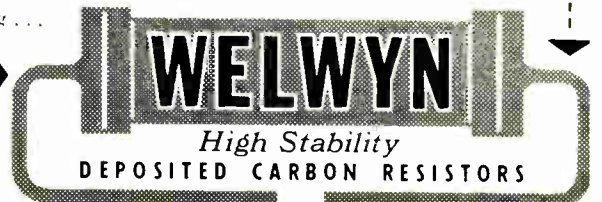

Write to Dept. AJ-4

ROCKBAR CORPORATION, 211 East 37th Street, New York 16, N. Y.

Professional Cards

(Continued from page 141A)

FREDERICK RESEARCH CORP.

BETHESDA 14, MARYLAND
Carl L. Frederick, D.Sc., Pres.
Tel: Washington, D.C., OLiver 4-3229

Research, Specifications, Development, Engineering, Manufacture, Technical Writing, Offset Printing—Fields of Test Equipment, Radio Interference, Tuners, Circuits, Electromechanical Systems, Components.

HARRIS GALLAY Consultant

Electronic Project Development for Industry
Day, Week, and Duration of Project Services

Our Laboratory Facilities Optional

Plymouth 9-4237 60 Perry St., Belleville 9, N.J.

PAUL GODLEY CO.

Consulting Radio Engineers

P.O. Box J, Upper Montclair, N.J.

Offs & Lab.: Great Notch, N.J.

Phone: Montclair 3-3000

Established 1926

GOVERNMENT CONTRACT LIAISON AND CONSULTANTS

GORDON ASSOCIATES, INC.

Specializing in Signal Corps Electronic Requirements, Technical Manuals, Tabular List of Parts, Drawings

L. Gordon, Pres. P. Treston, Ch. Engr.
157 Broad Street Telephone
Red Bank, New Jersey Red Bank 6-2743

HIGHLAND ENGINEERING CO.

William R. Spittal & Staff

Design, Development and Manufacture of Transformers, Chokes, Etc.

for the

Electronic, Industrial and Allied Fields
Main & Urban, Westbury, L.I., N.Y.
WE-7-2933

HOGAN LABORATORIES, INC.

John V. L. Hogan, Pres.

APPLIED RESEARCH, DEVELOPMENT, ENGINEERING

Est. 1929. Electronics, Optics, Mechanisms, Facsimile Communication, Digital Computers, Electro-sensitive recording media, Instrumentation.

155 Perry Street, New York 14 CHelsea 2-7856

LEONARD R. KAHN

Consultant in Communications and Electronics

Single-Sideband and Frequency-Shift Systems

Diversity Reception - Modulation Theory

Applications of Magnetic Tape Recording

Elizabeth Bldg., 22 Pine St., Freeport, L.I., N.Y.
Freeport 9-8800

DAVID C. KALBFELL, Ph.D.

KAY-LAB Electronic Instruments

Laboratory and Manufacturing Facilities

Specializing in Electronic

Instrumental and Industrial Problems

1090 Morena Blvd. Woodcrest 6359

San Diego 10, California

HARRY R. LUBCKE

CONSULTING TELEVISION ENGINEER

Television Engineering Since 1929

Electronics

2443 CRESTON WAY HO. 9-3266
HOLLYWOOD 28, CALIFORNIA

(Continued on page 147A)



Measure PHASE Difference Directly 0°-360° . . .

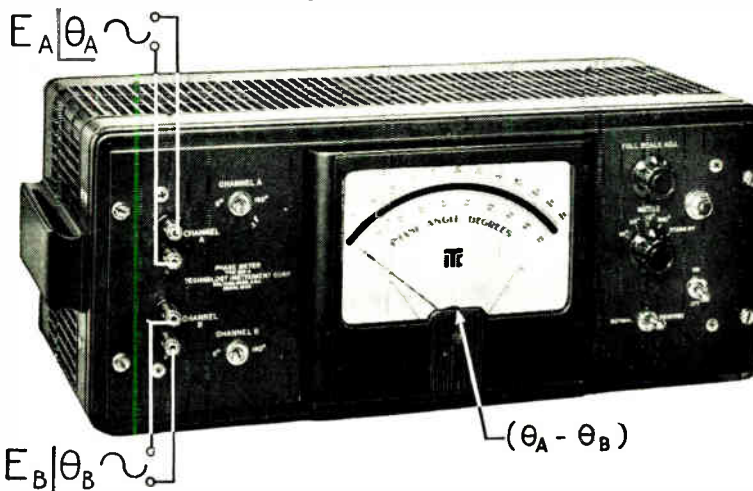

Type 320AB PHASEMETER

- . . . In 4 full scale ranges, 0°-36°, 0°-90°, 0°-180°, 0°-360°, without ambiguity
- . . . Independent of voltage amplitude from 1 to 170 volts peak
- . . . Independent of voltage wave form
- . . . Independent of frequency from 2cps. to 100kc. (accuracy: 20cps-20kc, 1% of full scale +3°; error increases slightly above 20kc.)
- Large, easily read, mirrored scale panel meter
- Ease of operation — ideal for production testing or laboratory use
- Eliminates tedious and inaccurate oscilloscope techniques
- Terminals for recorder . . . instantaneous response of output voltage to phase changes
- Incremental accuracy better than 1% of full scale
- Proven performance and quality workmanship

In audio facilities, ultrasonics, servomechanisms, geophysics, vibration, acoustics, aerial navigation, electric power transformation or signalling, . . . in mechanical applications such as printing register, torque measurement, dynamic balancing, textile and packaging machinery and other uses where an accurate measure of the relative position of moving parts is required . . . the type 320AB Phase Meter has achieved widespread approval as a unique and versatile measuring instrument.

For further information on measuring phase, send for specification bulletin and TIC Laboratory Reports

Engineering Representatives

Chicago, Ill. — UPTown 8-1141
Cleveland, Ohio — PProspect 1-6171
Waltham, Mass. — WAltham 5-6900
Rochester, N.Y. — Monroe 3143

Arnprior, Ont., Can. — Arnprior 400
New York, N.Y. — Murray Hill 8-5858
Hollywood, Cal. — HOLlywood 9-6305
Dallas, Texas — DIXon 9918

Dayton, Ohio — Michigan 8721

TECHNOLOGY INSTRUMENT CORP.

533 Main Street, Acton, Massachusetts, Telephone: Acton 3-7711

MYCALEX GLASS-BONDED MICA CERTIFIES STABILITY FOR 20 YEARS

"STABILITY for 20 years must be certified." That is the specification requirement that Mycalex glass-bonded mica accepted when others had refused it.

Mycalex glass-bonded mica is electrically stable, dimensionally stable, immune to moisture, arc resistant, impossible to carbonize, corona resistant, radiation resistant, inert to organic solvents.

Optically Flat Disc

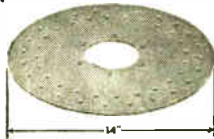

Ignitron Tube Base



Feed-Through Insulator

YES, Mycalex glass-bonded mica can be certified to be stable for 20 years. But why not write for the full story? Our Engineers Handbook & Catalog is yours for the asking.

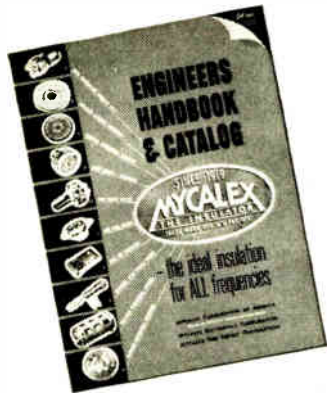

MYCALEX CORPORATION of AMERICA
World's Largest Manufacturer of Glass-bonded Mica Products
Executive Offices: 30 Rockefeller Plaza, New York 20, N.Y.
GENERAL OFFICES AND PLANT
11 CLIFTON BOULEVARD, CLIFTON, N. J.

4A

WAVEGUIDE BENDS

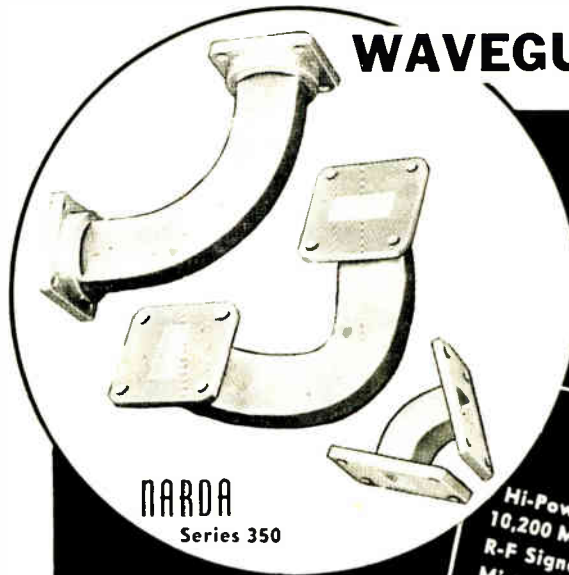

NARDA

Series 350

Waveguide Sizes	Radii in inches							
	1/2	3/4	1	1 1/4	1 1/2	2	4	
.702 x .391	✓	✓	✓	✓	✓			
1 x 1/2	✓	✓	✓	✓	✓			
1 1/4 x 5/8						✓		
1 1/2 x 3/4							✓	
2 x 1								✓

STANDARD or SPECIAL
E and H BENDS.

ELECTROFORMED BEND
AVAILABLE UPON REQUEST

V S W R LESS THAN 1.05

SILVER and
RHODIUM PLATED.

The NARDA Line
INCLUDES:

Hi-Power Impedance Meters • 2400-
10,200 MC Frequency Meter • Pulsed
R-F Signal Generators • Microwave
Mixers and Detectors • Microwave
Laboratory Test Eqm't. • Field and
and Microwave Consulting, Design
and Testing • Electroformed Cavities
Custom built Electronic and Micro-
wave Equipment.

Send for additional data on this and other Narda Models.

NARDA

NASSAU RESEARCH & DEVELOPMENT ASSOCIATES INCORPORATED
66 MAIN STREET
MINEOLA, NEW YORK

Subsidiary of PEERLESS INSTRUMENT CO., INC. GARDEN CITY 3-3570

Precision PAPER TUBES

2000 SIZES
in any shape
ID or OD

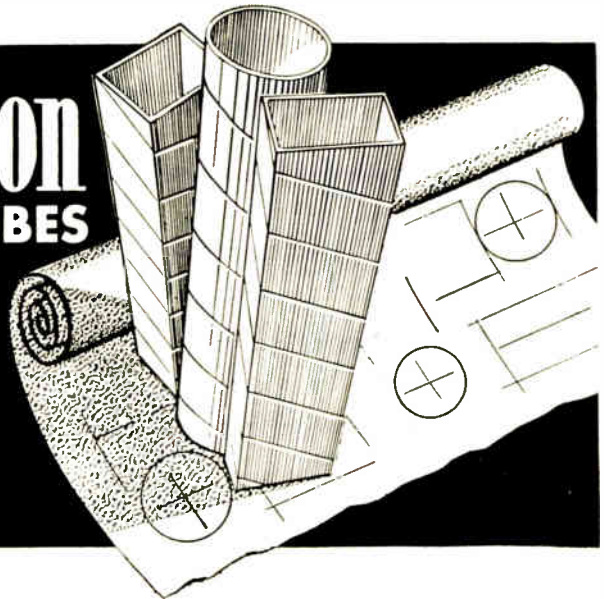

Whatever your specific needs, depend on PRECISION PAPER TUBES to meet all requirements. Spirally wound under pressure, PRECISION PAPER TUBES are subjected to rigid tolerance control to insure strict adherence to specifications and provide maximum winding space. PRECISION PAPER TUBES possess 15 to 20% greater strength, yet are light in weight.

Made from the finest dielectric kraft or fish paper, phenol impregnated, acetate or combinations, PRECISION PAPER TUBES afford high insulation, heat dissipation and moisture resistance. Available in any size, shape, I.D., or O.D.—any quantity.

Write today for Arbor List of over 2000 sizes. . . . Send specifications for free sample.

PRECISION PAPER TUBE CO.

2051 WEST CHARLESTON STREET • CHICAGO 47 • ILLINOIS
Plant No. 2: 79 Chapel St., Hartford, Conn. — Also Mfrs. of PRECISION Coil Bobbins

PROCEEDINGS OF THE I.R.E. September, 1953

MYCALEX GLASS-BONDED MICA WITHSTANDS ADVERSE COMBINATIONS

MYCALEX glass-bonded mica will withstand more — much more — of combined high temperature, radiation effects, thermal shock, high voltage, high frequency, mechanical stresses and high altitude than traditional electrical design calculation tables say that any insulation can stand.

It is the high "across the board" average that causes engineers to call Mycalex glass-bonded mica "the world's most nearly perfect insulation."

Fire Detector Housing

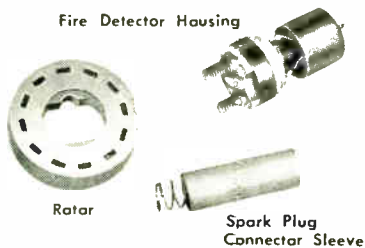

YES, bad conditions can "gang" Mycalex glass-bonded mica, or they can attack it one at a time. Mycalex glass-bonded mica, the only Ceramoplast, will endure them no matter how they come.

Write for the whole story.

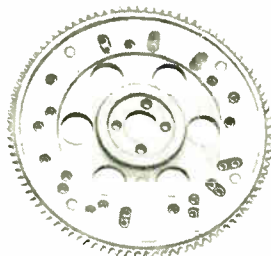

Insulated gear illustrates breakage resistance under wide temperature changes, even with large inserts.



MYCALEX CORPORATION of AMERICA

World's Largest Manufacturer of Glass-bonded Mica Products

Executive Offices: 30 Rockefeller Plaza, New York 20, N. Y.

GENERAL OFFICES AND PLANT

111 CLIFTON BOULEVARD, CLIFTON, N. J.

Positions Wanted

(Continued from page 139-1)

ENGINEER

BS in EE 1951. Single, Age 32. Two years design and development of terminal equipment for radio teletype. Four years broadcast station engineer. Three years Army Air Force Radar Maintenance Engineering. Interested in responsible position in Systems Engineering. Prefers to locate in East or South. Box 692 W.

News—New Products

These manufacturers have invited PROCEEDINGS readers to write for literature and further technical information. Please mention your I.R.E. affiliation.

(Continued from page 142A)

Junction Diodes

Transistor Div., National Union Radio Corp., Hatboro, Pa., announces a line of small-area junction diodes of miniature size. These instruments have relatively high dissipation ratings and high ratios of back-to-forward resistance, an order of magnitude greater than those obtainable in conventional point-contact diodes, the manufacturer claims. In addition, these diodes, which carry the trade name "Union," are capable of withstanding high temperature-humidity ambient conditions.



The rectifying action is performed by a small-area junction which replaces the more conventional point contact as the electrical connections. Since the junction is mechanically rigid, a more rugged and stable unit is obtained.

By using a small-area junction, the diode exhibits rapid switching action and good high frequency characteristics. Electrically, the characteristics are such that they will operate at higher currents and/or higher voltages well beyond the capabilities of point-contact diodes.

The protecting capsule is a thermo-setting plastic molded in place after the diode is fabricated. For details request Bulletin #1002.

Edison Purchases Measurements

Effective July 1, 1953, Measurements Corp., Boonton, N. J., became a wholly-owned subsidiary of Thomas A. Edison, Inc., West Orange, N. J. Under the purchase plan, there will be no basic change in policies or personnel of the organization. H. W. Houck became Vice President and General Manager of Measurements Corp.

(Continued on page 146A)

YOU CAN'T do THAT with MYCALEX GLASS-BONDED MICA

YOU CAN'T use Mycalex glass-bonded mica as a hammer head to drive a nail.

BUT it is used in one installation because it is the only high temperature insulation that will stand the abuse that mechanics give it when installing the equipment.

YOU CAN'T use Mycalex glass-bonded mica as a crucible over a Bunsen flame.

BUT you can solder and re-solder the hardware or inserts molded into, or fastened to, this material. It withstands assembly line abuse.

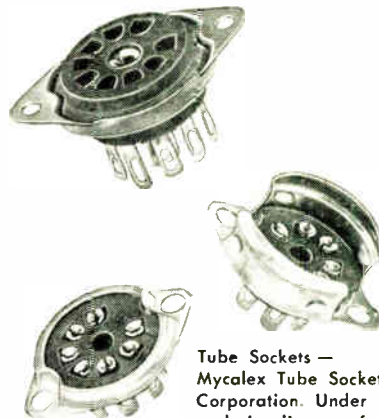

Tube Sockets — Mycalex Tube Socket Corporation. Under exclusive license of Mycalex Corporation of America

THE LIMITATIONS AND ABILITIES of Mycalex glass-bonded mica have been carefully studied. Here is a major engineering material that you can specify with confidence. The very stability of Mycalex glass-bonded mica guarantees that its properties will be true, constant and enduring. Write for the full story.



MYCALEX CORPORATION of AMERICA

World's Largest Manufacturer of Glass-bonded Mica Products

Executive Offices: 30 Rockefeller Plaza, New York 20, N. Y.

GENERAL OFFICES AND PLANT

111 CLIFTON BOULEVARD, CLIFTON, N. J.

Quality...



is Standard with Standard Piezo

Standard Piezo guarantees accurate and dependable quartz crystals to meet all private plane or commercial air carrier requirements.

Whether they are high or low in frequency, for use at low or high altitudes, you'll find Standard Piezo quality is consistently superior.

For your crystal requirements, standard or custom, write or call us.



Standard Piezo Co.
CARLISLE, PENNA.
Phone 1495

MODEL 503 Fast-Rise Pulse Generator

The -SKL- Model 503 Fast-Rise Pulse Generator has been designed to meet the growing need for a convenient source of extremely fast and short rectangular pulses. In radar, nuclear physics, high speed oscillography, and in the determination of network characteristics, the fast rise time and short pulse capabilities of the Model 503 find many uses. The variable repetition rate of 50 to 150 pps, pulse amplitude of .1 to 150 volts, and impedance of 50 ohms meet the great majority of needs encountered in this type of work. Convenience in the practical situation is enhanced by providing either positive or negative pulses, controlled by a switch, and an external trigger input which allows control of the repetition rate from an outside source. It is housed in a lightweight aluminum cabinet with convenient grouping of controls. The -SKL- Model 503 will be found indispensable for high speed, fast rise time research, development and testing.

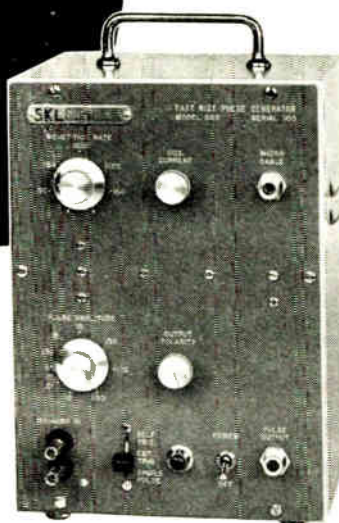

SPECIFICATIONS:

- Rise Time: 10^{-9} sec. (1 millimicrosecond)
- Impedance: 50 ohms
- Rep Rate: 50 to 150 pps.
- Pulse Amplitude: 0.1 to 150 volts
- Pulse Width: Calculated minimum width is 6×10^{-10} sec.

SKL SPENCER-KENNEDY LABORATORIES, INC.
186 MASSACHUSETTS AVE., CAMBRIDGE 39, MASS.

News—New Products

These manufacturers have invited PROCEEDINGS readers to write for literature and further technical information. Please mention your I.R.E. affiliation.

(Continued from page 145A)

and will also serve on its Board of Directors. Jerry B. Minter and John M. van Beuren will serve as vice presidents of the subsidiary company, Henry G. Riter, 3rd, President of Thomas A. Edison, Inc., will also be President of Measurements Corp.

Thomas A. Edison established his business at West Orange in 1867, and the Company has long been a manufacturer of electronic dictating equipment, alkaline storage batteries, primary batteries, aircraft instruments and other products.

Edison's full resources and facilities, including the recently opened Edison Research Laboratory, will be at the disposal of Measurement Corp.

High Power Heavy Duty Vacuum Capacitors

Jennings Radio Mfg. Corp., P.O. Box 1278, 970 McLaughlin Ave., San Jose 8, Calif., has designed two new vacuum capacitors specifically for high current rf applications such as are encountered in induction and dielectric heating circuits.

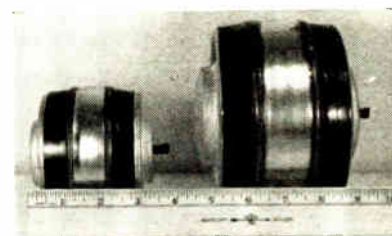

The MC-1 1,000 μf unit with a voltage rating of 10 or 15 kv peak and a current rating of 100 amperes has an over-all length of less than 5 inches. These short physical lengths reduce inductive losses to minimum according to the manufacturer. This reduction in size and increase in current carrying capacity is made possible by mounting the capacitor plates directly against the anodes. The result is greater heat dissipation, more capacity in less space, and the least possible capacitance drift with variation in temperature.

Low Cost Resistor

The latest wire-wound control (Series 39) now manufactured by Clarostat Manufacturing Company, Dover, New Hamp-



shire, has been stripped down to the barest essentials. Registered at the U. S. Patent

(Continued on page 148A)

Professional Cards

(Continued from page 143A)

MEASUREMENTS CORP. RESEARCH & MANUFACTURING ENGINEERS

Harry W. Houck Jerry B. Minter
John M. van Beuren
Specialists in the Design and
Development of Electronic Test Instruments
BOONTON, N.J.

L. J. CASTRIOTA M. WIND
S. W. ROSENTHAL P. G. MARIOTTI

Microwave Consultants

Radio Frequency and Microwave Components
Cable—Waveguide—Coax

Telephone G.P.O. Box 844
BOulevard 3-2096 Brooklyn 1, N.Y.

Microwave Development Laboratories Inc.

Henry J. Riblet, Pres.

Design, Development and Fabrication
of Waveguide Components

Waltham 5-6708 220 Grove Street
Waltham 5-7725 Waltham, Mass.

MICROWAVE SERVICES, INC.

"Architects of Modern Communications"

ENGINEERS AND GENERAL CONTRACTORS

Field Surveys, Towers, Antennas, Buildings
System Installation and Acceptance Tests

S. K. Wolf, V. J. Nexon, M. Sheldon, and Associates
45 Rockefeller Plaza, New York 20 Circle 7-4953

PICKARD AND BURNS, INC.

Consulting Electronic Engineers

Analysis and Evaluation of Radio Systems

Research, Development, Design and Production
of Special Electronic Equipment and Antennas.

240 Highland Ave. Needham 94, Mass.

PSC APPLIED RESEARCH LTD.

Development & Production

AIRCRAFT and INDUSTRIAL

INSTRUMENTS • AIDS • SYSTEMS

Navigation - Survey - Processing - Servo

Gyro - Photo - Magnetic - Electronic

Radiation - Optical

J. M. Bridgman, General Manager

1450 O'Connor Drive Toronto, Canada

Paul Rosenberg Associates

Consulting Physicists

100 STEVENS AVE. • MOUNT VERNON, NEW YORK

CABLE: PHYSICIST MOUNT VERNON 7-8040

TELECHROME, INC.

Electronic Design Specialists

COLOR TV INSTRUMENTATION AND

BROADCAST EQUIPMENT

Flying Spot Scanners, Color Synthesizers, Keyers,

Monitors, Oscilloscopes and Related Apparatus

J. R. Popkin-Curman, Pres. & Ch. Engr.

88 Merrick Rd. Amityville, L.I., N.Y.

TELREX, INC.

M. D. Ercolino, Pres.

H. F. ANTENNA SPECIALISTS

Communication Arrays

Reception or Transmission

For FM, TV, and Amateur Service.

Asbury Park, N.J.—Phone AP 2-7252

(Continued on page 148A)

teflon*

... and We Can Deliver!

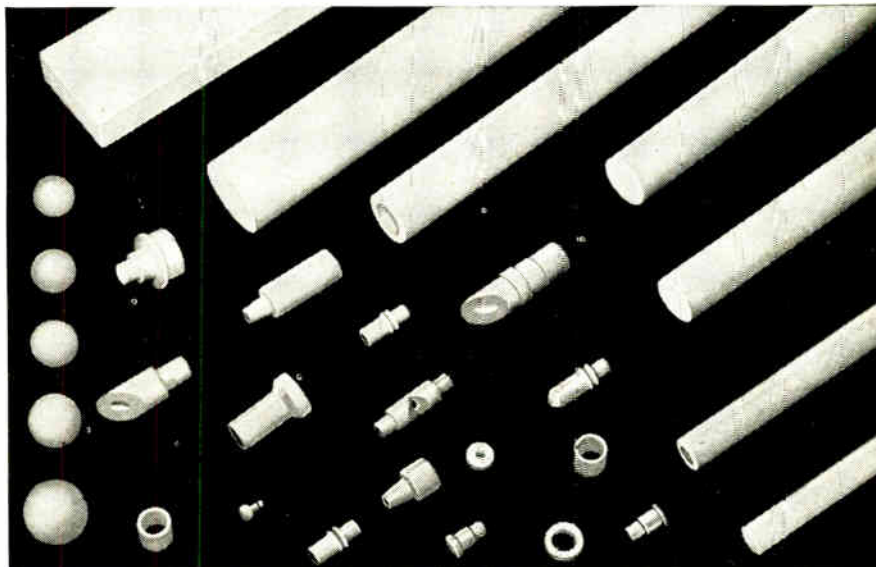

EXTRUDED MOLDED ROD and TUBE

Small Machined Parts! Sheets!

Heavy demand has put many TEFLON fabricators in a "back ordered" condition. The effect — stymied or crippled production on your end.

At FLEXROCK we have licked this problem. New TEFLON producing equipment has been added. We have substantially increased capacity. We can't take on all things just yet. But soon we will be ready to "throw the book at you" with a complete range of TEFLON services. RIGHT NOW we are set to ship you TEFLON Rod and Tube, extruded or molded, Sheets, and small parts — no matter how intricate — machined from Rod and Tube. We can promise good delivery — yes, FAST DELIVERY ... with closest possible tolerances on your small parts. Tell us your needs — we will be happy to quote delivery and price.

*DuPont trade-mark for
tetrafluoroethylene resin

for teflon it's

FLEXROCK

PHILADELPHIA 4, PA.

SEND US YOUR "SPECS"
LET US QUOTE

FLEXROCK COMPANY, 3808-A Filbert St., Phila. 4, Pa.

- We are enclosing sample, specs, and quantity
for our TEFLON requirements. Please furnish quotation.
 Please send us your TEFLON Bulletin including stock list.

Name

Company

Address

City Zone State

USE "Double Feature"

INSULATING TUBING AND SLEEVING

TURBOTUF



Easily the most economical insulating tubing and sleeving for commercial use . . . equally and ideally suitable for the insulation demands of Classes A & B. Separate A & B inventories unnecessary — space and dollars saved when you use TURBOTUF.

Easily the finest insulating tubing and sleeving — Meets exacting specifications for durable resistance to icy or sweltering temperatures . . . made of superior materials to give long wear — won't crack, bend, chip, or peel under rigorous abrasion . . . excellent pliability — can be knotted, bent, tugged at, stamped on — springs back in perfect condition . . . easier to handle because of its uniformity . . . won't fray . . . not affected by oils, alcohols, alkalis and weak acids — high dielectric strength and long life.

PROTECT YOUR EQUIPMENT — SAVE MONEY — GET "DOUBLE FEATURE" TURBOTUF

Insulating Material

TURBO

Specialists Since 1920

The William BRAND and Co., Inc.

Dept. P-9

Willimantic, Conn., U.S.A., Tel. HARRISON 3-1661

TURBOTUF Insulating Tubing and Sleeving • TURBO Insulated Wires • Wire Markers • Extruded Tubing • Varnished Saturated Sleeving and Tubing • Cambric Cloths, Tapes, Papers • Mica

SALES REPRESENTATIVES IN PRINCIPAL CITIES

World Radio History

Professional Cards

(Continued from page 147A)

VRL VIBRATION RESEARCH LABORATORIES, INC.
VIBRATORS • VIBRATOR POWER SUPPLIES

• 42 OAK AVENUE
• TUCKAHOE, N. Y.
J. A. Mas, Chief Engineer • TUckahoe 3-5502

WHEELER LABORATORIES, INC.
Radio and Electronics
Consulting — Research — Development
R-F Circuits — Lines — Antennas
Microwave Components — Test Equipment
Harold A. Wheeler and Engineering Staff
Great Neck, N.Y. Great Neck 2-7806

News—New Products

These manufacturers have invited PROCEEDINGS readers to write for literature and further technical information. Please mention your I.R.E. affiliation.

(Continued from page 146A)

Office under the name "Humdinger," it meets the economy requirements of low-cost radio-electronic and electrical assemblies.

This component is an inexpensive, extra-compact, convenient control. It has no shaft, but is screwdriver-adjusted by means of a slot in the rotor. Mounting is by means of rivets or screws. The mounting surface serves as the cover. The contact arm is grounded to the case, while an insulated terminal protrudes either parallel, or at right angle to, the mounting surface. Available with two terminals for use as a potentiometer.

The Series 39 control is of the semi-fixed type intended factory-adjusted settings or for rare adjustment in actual use. Available resistance values are from 4 ohms to 5000 ohms. Linear only. Resistance tolerance is ± 20 per cent. The insulation will withstand 500 volts ac between terminals and housing with the contact arm off winding. There is a mechanical and electrical rotation of 245°, without bias resistor stop.

Tension Gauge

Spring tensions, or the resistive force of any device that opposes motion, can be checked in the range from 4 to 2500 grams

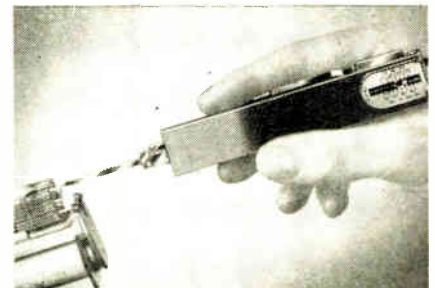

by means of a new tension gauge, made by The General Electric Co., Ltd., of England.

(Continued on page 150A)

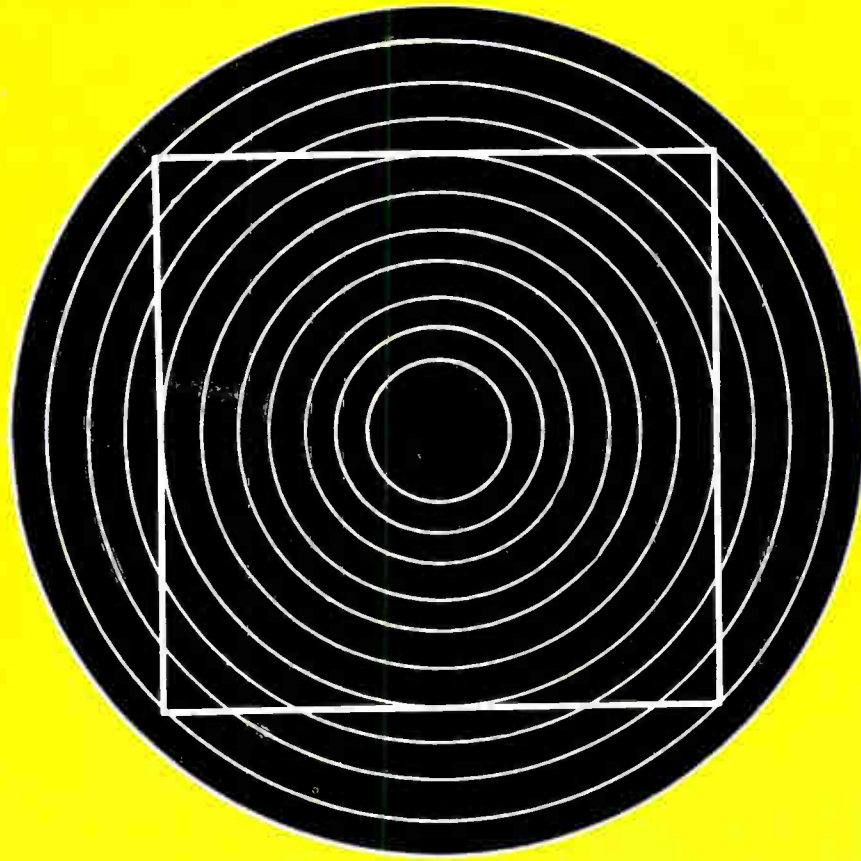

things are NOT as they seem . . .

This is a perfect square within the circle — it is an optical illusion that the sides bend



Things are not as they seem . . .
These two fuses look alike . . .
But they are not.



This fuse may burn out anywhere along the length of the filament even in the cap—this blown fuse is impossible to detect visually.



This Littelfuse has a controlled blowing point—the filament is plated throughout its length except in the very center—the fuse will always blow here. A blown Littelfuse can be detected immediately—Littelfuse feature.

Littelfuse holds more design patents on fuses than all other manufacturers combined.

LITTELFUSE

DES PLAINES, ILLINOIS

News—New Products

These manufacturers have invited PROCEEDINGS readers to write for literature and further technical information. Please mention your I.R.E. affiliation.

(Continued from page 148A)

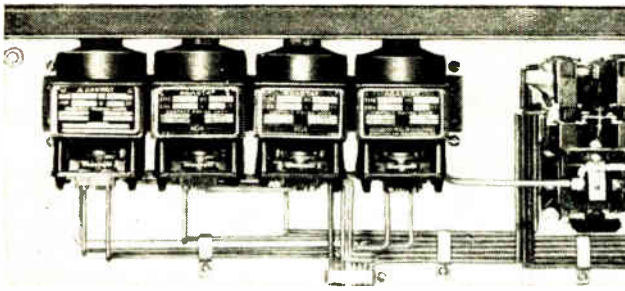

Cleaver-Brooks chooses Agastat time delay relays

for Boiler Control Circuit Timing

4 AGASTATS handle these applications:

- 1 . . . allows 30 seconds for warmup of tubes in electronic control relay
- 2 . . . delays fuel delivery to burner for 15 seconds to permit boiler purge
- 3 . . . controls a 15-second ignition period
- 4 . . . delays full capacity delivery of fuel oil to burner for 3 (or 5) seconds, facilitating smooth lighting

AGASTAT time delay relays are solenoid actuated and pneumatically timed. They are light, compact, *dust-proof* and can be furnished to operate mounted in any position.

Write for Bulletin—
Dept. A3-97

A-G-A

Division of Elastic Stop Nut Corporation of America
1027 Newark Avenue, Elizabeth 3, New Jersey

The gauge is preset to the required tension by means of a knurled micrometer screw. The end of the gauge operating strip is then applied to the point at which the opposing force is to be checked, such as the tip of a spring. Deflection of the operating strip, at the same time that the resisting element moves, indicates that the opposing force is equal to the gauge setting. Attention is concentrated on one point only, movement at the point of contact.

The gauges are precision calibrated, with adjustable zero correction. Knife-edge bearings provide negligible friction, and gravitational effects are accurately counter-balanced. Six models are available to cover the following ranges in grams: 4 to 24, 10 to 80, 50 to 250, 100 to 500, 200 to 1600, and 500 to 2500. In the three lighter gauges, interchangeable operating strips are provided to suit the type and position of the spring or other mechanism under test.

For a free illustrated catalog and complete price list write to **IMTRA Corp.**, 58 Charles St., Cambridge, Mass.

Square Wave Generator

A new moderately priced Model 504 square-wave generator that produces square-wave voltages without tilt or overshoot, has been developed by **Spencer-Kennedy Labs., Inc.**, 186 Massachusetts Ave., Cambridge 39, Mass. A rise time of less than 30 millimicroseconds makes the Model 504 suitable for testing the response of IF, rf and video amplifiers.



The calibrated voltage generator is continuously variable from 0 to 11 volts. A synchronizing pulse output is provided on the front panel to permit triggering of an oscilloscope or similar network. Another front-panel terminal pair allows the instrument to be synchronized with an external voltage source.

This model has a frequency switch with nine positions. The first step permits operation at any frequency as determined by an external capacitor. The remaining seven positions provide frequencies from 0.5 cps to 500,000 cps in decade steps. The seven decade steps provide a source of time bases from one second to one microsecond. Power supply is self contained. cabinet is aluminum and suitable for bench use.

(Continued on page 160A)

• To meet the growing demand from producers of light-weight, high-frequency Galvanometer movements, we have expanded our facilities designed to process *Wire of 2S Aluminum* . . . This wire can be supplied in diameters ranging from approximately .001 inch through .005 inch . . . Anodized with an exceptionally thin and flexible dielectric coating.

Also available: wires of aluminum alloys *enameled* as small as .001 inch diameter, to meet rigid specifications of resistance, size and straightness.

SINCE 1901

Write for Latest List of Products

MUND COHN CORP. 121 So. Columbus Avenue • Mount Vernon, N.Y.

THE 10-MEGACYCLE SCOPE

for
detailed
waveform
analysis

model **OL-23**

- Expansion of any image detail is possible up to the maximum writing rate of the 'scope.
- AND the sweep maintains its accurate calibration independent of the degree of expansion.

REALLY IMPORTANT
image expansion
by means of stable
SWEEP DELAY

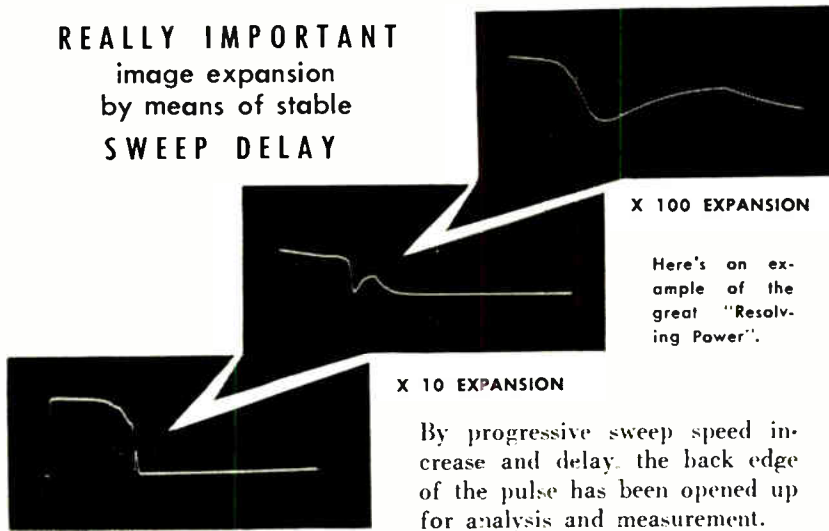

NORMAL PRESENTATION

"Sweep-Lok" synchronization

- easy to set - locks in and stays locked over broad ranges

SPECIFICATIONS

- 5 cycle to 10 mc vertical amplifier with signal delay line — .035 μ sec rise time
- Accurately calibrated triggered or recurrent sweeps 0.1 μ sec/cm to .011 sec/cm
- Vertical calibration voltage variable to 100 peak-to-peak
- Built-in trigger generator with positive and negative outputs
- Continuously variable sweep delays up to 10,000 μ sec without jitter
- 4000 volts accelerating potential on 5YP tube for bright, clear, trace
- Interior designed for accessibility and ruggedness, the exterior for that "Professional Appearance"

MODEL OL-23
OSCILLOSYNCHROSCOPE

\$890.⁰⁰

f.o.b. Winchester



BROWNING
Laboratories, Inc.
Winchester, Mass.
ENGINEERED FOR ENGINEERS

Write for descriptive
literature

if you are
concerned with
**POWER
SUPPLIES**

you should have
the new and
comprehensive

LAMBDA
catalog

of electronically
regulated
laboratory

power supplies.

Manufactured by
one of America's
pioneer specialists,
this field-proven
precision equipment
is priced
surprisingly low.



SEND FOR NEW CATALOG

Lambda Electronics Corp.
103-02 Northern Blvd., Corona 68, N. Y.
Please send me the new Lambda Power
Supplies Catalog as soon as it comes off
the press.

Name _____
(Please print)

Title _____

Company _____

Street _____

City _____ Zone _____ State _____ IRE-953

*"An Unexcelled Opportunity
For Professional Growth . . ."*

**Electronic
ENGINEERS & PHYSICISTS
IN RESEARCH AND DEVELOPMENT**

Guided Missiles—Radar—Solid State Physics
Vacuum Tubes—Electronic Navigation—
Television—Microwaves—Antennas—
Radio—Computers

Direct Inquiries to:

The Employment Dept.
CAPEHART-FARNSWORTH
CORPORATION
FORT WAYNE, INDIANA



MISSILE
Engineers and Technicians

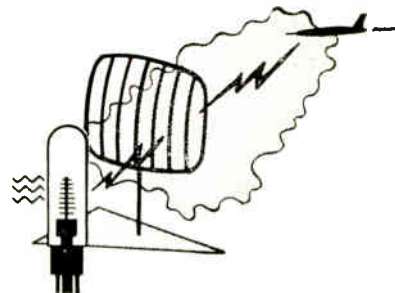

**For Field Test Positions in
NEW MEXICO**
"The Land of Enchantment"
ON

Guidance Flight Testing
Servomechanisms
Telemetry Test Equipment
Airborne Electronics Equipment
IDEAL WORKING CONDITIONS

WRITE: FIELD TEST DIRECTOR
P. O. BOX 391
HOLLOMAN AIR DEVELOPMENT CENTER
NEW MEXICO



ELECTRONICS ENGINEERS

Project • Design • Group • Packaging • Senior

AIRCRAFT ARMAMENTS' development engineering program in the fields of radar, fire control and associated equipment has provided more openings for men at all levels of experience.

If you are considering a change and are looking for a young, growing company with a continuing program of development work, we would appreciate receiving your resume and would welcome the opportunity of providing you with information about our company.

D. J. WISHART
Director of Personnel



WANTED
ENGINEER WITH
EXPERIENCE IN
VHF OR UHF

Interesting creative work with the most resourceful and progressive firm in the field of television equipment.

This position is permanent. It will offer every opportunity for unlimited advancement and for developing a successful career. The plant is now housed in a newly-acquired larger building, only 22 miles from downtown New York City. The surroundings and atmosphere are stimulating and congenial.

Attractive Salary
Write stating qualifications.

BLONDER-TONGUE LABORATORIES
526-536 NORTH AVENUE
WESTFIELD, NEW JERSEY

WANTED—MANUFACTURERS' REPRESENTATIVE

World renowned Electronic Instrument Manufacturers require progressive Sales Organization to sell Precision Test and Measuring Instruments to Industrial, Educational, and Government Accounts. Applicants must be well qualified, technically and sales-wise in this field. Liberal commission, active promotional backing. Many territories available. Write to:

Box 744
INSTITUTE OF RADIO ENGINEERS
1 East 79 St., New York 21, N.Y.

Exceptional Opportunities for...



electrical engineers
mechanical engineers
mechanical designers

•
in the field of electronic computers and associated equipment for use in business machines.

Write, giving education and experience to Employment Manager.

Reply to Department D.

THE NATIONAL CASH REGISTER COMPANY, Dayton 9, Ohio

BIG opportunities for JUNIOR ENGINEERS with new Bendix plant!

Here, indeed, are outstanding opportunities for recent college graduates. In this new, fast-growing Bendix Division, the future holds advancement commensurate with your ability to assume additional responsibility. Fascinating work on NEW ELECTRONIC PRODUCTS. Good salaries, paid vacations and holidays and ideal living conditions in beautiful suburban area.

•
**BENDIX
YORK ALSO
NEEDS
ENGINEERS
AT THE
INTER-
MEDIATE
LEVEL!**

Send Resume of Education and Experience to:

Mr. L. D. Smith,
Employment Supervisor,
Dept. Y-2



**AVIATION CORPORATION
YORK DIVISION**

Phone: York 5521

York, Penna.

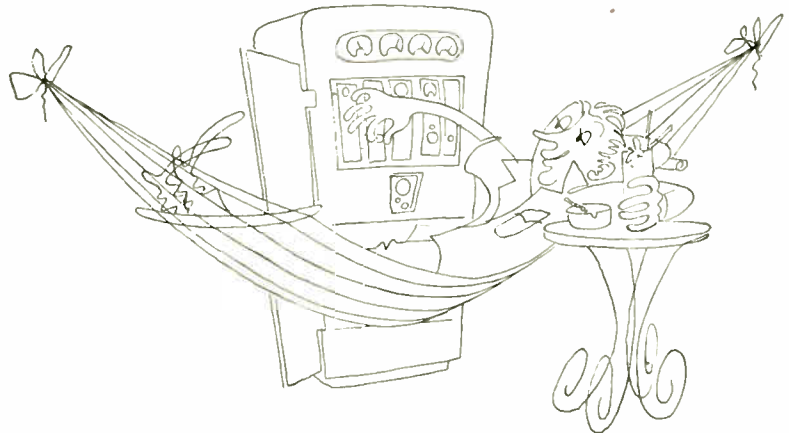

Pleasant Working Conditions

So we're exaggerating a little! If you want to get technical about it (and you probably do) your life at our company won't be quite this cushy. We can promise this though—even the sky's not the limit for future opportunity. You work with a congenial group of engineers. People will listen to your ideas. The boss's door is always open.

Who you are—You're an Electronic or Mechanical Engineer. You're experienced in air communication and navigation circuitry and development. You have worked with low or high frequency circuits, instrumentation, component utilization or associated problems.

What you do now—Simple! Just contact:

Arthur E. Harrison, Vice President, Engineering

wilcox Electric Company, Inc.

Fourteenth & Chestnut, Kansas City 27, Mo.

to
men
who
want
the
best

ENGINEERS, EE

1. Development of radio and radar components and systems.
2. Design of components for the magnetic deflection of Cathode Ray Tubes.
3. For component and system development work in airborne navigational equipment.

DESIGNERS

1. For work in the design of electromechanical navigational computers.

Kollsman provides excellent facilities for the design and development of America's finest aircraft instruments. In our modern laboratories you'll find a congenial atmosphere in which you can do your best work. You'll be encouraged to advance as our progressive organization continues to grow.

At Kollsman you'll receive liberal benefits including paid life, hospitalization, surgical, accident and health insurance. Not to be overlooked is the convenient location in a quiet residential section only 20 minutes from the heart of New York City. Why not find out what Kollsman has to offer you?



KOLLSMAN INSTRUMENT CORP.

80-08 45th Ave., Elmhurst, L.I., New York

ENGINEERS

Systems
Radar
Servo
Computer

BACKGROUND:

Responsible positions open for top level development and project engineers with practical and research experience in:

Advanced Electronic Circuits and Systems

Microwave Radar

Microwave Receivers and Transmitters

Also Engineering Design and Analysis relating to fields such as:

Analogue and Digital Computers

Servomechanisms

Communications

Navigation

Fire Control

Requirements emphasize advanced analytical and/or management experience on highly complex electronic and electro-mechanical systems.

PHYSICISTS

and

ELECTRONIC ENGINEERS

Physicists, Junior and Senior Electronic Engineers are needed for employment with expanding research and development laboratory specializing in Instrumentation, Radio Telemetering, Data Handling and Analysis, and special electro-mechanical devices.

Electronic Engineers are needed for design of RF Transmitters and Receivers and Pulse Circuitry.

Physicists are needed for the study of electrical and mechanical properties of sliding contacts including analysis of contact materials, lubricants and vibration damping.

Replies will be held in strictest confidence.

Please send complete resumes to:



WE PROVIDE ▲ THE LEVER • YOU MOVE THE WORLD

APPLIED SCIENCE CORP. OF PRINCETON

P.O. Box 44, Princeton, N.J.

Plainsboro 3-4141



Kindly send
resume and
salary re-
quirements to:

The W.L. MAXSON CORP.
460 W. 34th ST., NEW YORK 1, N.Y.

The WHEELS of INDUSTRY ARE ROLLING SOUTH

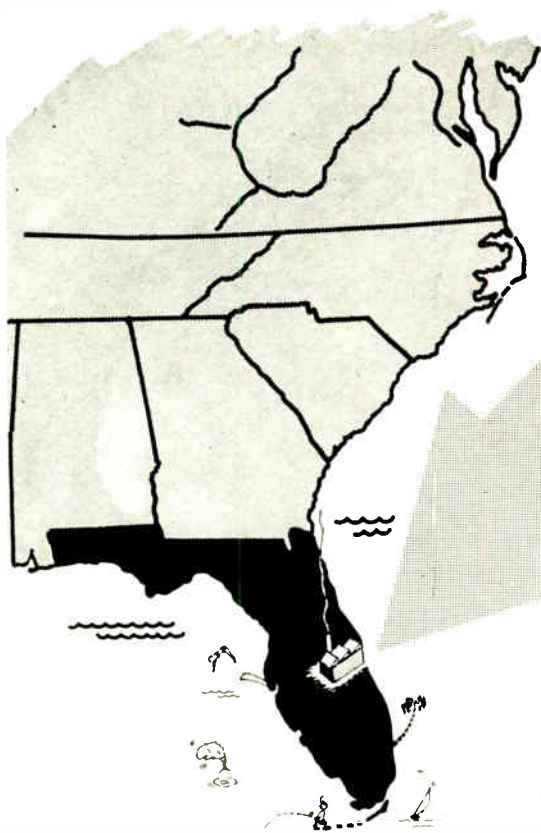
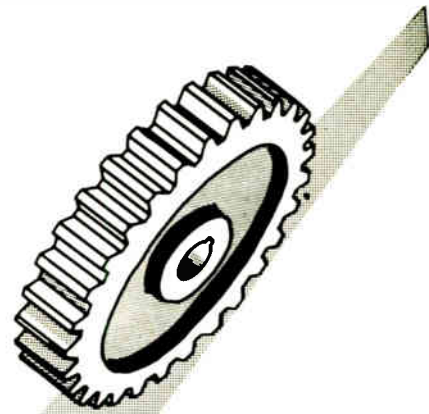

More and more progressive engineering firms are realizing the many advantages of a Florida location —

- Modern, comfortable housing
- Pleasant working conditions
- Year 'round outdoor life
- Healthful climate
- Low taxes

RADIATION, INC. offers its engineers these advantages plus the opportunities of a young, expanding organization —

- Recognition
- Advancement
- Profit sharing
- Association with other leading engineers and consultants

Address inquiries to:
Director of Personnel
RADIATION, Inc.
Melbourne, Florida

RADIATION, INC.

Electronic RESEARCH .. DEVELOPMENT .. PRODUCTION

MELBOURNE, FLA. - ORLANDO, FLA.

Engineering

WRITERS

ENGINEERS, E. E. or PHYSICS GRADUATES, for preparation of technical manuals...

HUGHES RESEARCH AND DEVELOPMENT LABORATORIES' expanding program for production of radar, electronic digital computers, guided missiles and other military advanced electronic systems and devices requires the following:

1 ELECTRICAL ENGINEERING AND PHYSICS GRADUATES to prepare operating, servicing and overhauling instructions for complex electronic equipment. Those with previous maintenance experience on military equipment preferred. Writers will participate in a three-month program in our technical training school to become familiar with the latest Hughes equipment prior to writing assignments.

2 ENGINEERS EXPERIENCED in the writing and preparation of maintenance manuals for electronic equipment or guided missiles. These specialists will work step-by-step with the people designing, developing and manufacturing the products involved. Experience in the writing of engineering reports is of value.

HOW TO APPLY

Write full details of your qualifications to

HUGHES

Research and Development Laboratories

SCIENTIFIC AND ENGINEERING STAFF

Culver City, Los Angeles County California

Assurance is required that relocation of the applicant will not cause disruption of an urgent military project.

ENGINEERS — PHYSICISTS

needed for
Research • Development • Design

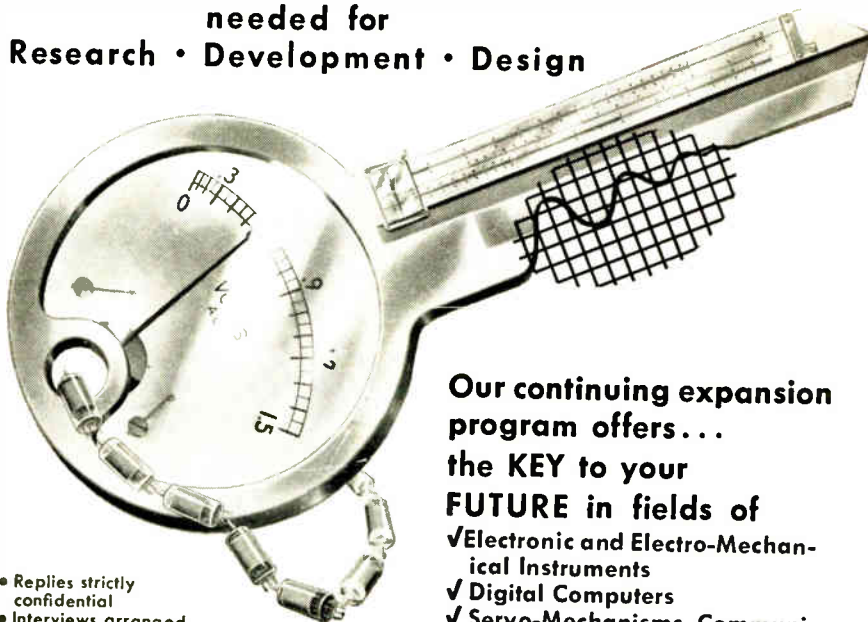

- Replies strictly confidential
- Interviews arranged at our expense
- Household goods moving expenses paid.

Our continuing expansion program offers...
the **KEY** to your **FUTURE** in fields of
✓ Electronic and Electro-Mechanical Instruments
✓ Digital Computers
✓ Servo-Mechanisms, Communication and Recording Devices
✓ Magnetic and Dielectric Recording

ENGINEERING RESEARCH ASSOCIATES

DIVISION OF **Remington Rand**

1902 W. Minnehaha Ave.

St. Paul W4, Minnesota

You will enjoy **LIVING** in Minnesota

NEED SERVICE?

Perhaps you have a small sub-assembly or even a complete unit that you would like to manufacture but just can't find the space or extra help to produce it. You may find that by sub-contracting these items to us you can keep your overhead down.

We have facilities to handle production run items as well as small run production or specialized units. Our staff includes competent Mechanical, Electrical and Electronic Engineers that are well versed in production methods to give you a fast, reliable and economical service.

If you have an item that you would like to put into production on a sub contract basis or if you have a specialized item that you would like to have manufactured to your specifications, write and give us the details. We feel sure that you will be more than pleased with the service we can offer you.

OMNI ELECTRONICS CORPORATION
914 Milwaukee Avenue, Chicago 22, Illinois

Data!

From test equipment to waveguides—from printed circuits to power supplies, the IRE DIRECTORY supplies buying data you need.

475 manufacturers—the cream of the radio-electronic supply firms, have furnished you specific information in this book!

They tell you their story from "Yes, we have it" to full specifications, and detailed application data.

Use the 1953 IRE Directory

... TO A SENIOR ENGINEER

Interested in a
challenge as great
as all tomorrow
If..

you're the man we *hope* you are, you now have a good position. Perhaps you have not thought of a change but will consider the *right* opportunity.

You have at least five years of experience in electronics or an allied field. You desire to do more than just carry assignments to satisfactory conclusions. You have a burning desire to blaze new trails on the horizon, and feel yourself *ready* to do it.

You would appreciate an opportunity and the "go ahead" to pioneer . . . at your own pace. You've matured in engineering . . . you know where you've been . . . you *now* want to know where you're going . . . and what you personally can achieve through your creative engineering talent.

If you fill these qualifications, we have an opportunity that will fascinate you. You will work with one of the foremost engineering teams in the world, and enjoy rare freedom and encouragement. The last word in equipment would be at your fingertips. No richer benefits are offered anywhere . . . regardless of the standards by which you measure.

Are YOU the man we hope you are? If so, write us with full trust.

Send your resume to:

JOHN C. WELD
Supervisor of Employment
254 Rano Street, Buffalo 7, New York

DONALD BRADLEY
Personnel Supervisor
70 Forsyth Street
Boston, Mass.



SYLVANIA
ELECTRIC PRODUCTS INC.
RADIO AND TELEVISION DIVISION
254 RANO STREET
BUFFALO 7, NEW YORK



SPECIAL OPPORTUNITIES FOR SENIOR ENGINEERS

Convair in beautiful, sunshiny San Diego invites you to join an "engineers" engineering department. Interesting, challenging, essential long-range projects in commercial aircraft, military aircraft, missiles, engineering research and electronics development. Positions open in these specialized fields:

Electrical Design	Servo-mechanisms
Mechanical Design	Aerodynamics
Structural Design	Thermodynamics
Structures	Operation Analysis
Weights	System Analysis

Generous travel allowances to those accepted. For free brochure, write Mr. H. T. Braks, Engineering Dept. 800

CONVAIR

IN BEAUTIFUL

SAN DIEGO

3302 PACIFIC HIWAY
SAN DIEGO 12, CALIFORNIA

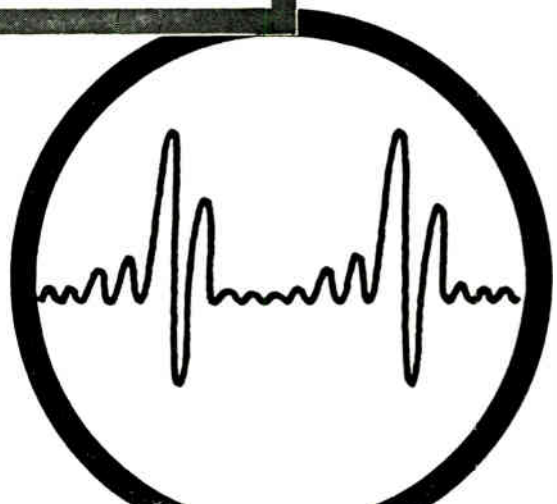

ENGINEERS

looking for . . .

- . . . a good start?
- . . . rapid development of your professional skill?

You can have either at Sperry,

PIONEERS IN A WIDE RANGE OF FIELDS, FOR MORE THAN 43 YEARS

We invite you to investigate the exceptional employment opportunities available on our unusually large research, design, and development staff, in many fields including the following:

Vacuum Tube Techniques • Analogue Computers • Radar • Hydraulics • Communication Equipment • Pulse Transformers • Servo Mechanisms • Electronic Circuits • Aircraft Controls • Instrumentation • Fractional H.P. Motors • Magnetic Amplifiers • Radio Frequency & Microwave Measurement.

PUBLICATIONS ENGINEERS To write manuals and engineering reports.

FIELD ENGINEERS For applications engineering work in the fields of electronics, fire control equipment, and gyroscopes.

Advanced and challenging assignments • Association with top Engineers • Interesting, diversified work • Remuneration based on professional abilities • Modern plant—latest laboratory facilities • Adequate housing • And of course, employee benefits, and congenial surroundings, among the finest.

Please submit resume to our Engineering Personnel Section. (Personal interviews may be arranged in your city.)

SPERRY GYROSCOPE CO.

Division of the Sperry Corp.
Great Neck, Long Island, N.Y.

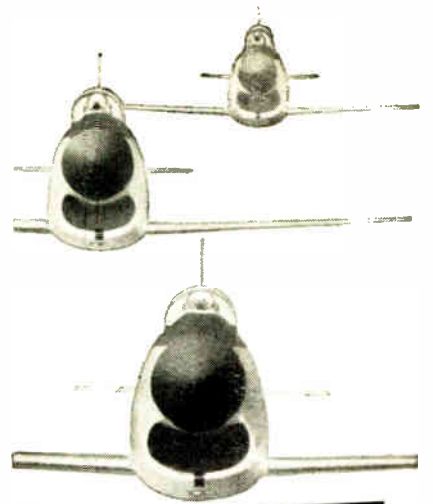

Engineers — PICK A WINNER

The Engineering Department which designed the Sabre and other headline-making military airplanes has openings for engineers—experienced in aircraft, recent engineering grads, or men from other fields with adaptable experience. Long-term military projects and twenty-five years of continuous expansion underwrite your future at North American. Current openings in:

All Design Fields
 Thermodynamics | Aerodynamics
 System Analysis | Structures
 Servo-mechanisms | Electronics
 Specialists in all major aircraft fields
 Liberal travel and moving allowances

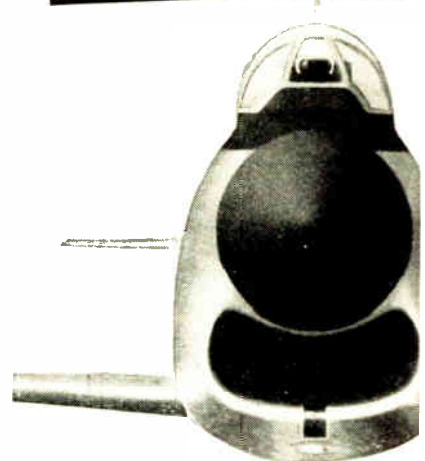

Write to

North American Aviation, Inc.

DEPT. 7, ENGINEERING PERSONNEL OFFICE
LOS ANGELES INTERNATIONAL AIRPORT
LOS ANGELES 45, CALIFORNIA
or
COLUMBUS 16, OHIO

**NORTH AMERICAN HAS BUILT MORE AIRPLANES
THAN ANY OTHER COMPANY IN THE WORLD**

Electrical Engineers and Physicists

- Radar Simulation
- Advanced Circuitry
- Analog Computers
- Ballistics
- Mapping
- Telemetering

Senior and Junior Engineers

Join a Firm with a Future

Our future is bright . . . we're small but we're growing. We offer you the opportunity to grow with us . . . to gain individual recognition by working closely with technical management . . . to advance rapidly. You will work and live in a delightful suburban community . . . associate with other top-notch engineers, and with them, develop yourself by contact with a complete project, not just a segment of a project. If you are interested in allying your future with a firm with a future . . . write:

Industrial Research Laboratories
Hilltop and Frederick Roads
Baltimore 28, Maryland



.... An Invitation To Experienced ELECTRONIC ENGINEERS and PHYSICISTS

We have several positions of technical leadership available in our growing Guided Missile Division. Applicants must have over four years experience and/or advanced degrees in either missile guidance systems, radar, servomechanisms, fire control computers, or U.H.F. techniques.

Our plant is located in beautiful suburban St. Louis, where you can enjoy the comforts of "county" living with easy access to "big city" shopping, entertainment, medical and educational facilities. Moving allowance for qualified applicants. Our Housing Representative will assist you in relocating.

Address replies to:
Technical Placement Supervisor
Box 516, St. Louis 3, Mo.

MCDONNELL
Aircraft Corporation
ST. LOUIS 3, MO

**Within 6 Months, Five Qualified
Electronics Engineers will say:
"I'm with GILFILLAN"**



Will You Be One Of The Five?

If you qualify for one of five opportunities now open at Gilfillan, you will be working for the pioneer of GCA Radar—the first name in GCA, Radar and Electronics research, design and production today.

Present Gilfillan projects include navigational systems for military and civilian application; missile guidance; E.C.M.; automatic GCA; and classified projects.

There are many reasons why you will like Gilfillan. We are big enough to handle all phases of engineering, production, and final test; yet not so large that the individual is lost. We work as a team, yet each man gets individual recognition. Pay is paced to ability, not seniority.

Work is creative at Gilfillan because ideas begin here. At present, we are

designing equipment for all three military services, dealing with advanced or unsolved techniques. Each day presents a challenge. Each day adds to your value, because you work in coming fields. Yet, at Gilfillan, we also follow through. You have the satisfaction of seeing the practical achievements of equipment in the field.

Technical seminars conducted by staff experts are almost always in session. Gilfillan pays the tuition of ambitious men for evening courses at USC and UCLA.

General working conditions and salaries at Gilfillan are unsurpassed in the field. The benefits of Southern California living are legendary, and Gilfillan will assist you in establishing your new home.

YOUR QUALIFICATIONS—HOW TO APPLY

An E.E. or Physics degree and experience in one or more of the following fields: general radar and computing systems; micro-wave circuit design; antenna design; generalized systems analysis; servomechanisms; radar transmitter-modulators; indicator systems; wide band IF amplifiers and receivers; general pulse circuits; electro-mechanical design.

Send a general resume of your experience to R. E. Bell, Gilfillan Bros., 1815 Venice Boulevard, Los Angeles 6, California. Personal interview at a

convenient locality will be arranged. Or, if you wish for more information before application, send for our brochure. However, given equal qualifications, first applications will be given first consideration.



**ENGINEERING
OPPORTUNITIES**

**WITH THE
PACEMAKER IN
AVIATION PROGRESS**



**NEEDS
MISSILE**

Engineers and Technicians

For Field Test Positions

IN

NEW MEXICO

"The Land of Enchantment"

ON

GUIDANCE

FLIGHT TESTING

SERVOMECHANISMS

TELEMETERING

TEST EQUIPMENT

**AIRBORNE ELECTRONICS
EQUIPMENT**

IDEAL WORKING CONDITIONS

WRITE:

Field Test Director
Bell Aircraft Corporation
Post Office Box 391
Holloman Air Development Center
Alamogordo, New Mexico

News—New Products

These manufacturers have invited PROCEEDINGS readers to write for literature and further technical information. Please mention your I.R.E. affiliation.

(Continued from page 150A)

Step Variable Delay Line

Advance Electronics Corp., P.O. Box 394, Passaic, N. J., has designed the Type 702 Step Variable Delay Line, a bilateral, linear network, capable of producing variable time delay up to 10 microseconds and having equal input and output impedance. These variable delay lines consist of 55 sections of lumped-parameter L-C filter networks. Each section of these

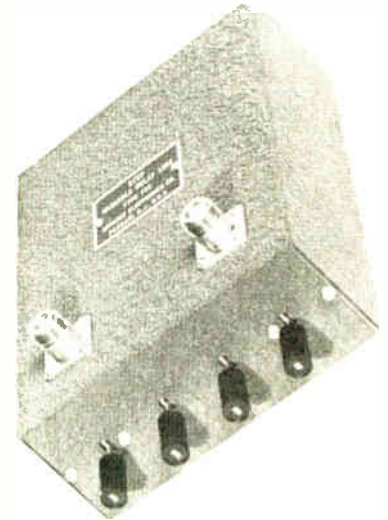

networks was specially designed to give linear phase shift up to 70 per cent of its cutoff frequency, and a frequency response curve being Gaussian in shape. As a result, Type 702 step variable delay line produces essentially zero over-shoot and has a very rapid rise time. Other outstanding features include freedom of time jitter, no limit in repetition rate, small size, light weight, and very wide frequency band-width.

The time delay is variable in step of 1 microsecond up to 10 microseconds by means of a four-position push button switch. The characteristic impedance is 190 ohms nominal for both input and output. The rise time is less than 0.45 microsecond at any step. The nominal cutoff frequency is 1.27 mc. The maximum applied voltage is 500 volts peak. The dimensions are $2 \times 5\frac{1}{2} \times 8$ inches.

Ultra-High Speed Relays

Stevens-Arnold, Inc., 22 Elkins St., South Boston, Mass., states that their new millisecc relays are the world's fastest plug-in, factory sealed relays.

They are now being offered to cover a wide range of temperatures, in a larger variety of types, and with a choice between gold and platinum-rhodium contacts.

The use of gold contacts is employed to meet the request for the combination of ultra-high speed and low current, low voltage contact operation. It is the firm's opinion that in such applications, platinum-rhodium contacts, as previously offered exclusively, are at a disadvantage. After

(Continued on page 163A)

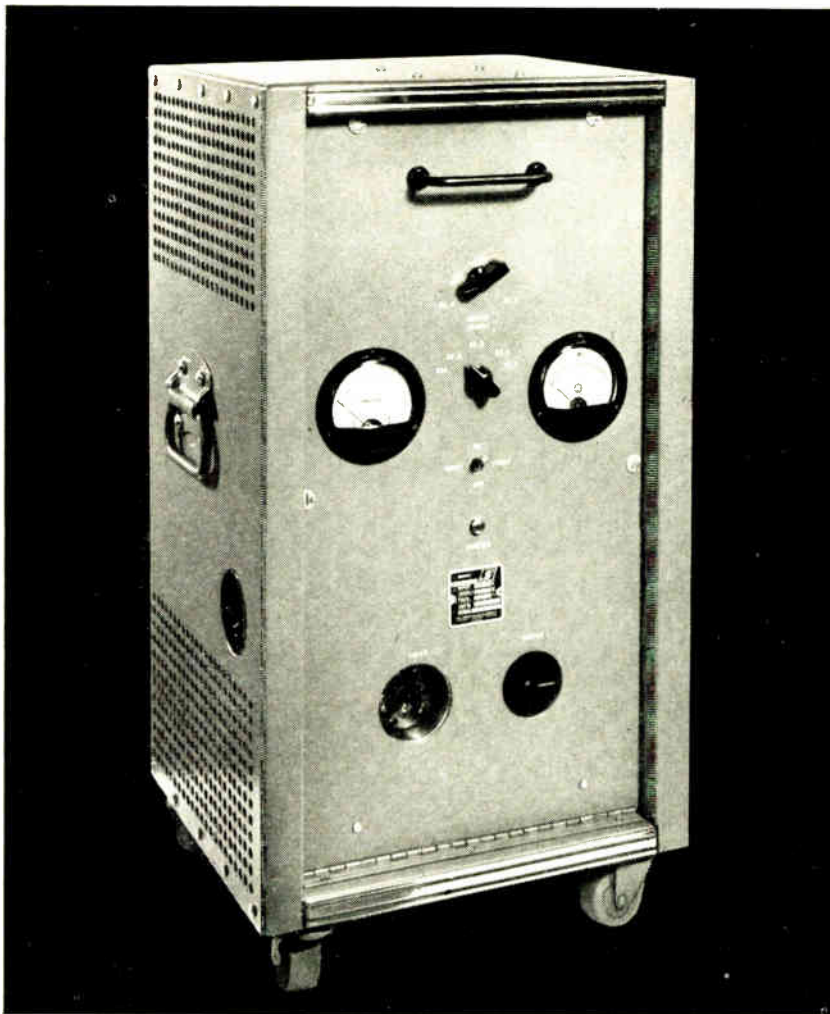

TUBELESS MAGNETIC AMPLIFIER DC SUPPLIES

for Automotive
and Aircraft Industries

Sorensen Nobatrons Model MA6/15 and Model MA2850 are tubeless — using magnetic amplifier principles. They have plenty of current capacity — 100 amps at 6 volts or 75 amps at 12 volts in the MA6/15 and 50 amps at 28 volts in the MA2850. Please see the specs below.

The MA6/15 is designed primarily as an automotive production test instrument for use in checking window motors, heaters, clocks, radios, headlight dimmers, ignition systems, air conditioners, cigarette lighters. The MA2850 can be used for testing aircraft heaters, pitch changers, inverters, radar, fire control systems, etc. Built around tubeless circuits, both models are carefully engineered and built to give you years of trouble-free, dependable service. Write for information now!

SPECIFICATIONS

Model MA2850

Input voltage range	190-230, 3 ϕ , 4 wire, 60 ~
Output	28 volts DC, adjustable between 23 and 36 volts.
Current	0 - 50 amperes
Ripple	3% max RMS
Regulation accuracy	$\pm 1\%$ against line and load combined
Time constant	0.5 seconds under worst conditions
Dimensions	15 $\frac{1}{2}$ " wide x 25 $\frac{3}{8}$ " high x 13" deep

Meters are standard.
Units are self contained.

Model MA6/15

Input voltage range	210-250 VAC, 1 ϕ , 60 ~
Output	Adjustable 6 - 7.7 volts DC from 0-100 amperes Adjustable 12 - 15.4 volts DC from 0 - 75 amperes
Ripple	1% max RMS
Regulation accuracy	$\pm 1\%$ against line and load combined
Time constant	0.2 seconds under worst conditions
Dimensions	21" wide x 36" high x 15" deep

Meters are standard. Cabinets optional.

SORENSEN

SORENSEN AND COMPANY, 375 Fairfield Ave., Stamford 13, Conn.

DO YOU KNOW WHAT THIS IS???

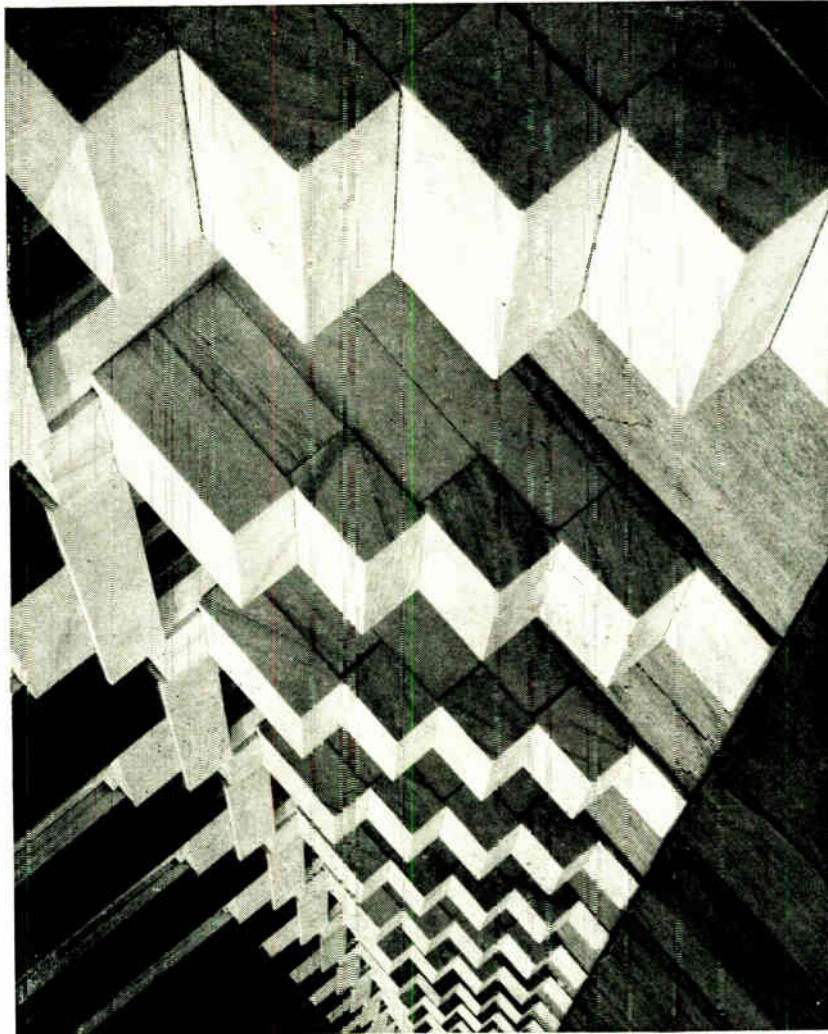

Photo from
"My Maryland"
A. Aubrey Bodine

...AND WHAT IT MEANS TO YOUR FUTURE?

These are the traditional white marble steps^o of Baltimore, photographed from an unusual angle. There are no unusual angles of employment with Westinghouse in Baltimore, since every opening is a step toward a well-planned future.

In your plans, be sure to include the Baltimore Divisions of Westinghouse. Here operations are delicately keyed to a balance between civilian and military work, which means that continued peak production is a matter of policy, rather than chance.

Salaries are commensurate with training, experience and ability. In addition to a highly respected patent award plan, opportunities for advanced degrees, and relocation expenses, Westinghouse offers all of the usual employee benefits, *plus!*

^o Actually, most Baltimoreans now prefer to live in the spacious and attractive suburbs which surround the city.

Currently we have an opening for a:
COMMUNICATIONS AND TELEPHONE ENGINEER
• **ANTENNA AND WAVEGUIDE ENGINEER** •
MAGNETIC AMPLIFIER ENGINEER • **TECHNICAL WRITER** • **MATHEMATICIAN (Ph.D. level)**
... and other engineers who can complement our already fine organization.

To apply, send résumé to—

R. M. SWISHER, JR.
Employment Supervisor
Dept. S-2

Westinghouse

Electric Corporation

109 West Lombard Street, Baltimore 1, Md.

If you are already employed at your highest skill in a defense industry, do not apply.

COMMUNICATIONS EQUIPMENT CO.

RADAR TEST SETS

TS 268/UP

Crystal Test Set, for checking type 1N21, 1N21A, 1N22, 1N23, etc. Extremely compact, reliable, rugged. Operates from one flashlight cell. In portable wood case. New **\$42.50**

TS 270A/UP:

Echo-Box for checking overall performance of radar equipment operating in S_q Band. Brand new, complete with pick-up horn, spare crystals, curds, etc. P.O.R.*

SPERRY MICROLINE

S-12 Power Supply and Modulator, for operating 2K39, 2K41, 417A, etc. Operates from 115V, 60 CY. Used. Excellent supplied with 2-417A Klystrons. P.O.R.

*P.O.R. Price on Request

TS-36 POWER METER

Operates 8500-9500 MC. Thermistor bridge feeds 0-200 microamp meter and video output jack. Calibration chart plots power-vs-meter reading. Waveguide input 1/4" x 3/8" size. Bridge uses 4-1/2 V size C Dry Cells. Power Range: 0.1-1000 MW **NEW \$175**

TS 159 TPX:

Combined wavemeter, freq. meter, signal generator, voltmeter and power meter. Freq. 150-190 MC. Volt-meter: 0-500 VDC. Power Meter 0-800 Watts Peak. Uses 10 MC crystal for checking calibration. Power 115V 400 Cycles. New. Complete with calibration chart **\$49.50**

TS-56A/AP SLOTTED LINE

Frequency Range and Characteristic Impedance

The Model TS-56A/AP Slotted Line is designed for operation over a frequency range of 260 to 675 megacycles. The slotted line has a characteristic impedance of 51 ohms.

Indicator

The indicator consists of a detector and meter which when mounted on the slotted line indicates the voltage along the line.

The indicator is divided into two separable units: the meter box and the resonator box. The meter box contains the meter, battery and all wiring. The resonator box contains the 957 tube, the probe and the tuning condenser in the resonant chamber.

The frequency limit as set by the resonant cavity of the indicator box is 340-600 megacycles.

Slotted Line

Since the length of the slot is 41.9 centimeters no wave or wave length greater than two times 41.9 centimeters can be used on the slotted line. This wavelength corresponds to a frequency of 358 megacycles. The slotted line has no upper frequency limits. However, the frequency limits of the complete unit are set by tuning range of the indicator box.

The cable simulated is the RG-8/U co-axial cable terminated by two Amphenol 93-M connectors. The nominal characteristic impedance of the cable is 52 ohms. The dielectric is stabilized polyethylene and the normal overall diameter is 0.405 inches.

The amphenol 93-M connectors are provided with a special insert which is in the form of a shell that makes contact with the braid and the 93-M connector. The insert maintains the cable in an position and also provides electrical continuity between the slotted line and the cable.

Adapters

Two "Amphenol to Selector" adapters are provided for use with an Amphenol 93-F connector (on end of slotted line) and a Selector C-49195 connector. To connect a cable with a Selector C-49195 connector to the end of the slotted line, the adapter must be used.

NEW COMP. WITH ALL ACCESSORIES AND CARRYING CHEST \$235

MAGNETRONS

Type	Price	Type	Price
2121	\$ 8.75	2139	\$24.50
2122	7.50	2149	59.50
2127	19.95	2161	34.50
2131	24.90	2162	34.50
2132	28.50	2131	85.00
2137	12.50	725-A	Write
2138	16.50	730-A	24.50

QK 60, 61, 62—\$85 ea.



KLYSTRONS

723A	\$12.50	2K25/723A/B	\$27.50
723A/B	19.50	417-A (Sperry)	17.50

SELSYNS

115 VAC	60 CYCLES	1 PHASE
I—Transmitter 2C-78248		Per Set
I—Differential 2C-78249		\$24.50
Transmitter Units Only		\$17.50 ea.

MICROWAVE COMPONENTS

"S BAND," RG48/U WAVEGUIDE

POWER SPLITTER for use with type 726 or any 10 CM Shepherd Klystron. Energy is fed from Klystron antenna through dual pick-up system to 2 type "N" connectors. **\$22.50 EACH**

DIRECTIONAL COUPLER, Broadband type "N" Coupling, 20 db, with std. flanges. Navy 20ABV 47AAN-2 **\$37.50**

LHTR. LIGHTHOUSE ASSEMBLY, Part of IIT39 APG 5 & APG 15, Receiver and Trans. Cavities w/Assoc. Tr. Cavity and Type X C.P.L.S. To Recv. Uses 2C40, 2C42, 1B27, Tunable APX 2400-2700 MGS. Silver Plated. **\$49.50**

BEACON LIGHTHOUSE cavity 10 cm. Mfg. Bernard Rice, each **\$47.50**

MAGNETRON TO WAVEGUIDE Coupler with 21A Duplexer Cavity, gold plated **\$45.00**

RT-39 APG-5 10 cm. lighthouse HP head 670 Xmt. Receiver, cavity comp. recvr. & 30 MC LF strip using 60K5 (2C40, 2C43, 1B27 lineup) w/Tubes. **\$12.50**

721A TR BOX complete with tube and tuning plungers **\$12.50**

NONALLY KLYSTRON CAVITIES for 707B or 2K39 **\$4.00**

F 29 SPR-2 FILTERS, type "N" input and output **\$12.50**

WAVEGUIDE TO 3/8" RIGID COAX "DOOR-KNOB" ADAPTER CHOKE FLANGE, SILVER PLATED BROAD BAND **\$32.50**

AS14 AP-10 CM Pick up Dipole with "N" Cable **\$4.50**

OAJ ECHO BOX, 10 CM TUNABLE **\$22.50**

HOMERELL-TO-TYPE "N" Male Adapters, W. E. 2104284 **\$2.75**

1. F. AMP. STRIP, 30 MC, 35 db gain, 3 1/2" Bandwidth, uses 6A7T's with video detector, less tubes **\$24.50**

POLYKUD ANTENNA, AT49A/APR: Broadband Conical, 300-3500 MC Type "N" Feed **\$12.50**

"E" or "H" PLANE BENDS, 90 Deg. less flanges **\$7.50**

3/8" RIGID COAX—3/8" I. C.

ROTARY JOINT, Stub-supported, UG 46/UG 45 fittings **\$27.50**

10 CM STABILIZER Cavity, tunable, standard UG46/UG 45 fittings **\$45.00**

RG 44/U RIGID COAX, stub support, 5 ft. sections, with UG46/UG45 connectors **\$17.50**

RT ANGLES for above **\$2.50**

HIGH ANGLE BEND, with flexible coax output pickup loop **\$8.00**

SHORT RIGHT ANGLE BEND, with pressurizing nipple **\$3.00**

RIGID COAX to flex. coax connector **\$24.50**

TR. ANGLE BEND 15" L. OA. **\$3.50**

FLEXIBLE SECTION, 15 L. Male to female **\$4.25**

3/8" RIGID COAX, BULKHEAD FEED-THRU **\$14.00**

X BAND—RG 52/U WAVEGUIDE

UG 39/U Flanges **\$1.10**

UG 40A/U Choke Flanges, Broadband **\$1.65**

1" x 1/2" wav-guide in 5' lengths, UG 39 flange to UG40 cover **per length \$7.50**

Rotating joints supplied either with or without deck mounting. With UG40 flanges **each, \$17.50**

Bulkhead Feed-Thru Assembly **\$15.00**

Pressure Gauge Section 15 lb. gauge and pressure nipple **\$10.00**

Pressure Gauge, 15 lbs. **\$2.50**

Directional Coupler, UG-40/U Take off 20 db, **\$17.50**

TR-ATR Upluxer section for above **\$8.50**

Waveguide Section 12" long choke to cover 45 deg. twist & 2 1/2" radius, 90 deg. bend **\$6.50**

Twist 90 deg. 5" choke to cover w/press nipple **\$6.50**

Waveguide Section 2 1/2 ft. long silver plated with choke flange **\$5.75**

Rotary joint choke to choke with deck mount **\$17.50**

1/2" mitered elbow "E" plane **\$12.00**

90 degree elbows, "E" or "H" plane 2 1/2" radius **\$12.50**

90 degree twist 6" long **\$8.00**

UG-40A/U—Broadband Choke Flange **\$1.65**

Microwave Receiver, 3 CM, Sensitivity: 10-13 μ

Wav. Comp. with I-F and A-F Mixer and Waveguide Input Circuits, 6 I.F. Stages give approximately 120 dB gain at a bandwidth of 1.7 MC. Video Bandwidth: 2 MC. Uses latest type AFC circuit. Complete with all tubes, including 725A/B Local Oscillator **\$175.00**

1 1/4" x 3/8" WAVEGUIDE

CG 98B/APQ 13 1/2" Flex. Sect. 1 1/4" x 3/8" (11) **\$10.00**

X Band Wav. GD, 1 1/4" x 3/8" O.D., 1/16" wall aluminum **per ft. 75c**

Slug Tuner Attenuator W.E. guide, old plated **\$6.50**

B1-Directional Coupler, Type "N" Takeoff 25 db, coupling **\$27.95**

B1-Directional Coupler, UG-52, Takeoff 25 db, coupling **\$24.95**

Waveguide-to-Type "N" Adapter, Broadband **\$22.50**



MICROWAVE MIXER

CV-12/APR-8: Waveguide/mixer unit, 4000-6000 mc. Designed for use with microwave receiver. Has pick up loop for coupling to lighthouse cavity local oscillator. RF input is to 1" x 3/8" waveguide (contact flange). Output (through 1n21 xtl.) is from standard 50-ohm coax connector. Brand new, complete with crystal. As shown **\$35.00**

PULSE NETWORKS

15A-1-400-50: 15 KV, "A" CKT. 1 microsec, 400 PPS, 50 ohms imp. **\$37.50**

G.E. 23E (2-84-810), 8-234-1051 50P4T, 3KV "E" CKT. Dual Unit; Unit 1, 2 sections, 0.84 microsec, 810 PPS, 50 ohms imp.; Unit 2, 8 Sections, 2.24 microsec, 405 PPS 50 ohms imp. **\$6.53**

7-5E3-1-200-67P, 7.5 KV "E" Circuit, 1 microsec, 200 PPS, 67 ohms impedance 3 sections **\$7.50**

7-5E4-16-60, 67P, 7.5 KV "E" Circuit, 4 sections 16 microsec, 60 PPS, 67 ohms impedance **\$15.00**

7-5E3-3-200-67P, 7.5 KV, "E" Circuit, 3 microsec, 200 PPS, ohms imp, 3 sections **\$12.50**

275: 10KV, 2.20-sec, 375 PPS, 50 ohms imp. **\$7.50**

2754: 10KV, 0.85μsec, 750 PPS, 50 ohms imp. **\$ 7.50**

KS8965 CHARGING CHOKE: 115-150 H @ .024, 32-40H @ .08A, 30,700V Corona Test, 21KV Test **\$37.50**

G.E. 25E5-1-350-50 P2T, "B" SKT, 1 Microsec, Pulse @ 350 PPS, 50 OHMS Impedance **\$69.50**

KS9623 CHARGING CHOKE: 16H @ 75 MA, 380 Ohms DCR, 3000 Vac test **\$14.95**

G.E. 6E3-5-2000 50 P2T: 6 KV, "E" Circuit 0.5 usec /2000 PPS/50 ohms/2 sections **\$7.50**

PULSE EQUIPMENT

MIT. MOD. 2 HARD TUBE PULSER: Output Pulse Power 134 KW (12 KV at 12 Amp). Duty Ratio: .001 max. Pulse duration: 5, 1.0, 2.0 microsec. Input voltage: 115 v. 400 to 2400 cps. Uses: 1-711B, 4-89-B, 3-72S, 1-72, New **Less Cover—\$135**

APQ-13 PULSE MODULATOR, Pulse Width .5 to 1.1 Micro Sec. Rise rate 624 to 1348 Pps. PK pwr. out 25 KW Energy 0.018 Joules **\$49.00**

TPS-3 PULSE MODULATOR, PK. power 50 amp, 24 KW (1200 KW pk); pulse rate 200 PPS, 1.5 micro-sec. pulse line impedance 50 ohms. Circuit series charging version of DC Resonance type. Uses two 505-A's as rectifiers, 115 v. 400 cycle input. New with all tubes **\$49.50**

PULSE TRANSFORMERS

G.E. K-2440: Line to magnetron; Pri: 50 ohms Z, 9.5 KV @ 80 Amp, Sec: 450 ohm Z: 28 KV @ 28 Amp. Peak pwr. 800 kw. (Pulse width: 1 usec @ 635 pps.) Twin bifilar secondary permits use of external filament transformer **\$62.50**

UTAH X-151T-1: Dual Transformer, 2 Wdgs. per section 1:1 Ratio per sec 13 MH inductance 30 ohms DCR **\$7.50**

UTAH X-150T-1: Two sections, 3 Wdgs. per section, 1:1:1 Ratio, 3 MH, 6 ohms DCR per Wdg. **\$7.50**

68G711: Ratio: 4:1 6.7 Ohms. Pri: 0.22 Ohms sec. \$4.50

TR1049: Ra'io: 2:1 Pri, 220 MH, 50 Ohms, sec. 0.75H, DCR 100 Ohms **\$6.75**

K-901695-501: Ratio 1:1, Pri. Imp. 40 Ohm, Sec. Imp. 40 Ohms, Passes pulse 0.6 usec with 0.05 usec rise **\$8.95**

G. E. K-2745 **\$39.50**

Ray UX 7836—Pulse Output Pri, 5v, sec. 41v. **\$7.50**

Ray UX 8442—Pulse inversion—40v + 40v **\$7.50**

PHILCO 352-7250, 352-7251, 352-7287

RAYTHEON: UX8693, UX5983 **\$5 ea.**

W.E.: D-166310, D-166638, KS 9830, KS9948.

UTAH 20262, with Cracked Beads, but will operate at full rated capacity **\$5.00**

UX 8693 (8S8 2229627-84): 3 Wdgs, 32 turns, 218 wire, DCR is: 362/372/4 ohms. Total voltage: 2500 vdc. **\$5.00**

D-166173: Input: 50 ohms Z, Output: 900 ohms Z, 3 Wdgs. Freq. range 10 kc-2mc, P/O AN/APQ-13 **\$12.50**

K-2450: Pulse-inversion auto-transformer; primary 13 kv, 4 usec. Output: 14 kv @ 100 kw peak **\$34.50**

K-2748-A: Line to magnetron. Has magnetron well and provision for external fil. trans. **\$37.50**

10 CM R.F. HEAD

Complete R.F. Head and Modulator delivers 50 KW Peak R.F. at 3000 MC. Pulsar delivers 12KV pulse at 12 Amp. to magnetron of 5, 1, or 2 microsec. duration at duty cycle of .001. Unit requires 115V, 400-2400 Cycles, 1 phase @ 3 SA. A's @ 24-28 VDC @ 2A. External sync. Pulse of 120V Req'd. Brand New. Complete with schematic and all tubes **\$375.00**

MAIL ORDERS PROMPTLY FILLED. ALL PRICES F.O.B. NEW YORK CITY. SEND M.O. OR CHECK. ONLY SHIPPING SENT C.O.D. RATED CONCERNS SEND P.O. ALL MDSE. SUBJECT TO PRIOR SALE, AND PRICES SUBJECT TO CHANGE WITHOUT NOTICE.

PARCELS IN EXCESS OF 20 POUNDS WILL BE SHIPPED VIA CHEAPEST TRUCK OR RAILEX.

131 Liberty St., New York 7, N. Y. Dept I-9 Chas. Rosen Phone: Dlgby 9-4124

News—New Products

These manufacturers have invited PROCEEDINGS readers to write for literature and further technical information. Please mention your I.R.E. affiliation.

(Continued from page 160A)

continued use at high speed they exhibit a tendency to increase their contact resistance. The amount of this increase is unpredictable in advance, but is considerable.

In order to provide low contact resistance originally, that will remain stable over a long life at high speeds, a choice of either gold alloy contacts or platinum-rhodium contacts is offered.

The gold is used to cover the range of 0 to $\frac{1}{4}$ ampere at 0 to 110 volts dc. The platinum-rhodium is used to cover the range of 0 to $\frac{1}{2}$ ampere at 10 to 110 volts dc.

A listing of the additional types, together with complete engineering information is given in a new Catalog 337.

UHF-VHF Signal Booster

Grayburne Manufacturing Co., Inc., 4-6 Radford Pl., Yonkers, N. Y., announces the production of their Model TSB-1, an IF signal booster for UHF and VHF. The unit, now available at parts distributors, provides an extra stage of IF to amplify both UHF and VHF signals without switching. The booster, which is supplied in adaptor form, is installed in an existing tube socket and requires but one wire connection to ground.



This new signal booster amplifies signals passing through the IF stages and offers all the advantages which would be contributed by an additional stage of IF. It is said to improve performance in near fringe areas, increase picture brightness, amplify signals over 20 per cent, and clear "snow" effects.

(Continued on page 165A)

FOR FASTER, MORE ACCURATE MEASUREMENT OF...

YOU CAN READ THE ANSWER DIRECTLY ACCURATELY AND EASILY

without computation or interpolation on this Potter Megacycle Frequency-Time Counter. For maximum versatility, complete reliability, and proved performance, this unique instrument is outstanding. One compact unit provides the means for these basic tests.

DIRECT FREQUENCY from 0 to one megacycle.

PERIOD for one or ten cycles of the unknown.

TIME INTERVAL from 30 microseconds to 1,000,000 seconds.

FREQUENCY RATIO for two unknown frequencies.

TOTAL COUNT from 1 to 10^6 .

RPM with an accuracy of ± 1 rpm at any speed.

TIMING in increments of 10 or 100 usec; 1, 10, or 100 millisecs; or 1 sec.

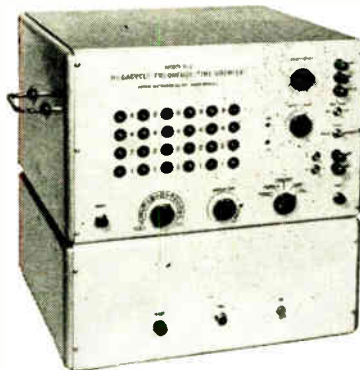

OPTIONAL FEATURES

such as additional decades, mechanical registers, preamplifiers, and 1 mc crystal for interval resolutions to one usec, further increase the utility of the Model 850.

Only Potter Instruments offer a choice of the famous Potter 1-2-4-8 four lamp readout for maximum reliability and readability or the 0-9 ten lamp readout for direct digital indication. Adjustable display time for either indication provides automatic or manual reset after the reading period.

As accessory equipment the Potter Instrument Company can also supply high speed printers and digital magnetic tape handlers for recording the digital information.

If you are now using awkward, time-consuming methods of measurement, you can save time and money by putting this universal measuring instrument into your program now. Like every Potter product, the Model 850 is the industry standard, and is always specified wherever results are important. For complete information and our recommendations on your specific laboratory or production problem, write to Department 9-E the Potter Instrument Co., Inc., Great Neck, New York.



and

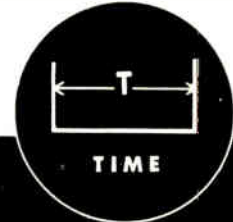

The Only Universal

Megacycle
Frequency
Time
Counter

Potter

Use it, too, as an accurate secondary frequency standard with outputs of 100, 10 and 1 kc; 100, 10, 1 and .1 cps.



POTTER INSTRUMENT CO., INC.

115 CUTTER MILL ROAD

GREAT NECK, N. Y.

113

SILVER GRAPHALLOY

BRUSHES

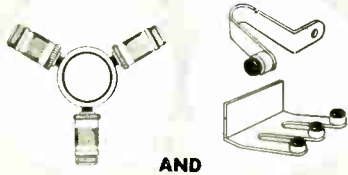

AND

CONTACTS



... for applications requiring low electrical noise, low and constant contact drop, high current density and minimum wear.



EXTENSIVELY USED IN

SELSYNS
ROTATING THERMOCOUPLE and STRAIN-GAGE CIRCUITS
ROTATING JOINTS
GUN-FIRE CONTROLS
DYNAMOTORS etc.

Wide range of grades available for standard and special applications.

Brush holders and coinsilver slip rings available for use with Silver Graphalloy Brushes.

OTHER GRAPHALLOY PRODUCTS:

Oil-free self-lubricating Bushings and Bearings, Oil-free Piston Rings, Seal Rings, Thrust and Friction Washers, Pump Vanes.



GRAPHITE METALLIZING CORPORATION

1007 NEPPERHAN AVENUE • YONKERS, NEW YORK

Please send data on Graphalloy BRUSHES and CONTACTS
 Send data on BUSHINGS.

NAME & TITLE _____
COMPANY _____
STREET _____
CITY _____ ZONE _____ STATE _____

FINNFLEX

AIRBORNE MOUNTING BASES

Conform to JAN-C-172A SPECIFICATIONS ... but are actually made to exceed AN-E-19 Drop Test requirements

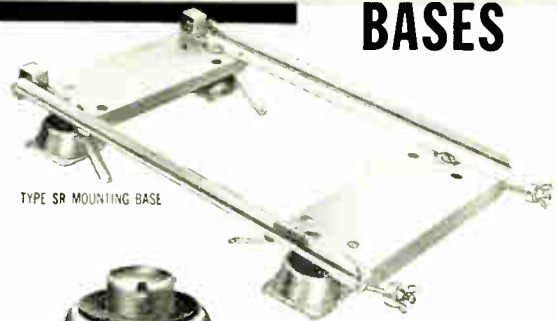

TYPE SR MOUNTING BASE

RUGGED PROTECTION for VITAL EQUIPMENT: Finnflex Mounts isolate vibration and shock from Electronic, Communication, and Control Equipment. They offer unimpaired efficiency from -80° to +250°F. "Selective Action" friction dampening, non-linear steel springs, and other features. Wide range of sizes and load ratings available.



TYPE TPM VIBRATION ISOLATOR

SHOCK MOUNTS for Signal Corps Mobile Equipment and for Naval Fire Control Units.

SPECIAL PROBLEMS: Complete facilities for designing and fabricating Shock and Vibration Mounts to order — regardless of size or weight of equipment mounted.

Specify FINNFLEX—for Ruggedness, Efficiency, and Economy.

Write for Catalog MB-110

T. R. FINN & COMPANY, Inc.

Specialists in Vibration Control

333 JACKSON AVENUE, NEW YORK 54, N. Y.

Phone: CYpress 2-4192-3-4

VIBRATION ISOLATORS and SHOCK MOUNTS

To JAN-C-172A SPECIFICATIONS and TO ORDER

SECON

DEVELOPMENT and PRODUCTION METALLURGISTS

Fine wire and ribbon in base rare and precious metals, and alloys for new and highly engineered applications. In small units and sizes, and to close tolerances.

Further details on request.



SECON METALS CORPORATION

228 East 45th Street, N. Y. 17, N. Y., MU 7-1594

News—New Products

These manufacturers have invited PROCEEDINGS readers to write for literature and further technical information. Please mention your I.R.E. affiliation.

(Continued from page 163A)

Twin Power Triode

Chatham Electronics Corp., Livingston, N. J., announces a new high permeance, high plate dissipation twin power triode for voltage regulation. Used as a series tube, this type will "pass" a minimum of 150 ma per section at 40 volts dc ep, and the same current at 200 volts dc ep, using a grid bias of -60 volts.

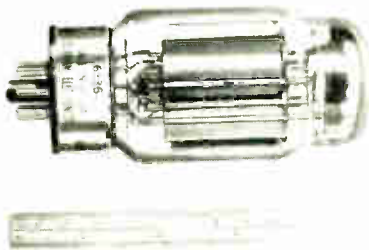

This tube features a hard glass envelope and a 8-pin butt stem. Pin connections are the same as Chatham Types 6AS7G and 6080. Height 4.75 inches maximum and bulb diameter is 2.07 inches maximum. mounting position: any, shock: 30° angle. EF is 6.3 Volts; 5 amperes maximum. Maximum bulb temperature is 250 C.

Forced ventilation is not necessary at ambient room temperature. Mu is 2.7. GM: 11,000 micromhos, Rp: 250 ohms. Life 1000 hours minimum. Designated Type 6336 by the manufacturer.

Reader inquiries are invited.

RF Choke

The Grayburne Corp., 46 Radford Pl., Yonkers, N. Y., announces the development of its "P-Wee RF Choke." This unit incorporates a high permeability ferrite core resulting in good operating characteristics and extremely small size. The P-Wee Choke is recommended for use in computer circuits and other applications where component size is a critical factor.

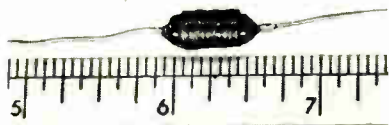

The electrical characteristics of the choke are as follows: dc resistance, 120 ohms; induction, 25 mh \pm 5 per cent; distributed capacity is 8 μ f; Q at 100 kc is 115; Q at 450 kc is 80; and current carrying capacity is 100 ma.

1953 IRE Directory
Coming in
September

Don't Overlook Buttons

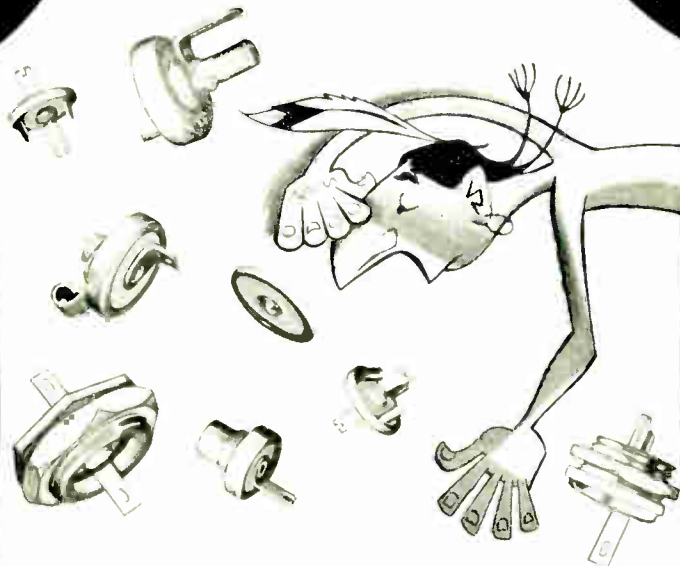

for VHF and UHF applications

Silvered mica button capacitors meet all requirements as components for better VHF and UHF performance. Exceptionally small and light in weight, they are a valuable aid to miniaturization. Extremely low series inductance makes them ideal for application in high frequency circuits.

Sangamo Button Capacitors are encased in silver plated corrosion resistant brass and are stable over an operating temperature range from minus 50° C to plus 85° C. The silver plated case performs the dual purpose of shielding and serving as the low potential terminal.

Sangamo Buttons can be furnished with temperature coefficients and drift characteristics up to and including "E" of JAN-C-5. They are available in a wide variety of styles and in multi-section assemblies to facilitate installation in miniaturized equipment.

Engineering Bulletin TS-110 gives detailed information. Write for your copy today.

SC53-11



Those who know...choose Sangamo

SANGAMO ELECTRIC CO. MARION, ILLINOIS

INDEX AND DISPLAY ADVERTISERS

Meetings with Exhibits	2A
News and New Products	44A
Industrial Engineering Notes	66A
Section Meetings	80A
Student Branch Meetings	82A
Membership	82A
Positions Open	130A
Positions Wanted by Armed Forces Veterans	137A

DISPLAY ADVERTISERS

A'G'A Div. Elastic Stop Nut Corp. of America	150A
Acme Electric Corp.	92A
Advance Electronics Co.	140A
Aerovox Corp. (Acme Div.)	112A
Aerovox Corp. (Hi-Q Div.)	113A
Aircraft Armaments Inc.	152A
Aircraft Radio Corp.	75A
Aircraft Transformer Corp.	101A
Airtron Inc.	76A
Alden Products Co.	26A
Allfax Paper & Engineering Co.	123A
Allen-Bradley Co.	42A
Allied Radio Corp.	133A
American Electrical Heater Co.	80A
American Electronic Mfg. Inc.	120A
American Lava Corp.	19A
American Phenolic Corp.	106A & 107A
American Television & Radio Co.	79A
Ampex Electric Corp.	9A
Andrew Corp.	10A
Apex Coated Fabrics, Inc.	119A
Applied Science Corp. of Princeton	154A
Arnold Engineering Co.	16A
Audio Engineering Society (Audio Fair)	124A
Ballantine Laboratories, Inc.	40A
Barber Laboratories, Alfred W.	141A
Barker & Williamson, Inc.	109A
Bell Aircraft Corp.	152A, 159A
Bell Telephone Laboratories, Inc.	4A
Bell Telephone Laboratories, Inc. (Empl.)	132A
Bendix Aviation Corp. (Eclipse-Pioneer)	27A
Bendix Aviation Corp. (Prod. Div. Empl.)	134A
Bendix Aviation Corp. (York Div.)	153A
Blaw-Knox Co.	39A
Blonder-Tongue Labs, Inc.	152A
Bodnar Industries, Inc.	124A
Brand & Co., William	148A
Browning Laboratories, Inc.	151A
Buggie and Company, H. H.	102A
Burroughs Corp. (Elec. Instr. Div.)	85A
Bussmann Mfg. Co.	7A
Cambridge Thermionic Corp.	105A
Cannon Electric Co.	86A
Capehart-Farnsworth Corp.	152A
Cascade Research	59A
Centrafab (Div. Globe Union)	23A
Chicago Telephone Supply Co.	20A & 21A
Cleveland Container Co.	103A
Cohn Corp., Sigmund	150A
Collins Radio Co.	67A
Communications Equipment Co.	162A
Cons. Vultee Aircraft Corp. (Convair)	157A
Constantin & Co., L.L.	109A
Content, Edward J.	141A
Cornell Aeronautical Laboratory, Inc.	134A
Cornell-Dubilier Electric Corp.	Cov. III
Corning Glass Works	15A
Cornish Wire Co. Inc.	124A
Crosby Laboratories, Inc.	141A
Custom Gear Co.	128A
DX Radio Products Inc.	128A
Dalis Inc., H. L.	121A
Dalmo-Victor, Inc.	56A
Daven Co.	45A
Dialight Corp.	117A
DuMont Laboratories, Inc., Allen B.	166A

PRECISION SERIES EV-10A VTVM-Megohmmeter



TRUE ZERO CENTER VTVM 7" FULL VIEW METER

with DIRECT PEAK READING HIGH FREQ. SCALES
Plus Standard 1000 Ohms per Volt Functions

59 Ranges to: 6000 Volts, 2000 Megohms
12 Amperes. + 77DB

D.C. VTVM ranges to ± 60 KV when used
with TV-4 High Voltage Safety Test Probe.

RANGE SPECIFICATIONS

- ★ EIGHT ZERO-CENTER VTVM RANGES:
 $\pm 3, \pm 12, \pm 60, \pm 120, \pm 300, \pm 600,$
 $\pm 1200, \pm 6000$ volts D.C.
- ★ HIGH INPUT RESISTANCE—
13 1/2 megs. to 600 V., 26 2/3 megs. at
1200 V., 133 1/3 megs. at 6000 volts.
- ★ FOUR DIRECT PEAK READING RANGES:
0-3-12-60-120 peak volts.
(Requires Series RF-10A high Frequency
Probe described below.)
- ★ SIX OHM and MEGOHMMETER RANGES:
0-2000-200,000 ohms.
0-2-20-200-2000 megohms.
- ★ EIGHT EXTRA A.C.-D.C. VOLT RANGES
at 1000 Ω/V . for routine circuit testing.
0-3-12-60-120-300-600-1200-6000 volts.
- ★ EIGHT D.C. CURRENT RANGES:
0-300 microamperes.
0-1.2-5-30-600-1200 MA. $\frac{1}{2}$ -1.2 Amperes.
- ★ EIGHT DB RANGES: —20 to + 77 db.
Calibrated for 1 MW., 600 ohms zero db.

IMPORTANT FEATURES

- ★ Voltage Regulated-Bridge Type Circuit.
- ★ True Zero-Center VTVM—Simultaneously
indicates both voltage and polarity.
- ★ Rotary Range and Function Selectors.
- ★ Recessed 6000 volt Safety Jacks.
- ★ Shielded Coax Test-Cable Connectors
for both D.C. and R.F. probes.
- ★ Electronic-Bridge Ohm-Megohmmeter.
Uses 2 self-contained 1.5 V. batteries.
- ★ Extra-large 7" Rectangular PACE Meter.
200 microampere, $\pm 2\%$ sensitivity.
- ★ 1% Film Type and Wire-Wound Resistors.

EV-10A (MCP) in black ripple finished,
heavy gauge steel case. Size 10 1/2" x 12"
x 6". Complete with coaxial circuit isolating
test probe, shielded ohmmeter test
cable, standard test leads, ohmmeter
battery and manual. \$99.75



SERIES RF-10A R.F. Probe

Accessory for Series
EV-10A above; affords
direct high frequency
peak voltage measure-
ments. Employs 9002
miniature tube \$14.40

PRECISION APPARATUS COMPANY, INC.

92-27 HORACE HARDING BLVD., ELMHURST 13, N. Y.
Export Division 458 Broadway, New York 13, U.S.A. • Cables—Moshans
In Canada: Atlas Radio Corp., Ltd. 560 King Street, W. Toronto 28

FIRST WITH THE FINEST IN . . .

• CATHODE-RAY OSCILLOG- RAPHY

Instrument Division,
760 Bloomfield Ave., Clifton, N.J.

• CATHODE-RAY TUBES AND COMPONENTS

Cathode-ray Tube Division,
750 Bloomfield Ave., Clifton, N.J.

• TELEVISION TRANSMIT- TING EQUIPMENT

Television Transmitter Division,
1500 Main Ave., Clifton, N.J.

DU MONT

ALLEN B. DU MONT
LABORATORIES, INC.

ZOPHAR

---WAXES
---COMPOUNDS

Zophar Waxes, resins and
compounds to impregnate,
dip, seal, embed, or pot elec-
tronic and electrical equip-
ment or components of all
types; radio, television, etc.
Cold flows from 100°F. to
285°F. Special waxes non-
cracking at —76°F. Com-
pounds meeting Government
specifications plain or fungus
resistant. Let us help you with
your engineering problems.



ZOPHAR MILLS, INC.
112-130 26th Street,
Brooklyn 32, N. Y.

STRETCH YOUR OPERATING RANGE



ONLY NPN "Grown-Junction" TRANSISTORS COVER THESE OPERATING RANGES

- POWER GAINS AT OVER 3 MEGACYCLES
- FIELD PROVEN PERFORMANCE FROM -50°C to $+85^{\circ}\text{C}$
- HIGHER FREQUENCY RESPONSE

IMMEDIATE DELIVERY . . . Available in large quantities for mass production applications. Uniform production assures a reliable source of supply.

TIME PROVEN . . . Germanium Products transistors are not a laboratory prototype, but time-tested superior types that have shown ruggedness and dependability over a long period in the field, under the most severe conditions.

MORE VERSATILE . . . Because of their stable characteristics, greater operational, higher frequency and temperature ranges, "Grown-Junction" transistors have been selected for the most difficult assignments. They have proved their reliability in a wide variety of tasks such as: instrumentation, telemetering, servo systems, computer circuits, timing pulses, d.c. and r.f. amplifiers, etc. Consult Federated's Engineering Service to find a quick solution to your particular transistor problem.

TYPICAL CHARACTERISTICS

	RD2517	RD2520	RD2521	RD2525
ALPHA	.93	.98	.98	.995
ALPHA CUT-OFF FREQUENCY	1.5 megacycles	3.0 megacycles	3.0 megacycles	5.0 megacycles
COLLECTOR RESISTANCE	.25 megohms	1 megohm	2 megohm	1 megohm
MAXIMUM COLLECTOR VOLTAGE	30 volts	40 volts	50 volts	30 volts
POWER RATINGS	50 mw	50 mw	100 mw	25 mw

Federated

SEMI-CONDUCTOR CO.

EXCLUSIVE SALES AGENTS FOR GERMANIUM PRODUCTS CORP.
66 Dey Street, N. Y. 7, N. Y. DI-9-3050 Teletype: NY 1-2859 (N. Y., N. Y.)

911 S. Grand Ave.
Los Angeles 15, Cal.
TRinity 1761
Teletype: LA-572

925 Northampton St.
Easton, Penna.
EAston 4259

1115 Hamilton St.
Allentown, Penna.
HEmlock 3-7441
Teletype: AN-2^o

114 Hudson St.
Newark 4, N. J.
MArket 3-9035

DISPLAY ADVERTISERS

Eby, Inc., Hugh H.	101A
Eitel-McCullough, Inc.	8A, 81A
Elco Corp.	140A
Eldico of New York, Inc.	141A
Electrical Industries	77A
Electrical & Physical Instrument Corp.	110A
Electro-Metric Instrument Co.	141A
Electro-Motive Mfg. Co., Inc.	49A
Electro Search	141A
Electronic Associates, Inc.	123A
Electronic Engineering Co. of Calif.	134A
Elk Electronic Laboratories, Inc.	141A
Engineering Associates	128A
Engineering Research Assoc. Inc.	156A
Epcro Products, Inc.	142A
Erie Resistor Corp.	30A
F-R Machine Works	141A
Fairchild Camera & Instrument Co.	114A
Fairchild Engine & Airplane Corp. (G.M.)	111A
Fast & Co., John E.	92A
Federal Telephone & Radio Corp.	91A
Federated Semi-Conductor Co.	167A
Finn & Co., Inc., T. R.	164A
Flexrock Co.	147A
Ford Instrument Co.	24A
Frederick Research Corp.	143A
Freed Transformer Co., Inc.	53A
Frequency Standards	97A
Gallay, Harris	143A
General Dyestuff Corp. (Antara)	18A
General Electric Co. (Apparatus)	94A & 95A
General Electric Co. (Capacitor)	32A
General Electric Co. (Tech. Pers.)	135A
General Electric Co. (Germanium Diode)	43A
General Electric Co. (I. & T. Tubes)	17A
General Precision Laboratory, Inc.	36A & 37A
General Precision Laboratory, Inc. (Empl.)	130A
General Radio Co.	Cov. IV
Giannini Co., G. M.	104A
Gilfillan Bros., Inc.	159A
Godley Co., Paul	143A
Gordon Assoc.	143A
Graphite Metallizing Corp.	164A
Great American Industries (Rubatex)	22A
Griffin Co., John	119A
Guardian Electric Mfg. Co.	51A
Gudebrod Bros. Silk Co., Inc. (Electronic Div.)	118A
Hammarlund Mfg. Co., Inc.	102A
Harvey Radio Co., Inc.	82A
Heiland Research Corp.	82A
Heinemann Electric Co.	125A
Helipot Corp.	65A
Heppner Mfg. Co.	121A
Hermetic Seal Products Co.	33A
Hewlett Packard Co.	68A
Hickok Electrical Instrument Co.	101A
Highland Engineering Co.	143A
Hogan Laboratories, Inc.	143A
Hughes Aircraft Co.	41A
Hughes Research & Development Labs.	93A, 156A
Hycor Co., Inc.	118A
Industrial Research Laboratories	158A
Institute of Radio Engineers	2A, 70A
International Resistance Co.	60A & 61A
Jennings Radio Mfg. Co.	100A
Johnson Co., E. F.	96A
Kahle Engineering Co.	111A
Kahn, Leonard R.	143A
Kalbfell Laboratories	143A
Kay Electric Co.	123A
Kearfott Co., Inc.	141A
Kenyon Transformer Co., Inc.	98A
Ketay Mfg. Corp.	58A
Kings Electronics Co., Inc.	29A
Knights Co., James	136A
Kollsman Instrument Corp.	154A
Laboratory for Electronics, Inc.	63A
Lambda Electronics Corp.	151A
Lapp Insulator Co., Inc.	126A
Lavoie Laboratories, Inc.	71A
Lenz Electric Mfg. Co.	38A
Littelfuse, Inc.	149A
Lubcke, Harry R.	143A

DISPLAY ADVERTISERS

Magnetics, Inc.	127A
Mallory & Co., Inc., P. R.	28A
Marion Elec. Instr. Co.	6A
Martin Co., Glenn L.	133A
Maxson Corp., W. L.	154A
McDonnell Aircraft Corp.	158A
Measurements Corp.	108, 120A, 147A
Melpar, Inc.	132A
Meridian Metalcraft, Inc.	119A
Microwave Consultants	147A
Microwave Development Laboratories, Inc.	147A
Microwave Services, Inc.	147A
Midland Mfg. Co., Inc.	57A
Millen Co., James	142A
Model Engineering & Mfg. Co. Inc. (TRU-OHM Div.)	55A
Mycalex Corp. of America	144A & 145A
N.R.K. Mfg. & Engineering Co.	122A
Nassau Research & Dev. Assoc., Inc. (Narda)	144A
National Cash Register Co.	153A
National Union Radio Corp. (Research Div.)	135A
North American Aviation, Inc.	158A
Northern Radio Co., Inc.	46A
Ohmite Mfg. Co.	62A
Omni Electronics Corp.	156A
PSC Applied Research Ltd.	147A
Panoramic Radio Products, Inc.	139A
Paramount Paper Tube Corp.	84A
Par-Metal Products Corp.	127A
Phillips Control Corp.	116A
Pickard & Burns, Inc.	147A
Plastic Capacitors, Inc.	115A
Polarad Electronics Corp.	89A
Polytechnic Research & Dev. Co., Inc.	99A
Potter & Brumfield	87A
Potter Instrument Co., Inc.	163A
Precision Apparatus Co., Inc.	166A
Precision Paper Tube Co.	144A
Premier Instrument Corp.	115A
Presto Recording Corp.	78A
R.F.I. Shielded Enclosures, Inc.	97A
Radiation, Inc.	155A
Radio Corp. of America (Empl.)	31A
Radio Corp. of America (Tubes)	64A
Radio Materials Corp.	11A
Raytheon Mfg. Co. (Rec. Tubes)	3A
Remier & Co. Ltd.	84A
Resinite Corp.	122A
Resistoflex Corp.	74A
Rex Corp.	54A
Riester & Thesmacher Co.	88A
Rockbar Corp.	142A
Rosenberg Associates, Paul A.	177A
Rutherford Electronics Co.	138A
Sanborn Co.	50A
Sangamo Electric Co. (Capacitor Div.)	145A
Saratoga Industries, Inc.	110A, 138A
Secon Metals Corp.	164A
Servo Corp. of America	127A
Shallcross Mfg. Co.	48A
Shure Bros., Inc.	79A
Simpson Electric Co.	73A, 75A
Sorensen & Co., Inc.	160A
Sound Scriber Corp.	31A
Spencer-Kennedy Labs., Inc.	146A
Sperry Gyroscope Co.	158A
Sperry Products, Inc.	130A
Sprague Electric Co. (Resistor Div.)	1A
Stackpole Carbon Co.	35A
Standard Piezo Co.	146A
Steward Mfg. Co., D. M.	97A
Stoddard Aircraft Radio Co.	69A
Superior Electric Co.	5A
Superior Tube Co.	13A
Surprenant Mfg. Co.	117A
Sylvania Electric Products, Inc. (Tung. & Chem.)	34A
Sylvania Electric Products, Inc. (Radio & TV)	14A
Sylvania Electric (Woburn)	135A
Sylvania Electric Products, Inc.	157A
Technology Instrument Corp.	143A
Tektronix, Inc.	66A
Teledrome, Inc.	147A
Telecomputing Corp.	25A
Telrex, Inc.	147A
Texas Instruments, Inc.	47A
Thomas & Skinner Steel Products Co.	83A
Transradio, Ltd.	83A
Triad Transformer Mfg. Co.	40A
Truscon Steel Co.	12A
United States Gasket Co.	168A
United Transformer Co.	Cover II
Varian Associates	52A
Vibration Research Laboratories, Inc.	148A
Victoreen Instrument Co.	137A
Waterman Products Co., Inc.	90A
Westinghouse Electric Corp.	161A
Wheeler Laboratories, Inc.	148A
White Dental Mfg. Co., S. S.	72A
Wilcox Electric Co., Inc.	129A
Wilcox Electric Co., Inc. (Empl.)	153A
Zophar Mills, Inc.	166A

- cuts assembly time and cost
- extremely small size
- low loss for UHF

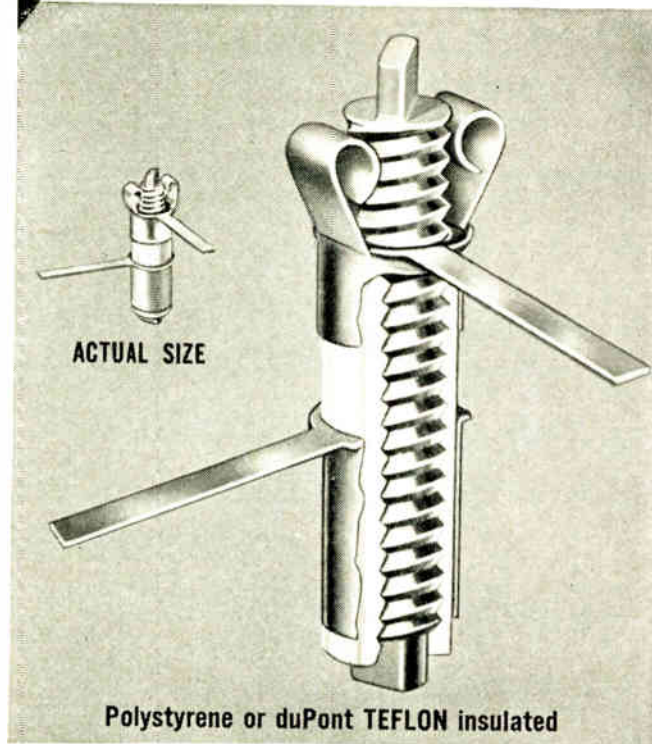

Chemelec TYPE 535 TUBULAR TRIMMER

● Economical price, compact size, easy mounting—plus features for UHF operation—are combined in Chemelec Type 535 Tubular Trimmers.

Simplicity of design is responsible for very low inductance and uniform, straight line, noiseless adjustment. They may be mounted close to associated circuit elements. Ribbon type leads minimize inductance in UHF circuits. Polystyrene or

duPont TEFLON keep electrical losses to a minimum.

Assembly is accomplished from only one side of chassis—another production cost feature. There is no danger of breakage as with ceramic trimmers.

Capacity ranges from 0.5 to 2.0mmf., (Teflon body), and 0.7 to 3.0 (Polystyrene body). Working voltage is 500 volts. Write for information and samples.

**UNITED
STATES
GASKET
COMPANY**

**FLUOROCARBON
PRODUCTS, INC., DIVISION
CAMDEN 1 • NEW JERSEY**

Representatives in Principal
Cities Throughout the World

C onsistently D ependable

DYKANOL*

CAPACITORS

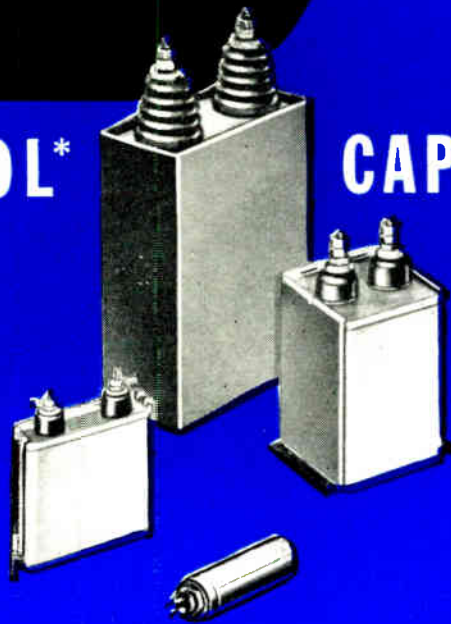

* COPYRIGHTED TRADE MARK OF C-D IMPREGNATES



Nobody knows oil capacitors like C-D. It's generally acknowledged that "nobody can duplicate C-D's Dykanol capacitor." You can count on the ruggedness and durability that have made C-D capacitors famous for 42 years and that is all too rare these days. Catalog No. 400 will show you how broad the line is. Write for it to: Dept. M-93 Cornell-Dubilier Electric Corp., South Plainfield, N. J.

CORNELL-DUBILIER

world's largest manufacturers of capacitors



ANTENNAS



ROTATORS



CAPACITORS



VIBRATORS



CONVERTERS

SOUTH PLAINFIELD, N. J. • NEW BEDFORD, WORCESTER AND CAMBRIDGE, MASS. • PROVIDENCE, R. I. • INDIANAPOLIS, IND. • FLOUQUAY SPRINGS, N. C. • SUBSIDIARY, THE RADART CORP., CLEVELAND, O.

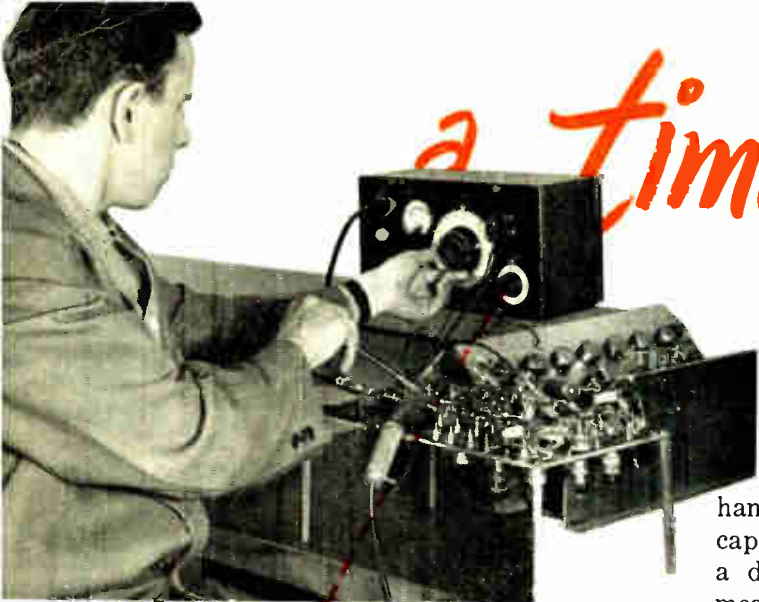

a Time Saver

for Every DEVELOPMENT ENGINEER

The Type 1612-A Capacitance Meter is an extremely handy instrument for the rapid measurement of circuit capacitances up to 1200 $\mu\mu\text{f}$. This unit may be set up beside a development model and is ready whenever needed for measuring interstage capacitance, interelectrode and stray capacitance, and for checking mica and ceramic trimmers, and other small condensers. It operates at 1 Mc, takes very little bench space and is completely self-contained.

Operation with the Capacitance Meter is very convenient. The unknown is simply connected across a precision variable capacitor whose value is then reduced until resonance is re-established, as indicated by the panel meter. A simple test jig will permit rapid production testing.

This instrument is highly recommended where the accuracy and complications of more expensive bridges is not required.

Engineer checks variable condenser in breadboard model prior to replacing it with fixed ceramic condenser. Speed of measurement is a great asset over bridge measurements which may require dissipation factor balances and other tuning prior to indicating capacitance.



SPECIFICATIONS

Type 1612-A \$170.00

- Range:** 0 to 80 $\mu\mu\text{f}$ and 0 to 1200 $\mu\mu\text{f}$
in two bands
Ranges are switched automatically
as dial is rotated
- Accuracy:** $\pm 0.4 \mu\mu\text{f}$ below 10 $\mu\mu\text{f}$ } Low
 $\pm 4\%$ above 10 $\mu\mu\text{f}$ } Range
 $\pm 4 \mu\mu\text{f}$ below 100 $\mu\mu\text{f}$ } High
 $\pm 4\%$ above 100 $\mu\mu\text{f}$ } Range
- Frequency:** 1 Mc $\pm 1\%$ adjusted at factory
(movable dust core permits
frequency readjustments)
- Dissipation Factor:**
Meter reading at resonance gives relative
indication of loss
- Internal Detector:**
1N34 crystal rectifier with microammeter
indicates resonance
- Internal Power Supply:**
115 volts, 50 to 60 cycles,
a-c or d-c can be used
- Compactness:** Length 12—Height 6 $\frac{3}{8}$ —
Depth 7 $\frac{1}{2}$ inches, overall.
Weight is 12 pounds, 4 ounces



GENERAL RADIO Company
275 Massachusetts Avenue, Cambridge 39, Massachusetts, U. S. A.
90 West St. NEW YORK 6 920 S. Michigan Ave. CHICAGO 8 1000 N. Seward St. LOS ANGELES 28

- Admittance Meters \star Coaxial Elements \star Decade Capacitors
- Decade Inductors \star Decade Resistors \star Distortion Meters
- Frequency Meters \star Frequency Standards \star Geiger Counters
- Impedance Bridges \star Modulation Meters \star Oscillators
- Variacs \star Light Meters \star Megohmmeters \star Motor Controls
- Noise Meters \star Null Detectors \star Precision Capacitors
- Pulse Generators \star Signal Generators \star Vibration Meters \star Stroboscopes \star Wave Filters
- U-V-F Measuring Equipment \star V-T Voltmeters \star Wave Analyzers \star Polariscopes