

# PROCEEDINGS OF The Institute of Radio Engineers

Volume 8

JUNE, 1920

Number 3

## CONTENTS

	PAGE
OFFICERS OF THE INSTITUTE OF RADIO ENGINEERS . . . . .	170
A. HOYT TAYLOR AND A. CROSSLEY, "THE USE OF GROUND WIRES AT REMOTE CONTROL STATIONS" . . . . .	171
DISCUSSION ON THE ABOVE PAPER . . . . .	191
CYRIL F. ELWELL, "THE ROME RADIO STATION OF THE ITALIAN NAVY" . . . . .	193
NOBORU MARUMO, "SIMULTANEOUS TRANSMISSION AND RECEPTION IN RADIO TELEPHONY" . . . . .	199
MARIUS LATOUR, "RADIO FREQUENCY ALTERNATORS" . . . . .	220
JOHN H. MORECROFT, "SOME NOTES ON VACUUM TUBES" . . . . .	239

## GENERAL INFORMATION

The PROCEEDINGS of the Institute are published every two months and contain the papers and the discussions thereon as presented at the meetings in New York, Washington, Boston, Seattle, San Francisco, or Philadelphia.

Payment of the annual dues by a member entitles him to one copy of each number of the PROCEEDINGS issued during the period of his membership.

Subscriptions to the PROCEEDINGS are received from non-members at the rate of \$1.50 per copy or \$9.00 per year. To foreign countries the rates are \$1.60 per copy or \$9.60 per year. A discount of 25 per cent is allowed to libraries and booksellers. The English distributing agency is "The Electrician Printing and Publishing Company," Fleet Street, London, E. C.

The right to reprint limited portions or abstracts of the articles, discussions, or editorial notes in the PROCEEDINGS is granted on the express condition that specific reference shall be made to the source of such material. Diagrams and photographs in the PROCEEDINGS may not be reproduced without securing permission to do so from the Institute thru the Editor.

It is understood that the statements and opinions given in the PROCEEDINGS are the views of the individual members to whom they are credited, and are not binding on the membership of the Institute as a whole.

PUBLISHED BY

THE INSTITUTE OF RADIO ENGINEERS, INC.  
THE COLLEGE OF THE CITY OF NEW YORK

EDITED BY

ALFRED N. GOLDSMITH, Ph.D.

# OFFICERS AND BOARD OF DIRECTION, 1920

(Terms expire January 1, 1921; except as otherwise noted.)

**PRESIDENT**  
JOHN V. L. HOGAN

**VICE-PRESIDENT**  
ERNST F. W. ALEXANDERSON

**TREASURER**  
WARREN F. HUBLEY

**SECRETARY**  
ALFRED N. GOLDSMITH

**EDITOR OF PUBLICATIONS**  
ALFRED N. GOLDSMITH

**MANAGERS**  
(Serving until January 4, 1921)

FULTON CUTTING  
LLOYD ESPENSCHIED

CAPTAIN GUY HILL  
DONALD McNICOL

DAVID SARNOFF  
(Serving until January 3, 1922)

EDWIN H. ARMSTRONG  
ROBERT H. MARRIOTT

ADMIRAL W. H. G. BULLARD  
MAJOR-GENERAL G. O. SQUIER

**ADVERTISING MANAGER**  
LOUIS G. PACENT

## WASHINGTON SECTION ACTING EXECUTIVE COMMITTEE

**CHAIRMAN**  
B. R. CUMMINGS  
Navy Department,  
Washington, D. C.

LOUIS W. AUSTIN  
Navy Department,  
Washington, D. C.

CAPTAIN GUY HILL  
War Department,  
Washington, D. C.

COMM. A. HOYT TAYLOR  
Navy Department,  
Washington, D. C.

## BOSTON SECTION

**CHAIRMAN**  
A. E. KENNELLY,  
Harvard University,  
Cambridge, Mass.

**SECRETARY-TREASURER**  
MELVILLE EASTHAM  
11 Windsor St.,  
Cambridge, Mass.

## SEATTLE SECTION

**CHAIRMAN**  
L. F. CURTIS,  
University of Washington,  
Seattle, Washington

**SECRETARY**  
J. R. TOLMIE,  
University of Washington,  
Seattle, Washington.

**TREASURER**  
E. H. I. LEE, Seattle, Washington

## SAN FRANCISCO SECTION EXECUTIVE COMMITTEE

**CHAIRMAN**  
W. W. HANSCOM,  
848 Clayton Street,  
San Francisco, Cal.

**SECRETARY-TREASURER**  
MAJOR J. F. DILLON,  
526 Custom House,  
San Francisco, Cal.

ABRAHAM PRESS  
University of California,  
Berkeley, Cal.

COPYRIGHT, 1920, BY  
THE INSTITUTE OF RADIO ENGINEERS, INC.  
THE COLLEGE OF THE CITY OF NEW YORK  
NEW YORK, N. Y.

# THE USE OF GROUND WIRES AT REMOTE CONTROL STATIONS\*

By

A. HOYT TAYLOR

(LIEUTENANT-COMMANDER, UNITED STATES NAVAL RESERVE FORCE)

AND

A. CROSSLEY

(LIEUTENANT (J. G.), UNITED STATES NAVAL RESERVE FORCE)

In previous papers, one of the writers has indicated some of the advantages of a subterranean receiving system for remote control purposes. Those advantages may be briefly enumerated again here.

First. Ground wires have a high degree of directivity which can be utilized for shutting out nearby interference.

Second. For short waves they have an optimum wire length which may be utilized to obtain a far higher degree of selectivity than is possible with an ordinary antenna.

Third. Static is entirely eliminated, permitting successful operation without danger to the operators thru heavy storms.

Fourth. All strays are greatly reduced if it is possible to obtain moist ground for the installation.

Fifth. The ground wires lend themselves readily, under proper conditions of installation, to the use of balanced or stray eliminating systems.

In view of these advantages it seemed possible that a type of remote control might be developed which would not really be remote at all, but could be operated in very close proximity of the sending station. The first experimental work on ground wires with the direct object of studying remote control problems was done at New Orleans by Mr. H. H. Lyon under the supervision of Lieutenant-Commander E. H. Loftin. The first reports of this work were perhaps a little too enthusiastic. Subsequent developments at New Orleans, which will be discussed in detail later, showed that the early investigations at New

\* Received by the Editor, May 24, 1919. Presented before THE INSTITUTE OF RADIO ENGINEERS, New York.

Orleans had overlooked one or two important advantages of the ground wire system and also several serious difficulties, which are sure to be encountered in the location of a receiving set within a short distance of a powerful transmitter. The writers, therefore, undertook elaborate experiments at Great Lakes which resulted finally in the building of the Great Lakes remote control station at the foot of the bluff, distant only 600 feet (183 m.) from the nearest tower of the transmitting station. The preliminary work was done in a tent on the beach, the wires being laid north and south as nearly as possible at right angles to a line drawn to the base of the transmitting antennas, of which there were two, both "T" antennas, one suspended from the tops of the two 400-foot (122 m.) towers and the other from points 150 feet (45.8 m.) above the earth. The lower antenna was used on spark work from 600 to 1,500 meters, in connection with a 5-kilowatt Telefunken set, and the larger antenna was used on spark work from 1,500 meters to 3,400 meters and on arc work from 3,000 to 10,000 meters. The arc set was 30 kilowatt and at 6,000 meters would put 50 amperes into the antenna. The wave lengths commonly used were 4,000 meters and 6,000 meters for the arc, and 600 and 1,600 meters for the spark. At these wave lengths, the two antennas, altho one was directly under the other, did not seem to create any serious mutual interference, and it proved to be possible to operate both the spark and arc simultaneously without experiencing any trouble. The desirability of having a remote control station at Great Lakes was brought about by the fact that it was necessary at times to suspend ship-to-shore work on the spark set in order to carry on transmission and reception on long waves. It was deemed desirable to build a remote control station for this purpose, so that spark and arc work might be carried on simultaneously without mutual interference. The preliminary work on the beach developed at once the necessity of having the receiving sets perfectly screened from direct radiation. The tent was therefore covered with wire screening, which had no effect whatever, apparently, until this was made to include the floor and all joints were carefully sewed with wire so as to make a good connection. A very small crack in the door of the screen cage would admit sufficient energy from the nearby transmitter to play havoc with the reception of distant signals. It was even found necessary carefully to screen the leads from the ground wires where they came up into the tent, pieces of screening being wrapped carefully around them to within two inches (5 cm.)

of the receiving set. This screening was connected to the main cage. There seemed to be little difference whether the cage was grounded to the wet sand or whether it was left insulated. Having thus perfected the screening of the receiving sets, both for long wave and short waves, from direct action, the leads of a pair of ground wires were laid as nearly as possible so as to be at right angles to the direction of the transmitter. There was, nevertheless, sufficient asymmetry in the ground to the north and south of the tent, or there was some small deviation from the  $90^\circ$  relationship, so that an undesirable amount of signal, especially on certain wave lengths, penetrated to the receivers. It was found possible to offset this by the use of a very small loop in series with one of the ground wires and placed outside of the tent. By rotating this loop a component in the opposing direction could be picked up, which would nearly neutralize any accidental asymmetry of the ground wires. This loop was only found necessary when transmitting and receiving simultaneously on identical wave lengths. This is a rather difficult feat to accomplish when the nearest transmitting tower is only 600 feet (183 m.) distant. It was, however, very successfully accomplished with the Naval Station at Milwaukee, 50 miles (80 km.) to the north. Signals from Milwaukee were perfectly received and with many times the audibility necessary for readability, at the same time that the Great Lakes transmitter was working ships on 600 meters, that is to say, on the same wave on which Milwaukee transmitted. Simultaneous transmission and reception on identical waves, altho demonstrated by these experiments to be possible, is not recommended as a practical proposition, as the adjustments are admittedly very delicate and the greatest precautions have to be taken to get exact compensation or balancing out of the transmitter signals on the two halves of the underground collecting system. When transmitting and receiving on different wave lengths, altho desirable, it is not absolutely necessary that the receiving wires lie at right angles to the direction of the transmitter. The ground wires have one very remarkable and interesting property when used very close to the transmitter, namely, the electrical impulses which they pick up are not nearly as strong as might be expected. It appears that before the wave obtains the necessary forward slant which makes ground wire reception possible, they must travel some little distance from the transmitter. Perhaps a better way of looking at it would be to say that the ground currents which go with the actual radiation are, in the

immediate neighborhood of the antenna, partially offset by true conduction currents. Whatever the reason may be, it is certainly a fact that a ground wire led within a few hundred feet (a hundred meters) of the antenna, does not receive the tremendous signal that one might expect when one compares that with what might be received on an ordinary antenna equally near. For instance, a wire leading straight east into the lake 500 feet (153 m.) long was tuned to 8,600 meters and brought in a signal from New Brunswick of audibility in excess of 10,000. At the same time Great Lakes was transmitting on 6,000 meters with 50 amperes in the antenna, and the audibility of Great Lakes signals was only 200. If it were not for this feature of the ground wires, it would be necessary for the control station, which may perhaps no longer be called remote control station, to be split into two parts, one a short distance south or north of the transmitter, and receiving on east-and-west wires, and the other a short distance east or west of the transmitter and receiving on north-and-south wires. Only in this way could reception from all points of the compass be covered. Thanks to the peculiar lack, or rather relative lack of responsiveness of the ground wires in the immediate vicinity of the transmitter, it is possible to effect a compromise and receive fairly well on a wire which is in line with the transmitter, provided transmission and reception are not attempted on waves which are too close together. During the reception of arc signals on long waves at the beach station in the shielded tent, using north-and-south wires, it was practically impossible to tell when Great Lakes was working on the spark set on either 600 or 1,500 meters. It was to be expected, however, that when an easterly wire was used against the ground, that the spark signals would come in the arc receiving set with tremendous intensity. It was an agreeable surprise to find that the audibility of the Great Lakes spark waves up to 1,500 meters seldom rose to more than 15 on the east-and-west combination. 18 amperes was radiated into the large antenna on the 1,500-meter spark and it always caused greater interference on long waves than on 600-meter spark, but even when using the easterly wires and copying, say Arlington on 6,000 meters or San Diego on 12,500 meters, the operation of the 1,500 meter spark was barely noticeable. An analysis of the Great Lakes traffic showed that most ships were worked either when considerably north of Great Lakes or just after leaving Chicago, in which case they were nearly south of Great Lakes. It was believed therefore that north-and-south

wires adjusted for 600 meters would handle all of the necessary ship-to-shore work. Such subsequently proved to be the case. On the other hand, the arc work was all, at that time, east and west, but owing to the non-interference of the spark on the long waves, even when the east wire was used, it was evident that all traffic could be well cared for by locating the remote control station at the foot of the bluff, due east, and 600 feet (183 m.) distant from the nearest tower. Land had been purchased at a point three and a half miles (5.6 km.) distant, but all plans for a station at that place were abandoned, and it was decided by the Bureau of Steam Engineering to put in the new type of remote control, which is no longer remote, at Great Lakes.

#### REMOTE CONTROL STATION, GREAT LAKES, ILLINOIS

In accordance with recommendations submitted to the Bureau of Steam Engineering, Navy Department, the remote control station was located on the beach, six hundred feet (183 m.) due east from the nearest tower and approximately nine hundred feet (275 m.) from the radio station. Due to the presence of shifting sands, the building was located forty feet (12 m.) back from the edge of the beach, where a hard-pan clay foundation was obtained. To prevent action from the shifting sands and winter ice from disturbing the foundation of the building, a crescent shaped breakwater was built in front of the building and filled in with cinders and rock. To protect the building further and to prevent the face of the bluff from sliding down upon the building from the rear, a retaining wall consisting of wooden piling with 2"×8" (5.1×20.3 cm.) cross planking was installed ten feet (3.1 m.) back from the remote control station, and the intervening space between the building and the retaining wall was levelled off. A general sketch showing location of the remote control building is given in Figure 1.

The remote control building consists of a one story brick structure 16.5×17.5 feet (5.0×5.3 m.). The interior of the building is divided into four rooms, one operating room 8×10 feet (2.4×3.1 m.),<sup>1</sup> one apparatus room, one clerk's room, and a toilet on the main floor, with a basement containing two rooms, one for fuel storage and the other housing the hot water heating unit. The operating room is electrostatically shielded, the walls, ceiling, and floor of same being covered with metal lath, the doors with number 22 galvanized sheet iron\* and the windows with 0.25-inch (6-mm.) mesh, galvanized iron netting. All doors

\* Thickness of number 22 gauge sheets = 0.025 inch = 0.063 cm.

and windows are electrically connected to the walls by means of suitable switches, which complete the electrical screening effect.

In order to minimize trouble from high voltage alternating current power leads, one man-hole was built in the bluff 110 feet (33.6 m.) north of the remote control building. The 2,300-volt,

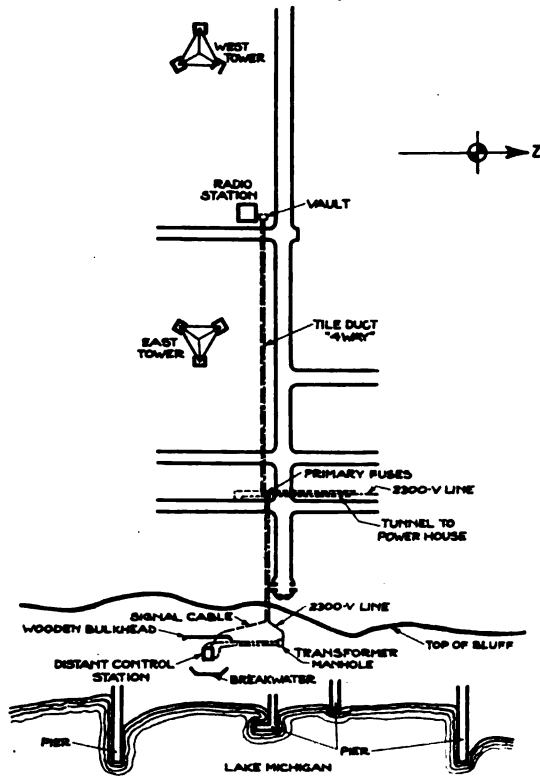

FIGURE 1

three-phase supply mains were led from the local power house by means of underground armored cable into this man-hole, and by means of two transformers, a 110-volt lighting and a 220-volt power source were led into the remote control building by means of two underground armored cables. The power mains supplied current for the battery charging unit which was situated in the basement of the building. All wiring of power and lighting circuits was run in Underwriter's standard conduit.

To minimize induction further from overhead telegraph



lines, all telegraph and telephone leads from the main station to the remote control station were run in a seven-pair standard, paper-insulated, lead-covered, armored, underground telephone cable. The armor of all telegraph, power, and lighting cables was grounded to the water mains upon entering the building. The telephone cable terminates at both the remote control and the main station in an eleven-pair cable terminal box (W. E. Type 14-B). At the remote station, all control and telephone leads from the cable terminal box are run in number 14 duplex, rubber-covered, lead-covered cable\* to the various keys and switches. Lead-covered cable was also used at the transmitting station for leads to the various relays and switches. The telegraph equipment for the remote control system consists of six telephone pairs, one pair for each of the following circuits:— spark telegraph, arc telegraph, signal, stop-start switch, local station telephone, and long distance telephone. The spark and arc telegraph circuits control the spark and arc transmitting sets. The signal circuit is used to notify the transmitting station operator when to start and stop the transmitting sets and to change to the different wave lengths. The stop-start switch is connected to the automatic starting panel of the spark transmitting set and allows the remote control operator to operate the spark transmitting set independent of the main station operator. Using 150-ohm relays on various circuits, we found that a voltage of 12 volts was sufficient to operate the relays satisfactorily. Schematic diagram of the control circuits are shown in Figure 2.

The wave lengths used for general work were 600 meters (commercial lake business), 4,000, and 6,000 meters (trans-continental Naval work). Underground and underwater wires of optimum length for these wave lengths were installed. Due to previous experiments on short wave lengths, which proved that the efficiency of reception was increased six-fold when wires were laid in the lake as compared with wires laid in wet sand, it was decided that all wires should be submerged in the lake. This scheme, due to shifting sands, heavy surf, and winter ice, was abandoned for the installation of short wave length wires, with the exception of the due-east 600-meter wire, while for long wave length wires, the substitution of number 2 stranded conductor, † rubber-covered wire for the first one hundred feet (30 m.) for the shore end and of standard underground cable for

---

\* Diameter of number 14 wire = 0.034 inch = 0.162 cm.

† Diameter of number 2 wire = 0.257 inch = 0.655 cm.

the rest of the length, proved a very satisfactory installation. The short wave length wires were then installed in the sandy beach at a depth which insured permanent water level. The lake wires were made fast to concrete mushroom anchors, at each two hundred feet (60 m.) distance from shore. These anchors were of the following dimensions—12×12×4 inches (30.5×30.5×10.2 cm.) and were fitted with eye-bolts. The

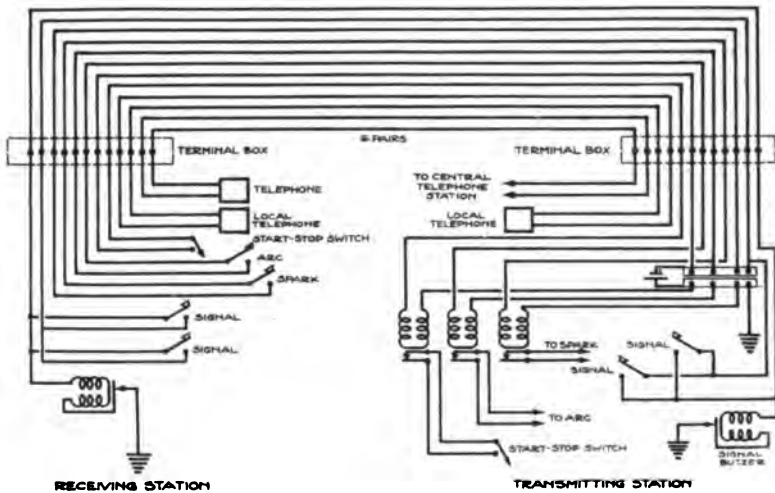

FIGURE 2

underground wire used for the installation consists of seven strands of number 22 tinned copper†, insulated with .025-inch (6-mm.) layer of 40 per cent Para rubber and two layers of braid. This wire was given three coats of R. I. W. water-proofing paint, each coat applied evenly by means of two reels and a paint container. The wire was taken from one reel, run thru the paint container, and then wound upon the second reel. Each coat was allowed to dry for three days. See Figure 3 for diagram of container and reels. The above mentioned method of applying paint to wires saves time and trouble and allows the paint to dry without being rubbed off, as is generally the case when paint is applied by ordinary methods. The ends of all underground wires were insulated with rubber tape, and the tape vulcanized and then immersed in a six inch section of

† Diameter of number 22 wire = 0.025 inch = 0.064 cm.

0.75-inch (1.9-cm.) iron pipe, this pipe being filled with asphaltum. The pipe was then dipped into hot asphaltum, and the pipe and wire for a distance of 12 inches (30.5 cm.) served with marline and the same painted with two coats of R. I. W. paint. The method used in vulcanizing the rubber tape consisted of

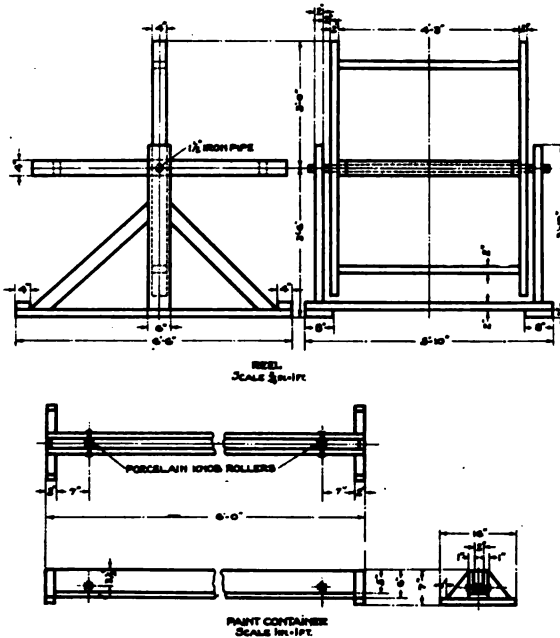

FIGURE 3

holding a lighted paper under the taped joint and revolving the wire, using the hands to compress the heated rubber. The heat from the lighted paper in all cases was sufficient to vulcanize any size joint, and served our purpose very well. To facilitate testing and repairing underground wires, all wires were led to an outlet box situated twenty feet (6 m.) from the water's edge and at the base of the breakwater. Leading from this box to the terminal manhole is a wooden duct, twenty feet (6 m.) long, twelve inches (30.5 cm.) high and twenty inches (50.8 cm.) wide. This duct is approximately nine feet (2.7 m.) underground. The terminal man-hole is made of red brick and is four feet (1.2 m.) square and ten feet (3.1 m.) deep, the top and sides being electrostatically screened and the top fitted

with a circular iron man-hole plate. The underground wires were brought into the man-hole, from thence were run thru conduit to the operating tables. The short wave length wires were separated from the long wave length wires and brought into the building at different levels, in order to minimize interference between wires when working, both receiving sets using autodyne reception. The long wave lengths wires terminated at the selector switch on the arc receiving operator's table, while the short wave length wires terminated on the spark receiving operator's table. The selector switch consists of a series of nickel-plated brass studs placed in a semi-circular form and spaced a short distance apart from each other on a bakelite panel. Situated in the center of this semi-circular form are two movable contact fingers, insulated from each other and connected to two separate binding posts at the base of the panel. The different underground wires are soldered to the various studs and by means of the movable contact fingers, any combination of underground wires may be obtained. From the binding posts on the selector switch leads are run to the receiving set. The receiving apparatus consists of the regular inductively coupled receiver, an audion detector and a two stage audio-frequency amplifier. For continuous wave reception a so-called tickler coupling is used between the secondary of the receiver and the plate circuit of the audion detector.

As a "safety first" measure, should an accident occur due to ice floes during the early spring damaging our long wave length lake wires, a rectangle or loop consisting of twelve turns of antenna wire spaced nine inches (22.9 cm.) apart, eighty feet (24.4 m.) long by twenty feet high (6.1 m.), was constructed. This rectangle was situated fifteen feet (4.6 m.) south of the building, with its plane pointing towards Mare Island, California. Leads from this rectangle were led into the building to the selector switch in armored cable ("BX" Type). To prevent bringing external interference into the building from the rectangle when same was not in use, a double-pole double-throw switch was inserted in series with the rectangle leads. By means of this switch the rectangle can be grounded or connected to the receiving apparatus at will. This switch was placed in a weather-proof box on the outer south wall of the building. Figure 4 shows plan of underground system and rectangle.

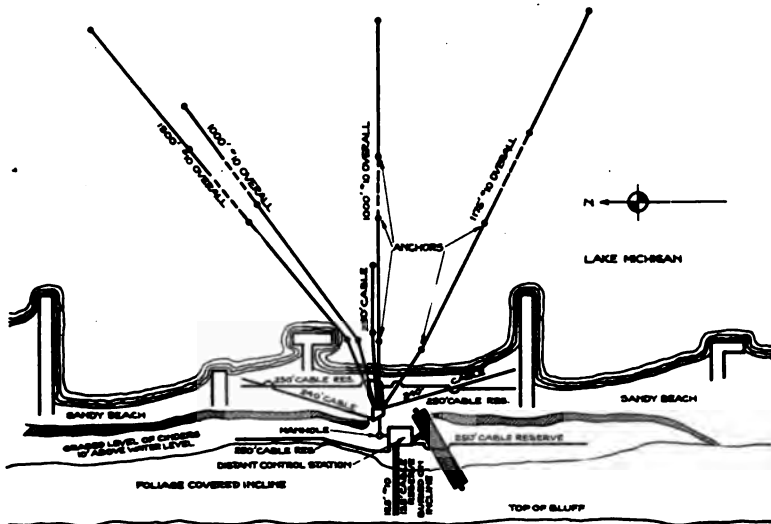

FIGURE 4

#### REMOTE CONTROL RADIO STATION, NAVAL BASE, HAMPTON ROADS, VIRGINIA

Due to the enormous amount of radio traffic thrust upon the Norfolk Navy Yard radio station and the inability of this station to handle this traffic, the Bureau of Steam Engineering, Navy Department, decided to control remotely the Navy Yard station from the site of the old Jamestown Exposition, a distance of 7.8 miles (12.5 km.) north of the Navy Yard. The underground system having proved efficient for remote control work, it was decided to install the same at the Naval Base to control remotely two 5-kilowatt spark and one 30-kilowatt arc transmitting sets at the Navy Yard.

The site for the control station was selected by the local radio organization, the same being three rooms on the second floor of the administration building and the Bureau of Steam Engineering's representative had to fit the installation to the allotted quarters. One concrete man-hole of hexagonal shape, six feet (1.8 m.) in diameter was constructed in the basement of the above mentioned building directly under the center receiving room. From this man-hole trenches were dug in the following directions—East, West, North 6° East, and South 40° East, to a depth that insured permanent water level. The water level obtained in the various trenches varied from 3.5 to 9 feet (1.1 to 2.7 m.),

and consequently the depth of each trench varied in accordance with these depths.

In order to facilitate quick repair to underground wires, concrete manholes  $2 \times 3.5 \times 6$  feet ( $0.6 \times 1.1 \times 1.8$  m.) were situated 490 feet (149 m.) apart in each direction. These man-holes were fitted with concrete covers, which, when laid in position, were flush with the graded level of the ground in that vicinity. Figure 5 shows detail of external manholes and center man-hole.

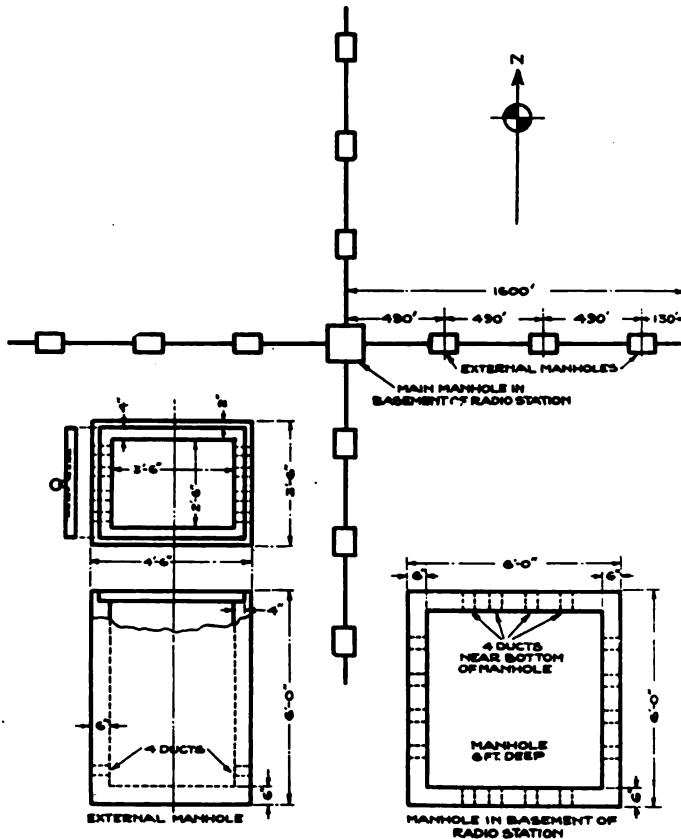

FIGURE 5

The general scheme of the underground wires used consists of five wires buried in each trench, two 600-meter wires 250 feet (76 m.) in length, one 952-meter wire 387 feet (118 m.) in length, one 1,600-meter wire 650 feet (198 m.) in length

and one 4,000-meter wire 1,600 feet (488 m.) in length. The underground wires used at the Naval Base are of similar construction to the wires used at Great Lakes, with the exception that the Norfolk wires have an extra insulation of three layers of empire cloth. These extra layers of empire cloth are located between the rubber and braid. The Norfolk wire is classified in the Navy stock list as the "Standard Packard Ignition Cable." All underground wires were painted similarly to the wires at Great Lakes before being buried, and in all cases splices were made in the various man-holes. After all wires were laid and before the trenches were back-filled, tests were made on wires for grounds, using a volt meter and a 110-volt direct current testing source. Any wire showing a ground exceeding one volt was replaced or cause for poor insulation remedied. The general lay-out of the underground wires, together with a plan of the wiring of the main man-hole, is given in Figure 6.

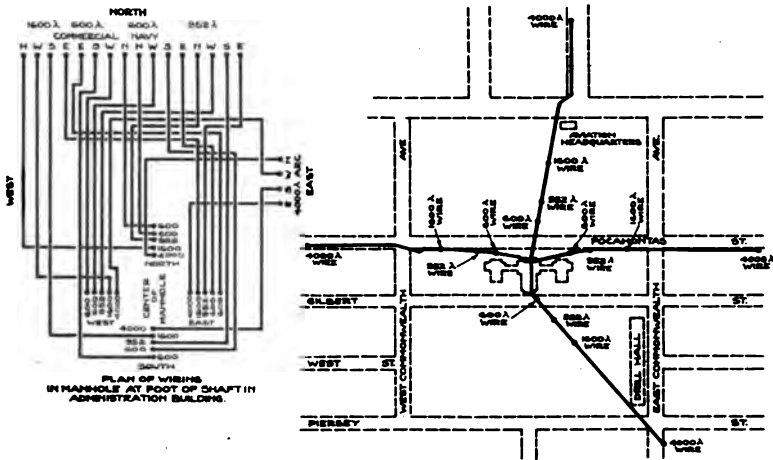

FIGURE 6

From the main man-hole, the wires are led up thru a wooden shaft and under the flooring of the second story to the different receiving rooms. All wires after leaving the manhole are spliced to lengths of number 10 rubber covered wires\* and these lengths insulated from the shaft by porcelain knobs, these knobs being secured to the woodwork with brass screws. Where wires cross

\* Diameter of number 10 wire=0.101 inch = 0.258 cm.

beams or lead thru flooring, loom is used for insulation purposes and for protection from abrasion between the floor and the operating table, the wires were run thru 0.375-inch (9-mm.) brass tubing. Figure 7 shows general scheme of wiring to the different selector switches in the various receiving rooms at Norfolk.

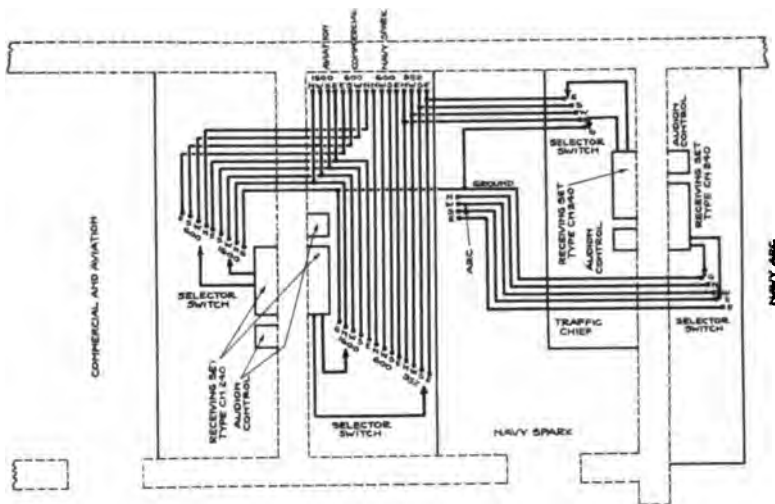

FIGURE 7

There are three receiving rooms, the aviation and commercial, the Navy spark, and the Navy arc. The Navy spark room is situated over the shaft, the aviation and commercial room is west of the Navy spark room, and the Navy arc room is east of the Navy Spark room. Four 600-meter, four 1,600-meter, and one ground wire lead to the selector switch in the aviation and commercial room. Four 600-meter, four 1,600-meter, four 952-meter, and one ground wire lead to the selector switch on the operator's table in the Naval spark room, and from the four 952-meter wires, taps were run to the selector switch on the traffic chief's table in the same room. Four 4,000-meter and one ground wire are led to the selector switch on the table in the Navy arc room. The ground wire referred to in this paragraph consists of a number 4 stranded, rubber-covered cable\* which is grounded to the water system and also to a fan net-work of wires

\* Diameter of number 4 wire = 0.204 inch = 0.515 cm.



under the building. The connections of the receiving apparatus are identical to those used at Great Lakes. Figure 8 shows schematic diagram of receiving system used with the underground wires.

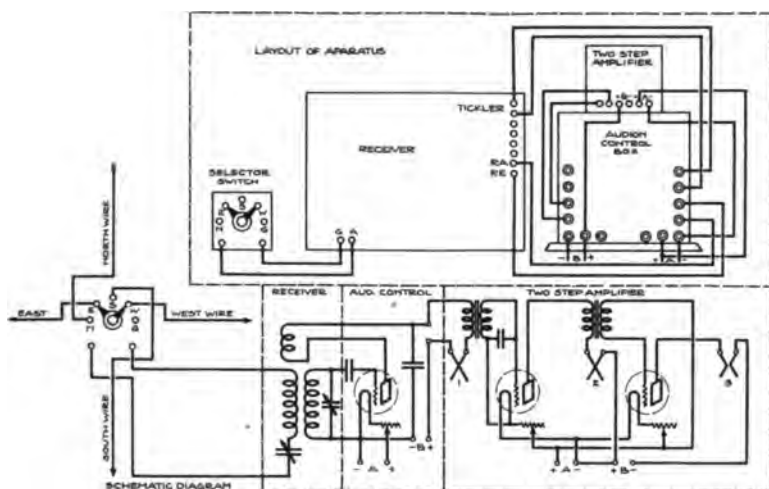

FIGURE 8

The telegraph equipment between the remote control station and the transmitting station, consists of six pairs in lead-covered cable, one pair for each of the two spark transmitting sets, one pair for the arc transmitting set, and one pair for the operator's signal, leaving two spare pairs for future expansion and emergency purposes. At each station all pairs terminate at a ten-pair Western Union button switch, and from this switch leads are run to the various keys and relays. The source of current supply for the telegraph system is obtained from a bank of Edison storage batteries, giving a voltage of 100 volts and a capacity of 37.5 ampere hours. This battery is looped in series with each pair and all pairs are fused with a standard one-ampere telephone fuse. Two motor generator charging sets of 60-volt, 30-ampere capacity are used at the control station for charging the telegraph and audion batteries, one set being used as a spare for emergency purposes. The room in which the motor generators and telegraph batteries and terminal boxes are situated, is electrostatically screened, and is of similar construction to the operating room at the remote control station at Great Lakes.

This screening protects the receiving rooms from stray electric fields from the motor generator charging units. All leads from the charging room to the receiving rooms are run in lead-covered number 14 rubber-covered duplex cable\* further to minimize external interference. A schematic diagram showing the telegraph control lines is given in Figure 9.

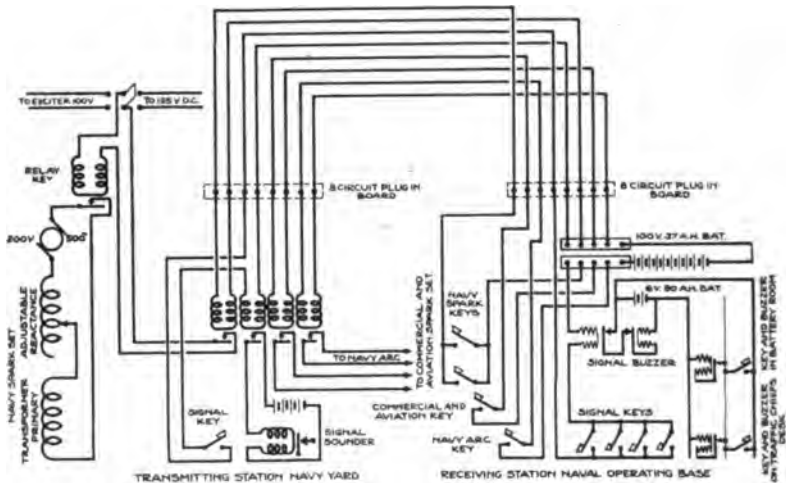

FIGURE 9

### REMOTE CONTROL INSTALLATION AT NAVAL RADIO STATION, NEW ORLEANS, LOUISIANA

The Naval radio station at New Orleans is now being equipped with the underground receiving system, by means of which one 5-kilowatt spark and one 30-kilowatt are being remotely controlled from a receiving station which is approximately 2,200 feet (671 m.) distant from the center of capacity of the main transmitting antenna. The general scheme as used at New Orleans is similar to that used at the Naval Base at Hampton Roads, with the exception that a double Faraday cage is used to protect the receiving instruments at the receiving station. This double Faraday cage consists of two cages, the outer cage being grounded and the inner cage insulated by means of ebonite or porcelain insulators from the outer cage. These cages are constructed by the use of copper mosquito netting. The double

\* Diameter of number 14 wire = 0.004 inch = 0.162 cm.

Faraday cage gives much better screening effect than a single cage and has been used with great success in foreign countries.

#### CHARACTERISTICS OF THE UNDERGROUND SYSTEM

The underground system for long wave reception, using optimum length wires, gives roughly the same signal strength as an average 100-foot (31-m.) antenna; while for short wave lengths the signal strength received is a function of the wave length, and it may be said that the shorter the wave length, the weaker the signal. This may be attributed to the skin effect of radio frequency current with reference to the penetrating qualities of such current thru a partial conductor. For a wave length of 600 meters, the signal strength as received by the underground system, is approximately one-twelfth as strong as a signal received with the overhead antenna. For efficient reception on short wave lengths, it requires an amplifier using three stages of radio-frequency, which gives a signal that is approximately of the same strength as that of a signal received on the overhead antenna unamplified.

The question is brought up concerning the efficiency of the system on short wave lengths when using high amplification. To this we may say that reception on short wave lengths by means of the underground system has never been affected by local static. This statement is based upon tests covering a period of two years, wherein the underground system for short wave lengths has been used thru all atmospheric conditions, and at no time have the operators been required to leave the instruments on account of the dangerous effect of local lightning storms. The foregoing statements have been verified at Norfolk, Great Lakes, and New Orleans, where many cases were recorded when the regular antenna had to be grounded to prevent damage to the set, and that during this time the underground system was used exclusively to handle all traffic. Stray elimination by the underground system on long wave lengths is not so pronounced as it is on short wave lengths, but by the use of the underground system in conjunction with the balanced system, this trouble is overcome.

The underground system has excellent directional qualities. Using two wires in the direction of the transmitting station, the maximum signal is obtained; while using two wires which lie in a direction which is at right angles to the transmitting station, the minimum signal is obtained, and in many cases the signal is not heard. It is possible that the operator on watch can, at

any time, ascertain the approximate direction from which the signals are coming by means of using various combinations of wires. A good stand-by tune, by which the operator can hear all stations, is obtained by the use of two wires at right angles to each other, namely an east-and-south or east-and-north combination, and so on.

Because of the selectivity of the system and the sharp tuning of the primary, the system is admirably adapted to distant control work. Using a comparatively tight coupling at the remote control station, Naval Base, Norfolk, no difficulty is had in reading stations with one hundred meters difference in wave length when Norfolk is transmitting. The Norfolk Navy Yard being due south of the distant control station, ships operating on 952 meters at sea, east of the remote control station, are readable thru Norfolk when both stations are transmitting on 952 meters. Many combinations are obtained by using different sets of wires, which help out the operator in eliminating interfering stations.

It is very essential in this system that all wires be perfectly insulated; wires that are grounded bring in more strays altho when wires have been perfectly grounded, the stray ratio is still equal to and often better than that of the regular antenna. However, to obtain the best results from the system, the wires should be clear of all grounds. Grounded wires do not appreciably affect the received signal strength. This, of course, depends upon the conductivity of the medium in which these wires are buried, the greater the conductivity, the weaker the signal.

For short wave lengths it is highly essential that the optimum length of wire for each wave length be used. Altho by means of high amplification the proper signal strength may be obtained, for efficient results the optimum length should be used. For long wave length reception it has been found that a length of 1,500 feet (458 m.) of wire is capable of receiving signals up to 17,000 meters wave length, but where available space can be obtained, it will be of great advantage to use wires as near optimum length as possible, as by the use of these wires, minimum amplification is needed, and therefore troubles experienced from internal amplifier noises are reduced to a minimum. Referring to a previous statement in this paper, with reference to the depth to which wires should be buried to obtain proper water level, it may be stated that there are many cases where the cost of digging trenches to the proper water level will be prohibitive. In this case it may be said that excellent results have been ob-

tained at various stations, where wires have been buried from two to four feet (0.6 to 1.2 m.) below the surface. As regards stations situated along the seacoast, it may be stated that it is highly detrimental to the efficiency of the station if short wave length wires are buried or submerged in salt water or salt water marshes, whereby these wires will be at times covered to a certain depth with salt water. The salt water being many times more conductive than fresh water, absorbs to a great extent short wave length signals, while for long wave lengths this effect is not so pronounced. For long wave lengths the depth of penetration is a function of the wave length, and the longer the wave length the greater the penetration. In the case of installing a system along the seacoast, it is recommended that the short wave lengths wires be buried in moist ground and not in salt water marshes. The case is opposite where fresh water lakes or rivers are near the site of the receiving station, for in this case it has been found that wires submerged in fresh water lakes or rivers give much better results than wires buried in moist ground or salt water marshes.

There is a tendency on the part of operators to disparage the ground wire system during the winter months when strays are at a minimum, because of the fact that the signals are so much weaker than they are on an antenna with the same degree of amplification, but during the summer months the ground wire system demonstrates its superiority. In the matter of eliminating interference from nearby stations it is, of course, always superior. The first short wave receiving sets supplied for ground wire work were decidedly inefficient, and for this reason short wave signals were not what they should have been. This difficulty is being remedied at the present time by issuing, for short wave work, highly efficient regenerative receivers with both radio and audio frequency amplification. Preliminary tests of these receivers have shown that they are peculiarly well adapted for this work and no further difficulties in short wave reception on ground wires are anticipated.

#### SUMMARY

1. The general theory of remote control using the ground wire installation for receiving has been discussed.
2. The installation at Great Lakes has been described in detail.
3. The installation at Norfolk has been described in detail.

4. The work under way at New Orleans has been briefly mentioned.

5. The general peculiarities of the system in actual operation have been commented upon.

**SUMMARY:** By utilizing the directional selectivity of subterranean receiving antennas, it has proven possible to install receiving stations in the immediate vicinity of transmitting stations.

The proper design of the underground antennas, the construction of the shielded rooms for the receiving sets, and the mode of "remotely" controlling the nearby transmitting station are described in detail.

The complete design, lay-out, and installation of several such Naval "remote" control stations is then given. Their proper mode of use and advantages are considered.

## DISCUSSION

**John Mills:** Commander Taylor in the present paper and in several recent and interesting papers, has described methods of reducing static strays and also foreign station interference. In some instances he has described his results in terms of a ratio giving the advantage of one system over another. The subject is one of very great interest. In his own papers and in others which have recently appeared, the results of work were given in a form which I am unable to interpret quantitatively. I wish, therefore, to suggest for the consideration of the Institute a method for the quantitative comparison of receiving systems so far as concerns their ability to reduce static or interference. As it happens, the method which I am suggesting is one which I devised in the early part of 1916 when, for two or three months, I was employed in studying receiving circuits.

It is first necessary to choose arbitrarily some simple receiving circuit and antenna as a standard of comparison to which all other forms of receiving circuit or antennas may be referred. A switching system is provided so that one may listen alternately on the standard system and on the one under examination. Tests should be made by reading signals in code, not ordinary English words, for two minute intervals, first on one system and then on the other over a considerable period of time. The tests should be made not only by good operators and those specially gifted with the sense of absolute pitch, but by mediocre and even poor operators. The signals should be locally generated and supplied to the antenna thru some coupling arrangement, either a loose inductive coupling or a unilateral device like a vacuum tube. These signals are superimposed upon the static or interference. The intensity of the signals should be adjusted to be equal in the two systems as observed in the telephones. Their intensities should also be so adjusted with reference to the static or interference that the latter are appreciably troublesome. As a rough measure of the advantage of the system under examination, we then have the ratio of the percent of correct signals received thru it to the corresponding number received on the standard system. Let these percentages be  $N_2$  and  $N_1$ , respectively.

To obtain a more exact and physical measure of the advantages of one system over the other, I would proceed as follows: Work entirely with the standard system and so adjust the current, energy, voltage or audibility of the signal, whichever one wishes, that the percentage of intelligible signals is  $N_1$ . Now

alter the intensity of the locally generated signals until the percent of correctly received signals is altered to a second value of  $N_2$ . Personally I prefer to deal with the energies which are supplied in the two cases, that is, the square of the input currents rather than with current, voltage or audibility. Let the energies corresponding to the conditions of the receiving set, which have just been described, be respectively,  $E_1$  and  $E_2$ . Then the ratio of  $E_2: E_1$  gives a quantitative expression for the efficiency of system number 2 as compared to the standard system.

It is evident that as long as the type of interference and the intensity of interference does not change, there will be a fairly definite relation between the percentage of intelligibility and the energy of the local signal in the standard circuit. Under certain conditions, therefore, it may not be necessary to form the calibration described above, for all of the conditions made within the circuits under test, since the relation of  $N$  and  $E$ , just mentioned, can be determined by a few observations.

It is also evident that the system which is described permits of a very satisfactory quantitative measure of static or station interference. It does not, of course, give root-mean-square or peak value of static, which are probably only of academic interest, but it does give a measure of what the engineer is usually interested in, namely, the difficulty of getting a message thru. Using therefore, a calibrated detector and a calibrated oscillator as a source of local signals, it is possible to compare static or station interference on different occasions by the inverse ratio of the percentages of correct signals which are received on the two different occasions, assuming, of course, the same efficiency of detection and also of strength of local signal.

I make no claim, of course, that this is the optimum system for the quantitative comparison of receiving systems or static and station interference. I feel, however, that so much is now being written and published on these matters that it would be of great advantage to the Institute to consider seriously the adoption of some simple and standard method for expressing the results obtained.



# THE ROME RADIO STATION OF THE ITALIAN NAVY\*

BY

CYRIL F. ELWELL

(RADIO ENGINEER, PARIS, FRANCE)

The design of a high-power radio plant under the stress of war conditions tends to emphasize factors which would not have to be considered in peace time. It may be of interest to review the reasoning which resulted in the design hereafter described. Naturally, the outstanding factor was that of time, as the plant was required because of the congestion of both the cable and radio equipment to America, as well as to the Italian colonies in Africa.

## ANTENNA SUPPORTS

### SELECTION OF TYPE

Of the three available forms of antenna support, namely: self-supporting steel towers, guyed steel masts, and guyed wooden masts, the first was immediately rejected as not being compatible with the essential factor of time. The choice then lay between steel and wood. The distance over which good communication was desired being 4,200 miles (7,000 km.), a large effective height was a necessity. For the same height of mast, wood gives an effective height appreciably superior to steel. Altho the highest existing wooden masts were 608 ft. (185 m.) high, it was considered feasible to adopt the same type of construction for masts of 714 ft. (218 m.) in height, without having recourse to excessively large timbers in the bottom sections. To obtain the same effective height with steel, it would have been necessary to erect masts of at least 750 ft. (228 m.), which with the lightest design would have entailed the employment of about 300 tons (27,000 kg.) of fabricated steel for three masts. With demands much above possible production, the factors of price and time of delivery were such as made the decision in favor of 105,000 board feet (248 cu. m.) of pitch pine an easy matter.

\* Received by the Editor, October 14, 1919.

## DESIGN DETAILS

Wind load employed for the calculation of the stresses in the guys, bracing and columns—61.5 lb. ft.<sup>2</sup> (300 kg. m.<sup>2</sup>).

Horizontal component of the antenna pull—22,000 lb. (10,000 kg.).

Factor of safety allowed for the guys—varied from 3 to 4, as a single size of wire rope was used for simplicity.

Maximum stress allowed in the wood—1,000 lb. in.<sup>2</sup> (70 kg. cm.<sup>2</sup>).

Number of sections—eleven.

Longest unsupported section—72 ft. (22 m.).

Number of supporting guys—11 sets of three at 120°.

Longest section of guy—between porcelain insulating breaks—82 ft. (25 m.).

Size of bottom column—12.6 in. × 16 in. (32 × 40 cm.).

Size of top columns—12.6 in. × 7.1 in. (32 × 18 cm.).

Figure 1 shows the bottom of a mast in detail. Figure 2 shows one complete mast, and Figure 3 the complete station.

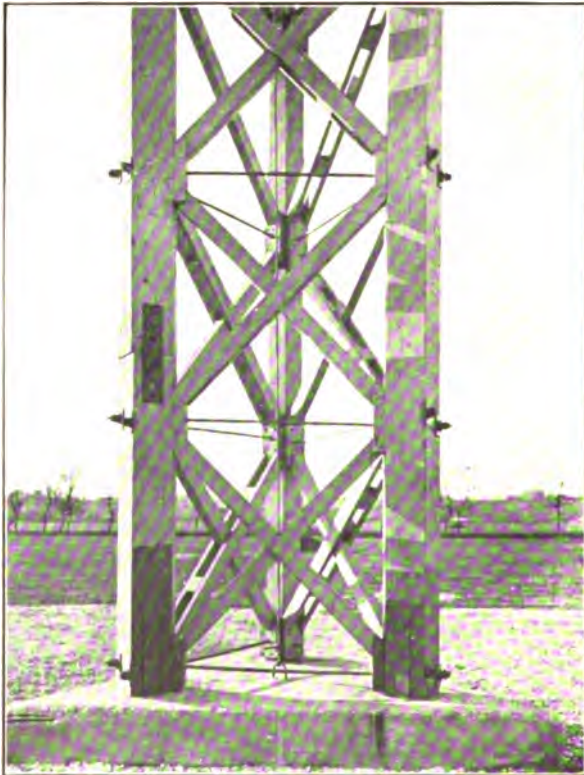

FIGURE 1—Foot of Wooden Tower

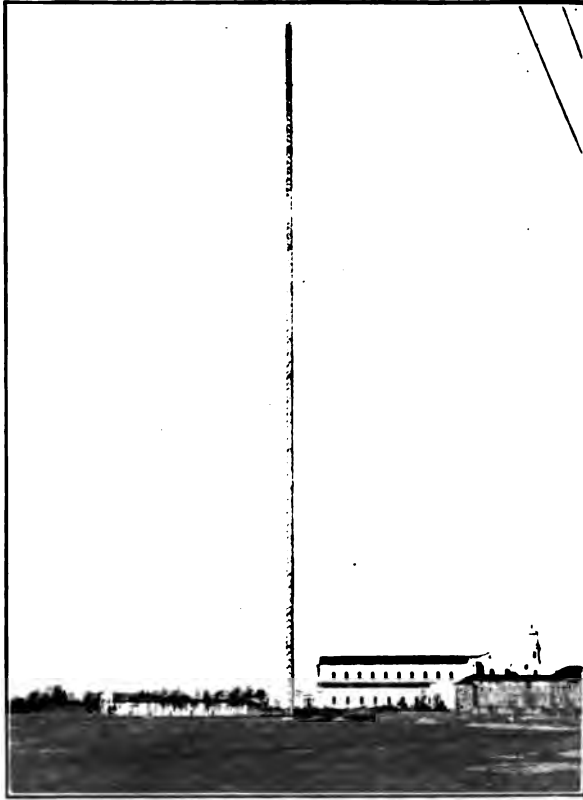

FIGURE 2—Wooden Mast 714 Feet (218 Meters) High

#### ANTENNA

As large an antenna capacity as possible being required, it was considered feasible to place three masts at the corners of an equilateral triangle with sides of 984 ft. (300 m.), without exceeding the horizontal pull of 22,000 lb. (10,000 kg.) allowed in the design of the masts.

The triangular form of antenna, with only three strings of insulators to support it, is as close to the ideal as can be realized. The arc generator is very sensitive to poor antenna insulation, and an antenna with a minimum number of strings of insulators to support it, is always to be preferred.

The individual antenna wires were cut so that the sag in the messenger cables (guys between towers) was accentuated in the horizontal plane, in order to avoid too large a sag, and consequent loss of effective height, in the vertical plane.

The capacity of the antenna is 0.011 mfd.

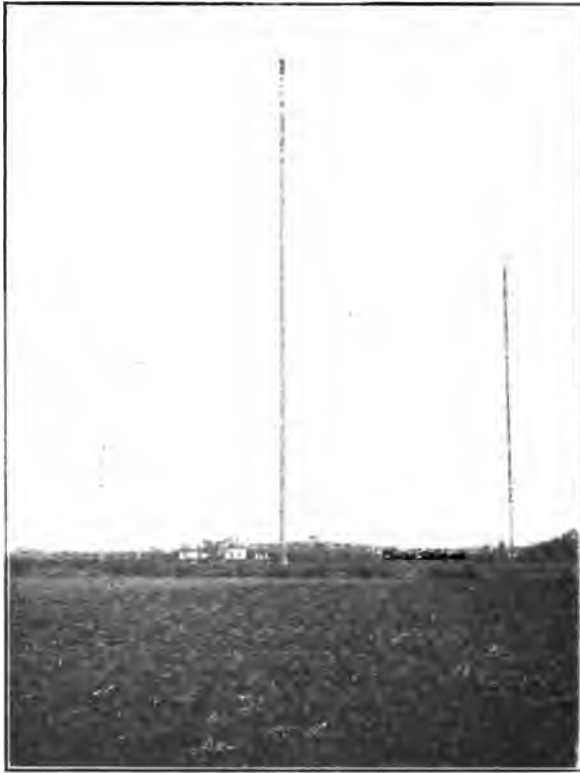

FIGURE 3—Radio Station at San Paolo, Rome, Italy

#### GROUND CONNECTION

The usual radiating network of buried copper wires covering an area greater than the antenna was employed. This was supplemented by means of a number of wells down to ground water.

#### RADIO APPARATUS

The arc generator rated at 200 kilowatts (250 amperes at 800 volts), installed in duplicate, is shown in Figure 4. Its weight, without concrete support, is 3.75 tons (3,750 kg.).

The control switchboard consists of five marble panels. Two panels for each arc generator and a change-over panel for the dynamo protection coils and the respective anodes.

The series resistance for starting the arc is reduced to zero

by means of five electromagnetic contactors controlled by means of a master switch mounted on the control panel.

The water supply for cooling the anode, cathode, chamber, lid, and other parts of the arc generator, is electrically interlocked with the 750-volt direct current supply.

The sending inductance is wound with 1.5 in. (38 mm.) diameter copper tubing. Its maximum value is 2,500 microhenrys.

The choke coils for the protection of the d. c. dynamo, each with an inductance of 5,000 microhenrys, being wound with flat copper strip.

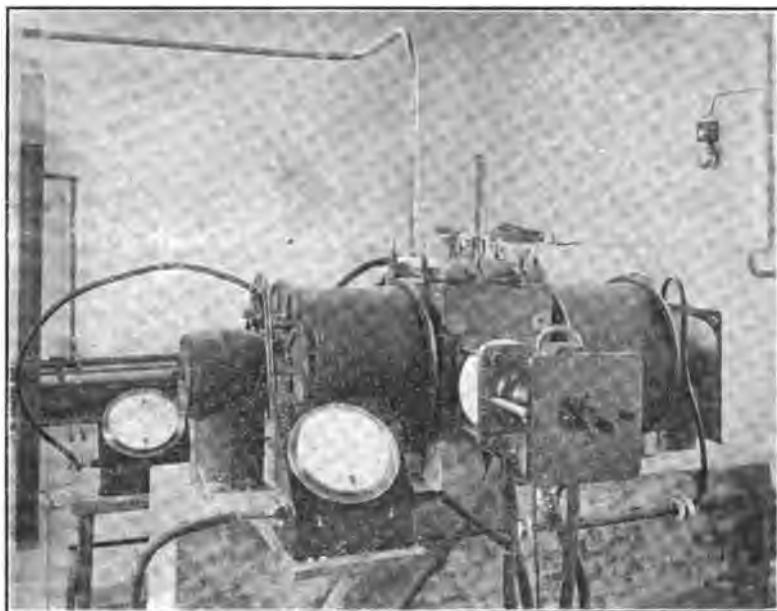

FIGURE 4—200-Kilowatt Arc at Rome Radio Station

The motor-generator set, shown in Figure 5, consists of a 3-phase, 42-period, 500-volt motor, direct coupled to a 350-ampere, 750-volt, compound wound, interpole dynamo made by Ercole, Marelli and Company, of Milan.

For over a year this station has played a by no means unimportant part in the fight for Liberty which has just been brought to the only issue possible for the peace and progress of the world.



FIGURE 5—Motor Generator and Control Panels, Rome Radio Station

I take this opportunity to thank Admirals Pinelli and Simion, Commandants Micchiardi and Pession, Professor Vallauri and Mr. S. P. Wing for their invaluable help and co-operation.

**SUMMARY:** The antenna, ground system, arc, generating and control equipment at the Rome transmitting station are described with numerical data.

# SIMULTANEOUS TRANSMISSION AND RECEPTION IN RADIO TELEPHONY\*

By

NOBORU MARUMO

(IMPERIAL JAPANESE ELECTRO-TECHNICAL LABORATORY, TOKYO, JAPAN)

## INTRODUCTION

In spite of the various devices which have been tried to minimize induction into the receiving system from its own transmitter, the effect has generally been too strong to permit maintaining the detector in sensitive adjustment, and it has been practically impossible to receive signals while the nearby transmitter was radiating. Even tho many inventors have tried to overcome this difficulty, and to succeed in sending and receiving simultaneously in radio telegraphy and telephony, the only practical duplex radio telegraph system seems to have been that of the Marconi Company using their well-known antenna arrangement, as shown in Figure 1. This requires sending and receiving stations several miles apart, and is therefore not suitable for adoption in small radio telephonic stations, and particularly not in ship stations. However, the recent development of the vacuum

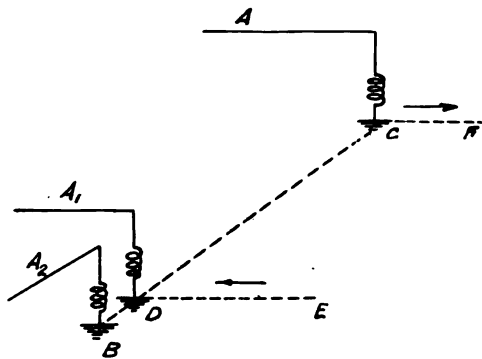

FIGURE 1

\* Received by the Editor, April 7, 1919.

tube has improved conditions considerably, and we have succeeded in permanently connecting receiving and transmitting circuits, even to the same antenna, without objectionable effects.

Dr. Wichi Torikata and his staff in the Imperial Japanese Electro-Technical Laboratory, Tokyo, including the writer, have published an account of the practical and successful results obtained by duplex or simultaneous sending and receiving in radio telephony, in the "Proceedings of the Electrical Engineers' Society, Japan," August 31, 1917. The connections used are shown in the diagram of Figure 2. It is based on the use of the vacuum tube as detector as well as oscillator, on the sending and receiving circuits being permanently connected to the same antenna, and on minimizing induction to the receiving bulb by properly coupling the balancing coil  $L_2''$  or the absorbing circuit  $W$  to the receiving set primary or secondary.

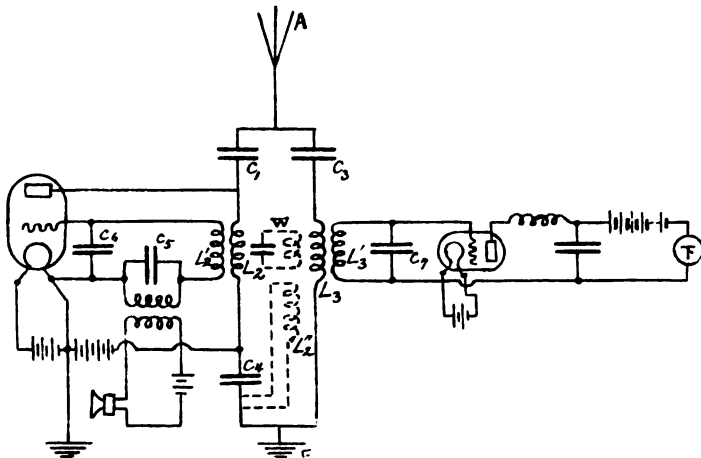

FIGURE 2

So far as the writer is aware, a list of all descriptions previously published dealing with duplex or simultaneous sending and receiving systems in radio telephony follows\*.

(1) Device patented by Marconi Company<sup>1</sup>. Figure 1, published 1911.

\*<sup>1</sup> British patent to G. Marconi, and Marconi's Wireless Telegraph Company, number 13.020 of May 30, 1911.



(2) Device patented by Yokoyama<sup>2</sup>. Figure 3, published 1913.

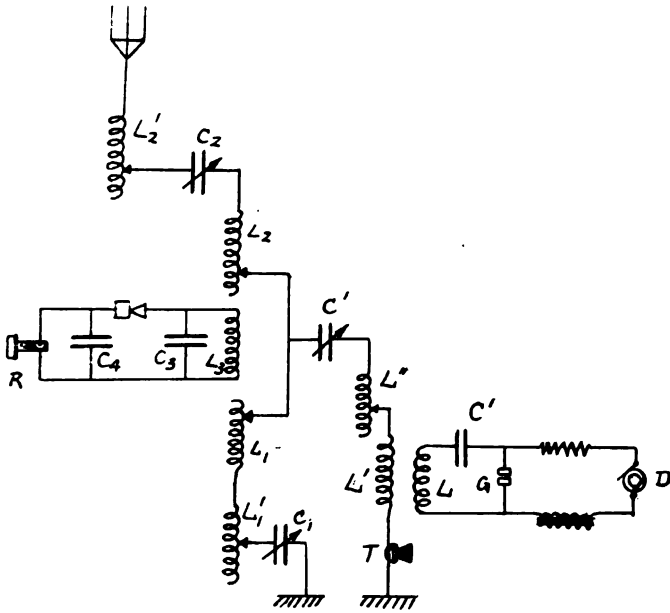

FIGURE 3

(3) Device published by Torikata.<sup>3</sup> Figure 4, published 1912.

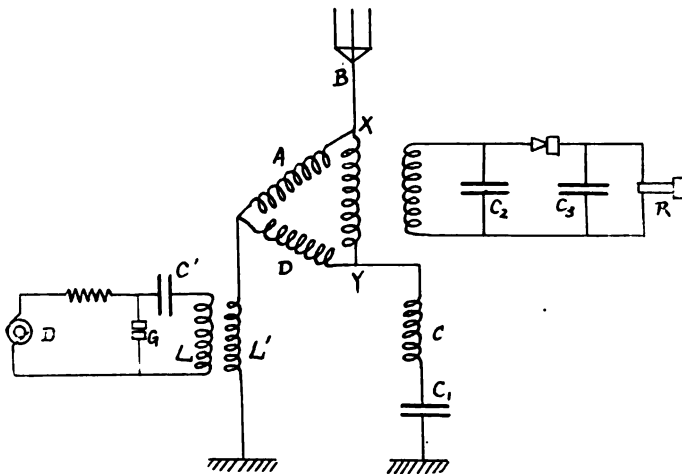

FIGURE 4

<sup>2</sup> Japanese patent to E. Yokoyama, number 25,140 of December 17, 1913.

<sup>3</sup> M. Kitamura, "Dainibu Kenyu Kaishi," published by Imperial Japanese Electro-Technical Laboratory, Tokyo, in April, 1913.

(4) Device patented by Fessenden.<sup>4</sup> Figure 5, published 1916.

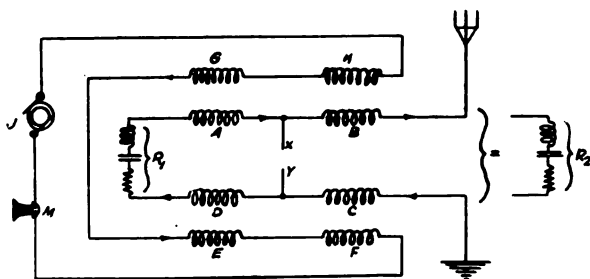

FIGURE 5

(5) Device patented by Carson.<sup>5</sup> Figure 6, published 1916.

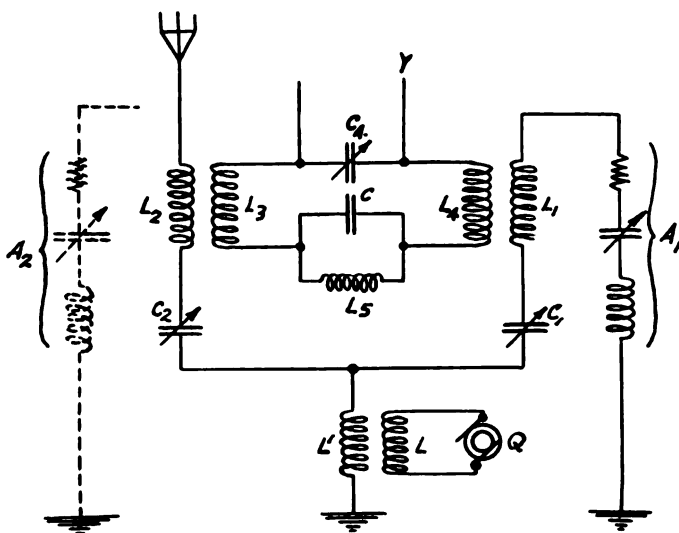

FIGURE 6

(6) Device published by Torikata and his staff.<sup>6</sup> Figure 2, published 1917.

<sup>4</sup>U. S. Patent to R. A. Fessenden, number 1,170,969 of February 8, 1916.

<sup>5</sup>U. S. Patent to J. R. Carson, number 1,188,531 of June 27, 1916.

<sup>6</sup>W. Torikata, "Proceedings of Electrical Engineers' Society, Japan," number 349, August 31, 1917.

(7) Device published by Saeki.<sup>7</sup> Figure 7, published 1917.

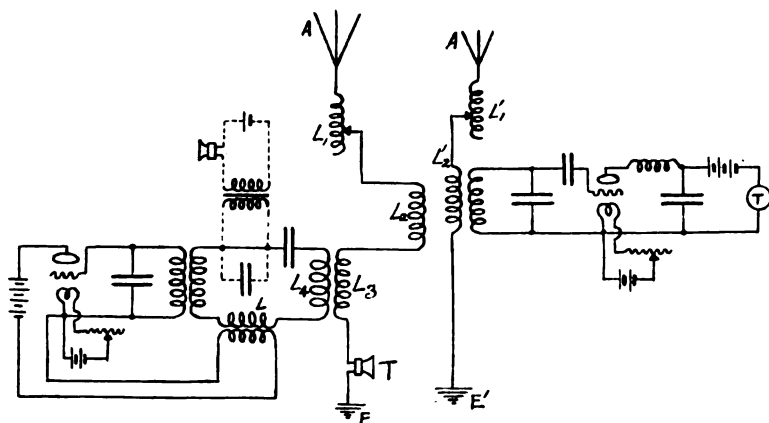

FIGURE 7

(8) Device patented by Englund.<sup>8</sup> Figure 8, published 1917, 1918.

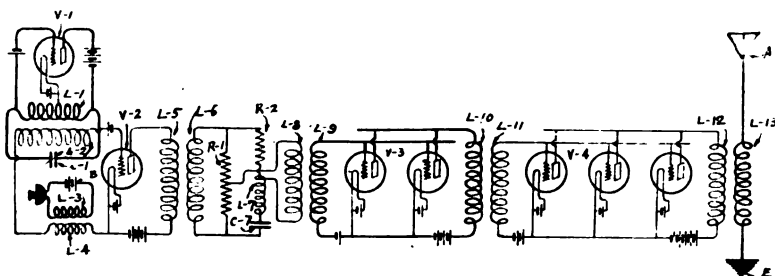

FIGURE 8

(9) Device patented by Espenschied.<sup>9</sup> Figures 9a and Figure 9b, published 1918.

As regards the practical utility of these devices, the writer has no detailed information as to the European and American devices, but the device described by Dr. Torikata and his staff, as shown in Figure 2, is quite successful in actual communica-

<sup>7</sup> M. Saeki, "Proceedings of Telegraph and Telephone Engineers' Society, Japan," number 4, November 20, 1917.

<sup>8</sup> U. S. Patent to C. R. Englund, number 1,245,446 of November, 1917, and number 1,258,548 of March, 1918.

<sup>9</sup> U. S. Patent to L. Espenschied, number 1,256,889 of February 19, 1918.

...ships in the harbor to  
 ...the subscriber. Moreover,  
 ...considerable utilization of  
 ...communication) over ordinary  
 ...also over power transmission  
 ...desirable to give the principles of  
 ...in the following pages.

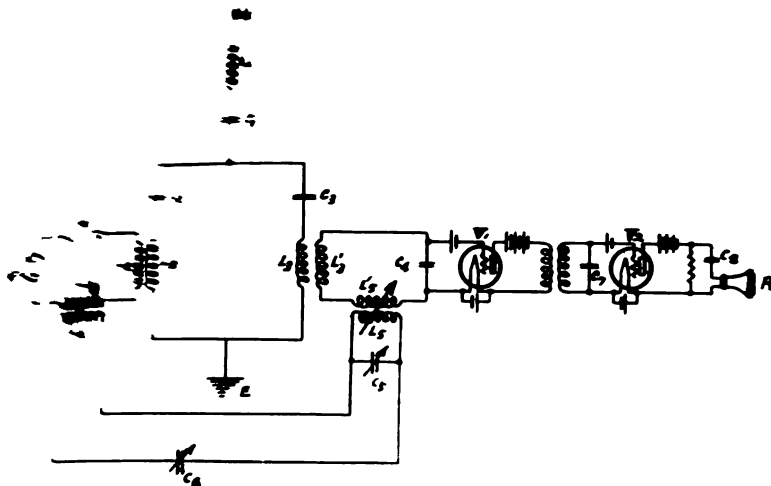

FIGURE 9A

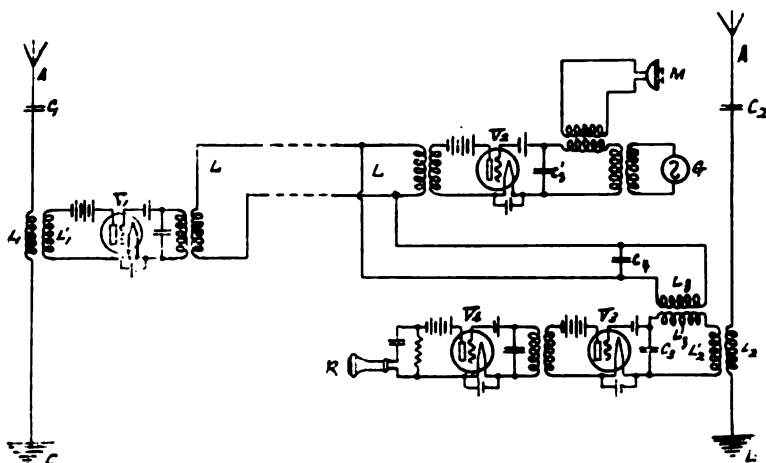

FIGURE 9B

## 2. SOME REQUIREMENTS FOR SIMULTANEOUS TRANSMISSION AND RECEPTION

On putting the simultaneous transmission and reception in radio communication into practice, great difficulty was experienced in excluding induction into the receiving circuit from its own transmitter, as mentioned above. The methods devised by many investigators, such as those described in the preceding articles, can be considered to be based on one or more of the following principles:

- a. Using separate sending and receiving antennas
- b. Using different wave lengths
- c. Using differential or bridging circuits
- d. Using balancing-out or neutralization circuits
- e. Using voice-controlled switching arrangements.

Systems based on these principles may be feasible or valuable or neither, depending on conditions at the station. The experience of the writer indicates that the arrangement of Figure 10 is very convenient in practice for radio telephony, as is also the arrangement of Figure 11 for the "wired wireless" (guided radio) telephony.

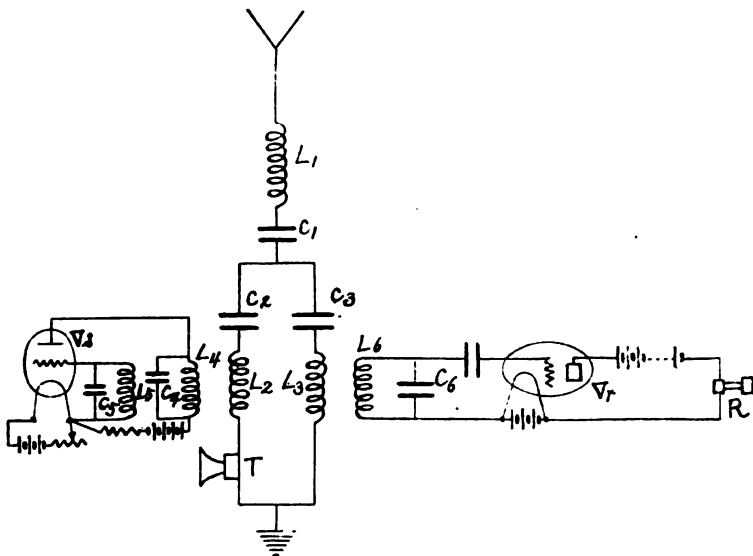

FIGURE 10

The behavior and basic principles of the circuits shown in Figure 10 and Figure 11 are explained below.

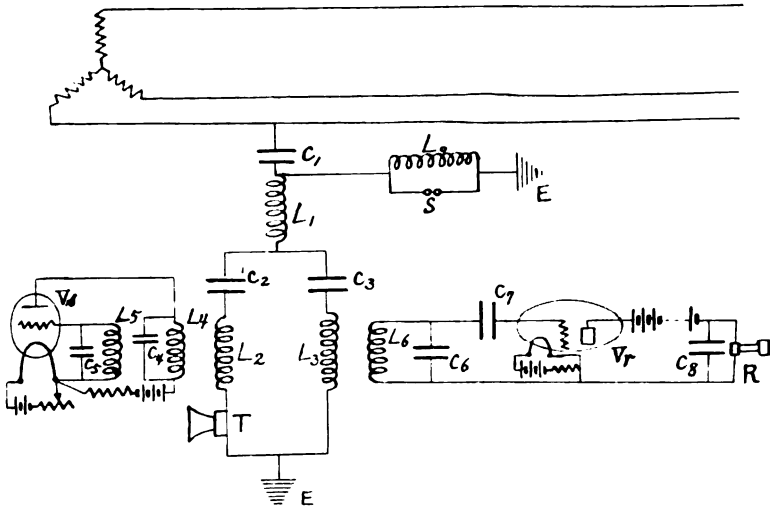

FIGURE 11

### 3. GENERAL THEORY

In Figure 12, the current in the antenna, as well as that in the sending and receiving coils, may not be constant thruout the circuit, but may have a variable distribution in the circuit. The antenna capacity is distributed along its wires. However, to simplify the problem, we assume the current at any point .1 in the circuit to be constant thruout the circuit, as indicated in Figures 12 and 13, and we shall call the equivalent capacity, inductance, and resistance of the antenna, sending, and receiving circuits respectively  $C_1, L_1, R_1$ ;  $C_2, L_2, R_2$ ; and  $C_3, L_3, R_3$ , as indicated in Figure 13.

Suppose now an undamped oscillation  $e_1 = E_1 \varepsilon^{j\omega t}$  is induced in the circuit  $L_1 C_1$  by the incoming signals. Then we have

$$\left( L_1 \frac{di_1}{dt} + R_1 i_1 + \frac{1}{C_1} \int i_1 dt \right) - \left( L_2 \frac{di_2}{dt} + R_2 i_2 + \frac{1}{C_2} \int i_2 dt \right) = E \varepsilon^{j\omega t} \quad (1)$$

$$L_2 \frac{di_2}{dt} + R_2 i_2 + \frac{1}{C_2} \int i_2 dt = L_3 \frac{di_3}{dt} + R_3 i_3 + \frac{1}{C_3} \int i_3 dt \quad (2)$$

$$i_1 + i_2 + i_3 = 0 \quad (3)$$

Putting

$$i_1 = A_1 \epsilon^{j\omega_1 t}, \quad i_2 = A_2 \epsilon^{j\omega_1 t}, \quad \text{and} \quad i_3 = A_3 \epsilon^{j\omega_1 t} \quad (4)$$

where  $A_1$ ,  $A_2$ , and  $A_3$  are certain complex quantities, we have

$$\left. \begin{aligned} A \left\{ R_1 + j \left( \omega_1 L_1 - \frac{1}{\omega_1 C_1} \right) \right\} - A_2 \left\{ R_2 + j \left( \omega_1 L_2 - \frac{1}{\omega_1 C_2} \right) \right\} &= E \\ A_2 \left\{ R_2 + j \left( \omega_1 L_2 - \frac{1}{\omega_1 C_2} \right) \right\} &= A_3 \left\{ R_3 + j \left( \omega_1 L_3 - \frac{1}{\omega_1 C_3} \right) \right\} \\ A_1 + A_2 + A_3 &= 0. \end{aligned} \right\} \quad (5)$$

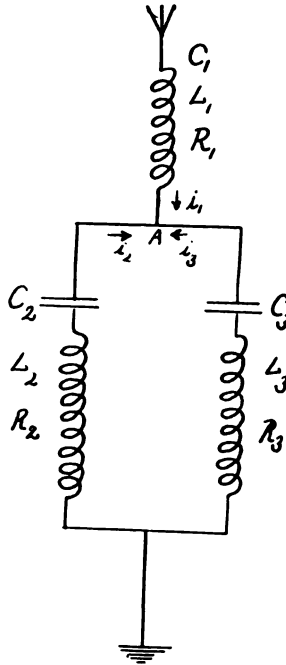

FIGURE 12

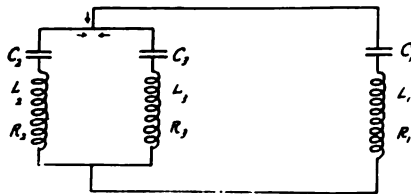

FIGURE 13

300 2 2

11 11 11  
11 11 11  
11 11 11

1  
1



we have, from equation (5),

$$\begin{aligned}
 A_1 &= \frac{\{(R_2 + R_3) + j(S_2 + S_3)\} E}{\{(R_1 R_2 + R_2 R_3 + R_3 R_1) - (S_1 S_2 + S_2 S_3 + S_3 S_1)\} + j \{R_1 (S_2 + S_3) + R_2 (S_3 + S_1) + R_3 (S_1 + S_2)\}} \\
 A_2 &= \frac{- (R_3 + j S_3) E}{\{(R_1 R_2 + R_2 R_3 + R_3 R_1) - (S_1 S_2 + S_2 S_3 + S_3 S_1)\} + j \{R_1 (S_2 + S_3) + R_2 (S_3 + S_1) + R_3 (S_1 + S_2)\}} \\
 A_3 &= \frac{- (R_2 + j S_2) E}{\{(R_1 R_2 + R_2 R_3 + R_3 R_1) - (S_1 S_2 + S_2 S_3 + S_3 S_1)\} + j \{R_1 (S_2 + S_3) + R_2 (S_3 + S_1) + R_3 (S_1 + S_2)\}}
 \end{aligned}
 \tag{7}$$

Similarly when the electromotive force  $e_2 = E_2 e^{j\omega t}$  is induced in the circuit, we have

$$\begin{aligned}
 A_1' &= \frac{- (R_3 + j S_3') E_2}{\{(R_1 R_2 + R_2 R_3 + R_3 R_1) - (S_1' S_2' + S_2' S_3' + S_3' S_1')\} + j \{R_1 (S_2' + S_3') + R_2 (S_3' + S_1') + R_3 (S_1' + S_2')\}} \\
 A_2' &= \frac{\{(R_1 + R_2) + j (S_1' + S_3')\} E_2}{\{(R_1 R_2 + R_2 R_3 + R_3 R_1) - (S_1' S_2' + S_2' S_3' + S_3' S_1')\} + j \{R_1 (S_2' + S_3') + R_2 (S_3' + S_1') + R_3 (S_1' + S_2')\}} \\
 A_3' &= \frac{- (R_1 + j S_1') E_2}{\{(R_1 R_2 + R_2 R_3 + R_3 R_1) - (S_1' S_2' + S_2' S_3' + S_3' S_1')\} + j \{R_1 (S_2' + S_3') + R_2 (S_3' + S_1') + R_3 (S_1' + S_2')\}}
 \end{aligned}
 \tag{8}$$

Expressing the amplitude of  $A_1, A_2, A_3$ , and  $A_1', A_2', A_3'$  respectively with  $[A_1], [A_2], [A_3]$ , and  $[A_1'], [A_2'], [A_3']$ , we have

$$[A_1]:[A_2]:[A_3]::\sqrt{(R_2+R_3)^2+(S_2+S_3)^2}:\sqrt{R_3^2+S_3^2}:\sqrt{R_2^2+S_2^2} \quad (9)$$

$$[A_1']:[A_2']:[A_3']::\sqrt{R_3^2+S_3'^2}:\sqrt{(R_1+R_3)^2+(S_1'+S_3')^2}:\sqrt{R_1^2+S_1'^2} \quad (10)$$

$$\frac{[A_3]}{[A_2]} = \frac{\sqrt{R_2^2+S_2^2}}{\sqrt{R_3^2+S_3^2}} \quad \text{in receiving circuit} \quad (11)$$

$$\frac{[A_1']}{[A_3']} = \frac{\sqrt{R_3^2+S_3'^2}}{\sqrt{R_1^2+S_1'^2}} \quad \text{in sending circuit} \quad (12)$$

That is, the receiving current divides between the receiver and the transmitter circuits in inverse proportion to their impedances, as also does the transmitting current between the antenna and receiving circuits.

As for the natural frequency of the system, putting  $E_1=0$  in equation (5) and eliminating  $A_1, A_2$ , and  $A_3$ , we have

$$\{(R_1 R_2 + R_2 R_3 + R_1 R_3) - (S_1 S_2 + S_2 S_3 + S_3 S_1)\} + j \{R_1 (S_2 + S_3) + R_2 (S_1 + S_3) + R_3 (S_2 + S_1)\} = 0 \quad (13)$$

The equation is of the second order in  $\omega_1$ , and therefore we have

$$\left. \begin{aligned} \omega_1 &= \omega_3 + j a_1 \\ \omega_1 &= \omega_4 + j a_2 \end{aligned} \right\} \quad (14)$$

where  $\omega_3, \omega_4$  and  $a_1, a_2$  are functions of  $R_1, R_2, R_3, L_1, L_2, L_3$ , and  $C_1, C_2, C_3$ . Assuming  $R_1, R_2$ , and  $R_3$  to be small and neglecting them, we have, from (13),

$$\left. \begin{aligned}
 S_1 S_2 + S_2 S_3 + S_3 S_1 = 0 \\
 \left( \omega_1 L_1 - \frac{1}{\omega_1 C_1} \right) \left( \omega_1 L_2 - \frac{1}{\omega_1 C_2} \right) + \left( \omega_1 L_2 - \frac{1}{\omega_1 C_2} \right) \left( \omega_1 L_3 - \frac{1}{\omega_1 C_3} \right) + \left( \omega_1 L_1 - \frac{1}{\omega_1 C_1} \right) \left( \omega_1 L_3 - \frac{1}{\omega_1 C_3} \right) = 0
 \end{aligned} \right\} (15)$$

$$\left. \begin{aligned}
 \left\{ \frac{1}{C_1} (L_2 + L_3) + \frac{1}{C_2} (L_1 + L_3) + \frac{1}{C_3} (L_1 + L_2) \right\}^2 - \\
 \frac{4 (L_1 L_2 + L_2 L_3 + L_3 L_1) \left( \frac{1}{C_1 C_2} + \frac{1}{C_2 C_3} + \frac{1}{C_3 C_1} \right)}{2 (L_1 L_2 + L_1 L_3 + L_3 L_1)}
 \end{aligned} \right\} = (16)$$

This is the formula obtained by W. H. Eccles and A. J. Makower<sup>10</sup>.

<sup>10</sup> W. H. Eccles and A. J. Makower, "The Electrician," volume 75, number 25, page 905, September 24, 1915.

The object here is to minimize the current flowing in the receiving circuit due to the sending current essential in successful transmission (transmission and reception). In the arrangements shown in Figures 10 and 11 the best result will be obtained by the following adjustment:

1. Make the sending wire length to one of the natural wave lengths of the system, say  $\lambda$ , and the receiving wave length to the other, say  $2\lambda$ .

2. Adjust the circuit to minimize the current flowing in the receiving circuit due to the sending current by making the ratio  $\frac{A_1}{A_2} = \sqrt{R_1^2 + S_1^2}$  a maximum.

3. Adjust the circuit to make the ratio  $\frac{A_1}{A_2} = \sqrt{R_1^2 + S_1^2}$  as large as possible, thus improving the receiving efficiency while maintaining the above conditions 1 and 2.

It is seen that the second condition will satisfy also the requirement of adjusting the circuit to get the maximum transmitting efficiency.

For the second condition above, remembering equation 12, we have:

$$\frac{A_1}{A_2} = \frac{\sqrt{R_1^2 + S_1^2}}{\sqrt{R_2^2 + S_2^2}} = \frac{\sqrt{R_1^2 - \left(\omega_2 L_1 - \frac{1}{\omega_2 C_1}\right)^2}}{\sqrt{R_2^2 - \left(\omega_2 L_2 - \frac{1}{\omega_2 C_2}\right)^2}}$$

where  $\frac{\omega_2}{2\pi}$  is the frequency of the transmitting current oscillation. And when  $R_1 \pm R_2 \neq 0$ ,  $\omega_2 L_1 - \frac{1}{\omega_2 C_1} \neq 0$ , the second condition must fulfil the next equation,

$$\left. \begin{aligned} \omega_2 L_1 - \frac{1}{\omega_2 C_1} &= 0 \\ \omega_2^2 &= \frac{1}{C_1 L_1} \end{aligned} \right\} (17)$$

From the first condition,  $\frac{\omega_2}{2\pi}$  must be one of the natural

frequencies of the circuit, say  $\frac{\omega_3}{2\pi}$ , that is, it must satisfy equation (15). Therefore we have:

$$\left. \begin{aligned} C_1 L_1 &= C_2 L_2 \\ \omega_2^2 &= \frac{1}{C_1 L_1} = \frac{1}{C_2 L_2} \end{aligned} \right\} (18)$$

From (15) and (18), we have, as regards the other natural frequency  $\frac{\omega_4}{2\pi}$  which must be tuned to the received current frequency:

$$\left( \omega_4 L_1 - \frac{1}{\omega_4 C_1} \right) \left( \omega_4 L_2 - \frac{1}{\omega_4 C_2} \right) + \left( \omega_4 L_2 - \frac{1}{\omega_4 C_2} \right) \left( \omega_4 L_3 - \frac{1}{\omega_4 C_3} \right) + \left( \omega_4 L_1 - \frac{1}{\omega_4 C_1} \right) \left( \omega_4 L_3 - \frac{1}{\omega_4 C_3} \right) = 0 \quad (19)$$

and

$$\left. \begin{aligned} \frac{1}{C_1 L_1} &= \frac{1}{C_2 L_2} \\ \omega_4^2 &= \frac{\frac{L_2}{C_1} + \frac{1}{C_3} (L_1 + L_2)}{L_1 L_2 + L_2 L_3 + L_3 L_1} \end{aligned} \right\} (20)$$

That is, we have to tune the natural frequency of the antenna circuit relative to that of the sending circuit so as to make the transmitting efficiency a maximum or the branch current to the receiver circuit a minimum, thus disturbing the receiver bulb as little as possible.

Again, from (18) and (20), we have—for transmitter current:

$$\frac{[A_1']}{[A_3']} = \frac{\sqrt{R_3^2 + \left( \omega_2 L_3 - \frac{1}{\omega_2 C_3} \right)^2}}{R_1} \quad (21)$$

For receiver current

$$\frac{[A_3]}{[A_2]} = \frac{\sqrt{R_2^2 + \left( \omega_1 L_2 - \frac{1}{\omega_1 C_2} \right)^2}}{\sqrt{R_3^2 + \left( \omega_1 L_3 - \frac{1}{\omega_1 C_3} \right)^2}} = \frac{\omega_1 L_2 - \frac{1}{\omega_2 C_2}}{\omega_1 L_3 - \frac{1}{\omega_2 C_3}} \quad (22)$$

taking  $R_2 = 0$  and  $R_3 = 0$ , and putting  $C_1 L_1 = C_2 L_2$  and  $\omega_1 = \omega_4$ , from (20)

$$\frac{[A_3]}{[A_2]} = - \left( 1 + \frac{L_2}{L_1} \right) \quad (23)$$

To fulfil the first condition and to improve the receiving efficiency,

we have to make  $\frac{[A_3]}{[A_2]}$  larger or  $\frac{L_2}{L_1}$  as large as possible, that is, to make the transmitter inductance large compared with the antenna inductance. In the arrangement shown in Figure 2, the secondary coil  $L_2$  of the coupling transformer has generally optimum value of self inductance required to obtain the maximum sending antenna current and the generated wave is one of the "coupling waves," as known from the principles of the pliotron oscillator.<sup>11</sup>

The treatment in this case, that is, when the coupling  $L_2 L_2'$  is fairly close, will become more complex; but the same result as above for the best adjustment of the antenna system will be obtained by a similar treatment.

### 5. EFFECT OF THE BALANCING COIL

Notwithstanding the various adjustments which were tried to minimize the effect of induction on the receiving circuit, it was practically impossible to get rid of the induction entirely, and the balancing coil was found to be effective in cancelling out even small traces of induction. The induced electromotive force tends to ruin the detector, and the electromotive force of the balancing coil to balance it out must be the same in magnitude and opposite in phase.

From equation (8), the phase difference  $\phi$  between  $A_2'$  and  $A_3'$  is:

$$\phi = \tan^{-1} \frac{S_1' + S_3'}{R_1 + R_3} + \tan^{-1} \frac{S_1'}{R_1}$$

Thus, in the adjustment,  $S' = 0$ , and we have

$$\phi = \tan^{-1} \frac{S_3'}{R_1 + R_3}$$

where  $S_3$ , generally speaking, is very large compared with  $R_1$  and  $R_2$ , and therefore

$$\phi = \frac{\pi}{2} \text{ approximately.}$$

But it is nearly impossible to make  $S' = 0$  rigorously, and when  $S'$  is large compared with  $R_1$ , then

$$\phi = \pi \text{ approximately.}$$

It will be seen from this result that the counter-balancing coil is less effective in the former case than the latter, and its effectiveness depends upon the value of  $\phi$  which can be varied from zero to  $\pi$  according to the adjustment. But in the arrangement shown

<sup>11</sup>T. Kikuchi, "Proc. Physico-Math. Soc. Japan," volume 1, page 14, February, 1919.

in Figure 2 the writer found from test that the balancing coil works quite satisfactorily when it is coupled to the secondary coil of the receiving oscillation transformer.

The disturbance in the receiver circuit consists of two currents, one from the branch current from the sending coil, and the other being the current induced in the receiving system directly by the transmitting antenna current. The balancing coil is quite effective in balancing out the latter even tho it may not eliminate the former. Generally speaking, the balancing coil is sometimes very effective, but it is not absolutely necessary when the circuit is in its best adjustment, especially when the receiving apparatus operates with regenerative action.

Consequently, to get the best adjustment for simultaneous sending and receiving, we choose the natural wave length of the antenna ( $C_1 L_1$ ) equal to that of the transmitter circuit ( $C_2 L_2$ ), and make the aerial capacity ( $C_1$ ) as large as possible and at the same time the transmitter capacity ( $C_2$ ) as small as possible.

#### 6. MULTIPLEX SYSTEM OF WAVE TELEPHONY AND TELEGRAPHY

The above duplex system has proven to be of great utility, enabling (1) successful simultaneous radio telephone and telegraph communication between two radio stations, (2) successful simultaneous communication between a radio station (for example, on board ship, and a land wire telephone subscriber), radio and wire communication being automatically relayed in both directions (3), any number of multiplex wave telephone and telegraphs superposed on an ordinary telephone and telegraph line, and (4) any number of multiplex wave telephone and telegraph superposed on a power transmission line.

These various uses of wave telephony and telegraphy have been developed in Japan for the last three or four years.

As the result of many experiments, we are now (1) installing a station in Kobe to enable persons on ships to speak directly with the land wire telephone subscriber in Kobe, Osaka, and so on, (2) installing instruments in Tokyo, Yokohama, Osaka, and Kobe to provide a multiplex system of wave telephony and telegraphy by superposing modulated radio frequency waves on the telephone wires. These arrangements will be opened to the public before the end of March, 1919.

Generally speaking, telephone lines used near power transmission lines are subject to marked disturbances from induction, but most of this induction is of low frequency and causes no inter-

ference with wave telephony even when the wave is superposed on the power line itself for 50,000-volt transmission systems.

Dr. Torikata and his staff have carried out wave telephony over a power line successfully in May, 1918. The transmission power line of the Kinugawa Hydro-Electric Company, 90 miles (144 km.) in length was used. Since December, 1918, their system has been used in practice by the Fuji Hydro-Electric Company.

Details of the developments in certain directions are not yet available for publication, but the writer has been permitted to explain the operation of the guided wave telephone and telegraph, now successfully used by the Fuji Hydro-Electric Company, to the readers of the PROCEEDINGS OF THE INSTITUTE OF RADIO ENGINEERS.

## 7. "WIRED RADIO" TELEPHONE AND TELEGRAPH OVER POWER TRANSMISSION LINE

Figure 14 is the actual connection diagram of the wired wave telephone and telegraph used by the Fuji Hydro-Electric Company. In the Figure, (2) and (23) are the power stations connected to the 22,000-volt, 3-phase transmission line, (3) the receiving substation and (24) any intermediate station. Condenser (6) is designed to be quite safe at the line voltage, and inductance (7) is made nearly a dead short-circuit at the power frequency and a practically perfect choke coil at the radio telephone frequency. Oscillations are produced in the entire line by the bulb (15), which is also used as the receiving bulb, at station (2). Any two stations of (2), (3), (23), and (24) may speak with each other using the wave produced by the bulb (15). Calling may be accomplished by using the bulb amplifier and a loud speaking telephone, but may also be obtained by using the small transformer (26), the quenched spark gap (25), bulb rectifier (28), relay (29), and call bell (30). Arrangements are made to use sounder (36) and key (33) for wave telegraphy. At the intermediate stations, portable sets provided with "Koseki" or crystal detectors (34), microphone transmitters (17), and telephone receivers (21) are used. In the arrangement shown in Figure 14, the oscillations generated by the bulb (15) connected as in the Figure, are supplied to the overhead transmission line (1) thru the oscillation transformer (10). The amplitude of the current then flowing thru the line is modulated by the microphone transmitter (17) at the speaking station, and this enables the mutual or two-way conversation between any two stations, some



of which may have a transmitting bulb, as at station (2), or which may not have such a bulb as at stations (3), (23), and (24). It is evident that conversation between two stations, both of which have transmitting bulbs, will give excellent results, but the sending arrangement in this case gives rise to much more expense and trouble. Consequently, the arrangement shown in Figure 14, which enables two stations, such as (23) and (3), neither having a transmitting bulb, to converse with each other, was adopted by Dr. Torikata for the Fuji Hydro-Electric Company. The working principle of this system is that, in guided radio communication, the efficiency of transmission of energy is much larger than the case in radio communication in space.

Thus in guided radio signaling we can modulate the current in the entire line by varying the absorptions, resistances, or other constants of the whole system by a microphone transmitter, for example, and carry on two-way speech even without using the connections and careful adjustment indicated in Figure 2.

In conclusion, the writer wishes to express his hearty appreciation and thanks to Dr. Wichi Torikata for kind co-operation in the preparation of this paper.

**SUMMARY:** After reviewing the methods of duplex radio communication previously proposed, the author describes a divided-branch antenna arrangement with supplementary balancing coil, for this purpose. The theory and mode of adjustment of the system are explained.

The application of this method in practice to ship-to-shore radio telephony is described, and reference is made to the necessary wire-to-radio and reverse transfers.

Guided radio telephony and telegraphy over high tension transmission lines is considered. The use of a single oscillation generator for a number of stations is shown to be possible. An actual transmission of this type is described in detail.

## RADIO FREQUENCY ALTERNATORS\*

BY

MARIUS LATOUR

(This article is partly a reproduction of a communication recently presented before the Société Française des Electriciens<sup>1</sup> by Marius Latour. It describes the different types of alternators capable of practical application to the direct production of radio-frequency currents. The author pays particular attention to the French designs of alternators, which he describes as "homopolar alternators with partial utilization of the periphery" and "homopolar variable reluctance alternators.")

In the last few years alternators of considerable output (exceeding 100 kilowatts) and of a frequency corresponding to the natural frequency of radio antennas have been built. The direct feeding of antennas from alternators without transformation of any kind and with the advantages inherent in sustained oscillations has thus become possible. Numerous papers on this subject have appeared. Mr. Bethenod among others has presented a particularly interesting paper before the Congress of Lyons in June, 1914.

This article intends to give a general survey of the different types of alternators that can be utilized practically for the generation of radio frequency currents.

The method of multiplying the frequency of the generator by means of transformers is not considered. It will suffice to remark that this method (used by the Telefunken Company) is based on the saturation of the magnetic circuit of a transformer by direct current for the purpose of producing harmonics in the curve of the primary alternating current. This method has been studied in France, as regards the second harmonic, by Leonard and Weber, and by Maurice Joly (who pointed out the importance of the method for the production of high frequency),

\* Received by the Editor, July 17, 1919.

<sup>1</sup>"Bulletin de la Société Française des Electriciens," February, 1919, volume 9 (3d series), pages 97-115.

and, as regards the third harmonic, by J. Bethenod.<sup>2</sup> This method may form the subject of another article. The present paper considers exclusively alternators generating radio frequency current directly and without the help of supplementary apparatus.

The different systems capable of industrial application will here be classified as follows:

- (1) Alternators in cascade.
- (2) Internal Cascade Alternators.
- (3) Homopolar disc alternators.
- (4) Homopolar variable reluctance alternators.
- (5) Alternators with partial utilization of periphery.

#### ALTERNATORS IN CASCADE

General Ferrié, as early as 1904, took an interest in the industrial production of radio frequency currents and has set up the problem of the generation of currents of the order of 80,000 cycles per second. Alternators giving 10,000 cycles per second were already known at that time; Lamme, for instance, has described before the American Institute of Electrical Engineers in 1904 a homopolar machine (to which I will come back later), which at a comparatively moderate peripheral speed gave several kilowatts at 10,000 cycles per second.

The generation of a frequency of the order of 80,000 cycles seemed to me to require new methods, and I proposed at that time the connection of a number of alternators in cascade. The arrangement is shown in Figure 1.

Let  $A_1-B_1$ ,  $A_2-B_2$ ,  $A_3-B_3$ ,  $A_4-B_4$  be four machines with alternate poles, mounted on the same shaft and having the same number of poles. Both the stationery and moving parts carry two-phase windings.  $A_1-B_1$  being excited by direct current in  $A_1$ , gives two-phase currents of frequency of frequency  $f$  in  $B_1$ . These two-phase currents of frequency  $f$  are collected by means of rings not represented on the figure and made to feed the two-phase winding of the inductor  $A_2$  of  $A_2-B_2$  in such a way as to produce a revolving field in a direction opposite to that of rotation of the shaft: two-phase currents of frequency  $2f$  are then generated in  $B_2$ . These latter currents are in their turn made to supply the inductor  $A_3$  of  $A_3-B_3$  in such a way that the revolving field created moves in a direction opposite to that of rotation of the rotation of the shaft: the current obtained in  $B_3$

<sup>2</sup>The Bethenod process differs from that of Joly in that the latter uses the alternating current itself to produce saturation. The Joly process is best adapted to the production of relatively low frequency.

has the frequency  $3f$ . These currents of frequency  $3f$  are fed into  $A_4$  of the machine  $A_4-B_4$ . The current of frequency  $4f$  in armature  $B_4$  is used to supply the antenna. By increasing the number of alternators, one can multiply the frequency indefinitely. With  $n$  alternators a frequency of  $nf$  is obtained, where  $f$  is the frequency of each single alternator.

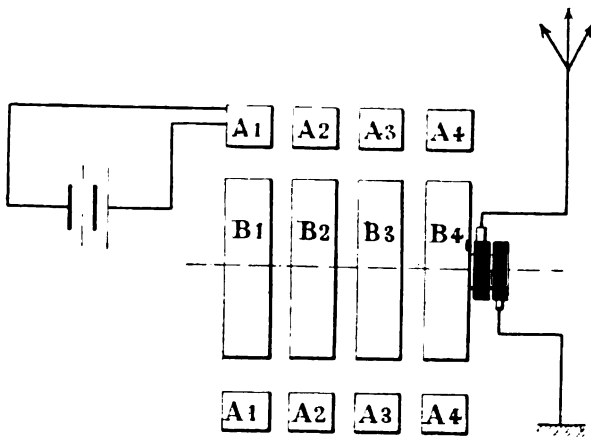

FIGURE 1

The use of collector rings between the successive circuits and at  $B_4$  can be avoided by making the stationary and revolving parts alternately inductor and armature. In the figure  $A_1, B_2, A_3, B_4$  would be made inductors;  $B_1, A_2, B_3, A_4$ —armatures. Between the different alternators condensers can be interposed to compensate for the reactance of the windings. When I first conceived the idea, different priorities were brought to my attention and I abandoned for the time being the project. The different new elements introduced by me, such as multiplication of frequency by means of polyphase instead of single phase windings and the avoidance of collector rings are, however, of real practical value. No attempt to carry out this idea in practice was made either in France or abroad until 1912. At that date Bethenod constructed the first high frequency alternator based on the principal of Figure 1. In this experimental alternator each elementary machine had a frequency of 6,000 cycles per second at a peripheral speed of 120 meters (393 ft.) per second. Altho the sheets used (silicon steel 0.25 mm. or 0.01 inch thick)

were such as to cause high losses at the frequency used, Bethenod has obtained on the antenna a power of the order of one kilowatt at the frequency  $4 \times 6000 = 24,000$  cycles per second. The system of Figure 1 operates as follows. The first alternator  $A_1-B_1$  acts only as a generator, the second alternator  $A_2-B_2$  acts one-half as a generator and one-half as a transformer; the third  $A_3-B_3$  one-third as a generator and two-thirds as a transformer, the fourth alternator one-fourth as a generator, and three-fourths as a transformer. Generally, the  $n$ th alternator acts to  $1/n$ th part as a generator and to one- $\frac{n-1}{n}$ th part as a transformer.

#### INTERNAL CASCADE ALTERNATORS

P. Boucherot has announced in 1893 (see "La Lumière Electrique" of the 25th of March, 1893, page 544) the following theorem:

"In an alternator with alternate poles delivering simple alternating current the armature is the seat of an electromotive force and a current represented by an infinite series of the odd terms of a Fourier series, the inductors are the seat of an electromotive force and a current represented by an infinite series of the even terms of a Fourier series."

Boucherot writes as follows:

"The coefficients of the currents of successive frequencies are naturally decreasing very rapidly on account of the self inductance of the two circuits, which reduces the intensities the more the higher the frequency. This is, however, not to be regarded as inevitable; it is possible to make the coefficients increase instead of decreasing; it is equally possible by utilizing the remarkable properties of condensers to cause these coefficients to increase up to the  $n$ th term and to decrease afterward. This allows the production of currents of very high frequency and the construction of alternators giving all sorts of frequencies but such that the currents of a given frequency are the most intense and can be considered as the main currents."

The Goldschmidt machine represented schematically by Figure 2 is a practical realization in 1907 of the ideas expressed by Boucherot in 1893.

The stator and rotor of the single phase radio frequency alternator of Goldschmidt type are indicated on the figure by the letters  $S$  and  $R$ .

In this alternator the *odd* frequencies  $f$  and  $3f$  in the rotor and the even frequencies  $2f$  and  $4f$  in the stator are reinforced; this latter frequency  $4f$  becomes, properly speaking, the utilized frequency. The rotor circuit is closed over such a system of

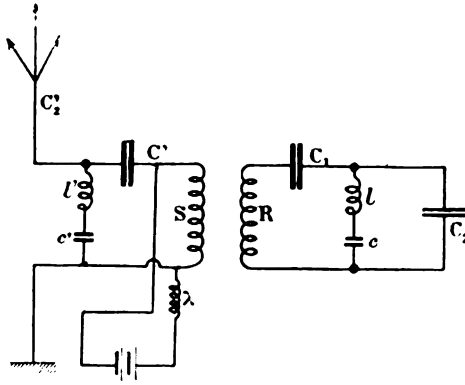

FIGURE 2

inductance and capacity that it can simultaneously enter into resonance with the two odd frequencies  $f$  and  $3f$ . To accomplish this, the shunt  $L$ - $C$  is so proportioned as to form a short-circuit for the frequency  $f$ ; the capacity  $C_1$  is of such value as to balance the reactance of the rotor at the frequency  $f$ , and the capacity  $C_2$  is such that, combined with the shunt  $L$ - $C$  and the capacity  $C_1$ , it balances the reactance of the rotor at frequency  $3f$ . The stator is excited by means of direct current thru the protective reactance  $\lambda$ , and is connected to a system of inductances and capacities  $L', C', C_1', C_2'$  which allows resonance with the frequencies  $2f$  and  $4f$ . The capacity  $C_2'$  is in practice represented by the antenna circuit.

This Goldschmidt alternator seems to have exerted a fascination on the investigators of all countries, and is often spoken of as the "remarkable" Goldschmidt machine. This alternator does not, however, differ either in principle or in practical value from the system of alternators in cascade.

The current of frequency  $f$  generated in the rotor produces an alternating field, which, by Fresnel's theorem, can be decomposed into two revolving fields of half magnitude. One of these fields rotates in the same direction as the rotor and therefore gives rise in the stator to a current of frequency  $2f$  in exact ac-

cordance with the principle of alternators in cascade. This current of frequency  $2f$  sets up an alternating field which in its turn is decomposable into two revolving fields of which one is rotating in a direction opposite to that of the shaft, and again in accordance with the cascade principle, generates a current of frequency  $3f$  in the rotor. This current of frequency  $3f$  in its turn produces a revolving field of frequency  $3f$ , which, taken along by the rotor, gives rise in the stator to a current of frequency  $4f$ . To sum up, the alternator of Figure 2 is essentially an assembly in one machine of the four machines mounted in cascade of Figure 1. The concentration of several machines in one is however irrelevant both from the point of view of efficiency and of specific power as we had already occasion to prove elsewhere (see "La Lumière Electrique" of June 22, 1912, page 357).

Let us first consider the iron losses, and let us designate by  $p$  the losses caused by a field  $\phi$  rotating in a positive or negative direction with the velocity  $\omega$ —with respect to the iron. Fields  $\phi_1, \phi_2, \phi_3 \dots$ ,—rotating with velocities  $\omega_1, \omega_2, \omega_3 \dots$ ,—differing in magnitude and direction, will then, if considered separately, cause losses  $p_1, p_2, p_3 \dots$ . If all these revolving fields coexist, the total loss is simply equal to the sum:

$$p_1 + p_2 + p_3 \dots$$

Likewise, for the copper losses, let us designate by  $\omega$  the Joulean losses in the windings due to the system of currents  $i$  producing the field which rotates with the velocity  $\omega$  in a positive or negative direction. Systems of currents  $i_1, i_2, i_3 \dots$  giving rise to fields revolving with velocities differing in magnitude or direction will cause, if considered separately, the losses  $\omega_1, \omega_2, \omega_3 \dots$ . If all these different current systems coexist in the same windings, they cause total losses which are simply equal to the sum of the separate losses  $\omega_1 + \omega_2 + \omega_3 +$

When the losses of the separate machines are combined in a single machine, it is necessary in order to limit the temperature rise to the same value, to give to the single machine a size equal to that of the several machines placed side by side and no beneficial effect is secured.

From these considerations, that I have formulated in "La Lumière Electrique," as far back as 1912, it follows that in radio frequency alternators with alternate poles as well as in all alternators operating far from saturation, the electrical efficiency is independent of the heating effect, that is, of the overload. If the inductor flux and the output are doubled, the losses are quadrupled, but so also is the power. The ratio between the

losses and the power remains constant. The power per unit volume is thus limited by the facility with which the generated heat can be dissipated. The advantage of artificial cooling becomes apparent. This cooling is the more advantageous as the great peripheral speeds used in radio frequency alternators cause large ventilation losses which are relatively the less the larger the power output.

In order to diminish the ventilation losses I have proposed (see "La Lumière Electrique," June 22, 1912, page 356) to run the alternator under reduced air pressure. It is for experiment and test to weigh and overcome the complications involved in this proposal.

The advantage of the Goldschmidt machine is that it permits the use of a single-phase winding on the rotor, its disadvantage is that it does not permit of subdivision of power as does the external cascade system.

#### HOMOPOLAR DISC ALTERNATORS

The homopolar alternator has no windings on the moving parts. This is of great advantage at high peripheral speeds, and this type of alternator was therefore used from the very first for the generation of radio frequencies. Thury has built between 1893 and 1900 about a dozen homopolar alternators giving currents of 10,000 cycles per second. One of these alternators was exhibited at the Exposition of Geneva in 1896 (see "L'Eclairage Electrique" of October 24, 1896, page 157). This alternator was of the "bell" type favored by Thury at that time. The revolving inductor carried 200 polar projections and run at 3,000 revolutions per minute for a frequency of 10,000 cycles per second. It delivered 3 to 4 kilowatts, at this frequency and had an open circuit voltage of 150 volts. Thury used both solid and laminated inductors.

In 1904, Lamme described in detail in the "Transactions of the American Institute of Electrical Engineers" a homopolar alternator built by him. This alternator is of the normal type, but in its construction are used for the first time specially thin steel sheets of only 0.075 mm. (0.003 inch) in thickness. The diameter of the inductor was 62 cm. (24.4 inches), the number of revolutions 3,000 per minute; the peripheral speed was thus 100 m. (305 feet) per second. It would seem that by pushing further the excitation of the machine and by compensating the reactance of the armature by a series condenser, a much larger



power output than that given by Lamme (2 kilowatts) could be obtained.

In order to utilize higher peripheral speeds up to 200 and 300 meters (610 and 915 feet) per second, Alexanderson has designed the disc type of the homopolar alternator. Figure 3 represents an Alexanderson homopolar alternator. The winding *B* creates a continuous field which traverses the disc *A* and the laminated armature *C*. The disc carries on either side radial polar projections; the armature carries a winding, the conductors of which are placed in radial slots.

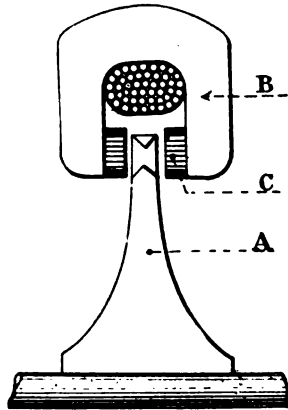

FIGURE 3

Alexanderson first sought to reduce the ventilation loss by inserting non-magnetic pieces between the polar projections of the disc so as to obtain a perfectly smooth surface. Later on he replaced these non-magnetic pieces by conducting pieces connected externally in such a way as to form a sort of a squirrel-cage on each face of the disc. Such an amortisseur system is capable of reducing the losses due to the machine output.

One could, as a matter of fact, place the laminated polar pieces in openings secured in a solid bronze disc as shown in Figure 4, which construction would reduce the losses in the moving part to a minimum.

The open-circuit characteristic of homopolar machines has an interesting particularity that has been pointed out long ago (for instance by Alexanderson, "Proceedings of the American Institute of Electrical Engineers," 1909, page 410). While

the characteristic of alternators with alternate poles is somewhat similar to that of the magnetisation curve of iron, that of the homopolar machines has the form represented on Figure 5. The open-circuit voltage first increases with the excitation, passed thru a maximum and then diminishes.

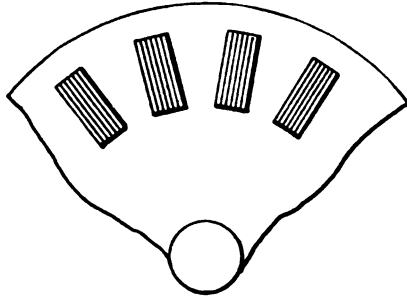

FIGURE 4

The reason of this particular behaviour lies in the fact that saturation acts in two different ways; first in the usual way, by diminishing the ratio of the flux-increase to the excitation increase, and second, by so to say effacing the poles of the rotor, since the interspaces finally begin to emit flux as well as the polar projections. The difference of flux emission between the vacant spaces and the poles which constitutes the flux variation in the alternator tends thus to disappear as saturation is approached.

As a result of these two causes there exists a voltage maximum for a certain excitation. To get the maximum power out of the alternator it is necessary to operate near this maximum voltage, which does not correspond in general to an excessively large variation of flux in the armature teeth. Under these conditions it is not justifiable to say that the electric efficiency of the homopolar alternator is independent of the load. This was true of the machines with alternate poles, but the simple reasoning holding in that case is no more applicable. The losses are no longer proportional to the output, and consequently the electric efficiency diminishes with overload.

Another remark regarding the hysteresis losses in homopolar machines is here appropriate.

According to measurements by John D. Ball, reported by Steinmetz, ("Theory and Calculation of Electric Circuits,")

1917, page 76), the hysteresis losses on passing from induction  $B_1$  to induction  $B_2$ —corresponding to an alternating variation of induction  $\frac{B_1 - B_2}{2}$ —are the greater, the larger the mean induction  $\frac{B_1 + B_2}{2}$ . In other words, the Steinmetz coefficient depends on the mean value of induction around which the flux variation takes place. Figure 6 gives  $\gamma$  as a function of  $\frac{B_1 + B_2}{2}$ .

From this figure we may derive, for instance, that at the mean induction of 10,000 gauss the hysteresis losses are multiplied by 2.3, at 14,000 gauss by 3.5.

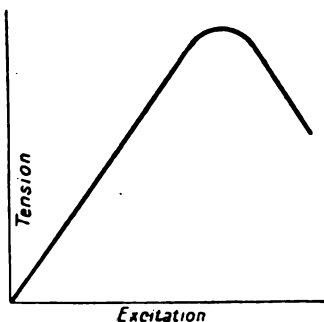

FIGURE 5

We conclude from this that the hysteresis losses are larger in homopolar alternators than in alternators with alternate poles, and that therefore the subdivision of the iron or changes in its silicon content, which reduce only the eddy losses, are of less importance.

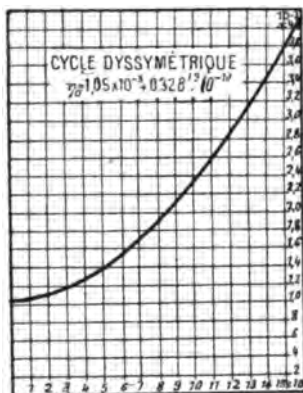

FIGURE 6

Asymmetric Cycle,  $\gamma = 1.05 (10)^{-8} + 0.32 B^{1.9} (10)^{-10}$

## HOMOPOLAR ALTERNATORS WITH VARIABLE RELUCTANCE

One form of this type of alternator is shown in Figure 7. It comprises an excitation winding on the stator, which, as pointed out by Bethenod, may at the same time constitute the armature winding, provided an inductance is inserted as shown in the figure. When the rotor teeth are facing the stator teeth there

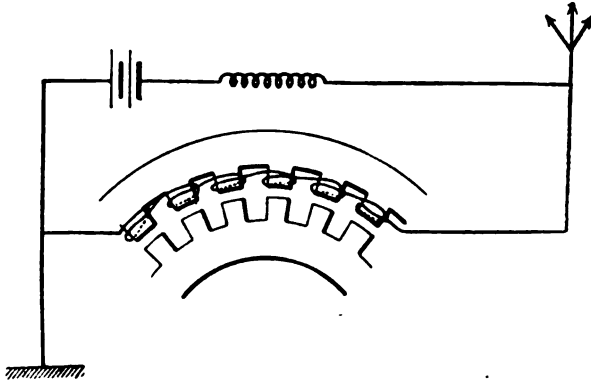

FIGURE 7

is maximum flux in the armature; when the interspaces are facing the teeth, the flux is at its minimum. This produces an electromotive force of the same frequency as that of a homopolar alternator having the same number of teeth or polar projections on the rotor, and only half the number of slots on the stator. The slots must, however, in this case allow the passage of direct current. The rotor is necessarily laminated as it is subject to a varying flux.

To obtain high frequency the rotor teeth must be very thin and closely spaced and the flux variation effective in the armature becomes very small in comparison with the total flux. The flux changes its sign in each rotor tooth for each displacement corresponding to the pole pitch and as a result the rotor losses may become much larger than the stator losses. The efficiency of this form of variable impedance alternator soon becomes inferior to that of the homopolar alternator, the polar of which projections are always traversed by a uni-directional flux.

The variable impedance alternator can, however, also be given the homopolar form.<sup>3</sup> It is sufficient to imagine a homo-

<sup>3</sup> See Latour, British patent number 102,738.

polar alternator entirely laminated in a direction parallel to the shaft, having a stator with open slots without windings carrying a number of teeth equal to that on the rotor (see Figures 8 and 9). The central excitation coil is then traversed exactly as in Figure 7 by a maximum or minimum flux according to the position of the rotor teeth in relation to the stator teeth. The flux

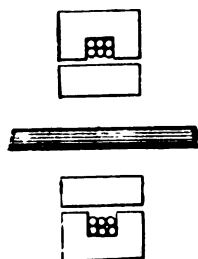

FIGURE 8

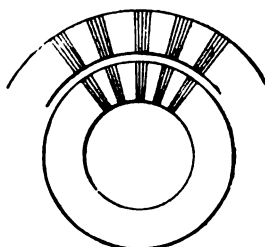

FIGURE 9

does not now change its direction in the rotor teeth and the advantages of the ordinary homopolar alternator as regards losses are present.

Theoretically, as there are no conductors to be placed in the vacant spaces of the stator, this alternator could be built for any desired frequency. For instance, with a peripheral speed of 150 meters (458 feet) second and teeth of the order of one millimeter (0.04 inch), a frequency of 100,000 cycles per second would be reached. In reality one would have to make the mechanically impossible assumption that the air-gap diminishes with the width of the teeth. It is easily seen that as soon as the width of a tooth becomes of the same order of magnitude as that of the air-gap, the reluctances for the two extreme positions of Figures 10 and 11 become about equal. With an air-gap of 0.5 mm. (0.02 inch) it is feasible to have teeth 2 mm. (0.08 inch) wide and to obtain directly a frequency of the order of 40,000 cycles per second. At the present time, I have under construction homopolar generators of variable reluctance, giving at a peripheral speed of 150 meters (457 feet) per second, a frequency of 60,000 cycles. These are covered by British patent number 102,738; and the United States patent is expected to appear soon.

It is possible to increase the difference between the maximum and the minimum flux correspondingly to the two extreme

positions of Figures 10 and 11, by disposing in the polar inter-spaces of the stator and of the rotor conducting elements which serve as amortisseurs to the flux emitted by the teeth flanks.

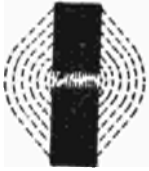

FIGURE 10



FIGURE 11

In the position of Figure 10 (maximum flux) each tooth emits one flux in the air-gap and two identical lateral fluxes. In the position of Figure 11 (minimum flux) each tooth emits four identical fluxes which link respectively a tooth-face with a tooth-flank.

Let us consider the excitation produced by unit current and let us call

$\Phi$ —the air-gap flux of a tooth in the position of Figure 10.

$\phi$ —the lateral flux emitted by each tooth-flank in the position of Figure 10.

$\psi$ —the flux linking a tooth-face with a tooth-flank in case of Figure 11.

The flux enclosed by the armature varies between the values  $(\Phi + 2\phi)$  and  $4\psi$ .

With conducting elements acting as dampers, the flux emitted by the flanks of the teeth cannot vary; as a result of the damping currents this flux will remain fixed at the average value of  $\frac{\phi + \psi}{2}$ .

The flux will therefore oscillate between the values

$$(\Phi + \phi + \psi) \text{ and } 2(\phi + \psi)$$

If, as a first approximation, one assumes, as in the figures,  $\psi = 2\phi$ , one finds that without amortisseurs, the flux oscillates between  $(\Phi + 2\phi)$  and  $8\phi$ , and with amortisseurs, between  $(\Phi + 3\phi)$  and  $6\phi$ .

In the first case the flux variation is  $(\Phi - 6\phi)$ , in the second  $\Phi - 3\phi$ .

By a numerical example one can readily form an estimate of the very considerable improvement produced by the introduction of amortisseurs.

By reducing the reaction flux and the losses caused thereby

the amortisseurs also have an important influence on the output  $I \sin \omega t$ . It is easily seen, that the only alternating reaction flux possible is the one corresponding to the air-gap flux  $\Phi$  proper. The flux emitted by the flanks of the teeth is of the form

$$I \frac{\psi + \phi}{2} \sin \omega t + I \frac{\psi - \phi}{4} [\cos \alpha - \cos (2 \omega t - \alpha)]$$

and on account of its alternating character is reduced to zero by the amortisseurs. The continuous part of the flux causes no losses.

The variable reluctance alternator is able to multiply the frequency in a way analogous to the Goldschmidt alternator. The basis of this is formed by the second theorem of Boucherot ("La Lumière Electrique" of March 4, 1893, page 500), which is as follows: "In an alternator with non-alternate poles the inductor and the armature carry currents represented by all the even and odd terms of the Fourier series."

The variable reluctance alternator can thus give the highest frequencies without excessive peripheral speeds.

For instance, considering the doubling of the frequency, the output of current  $I \sin \omega t$  creates a reaction flux

$$\frac{I \Phi}{2} \sin \omega t - \frac{I \Phi}{4} [\cos \alpha - \cos (2 \omega t - \alpha)]$$

which causes the appearance of a voltage of double frequency

$$\frac{\omega I \Phi}{2} \sin (2 \omega t - \alpha)$$

In a variable reluctance alternator it is possible to work sufficiently far from saturation so as to have the efficiency independent of overload in the same way as in cascaded alternators. If, by placing an appropriate capacity in series with the armature, one brings the reaction flux and the voltage-generating flux ( $v$ ) in quadrature, the electric losses on open circuit and those due to the load  $I$  will simply superimpose, and the best efficiency will obviously be obtained when the load-losses are equal to the open-circuit losses. This follows from the consideration that the available power is  $v I$ , while the losses<sup>4</sup> have the form

$$k' v^2 + k'' I^2.$$

<sup>4</sup>It is well to note that the use of a series capacity to compensate for the total inductance of the armature does not lead in all cases to optimum efficiency. In order to work with a minimum resultant flux, and therefore with minimum iron losses for a given power, it is necessary to increase the excitation with the load and compensate with the capacity only the inductance due to leakage. The use of capacity for the compensation of inductance results in a reduction of copper losses and in certain cases, near saturation, is all that makes it possible to develop power. The above considerations apply to all radio frequency alternators.

## ALTERNATORS WITH PARTIAL UTILIZATION OF PERIPHERY

The difficulty in designing ordinary homopolar or alternate pole alternators for radio frequencies without undue increase of peripheral speed is due to the practical impossibility of placing coils in the slots which soon become too narrow. For instance, with a peripheral speed of 150 meters (458 feet) per sec. and for 30,000 cycles per second, the pole-pitch is 2.5 mm. (0.1 inch). With a tooth-wide of only 2 mm. (0.08 inch) there is left only 0.5 mm. (0.01 inch) for the slot. To overcome this, the idea suggests itself to place in one alternator only a fraction of the needed poles and to combine several alternators among which the totality of poles is distributed. Instead of one alternator one could, for example, consider a system of three alternators I, II, III (see Figure 12), in which the successive poles are found by passing from one alternator to the next and two of every three poles are omitted in each alternator. The space left by the missing poles in each alternator then permits placing the coils more easily. Figure 12 represents, to the left, the rotors and, to the right, the stators of the three alternators, and is sufficiently explicit. A first north pole being in alternator I, the correspond-

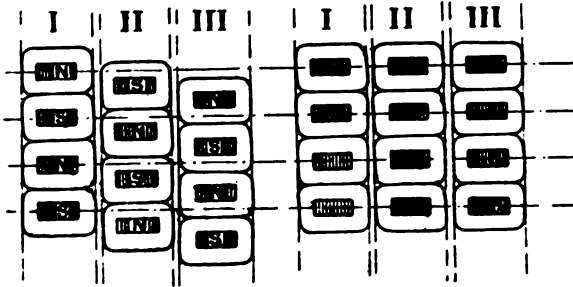

FIGURE 12

ing south pole is in alternator II, the second north pole in alternator III, the second south pole is again in alternator I, and so on. In each rotor, two out of every three poles are omitted. In the three corresponding stators two teeth out of every three are likewise omitted.

This construction is of general application and can be used in homopolar alternators and in non-homopolar variable impedance alternators such as that of Figure 7.



In these latter, there is no excitation winding on the rotor and the vacant spaces are to be considered as simply replacing the poles of opposite sign.

Figure 13 relates to homopolar alternators, Figure 14 to variable reluctance alternators.

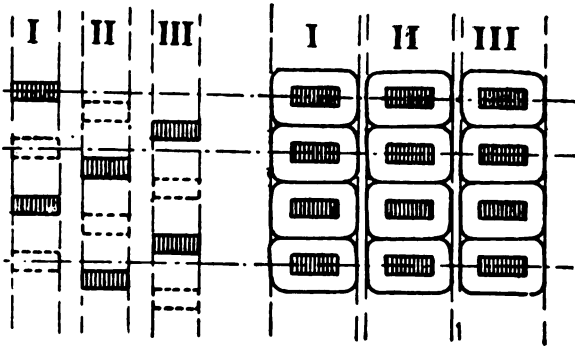

FIGURE 13

In thus distributing the poles of one alternator among three, it is assumed, as a first approximation, that the air gap is infinitely small, so that the flux emitted by each inductor pole is concentrated on its width facing the air gap, and that the flux issued from the flanks can be neglected. In reality, this latter flux may be quite appreciable, and therefore, beside the frequency which results from the combination of the three alternators, there will be a fundamental frequency given by each alternator which is  $\frac{1}{3}$  of the frequency given by the combination. In other words, the arrangement of narrow poles represented on Figures 12, 13, and 14 gives rise in each alternator to a third harmonic, which harmonic is brought out by connecting in series the three alternators displaced in phase  $\frac{2\pi}{3}$ . The idea of purposely producing the harmonics of alternators in order to obtain high frequencies is old, and dates back to Max Wien (1902). The explanations given above have permitted us to determine the width of the poles necessary to produce the third harmonic.

Beside the losses due to the harmonic frequency, there are in each alternator losses due to the fundamental frequency, which may be much more serious than the first mentioned.

The partial utilization of periphery may, however, be limited to the stator only, by sliding the three alternators of Figure 12 into one, in which case the fundamental frequency disappears. For the homopolar and the variable reluctance alternator, the arrangements shown on Figures 15 and 16 are respectively arrived at. In these alternators the polarity of the rotor is three times that of the stator. The frequency is determined by the polarity of the rotor<sup>5</sup>.

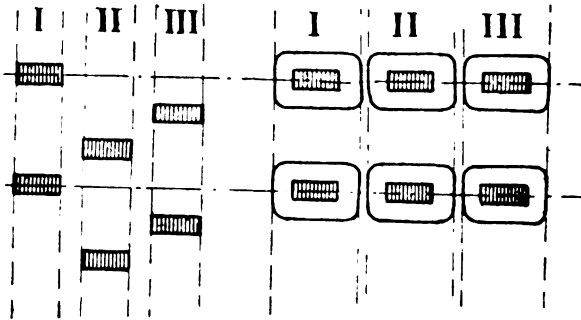

FIGURE 14

Figures 17 and 18 represent the contours of the stator and rotor of the homopolar and of the non-homopolar variable impedance alternator.

Bethenod and his assistant Billieux have built homopolar alternators on the above principle. The rotor was laminated, and constructed according to a design previously intended for

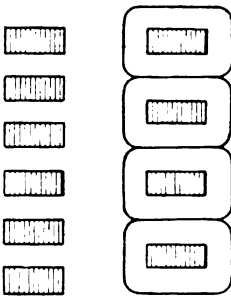

FIGURE 15

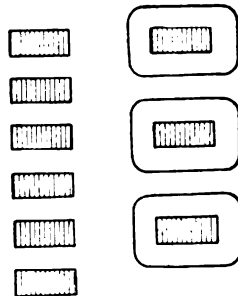

FIGURE 16

<sup>5</sup> See my U. S. Patent 1,234,912.

the variable reluctance alternator, as in Figure 7 which was first suggested by Bethenod.

The work on the radio frequency alternators has been conducted in France during the war at the request of Colonel (now General) Ferrié, who ever since 1904 has interested himself in this subject.

All the possible solutions have been taken up in order, and we feel that, thanks to the instigation of the Military Telegraph Department, this question has been very thoroughly and practically conclusively investigated in this country.

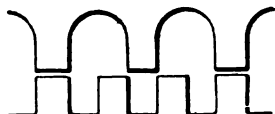

FIGURE 17

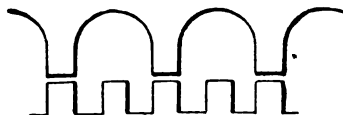

FIGURE 18

In Figure 19 is shown a 225-kilowatt, 20,000-cycle radio frequency alternator. This is a homopolar generator with partial utilisation of the periphery.

**SUMMARY:** The various types of radio frequency alternators are described. They are historically considered; and the general principles underlying their design are given. The special types most used in France at present are considered in detail.

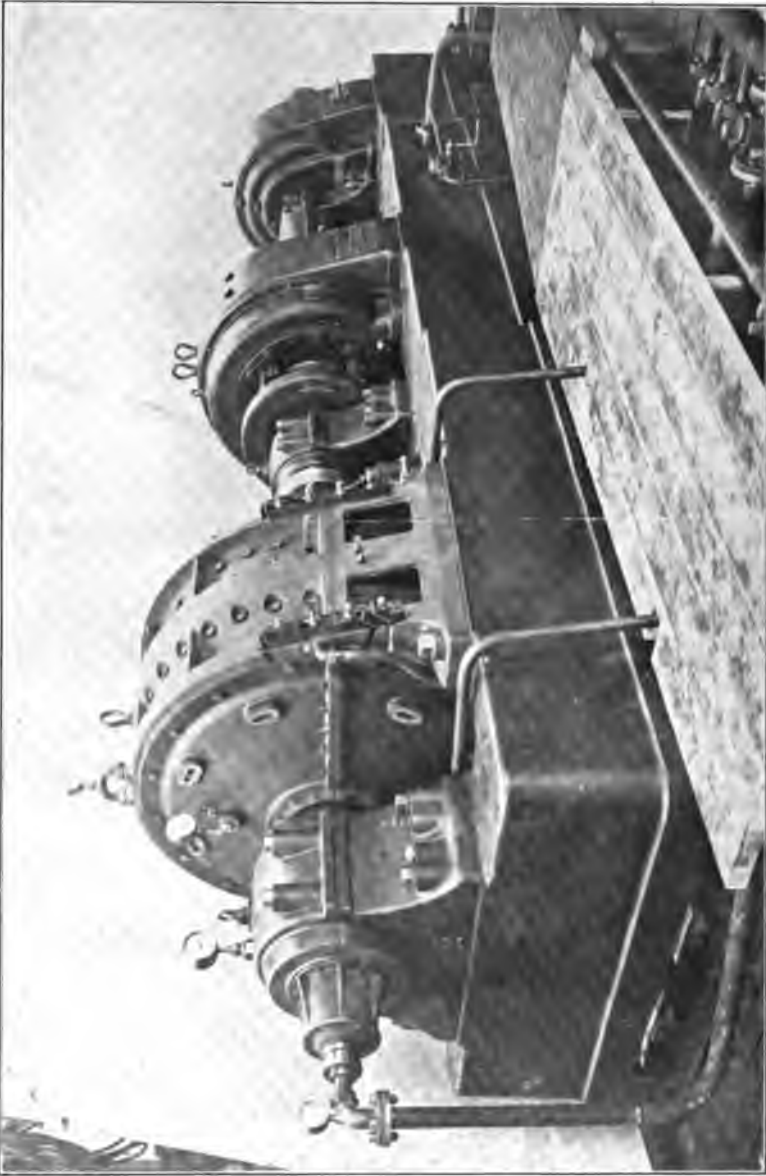

FIGURE 19—225-Kilowatt, 20,000-Cycle Latour Radio Frequency Alternator

## SOME NOTES ON VACUUM TUBES\*

BY

JOHN H. MORECROFT

(ASSOCIATE PROFESSOR OF ELECTRICAL ENGINEERING, COLUMBIA  
UNIVERSITY, NEW YORK)

### FORM OF PLATE CURRENT CURVE

The general theory of vacuum tubes has been well covered by Langmuir, van der Bijl, and others; it is the purpose of these notes to point out some of the more detailed actions of a tube with the idea of helping those who attempt to teach the theory and operation of tubes, and who will, unless they have tested many tubes, have difficulty in reconciling their experimental results with the theory as it has been presented to date.

The general expression for the plate current of a tube is

$$I_p = a (E_p + \mu_o E_g + \epsilon)^2.$$

The quantity  $\epsilon$  is very small, especially with oxide-coated filaments, as may easily be proved by connecting both the grid and plate to the negative end of the filament (that is, having both  $E_p$  and  $E_g$  equal to zero), and noting how much current flows to the plate. This is so small that a sensitive galvanometer is required to measure it with the ordinary tube.

One of the factors determining the value of  $\epsilon$  is the velocity with which the electrons are expelled from the filament, which, increasing with temperature, is evidently greater for tungsten filaments than for oxide filaments. To show how the temperature affects this quantity,  $\epsilon$ , a tungsten filament tube, having two electrodes only, had its plate connected to the negative end of its filament thru a microammeter, and the current thru the meter was noted for various filament currents. As there was no battery in the plate circuit, and it was connected to the negative end of the filament, the only force causing the electrons to flow from the filament to the plate was due to the velocity with which they were ejected from the hot filament. The result of this test is shown in Figure 1; the normal current thru the filament is 1.1 amperes. The plate current for this filament current

\* Received by the Editor, June 10, 1919.

was only a fraction of a microampere but it increased rapidly as the temperature was raised due to the fact that there were more electrons being emitted and at a higher average velocity. It may be appreciated how small an effect this quantity  $\epsilon$  has, when it is noted that with normal filament current the plate current increased from 0.8 microampere to 500 microamperes by merely connecting the plate to the positive end of the filament, thus giving it a potential higher than the filament by perhaps 1 volt, on the average.

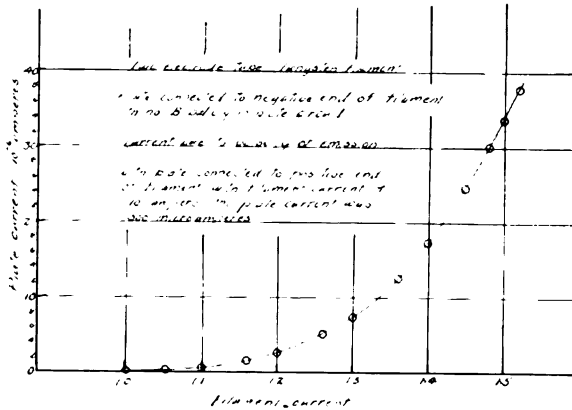

FIGURE 1

Having thus disposed of  $\epsilon$  as being generally negligible let us further suppose that  $E_g$  is made zero by connecting the grid to the negative end of the filament, thus reducing the expression for the plate current to the simple form

$$I_p = \alpha E_p^x$$

The value of this exponent  $x$  has been given as 1.5 and 2.0, the former a theoretically derived value and the latter an experimentally determined value. Now for a certain class of tubes which will probably be extensively used in laboratory work, namely those designed for low plate voltage, the exponent  $x$  varies widely from both of the values given above. Figure 2 gives the variation of plate current in an oxide-coated filament tube designed for a plate voltage between 20 and 40, as the plate voltage was varied, the grid voltage being zero. On the same plot is shown the value of the exponent  $x$  for various plate voltages. It is seen that not only does the value not lie between

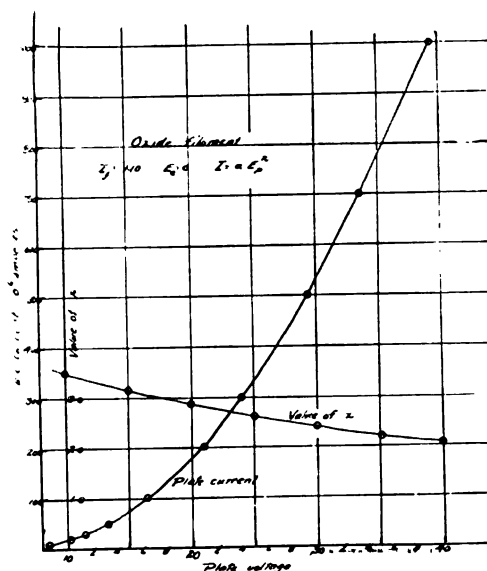

FIGURE 2

the values 1.5 and 2.0 but it varies with the plate voltage. Figure 3 shows the same condition for a tungsten filament tube designed for the same plate voltage.

In Figure 4 are shown these two curves plotted on logarithmic co-ordinate paper, as is also the straight line given by a curve having an exponent equal to 2.

Twelve tubes of each of the types used for the results shown in Figures 2 and 3 were selected at random from a large collection and the variation of plate current with plate voltage determined, and the results plotted on logarithmic paper; the result is shown in Figure 5. The twelve curves for each type lay inside the area indicated by the cross hatching, in general not lying parallel to the boundary lines of the areas, but crossing each other in haphazard fashion. It has of course been recognized that when the plate voltage becomes equal to, or less than, the  $IR$  drop in the filament, the ordinary form of equation does not hold, but the curves obtained from these twenty-four tubes differ in their exponents by a ratio of five to one, with plate voltages still greater than the filament  $IR$  drop.

One of the principal reasons for the variation of the exponent as the plate voltage varies is the fact that there is a different voltage between each part of the filament and the plate. This

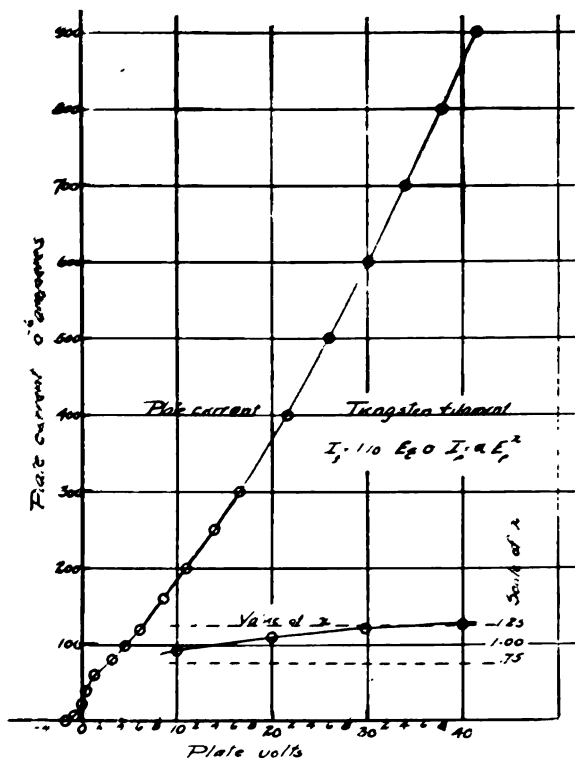

FIGURE 3

large change in the exponent does not occur if the surface emitting the electrons is an equipotential surface; such a tube, having an electrically heated equipotential surface was described and used by the writer some years ago.\* With such a tube, the theoretical relations between space charge and plate voltage are more closely obeyed.

#### RESISTANCE OF A TUBE

The output resistance of a tube is the ratio of the change in plate voltage to the corresponding change in plate current, other conditions remaining the same. It is the reciprocal of the partial derivative of the plate current with respect to the plate voltage. The resistance of this circuit would ordinarily be obtained by dividing the plate voltage by the plate current as for any other circuit. This value of resistance however would be

\* "Physical Review," volume 8, number 5, page 563.



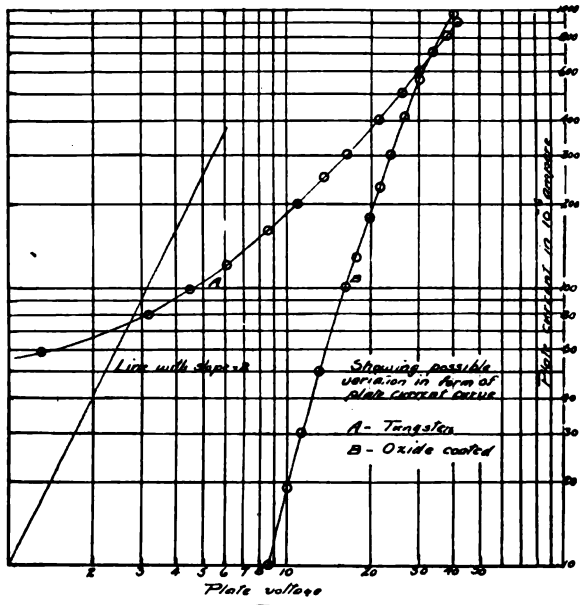

FIGURE 4

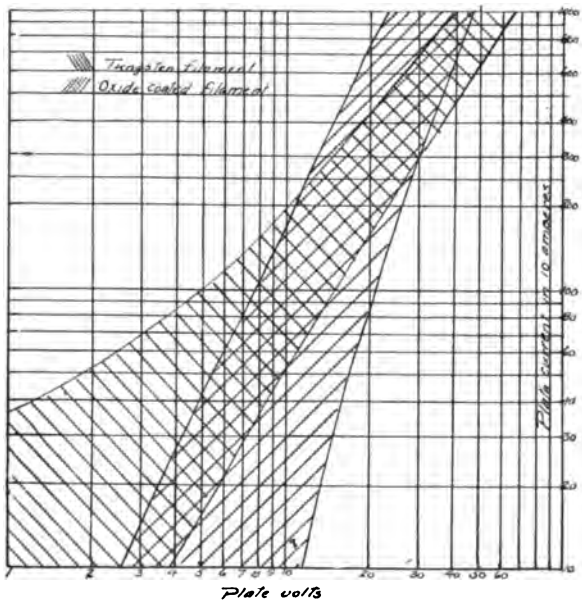

FIGURE 5

the resistance for continuous current only and is generally greatly in excess of the alternating current resistance, obtained as indicated above. However there is a simple relation between the continuous current resistance and the alternating current resistance. Calling the two values of resistance  $R_{ac}$  and  $R_{cc}$  it is seen that if  $I_p = aE_p^x$ , then  $R_{ac} = R_{cc}/x$ . Hence it should be possible to calculate the a.c. resistance from the c.c. resistance, it being supposed that  $x$  is known.

In Figure 6 are shown the two resistance curves for a tube, the one being the quotient of the plate voltage and the plate current and the other having been obtained by the method first described by Miller, using a low voltage when making the measurement. Points indicated by circles are the experi-

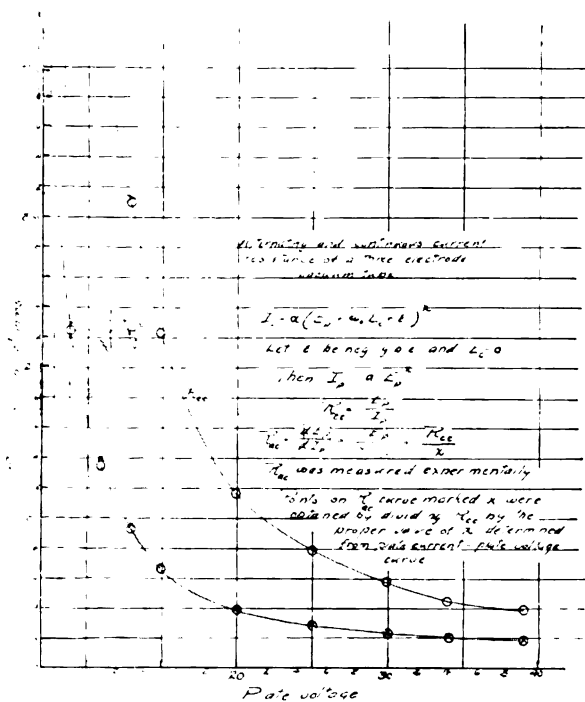

FIGURE 6

mentally determined points; on the curve of alternating current resistance are shown a series of points indicated by crosses; these are the values obtained by dividing the c.c. resistance by the value of  $x$  of the tube for that particular voltage, this  $x$  having previously been determined.

The value of  $R_{ac}$  will be constant thruout a certain variation of the excitation voltage. For large values of alternating voltage impressed on the grid,  $R_{ac}$  will increase and may become equal to  $R_{cc}$ .

#### DISTORTION EFFECT IN AN AMPLIFIER TUBE

If the grid of an amplifying tube is excited by an alternating emf.  $E_g \sin \omega t$ , and the plate current is of the form assumed by van der Bijl then the plate current becomes

$$I_p = a (\tau E_p + E_c + \varepsilon)^2 + 2 a (\tau E_p + E_c + \varepsilon) E_g \sin \omega t + \frac{a E_g^2}{2} (\cos 2 \omega t + \pi) + \frac{a E_g^2}{2}$$

as was pointed out by him. A direct current meter in the plate circuit will respond to the first and fourth terms only. The third term represents distortion and, as has been pointed out, it may be made as small as desired by adding sufficient resistance in the plate circuit. Now the third term has the same coefficient as the fourth, and as the fourth term is shown by a direct current meter it is possible to predict the distorting effect of a tube by making a test with a continuous current meter in the plate circuit. If, as the alternating emf. impressed on the grid is increased, the reading of the continuous current ammeter in the plate circuit remains constant, the third term of the plate current expression (that is, distortion) is absent.

Figure 7 shows the effect on the reading of a c.c. ammeter in the plate circuit of an amplifying tube as the alternating emf impressed on the grid is increased by small steps. Curve 1 shows the effect on the plate current when there is no added resistance in the plate circuit. The increase in the current is due to the fourth term of the current expression; this increase plotted on logarithmic paper with the grid voltage ( $E_g$ ) as the other ordinate gives very nearly a straight line, the slope of which is 1.9. It is evident, therefore that the exponent 2 in the expression for plate current is nearly correct for this special tube within the narrow range of grid voltage used. Curves 2, 3, and 4 show the effect of adding resistance in the plate circuit keeping the voltage of the plate circuit,  $E_B$ , constant. The plate current is of course diminished as the plate circuit resistance is increased because of the decreased plate voltage brought about by the  $IR$  drop in the plate circuit resistance. Curve 4 shows a constant plate current as the grid voltage is varied thru a range of two volts.

Figure 8 shows how the plate current of a tube may be ex-

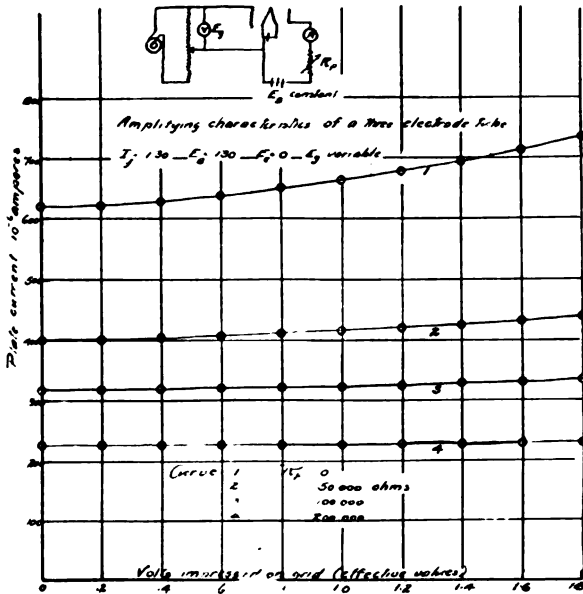

FIGURE 7

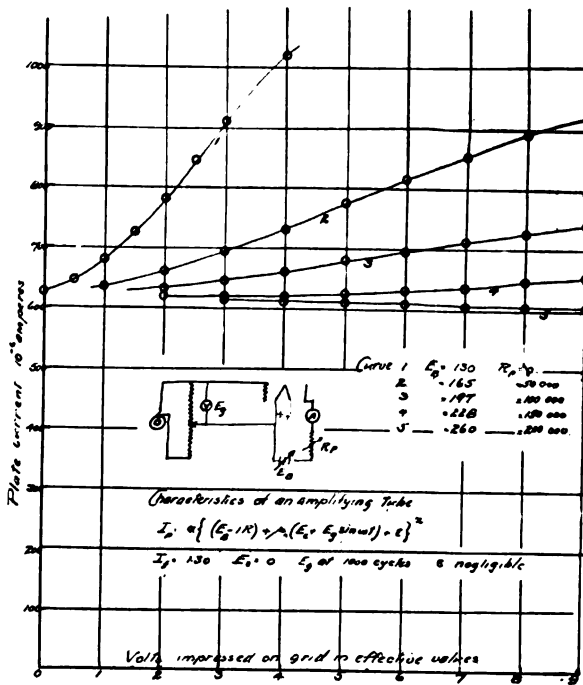

FIGURE 8

pected to vary (with an alternating voltage impressed on the grid) if various resistances are inserted in the plate circuit and the plate circuit voltage is sufficiently increased each time to give the same voltage on the plate, the grid voltage being zero. It is seen that if too much resistance is added in the plate circuit the plate current actually decreases as the grid voltage increases, thus again bringing about distortion.

#### CAPACITY AND CONDUCTANCE OF VACUUM TUBES

The internal capacity of a vacuum tube is of little importance at telephone frequencies, or at radio frequencies when large capacities are used in the tuning circuits of the tubes; but when the circuit condensers are small and the frequencies are high, the internal capacity may become of extreme importance. In the design of amplifiers and detectors, this internal capacity plays an important role. In many laboratory experiments it had seemed to the writer that the capacity of the tube must be playing a much more important part than might be supposed, so a series of tests were undertaken to determine just how much the internal capacity of a tube might be and what conditions affected it. The work was started two years ago but it was stopped by pressure of war work on another problem.

As the capacities to be measured are of the order of a few micro-microfarads it is evident that some sort of differential method must be used to obtain accurate results; also to make the reactances to be measured of a reasonably small value radio frequencies must be employed. I tried at first to make the measurements by noting the change in the beat note of two small continuous wave sets with and without the capacity to be measured being connected in the circuit. I listened to the beat note without the desired capacity connected and then connected it in parallel with the condenser of the generating set and the received note changed. The note could then be brought to its original value by changing the condenser of the transmitter and the amount of this change noted. The scheme proved too difficult to manipulate, however; control of the voltage impressed on the tube to be tested and the separation of the effects of the conductance and the capacity made the method cumbersome and unreliable.

I therefore decided to carry out the measurements on the Wheatstone bridge, by which method the effects of conductance and capacity could be analyzed separately. Professor Pupin and his assistant, Mr. J. G. Aceves, had done a great deal of

development work on the high frequency bridge, and it had proved to be reliable when proper precautions were taken, with frequencies of perhaps 300,000 cycles. I had the benefit of Mr. Aceves' assistance in obtaining the data given hereafter.

The bridge was arranged as shown in Figure 9. The source of power was a calibrated oscillator which was adjustable from 1,000 to 300,000 cycles a second. The output of this set was

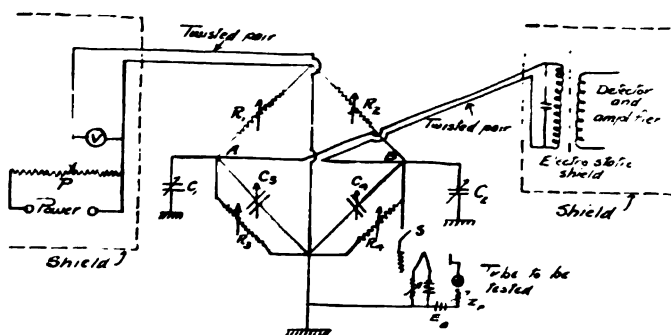

FIGURE 9

supplied to a potentiometer  $P$  from which a known, adjustable voltage could be supplied to the bridge. Knowing the impedance of the bridge arms, the voltage impressed on the device to be tested can easily be calculated. The detector set was connected as shown and consisted of an oscillating tube circuit, the output of this circuit being supplied to a three-stage low-frequency amplifier, equipped with a loud speaking horn so that the bridge operator could make the balance without having the inconvenience of wearing a telephone receiver all the time. The low frequency amplifier had a voltage increase of about 1,000 and the heterodyne gave considerable amplification, the amount depending on the conditions.

The power generating set and the detector set were placed far apart and each was completely enclosed in a suitably designed screening chamber. The power and detector lines leading to the bridge were twisted pairs covered with a grounded shield. The pair of wires leading to the detector did not connect to the oscillating tube circuit but connected to a coil which acted on the detector proper by magnetic induction. The electrostatic induction into the detector circuit was completely eliminated by a suitable shield which permitted magnetic induction but short-

circuited electrostatic effects. This precaution is necessary because even when the bridge is balanced the line leading to the detector is excited by the power set as the middle points of the bridge, to which the detector is connected, are considerably above ground potential. The shielding was done so well that no signal was audible in the detector circuit unless the detector line was actually connected to the bridge.

The bridge itself was sufficiently well constructed that no errors due to high frequency effects could be found with currents of 300,000 cycles a second. It could probably be used at frequencies as high as  $10^6$  cycles a second without large error.

The two condensers  $C_1$  and  $C_2$  serve to correct for any distributed capacity in the bridge and its connections; with the (3) and (4) arms open, these two small condensers are adjusted so that the bridge is balanced, thus bringing the two points  $A$  and  $B$  to the same potential with respect to ground. If now the  $R_3$ ,  $C_3$ , and  $R_4$ ,  $C_4$ , arms are connected in and the bridge balanced by suitable adjustment of these four quantities, then the impedances of these arms (and of course the respective components of the impedances) are in proportion to the values of resistance in the ratio arms.

The radio frequency bridge seems to be most reliable if resistances of the order of a few hundred ohms are used in the ratio arms. Resistance units of about 100 ohms seem to have minimum error due to the combination of skin effect and internal capacity.

The tube to be tested was connected as indicated in Figure 9, the switch  $S$  serving to connect it or disconnect it as desired. The bridge having been balanced (with  $S$  open) by adjustment of  $C_4$  and  $R_4$ , the switch  $S$  was closed; the capacity and conductance thus introduced into the bridge destroy the balance, and it is restored by decreasing  $C_4$  and suitably changing  $R_4$  (decrease or increase as the case may require). The amount of change in  $C_4$  gives the capacity of the tube, and the required change in  $R_4$  permits the calculation of the conductance of the tube.

The various types of tubes at present available were thus measured, with no filament current and no plate voltage, to determine what I call the geometrical capacity of the tube, that is, the capacity of the various parts with respect to one another without the presence of electrons or any of the various interactions which occur when the tube is connected in an operating circuit. By proper differential measurements the capacity of the leads, tube holders, etc., were eliminated so that the constants of the

tubes themselves were obtained. When in operation on a circuit, the capacities will be somewhat greater due to the bases, connecting wires and so on.

The tubes tested had the following approximate ratings:

Number	Filament current	Plate volts	Plate current	Type of Filament	Intended service
1	1.1	20	$6 \times 10^{-4}$	Oxide	Detector and Amplifier
2	1.1	20	$4 \times 10^{-4}$	Tungsten	Detector and Amplifier
3	1.3	130	$7 \times 10^{-4}$	Oxide	Amplifier
4	1.75	350	$5 \times 10^{-2}$	Tungsten	Power
5	1.35	300	$4 \times 10^{-2}$	Oxide	Power
6	6.5	500	$15 \times 10^{-2}$	Tungsten	Power
7	3.65	1,000	$25 \times 10^{-2}$	Tungsten	Power

Several tubes of each kind were tested giving typical results as tabulated herewith; the capacities being in  $10^{-12}$  farads.

	1	2	3	4	5	6	7
Grid to filament, plate free	10.4	6.4	6.8	5.6	7.6	8.0	55.6
Grid to plate, filament free	14.4	4.4	7.6	3.0	8.4	8.0	22.0
Grid to plate and filament, these being connected together	17.0	7.2	12.4	7.2	11.2	10.2	69.6

These values are good to about 0.5 of a micro-microfarad, it not being thought while to work for a greater precision. The conductance was in all cases negligible, being only a small fraction of a micromho.

These magnitudes of capacity are such that they might well be neglected except for very high frequency circuits or for very carefully designed high frequency amplifiers. It seemed quite possible that when the space between the grid was saturated with electrons, these values of capacity might be greatly increased so the next set of values were taken to see whether the tube had more capacity when the filament was heated than when the tube



was cold. It seems plausible to believe that these electrons, between the two plates of the condenser increase the capacity in the same way that it would be increased if a piece of metal (having electrons free to move) were placed in the space between the grid and filament. For all the tubes tested the increase in capacity due to heating the filament was less than one micro-microfarad. There was distinct evidence that the effect was present but as the purpose of the research was to discover in tubes, capacities of sufficient magnitude to effect their behaviour in ordinary circuits I did not try to refine the measurements really to investigate this point.

As soon as the filament was heated the conductance increased very rapidly, depending upon the value of the filament current, amount of negative voltage used on the grid, magnitude of the plate voltage, and the magnitude of the voltage impressed on the grid for the purpose of balancing the bridge. Figures 10, 11, 12, and 13 show the effect of these various quantities for one of the tubes used; the others showed similar effects.

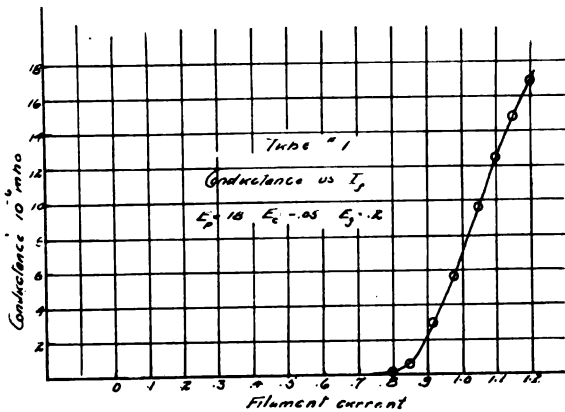

FIGURE 10

The next condition investigated was the plate circuit impedance, this promising very considerable effect as an elementary analysis showed that the capacity between the grid and ground might be expected to vary a great deal as the impedance in the plate circuit was varied. Figure 14 serves to show the elements of the problem; the filament is ordinarily grounded and, as the plate is also grounded by its connection thru the plate im-

tube  
the  
ing

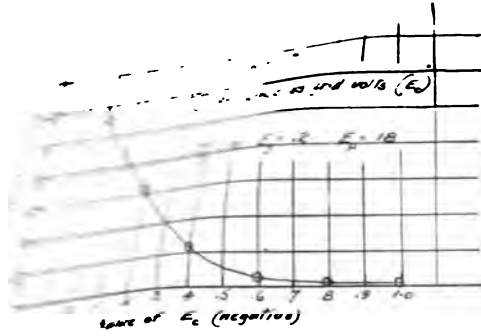

FIGURE 11

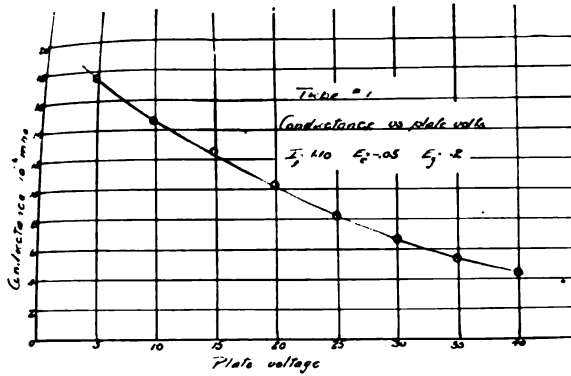

FIGURE 12

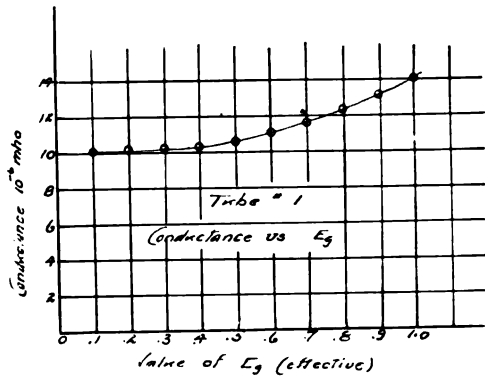

FIGURE 13

pedance  $Z_p$  and the battery  $E_B$ , any alternating emf. impressed between the grid and filament must produce a charging current sufficient not only to charge the condenser consisting of the grid and filament, but also to supply that for the condenser made up of the grid and plate. Suppose a voltage  $E_g$  is impressed between

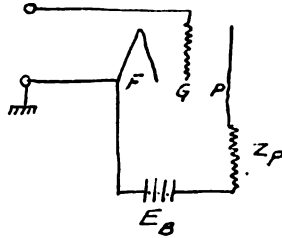

FIGURE 14

the grid and filament; there must be a charging current equal to  $I = 2\pi f C_{g-f} E_g$  to supply the electrostatic energy for this condenser. Now due to the amplifying action of the tube, the voltage  $E_g$  from grid to filament produces a voltage between grid and plate nearly equal to  $(\mu + 1) E_g$ ,  $\mu$  being the voltage amplification factor of the tube and its attached circuit. The charging current for the condenser, grid-plate, must be supplied from the source supplying  $E_g$ , so that the total charging current required by the input circuit is given by the equation

$$I = 2\pi f E_g [C_{g-f} + (\mu + 1) C_{g-p}]$$

which means that the effective capacity between grid and ground is

$$C = C_{g-f} + (\mu + 1) C_{g-p}$$

With this idea in mind it is seen at once that the capacity of the input circuit is much greater than might be supposed, and that it varies moreover with any factor which changes the amplification factor.

It might seem that the factor  $\mu$  instead of  $(\mu + 1)$  should be used when taking into account the grid-plate capacity but it must be remembered that  $\mu$  is the ratio of amplitudes of the plate-filament and grid-filament voltages (alternating current values, of course) and that the phase of these two voltages differs by nearly 180 degrees; this makes the potential difference of the

grid-plate nearly equal to  $(\mu + 1) E_p$ . If the two voltages were exactly 180 degrees apart the expression  $(\mu + 1)$  would be correct.

Moreover, because of the reaction of the plate-filament field on the potential of the grid, it might be expected that the conductance curve of grid to ground might also show very different characteristics than it does without the reaction of the plate field. A complete series of results were taken therefore to investigate these two effects and the expectations were fully justified.

Figure 15 shows the capacity and conductance of tube number 1 as the resistance of the plate circuit was varied; on the same curve sheet is shown the value of the voltage amplification factor of the tube for the various plate circuit resistances.

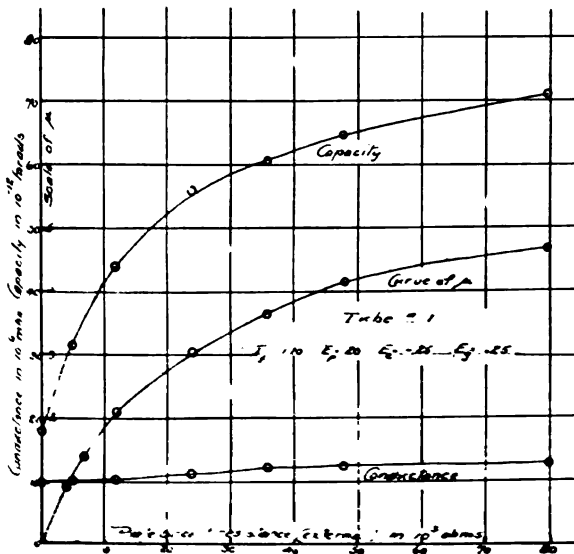

FIGURE 15

It is seen that the capacity of the grid to ground increases from 17  $\mu\mu$  farads to 71  $\mu\mu$  farads as the plate circuit resistance was increased from zero to 80 kilohms. As the capacity of the grid to filament is 10.4 and that of the grid to plate is 14.4, it might be expected that for the plate circuit resistance of 80 kilohms, the capacity should be equal to  $[10.4 \div 4.65 + 1]14.4 = 91.6 \mu\mu$  farads. This calculation would undoubtedly give a very close approximation were it not for the fact that a considerable part of the plate-grid capacity is mutual with that of the grid-fila-

ment capacity, this mutual capacity having the effect of decreasing the grid-plate capacity.

The conductance of the grid-ground circuit gradually increased as the plate circuit resistance was increased.

In Figure 16 are shown the capacity and conductance of the grid-ground circuit of tube number 1 when reactance was used in the plate circuit instead of resistance. In this case the pre-

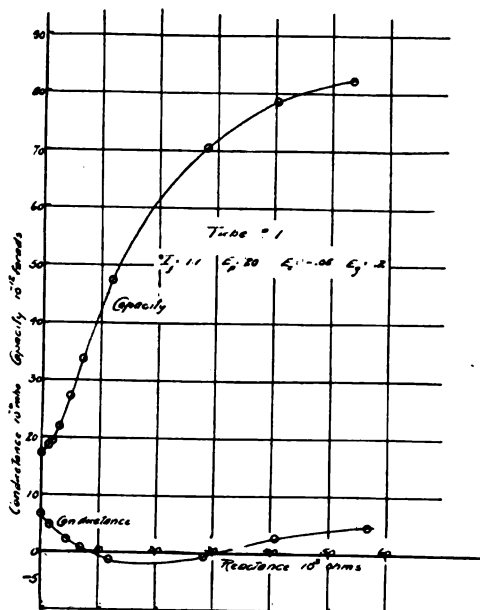

FIGURE 16

dicted increase in capacity is more nearly realized than when resistance is used in the plate circuit. Thus, with a reactance in the plate circuit of 50 kilohms (the value of  $\mu$  being 4.2) the calculated capacity is 85.2 whereas the experimental value is 81.5  $\mu\mu$  farads.

That any capacity present between plate and grid and which is not in the field of the grid-filament capacity is increased by the factor  $(\mu + 1)$  was proved by actually connecting a capacity of 20  $\mu\mu$  farads across the plate-grid terminals of the tube and noting the increase in the apparent capacity of the grid-ground circuit. It increased by 102  $\mu\mu$  farads.

The conductance of the input circuit of the tube becomes

negative for certain values of plate circuit reactance, showing that, to a certain extent, the reaction of the plate circuit on the grid circuit is such as to supply energy from the plate circuit to the grid circuit, with no other coupling than that in the tube itself. It is of course known that under certain conditions the capacity coupling in the tube itself is sufficient to maintain oscillations, a condition which can be readily predicted from the conductance curve given.

Figures 17-21 show the characteristic curves of some of the other types of tubes tested. It is seen that the same general shape holds for all three electrode tubes, the difference being one of degree only. The capacity of the grid-ground circuit

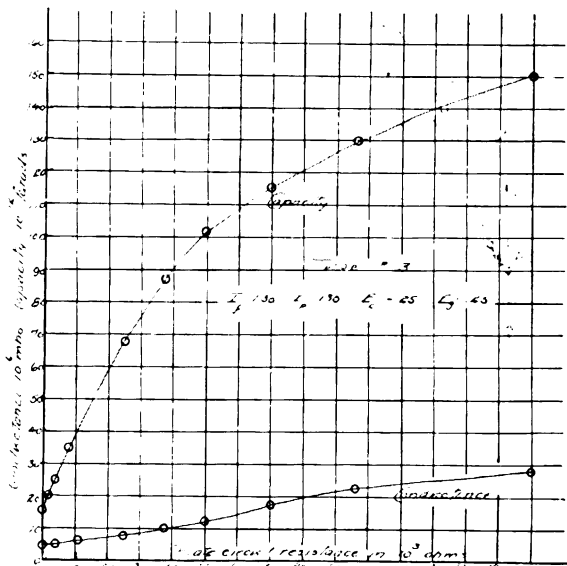

FIGURE 17

of the tube, when the tube is operating with a normal amount of resistance or reactance in the plate circuit, is from 5 to 10 times as much as the geometrical capacity of this circuit and the amount of this increase is controlled by the capacity between the grid and plate.

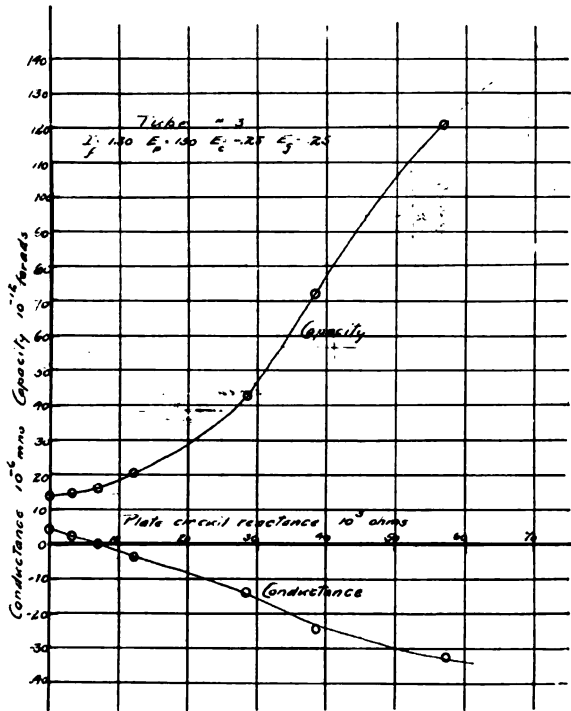

FIGURE 18

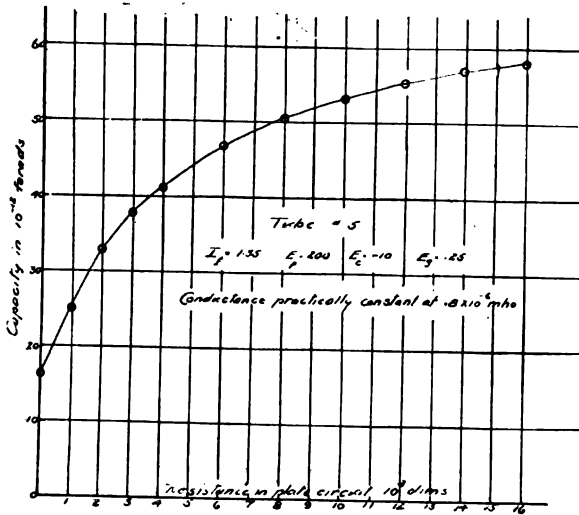

FIGURE 19

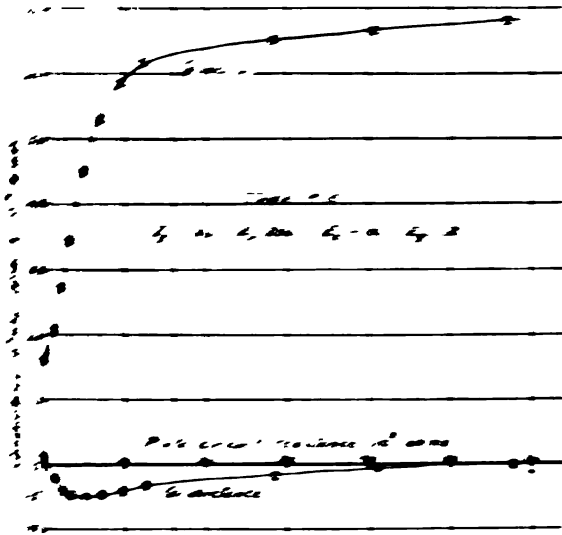

FIGURE 20

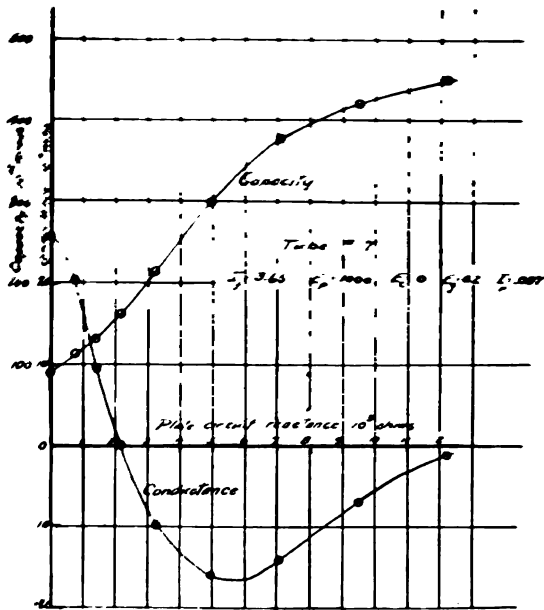
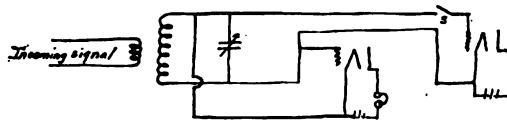

FIGURE 21



## DETECTING ACTION OF A TUBE WITHOUT GRID CONDENSER

The suggestion has been made\* that when a three electrode tube is used as a detector of radio frequency oscillations without the use of a condenser in series with the grid, the detecting action is due to the asymmetrical character of the conductance of the grid-ground circuit, this asymmetry in conductance producing an asymmetry in the voltage wave in the closed receiving circuit. Calculation shows that this is at least a plausible explanation of the action but so many assumptions must be made in calculating the problem that experimental verification seemed wise. A circuit was arranged as shown in Figure 22; two detecting circuits being arranged to receive the same signal. The second tube circuit could be connected or not as desired by the switch *S*. It will be seen that the connection of the grid-filament circuit is so arranged that any asymmetry caused by the peculiar conductance value of the grid-filament of one tube is just neutralized by the action of the other tube. The audibility of the signal was



*Each tube with its A and B heaters was completely insulated from ground*

FIGURE 22

measured with and without the second tube connected and no appreciable difference in the audibility under the two conditions could be detected, altho the tuning was not quite as sharp with two tubes connected as with only one. This effect is of course to be expected. The test seems to prove that the asymmetry of the grid-filament circuit of the tube plays an unimportant role in the detecting action of the tube.

Marcellus Hartley Research Laboratory,  
Columbia University, June 4, 1919.

**SUMMARY:** The value of the exponent connecting plate current and plate and grid potentials is experimentally investigated for a number of tubes. It is found to be markedly different for different tubes, and for the same tube at different plate voltages. Particularly is this the case for low plate voltage tubes.

\* Bown, "Physical Review," volume 10, number 3, page 257.

After becoming briefly familiar with amplifying tubes, the capacity and inductance within tubes is considered. Experimentally determined data governing these quantities are given, these being obtained on a carefully designed radio frequency Wheatstone bridge.

An experiment on the selecting action of a tube without grid condenser seems to prove that grid-to-filament circuit asymmetry of characteristic is not responsible for the selecting action.